

**EMC Test Report****Application for FCC Grant of Equipment Authorization  
Canada Certification****Innovation, Science and Economic Development Canada  
RSS-Gen Issue 5 / RSS-247 Issue 2  
FCC Part 15 Subpart C****Model: NVG5XDBAX**IC CERTIFICATION #: 3439B- NVG5XDBAX  
FCC ID: PGR-NVG5XDBAXAPPLICANT: Arris  
310 Providence Mine Road  
Nevada City, CA 95959TEST SITE(S): National Technical Systems  
41039 Boyce Road.  
Fremont, CA. 94538-2435

IC SITE REGISTRATION #: 2845B-3; 2845B-4, 2845B-5, 2845B-7

PROJECT NUMBER: PR101106

REPORT DATE: November 8, 2019

REISSUE DATE: March 12, 2020

FINAL TEST DATES: July 9, 11, 12, 15, 16, 17, 18, 19, 22, 24, 25, 26,  
29, 30 and 31, September 20, October 1 and 10  
and December 20-30, 2019 and February 3 and  
4, 2020

TOTAL NUMBER OF PAGES: 149



This report and the information contained herein represent the results of testing of only those articles / products identified in this document and selected by the client. The tests were performed to specifications and/or procedures selected by the client. National Technical Systems (NTS) makes no representations expressed or implied that such testing fully demonstrates efficiency, performance, reliability, or any other characteristic of the articles being tested, or similar products. This report should not be relied upon as an endorsement or certification by NTS of the equipment tested, nor does it present any statement whatsoever as to its merchantability or fitness of the test article or similar products, for a particular purpose. This report shall not be reproduced except in full without written approval from NTS.



---

**VALIDATING SIGNATORIES**

PROGRAM MGR

David W. Bare  
Chief Engineer

TECHNICAL REVIEWER:

David W. Bare  
Chief Engineer

FINAL REPORT PREPARER:

David Guidotti  
Senior Technical Writer

QUALITY ASSURANCE DELEGATE

Jesse Reel  
Technical Writer



**REVISION HISTORY**

Rev#	Date	Comments	Modified By
-	November 8, 2019	First release	
1	February 28, 2020	Revised report to add ax mode test data	David Guidotti
2	March 12, 2020	Revised report to correct formatting in Appendix B, remove test configuration photograph and correct antenna gains for single chain legacy modes	David Guidotti

**TABLE OF CONTENTS**

**VALIDATING SIGNATORIES .....2**

**REVISION HISTORY .....3**

**TABLE OF CONTENTS .....4**

**SCOPE.....5**

**OBJECTIVE .....5**

**STATEMENT OF COMPLIANCE .....6**

**DEVIATIONS FROM THE STANDARDS.....6**

**TEST RESULTS SUMMARY .....7**

    DIGITAL TRANSMISSION SYSTEMS (2400 – 2483.5MHZ) .....7

    MEASUREMENT UNCERTAINTIES .....9

**EQUIPMENT UNDER TEST (EUT) DETAILS.....10**

    GENERAL.....10

    OTHER EUT DETAILS .....10

    ANTENNA SYSTEM .....10

    ENCLOSURE.....10

    MODIFICATIONS.....10

    SUPPORT EQUIPMENT .....10

    EUT INTERFACE PORTS .....11

    EUT OPERATION .....11

**TEST SITE.....12**

    GENERAL INFORMATION .....12

    CONDUCTED EMISSIONS CONSIDERATIONS .....12

    RADIATED EMISSIONS CONSIDERATIONS .....12

**MEASUREMENT INSTRUMENTATION .....13**

    RECEIVER SYSTEM .....13

    INSTRUMENT CONTROL COMPUTER .....13

    LINE IMPEDANCE STABILIZATION NETWORK (LISN).....13

    FILTERS/ATTENUATORS .....14

    ANTENNAS.....14

    ANTENNA MAST AND EQUIPMENT TURNTABLE.....14

    INSTRUMENT CALIBRATION.....14

**TEST PROCEDURES .....15**

    EUT AND CABLE PLACEMENT .....15

    CONDUCTED EMISSIONS.....15

    RADIATED EMISSIONS.....15

    CONDUCTED EMISSIONS FROM ANTENNA PORT .....19

    BANDWIDTH MEASUREMENTS .....19

    SPECIFICATION LIMITS AND SAMPLE CALCULATIONS .....20

    CONDUCTED EMISSIONS SPECIFICATION LIMITS: FCC 15.207; FCC 15.107(A), RSS GEN .....20

    GENERAL TRANSMITTER RADIATED EMISSIONS SPECIFICATION LIMITS .....20

    OUTPUT POWER LIMITS – DIGITAL TRANSMISSION SYSTEMS .....21

    TRANSMIT MODE SPURIOUS RADIATED EMISSIONS LIMITS – FHSS AND DTS SYSTEMS.....21

    SAMPLE CALCULATIONS - CONDUCTED EMISSIONS .....22

    SAMPLE CALCULATIONS - RADIATED EMISSIONS.....22

    SAMPLE CALCULATIONS - FIELD STRENGTH TO EIRP CONVERSION.....23

**APPENDIX A TEST EQUIPMENT CALIBRATION DATA .....24**

**APPENDIX B TEST DATA .....28**

**END OF REPORT .....149**

## **SCOPE**

An electromagnetic emissions test has been performed on the Arris model NVG5XDBAX, pursuant to the following rules:

RSS-Gen Issue 5 “General Requirements for Compliance of Radio Apparatus”  
RSS 247 Issue 2 “Digital Transmission Systems (DTSs), Frequency Hopping Systems (FHSS) and Licence-Exempt Local Area Network (LE-LAN) Devices”  
FCC Part 15 Subpart C

Conducted and radiated emissions data has been collected, reduced, and analyzed within this report in accordance with measurement guidelines set forth in the following reference standards and as outlined in National Technical Systems test procedures:

ANSI C63.10-2013  
FCC DTS Measurement Guidance KDB558074

The intentional radiator above has been tested in a simulated typical installation to demonstrate compliance with the relevant Industry Canada performance and procedural standards.

Final system data was gathered in a mode that tended to maximize emissions by varying orientation of EUT, orientation of power and I/O cabling, antenna search height, and antenna polarization.

Every practical effort was made to perform an impartial test using appropriate test equipment of known calibration. All pertinent factors have been applied to reach the determination of compliance.

National Technical Systems is accredited by the A2LA, certificate number 0214.26, to perform the test(s) listed in this report, except where noted otherwise.

## **OBJECTIVE**

The primary objective of the manufacturer is compliance with the regulations outlined in the previous section.

Prior to marketing in the USA, all unlicensed transmitters and transceivers require certification. Receive-only devices operating between 30 MHz and 960 MHz are subject to either certification or a manufacturer’s declaration of conformity, with all other receive-only devices exempt from the technical requirements.

Prior to marketing in Canada, Class I transmitters, receivers and transceivers require certification. Class II devices are required to meet the appropriate technical requirements but are exempt from certification requirements.

Certification is a procedure where the manufacturer submits test data and technical information to a certification body and receives a certificate or grant of equipment authorization upon successful completion of the certification body's review of the submitted documents. Once the equipment authorization has been obtained, the label indicating compliance must be attached to all identical units, which are subsequently manufactured.

Maintenance of compliance is the responsibility of the manufacturer. Any modification of the product which may result in increased emissions should be checked to ensure compliance has been maintained (i.e., printed circuit board layout changes, different line filter, different power supply, harnessing or I/O cable changes, etc.).

### **STATEMENT OF COMPLIANCE**

The tested sample of Arris model NVG5XDBAX complied with the requirements of the following regulations:

RSS-Gen Issue 5 "General Requirements for Compliance of Radio Apparatus"

RSS 247 Issue 2 "Digital Transmission Systems (DTSs), Frequency Hopping Systems (FHSS) and Licence-Exempt Local Area Network (LE-LAN) Devices"

FCC Part 15 Subpart C

Maintenance of compliance is the responsibility of the manufacturer. Any modifications to the product should be assessed to determine their potential impact on the compliance status of the device with respect to the standards detailed in this test report.

The test results recorded herein are based on a single type test of Arris model NVG5XDBAX and therefore apply only to the tested sample. The sample was selected and prepared by Mark Rieger of Arris.

### **DEVIATIONS FROM THE STANDARDS**

No deviations were made from the published requirements listed in the scope of this report.

**TEST RESULTS SUMMARY**
**DIGITAL TRANSMISSION SYSTEMS (2400 – 2483.5MHz)**

FCC Rule Part	RSS Rule Part	Description	Measured Value / Comments	Limit / Requirement	Result
15.247(a)	RSS 247 5.2	Digital Modulation	Systems uses OFDM / DSSS techniques	System must utilize a digital transmission technology	Complies
15.247 (a) (2)	RSS 247 5.2 (1)	6dB Bandwidth	Minimum of all modes: 7.07 MHz	>500kHz	Complies
15.247 (b) (3)	RSS 247 5.4 (4)	Output Power (multipoint systems) (n, ac and ax modes use same power)	b: 23.3 dBm g: 25.1 dBm ac20: 29.3 dBm ac40: 28.8 dBm  EIRP = 1.32 W <sup>Note 1</sup>	1Watt, EIRP limited to 4 Watts.	Complies
15.247(e)	RSS 247 5.2 (2)	Power Spectral Density	b: 3.8 dBm/3kHz g: 0.2 dBm/3kHz ac20: 4.6 dBm/3kHz ac40: 6.5 dBm/10kHz ax20: 2.6 dBm/3kHz ax40: 4.5 dBm/10kHz	6.7dBm/3kHz	Complies
15.247(d)	RSS 247 5.5	Antenna Port Spurious Emissions 30MHz – 25 GHz	All emissions below -30dBc limit	< -30dBc <sup>Note 2</sup>	Complies
15.247(d) / 15.209	RSS 247 5.5	Radiated Spurious Emissions 30MHz – 25 GHz	51.7 dBμV/m @ 2390.0 MHz (-2.3 dB)	Refer to the limits section (p20) for restricted bands, all others <-30dBc <sup>Note 2</sup>	Complies
Note 1: EIRP calculated using antenna gains as described in the detailed test results for the highest EIRP system. Note 2: Limit of -30dBc used because the maximum conducted power was measured over a transmission burst. Note 3: the device is operating under the smart antenna rules as detailed in FCC 15.247(c) (2) / RSS 247 5.4 (6). Refer to the operational description for additional justification.					

**GENERAL REQUIREMENTS APPLICABLE TO ALL BANDS**

FCC Rule Part	RSS Rule part	Description	Measured Value / Comments	Limit / Requirement	Result (margin)
15.203	-	RF Connector	Antennas connected via U.FL connectors	Unique or integral antenna required	Complies
15.207	RSS-Gen Table 4	AC Conducted Emissions	27.4 dB $\mu$ V @ 0.509 MHz (-18.6 dB)	Refer to page 20	Complies
15.247 (i)	RSS 102	RF Exposure Requirements	Refer to MPE calculations in separate exhibit, RSS 102 declaration and User Manual statements.	Refer to OET 65, FCC Part 1 and RSS 102	Complies
-	RSS-Gen 6.8	User Manual		Statement for products with detachable antenna	Complies
-	RSS-Gen 8.4	User Manual		Statement for all products	Complies
-	RSP-100 RSS-Gen 6.7	Occupied Bandwidth	b: 10.796 MHz g: 16.914 MHz ac20: 18.324 MHz ac40: 36.441 MHz ax20: 19.2MHz ax40: 37.8MHz	Information only	N/A



**MEASUREMENT UNCERTAINTIES**

ISO/IEC 17025 requires that an estimate of the measurement uncertainties associated with the emissions test results be included in the report. The measurement uncertainties given below are based on a 95% confidence level and were calculated in accordance with UKAS document LAB 34.

Measurement Type	Measurement Unit	Frequency Range	Expanded Uncertainty
RF power, conducted (power meter)	dBm	25 to 7000 MHz	$\pm 0.52$ dB
RF power, conducted (Spectrum analyzer)	dBm	25 to 7000 MHz	$\pm 0.7$ dB
Conducted emission of transmitter	dBm	25 to 26500 MHz	$\pm 0.7$ dB
Conducted emission of receiver	dBm	25 to 26500 MHz	$\pm 0.7$ dB
Radiated emission (substitution method)	dBm	25 to 26500 MHz	$\pm 2.5$ dB
Radiated emission (field strength)	dB $\mu$ V/m	25 to 1000 MHz	$\pm 3.6$ dB
		1000 to 40000 MHz	$\pm 6.0$ dB
Conducted Emissions (AC Power)	dB $\mu$ V	0.15 to 30 MHz	$\pm 2.4$ dB

## EQUIPMENT UNDER TEST (EUT) DETAILS

### GENERAL

The Arris model NVG5XDBAX is an 802.11 radio module that is designed to be installed in Arris host equipment. Since the EUT would be installed in a host device during operation, the EUT was treated as tabletop equipment during testing to simulate the end-user environment. The electrical rating of the EUT is 3.3 Volts DC supplied from the host device.

The sample was received on July 9, 2019 and tested on July 9, 11, 12, 15, 16, 17, 18, 19, 22, 24, 25, 26, 29, 30 and 31, September 20, October 1 and 10 and December 20-30, 2019 and February 3 and 4, 2020. The EUT consisted of the following component(s):

Company	Model	Description	Serial Number	FCC ID
Arris	NVG5XDBAX	Radio Module	M11917QW000T	PGR-NVG5XDBAX

### OTHER EUT DETAILS

The following EUT details should be noted: The EUT was installed on a metal carrier along with the Gateway PCB to allow testing. The antennas are mounted to a plastic holder as will be used in the host product. Canadian Certification number IC: 3439B-NVG5XDBAX

### ANTENNA SYSTEM

The antenna system consists of 4 Airgain N2420DAR1 and 4 Airgain 5X30AR1 antennas mounted on a plastic carrier. Details of antenna gain are provided in a separate exhibit.

### ENCLOSURE

The EUT does not have an enclosure. The PCB measures approximately 9.5 cm wide by 19 cm high.

### MODIFICATIONS

No modifications were made to the EUT during the time the product was at NTS Silicon Valley.

### SUPPORT EQUIPMENT

The following equipment was used as support equipment for testing:

Company	Model	Description	Serial Number	FCC ID
Arris	NBS40B120375M2	Power Supply	None	-
Arris	None	Gateway PCB	0015	-

The following equipment was used as remote support equipment for emissions testing:

Company	Model	Description	Serial Number	FCC ID
Dell	Precision M6700	Laptop	9WB3CW1	-

**EUT INTERFACE PORTS**

The I/O cabling configuration during testing was as follows:

EUT

Port	Connected To	Description	Cable(s)	
			Shielded or Unshielded	Length(m)
Antenna (x8)	Antennas	Coax	Shielded	Various

Additional on Support Equipment

Port	Connected To	Description	Cable(s)	
			Shielded or Unshielded	Length(m)
Gateway PCB Ethernet (x2)	Laptop Ethernet	Cat 6	Unshielded	7.5
Gateway PCB Power Input	Power Supply	Two wire	Unshielded	1
Power Supply AC	Mains	Two wire	Unshielded	1

**EUT OPERATION**

During emissions testing the EUT was commanded to operate continuously with the noted duty cycle on the desired channel at the selected power level using Mtool software on the Laptop communicating through the Gateway PCB.

**TEST SITE**

**GENERAL INFORMATION**

Final test measurements were taken at the test sites listed below. Pursuant to section 2.948 of the FCC’s Rules and section 6.2 of RSS-GEN, NTS has been recognized as an accredited test laboratory by the Commission and Innovation, Science and Economic Development Canada. A description of the facilities employed for testing is maintained by NTS.

Site	Company / Registration Numbers		Location
	FCC	Canada	
Chamber 7	US1031	2845B (Wireless test lab #US0027)	41039 Boyce Road Fremont, CA 94538-2435

ANSI C63.4 recommends that ambient noise at the test site be at least 6 dB below the allowable limits. Ambient levels are below this requirement. The test site(s) contain separate areas for radiated and conducted emissions testing. Results from testing performed in this chamber have been correlated with results from an open area test site. Considerable engineering effort has been expended to ensure that the facilities conform to all pertinent requirements of ANSI C63.4.

**CONDUCTED EMISSIONS CONSIDERATIONS**

Conducted emissions testing is performed in conformance with ANSI C63.10. Measurements are made with the EUT connected to the public power network through a nominal, standardized RF impedance, which is provided by a line impedance stabilization network, known as a LISN. A LISN is inserted in series with each current-carrying conductor in the EUT power cord.

**RADIATED EMISSIONS CONSIDERATIONS**

The FCC has determined that radiation measurements made in a shielded enclosure are not suitable for determining levels of radiated emissions. Radiated measurements are performed in an open field environment or in a semi-anechoic chamber. The test sites are maintained free of conductive objects within the CISPR defined elliptical area incorporated in ANSI C63.4 guidelines and meet the Normalized Site Attenuation (NSA) requirements of ANSI C63.4.

## **MEASUREMENT INSTRUMENTATION**

### **RECEIVER SYSTEM**

An EMI receiver as specified in CISPR 16-1-1 is used for emissions measurements. The receivers used can measure over the frequency range of 9 kHz up to 2000 MHz. These receivers allow both ease of measurement and high accuracy to be achieved. The receivers have Peak, Average, and CISPR (Quasi-peak) detectors built into their design so no external adapters are necessary. The receiver automatically sets the required bandwidth for the CISPR detector used during measurements. If the repetition frequency of the signal being measured is below 20Hz, peak measurements are made in lieu of Quasi-Peak measurements.

For measurements above the frequency range of the receivers, a spectrum analyzer is utilized because it provides visibility of the entire spectrum along with the precision and versatility required to support engineering analysis. Average measurements above 1000MHz are performed on the spectrum analyzer using the linear-average method with a resolution bandwidth of 1 MHz and a video bandwidth of 10 Hz, unless the signal is pulsed in which case the average (or video) bandwidth of the measuring instrument is reduced to onset of pulse desensitization and then increased.

### **INSTRUMENT CONTROL COMPUTER**

Software is used to view and convert receiver measurements to the field strength at an antenna or voltage developed at the LISN measurement port, which is then compared directly with the appropriate specification limit. This provides faster, more accurate readings by performing the conversions described under Sample Calculations within the Test Procedures section of this report. Results are printed in a graphic and/or tabular format, as appropriate. A personal computer is used to record all measurements made with the receivers. The software used for radiated and conducted emissions measurements is NTS EMI Test Software (rev 2.10)

### **LINE IMPEDANCE STABILIZATION NETWORK (LISN)**

Line conducted measurements utilize a fifty microhenry Line Impedance Stabilization Network as the monitoring point. The LISN used also contains a 250 uH CISPR adapter. This network provides for calibrated radio frequency noise measurements by the design of the internal low pass and high pass filters on the EUT and measurement ports, respectively.

**FILTERS/ATTENUATORS**

External filters and precision attenuators are often connected between the receiving antenna or LISN and the receiver. This eliminates saturation effects and non-linear operation due to high amplitude transient events.

**ANTENNAS**

A loop antenna is used below 30 MHz. For the measurement range 30 MHz to 1000 MHz either a combination of a biconical antenna and a log periodic or a bi-log antenna is used. Above 1000 MHz, horn antennas are used. The antenna calibration factors to convert the received voltage to an electric field strength are included with appropriate cable loss and amplifier gain factors to determine an overall site factor, which is then programmed into the test receivers or incorporated into the test software.

**ANTENNA MAST AND EQUIPMENT TURNTABLE**

The antennas used to measure the radiated electric field strength are mounted on a non-conductive antenna mast equipped with a motor-drive to vary the antenna height. Measurements below 30 MHz are made with the loop antenna at a fixed height of 1m above the ground plane.

ANSI C63.10 specifies that the test height above ground for table mounted devices shall be 80 centimeters for testing below 1 GHz and 1.5m for testing above 1 GHz. Floor mounted equipment shall be placed on the ground plane if the device is normally used on a conductive floor or separated from the ground plane by insulating material from 3 to 12 mm if the device is normally used on a non-conductive floor as specified in ANSI C63.4. During radiated measurements, the EUT is positioned on a motorized turntable in conformance with this requirement.

**INSTRUMENT CALIBRATION**

All test equipment is regularly checked to ensure that performance is maintained in accordance with the manufacturer's specifications. All antennas are calibrated at regular intervals with respect to tuned half-wave dipoles. An exhibit of this report contains the list of test equipment used and calibration information.

## TEST PROCEDURES

### EUT AND CABLE PLACEMENT

The regulations require that interconnecting cables be connected to the available ports of the unit and that the placement of the unit and the attached cables simulate the worst case orientation that can be expected from a typical installation, so far as practicable. To this end, the position of the unit and associated cabling is varied within the guidelines of ANSI C63.10, and the worst-case orientation is used for final measurements.

### CONDUCTED EMISSIONS

Conducted emissions are measured at the plug end of the power cord supplied with the EUT. Excess power cord length is wrapped in a bundle between 30 and 40 centimeters in length near the center of the cord. Preliminary measurements are made to determine the highest amplitude emission relative to the specification limit for all the modes of operation. Placement of system components and varying of cable positions are performed in each mode. A final peak mode scan is then performed in the position and mode for which the highest emission was noted on all current carrying conductors of the power cord.

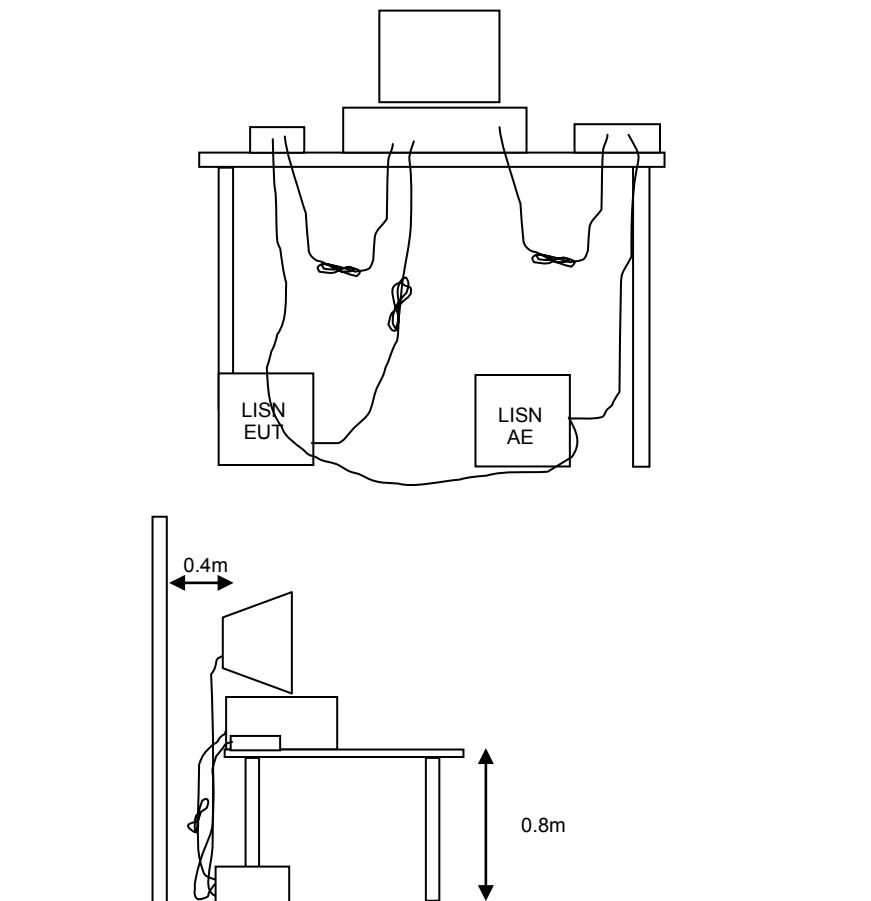

Figure 1 Typical Conducted Emissions Test Configuration

**RADIATED EMISSIONS**

A preliminary scan of the radiated emissions is performed in which all significant EUT frequencies are identified with the system in a nominal configuration. At least two scans are performed, one scan for each antenna polarization (horizontal and vertical; loop parallel and perpendicular to the EUT). During the preliminary scans, the EUT is rotated through 360°, the antenna height is varied (for measurements above 30 MHz) and cable positions are varied to determine the highest emission relative to the limit. Preliminary scans may be performed in a fully anechoic chamber for the purposes of identifying the frequencies of the highest emissions from the EUT.

A speaker is provided in the receiver to aid in discriminating between EUT and ambient emissions. Other methods used during the preliminary scan for EUT emissions involve scanning with near field magnetic loops, monitoring I/O cables with RF current clamps, and cycling power to the EUT.

Final maximization is a phase in which the highest amplitude emissions identified in the spectral search are viewed while the EUT azimuth angle is varied from 0 to 360 degrees relative to the receiving antenna. The azimuth, which results in the highest emission is then maintained while varying the antenna height from one to four meters (for measurements above 30 MHz, measurements below 30 MHz are made with the loop antenna at a fixed height of 1m). The result is the identification of the highest amplitude for each of the highest peaks. Each recorded level is corrected in the receiver using appropriate factors for cables, connectors, antennas, and preamplifier gain.

When testing above 18 GHz, the receive antenna is located at 1 meter from the EUT and the antenna height is restricted to a maximum of 2.5 meters.



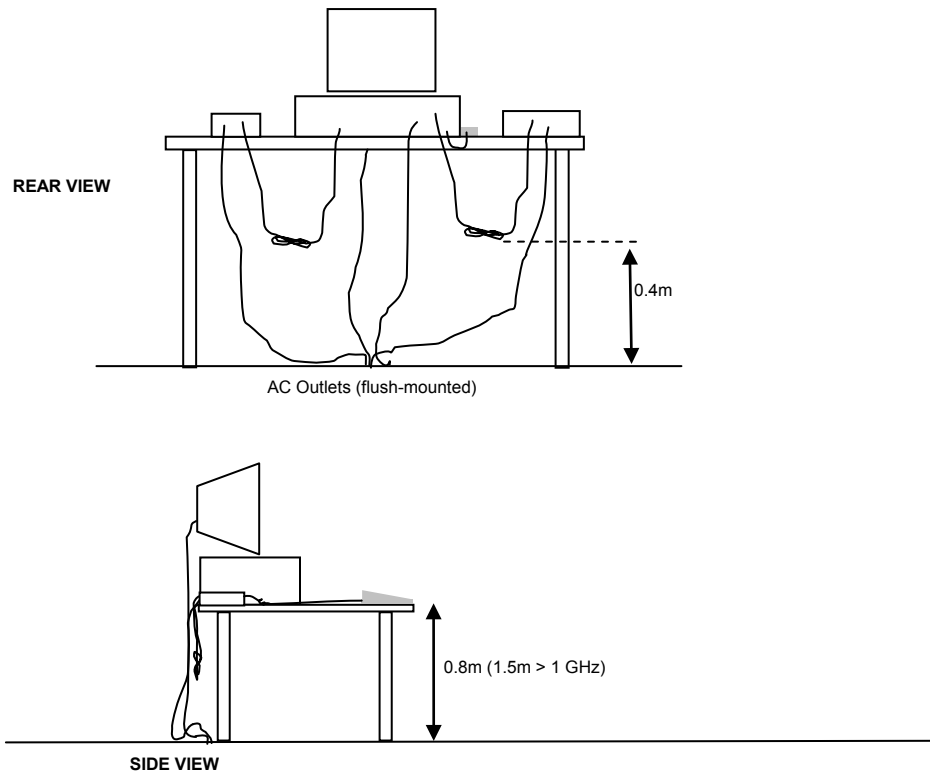

Typical Test Configuration for Radiated Field Strength Measurements

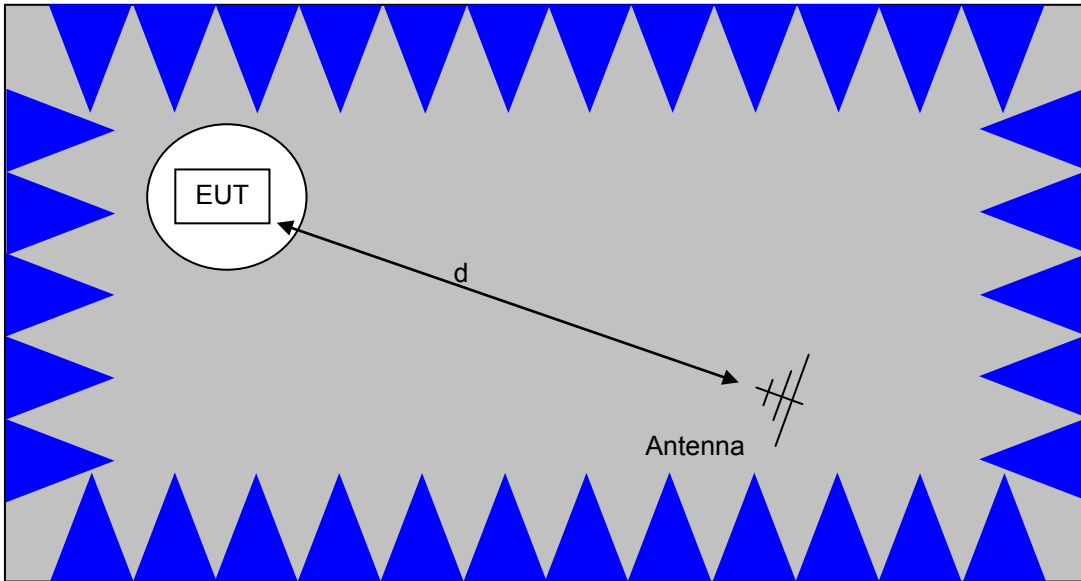

The anechoic materials on the walls and ceiling ensure compliance with the normalized site attenuation requirements of CISPR 16 / CISPR 22 / ANSI C63.4 for an alternate test site at the measurement distances used.

Floor-standing equipment is placed on the floor with insulating supports between the unit and the ground plane.

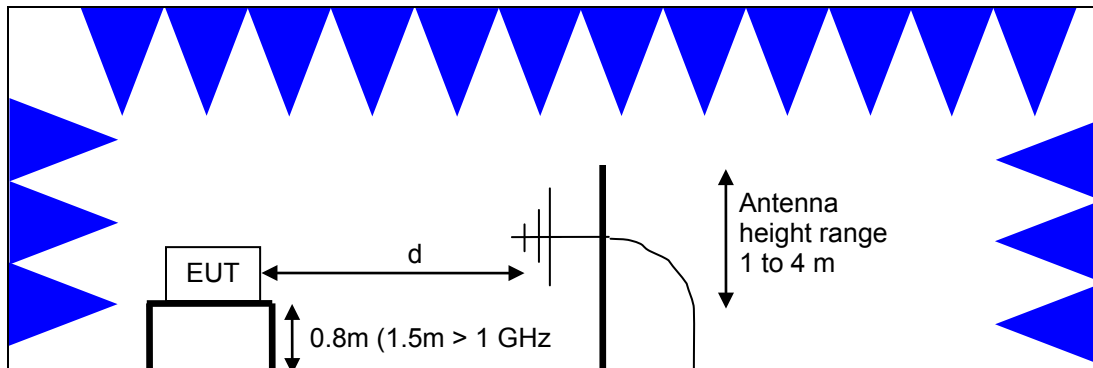

Test Configuration for Radiated Field Strength Measurements  
Semi-Anechoic Chamber, Plan and Side Views

**CONDUCTED EMISSIONS FROM ANTENNA PORT**

Direct measurements of power, bandwidth and power spectral density are performed, where possible, with the antenna port of the EUT connected to either the power meter or spectrum analyzer via a suitable attenuator and/or filter. These are used to ensure that the front end of the measurement instrument is not overloaded by the fundamental transmission.

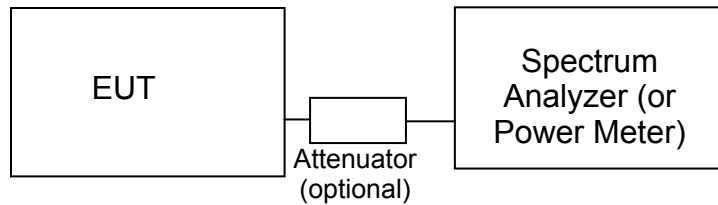

Test Configuration for Antenna Port Measurements

Measurement bandwidths (video and resolution) are set in accordance with the relevant standards and NTS Silicon Valley’s test procedures for the type of radio being tested. When power measurements are made using a resolution bandwidth less than the signal bandwidth the power is calculated by summing the power across the signal bandwidth using either the analyzer channel power function or by capturing the trace data and calculating the power using software. In both cases the summed power is corrected to account for the equivalent noise bandwidth (ENBW) of the resolution bandwidth used.

If power averaging is used (typically for certain digital modulation techniques), the EUT is configured to transmit continuously. Power averaging is performed using either the built-in function of the analyzer or, if the analyzer does not feature power averaging, using external software. In both cases the average power is calculated over a number of sweeps (typically 100). When the EUT cannot be configured to continuously transmit then either the analyzer is configured to perform a gated sweep to ensure that the power is averaged over periods that the device is transmitting or power averaging is disabled and a max-hold feature is used.

If a power meter is used to make output power measurements the sensor head type (peak or average) is stated in the test data table.

**BANDWIDTH MEASUREMENTS**

The 6dB, 20dB, 26dB and/or 99% signal bandwidth are measured using the bandwidths recommended by ANSI C63.10 and RSS GEN.

**SPECIFICATION LIMITS AND SAMPLE CALCULATIONS**

The limits for conducted emissions are given in units of microvolts, and the limits for radiated emissions are given in units of microvolts per meter at a specified test distance. Data is measured in the logarithmic form of decibels relative to one microvolt, or dB microvolts (dBuV). For radiated emissions, the measured data is converted to the field strength at the antenna in dB microvolts per meter (dBuV/m). The results are then converted to the linear forms of uV and uV/m for comparison to published specifications.

For reference, converting the specification limits from linear to decibel form is accomplished by taking the base ten logarithm, then multiplying by 20. These limits in both linear and logarithmic form are as follows:

**CONDUCTED EMISSIONS SPECIFICATION LIMITS: FCC 15.207; FCC 15.107(a), RSS GEN**

The table below shows the limits for the emissions on the AC power line from an intentional radiator and a receiver.

Frequency (MHz)	Average Limit (dBuV)	Quasi Peak Limit (dBuV)
0.150 to 0.500	Linear decrease on logarithmic frequency axis between 56.0 and 46.0	Linear decrease on logarithmic frequency axis between 66.0 and 56.0
0.500 to 5.000	46.0	56.0
5.000 to 30.000	50.0	60.0

**GENERAL TRANSMITTER RADIATED EMISSIONS SPECIFICATION LIMITS**

The table below shows the limits for the spurious emissions from transmitters that fall in restricted bands<sup>1</sup>.

Frequency Range (MHz)	Limit (uV/m)	Limit (dBuV/m @ 3m)
0.009-0.490	$2400/F_{\text{KHz}} @ 300\text{m}$	$67.6-20*\log_{10}(F_{\text{KHz}}) @ 300\text{m}$
0.490-1.705	$24000/F_{\text{KHz}} @ 30\text{m}$	$87.6-20*\log_{10}(F_{\text{KHz}}) @ 30\text{m}$
1.705 to 30	30 @ 30m	29.5 @ 30m
30 to 88	100 @ 3m	40 @ 3m
88 to 216	150 @ 3m	43.5 @ 3m
216 to 960	200 @ 3m	46.0 @ 3m
Above 960	500 @ 3m	54.0 @ 3m

<sup>1</sup> The restricted bands are detailed in FCC 15.205 and RSS-Gen Table 7

**OUTPUT POWER LIMITS – DIGITAL TRANSMISSION SYSTEMS**

The table below shows the limits for output power and output power density. Where the signal bandwidth is less than 20 MHz the maximum output power is reduced to the power spectral density limit plus 10 times the log of the bandwidth (in MHz).

Operating Frequency (MHz)	Output Power	Power Spectral Density
902 – 928	1 Watt (30 dBm)	8 dBm/3kHz
2400 – 2483.5	1 Watt (30 dBm)	8 dBm/3kHz
5725 – 5850	1 Watt (30 dBm)	8 dBm/3kHz

The maximum permitted output power is reduced by 1dB for every dB the antenna gain exceeds 6dBi. Fixed point-to-point applications using the 5725 – 5850 MHz band are not subject to this restriction.

**TRANSMIT MODE SPURIOUS RADIATED EMISSIONS LIMITS – FHSS and DTS SYSTEMS**

The limits for unwanted (spurious) emissions from the transmitter falling in the restricted bands are those specified in the general limits sections of FCC Part 15 and RSS 210. All other unwanted (spurious) emissions shall be at least 20dB below the level of the highest in-band signal level (30dB if the power is measured using the sample detector/power averaging method).

**SAMPLE CALCULATIONS - CONDUCTED EMISSIONS**

Receiver readings are compared directly to the conducted emissions specification limit (decibel form) as follows:

$$R_r - S = M$$

where:

$R_r$  = Receiver Reading in dBuV

S = Specification Limit in dBuV

M = Margin to Specification in +/- dB

**SAMPLE CALCULATIONS - RADIATED EMISSIONS**

Receiver readings are compared directly to the specification limit (decibel form). The receiver internally corrects for cable loss, preamplifier gain, and antenna factor. The calculations are in the reverse direction of the actual signal flow, thus cable loss is added and the amplifier gain is subtracted. The Antenna Factor converts the voltage at the antenna coaxial connector to the field strength at the antenna elements.

A distance factor, when used for electric field measurements above 30MHz, is calculated by using the following formula:

$$F_d = 20 * \text{LOG}_{10} (D_m/D_s)$$

where:

$F_d$  = Distance Factor in dB

$D_m$  = Measurement Distance in meters

$D_s$  = Specification Distance in meters

For electric field measurements below 30MHz the extrapolation factor is either determined by making measurements at multiple distances or a theoretical value is calculated using the formula:

$$F_d = 40 * \text{LOG}_{10} (D_m/D_s)$$

Measurement Distance is the distance at which the measurements were taken and Specification Distance is the distance at which the specification limits are based. The antenna factor converts the voltage at the antenna coaxial connector to the field strength at the antenna elements.

The margin of a given emission peak relative to the limit is calculated as follows:

$$R_c = R_r + F_d$$

and

$$M = R_c - L_s$$

where:

$R_r$  = Receiver Reading in dBuV/m

$F_d$  = Distance Factor in dB

$R_c$  = Corrected Reading in dBuV/m

$L_s$  = Specification Limit in dBuV/m

M = Margin in dB Relative to Spec

**SAMPLE CALCULATIONS - FIELD STRENGTH TO EIRP CONVERSION**

Where the radiated electric field strength is expressed in terms of the equivalent isotropic radiated power (eirp), or where a field strength measurement of output power is made in lieu of a direct measurement, the following formula is used to convert between eirp and field strength at a distance of d (meters) from the equipment under test:

$$E = \frac{1000000 \sqrt{30 P}}{d} \text{ microvolts per meter}$$

where P is the eirp (Watts)

For a measurement at 3m the conversion from a logarithmic value for field strength (dBuV/m) to an eirp power (dBm) is -95.3dB.

## Appendix A Test Equipment Calibration Data

<u>Manufacturer</u>	<u>Description</u>	<u>Model</u>	<u>Asset #</u>	<u>Calibrated</u>	<u>Cal Due</u>
<b>Duty Cycle, 09-Jul-19</b>					
Agilent Technologies	3Hz -44GHz PSA Spectrum Analyzer	E4446A	2796	5/21/2019	5/21/2020
<b>Conducted Emissions - AC Power Ports, 11-Jul-19</b>					
EMCO	LISN, 10 kHz-100 MHz	3825/2	1292	8/16/2018	8/16/2019
Rohde & Schwarz	Pulse Limiter	ESH3 Z2	1398	12/26/2018	12/26/2019
Rohde & Schwarz	EMI Test Receiver, 20 Hz-7 GHz	ESIB 7	1538	2/9/2019	2/9/2020
<b>Radiated Emissions, 1,000 - 6,000 MHz, 11-Jul-19</b>					
EMCO	Antenna, Horn, 1-18 GHz (SA40-Red)	3115	1142	9/18/2018	9/18/2020
Rohde & Schwarz	EMI Test Receiver, 20 Hz-7 GHz	ESIB 7	1538	2/9/2019	2/9/2020
<b>Radiated Emissions, 1,000 - 6,000 MHz, 12-Jul-19</b>					
EMCO	Antenna, Horn, 1-18 GHz (SA40-Red)	3115	1142	9/18/2018	9/18/2020
Rohde & Schwarz	EMI Test Receiver, 20 Hz-7 GHz	ESIB 7	9482	10/13/2018	10/13/2019
<b>Radiated Emissions, 1,000 - 6,000 MHz, 15-Jul-19</b>					
EMCO	Antenna, Horn, 1-18 GHz (SA40-Red)	3115	1142	9/18/2018	9/18/2020
Rohde & Schwarz	EMI Test Receiver, 20 Hz-7 GHz	ESIB 7	9482	10/13/2018	10/13/2019
<b>Radiated Emissions, 1,000 - 12,000 MHz, 16-Jul-19</b>					
EMCO	Antenna, Horn, 1-18 GHz	3115	487	8/9/2018	8/9/2020
Hewlett Packard	Microwave Preamplifier, 1-26.5GHz	8449B	785	9/5/2018	9/5/2019
Hewlett Packard	Spectrum Analyzer (SA40) Red 30 Hz -40 GHz	8564E (84125C)	1148	9/27/2018	9/27/2019
Micro-Tronics	Band Reject Filter, 2400-2500 MHz 18GHz	BRM50702-02	2238	4/26/2019	4/26/2020
Micro-Tronics	Band Reject Filter, 5150-5350 MHz	BRC50703-02	2251	7/15/2019	7/15/2020
<b>Radiated Emissions, 1,000 - 18,000 MHz, 17-Jul-19</b>					
EMCO	Antenna, Horn, 1-18 GHz	3115	487	8/9/2018	8/9/2020
Hewlett Packard	Microwave Preamplifier, 1-26.5GHz	8449B	785	9/5/2018	9/5/2019
Hewlett Packard	Spectrum Analyzer (SA40) Red 30 Hz -40 GHz	8564E (84125C)	1148	9/27/2018	9/27/2019
Hewlett Packard	High Pass filter, 8.2 GHz (Purple System)	P/N 84300-80039	1767	7/15/2019	7/15/2020
Micro-Tronics	Band Reject Filter, 2400-2500 MHz 18GHz	BRM50702-02	2238	4/26/2019	4/26/2020
Micro-Tronics	Band Reject Filter, 5150-5350 MHz	BRC50703-02	2251	7/15/2019	7/15/2020





<u>Manufacturer</u>	<u>Description</u>	<u>Model</u>	<u>Asset #</u>	<u>Calibrated</u>	<u>Cal Due</u>
Micro-Tronics	Band Reject Filter, 5725-5875 MHz	BRC50705-01	2738	7/15/2019	7/15/2020
<b>Radiated Emissions, 12,000 - 18,000 MHz, 18-Jul-19</b>					
EMCO	Antenna, Horn, 1-18 GHz	3115	487	8/9/2018	8/9/2020
Hewlett Packard	Microwave Preamplifier, 1-26.5GHz	8449B	785	9/5/2018	9/5/2019
Hewlett Packard	Spectrum Analyzer (SA40) Red 30 Hz -40 GHz	8564E (84125C)	1148	9/27/2018	9/27/2019
Hewlett Packard	High Pass filter, 8.2 GHz (Purple System)	P/N 84300-80039	1767	7/15/2019	7/15/2020
<b>Radiated Emissions, 18,000 - 40,000 MHz, 19-Jul-19</b>					
HP / Miteq	SA40 R Head HF preAmplifier, 18-40 GHz (w/1148)	TTA1840-45-5P-HG-S	1145	9/8/2018	9/8/2019
Hewlett Packard	Spectrum Analyzer (SA40) Red 30 Hz -40 GHz	8564E (84125C)	1148	9/27/2018	9/27/2019
A. H. Systems	System Horn, 18-40GHz	SAS-574, p/n: 2581	2161	7/8/2019	7/8/2021
<b>Radiated Emissions, 1,000 - 40,000 MHz, 22-Jul-19</b>					
EMCO	Antenna, Horn, 1-18 GHz	3115	487	8/9/2018	8/9/2020
Hewlett Packard	Microwave Preamplifier, 1-26.5GHz	8449B	785	7/18/2019	7/18/2020
HP / Miteq	SA40 R Head HF preAmplifier, 18-40 GHz (w/1148)	TTA1840-45-5P-HG-S	1145	9/8/2018	9/8/2019
Hewlett Packard	Spectrum Analyzer (SA40) Red 30 Hz -40 GHz	8564E (84125C)	1148	9/27/2018	9/27/2019
Hewlett Packard	High Pass filter, 8.2 GHz (Purple System)	P/N 84300-80039	1767	7/15/2019	7/15/2020
A. H. Systems	System Horn, 18-40GHz	SAS-574, p/n: 2581	2161	7/8/2019	7/8/2021
Micro-Tronics	Band Reject Filter, 2400-2500 MHz 18GHz	BRM50702-02	2238	4/26/2019	4/26/2020
Micro-Tronics	Band Reject Filter, 5150-5350 MHz	BRC50703-02	2251	7/15/2019	7/15/2020
<b>Radio Antenna Port (Power and Spurious Emissions), 24-Jul-19</b>					
Rohde & Schwarz	Signal Analyzer 20 Hz - 26.5 GHz	FSQ26	2327	7/4/2019	7/4/2020
<b>Radiated Emissions, 0.03 - 1,000 MHz, 24-Jul-19</b>					
National Technical Systems	NTS EMI Software (rev 2.10)	N/A	0		N/A
Sunol Sciences	Biconilog, 30-3000 MHz	JB3	1549	3/11/2019	3/11/2021
Micro-Tronics	Band Reject Filter, 5470-5725 MHz 12GHz	BRC50704-02	1681	3/20/2019	3/20/2020
Micro-Tronics	Band Reject Filter, 2400-2500 MHz 18GHz	BRM50702-02	2238	4/26/2019	4/26/2020
Micro-Tronics	Band Reject Filter, 5150-5350 MHz	BRC50703-02	2251	7/15/2019	7/15/2020
Hewlett Packard	9KHz-1300MHz pre-amp	8447F	2777	12/20/2018	12/20/2019
Rohde & Schwarz	EMI Test Receiver, 20 Hz-7 GHz	ESIB 7	9482	10/13/2018	10/13/2019



<u>Manufacturer</u>	<u>Description</u>	<u>Model</u>	<u>Asset #</u>	<u>Calibrated</u>	<u>Cal Due</u>
Rhode & Schwarz	Magnetic Loop Antenna, 9 kHz-30 MHz	HFH2-Z2	WC062457	1/5/2018	1/5/2020
<b>Radio Antenna Port (Power and Spurious Emissions), 25-Jul-19</b>					
Rohde & Schwarz	Signal Analyzer 20 Hz - 26.5 GHz	FSQ26	2327	7/4/2019	7/4/2020
<b>Radio Antenna Port (Power and Spurious Emissions), 26-Jul-19</b>					
Rohde & Schwarz	Signal Analyzer 20 Hz - 26.5 GHz	FSQ26	2327	7/4/2019	7/4/2020
<b>Radio Antenna Port (Power and Spurious Emissions), 29-Jul-19</b>					
Agilent Technologies	PSA, Spectrum Analyzer, (installed options, 111, 115, 123, 1DS, B7J, HYX,	E4446A	2139	7/18/2019	7/18/2020
<b>Radio Antenna Port (Power and Spurious Emissions), 30-Jul-19</b>					
Agilent Technologies	PSA, Spectrum Analyzer, (installed options, 111, 115, 123, 1DS, B7J, HYX,	E4446A	2139	7/18/2019	7/18/2020
<b>Radio Antenna Port (Power and Spurious Emissions), 31-Jul-19</b>					
Agilent Technologies	PSA, Spectrum Analyzer, (installed options, 111, 115, 123, 1DS, B7J, HYX,	E4446A	2139	7/18/2019	7/18/2020
<b>Band edge Measurement, 20-Sep-19</b>					
EMCO	Horn Antenna	3115	WC062583	7/9/2018	7/9/2020
Rohde & Schwarz	EMI test receiver	ESI 40	WC068000	3/15/2019	3/15/2020
<b>Radiated Emissions, 1,000 - 40,000 MHz, 01-Oct-19</b>					
Hewlett Packard	Spectrum Analyzer (Red)	8564E (84125C)	WC055584	9/27/2019	9/27/2020
Hewlett Packard	Microwave Preamplicifier Head, 18-40 GHz (Red)	84125C Head	WC055586	7/25/2019	7/25/2020
EMCO	Horn Antenna	3115	WC062583	7/9/2018	7/9/2020
Hewlett Packard	Microwave Preamplicifier, 1-26.5GHz	8449B	WC064416	7/18/2019	7/18/2020
Hewlett Packard	High Pass filter, 8.2 GHz	P/N 84300-80039	WC064433	4/25/2019	4/25/2020
A. H. Systems	Antenna, Horn, 18-40GHz	SAS-574	WC064553	9/5/2017	8/8/2020
Rohde & Schwarz	EMI test receiver	ESI 40	WC068000	3/15/2019	3/15/2020
<b>Radio Antenna Port (Power and Spurious Emissions), 10-Oct-19</b>					
National Technical Systems	NTS UNII Power Software (rev 4.0)	N/A	WC022700	N/A	
Rohde & Schwarz	Spectrum Analyzer	FSQ26	WC055662	7/4/2019	7/4/2020
<b>Radiated Emissions, 1,000 - 6,000 MHz, 20 through 30-Dec-19</b>					
National Technical Systems	NTS EMI Software (rev 2.10)	N/A	WC022452	N/A	
National Technical Systems	NTS Capture Analyzer Software (rev 4.0)	N/A	WC022706	N/A	
Agilent Technologies	PSA B	E4446A	WC055670	5/21/2019	5/21/2020



<u>Manufacturer</u>	<u>Description</u>	<u>Model</u>	<u>Asset #</u>	<u>Calibrated</u>	<u>Cal Due</u>
Hewlett Packard	Spectrum Analyzer (Spare SA26) 9 KHz-26.5 GHz, Non-Program	8563E	WC064401	6/12/2019	6/12/2020
EMCO	Antenna, Horn, 1-18 GHz	3115	WC064404	8/9/2018	8/9/2020
Rohde & Schwarz	EMI test receiver	ESI 40	WC068000	3/15/2019	3/15/2020
<b>Radio Antenna Port (Power and Spurious Emissions), 3-4- Feb-2020</b>					
Rohde & Schwarz	Spectrum Analyzer	FSQ26	WC055662	7/4/2019	7/4/2020
Rohde & Schwarz	Open Switch and Control Unit, p/s	OSP 120 with B157	WC064756	7/16/2019	7/16/2020

## **Appendix B Test Data**

TL-101106-RANA Pages 29 – 148



## EMC Test Data

Client:	Arris	PR Number:	PR101106
Product:	NVG5XDBAX	T-Log Number:	TL-101106-RANA
System Configuration:	Radio Module	Project Manager:	Deepa Shetty
Contact:	Mark Rieger	Project Engineer:	David Bare
Emissions Standard(s):	FCC Part 15, RSS-247	Class:	-
Immunity Standard(s):	-	Environment:	Radio

## EMC Test Data

For The

**Arris**

Product

NVG5XDBAX

Date of Last Test: 3/11/2020



# EMC Test Data

Client: Arris	PR Number: PR101106
Model: NVG5XDBAX	T-Log Number: TL-101106-RANA
	Project Manager: Deepa Shetty
Contact: Mark Rieger	Project Engineer: David Bare
Standard: FCC Part 15, RSS-247	Class: -

## Conducted Emissions

*(NTS Silicon Valley, Fremont Facility, Semi-Anechoic Chamber)*

### Test Specific Details

Objective: The objective of this test session is to perform final qualification testing of the EUT with respect to the specification listed above.

Date of Test: 7/11/2019	Config. Used: 1
Test Engineer: Rafael Varelas	Config Change: None
Test Location: Fremont Chamber #7	EUT Voltage: 120V/60Hz

### General Test Configuration

For tabletop equipment, the EUT and host system were located on a wooden table inside the semi-anechoic chamber, 40 cm from a vertical coupling plane and 80cm from the LISN. A second LISN was used for all local support equipment. Remote support equipment was located outside of the semi-anechoic chamber. Any cables running to remote support equipment where routed through metal conduit and when possible passed through a ferrite clamp upon exiting the chamber.

<b>Ambient Conditions:</b>	Temperature:	22.4 °C
	Rel. Humidity:	41 %

### Summary of Results

Run #	Test Performed	Limit	Result	Margin
1	CE, AC Power, 120V/60Hz	15.207	Pass	27.4 dBµV @ 0.509 MHz (-18.6 dB)

### Modifications Made During Testing

No modifications were made to the EUT during testing

### Deviations From The Standard

No deviations were made from the requirements of the standard.



# EMC Test Data

Client: Arris	PR Number: PR101106
Model: NVG5XDBAX	T-Log Number: TL-101106-RANA
Contact: Mark Rieger	Project Manager: Deepa Shetty
Standard: FCC Part 15, RSS-247	Project Engineer: David Bare
	Class: -

Run #1: AC Power Port Conducted Emissions, 0.15 - 30MHz, 120V/60Hz  
EUT Configured to transmit at 80211b on Channel 1 and 802.11a on Channel 36

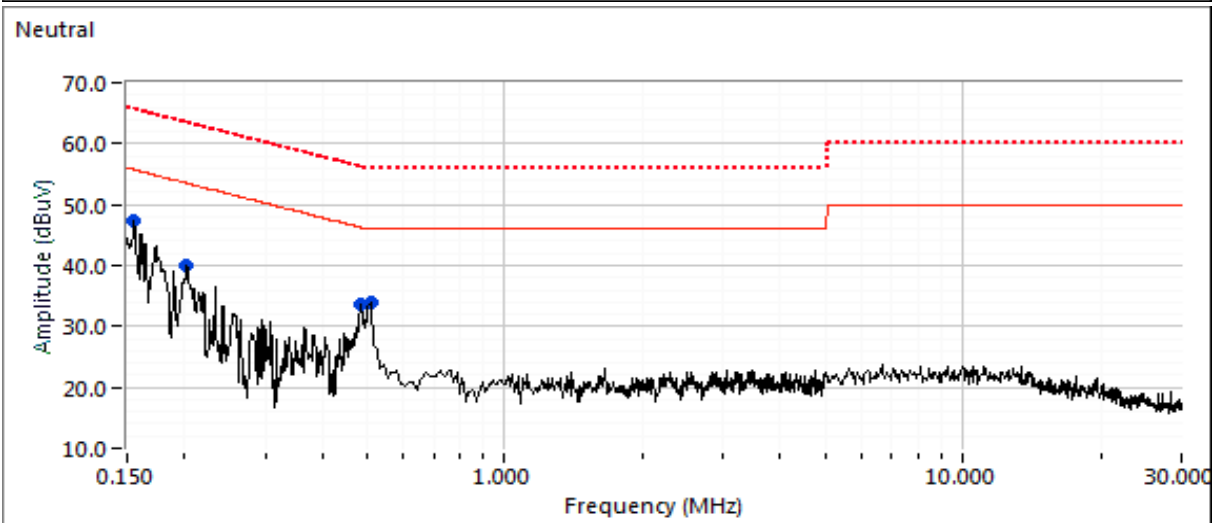
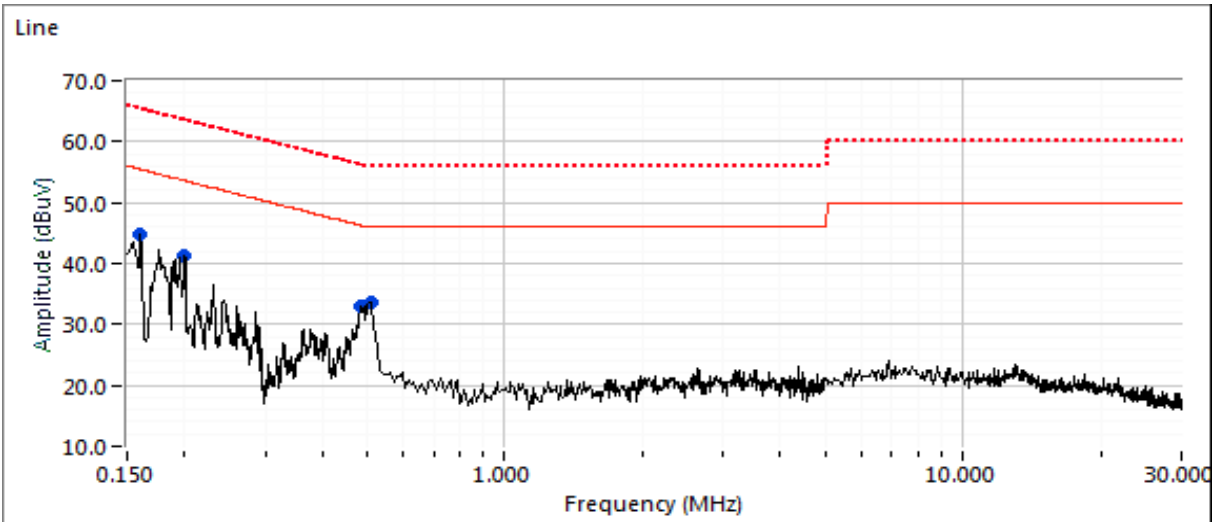



# EMC Test Data

Client:	Arris	PR Number:	PR101106
Model:	NVG5XDBAX	T-Log Number:	TL-101106-RANA
Contact:	Mark Rieger	Project Manager:	Deepa Shetty
Standard:	FCC Part 15, RSS-247	Project Engineer:	David Bare
		Class:	-

### Preliminary peak readings captured during pre-scan (peak readings vs. average limit)

Frequency MHz	Level dB $\mu$ V	AC Line	15.207		Detector QP/Ave	Comments
			Limit	Margin		
0.158	44.9	Line 1	55.4	-10.5	Peak	
0.200	41.3	Line 1	53.6	-12.3	Peak	
0.487	32.9	Line 1	46.2	-13.3	Peak	
0.509	33.6	Line 1	46.0	-12.4	Peak	
0.154	47.5	Neutral	55.7	-8.2	Peak	
0.204	39.9	Neutral	53.5	-13.6	Peak	
0.484	33.6	Neutral	46.2	-12.6	Peak	
0.509	33.8	Neutral	46.0	-12.2	Peak	

### Final quasi-peak and average readings

Frequency MHz	Level dB $\mu$ V	AC Line	15.207		Detector QP/Ave	Comments
			Limit	Margin		
0.509	27.4	Line 1	46.0	-18.6	AVG	AVG (0.10s)
0.509	26.3	Neutral	46.0	-19.7	AVG	AVG (0.10s)
0.154	42.7	Neutral	65.8	-23.1	QP	QP (1.00s)
0.509	32.7	Line 1	56.0	-23.3	QP	QP (1.00s)
0.509	32.4	Neutral	56.0	-23.6	QP	QP (1.00s)
0.158	40.4	Line 1	65.6	-25.2	QP	QP (1.00s)
0.154	28.3	Neutral	55.8	-27.5	AVG	AVG (0.10s)
0.204	35.3	Neutral	63.4	-28.1	QP	QP (1.00s)
0.200	35.0	Line 1	63.6	-28.6	QP	QP (1.00s)
0.204	24.4	Neutral	53.4	-29.0	AVG	AVG (0.10s)
0.200	24.4	Line 1	53.6	-29.2	AVG	AVG (0.10s)
0.158	25.0	Line 1	55.6	-30.6	AVG	AVG (0.10s)





# EMC Test Data

Client: Arris	PR Number: PR101106
Model: NVG5XDBAX	T-Log Number: TL-101106-RANA
	Project Manager: Deepa Shetty
Contact: Mark Rieger	Project Engineer: David Bare
Standard: FCC Part 15, RSS-247	Class: N/A

## RSS-247 and FCC 15.247 (DTS) Radiated Spurious Emissions

### Test Specific Details

Objective: The objective of this test session is to perform final qualification testing of the EUT with respect to the specification listed above.

### General Test Configuration

The EUT and all local support equipment were located on the turntable for radiated spurious emissions testing. For radiated emissions testing the measurement antenna was located 3 meters from the EUT, unless otherwise noted.

**Ambient Conditions:** Temperature: 19-23 °C  
Rel. Humidity: 42-45 %

### Summary of Results - Device Operating in the 2400-2483.5 MHz Band

Run #	Mode	Channel	Target Power	Power Setting	Test Performed	Limit	Result / Margin
1	b / a	1 & 36	26 / 26	26 / 26	Restricted Band Edge (2390 MHz)	FCC Part 15.209 / 15.247( c)	39.9 dBµV/m @ 2375.1 MHz (-14.1 dB)
	b / a	11 & 64	26 / 26	26 / 26	Restricted Band Edge (2483.5 MHz)	FCC Part 15.209 / 15.247( c)	46.4 dBµV/m @ 2483.6 MHz (-7.6 dB)
2	g / a	1 & 100	26 / 26	26 / 26	Restricted Band Edge (2390 MHz)	FCC Part 15.209 / 15.247( c)	42.1 dBµV/m @ 2390.0 MHz (-11.9 dB)
	g / a	11 & 140	26 / 26	26 / 26	Restricted Band Edge (2483.5 MHz)	FCC Part 15.209 / 15.247( c)	47.5 dBµV/m @ 2483.5 MHz (-6.5 dB)
3	ac20	1 & 36	24 / 24	24 / 24	Restricted Band Edge (2390 MHz)	FCC Part 15.209 / 15.247( c)	41.8 dBµV/m @ 2375.1 MHz (-12.2 dB)
	ac20	11 & 64	24 / 18	24 / 18	Restricted Band Edge (2483.5 MHz)	FCC Part 15.209 / 15.247( c)	50.2 dBµV/m @ 2483.6 MHz (-3.8 dB)
4	ac40	3 & 102	24 / 18	24 / 18	Restricted Band Edge (2390 MHz)	FCC Part 15.209 / 15.247( c)	51.7 dBµV/m @ 2390.0 MHz (-2.3 dB)
	ac40	9 & 134	24 / 18	24 / 18	Restricted Band Edge (2483.5 MHz)	FCC Part 15.209 / 15.247( c)	49.4 dBµV/m @ 2483.8 MHz (-4.6 dB)

### Modifications Made During Testing

No modifications were made to the EUT during testing

### Deviations From The Standard

No deviations were made from the requirements of the standard.



# EMC Test Data

Client: Arris	PR Number: PR101106
Model: NVG5XDBAX	T-Log Number: TL-101106-RANA
	Project Manager: Deepa Shetty
Contact: Mark Rieger	Project Engineer: David Bare
Standard: FCC Part 15, RSS-247	Class: N/A

## Sample Notes

Sample S/N: M11917QW000T  
Driver:

## Procedure Comments:

Measurements performed in accordance with FCC KDB 558074  
Peak measurements performed with: RBW=1MHz, VBW=3MHz, peak detector, max hold, auto sweep time  
Unless otherwise stated/noted, emission has a duty cycle  $\geq 98\%$  and was measured using RBW=1MHz, VBW=10Hz, peak detector, linear average mode, auto sweep time, max hold.

Mode	Data Rate	Duty Cycle (x)	Constant DC?	T (ms)	Pwr Cor Factor*	Lin Volt Cor Factor**	Min VBW for FS (Hz)	Packet	pkt duty
11b	1	99.2%	Yes	12.422	0.0	0.0	10	1285	-1
11a/g	6	99.0%	Yes	5.06	0.0	0.0	10	7974	-1
ac20	6.5	97.6%	Yes	5.271	0.1	0.2	190	4324	-1
ac40	13.5	97.3%	Yes	5.24	0.1	0.2	191	8811	-1

## Measurement Specific Notes:

Note 1:	Emission in non-restricted band, but limit of 15.209 used.
Note 2:	Emission in non-restricted band, the limit was set 30dB below the level of the fundamental and measured in 100kHz.
Note 3:	Emission has a duty cycle $\geq 98\%$ , average measurement performed: RBW=1MHz, VBW=3MHz, RMS, Power averaging, auto sweep, trace average 100 traces
Note 4:	Emission has constant duty cycle $< 98\%$ , average measurement performed: RBW=1MHz, VBW> $> 1/T$ but not less than 10Hz, peak detector, linear averaging, auto sweep, trace average 100 traces, measurement corrected by Linear voltage correction factor
Note 5:	Emission has constant duty cycle $< 98\%$ , average measurement performed: RBW=1MHz, VBW=3MHz, RMS, Power averaging, auto sweep, trace average 100 traces, measurement corrected by Pwr correction factor
Note 6:	Emission has non constant duty cycle $< 98\%$ , average measurement performed: RBW=1MHz, VBW $> 1/T$ , peak detector, linear average mode, sweep time auto, max hold. Max hold for $50*(1/DC)$ traces
Note 7:	Emission has non constant duty cycle $< 98\%$ , average measurement performed: RBW=1MHz, VBW $> 1/T$ , RMS detector, sweep time auto, max hold. Max hold for $50*(1/DC)$ traces
Note 8:	Plots of the average and peak bandedge do not account for any duty cycle correction. Refer to the tabular results for final measurements.
Note 9:	For SISO measurement, evaluation of each chain showed that chain 4 has the highest power measurement. All SISO test measurement were performed with chain 4 active.



# EMC Test Data

Client: Arris	PR Number: PR101106
Model: NVG5XDBAX	T-Log Number: TL-101106-RANA
Contact: Mark Rieger	Project Manager: Deepa Shetty
Standard: FCC Part 15, RSS-247	Project Engineer: David Bare
	Class: N/A

## Run #1: Radiated Bandedge Measurements

Date of Test: 07/11/19  
 Test Engineer: Mehran Birgani  
 Test Location: FT Chamber #7  
 Config. Used: 1  
 Config Change: None  
 EUT Voltage: 120V/60Hz

Channel: 1                      Mode: b                      Pwr Setting: 26 (q104)  
 Tx Chain: 1TX                  Data Rate: 1

## Band Edge Signal Field Strength - Direct measurement of field strength

Frequency	Level	Pol	15.209 / 15.247		Detector	Azimuth	Height	Comments
MHz	dB $\mu$ V/m	V/H	Limit	Margin	Pk/QP/Avg	degrees	meters	
2375.090	39.9	V	54.0	-14.1	AVG	292	1.2	RB 1 MHz; VB: 10 Hz
2375.050	49.4	V	74.0	-24.6	PK	292	1.2	RB 1 MHz; VB: 3 MHz
2375.090	39.8	H	54.0	-14.2	AVG	220	1.2	RB 1 MHz; VB: 10 Hz
2374.930	49.6	H	74.0	-24.4	PK	220	1.2	RB 1 MHz; VB: 3 MHz

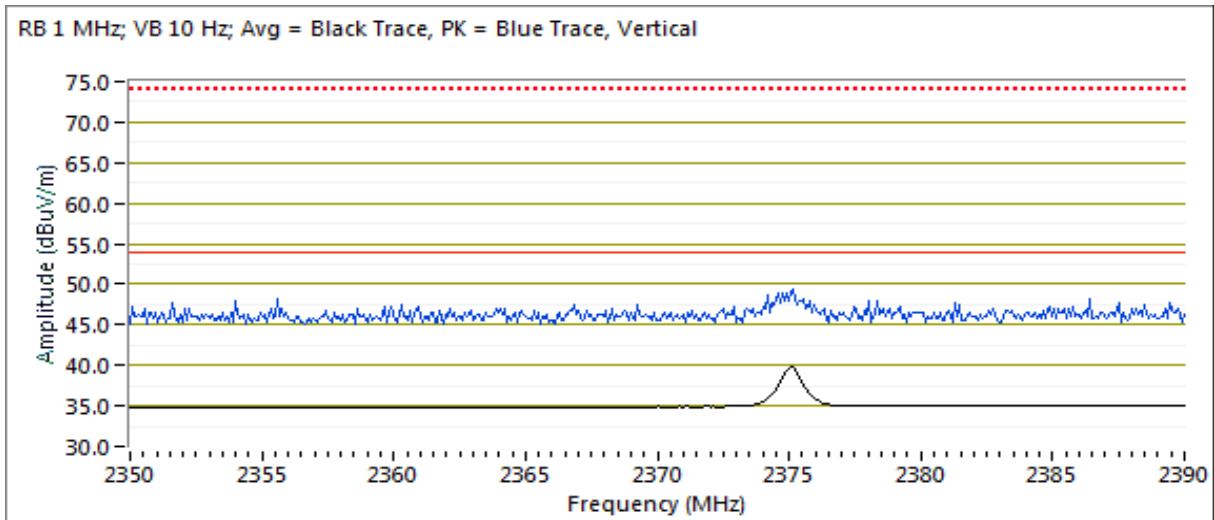



# EMC Test Data

Client: Arris	PR Number: PR101106
Model: NVG5XDBAX	T-Log Number: TL-101106-RANA
Contact: Mark Rieger	Project Manager: Deepa Shetty
Standard: FCC Part 15, RSS-247	Project Engineer: David Bare
	Class: N/A

Channel: 11                      Mode: b                      Pwr Setting: 26 (q104)  
 Tx Chain: 1TX                      Data Rate: 1

### Band Edge Signal Field Strength - Direct measurement of field strength

Frequency MHz	Level dB $\mu$ V/m	Pol V/H	15.209 / 15.247		Detector Pk/QP/Avg	Azimuth degrees	Height meters	Comments
			Limit	Margin				
2483.580	46.4	V	54.0	-7.6	AVG	209	1.6	RB 1 MHz; VB: 10 Hz
2484.660	59.9	V	74.0	-14.1	PK	209	1.6	RB 1 MHz; VB: 3 MHz
2500.000	39.5	H	54.0	-14.5	AVG	265	1.7	RB 1 MHz; VB: 10 Hz
2499.740	49.6	H	74.0	-24.4	PK	265	1.7	RB 1 MHz; VB: 3 MHz

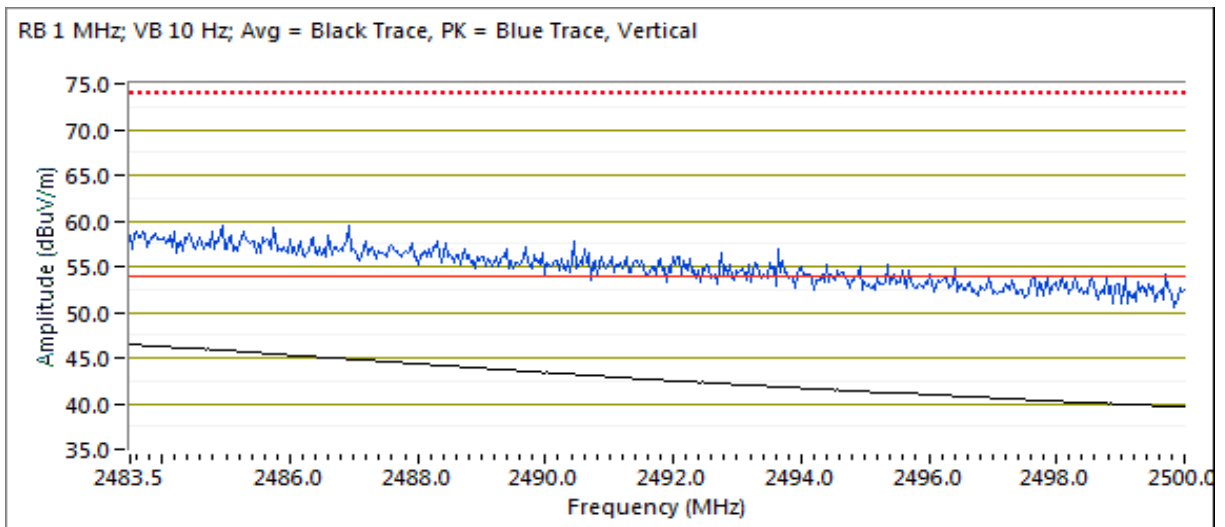



# EMC Test Data

Client: Arris	PR Number: PR101106
Model: NVG5XDBAX	T-Log Number: TL-101106-RANA
Contact: Mark Rieger	Project Manager: Deepa Shetty
Standard: FCC Part 15, RSS-247	Project Engineer: David Bare
	Class: N/A

## Run #2: Radiated Bandedge Measurements

Date of Test: 07/11/19

Test Engineer: Mehran Birgani

Test Location: FT Chamber #7

Config. Used: 1

Config Change: None

EUT Voltage: 120V/60Hz

Channel: 1                      Mode: g                      Pwr Setting: 26 (q104)  
 Tx Chain: 1TX                Data Rate: 6

## Band Edge Signal Field Strength - Direct measurement of field strength

Frequency	Level	Pol	15.209 / 15.247		Detector	Azimuth	Height	Comments
MHz	dB $\mu$ V/m	V/H	Limit	Margin	PK/QP/Avg	degrees	meters	
2390.000	42.1	V	54.0	-11.9	AVG	314	1.7	RB 1 MHz; VB: 10 Hz
2389.960	61.0	V	74.0	-13.0	PK	314	1.7	RB 1 MHz; VB: 3 MHz
2375.090	40.8	H	54.0	-13.2	AVG	310	1.7	RB 1 MHz; VB: 10 Hz
2389.920	55.0	H	74.0	-19.0	PK	310	1.7	RB 1 MHz; VB: 3 MHz

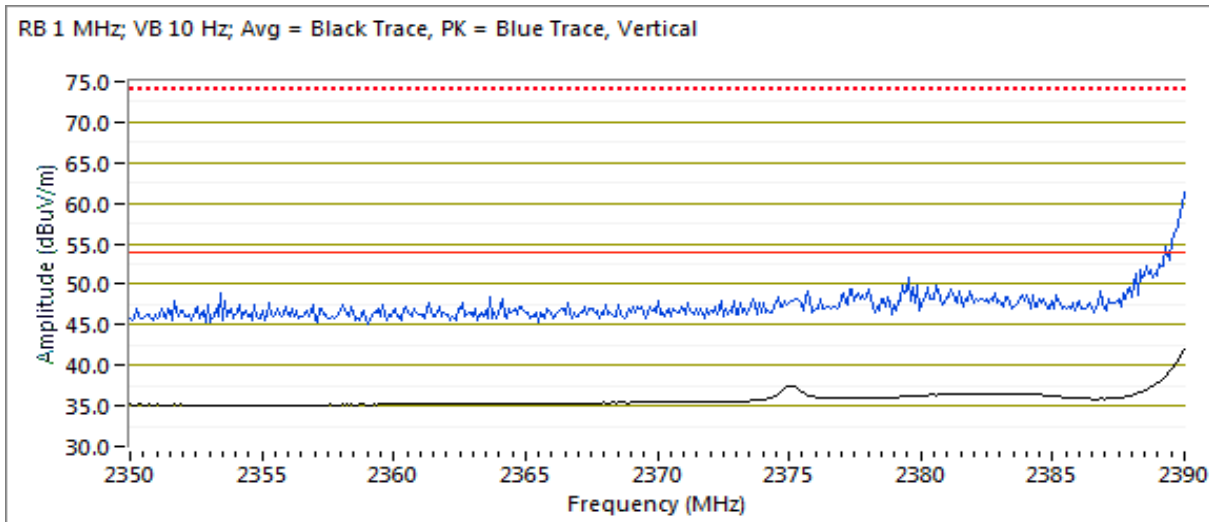





# EMC Test Data

Client: Arris	PR Number: PR101106
Model: NVG5XDBAX	T-Log Number: TL-101106-RANA
	Project Manager: Deepa Shetty
Contact: Mark Rieger	Project Engineer: David Bare
Standard: FCC Part 15, RSS-247	Class: N/A

### Run #3: Radiated Bandedge Measurements

Date of Test: 07/11/19 Config. Used: 1  
 Test Engineer: Rafael Varelas Config Change: None  
 Test Location: FT Chamber #7 EUT Voltage: 120V/60Hz

Channel: 1 Mode: ac20 Pwr Setting: 24 (q96)  
 Tx Chain: 4Tx Data Rate: 6.5

### Band Edge Signal Field Strength - Direct measurement of field strength

Frequency	Level	Pol	15.209 / 15.247		Detector	Azimuth	Height	Comments
MHz	dB $\mu$ V/m	V/H	Limit	Margin	PK/QP/Avg	degrees	meters	
2375.100	41.8	H	54.0	-12.2	VAVG	309	1.9	Note 4; RB 1MHz; VB 200Hz
2374.780	50.7	H	74.0	-23.3	PK	309	1.9	RB 1MHz; VB 3MHz
2375.100	40.4	V	54.0	-13.6	VAVG	302	1.2	Note 4; RB 1MHz; VB 200Hz
2374.820	50.4	V	74.0	-23.6	PK	302	1.2	RB 1MHz; VB 3MHz

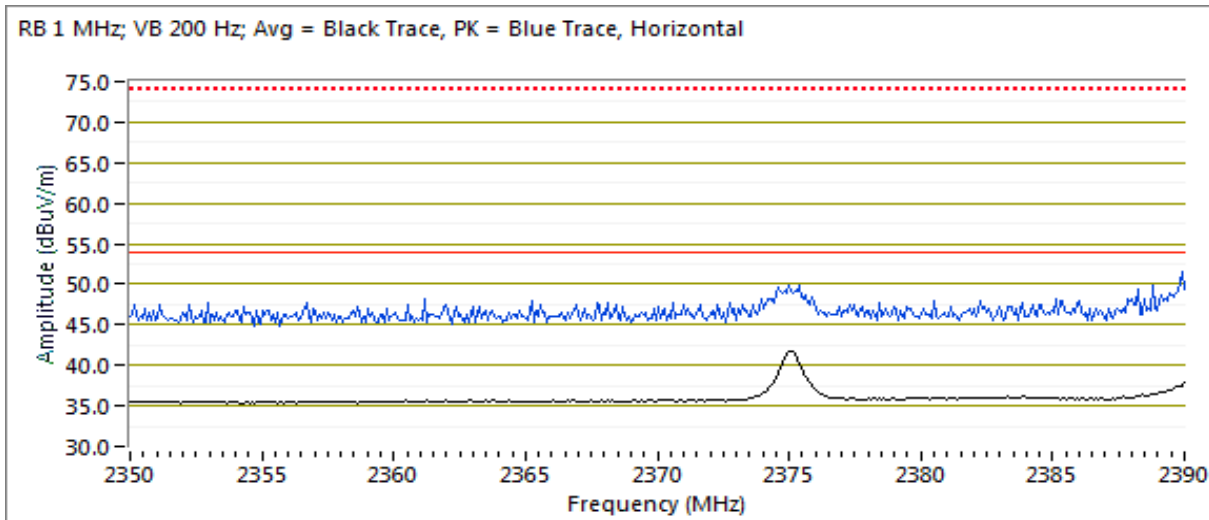



# EMC Test Data

Client: Arris	PR Number: PR101106
Model: NVG5XDBAX	T-Log Number: TL-101106-RANA
Contact: Mark Rieger	Project Manager: Deepa Shetty
Standard: FCC Part 15, RSS-247	Project Engineer: David Bare
	Class: N/A

Channel: 11                      Mode: ac20                      Pwr Setting: 24 (q96)  
 Tx Chain: 4Tx                      Data Rate: 6.5

### Band Edge Signal Field Strength - Direct measurement of field strength

Frequency MHz	Level dB $\mu$ V/m	Pol V/H	15.209 / 15.247		Detector Pk/QP/Avg	Azimuth degrees	Height meters	Comments
			Limit	Margin				
2483.640	50.2	V	54.0	-3.8	VAVG	119	1.6	Note 4; RB 1MHz; VB 200Hz
2484.400	68.9	V	74.0	-5.1	PK	119	1.6	RB 1MHz; VB 3MHz
2484.110	46.9	H	54.0	-7.1	VAVG	132	1.5	Note 4; RB 1MHz; VB 200Hz
2484.030	65.9	H	74.0	-8.1	PK	132	1.5	RB 1MHz; VB 3MHz

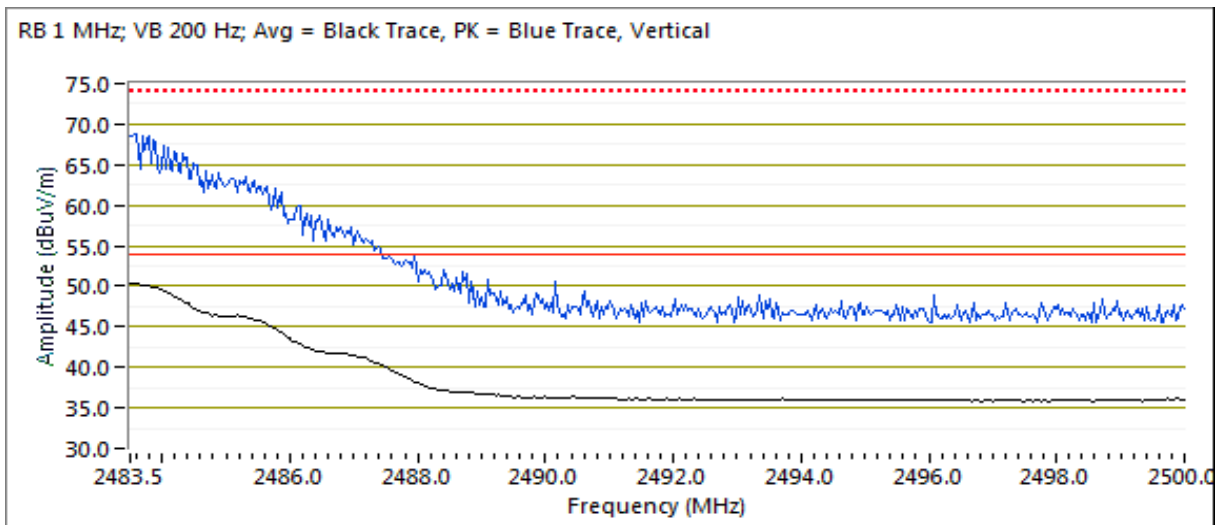





# EMC Test Data

Client: Arris	PR Number: PR101106
Model: NVG5XDBAX	T-Log Number: TL-101106-RANA
Contact: Mark Rieger	Project Manager: Deepa Shetty
Standard: FCC Part 15, RSS-247	Project Engineer: David Bare
	Class: N/A

### Run #4: Radiated Bandedge Measurements

Date of Test: 07/11/19

Test Engineer: R. Varelas & M. Birgani

Test Location: FT Chamber #7

Config. Used: 1

Config Change: None

EUT Voltage: 120V/60Hz

Channel: 3

Mode: ac40

Pwr Setting: 24 (q96)

Tx Chain: 4Tx

Data Rate: 13.5

### Band Edge Signal Field Strength - Direct measurement of field strength

Frequency	Level	Pol	15.209 / 15.247		Detector	Azimuth	Height	Comments
MHz	dB $\mu$ V/m	V/H	Limit	Margin	PK/QP/Avg	degrees	meters	
2390.000	51.7	V	54.0	-2.3	VAVG	104	1.6	Note 4; RB 1MHz; VB 200Hz
2389.860	64.0	V	74.0	-10.0	PK	104	1.6	RB 1MHz; VB 3MHz
2390.000	50.0	H	54.0	-4.0	VAVG	106	1.5	Note 4; RB 1MHz; VB 200Hz
2390.000	65.0	H	74.0	-9.0	PK	106	1.5	RB 1MHz; VB 3MHz

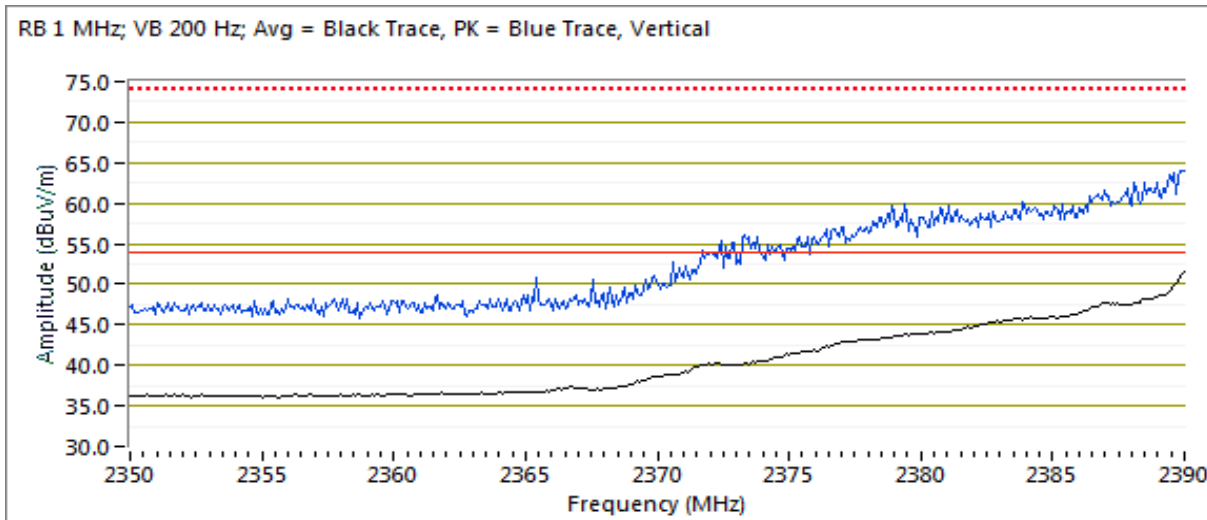



# EMC Test Data

Client:	Arris	PR Number:	PR101106
Model:	NVG5XDBAX	T-Log Number:	TL-101106-RANA
Contact:	Mark Rieger	Project Manager:	Deepa Shetty
Standard:	FCC Part 15, RSS-247	Project Engineer:	David Bare
		Class:	N/A

Channel: 9                                      Mode: ac40                                      Pwr Setting: 24 (q96)  
 Tx Chain: 4TX                                      Data Rate: 13.5

### Band Edge Signal Field Strength - Direct measurement of field strength

Frequency MHz	Level dB $\mu$ V/m	Pol V/H	15.209 / 15.247		Detector Pk/QP/Avg	Azimuth degrees	Height meters	Comments
			Limit	Margin				
2483.810	49.4	V	54.0	-4.6	VAVG	112	1.8	Note 4; RB 1MHz; VB 200Hz
2485.590	65.3	V	74.0	-8.7	PK	112	1.8	RB 1MHz; VB 3MHz
2484.290	48.6	H	54.0	-5.4	VAVG	141	1.3	Note 4; RB 1MHz; VB 200Hz
2484.500	63.3	H	74.0	-10.7	PK	141	1.3	RB 1MHz; VB 3MHz

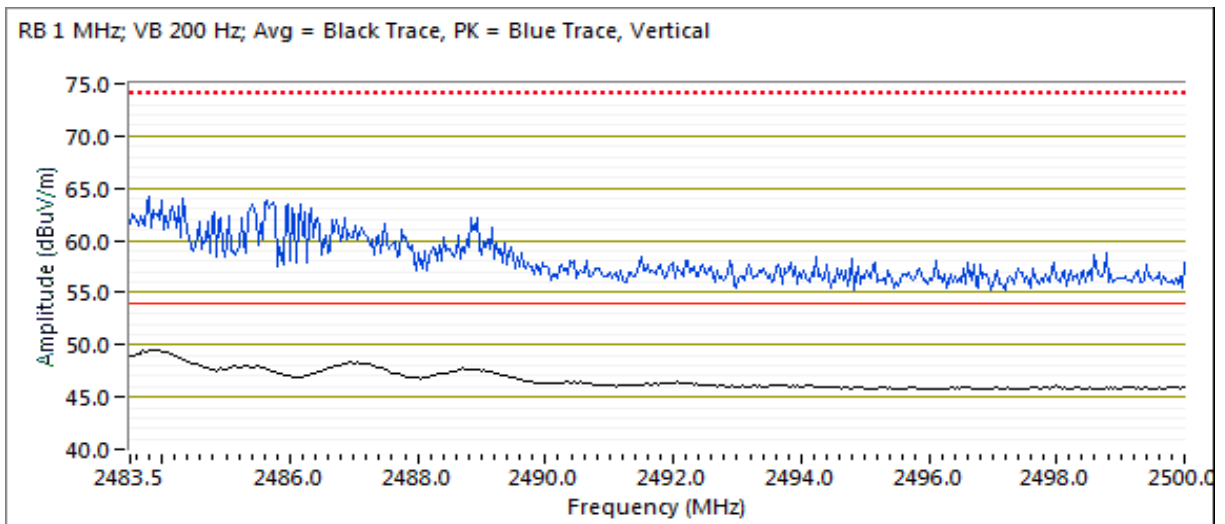



# EMC Test Data

Client: Arris	PR Number: PR101106
Model: NVG5XDBAX	T-Log Number: TL-101106-RANA
	Project Manager: Deepa Shetty
Contact: Mark Rieger	Project Engineer: David Bare
Standard: FCC Part 15, RSS-247	Class: N/A

## RSS-247 and FCC 15.247 (DTS) Radiated Spurious Emissions

### Test Specific Details

Objective: The objective of this test session is to perform final qualification testing of the EUT with respect to the specification listed above.

### General Test Configuration

The EUT and all local support equipment were located on the turntable for radiated spurious emissions testing. For radiated emissions testing the measurement antenna was located 3 meters from the EUT, unless otherwise noted.

**Ambient Conditions:** Temperature: 21.8 °C  
Rel. Humidity: 43 %

### Summary of Results - Device Operating in the 2400-2483.5 MHz Band

Run #	Mode	Channel	Power Setting	Test Performed	Limit	Result / Margin
3	ax20	1 & 36	24 / 24	Restricted Band Edge (2390 MHz)	FCC Part 15.209 / 15.247( c)	50.1 dBµV/m @ 2390.0 MHz (-3.9 dB)
	ax20	11 & 165	24 / 24	Restricted Band Edge (2483.5 MHz)	FCC Part 15.209 / 15.247( c)	50.1 dBµV/m @ 2484.1 MHz (-3.9 dB)
4	ax40	3 & 38	24 / 24	Restricted Band Edge (2390 MHz)	FCC Part 15.209 / 15.247( c)	53.5 dBµV/m @ 2390.0 MHz (-0.5 dB)
	ax40	9 & 159	24 / 24	Restricted Band Edge (2483.5 MHz)	FCC Part 15.209 / 15.247( c)	52.5 dBµV/m @ 2484.8 MHz (-1.5 dB)

### Modifications Made During Testing

No modifications were made to the EUT during testing

### Deviations From The Standard

No deviations were made from the requirements of the standard.

### Sample Notes

Sample S/N: M11917QW000T



# EMC Test Data

Client:	Arris	PR Number:	PR101106
Model:	NVG5XDBAX	T-Log Number:	TL-101106-RANA
		Project Manager:	Deepa Shetty
Contact:	Mark Rieger	Project Engineer:	David Bare
Standard:	FCC Part 15, RSS-247	Class:	N/A

## Procedure Comments:

Measurements performed in accordance with ANSI C63.10

Peak measurements performed with: RBW=1MHz, VBW=3MHz, peak detector, max hold, auto sweep time

Unless otherwise stated/noted, emission has a duty cycle  $\geq 98\%$  and was measured using RBW=1MHz, VBW=10Hz, peak detector, linear voltage average, auto sweep time, max hold.

Mode	Data Rate	Duty Cycle (x)	Constant DC?	T (ms)	Pwr Cor Factor*	Lin Volt Cor Factor**	Min VBW for FS (Hz)
ax20	MCS 0	95.8%	Yes	1.47	0.2	0.4	682
ax40	MCS 0	91.9%	Yes	0.74	0.4	0.7	1351

## Measurement Specific Notes:

Note 1:	Emission in non-restricted band, but limit of 15.209 used.
Note 2:	Emission in non-restricted band, the limit was set 30dB below the level of the fundamental and measured in 100kHz.
Note 3:	Emission has a duty cycle $\geq 98\%$ , average measurement performed: RBW=1MHz, VBW=3MHz, RMS, Power averaging, auto sweep, trace average 100 traces
Note 4:	Emission has constant duty cycle $< 98\%$ , average measurement performed: RBW=1MHz, VBW $> 1/T$ but not less than 10Hz, peak detector, linear averaging, auto sweep, trace average 100 traces, measurement corrected by Linear voltage correction factor
Note 5:	Emission has constant duty cycle $< 98\%$ , average measurement performed: RBW=1MHz, VBW=3MHz, RMS, Power averaging, auto sweep, trace average 100 traces, measurement corrected by Pwr correction factor
Note 6:	Emission has non constant duty cycle $< 98\%$ , average measurement performed: RBW=1MHz, VBW $> 1/T$ , peak detector, linear voltage average, sweep time auto, max hold. Max hold for $50*(1/DC)$ traces
Note 7:	Emission has non constant duty cycle $< 98\%$ , average measurement performed: RBW=1MHz, VBW $> 1/T$ , RMS detector, sweep time auto, max hold. Max hold for $50*(1/DC)$ traces
Note 8:	Plots of the average and peak bandedge do not account for any duty cycle correction. Refer to the tabular results for final measurements.



# EMC Test Data

Client: Arris	PR Number: PR101106
Model: NVG5XDBAX	T-Log Number: TL-101106-RANA
Contact: Mark Rieger	Project Manager: Deepa Shetty
Standard: FCC Part 15, RSS-247	Project Engineer: David Bare
	Class: N/A

### Run #3: Radiated Bandedge Measurements

Date of Test: 12/20/2019 0:00  
 Test Engineer: Rafael Varelas  
 Test Location: FT Chamber #7

Config. Used: 1  
 Config Change: -  
 EUT Voltage: 120V/ 60Hz

Channel: 1 & 36                      Mode: ax20                      Pwr Setting: 24 (q96)  
 Tx Chain: All chains                Data Rate: MCS 0

### Band Edge Signal Field Strength - Direct measurement of field strength

Frequency	Level	Pol	15.209 / 15.247		Detector	Azimuth	Height	Comments
MHz	dB $\mu$ V/m	V/H	Limit	Margin	Pk/QP/Avg	degrees	meters	
2390.000	50.1	H	54.0	-3.9	Avg	123	1.6	Note 4:POS Vavg:100; RB 1 MHz; VB
2389.880	67.6	H	74.0	-6.4	PK	123	1.6	POS; RB 1 MHz; VB: 3 MHz
2390.000	47.2	V	54.0	-6.8	Avg	98	1.9	Note 4:POS Vavg:100; RB 1 MHz; VB
2389.890	62.7	V	74.0	-11.3	PK	98	1.9	POS; RB 1 MHz; VB: 3 MHz

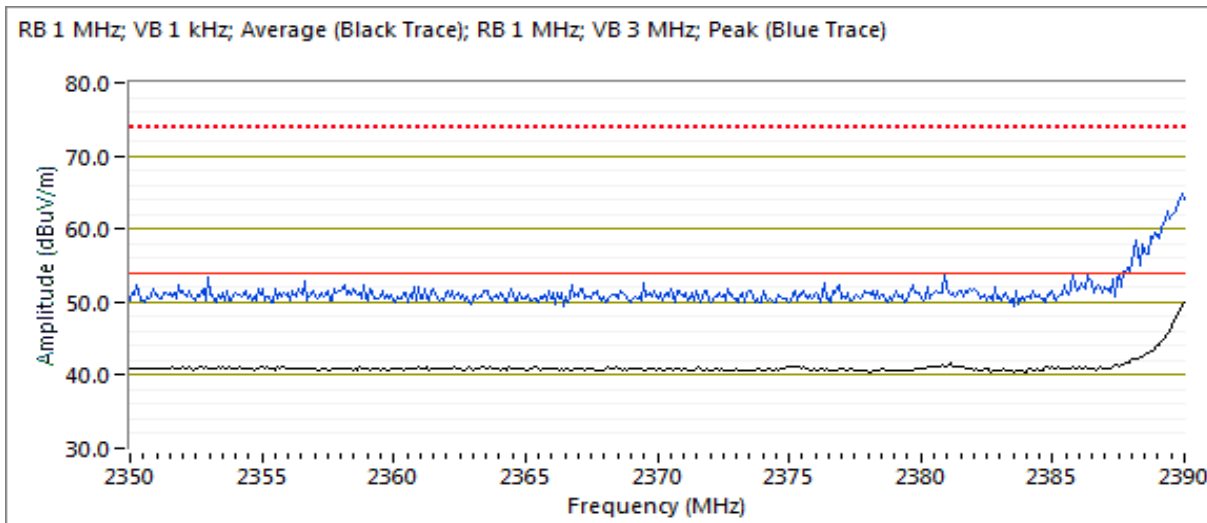



# EMC Test Data

Client: Arris	PR Number: PR101106
Model: NVG5XDBAX	T-Log Number: TL-101106-RANA
Contact: Mark Rieger	Project Manager: Deepa Shetty
Standard: FCC Part 15, RSS-247	Project Engineer: David Bare
	Class: N/A

Channel: 11 & 165      Mode: ax20      Pwr Setting: 24 (q96)  
 Tx Chain: All chains      Data Rate: MCS 0

### Band Edge Signal Field Strength - Direct measurement of field strength

Frequency MHz	Level dB $\mu$ V/m	Pol V/H	15.209 / 15.247		Detector Pk/QP/Avg	Azimuth degrees	Height meters	Comments
			Limit	Margin				
2484.090	50.1	V	54.0	-3.9	Avg	108	1.9	Note 4:POS Vavg:100; RB 1 MHz; VB
2483.740	66.4	V	74.0	-7.6	PK	108	1.9	POS; RB 1 MHz; VB: 3 MHz
2483.720	48.8	H	54.0	-5.2	Avg	299	1.3	Note 4:POS Vavg:100; RB 1 MHz; VB
2483.610	65.9	H	74.0	-8.1	PK	299	1.3	POS; RB 1 MHz; VB: 3 MHz

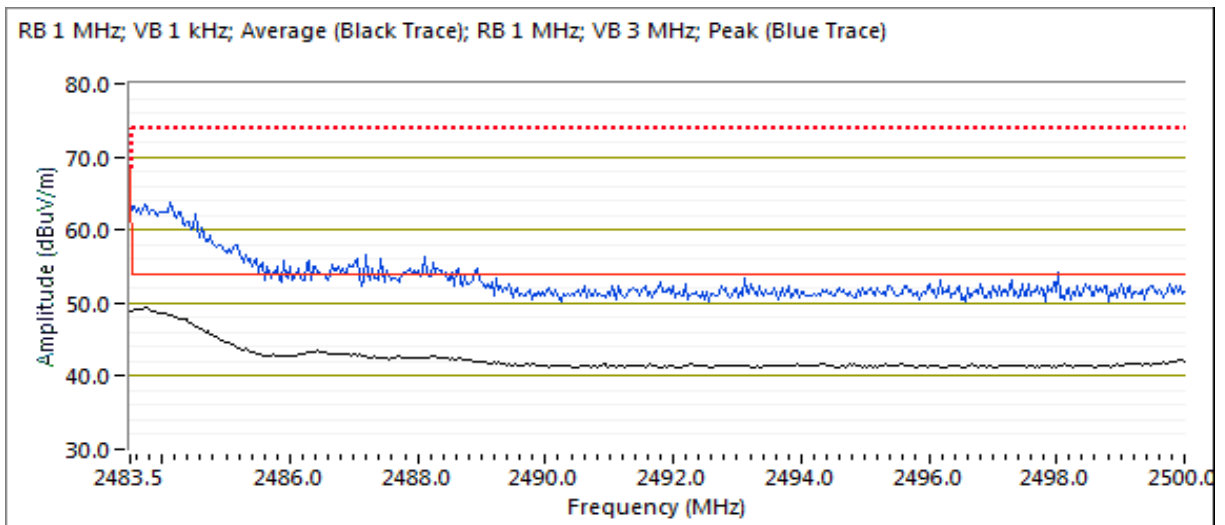



# EMC Test Data

Client: Arris	PR Number: PR101106
Model: NVG5XDBAX	T-Log Number: TL-101106-RANA
Contact: Mark Rieger	Project Manager: Deepa Shetty
Standard: FCC Part 15, RSS-247	Project Engineer: David Bare
	Class: N/A

### Run #4: Radiated Bandedge Measurements

Date of Test: 12/20/2019 0:00  
 Test Engineer: Rafael Varelas  
 Test Location: FT Chamber #7

Config. Used: 1  
 Config Change: -  
 EUT Voltage: 120V/ 60Hz

Channel: 3 & 38                      Mode: ax40                      Pwr Setting: 24 (q96)  
 Tx Chain: All chains                Data Rate: MCS 0

### Band Edge Signal Field Strength - Direct measurement of field strength

Frequency	Level	Pol	15.209 / 15.247		Detector	Azimuth	Height	Comments
MHz	dB $\mu$ V/m	V/H	Limit	Margin	Pk/QP/Avg	degrees	meters	
2390.000	53.5	H	54.0	-0.5	Avg	126	1.3	Note 4:POS Vavg:100; RB 1 MHz; VB
2388.860	66.4	H	74.0	-7.6	PK	126	1.3	POS; RB 1 MHz; VB: 3 MHz
2390.000	49.6	V	54.0	-4.4	Avg	165	1.7	Note 4:POS Vavg:100; RB 1 MHz; VB
2389.990	62.3	V	74.0	-11.7	PK	165	1.7	POS; RB 1 MHz; VB: 3 MHz

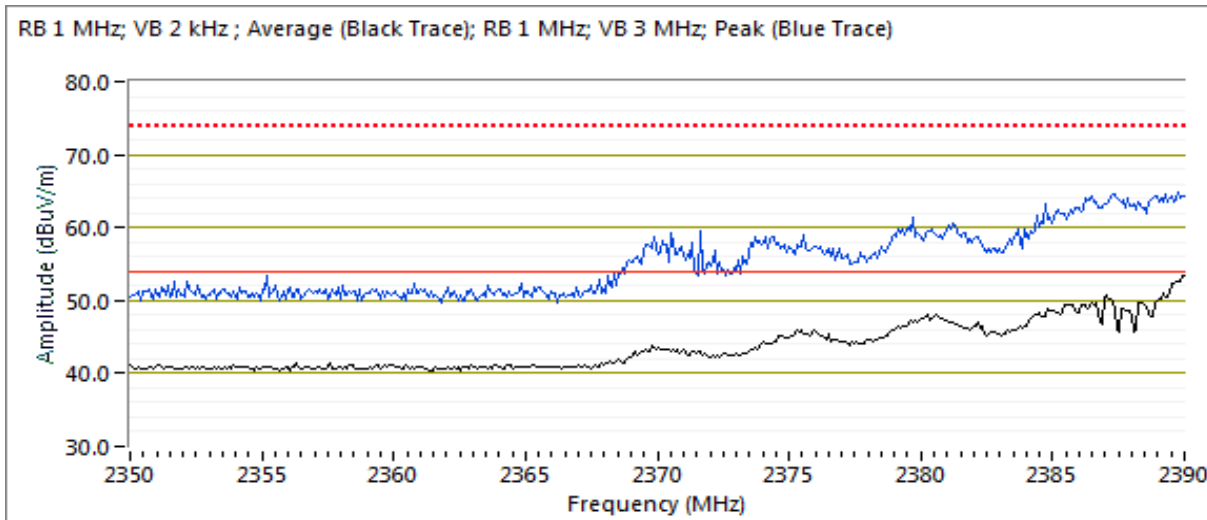



# EMC Test Data

Client: Arris	PR Number: PR101106
Model: NVG5XDBAX	T-Log Number: TL-101106-RANA
Contact: Mark Rieger	Project Manager: Deepa Shetty
Standard: FCC Part 15, RSS-247	Project Engineer: David Bare
	Class: N/A

Channel: 9 & 159      Mode: ax40      Pwr Setting: 24 (q96)  
 Tx Chain: All chains      Data Rate: MCS 0

### Band Edge Signal Field Strength - Direct measurement of field strength

Frequency MHz	Level dB $\mu$ V/m	Pol V/H	15.209 / 15.247		Detector Pk/QP/Avg	Azimuth degrees	Height meters	Comments
			Limit	Margin				
2484.780	52.5	V	54.0	-1.5	Avg	106	1.9	Note 4:POS Vavg:100; RB 1 MHz; VB
2484.920	67.5	V	74.0	-6.5	PK	106	1.9	POS; RB 1 MHz; VB: 3 MHz
2485.450	48.4	H	54.0	-5.6	Avg	156	1.1	POS Vavg:100; RB 1 MHz; VB: 2 kHz
2485.830	63.1	H	74.0	-10.9	PK	156	1.1	POS; RB 1 MHz; VB: 3 MHz

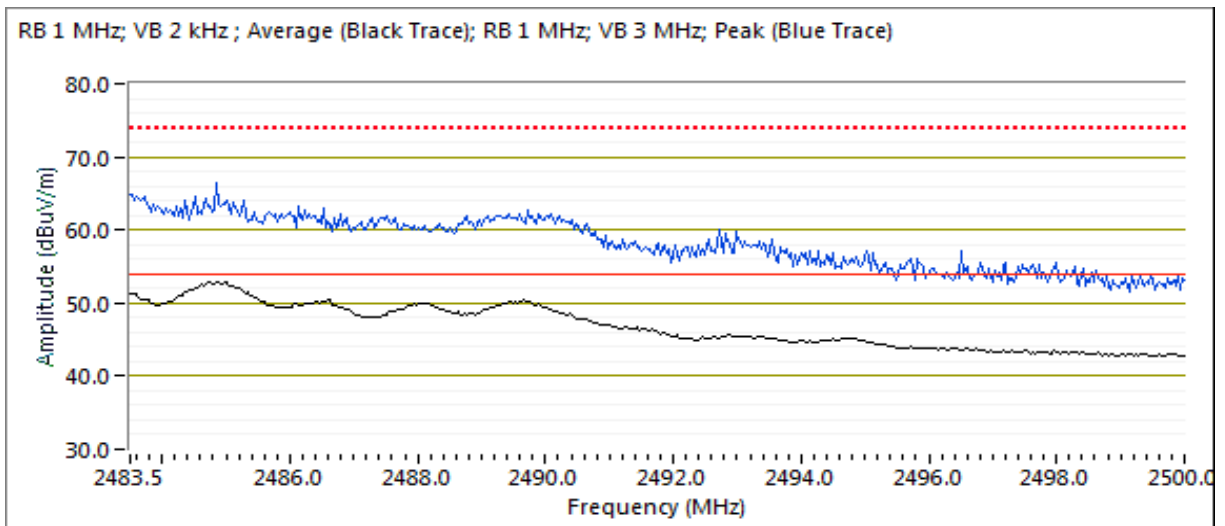





## EMC Test Data

Client:	Arris	PR Number:	PR101106
Model:	NVG5XDBAX	T-Log Number:	TL-101106-RANA
Contact:	Mark Rieger	Project Manager:	Deepa Shetty
Standard:	FCC Part 15, RSS-247	Project Engineer:	David Bare
		Class:	N/A

### RSS-247 and FCC 15.407 (UNII) Radiated Spurious Emissions

#### Test Specific Details

Objective: The objective of this test session is to perform final qualification testing of the EUT with respect to the specification listed above.

#### General Test Configuration

The EUT and all local support equipment were located on the turntable for radiated spurious emissions testing.  
For radiated emissions testing the measurement antenna was located 3 meters from the EUT, unless otherwise noted.

**Ambient Conditions:**

Temperature:	22-25 °C
Rel. Humidity:	39-43 %

#### Modifications Made During Testing

No modifications were made to the EUT during testing

#### Deviations From The Standard

No deviations were made from the requirements of the standard.



# EMC Test Data

Client: Arris	PR Number: PR101106
Model: NVG5XDBAX	T-Log Number: TL-101106-RANA
Contact: Mark Rieger	Project Manager: Deepa Shetty
Standard: FCC Part 15, RSS-247	Project Engineer: David Bare
	Class: N/A

## Summary of Results

Run #	Mode	Channel	Power Setting	Measured Power	Test Performed	Limit	Result / Margin
Scans on "center" channel in all four OFDM modes to determine the worst case mode.							
1	g / a	6 & 40	26 / 26	26 / 26	Radiated Emissions, 1 - 40 GHz	FCC 15.209 / 15 E	52.6 dBµV/m @ 5149.9 MHz (-1.4 dB)
	ac20	6 & 40	24 / 24	24 / 23	Radiated Emissions, 1 - 40 GHz	FCC 15.209 / 15 E	53.8 dBµV/m @ 5148.8 MHz (-0.2 dB)
	ac40	6 & 46	24 / 24	24 / 24	Radiated Emissions, 1 - 40 GHz	FCC 15.209 / 15 E	52.8 dBµV/m @ 5353.7 MHz (-1.2 dB)
	b/ac80	6 & 42	24 / 24	22.25 / 23	Radiated Emissions, 1 - 40 GHz	FCC 15.209 / 15 E	53.8 dBµV/m @ 5350.1 MHz (-0.2 dB)
Measurements on low and high channels in worst-case OFDM mode.							
2	ac20	1 & 36	24 / 22	24 / 22	Radiated Emissions, 1 - 40 GHz	FCC 15.209 / 15 E	53.2 dBµV/m @ 4813.8 MHz (-0.8 dB)
	ac20	11 & 48	24 / 24	23 / 24	Radiated Emissions, 1 - 40 GHz	FCC 15.209 / 15 E	53.4 dBµV/m @ 4924.0 MHz (-0.6 dB)
Scans on "center" channel in all four OFDM modes to determine the worst case mode.							
3	g / a	6 & 157	26 / 26	26 / 26	Radiated Emissions, 1 - 40 GHz	FCC 15.209 / 15 E	65.2 dBµV/m @ 17350.3 MHz (-3.1 dB)
	ac20	6 & 157	24 / 24	24 / 24	Radiated Emissions, 1 - 40 GHz	FCC 15.209 / 15 E	50.7 dBµV/m @ 4878.7 MHz (-3.3 dB)
	ac40	6 & 159	24 / 24	24 / 24	Radiated Emissions, 1 - 40 GHz	FCC 15.209 / 15 E	50.6 dBµV/m @ 2483.6 MHz (-3.4 dB)
	b / ac80	6 & 155	24 / 24	22 / 24	Radiated Emissions, 1 - 40 GHz	FCC 15.209 / 15 E	68.2 dBµV/m @ 6003.6 MHz (-0.1 dB)
Measurements on low and high channels in worst-case OFDM mode.							
4	b / ac20	1 & 149	26 / 24	18.25 / 24	Radiated Emissions, 1 - 40 GHz	FCC 15.209 / 15 E	53.5 dBµV/m @ 4824.1 MHz (-0.5 dB)
	b / ac20	11 & 165	26 / 24	16.25 / 24	Radiated Emissions, 1 - 40 GHz	FCC 15.209 / 15 E	53.4 dBµV/m @ 4924.0 MHz (-0.6 dB)
Measurements on low and high channels in g mode.							
5	g / ac40	1 & 38	26 / 24	26 / 24	Radiated Emissions, 1 - 40 GHz	FCC 15.209 / 15 E	52.7 dBµV/m @ 4815.5 MHz (-1.3 dB)
	g / a	11 & 48	26 / 26	26 / 25	Radiated Emissions, 1 - 40 GHz	FCC 15.209 / 15 E	53.8 dBµV/m @ 4924.0 MHz (-0.2 dB)

Scan 1-3.5GHz using 10+6dB pads and 5GHz notch filter (RB 100kHz VB 100kHz)  
 Scan 3.5-6GHz using 10dB pad and 2.4GHz notch filter (RB 100kHz VB 100kHz)  
 Scan 6-12GHz using 5GHz and 2.4GHz notch filters (RB 300kHz VB 100kHz)



# EMC Test Data

Client:	Arris	PR Number:	PR101106
Model:	NVG5XDBAX	T-Log Number:	TL-101106-RANA
		Project Manager:	Deepa Shetty
Contact:	Mark Rieger	Project Engineer:	David Bare
Standard:	FCC Part 15, RSS-247	Class:	N/A

## Procedure Comments:

Measurements performed in accordance with FCC KDB 789033

Peak measurements performed with: RBW=1MHz, VBW=3MHz, peak detector, max hold, auto sweep time

Unless otherwise stated/noted, emission has duty cycle  $\geq 98\%$  and was measured using RBW=1MHz, VBW=10Hz, peak detector, linear average mode, auto sweep time, max hold 50 traces. (method VB of KDB 789033)

Mode	Data Rate	Duty Cycle (x)	Constant DC?	T (ms)	Pwr Cor Factor*	Lin Volt Cor Factor**	Min VBW for FS (Hz)	Packet	pkt duty
11b	1	99.2%	Yes	12.422	0.0	0.0	10	1285	-1
11a/g	6	99.0%	Yes	5.06	0.0	0.0	10	7974	-1
ac20	6.5	97.6%	Yes	5.271	0.1	0.2	190	4324	-1
ac40	13.5	97.3%	Yes	5.24	0.1	0.2	191	8811	-1
ac80	29.3	96.0%	Yes	1.432	0.2	0.4	698	5159	-1
ac160	58.5	95.6%	Yes	1.439	0.2	0.4	695	10443	-1

## Sample Notes

Sample S/N: M11917QW000T

Driver:

## Measurement Specific Notes:

Note 1:	For emissions outside of the restricted bands the limit is -27dBm/MHz eirp (68.3dBuV/m). The measurement method required is a peak measurement (RB=1MHz, VB $\geq$ 3MHz, peak detector). Per KDB 789033 2) c) (i), compliance can be demonstrated by meeting the average and peak limits of 15.209, as an alternative.
Note 2:	Emission has a duty cycle $\geq 98\%$ , average measurement performed: RBW=1MHz, VBW=3MHz, RMS, Power averaging, auto sweep, trace average 100 traces (method AD of KDB 789033)
Note 3:	Emission has constant duty cycle $< 98\%$ , average measurement performed: RBW=1MHz, VBW $>$ 1/T but not less than 10Hz, peak detector, linear averaging, auto sweep,max hold 50*1/DC traces (method VB of KDB 789033)
Note 4:	Emission has a duty cycle $< 98\%$ , average measurement performed: RBW=1MHz, VBW=3MHz, RMS, Power averaging, auto sweep, trace average 100*1/DC traces, measurement corrected by Pwr correction factor (method AD of KDB 789033)
Note 5:	For SISO measurement, evaluation of each chain showed that chain 4 has the highest power measurement. All SISO test measurement were performed with chain 4 active.





# EMC Test Data

Client: Arris	PR Number: PR101106
Model: NVG5XDBAX	T-Log Number: TL-101106-RANA
Contact: Mark Rieger	Project Manager: Deepa Shetty
Standard: FCC Part 15, RSS-247	Project Engineer: David Bare
	Class: N/A

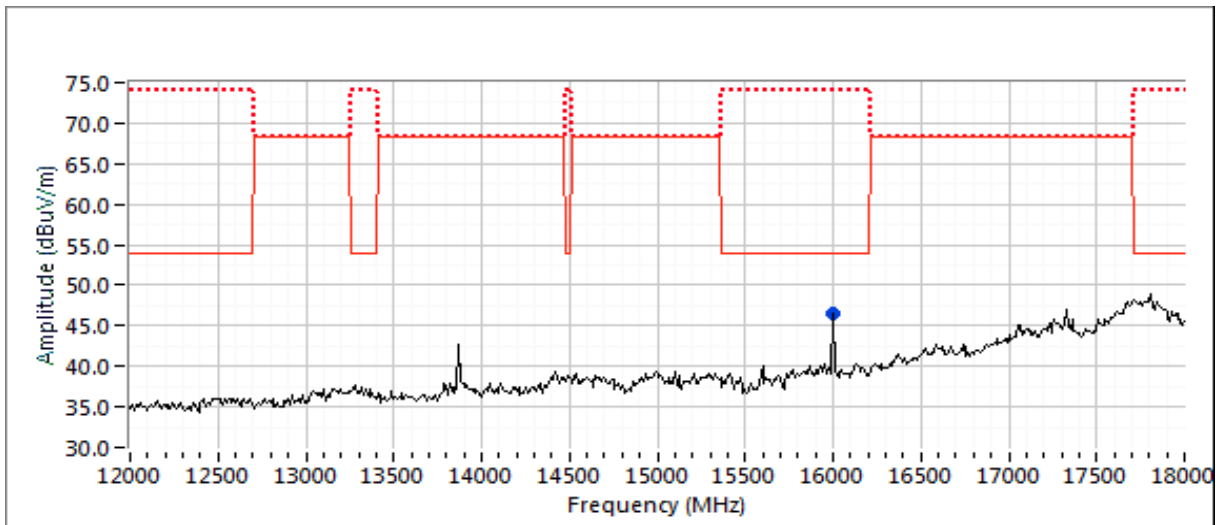
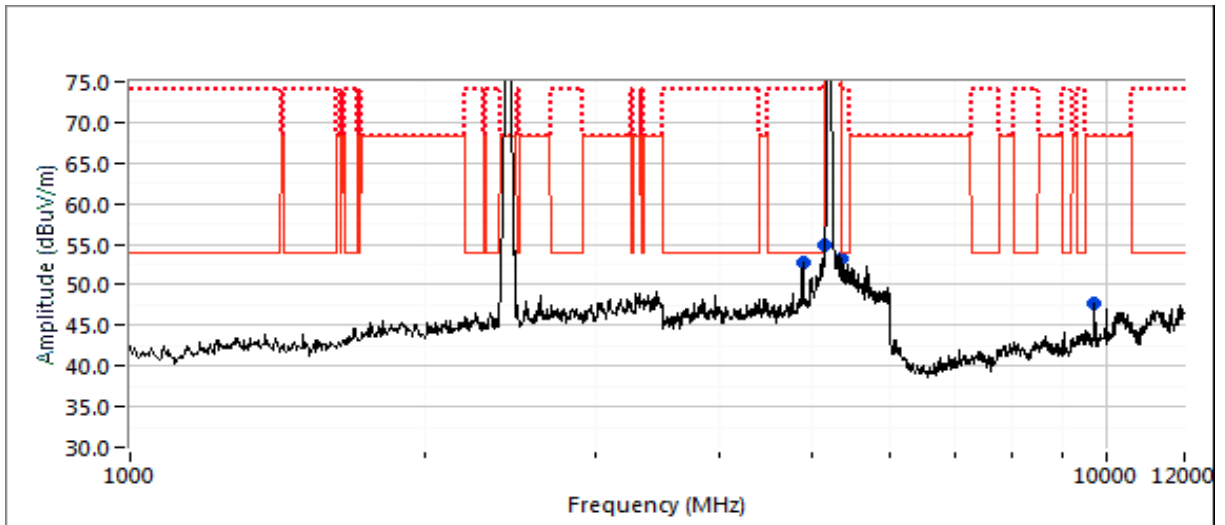



# EMC Test Data

Client: Arris	PR Number: PR101106
Model: NVG5XDBAX	T-Log Number: TL-101106-RANA
Contact: Mark Rieger	Project Manager: Deepa Shetty
Standard: FCC Part 15, RSS-247	Project Engineer: David Bare
	Class: N/A

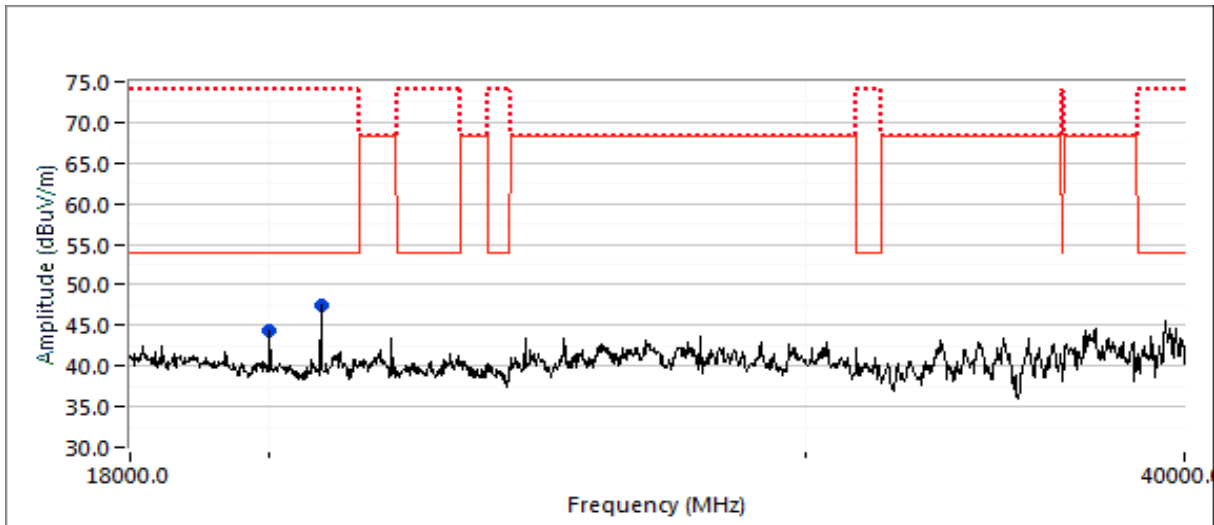





# EMC Test Data

Client: Arris	PR Number: PR101106
Model: NVG5XDBAX	T-Log Number: TL-101106-RANA
Contact: Mark Rieger	Project Manager: Deepa Shetty
Standard: FCC Part 15, RSS-247	Project Engineer: David Bare
	Class: N/A

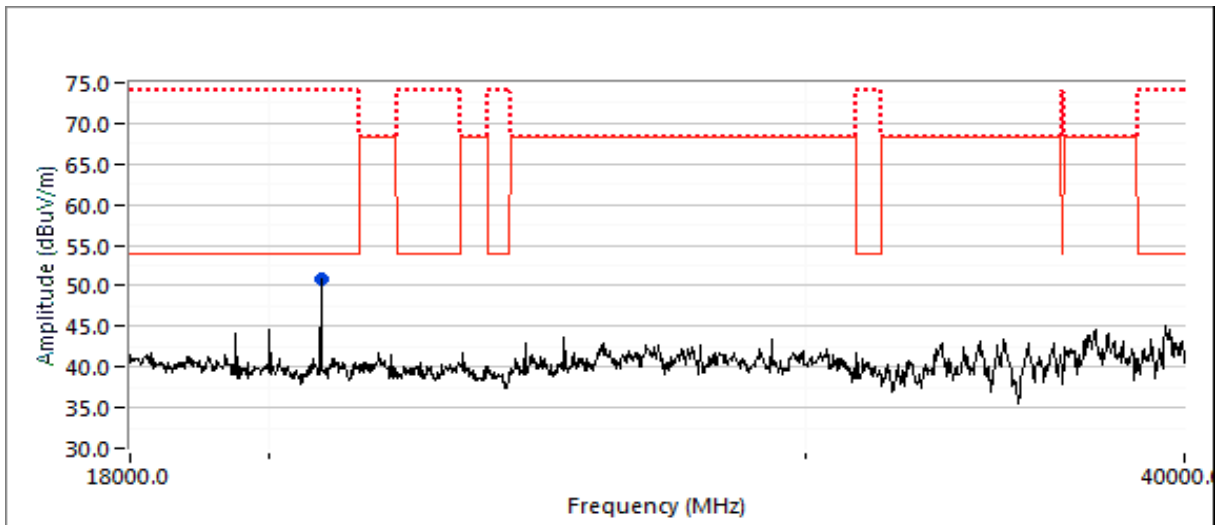
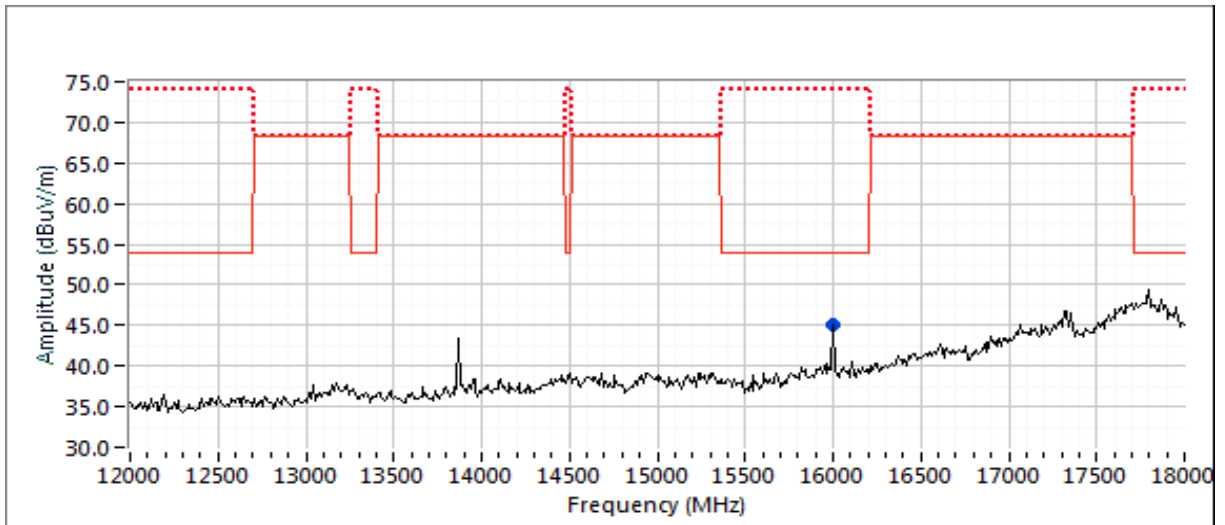







# EMC Test Data

Client: Arris	PR Number: PR101106
Model: NVG5XDBAX	T-Log Number: TL-101106-RANA
Contact: Mark Rieger	Project Manager: Deepa Shetty
Standard: FCC Part 15, RSS-247	Project Engineer: David Bare
	Class: N/A

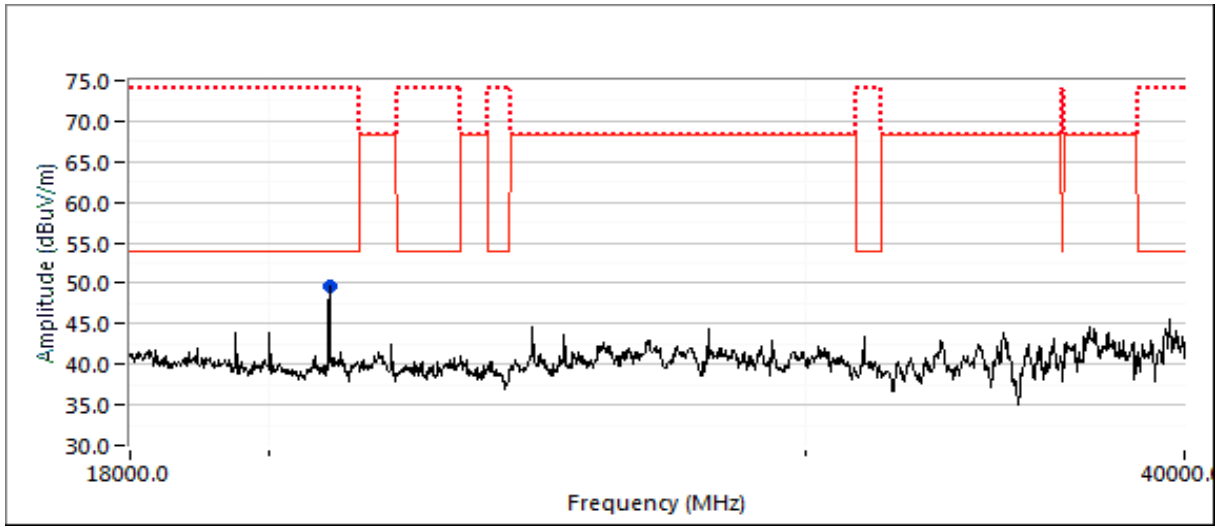
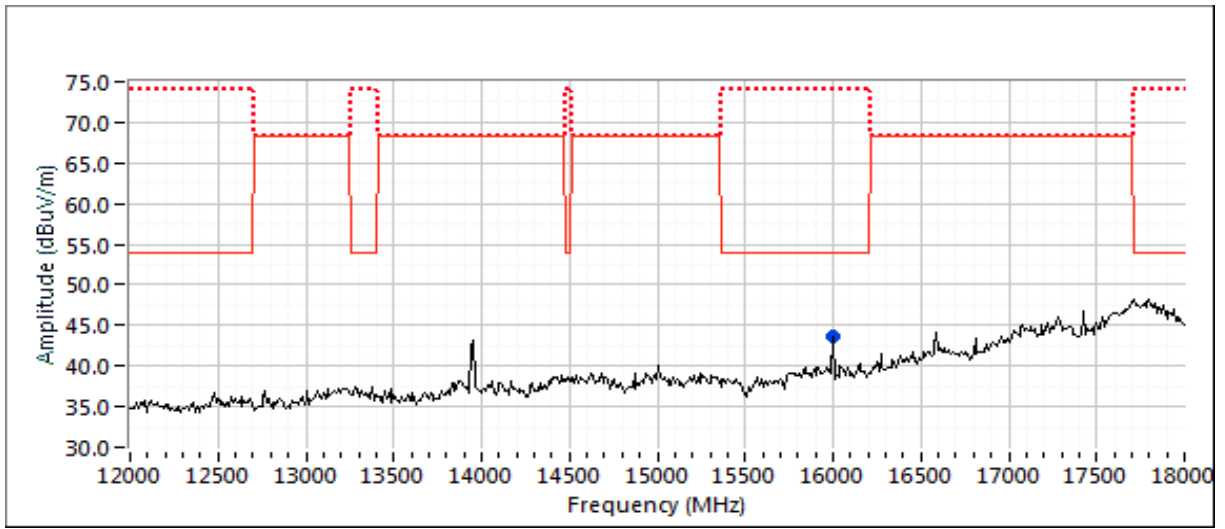





# EMC Test Data

Client: Arris	PR Number: PR101106
Model: NVG5XDBAX	T-Log Number: TL-101106-RANA
Contact: Mark Rieger	Project Manager: Deepa Shetty
Standard: FCC Part 15, RSS-247	Project Engineer: David Bare
	Class: N/A

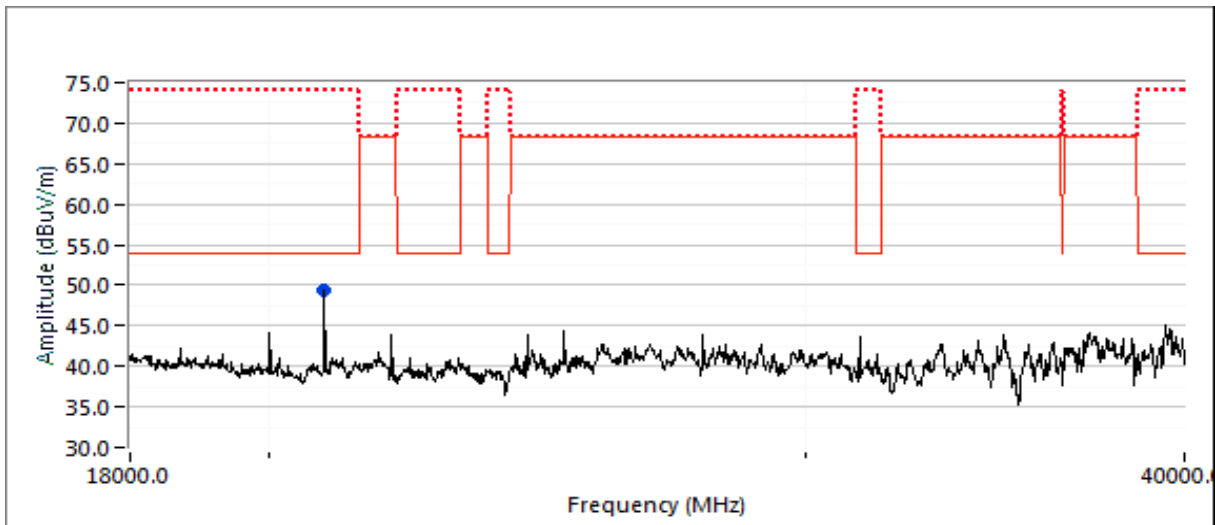
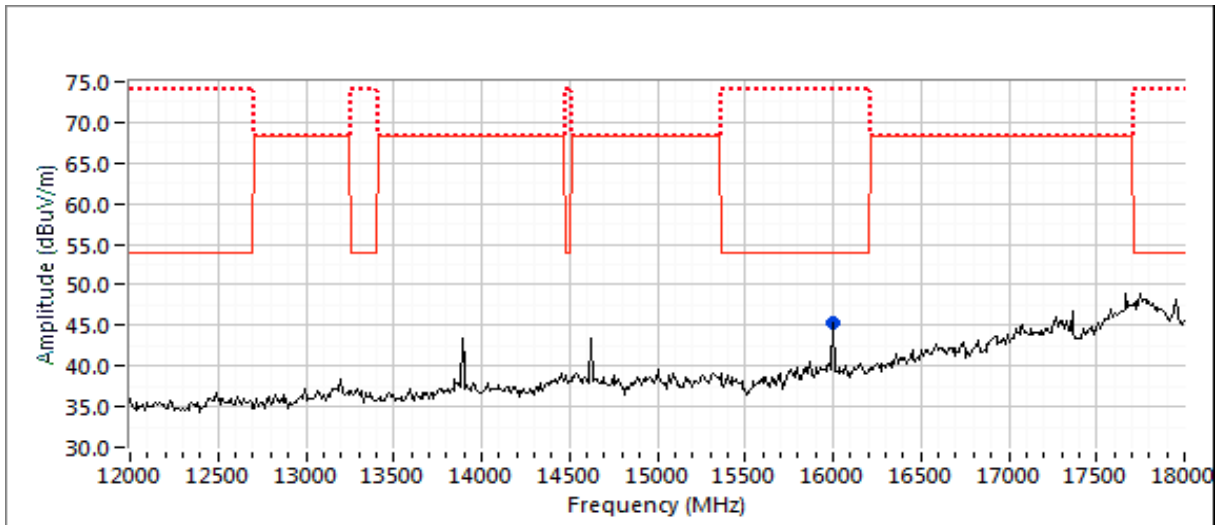



# EMC Test Data

Client: Arris	PR Number: PR101106
Model: NVG5XDBAX	T-Log Number: TL-101106-RANA
Contact: Mark Rieger	Project Manager: Deepa Shetty
Standard: FCC Part 15, RSS-247	Project Engineer: David Bare
	Class: N/A

Run #2: Radiated Spurious Emissions, 1,000 - 40000 MHz. Operating Mode: Worse case from Run #1

Date of Test: 07/16/19  
 Test Engineer: M. Birgani  
 Test Location: Chamber #5  
 Config. Used: 1  
 Config Change: -  
 EUT Voltage: 120V/ 60Hz

Run #2a: Low Channel

Channel: 1 & 36  
 Tx Chain: 4TX  
 Mode: ac20  
 Data Rate: 6.5 Mbps  
 Pwr Setting: 24 (q96) & 22 (q88)

Frequency MHz	Level dB $\mu$ V/m	Pol V/H	15.209 / 15E		Detector Pk/QP/AVG	Azimuth degrees	Height meters	Comments
			Limit	Margin				
4813.810	53.2	V	54.0	-0.8	AVG	331	1.6	Note 3; RB 1 MHz;VB 300 Hz
4813.640	68.3	V	74.0	-5.7	PK	331	1.6	RB 1 MHz;VB 3 MHz
9709.620	54.9	H	68.3	-13.4	PK	275	1.5	RB 1 MHz;VB 3 MHz
2874.880	42.3	H	54.0	-11.7	AVG	206	1.0	RB 1 MHz;VB 10 Hz
2874.980	54.4	H	74.0	-19.6	PK	206	1.0	RB 1 MHz;VB 3 MHz
16000.230	44.7	H	54.0	-9.3	AVG	265	1.5	Note 3; RB 1 MHz;VB 300 Hz
16000.000	52.7	H	74.0	-21.3	PK	265	1.5	RB 1 MHz;VB 3 MHz
20719.890	50.0	H	54.0	-4.0	AVG	161	1.3	RB 1 MHz;VB 300 Hz;Peak
20720.030	54.2	H	74.0	-19.8	PK	161	1.3	RB 1 MHz;VB 3 MHz;Peak

- Note 1: For emissions in restricted bands, the limit of 15.209 was used which requires average and peak measurements.
- Note 2: For emissions outside of the restricted bands the limit is -27dBm/MHz eirp (68.3dBuV/m). The measurement method required is a peak measurement (RB=1MHz, VB $\geq$ 3MHz, peak detector).

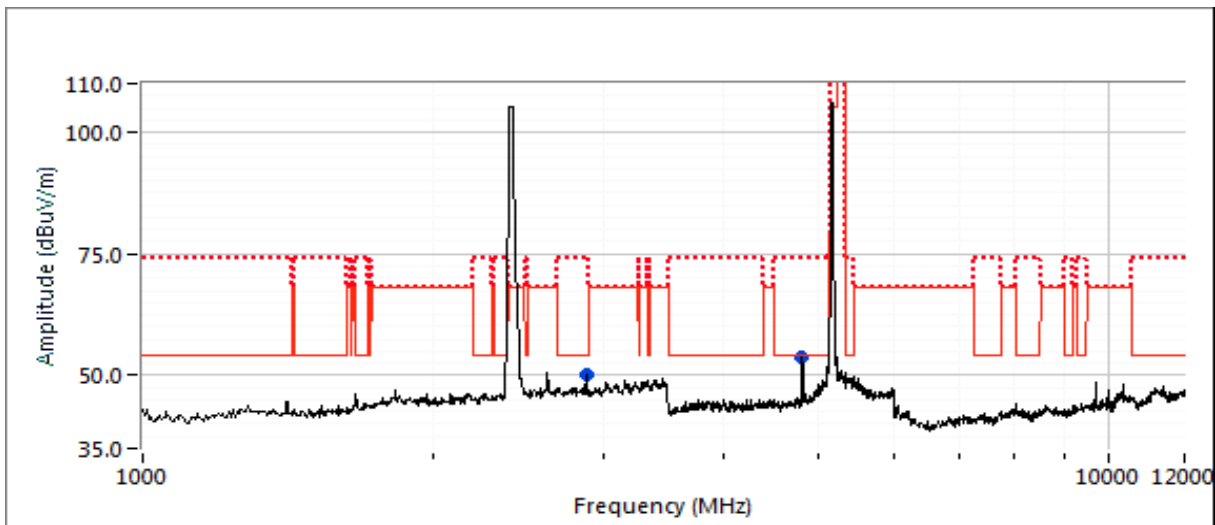



# EMC Test Data

Client:	Arris	PR Number:	PR101106
Model:	NVG5XDBAX	T-Log Number:	TL-101106-RANA
Contact:	Mark Rieger	Project Manager:	Deepa Shetty
Standard:	FCC Part 15, RSS-247	Project Engineer:	David Bare
		Class:	N/A

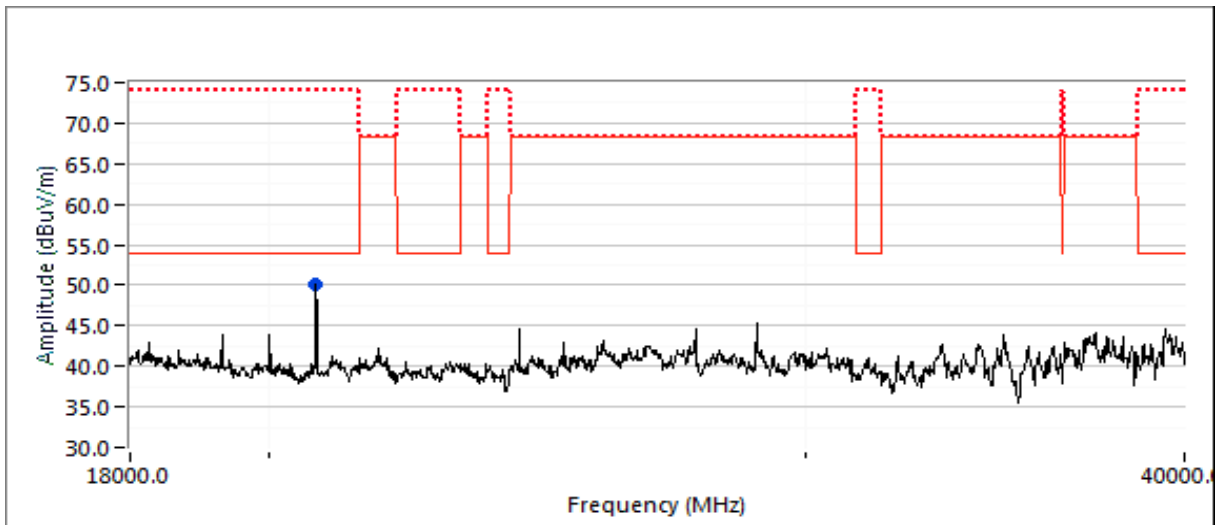
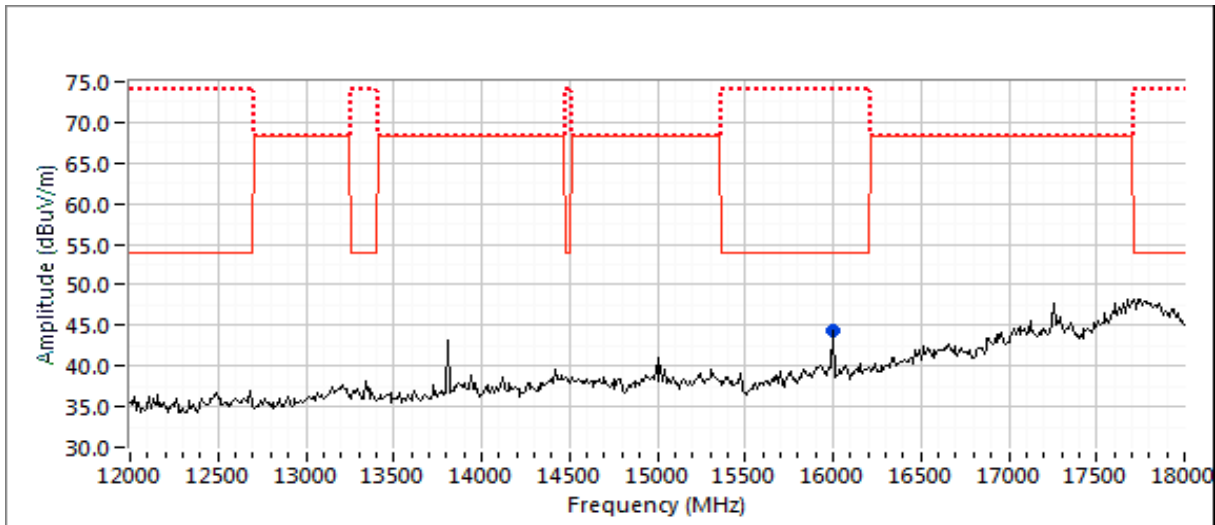





# EMC Test Data

Client: Arris	PR Number: PR101106
Model: NVG5XDBAX	T-Log Number: TL-101106-RANA
Contact: Mark Rieger	Project Manager: Deepa Shetty
Standard: FCC Part 15, RSS-247	Project Engineer: David Bare
	Class: N/A

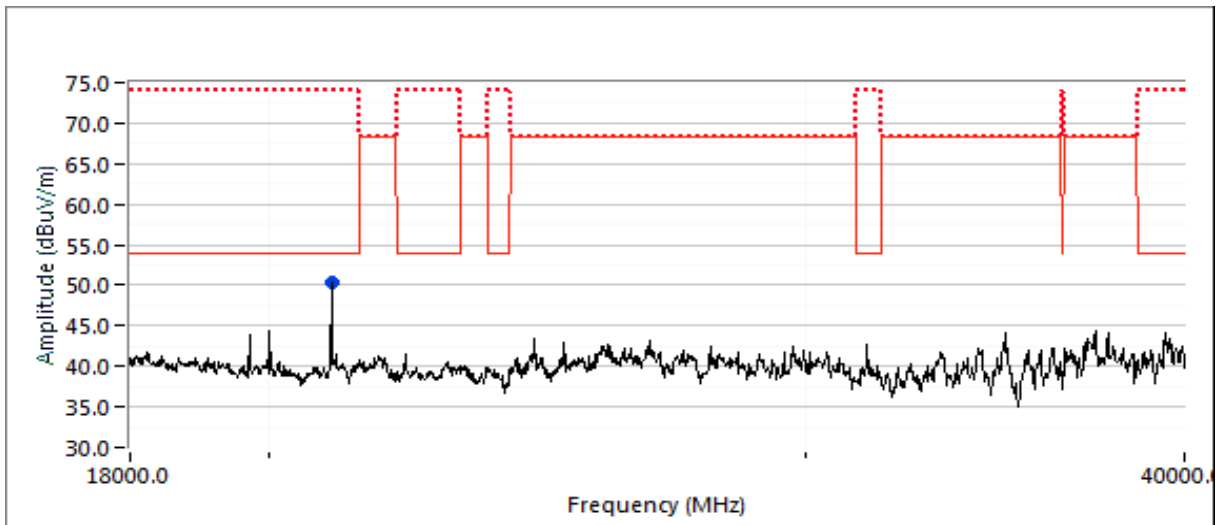
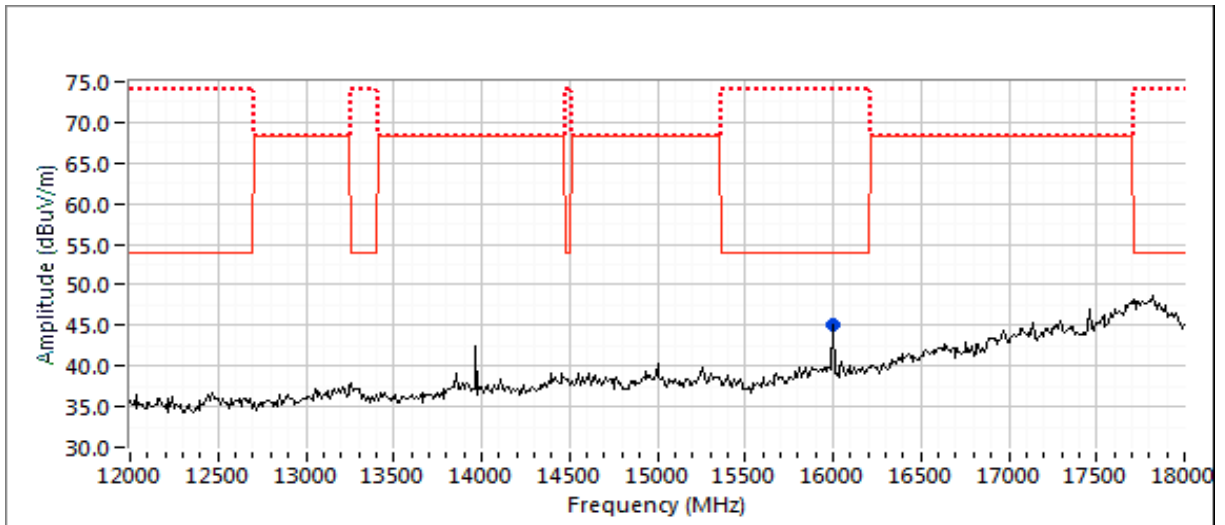





# EMC Test Data

Client: Arris	PR Number: PR101106
Model: NVG5XDBAX	T-Log Number: TL-101106-RANA
	Project Manager: Deepa Shetty
Contact: Mark Rieger	Project Engineer: David Bare
Standard: FCC Part 15, RSS-247	Class: N/A

**Run #3: Radiated Spurious Emissions, 1,000 - 40,000 MHz. Operation in the 5725-5850 MHz Band**

Date of Test: 7/16 & 7/17/2019      Config. Used: 1  
 Test Engineer: M. Birgani / R. Varelas      Config Change: -  
 Test Location: Chamber #5      EUT Voltage: 120V/ 60Hz

**Run #3a: Center Channel**

Channel: 6 & 157      Mode: g/a      Pwr Setting: 26 (q104) & 26 (q104)  
 Tx Chain: 1TX      Data Rate: 6.0 Mbps

Frequency MHz	Level dB $\mu$ V/m	Pol V/H	15.209 / 15E		Detector Pk/QP/AVG	Azimuth degrees	Height meters	Comments
			Limit	Margin				
17350.330	65.2	H	68.3	-3.1	PK	157	1.0	RB 1 MHz;VB 3 MHz;Peak
4880.870	45.3	V	54.0	-8.7	AVG	325	2.0	RB 1 MHz;VB 10 Hz
4883.670	60.8	V	74.0	-13.2	PK	325	2.0	RB 1 MHz;VB 3 MHz
9710.000	54.7	H	68.3	-13.6	PK	294	1.5	RB 1 MHz;VB 3 MHz
15426.640	46.7	H	54.0	-7.3	AVG	149	1.0	RB 1 MHz;VB 10 Hz;Peak
15426.220	59.0	H	74.0	-15.0	PK	149	1.0	RB 1 MHz;VB 3 MHz;Peak
16000.240	47.8	H	54.0	-6.2	AVG	300	1.0	RB 1 MHz;VB 10 Hz;Peak
15999.690	59.4	H	74.0	-14.6	PK	300	1.0	RB 1 MHz;VB 3 MHz;Peak
19283.290	48.6	H	54.0	-5.4	AVG	138	1.5	RB 1 MHz;VB 300 Hz;Peak
19283.180	54.1	H	74.0	-19.9	PK	138	1.5	RB 1 MHz;VB 3 MHz;Peak
23138.790	59.4	V	68.3	-8.9	PK	123	1.6	RB 1 MHz;VB 3 MHz;Peak
28924.740	58.7	H	68.3	-9.6	PK	139	1.9	RB 1 MHz;VB 3 MHz;Peak

Note 1: For emissions in restricted bands, the limit of 15.209 was used which requires average and peak measurements.  
 Note 2: For emissions outside of the restricted bands the limit is -27dBm/MHz eirp (68.3dBuV/m). The measurement method required is a peak measurement (RB=1MHz, VB $\geq$ 3MHz, peak detector).



# EMC Test Data

Client: Arris	PR Number: PR101106
Model: NVG5XDBAX	T-Log Number: TL-101106-RANA
Contact: Mark Rieger	Project Manager: Deepa Shetty
Standard: FCC Part 15, RSS-247	Project Engineer: David Bare
	Class: N/A

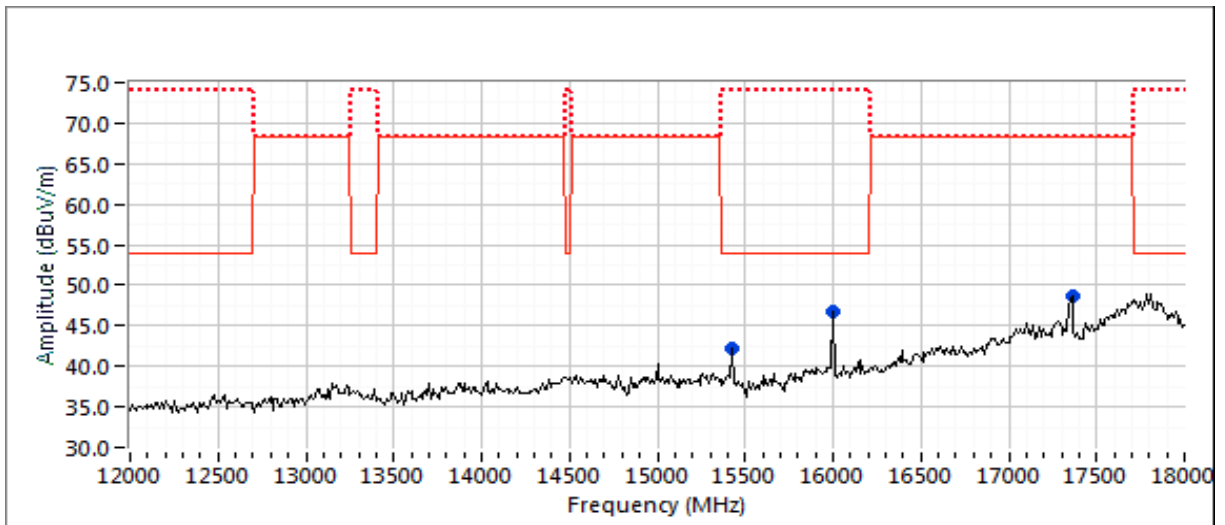
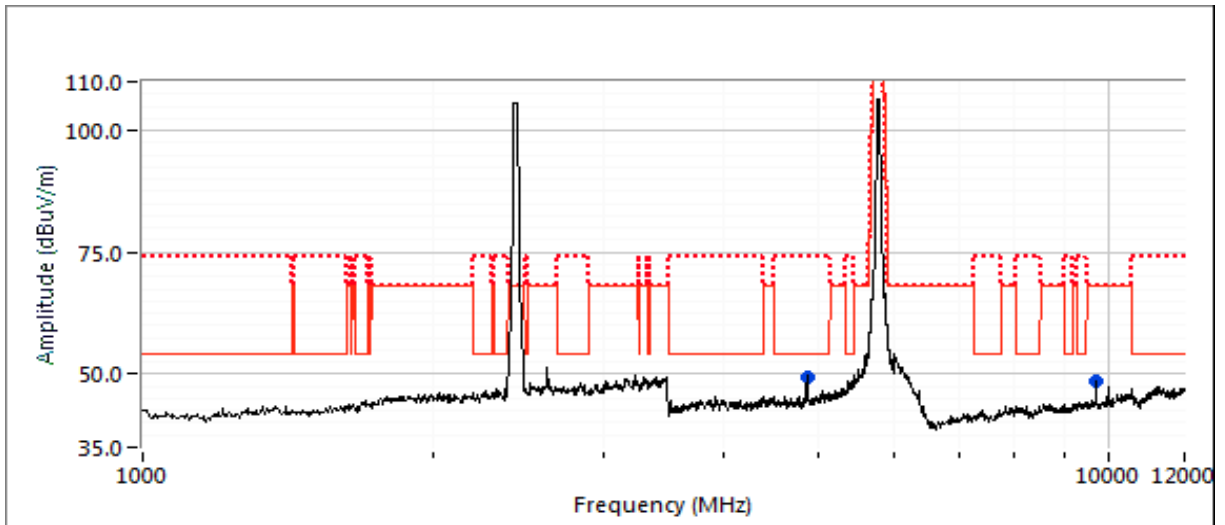



# EMC Test Data

Client: Arris	PR Number: PR101106
Model: NVG5XDBAX	T-Log Number: TL-101106-RANA
Contact: Mark Rieger	Project Manager: Deepa Shetty
Standard: FCC Part 15, RSS-247	Project Engineer: David Bare
	Class: N/A

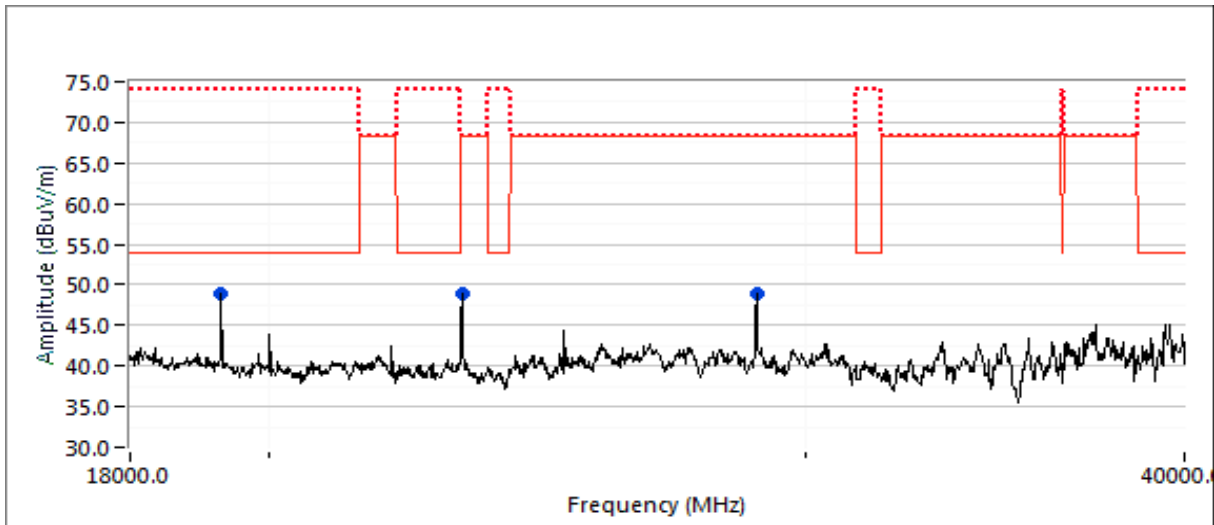





# EMC Test Data

Client: Arris	PR Number: PR101106
Model: NVG5XDBAX	T-Log Number: TL-101106-RANA
Contact: Mark Rieger	Project Manager: Deepa Shetty
Standard: FCC Part 15, RSS-247	Project Engineer: David Bare
	Class: N/A

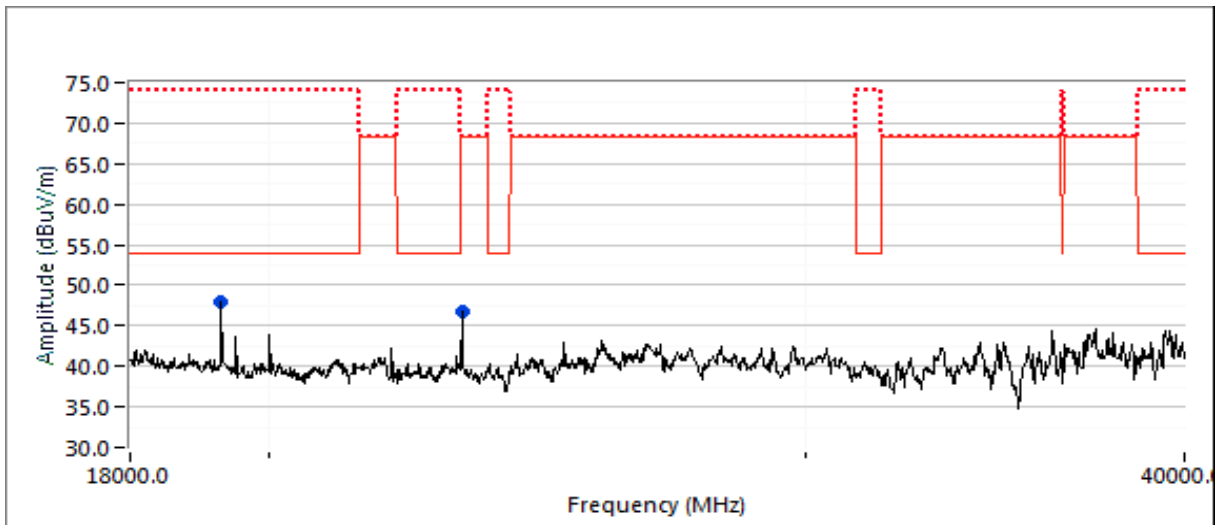
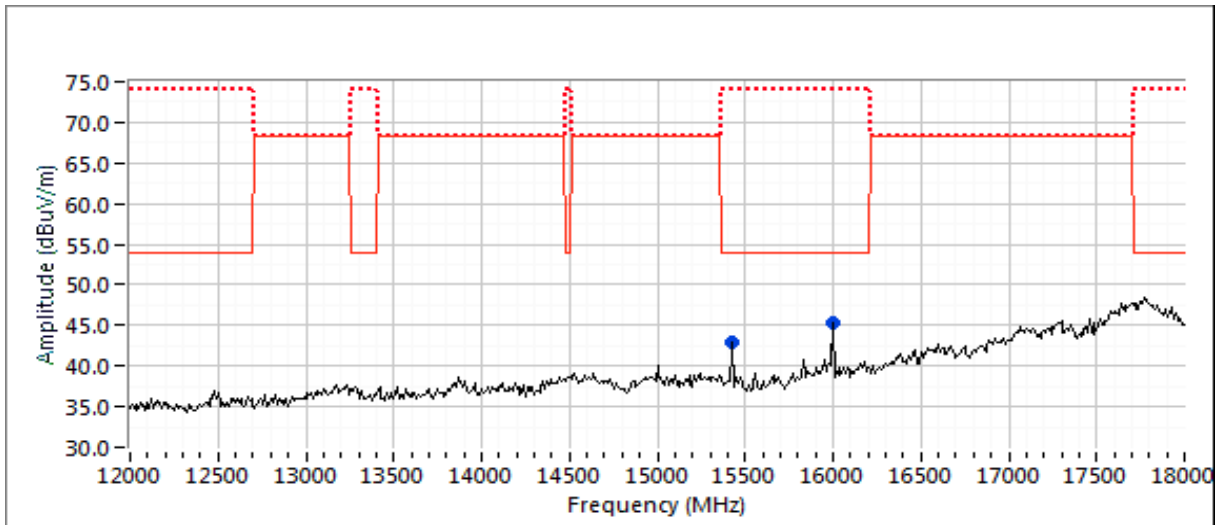

Client: Arris	PR Number: PR101106
Model: NVG5XDBAX	T-Log Number: TL-101106-RANA
Contact: Mark Rieger	Project Manager: Deepa Shetty
Standard: FCC Part 15, RSS-247	Project Engineer: David Bare
	Class: N/A

### Run #3c: Center Channel

Channel: 6 & 159                                      Mode: ac40                                      Pwr Setting: 24 (q96) & 24 (q96)  
 Tx Chain: 4Tx    Data Rate: 13.5 Mbps

Frequency MHz	Level dB $\mu$ V/m	Pol V/H	15.209 / 15E		Detector Pk/QP/AVG	Azimuth degrees	Height meters	Comments
			Limit	Margin				
2483.610	50.6	H	54.0	-3.4	AVG	106	1.6	RB 1 MHz;VB 10 Hz;Peak AVG 100
2484.340	68.7	H	74.0	-5.3	PK	106	1.6	RB 1 MHz;VB 3 MHz;Peak
2389.990	48.9	H	54.0	-5.1	AVG	99	1.5	RB 1 MHz;VB 10 Hz;Peak AVG 100
2389.740	68.2	H	74.0	-5.8	PK	99	1.5	RB 1 MHz;VB 3 MHz;Peak
4890.020	49.2	V	54.0	-4.8	AVG	153	1.7	RB 1 MHz;VB 300 Hz;Peak
4890.330	63.8	V	74.0	-10.2	PK	153	1.7	RB 1 MHz;VB 3 MHz;Peak
9706.000	55.8	H	68.3	-12.5	PK	281	1.3	RB 1 MHz;VB 3 MHz;Peak
9999.880	54.5	H	68.3	-13.8	PK	127	1.0	RB 1 MHz;VB 3 MHz;Peak
16000.180	47.7	H	54.0	-6.3	AVG	321	1.0	RB 1 MHz;VB 300 Hz;Peak
16000.250	59.3	H	74.0	-14.7	PK	321	1.0	RB 1 MHz;VB 3 MHz;Peak
15453.270	46.8	H	54.0	-7.2	AVG	151	1.0	RB 1 MHz;VB 300 Hz;Peak
15452.980	58.5	H	74.0	-15.5	PK	151	1.0	RB 1 MHz;VB 3 MHz;Peak
19316.600	47.9	H	54.0	-6.1	AVG	138	1.4	RB 1 MHz;VB 300 Hz;Peak
19316.540	53.3	H	74.0	-20.7	PK	138	1.4	RB 1 MHz;VB 3 MHz;Peak
23179.660	52.7	H	68.3	-15.6	PK	156	2.0	RB 1 MHz;VB 3 MHz;Peak

- Note 1: For emissions in restricted bands, the limit of 15.209 was used which requires average and peak measurements.
- Note 2: For emissions outside of the restricted bands the limit is -27dBm/MHz eirp (68.3dBuV/m). The measurement method required is a peak measurement (RB=1MHz, VB≥3MHz, peak detector).

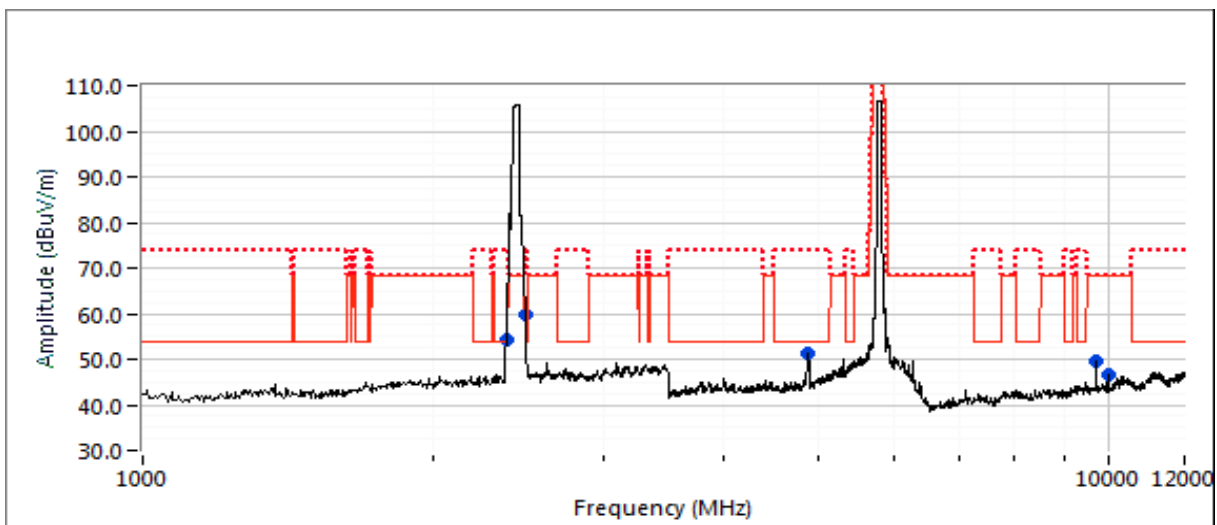



# EMC Test Data

Client: Arris	PR Number: PR101106
Model: NVG5XDBAX	T-Log Number: TL-101106-RANA
Contact: Mark Rieger	Project Manager: Deepa Shetty
Standard: FCC Part 15, RSS-247	Project Engineer: David Bare
	Class: N/A

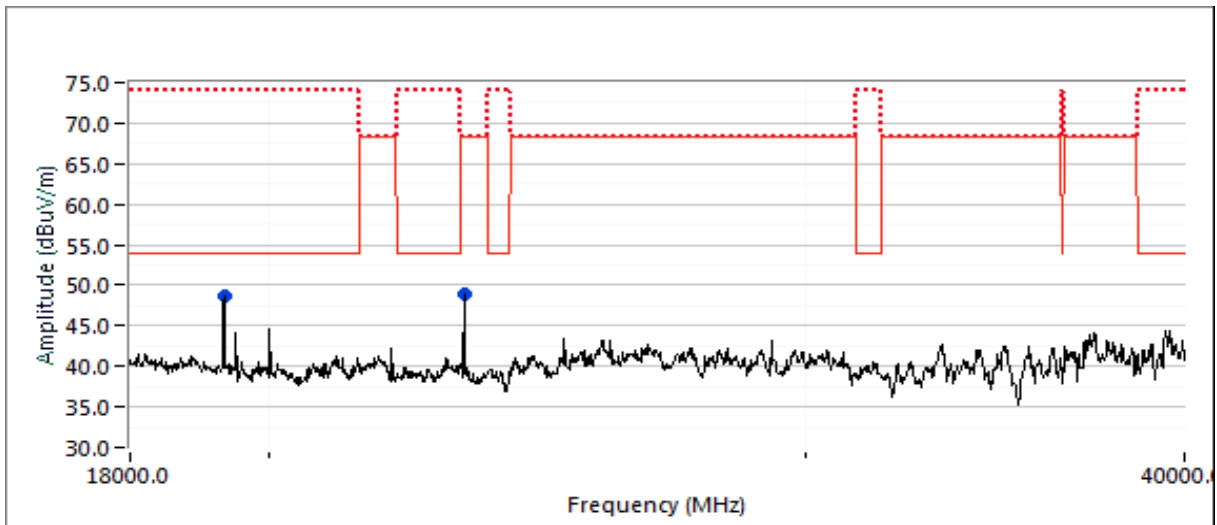
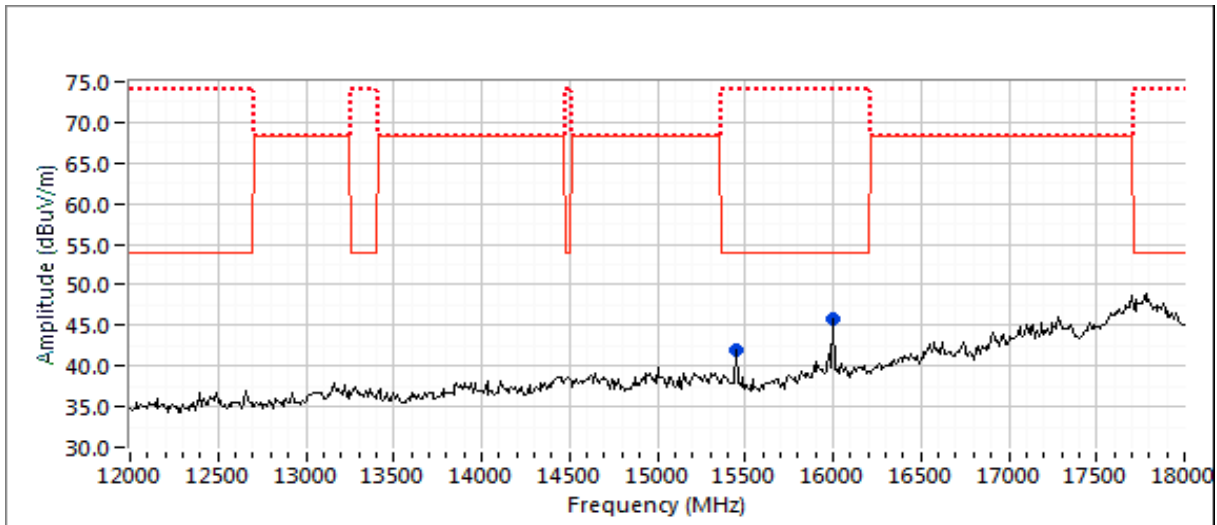



# EMC Test Data

Client: Arris	PR Number: PR101106
Model: NVG5XDBAX	T-Log Number: TL-101106-RANA
Contact: Mark Rieger	Project Manager: Deepa Shetty
Standard: FCC Part 15, RSS-247	Project Engineer: David Bare
	Class: N/A

## Run #3d: Center Channel

Channel: 6 & 155  
Tx Chain: 1Tx & 4Tx

Mode: b & ac80  
Data Rate: 1 & 29.3 Mbps

Pwr Setting: 22 (q88) & 24 (q96)

Frequency MHz	Level dB $\mu$ V/m	Pol V/H	15.209 / 15E		Detector Pk/QP/AVG	Azimuth degrees	Height meters	Comments
			Limit	Margin				
6003.640	68.2	V	68.3	-0.1	PK	24	1.7	RB 1 MHz;VB 3 MHz;Peak
9711.830	54.0	V	68.3	-14.3	PK	251	1.0	RB 1 MHz;VB 3 MHz;Peak
4874.010	53.9	V	54.0	-0.1	AVG	197	1.6	RB 1 MHz;VB 10 Hz;Peak
4873.870	60.3	V	74.0	-13.7	PK	197	1.6	RB 1 MHz;VB 3 MHz;Peak
15399.890	46.6	H	54.0	-7.4	AVG	324	1.4	RB 1 MHz;VB 1 kHz;Peak
15400.200	58.5	H	74.0	-15.5	PK	324	1.4	RB 1 MHz;VB 3 MHz;Peak
16000.230	48.0	H	54.0	-6.0	AVG	326	1.0	RB 1 MHz;VB 1 kHz;Peak
16000.030	59.3	H	74.0	-14.7	PK	326	1.0	RB 1 MHz;VB 3 MHz;Peak
19249.950	48.3	H	54.0	-5.7	AVG	134	1.6	RB 1 MHz;VB 1 kHz;Peak
19250.020	53.6	H	74.0	-20.4	PK	134	1.6	RB 1 MHz;VB 3 MHz;Peak
23099.930	52.6	H	74.0	-21.4	PK	134	1.8	RB 1 MHz;VB 3 MHz;Peak

Note 1: For emissions in restricted bands, the limit of 15.209 was used which requires average and peak measurements.

Note 2: For emissions outside of the restricted bands the limit is -27dBm/MHz eirp (68.3dBuV/m). The measurement method required is a peak measurement (RB=1MHz, VB $\geq$ 3MHz, peak detector).

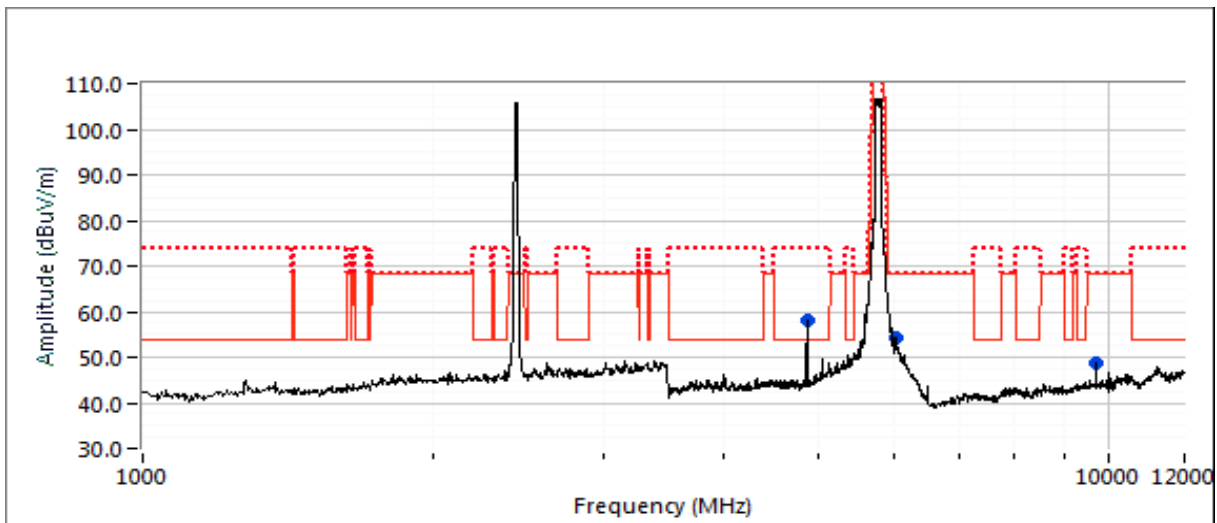





# EMC Test Data

Client: Arris	PR Number: PR101106
Model: NVG5XDBAX	T-Log Number: TL-101106-RANA
Contact: Mark Rieger	Project Manager: Deepa Shetty
Standard: FCC Part 15, RSS-247	Project Engineer: David Bare
	Class: N/A

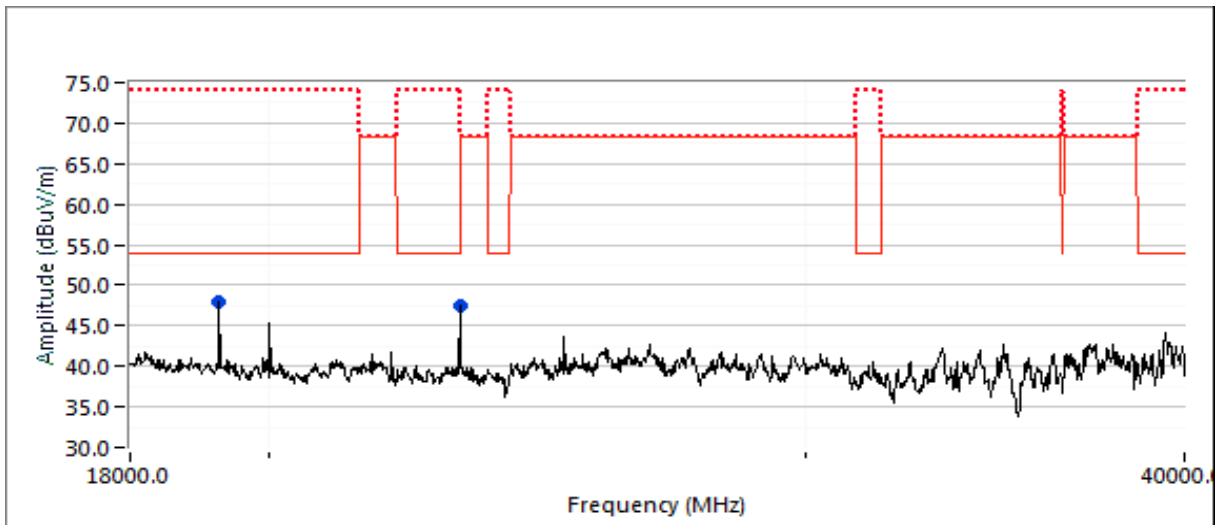
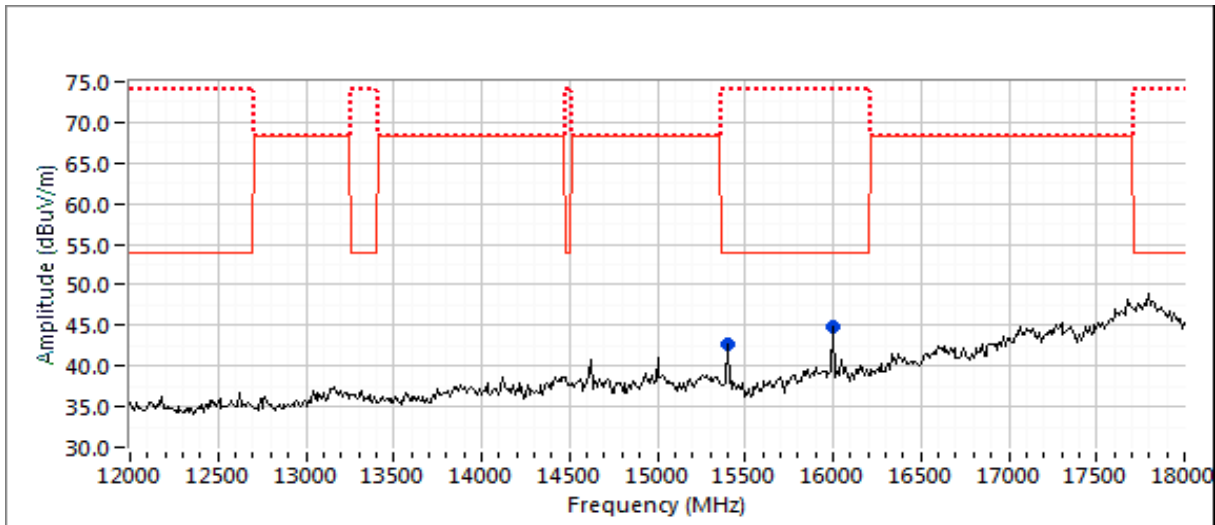





# EMC Test Data

Client: Arris	PR Number: PR101106
Model: NVG5XDBAX	T-Log Number: TL-101106-RANA
Contact: Mark Rieger	Project Manager: Deepa Shetty
Standard: FCC Part 15, RSS-247	Project Engineer: David Bare
	Class: N/A

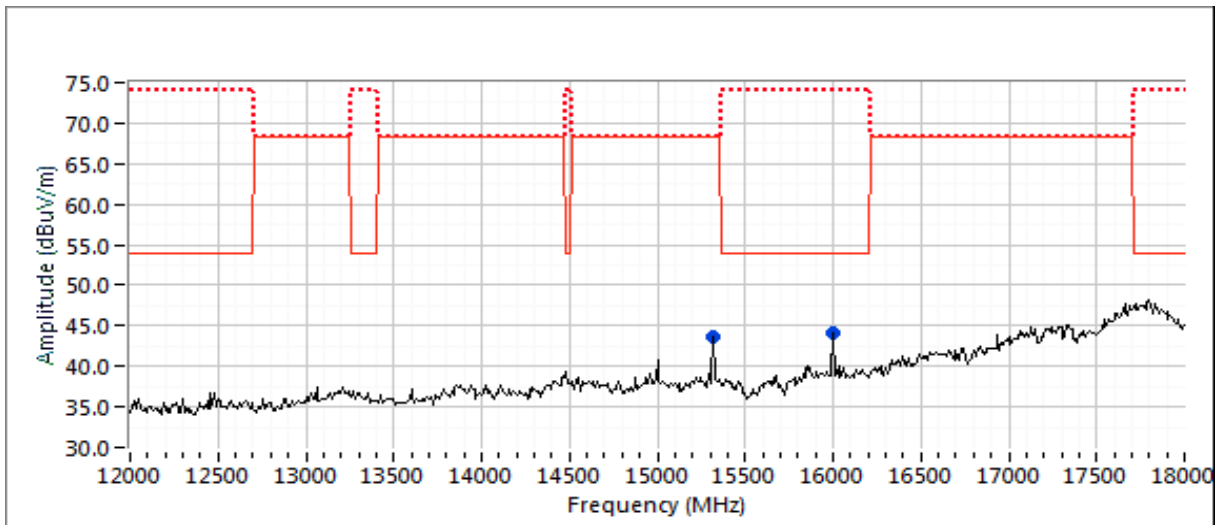
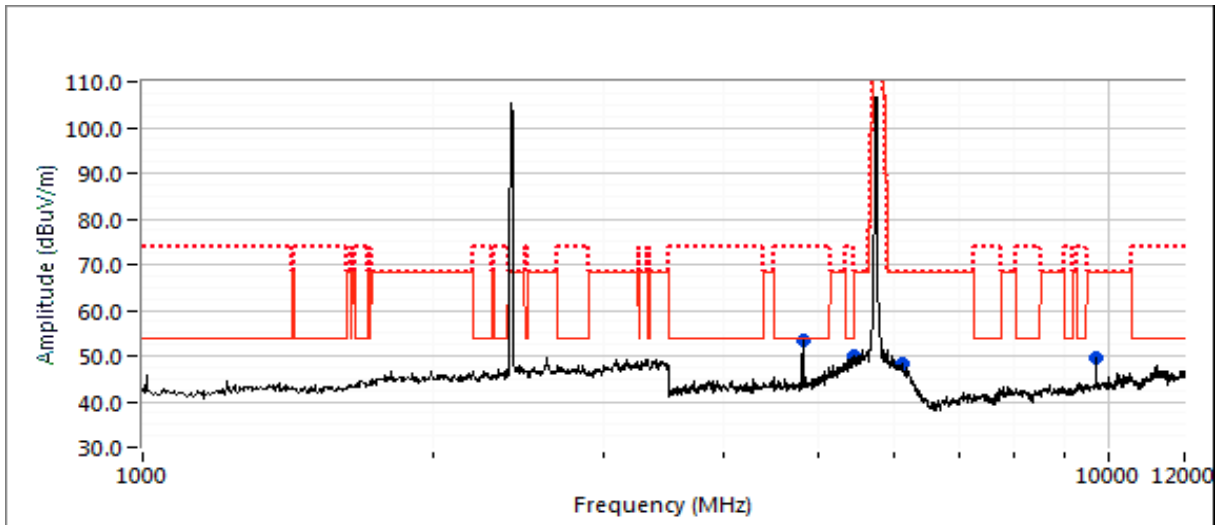



# EMC Test Data

Client: Arris	PR Number: PR101106
Model: NVG5XDBAX	T-Log Number: TL-101106-RANA
Contact: Mark Rieger	Project Manager: Deepa Shetty
Standard: FCC Part 15, RSS-247	Project Engineer: David Bare
	Class: N/A

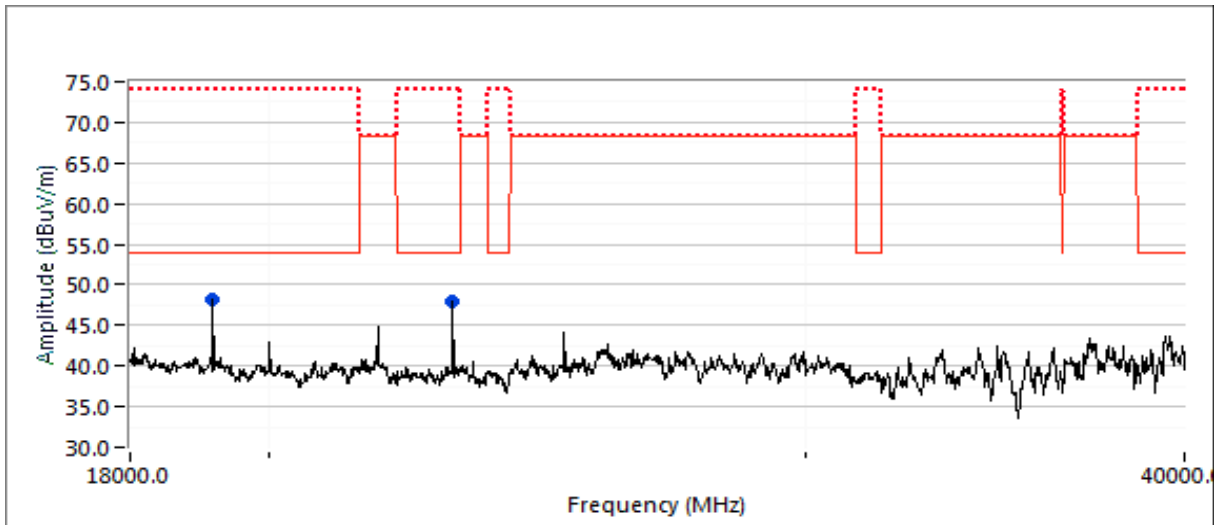





# EMC Test Data

Client:	Arris	PR Number:	PR101106
Model:	NVG5XDBAX	T-Log Number:	TL-101106-RANA
Contact:	Mark Rieger	Project Manager:	Deepa Shetty
Standard:	FCC Part 15, RSS-247	Project Engineer:	David Bare
		Class:	N/A

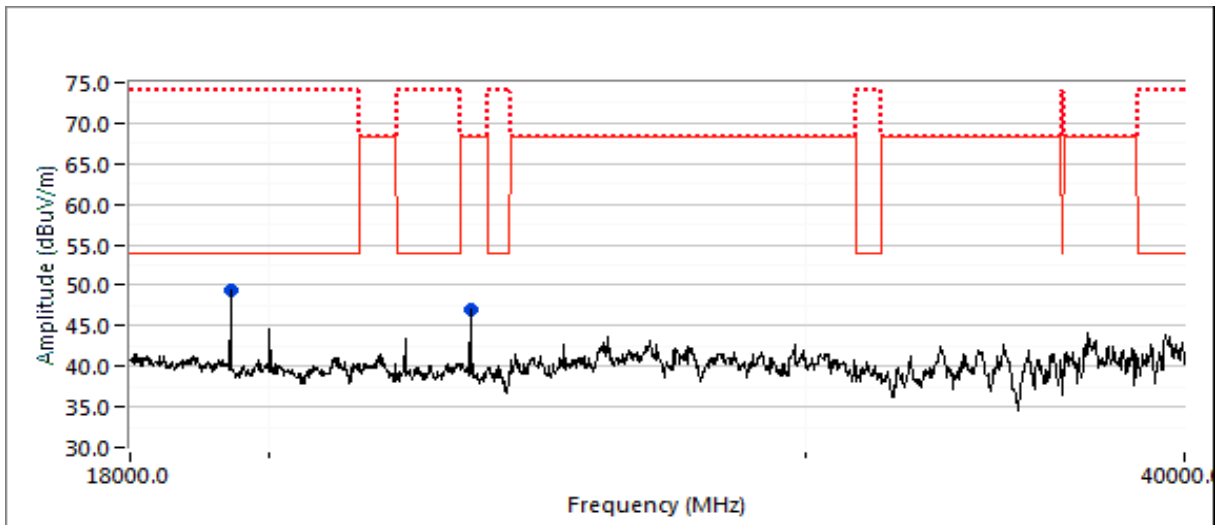
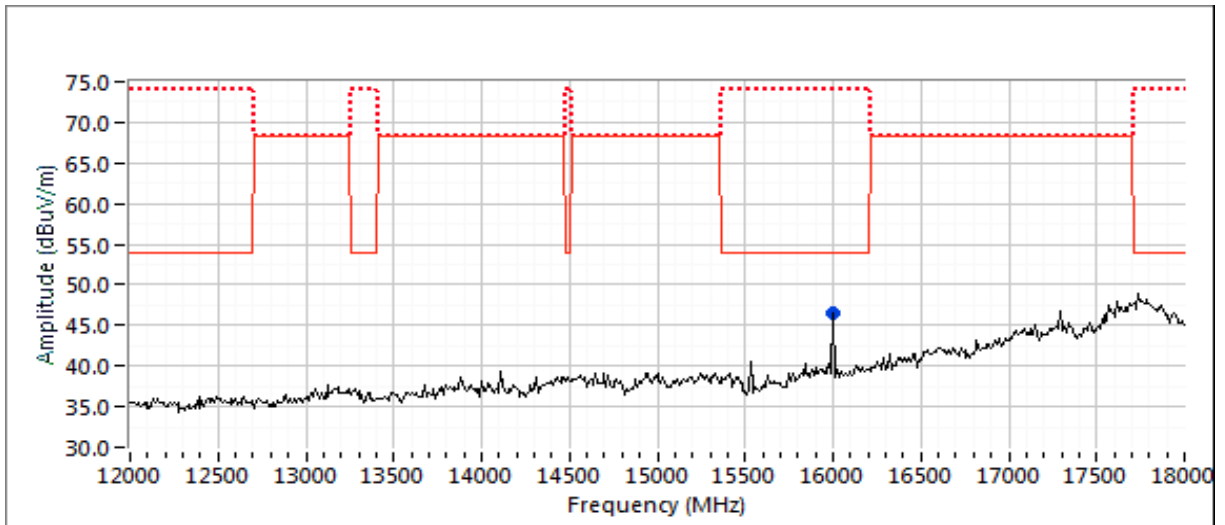



# EMC Test Data

Client: Arris	PR Number: PR101106
Model: NVG5XDBAX	T-Log Number: TL-101106-RANA
Contact: Mark Rieger	Project Manager: Deepa Shetty
Standard: FCC Part 15, RSS-247	Project Engineer: David Bare
	Class: N/A

### Run #5: Radiated Spurious Emissions, 1,000 - 40,000 MHz

Date of Test: 07/22/19

Test Engineer: M. Birgani / R. Varelas

Test Location: Chamber #5

Config. Used: 1

Config Change: -

EUT Voltage: 120V/ 60Hz

### Run #5a: Low Channel

Channel: 1 & 38

Tx Chain: 1Tx & 4Tx

Mode: g & ac40

Data Rate: 6 & 13.5 Mbps

Pwr Setting: 26 (q104) & 24 (q96)

Frequency MHz	Level dB $\mu$ V/m	Pol V/H	15.209 / 15E		Detector Pk/QP/AVG	Azimuth degrees	Height meters	Comments
			Limit	Margin				
4815.520	52.7	V	54.0	-1.3	AVG	143	1.7	RB 1 MHz;VB 10 Hz
20759.890	49.7	H	54.0	-4.3	AVG	156	1.3	Note 3; RB 1 MHz;VB 300 Hz
4817.890	66.7	V	74.0	-7.3	PK	143	1.7	RB 1 MHz;VB 3 MHz
9705.760	55.1	H	68.3	-13.2	PK	286	1.4	RB 1 MHz;VB 3 MHz
16000.160	39.1	H	54.0	-14.9	AVG	258	1.4	RB 1 MHz;VB 10 Hz
20759.800	54.3	H	74.0	-19.7	PK	156	1.3	RB 1 MHz;VB 3 MHz
16000.300	49.0	H	74.0	-25.0	PK	258	1.4	RB 1 MHz;VB 3 MHz
5104.170	53.0	V	54.0	-1.0	Peak	198	1.6	Refer to BE test data

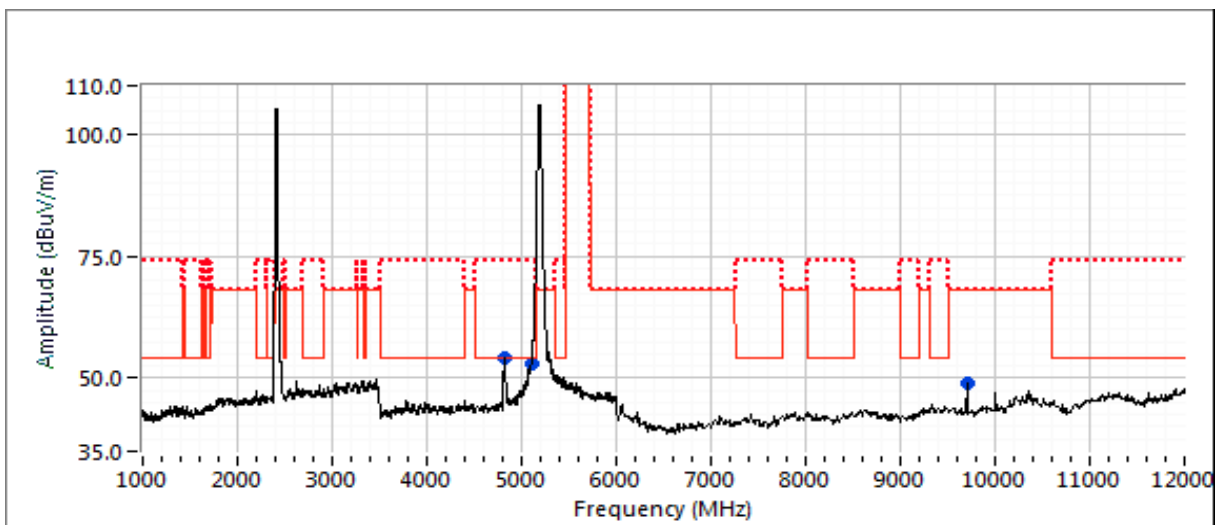



# EMC Test Data

Client: Arris	PR Number: PR101106
Model: NVG5XDBAX	T-Log Number: TL-101106-RANA
Contact: Mark Rieger	Project Manager: Deepa Shetty
Standard: FCC Part 15, RSS-247	Project Engineer: David Bare
	Class: N/A

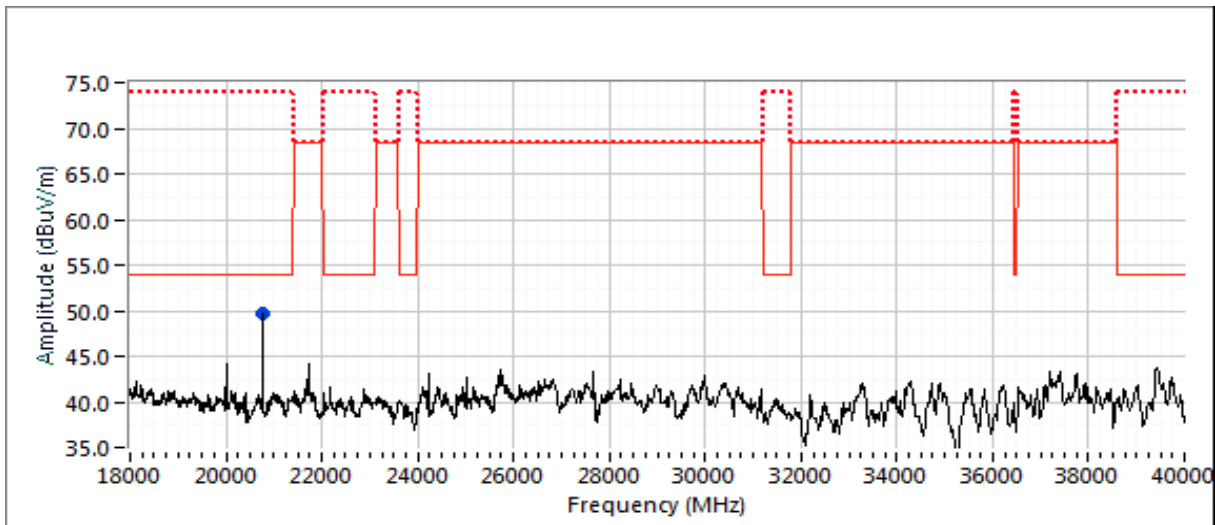
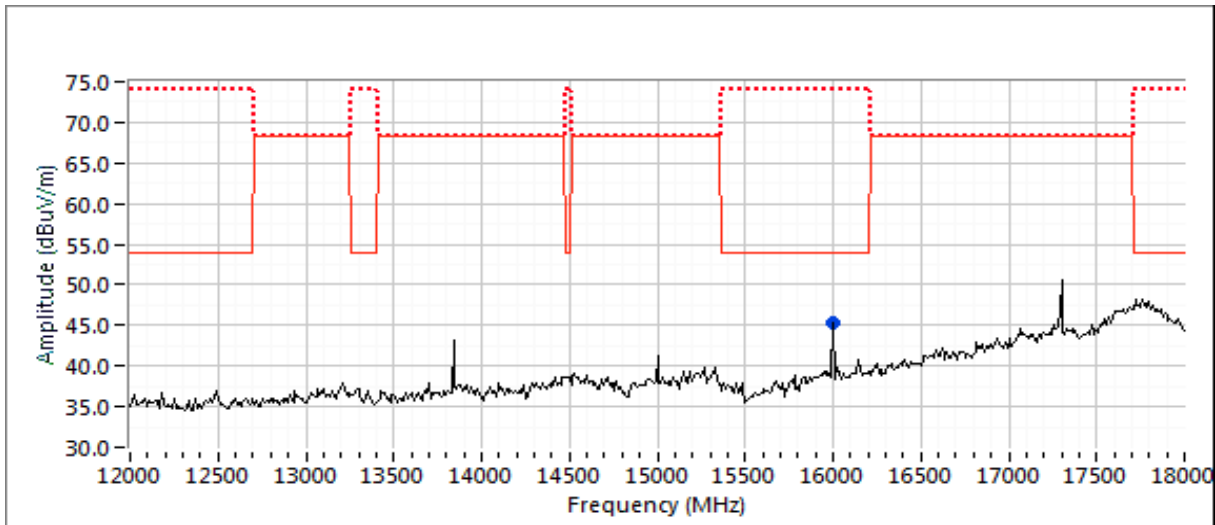







# EMC Test Data

Client:	Arris	PR Number:	PR101106
Model:	NVG5XDBAX	T-Log Number:	TL-101106-RANA
Contact:	Mark Rieger	Project Manager:	Deepa Shetty
Standard:	FCC Part 15, RSS-247	Project Engineer:	David Bare
		Class:	N/A

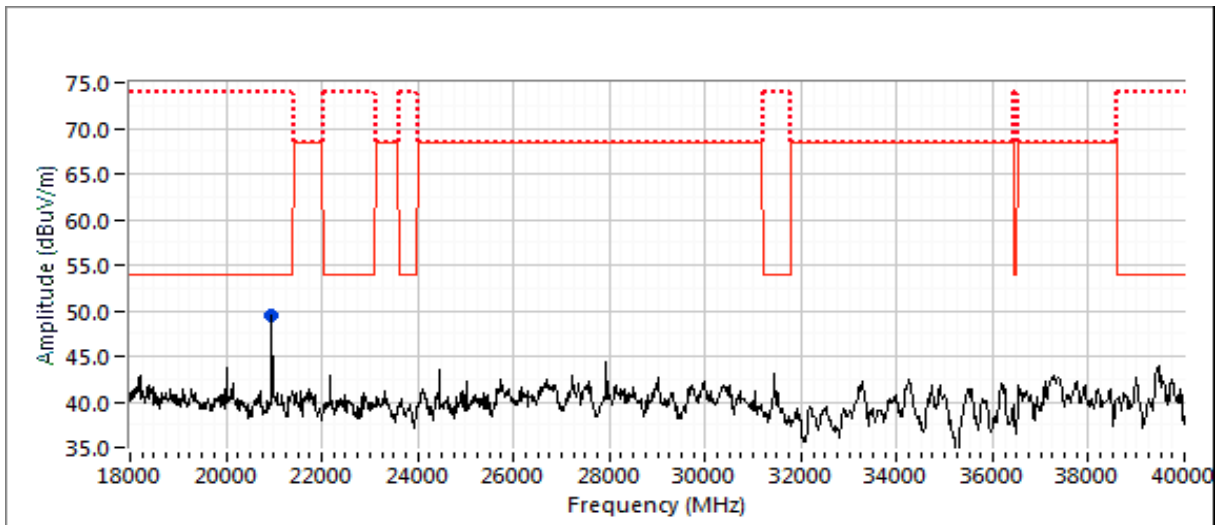
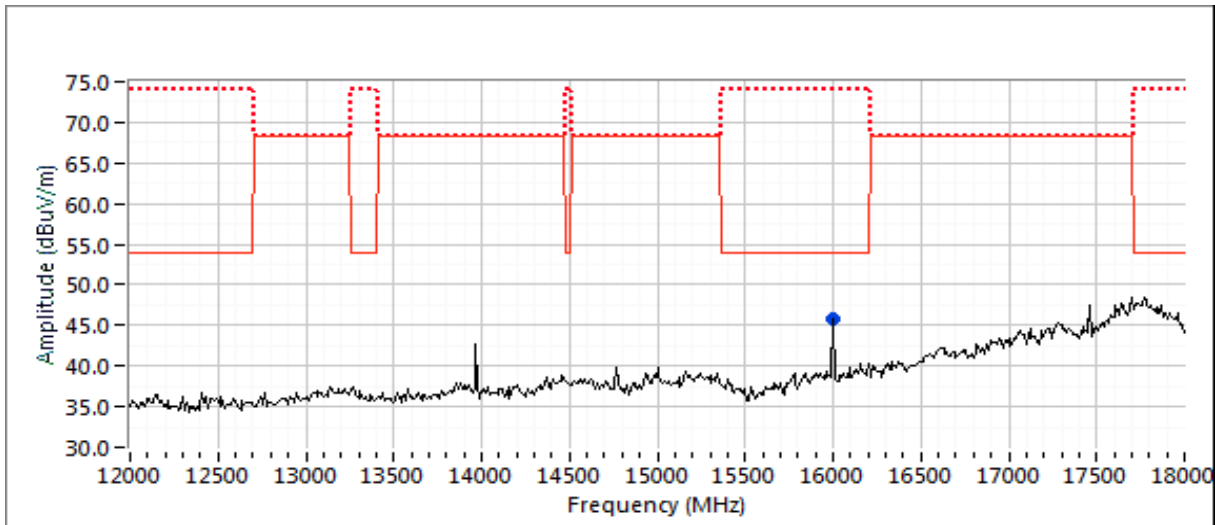



## EMC Test Data

Client:	Arris	PR Number:	PR101106
Model:	NVG5XDBAX	T-Log Number:	TL-101106-RANA
Contact:	Mark Rieger	Project Manager:	Deepa Shetty
Standard:	FCC Part 15, RSS-247	Project Engineer:	David Bare
		Class:	-

### Radiated Emissions

*(NTS Silicon Valley, Fremont Facility, Semi-Anechoic Chamber)*

#### Test Specific Details

Objective: The objective of this test session is to perform final qualification testing of the EUT with respect to the specification listed above.

Date of Test: 7/24/2019  
Test Engineer: M. Birgani  
Test Location: Fremont Chamber #5

Config. Used: 1  
Config Change: -  
Host EUT Voltage: 110V/ 60Hz

#### General Test Configuration

The EUT and any local support equipment were located on the turntable for radiated emissions testing. Any remote support equipment was located outside the semi-anechoic chamber. Any cables running to remote support equipment were routed through metal conduit and when possible passed through a ferrite clamp upon exiting the chamber.

Radiated emissions tests above 1 GHz to FCC Part 15 were performed with floor absorbers in place in accordance with the test methods of ANSI C63.4 and CISPR 16-1-4.

The test distance and extrapolation factor (if applicable) are detailed under each run description.

Note, preliminary testing indicates that the emissions were maximized by orientation of the EUT and elevation of the measurement antenna. Maximized testing indicated that the emissions were maximized by orientation of the EUT, elevation of the measurement antenna, and manipulation of the EUT's interface cables.

Ambient Conditions:                      Temperature:      22-25 °C  
   Rel. Humidity:    39-43 %

#### Modifications Made During Testing

No modifications were made to the EUT during testing

#### Deviations From The Standard

No deviations were made from the requirements of the standard.



## EMC Test Data

Client:	Arris	PR Number:	PR101106
Model:	NVG5XDBAX	T-Log Number:	TL-101106-RANA
Contact:	Mark Rieger	Project Manager:	Deepa Shetty
Standard:	FCC Part 15, RSS-247	Project Engineer:	David Bare
		Class:	-

### Summary of Results

Run #	Test Performed	Limit	Result	Margin
1a	Radiated Spurious Emissions 30 - 1000 MHz, WiFi	15.209	PASS	36.8 dB $\mu$ V/m @ 105.66 MHz (Margin: -6.7 dB)
1b			PASS	37.2 dB $\mu$ V/m @ 105.71 MHz (Margin: -6.3 dB)
2	Radiated Emissions 30 - 1000 MHz, Maximized	15.209	PASS	37.2 dB $\mu$ V/m @ 105.71 MHz (Margin: -6.3 dB)
3	30 kHz - 30 MHz	15.209	PASS	All signals were more than 40dB below the limit.

Test Parameters for Preliminary Scan(s)			
Frequency Range (MHz)	Prescan Distance (meters)	Limit Distance (meters)	Extrapolation Factor (dB, applied to data)
30 - 1000	3	3	0.0
0.009 - 0.490 MHz	3	300	-80.0
0.490 - 30 MHz	3	30	-40.0



# EMC Test Data

Client: Arris	PR Number: PR101106
Model: NVG5XDBAX	T-Log Number: TL-101106-RANA
Contact: Mark Rieger	Project Manager: Deepa Shetty
Standard: FCC Part 15, RSS-247	Project Engineer: David Bare
	Class: -

Run #1a: Preliminary Radiated Emissions, 30 - 1000 MHz (802.11ac20 on Channels 6 and 100)

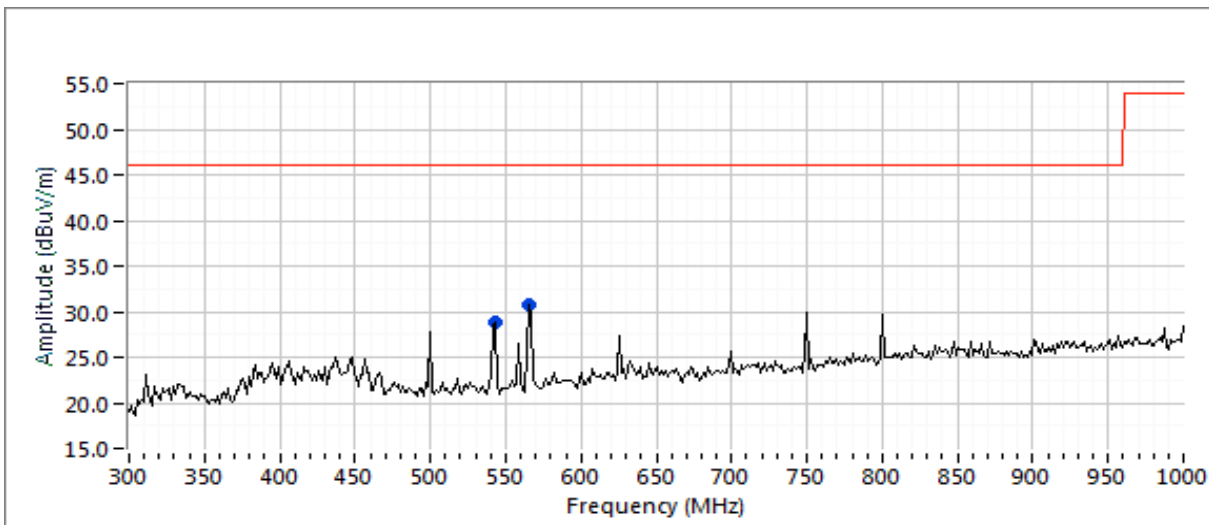
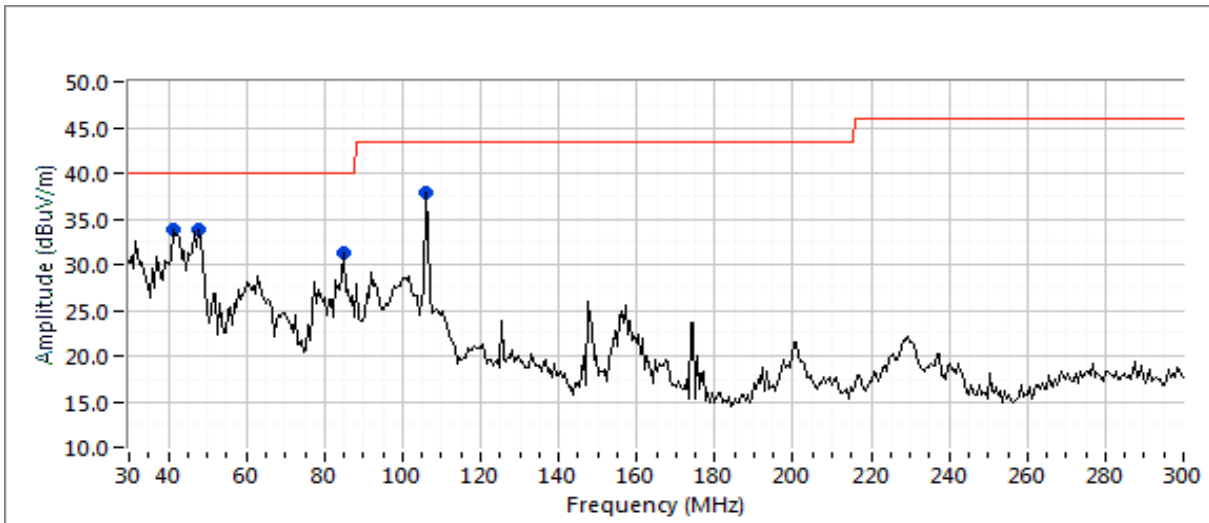



# EMC Test Data

Client: Arris	PR Number: PR101106
Model: NVG5XDBAX	T-Log Number: TL-101106-RANA
Contact: Mark Rieger	Project Manager: Deepa Shetty
Standard: FCC Part 15, RSS-247	Project Engineer: David Bare
	Class: -

**Run #1a: Preliminary Radiated Emissions, 30 - 1000 MHz (802.11ac20 on Channels 6 and 100)**

**Preliminary peak readings captured during pre-scan**

Frequency	Level	Pol	15.209		Detector	Azimuth	Height	Comments
MHz	dB $\mu$ V/m	V/H	Limit	Margin	Pk/QP/Avg	degrees	meters	
105.664	37.8	V	43.5	-5.7	Peak	181	2.5	
47.645	33.8	V	40.0	-6.2	Peak	197	1.0	
42.821	33.8	V	40.0	-6.2	Peak	57	1.0	
83.693	31.2	V	40.0	-8.8	Peak	294	1.0	
564.128	30.8	V	46.0	-15.2	Peak	184	1.0	
540.387	28.9	V	46.0	-17.1	Peak	178	1.0	

**Preliminary quasi-peak readings (no manipulation of EUT interface cables)**

Frequency	Level	Pol	15.209		Detector	Azimuth	Height	Comments
MHz	dB $\mu$ V/m	V/H	Limit	Margin	Pk/QP/Avg	degrees	meters	
105.664	36.8	V	43.5	-6.7	QP	179	2.5	QP (1.00s)
47.645	27.0	V	40.0	-13.0	QP	197	1.0	QP (1.00s)
42.821	24.6	V	40.0	-15.4	QP	60	1.0	QP (1.00s)
564.128	28.5	V	46.0	-17.5	QP	184	1.0	QP (1.00s)
83.693	21.6	V	40.0	-18.4	QP	298	1.0	QP (1.00s)
540.387	25.5	V	46.0	-20.5	QP	178	1.0	QP (1.00s)



# EMC Test Data

Client: Arris	PR Number: PR101106
Model: NVG5XDBAX	T-Log Number: TL-101106-RANA
Contact: Mark Rieger	Project Manager: Deepa Shetty
Standard: FCC Part 15, RSS-247	Project Engineer: David Bare
	Class: -

Run #1b: Preliminary Radiated Emissions, 30 - 1000 MHz (802.11b on Channel 1 and 802.11a on Channel 36)

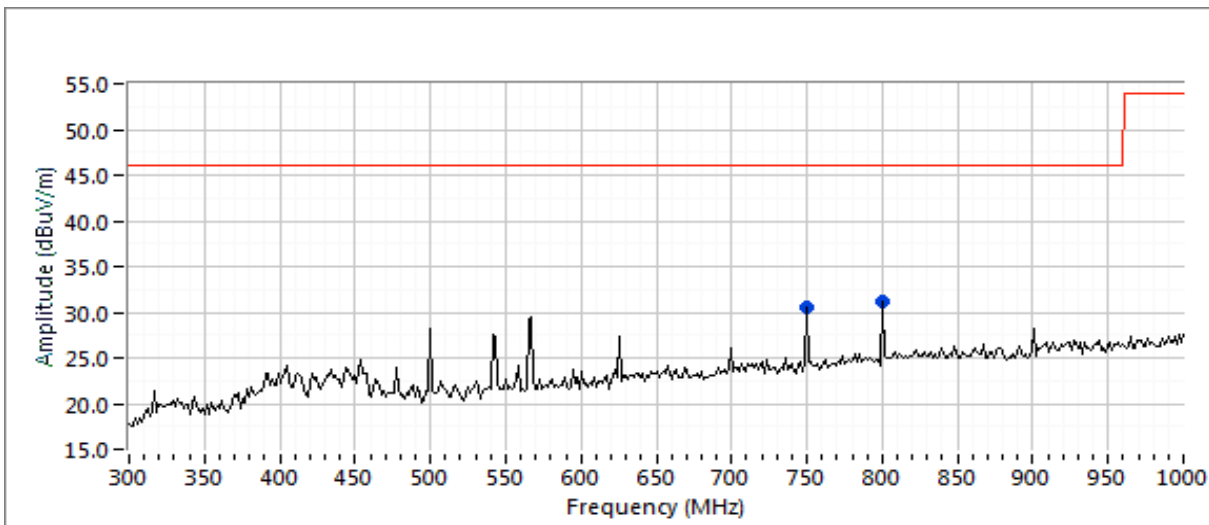
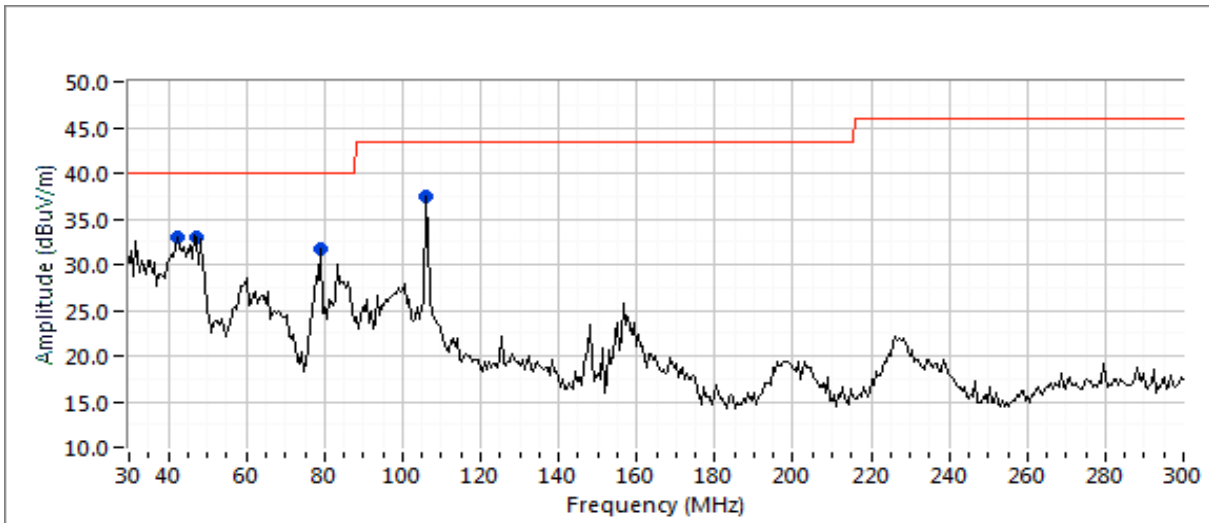



# EMC Test Data

Client:	Arris	PR Number:	PR101106
Model:	NVG5XDBAX	T-Log Number:	TL-101106-RANA
Contact:	Mark Rieger	Project Manager:	Deepa Shetty
Standard:	FCC Part 15, RSS-247	Project Engineer:	David Bare
		Class:	-

**Run #1b: Preliminary Radiated Emissions, 30 - 1000 MHz (80211b on Channel 1 and 802.11a on Channel 36)**  
**Preliminary peak readings captured during pre-scan**

Frequency	Level	Pol	15.209		Detector	Azimuth	Height	Comments
MHz	dB $\mu$ V/m	V/H	Limit	Margin	Pk/QP/Avg	degrees	meters	
105.710	37.4	V	43.5	-6.1	Peak	204	2.0	
45.903	33.0	V	40.0	-7.0	Peak	225	1.5	
43.169	32.9	V	40.0	-7.1	Peak	278	1.0	
78.702	31.6	V	40.0	-8.4	Peak	291	1.0	
800.730	31.2	H	46.0	-14.8	Peak	94	2.0	
750.023	30.6	H	46.0	-15.4	Peak	64	1.5	

**Preliminary quasi-peak readings (no manipulation of EUT interface cables)**

Frequency	Level	Pol	15.209		Detector	Azimuth	Height	Comments
MHz	dB $\mu$ V/m	V/H	Limit	Margin	Pk/QP/Avg	degrees	meters	
105.710	37.2	V	43.5	-6.3	QP	208	2.0	QP (1.00s)
43.169	25.6	V	40.0	-14.4	QP	280	1.0	QP (1.00s)
45.903	24.2	V	40.0	-15.8	QP	229	1.5	QP (1.00s)
750.023	29.3	H	46.0	-16.7	QP	69	1.5	QP (1.00s)
78.702	20.8	V	40.0	-19.2	QP	294	1.0	QP (1.00s)
800.730	21.7	H	46.0	-24.3	QP	96	2.0	QP (1.00s)

**Run #2: Maximized Readings From Run #1**

**Maximized quasi-peak readings (includes manipulation of EUT interface cables)**

Frequency	Level	Pol	15.209		Detector	Azimuth	Height	Comments
MHz	dB $\mu$ V/m	v/h	Limit	Margin	Pk/QP/Avg	degrees	meters	
105.710	37.2	V	43.5	-6.3	QP	208	2.0	QP (1.00s)
43.169	25.6	V	40.0	-14.4	QP	280	1.0	QP (1.00s)
45.903	24.2	V	40.0	-15.8	QP	229	1.5	QP (1.00s)
750.023	29.3	H	46.0	-16.7	QP	69	1.5	QP (1.00s)
78.702	20.8	V	40.0	-19.2	QP	294	1.0	QP (1.00s)
800.730	21.7	H	46.0	-24.3	QP	96	2.0	QP (1.00s)





## EMC Test Data

Client: Arris	PR Number: PR101106
Model: NVG5XDBAX	T-Log Number: TL-101106-RANA
	Project Manager: Deepa Shetty
Contact: Mark Rieger	Project Engineer: David Bare
Standard: FCC Part 15, RSS-247	Class: N/A

### RSS-247 and FCC 15.247 (DTS) Antenna Port Measurements MIMO and Smart Antenna Systems Power, PSD, Bandwidth and Spurious Emissions

#### Test Specific Details

Objective: The objective of this test session is to perform final qualification testing of the EUT with respect to the specification listed above.

Date of Test: 7/9/2019	Config. Used: 1
Test Engineer: D. Bare / R. Varelas / M. Birgani	Config Change: None
Test Location: Fremont EMC Lab #4B	EUT Voltage: 3.3VDC

#### General Test Configuration

The EUT was connected to the spectrum analyzer or power meter via a suitable attenuator. All measurements were made on individual chains as noted.

All measurements have been corrected to allow for the external attenuators used.

Ambient Conditions:	Temperature:	22 °C
	Rel. Humidity:	41 %

#### Modifications Made During Testing

No modifications were made to the EUT during testing

#### Deviations From The Standard

No deviations were made from the requirements of the standard.

#### Sample Notes

Sample S/N: M11917QW000T



# EMC Test Data

Client: Arris	PR Number: PR101106
Model: NVG5XDBAX	T-Log Number: TL-101106-RANA
Contact: Mark Rieger	Project Manager: Deepa Shetty
Standard: FCC Part 15, RSS-247	Project Engineer: David Bare
	Class: N/A

## Summary of Results

Run #	Pwr setting	Avg Pwr	Test Performed	Limit	Pass / Fail	Result / Margin
1			Output Power	15.247(b)	Pass	b: 23.3 dBm g: 25.1 dBm ac20: 29.3 dBm ac40: 28.8 dBm
2			Power spectral Density (PSD)	15.247(d)	Pass	b: 3.8 dBm/3kHz g: 0.2 dBm/3kHz ac20: 4.6 dBm/3kHz ac40: 6.5 dBm/10kHz
3			Minimum 6dB Bandwidth	15.247(a)	Pass	Minimum 7.07 MHz
3			99% Bandwidth	RSS GEN	Pass	See Below
4			Spurious emissions	15.247(b)	Pass	All emissions below -30dBc limit

## Procedure Comments:

Measurements performed in accordance with FCC KDB 558074 and ANSI C63.10

## Antenna Gain Information

Freq	Antenna Gain (dBi) / Chain				BF	MultiChain Legacy	CDD	Sectorized / Xpol	Dir G (PWR)	Dir G (PSD)
	1	2	3	4						
2410 MHz	3.4	2.9	3.5	5.9	Yes	Yes	Yes	Yes	1.9	7.6
2440 MHz	3.5	3.6	3.3	5.6	Yes	Yes	Yes	Yes	1.7	7.4
2460 MHz	3.8	3.9	3.6	5.3	Yes	Yes	Yes	Yes	1.6	7.3

## For devices that support CDD modes

Min # of spatial streams: 1	Chain 1 = Yellow antenna cable	Chain 3 = Red antenna cable
Max # of spatial streams: 4	Chain 2 = Brown antenna cable	Chain 4 = Green antenna cable



# EMC Test Data

Client:	Arris	PR Number:	PR101106
Model:	NVG5XDBAX	T-Log Number:	TL-101106-RANA
Contact:	Mark Rieger	Project Manager:	Deepa Shetty
Standard:	FCC Part 15, RSS-247	Project Engineer:	David Bare
		Class:	N/A

Legacy modes operate on single chain  
 Power for BF mode is lower due to higher directional gain for correlated signals is used for these modes  
 CDD active for single stream modes

Note 1A:	Duty Cycle $\geq$ 98%. Output power measured using a spectrum analyzer (see plots below) with RBW= 1-5% of OBW and $\leq$ 1 MHz, $VB \geq 3 * RBW$ , Span $\geq$ 1.5 of OBW, auto sweep time, RMS detector, power averaging on, and power integration over the OBW, trace average 100 traces (option AVGSA-1 in ANSI C63.10). Spurious limit becomes -30dBc.
Note 1B:	Constant Duty Cycle $<$ 98%. Output power measured using a spectrum analyzer (see plots below) with RBW= 1-5% of OBW and $\leq$ 1 MHz, $VB \geq 3 * RBW$ , Span $\geq$ 1.5 of OBW, RMS detector, auto sweep time, power averaging on, and power integration over the OBW, trace average 100 traces (option AVGSA-2 in ANSI C63.10). Measurement corrected by Pwr Cor Factor. Spurious limit becomes -30dBc.
Note 2:	Power setting - the software power setting used during testing, included for reference only.
Notes:	BF = beamforming mode supported, Multichain Legacy = 802.11 legacy data rates supported for multichain transmissions, CDD = Cyclic Delay Diversity (or Cyclic Shift Diversity) modes supported, Sectorized / Xpol = antennas are sectorized or cross polarized (For each band 2 antennas are Vertical and 2 are Horizontal)
Notes:	Dir G (PWR) = total gain (Gant + Array Gain) for power calculations; Dir G (PSD) = total gain for PSD calculations based on FCC KDB 662911 D01. Depending on the modes supported, the Array Gain value for power could be different from the PSD value.
Notes:	Array gain for power/psd calculated per KDB 662911 D01.

Mode	Data Rate	Duty Cycle (x)	Constant DC?	T (ms)	Pwr Cor Factor*	Lin Volt Cor Factor**	Min VBW for FS (Hz)	Packet	pkt duty
11b	1	99.2%	Yes	12.422	0.0	0.0	81	1285	-1
11g	6	99.0%	Yes	5.06	0.0	0.0	198	7974	-1
ac20	6.5	97.6%	Yes	5.271	0.1	0.2	190	4324	-1
ac40	13.5	97.3%	Yes	5.24	0.1	0.2	191	8811	-1



# EMC Test Data

Client: Arris	PR Number: PR101106
Model: NVG5XDBAX	T-Log Number: TL-101106-RANA
Contact: Mark Rieger	Project Manager: Deepa Shetty
Standard: FCC Part 15, RSS-247	Project Engineer: David Bare
	Class: N/A

## Run #1: Output Power

Operating Mode: 802.11b  
 Peak Gain (dBi): 3.9  
 Ant 5

Max EIRP (mW): 524.8

Frequency (MHz)	Chain	Software Setting	Power <sup>1</sup>		Total		Max Power (W)	Limit dBm	Result	Power (dBm) <sup>3</sup>
			dBm	mW	mW	dBm				
2412		18			97.7	19.9	0.214	30.0	Pass	
	4		19.9	97.7						
2437		22			213.8	23.3				
	4		23.3	213.8						
2462		16			41.7	16.2				
	4		16.2	41.7						

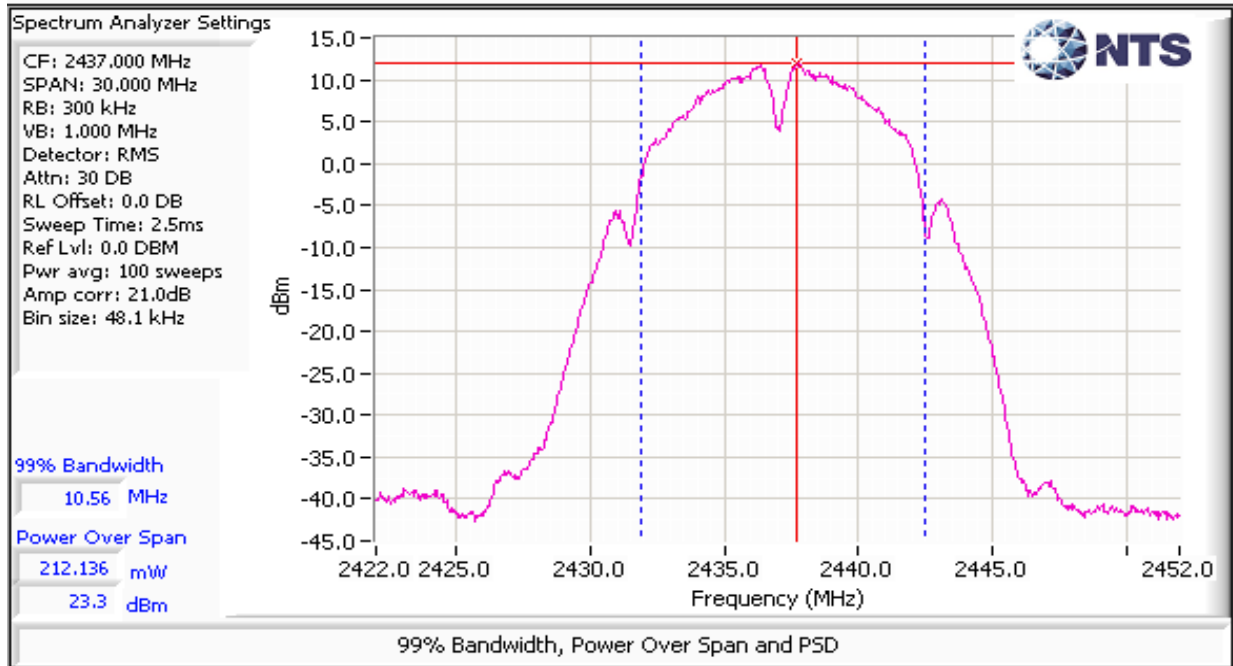



# EMC Test Data

Client: Arris	PR Number: PR101106
Model: NVG5XDBAX	T-Log Number: TL-101106-RANA
Contact: Mark Rieger	Project Manager: Deepa Shetty
Standard: FCC Part 15, RSS-247	Project Engineer: David Bare
	Class: N/A

Peak Gain (dBi): 3.9      Operating Mode: 802.11g  
 Ant 5      Max EIRP (mW): 794.3

Frequency (MHz)	Chain	Software Setting	Power <sup>1</sup>		Total		Max Power (W)	Limit dBm	Result	Power (dBm) <sup>3</sup>
			dBm	mW	mW	dBm				
2412	4	24	23.4	218.8	218.8	23.4	0.324	30.0	Pass	
2437	4	26	25.1	323.6	323.6	25.1		30.0	Pass	
2462	4	26	24.5	281.8	281.8	24.5		30.0	Pass	

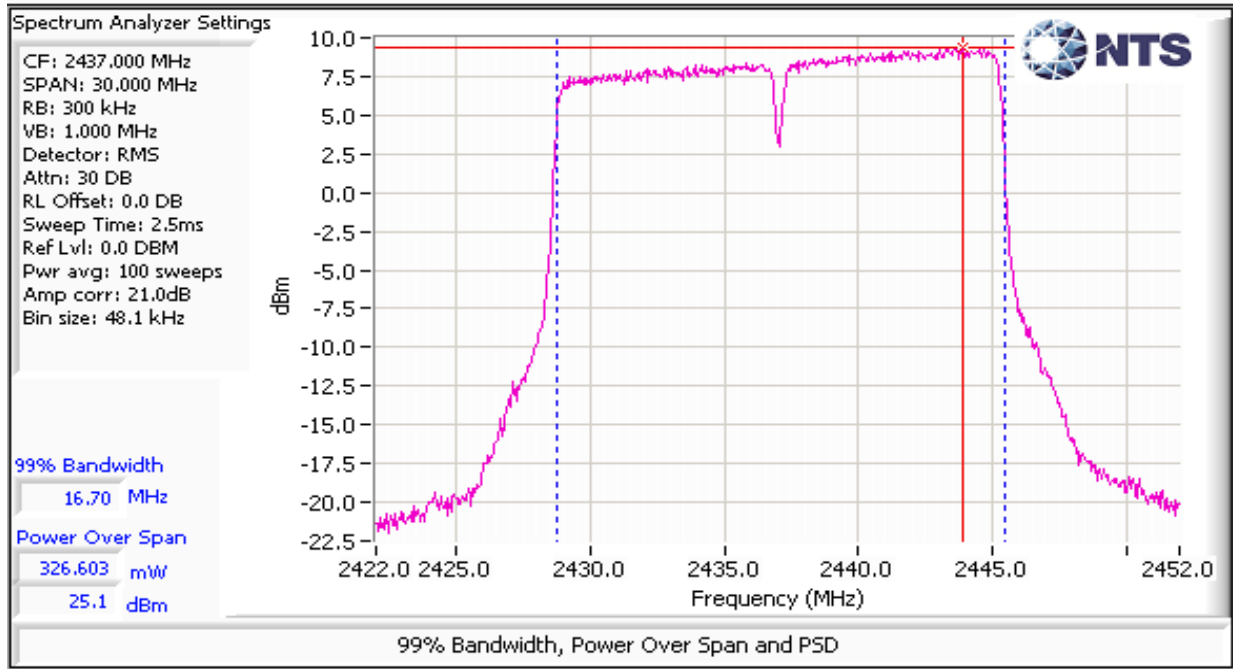



# EMC Test Data

Client: Arris	PR Number: PR101106
Model: NVG5XDBAX	T-Log Number: TL-101106-RANA
Contact: Mark Rieger	Project Manager: Deepa Shetty
Standard: FCC Part 15, RSS-247	Project Engineer: David Bare
	Class: N/A

Directional Gain (dBi): 1.9

Operating Mode: 802.11ac20

Max EIRP (mW): 1320.3

Frequency (MHz)	Chain	Software Setting	Power <sup>1</sup>		Total		Max Power (W)	Limit dBm	Result	Power (dBm) <sup>3</sup>
			dBm	mW	mW	dBm				
2412	1	24	23.0	199.5	852.5	29.3	0.852	30.0	Pass	
	3		23.1	204.2						
	4		23.5	223.9						
	2		23.5	224.9						
2437	1	24	22.5	177.8	776.5	28.9				
	3		23.1	204.2						
	4		22.9	195.0						
	2		23.0	199.5						
2462	1	23	20.6	114.8	525.9	27.2				
	3		21.5	141.3						
	4		21.3	134.9						
	2		21.3	134.9						

Notes: Power correction factor of 0.1dB was added to reading the final reading per note 1B.

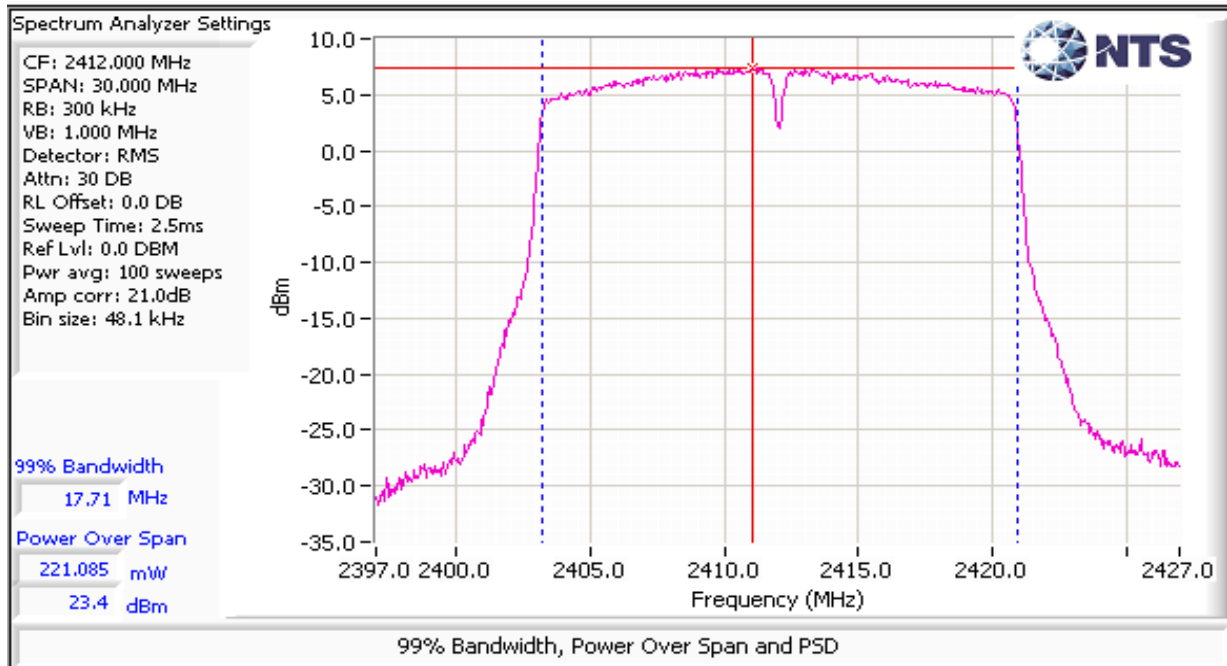



# EMC Test Data

Client: Arris	PR Number: PR101106
Model: NVG5XDBAX	T-Log Number: TL-101106-RANA
	Project Manager: Deepa Shetty
Contact: Mark Rieger	Project Engineer: David Bare
Standard: FCC Part 15, RSS-247	Class: N/A

Directional Gain (dBi): 7.6      Operating Mode: 802.11ac20 w/ BF  
Max EIRP (mW): 3891.9

Frequency (MHz)	Chain	Software Setting	Power <sup>1</sup>		Total		Max Power (W)	Limit dBm	Result	Power (dBm) <sup>3</sup>
			dBm	mW	mW	dBm				
2412	1	23	22.0	158.5	676.3	28.3	0.676	28.4	Pass	
	3		22.1	162.2						
	4		22.5	177.8						
	2		22.5	177.8						
2437	1	23	21.5	141.3	616.8	27.9	0.676	28.4	Pass	
	3		22.1	162.2						
	4		21.9	154.9						
	2		22.0	158.5						
2462	1	23	20.6	114.8	525.9	27.2	0.676	28.4	Pass	
	3		21.5	141.3						
	4		21.3	134.9						
	2		21.3	134.9						

Notes: Power correction factor of 0.1dB was added to reading the final reading per note 1B.

add plot here

Directional Gain (dBi): 1.9      Operating Mode: 802.11ac40  
Max EIRP (mW): 1187.8

Frequency (MHz)	Chain	Software Setting	Power <sup>1</sup>		Total		Max Power (W)	Limit dBm	Result	Power (dBm) <sup>3</sup>
			dBm	mW	mW	dBm				
2422	1	24	22.9	195.0	758.1	28.8	0.767	30.0	Pass	
	3		22.9	195.0						
	4		22.7	186.2						
	2		22.6	182.0						
2437	1	24	22.9	195.0	766.9	28.8	0.767	30.0	Pass	
	3		23.0	199.5						
	4		22.7	186.2						
	2		22.7	186.2						
2452	1	24	22.5	177.8	712.6	28.5	0.767	30.0	Pass	
	3		22.9	195.0						
	4		22.4	173.8						
	2		22.2	166.0						

Notes: Power correction factor of 0.1dB was added to reading the final reading per note 1B.



# EMC Test Data

Client: Arris	PR Number: PR101106
Model: NVG5XDBAX	T-Log Number: TL-101106-RANA
Contact: Mark Rieger	Project Manager: Deepa Shetty
Standard: FCC Part 15, RSS-247	Project Engineer: David Bare
	Class: N/A

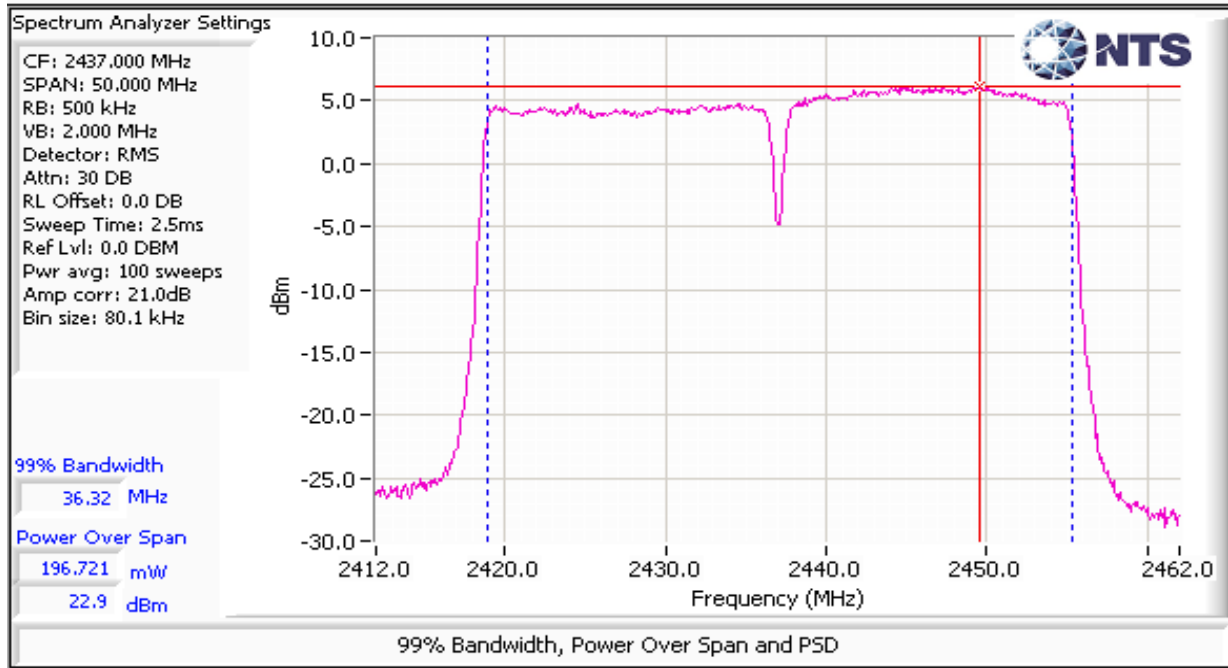

Directional Gain (dBi): 7.6

Operating Mode: 802.11ac40 w/ BF  
Max EIRP (mW): 3505.5

Frequency (MHz)	Chain	Software Setting	Power <sup>1</sup>		Total		Max Power (W)	Limit (dBm)	Result	Power (dBm) <sup>3</sup>
			dBm	mW	mW	dBm				
2422	1	23	21.9	154.9	602.2	27.8	0.609	28.4	Pass	
	3		21.9	154.9						
	4		21.7	147.9						
	2		21.6	144.5						
2437	1	23	21.9	154.9	609.2	27.8	0.609	28.4	Pass	
	3		22.0	158.5						
	4		21.7	147.9						
	2		21.7	147.9						
2452	1	23	21.5	141.3	566.0	27.5	28.4	Pass		
	3		21.9	154.9						
	4		21.4	138.0						
	2		21.2	131.8						

Notes: Power correction factor of 0.1dB was added to reading the final reading per note 1B.

add plot here





# EMC Test Data

Client: Arris	PR Number: PR101106
Model: NVG5XDBAX	T-Log Number: TL-101106-RANA
Contact: Mark Rieger	Project Manager: Deepa Shetty
Standard: FCC Part 15, RSS-247	Project Engineer: David Bare
	Class: N/A

## Run #2: Power spectral Density

Mode: 11b

Power Setting	Frequency (MHz)	PSD (dBm/3kHz) <sup>Note 1</sup>				Total	Limit dBm/3kHz	Result
		Chain 1	Chain 2	Chain 3	Chain 4			
18	2412				0.1	0.1	6.4	Pass
22	2437				3.8	3.8	6.6	Pass
16	2462				-3.7	-3.7	6.7	Pass

Mode: 11g

Power Setting	Frequency (MHz)	PSD (dBm/3kHz) <sup>Note 1</sup>				Total	Limit dBm/3kHz	Result
		Chain 1	Chain 2	Chain 3	Chain 4			
24	2412				-1.8	-1.8	6.4	Pass
26	2437				0.2	0.2	6.6	Pass
26	2462				0.0	0.0	6.7	Pass

Mode: ac20

Power Setting	Frequency (MHz)	PSD (dBm/3kHz) <sup>Note 1</sup>				Total	Limit dBm/3kHz	Result
		Chain 1	Chain 2	Chain 3	Chain 4			
24	2412	-1.4	-1.6	-1.6	-1.1	4.6	6.4	Pass
24	2437	-1.6	-1.3	-1.7	-1.4	4.5	6.6	Pass
23	2462	-3.2	-1.5	-3.4	-2.1	3.5	6.7	Pass

Mode: ac40

Power Setting	Frequency (MHz)	PSD (dBm/10kHz) <sup>Note 1</sup>				Total	Limit dBm/3kHz	Result
		Chain 1	Chain 2	Chain 3	Chain 4			
24	2422	0.6	0.1	0.3	0.4	6.4	6.4	Pass
24	2437	0.4	0.4	0.5	0.8	6.5	6.6	Pass
24	2452	-0.1	0.6	0.8	0.6	6.5	6.7	Pass

Note 1: Test performed per method PKSPD, in KDB 558074. Power spectral density measured using: 3kHz ≤ RBW ≤ 100kHz, VBW=3\*RBW, peak detector, span = 1.5\*DTS BW, auto sweep time, max hold.



# EMC Test Data

Client: Arris	PR Number: PR101106
Model: NVG5XDBAX	T-Log Number: TL-101106-RANA
Contact: Mark Rieger	Project Manager: Deepa Shetty
Standard: FCC Part 15, RSS-247	Project Engineer: David Bare
	Class: N/A

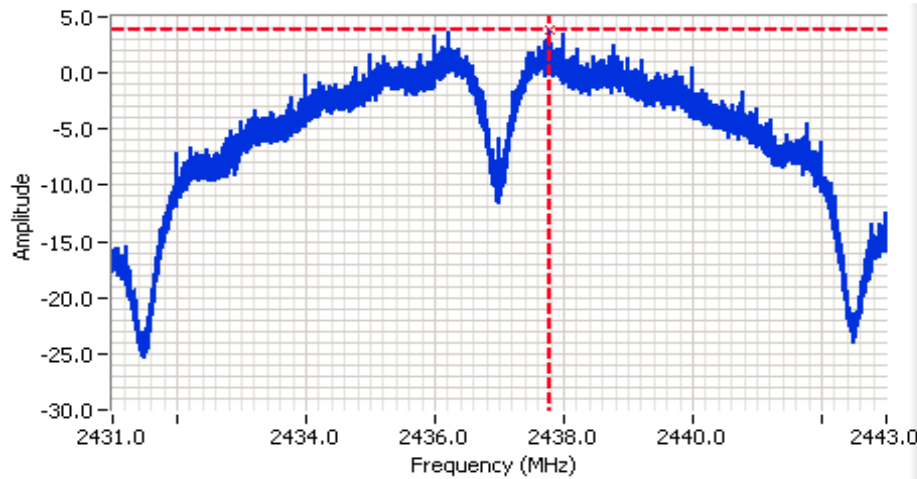

**Analyzer Settings**

CF: 2437.000 MHz  
SPAN: 12.000 MHz  
RB: 3.00 kHz  
VB: 10.0 kHz  
Detector: POS  
Attn: 10 DB  
RL Offset: 21.0 DB  
Sweep Time: 1.4s  
Ref Lvl: 10.0 DBM

**Comments**

802.11b  
Chain: 4  
PSD: 3.8 dBm/3kHz

Cursor 1 2437.777000 3.8

0.000000 0.0

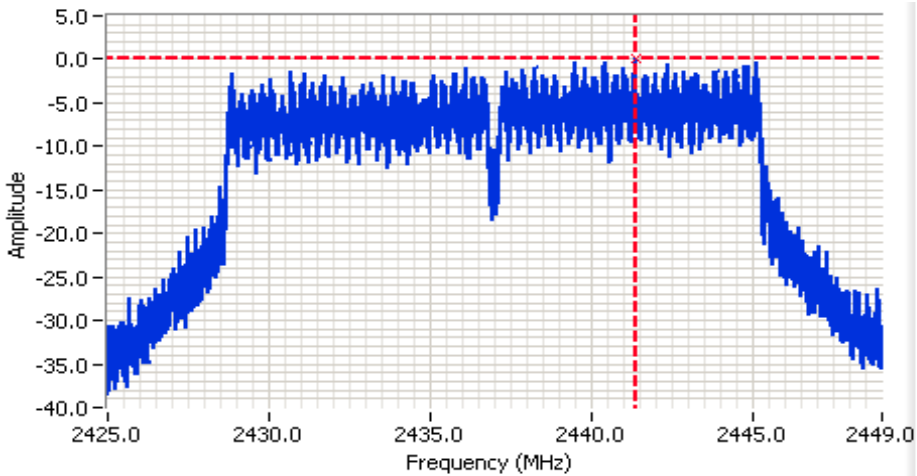

**Analyzer Settings**

CF: 2437.000 MHz  
SPAN: 24.000 MHz  
RB: 3.00 kHz  
VB: 10.0 kHz  
Detector: POS  
Attn: 10 DB  
RL Offset: 21.0 DB  
Sweep Time: 2.7s  
Ref Lvl: 10.0 DBM

**Comments**

802.11g  
Chain: 4  
PSD: 0.2 dBm/3kHz

Cursor 1 2441.360500 0.2

0.000000 0.0





# EMC Test Data

Client: Arris	PR Number: PR101106
Model: NVG5XDBAX	T-Log Number: TL-101106-RANA
Contact: Mark Rieger	Project Manager: Deepa Shetty
Standard: FCC Part 15, RSS-247	Project Engineer: David Bare
	Class: N/A

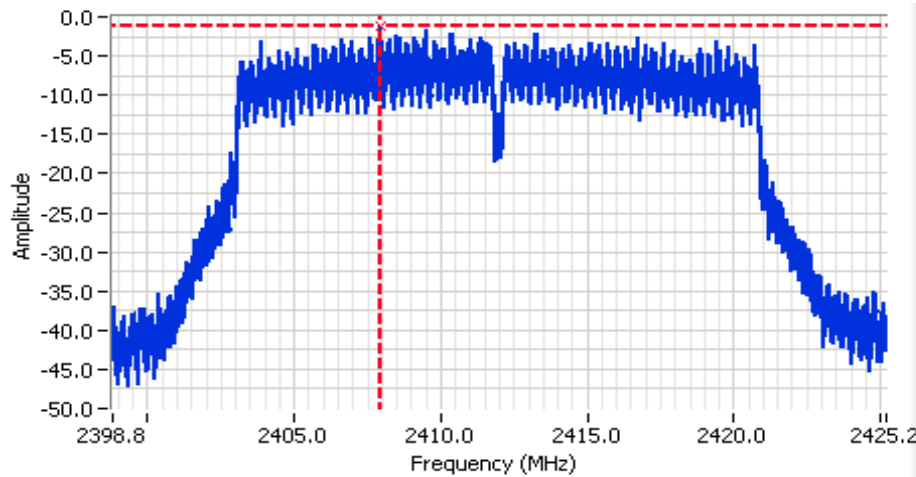

**Analyzer Settings**

CF: 2412.000 MHz  
SPAN: 26.400 MHz  
RB: 3.00 kHz  
VB: 10.0 kHz  
Detector: POS  
Attn: 10 DB  
RL Offset: 21.0 DB  
Sweep Time: 3.0s  
Ref Lvl: 10.0 DBM

**Comments**

802.11ac 20 MHz  
Chain: 4  
PSD: -1.1 dBm/3kHz

Cursor 1 2407.950000 -1.1

0.000000 0.0

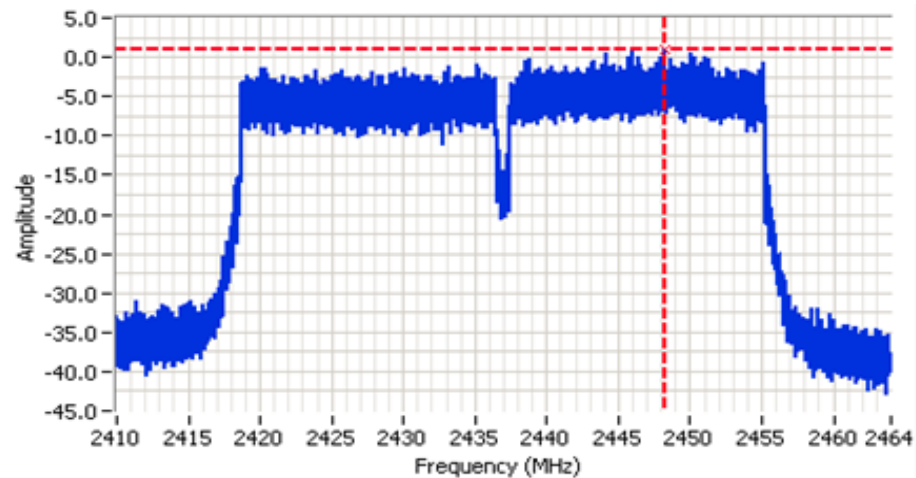

**Analyzer Settings**

CF: 2437.000 MHz  
SPAN: 54.000 MHz  
RB: 10.0 kHz  
VB: 30.0 kHz  
Detector: POS  
Attn: 10 DB  
RL Offset: 21.0 DB  
Sweep Time: 0.5s  
Ref Lvl: 10.0 DBM

**Comments**

802.11ac 40MHz  
Chain: 3  
PSD: 0.8 dBm/10kHz

Cursor 1 2448.240000 0.8

0.000000 0.0





# EMC Test Data

Client: Arris	PR Number: PR101106
Model: NVG5XDBAX	T-Log Number: TL-101106-RANA
Contact: Mark Rieger	Project Manager: Deepa Shetty
Standard: FCC Part 15, RSS-247	Project Engineer: David Bare
	Class: N/A

## Run #3: Signal Bandwidth

Note 1: DTS BW: RBW=100kHz, VBW ≥ 3\*RBW, peak detector, max hold, auto sweep time, Span 2-5 times measured BW.  
 99% BW: RBW=1-5% of 99%BW, VBW ≥ 3\*RBW, peak detector, max hold, auto sweep time. Span 1.5-5 times OBW.

Note 2: Measurements performed on chain 1 (Yellow antenna cable)

Mode: 11b

Power Setting	Frequency (MHz)	Bandwidth (MHz)		RBW Setting (MHz)	
		6dB	99%	6dB	99%
22	2412	7.07	10.197	0.1	0.12
22	2437	7.53	10.696	0.1	0.12
22	2462	7.07	10.796	0.1	0.12

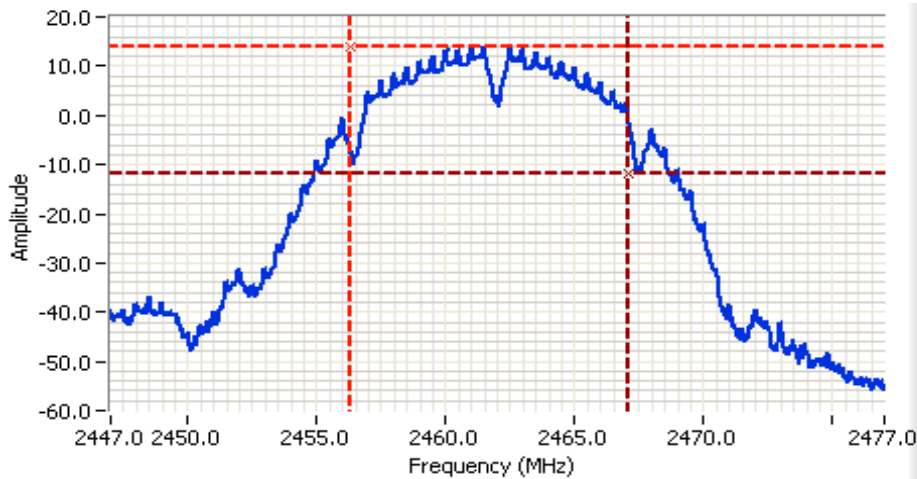

### Analyzer Settings

Agilent Technologies, E4446A  
 CF: 2462.000 MHz  
 SPAN: 30.000 MHz  
 RB: 120 kHz  
 VB: 360 kHz  
 Detector: POS  
 Attn: 20 DB  
 RL Offset: 14.5 DB  
 Sweep Time: 2.0ms  
 Ref Lvl: 20.0 DBM

### Comments

99% power BW: 10.796 MHz

Cursor 1	2456.276908	14.0	⊕ ⊖ ⊞ ⊚
Cursor 2	2467.073309	-12.0	⊕ ⊖ ⊞ ⊚

Delta Freq. 10.796  
 Delta Amplitude 26.0





# EMC Test Data

Client: Arris	PR Number: PR101106
Model: NVG5XDBAX	T-Log Number: TL-101106-RANA
Contact: Mark Rieger	Project Manager: Deepa Shetty
Standard: FCC Part 15, RSS-247	Project Engineer: David Bare
	Class: N/A

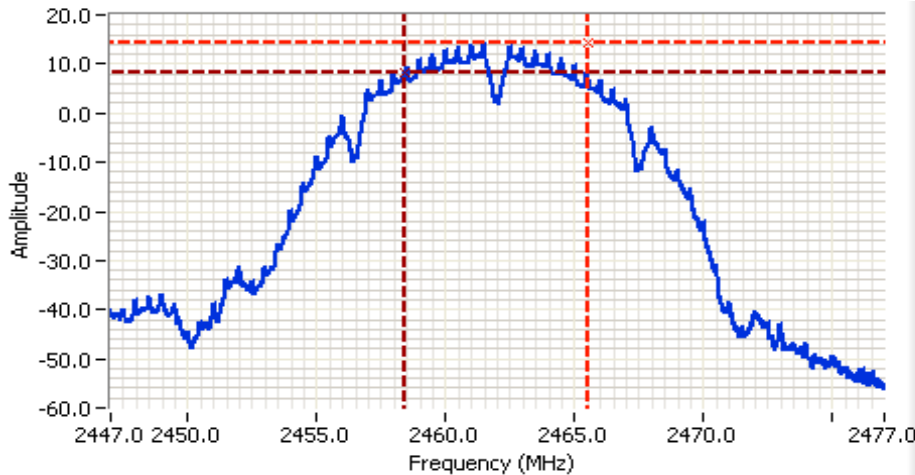

**Analyzer Settings**

Agilent Technologies, E4446A  
 CF: 2462.000 MHz  
 SPAN: 30.000 MHz  
 RB: 100 kHz  
 VB: 300 kHz  
 Detector: POS  
 Attn: 20 DB  
 RL Offset: 14.5 DB  
 Sweep Time: 3.0ms  
 Ref Lvl: 20.0 DBM

**Comments**

6dB BW: 7.070 MHz

Cursor 1 2465.510000 14.1

Cursor 2 2458.440000 8.1

Delta Freq. 7.070

Delta Amplitude 6.0



Mode: 11g

Power Setting	Frequency (MHz)	Bandwidth (MHz)		RBW Setting (MHz)	
		6dB	99%	6dB	99%
26	2412	16.333	16.594	0.1	0.2
26	2437	16.120	16.834	0.1	0.2
26	2462	15.947	16.914	0.1	0.2



# EMC Test Data

Client: Arris	PR Number: PR101106
Model: NVG5XDBAX	T-Log Number: TL-101106-RANA
Contact: Mark Rieger	Project Manager: Deepa Shetty
Standard: FCC Part 15, RSS-247	Project Engineer: David Bare
	Class: N/A

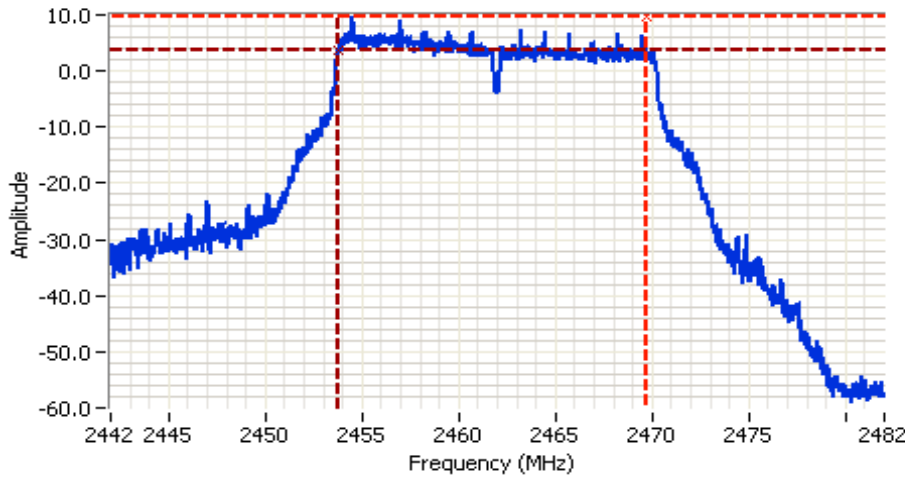

**Analyzer Settings**  
 Agilent Technologies, E4446A  
 CF: 2462.000 MHz  
 SPAN: 40.000 MHz  
 RB: 100 kHz  
 VB: 300 kHz  
 Detector: POS  
 Attn: 20 DB  
 RL Offset: 14.5 DB  
 Sweep Time: 4.0ms  
 Ref Lvl: 20.0 DBM

**Comments**  
 6dB BW: 15.947 MHz

Cursor 1 2469.746667 9.6

Cursor 2 2453.800000 3.6

Delta Freq. 15.947

Delta Amplitude 6.0

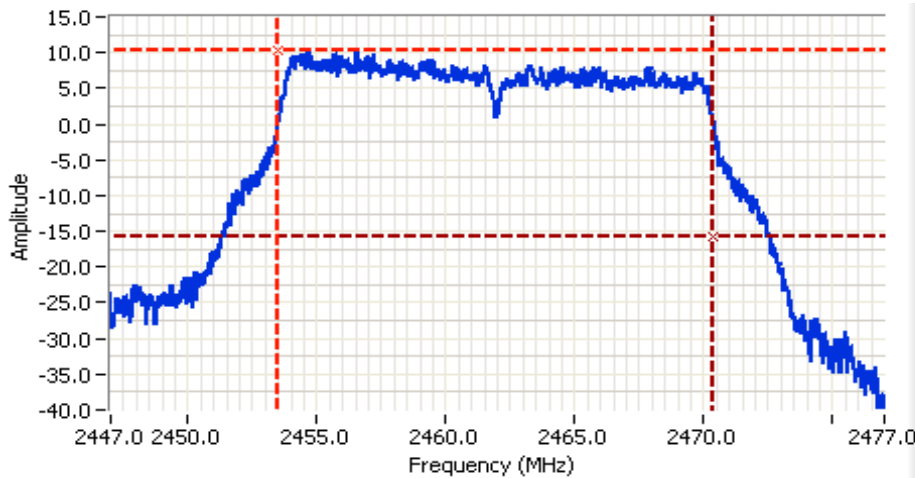

**Analyzer Settings**  
 Agilent Technologies, E4446A  
 CF: 2462.000 MHz  
 SPAN: 30.000 MHz  
 RB: 200 kHz  
 VB: 620 kHz  
 Detector: POS  
 Attn: 20 DB  
 RL Offset: 14.5 DB  
 Sweep Time: 1.0ms  
 Ref Lvl: 20.0 DBM

**Comments**  
 99% power BW: 16.914 MHz

Cursor 1 2453.457847 10.4

Cursor 2 2470.372209 -15.6

Delta Freq. 16.914

Delta Amplitude 26.0





# EMC Test Data

Client: Arris	PR Number: PR101106
Model: NVG5XDBAX	T-Log Number: TL-101106-RANA
Contact: Mark Rieger	Project Manager: Deepa Shetty
Standard: FCC Part 15, RSS-247	Project Engineer: David Bare
	Class: N/A

Mode: ac20

Power Setting	Frequency (MHz)	Bandwidth (MHz)		RBW Setting (MHz)	
		6dB	99%	6dB	99%
24	2412	17.547	17.894	0.1	0.3
24	2437	17.600	18.124	0.1	0.3
24	2462	17.360	18.324	0.1	0.3

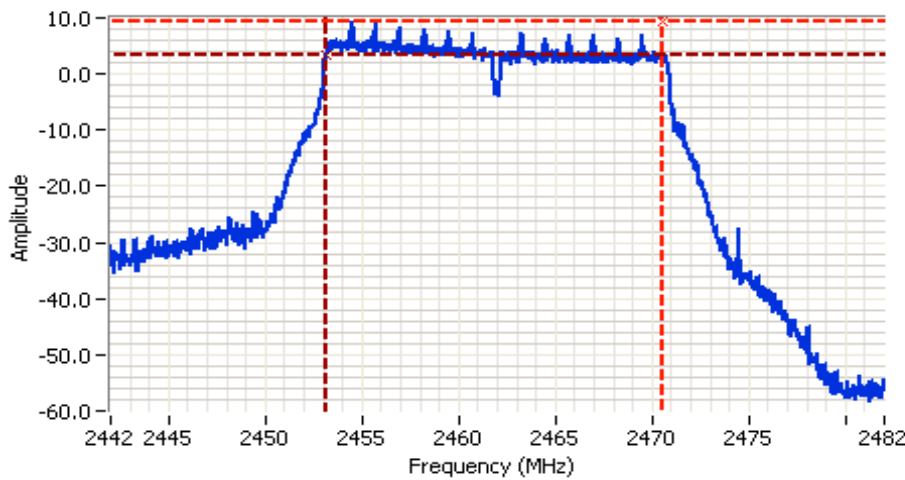

**Analyzer Settings**  
 Agilent Technologies, E4446A  
 CF: 2462.000 MHz  
 SPAN: 40.000 MHz  
 RB: 100 kHz  
 VB: 300 kHz  
 Detector: POS  
 Attn: 20 DB  
 RL Offset: 14.5 DB  
 Sweep Time: 4.0ms  
 Ref Lvl: 20.0 DBM

**Comments**  
 6dB BW: 17.360 MHz

Cursor 1	2470.546667	9.3	
Cursor 2	2453.186667	3.3	

Delta Freq. 17.360  
 Delta Amplitude 6.0





# EMC Test Data

Client: Arris	PR Number: PR101106
Model: NVG5XDBAX	T-Log Number: TL-101106-RANA
Contact: Mark Rieger	Project Manager: Deepa Shetty
Standard: FCC Part 15, RSS-247	Project Engineer: David Bare
	Class: N/A

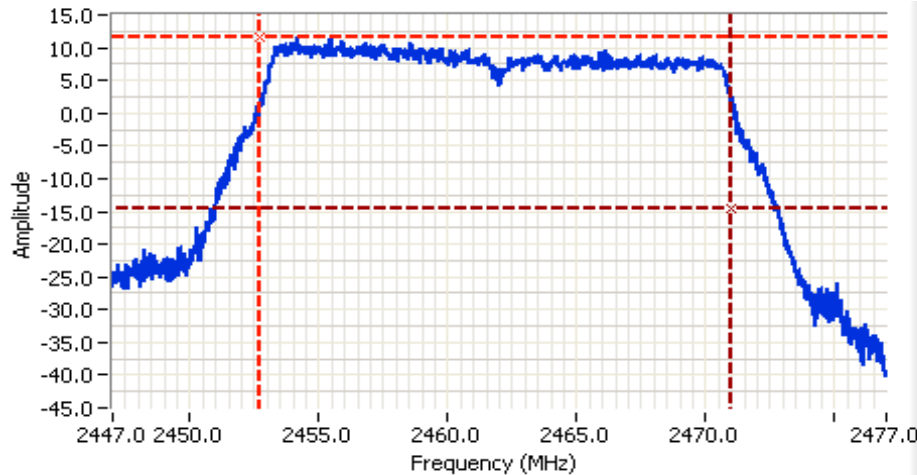

**Analyzer Settings**

Agilent Technologies, E4446A  
 CF: 2462.000 MHz  
 SPAN: 30.000 MHz  
 RB: 300 kHz  
 VB: 910 kHz  
 Detector: POS  
 Attn: 20 DB  
 RL Offset: 14.5 DB  
 Sweep Time: 1.0ms  
 Ref Lvl: 20.0 DBM

**Comments**

99% power BW: 18.324 MHz

Cursor 1 2452.688104 11.5

Cursor 2 2471.011996 -14.5

Delta Freq. 18.324

Delta Amplitude 26.0



Mode: ac40

Power Setting	Frequency (MHz)	Bandwidth (MHz)		RBW Setting (MHz)	
		6dB	99%	6dB	99%
24	2422	36.293	36.415	0.1	0.5
24	2437	36.027	36.441	0.1	0.5
24	2452	35.093	36.201	0.1	0.5





# EMC Test Data

Client: Arris	PR Number: PR101106
Model: NVG5XDBAX	T-Log Number: TL-101106-RANA
Contact: Mark Rieger	Project Manager: Deepa Shetty
Standard: FCC Part 15, RSS-247	Project Engineer: David Bare
	Class: N/A

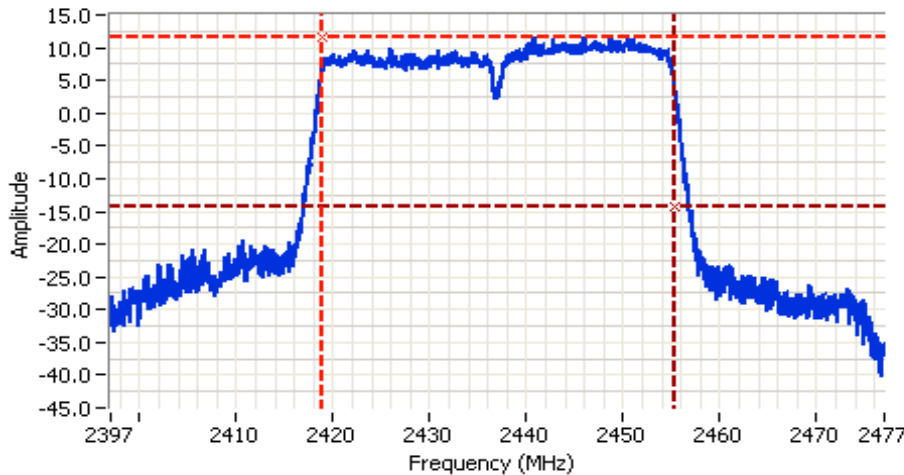

**Analyzer Settings**  
 Agilent Technologies, E4446A  
 CF: 2437.000 MHz  
 SPAN: 80.000 MHz  
 RB: 510 kHz  
 VB: 1.500 MHz  
 Detector: POS  
 Attn: 20 DB  
 RL Offset: 14.5 DB  
 Sweep Time: 1.0ms  
 Ref Lvl: 20.0 DBM

**Comments**  
 99% power BW: 36.441 MHz

Cursor 1 2418.806065 11.6

Cursor 2 2455.247251 -14.4

Delta Freq. 36.441

Delta Amplitude 26.0

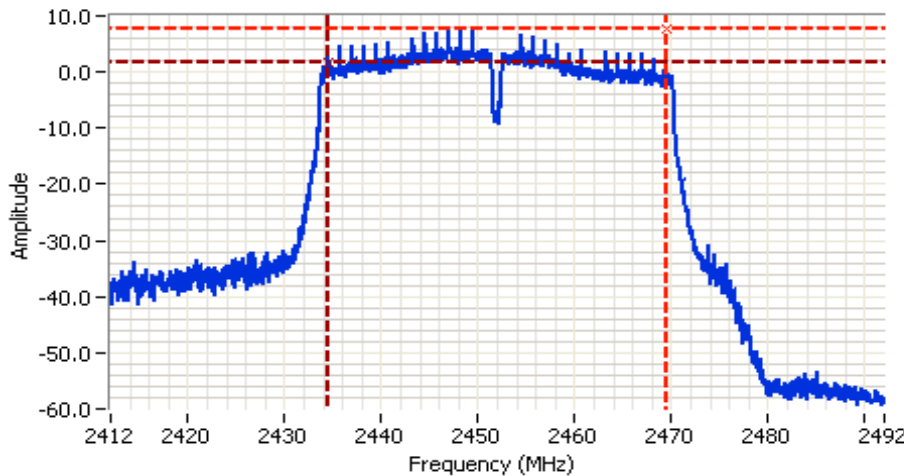

**Analyzer Settings**  
 Agilent Technologies, E4446A  
 CF: 2452.000 MHz  
 SPAN: 80.000 MHz  
 RB: 100 kHz  
 VB: 300 kHz  
 Detector: POS  
 Attn: 20 DB  
 RL Offset: 14.5 DB  
 Sweep Time: 7.8ms  
 Ref Lvl: 20.0 DBM

**Comments**  
 6dB BW: 35.093 MHz

Cursor 1 2469.520000 7.7

Cursor 2 2434.426667 1.7

Delta Freq. 35.093

Delta Amplitude 6.0





# EMC Test Data

Client: Arris	PR Number: PR101106
Model: NVG5XDBAX	T-Log Number: TL-101106-RANA
	Project Manager: Deepa Shetty
Contact: Mark Rieger	Project Engineer: David Bare
Standard: FCC Part 15, RSS-247	Class: N/A

## Run #4a: Out of Band Spurious Emissions

Power Setting Per Chain (All the same)				Mode	Frequency (MHz)	Limit	Result
#1	#2	#3	#4				
26	26	26	26	11b	2412	-30dBc	Pass
26	26	26	26	11b	2437	-30dBc	Pass
26	26	26	26	11b	2462	-30dBc	Pass
24	24	24	24	11g	2412	-30dBc	Pass
26	26	26	26	11g	2437	-30dBc	Pass
26	26	26	26	11g	2462	-30dBc	Pass
24	24	24	24	11ac20	2412	-30dBc	Pass
24	24	24	24	11ac20	2437	-30dBc	Pass
24	24	24	24	11ac20	2462	-30dBc	Pass
24	24	24	24	11ac40	2422	-30dBc	Pass
24	24	24	24	11ac40	2437	-30dBc	Pass
24	24	24	24	11ac40	2452	-30dBc	Pass

Note 1: All plots use 100 kHz RBW and VBW at least 3 times the RBW

Note 2: Measured on each chain individually

802.11b

Plots for low channel

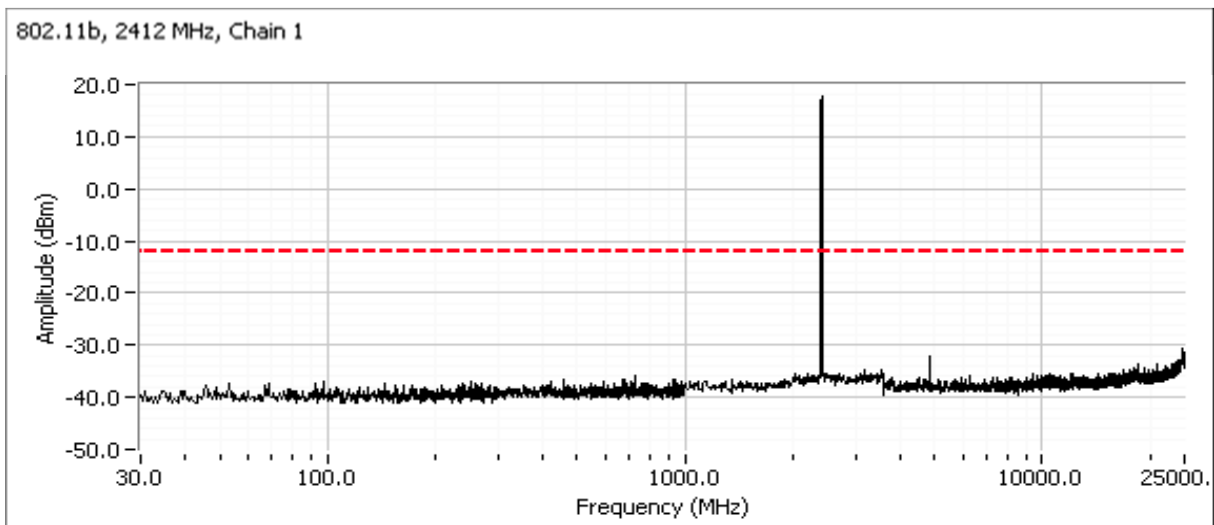



# EMC Test Data

Client: Arris	PR Number: PR101106
Model: NVG5XDBAX	T-Log Number: TL-101106-RANA
Contact: Mark Rieger	Project Manager: Deepa Shetty
Standard: FCC Part 15, RSS-247	Project Engineer: David Bare
	Class: N/A

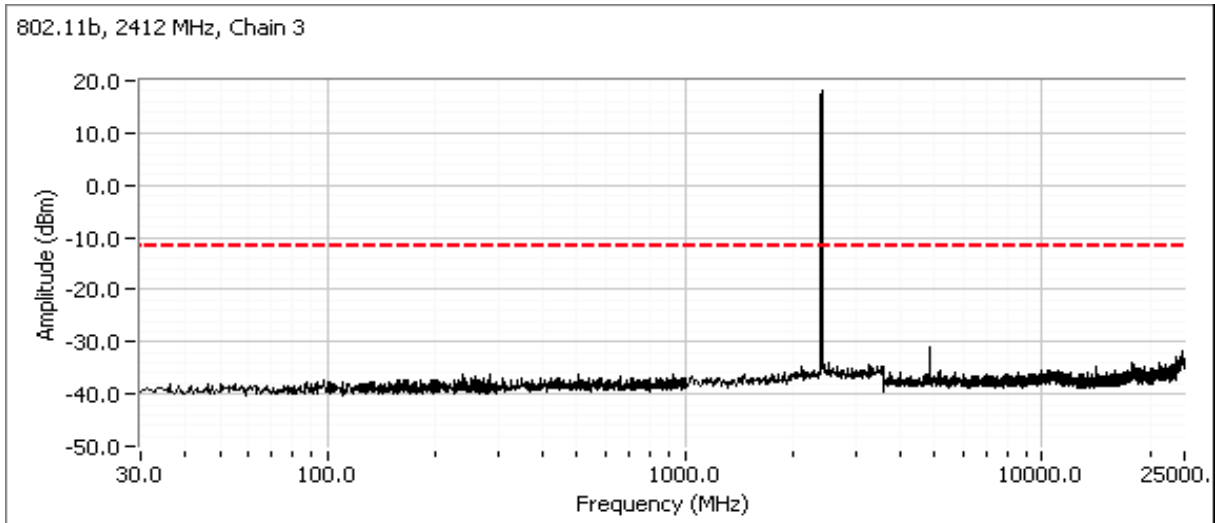
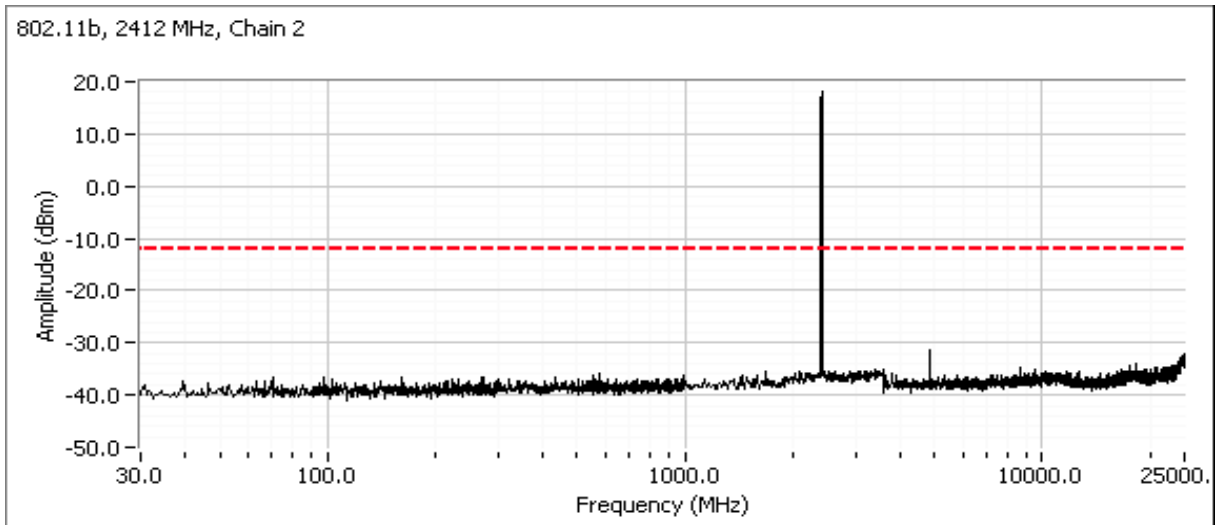



# EMC Test Data

Client: Arris	PR Number: PR101106
Model: NVG5XDBAX	T-Log Number: TL-101106-RANA
Contact: Mark Rieger	Project Manager: Deepa Shetty
Standard: FCC Part 15, RSS-247	Project Engineer: David Bare
	Class: N/A

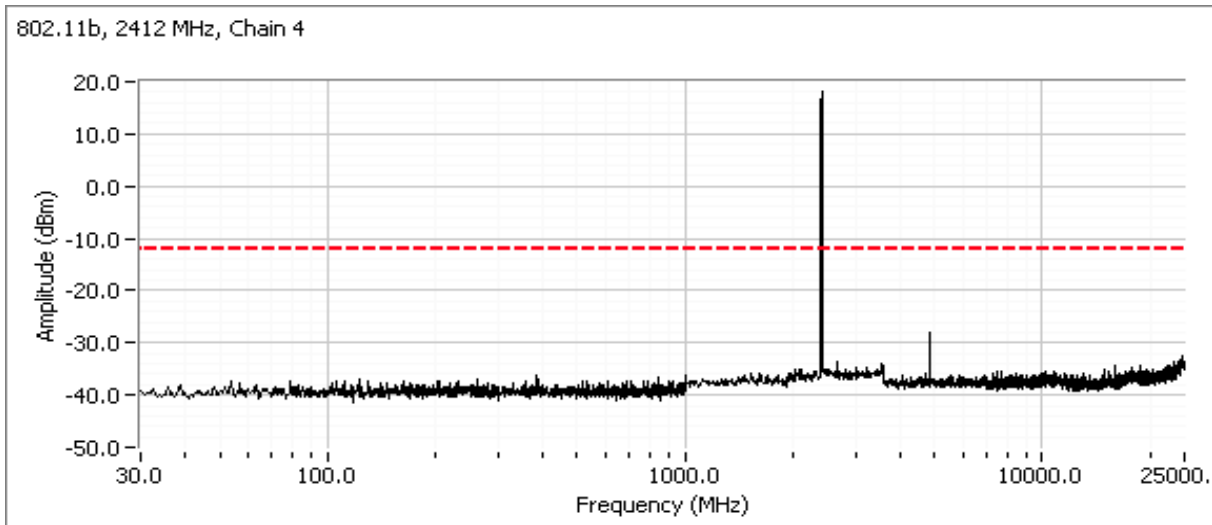

Additional plot showing compliance with -30dBc limit from 2390 MHz to 2400 MHz. Radiated measurements used to show compliance with the limits in the restricted band below 2390 MHz.

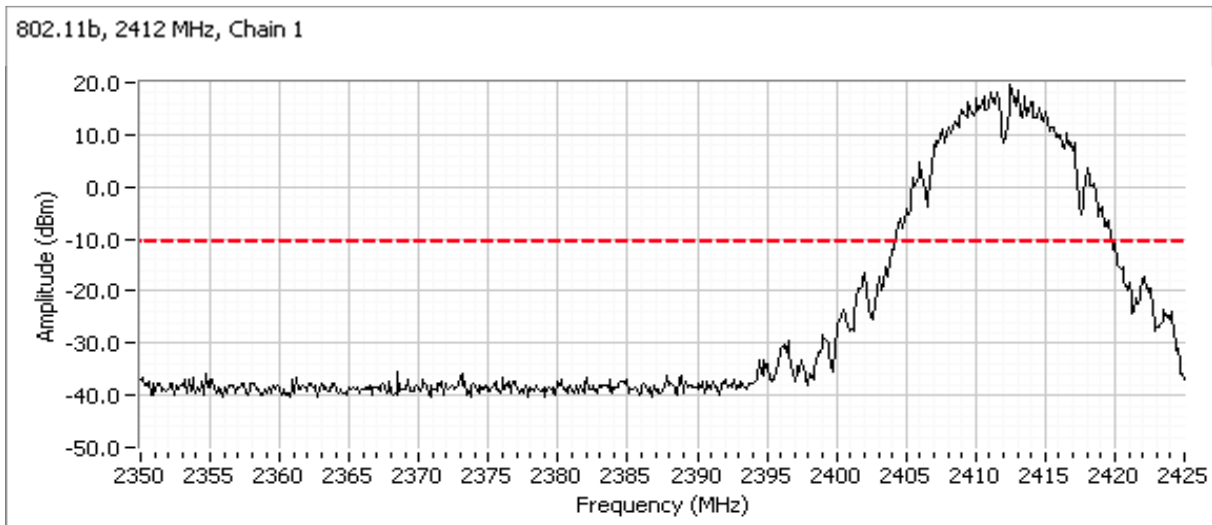



# EMC Test Data

Client: Arris	PR Number: PR101106
Model: NVG5XDBAX	T-Log Number: TL-101106-RANA
Contact: Mark Rieger	Project Manager: Deepa Shetty
Standard: FCC Part 15, RSS-247	Project Engineer: David Bare
	Class: N/A

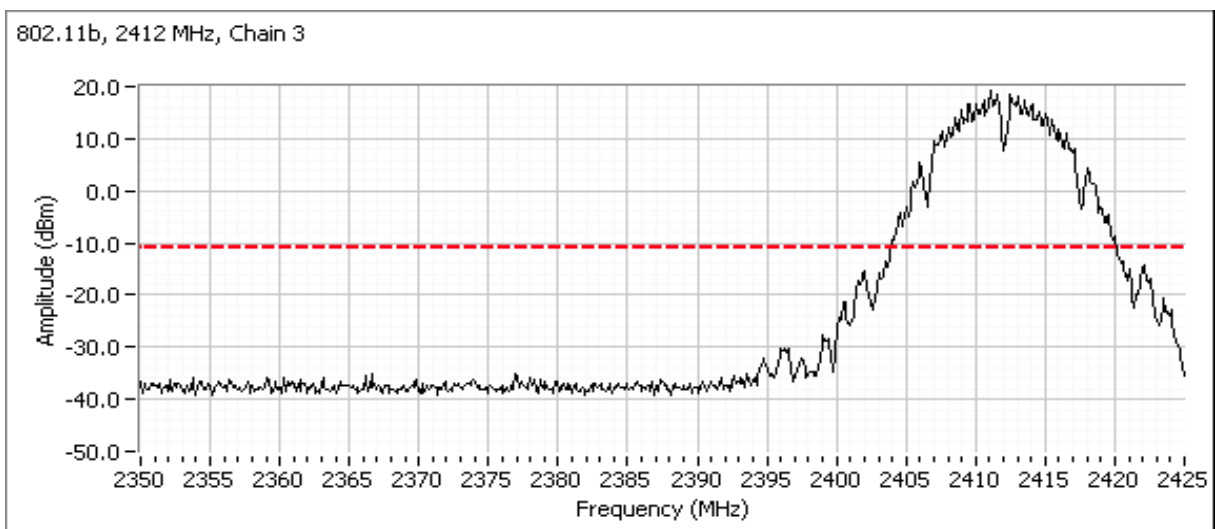
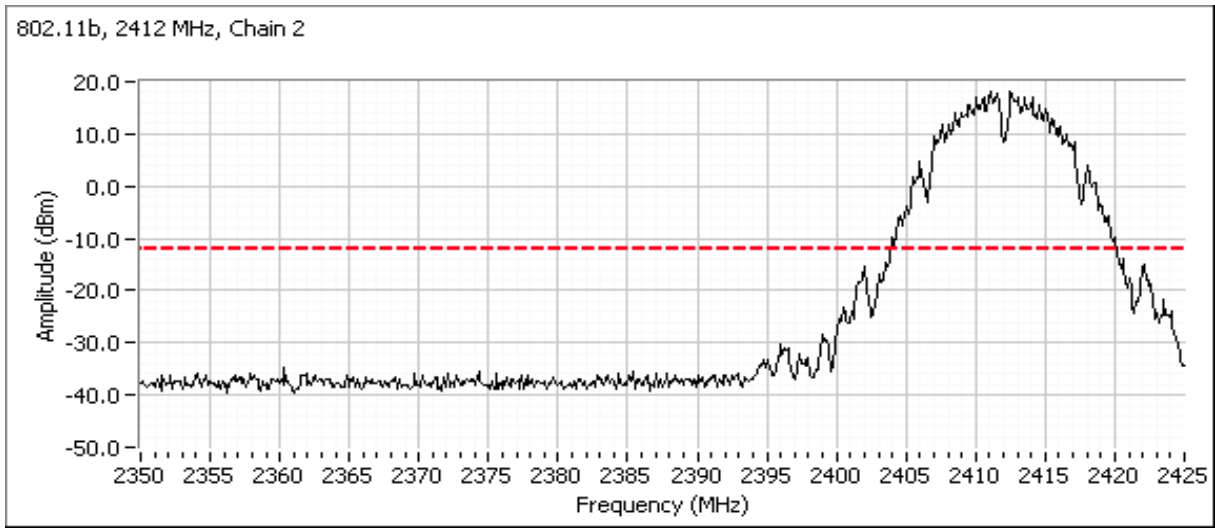



# EMC Test Data

Client: Arris	PR Number: PR101106
Model: NVG5XDBAX	T-Log Number: TL-101106-RANA
Contact: Mark Rieger	Project Manager: Deepa Shetty
Standard: FCC Part 15, RSS-247	Project Engineer: David Bare
	Class: N/A

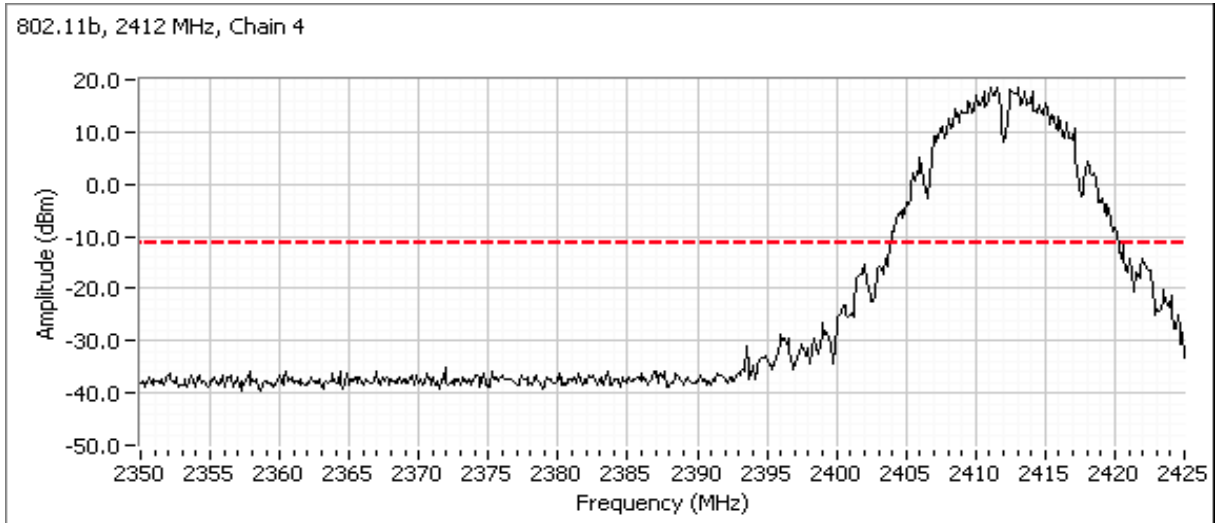

Plots for center channel

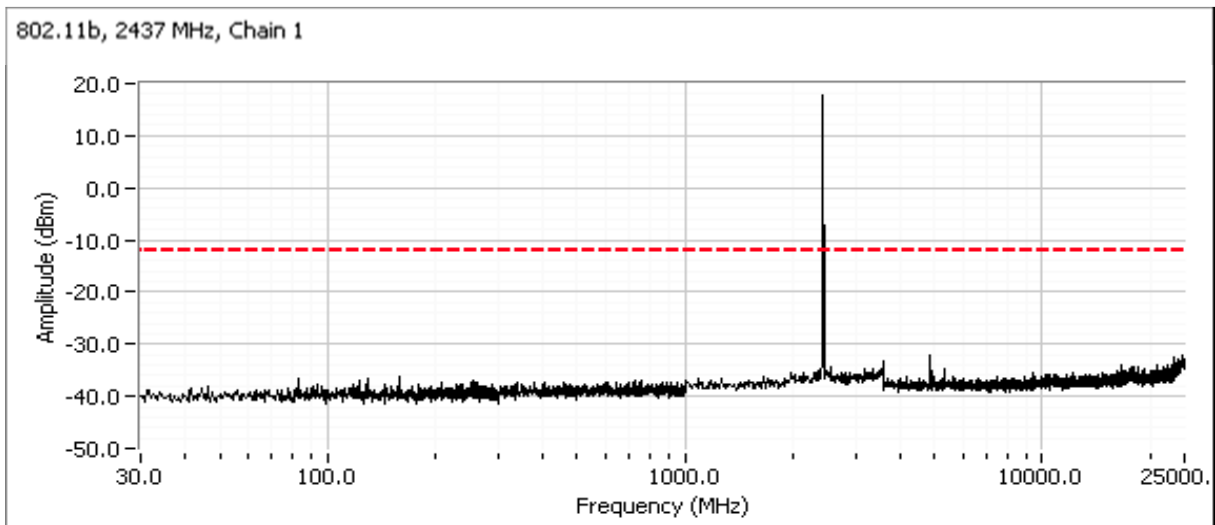



# EMC Test Data

Client: Arris	PR Number: PR101106
Model: NVG5XDBAX	T-Log Number: TL-101106-RANA
Contact: Mark Rieger	Project Manager: Deepa Shetty
Standard: FCC Part 15, RSS-247	Project Engineer: David Bare
	Class: N/A

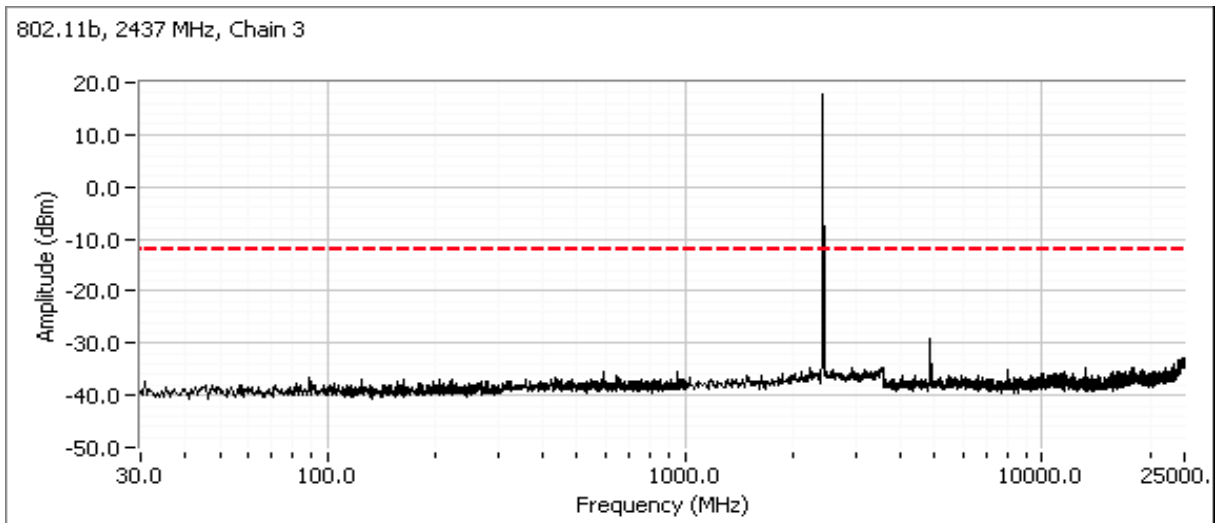
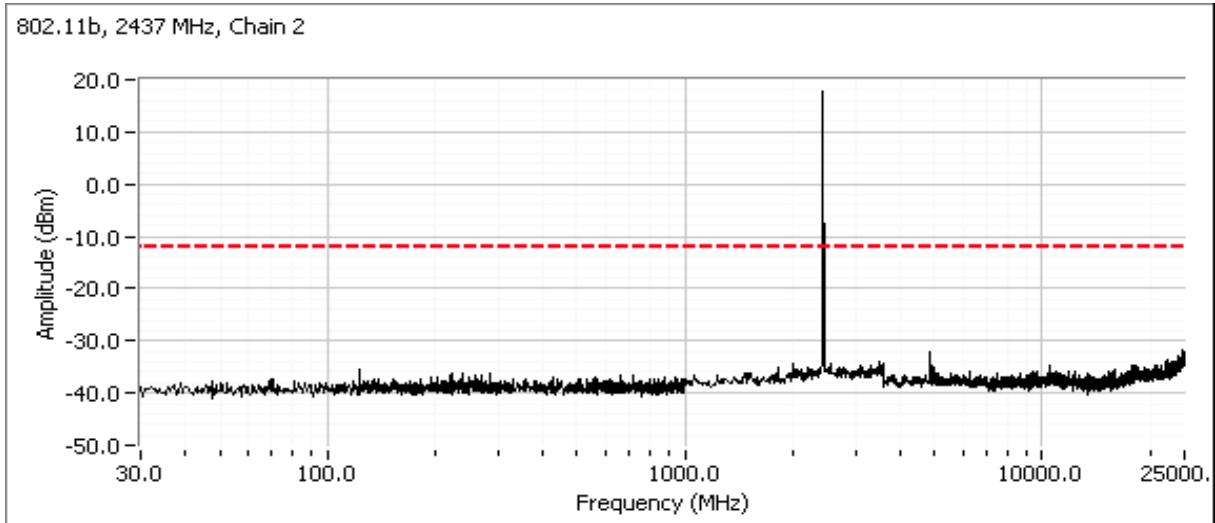



# EMC Test Data

Client: Arris	PR Number: PR101106
Model: NVG5XDBAX	T-Log Number: TL-101106-RANA
Contact: Mark Rieger	Project Manager: Deepa Shetty
Standard: FCC Part 15, RSS-247	Project Engineer: David Bare
	Class: N/A

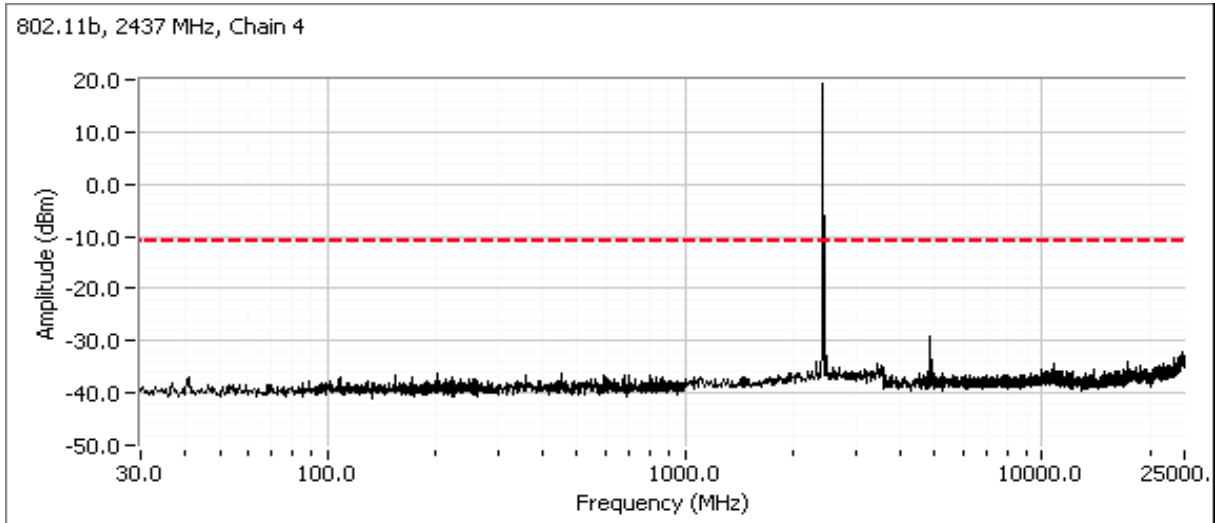

Plots for high channel

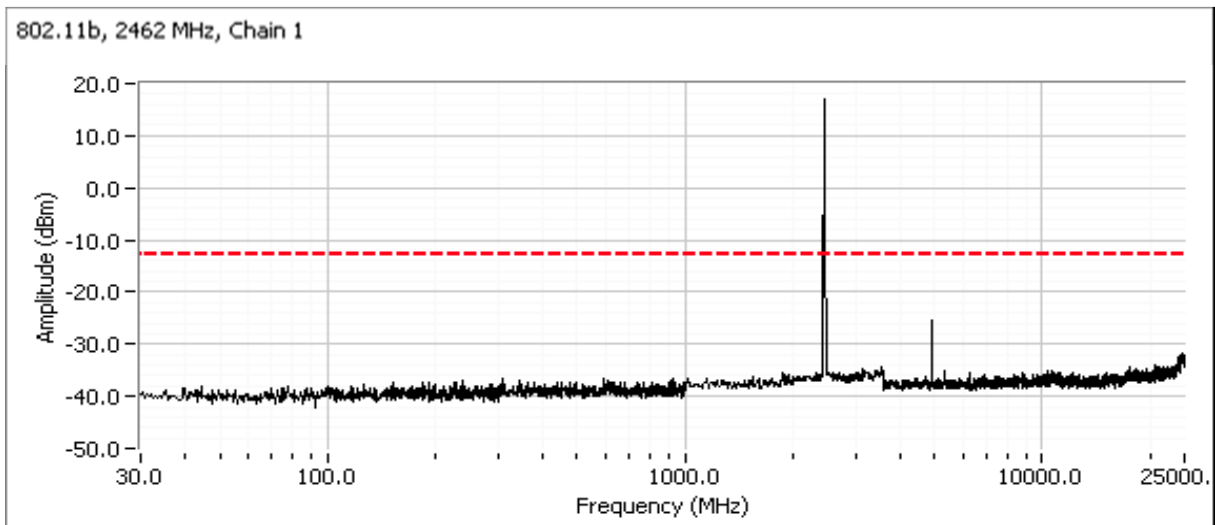





# EMC Test Data

Client: Arris	PR Number: PR101106
Model: NVG5XDBAX	T-Log Number: TL-101106-RANA
Contact: Mark Rieger	Project Manager: Deepa Shetty
Standard: FCC Part 15, RSS-247	Project Engineer: David Bare
	Class: N/A

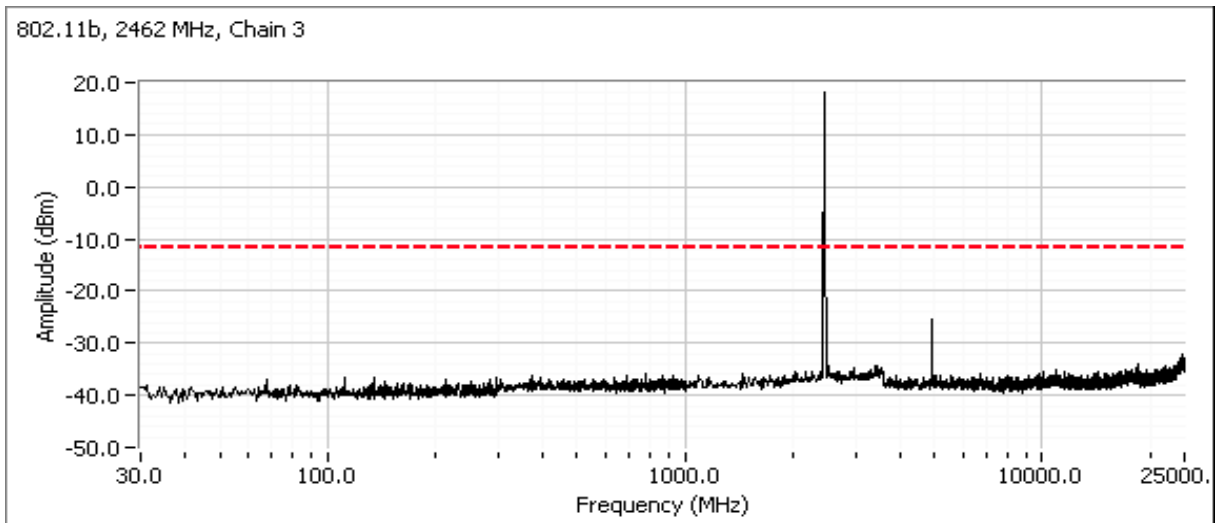
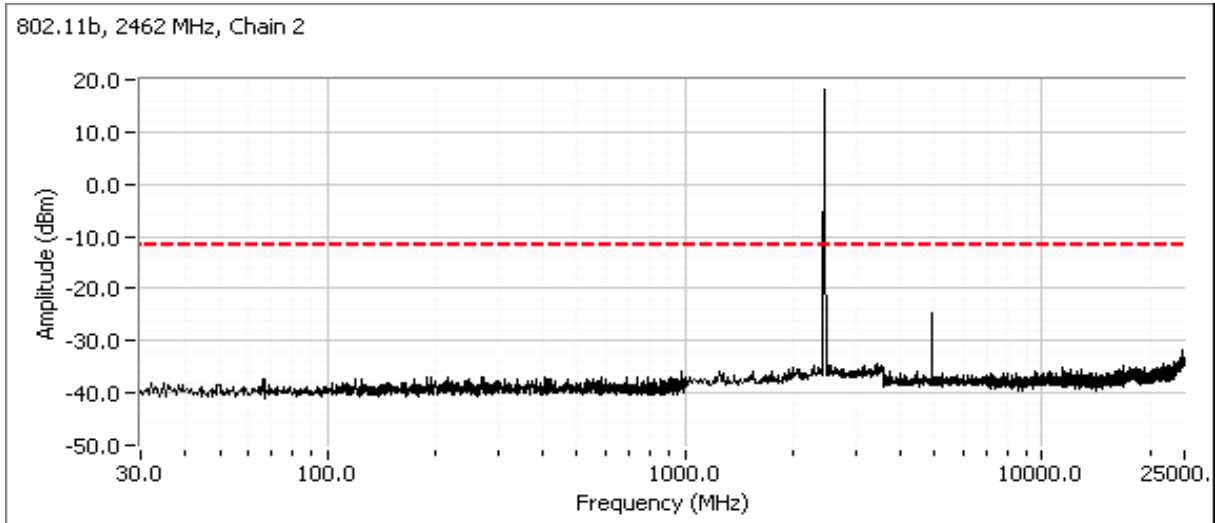



# EMC Test Data

Client: Arris	PR Number: PR101106
Model: NVG5XDBAX	T-Log Number: TL-101106-RANA
Contact: Mark Rieger	Project Manager: Deepa Shetty
Standard: FCC Part 15, RSS-247	Project Engineer: David Bare
	Class: N/A

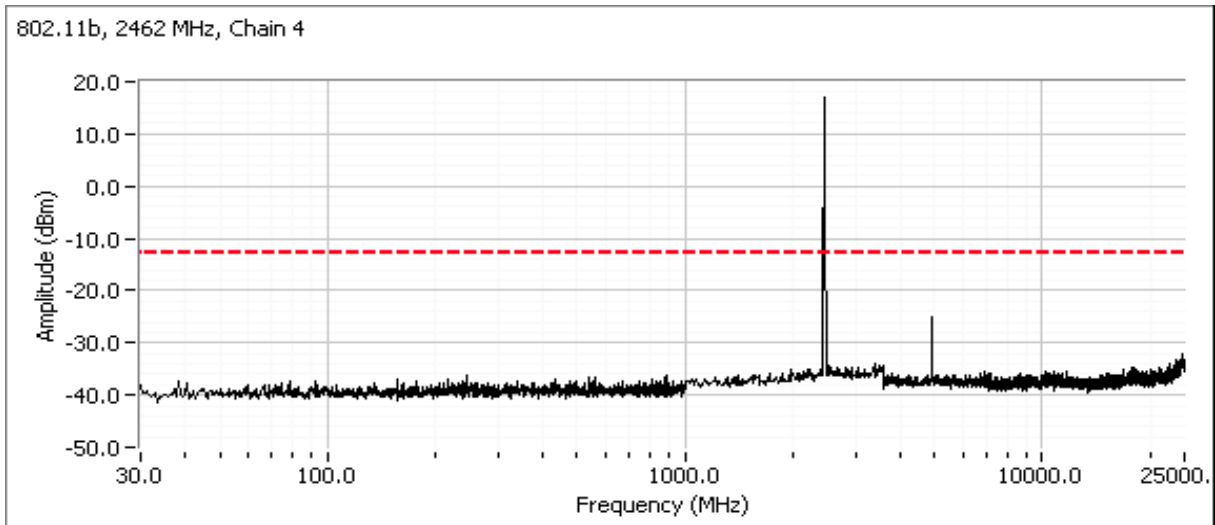

802.11g

Plots for low channel

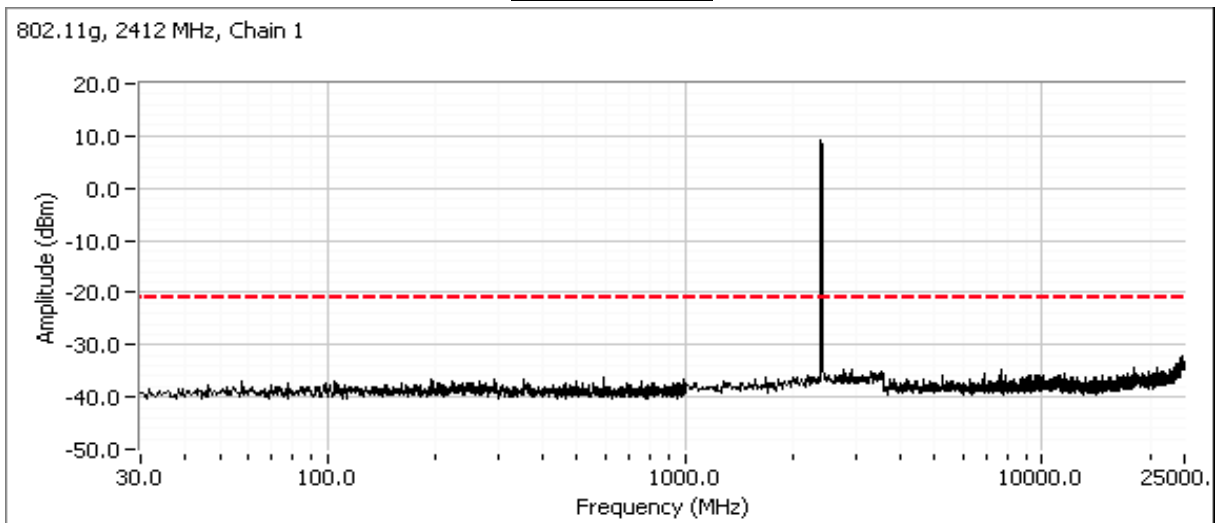



# EMC Test Data

Client: Arris	PR Number: PR101106
Model: NVG5XDBAX	T-Log Number: TL-101106-RANA
Contact: Mark Rieger	Project Manager: Deepa Shetty
Standard: FCC Part 15, RSS-247	Project Engineer: David Bare
	Class: N/A

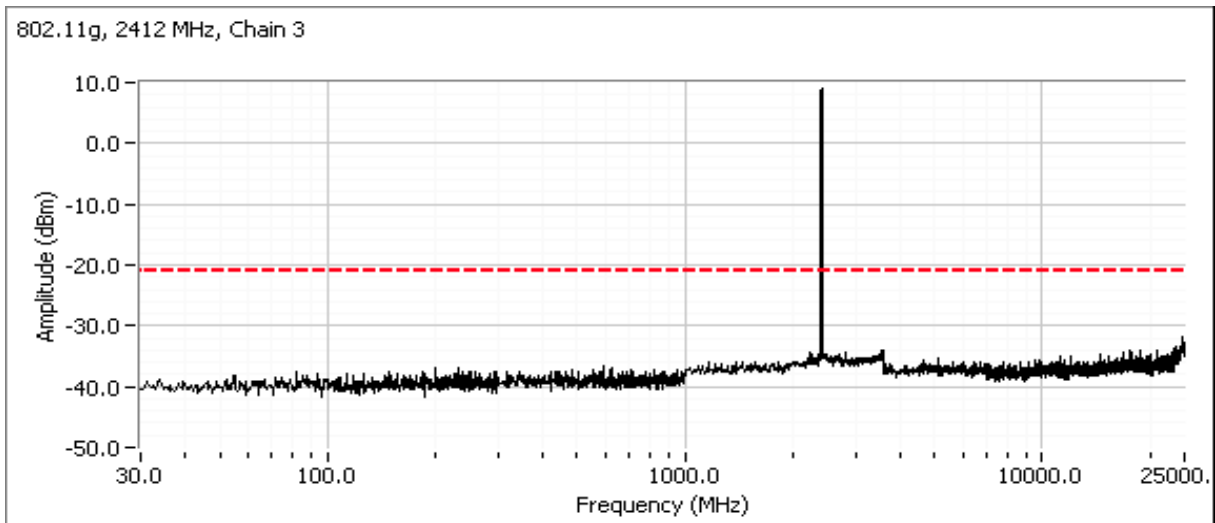
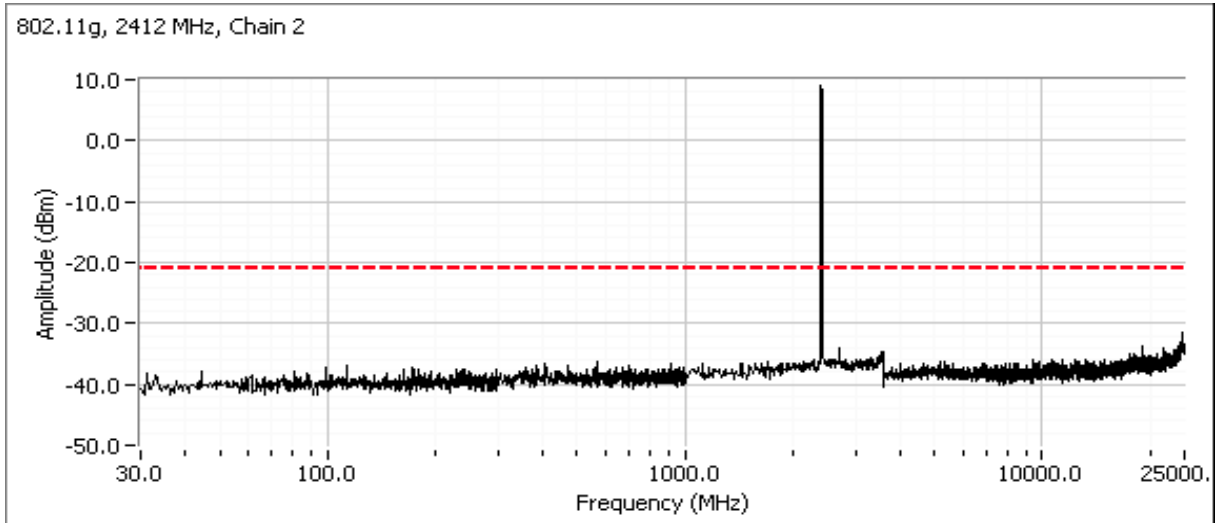



# EMC Test Data

Client: Arris	PR Number: PR101106
Model: NVG5XDBAX	T-Log Number: TL-101106-RANA
Contact: Mark Rieger	Project Manager: Deepa Shetty
Standard: FCC Part 15, RSS-247	Project Engineer: David Bare
	Class: N/A

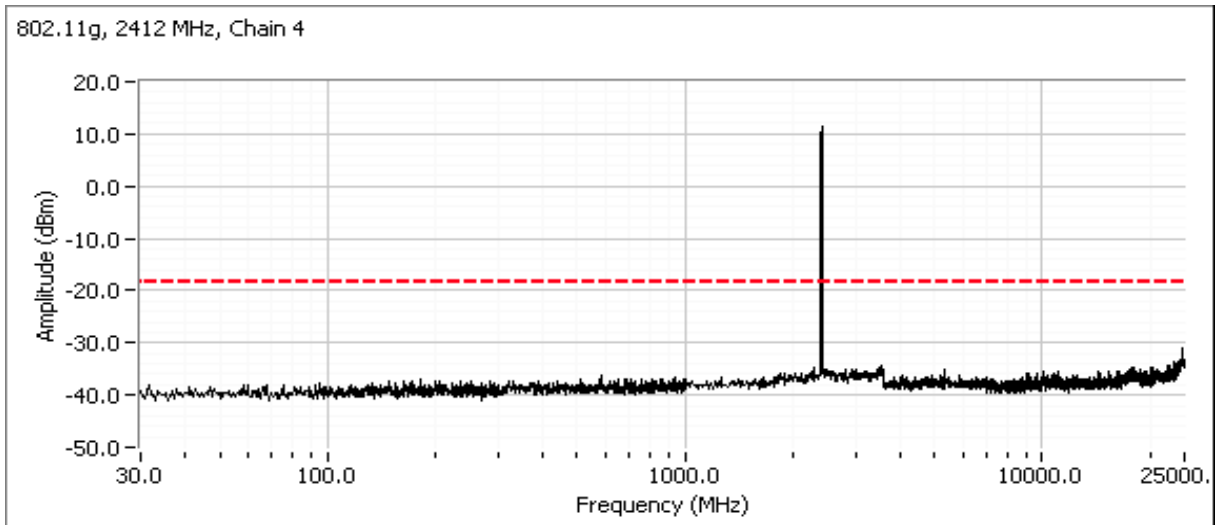

Additional plot showing compliance with -30dBc limit from 2390 MHz to 2400 MHz. Radiated measurements used to show compliance with the limits in the restricted band below 2390 MHz.

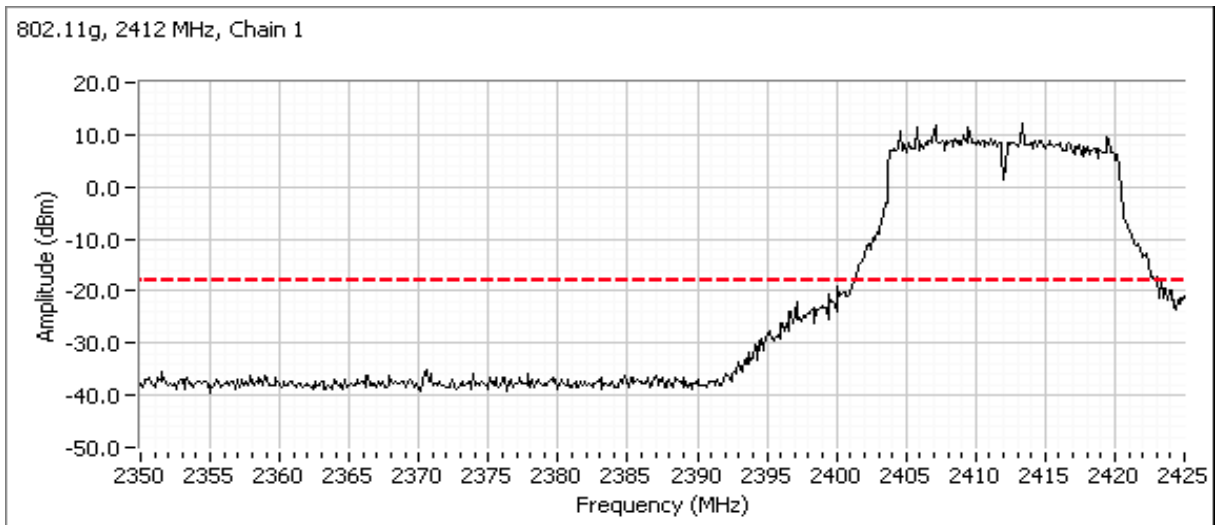



# EMC Test Data

Client: Arris	PR Number: PR101106
Model: NVG5XDBAX	T-Log Number: TL-101106-RANA
Contact: Mark Rieger	Project Manager: Deepa Shetty
Standard: FCC Part 15, RSS-247	Project Engineer: David Bare
	Class: N/A

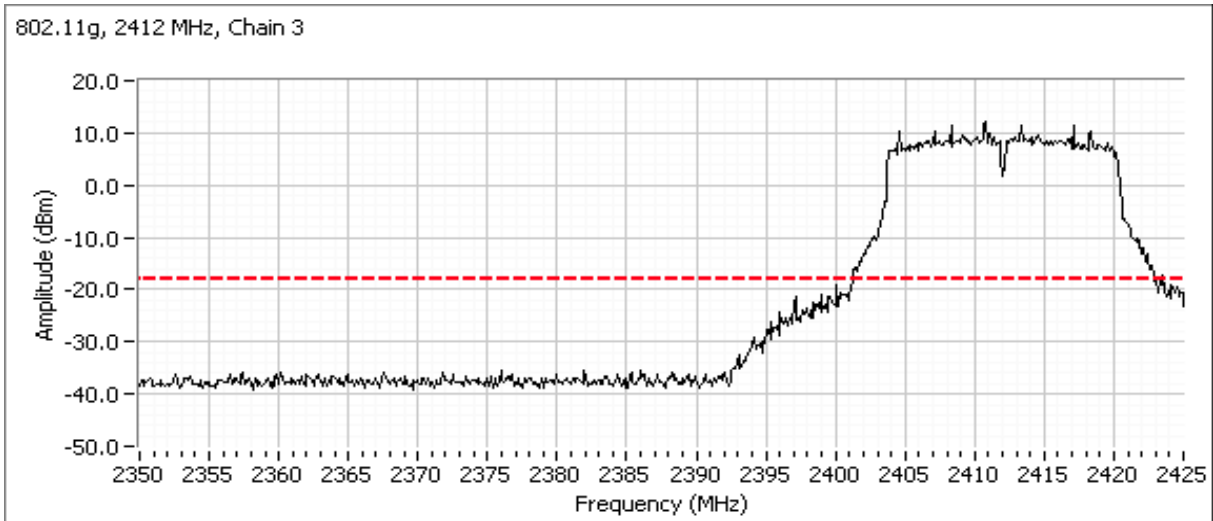
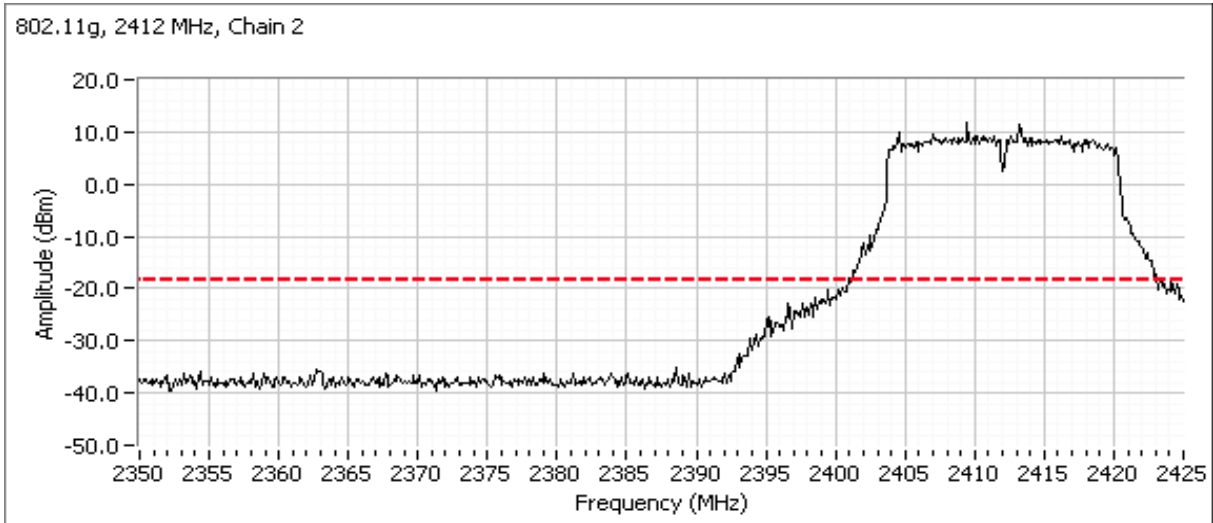



# EMC Test Data

Client: Arris	PR Number: PR101106
Model: NVG5XDBAX	T-Log Number: TL-101106-RANA
Contact: Mark Rieger	Project Manager: Deepa Shetty
Standard: FCC Part 15, RSS-247	Project Engineer: David Bare
	Class: N/A

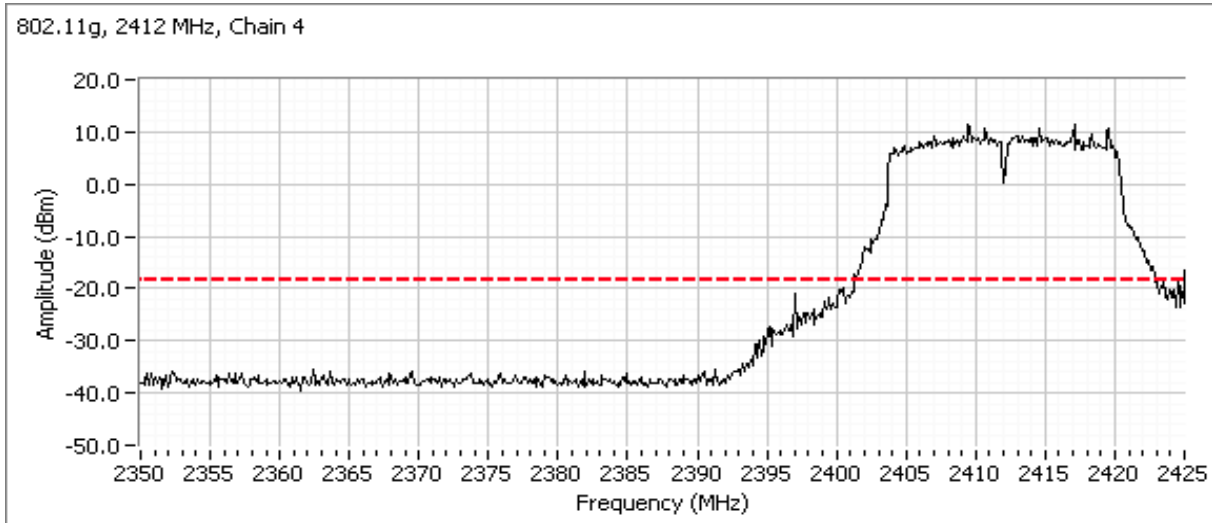

Plots for center channel

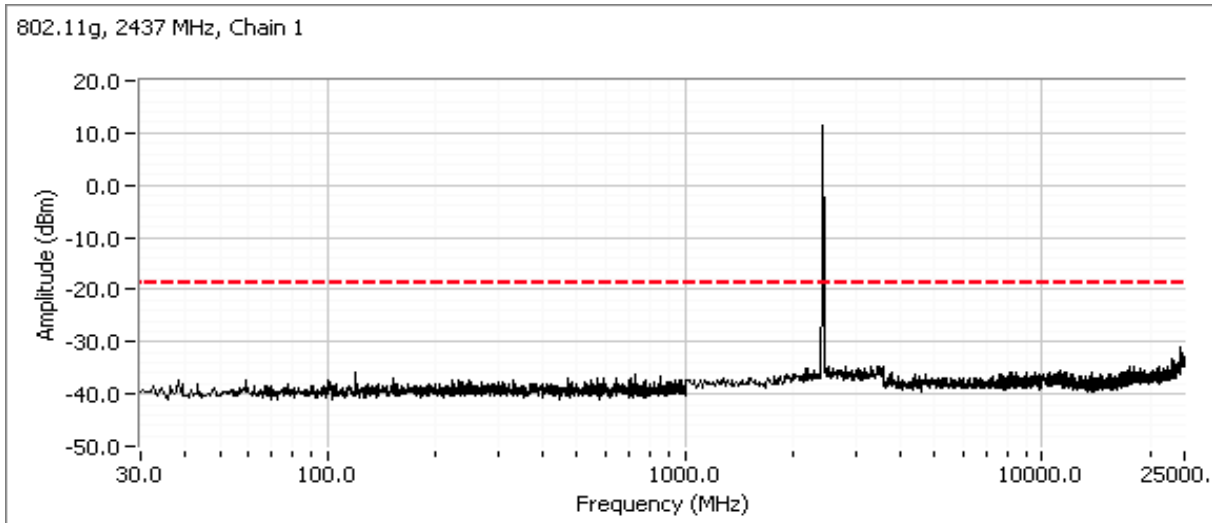



# EMC Test Data

Client: Arris	PR Number: PR101106
Model: NVG5XDBAX	T-Log Number: TL-101106-RANA
Contact: Mark Rieger	Project Manager: Deepa Shetty
Standard: FCC Part 15, RSS-247	Project Engineer: David Bare
	Class: N/A

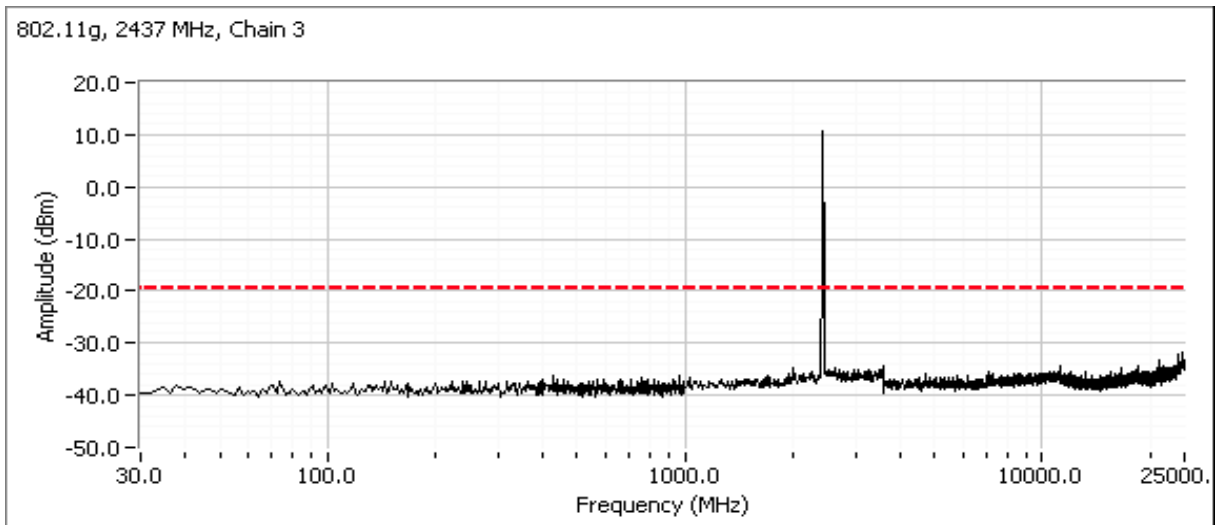
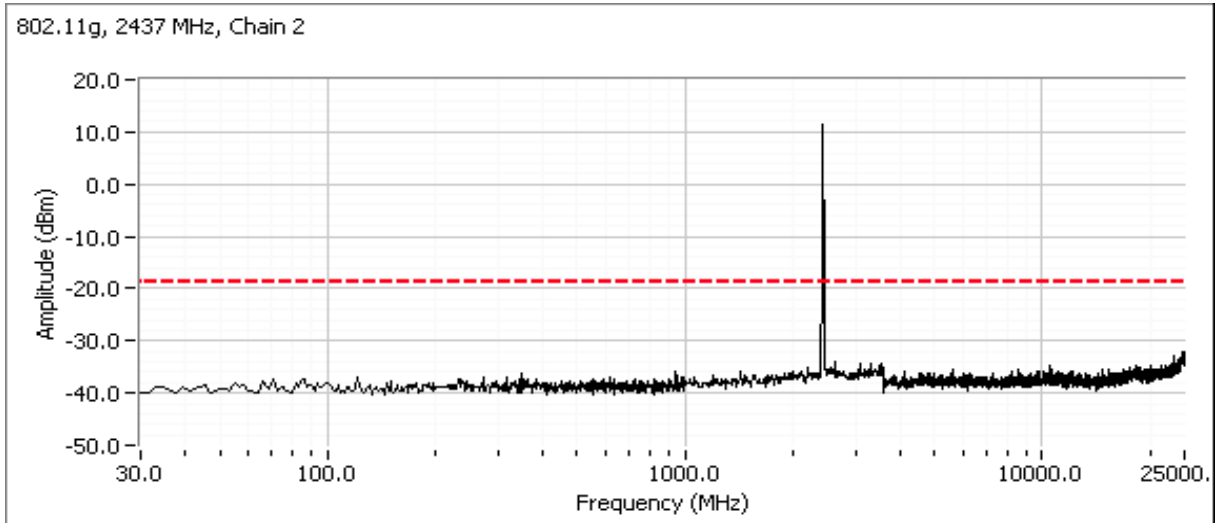



# EMC Test Data

Client: Arris	PR Number: PR101106
Model: NVG5XDBAX	T-Log Number: TL-101106-RANA
Contact: Mark Rieger	Project Manager: Deepa Shetty
Standard: FCC Part 15, RSS-247	Project Engineer: David Bare
	Class: N/A

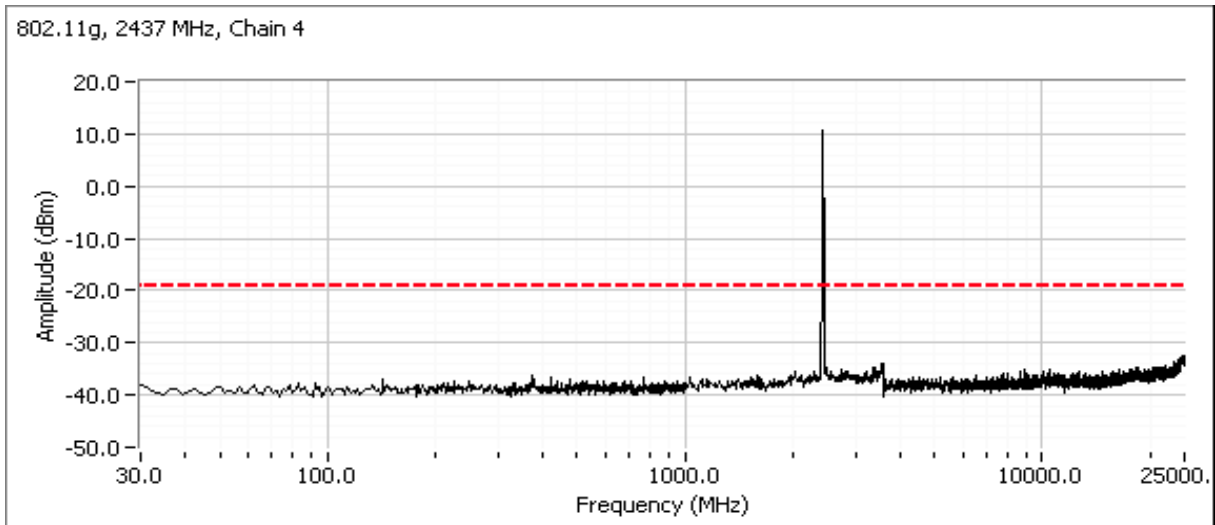

Plots for high channel

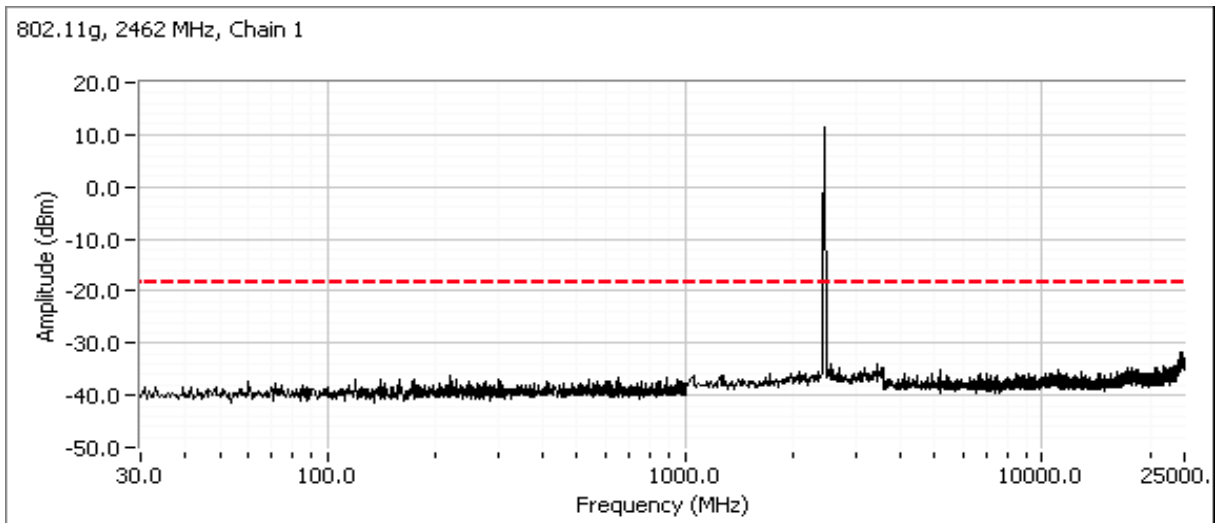





# EMC Test Data

Client: Arris	PR Number: PR101106
Model: NVG5XDBAX	T-Log Number: TL-101106-RANA
Contact: Mark Rieger	Project Manager: Deepa Shetty
Standard: FCC Part 15, RSS-247	Project Engineer: David Bare
	Class: N/A

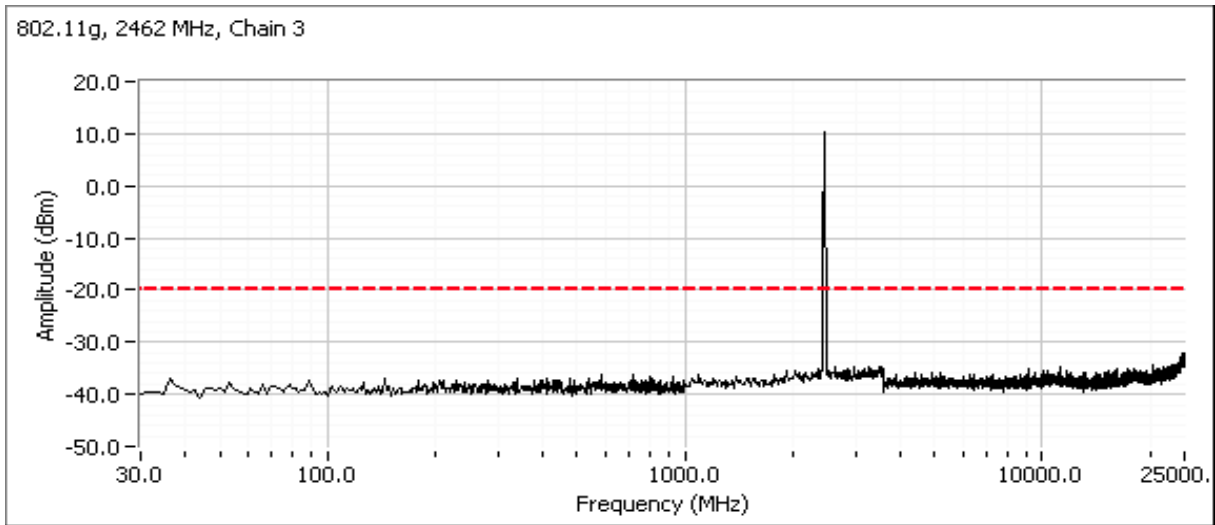
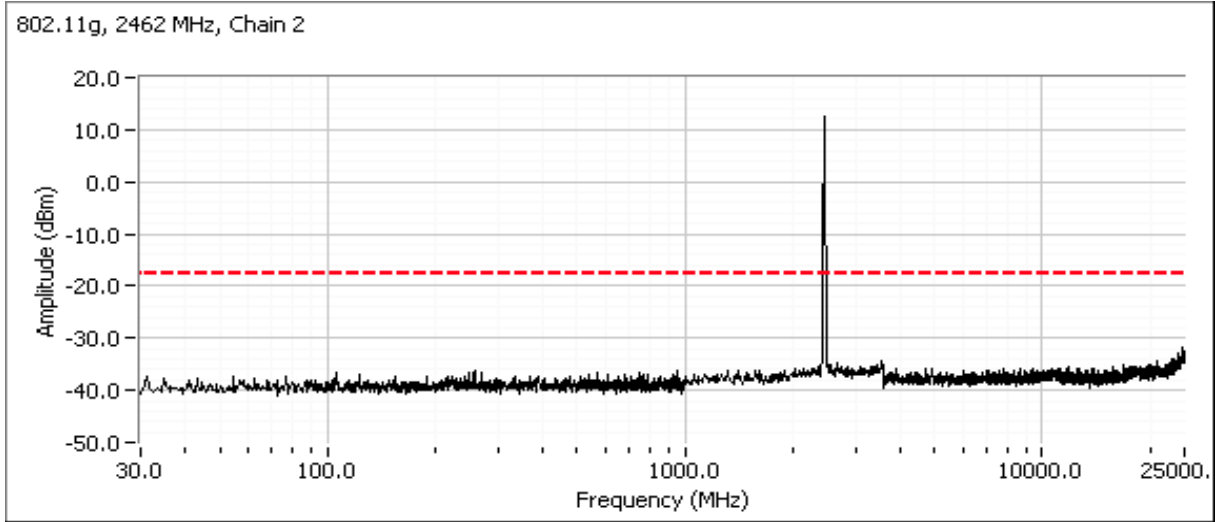



# EMC Test Data

Client: Arris	PR Number: PR101106
Model: NVG5XDBAX	T-Log Number: TL-101106-RANA
Contact: Mark Rieger	Project Manager: Deepa Shetty
Standard: FCC Part 15, RSS-247	Project Engineer: David Bare
	Class: N/A

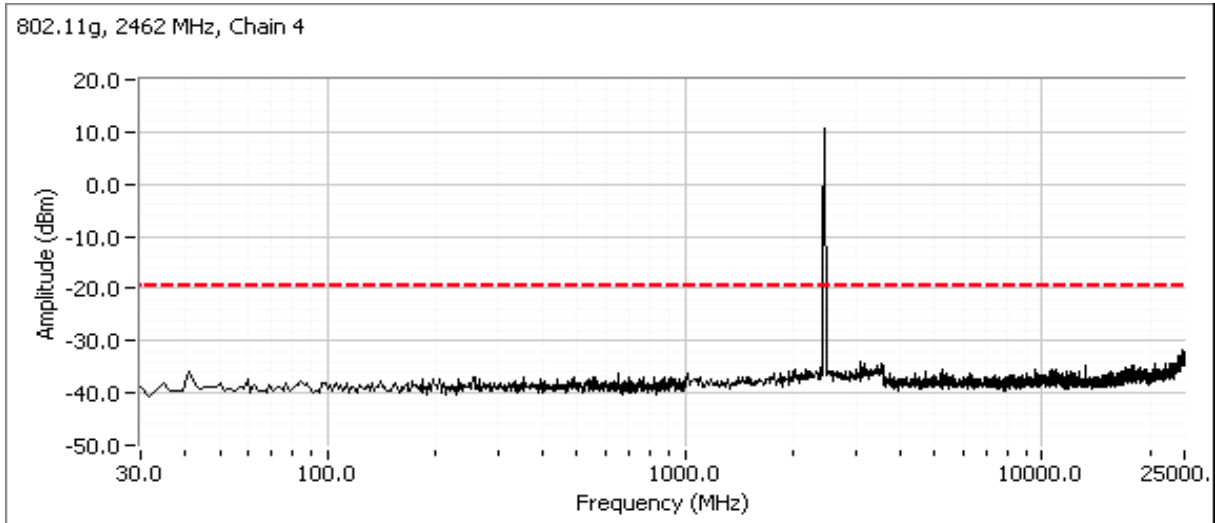

802.11ac20

Plots for low channel

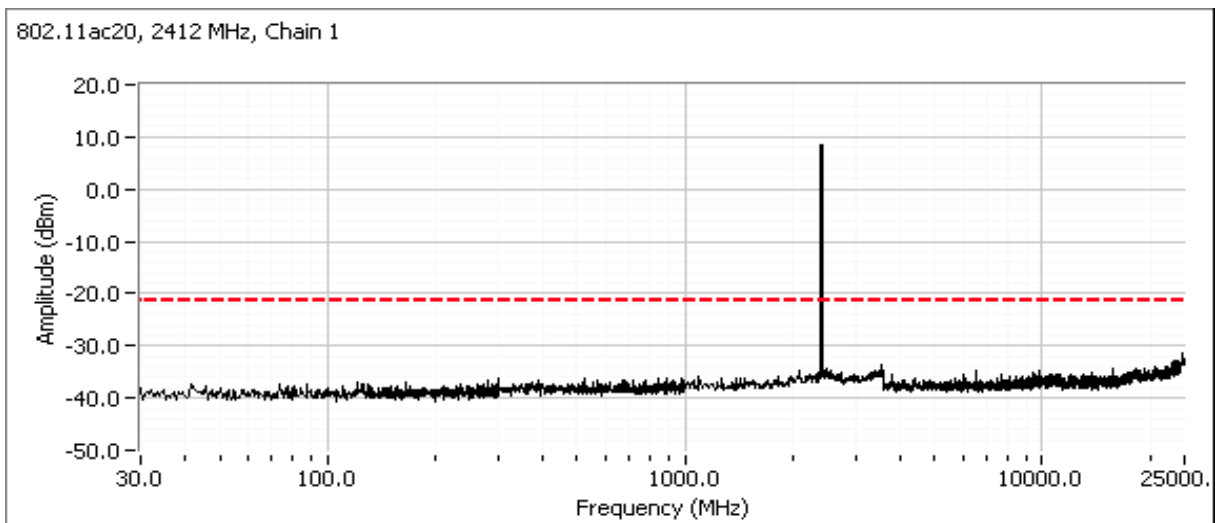



# EMC Test Data

Client: Arris	PR Number: PR101106
Model: NVG5XDBAX	T-Log Number: TL-101106-RANA
Contact: Mark Rieger	Project Manager: Deepa Shetty
Standard: FCC Part 15, RSS-247	Project Engineer: David Bare
	Class: N/A

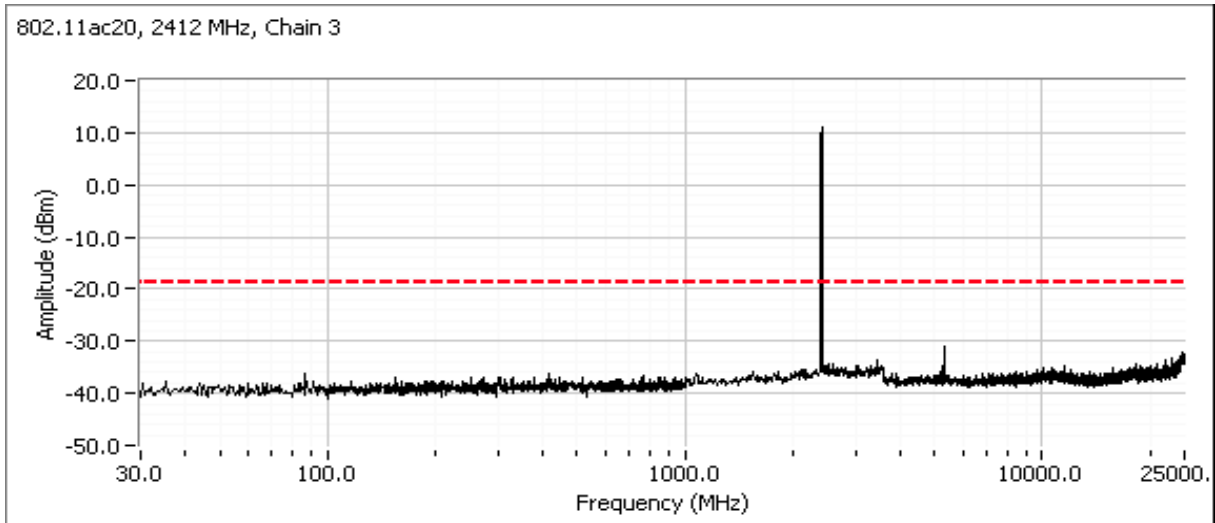
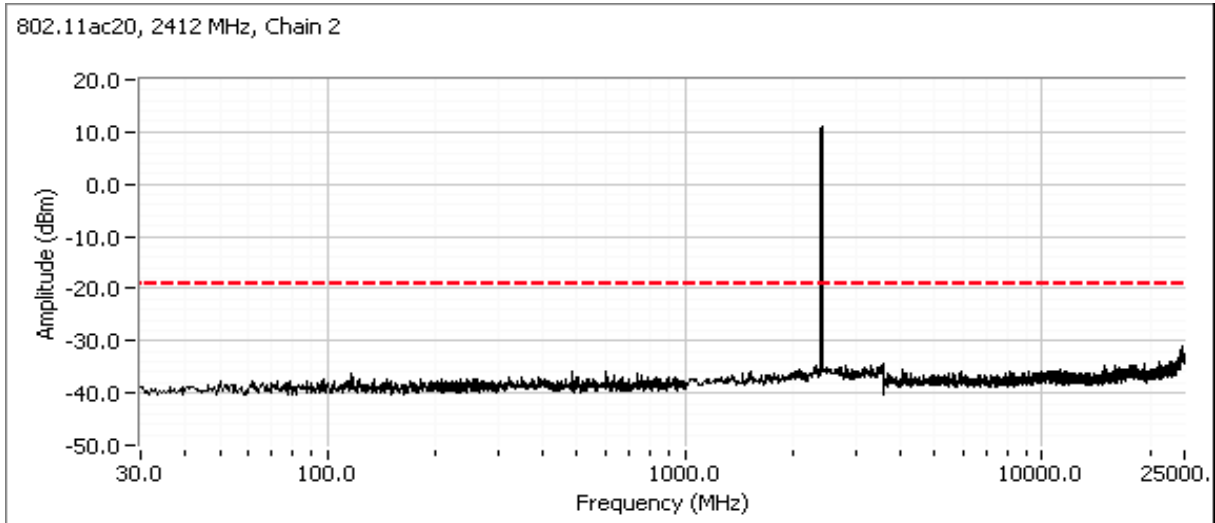



# EMC Test Data

Client: Arris	PR Number: PR101106
Model: NVG5XDBAX	T-Log Number: TL-101106-RANA
Contact: Mark Rieger	Project Manager: Deepa Shetty
Standard: FCC Part 15, RSS-247	Project Engineer: David Bare
	Class: N/A

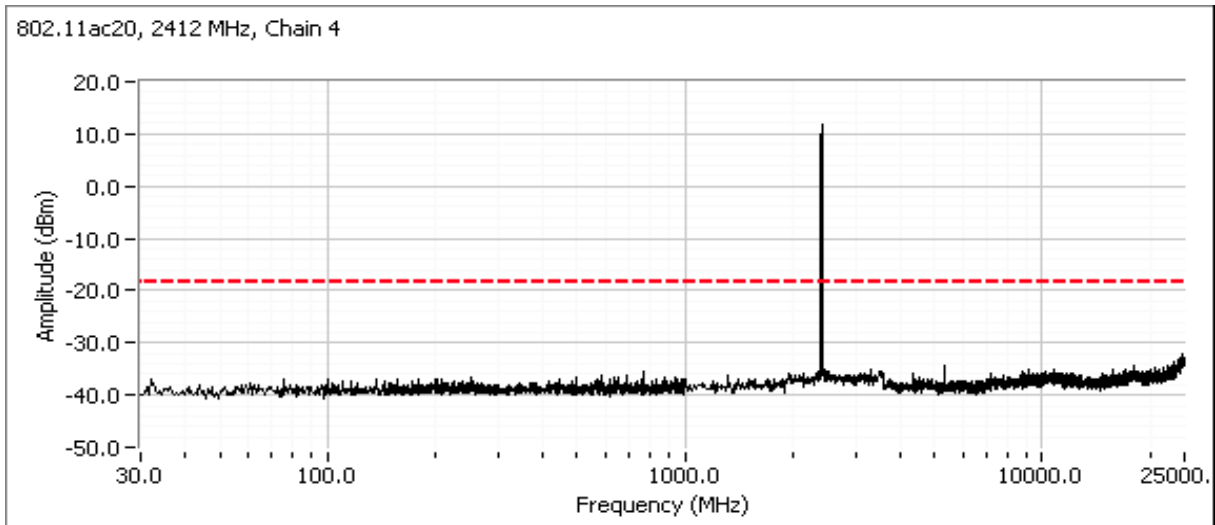

Additional plot showing compliance with -30dBc limit from 2390 MHz to 2400 MHz. Radiated measurements used to show compliance with the limits in the restricted band below 2390 MHz.

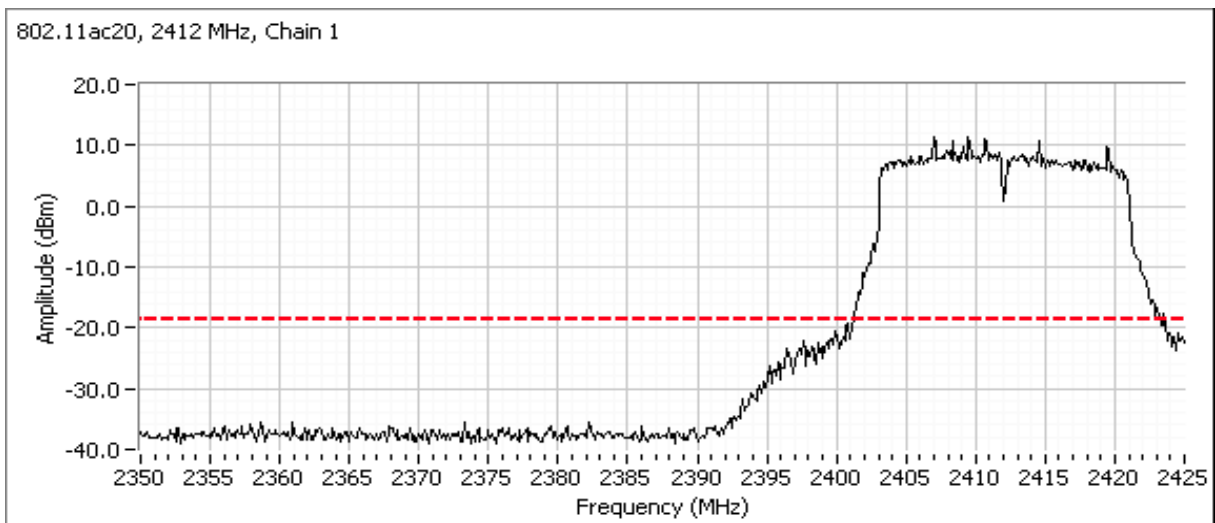



# EMC Test Data

Client: Arris	PR Number: PR101106
Model: NVG5XDBAX	T-Log Number: TL-101106-RANA
Contact: Mark Rieger	Project Manager: Deepa Shetty
Standard: FCC Part 15, RSS-247	Project Engineer: David Bare
	Class: N/A

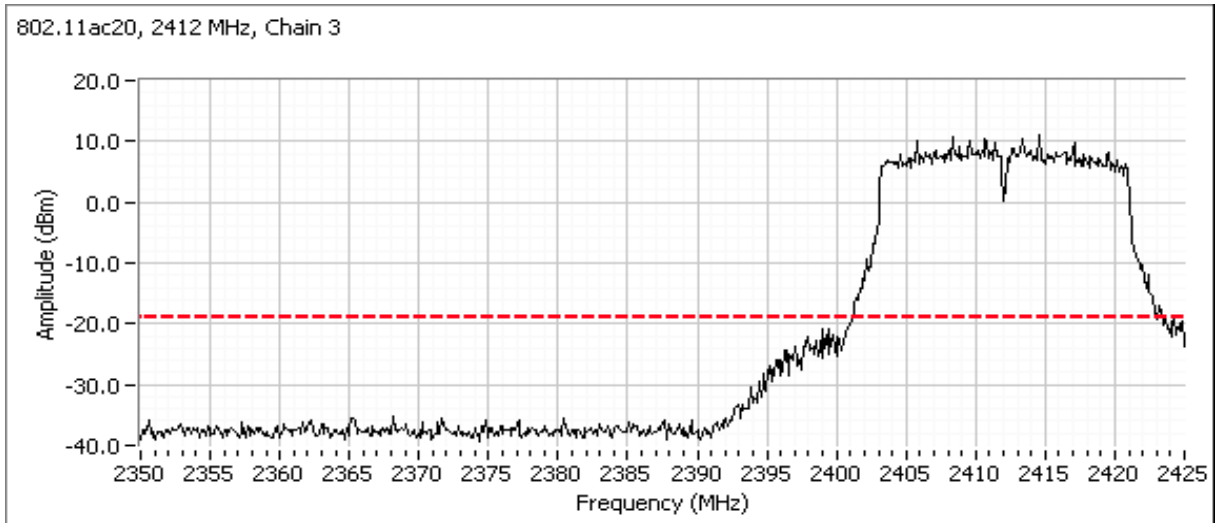
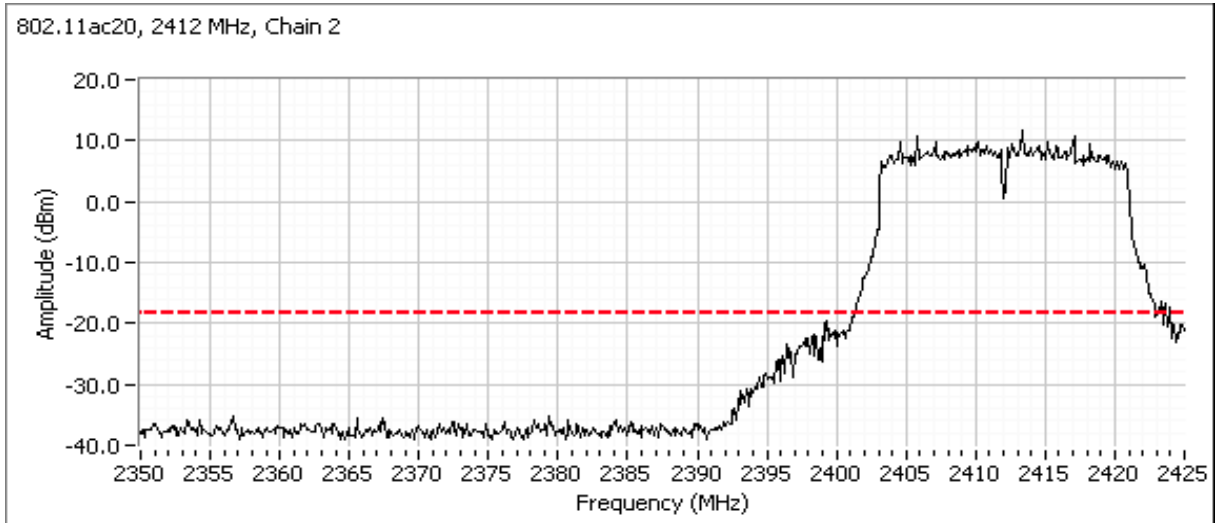



# EMC Test Data

Client: Arris	PR Number: PR101106
Model: NVG5XDBAX	T-Log Number: TL-101106-RANA
Contact: Mark Rieger	Project Manager: Deepa Shetty
Standard: FCC Part 15, RSS-247	Project Engineer: David Bare
	Class: N/A

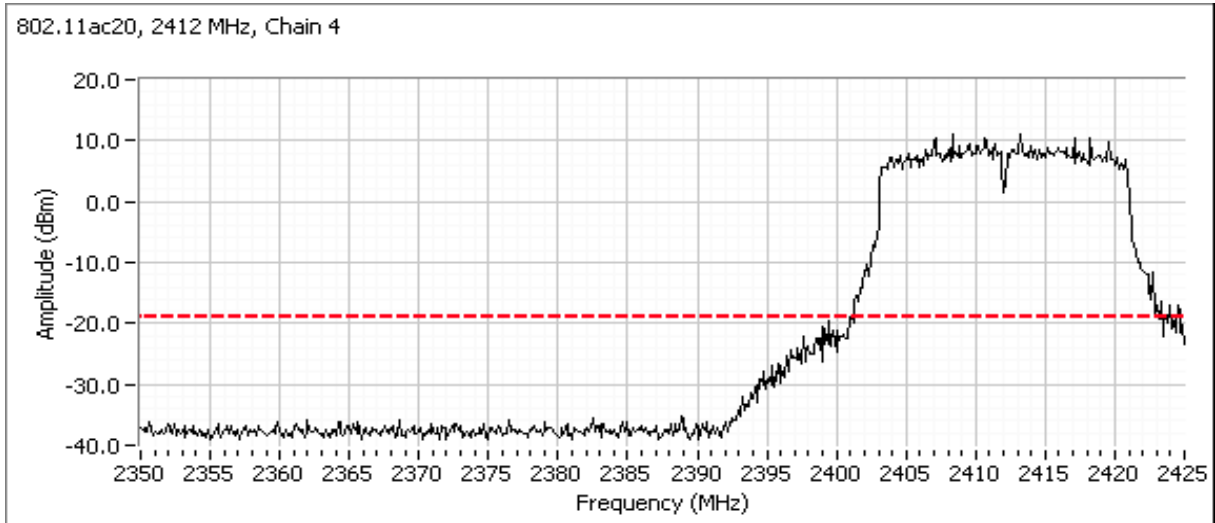

Plots for center channel

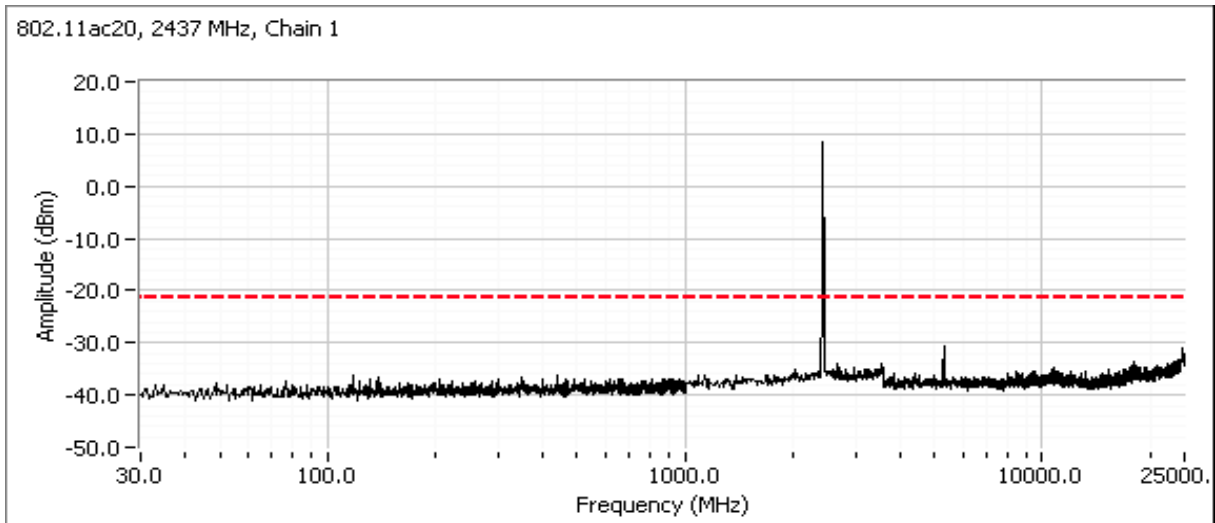



# EMC Test Data

Client: Arris	PR Number: PR101106
Model: NVG5XDBAX	T-Log Number: TL-101106-RANA
Contact: Mark Rieger	Project Manager: Deepa Shetty
Standard: FCC Part 15, RSS-247	Project Engineer: David Bare
	Class: N/A

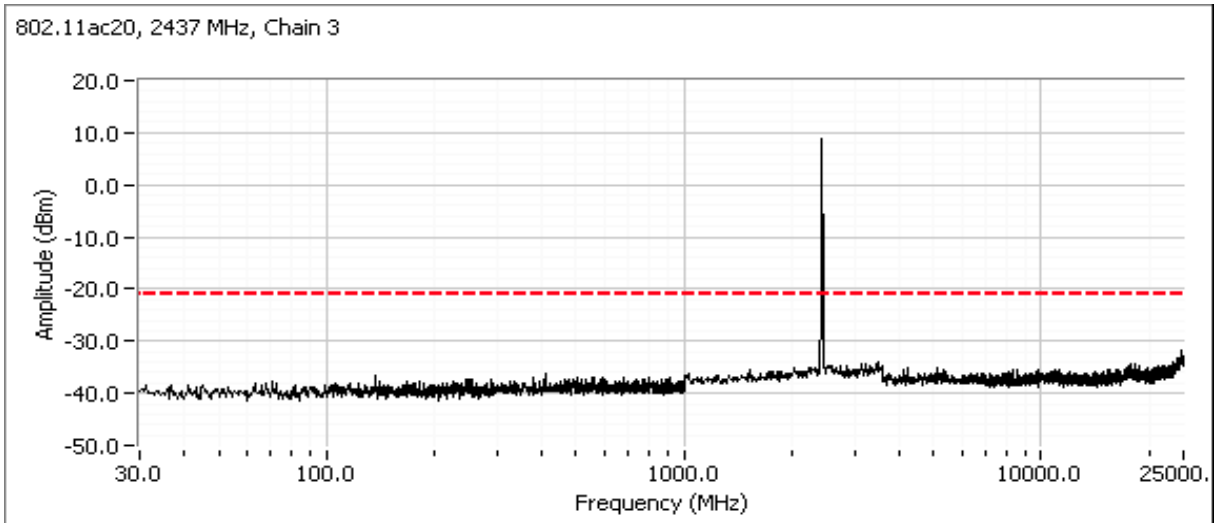
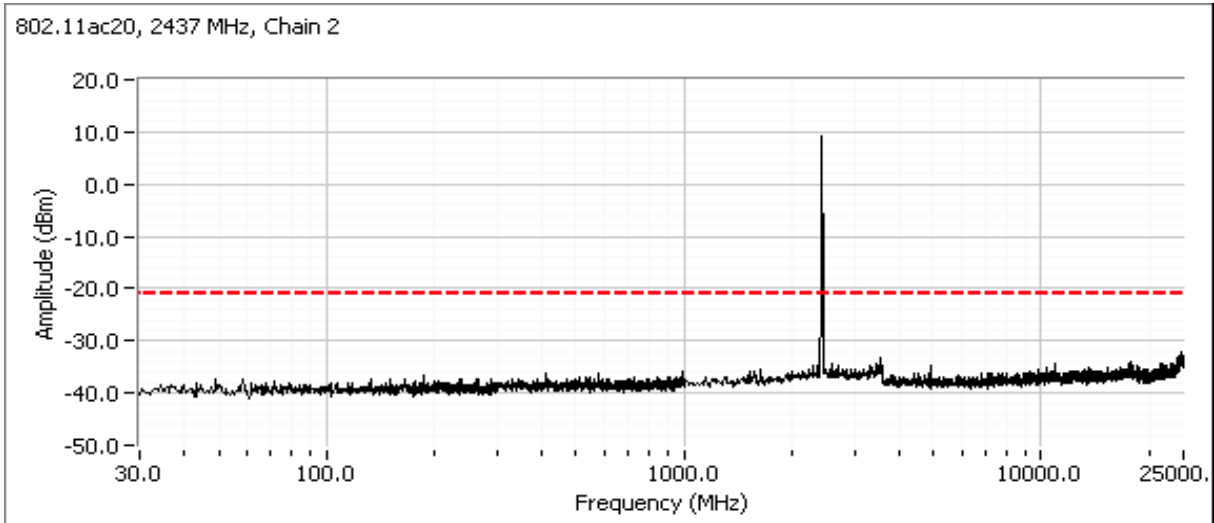



# EMC Test Data

Client: Arris	PR Number: PR101106
Model: NVG5XDBAX	T-Log Number: TL-101106-RANA
Contact: Mark Rieger	Project Manager: Deepa Shetty
Standard: FCC Part 15, RSS-247	Project Engineer: David Bare
	Class: N/A

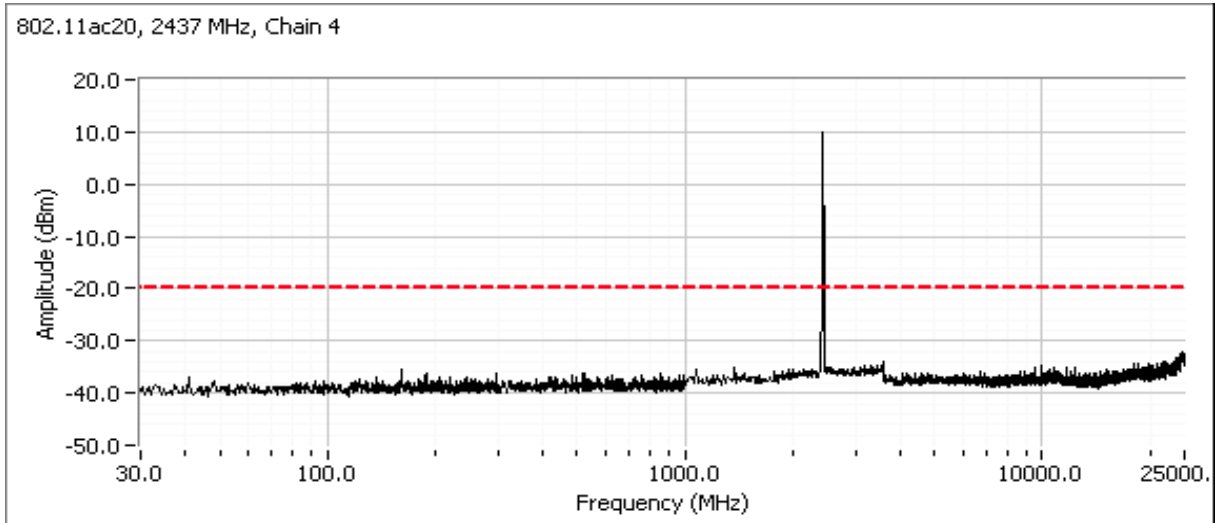

Plots for high channel

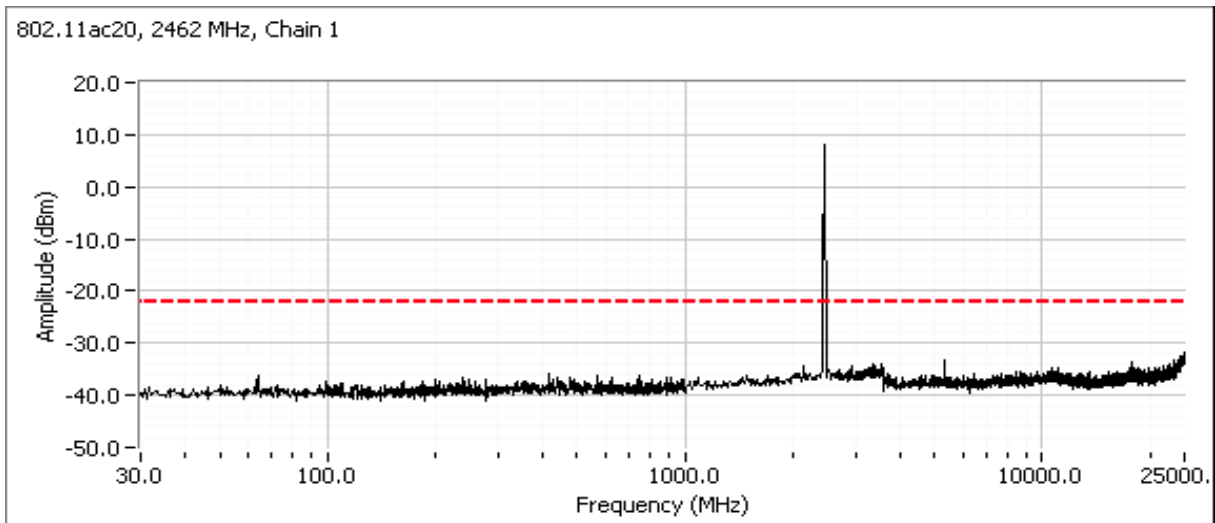





# EMC Test Data

Client: Arris	PR Number: PR101106
Model: NVG5XDBAX	T-Log Number: TL-101106-RANA
Contact: Mark Rieger	Project Manager: Deepa Shetty
Standard: FCC Part 15, RSS-247	Project Engineer: David Bare
	Class: N/A

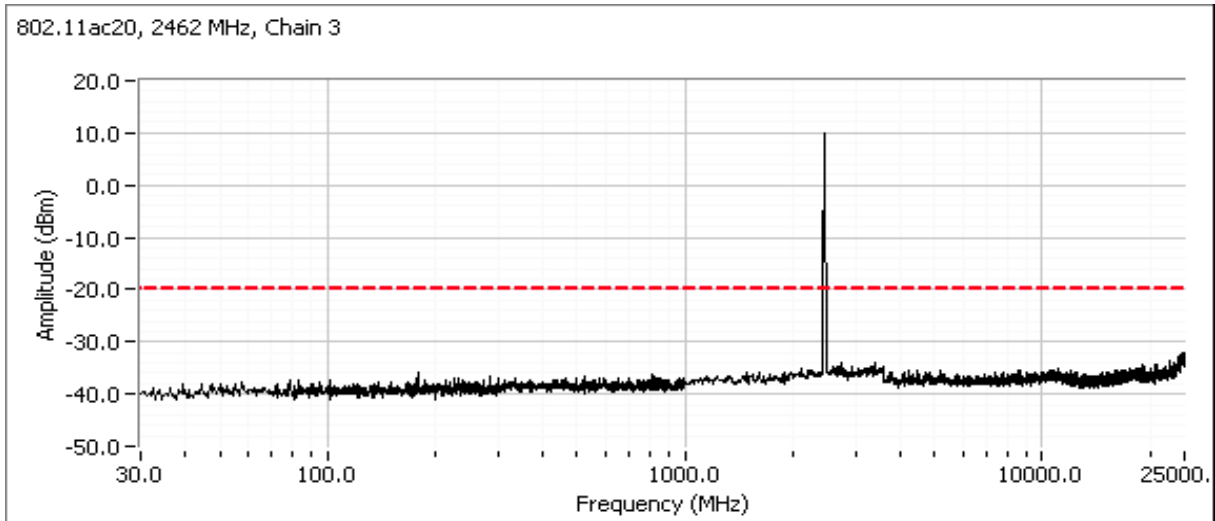
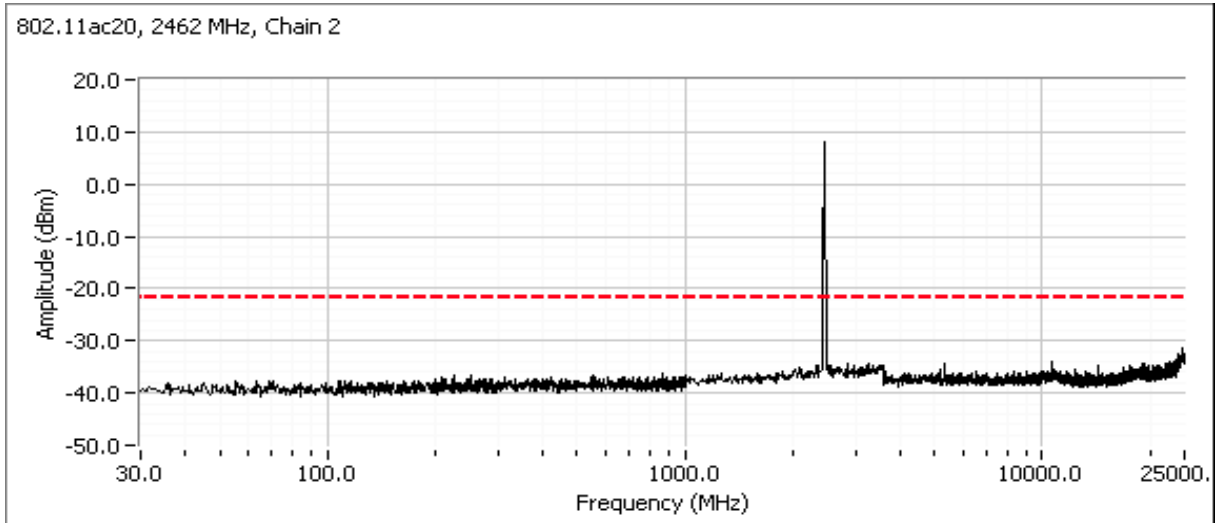



# EMC Test Data

Client: Arris	PR Number: PR101106
Model: NVG5XDBAX	T-Log Number: TL-101106-RANA
Contact: Mark Rieger	Project Manager: Deepa Shetty
Standard: FCC Part 15, RSS-247	Project Engineer: David Bare
	Class: N/A

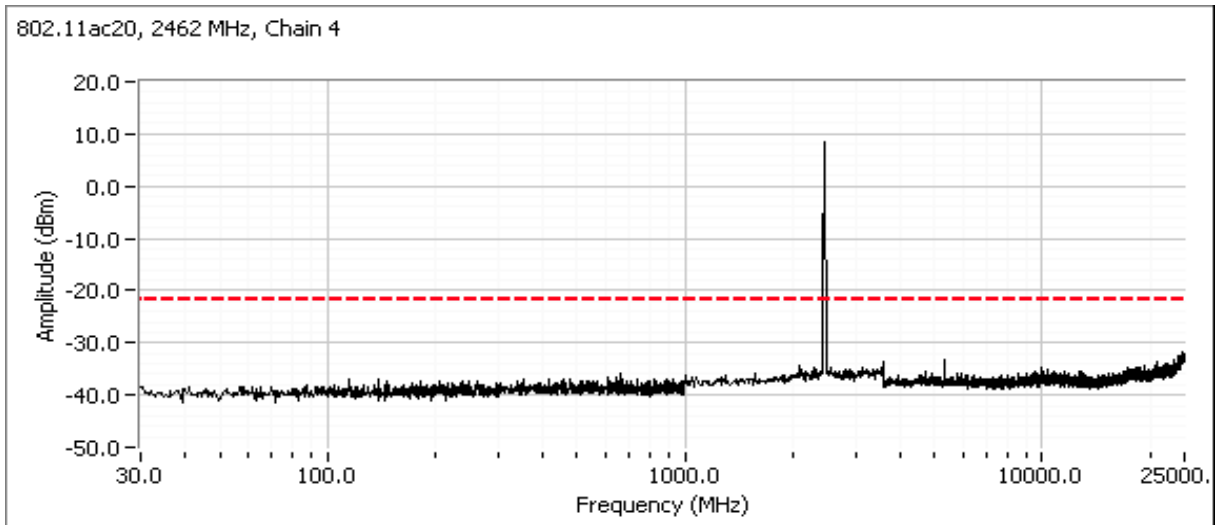

802.11ac40

Plots for low channel

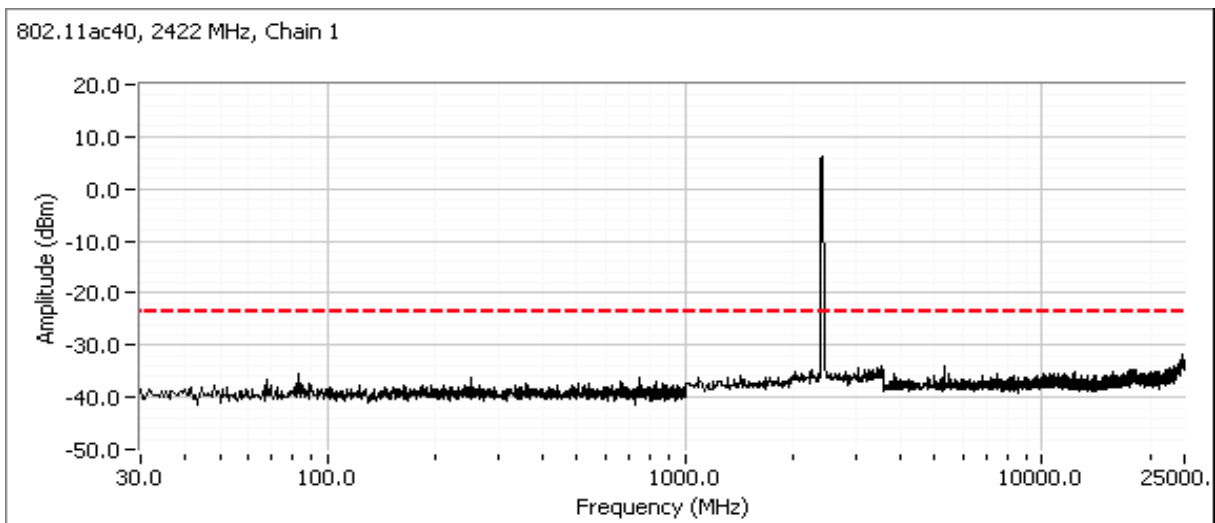



# EMC Test Data

Client: Arris	PR Number: PR101106
Model: NVG5XDBAX	T-Log Number: TL-101106-RANA
Contact: Mark Rieger	Project Manager: Deepa Shetty
Standard: FCC Part 15, RSS-247	Project Engineer: David Bare
	Class: N/A

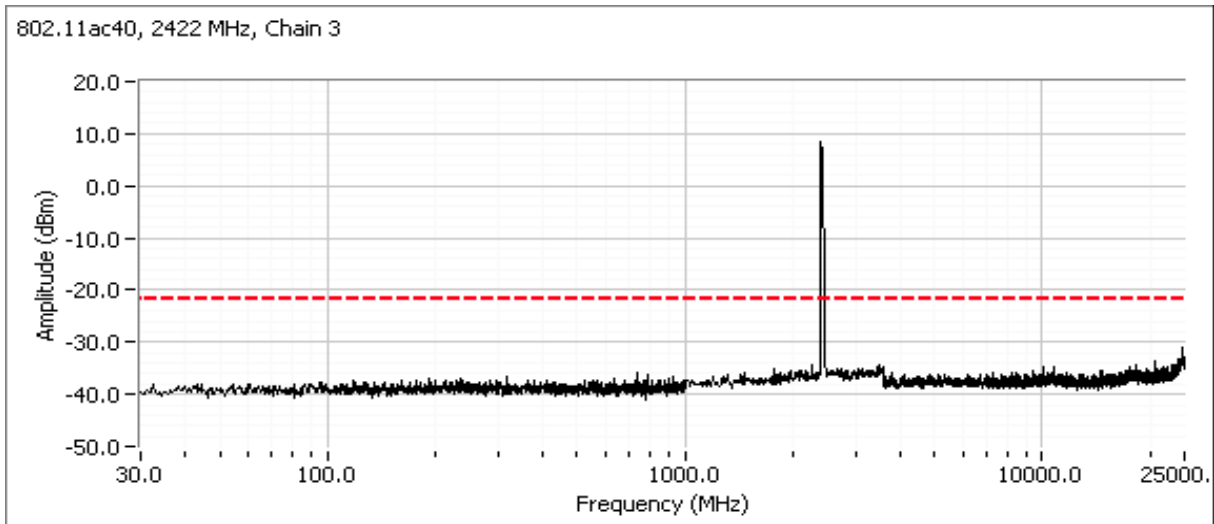
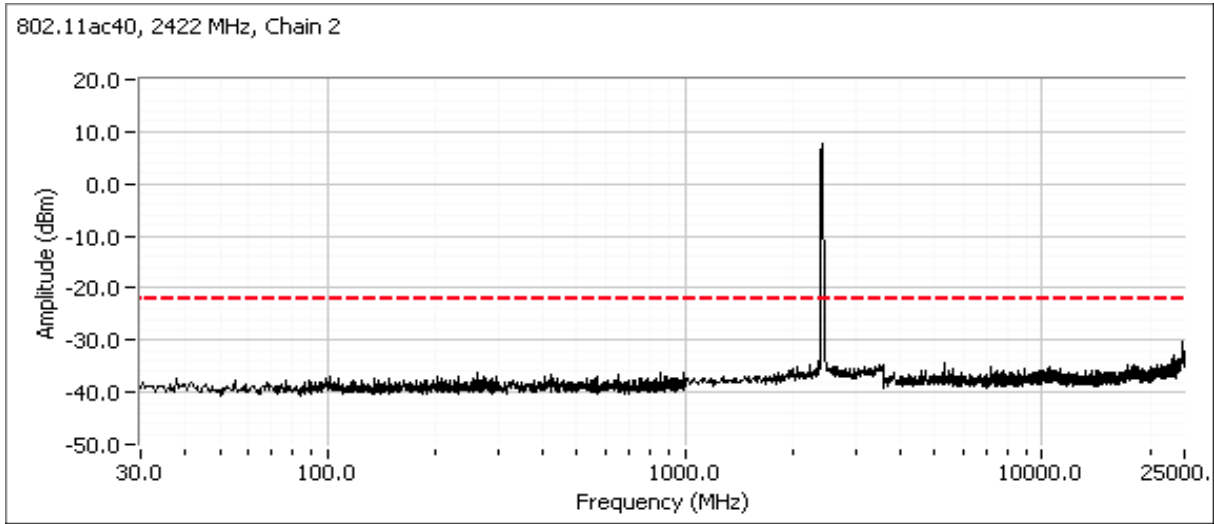



# EMC Test Data

Client: Arris	PR Number: PR101106
Model: NVG5XDBAX	T-Log Number: TL-101106-RANA
Contact: Mark Rieger	Project Manager: Deepa Shetty
Standard: FCC Part 15, RSS-247	Project Engineer: David Bare
	Class: N/A

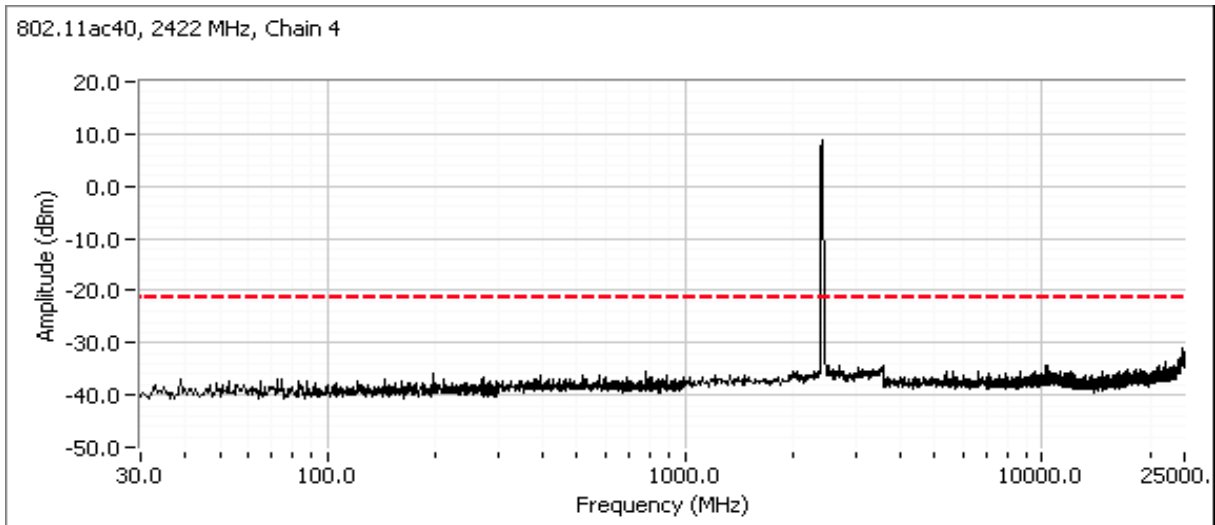

Additional plot showing compliance with -30dBc limit from 2390 MHz to 2400 MHz. Radiated measurements used to show compliance with the limits in the restricted band below 2390 MHz.

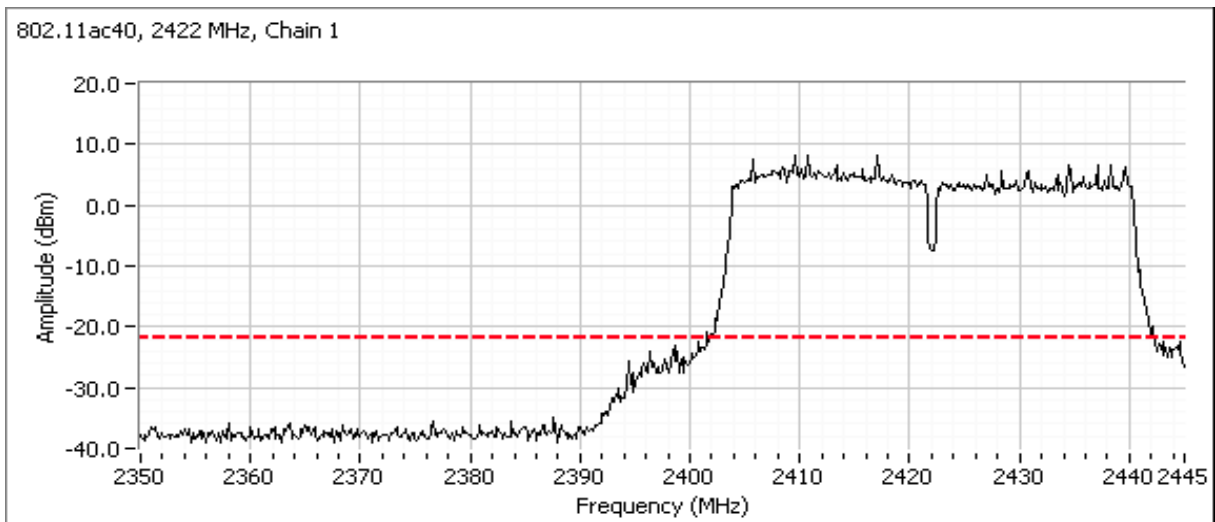



# EMC Test Data

Client: Arris	PR Number: PR101106
Model: NVG5XDBAX	T-Log Number: TL-101106-RANA
Contact: Mark Rieger	Project Manager: Deepa Shetty
Standard: FCC Part 15, RSS-247	Project Engineer: David Bare
	Class: N/A

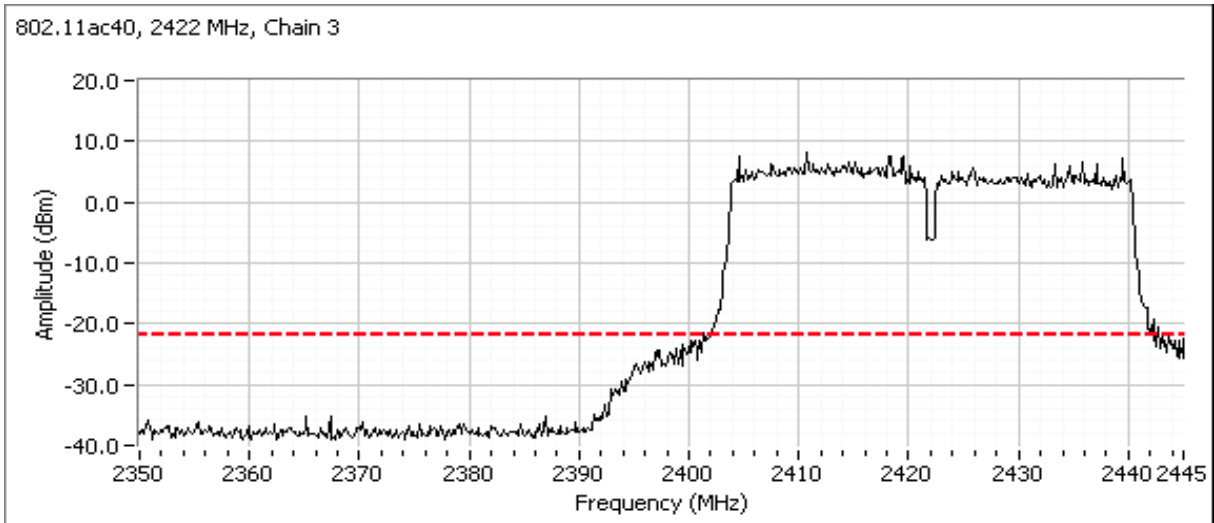
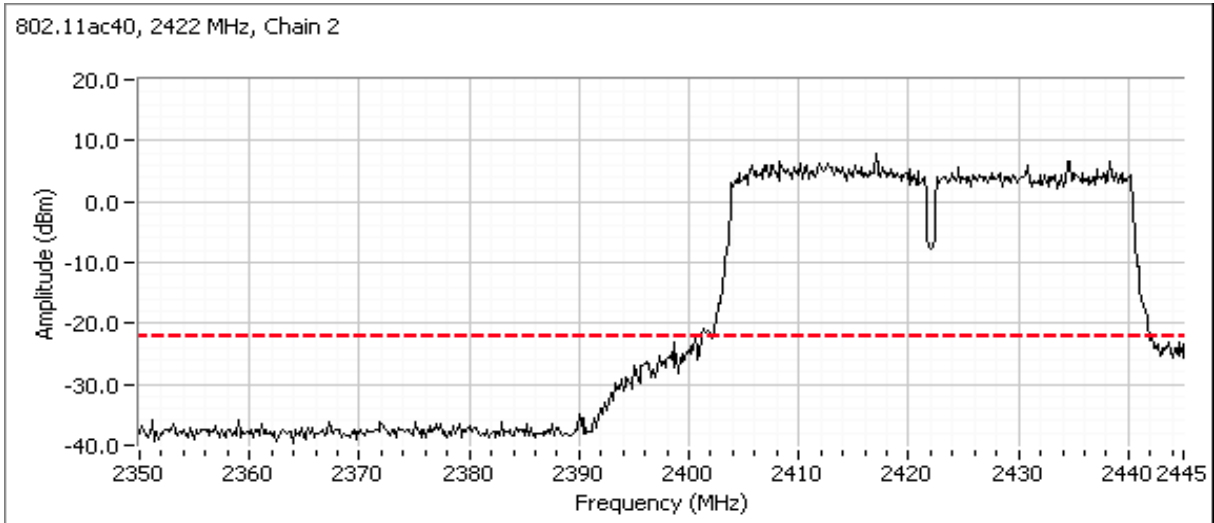



# EMC Test Data

Client: Arris	PR Number: PR101106
Model: NVG5XDBAX	T-Log Number: TL-101106-RANA
Contact: Mark Rieger	Project Manager: Deepa Shetty
Standard: FCC Part 15, RSS-247	Project Engineer: David Bare
	Class: N/A

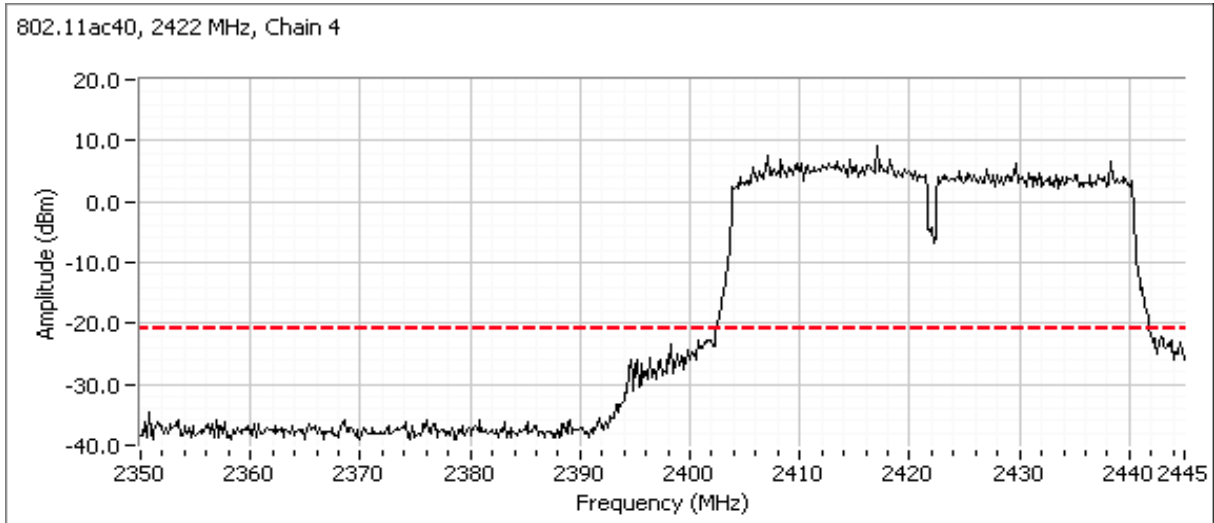

Plots for center channel

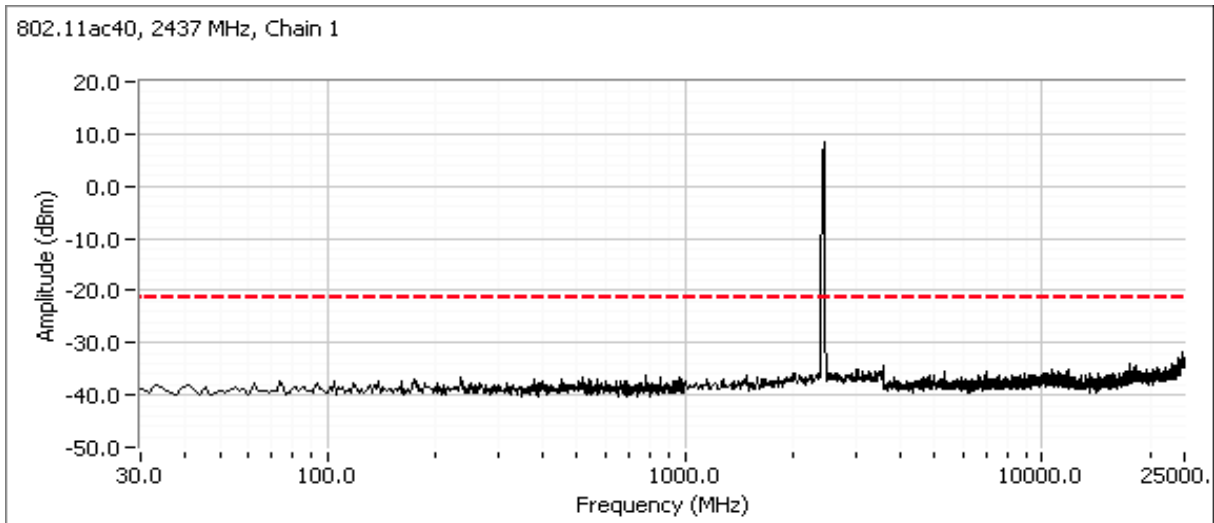



# EMC Test Data

Client: Arris	PR Number: PR101106
Model: NVG5XDBAX	T-Log Number: TL-101106-RANA
Contact: Mark Rieger	Project Manager: Deepa Shetty
Standard: FCC Part 15, RSS-247	Project Engineer: David Bare
	Class: N/A

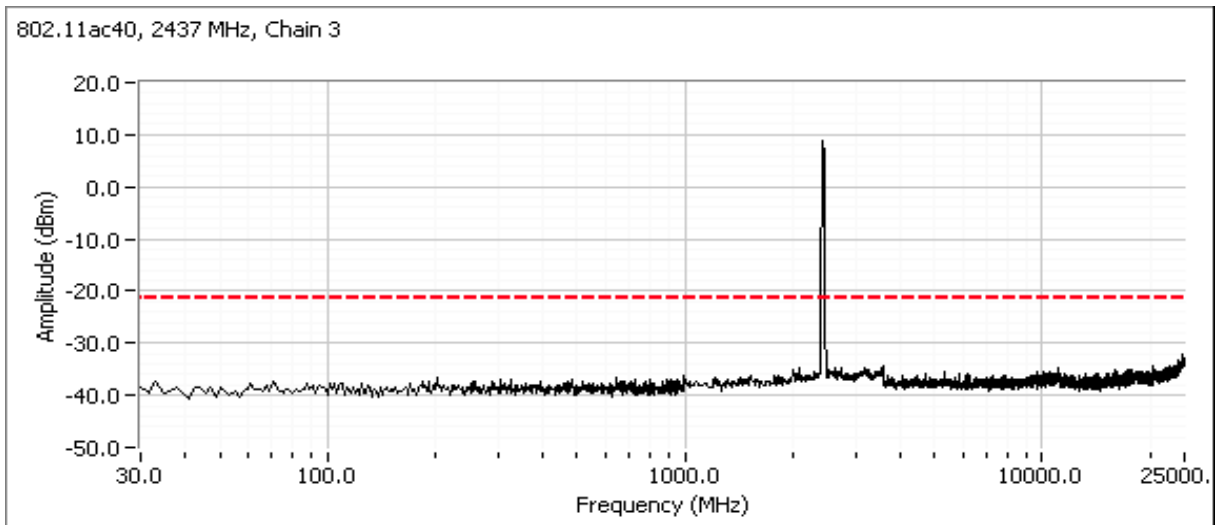
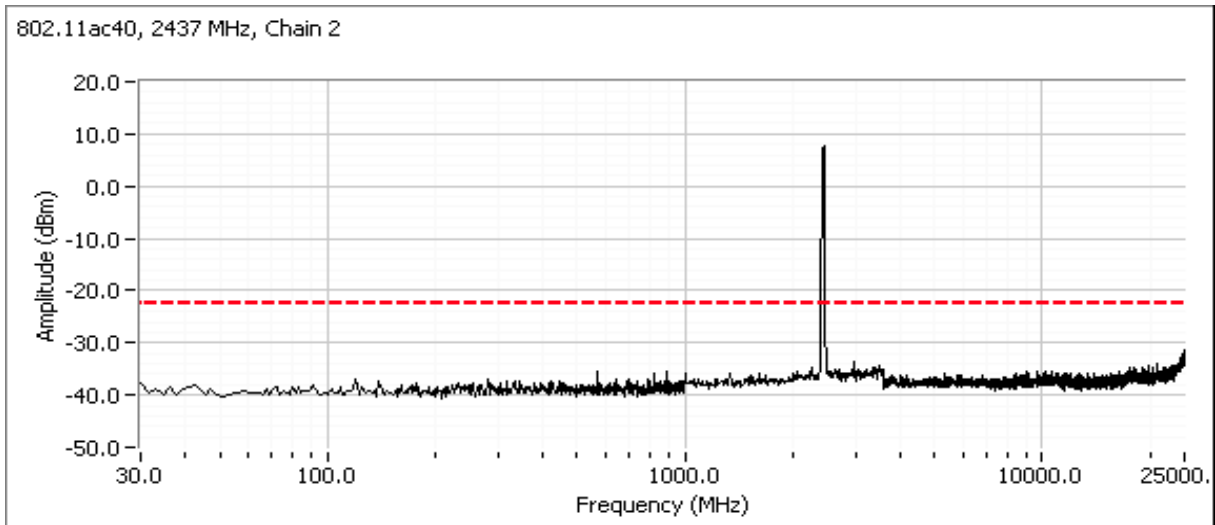



# EMC Test Data

Client: Arris	PR Number: PR101106
Model: NVG5XDBAX	T-Log Number: TL-101106-RANA
Contact: Mark Rieger	Project Manager: Deepa Shetty
Standard: FCC Part 15, RSS-247	Project Engineer: David Bare
	Class: N/A

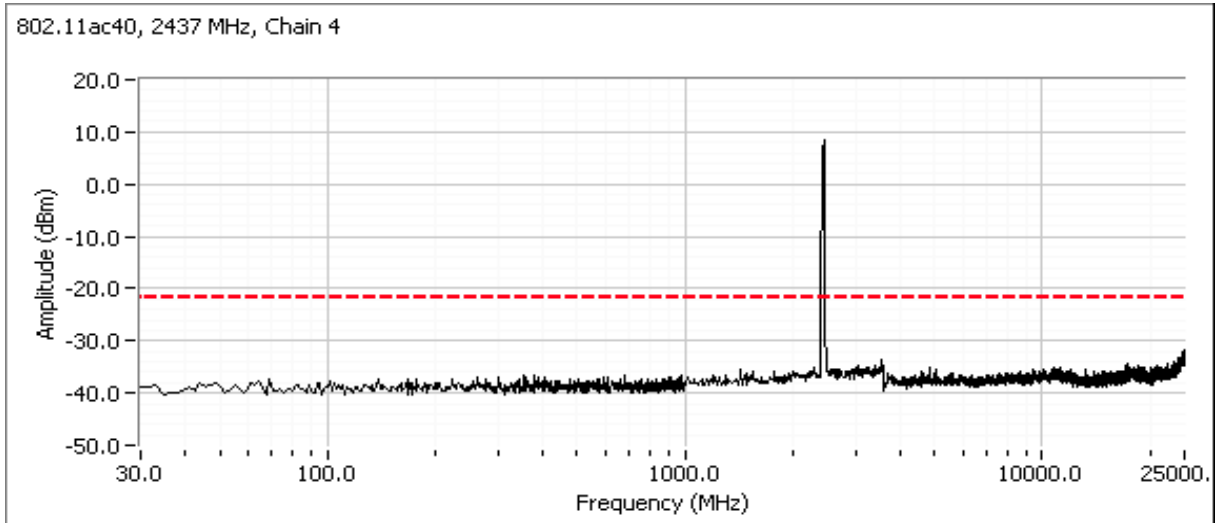

Plots for high channel

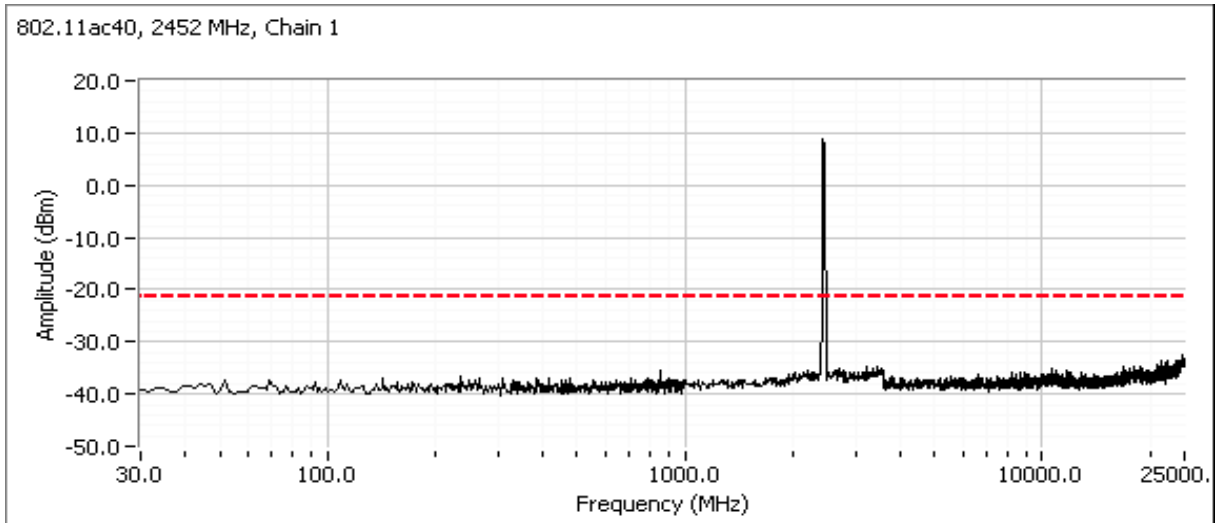





# EMC Test Data

Client: Arris	PR Number: PR101106
Model: NVG5XDBAX	T-Log Number: TL-101106-RANA
Contact: Mark Rieger	Project Manager: Deepa Shetty
Standard: FCC Part 15, RSS-247	Project Engineer: David Bare
	Class: N/A

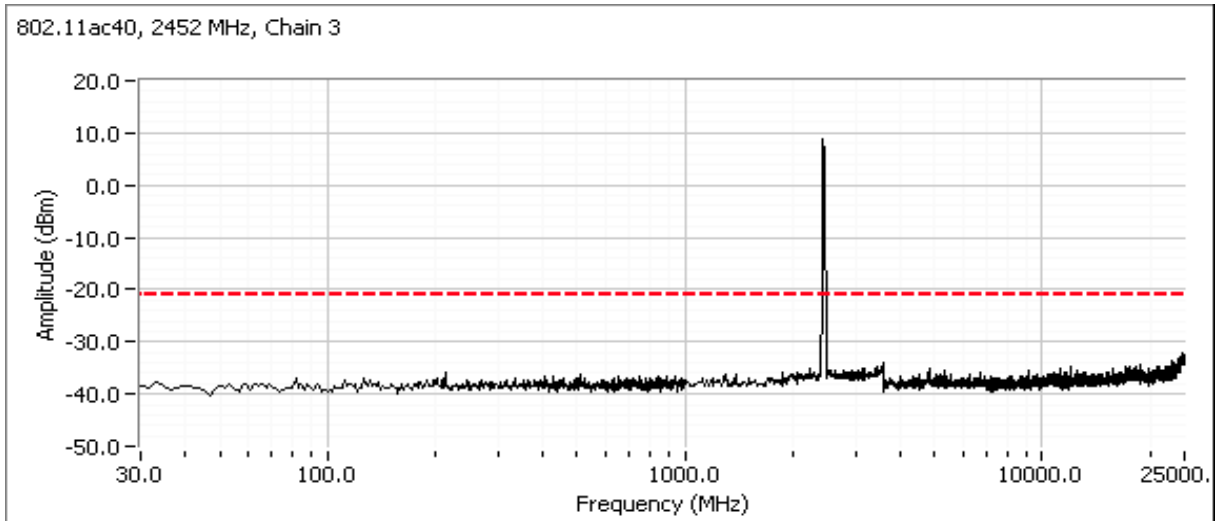
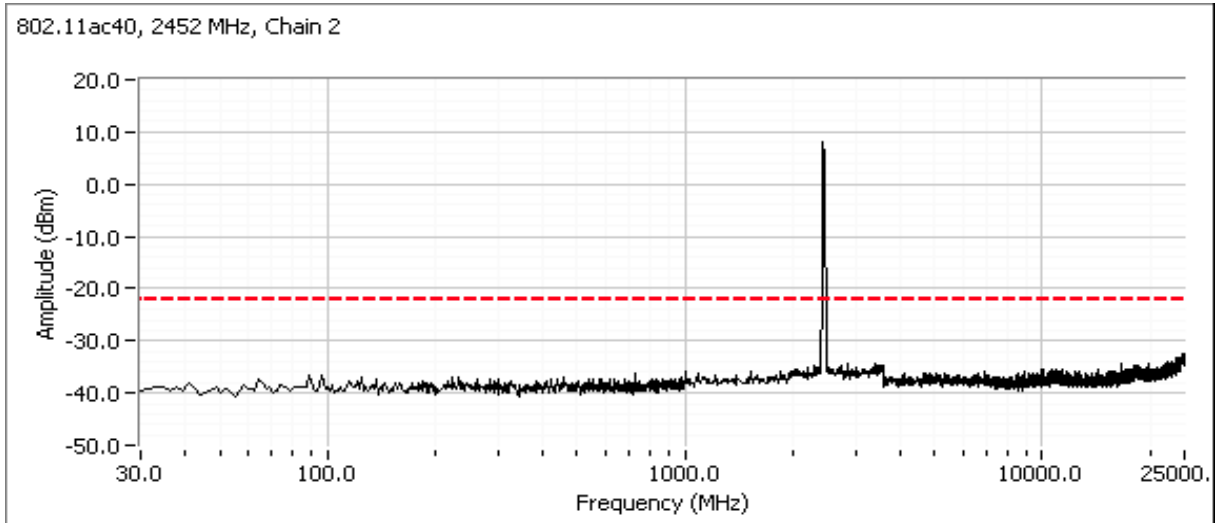



# EMC Test Data

Client: Arris	PR Number: PR101106
Model: NVG5XDBAX	T-Log Number: TL-101106-RANA
Contact: Mark Rieger	Project Manager: Deepa Shetty
Standard: FCC Part 15, RSS-247	Project Engineer: David Bare
	Class: N/A

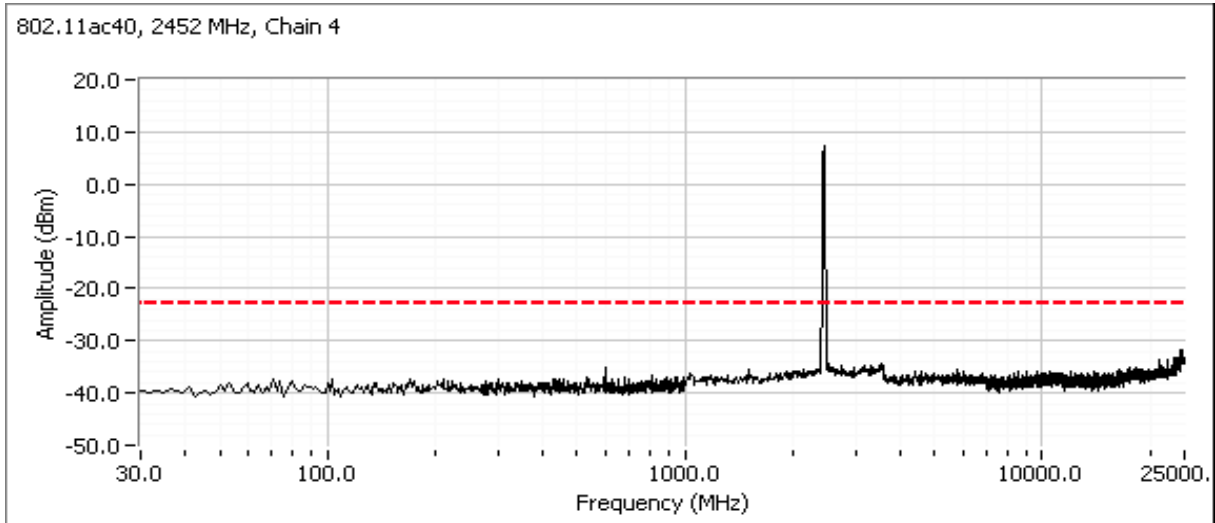



## EMC Test Data

Client: Arris	PR Number: PR101106
Model: NVG5XDBAX	T-Log Number: TL-101106-RANA
	Project Manager: Deepa Shetty
Contact: Mark Rieger	Project Engineer: David Bare
Standard: FCC Part 15, RSS-247	Class: N/A

### RSS-247 and FCC 15.247 (DTS) Antenna Port Measurements MIMO and Smart Antenna Systems Power, PSD, Bandwidth and Spurious Emissions

#### Test Specific Details

Objective: The objective of this test session is to perform final qualification testing of the EUT with respect to the specification listed above.

Date of Test: 2/3/2020  
Test Engineer: M. Birgani  
Test Location: Fremont EMC Lab #3

Config. Used: 1  
Config Change: None  
EUT Voltage: 3.3VDC

#### General Test Configuration

The EUT was connected to the spectrum analyzer or power meter via a suitable attenuator. All measurements were made on individual chains as noted.

All measurements have been corrected to allow for the external attenuators used.

**Ambient Conditions:** Temperature: 20-21 °C  
Rel. Humidity: 34-35 %

#### Modifications Made During Testing

No modifications were made to the EUT during testing

#### Deviations From The Standard

No deviations were made from the requirements of the standard.

#### Sample Notes

Sample S/N: M11917QW000T



# EMC Test Data

Client: Arris	PR Number: PR101106
Model: NVG5XDBAX	T-Log Number: TL-101106-RANA
Contact: Mark Rieger	Project Manager: Deepa Shetty
Standard: FCC Part 15, RSS-247	Project Engineer: David Bare
	Class: N/A

## Summary of Results

Run #	Pwr setting	Avg Pwr	Test Performed	Limit	Pass / Fail	Result / Margin
2			Power spectral Density (PSD)	15.247(d)	Pass	ax20: 2.6 dBm/3kHz ax40: 4.5 dBm/10kHz
3			Minimum 6dB Bandwidth	15.247(a)	Pass	19.0 MHz
3			99% Bandwidth	RSS GEN	Pass	ax20: 19.2MHz ax40: 37.8MHz
4			Band Edge Spurious emissions	15.247(b)	Pass	All emissions below -30dBc limit

## Procedure Comments:

Measurements performed in accordance with FCC KDB 558074 and ANSI C63.10

## Antenna Gain Information

Freq	Antenna Gain (dBi) / Chain				BF	MultiChain Legacy	CDD	Sectorized / Xpol	Dir G (PWR)	Dir G (PSD)
	1	2	3	4						
2410 MHz	3.4	2.9	3.5	5.9	Yes	Yes	Yes	Yes	1.9	7.6
2440 MHz	3.5	3.6	3.3	5.6	Yes	Yes	Yes	Yes	1.7	7.4
2460 MHz	3.8	3.9	3.6	5.3	Yes	Yes	Yes	Yes	1.6	7.3

## For devices that support CDD modes

Min # of spatial streams: 1	Chain 1 = Yellow antenna cable	Chain 3 = Red antenna cable
Max # of spatial streams: 4	Chain 2 = Brown antenna cable	Chain 4 = Green antenna cable



# EMC Test Data

Client:	Arris	PR Number:	PR101106
Model:	NVG5XDBAX	T-Log Number:	TL-101106-RANA
Contact:	Mark Rieger	Project Manager:	Deepa Shetty
Standard:	FCC Part 15, RSS-247	Project Engineer:	David Bare
		Class:	N/A

Legacy modes operate on single chain  
 Power for BF mode is lower due to higher directional gain for correlated signals is used for these modes  
 CDD active for single stream modes

Note 1A:	Duty Cycle $\geq 98\%$ . Output power measured using a spectrum analyzer (see plots below) with RBW= 1-5% of OBW and $\leq 1$ MHz, $VB \geq 3 * RBW$ , Span $\geq 1.5$ of OBW, auto sweep time, RMS detector, power averaging on, and power integration over the OBW, trace average 100 traces (option AVGSA-1 in ANSI C63.10). Spurious limit becomes -30dBc.
Note 1B:	Constant Duty Cycle $< 98\%$ . Output power measured using a spectrum analyzer (see plots below) with RBW= 1-5% of OBW and $\leq 1$ MHz, $VB \geq 3 * RBW$ , Span $\geq 1.5$ of OBW, RMS detector, auto sweep time, power averaging on, and power integration over the OBW, trace average 100 traces (option AVGSA-2 in ANSI C63.10). Measurement corrected by Pwr Cor Factor. Spurious limit becomes -30dBc.
Note 2:	Power setting - the software power setting used during testing, included for reference only.
Notes:	BF = beamforming mode supported, Multichain Legacy = 802.11 legacy data rates supported for multichain transmissions, CDD = Cyclic Delay Diversity (or Cyclic Shift Diversity) modes supported, Sectorized / Xpol = antennas are sectorized or cross polarized (For each band 2 antennas are Vertical and 2 are Horizontal)
Notes:	Dir G (PWR) = total gain (Gant + Array Gain) for power calculations; Dir G (PSD) = total gain for PSD calculations based on FCC KDB 662911 D01. Depending on the modes supported, the Array Gain value for power could be different from the PSD value.
Notes:	Array gain for power/psd calculated per KDB 662911 D01.

Mode	Data Rate	Duty Cycle (x)	Constant DC?	T (ms)	Pwr Cor Factor*	Lin Volt Cor Factor**	Min VBW for FS (Hz)	Packet	pkt duty
11b	1	99.2%	Yes	12.422	0.0	0.0	81	1285	-1
11g	6	99.0%	Yes	5.06	0.0	0.0	198	7974	-1
ac20	6.5	97.6%	Yes	5.271	0.1	0.2	190	4324	-1
ac40	13.5	97.3%	Yes	5.24	0.1	0.2	191	8811	-1



# EMC Test Data

Client: Arris	PR Number: PR101106
Model: NVG5XDBAX	T-Log Number: TL-101106-RANA
Contact: Mark Rieger	Project Manager: Deepa Shetty
Standard: FCC Part 15, RSS-247	Project Engineer: David Bare
	Class: N/A

## Run #2: Power spectral Density

Note 1: Test performed per method PKSPD, in KDB 558074. Power spectral density measured using:  $3\text{kHz} \leq \text{RBW} \leq 100\text{kHz}$ ,  $\text{VBW}=3*\text{RBW}$ , peak detector, span =  $1.5*\text{DTS BW}$ , auto sweep time, max hold.

Mode: ax20

Power Setting	Frequency (MHz)	PSD (dBm/3kHz) <sup>Note 1</sup>				Total	Limit dBm/3kHz	Result
		Chain 1	Chain 2	Chain 3	Chain 4			
24	2412	-3.7	-3.9	-4.3	-3.5	2.2	6.4	Pass
24	2437	-3.5	-3.3	-3.5	-3.2	2.6	6.6	Pass
23	2462	-5.4	-5.0	-6.2	-5.1	0.6	6.7	Pass

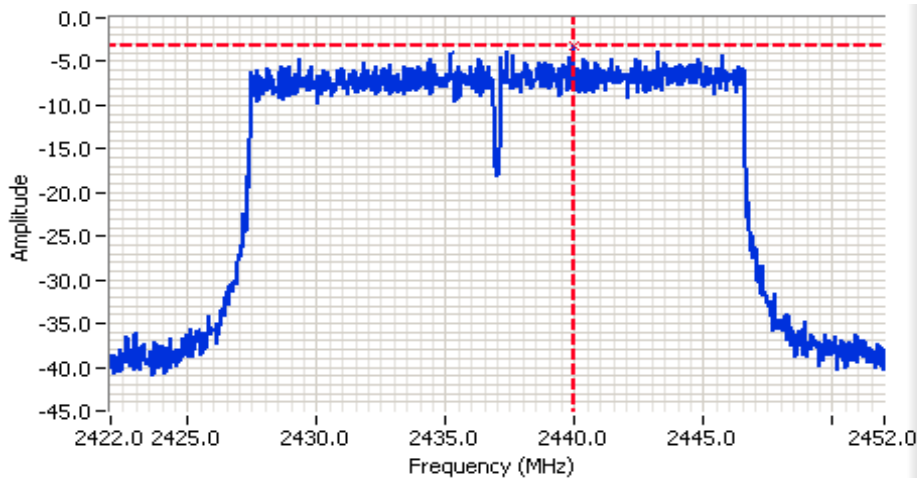

### Analyzer Settings

CF: 2437.000 MHz  
 SPAN: 30.000 MHz  
 RB: 3.00 kHz  
 VB: 10.0 kHz  
 Detector: POS  
 Attn: 30 DB  
 RL Offset: 18.3 DB  
 Sweep Time: 3.4s  
 Ref Lvl: 20.0 DBM

### Comments

802.11ax 20MHz Chain 4  
 PSD: -3.2 dBm/3kHz

Cursor 1	2439.970000	-3.2	
	0.000000	0.0	





# EMC Test Data

Client: Arris	PR Number: PR101106
Model: NVG5XDBAX	T-Log Number: TL-101106-RANA
Contact: Mark Rieger	Project Manager: Deepa Shetty
Standard: FCC Part 15, RSS-247	Project Engineer: David Bare
	Class: N/A

Mode: ax40

Power Setting	Frequency (MHz)	PSD (dBm/10kHz) <sup>Note 1</sup>				Total	Limit dBm/3kHz	Result
		Chain 1	Chain 2	Chain 3	Chain 4			
24	2422	-1.9	-1.3	-2.3	-2.4	4.1	6.4	Pass
24	2437	-1.1	-1.6	-1.8	-1.8	4.5	6.6	Pass
24	2452	-2.3	-2.1	-2.1	-2.2	3.8	6.7	Pass

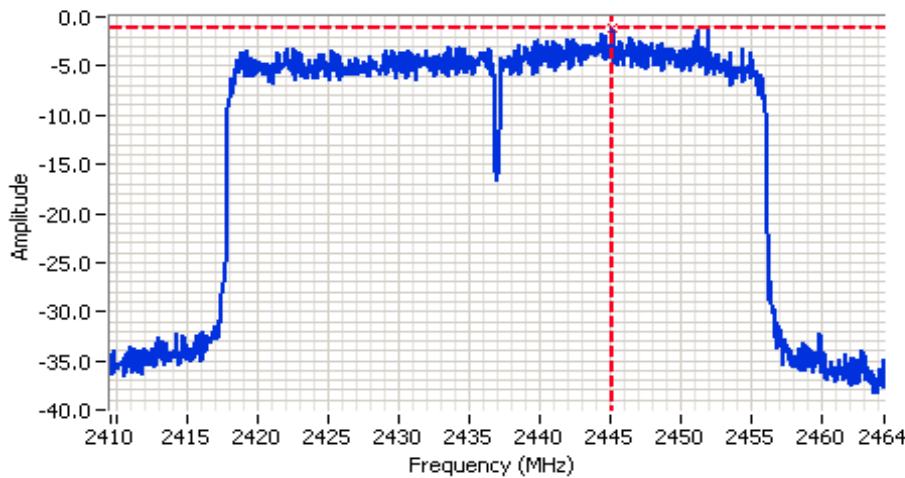

### Analyzer Settings

CF: 2437.000 MHz  
 SPAN: 55.000 MHz  
 RB: 10.0 kHz  
 VB: 30.0 kHz  
 Detector: POS  
 Attn: 20 DB  
 RL Offset: 18.3 DB  
 Sweep Time: 0.6s  
 Ref Lvl: 20.0 DBM

### Comments

802.11ax 40MHz Chain 1  
 PSD: -1.1 dBm/10kHz

Cursor 1 2445.140000 -1.1

0.000000 0.0





# EMC Test Data

Client: Arris	PR Number: PR101106
Model: NVG5XDBAX	T-Log Number: TL-101106-RANA
Contact: Mark Rieger	Project Manager: Deepa Shetty
Standard: FCC Part 15, RSS-247	Project Engineer: David Bare
	Class: N/A

## Run #3: Signal Bandwidth

Note 1: DTS BW: RBW=100kHz, VBW ≥ 3\*RBW, peak detector, max hold, auto sweep time, Span 2-5 times measured BW.  
 99% BW: RBW=1-5% of 99%BW, VBW ≥ 3\*RBW, peak detector, max hold, auto sweep time. Span 1.5-5 times OBW.

Note 2: Measurements performed on chain 1 (Yellow antenna cable)

Mode: ax20

Power Setting	Frequency (MHz)	Bandwidth (MHz)		RBW Setting (MHz)	
		6dB	99%	6dB	99%
24	2412	19.0	19.1	0.1	0.3
24	2437	19.0	19.2	0.1	0.3
24	2462	19.0	19.2	0.1	0.3

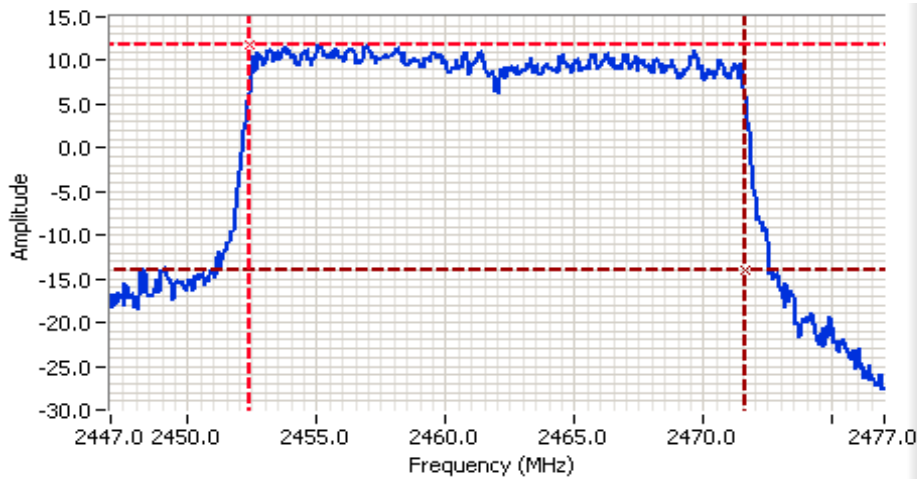

### Analyzer Settings

CF: 2462.000 MHz  
 SPAN: 30.000 MHz  
 RB: 300 kHz  
 VB: 100 kHz  
 Detector: POS  
 Attn: 30 DB  
 RL Offset: 18.3 DB  
 Sweep Time: 2.5ms  
 Ref Lvl: 20.0 DBM

### Comments

99% BW: 19.2 MHz

Cursor 1	2452.376000	11.9	
Cursor 2	2471.576000	-14.1	

Delta Freq.	19.200
Delta Amplitude	26.0







# EMC Test Data

Client: Arris	PR Number: PR101106
Model: NVG5XDBAX	T-Log Number: TL-101106-RANA
Contact: Mark Rieger	Project Manager: Deepa Shetty
Standard: FCC Part 15, RSS-247	Project Engineer: David Bare
	Class: N/A

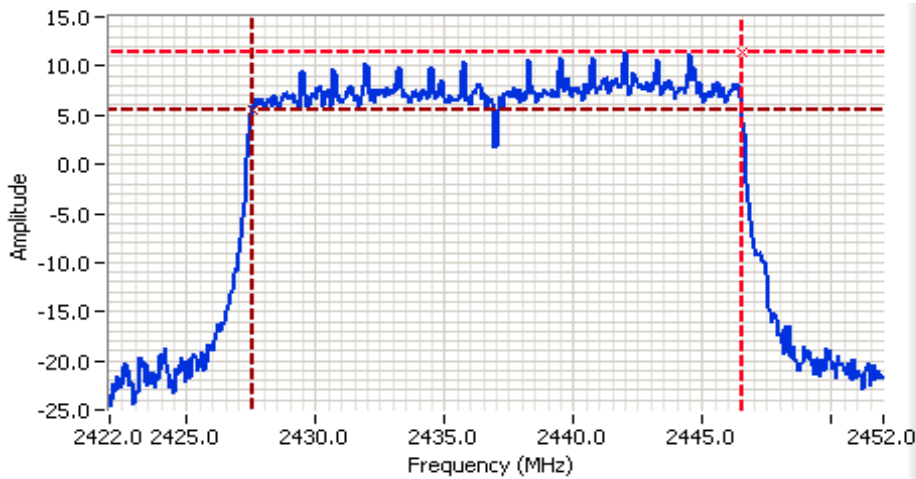

**Analyzer Settings**

CF: 2437.000 MHz  
 SPAN: 30.000 MHz  
 RB: 100 kHz  
 VB: 300 kHz  
 Detector: POS  
 Attn: 30 DB  
 RL Offset: 18.3 DB  
 Sweep Time: 15.0ms  
 Ref Lvl: 20.0 DBM

**Comments**

DTS BW: 19.0 MHz

Cursor 1: 2446.519231, 11.5

Cursor 2: 2427.528846, 5.5

Delta Freq: 18.990

Delta Amplitude: 6.0



Mode: ax40

Power Setting	Frequency (MHz)	Bandwidth (MHz)		RBW Setting (MHz)	
		6dB	99%	6dB	99%
24	2422	36.9	37.7	0.1	0.5
24	2437	37.6	37.8	0.1	0.5
24	2452	37.7	37.8	0.1	0.5



# EMC Test Data

Client: Arris	PR Number: PR101106
Model: NVG5XDBAX	T-Log Number: TL-101106-RANA
Contact: Mark Rieger	Project Manager: Deepa Shetty
Standard: FCC Part 15, RSS-247	Project Engineer: David Bare
	Class: N/A

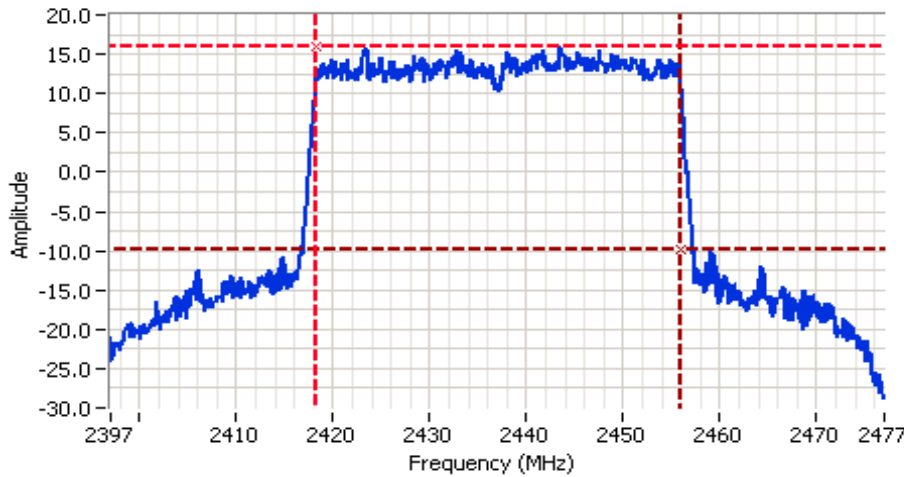

**Analyzer Settings**

CF: 2437.000 MHz  
 SPAN: 80.000 MHz  
 RB: 500 kHz  
 VB: 2.000 MHz  
 Detector: POS  
 Attn: 20 DB  
 RL Offset: 18.3 DB  
 Sweep Time: 5.0ms  
 Ref Lvl: 20.0 DBM

**Comments**

99% BW: 37.8 MHz

Cursor 1: 2418.178821 16.1 [Icons]

Cursor 2: 2455.981019 -9.9 [Icons]

Delta Freq. 37.802

Delta Amplitude 26.0

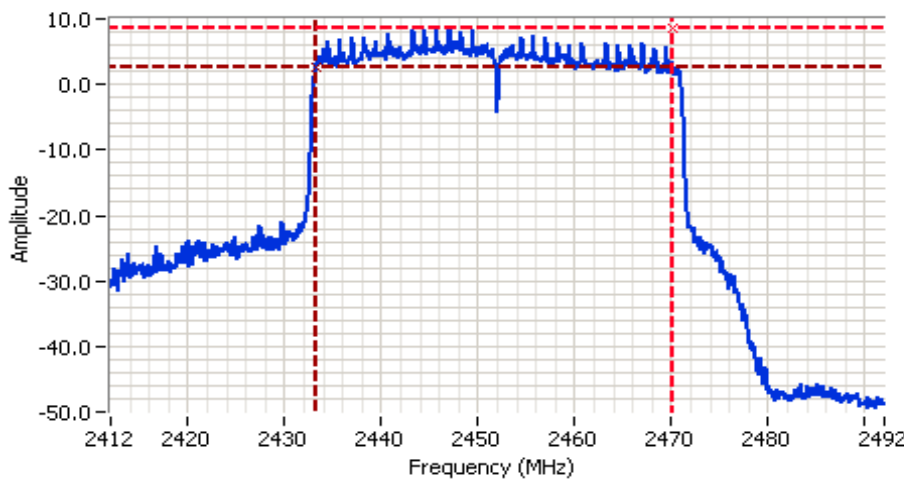

**Analyzer Settings**

CF: 2452.000 MHz  
 SPAN: 80.000 MHz  
 RB: 100 kHz  
 VB: 300 kHz  
 Detector: POS  
 Attn: 20 DB  
 RL Offset: 18.3 DB  
 Sweep Time: 10.0ms  
 Ref Lvl: 20.0 DBM

**Comments**

DTS BW: 36.9 MHz

Cursor 1: 2470.080000 8.6 [Icons]

Cursor 2: 2433.200000 2.6 [Icons]

Delta Freq. 36.880

Delta Amplitude 6.0





# EMC Test Data

Client: Arris	PR Number: PR101106
Model: NVG5XDBAX	T-Log Number: TL-101106-RANA
Contact: Mark Rieger	Project Manager: Deepa Shetty
Standard: FCC Part 15, RSS-247	Project Engineer: David Bare
	Class: N/A

## Run #4a: Band Edge Spurious Emissions

Note 1:	All plots use 100 kHz RBW and VBW at least 3 times the RBW
Note 2:	Measured on each chain individually

802.11ax 20MHz: Plots showing compliance with -30dBc limit from 2390 MHz to 2400 MHz. Radiated measurements used to show compliance with the limits in the restricted band below 2390 MHz.

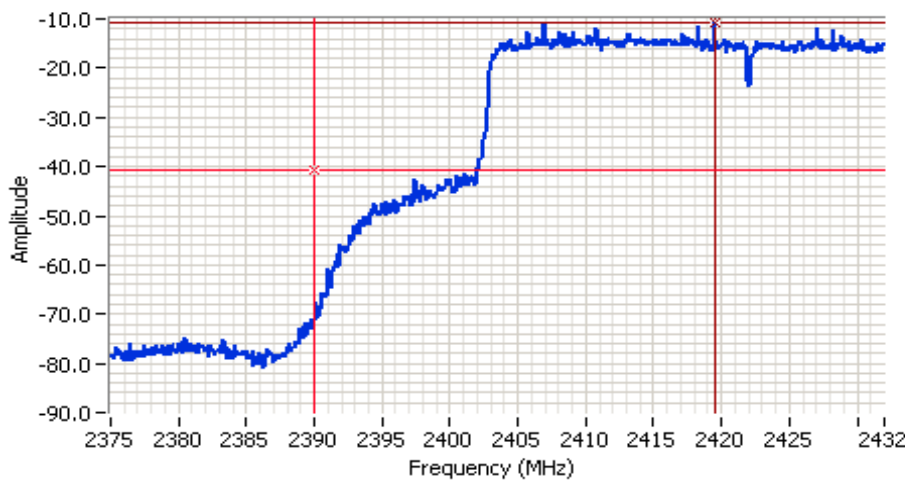

**Analyzer Settings**

- CF: 2403.500 MHz
- SPAN: 57.000 MHz
- RB: 100 kHz
- VB: 300 kHz
- Detector: POS
- Attn: 10 DB
- RL Offset: 0.0 DB
- Sweep Time: 1.0s
- Ref Lvl: -7.0 DBM

**Comments**

802.11ax 20MHz (all chains)

Cursor 1	2389.992187	-40.8	↔	✖	🔒
Cursor 2	2419.485596	-10.8	↔	✖	🔒

Delta Freq.	29.493
Delta Amplitude	30.0





# EMC Test Data

Client: Arris	PR Number: PR101106
Model: NVG5XDBAX	T-Log Number: TL-101106-RANA
Contact: Mark Rieger	Project Manager: Deepa Shetty
Standard: FCC Part 15, RSS-247	Project Engineer: David Bare
	Class: N/A

802.11ax 40MHz: Plots showing compliance with -30dBc limit from 2390 MHz to 2400 MHz. Radiated measurements used to show compliance with the limits in the restricted band below 2390 MHz.

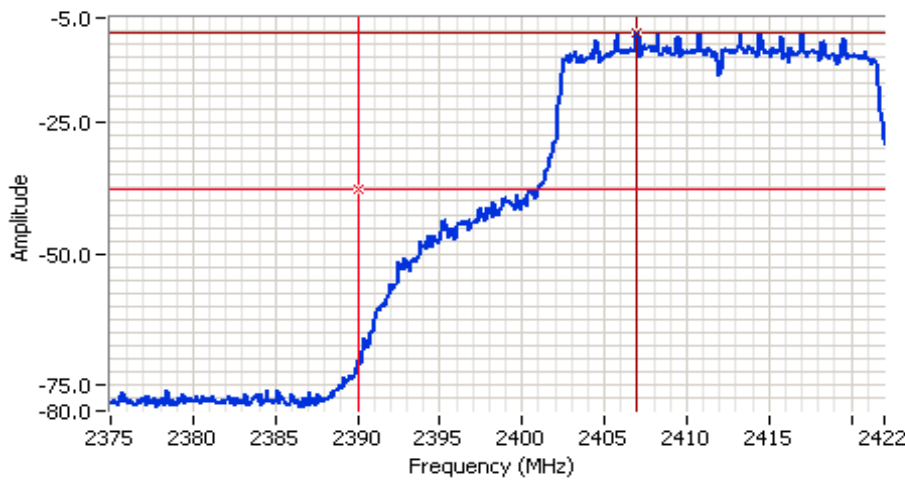

**Analyzer Settings**

- CF: 2403.500 MHz
- SPAN: 57.000 MHz
- RB: 100 kHz
- VB: 300 kHz
- Detector: POS
- Attn: 10 DB
- RL Offset: 0.0 DB
- Sweep Time: 1.0s
- Ref Lvl: -7.0 DBM

**Comments**

802.11ax 40MHz (all chains)

Cursor 1	2390.072021	-37.8	Delta Freq.	16.899
Cursor 2	2406.971191	-7.8	Delta Amplitude	30.0



***End of Report***

This page is intentionally blank and marks the last page of this test report.