

TEST REPORT

Test report no.: 1-0387/20-02-02

Testing laboratory

CTC advanced GmbH

Untertuerkheimer Strasse 6 – 10
66117 Saarbruecken / Germany

Phone: + 49 681 5 98 - 0

Fax: + 49 681 5 98 - 9075

Internet: <https://www.ctcadvanced.com>

e-mail: mail@ctcadvanced.com

Accredited Testing Laboratory:

The testing laboratory (area of testing) is accredited according to DIN EN ISO/IEC 17025 (2018-03) by the Deutsche Akkreditierungsstelle GmbH (DAkkS)

The accreditation is valid for the scope of testing procedures as stated in the accreditation certificate starting with the registration number: D-PL-12076-01.

Applicant

Baumer Electric AG

Hummelstr. 17
8501 Frauenfeld / SWITZERLAND

Contact: Pascal Holenstein

e-mail: pholenstein@baumer.com

Phone: +41 52 728 11 39

Manufacturer

Baumer Electric AG

Hummelstr. 17
8501 Frauenfeld / SWITZERLAND

Test standard/s

FCC - Title 47 CFR Part 15

RSS - Gen Issue 5 incl. Amendment 1 & 2*

RSS - 210 Issue 10*

FCC - Title 47 of the Code of Federal Regulations; Chapter I; Part 15 - Radio frequency devices

Spectrum Management and Telecommunications Radio Standards Specification - General Requirements for Compliance of Radio Apparatus

Spectrum Management and Telecommunications Radio Standards Specification - Licence-Exempt Radio Apparatus: Category I Equipment

For further applied test standards please refer to section 3 of this test report.

Test Item

Kind of test item: 122-123 GHz FMCW Radar (Projekt 98000331)

Model name: RR30-Serie (Lens 1)

FCC-ID PGP-RR30

IC-ID 24812-RR30

Frequency: 122 GHz – 123 GHz

Technology tested: FMCW Radar

Antenna: Integrated antennas: 1 Transmitter, 1 Receiver

Power supply: 12 V to 30 V DC by external power supply

Temperature range: -40°C to +65°C



This test report is electronically signed and valid without handwritten signature. For verification of the electronic signatures, the public keys can be requested at the testing laboratory.

Test report authorized:

Thomas Vogler
Lab Manager
Radio Communications

Test performed:

Frank Heussner
Testing Manager
Radio Communications

1 Table of contents

1	Table of contents	2
2	General information	3
2.1	Notes and disclaimer	3
2.2	Application details.....	3
2.3	Test laboratories sub-contracted	3
3	Test standard/s, references and accreditations.....	4
4	Test environment.....	4
5	Reporting statements of conformity – decision rule	5
6	Test item	6
6.1	General description	6
6.2	Additional information	6
7	Sequence of testing	7
7.1	Sequence of testing radiated spurious 9 kHz to 30 MHz.....	7
7.2	Sequence of testing radiated spurious 30 MHz to 1 GHz.....	8
7.3	Sequence of testing radiated spurious 1 GHz to 18 GHz.....	9
7.4	Sequence of testing radiated spurious above 18 GHz	10
7.5	Sequence of testing radiated spurious above 50 GHz with external mixers	11
8	Description of the test setup.....	12
8.1	Shielded semi anechoic chamber.....	13
8.2	Radiated measurements fully anechoic chamber.....	15
8.3	Radiated measurements 18 GHz to 50 GHz in test lab	17
8.4	Radiated measurements > 50 GHz in test lab.....	17
9	Measurement uncertainty	21
10	Far field consideration for measurements above 18 GHz	22
11	Measurement results	23
11.1	Summary	23
12	Measurement results	24
12.1	Occupied bandwidth (6 dB Bandwidth).....	24
12.2	Maximum E.I.R.P.	27
12.3	Spurious emissions radiated.....	32
12.4	Frequency Stability	52
12.5	Conducted emissions < 30MHz	56
13	Glossary.....	59
14	Document history	60
15	Accreditation Certificate – D-PL-12076-01-04	60
16	Accreditation Certificate – D-PL-12076-01-05	61

2 General information

2.1 Notes and disclaimer

The test results of this test report relate exclusively to the test item specified in this test report. CTC advanced GmbH does not assume responsibility for any conclusions and generalizations drawn from the test results with regard to other specimens or samples of the type of the equipment represented by the test item.

The test report may only be reproduced or published in full. Reproduction or publication of extracts from the report requires the prior written approval of CTC advanced GmbH.

The testing service provided by CTC advanced GmbH has been rendered under the current "General Terms and Conditions for CTC advanced GmbH".

CTC advanced GmbH will not be liable for any loss or damage resulting from false, inaccurate, inappropriate or incomplete product information provided by the customer.

Under no circumstances does the CTC advanced GmbH test report include any endorsement or warranty regarding the functionality, quality or performance of any other product or service provided.

Under no circumstances does the CTC advanced GmbH test report include or imply any product or service warranties from CTC advanced GmbH, including, without limitation, any implied warranties of merchantability, fitness for purpose, or non-infringement, all of which are expressly disclaimed by CTC advanced GmbH.

All rights and remedies regarding vendor's products and services for which CTC advanced GmbH has prepared this test report shall be provided by the party offering such products or services and not by CTC advanced GmbH. In no case this test report can be considered as a Letter of Approval.

This test report is electronically signed and valid without handwritten signature. For verification of the electronic signatures, the public keys can be requested at the testing laboratory.

2.2 Application details

Date of receipt of order:	2021-02-09
Date of receipt of test item:	2021-03-01 (Sample 5,6,8,9,10,11) & 2021-04-09 (Sample 7b)
Start of test:*	2021-03-11
End of test:*	2021-05-07
Person(s) present during the test:	-/-

*Date of each measurement, if not shown in the plot, can be requested. Dates are stored in the measurement software.

2.3 Test laboratories sub-contracted





None

3 Test standard/s, references and accreditations

Test standard	Date	Description
FCC - Title 47 CFR Part 15		FCC - Title 47 of the Code of Federal Regulations; Chapter I; Part 15 - Radio frequency devices
RSS - Gen Issue 5 incl. Amendment 1 & 2*	February 2021	Spectrum Management and Telecommunications Radio Standards Specification - General Requirements for Compliance of Radio Apparatus
RSS - 210 Issue 10*	December 2019	Spectrum Management and Telecommunications Radio Standards Specification - Licence-Exempt Radio Apparatus: Category I Equipment

*For information only. Frequency band of operation is not subject to RSS-210 Issue 10.

Guidance	Version	Description
ANSI C63.4-2014	-/-	American National Standard for Methods of Measurement of Radio-Noise Emissions from Low-Voltage Electrical and Electronic Equipment in the Range of 9 kHz to 40 GHz
ANSI C63.10-2013	-/-	American National Standard of Procedures for Compliance Testing of Unlicensed Wireless Devices

Accreditation	Description	
D-PL-12076-01-04	Telecommunication and EMC Canada https://www.dakks.de/as/ast/d/D-PL-12076-01-04e.pdf	  Deutsche Akkreditierungsstelle D-PL-12076-01-04
D-PL-12076-01-05	Telecommunication FCC requirements https://www.dakks.de/as/ast/d/D-PL-12076-01-05e.pdf	  Deutsche Akkreditierungsstelle D-PL-12076-01-05

4 Test environment

Temperature	:	T_{nom} +22 °C during room temperature tests T_{max} +50 °C during high temperature tests T_{min} -20 °C during low temperature tests
Relative humidity content	:	49 %
Barometric pressure	:	990 hPa to 1010 hPa
Power supply	:	V_{nom} 24 V DC V_{max} 27.6 V DC V_{min} 20.4 V DC

5 Reporting statements of conformity – decision rule

Only the measured values related to their corresponding limits will be used to decide whether the equipment under test meets the requirements of the test standards listed in chapter 3.

The measurement uncertainty is mentioned in this test report, see chapter 9, but is not taken into account - neither to the limits nor to the measurement results. Measurement results with a smaller margin to the corresponding limits than the measurement uncertainty have a potential risk of more than 5% that the decision might be wrong.

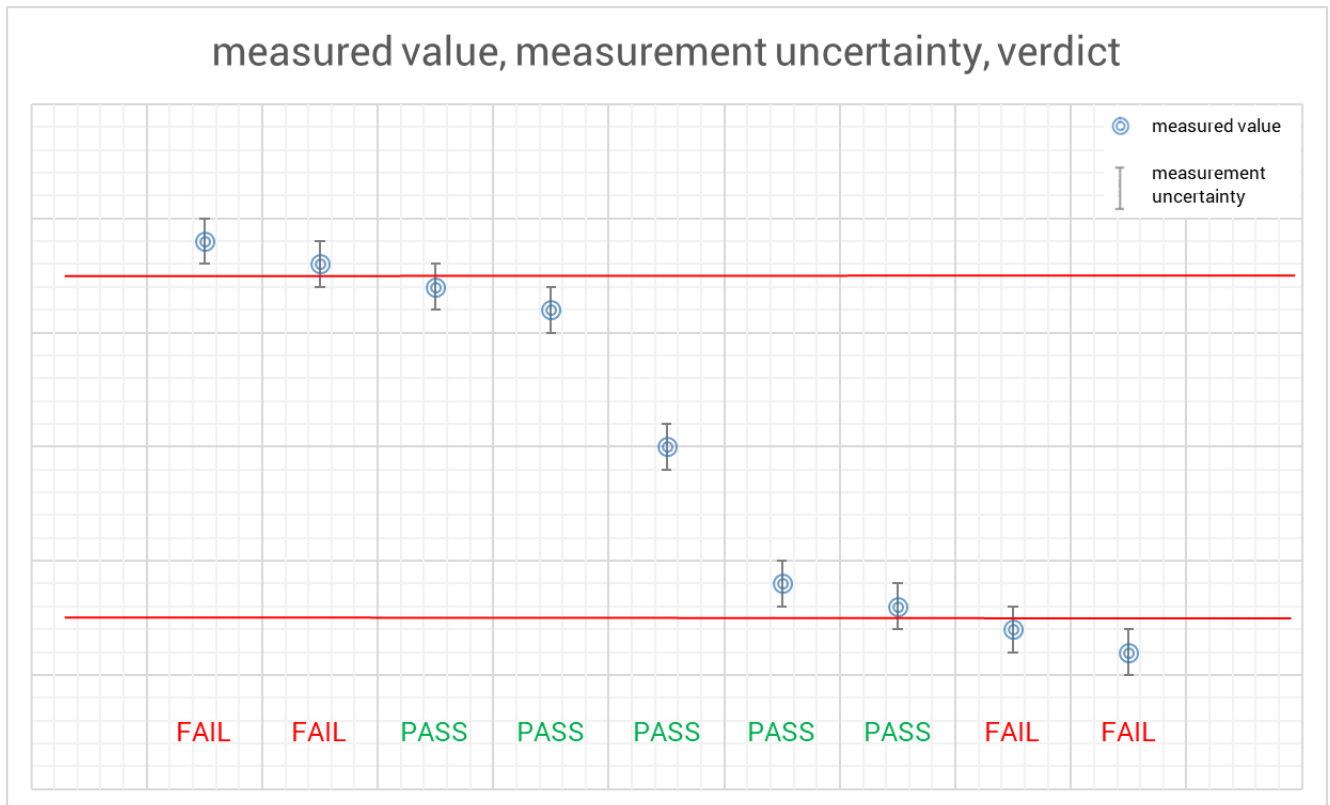

6 Test item

6.1 General description

Kind of test item	:	122-123 GHz FMCW Radar (Projekt 98000331)
Model name:	:	RR30-Serie (Lens 1)
HMN	:	-/-
PMN	:	RR30.DAJ2-11221309, RR30.DAJ2-11221333, RR30.DAJ2-11230003, RR30.DAO0-11221320, RR30.DAO0-11221321, RR30.RAK0-11234882, RR30.RAQ0-11234883
HVIN	:	11221309, 11221333, 11230003, 11221320, 11221321, 11234882, 11234883
FVIN	:	RR30AI0F_S, RR30AIRF_S
S/N serial number	:	Sample 7b, RR30.RAK0-11234882 Sample 8, RR30.RAK0-11234882 (RF-Chirp stopped, low frequency) Sample 9, RR30.RAK0-12234882 (RF-Chirp stopped, middle frequency) Sample 10, RR30.RAK0-11234882 (RF-Chirp stopped, high frequency) Delta-Tests: Sample 5, RR30.DAJ2-11221333 Sample 6, RR30.DAO0-11221321 Sample 11, RR30.RAQ0-11234883
Hardware status	:	11175059, 11219037, 11220535, 11151620
Software status	:	-/-
Firmware status	:	RR30AI0F_S_01-06-00, RR30AIRF_S_01-01-00
Frequency band	:	122 GHz – 123 GHz
Type of modulation	:	FMCW
Number of channels	:	1
Antenna	:	Integrated antennas: 1 Transmitter, 1 Receiver
Power supply	:	12 V to 30 V DC by external power supply
Temperature range	:	-40°C to +65°C

6.2 Additional information

The content of the following annexes is defined in the QA. It may be that not all of the listed annexes are necessary for this report, thus some values in between may be missing.

Test setup and EUT photos are included in test report: 1-0387/20-02-01_AnnexA
1-0387/20-02-01_AnnexD

7 Sequence of testing

7.1 Sequence of testing radiated spurious 9 kHz to 30 MHz

Setup

- The equipment is set up to simulate normal operation mode as described in the user manual or defined by the manufacturer.
- If the EUT is a tabletop system, it is placed on a table with 0.8 m height.
- If the EUT is a floor standing device, it is placed directly on the turn table.
- Auxiliary equipment and cables are positioned to simulate normal operation conditions as described in ANSI C 63.4.
- The AC power port of the EUT (if available) is connected to a power outlet below the turntable.
- Measurement distance is 3 m (see ANSI C 63.4) – see test details.
- EUT is set into operation.

Premeasurement*

- The turntable rotates from 0° to 315° using 45° steps.
- The antenna height is 1 m.
- At each turntable position the analyzer sweeps with positive-peak detector to find the maximum of all emissions.

Final measurement

- Identified emissions during the pre-measurement are maximized by the software by rotating the turntable from 0° to 360°.
- Loop antenna is rotated about its vertical axis for maximum response at each azimuth about the EUT. (For certain applications, the loop antenna plane may also need to be positioned horizontally at the specified distance from the EUT)
- The final measurement is done in the position (turntable and elevation) causing the highest emissions with quasi-peak (as described in ANSI C 63.4).
- Final levels, frequency, measuring time, bandwidth, turntable position, correction factor, margin to the limit and limit will be recorded. A plot with the graph of the premeasurement and the limit is stored.

*)Note: The sequence will be repeated three times with different EUT orientations.

7.2 Sequence of testing radiated spurious 30 MHz to 1 GHz

Setup

- The equipment is set up to simulate normal operation mode as described in the user manual or defined by the manufacturer.
- If the EUT is a tabletop system, a table with 0.8 m height is used, which is placed on the ground plane.
- If the EUT is a floor standing device, it is placed on the ground plane with insulation between both.
- Auxiliary equipment and cables are positioned to simulate normal operation conditions as described in ANSI C 63.4.
- The AC power port of the EUT (if available) is connected to a power outlet below the turntable.
- Measurement distance is 10 m or 3 m (see ANSI C 63.4) – see test details.
- EUT is set into operation.

Premeasurement

- The turntable rotates from 0° to 315° using 45° steps.
- The antenna is polarized vertical and horizontal.
- The antenna height changes from 1 m to 3 m.
- At each turntable position, antenna polarization and height the analyzer sweeps three times in peak to find the maximum of all emissions.

Final measurement

- The final measurement is performed for at least six highest peaks according to the requirements of the ANSI C63.4.
- Based on antenna and turntable positions at which the peak values are measured the software maximize the peaks by changing turntable position $\pm 45^\circ$ and antenna height between 1 and 4 m.
- The final measurement is done with quasi-peak detector (as described in ANSI C 63.4).
- Final levels, frequency, measuring time, bandwidth, antenna height, antenna polarization, turntable angle, correction factor, margin to the limit and limit are recorded. A plot with the graph of the premeasurement with marked maximum final results and the limit is stored.

7.3 Sequence of testing radiated spurious 1 GHz to 18 GHz

Setup

- The equipment is set up to simulate normal operation mode as described in the user manual or defined by the manufacturer.
- If the EUT is a tabletop system, a 2-axis positioner with 1.5 m height is used.
- If the EUT is a floor standing device, it is placed directly on the turn table.
- Auxiliary equipment and cables are positioned to simulate normal operation conditions as described in ANSI C 63.4.
- The AC power port of the EUT (if available) is connected to a power outlet below the turntable.
- Measurement distance is 3 m (see ANSI C 63.4) – see test details.
- EUT is set into operation.

Premeasurement

- The turntable rotates from 0° to 315° using 45° steps.
- The antenna is polarized vertical and horizontal.
- The antenna height is 1.5 m.
- At each turntable position and antenna polarization the analyzer sweeps with positive peak detector to find the maximum of all emissions.

Final measurement

- The final measurement is performed for at least six highest peaks according to the requirements of the ANSI C63.4.
- Based on antenna and turntable positions at which the peak values are measured the software maximizes the peaks by rotating the turntable from 0° to 360°. This measurement is repeated for different EUT-table positions (0° to 150° in 30°-steps) and for both antenna polarizations.
- The final measurement is done in the position (turntable, EUT-table and antenna polarization) causing the highest emissions with Peak and RMS detector (as described in ANSI C 63.4).
- Final levels, frequency, measuring time, bandwidth, turntable position, EUT-table position, antenna polarization, correction factor, margin to the limit and limit are recorded. A plot with the graph of the premeasurement with marked maximum final results and the limit is stored.

7.4 Sequence of testing radiated spurious above 18 GHz

Setup

- The equipment is set up to simulate normal operation mode as described in the user manual or defined by the manufacturer.
- Auxiliary equipment and cables are positioned to simulate normal operation conditions as described in ANSI C 63.4.
- The AC power port of the EUT (if available) is connected to a power outlet.
- The measurement distance is as appropriate (e.g. 0.5 m).
- The EUT is set into operation.

Premeasurement

- The test antenna is handheld and moved carefully over the EUT to cover the EUT's whole sphere and different polarizations of the antenna.

Final measurement

- The final measurement is performed at the position and antenna orientation causing the highest emissions with Peak and RMS detector (as described in ANSI C 63.4).
- Final levels, frequency, measuring time, bandwidth, correction factor, margin to the limit and limit are recorded. A plot with the graph of the premeasurement and the limit is stored.

7.5 Sequence of testing radiated spurious above 50 GHz with external mixers

Setup

- The equipment is set up to simulate normal operation mode as described in the user manual or defined by the manufacturer.
- Auxiliary equipment and cables are positioned to simulate normal operation conditions as described in ANSI C 63.4.
- The AC power port of the EUT (if available) is connected to a power outlet.
- The measurement distance is as appropriate for far field (e.g. 0.25 m).
- The EUT is set into operation.

Premeasurement

- The test antenna with external mixer is handheld and moved carefully over the EUT to cover the EUT's whole sphere and different polarizations of the antenna.
- Caution is taken to reduce the possible overloading of the external mixer.

Final measurement

- The final measurement is performed at the position and antenna orientation causing the highest emissions with Peak and RMS detector (as described in ANSI C 63.4).
- As external mixers may generate false images care is taken to ensure that any emission measured by the spectrum analyzer does indeed originate in the EUT. Signal identification feature of spectrum analyzer is used to eliminate false mixer images (i.e., it is not the fundamental emission or a harmonic falling precisely at the measured frequency).
- Final levels, frequency, measuring time, bandwidth, correction factor, margin to the limit and limit are recorded. A plot with the graph of the premeasurement and the limit is stored.

8 Description of the test setup

Typically, the calibrations of the test apparatus are commissioned to and performed by an accredited calibration laboratory. The calibration intervals are determined in accordance with the DIN EN ISO/IEC 17025. In addition to the external calibrations, the laboratory executes comparison measurements with other calibrated test systems or effective verifications. Weekly chamber inspections and range calibrations are performed. Where possible, RF generating and signaling equipment as well as measuring receivers and analyzers are connected to an external high-precision 10 MHz reference (GPS-based or rubidium frequency standard).

In order to simplify the identification of the equipment used at some special tests, some items of test equipment and ancillaries can be provided with an identifier or number in the equipment list below (Lab/Item).

Agenda: Kind of Calibration

k	calibration / calibrated	EK	limited calibration
ne	not required (k, ev, izw, zw not required)	zw	cyclical maintenance (external cyclical maintenance)
ev	periodic self verification	izw	internal cyclical maintenance
Ve	long-term stability recognized	g	blocked for accredited testing
vlk!	Attention: extended calibration interval		
NK!	Attention: not calibrated	*)	next calibration ordered / currently in progress

8.1 Shielded semi anechoic chamber

The radiated measurements are performed in vertical and horizontal plane in the frequency range from 9 kHz to 1 GHz in semi-anechoic chambers. The EUT is positioned on a non-conductive support with a height of 0.80 m above a conductive ground plane that covers the whole chamber. The receiving antennas are confirmed with specifications ANSI C63. These antennas can be moved over the height range between 1.0 m and 4.0 m in order to search for maximum field strength emitted from EUT. The measurement distances between EUT and receiving antennas are indicated in the test setups for the various frequency ranges. For each measurement, the EUT is rotated in all three axes until the maximum field strength is received. The wanted and unwanted emissions are received by spectrum analyzers where the detector modes and resolution bandwidths over various frequency ranges are set according to requirement ANSI C63.

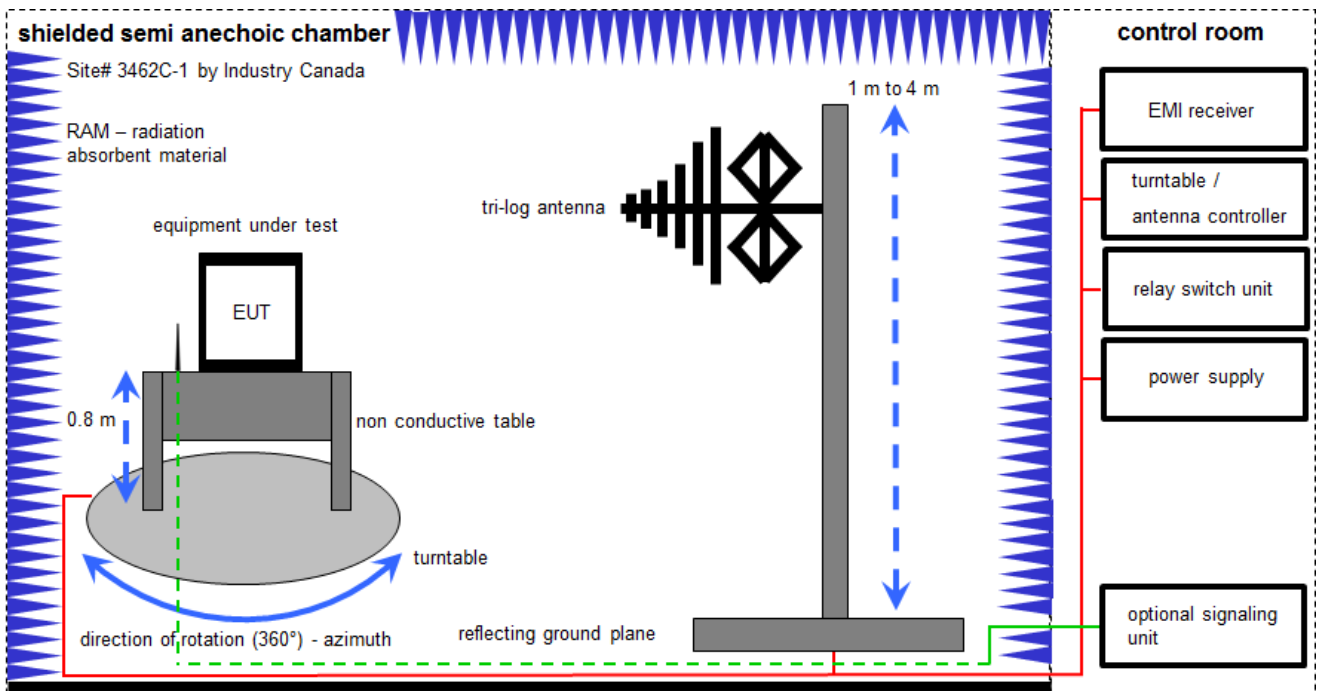

Measurement distance: tri-log antenna 10 meter

$$FS = UR + CL + AF$$

(FS-field strength; UR-voltage at the receiver; CL-loss of the cable; AF-antenna factor)

Example calculation:

$$FS \text{ [dB}\mu\text{V/m]} = 12.35 \text{ [dB}\mu\text{V/m]} + 1.90 \text{ [dB]} + 16.80 \text{ [dB/m]} = 31.05 \text{ [dB}\mu\text{V/m]} \text{ (35.69 } \mu\text{V/m)}$$

Equipment table:

No.	Lab / Item	Equipment	Type	Manufacturer	Serial No.	INV. No.	Kind of Calibration	Last Calibration	Next Calibration
1	n. a.	Switch-Unit	3488A	HP	2719A14505	300000368	ev	-/-	-/-
2	n. a.	DC power supply, 60Vdc, 50A, 1200 W	6032A	HP	2920A04466	300000580	ne	-/-	-/-
3	n. a.	Semi anechoic chamber	300023	MWB AG	-/-	300000551	ne	-/-	-/-
4	n. a.	Antenna Tower	Model 2175	ETS-Lindgren	64762	300003745	izw	-/-	-/-
5	n. a.	Positioning Controller	Model 2090	ETS-Lindgren	64672	300003746	izw	-/-	-/-
6	n. a.	Turntable Interface-Box	Model 105637	ETS-Lindgren	44583	300003747	izw	-/-	-/-
7	n. a.	TRILOG Broadband Test-Antenna 30 MHz - 3 GHz	VULB9163	Schwarzbeck Mess - Elektronik	318	300003696	vKI!	04.09.2019	03.09.2021
8	n. a.	EMI Test Receiver	ESR3	Rohde & Schwarz	102587	300005771	k	10.12.2020	09.06.2022
9	n. a.	PC	TecLine	F+W	-/-	300004388	ne	-/-	-/-

8.2 Radiated measurements fully anechoic chamber

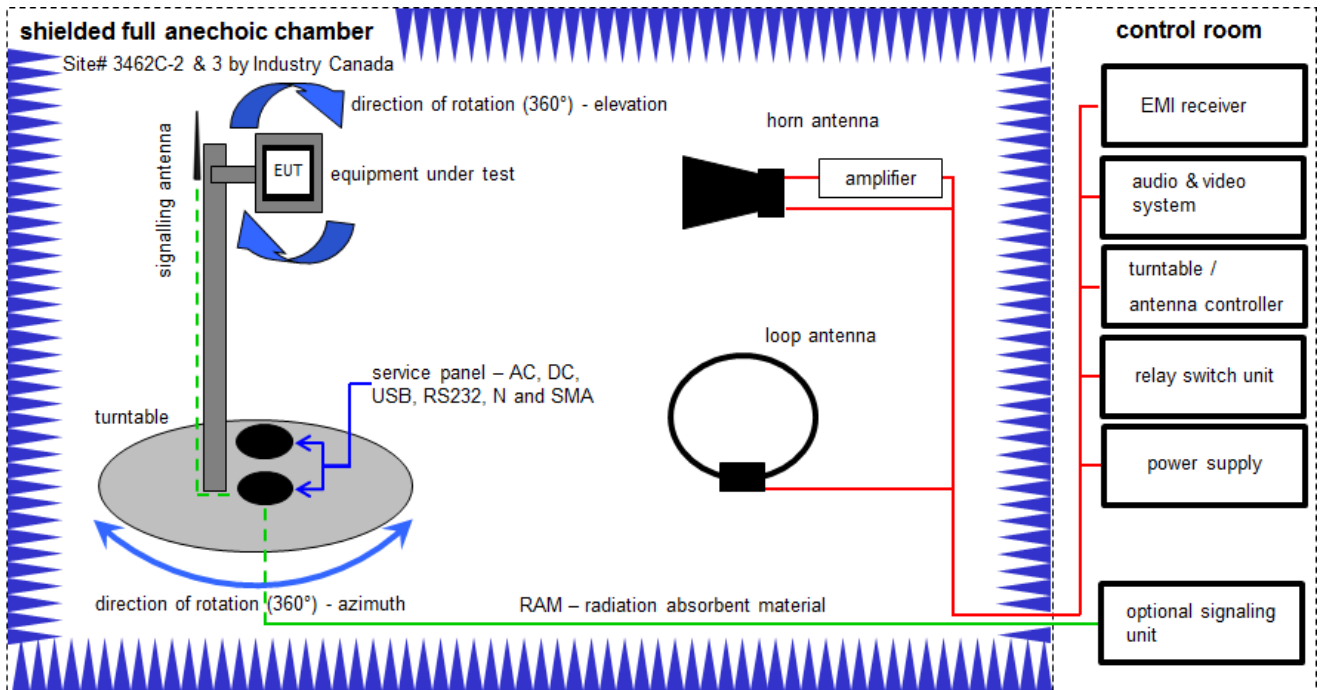

Measurement distance: horn antenna 3 meter; loop antenna 3 meter / 1 meter

$$FS = UR + CA + AF$$

(FS-field strength; UR-voltage at the receiver; CA-loss of the signal path; AF-antenna factor)

Example calculation:

$$FS [dB\mu V/m] = 40.0 [dB\mu V/m] + (-35.8) [dB] + 32.9 [dB/m] = 37.1 [dB\mu V/m] (71.61 \mu V/m)$$

$$OP = AV + D - G + CA$$

(OP-radiated output power; AV-analyzer value; D-free field attenuation of measurement distance; G-antenna gain+amplifier gain; CA-loss signal path)

Example calculation:

$$OP [dBm] = -39.0 [dBm] + 57.0 [dB] - 12.0 [dBi] + (-36.0) [dB] = -30 [dBm] (1 \mu W)$$

Equipment table (Chamber C):

No.	Lab / Item	Equipment	Type	Manufacturer	Serial No.	INV. No.	Kind of Calibration	Last Calibration	Next Calibration
1	n. a.	DC power supply, 60Vdc, 50A, 1200 W	6032A	HP	2818A03450	300001040	vKI!	09.12.2020	08.12.2023
2	n. a.	Active Loop Antenna 9 kHz to 30 MHz	6502	EMCO	2210	300001015	vKI!	13.06.2019	12.06.2021
3	n. a.	Anechoic chamber	FAC 3/5m	MWB / TDK	87400/02	300000996	ev	-/-	-/-
4	n. a.	Double-Ridged Waveguide Horn Antenna 1-18.0GHz	3115	EMCO	9107-3697	300001605	vKI!	12.03.2021	11.03.2023
5	n. a.	Switch / Control Unit	3488A	HP	*	300000199	ne	-/-	-/-
6	n. a.	Variable isolating transformer	MPL IEC625 Bus Variable isolating transformer	Erfi	91350	300001155	ne	-/-	-/-
7	n. a.	EMI Test Receiver 20Hz- 26,5GHz	ESU26	R&S	100037	300003555	k	11.12.2020	10.12.2021
8	n. a.	Highpass Filter	WHKX7.0/18G-8SS	Wainwright	19	300003790	ne	-/-	-/-
9	n. a.	Broadband Amplifier 0.5-18 GHz	CBLU5184540	CERNEX	22049	300004481	ev	-/-	-/-
10	n. a.	Broadband Amplifier 5-13 GHz	CBLU5135235	CERNEX	22010	300004491	ev	-/-	-/-
11	n. a.	4U RF Switch Platform	L4491A	Agilent Technologies	MY50000037	300004509	ne	-/-	-/-
12	n. a.	NEXIO EMV-Software	BAT EMC V3.16.0.49	EMCO		300004682	ne	-/-	-/-
13	n. a.	PC	ExOne	F+W		300004703	ne	-/-	-/-
14	n. a.	RF-Amplifier	AMF-6F06001800-30-10P-R	NARDA-MITEQ Inc	2011572	300005241	ev	-/-	-/-

8.3 Radiated measurements 18 GHz to 50 GHz in test lab

Radiated measurements > 12.75 GHz

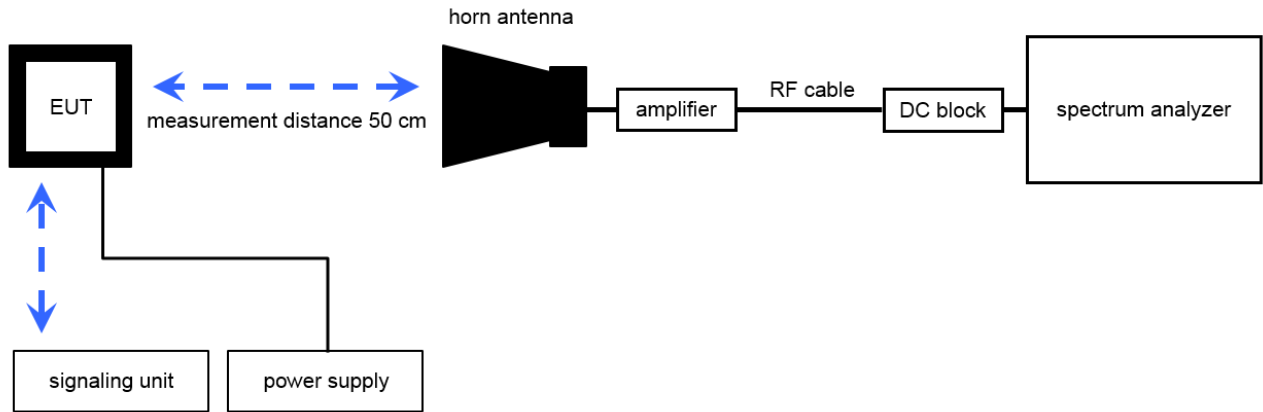

8.4 Radiated measurements > 50 GHz in test lab

Radiated measurements RF laboratory

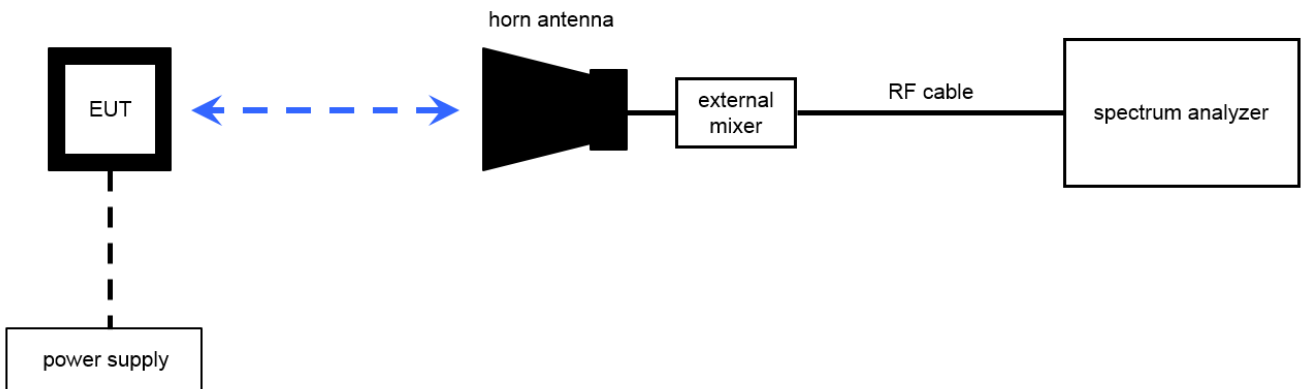

Note: conversion loss of mixer is already included in analyzer value.

Equipment table:

No.	Lab / Item	Equipment	Type	Manufacturer	Serial No.	INV. No.	Kind of Calibration	Last Calibration	Next Calibration
1	n.a.	Horn Antenna 18,0-40,0 GHz	LHAF180	Microw.Devel	39180-103-021	300001747	vKI!	18.02.2019	17.02.2022
2	n. a.	Std. Gain Horn Antenna 18.0-26.5 GHz	638	Narda		300000486	vKI!	21.01.2020	20.01.2022
3	n. a.	Std. Gain Horn Antenna 26.5-40.0 GHz	V637	Narda	82-16	300000510	vKI!	23.01.2020	22.01.2022
4	n.a.	Std. Gain Horn Antenna 33.0-50.1 GHz	2324-20	Flann	57	400000683	ne	-/-	-/-
5	n. a.	Std. Gain Horn Antenna 49.9-75.8 GHz	2524-20	Flann	*	300001983	ne	-/-	-/-
6	n. a.	Std. Gain Horn Antenna 60-90 GHz	COR 60_90	Thomson CSF		300000814	ev	-/-	-/-
7	n. a.	Std. Gain Horn Antenna 73.8-112 GHz	2724-20	Flann	*	300001988	ne	-/-	-/-
8	n.a.	Std. Gain Horn Antenna 92.3-140 GHz	2824-20	Flann		300001993	ne	-/-	-/-
9	n. a.	Std. Gain Horn Antenna 114-173 GHz	2924-20	Flann	*	300001999	ne	-/-	-/-
10	n. a.	Std. Gain Horn Antenna 145-220 GHz	3024-20	Flann	*	300002000	ne	-/-	-/-
11	n. a.	Std. Gain Horn Antenna 217-330 GHz	32240-20	Flann	233278	300004960	ne	-/-	-/-
12	n. a.	Standard Gain Horn 325-500 GHz	570240-20 1785-2a	Flann	273569	300006097	ev	25.05.2020	24.05.2022
13	n. a.	Broadband LNA 18-50 GHz	CBL18503070PN	CERNEX	25240	300004948	ev	09.03.2020	08.03.2022
14	n. a.	Harmonic Mixer 3-Port, 50-75 GHz	FS-Z75	Rohde & Schwarz	101578	300005788	k	17.06.2020	16.06.2021
15	n. a.	Harmonic Mixer 3-Port, 60-90 GHz	FS-Z90	R&S	101555	300004691	k	08.07.2020	07.07.2021
16	n. a.	Harmonic Mixer 3-Port, 75-110 GHz	FS-Z110	R&S	101411	300004959	k	19.06.2020	18.06.2021
17	n.a.	Harmonic Mixer 3-port, 90-140 GHz	FS-Z140	Rohde & Schwarz	101119	300005581	k	09.07.2020	08.07.2021
18	n. a.	Harmonic Mixer 3-Port, 110-170 GHz	FS-Z170	Radiometer Physics GmbH	100014	300004156	k	28.05.2020	27.05.2021
19	n. a.	Harmonic Mixer 3-Port, 140-220 GHz	SAM-220	Radiometer Physics GmbH	200001	300004157	k	14.07.2020	13.07.2021
20	n. a.	Harmonic Mixer 3-Port, 220-325 GHz	SAM-325	Radiometer Physics GmbH	100002	300004158	k	23.07.2020	22.07.2021
21	n.a.	Harmonic Mixer 325-500GHz	FS-Z500	Radiometer Physics GmbH	101016	300006096	k	25.05.2020	24.05.2021
22	n. a.	Spectrum Analyzer 2 Hz - 85 GHz	FSW85	R&S	101333	300005568	k	17.06.2020	16.06.2021
23	n. a.	Spectrum Analyzer	FSW50	Rohde & Schwarz	101332	300005935	k	05.03.2021	04.03.2022
24	n. a.	Spectrum Analyzer	FSW50	Rohde & Schwarz	101560	300006179	k	19.02.2021	18.02.2022
25	n.a.	DC Power Supply, 60V, 10A	6038A	HP	2933A08295	300001519	vKI!	08.12.2020	07.12.2023

8.5 Radiated power measurements using RF detector according to ANSI C63.10-2013

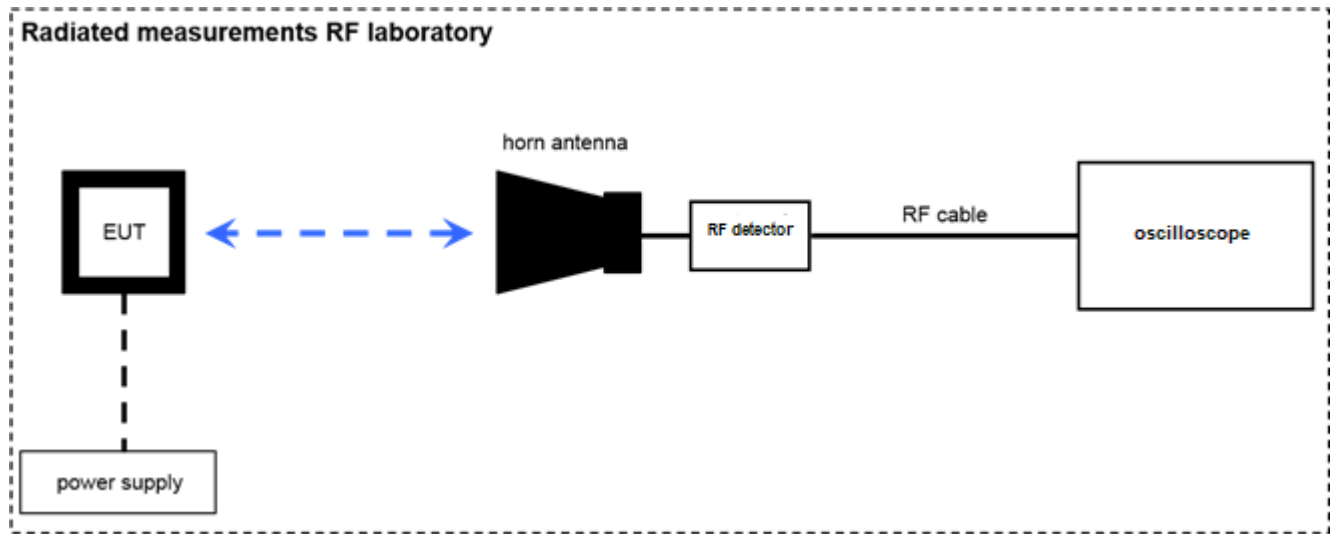

Note: EUT is replaced by reference source for substitution measurement

No.	Lab / Item	Equipment	Type	Manufacturer	Serial No.	INV. No.	Kind of Calibration	Last Calibration	Next Calibration
1	n.a.	Std. Gain Horn Antenna 90-140 GHz	COR 90_140	Thomson CSF		300000799	ev	-/-	-/-
2	n.a.	F-Band Positive Amplitude Detector	SFD-903144-08SF-P1	Sage Millimeter Inc.	07354-1	300006119	ev	-/-	-/-
3	n.a.	SG Extension Module 110 - 170 GHz	E8257DV06	VDI	US53250018	300005540	ev	-/-	-/-
4	n.a.	Std. Gain Horn Antenna 114-173 GHz	2924-20	Flann	*	300001999	ne	-/-	-/-
5	n.a.	Synthesized Sweeper 10 MHz - 40 GHz	83640A	HP	3119A00458	300002266	vKI!	13.12.2019	12.12.2021
6	n.a.	2.5 GHz Digital Phosphor Oscilloscope	DPO7254	Tektronix	B022702	300003573	vKI!	07.12.2020	06.12.2022

8.6 AC conducted

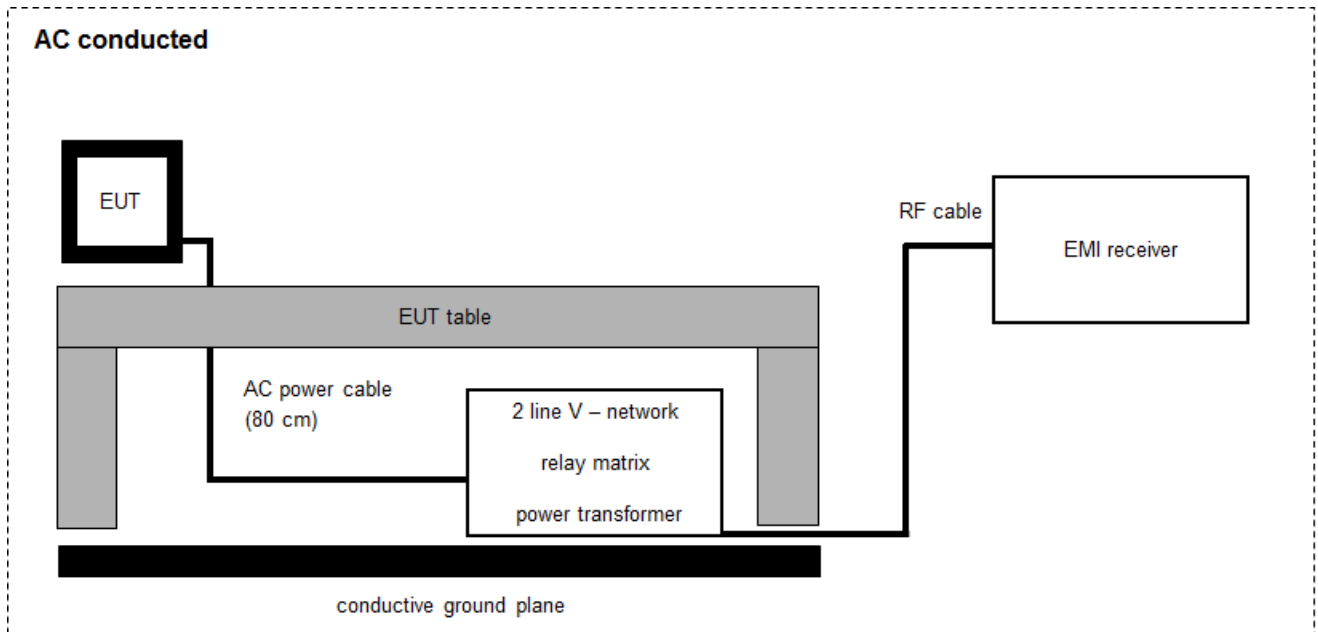

$$FS = UR + CF + VC$$

(FS-field strength; UR-voltage at the receiver; CR-loss of the cable and filter; VC-correction factor of the ISN)

Example calculation:

$$FS [dB\mu V/m] = 37.62 [dB\mu V/m] + 9.90 [dB] + 0.23 [dB] = 47.75 [dB\mu V/m] (244.06 \mu V/m)$$

Equipment table:

No.	Lab / Item	Equipment	Type	Manufacturer	Serial No.	INV. No.	Kind of Calibration	Last Calibration	Next Calibration
1	n. a.	Two-line V-Network (LISN) 9 kHz to 30 MHz	ESH3-Z5	R&S	892475/017	300002209	vKI!	11.12.2019	10.12.2021
2	n. a.	Analyzer-Reference-System (Harmonics and Flicker)	ARS 16/1	SPS	A3509 07/0 0205	300003314	vKI!	17.01.2020	16.01.2022
3	n. a.	Hochpass 150 kHz	EZ-25	R&S	100010	300003798	ev	-/-	-/-
4	n. a.	EMI Test Receiver	ESCI 3	R&S	100083	300003312	k	09.12.2020	08.12.2021
5	n. a.	PC	Tecline	F+W	-/-	300003532	ne	-/-	-/-

9 Measurement uncertainty

Test case	Uncertainty
Equivalent isotropically radiated power (e.i.r.p.)	Conducted value ± 1 dB Radiated value ± 3 dB
Permitted range of operating frequencies	± 100 kHz
Conducted unwanted emissions in the spurious domain (up to 18 GHz)	± 1 dB
Radiated unwanted emissions in the spurious domain (up to 18 GHz)	± 3 dB
Conducted unwanted emissions in the spurious domain (18 to 40 GHz)	± 4 dB
Radiated unwanted emissions in the spurious domain (18 to 40 GHz)	± 4 dB
Conducted unwanted emissions in the spurious domain (40 to 50 GHz)	± 4.5 dB
Radiated unwanted emissions in the spurious domain (40 to 50 GHz)	± 4.5 dB
Conducted unwanted emissions in the spurious domain (above 50 GHz)	± 5 dB
Radiated unwanted emissions in the spurious domain (above 50 GHz)	± 5 dB
DC and low frequency voltages	± 3 %
Temperature	± 1 °C
Humidity	± 3 %

10 Far field consideration for measurements above 18 GHz

Far field distance calculation:

$$D_{ff} = 2 \times D^2 / \lambda$$

with

D_{ff} Far field distance
 D Antenna dimension
 λ wavelength

Spurious emission measurements:

Antenna frequency range in GHz	Highest measured frequency in GHz	D in cm	λ in cm	D_{ff} in cm
18-26	26	3.4	1.15	20.04
26-40	40	2.2	0.75	12.91
40-50	50	2.77	0.60	25.58
50-75	75	1.85	0.40	17.11
75-110	110	1.24	0.27	11.28
90-140	140	1.02	0.22	9.72
110-170	170	0.85	0.18	8.19
140-220	220	0.68	0.14	6.78
220-325	325	0.43	0.09	4.01
325-500	500	0.26	0.06	2.22

In band measurement (OBW):

Antenna frequency range in GHz	Highest measured frequency in GHz	Antenna dimension in cm	Wavelength in cm	far field distance in cm
90 - 140	123.5	1.02	0.24	8.57

11 Measurement results

11.1 Summary

<input checked="" type="checkbox"/>	No deviations from the technical specifications were ascertained
<input type="checkbox"/>	There were deviations from the technical specifications ascertained
<input type="checkbox"/>	This test report is only a partial test report. The content and verdict of the performed test cases are listed below.

TC identifier	Description	verdict	date	Remark
RF-Testing	FCC 47 CFR Part 15 RSS - Gen Issue 5* RSS - 210 Issue 10*	see below	2021-06-08	-/-

Test specification clause	Test case	Temperature conditions	Power supply	Pass	Fail	NA	NP	Results (max.)
§15.258 (d) RSS - Gen Issue 5* RSS - 210 Issue 10*	Occupied bandwidth	Nominal	Nominal	<input checked="" type="checkbox"/>	<input type="checkbox"/>	<input type="checkbox"/>	<input type="checkbox"/>	complies
§15.258(b) (1) / (3) RSS - Gen Issue 5* RSS - 210 Issue 10*	Maximum E.I.R.P.	Nominal	Nominal	<input checked="" type="checkbox"/>	<input type="checkbox"/>	<input type="checkbox"/>	<input type="checkbox"/>	complies
§15.258(c) RSS - Gen Issue 5* RSS - 210 Issue 10*	Spurious Emissions	Nominal	Nominal	<input checked="" type="checkbox"/>	<input type="checkbox"/>	<input type="checkbox"/>	<input type="checkbox"/>	complies
§15.258(d) RSS - Gen Issue 5* RSS - 210 Issue 10*	Frequency stability	Extreme Nominal	Extreme Nominal	<input checked="" type="checkbox"/>	<input type="checkbox"/>	<input type="checkbox"/>	<input type="checkbox"/>	complies
§15.207 RSS - Gen Issue 5* RSS - 210 Issue 10*	Conducted emissions < 30 MHz	Nominal	Nominal	<input checked="" type="checkbox"/>	<input type="checkbox"/>	<input type="checkbox"/>	<input type="checkbox"/>	complies

*For information only. Frequency band of operation is not subject to RSS-210 Issue 10.

Note: C = Compliant; NC = Not compliant; NA = Not applicable; NP = Not performed

12 Measurement results

12.1 Occupied bandwidth (6 dB Bandwidth)

Description:

Measurement of the bandwidth of the wanted signal.

Measurement:

Measurement parameter	
Detector:	Pos-Peak
Resolution bandwidth:	100 kHz
Video bandwidth:	300 kHz
Trace-Mode:	Max Hold

Limits:

FCC
CFR Part 15.258
The occupied bandwidth from intentional radiators operated within the specified frequency band shall comply with the following:
Frequency range
116 GHz – 123 GHz

Measurement results:

Sample	Test condition	F _L in GHz	F _H in GHz	Occupied bandwidth in MHz
7b	T _{nom} / V _{nom}	122.0285	122.9735	945.1
5 (Delta-Test)	T _{nom} / V _{nom}	122.0272	122.9808	953.5
6 (Delta-Test)	T _{nom} / V _{nom}	122.0282	122.9708	942.5
11 (Delta-Test)	T _{nom} / V _{nom}	122.0282	122.9718	943.5
	Measurement uncertainty	± span/1000		

Plot 1: Sample 7b, 6 dB OBW

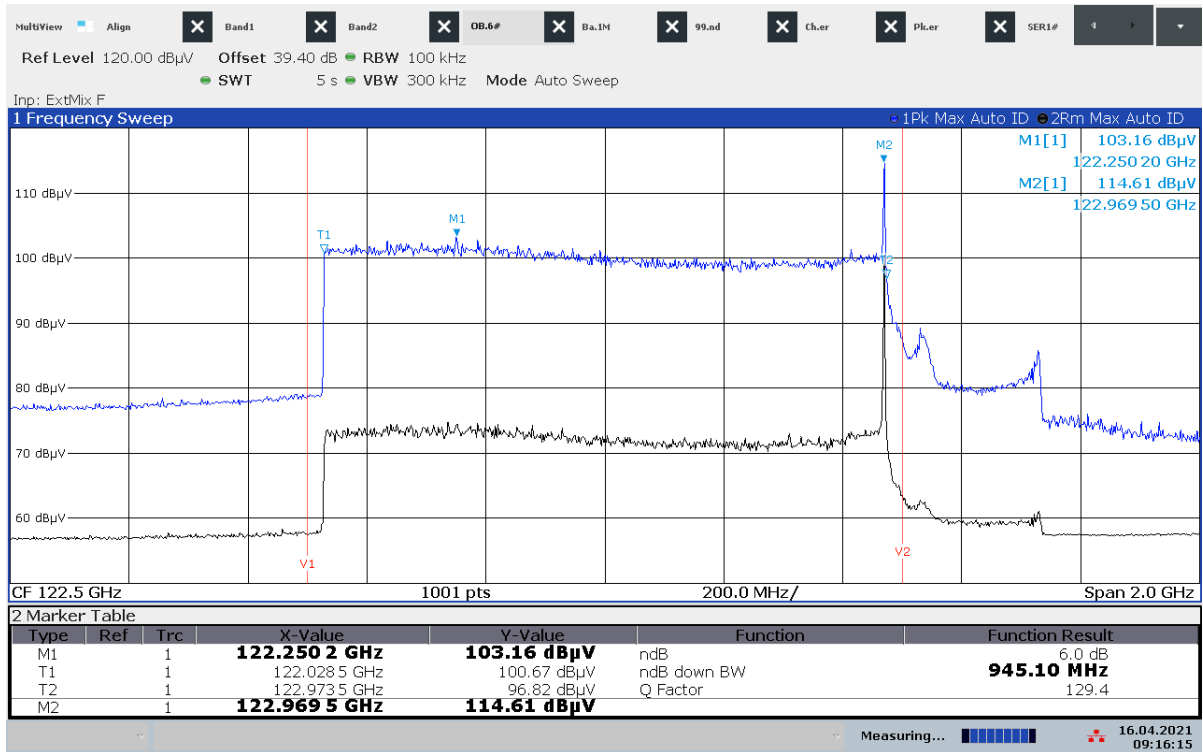

09:16:15 16.04.2021

Plot 2: Sample 5 (Delta-Test), 6 dB OBW

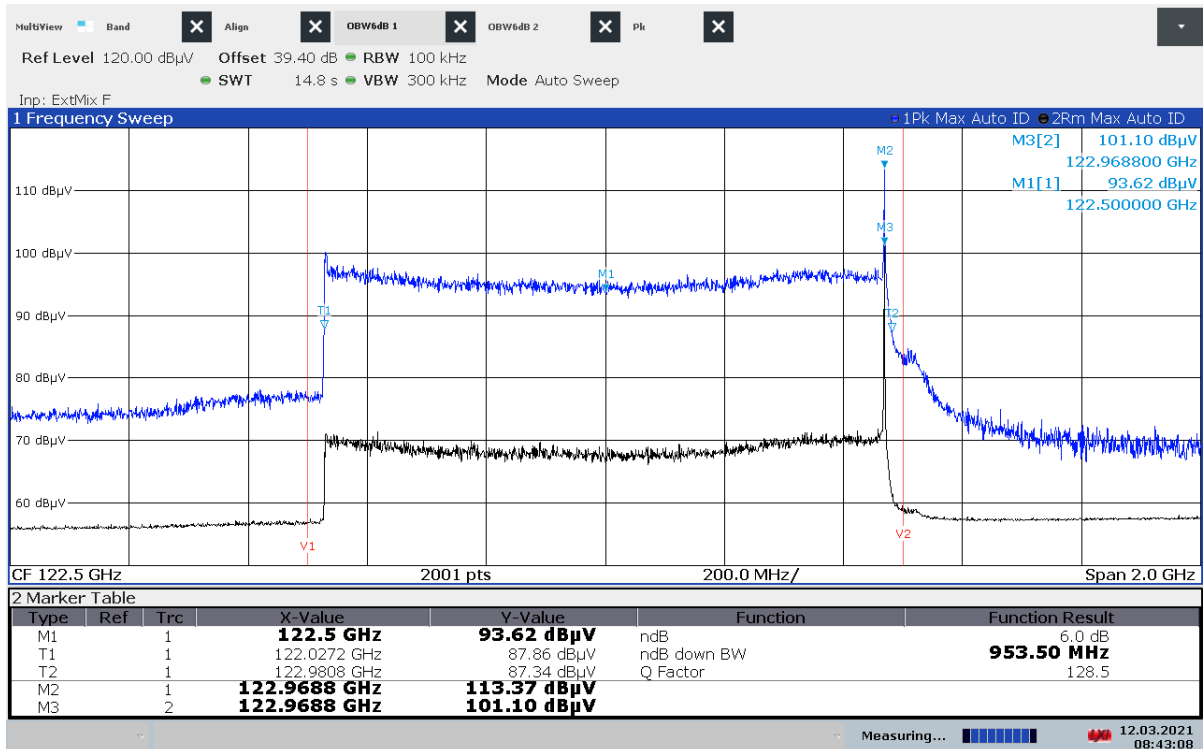

08:43:09 12.03.2021

Plot 3: Sample 6 (Delta-Test), 6 dB OBW

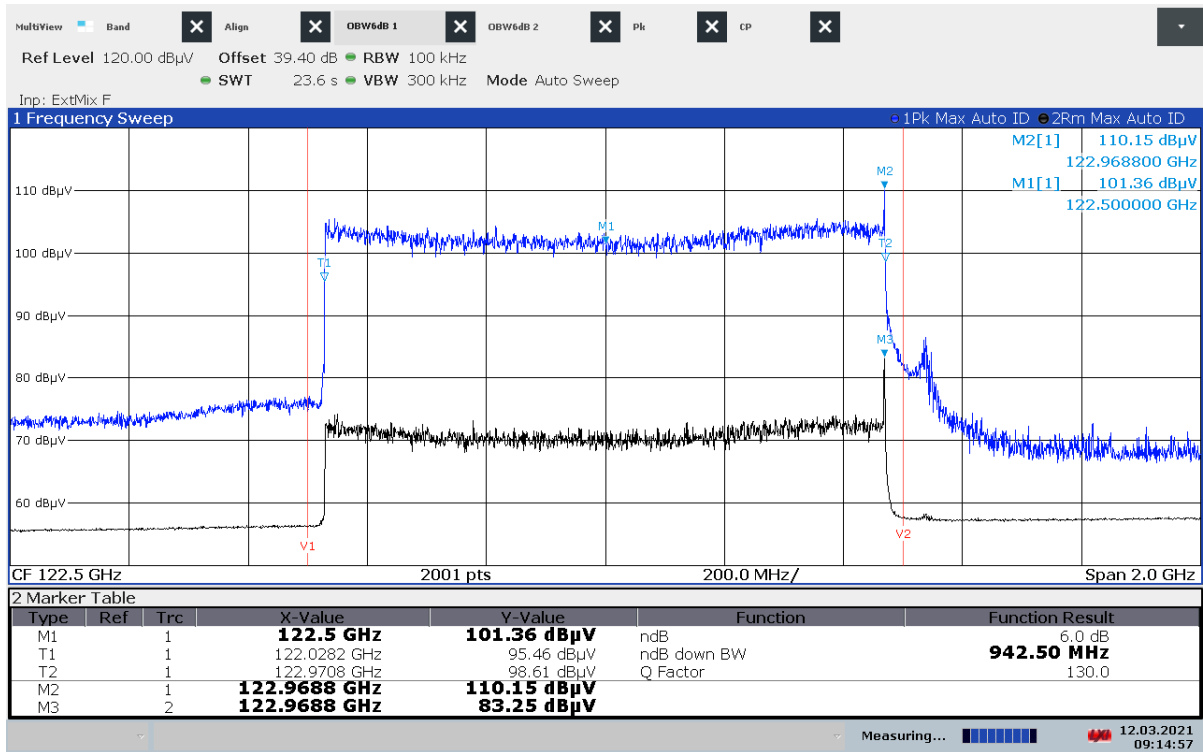

09:14:58 12.03.2021

Plot 4: Sample 11 (Delta-Test), 6 dB OBW

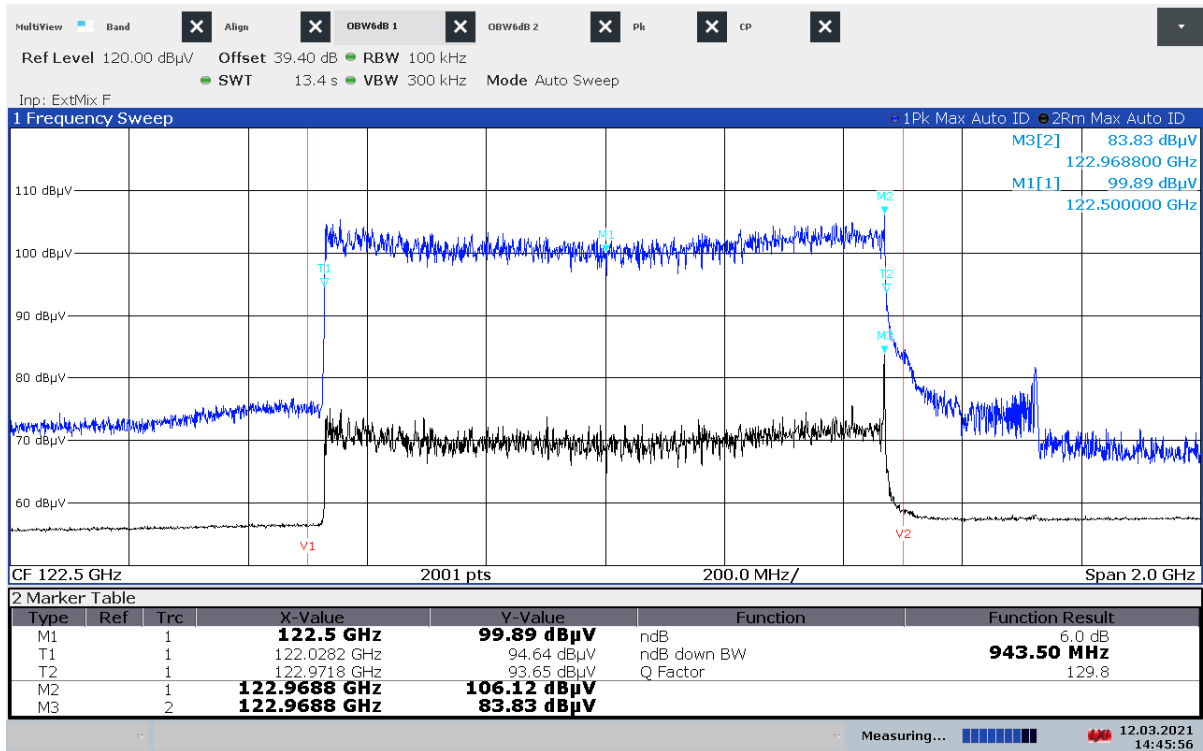

14:45:56 12.03.2021

12.2 Maximum E.I.R.P.

Description:

Measurement of the maximum radiated e.i.r.p. of the wanted signal.

Measurement:

Measurement parameter	
Detector:	Pos-Peak (RF-Detector)
Video bandwidth:	10 MHz
Trace-Mode:	Max Hold

Limits:

FCC Part 15.258 (b)

Emission levels within the 116-123 GHz, 174.8-182 GHz, 185-190 GHz and 244-246 GHz bands shall not exceed the following equivalent isotropically radiated power (EIRP) limits as measured during the transmit interval:

(1) The average power of any emission shall not exceed 40 dBm and the peak power of any emission shall not exceed 43 dBm.

(3) The peak power shall be measured with a detection bandwidth that encompasses the entire occupied bandwidth within the intended band of operation, e.g., 116-123 GHz, 174.8-182 GHz, 185-190 GHz or 244-246 GHz. The average emission levels shall be measured over the actual time period during which transmission occurs.

Measurement results:

Sample	Test condition	Max E.I.R.P. [dBm]	Average E.I.R.P. [dBm]	Duty cycle
7b	T_{nom} / V_{nom}	20.2	17.7	55.8 %
5 (Delta-Test)	T_{nom} / V_{nom}	19.0	15.5	44.3 %
6 (Delta-Test)	T_{nom} / V_{nom}	19.0	15.9	48.8 %
11 (Delta-Test)	T_{nom} / V_{nom}	18.2	15.7	55.8 %

E.I.R.P measurement by substitution method:

Step 1) EUT emission measured with RF-detector:

- Measurement distance: d_{EUT}
- Maximum readout value on oscilloscope: V_{max}
- Duty cycle: D

Step 2) Substitution of EUT by a cw reference source with a frequency of f_{ref} and a fixed output power P_{ref}

- Readout value on oscilloscope adjusted to V_{max} by far field attenuation \rightarrow Measurement distance d_{ref}

Step 3) Calculation of the Max E.I.R.P. of the EUT:

- Free space loss: $FSL(d) = 20 \times \log(4 \times \pi \times d \times f / c)$, c : speed of light
- Max E.I.R.P. = $P_{ref} - FSL(d_{ref}) + FSL(d_{EUT})$

Step 4) Calculation of the Average E.I.R.P. of the EUT:

- Average E.I.R.P. = Max E.I.R.P. + $10 \times \log(D)$

Measurement step	Measurement parameter	Sample			
		7b	5	6	11
1)	Measurement distance d_{EUT}	0.33 m	0.33 m	0.33 m	0.33 m
	Maximum readout value V_{max}	2.21 mV	1.74 mV	1.74 mV	1.51 mV
	Duty cycle D	55.8 %	44.3 %	48.8 %	55.8 %
2)	Output power P_{ref}	28.4 dBm	28.4 dBm	28.4 dBm	28.4 dBm
	Frequency f_{ref}	122.5 GHz	122.5 GHz	122.5 GHz	122.5 GHz
	Measurement distance d_{ref}	0.85 m	0.97 m	0.97 m	1.07 m
3)	Max E.I.R.P	20.2 dBm	19.0 dBm	19.0 dBm	18.2 dBm
4)	Average E.I.R.P	17.7 dBm	15.5 dBm	15.9 dBm	15.7 dBm

Setup of the substitution:

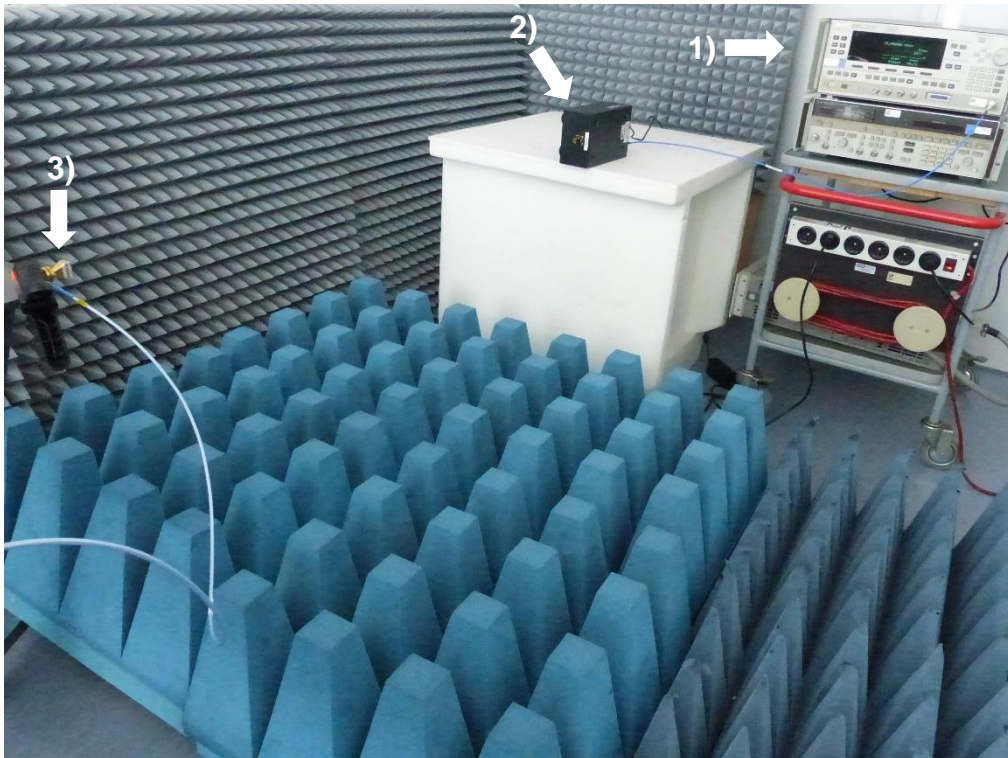

- 1) Synthesized Sweeper 10 MHz - 40 GHz
- 2) SG Extension Module 110 - 170 GHz & Std. Gain Horn Antenna 114-173 GHz
- 3) F-Band Positive Amplitude Detector & Std. Gain Horn Antenna 90-140 GHz

Plot 5: Sample 7b, Duty cycle



Plot 6: Sample 5, Duty cycle

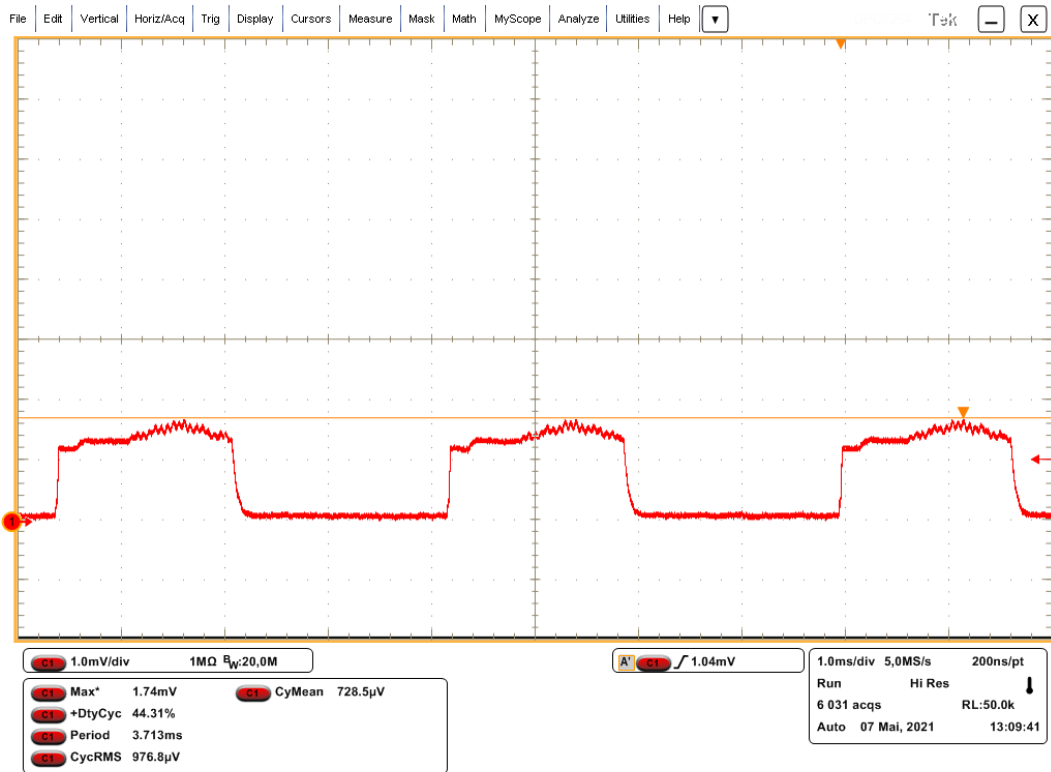

Plot 7: Sample 6, Duty cycle



Plot 8: Sample 11, Duty cycle

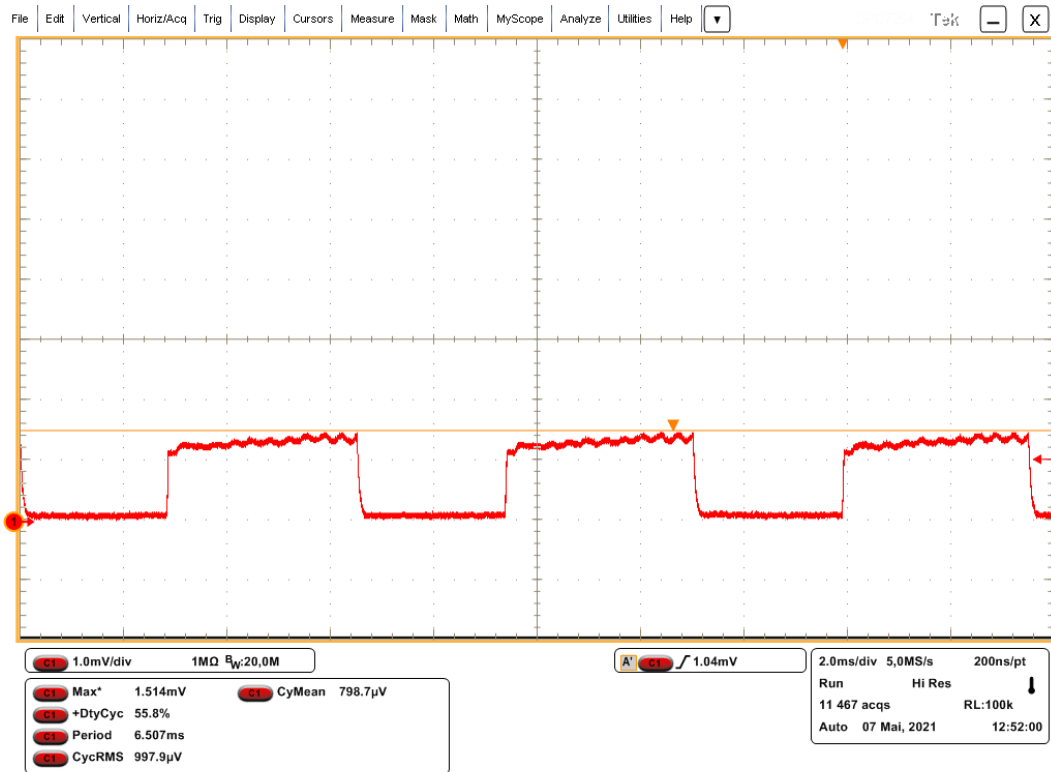

12.3 Spurious emissions radiated

Description:

Measurement of the radiated spurious emissions.

Measurement:

Measurement parameter	
Detector:	Quasi Peak / Pos-Peak / RMS
Sweep time:	Auto
Resolution bandwidth:	F < 1 GHz: 100 kHz F > 1 GHz: 1 MHz
Video bandwidth:	Auto
Frequency range:	30 MHz to 500 GHz
Trace-Mode:	Max Hold

Limits:

FCC Part 15.258 / RSS-210

(c) Spurious emissions shall be limited as follows:

- (1) The power density of any emissions outside the band of operation, e.g., 116-123 GHz, 174.8-182 GHz, 185-190 GHz or 244-246 GHz, shall consist solely of spurious emissions.
- (2) Radiated emissions below 40 GHz shall not exceed the general limits in §15.209.

FCC / IC		
CFR Part 15.209(a) / RSS-210 / RSS-Gen		
Radiated emission limits		
Frequency (MHz)	Field strength (microvolts/meter)	Measurement distance (meters)
0.009 – 0.490	2400/F(kHz)	300
0.490 – 1.705	24000/F(kHz)	30
1.705 – 30.0	30	30
30 – 88	100	3
88 – 216	150	3
216 – 960	200	3
Above 960	500	3

- (3) Between 40 GHz and the highest frequency specified in § 15.33, the level of these emissions shall not exceed 90 pW/cm² at a distance of 3 meters.
- (4) The levels of the spurious emissions shall not exceed the level of the fundamental emission.

Limit conversion:**ANSI C63.10-2013 9.6**Power density at the distance specified by the limit: PD [W/m²]

Equivalent isotropically radiated power: EIRP [dBm]

Distance at which the power density limit is specified: d [m]

$$\text{EIRP[dBm]} = 10 \times \log(4 \times \pi \times d^2 \times \text{PD[W/m}^2])$$

According to this formula, an emission limit of PD = 90 pW/cm² at a distance of 3 meters corresponds to EIRP = -10 dBm.

Measurement results:**Note:**

Measurements were performed in normal operation mode (frequency sweep) and in stopped mode (frequency sweep stopped at three positions within the range of operation: near top, near middle, near bottom) in accordance with §15.31(c), (m).

Samples:

- 7b (normal operation mode)
- 8 (frequency sweep stopped near bottom of the range of operation)
- 9 (frequency sweep stopped near middle of the range of operation)
- 10 (frequency sweep stopped near top of the range of operation)

If the results in the cases of the stopped frequency sweep are comparable, only the results with a stop in the middle of the operating frequency range are shown below.

Plot 9: 9 kHz – 30 MHz, normal mode

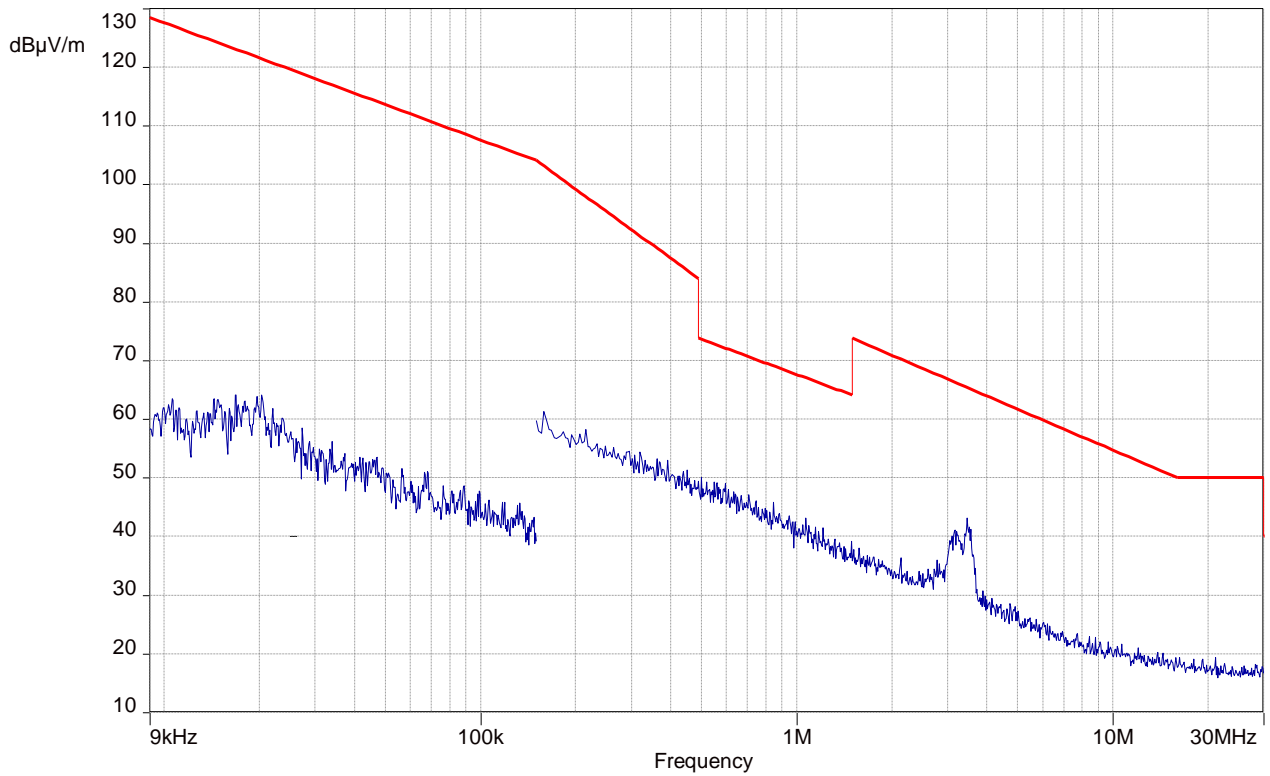

Plot 10: 9 kHz – 30 MHz, stopped mode (sweep stopped in the middle of the range of operation)

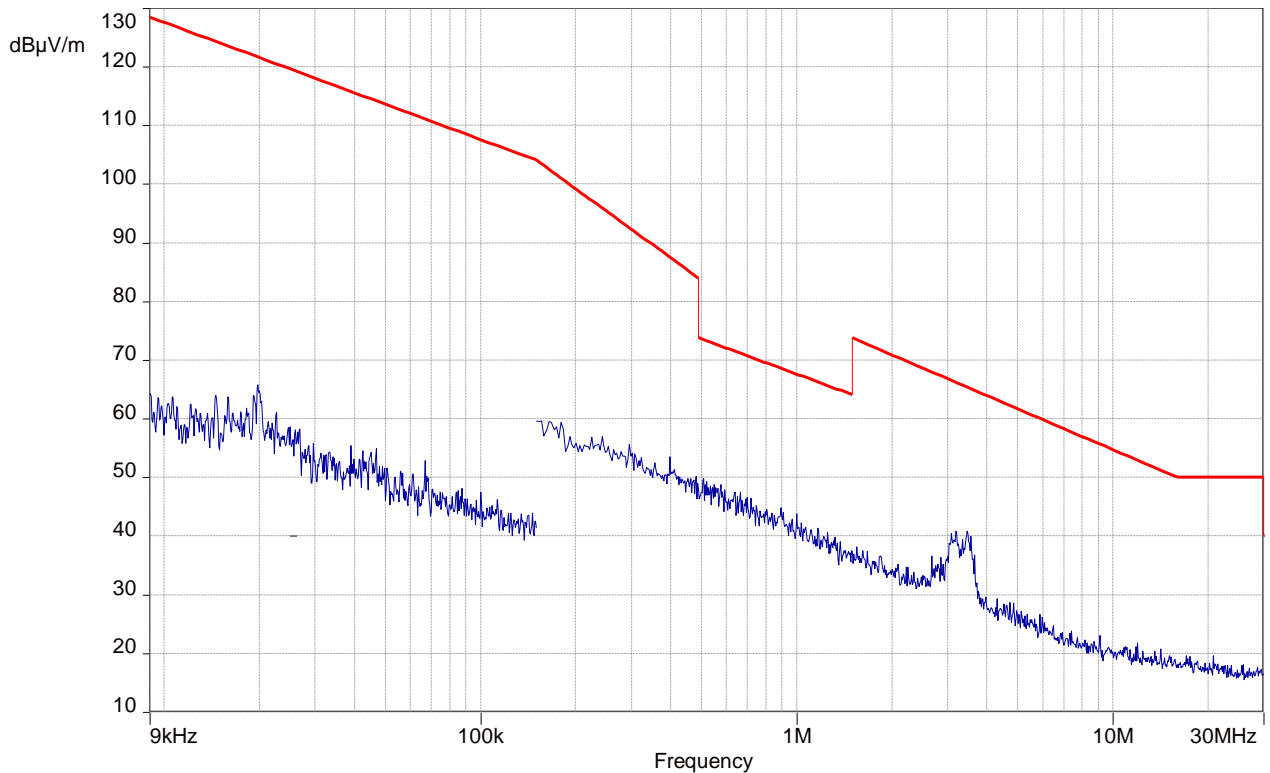

Plot 11: 30 MHz – 1 GHz, normal mode

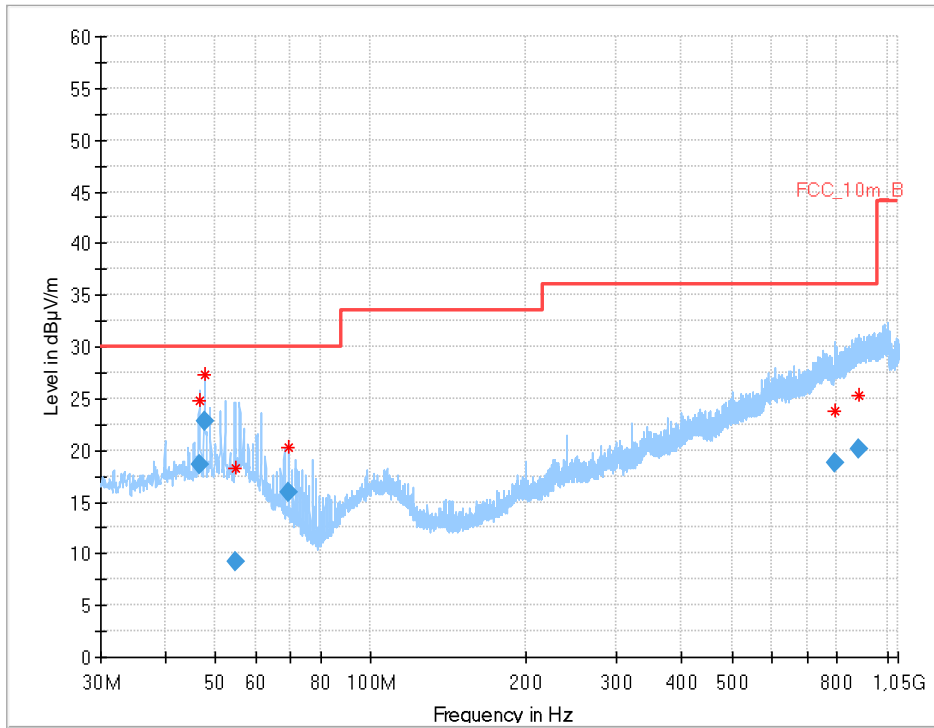

Final Result

Frequency (MHz)	QuasiPeak (dBµV/m)	Limit (dBµV/m)	Margin (dB)	Meas. Time (ms)	Bandwidth (kHz)	Height (cm)	Pol	Azimuth (deg)	Corr. (dB/m)
46.553	18.64	30.0	11.4	1000	120.0	116.0	V	175	14
47.643	22.77	30.0	7.2	1000	120.0	116.0	V	180	14
54.763	9.17	30.0	20.8	1000	120.0	200.0	V	166	14
69.170	15.92	30.0	14.1	1000	120.0	300.0	V	88	10
794.999	18.70	36.0	17.3	1000	120.0	206.0	V	45	22
883.481	20.12	36.0	15.9	1000	120.0	400.0	V	45	23

Plot 12: 30 MHz – 1 GHz, stopped mode (sweep stopped in the middle of the range of operation)

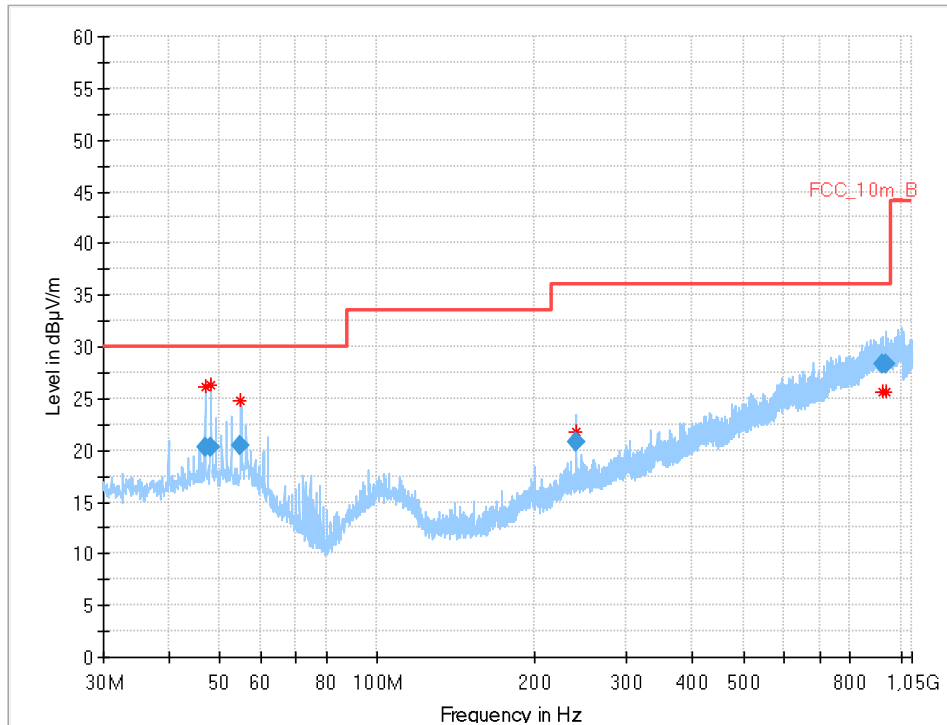

Final Result

Frequency (MHz)	QuasiPeak (dBµV/m)	Limit (dBµV/m)	Margin (dB)	Meas. Time (ms)	Bandwidth (kHz)	Height (cm)	Pol	Azimuth (deg)	Corr. (dB/m)
46.928	20.33	30.0	9.7	1000	120.0	101.0	V	202	14
48.081	20.28	30.0	9.7	1000	120.0	170.0	V	292	14
54.890	20.42	30.0	9.6	1000	120.0	101.0	V	202	14
239.997	20.81	36.0	15.2	1000	120.0	118.0	V	67	13
920.022	28.27	36.0	7.7	1000	120.0	170.0	H	292	24
935.380	28.29	36.0	7.7	1000	120.0	170.0	V	157	24

Plot 13: 1 GHz – 18 GHz, normal mode

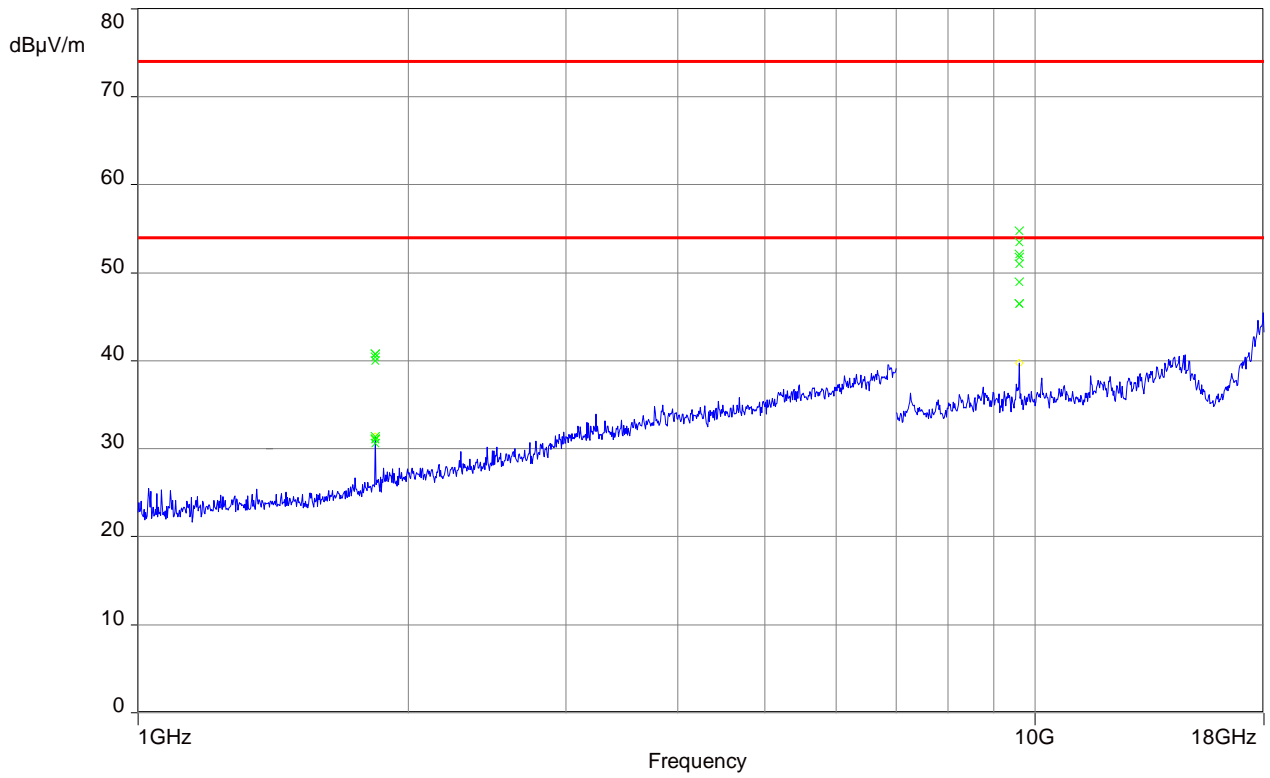

Frequency (MHz)	Peak (dBµV/m)	Peak Limit (dBµV/m)	Margin (dB)	Average (dBµV/m)	Average Limit (dBµV/m)	Margin (dB)
1837.6	40.78	74	33.22	31.41	54	22.59
9607	54.73	74	19.27	50.99	54	3.01

Plot 14: 1 GHz – 18 GHz, stopped mode (sweep stopped near the bottom of the range of operation)

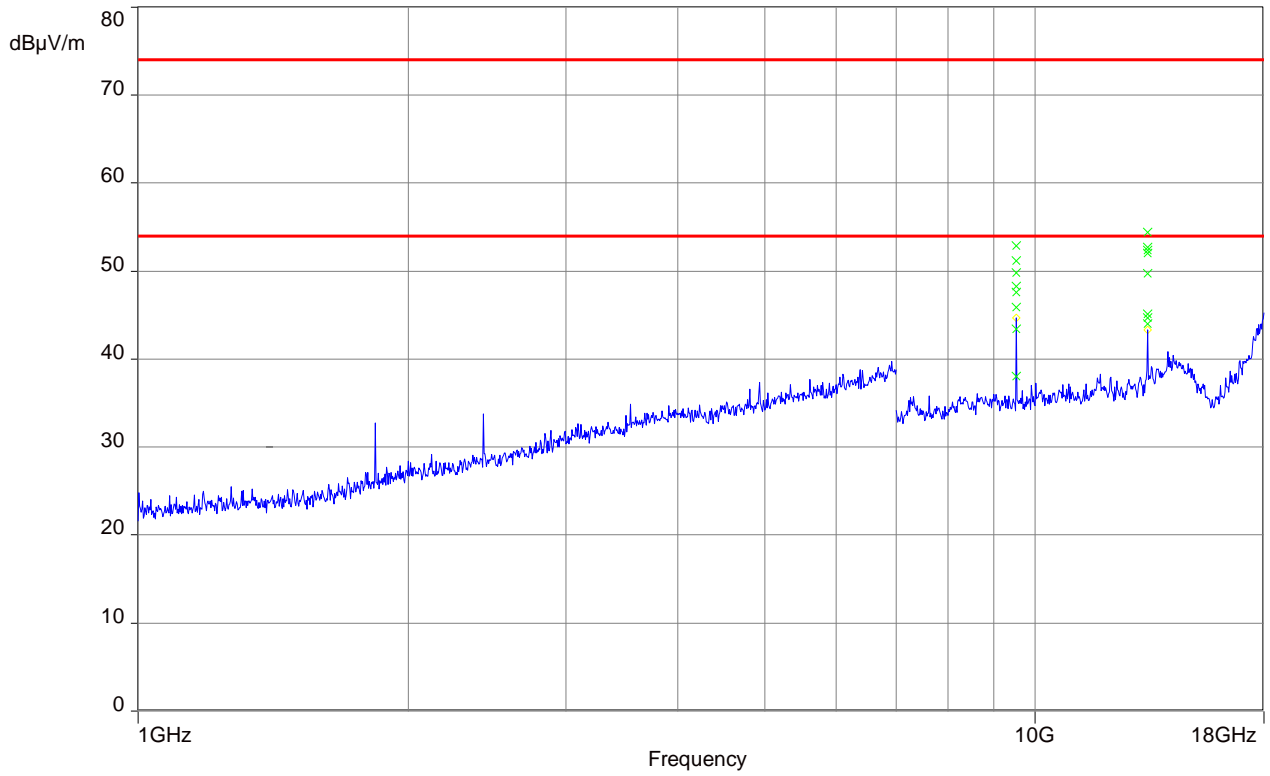

Frequency (MHz)	Peak (dBµV/m)	Peak Limit (dBµV/m)	Margin (dB)	Average (dBµV/m)	Average Limit (dBµV/m)	Margin (dB)
9533.3	52.88	74	21.12	48.27	54	5.73
13347	54.46	74	19.54	49.7	54	4.3

Plot 15: 1 GHz – 18 GHz, stopped mode (sweep stopped in the middle of the range of operation)

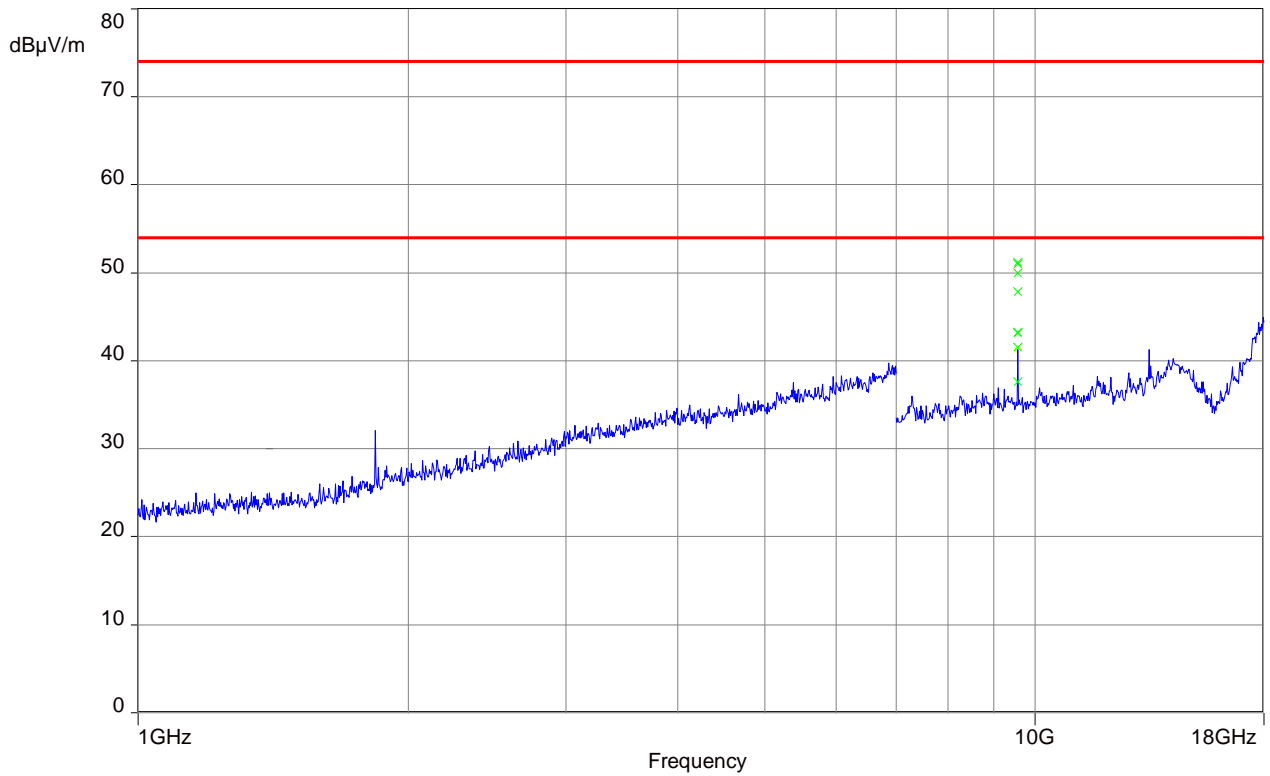

Frequency (MHz)	Peak (dBµV/m)	Peak Limit (dBµV/m)	Margin (dB)	Average (dBµV/m)	Average Limit (dBµV/m)	Margin (dB)
9569.6	51.14	74	22.86	43.27	54	10.73

Plot 16: 1 GHz – 18 GHz, stopped mode (sweep stopped near the top of the range of operation)

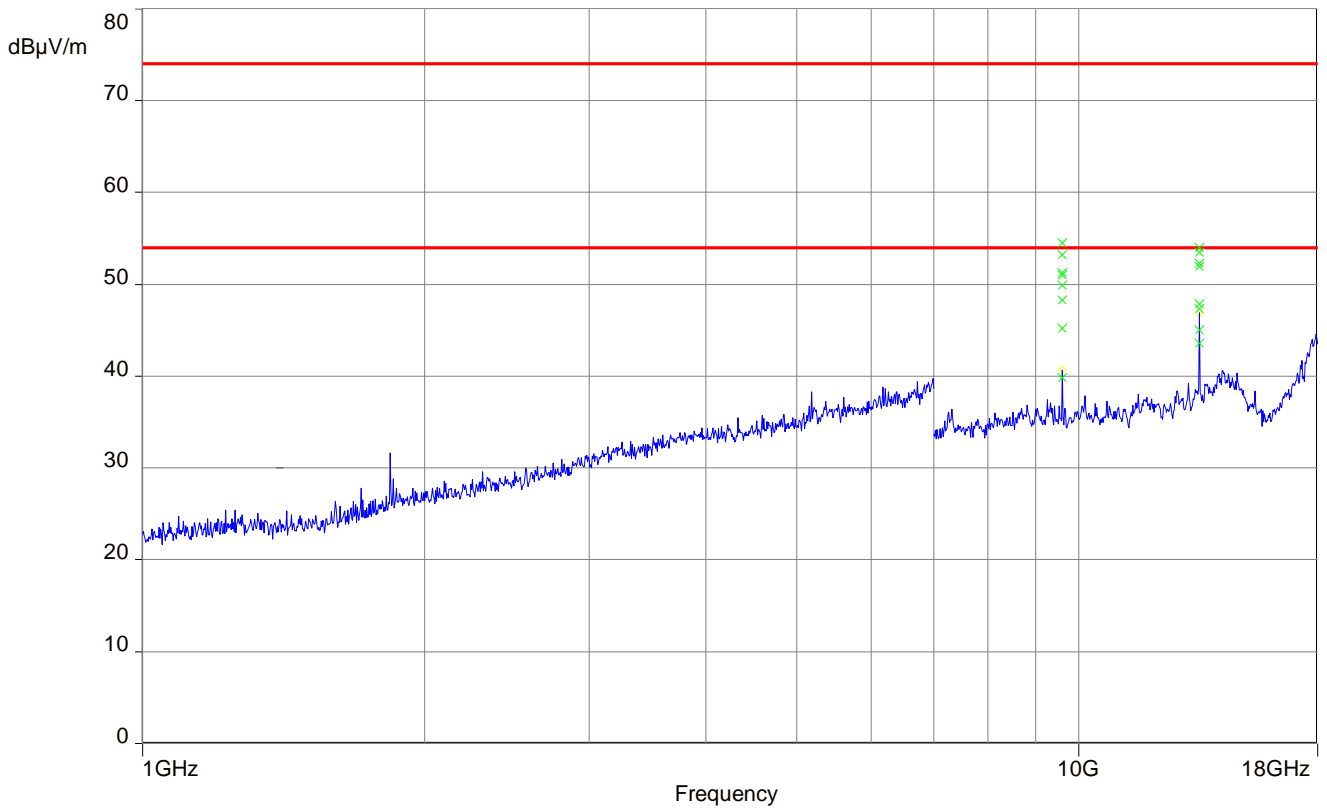

Frequency (MHz)	Peak (dBµV/m)	Peak Limit (dBµV/m)	Margin (dB)	Average (dBµV/m)	Average Limit (dBµV/m)	Margin (dB)
9607	54.49	74	19.51	50.99	54	3.01
13449.3	54.01	74	19.99	47.86	54	6.14

Plot 17: 18 GHz – 40 GHz, normal mode

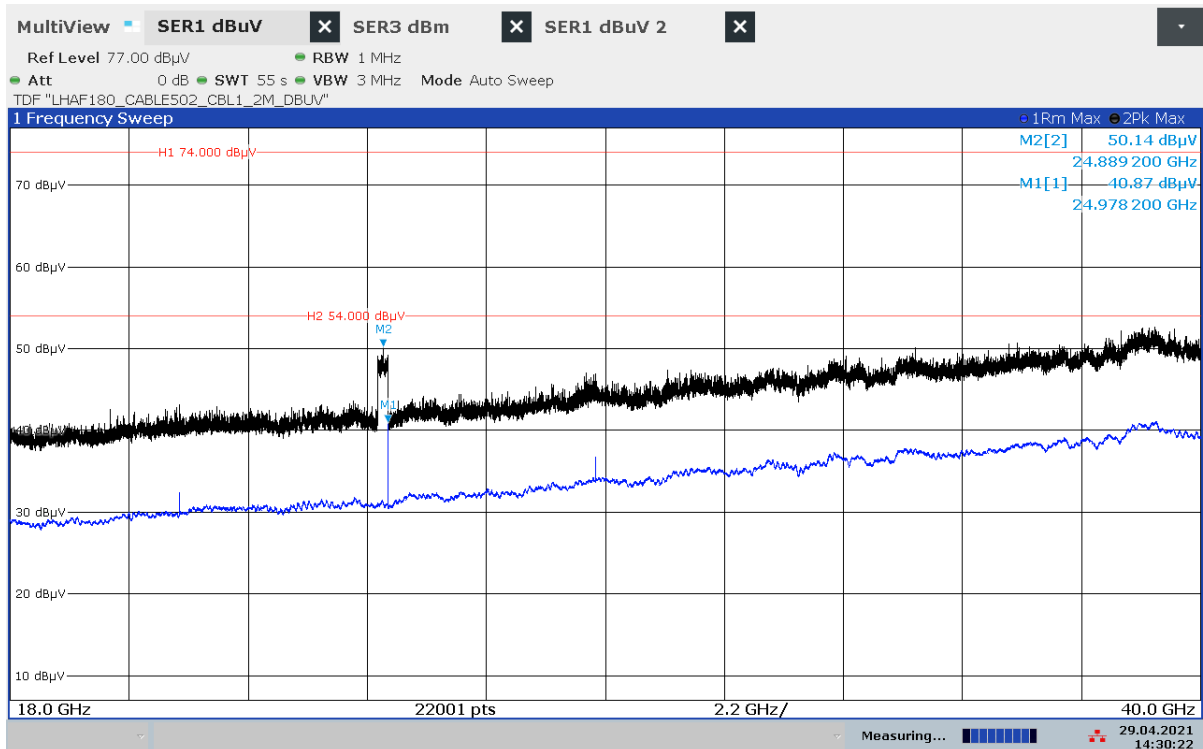

14:30:22 29.04.2021

Plot 18: 18 GHz – 40 GHz, stopped mode (sweep stopped in the middle of the range of operation)

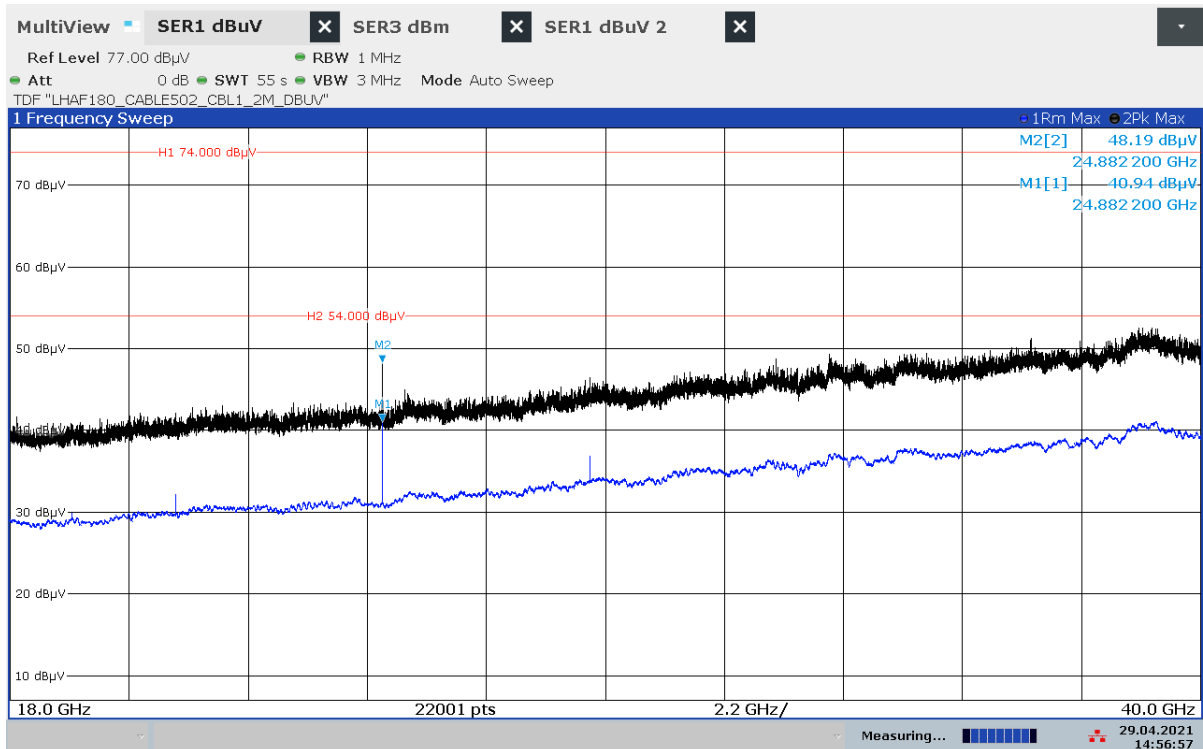

14:56:58 29.04.2021

Plot 19: 40 GHz – 50 GHz, normal mode

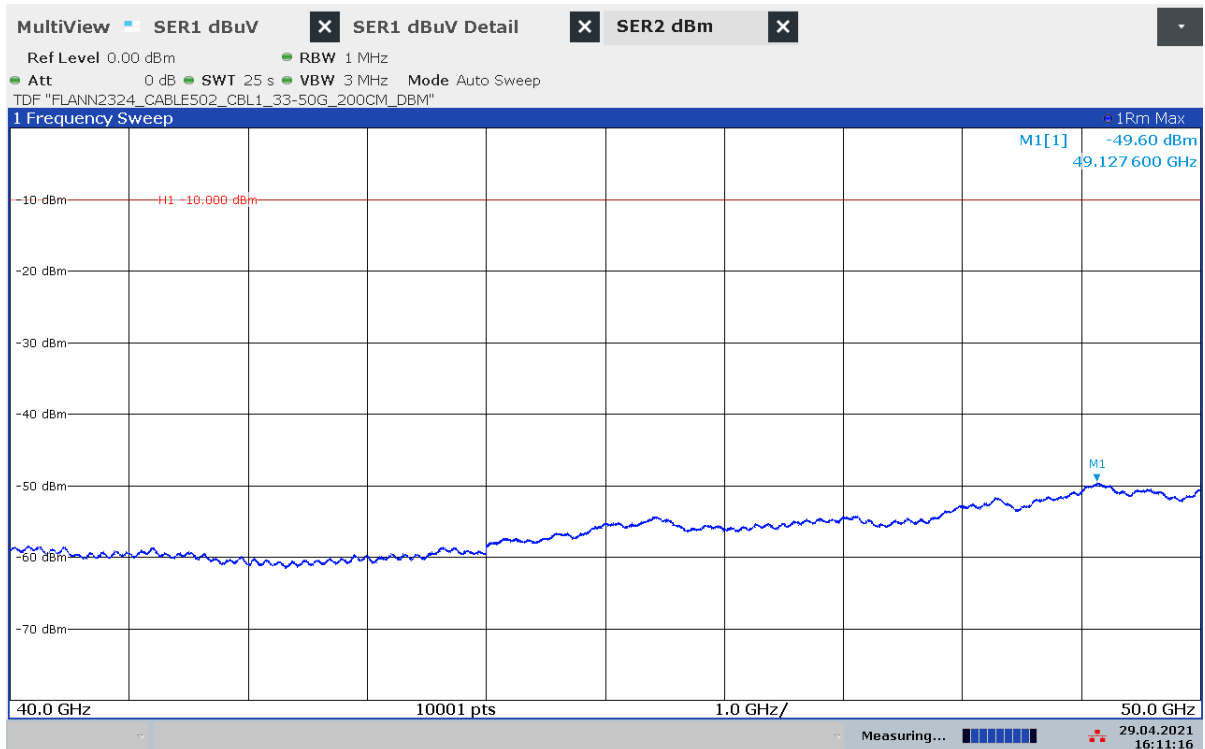

16:11:16 29.04.2021

Plot 20: 40 GHz – 50 GHz, stopped mode (sweep stopped in the middle of the range of operation)

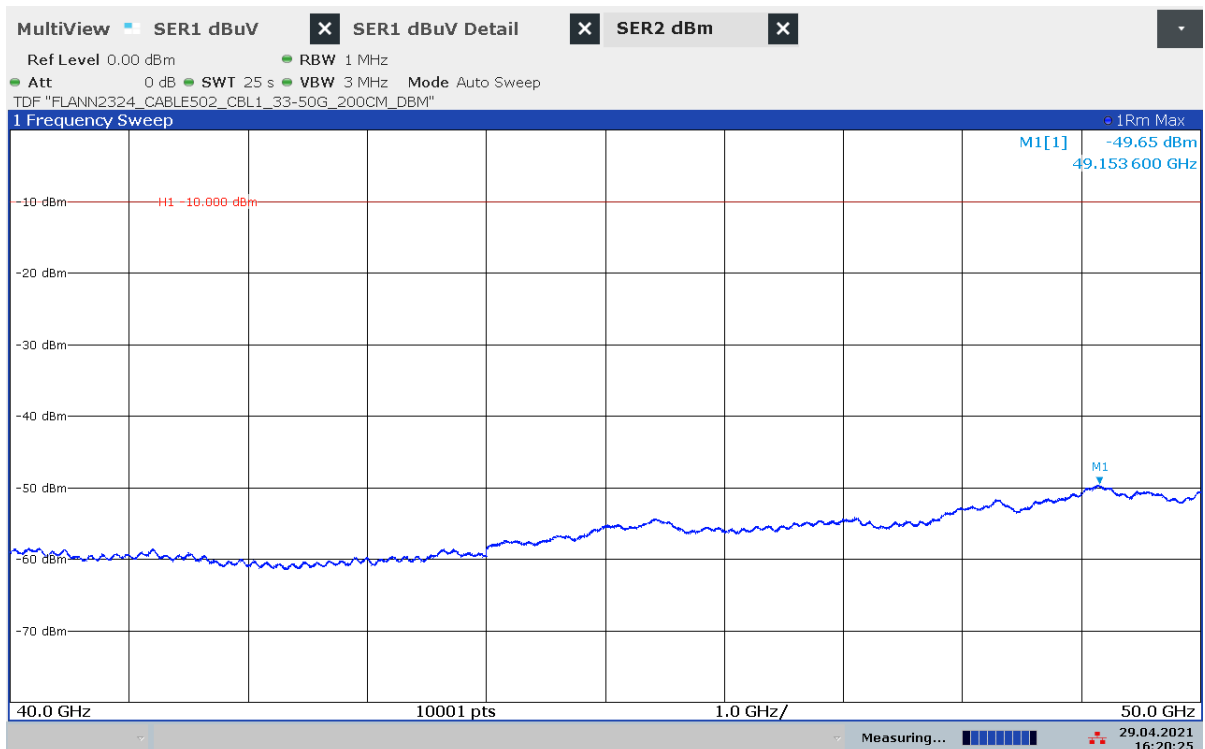

16:20:25 29.04.2021

Plot 21: 50 GHz – 75 GHz, normal mode

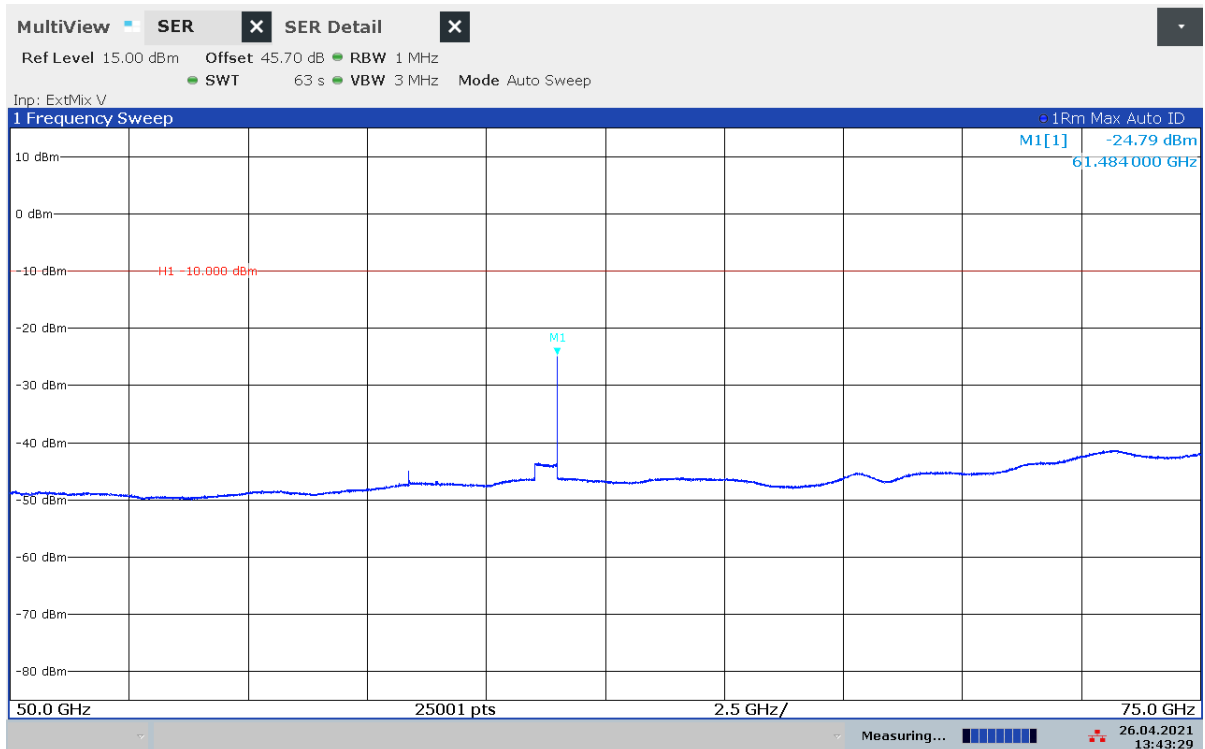

13:43:30 26.04.2021

Plot 22: 50 GHz – 75 GHz, stopped mode (sweep stopped near the middle of the range of operation)

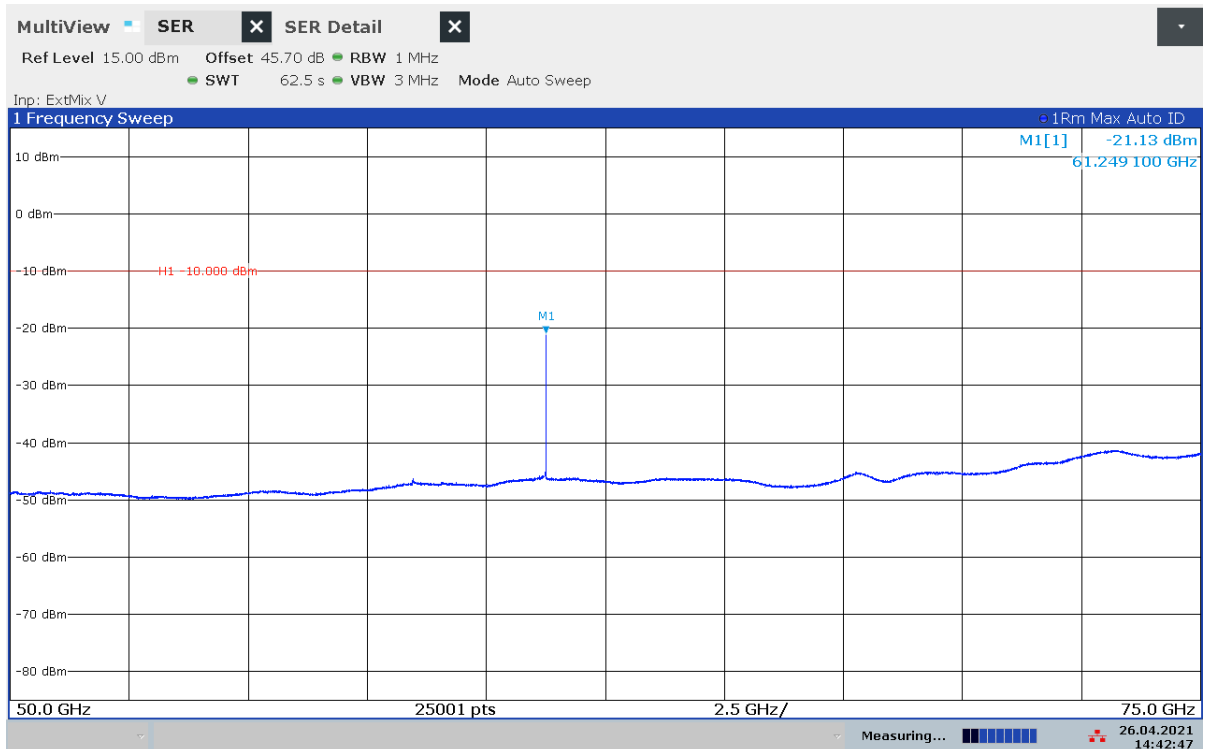

14:42:48 26.04.2021

Plot 23: 75 GHz – 90 GHz, normal mode

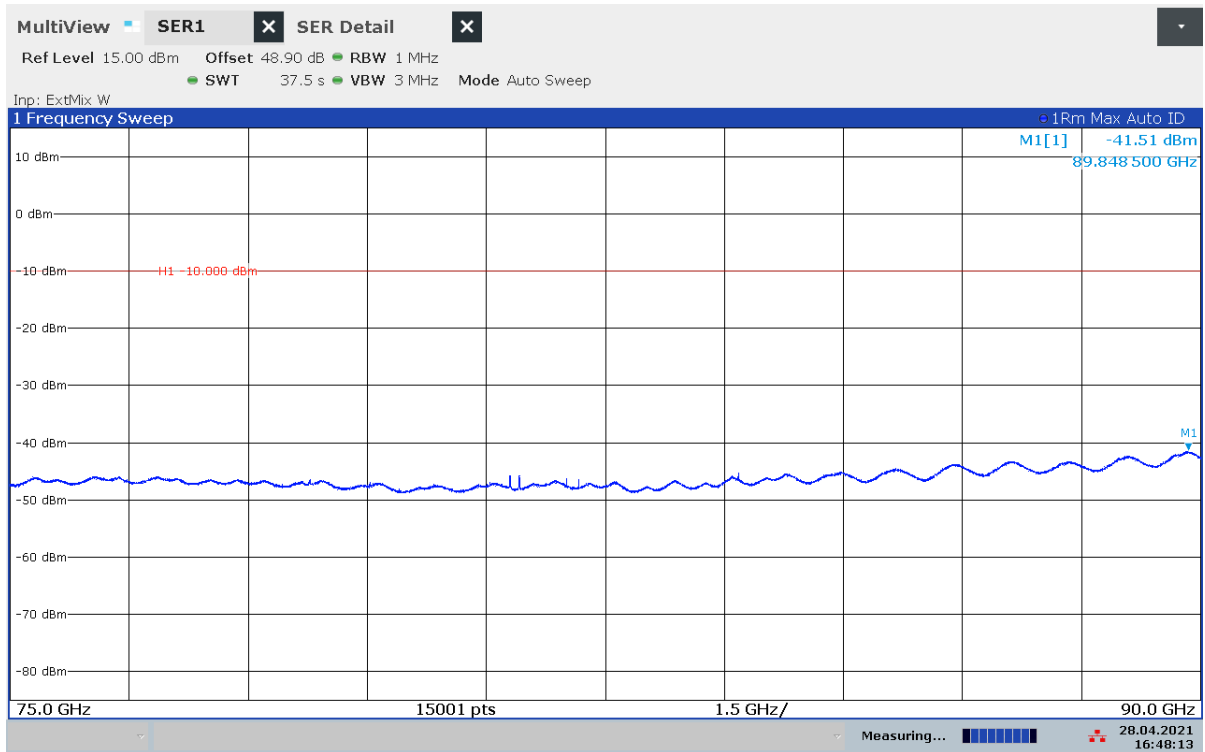

16:48:13 28.04.2021

Plot 24: 75 GHz – 90 GHz, stopped mode (sweep stopped in the middle of the range of operation)

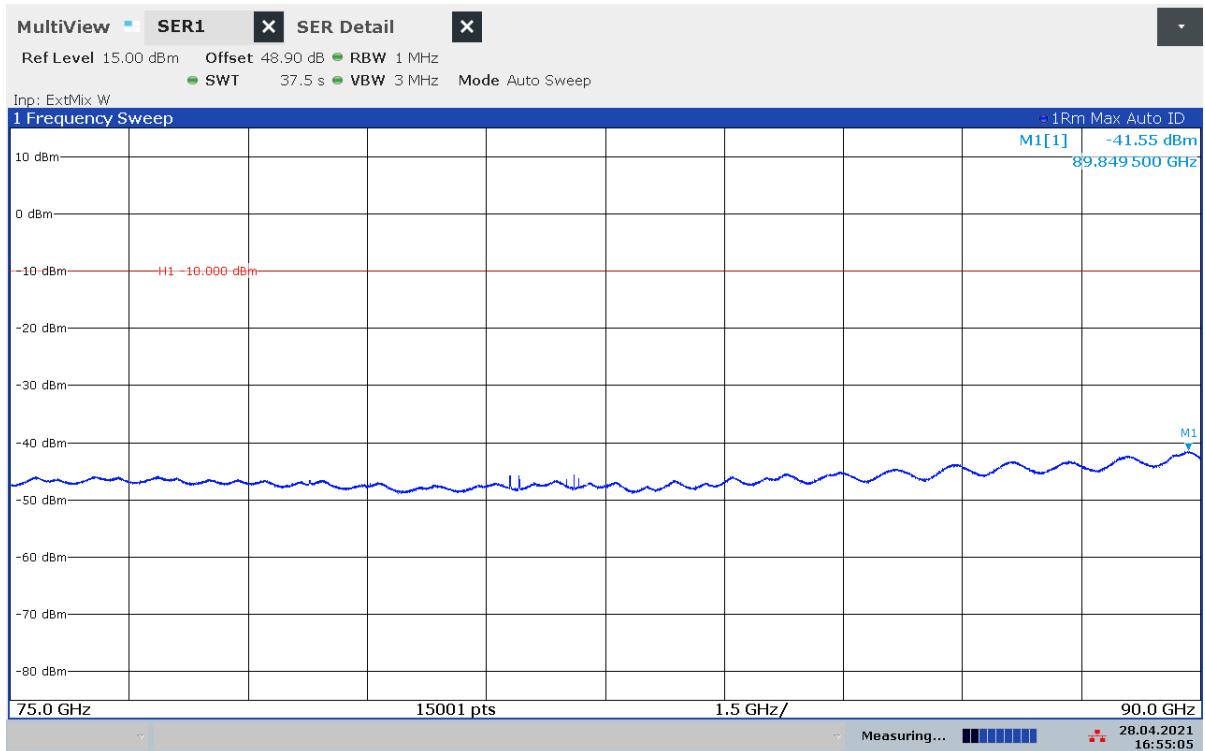

16:55:05 28.04.2021

Plot 25: 90 GHz – 122 GHz, normal mode

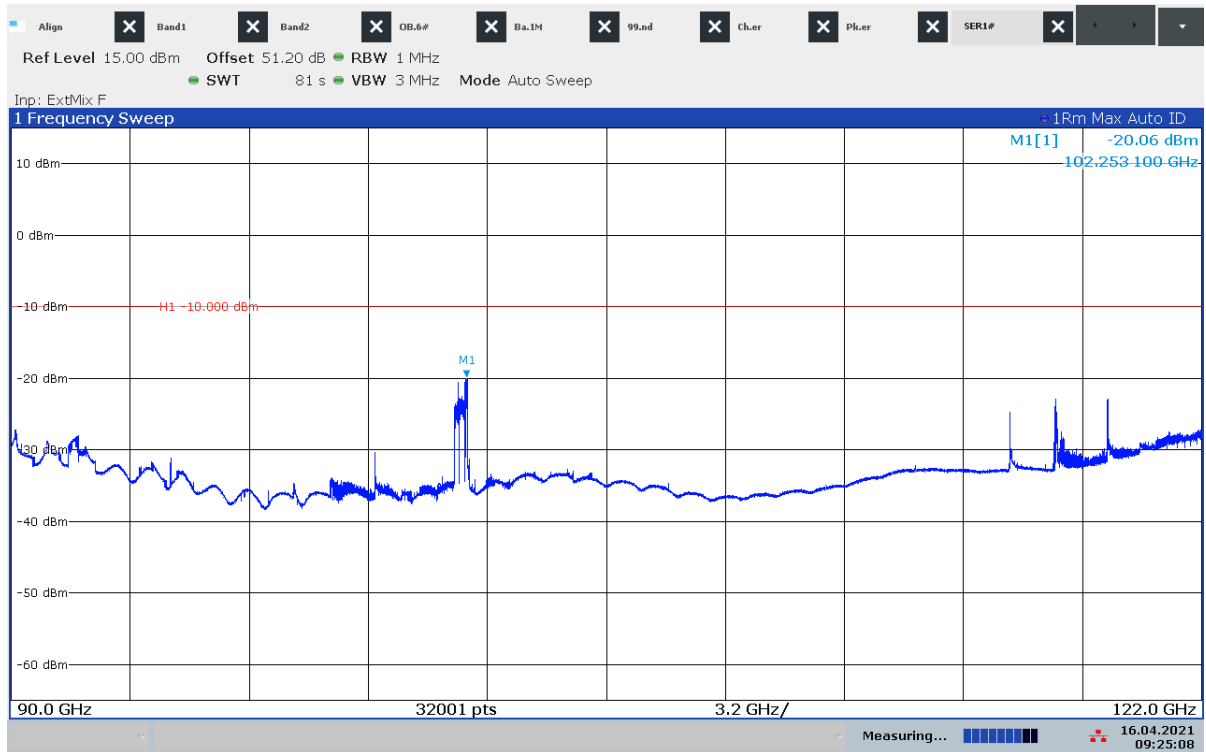

09:25:08 16.04.2021

Plot 26: 90 GHz – 122 GHz, stopped mode (sweep stopped in the middle of the range of operation)

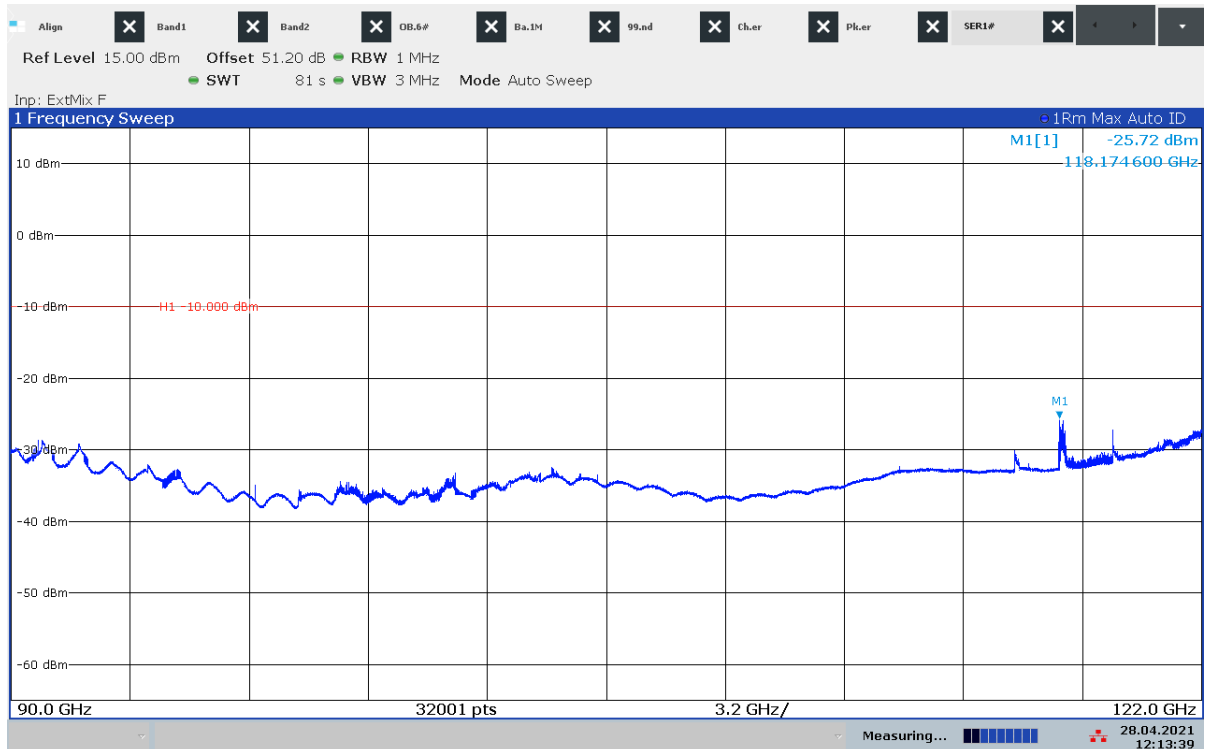

12:13:40 28.04.2021

Plot 27: lower band edge compliance, normal mode

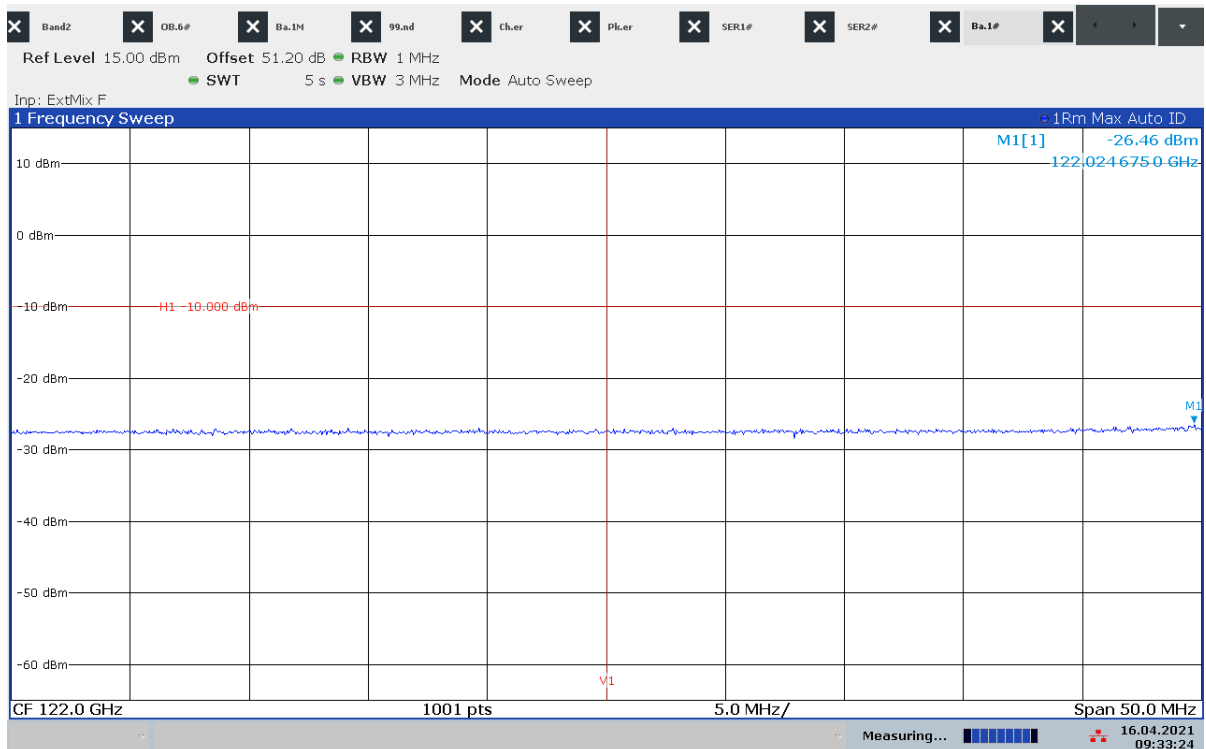

09:33:25 16.04.2021

Plot 28: lower band edge compliance, stopped mode (sweep stopped in the middle of the range of operation)

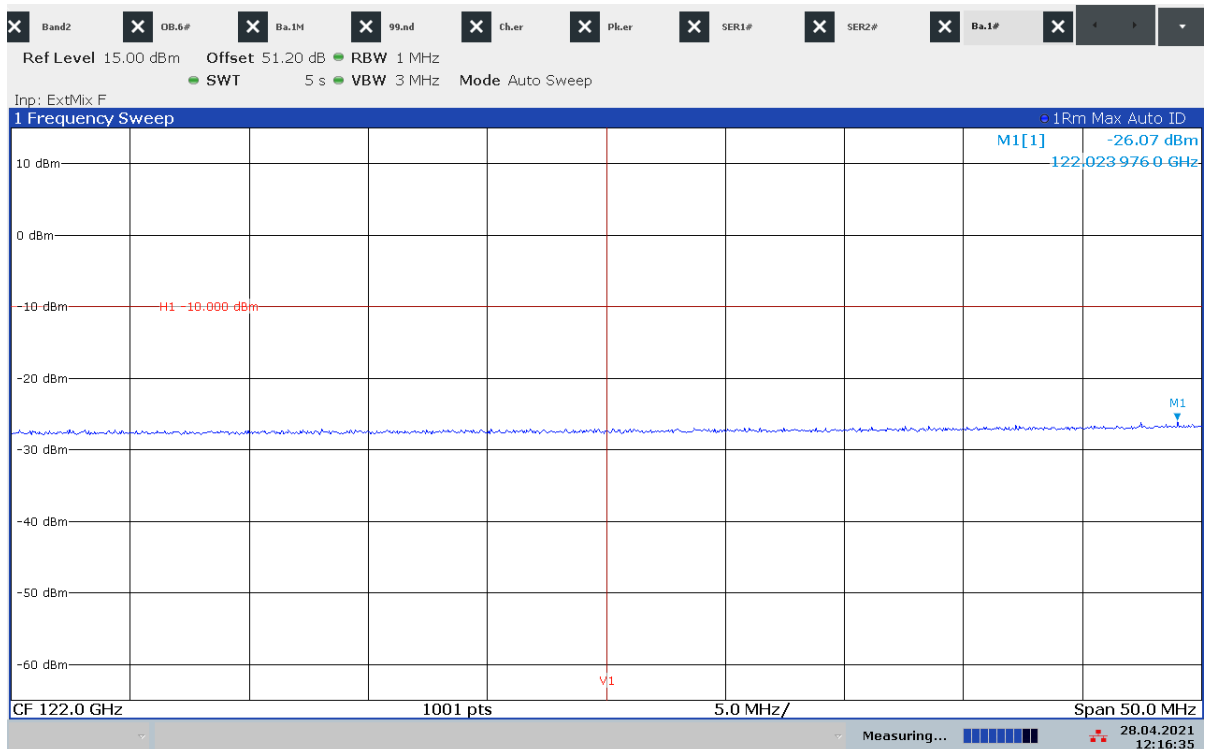

12:16:35 28.04.2021

Plot 29: upper band edge compliance, normal mode

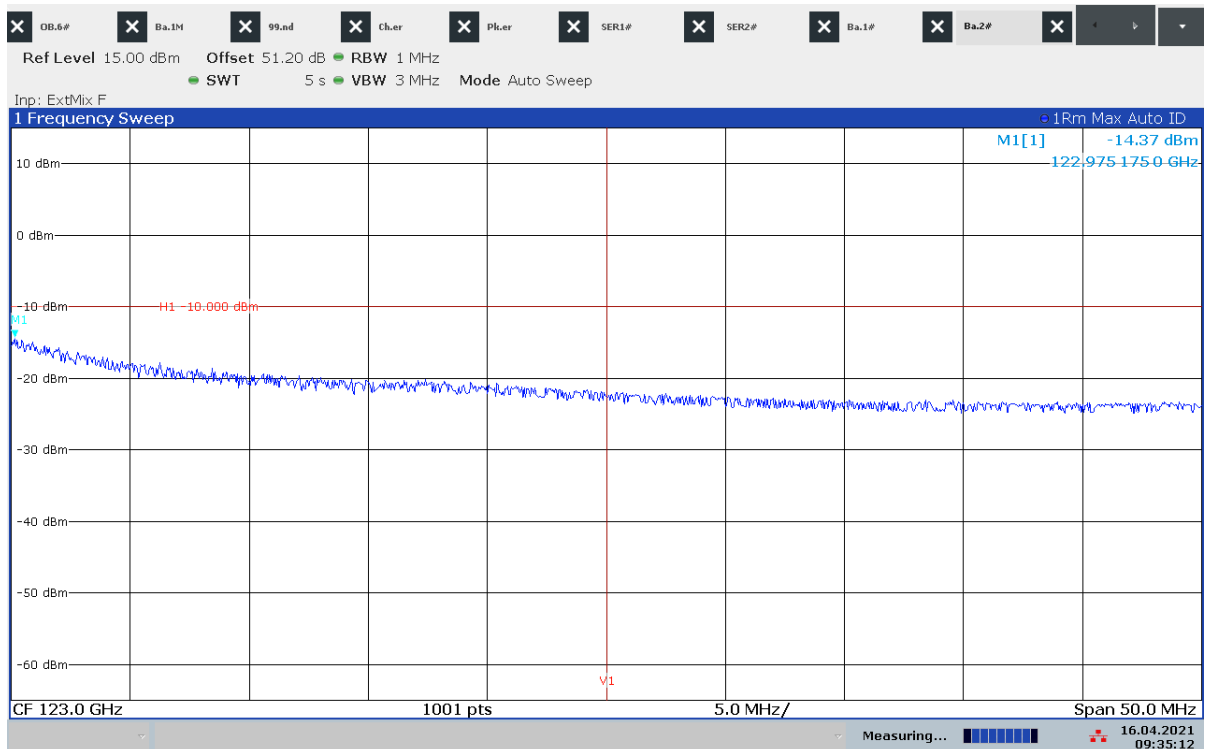

09:35:13 16.04.2021

Plot 30: upper band edge compliance, stopped mode (sweep stopped in the middle of the range of operation)

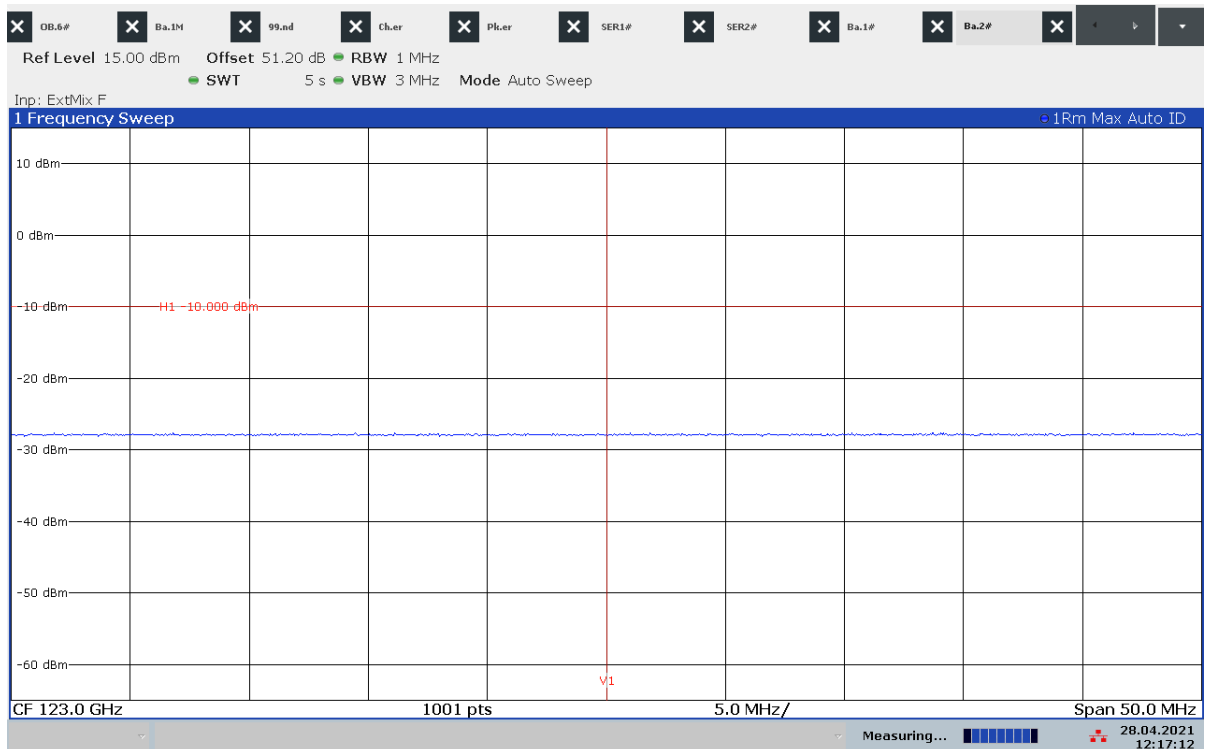

12:17:13 28.04.2021

Plot 31: 123 GHz – 140 GHz, normal mode

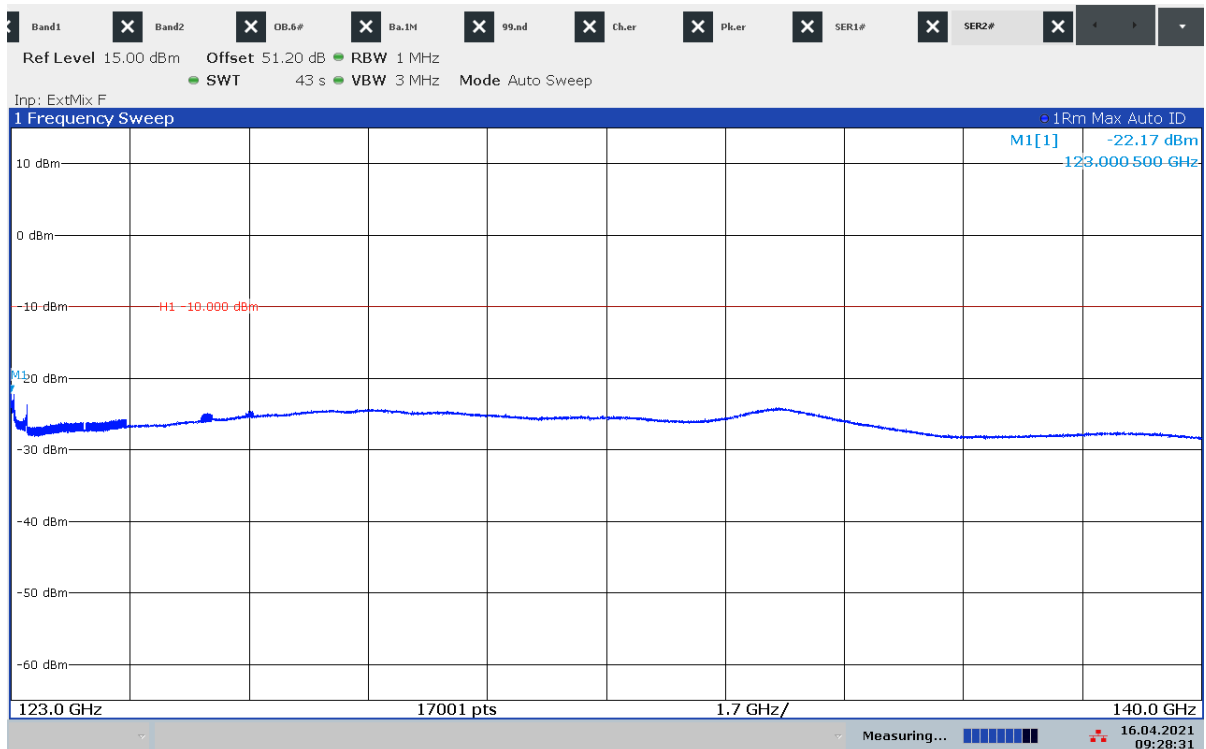

09:28:31 16.04.2021

Plot 32: 123 GHz – 140 GHz, stopped mode (sweep stopped in the middle of the range of operation)

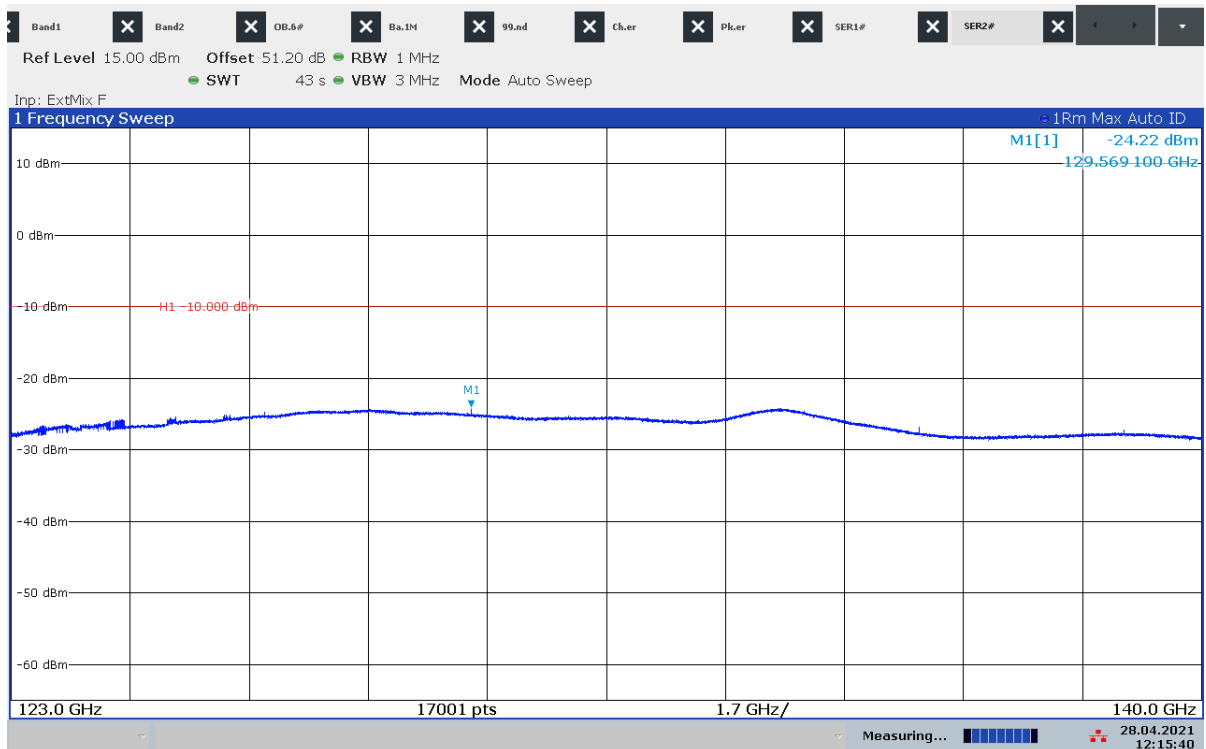

12:15:40 28.04.2021

Plot 33: 140 GHz – 220 GHz, normal mode

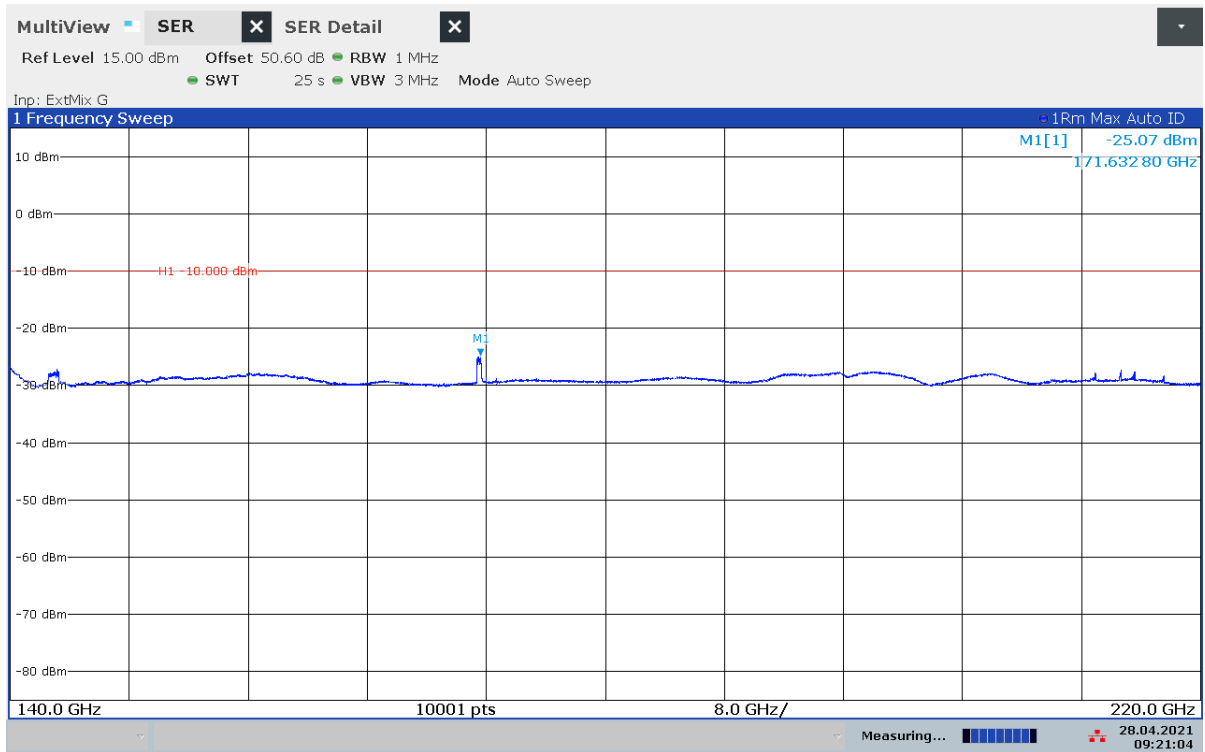

09:21:04 28.04.2021

Plot 34: 140 GHz – 220 GHz, stopped mode (sweep stopped in the middle of the range of operation)

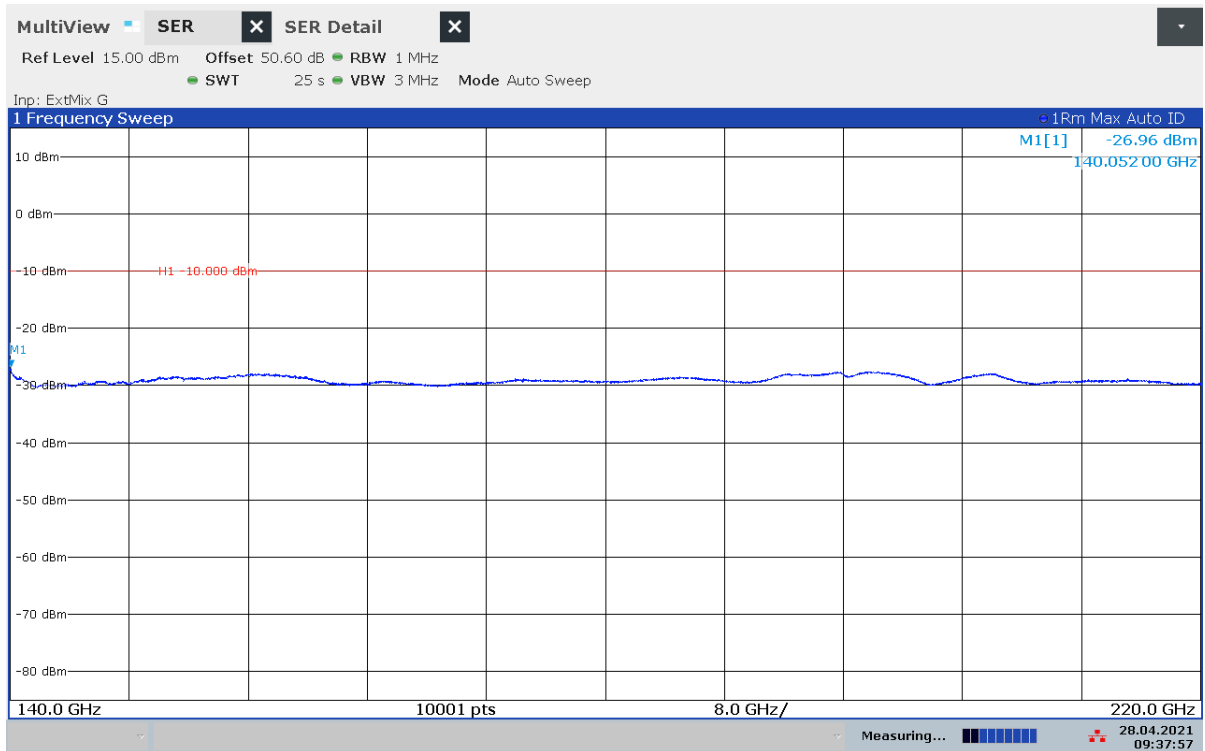

09:37:57 28.04.2021

Plot 35: 220 GHz – 325 GHz, normal mode

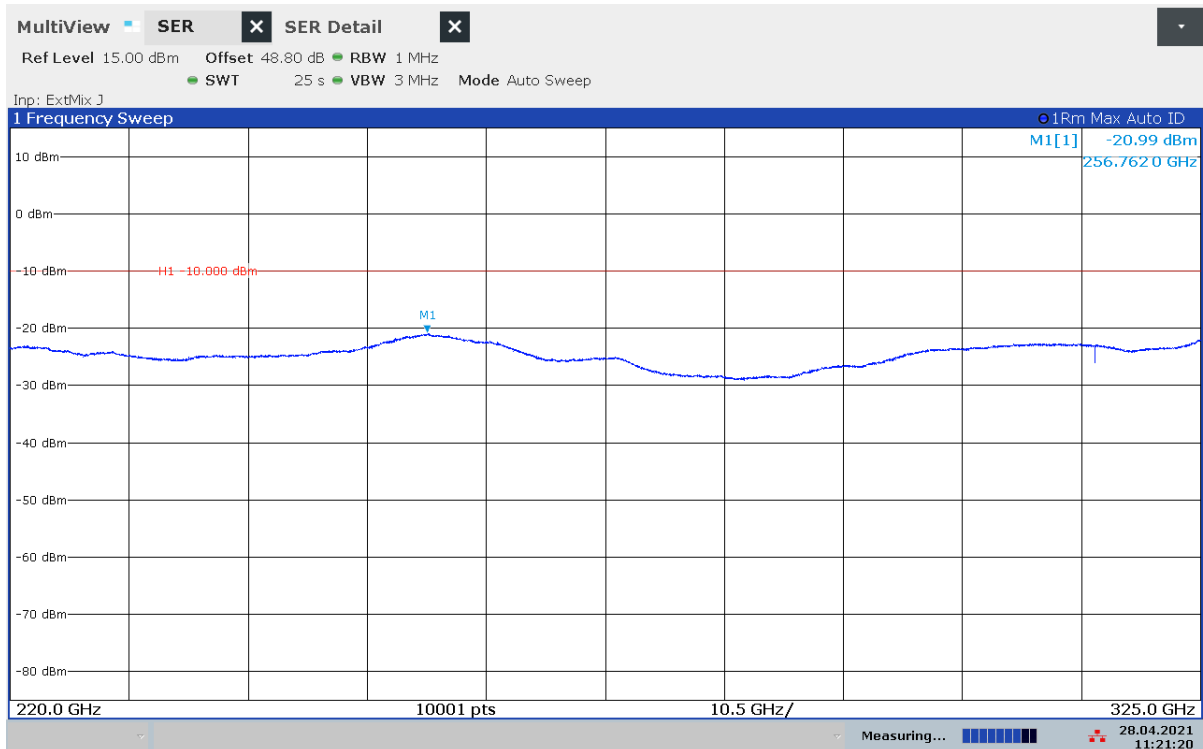

11:21:21 28.04.2021

Plot 36: 220 GHz – 325 GHz, stopped mode (sweep stopped in the middle of the range of operation)

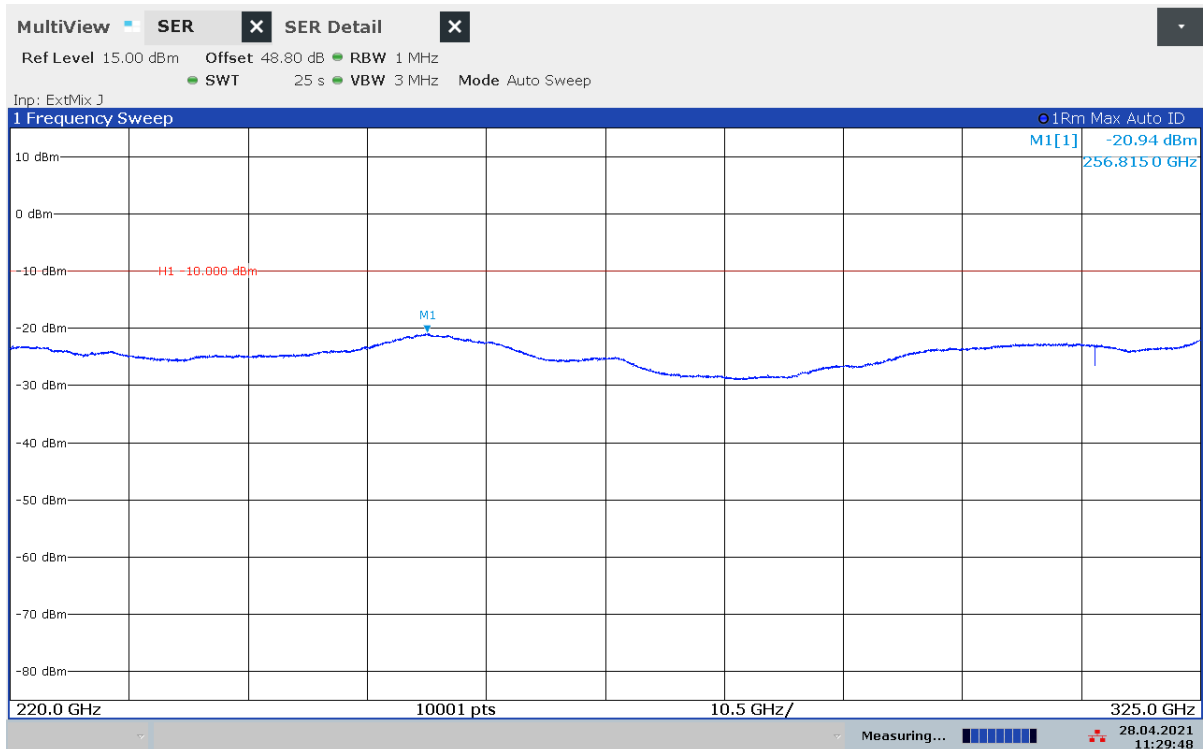

11:29:49 28.04.2021

Plot 37: 325 GHz – 400 GHz, normal mode



08:32:59 29.04.2021

Plot 38: 325 GHz – 400 GHz, stopped mode (sweep stopped in the middle of the range of operation)

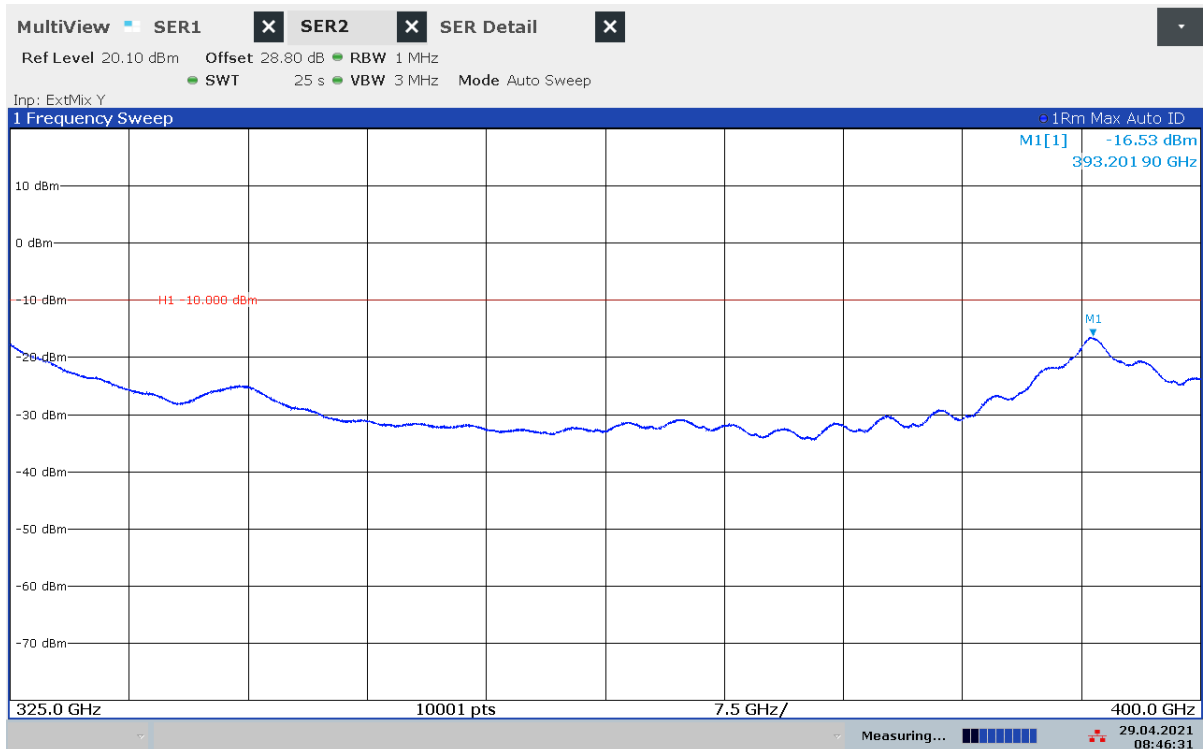

08:46:32 29.04.2021

12.4 Frequency Stability

Description:

§15.215(c) Intentional radiators operating under the alternative provisions to the general emission limits, as contained in §§15.217 through 15.257 and in subpart E of this part, must be designed to ensure that the 20 dB bandwidth of the emission, or whatever bandwidth may otherwise be specified in the specific rule section under which the equipment operates, is contained within the frequency band designated in the rule section under which the equipment is operated. In the case of intentional radiators operating under the provisions of subpart E, the emission bandwidth may span across multiple contiguous frequency bands identified in that subpart. The requirement to contain the designated bandwidth of the emission within the specified frequency band includes the effects from frequency sweeping, frequency hopping and other modulation techniques that may be employed as well as the frequency stability of the transmitter over expected variations in temperature and supply voltage. If a frequency stability is not specified in the regulations, it is recommended that the fundamental emission be kept within at least the central 80% of the permitted band in order to minimize the possibility of out-of-band operation.

§15.258 (d) Fundamental emissions must be contained within the frequency bands specified in this section during all conditions of operation. Equipment is presumed to operate over the temperature range -20 to + 50 degrees Celsius with an input voltage variation of 85% to 115% of rated input voltage, unless justification is presented to demonstrate otherwise.

Measurement:

Measurement parameter	
Detector:	Pos-Peak
Resolution bandwidth:	1 MHz
Video bandwidth:	3 MHz
Trace-Mode:	Max Hold

Limits:

FCC
CFR Part 15.258 (d)
The occupied bandwidth from intentional radiators operated within the specified frequency band shall comply with the following:
Frequency range
116 GHz – 123 GHz (regulatory) 122 – 123 GHz (EUT)

Measurement Results:

Test Conditions	Transmitter Frequency Range [GHz]		Occupied Bandwidth [MHz]
	F_L	F_H	
T_{nom} / V_{nom}	122.0285	122.9735	945.1
T_{min} / V_{nom}	122.0285	122.9735	945.1
T_{max} / V_{nom}	122.0285	122.9715	943.1
T_{nom} / V_{min}	122.0285	122.9735	945.1
T_{nom} / V_{max}	122.0285	122.9735	945.1

Note: Frequency stability tests performed with sample 7b.

Plot 39: T_{nom} / V_{nom}

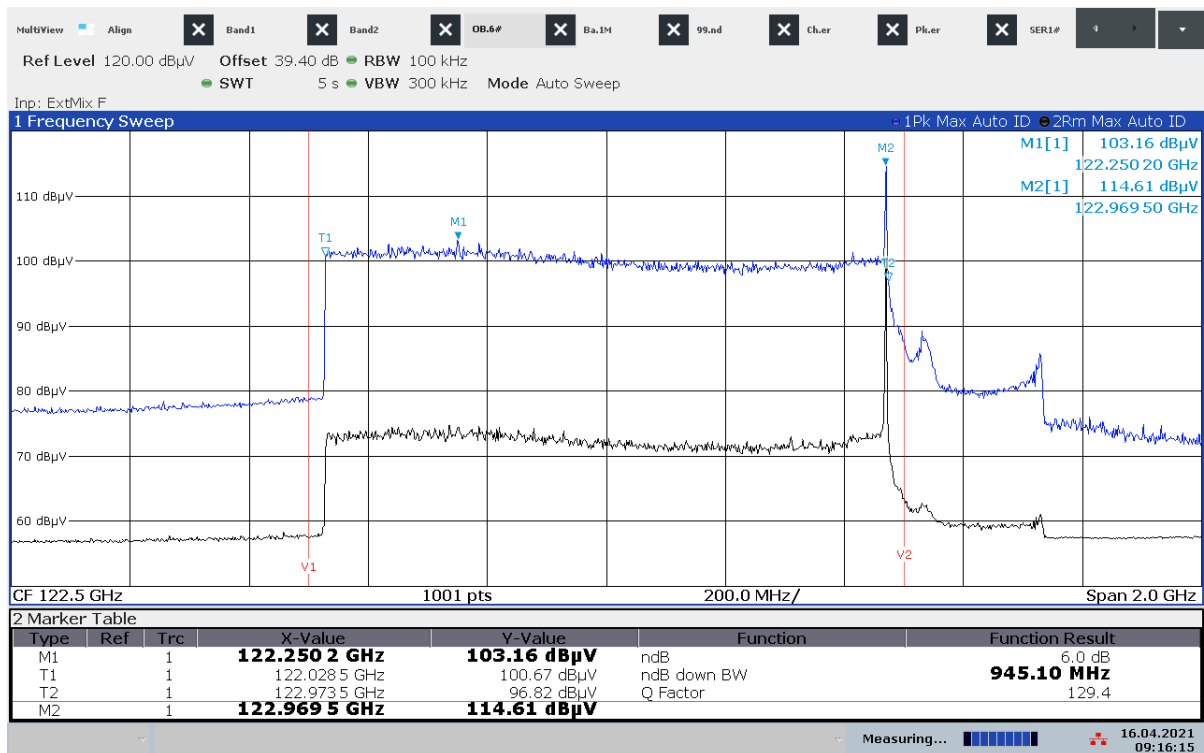

09:16:15 16.04.2021

Plot 40: T_{min} / V_{nom}

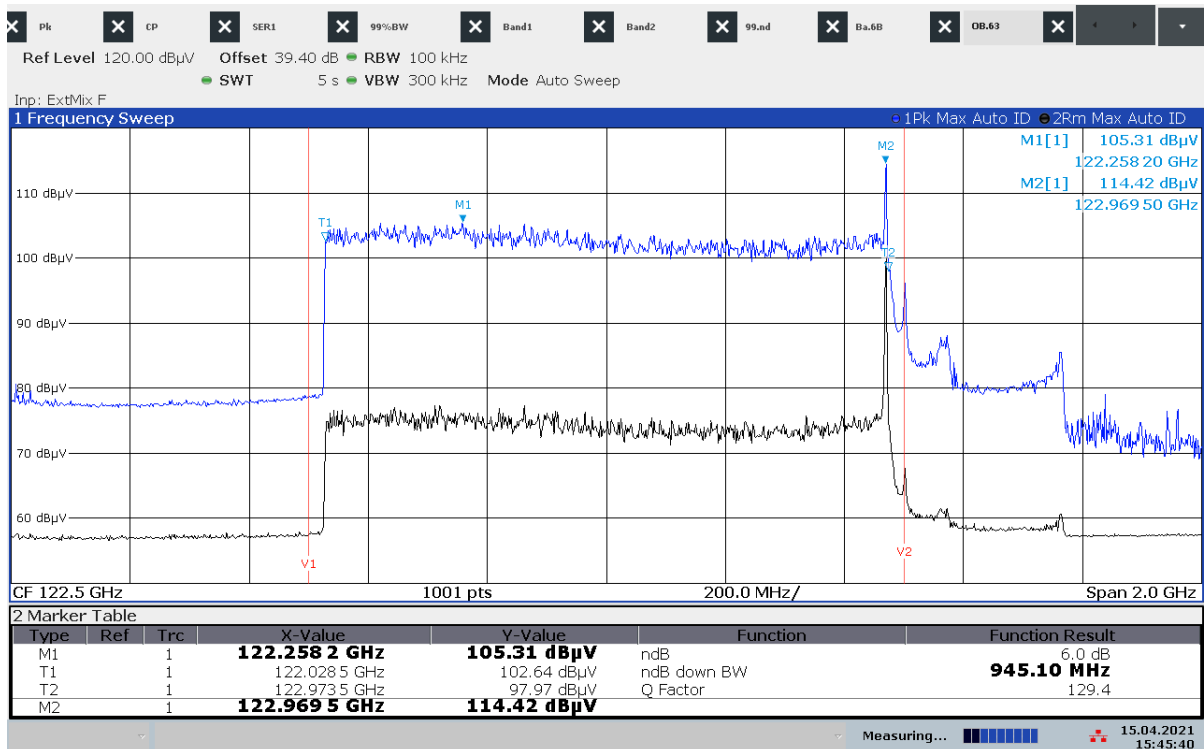

15:45:41 15.04.2021

Plot 41: T_{max} / V_{nom}

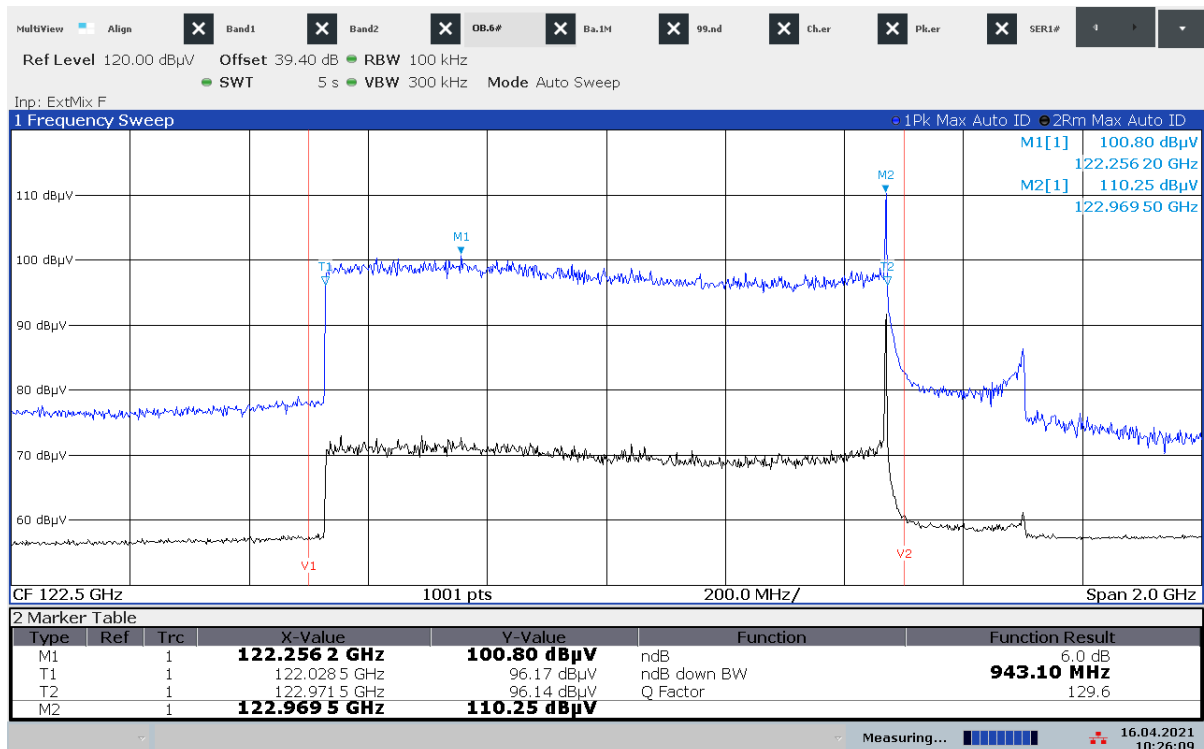

10:26:10 16.04.2021

Plot 42: T_{nom} / V_{min}

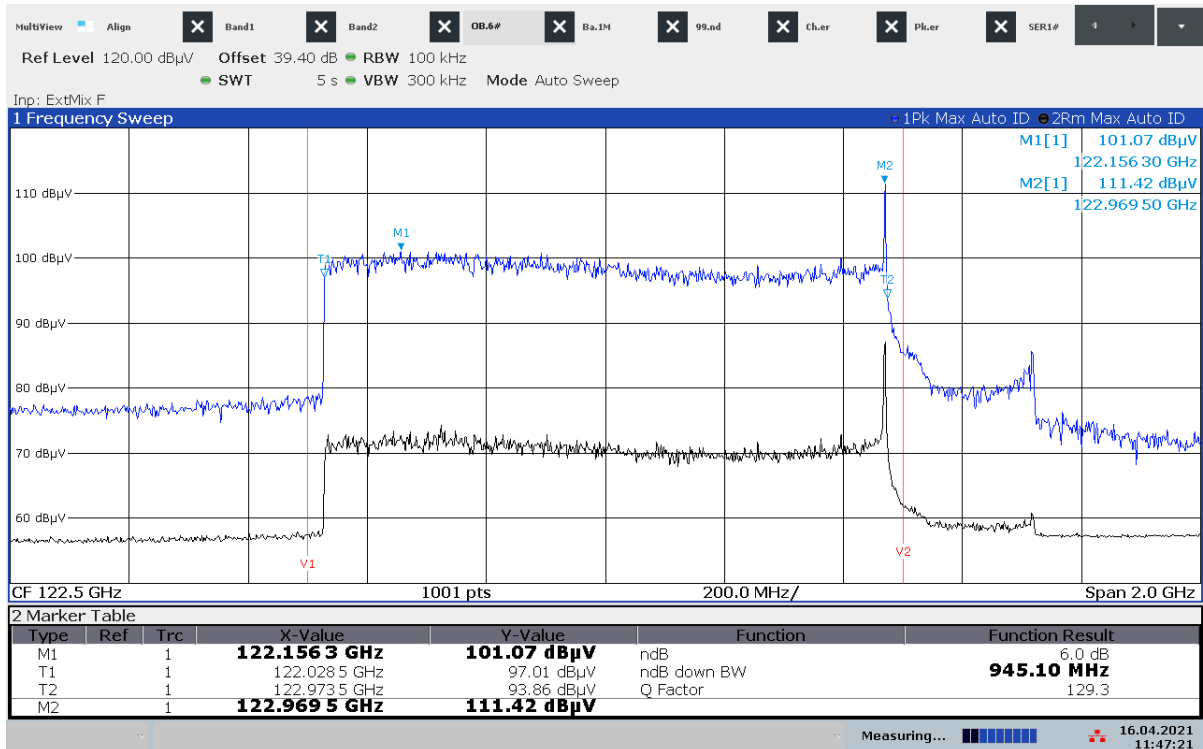

11:47:22 16.04.2021

Plot 43: T_{nom} / V_{max}

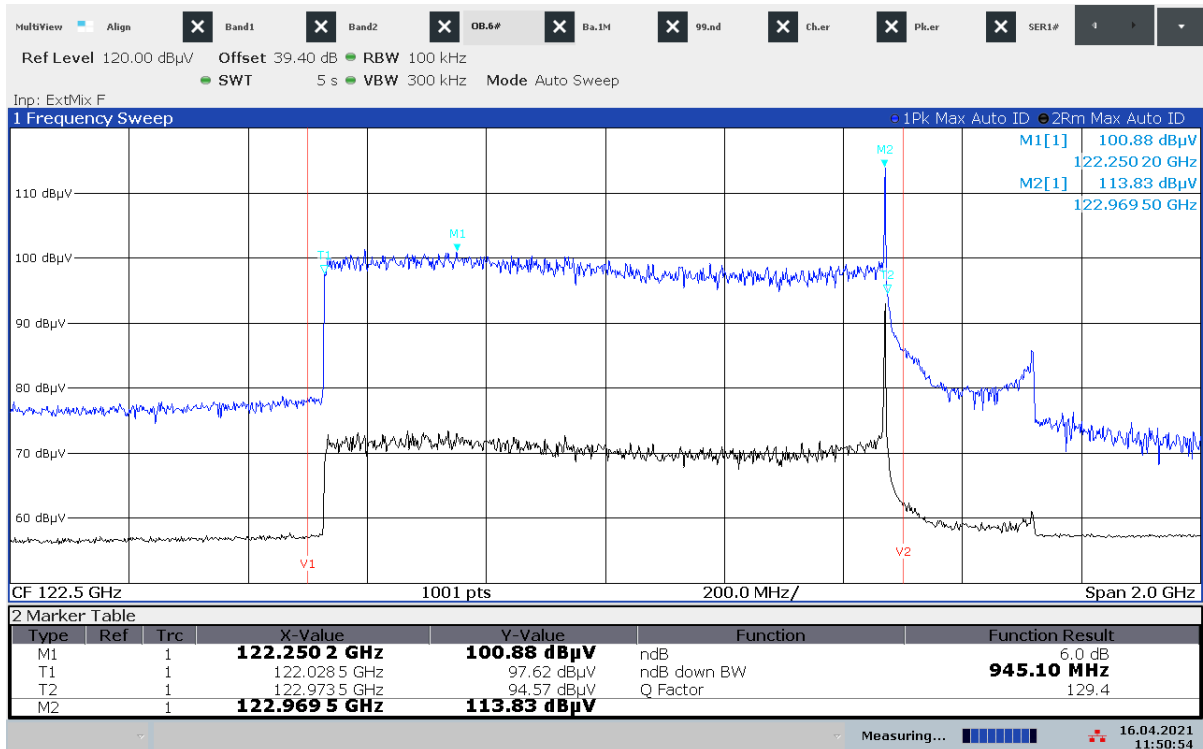

11:50:55 16.04.2021

12.5 Conducted emissions < 30MHz

Description:

Measurement of the conducted spurious emissions in transmit mode below 30 MHz. Both power lines, phase and neutral line, are measured. Found peaks are re-measured with average and quasi peak detection to show compliance to the limits.

Measurement:

Parameter	
Detector:	Peak - Quasi Peak / Average
Sweep time:	Auto
Video bandwidth:	F < 150 kHz: 200 Hz F > 150 kHz: 9 kHz
Resolution bandwidth:	F < 150 kHz: 1 kHz F > 150 kHz: 100 kHz
Span:	9 kHz to 30 MHz
Trace-Mode:	Max Hold

Limits:

FCC		IC	
CFR Part 15.207(a)		RSS-Gen 8.8	
Conducted Spurious Emissions < 30 MHz			
Frequency (MHz)	Quasi-Peak (dBµV)	Average (dBµV)	
0.15 – 0.5	66 to 56*	56 to 46*	
0.5 – 5	56	46	
5 – 30.0	60	50	

*Decreases with the logarithm of the frequency

§15.207(c)

Measurements to demonstrate compliance with the conducted limits are not required for devices which only employ battery power for operation and which do not operate from the AC power lines or contain provisions for operation while connected to the AC power lines. Devices that include, or make provisions for, the use of battery chargers which permit operating while charging, AC adapters or battery eliminators or that connect to the AC power lines indirectly, obtaining their power through another device which is connected to the AC power lines, shall be tested to demonstrate compliance with the conducted limits.

Measurement results:

Plot 44: Phase line

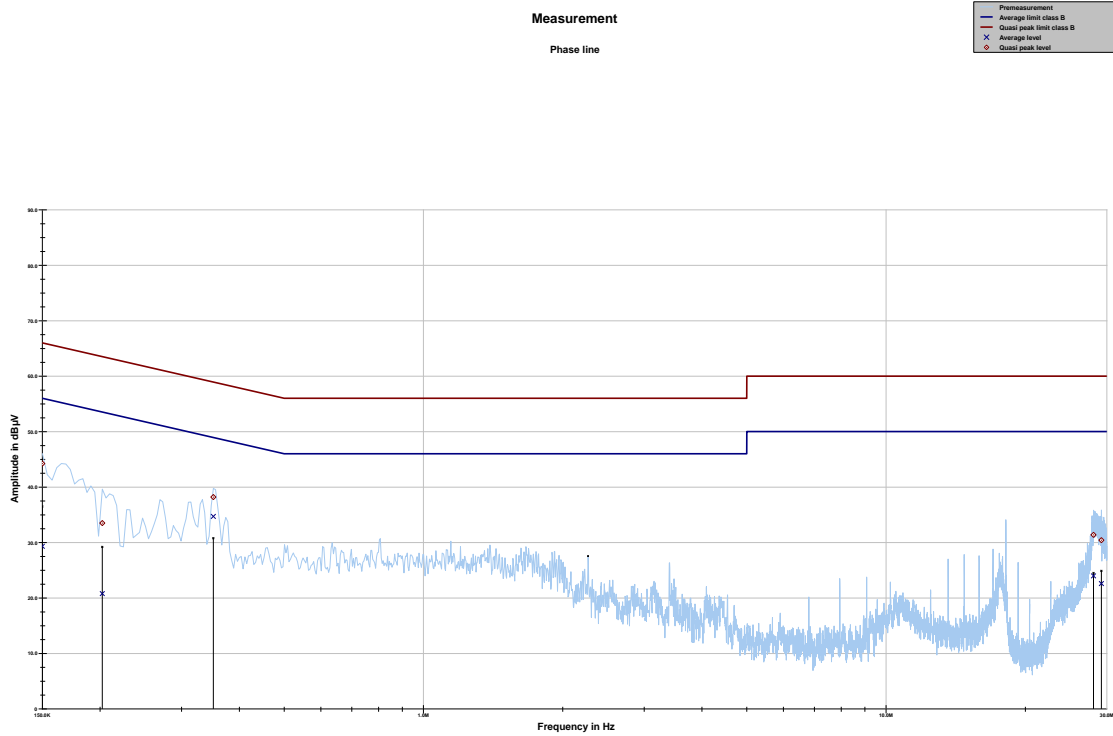

Project ID: 1-0387/20-02-02

Frequency	Quasi peak level	Margin quasi peak	Limit QP	Average level	Margin average	Limit AV
MHz	dBµV	dB	dBµV	dBµV	dB	dBµV
0.150000	44.23	21.77	66.000	29.31	26.69	56.000
0.202237	33.49	30.03	63.518	20.78	33.73	54.508
0.351488	38.18	20.74	58.927	34.69	15.55	50.243
28.089600	31.37	28.63	60.000	23.97	26.03	50.000
29.205244	30.42	29.58	60.000	22.59	27.41	50.000

Plot 45: Neutral line

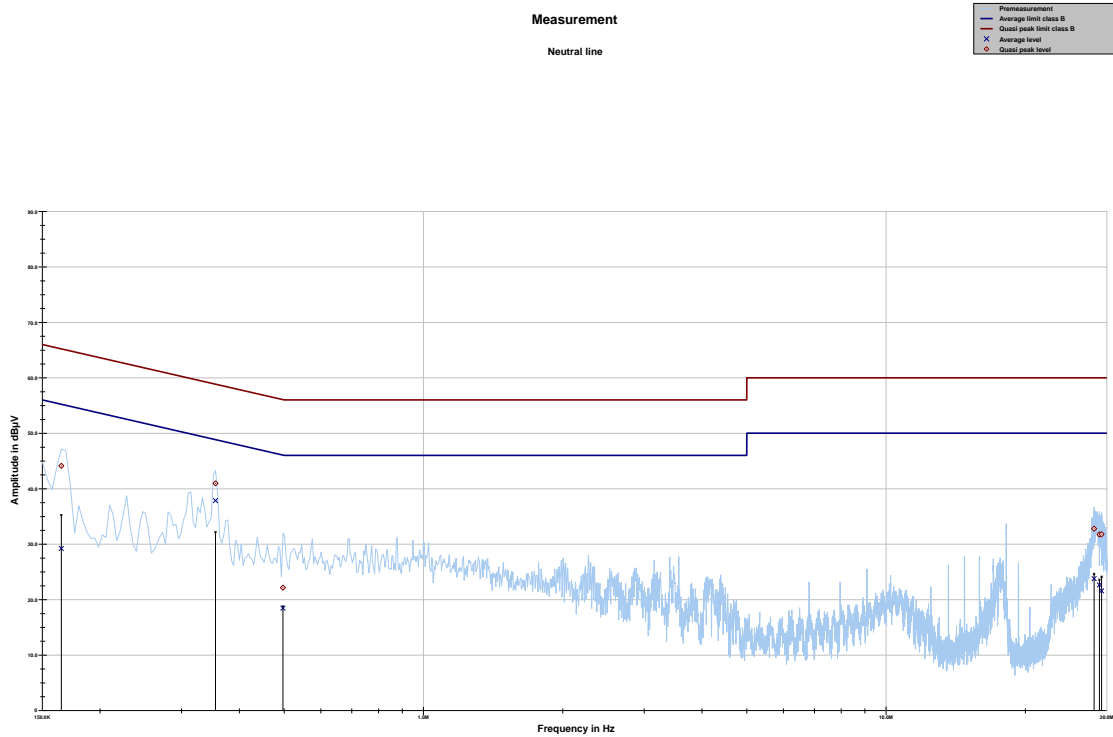

Project ID: 1-0387/20-02-02

Frequency	Quasi peak level	Margin quasi peak	Limit QP	Average level	Margin Average	Limit AV
MHz	dBµV	dB	dBµV	dBµV	dB	dBµV
0.164925	44.12	21.09	65.212	29.21	26.36	55.574
0.355219	40.96	17.88	58.840	37.86	12.27	50.137
0.497006	22.14	33.91	56.050	18.45	27.63	46.086
28.167956	32.78	27.22	60.000	23.76	26.24	50.000
28.921669	31.72	28.28	60.000	22.65	27.35	50.000
29.235094	31.78	28.22	60.000	21.57	28.43	50.000

13 Glossary

EUT	Equipment under test
DUT	Device under test
UUT	Unit under test
GUE	GNSS User Equipment
ETSI	European Telecommunications Standards Institute
EN	European Standard
FCC	Federal Communications Commission
FCC ID	Company Identifier at FCC
IC	Industry Canada
PMN	Product marketing name
HMN	Host marketing name
HVIN	Hardware version identification number
FVIN	Firmware version identification number
EMC	Electromagnetic Compatibility
HW	Hardware
SW	Software
Inv. No.	Inventory number
S/N or SN	Serial number
C	Compliant
NC	Not compliant
NA	Not applicable
NP	Not performed
PP	Positive peak
QP	Quasi peak
AVG	Average
OC	Operating channel
OCW	Operating channel bandwidth
OBW	Occupied bandwidth
OOB	Out of band
DFS	Dynamic frequency selection
CAC	Channel availability check
OP	Occupancy period
NOP	Non occupancy period
DC	Duty cycle
PER	Packet error rate
CW	Clean wave
MC	Modulated carrier
WLAN	Wireless local area network
RLAN	Radio local area network
DSSS	Dynamic sequence spread spectrum
OFDM	Orthogonal frequency division multiplexing
FHSS	Frequency hopping spread spectrum
GNSS	Global Navigation Satellite System
C/N₀	Carrier to noise-density ratio, expressed in dB-Hz

14 Document history

Version	Applied changes	Date of release
-/-	Initial release	2021-06-08

15 Accreditation Certificate – D-PL-12076-01-04

first page	last page
 <p>DAkKS Deutsche Akkreditierungsstelle</p> <p>Deutsche Akkreditierungsstelle GmbH</p> <p>Entrusted according to Section 8 subsection 1 AkkStelleG in connection with Section 1 subsection 1 AkkStelleGBV Signatory to the Multilateral Agreements of EA, ILAC and IAF for Mutual Recognition</p> <p>Accreditation </p> <p>The Deutsche Akkreditierungsstelle GmbH attests that the testing laboratory CTC advanced GmbH Untertürkheimer Straße 6-10, 66117 Saarbrücken is competent under the terms of DIN EN ISO/IEC 17025:2018 to carry out tests in the following fields: Telecommunication (TC) and Electromagnetic Compatibility (EMC) for Canadian Standards</p> <p>The accreditation certificate shall only apply in connection with the notice of accreditation of 09.06.2020 with the accreditation number D-PL-12076-01. It comprises the cover sheet, the reverse side of the cover sheet and the following annex with a total of 07 pages. Registration number of the certificate: D-PL-12076-01-04</p> <p>Frankfurt am Main, 09.06.2020 by order of  Ingrid Egner Head of Division</p> <p><small>The certificate together with its annex reflects the status at the time of the date of issue. The current status of the scope of accreditation can be found in the database of accredited bodies of Deutsche Akkreditierungsstelle GmbH. https://www.dakks.de/en/content/accredited-bodies-dakks See notes annex.</small></p>	 <p>Deutsche Akkreditierungsstelle GmbH</p> <p>Office Berlin Spittelmarkt 10 10117 Berlin</p> <p>Office Frankfurt am Main Europa-Allee 52 60327 Frankfurt am Main</p> <p>Office Braunschweig Bundesallee 100 38116 Braunschweig</p> <p>The publication of extracts of the accreditation certificate is subject to the prior written approval by Deutsche Akkreditierungsstelle GmbH (DAKKS). Exempted is the unchanged form of separate disseminations of the cover sheet by the conformity assessment body mentioned overleaf.</p> <p>No impression shall be made that the accreditation also extends to fields beyond the scope of accreditation attested by DAKKS.</p> <p>The accreditation was granted pursuant to the Act on the Accreditation Body (AkkStelleG) of 31 July 2009 (Federal Law Gazette I p. 2625) and the Regulation (EC) No 765/2008 of the European Parliament and of the Council of 9 July 2008 setting out the requirements for accreditation and market surveillance relating to the marketing of products (Official Journal of the European Union L 218 of 9 July 2008, p. 30). DAKKS is a signatory to the Multilateral Agreements for Mutual Recognition of the European co-operation for Accreditation (EA), International Accreditation Forum (IAF) and International Laboratory Accreditation Cooperation (ILAC). The signatories to these agreements recognise each other's accreditations.</p> <p>The up-to-date state of membership can be retrieved from the following websites: EA: www.european-accreditation.org ILAC: www.ilac.org IAF: www.iaf.nu</p>

Note: The current certificate annex is published on the website (link see below) of the Accreditation Body DAKKS or may be received by CTC advanced GmbH on request

<https://www.dakks.de/as/ast/d/D-PL-12076-01-04e.pdf>

16 Accreditation Certificate – D-PL-12076-01-05

first page	last page			
 <p>Deutsche Akkreditierungsstelle GmbH</p> <p>Entrusted according to Section 8 subsection 1 AkkStelleG in connection with Section 1 subsection 1 AkkStelleGBV Signatory to the Multilateral Agreements of EA, ILAC and IAF for Mutual Recognition</p>  <p>Accreditation</p> <p>The Deutsche Akkreditierungsstelle GmbH attests that the testing laboratory CTC advanced GmbH Untertürkheimer Straße 6-10, 66117 Saarbrücken is competent under the terms of DIN EN ISO/IEC 17025:2018 to carry out tests in the following fields: Telecommunication (FCC Requirements)</p> <p>The accreditation certificate shall only apply in connection with the notice of accreditation of 09.06.2020 with the accreditation number D-PL-12076-01. It comprises the cover sheet, the reverse side of the cover sheet and the following annex with a total of 05 pages.</p> <p>Registration number of the certificate: D-PL-12076-01-05</p> <p>Frankfurt am Main, 09.06.2020</p>  <p>by orig. Dipl.-Ing. (FH) Ralf Egnier Head of Division</p> <p><small>The certificate together with its annex reflects the status at the time of the date of issue. The current status of the scope of accreditation can be found in the database of accredited bodies of Deutsche Akkreditierungsstelle GmbH. https://www.dakks.de/en/content/accredited-bodies-dakks See notes annex 1.</small></p>	<p>Deutsche Akkreditierungsstelle GmbH</p> <table border="0"> <tr> <td>Office Berlin Spittelmarkt 10 10117 Berlin</td> <td>Office Frankfurt am Main Europa-Allee 52 60327 Frankfurt am Main</td> <td>Office Braunschweig Bundesallee 100 38116 Braunschweig</td> </tr> </table> <p>The publication of extracts of the accreditation certificate is subject to the prior written approval by Deutsche Akkreditierungsstelle GmbH (DAkKS). Exempted is the unchanged form of separate disseminations of the cover sheet by the conformity assessment body mentioned overleaf.</p> <p>No impression shall be made that the accreditation also extends to fields beyond the scope of accreditation attested by DAkKS.</p> <p>The accreditation was granted pursuant to the Act on the Accreditation Body (AkkStelleG) of 31 July 2009 (Federal Law Gazette I p. 2625) and the Regulation (EC) No 765/2008 of the European Parliament and of the Council of 9 July 2008 setting out the requirements for accreditation and market surveillance relating to the marketing of products (Official Journal of the European Union L 218 of 9 July 2008, p. 30). DAkKS is a signatory to the Multilateral Agreements for Mutual Recognition of the European co-operation for Accreditation (EA), International Accreditation Forum (IAF) and International Laboratory Accreditation Cooperation (ILAC). The signatories to these agreements recognise each other's accreditations.</p> <p>The up-to-date state of membership can be retrieved from the following websites: EA: www.european-accrreditation.org ILAC: www.ilac.org IAF: www.iaf.nu</p>	Office Berlin Spittelmarkt 10 10117 Berlin	Office Frankfurt am Main Europa-Allee 52 60327 Frankfurt am Main	Office Braunschweig Bundesallee 100 38116 Braunschweig
Office Berlin Spittelmarkt 10 10117 Berlin	Office Frankfurt am Main Europa-Allee 52 60327 Frankfurt am Main	Office Braunschweig Bundesallee 100 38116 Braunschweig		

Note: The current certificate annex is published on the website (link see below) of the Accreditation Body DAkKS or may be received by CTC advanced GmbH on request

<https://www.dakks.de/as/ast/d/D-PL-12076-01-05e.pdf>

END OF TEST REPORT