

PCTEST Engineering Laboratory, Inc.

6660-B Dobbin Road • Columbia, MD 21045 • U.S.A.

TEL (410) 290-6652 • FAX (410) 290-6654

<http://www.pctestlab.com>

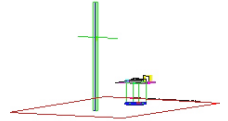

CERTIFICATE OF COMPLIANCE

CREWAVE Co., Ltd.
F7, Pureun Bldg. 28-1 Jamwon-dong, Seocho-gu
Seoul, KOREA 137-030
Attention: Charlie Park

Dates of Tests: August 13-14, 2001
Test Report S/N: 15.210719498.PFT
Test Site: PCTEST Lab, Columbia MD

FCC ID

PFTCW-1100USB

APPLICANT

CREWAVE Co., Ltd.

FCC Rule Part(s):	§ 15.247; ANSI C-63.4 (1992)
Classification:	Spread Spectrum Transceiver (DSS)
Method/System:	Direct Sequence System
Equipment Type:	Wireless LAN USB
Max Output Power:	0.036 W (15.57 dBm)
Frequency Range:	2412 – 2483.5 MHz
Trade/Model No(s):	CREWAVE CW-1100USB

This equipment has been shown to be capable of compliance with the applicable technical standards as indicated in the measurement report and was tested in accordance with the measurement procedures specified in ANSI C-63-4.

I attest to the accuracy of data. All measurements reported herein were performed by me or were made under my supervision and are correct to the best of my knowledge and belief. I assume full responsibility for the completeness of these measurements and vouch for the qualifications of all persons taking them.

PCTEST certifies that no party to this application has been denied the FCC benefits pursuant to Section 5301 of the Anti-Drug Abuse Act of 1988, 21 U.S.C. 862.

Randy Ortanez
President



NVLAQ[®]
LAB CODE 100431-0

TABLE OF CONTENTS

ATTACHMENT A – COVER LETTER	
ATTACHMENT B - TEST REPORT	
SCOPE	1
INTRODUCTION (SITE DESCRIPTION)	2
PRODUCT INFORMATION	3
DESCRIPTION OF TESTS	
A. CONDUCTED EMISSIONS	4
B. RADIATED EMISSIONS	5
C. RESTRICTED BANDS	6
D. ANTENNA REQUIREMENT	7
E. DIRECT SEQUENCE BANDWIDTH	8
F. MAXIMUM PEAK POWER OUTPUT	9
G. POWER DENSITY	10
RADIATED MEASUREMENTS (FUNDAMENTAL & HARMONICS)	11-13
FREQUENCY MEASUREMENTS (SPURIOUS)	14
PROCESSING GAIN	15-28
LIST OF TEST EQUIPMENT	29
CONCLUSION	30
ATTACHMENT C - TEST PLOTS	
ATTACHMENT D - FCC ID LABEL & LOCATION	
ATTACHMENT E - BLOCK DIAGRAM(S)	
ATTACHMENT F - SCHEMATIC(S)	
ATTACHMENT G - OPERATIONAL DESCRIPTION	
ATTACHMENT H - PHOTOGRAPHS OF TEST SET-UP	
ATTACHMENT I - EUT PHOTOGRAPHS	
ATTACHMENT J - USER'S MANUAL	

MEASUREMENT REPORT

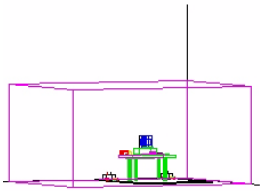

Scope - Measurement and determination of electromagnetic emissions (EME) of radio frequency devices including intentional and/or unintentional radiators for compliance with the technical rules and regulations of the Federal Communications Commission.

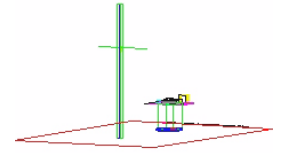

§2.983(a) General Information

Applicant Name:	CREWAVE Co., Ltd.
Address:	F7, Pureun Bldg. 28-1 Jamwon-dong, Seocho-gu Seoul, KOREA 137-030
Attention:	Charlie Park

- FCC ID: **PFTCW-1100USB**
- Class: Spread Spectrum Transceiver (DSS)
- Type: Wireless LAN USB
- Freq. Range: 2412 – 2483.5 MHz
- Method/System: Direct Sequence System (DSS)
- Model No(s): **CW-1100USB**
- Max. RF Output Power: 0.036 W (15.57 dBm)
- Rule Part(s): § 15.247
- Dates of Tests: August 13-14, 2001
- Place of Tests: PCTEST Lab, Columbia, MD U.S.A.
- Test Report S/N: 15.210719498.PFT

INTRODUCTION

The measurement procedure described in American National Standard for Methods of Measurement of Radio-Noise Emissions from Low-Voltage Electrical and Electronic Equipment in the Range of 9KHz to 40GHz (ANSI C63.4-1992) and FCC Public Notice dated July 12, 1995 entitled "Guidance on Measurement for Direct Sequence Spread Spectrum Systems" were used in the measurement of **CREWAVE Spread Spectrum Wireless LAN USB**.

These measurement tests were conducted at **PCTEST Engineering Laboratory, Inc.** facility in New Concept Business Park, Guilford Industrial Park, Columbia, Maryland. The site address is 6660-B Dobbin Road, Columbia, MD 21045. The test site is one of the highest points in the Columbia area with an elevation of 390 feet above mean sea level. The site coordinates are 39° 11'15" N latitude and 76° 49'38" W longitude. The facility is 1.5 miles North of the FCC laboratory, and the ambient signal and ambient signal strength are approximately equal to those of the FCC laboratory. There are no FM or TV transmitters within 15 miles of the site. The detailed description of the measurement facility was found to be in compliance with the requirements of § 2.948 according to ANSI C63.4 on October 19, 1992.

PCTEST Location

The map at right shows the location of the PCTEST Lab, its proximity to the FCC Lab, the Columbia vicinity area, the Baltimore-Washington International (BWI) airport, and the city of Baltimore, and the Washington, D.C. area. (see Figure1).

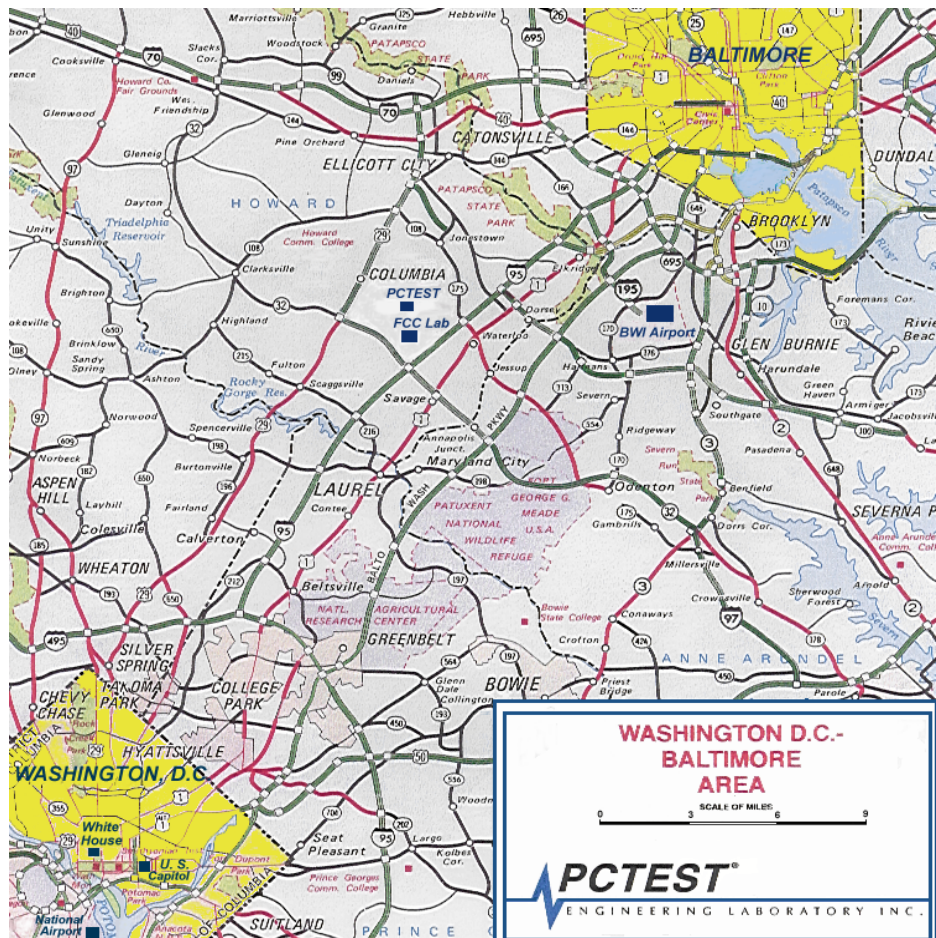

Figure 1. Map of the Greater Baltimore and Metropolitan Washington, D.C. area.

PRODUCT INFORMATION

Equipment Description:

The Equipment under test (EUT) is the **Crewave CW-1100USB** wireless LAN using spread spectrum direct sequence and time division duplex techniques.

Frequency Range:	2412 – 2483.5 MHz
Modulation:	CCK, DBPSK, DQPSK
Max RF Output Power:	0.036 W (15.57 dBm)
Power Consumption:	370mA
Dimensions (WxHxD):	68 x 11 x 90 mm
Weight (Net):	180g

Description of Tests

Conducted Emissions

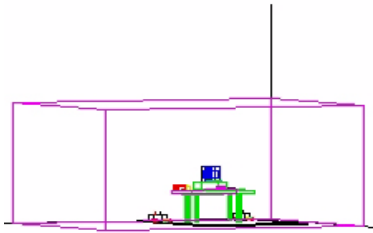

Figure 4. Shielded Enclosure Line-Conducted Test Facility

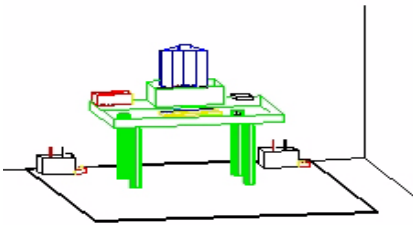

Figure 2. Line Conducted Emission Test Set-Up

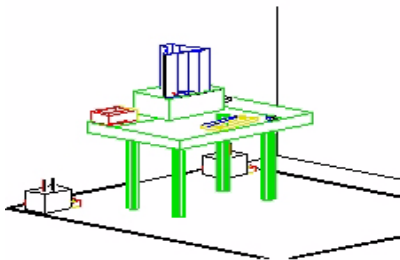

Figure 3. Wooden Table & Bonded LISNs

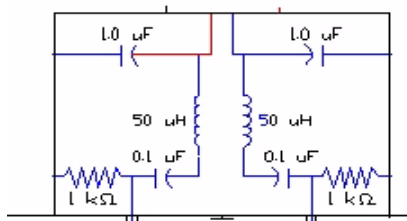

Figure 5. LISN Schematic Diagram

The line-conducted facility is located inside a 16'x20'x10' shielded enclosure. It is manufactured by Ray Proof Series 81 (see Figure 2). The shielding effectiveness of the shielded room is in accordance with MIL-Std-285 or NSA 65-6. A 1m. x 1.5m. wooden table 80cm. high is placed 40cm. away from the vertical wall and 1.5m away from the side wall of the shielded room (see Figure 3). Solar Electronics and EMCO Model 3725/2 (10kHz-30MHz) 50 Ω /50 μ H Line-Impedance Stabilization Networks (LISNs) are bonded to the shielded room (see Figure 4). The EUT is powered from the Solar LISN and the support equipment is powered from the EMCO LISN. Power to the LISNs are filtered by a high-current high-insertion loss Ray Proof power line filters (100dB 14kHz-10GHz). The purpose of the filter is to attenuate ambient signal interference and this filter is also bonded to the shielded enclosure. All electrical cables are shielded by braided tinned copper zipper tubing with inner diameter of 1/2". If the EUT is a DC-powered device, power will be derived from the source power supply it normally will be powered from and this supply lines will be connected to the Solar LISN. LISN schematic diagram is shown in Figure 5. All interconnecting cables more than 1 meter were shortened by non-inductive bundling (serpentine fashion) to a 1-meter length. Sufficient time for the EUT, support equipment, and test equipment was allowed in order for them to warm up to their normal operating condition. The RF output of the LISN was connected to the spectrum analyzer to determine the frequency producing the maximum EME from the EUT. The spectrum was scanned from 450kHz to 30MHz with 20 msec. sweep time. The frequency producing the maximum level was reexamined using EMI/ Field Intensity Meter and Quasi-Peak adapter. The detector function was set to CISPR quasi-peak mode. The bandwidth of the receiver was set to 10 kHz. The EUT, support equipment, and interconnecting cables were arranged and manipulated to maximize each EME emission. Each emission was maximized by: switching power lines; varying the mode of operation or resolution; clock or data exchange speed; scrolling H pattern to the EUT and/or support equipment, and powering the monitor from the floor mounted outlet box and the computer aux AC outlet, if applicable; whichever determined the worst-case emission. Photographs of the worst-case emission can be seen in Attachment H. Each EME reported was calibrated using the HP8640B signal generator.

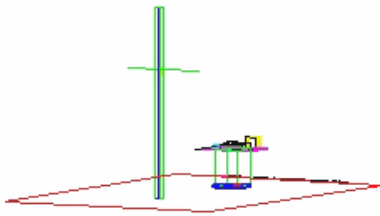

Figure 6. 3-Meter Test Site

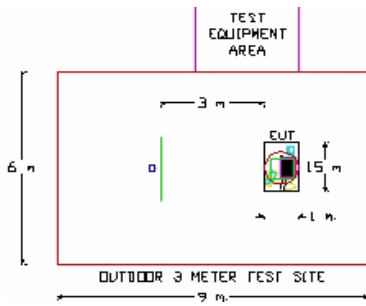

Figure 7. Dimensions of Outdoor Test Site

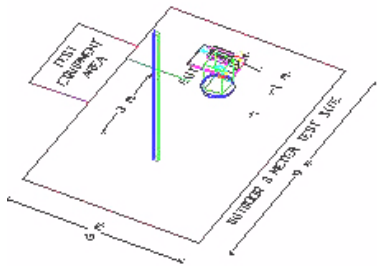

Figure 8. Turntable and System Setup

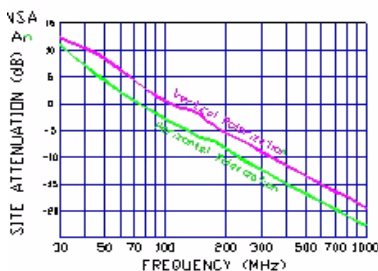

Figure 9. Normalized Site Attenuation Curves (H&V)

Description of tests (Continued)

Radiated Emissions

Preliminary measurements were made indoors at 1 meter using broadband antennas, broadband amplifier, and spectrum analyzer to determine the frequency producing the maximum EME. Appropriate precaution was taken to ensure that all EME from the EUT were maximized and investigated. The system configuration, clock speed, mode of operation or video resolution, turntable azimuth with respect to the antenna were noted for each frequency found. The spectrum was scanned from 30 to 200 MHz using biconical antenna and from 200 to 1000 MHz using log-spiral antenna. Above 1 GHz, linearly polarized double ridge horn antennas were used.

Final measurements were made outdoors at 3-meter test range using Roberts™ Dipole antennas or horn antenna (see Figure 6). The test equipment was placed on a wooden and plastic bench situated on a 1.5 x 2 meter area adjacent to the measurement area (see Figure 7). Sufficient time for the EUT, support equipment, and test equipment was allowed in order for them to warm up to their normal operating condition. Each frequency found during pre-scan measurements was re-examined and investigated using EMI/Field Intensity Meter and Quasi-Peak Adapter. The detector function was set to CISPR quasi-peak mode and the bandwidth of the receiver was set to 100kHz or 1 MHz depending on the frequency or type of signal.

The half-wave dipole antenna was tuned to the frequency found during preliminary radiated measurements. The EUT, support equipment and interconnecting cables were re-configured to the set-up producing the maximum emission for the frequency and were placed on top of a 0.8-meter high non-metallic 1 x 1.5 meter table (see Figure 8). The EUT, support equipment, and interconnecting cables were re-arranged and manipulated to maximize each EME emission. The turntable containing the system was rotated; the antenna height was varied 1 to 4 meters and stopped at the azimuth or height producing the maximum emission. Each emission was maximized by: varying the mode of operation or resolution; clock or data exchange speed; scrolling H pattern to the EUT and/or support equipment, and powering the monitor from the floor mounted outlet box and the computer aux AC outlet, if applicable; and changing the polarity of the antenna, whichever determined the worst-case emission. Photographs of the worst-case emission can be seen in Attachment H. Each EME reported was calibrated using the HP8640B signal generator. The Theoretical Normalized Site Attenuation Curves for both horizontal and vertical polarization are shown in Figure 9.

§ 15.205 Restricted Bands

Special attention is made for the EUT's harmonic and spurious radiated emission in the restricted bands of operation. The EUT was tested from 9kHz and up to the tenth harmonic of the fundamental frequency of the transmitter using CISPR quasi peak detector below 1GHz. Above 1 GHz, average measurements was used using RBW 1 MHz – VBW 10Hz and linearly polarized horn antennas. In addition, peak measurements were taken to ensure that the peak levels are not more than 20dB above the average limit. All out of band emissions, other than those created by the spreading sequency, data sequence, and the carrier modulation must not exceed the limits show int Table 2 per 15.209.

Frequency (MHz)	F/S (UV/m)	Meas. Dist. (Meters)
0.009-0.490	2400/F (kHz)	300
0.490-1.705	24000/F (kHz)	30
1.705-30.00	30	30
30.0-88.0	100	3
88.0-216.0	150	3
216.0-960.0	200	3
Above 960	500	3

Tab. 2. Radiated Emission Limits Per 15.209

Test Equipment

HP 8566B	Spectrum Analyzer 100Hz-22GHz
HP83017A	Microwave Analyzer 40dB Gain (0.5 – 26.5 GHz)
HP 3784A	Digital Transmission Analyzer
Gigatronics	POWER METER MODEL 8651A
EMCO 3115	Horn Antenna (1 – 18GHz)
HP 8495A	20dB Attenuator (DC-40GHz) 0-70dB
HP 8493B	10dB Attenuator
MicroCoax Cables	Low Loss Microwave Cables (1-26.5 GHz)
CDI Dipoles	Dipole Antennas (30 – 1000 MHz)

§ 15.203 Antenna Requirement

An intentional radiator antenna shall be designed to ensure that no antenna other than that furnished by the applicant can be used with the device. The use of a permanently attached antenna or of an antenna that uses a unique coupling to the intentional radiator shall be considered sufficient to comply with this requirement.

CONCLUSION

The **Crewave CW-1100USB** complies with the requirement of §15.203. The antenna is **permanently attached**.

§ 15.247(a)(2) – Direct Sequence Bandwidth

Minimum Standard – The transmitter shall have a minimum 6 dB BW of 500 kHz.
These are conducted measurements.

Res. Bandwidth =	100 kHz (7dB/div)
Vid. BW =	100 kHz
Span =	40 MHz
Ref. Level	5 dBm
Sweep	10.0ms
Attenuator	16 dB ext. pad

FREQUENCY (MHz)	Channel	6dB Bandwidth (MHz)
2412	01	10.0
2438	06	10.1
2473	13	11.4

Table 3. 6dB Bandwidth measurements

REMARKS:

PASS

§ 15.247(b) Maximum Peak Output Power

Minimum Standard – The maximum peak output power of the transmitter shall not exceed 1 watt. These are conducted measurements

Res. Bandwidth = 3 MHz (7dB/div)
Vid. BW= 3 MHz
Span= 30 MHz
Ref. Level 16 dBm
Sweep 4 ms sec
Attenuator 16 dB ext. pad

Max. Power Peak + Atten = dBm \Rightarrow Watts

FREQUENCY (MHz)	Channel	Power Output Conducted (dBm)	Power Output Radiated (mW)
2412	01	13.61	23.0
2438	06	14.49	28.0
2473	13	15.53	35.8

Table 4. Output Power Measurements

Notes:

The Power Output measurements were taken with a Peak reading Power Meter.

REMARKS:

PASS

§ 15.247(c) Power Density

Minimum Standard – The transmitted power density averaged over any 1 second interval shall not be greater than 8dBm in any 3kHz bandwidth within these bands. These are conducted measurements

Res. Bandwidth = 3 kHz (7dB/div)
Vid. BW = 3 kHz
Span = 40 MHz
Ref. Level 5 dBm
Sweep 1000 sec
Attenuator 16 dB ext. pad

Peak + Atten = dBm \Rightarrow (Limit < 8dBm)

FREQ (MHz)	Channel	Power Density (dBm)
2412	01	-9.4
2438	06	-8.8
2473	13	-5.1

Table 5. Output Power Density Data.

REMARKS:

PASS

RADIATED Measurements (Fundamental & Harmonics)

Operating Frequency: 2412 MHz
 Distance of Measurements: 3 meters
 Channel: 01

FREQ. (MHz)	Level* (dBm)	AFCL (dB)	POL (H/V)	DET QP/AVG	F/S (μ V/m)	F/S (dB μ V/m)	Margin (dB)
2412.0	- 29.0	32.7	V	Peak	342768.0	110.7	n/a
4824.0	- 106.0	40.4	V	Peak	117.4	41.4	12.6
7236.0	- 121.0	47.4	V	Peak	46.9	33.4	77.3
14472.0	< - 132						

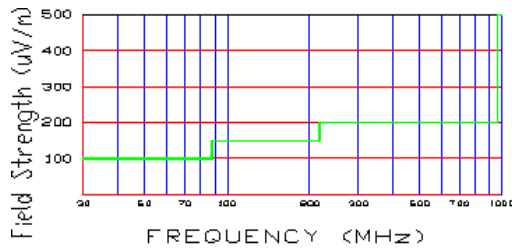

Figure 10. Restricted band harmonics and spurious limits.

Above 1 GHz limit is 500 uV/m (54dBu/m)

NOTES:

1. All harmonics in the restricted bands specified in §15.205 are below the limit shown in table 2. (note: * Restricted Band)
2. All harmonics/spurs are at least 20 dB below the highest emission in the authorized band using RBW = 100kHz
3. Average Measurements > 1GHz using RBW = 1 MHz VBW = 10 Hz
4. The peak emissions above 1 GHz are not more than 20 dB above the average limit.
5. The antenna is manipulated through typical positions, polarity and length during the tests.
6. The EUT is supplied with nominal AC voltage or/and a new/fully recharged battery.
7. The spectrum is measured from 9kHz to the 10th harmonic and the worst-case emissions are reported.
8. < - 132 are below the analyzer floor level.

RADIATED Measurements (Fundamental & Harmonics) (Cont.)

Operating Frequency: 2412 MHz
 Distance of Measurements: 3 meters
 Channel: 01

FREQ. (MHz)	Level* (dBm)	AFCL (dB)	POL (H/V)	DET QP/AVG	F/S (μ V/m)	F/S (dB μ V/m)	Margin (dB)
2412.0	- 29.0	32.7	V	Peak	342768.0	110.7	n/a
4824.0	- 106.0	40.4	V	Peak	117.4	41.4	12.6
7236.0	- 121.0	47.4	V	Peak	46.9	33.4	77.3
14472.0	< - 132						

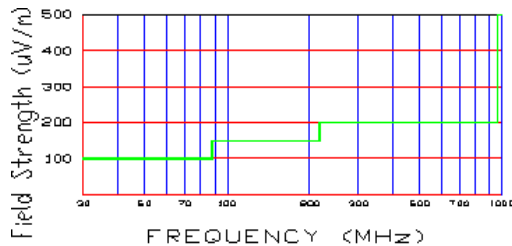

Figure 10. Restricted band harmonics and spurious limits.

Above 1 GHz limit is 500 uV/m (54dBu/m)

NOTES:

1. All harmonics in the restricted bands specified in §15.205 are below the limit shown in table 2. (note: * Restricted Band)
2. All harmonics/spurs are at least 20 dB below the highest emission in the authorized band using RBW = 100kHz
3. Average Measurements > 1GHz using RBW = 1 MHz VBW = 10 Hz
4. The peak emissions above 1 GHz are not more than 20 dB above the average limit.
5. The antenna is manipulated through typical positions, polarity and length during the tests.
6. The EUT is supplied with nominal AC voltage or/and a new/fully recharged battery.
7. The spectrum is measured from 9kHz to the 10th harmonic and the worst-case emissions are reported.
8. < - 132 are below the analyzer floor level.

RADIATED Measurements (Fundamental & Harmonics)

Operating Frequency: 2412 MHz
 Distance of Measurements: 3 meters
 Channel: 01

FREQ. (MHz)	Level* (dBm)	AFCL (dB)	POL (H/V)	DET QP/AVG	F/S (μ V/m)	F/S (dB μ V/m)	Margin (dB)
2412.0	- 29.0	32.7	V	Peak	342768.0	110.7	n/a
4824.0	- 106.0	40.4	V	Peak	117.4	41.4	12.6
7236.0	- 121.0	47.4	V	Peak	46.9	33.4	77.3
14472.0	< - 132						

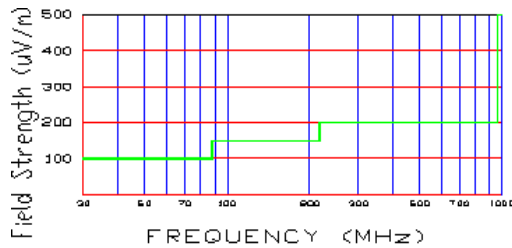

Figure 10. Restricted band harmonics and spurious limits.

Above 1 GHz limit is 500 uV/m (54dBu/m)

NOTES:

1. All harmonics in the restricted bands specified in §15.205 are below the limit shown in table 2. (note: * Restricted Band)
2. All harmonics/spurs are at least 20 dB below the highest emission in the authorized band using RBW = 100kHz
3. Average Measurements > 1GHz using RBW = 1 MHz VBW = 10 Hz
4. The peak emissions above 1 GHz are not more than 20 dB above the average limit.
5. The antenna is manipulated through typical positions, polarity and length during the tests.
6. The EUT is supplied with nominal AC voltage or/and a new/fully recharged battery.
7. The spectrum is measured from 9kHz to the 10th harmonic and the worst-case emissions are reported.
8. < - 132 are below the analyzer floor level.

RADIATED Measurements (Spurious)

Operating Frequency: 2412 – 2483.5 MHz
 Distance of Measurements: 3 meters
 Channel: 01

FREQ. (MHz)	Level* (dBm)	AFCL** (dB)	POL (H/V)	Height (m)	Azimuth (° angle)	F/S (μ V/m)	Margin*** (dB)
44.0	- 74.8	2.0	V	2.8	10	51.3	- 5.8
48.0	- 82.7	2.7	H	2.1	20	22.4	- 13.0
64.0	- 76.7	5.5	H	2.0	10	61.7	- 4.2
72.0	- 82.7	6.5	H	1.6	170	34.7	- 9.2
88.0	- 86.2	8.4	V	1.3	80	28.9	- 10.8
128.0	- 87.6	12.1	H	1.3	200	37.6	- 12.0

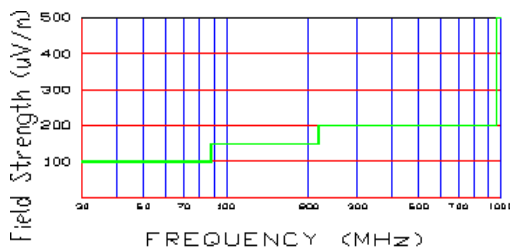

Figure 11. Restricted band harmonics and spurious limits.

Above 1 GHz limit is 500 uV/m (54dBu/m)

NOTES:

1. All emissions were investigated and the worst case emissions are reported
2. For hand-held devices, the EUT is rotated through three orthogonal axis to determine which configuration produces the maximum emissions.
3. The EUT is supplied with the minimal AC voltage or/and a new/fully recharged battery.
4. The EUT was tested up to the 10th harmonic (24 GHz) and no significant emission was found.

§ 15.247(e) PROCESSING GAIN (from Crewave)

See following Processing Gain data from Crewave.

Results:

PASS

The test results of Section 15.247(e) were confirmed by PCTEST Engineering Lab.

§ 15.247(e) PROCESSING GAIN (Cont.)

12.1 §15.247(E) PROCESSING GAIN

Product Name:

FCC Requirements: The processing gain of a direct sequence system shall be at least 10dB. The processing gain shall be determined from the ratio in dB of the signal-to-noise ratio with the system spreading code turned off to the signal-to-noise ratio with the system spreading code turned on, as measured at the demodulated output of the receiver.

This document contains theoretical calculation and test setup, procedure, measurement data and report.

Test equipment:

MS2602A Spectrum analyzer
HP ESG D4000A signal generator
HP437B Power meter
HP8494A attenuator 1dB steps
HP8495B attenuator 10dB steps
PD28-0725-SMA power splitter
Laptop

Theoretical calculation:

The Processing gain is related to the jamming margin as follows:

$$G_p = (S/N)_{\text{output}} + (J/S) + L_{\text{SYS}}$$

Where $BER_{\text{reference}}$ is the reference bit error ratio with its corresponding, theoretical output signal to noise ratio per symbol, $(S/N)_{\text{output}}$, (J/S) is the jamming margin (jamming signal power relative to desired signal power), and L_{SYS} is the system losses.

The maximum allowed total system implementation loss is 2 dB.

For 11Mbps case: The HFA 3861B direct sequence spread spectrum baseband processor uses CCK modulation which is a form of M-ary Orthogonal Keying. The Probability of error for generalized M-ary orthogonal signaling using coherent demodulation is given by:

§ 15.247(E) PROCESSING GAIN (CONT.)

Reference

[1]. Intersil processing gain test document(Attached file).

Test Block Diagram

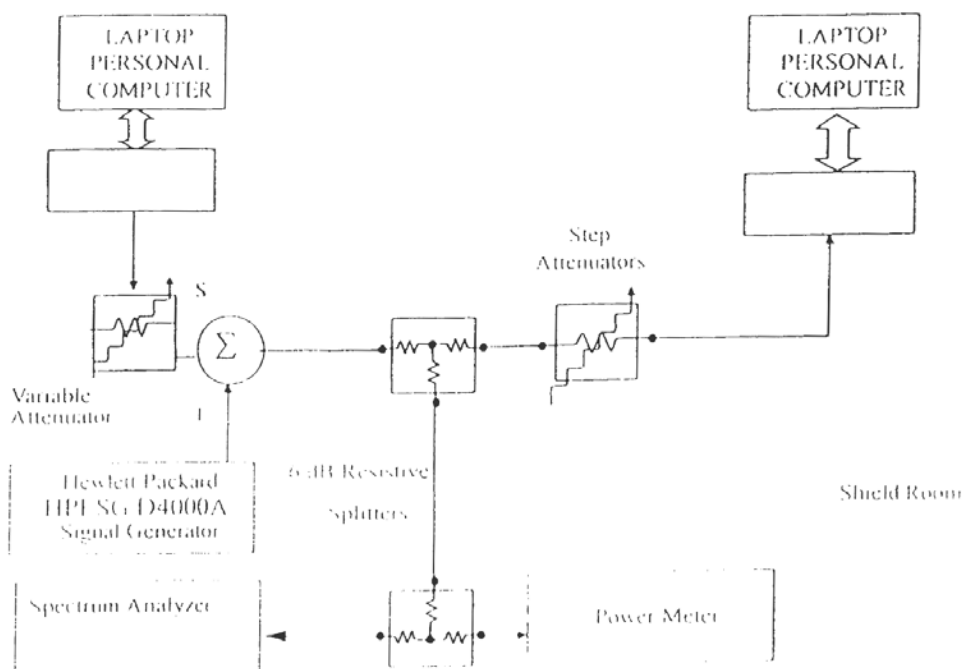

§ 15.247(e) PROCESSING GAIN (Cont.)

It is well known that the Eb/No of BPSK is 9.6dB for 1e-5BER, so therefore the coding gain of CCK over BPSK is 2.2dB. We add this to the processing gain of 9B to get 11.2dB overall processing gain for the CW jamming test.

Taking the calculation above, if the (J/S) is -8.4dB then the equipment passes the CW jamming test.

Test procedure:

Obtain the simplex link shown. Perform all independent instrumentation calibration prior to this procedure. Set operating levels using fixed and variable attenuator in system to meet the following objectives.

1. Signal Power at receiver is approximately -60dBm.
2. Signal Power at power meter between -20 and -30dBm.
3. Use spectrum analyzer to monitor test.
4. Ensure that CW jammer generator RF output is disabled and measure the power at the power meter port using HP437B power meter. This is relative power, Sr.
5. Disable TX and set CW jammer output frequency equal to the carrier frequency and enable generator output. Set reference CW jammer power level at power meter port 8.4dB below Sr (minimum J/S, or 10 dB processing gain reference level).
6. Disable CW jammer and re-establish Link. FER test should be essentially error free.
7. Enable the CW jammer at the reference power level and verify that FER at the reference power level and measure FER.
8. Repeat Step 7 for uniform steps in frequency increments of 50KHz across the receiver passband with the CW jammer. In this case, the receiver passband is 8.5MHz.

Test setup: as shown at next page

Processing Gain Test Result Summary:

Frequency Channel	Frequency (MHz)	Data Rate (Mbps)	Worst Point of the 8% FER (Limit is 20%)	Result
1	2412	11	18.8	Passed
6	2438	11	18.2	Passed
13	2472	11	19.1	Passed

§ 15.247(e) PROCESSING GAIN (Cont.)

$$P_e = 1 - P_{c1} = 1 - \frac{1}{\sqrt{2\pi}} \int_{\frac{S_{\text{net}}}{N_0}}^{\infty} \left[2(1 - Q\left\{z + \sqrt{2 \frac{E_b}{N_0} \eta}\right\}) \right]^{\frac{M}{2}-1} \exp\left\{-\frac{z^2}{2}\right\} dz$$

So the FER performance curve is given by [1] as below graph:

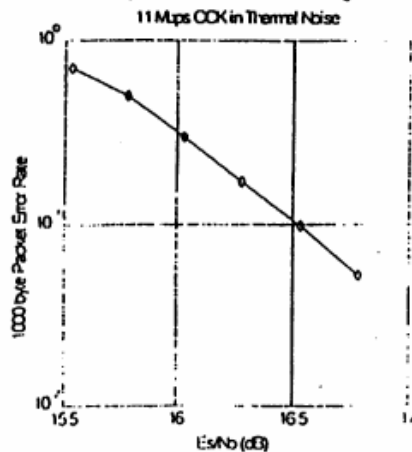

figure.1 1000 byte PER vs. Es/No

Therefore:

$$C_{ip} = (Es/No)_{\text{opt}} (J/S) + 1.5 \text{ sys} = 16.4 + 2.0 = 18.4 \text{ (J/S)}$$

$$C_{ip} = 18.4 \text{ (J/S) must } > 10 \text{ dB}$$

For the case of the HFA3861B, the bit rates are 1.2, 5.5 and 11Mbps. The corresponding symbol rates are 1, 1, 1.375 and 1.375 MSPS. And 1 and 11Mbps are used within our system.

The chip rate is always 11Mcps, so the ratio of chip rate to symbol rate is 11:1 for the 1Mbps and 8:1 for 11Mbps rate.

Since the symbol rate to bit rate is less than 10 for the higher rates, we supply the theoretical processing gain and coding are utilized. This is a reasonable in that they cannot be separated in the demodulation process. If a separable FEC coding scheme were used, we would not be comfortable making this assertion.

As can be seen from the curve of figure 1, the Es/No is 16.4dB at the PER of 8%.

§ 15.247(e) PROCESSING GAIN (Cont.)

Testing for compliance with FCC rules 15-247e

Scope

This report presents the test procedure, test configuration and test data associated with a FCC Part 15.247 (e) Jamming Margin test for the indirect measurement of processing gain.

Applicable Reference Documents.

1. "Operation within the bands 902-928 MHz, 2400-2483.5, and 5725-5850 MHz" *Title 47 Part 15 section 247 (e) Code of Federal Regulations. (47 CFR 15.247).*
2. "Report and Order: Amendment of Parts 2 and 15 of the Commission's Rules Regarding Spread Spectrum Transmitters. Appendix C: "Guidance on Measurements for Direct Sequence Spread Spectrum Systems" *FCC 97-114. ET Docket No. 96-8, RM-8435, RM-8608, RM-8609.*
3. "HFA3861A Direct Sequence Spread Spectrum Baseband Processor" *Harris Corporation Semiconductor Sector Preliminary Data Sheet. Melbourne FL, July 1999*
4. "M-ary Orthogonal Keying BER Curve".

Test Background and Procedure.

According to FCC regulations [1], a direct sequence spread spectrum system must have a processing gain, G_p , of at least 10 dB. Compliance to this requirement can be shown by demonstrating a relative bit-error-ratio (BER) performance improvement (and corresponding signal to noise ratio per symbol improvement of at least 10 dB) between

§ 15.247(e) PROCESSING GAIN (Cont.)

Intersil PRISM II radio Jamming Margin Test

the case where spread spectrum processes (coding, modulation) are engaged relative to the processes being bypassed. In some practical systems, the spread spectrum processing cannot simply be bypassed. In these cases, the processing gain can be indirectly measured by a jamming margin test [2]. In accordance with the new NPRM 99-231, if the vendor has a system with less than 10 chips per symbol, the CW jamming results must be supported by a theoretical explanation of the system processing gain.

Theoretical calculations

The processing gain is related to the jamming margin as follows [2]:

$$G_p = \left(\frac{S}{N} \right)_{\text{output}} + \left(\frac{J}{S} \right) + L_{\text{system}}$$

Where $BER_{\text{REFERENCE}}$ is the reference bit error ratio with its corresponding, theoretical output signal to noise ratio per symbol, $(S/N)_{\text{output}}$, (J/S) is the jamming margin (jamming signal power relative to desired signal power), and L_{system} are the system implementation losses.

The maximum allowed total system implementation loss is 2 dB.

The HFA3861A direct sequence spread spectrum baseband processor uses CCK modulation which is a form of M-ary Orthogonal Keying. The BER performance curve is given by [5]:

The probability of error for generalized M-ary Orthogonal signaling using coherent demodulation is given by:

$$P_e = 1 - P_{c1} = 1 - \frac{1}{\sqrt{2\pi}} \int_{S_m} \left[2(1 - Q\left\{ z + \sqrt{2 \frac{E_b}{\eta}} \right\}) \right]^{\frac{M}{2}-1} \exp\left\{ -\frac{z^2}{2} \right\} dz$$

§ 15.247(e) PROCESSING GAIN (Cont.)

intersil PRISM II radio Jamming Margin Test

This integral cannot be solved in closed form, and numerical integration must be used. There are error rate extensions for differential decoding and descrambling that are also to be accounted for. This is done in a MATHECAD environment and is displayed in graphical format below.

1.1 1000 byte PER vs. Es/No

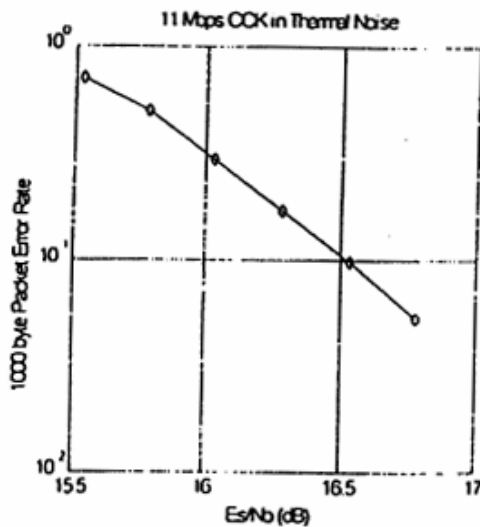

The reference PER is specified as 8%. The corresponding Es/No (signal to noise ratio per symbol) is 16.4 dB. The Es/No required to achieve the desired BER with maximum system implementation losses is 18.4 dB. The minimum processing gain is again, 10 dB, therefore:

$$G_p = \left(\frac{E_s}{N_o} \right)_{\text{required}} + \left(\frac{J}{S} \right) + L_{\text{system}} = 16.4 \text{ dB} + 2.0 \text{ dB} + \left(\frac{J}{S} \right) \geq 10 \text{ dB}$$

$$G_p = 18.4 \text{ dB} + \left(\frac{J}{S} \right) \geq 10 \text{ dB}$$

The minimum jammer to signal ratio is as follows.

§ 15.247(e) PROCESSING GAIN (Cont.)

intersil PRISM II radio Jamming Margin Test

$$\left(\frac{J}{S}\right) \geq -8.4 \text{ dB}$$

For the case of the HFA3861A, the bit rates are 1, 2, 5.5, and 11 Mbps. The corresponding symbol rates are 1, 1, 1.375, and 1.375 MSps. The chip rate is always 11 MCps, so the ratio of chip rate to symbol rate is 11:1 for the 1 and 2 Mbps rates and 8:1 for the 5.5 and 11 Mbps rates. Since the symbol rate to bit rate is less than 10 for the higher rates, we supply the theoretical processing gain calculation for these cases where spread spectrum processing gain with embedded coding gain is utilized. This is reasonable in that they cannot be separated in the demodulation process. If a separable FEC coding scheme were used, we would not be comfortable making this assertion.

As can be seen from the curve of figure 1, the E_s/N_0 is 16.4 dB at the PER of 8%. This PER can be related to a BER of $1e-5$ on 1000 byte packets. With 8 bits per symbol, the E_b/N_0 is then 7.4 dB or 9 dB less than the E_s/N_0 . It is well known that the E_b/N_0 of BPSK is 9.6 dB for $1e-5$ BER, so therefore the coding gain of CCK over BPSK is 2.2 dB. We add this to the processing gain of 9 dB to get 11.2 dB overall processing gain for the CW jammer test.

Faking the calculations above, if the $\left(\frac{J}{S}\right) \geq -8.4 \text{ dB}$ then the equipment passes the CW jamming test.

Test Configuration: CW Jamming Margin (15.247) (e)

§ 15.247(e) PROCESSING GAIN (Cont.)

intersil PRISM II radio Jamming Margin Test

Basic Test Block Diagram

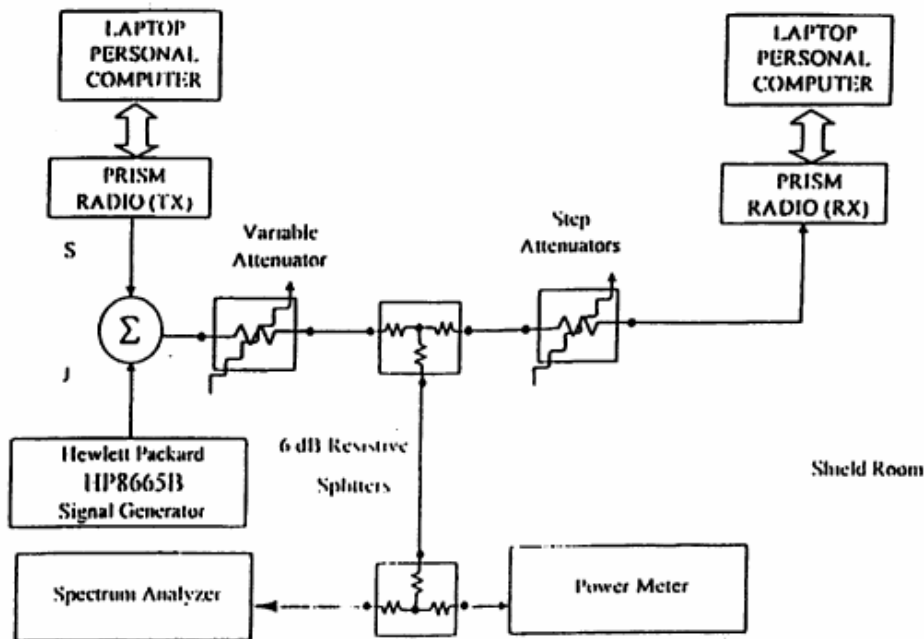

Test Procedure

Setup the simplex link shown. Perform all independent instrumentation calibrations prior to this procedure. Set operating power levels using fixed and variable attenuators in system to meet the following objectives:

- Signal Power at receiver approximately -60 dBm (above thermal sensitivity such that thermal noise does not cause bit errors).
- Signal Power at power meter (using high sensitivity probe) between -20 and -40 dBm for optimal linearity
- Use spectrum analyzer to monitor test.
- Ensure that CW Jammer generator RF output is disabled and measure the power at the power meter port using the power meter. This is the relative signal power, S_r .

§ 15.247(e) PROCESSING GAIN (Cont.)

PROCESSING GAIN MEASUREMENT PROCEDURE

- Disable Transmitter, and set CW Jammer generator RF output frequency equal to the carrier frequency and enable generator output. Set reference CW Jammer power level at power meter port 8.4 dB below S , (minimum J/S , or 10 dB processing gain reference level). Note the power level setting on the generator, this is the reference CW Jammer power setting, J .
- Disable CW Jammer, re-establish link. PER test should be operating essentially error-free.
- Adjust the CW Jammer level to that which causes 8% PER and verify that the S/J is less than 8.4 dB.
- Repeat step 7 for uniform steps in frequency increments of 50 kHz across the receiver passband with the CW Jammer. In this case the receiver passband is ± 8.5 MHz.

The number of points where the S/J fails to achieve 8.4 dB (is higher than 8.4 dB) is determined and if this is above 20% of the total, the test is failed otherwise it is passed.

The numerical data associated with the following radio channels is tabulated and presented for:

Channel 1: 2412 MHz
Channel 6: 2438 MHz
Channel 13: 2472 MHz

PRISM II Radio HWB3163-02 Rev A card Detailed Processing Gain Measurement Operating Instructions

- 1) Assemble equipment as shown in the block diagram
- 2) This test procedure assumes that the Computers are equipped with 3.3V PCMCIA slots and have the appropriate PCMCIA radio card Windows drivers installed. Also that the Prism 802.11 Wireless LAN Configuration Utility and CWIOCON Console Command Line program is installed.
- 3) Use two Prism II radio cards. This procedure is written for HWB3163-02 Rev A, newer radio cards may require different software/firmware. The HWB3163-02 rev A uses the HFA3861A baseband processor. These radio cards are loaded with firmware.

§ 15.247(e) PROCESSING GAIN (Cont.)

intersil PRISM II radio Jamming Margin Test

- Firmware may be loaded in Genesis mode using the program "Download" revision 3.7 a DOS based utility.
- 4) The following programs and files are used in this test procedure.
 - C:\laneval\laneval.exe (rev 2.03 or later) Windows LAN and PER utility.
 - C:\laneval\laneval.ini (autogenerated) Must edit this file to set the following:
 - PktDelay = 1 PktBurst = 6 (Settings for firmware 0709 rev 0.4+)
 - Pkt Size = 1000
 - PktFill = -1 (Random data or Optional data pattern may be specified with decimal byte value 0 to 255)
 - New firmware rev 0.4 will allow PktDelay less than 10.
 - C:\cw10con\cw10con.exe (rev 0.4)(8/4/99) Windows Console command line Utility
 - c:\cw10con\h3861ar1a.ini (8/4/99) Contains updated Baseband processor register values.
 - 5) Insert HWB3163-02 Rev A Prism II radio into PCMCIA extender card 68 pin connector socket. Note: The PRISM II radio uses only 3.3V power. Cards with coversets are "keyed" for low voltage slots and will not fit into 5V slots. Cards without coversets must be manually centered and inserted into the 68 pin extender card socket.
 - 6) Select desired frequency channel and data rate.
 - * Double Click the system icon at the lower left of the screen that looks like a "terminal with an antenna". This activates the "Prism 802.11 Wireless LAN Configuration Utility"
 - * Select the desired channel (1.6 or 11 recommended) and "Fixed 11Mb/s" for data rate on both the TX and RX radios. The Configuration Utility modifies these settings dynamically so that NO Reboot is necessary. However, when the channel setting is modified, Configuration Utility reinitializes the radio card reverting all register settings back to the firmware defaults. It will be necessary to perform step 7) after each change of channel setting.
 - * An alternate method of changing channels without reinitializing the radio card register values is available through the cw10con program, described in step 7) under "Other useful commands".
 - 7) Load correct Baseband processor (HFA3861) register values into both the TX and RX cards. Cards with firmware revision 0709 0.4+ have correct register settings and do not need modification except as indicated in step 7a)
 - * Execute program cw10con.exe (Enter > ? for a list of available commands)
 - (Enter > q for quit)
 - * Enter Command > bf h3861ar1a.ini (loads BBP registers contained in file)
 - * Other useful commands in the cw10con program.
 - Enter Command > c 0838 a (dynamically changes radio frequency to channel 10 ["a" Hex] without reinitializing the radio registers, the channel field is a HEX number from 1 to c [1 to 14 decimal])

§ 15.247(e) PROCESSING GAIN (Cont.)

intersil PRISM II radio Jamming Margin Test

Enter Command > c 0e38 5555 (Continuous transmit mode with data pattern 0101)
Enter Command > c 0f38 (Turn off transmit mode, refer to step 14)).
Enter Command > c 1338 (Run DC offset calibration on HFA3783)

- 7a) Cards with firmware 0709 rev 0.4+ or later require the CCA function turned off on the transmitter card during the Processing Gain test.
- * Execute program cw10con.exe
 - * Enter Command > bw 09 00 (Change register 09(Dec) to value 00(Hex) original value is 20(Hex) user can verify change using the command br 09).
- 8) Set the approximate power to the input of the RX card to -60dBm by adjusting the Variable Attenuator and step attenuators.
 - 9) Execute "Laneval.exe" on both TX and RX computers. Set for "Broadcast" mode and start transmission of the TX card. Set the RX card for "Broadcast" and start receiving with the RX card. Verify that the two cards are communicating by observing the "Total Packet Count" window of the RX computer. This window should be increasing in value as packets are received from the TX card. Also note the "Packet Error Rate" window should remain 0.0, indicating no errors in this large signal condition. Allow the radio cards, signal source and power meter to warm up for several hours.
 - 10) Click the Stop TX and Stop RX buttons in Laneval.
 - 11) Calibrate Power Sensor/Meter.
 - 12) Click the CW10CON window previously opened to bring forward. Set the TX card to continuous transmit. Enter Command > c 0e38 5555 (Continuous transmit data pattern 0101)
 - 13) Measure TX card output signal power and adjust Variable Attenuator for -30.0dBm at the power meter. This measurement should be taken quickly as the radio can change its output power about 0.5dB warming up in continuous mode. Remember that the RX card sees 30 dB less power than the power meter, so the RX card will see -60dBm.
 - 14) Disable the TX card output. Enter Command > c 0f38 (Turn off TX output)
 - 15) Set up Jammer Source. Adjust the frequency of the HP8665B (or equivalent) to center of the TX channel and adjust to output amplitude to -8.0dBm. Turn on the RF output of the Signal source.
 - 16) Measure the Jammer power level at the power meter. Adjust Jammer signal amplitude at the source until you measure -38.4dBm (-68.4dBm at the RX card). This will give a Signal to Jammer ratio of 8.4dB, the limit to pass the 10dB processing gain test for a PER of 8%. Record this Jammer source output setting as all measurements will be recorded relative to this level.
 - 17) Click the Laneval window at the TX computer and start transmitting in broadcast mode.
 - 18) Click the Laneval window at the RX computer and start the RX card receiving. Measure the PER of the receiving unit.

§ 15.247(e) PROCESSING GAIN (Cont.)

intersil PRISM II radio Jamming Margin Test

The tab and enter keys can replace the mouse click to start and stop the Laneval receive mode for PER measurements. The tab key will cycle through program options by highlighting the option button in the program window. Highlight the desired button with tab and then select the option with the Enter key.

The FCC specifies that the Processing Gain test will be measured with the CW Jammer in 50KHz steps across the bandwidth of the spread signal (+8.5MHz for Prism II) or 340 test points per channel. It is recommended to measure channels 1,6 and 11. Processing Gain is measured by adjusting the CW Jammer source to find the S/J ratio for 8% PER at each jamming frequency. Record the Jammer source output setting and calculate the Processing Gain at each Jammer frequency in the band. Care should be taken to allow enough time for an accurate measurement, 1 minute is a minimum. A maximum of 68 points, or 20%, may fall below 10dB Processing Gain for the radio to still pass the Processing Gain requirement.

- 19) It is recommended to power down the Prism II PCMCIA card before removing from its slot. This can be done from the PCMCIA card system icon at the bottom of the Windows screen. Place the mouse pointer over the icon and a text bar will appear naming the driver "Harris Prism IEEE802.11 PC Card Adapter/EVB". Mouse click this text bar. A dialog window will appear verifying that the PC card has been powered down and that it is safe to remove it.
- 20) When reinserting the Prism II radio PC card, it is acceptable to "hot" insert the card when Windows is running. The driver application will automatically sense the new hardware and apply the correct 3.3V bus power. On power up the Prism II card will execute its own initialization program stored in on board ROM. This program provides default values for the baseband processor and other radio settings. These default settings need to be updated on each card insertion as described in steps 6) and 7) above with the CWINCON program.

TEST EQUIPMENT

Type	Model	Cal. Due Date	S/N
Microwave Spectrum Analyzer	HP 8566B (100Hz-22GHz)	12/05/01	3638A08713
Microwave Spectrum Analyzer	HP 8566B (100Hz-22GHz)	04/17/02	2542A11898
Spectrum Analyzer/Tracking Gen.	HP 8591A (9kHz-1.8GHz)	06/02/02	3144A02458
Spectrum Analyzer	HP 8591A (9kHz-1.8GHz)	10/15/01	3108A02053
Spectrum Analyzer	HP 8594A (9kHz-2.9GHz)	11/02/01	3051A00187
Signal Generator*	HP 8640B (500Hz-1GHz)	06/02/02	2232A19558
Signal Generator*	HP 8640B (500Hz-1GHz)	06/02/02	1851A09816
Signal Generator*	Rohde & Schwarz (0.1-1000MHz)	09/11/01	894215/012
Ailtech/Eaton Receiver	NM 37/57A-SL (30-1000MHz)	04/12/02	0792-03271
Ailtech/Eaton Receiver	NM 37/57A (30-1000MHz)	03/11/02	0805-03334
Ailtech/Eaton Receiver	NM17/27A (0.1-32MHz)	09/17/01	0608-03241
Quasi-Peak Adapter	HP 85650A	08/09/02	2043A00301
Ailtech/Eaton Adapter	CCA-7 CISPR/ANSI QP Adapter	03/11/02	0194-04082
RG58 Coax Test Cable	No. 167		n/a
Harmonic/Flicker Test System	HP 6841A (IEC 555-2/3)		3531A00115
Broadband Amplifier (2)	HP 8447D		1145A00470, 1937A03348
Broadband Amplifier	HP 8447F		2443A03784
Transient Limiter	HP 11947A (9kHz-200MHz)		2820A00300
Horn Antenna	EMCO Model 3115 (1-18GHz)		9704-5182
Horn Antenna	EMCO Model 3115 (1-18GHz)		9205-3874
Horn Antenna	EMCO Model 3116 (18-40GHz)		9203-2178
Biconical Antenna (4)	Eaton 94455/Eaton 94455-1/Singer 94455-1/Compliance Design 1295, 1332, 0355		
Log-Spiral Antenna (3)	Ailtech/Eaton 93490-1		0608, 1103, 1104
Roberts Dipoles	Compliance Design (1 set) A100		5118
Ailtech Dipoles	DM-105A (1 set)		33448-111
EMCO LISN (2)	3816/2		1077, 1079
EMCO LISN	3725/2		2009
Microwave Preamplifier 40dB Gain	HP 83017A (0.5-26.5GHz)		3123A00181
Microwave Cables	MicroCoax (1.0-26.5GHz)		
Ailtech/Eaton Receiver	NM37/57A-SL		0792-03271
Spectrum Analyzer	HP 8591A		3034A01395
Modulation Analyzer	HP 8901A		2432A03467
NTSC Pattern Generator	Leader 408		0377433
Noise Figure Meter	HP 8970B		3106A02189
Noise Figure Meter	Ailtech 7510		TE31700
Noise Generator	Ailtech 7010		1473
Microwave Survey Meter	Holaday Model 1501 (2.450GHz)		80931
Digital Thermometer	Extech Instruments 421305		426966
Attenuator	HP 8495A (0-70dB) DC-4GHz		
Bi-Directional Coax Coupler	Narda 3020A (50-1000MHz)		
Shielded Screen Room	RF Lindgren Model 26-2/2-0		6710 (PCT270)
Shielded Semi-Anechoic Chamber	Ray Proof Model S81		R2437 (PCT278)
Environmental Chamber	Associated Systems Model 1025 (Temperature/Humidity)		PCT285

* Calibration traceable to the National Institute of Standards and Technology (NIST).

CONCLUSION

The data collected shows that the **Crowave FCC ID: PFTCW-1100USB spread spectrum Wireless LAN USB** complies with Part 15.247 of the FCC Rules.