

Electromagnetic Emission

FCC MEASUREMENT REPORT

CERTIFICATION OF COMPLIANCE

FCC Part 15 Certification Measurement

PRODUCT : HD Set-Top Box
MODEL/TYPE NO : DMS-2344UHDS / EVY527D02156
FCC ID : PFNDMS-2344UHDS
MULTIPLE MODEL : DX10HD
BRAND NAME : -
APPLICANT : Digital Multimedia Technology Co., Ltd.
2nd Fl., 926 Gwanyang-Dong, Dongan-Gu, Anyang-Si,
Gyeonggi-Do, 431-060 Korea
Attn.: Kee-Chul Lee / General Manager
MANUFACTURER : Hengdi Digital Technology (Shen Zhen) Co.,Ltd
A.B Building, Xin Shi Qiao Guanjie Industrial Park, Guihua Community,
Guanlan Street, Bao'an District, Shenzhen City, Guangdong Province,
China, 518-110
FCC CLASSIFICATION : HID - Part 15 TV Interface Device
RULE PART(S) : FCC Part 15 Subpart B
TEST PROCEDURE : ANSI C63.4-2009
TEST REPORT No. : ETL150518.0625
DATES OF TEST : July 30, 2015 to August 04, 2015
REPORT ISSUE DATE : August 05, 2015
TEST LABORATORY : ETL Inc. (FCC Designation Number: KR0022)

This HD Set-Top Box, Model DMS-2344UHDS has been tested in accordance with the measurement procedures specified in ANSI C63.4-2009 at the ETL/EMC Test Laboratory and has been shown to be complied with the electromagnetic radiated emission limits specified in FCC Rule Part15 Subpart B: I attest to the accuracy of data. All measurement herein was performed by me or was made under my supervision and is correct to the best of my knowledge and belief. I assume full responsibility for the completeness of these measurements and vouch for the qualifications of all persons taking them. The results of testing in this report apply to the product/system which was tested only. Other similar equipment will not necessarily produce the same results due to production tolerance and measurement uncertainties.

Prepared by: 

Chul Min, Ji (Test Engineer)

August 05, 2015

Reviewed by: 

Hyung Min, Choi (Chief Engineer)

August 05, 2015

ETL Inc.

Head office: #371-51, Gasan-dong, Geumcheon-gu, Seoul, 153-803, Korea

Open site: #499-1, Sagot-ri, Seosin-myeon, Hwaseong-si, Gyeonggi-do, 445-882, Korea

Tel: 82-2-858-0786 Fax: 82-2-858-0788

The test report merely corresponds to the test sample(s).

This report shall not be reproduced, in whole or in part without the written approval of ETL Inc.

Table of Contents

FCC Measurement Report

- 1. Introduction**
- 2. Product Information**
- 3. Description of Tests**
- 4. Test Condition**
- 5. Test Results**
 - 5.1 Summary of Test Results**
 - 5.2 AC Power line Conducted Emissions Measurement**
 - 5.3 Radiated Emissions Measurement**
 - 5.4 Antenna Power Conduction Measurement**
 - 5.5 Output Signal Level Measurement**
 - 5.6 Output Terminal Conducted Spurious Emission Measurement**
 - 5.7 Antenna Transfer Switch Measurement**
- 6. Sample Calculation**
- 7. List of test Equipment used for Measurement**

Appendix A. FCC Label and Location

Appendix B. Test Setup Photographs

Appendix C. External Photographs

Appendix D. Internal Photographs

FCC MEASUREMENT REPORT

Scope – Measurement and determination of electromagnetic emission(EME) of radio frequency devices including intentional radiators and/or unintentional radiators for compliance with the technical rules and regulations of the U.S Federal Communications Commission(FCC)

General Information

Applicant Name : Digital Multimedia Technology Co., Ltd.

Address : 2nd Fl., 926 Gwanyang-Dong, Dongan-Gu, Anyang-Si,
Gyeonggi-Do, 431-060 Korea

Attention : Kee-Chul Lee / General Manager

- **EUT Type** : HD Set-Top Box
- **Model Number** : DMS-2344UHDS
- **S/N** : EVY527D02156
- **Rule Part(s)** : FCC Part 15 Subpart B
- **Test Procedure** : ANSI C63.4-2009
- **FCC Classification** : HID - Part 15 TV Interface Device
- **Dates of Tests** : July 30, 2015 to August 04, 2015
- **Environmental of Tests** : Temperature: (26.4 ± 7.0) °C
Humidity: (57 ± 20) % R.H.
Atmospheric Pressure: (101.0 ± 0.5) kPa
- **Place of Tests** : ETL Inc. Testing Lab. (FCC Designation Number : KR0022)

Radiated Emission test 1;
#499-1, Sagot-ri, Seosin-myeon, Hwaseong-si,
Gyeonggi-do, 445-882, Korea

Radiated Emission test 2 and Conducted Emission test;
#371-51, Gasan-dong, Geumcheon-gu, Seoul, 153-803, Korea
- **Test Report No.** : ETLE150518.0625

1. INTRODUCTION

The measurement tests for radiated and conducted emission test were conducted at the ETL Inc. The site is constructed in conformance with the requirements of the ANSI C63.4-2009 and CISPR Publication 16. The ETL has site descriptions on file with the FCC for 3 m and 10 m site configurations. Detailed description of test facility was found to be in compliance with the requirements of Section 2.948 FCC Rules according to the ANSI C63.4-2009 and registered to the Federal Communications Commission (FCC Designation Number : KR0022).

The measurement procedure described in American National Standard for Method of Measurement of Radio-Noise Emission from Low-Voltage Electrical and Electronic Equipment in the Range of 9 kHz to 40 GHz (ANSI C63.4-2009) was used in determining radiated and conducted emissions from the Digital Multimedia Technology Co., Ltd., Model: DMS-2344UHDS.

2. PRODUCT INFORMATION

2.1 Equipment Description

The Equipment Under Test (EUT) is the HD Set-Top Box (model: DMS-2344UHDS).









The model DMS-2344UHDS is basic model that was tested.

The multi model DX10HD is identical to basic model, except for model designation.

The EUT has three types of AC/DC Adapter. And each has been tested.

(Model name of Type 1: EDF0500150A1BB, Model name of Type 2: EDF0500150A1BA-3, Model name of Type 3: EDF0500150A1BB-3)

AC/DC Adapter types may be used the one of three type selected by manufacturer.

Type of AC/DC Adapter	Adapter View		
Adapter type #1			
Adapter type #2			
Adapter type #3			

2.2 General Specification

A. General Features
MPEG-2 / MPEG-4 Part 10 / H.264
Video Display format with NTSC/480p/576p/720p/1080i
Favorite channel, Parental Lock
Dolby Digital AC3
HDMI 1.3a with HDCP 1.1
Automatic search for newly added transponder (Network Auto Search)
Stores up to 5000 channels
Plug-and-play data transfer system (DSR to DSR)
Timer function, automatically turns On/Off by setting function (daily, weekly, monthly and one time)
Automatic reserved channel moving system
Provide Electronic Program Guide (EPG)
More than 800 pages OSD Teletext (DVB ETS 300 706) and Subtitle function support
Support for various video output: HDMI, RF 3/4 Mod.
256 colors On-Screen-Display
PAL/NTSC automatically conversion
Last channel automatically saving

B. Engineering Specifications		
B-1. Front-End		
Tuner Input	Input frequency	105 MHz to 1002 MHz
	Connector	F-Type (1 Input)
Demodulator	Demodulation type	demodulation and FEC decoding
		in accordance with ITU-T J.83 Annex-A/B/C
		Demodulation - 64/256-QAM
	Symbol rate	5.5 Msps max
	IF Bandwidth	6 MHz, 7 MHz, 8 MHz
B-2. Demultiplexing		
In accordance with ISO 13818-1.		
- Maximum input band transport stream rate supported is 100 Mbps.		
- Maximum combined transport stream burst rate can be greater than 262 Mbps based on usage.		
- Maximum combined transport stream average rate after PID filtering is 262 Mbps.		
- Supports 256 PID filters via 128 PID channels.		
B-3. Video Processing		
Decompression	H.264/AVC main and high profile to level 4.1	
	VC-1 advanced profile @ level 3	
	VC-1 simple and main profile	
	HD MPEG-2 and SD MPEG-2	
	AVC/MPEG-2/VC-1 still picture decode simultaneous with live decode	
Video buffer	512 Mbits of DDR DRAM is provided	
Video output	480i/480p/576i/576p/720p/1080i/1080p (24 Hz/30 Hz) output formats	
	Macrovision 7.1 Support	
Video format	4:3, 16:9	

B-4. Audio Processing	
Decompression	MPEG I Layer 1, 2 / MPEG I Layer 3 (MP3)
	AAC LC, AAC LC+SBR Level 2, AAC+ Level 2, AAC+ Level 4
	Dolby Digital, Dolby Digital Plus
	Windows Media Audio (WMA)
Outputs	Stereo Channel
	Dual Mono
	Joint Stereo Channel
	Mono
	Spdif with AC-3
B-5. Baseband Inputs / Outputs	
RF Output Signal	NTSC
Video Carrier Frequency	(61.25 ± 90) kHz US 3 CH
	(67.25 ± 90) kHz US 4 CH
	IEC169-24, 1 x F-Type
B-6. HDMI Outputs	
Connector type	1 x HDMI 1.3a
	19 pin Type-A HDMI connect
B-7. Microprocessor	
Microprocessor	BCM7572QKFEB03G
Clock frequency	432 MHz
DDR-RAM Memory	128 MB (DDR2-RAM 1 GB x 1)
Flash memory	16 MB (Serial Flash)
B-8. Remote Control unit	
Transmission Type	Infrared
Number of keys	21 keys
Operating distance	15 m
Batteries	AA

B-9. Power Supply		
Type	Wallmount Type External Adapter (100 V ~ 120 V AC @ 50 Hz/60 Hz, 0.18 A)	
Main Output voltage	5.0 V DC / 1.5 A	
Nominal power consumption	5 Watts	
B-10. Physical Characteristics		
Front Panel	Display	2 color LED
Rear Panel	Connectors	1 RF Input (F-type)
		1 x CH 3/4(Slide Switch)
		1 x RF Modulator (1 F-type)
		1 x IR Input (3.5 mm)
		1 x HDMI
		1 x DC Power Jack
B-11. High Internal Frequency		
BCM7572 DDR Clock → 452 MHz		

3. DESCRIPTION OF TESTS

3.1 AC Power line Conducted Emission Measurement

AC Power line Conducted emissions measurements were made in accordance with section 12, "Measurement of unintentional radiators other than ITE" of ANSI C63.4-2009. The measurements were performed over the frequency range of 0.15 MHz to 30 MHz using a 50 Ω /50 μ H LISN as the input transducer to a Spectrum Analyzer or a Test Receiver. The measurements were made with the detector set for "Peak" amplitude within a bandwidth of 9 kHz or for "quasi-peak" within a bandwidth of 9 kHz.

The line-conducted emission test is conducted inside a shielded anechoic chamber room with 1 m x 1.5 m x 0.8 m wooden table which is placed 40 cm away from the vertical wall and 1.5 m away from the side wall of the chamber room. Two LISN are bonded to the shielded room. The EUT is powered from the LISN and the support equipment is powered from the other LISN. Powers to the LISNs are filtered by a noise cut power line filters. If the EUT is a DC-powered device, power will be derived from the source power supply it normally will be powered from and these supply lines will be connected to the LISN.

Non-inductive bundling to a 1 m length shortened all interconnecting cables more than 1 m. Sufficient time for the EUT, support equipment, and test equipment was allowed in order for them to warm up to their normal operating condition. The RF output of the LISN was connected to the EMI Test Receiver to determine the frequency producing the maximum emission from the EUT. The frequency producing the maximum level was reexamined using to set Quasi-Peak mode by manual, after scanned by automatic Peak mode from 0.15 MHz to 30 MHz. The bandwidth of the spectrum analyzer was set to 9 kHz. The EUT, support equipment, and interconnecting cables were arranged and manipulated to maximize each emission.

Photographs of the worst-case emission can be seen in photographs of conducted emission test setup in Appendix B.

3.2 Radiated Emission Measurement

Radiated emission measurements were made in accordance with section 12, "Measurement of unintentional radiators other than ITE" of ANSI C63.4-2009. The measurements were performed over the frequency range of 30 MHz to 40 GHz (or 5th harmonic of the highest frequency) in using antenna as the input transducer to a spectrum analyzer or a field intensity meter. The measurements below 1 GHz were made with the detector set for "Quasi-peak" within a bandwidth of 120 kHz. The measurements above 1 GHz were made with the detector set for "Peak and Average" within a bandwidth of 1 MHz.

Preliminary measurements were made at 3 m using broadband antennas, and spectrum analyzer to determined the frequency producing the maximum emission in shielded room. Appropriate precaution was taken to ensure that all emission from the EUT were maximized and investigated. The system configuration, mode of operation, turntable azimuth and height with respect to the antenna were noted for each frequency found. The spectrum was scanned from 30 MHz to 1 000 MHz using Log-Bicon antenna. Above 1 GHz, linearly polarized double ridge horn antennas were used. Final measurements were made open site or SVSWR chamber at 3 m. The test equipment was placed on a styrofoam table. Sufficient time for the EUT, support equipment, and test equipment was allowed in order for them to warm up to their normal operating condition. Each frequency found during pre-scan measurements was re-examined by manual. The EUT, support equipment and interconnecting cables were re-configured to the set-up producing the maximum emission for the frequency and were placed on top of a 0.8 m high nonmetallic 1 m x 1.5 m table. The EUT, support equipment, and interconnecting cables were re-arranged and manipulated to maximize each emission. The turntable containing the system was rotated; the antenna height was varied 1 m to 4 m and stopped at the azimuth or height producing the maximum emission. Each emission was maximized by: varying the mode of operation to the EUT and/or support equipment and changing the polarity of the antenna, whichever determined the worst-case emission.

Photographs of the worst-case emission can be seen in Photographs of the worst-case emission test setup can be seen in Appendix B.

3.3 Antenna Power Conducted Measurements

Power on the receive antenna terminals was to be determined by measurement of the voltage present at these terminals. An antenna-conducted power measurement is performed with the EUT antenna terminals connected directly to a spectrum analyzer, if the antenna impedance matches the impedance of the measuring instrument. Otherwise, use an impedance-matching network to connect the measuring instrument to the antenna terminals of the EUT. Losses in decibels in any impedance-matching network used are added to the measured value in dB μ V.

With the EUT tuned to one of the frequency over which device operates, measure both the frequency and voltage present at the antenna input terminals over the frequency range specified in the individual equipment requirements. Repeat this measurement with the receiver tuned to another frequency until the numbers of frequencies specified have been successively measured. Power on the receive antenna terminals is the ratio of V^2/R , where V is the loss-corrected voltage measured at the antenna terminals, and R is the impedance of the measuring instrument.

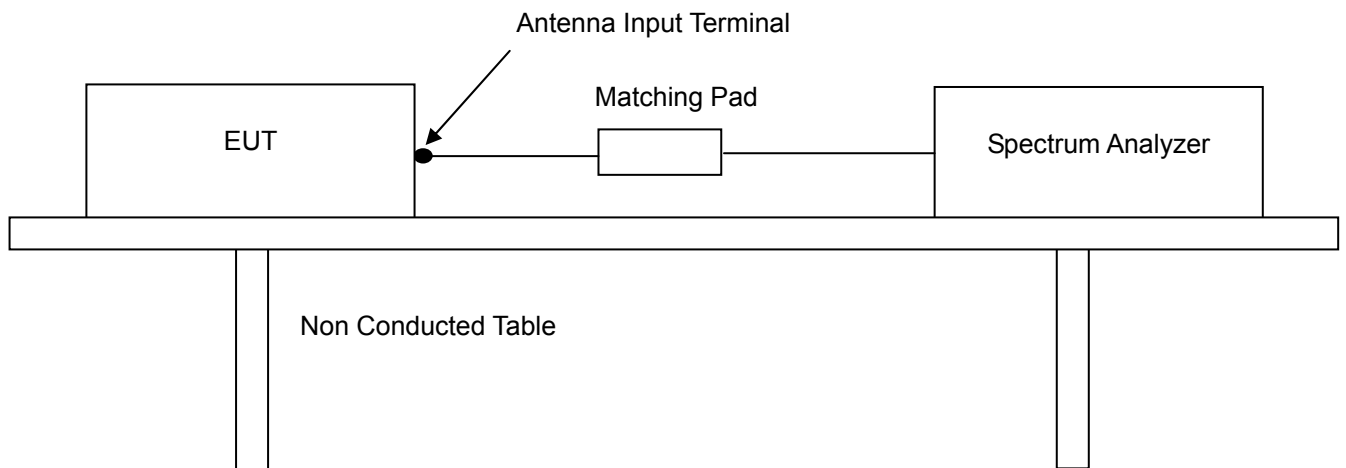

3.4 Output Signal Conducted Level Measurement

The output signal level is the maximum voltage level present at the output terminals of the EUT on a particular frequency during normal use of the device.

The signal level was measured by direct connection to the spectrum analyzer with 50 ohm/75 ohm matching transformer between the spectrum analyzer and the TV interface device. The RF output signal level measured was the highest RF level present at the output terminals during normal use of the device. Measurements were made of the levels of both the visual and audio carrier for each TV channel (3 and 4) on which the device operates. The Satellite Receiver was supported between the EUT and the measuring instrument in a straight horizontal line so it had at least 75 cm clearance from any conducting surface.

The EUT is provided with a typical signal consistent with normal operation. For each channel on which the EUT operates and in each mode in which the device operates, the video and audio carrier level is measured and recorded.

The voltage corresponding to the peak envelope power of the video modulated signal during maximum amplitude peaks across a resistance (R ohms) matching the rated output impedance of the device, must not exceed $692.8 R^{1/2} \mu\text{V}$ for all other TV interface device. The voltage corresponding to peak envelope power of the audio modulated signal, if provided by the TV interface device, must not exceed $155 R^{1/2} \mu\text{V}$ for Cable Receiver system terminal device of TV interface device used with a master antenna, and $77.5 R^{1/2} \mu\text{V}$ for all other TV interface device. Losses in decibels in any impedance-matching network used were added to the measured value in dBμV. The EUT was configured in accordance with ANSI C63.4-2009 Section 12.2 as below configuration block diagram.

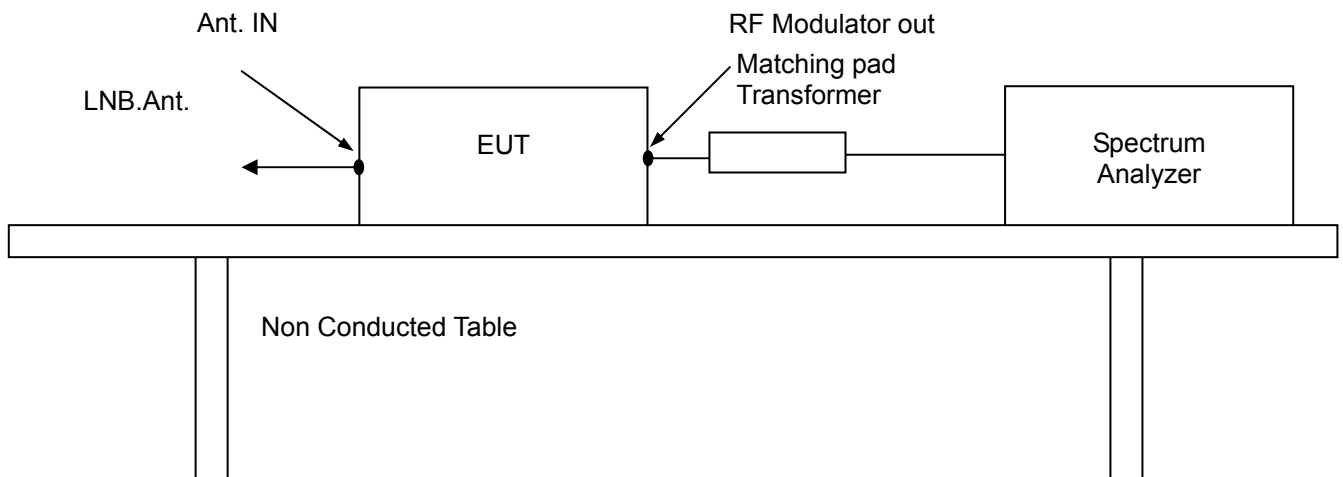

3.5 Output Terminal Conducted Spurious Emission Measurement

The RF output signal was fed to the TV receiver via coaxial Satellite Receiver. Measurements were made by direct connection to the spectrum analyzer and TV interface device with 50 ohm/75 ohm matching transformer. The frequency range 30 MHz to 1 000 MHz was investigated for significant emission.

The maximum RMS voltage of any emission appearing on frequencies removed by more than 4.6 MHz below and 7.4 MHz above the video carrier frequency on which the TV interface device is operated must not exceed $692.8 R^{1/2} \mu\text{V}$ for Cable Receiver system terminal device or TV interface device used with a master antenna and $10.95 R^{1/2} \mu\text{V}$ for all other TV interface device when terminated with a resistance (R ohms) matching the rated output impedance of the TV interface device. The EUT was configured in accordance with ANSI C63.4-2009 Section 12.2 as below configuration block diagram.

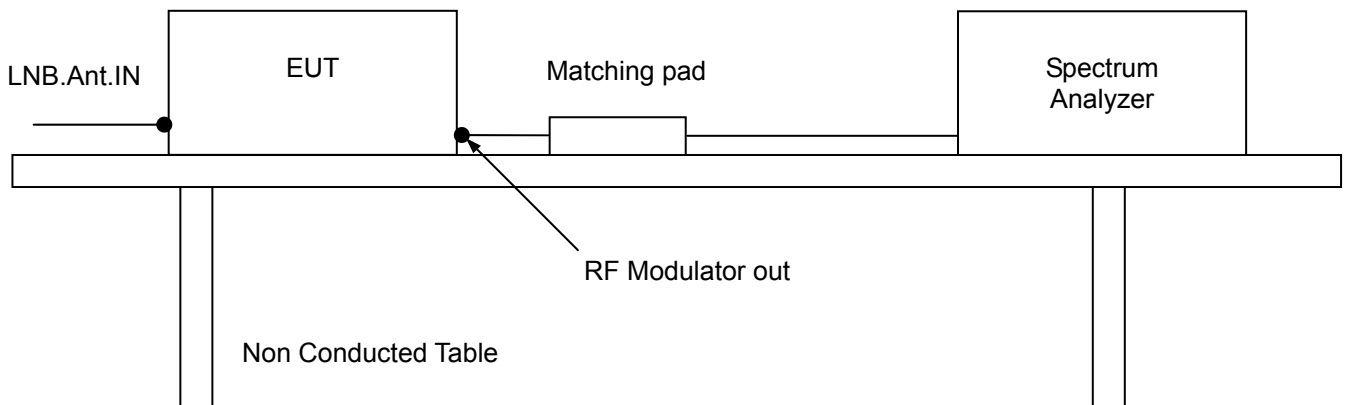

3.6 Antenna Transfer Switch Measurement

Isolation was measured for all positions of an antenna transfer switch on all output channels of the EUT. TV interface device transfer switch isolation is the difference the levels of a signal going into one antenna input port of the switch and that of the same signal coming out of another antenna terminal of transfer switch. The isolation of an antenna transfer switch equipped with coaxial connector performed by measuring the maximum voltage of the visual carrier. Measurements were made of the maximum RMS voltage at the antenna input terminals of the switch for all positions of the transfer switch. The maximum voltage corresponds to the peak envelope power of the video signal during maximum amplitude peaks. In either position of the receiver transfer switch, the maximum voltage at the receiving antenna input terminals of the switch when terminated with a resistance (R ohms) matching the rated impedance of the antenna input of the switch, must not exceed $0.346 R^{1/2} \mu V$.

The maximum voltage corresponds to the peak envelope power of the video modulated signal during maximum amplitude.

The EUT was configured in accordance with ANSI C63.4-2009 Section 12.2 as below configuration block diagram. And the EUT configuration can also be seen in Appendix B. Photographs of the test setup.

The unused RF input/output terminals are terminated in proper impedance. The antenna input terminal is connected to the input of preamplifier through the matching transformer coaxial Satellite Receiver. And the output of preamplifier is connected to the spectrum analyzer. Then, the signal level on the antenna input terminal is measured under the EUT condition produced the maximum signal level.

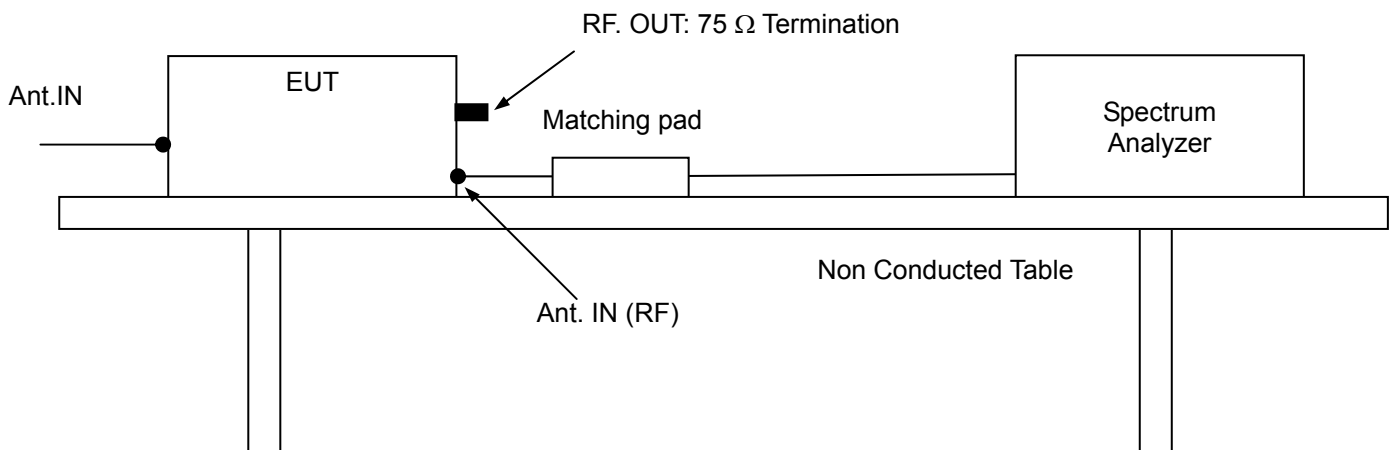

4. TEST CONDITION

4.1 Test Configuration

The device was configured for testing in a typical fashion (as a customer would normally use it). During the tests, the EUT and the supported equipments were installed to meet FCC requirement and operated in a manner which tends to maximize its emission level in a typical application.

4.2 EUT operation

The EUT was set to the normal receiving mode in a TV mode during all the testing in a manner similar to a typical use. For the EUT operation, the satellite live signal was fed to the EUT through the LNB input. During the preliminary testing, the worst case condition of the operating mode was ch.3

4.3 Support Equipment Used

Description	Model Name	Serial No.	Manufacturer	FCC
Adapter (for EUT, Type #1)	EDF0500150A1BB	NONE	ChungKwang Tech Inc.	-
Adapter (for EUT, Type #2)	EDF0500150A1BA-3	NONE	ChungKwang Tech Inc.	
Adapter (for EUT, Type #3)	EDF0500150A1BB-3	NONE	ChungKwang Tech Inc.	
Remote Control Unit (for EUT)	NONE	NONE	NONE	-
IR (for EUT)	NONE	NONE	NONE	-
LCD TV	ALED24HDTV	1401A23T0763	K-Tronics (SuZhou) Technology Co., Ltd.	-
Adapter (for LCD TV)	SUN-1200400	NONE	ShenZhen SOY Technology CO., Ltd.	-

4.4 Type of Cables Used

- Adapter type #1

Device from	Device to	Type of I/O port	Length[m]	Type of shield	Used ferrite core
EUT	LCD TV	HDMI	1.5	Shielded	X
EUT	LCD TV	TV OUT	> 3.0	Shielded	X
EUT	IR	IR IN	1.2	Shielded	X
EUT	Cable ANT.	Cable Tuner	> 3.0	Shielded	X
EUT	Adapter #1	DC Input	1.2	Shielded	X
LCD TV	Adapter	DC Input	1.2	Shielded	O

- Adapter type #2, #3

Device from	Device to	Type of I/O port	Length[m]	Type of shield	Used ferrite core
EUT	LCD TV	HDMI	1.5	Shielded	X
EUT	LCD TV	TV OUT	> 3.0	Shielded	X
EUT	IR	IR IN	1.2	Shielded	X
EUT	Cable ANT.	Cable Tuner	> 3.0	Shielded	X
EUT	Adapter #2 or #3	DC Input	2.0	Shielded	X
LCD TV	Adapter	DC Input	1.2	Shielded	O

4.5 The setup drawing(s)

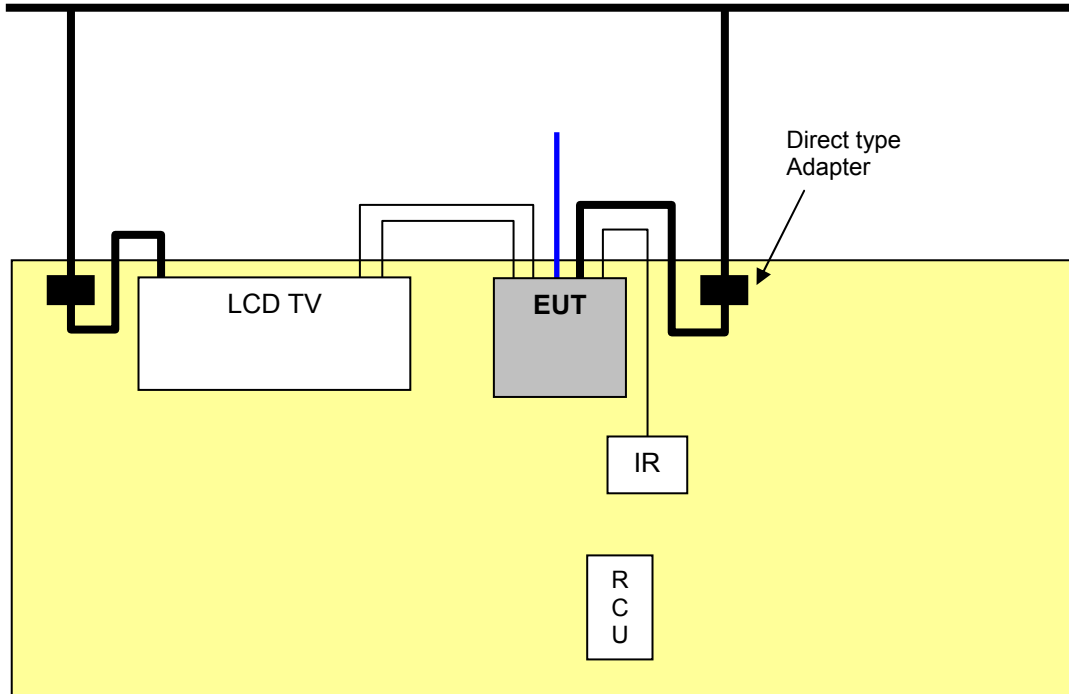

5. TEST RESULTS

5.1 Summary of Test Results

The measurement results were obtained with the EUT tested in the conditions described in this report. Detailed measurement data and plots showing the maximum emission of the EUT are reported.

FCC Rule	Measurement Required	Result
15.107(a)	AC Power line Conducted Emission Measurement	Passed by 3.10 dB
15.109(a)	Radiated Emission Measurement (Below 1 GHz)	Passed by 4.30 dB
15.109(a)	Radiated Emission Measurement (Above 1 GHz)	Passed by 17.80 dB
15.111(a)	Antenna Power Conduction Measurement	Passed by 10.80 dB
15.115(b)(1)(i)	Output Signal Level Measurement	Passed by 2.28 dB
15.115(b)(2)(ii)	Output Terminal Conducted Spurious Emission Measurement	Passed by 2.30 dB
15.115(c)(1)(ii)	Antenna Transfer Switch Measurement	Passed *

* During this test, no signal detected.

The data collected shows that the **Digital Multimedia Technology Co., Ltd. / HD Set-Top Box / DMS-2344UHDS** complied with technical requirements of above rules part 15.107(a) and 15.109(a), 15.111 and 15.115(b),(c) Limits.

The equipment is not modified anything, mechanical or circuits to improve EMI status during a measurement. No EMI suppression device(s) was added and/or modified during testing.

5.2 AC Power line Conducted Emissions Measurement

5.2.1 AC Power line Conducted Emissions Data

EUT	HD Set-Top Box / DMS-2344UHDS (S/N: EVY527D02156)
Limit apply to	FCC Part 15 Subpart B Section 15.107(a) Class B
Test Date	July 30, 2015
Environmental of Test	(20.4 ± 0.0) °C, (39 ± 0) % R.H., (101.3 ± 0.0) kPa
Operating Condition	TV Mode (Channel 3)
Adapter type	Adapter #1
Result	Passed by 3.40 dB

Conducted Emission Test Data

The following data and graph shows the highest levels of conducted emissions on both polarizations of hot and neutral line.

Detector mode: CISPR Quasi-Peak mode (6 dB Bandwidth: 9 kHz)

NOTES:

1. Please see the measured data and graph in next page.
2. The c.f value was included the LISN factor and cable loss.
3. Result value = Reading + c.f
4. Margin value = Limit - Result
5. Measurement were performed at the AC Power Inlet in the frequency band of 150 kHz ~ 30 MHz according to the FCC Part 15.107(a) Class B.
6. If the average limit is met when using a Quasi-peak detector receiver, the EUT shall be deemed to meet both limits and measurement with the average detector receiver is unnecessary.
7. Channel 3 was the worst case operation mode.

Final Result

--- N Phase ---

No.	Frequency [MHz]	Reading QP [dB(μV)]	Reading AV [dB(μV)]	c.f [dB]	Result QP [dB(μV)]	Result AV [dB(μV)]	Limit QP [dB(μV)]	Limit AV [dB(μV)]	Margin QP [dB]	Margin AV [dB]
33	18.0468	27.6	18.2	10.4	38.0	28.6	60.0	50.0	22.0	21.4
34	20.0146	30.6	21.2	10.5	41.1	31.7	60.0	50.0	18.9	18.3

EUT	HD Set-Top Box / DMS-2344UHDS (S/N: EVY527D02156)
Limit apply to	FCC Part 15 Subpart B Section 15.107(a) Class B
Test Date	July 30, 2015
Environmental of Test	(20.5 ± 0.0) °C, (39 ± 0) % R.H., (101.3 ± 0.0) kPa
Operating Condition	TV Mode (Channel 3)
Adapter type	Adapter #2
Result	Passed by 3.10 dB

Conducted Emission Test Data

The following data and graph shows the highest levels of conducted emissions on both polarizations of hot and neutral line.

Detector mode: CISPR Quasi-Peak mode (6 dB Bandwidth: 9 kHz)

NOTES:

1. Please see the measured data and graph in next page.
2. The c.f value was included the LISN factor and cable loss.
3. Result value = Reading + c.f
4. Margin value = Limit - Result
5. Measurement were performed at the AC Power Inlet in the frequency band of 150 kHz ~ 30 MHz according to the FCC Part 15.107(a) Class B.
6. If the average limit is met when using a Quasi-peak detector receiver, the EUT shall be deemed to meet both limits and measurement with the average detector receiver is unnecessary.
7. Channel 3 was the worst case operation mode.

Line: HOT

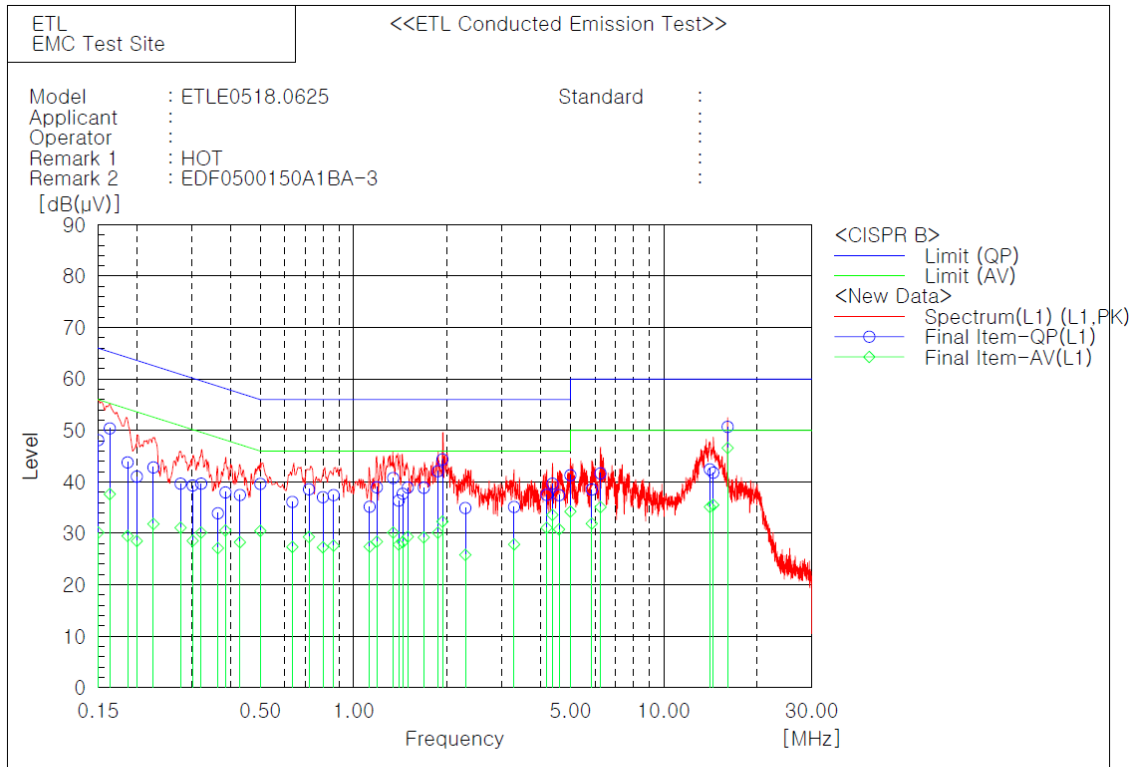

Final Result

No.	Frequency [MHz]	L1 Phase		c. f [dB]	Result		Limit		Margin	
		Reading QP [dB(μV)]	Reading AV [dB(μV)]		Result QP [dB(μV)]	Result AV [dB(μV)]	Limit QP [dB(μV)]	Limit AV [dB(μV)]	Margin QP [dB]	Margin AV [dB]
1	0.15011	36.9	18.9	11.2	48.1	30.1	66.0	56.0	17.9	25.9
2	0.16368	39.5	26.7	10.9	50.4	37.6	65.3	55.3	14.9	17.7
3	0.18669	33.1	18.8	10.7	43.8	29.5	64.2	54.2	20.4	24.7
4	0.20003	30.4	17.9	10.6	41.0	28.5	63.6	53.6	22.6	25.1
5	0.22631	32.3	21.3	10.5	42.8	31.8	62.6	52.6	19.8	20.8
6	0.27675	29.3	20.7	10.4	39.7	31.1	60.9	50.9	21.2	19.8
7	0.30285	28.9	18.2	10.4	39.3	28.6	60.2	50.2	20.9	21.6
8	0.32268	29.3	19.7	10.4	39.7	30.1	59.6	49.6	20.0	19.5
9	0.36507	23.6	16.8	10.3	33.9	27.1	58.6	48.6	24.7	21.5
10	0.38607	27.6	20.2	10.3	37.9	30.5	58.1	48.1	20.2	17.6
11	0.43008	27.2	18.0	10.3	37.5	28.3	57.3	47.3	19.8	19.0
12	0.50022	29.3	20.2	10.3	39.6	30.5	56.0	46.0	16.4	15.5
13	0.6349	25.8	17.1	10.3	36.1	27.4	56.0	46.0	19.9	18.6
14	0.71795	28.3	19.0	10.3	38.6	29.3	56.0	46.0	17.4	16.7
15	0.79555	26.7	17.0	10.3	37.0	27.3	56.0	46.0	19.0	18.7
16	0.86185	27.2	17.4	10.2	37.4	27.6	56.0	46.0	18.6	18.4
17	1.1265	25.0	17.2	10.2	35.2	27.4	56.0	46.0	20.8	18.6
18	1.18825	28.7	18.2	10.2	38.9	28.4	56.0	46.0	17.1	17.6
19	1.3416	30.5	20.0	10.2	40.7	30.2	56.0	46.0	15.3	15.8
20	1.3977	26.2	17.6	10.2	36.4	27.8	56.0	46.0	19.6	18.2
21	1.43945	27.5	18.1	10.2	37.7	28.3	56.0	46.0	18.3	17.7
22	1.4957	28.7	19.1	10.2	38.9	29.3	56.0	46.0	17.1	16.7
23	1.68355	28.6	19.0	10.2	38.8	29.2	56.0	46.0	17.2	16.8
24	1.8702	31.9	19.9	10.2	42.1	30.1	56.0	46.0	13.9	15.9
25	1.93335	34.2	22.1	10.2	44.4	32.3	56.0	46.0	11.6	13.7
26	2.29195	24.7	15.6	10.2	34.9	25.8	56.0	46.0	21.1	20.2
27	3.2907	25.0	17.8	10.1	35.1	27.9	56.0	46.0	20.9	18.1
28	4.18986	27.4	21.0	10.1	37.5	31.1	56.0	46.0	18.5	14.9
29	4.37772	29.6	23.5	10.1	39.7	33.6	56.0	46.0	16.3	12.4
30	4.59696	27.3	20.7	10.1	37.4	30.8	56.0	46.0	18.6	15.2
31	5.00064	31.2	24.1	10.1	41.3	34.2	60.0	50.0	18.7	15.8
32	5.8569	28.4	21.8	10.1	38.5	31.9	60.0	50.0	21.5	18.1

Final Result

--- L1 Phase ---

No.	Frequency [MHz]	Reading QP [dB(μV)]	Reading AV [dB(μV)]	c.f [dB]	Result QP [dB(μV)]	Result AV [dB(μV)]	Limit QP [dB(μV)]	Limit AV [dB(μV)]	Margin QP [dB]	Margin AV [dB]
33	6.25096	31.6	25.0	10.1	41.7	35.1	60.0	50.0	18.3	14.9
34	14.078	32.1	24.9	10.3	42.4	35.2	60.0	50.0	17.6	14.8
35	14.4442	31.5	25.2	10.3	41.8	35.5	60.0	50.0	18.2	14.5
36	16.0666	40.4	36.3	10.3	50.7	46.6	60.0	50.0	9.3	3.4

Line: Neutral

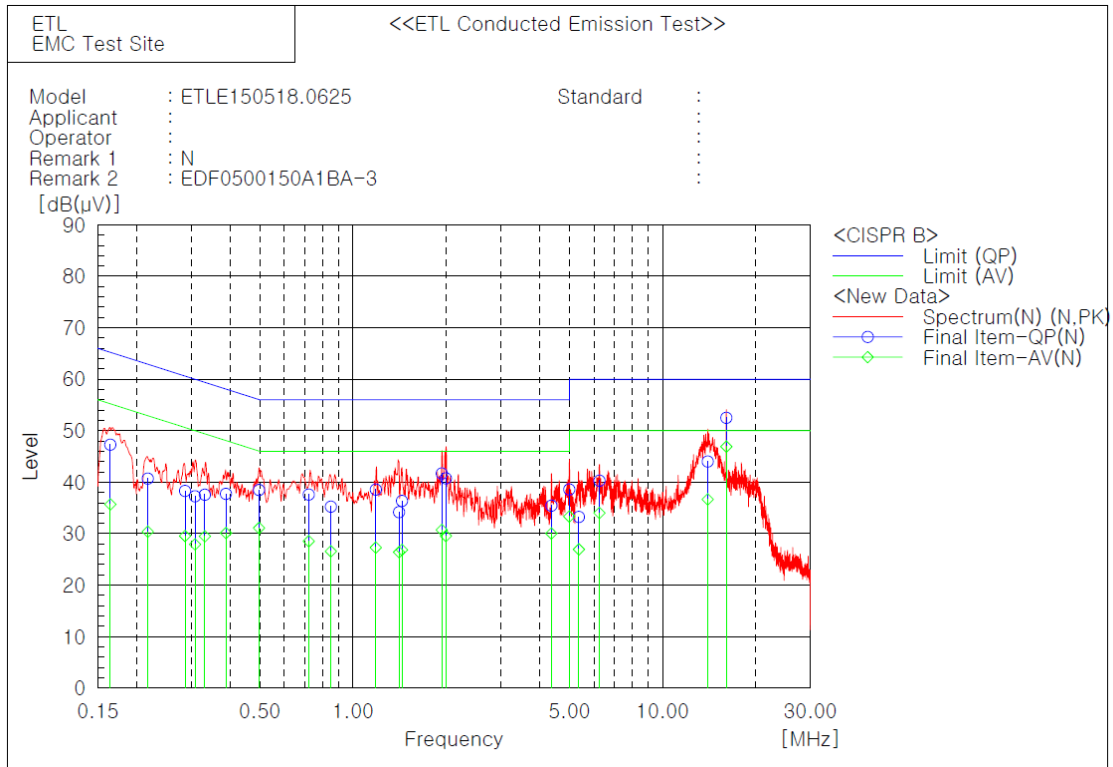

Final Result

--- N Phase ---

No.	Frequency [MHz]	Reading QP [dB(µV)]	Reading AV [dB(µV)]	c. f [dB]	Result QP [dB(µV)]	Result AV [dB(µV)]	Limit QP [dB(µV)]	Limit AV [dB(µV)]	Margin QP [dB]	Margin AV [dB]
1	0.16449	36.4	24.8	10.9	47.3	35.7	65.2	55.2	17.9	19.5
2	0.2174	30.1	19.8	10.6	40.7	30.4	62.9	52.9	22.2	22.5
3	0.28663	27.9	19.2	10.4	38.3	29.6	60.6	50.6	22.3	21.0
4	0.30877	26.9	17.5	10.4	37.3	27.9	60.0	50.0	22.7	22.1
5	0.33223	27.2	19.1	10.4	37.6	29.5	59.4	49.4	21.8	19.9
6	0.38873	27.4	19.8	10.3	37.7	30.1	58.1	48.1	20.4	18.0
7	0.49688	28.2	20.8	10.3	38.5	31.1	56.1	46.1	17.6	15.0
8	0.7194	27.3	18.2	10.3	37.6	28.5	56.0	46.0	18.4	17.5
9	0.84835	25.1	16.4	10.2	35.3	26.6	56.0	46.0	20.7	19.4
10	1.18475	28.4	17.1	10.2	38.6	27.3	56.0	46.0	17.4	18.7
11	1.40855	24.0	16.2	10.2	34.2	26.4	56.0	46.0	21.8	19.6
12	1.43885	26.2	16.7	10.2	36.4	26.9	56.0	46.0	19.6	19.1
13	1.9347	31.5	20.5	10.2	41.7	30.7	56.0	46.0	14.3	15.3
14	1.9958	30.5	19.4	10.2	40.7	29.6	56.0	46.0	15.3	16.4
15	4.37142	25.3	19.9	10.1	35.4	30.0	56.0	46.0	20.6	16.0
16	4.9968	28.5	23.2	10.1	38.6	33.3	56.0	46.0	17.4	12.7
17	5.36538	23.2	16.9	10.1	33.3	27.0	60.0	50.0	26.7	23.0
18	6.25032	30.2	23.9	10.1	40.3	34.0	60.0	50.0	19.7	16.0
19	13.9902	33.6	26.3	10.4	44.0	36.7	60.0	50.0	16.0	13.3
20	16.0672	42.1	36.5	10.4	52.5	46.9	60.0	50.0	7.5	3.1

EUT	HD Set-Top Box / DMS-2344UHDS (S/N: EVY527D02156)
Limit apply to	FCC Part 15 Subpart B Section 15.107(a) Class B
Test Date	July 30, 2015
Environmental of Test	(20.6 ± 0.0) °C, (39 ± 0) % R.H., (101.3 ± 0.0) kPa
Operating Condition	TV Mode (Channel 3)
Adapter type	Adapter #3
Result	Passed by 3.40 dB

Conducted Emission Test Data

The following data and graph shows the highest levels of conducted emissions on both polarizations of hot and neutral line.

Detector mode: CISPR Quasi-Peak mode (6 dB Bandwidth: 9 kHz)

NOTES:

1. Please see the measured data and graph in next page.
2. The c.f value was included the LISN factor and cable loss.
3. Result value = Reading + c.f
4. Margin value = Limit - Result
5. Measurement were performed at the AC Power Inlet in the frequency band of 150 kHz ~ 30 MHz according to the FCC Part 15.107(a) Class B.
6. If the average limit is met when using a Quasi-peak detector receiver, the EUT shall be deemed to meet both limits and measurement with the average detector receiver is unnecessary.
7. Channel 3 was the worst case operation mode.

Line: HOT

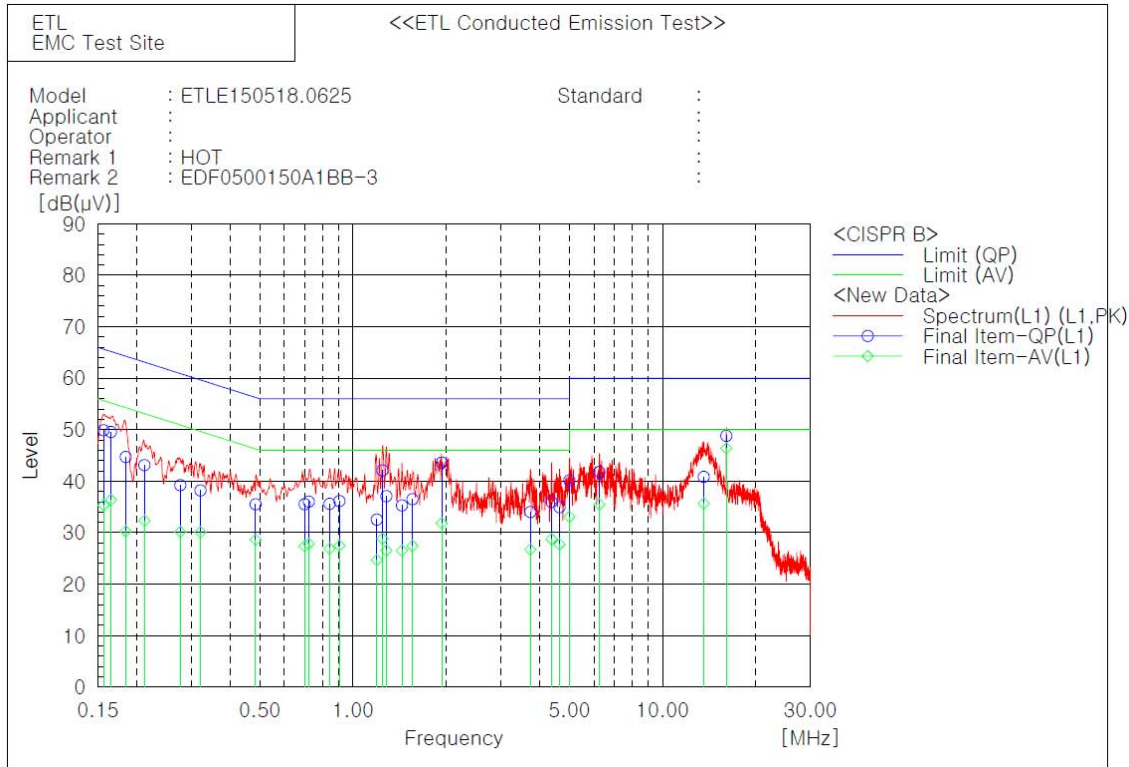

Final Result

No.	Frequency [MHz]	L1 Phase		c.f [dB]	Result		Limit		Margin	
		Reading QP [dB(μV)]	Reading AV [dB(μV)]		Result QP [dB(μV)]	Result AV [dB(μV)]	Limit QP [dB(μV)]	Limit AV [dB(μV)]	Margin QP [dB]	Margin AV [dB]
1	0.15655	38.9	24.3	11.0	49.9	35.3	65.6	55.6	15.7	20.3
2	0.16526	38.7	25.4	10.9	49.6	36.3	65.2	55.2	15.6	18.9
3	0.18446	34.0	19.5	10.7	44.7	30.2	64.3	54.3	19.6	24.1
4	0.21196	32.5	21.7	10.6	43.1	32.3	63.1	53.1	20.0	20.8
5	0.27689	28.8	19.8	10.4	39.2	30.2	60.9	50.9	21.7	20.7
6	0.32172	27.8	19.7	10.4	38.2	30.1	59.7	49.7	21.5	19.6
7	0.4848	25.2	18.3	10.3	35.5	28.6	56.3	46.3	20.8	17.7
8	0.6976	25.2	17.1	10.3	35.5	27.4	56.0	46.0	20.5	18.6
9	0.720	25.7	17.5	10.3	36.0	27.8	56.0	46.0	20.0	18.2
10	0.84025	25.4	16.7	10.2	35.6	26.9	56.0	46.0	20.4	19.1
11	0.90375	26.0	17.3	10.2	36.2	27.5	56.0	46.0	19.8	18.5
12	1.19405	22.4	14.5	10.2	32.6	24.7	56.0	46.0	23.4	21.3
13	1.24555	31.9	18.6	10.2	42.1	28.8	56.0	46.0	13.9	17.2
14	1.2823	26.9	16.3	10.2	37.1	26.5	56.0	46.0	18.9	19.5
15	1.440	25.1	16.3	10.2	35.3	26.5	56.0	46.0	20.7	19.5
16	1.5558	26.3	17.2	10.2	36.5	27.4	56.0	46.0	19.5	18.6
17	1.9345	33.4	21.6	10.2	43.6	31.8	56.0	46.0	12.4	14.2
18	3.7413	23.9	16.6	10.1	34.0	26.7	56.0	46.0	22.0	19.3
19	4.38078	25.9	18.6	10.1	36.0	28.7	56.0	46.0	20.0	17.3
20	4.64544	24.8	17.6	10.1	34.9	27.7	56.0	46.0	21.1	18.3
21	5.00184	30.0	23.0	10.1	40.1	33.1	60.0	50.0	19.9	16.9
22	6.25032	31.7	25.4	10.1	41.8	35.5	60.0	50.0	18.2	14.5
23	13.5846	30.5	25.3	10.3	40.8	35.6	60.0	50.0	19.2	14.4
24	16.066	38.5	36.1	10.3	48.8	46.4	60.0	50.0	11.2	3.6

Final Result

--- N Phase ---

No.	Frequency [MHz]	Reading QP [dB(μV)]	Reading AV [dB(μV)]	c. f [dB]	Result QP [dB(μV)]	Result AV [dB(μV)]	Limit QP [dB(μV)]	Limit AV [dB(μV)]	Margin QP [dB]	Margin AV [dB]
33	6.24888	31.9	25.4	10.1	42.0	35.5	60.0	50.0	18.0	14.5
34	13.1892	32.9	26.9	10.3	43.2	37.2	60.0	50.0	16.8	12.8
35	13.7234	32.1	25.8	10.4	42.5	36.2	60.0	50.0	17.5	13.8
36	16.0672	40.9	36.2	10.4	51.3	46.6	60.0	50.0	8.7	3.4

5.3 Radiated Emissions Measurement

5.3.1 Radiated Emissions Data

- Below 1 GHz

EUT	HD Set-Top Box / DMS-2344UHDS (S/N: EVY527D02156)
Limit apply to	FCC Part 15 Subpart B Section 15.109(a) Class B
Test Date	August 04, 2015
Environmental of Test	(32.3 ± 1.1) °C, (71 ± 2) % R.H., (100.5 ± 0.0) kPa
Operating Condition	TV Mode (Channel 3)
Adapter type	Adapter #1
Result	Passed by 4.30 dB

Radiated Emission Test Data

The following table shows the highest levels of radiated emissions on both polarizations of horizontal and vertical.
 Detector mode: CISPR Quasi-Peak mode (6 dB Bandwidth: 120 kHz)

Frequency [MHz]	Reading [dB(μV)]	Polarization (*H/**V)	Ant. Factor [dB/m]	Cable Loss [dB(μV)]	Height [cm]	Result [dB(μV/m)]	Limit [dB(μV/m)]	Margin [dB]
36.41	22.63	V	12.28	0.79	100	35.70	40.00	4.30
40.08	17.03	V	12.84	0.83	100	30.70	40.00	9.30
51.73	16.10	V	13.08	0.92	100	30.10	40.00	9.90
134.42	11.20	V	11.75	1.55	112	24.50	43.50	19.00
161.62	14.70	V	13.14	1.76	121	29.60	43.50	13.90
171.08	11.58	V	12.22	1.80	128	25.60	43.50	17.90
232.59	12.65	V	10.88	2.07	139	25.60	46.00	20.40
398.42	11.62	H	15.90	2.88	192	30.40	46.00	15.60

NOTES:

- * H : Horizontal polarization , ** V : Vertical polarization
- Result = Reading + Antenna factor + Cable loss
- Margin value = Limit - Result
- The measurement was performed for the frequency range 30 MHz ~ 1 000 MHz according to the FCC Part 15.109(a) Class B.
- Channel 3 was the worst case operation mode.

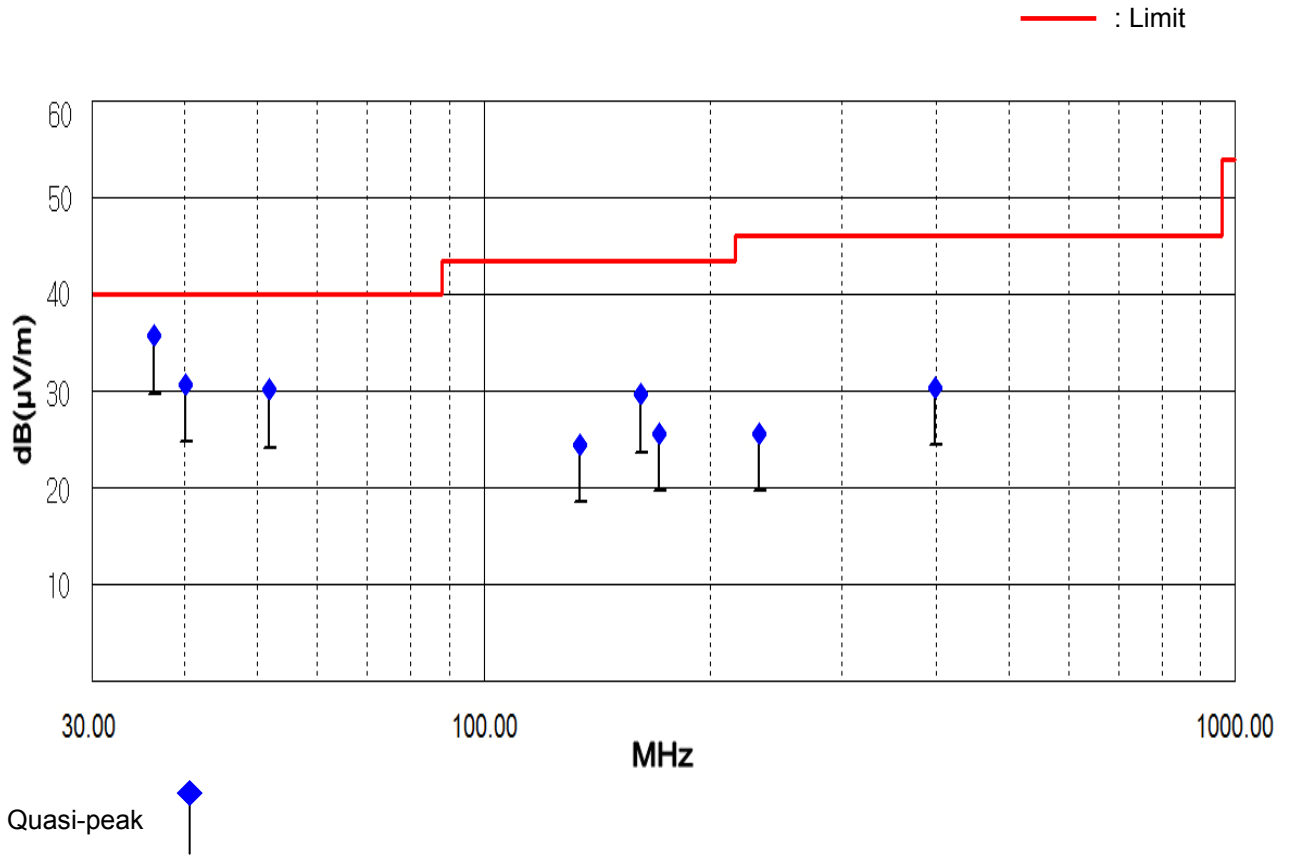

- Below 1 GHz

EUT	HD Set-Top Box / DMS-2344UHDS (S/N: EVY527D02156)
Limit apply to	FCC Part 15 Subpart B Section 15.109(a) Class B
Test Date	August 04, 2015
Environmental of Test	(31.2 ± 0.4) °C, (73 ± 1) % R.H., (100.5 ± 0.0) kPa
Operating Condition	TV Mode (Channel 3)
Adapter type	Adapter #2
Result	Passed by 6.70 dB

Radiated Emission Test Data

The following table shows the highest levels of radiated emissions on both polarizations of horizontal and vertical.
Detector mode: CISPR Quasi-Peak mode (6 dB Bandwidth: 120 kHz)

Frequency [MHz]	Reading [dB(μV)]	Polarization (*H/**V)	Ant. Factor [dB/m]	Cable Loss [dB(μV)]	Height [cm]	Result [dB(μV/m)]	Limit [dB(μV/m)]	Margin [dB]
36.41	20.23	V	12.28	0.79	100	33.30	40.00	6.70
40.08	15.03	V	12.84	0.83	100	28.70	40.00	11.30
50.61	14.42	V	13.18	0.90	100	28.50	40.00	11.50
112.25	16.34	V	9.44	1.42	106	27.20	43.50	16.30
137.62	11.69	V	12.14	1.57	114	25.40	43.50	18.10
171.08	12.48	V	12.22	1.80	128	26.50	43.50	17.00
226.73	12.65	V	10.61	2.04	135	25.30	46.00	20.70
398.42	11.22	H	15.90	2.88	192	30.00	46.00	16.00

NOTES:

1. * H : Horizontal polarization , ** V : Vertical polarization
2. Result = Reading + Antenna factor + Cable loss
3. Margin value = Limit - Result
4. The measurement was performed for the frequency range 30 MHz ~ 1 000 MHz according to the FCC Part 15.109(a) Class B.
5. Channel 3 was the worst case operation mode.

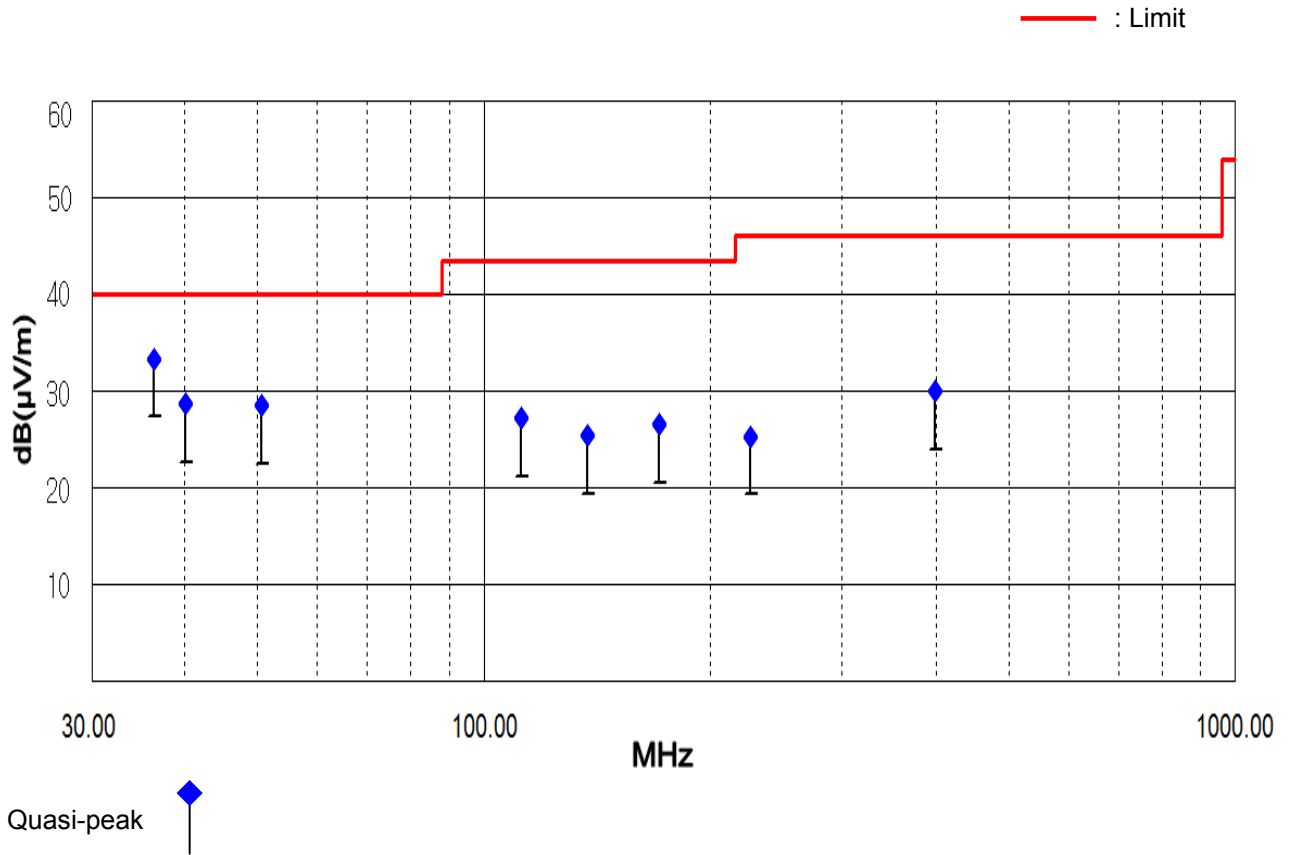

- Below 1 GHz

EUT	HD Set-Top Box / DMS-2344UHDS (S/N: EVY527D02156)
Limit apply to	FCC Part 15 Subpart B Section 15.109(a) Class B
Test Date	August 04, 2015
Environmental of Test	(30.3 ± 0.9) °C, (75 ± 2) % R.H., (100.5 ± 0.0) kPa
Operating Condition	TV Mode (Channel 3)
Adapter type	Adapter #3
Result	Passed by 6.70 dB

Radiated Emission Test Data

The following table shows the highest levels of radiated emissions on both polarizations of horizontal and vertical.
 Detector mode: CISPR Quasi-Peak mode (6 dB Bandwidth: 120 kHz)

Frequency [MHz]	Reading [dB(μV)]	Polarization (*H/**V)	Ant. Factor [dB/m]	Cable Loss [dB(μV)]	Height [cm]	Result [dB(μV/m)]	Limit [dB(μV/m)]	Margin [dB]
36.41	20.23	V	12.28	0.79	100	33.30	40.00	6.70
40.08	14.93	V	12.84	0.83	100	28.60	40.00	11.40
51.42	14.98	V	13.11	0.91	100	29.00	40.00	11.00
126.32	11.54	V	10.76	1.50	108	23.80	43.50	19.70
167.29	11.53	V	12.59	1.78	126	25.90	43.50	17.60
171.08	11.48	V	12.22	1.80	128	25.50	43.50	18.00
232.59	12.75	V	10.88	2.07	139	25.70	46.00	20.30
398.42	9.02	H	15.90	2.88	192	27.80	46.00	18.20

NOTES:

1. * H : Horizontal polarization , ** V : Vertical polarization
2. Result = Reading + Antenna factor + Cable loss
3. Margin value = Limit - Result
4. The measurement was performed for the frequency range 30 MHz ~ 1 000 MHz according to the FCC Part 15.109(a) Class B.
5. Channel 3 was the worst case operation mode.

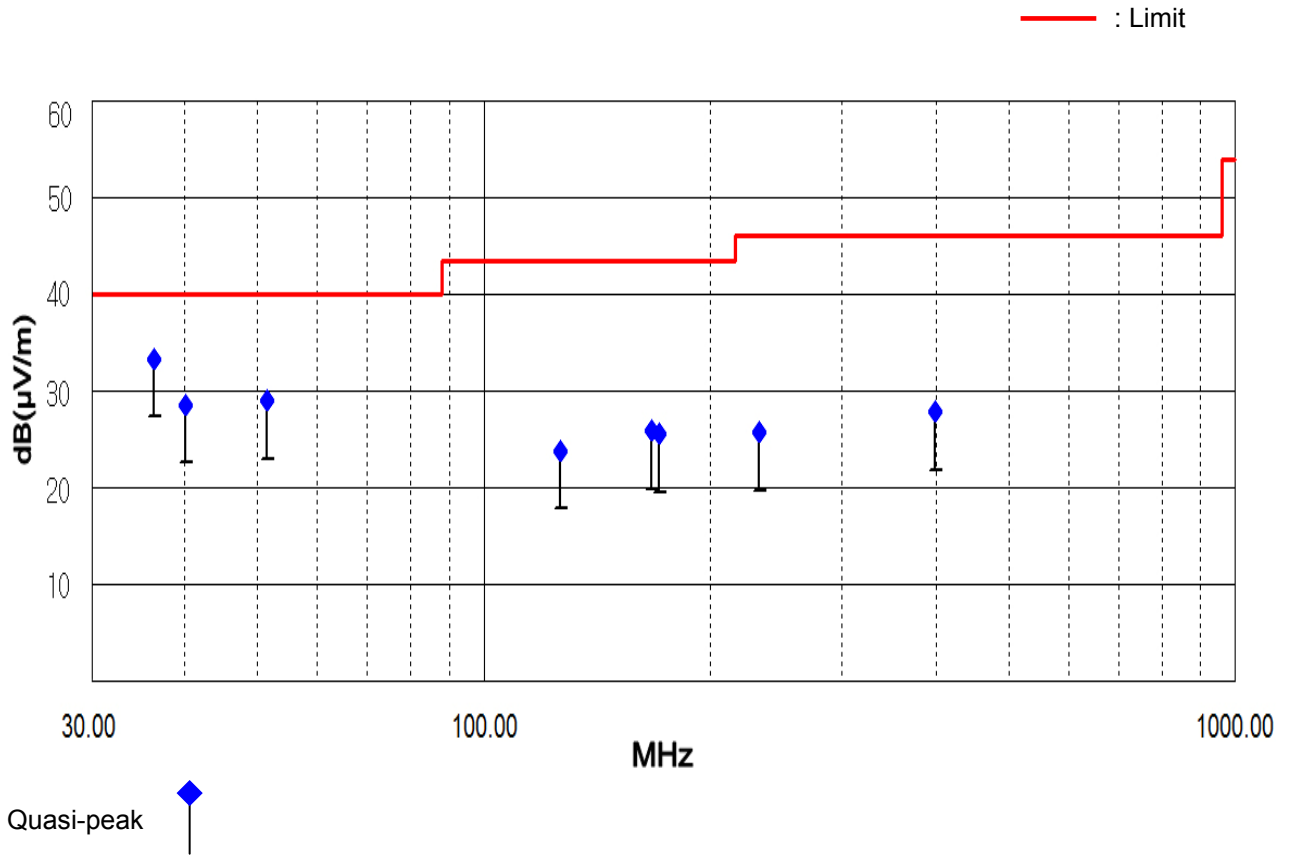

- Above 1 GHz

EUT	HD Set-Top Box / DMS-2344UHDS (S/N: EVY527D02156)
Limit apply to	FCC Part 15 Subpart B Section 15.109(a) Class B
Test Date	August 03, 2015
Environmental of Test	(21.2 ± 0.0) °C, (41 ± 0) % R.H., (101.2 ± 0.0) kPa
Operating Condition	TV Mode (Channel 3)
Adapter type	Adapter #1
Result	Passed by 17.80 dB

Radiated Emission Test Data

The following data and graph shows the highest levels of radiated emissions on both polarizations of horizontal and vertical.

Detector mode: CISPR Peak mode, Average mode

NOTES:

1. Please see the measured data and graph in next page.
2. H : Horizontal polarization , V : Vertical polarization
3. The c.f value was included the antenna factor, cable loss and Amp. Gain.
4. Result value = Reading + c.f
5. Margin value = Limit - Result
6. The measurement was performed for the frequency range 1 GHz ~ 6 GHz according to FCC Part 15.109(a) Class B.
7. Upper frequency of measurement range: 5th harmonic of the highest frequency.
8. Channel 3 was the worst case operation mode.

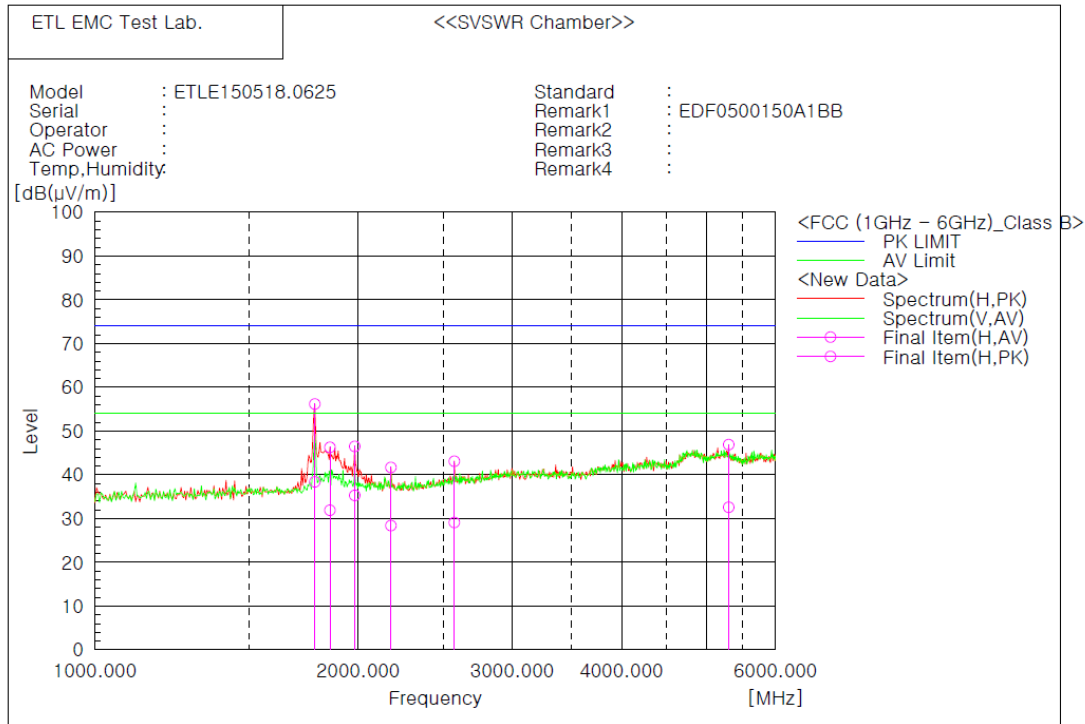

Final Result

— Horizontal Polarization (AV)—

No.	Frequency [MHz]	Reading [dB(μV)]	c.f [dB(1/m)]	Result [dB(μV/m)]	Limit [dB(μV/m)]	Margin [dB]
1	1783.760	51.1	-12.7	38.4	74.0	35.6
2	1856.480	44.4	-12.5	31.9	74.0	42.1
3	1981.720	47.4	-12.1	35.3	74.0	38.7
4	2179.680	39.8	-11.4	28.4	74.0	45.6
5	2575.600	38.7	-9.6	29.1	74.0	44.9
6	5302.800	33.5	-0.9	32.6	74.0	41.4

— Horizontal Polarization (PK)—

No.	Frequency [MHz]	Reading [dB(μV)]	c.f [dB(1/m)]	Result [dB(μV/m)]	Limit [dB(μV/m)]	Margin [dB]
1	1783.760	68.9	-12.7	56.2	74.0	17.8
2	1856.480	58.8	-12.5	46.3	74.0	27.7
3	1981.720	58.6	-12.1	46.5	74.0	27.5
4	2179.680	53.1	-11.4	41.7	74.0	32.3
5	2575.600	52.7	-9.6	43.1	74.0	30.9
6	5302.800	47.8	-0.9	46.9	74.0	27.1

- Above 1 GHz

EUT	HD Set-Top Box / DMS-2344UHDS (S/N: EVY527D02156)
Limit apply to	FCC Part 15 Subpart B Section 15.109(a) Class B
Test Date	August 03, 2015
Environmental of Test	(21.3 ± 0.0) °C, (41 ± 0) % R.H., (101.2 ± 0.0) kPa
Operating Condition	TV Mode (Channel 3)
Adapter type	Adapter #2
Result	Passed by 25.50 dB

Radiated Emission Test Data

The following data and graph shows the highest levels of radiated emissions on both polarizations of horizontal and vertical.

Detector mode: CISPR Peak mode, Average mode

NOTES:

1. Please see the measured data and graph in next page.
2. H : Horizontal polarization , V : Vertical polarization
3. The c.f value was included the antenna factor, cable loss and Amp. Gain.
4. Result value = Reading + c.f
5. Margin value = Limit - Result
6. The measurement was performed for the frequency range 1 GHz ~ 6 GHz according to FCC Part 15.109(a) Class B.
7. Upper frequency of measurement range: 5th harmonic of the highest frequency.
8. Channel 3 was the worst case operation mode.

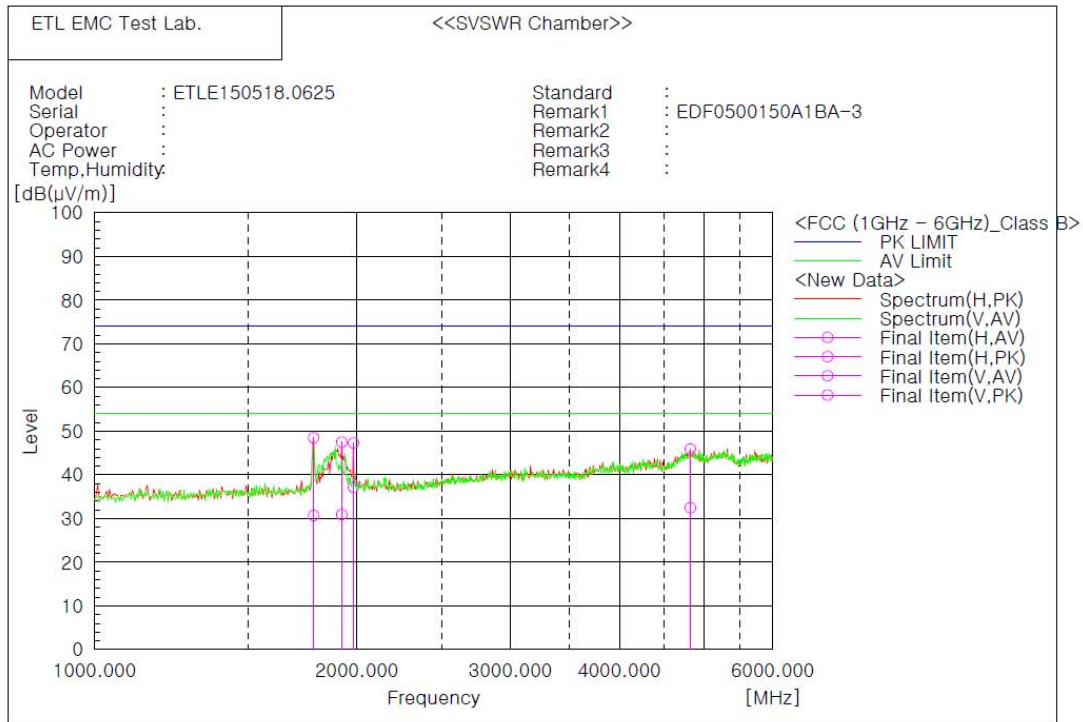

Final Result

--- Horizontal Polarization (AV)---							
No.	Frequency [MHz]	Reading [dB(μV)]	c.f [dB(1/m)]	Result [dB(μV/m)]	Limit [dB(μV/m)]	Margin [dB]	
1	1921.120	43.2	-12.3	30.9	74.0	43.1	
2	1981.720	49.3	-12.1	37.2	74.0	36.8	
--- Horizontal Polarization (PK)---							
No.	Frequency [MHz]	Reading [dB(μV)]	c.f [dB(1/m)]	Result [dB(μV/m)]	Limit [dB(μV/m)]	Margin [dB]	
1	1921.120	59.8	-12.3	47.5	74.0	26.5	
2	1981.720	59.4	-12.1	47.3	74.0	26.7	
--- Vertical Polarization (AV)---							
No.	Frequency [MHz]	Reading [dB(μV)]	c.f [dB(1/m)]	Result [dB(μV/m)]	Limit [dB(μV/m)]	Margin [dB]	
1	1783.760	43.4	-12.7	30.7	74.0	43.3	
2	4824.060	33.7	-1.2	32.5	74.0	41.5	
--- Vertical Polarization (PK)---							
No.	Frequency [MHz]	Reading [dB(μV)]	c.f [dB(1/m)]	Result [dB(μV/m)]	Limit [dB(μV/m)]	Margin [dB]	
1	1783.760	61.2	-12.7	48.5	74.0	25.5	
2	4824.060	47.1	-1.2	45.9	74.0	28.1	

- Above 1 GHz

EUT	HD Set-Top Box / DMS-2344UHDS (S/N: EVY527D02156)
Limit apply to	FCC Part 15 Subpart B Section 15.109(a) Class B
Test Date	August 03, 2015
Environmental of Test	(21.4 ± 0.0) °C, (41 ± 0) % R.H., (101.2 ± 0.0) kPa
Operating Condition	TV Mode (Channel 3)
Adapter type	Adapter #3
Result	Passed by 23.50 dB

Radiated Emission Test Data

The following data and graph shows the highest levels of radiated emissions on both polarizations of horizontal and vertical.

Detector mode: CISPR Peak mode, Average mode

NOTES:

1. Please see the measured data and graph in next page.
2. H : Horizontal polarization , V : Vertical polarization
3. The c.f value was included the antenna factor, cable loss and Amp. Gain.
4. Result value = Reading + c.f
5. Margin value = Limit - Result
6. The measurement was performed for the frequency range 1 GHz ~ 6 GHz according to FCC Part 15.109(a) Class B.
7. Upper frequency of measurement range: 5th harmonic of the highest frequency.
8. Channel 3 was the worst case operation mode.

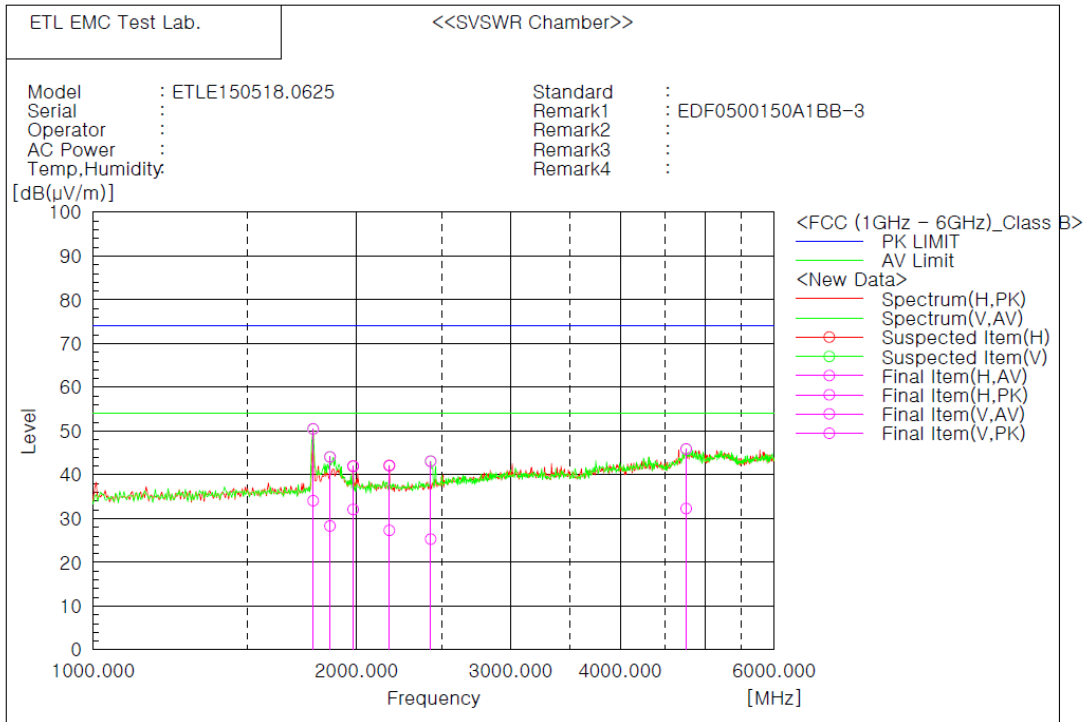

Final Result

— Horizontal Polarization (AV)—

No.	Frequency [MHz]	Reading [dB(μV)]	c.f [dB(1/m)]	Result [dB(μV/m)]	Limit [dB(μV/m)]	Margin [dB]
1	1981.720	44.2	-12.1	32.1	74.0	41.9
2	2179.680	38.7	-11.4	27.3	74.0	46.7

— Horizontal Polarization (PK)—

No.	Frequency [MHz]	Reading [dB(μV)]	c.f [dB(1/m)]	Result [dB(μV/m)]	Limit [dB(μV/m)]	Margin [dB]
1	1981.720	54.1	-12.1	42.0	74.0	32.0
2	2179.680	53.5	-11.4	42.1	74.0	31.9

— Vertical Polarization (AV)—

No.	Frequency [MHz]	Reading [dB(μV)]	c.f [dB(1/m)]	Result [dB(μV/m)]	Limit [dB(μV/m)]	Margin [dB]
1	1783.760	46.8	-12.7	34.1	74.0	39.9
2	1864.560	40.8	-12.5	28.3	74.0	45.7
3	2430.160	35.6	-10.3	25.3	74.0	48.7
4	4757.400	33.8	-1.5	32.3	74.0	41.7

— Vertical Polarization (PK)—

No.	Frequency [MHz]	Reading [dB(μV)]	c.f [dB(1/m)]	Result [dB(μV/m)]	Limit [dB(μV/m)]	Margin [dB]
1	1783.760	63.2	-12.7	50.5	74.0	23.5
2	1864.560	56.6	-12.5	44.1	74.0	29.9
3	2430.160	53.4	-10.3	43.1	74.0	30.9
4	4757.400	47.4	-1.5	45.9	74.0	28.1

5.4 Antenna Power Conduction Measurement

5.4.1 Antenna Power Conduction Measurement

EUT	HD Set-Top Box / DMS-2344UHDS (S/N: EVY527D02156)
Limit apply to	FCC Part 15 Subpart B Section 15.111(a)
Test Date	July 31, 2015
Environmental of Test	(21.1 ± 0.0) °C, (41 ± 0) % R.H., (101.1 ± 0.0) kPa
Operating Condition	Signal tuning mode
Adapter type	Adapter #1
Result	Passed by 11.40 dB

Antenna Power Conduction Test Data

Test port	Tuned Frequency [MHz]	Meter Reading [dB(μV)]	Correction Factor [dB]	Result [dB(μV)]	Limit [dB(μV)]	Margin [dB]
CABLE IN	54.300	6.00	23.70	29.70	50.00	20.30
	142.050	4.40	23.80	28.20	50.00	21.80
	1 310.500	12.40	26.20	38.60	50.00	11.40

NOTES:

1. **Result = Meter Reading + Correction Factor (Matching Loss + Cable loss)**
2. **Margin value = Limit - Result**
3. **Measurements using the CISPR Quasi-peak mode in the frequency range 30 MHz to 6 GHz and measurements using the CISPR peak mode in the frequency range above 1 GHz.**
4. **The limits is 2.0 μW in the frequency range section 15.33(b)(1) of FCC Part 15.**

EUT	HD Set-Top Box / DMS-2344UHDS (S/N: EVY527D02156)
Limit apply to	FCC Part 15 Subpart B Section 15.111(a)
Test Date	July 31, 2015
Environmental of Test	(21.3 ± 0.0) °C, (41 ± 0) % R.H., (101.1 ± 0.0) kPa
Operating Condition	Signal tuning mode
Adapter type	Adapter #2
Result	Passed by 10.80 dB

Antenna Power Conduction Test Data

Test port	Tuned Frequency [MHz]	Meter Reading [dB(μV)]	Correction Factor [dB]	Result [dB(μV)]	Limit [dB(μV)]	Margin [dB]
CABLE IN	54.300	10.80	23.70	34.50	50.00	15.50
	594.000	4.00	23.70	27.70	50.00	22.30
	1 353.625	13.20	26.00	39.20	50.00	10.80

NOTES:

1. **Result = Meter Reading + Correction Factor (Matching Loss + Cable loss)**
2. **Margin value = Limit - Result**
3. **Measurements using the CISPR Quasi-peak mode in the frequency range 30 MHz to 6 GHz and measurements using the CISPR peak mode in the frequency range above 1 GHz.**
4. **The limits is 2.0 μW in the frequency range section 15.33(b)(1) of FCC Part 15.**

EUT	HD Set-Top Box / DMS-2344UHDS (S/N: EVY527D02156)
Limit apply to	FCC Part 15 Subpart B Section 15.111(a)
Test Date	July 31, 2015
Environmental of Test	(21.4 ± 0.0) °C, (41 ± 0) % R.H., (101.1 ± 0.0) kPa
Operating Condition	Signal tuning mode
Adapter type	Adapter #3
Result	Passed by 11.00 dB

Antenna Power Conduction Test Data

Test port	Tuned Frequency [MHz]	Meter Reading [dB(μV)]	Correction Factor [dB]	Result [dB(μV)]	Limit [dB(μV)]	Margin [dB]
CABLE IN	53.625	8.20	23.70	31.90	50.00	18.10
	157.575	3.20	23.80	27.00	50.00	23.00
	748.000	4.40	23.70	28.10	50.00	21.90
	1 362.250	13.10	25.90	39.00	50.00	11.00

NOTES:

1. **Result = Meter Reading + Correction Factor (Matching Loss + Cable loss)**
2. **Margin value = Limit - Result**
3. **Measurements using the CISPR Quasi-peak mode in the frequency range 30 MHz to 6 GHz and measurements using the CISPR peak mode in the frequency range above 1 GHz.**
4. **The limits is 2.0 mW in the frequency range section 15.33(b)(1) of FCC Part 15.**

5.5 Output Signal Level Measurement

5.5.1 Output Signal Level Measurement

EUT	HD Set-Top Box / DMS-2344UHDS (S/N: EVY527D02156)
Limit apply to	FCC Part15 Subpart B Section 15.115(b)(1)(i)
Test Date	July 31, 2015
Environmental of Test	(22.1 ± 0.0) °C, (39 ± 0) % R.H., (101.4 ± 0.0) kPa
Operating Condition	TV Mode (Channel 3, Channel 4)
Adapter type	Adapter #1
Result	Passed by 2.33 dB

Output Signal Level Test Data

Test Channel	Emission Frequency [MHz]	Meter Reading [dB(μV)]	Correction Factor [dB]	Signal Level [dB(μV)]	Limit [dB(μV)]	Margin [dB]
3	61.250	65.67	7.50	73.17	75.50	2.33
	65.750	50.65	7.50	58.15	62.50	4.35
4	67.250	65.59	7.50	73.09	75.50	2.41
	71.750	50.57	7.50	58.07	62.50	4.43

NOTES:

1. The correction factor consist of the insertion loss of the impedance matching transformer and the coaxial Satellite Receiver used for the test.
2. The spectrum was checked in each test mode and operation mode, and the maximum measured data were reported.
3. Signal Level = Meter Reading + Correction Factor (Matching Loss + Cable loss)
4. Margin value = Limit - Signal Level

EUT	HD Set-Top Box / DMS-2344UHDS (S/N: EVY527D02156)
Limit apply to	FCC Part15 Subpart B Section 15.115(b)(1)(i)
Test Date	July 31, 2015
Environmental of Test	(22.2 ± 0.0) °C, (39 ± 0) % R.H., (101.4 ± 0.0) kPa
Operating Condition	TV Mode (Channel 3, Channel 4)
Adapter type	Adapter #2
Result	Passed by 2.28 dB

Output Signal Level Test Data

Test Channel	Emission Frequency [MHz]	Meter Reading [dB(μV)]	Correction Factor [dB]	Signal Level [dB(μV)]	Limit [dB(μV)]	Margin [dB]
3	61.250	65.72	7.50	73.22	75.50	2.28
	65.750	50.69	7.50	58.19	62.50	4.31
4	67.250	65.34	7.50	72.84	75.50	2.66
	71.750	50.29	7.50	57.79	62.50	4.71

NOTES:

1. The correction factor consist of the insertion loss of the impedance matching transformer and the coaxial receiver used for the test.
2. The spectrum was checked in each test mode and operation mode, and the maximum measured data were reported.
3. **Signal Level = Meter Reading + Correction Factor (Matching Loss + Cable loss)**
4. **Margin value = Limit - Signal Level**

EUT	HD Set-Top Box / DMS-2344UHDS (S/N: EVY527D02156)
Limit apply to	FCC Part15 Subpart B Section 15.115(b)(1)(i)
Test Date	July 31, 2015
Environmental of Test	(22.4 ± 0.0) °C, (39 ± 0) % R.H., (101.4 ± 0.0) kPa
Operating Condition	TV Mode (Channel 3, Channel 4)
Adapter type	Adapter #3
Result	Passed by 2.33 dB

Output Signal Level Test Data

Test Channel	Emission Frequency [MHz]	Meter Reading [dB(μV)]	Correction Factor [dB]	Signal Level [dB(μV)]	Limit [dB(μV)]	Margin [dB]
3	61.250	65.67	7.50	73.17	75.50	2.33
	65.750	50.67	7.50	58.17	62.50	4.33
4	67.250	65.30	7.50	72.80	75.50	2.70
	71.750	50.27	7.50	57.77	62.50	4.73

NOTES:

1. The correction factor consist of the insertion loss of the impedance matching transformer and the coaxial receiver used for the test.
2. The spectrum was checked in each test mode and operation mode, and the maximum measured data were reported.
3. **Signal Level = Meter Reading + Correction Factor (Matching Loss + Cable loss)**
4. **Margin value = Limit - Signal Level**

5.6 Output Terminal Conducted Spurious Emission Measurement

5.6.1 Output Terminal Conducted Spurious Emission Measurement

EUT	HD Set-Top Box / DMS-2344UHDS (S/N: EVY527D02156)
Limit apply to	FCC Part15 Subpart B Section 15.115(b)(2)(i)
Test Date	July 31, 2015
Environmental of Test	(20.4 ± 0.0) °C, (37 ± 0) % R.H., (101.2 ± 0.0) kPa
Operating Condition	TV Mode (Channel 3, Channel 4)
Adapter type	Adapter #1
Result	Passed by 2.30 dB

Output Terminal Conducted Spurious Test Data

Test Channel	Emission Frequency [MHz]	Meter Reading [dB(μV)]	Correction Factor [dB]	Result [dB(μV)]	Limit [dB(μV)]	Margin [dB]
3	57.000	50.60	7.50	58.10	75.50	17.40
	61.050	65.70	7.50	73.20	75.50	2.30
	65.775	50.60	7.50	58.10	75.50	17.40
	108.300	13.80	7.50	21.30	75.50	54.20
	122.475	19.50	7.50	27.00	75.50	48.50
	179.175	21.40	7.50	28.90	75.50	46.60
	183.900	34.30	7.50	41.80	75.50	33.70
	187.950	20.10	7.50	27.60	75.50	47.90
	252.075	19.40	7.50	26.90	75.50	48.60
980.750	28.30	7.50	35.80	75.50	39.70	

NOTES:

1. The correction factor consists of the insertion loss of the impedance matching transformer.
2. The spectrum was checked in each test mode and operation mode, and the maximum measured data were reported.
3. Result = Meter Reading + Correction (Matching Loss+ Cable loss)
4. Margin value = Limit - Signal Level

Test Channel	Emission Frequency [MHz]	Meter Reading [dB(μV)]	Correction Factor [dB]	Result [dB(μV)]	Limit [dB(μV)]	Margin [dB]
4	63.075	50.60	7.50	58.10	75.50	17.40
	67.125	64.50	7.50	72.00	75.50	3.50
	71.850	50.50	7.50	58.00	75.50	17.50
	108.300	14.00	7.50	21.50	75.50	54.00
	134.625	18.20	7.50	25.70	75.50	49.80
	197.400	19.10	7.50	26.60	75.50	48.90
	201.450	29.80	7.50	37.30	75.50	38.20
	206.175	18.30	7.50	25.80	75.50	49.70
	252.075	19.80	7.50	27.30	75.50	48.20
	264.225	14.60	7.50	22.10	75.50	53.40
	371.750	12.90	7.50	20.40	75.50	55.10

NOTES:

1. The correction factor consists of the insertion loss of the impedance matching transformer.
2. The spectrum was checked in each test mode and operation mode, and the maximum measured data were reported.
3. Result = Meter Reading + Correction (Matching Loss+ Cable loss)
4. Margin value = Limit - Signal Level

EUT	HD Set-Top Box / DMS-2344UHDS (S/N: EVY527D02156)
Limit apply to	FCC Part15 Subpart B Section 15.115(b)(2)(i)
Test Date	July 31, 2015
Environmental of Test	(20.6 ± 0.0) °C, (37 ± 0) % R.H., (101.2 ± 0.0) kPa
Operating Condition	TV Mode (Channel 3, Channel 4)
Adapter type	Adapter #2
Result	Passed by 3.40 dB

Output Terminal Conducted Spurious Test Data

Test Channel	Emission Frequency [MHz]	Meter Reading [dB(μV)]	Correction Factor [dB]	Result [dB(μV)]	Limit [dB(μV)]	Margin [dB]
3	57.000	50.60	7.50	58.10	75.50	17.40
	61.050	64.60	7.50	72.10	75.50	3.40
	65.775	50.60	7.50	58.10	75.50	17.40
	108.300	13.30	7.50	20.80	75.50	54.70
	122.475	18.50	7.50	26.00	75.50	49.50
	179.175	22.00	7.50	29.50	75.50	46.00
	183.900	34.20	7.50	41.70	75.50	33.80
	187.950	19.80	7.50	27.30	75.50	48.20
	252.075	14.90	7.50	22.40	75.50	53.10
	980.750	28.50	7.50	36.00	75.50	39.50

NOTES:

1. The correction factor consists of the insertion loss of the impedance matching transformer.
2. The spectrum was checked in each test mode and operation mode, and the maximum measured data were reported.
3. Result = Meter Reading + Correction (Matching Loss+ Cable loss)
4. Margin value = Limit - Signal Level

Test Channel	Emission Frequency [MHz]	Meter Reading [dB(μV)]	Correction Factor [dB]	Result [dB(μV)]	Limit [dB(μV)]	Margin [dB]
4	63.075	50.40	7.50	57.90	75.50	17.60
	67.125	64.50	7.50	72.00	75.50	3.50
	71.850	50.20	7.50	57.70	75.50	17.80
	108.300	13.50	7.50	21.00	75.50	54.50
	129.900	25.40	7.50	32.90	75.50	42.60
	134.625	37.40	7.50	44.90	75.50	30.60
	139.350	23.50	7.50	31.00	75.50	44.50
	197.400	17.10	7.50	24.60	75.50	50.90
	201.450	27.60	7.50	35.10	75.50	40.40
	206.175	16.10	7.50	23.60	75.50	51.90
	268.950	17.40	7.50	24.90	75.50	50.60

NOTES:

1. The correction factor consists of the insertion loss of the impedance matching transformer.
2. The spectrum was checked in each test mode and operation mode, and the maximum measured data were reported.
3. **Result = Meter Reading + Correction (Matching Loss+ Cable loss)**
4. **Margin value = Limit - Signal Level**

EUT	HD Set-Top Box / DMS-2344UHDS (S/N: EVY527D02156)
Limit apply to	FCC Part15 Subpart B Section 15.115(b)(2)(i)
Test Date	July 31, 2015
Environmental of Test	(20.9 ± 0.0) °C, (37 ± 0) % R.H., (101.2 ± 0.0) kPa
Operating Condition	TV Mode (Channel 3, Channel 4)
Adapter type	Adapter #3
Result	Passed by 3.50 dB

Output Terminal Conducted Spurious Test Data

Test Channel	Emission Frequency [MHz]	Meter Reading [dB(μV)]	Correction Factor [dB]	Result [dB(μV)]	Limit [dB(μV)]	Margin [dB]
3	57.000	50.60	7.50	58.10	75.50	17.40
	61.050	64.50	7.50	72.00	75.50	3.50
	65.775	50.60	7.50	58.10	75.50	17.40
	108.300	14.80	7.50	22.30	75.50	53.20
	122.475	18.50	7.50	26.00	75.50	49.50
	179.175	21.10	7.50	28.60	75.50	46.90
	183.900	33.20	7.50	40.70	75.50	34.80
	187.950	19.80	7.50	27.30	75.50	48.20
	252.075	14.70	7.50	22.20	75.50	53.30
	980.750	28.60	7.50	36.10	75.50	39.40

NOTES:

1. The correction factor consists of the insertion loss of the impedance matching transformer.
2. The spectrum was checked in each test mode and operation mode, and the maximum measured data were reported.
3. Result = Meter Reading + Correction (Matching Loss+ Cable loss)
4. Margin value = Limit - Signal Level

Test Channel	Emission Frequency [MHz]	Meter Reading [dB(μV)]	Correction Factor [dB]	Result [dB(μV)]	Limit [dB(μV)]	Margin [dB]
4	63.075	50.40	7.50	57.90	75.50	17.60
	67.125	64.10	7.50	71.60	75.50	3.90
	71.850	50.20	7.50	57.70	75.50	17.80
	108.300	13.10	7.50	20.60	75.50	54.90
	129.900	25.50	7.50	33.00	75.50	42.50
	134.625	38.50	7.50	46.00	75.50	29.50
	139.350	23.70	7.50	31.20	75.50	44.30
	197.400	16.80	7.50	24.30	75.50	51.20
	201.450	28.00	7.50	35.50	75.50	40.00
	206.950	15.50	7.50	23.00	75.50	52.50
	268.950	17.20	7.50	24.70	75.50	50.80

NOTES:

1. The correction factor consists of the insertion loss of the impedance matching transformer.
2. The spectrum was checked in each test mode and operation mode, and the maximum measured data were reported.
3. Result = Meter Reading + Correction (Matching Loss+ Cable loss)
4. Margin value = Limit - Signal Level

5.7 Antenna Transfer Switch Measurement

5.7.1 Antenna Transfer Switch Measurement

EUT	HD Set-Top Box / DMS-2344UHDS (S/N: EVY527D02156)
Limit apply to	FCC Part15 Subpart B Section 15.115(c)(1)(ii)
Test Date	July 31, 2015
Environmental of Test	(19.4 ± 0.0) °C, (41 ± 0) % R.H., (101.1 ± 0.0) kPa
Operating Condition	TV Mode (Channel 3, Channel 4)
Adapter type	Adapter #1
Result	Passed

Antenna Transfer Switch Test Data

Test Channel	Emission Frequency [MHz]	Meter Reading [dB(μV)]	Correction Factor [dB]	Result [dB(μV)]	Limit [dB(μV)]	Margin [dB]
3	61.250	During this test, no signal detected				-
4	67.250					-

NOTES:

1. No emission was observed during the test. The spectrum was checked in each test mode and operation mode Transfer switch isolation measurements were made on the Channel 3 or 4 video output frequency of 61.25 MHz or 67.25 MHz and both positions of the transfer switch were checked for compliance.
2. To clarify the emissions emanated from ANT. input terminal on the EUT, RF pre-amplifier was used. The gain of pre-amplifier at each frequency measured from the EUT was obtained after sufficient warm-up for stabilization of gain. The correction factor consists of the insertion loss of the impedance matching transformer, the coaxial Satellite Receiver used for the test and the gain of pre-amplifier.
3. Result = Meter Reading + Correction Factor (Matching Loss + Cable loss)
4. Margin value = Limit - Result
5. Spectrum analyzer setting: Frequency Span 1 MHz, Resolution bandwidth 100 kHz, Video bandwidth 300 kHz, Detector function Peak mode.

EUT	HD Set-Top Box / DMS-2344UHDS (S/N: EVY527D02156)
Limit apply to	FCC Part15 Subpart B Section 15.115(c)(1)(ii)
Test Date	July 31, 2015
Environmental of Test	(19.5 ± 0.0) °C, (41 ± 0) % R.H., (101.1 ± 0.0) kPa
Operating Condition	TV Mode (Channel 3, Channel 4)
Adapter type	Adapter #2
Result	Passed

Antenna Transfer Switch Test Data

Test Channel	Emission Frequency [MHz]	Meter Reading [dB(μV)]	Correction Factor [dB]	Result [dB(μV)]	Limit [dB(μV)]	Margin [dB]
3	61.250	During this test, no signal detected				-
4	67.250					-

NOTES:

1. No emission was observed during the test. The spectrum was checked in each test mode and operation mode Transfer switch isolation measurements were made on the Channel 3 or 4 video output frequency of 61.25 MHz or 67.25 MHz and both positions of the transfer switch were checked for compliance.
2. To clarify the emissions emanated from ANT. input terminal on the EUT, RF pre-amplifier was used. The gain of pre-amplifier at each frequency measured from the EUT was obtained after sufficient warm-up for stabilization of gain. The correction factor consists of the insertion loss of the impedance matching transformer, the coaxial Satellite Receiver used for the test and the gain of pre-amplifier.
3. Result = Meter Reading + Correction Factor (Matching Loss + Cable loss)
4. Margin value = Limit - Result
5. Spectrum analyzer setting: Frequency Span 1 MHz, Resolution bandwidth 100 kHz, Video bandwidth 300 kHz, Detector function Peak mode.

EUT	HD Set-Top Box / DMS-2344UHDS (S/N: EVY527D02156)
Limit apply to	FCC Part15 Subpart B Section 15.115(c)(1)(ii)
Test Date	July 31, 2015
Environmental of Test	(19.6 ± 0.0) °C, (41 ± 0) % R.H., (101.1 ± 0.0) kPa
Operating Condition	TV Mode (Channel 3, Channel 4)
Adapter type	Adapter #3
Result	Passed

Antenna Transfer Switch Test Data

Test Channel	Emission Frequency [MHz]	Meter Reading [dB(μV)]	Correction Factor [dB]	Result [dB(μV)]	Limit [dB(μV)]	Margin [dB]
3	61.250	During this test, no signal detected				-
4	67.250					-

NOTES:

1. No emission was observed during the test. The spectrum was checked in each test mode and operation mode Transfer switch isolation measurements were made on the Channel 3 or 4 video output frequency of 61.25 MHz or 67.25 MHz and both positions of the transfer switch were checked for compliance.
2. To clarify the emissions emanated from ANT. input terminal on the EUT, RF pre-amplifier was used. The gain of pre-amplifier at each frequency measured from the EUT was obtained after sufficient warm-up for stabilization of gain. The correction factor consists of the insertion loss of the impedance matching transformer, the coaxial Satellite Receiver used for the test and the gain of pre-amplifier.
3. Result = Meter Reading + Correction Factor (Matching Loss + Cable loss)
4. Margin value = Limit - Result
5. Spectrum analyzer setting: Frequency Span 1 MHz, Resolution bandwidth 100 kHz, Video bandwidth 300 kHz, Detector function Peak mode.

6. SAMPLE CALCULATION

Sample Field Strength Calculation

The field strength is calculated by adding the Antenna Factor and Cable Factor.
The basic equation with a sample calculation is as follows:

$$FS = RA + AF + CF - PA$$

Where FS = Field Strength

RA = Receiver Amplitude

AF = Antenna Factor

CF = Cable Attenuation Factor

PA* = Preamplifier Factor

* PA is only be used for the measuring frequency above 1 GHz.

$$dB(\mu V) = 20 \log_{10} (\mu V) : \text{Equation}$$

$$dB(\mu V) = dBm + 107$$

Example : @ 36.41 MHz

Class B Limit	=	40.00 dB(μV/m)
Reading	=	22.63 dB(μV)
Antenna Factor + Cable Loss	=	12.28 + 0.79 = 13.07 dB(μV/m)
Total	=	35.70 dB(μV/m)
Margin	=	40.00 – 35.70 = 4.30 dB
	=	4.30 dB below Limit

7. List of test equipments used for measurements

	Test Equipment	Model	Mfg.	Serial No.	Cal. Date	Cal. Due Date
<input checked="" type="checkbox"/>	EMI Test Receiver	ESVS 10	R&S	835165/001	15.03.17	16.03.17
<input checked="" type="checkbox"/>	EMI Test Receiver	ESPI3	R&S	100478	14.09.03	15.09.03
<input checked="" type="checkbox"/>	EMI Test Receiver	ESCS30	R&S	847793/005	15.03.17	16.03.17
<input checked="" type="checkbox"/>	EMI Test Receiver	ESCI7	R&S	100851	14.09.03	15.09.03
<input checked="" type="checkbox"/>	Two-Line V-Network	ENV216	R&S	958599/106	15.03.17	16.03.17
<input checked="" type="checkbox"/>	LISN	3816-2	EMCO	1002	15.04.22	16.04.22
<input checked="" type="checkbox"/>	Horn Antenna	BBHA 9120D	Schwarzbeck	826	14.04.02	16.04.02
<input checked="" type="checkbox"/>	Amplifier	TK-PA18	TESTEK.	120020	14.09.04	15.09.04
<input checked="" type="checkbox"/>	LogBicon Antenna	VULB9160	Schwarzbeck	3164	15.06.08	17.06.08
<input checked="" type="checkbox"/>	Spectrum Analyzer	E7405A	H.P.	US41160290	14.09.19	15.09.19
<input checked="" type="checkbox"/>	Matching Pad (RAM)	358.5414.02	R&S	101841	14.12.08	15.12.08
<input checked="" type="checkbox"/>	75 Ω Directional Bridge	86207A	Agilent	3140A00678	14.09.04	15.09.04
<input checked="" type="checkbox"/>	Turn-Table	DS1200-S	Innco Systems GmbH	2740311	N/A	N/A
<input checked="" type="checkbox"/>	Turn-Table	TT 1.35 SI	SES	-	N/A	N/A
<input checked="" type="checkbox"/>	Antenna Master	AM 4.5	SES	-	N/A	N/A