

EMC TEST REPORT

Report No. : EME-060338
Model No. : 36077, MB6077
Issued Date : Mar. 23, 2006

Applicant : SENTON Enterprises Limited
Flat 10, 17/F., Fotan Ind. Centre, 26-28 Au Pui Wan St.,
Fo Tan, Shatin, N. T. Hong Kong

Test By : Intertek Testing Services Taiwan Ltd.
No. 11, Lane 275, Ko-Nan 1 Street, Chia-Tung Li,
Shiang-Shan District, Hsinchu City, Taiwan

This test report consists of 25 pages in total. It may be duplicated completely for legal use with the allowance of the applicant. It shall not be reproduced except in full, without the written approval of Intertek Laboratory. The test result(s) in this report only applies to the tested sample(s).

Project Engineer



Reviewed By

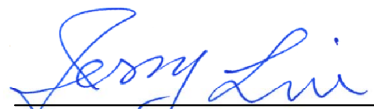

Jerry Liu

Table of Contents

Summary of Tests	3
1. General information.....	4
1.1 Identification of the EUT.....	4
1.2 Additional information about the EUT.....	4
1.3 Antenna description	5
1.4 Peripherals equipment	5
2. Test specifications.....	6
2.1 Test standard	6
2.2 Operation mode	6
2.3 Test equipment.....	7
3. Radiated emission test FCC 15.249 (C)	8
3.1 Operating environment.....	8
3.2 Test setup & procedure	8
3.3 Emission limit.....	9
3.3.1 Fundamental and harmonics emission limits.....	9
3.3.2 General radiated emission limits	10
3.4 Radiated spurious emission test data	11
3.4.1 Measurement results: frequencies equal to or less than 1 GHz.....	11
3.5 Measurement results: frequency above 1GHz.....	13
4. Radiated emission on the band edge FCC 15.249(C).....	17
5. Conducted emission test FCC 15.207	22
5.1 Operating environment.....	22
5.2 Test setup & procedure	22
5.3 Emission limit.....	23
5.4 Uncertainty of Conducted Emission.....	23
5.5 Power Line Conducted Emission test data	24

Summary of Tests

Cordless Phone -Model: 36077

FCC ID: PEG36077

Test	Reference	Results
Power Line Conducted Emission test	15.207	Complies
Radiated Emission test	15.249(c), 15.209	Complies

1. General information**1.1 Identification of the EUT**

Applicant	: SENTON Enterprises Limited
Product	: Cordless Phone
Model No.	: 36077
FCC ID.	: PEG36077
Frequency Range (Base)	: 2403.05MHz ~ 2405.00MHz
Frequency Range (Handset)	: 2474.00MHz ~ 2475.95MHz
Channel Number	: 40 channels
Frequency of Each Channel (Base)	: 2403.05MHz + 0.05k MHz k=0~39
Frequency of Each Channel (Handset)	: 2474MHz + 0.05k MHz k=0~39
Type of Modulation	: FM
Power Supply (Base)	: 120Vac, 60Hz with adapter (U090050D)
Power Supply (Handset)	: 3.6Vdc Battery
Power Cord	: N/A
Sample Received	: RJ-11 unshielded cable 10meter × 1
Sample Received	: Mar. 16, 2006
Test Date(s)	: Mar. 16, 2006 ~ Mar. 23, 2006

A DoC report has been generated for the client.

1.2 Additional information about the EUT

The EUT is a Cordless Phone; it consists of handsets unit and base unit.

The models listed below are identical to model 36077 (EUT).
Difference brand serves as marking strategy.

Trade Name	Model Number
Unical	36077
Bell Phone	36077
Moutain Bell	MB6077

For more detail features, please refer to User's manual as file name "Users Manual.pdf"

1.3 Antenna description

The EUT uses a permanently connected antenna.

Antenna Gain : 0dBi max

Antenna Type : Soldering antenna

Connector Type : Lead Wire

1.4 Peripherals equipment

Peripherals	Manufacturer	Product No.	Serial No.	FCC ID
Exchange Board	Teltone	250-00193-07	94948	FCC DoC Approved
Telephone	TENTEL	K-903S	0514000941	FCC DoC Approved
Earphone	N/A	N/A	N/A	N/A

2. Test specifications

2.1 Test standard

The EUT was performed according to the procedures in FCC Part 15 Subpart C Paragraph 15.249 for non-spread spectrum devices.

The test of radiated measurements according to FCC Part15 Section 15.33(a) had been conducted and the field strength of this frequency band were all meet limit requirement, thus we evaluate the EUT pass the specified test.

2.2 Operation mode

During radiated emission test, the EUT was operated in continuously transmitting. The EUT was operated in charging and ringing mode in conducted emission test.

2.3 Test equipment

Equipment	Brand	Frequency range	Model No.	Intertek ID No.	Next Cal. Date
EMI Test Receiver	Rohde & Schwarz	9kHz~2.75GHz	ESCS 30	EC303	04/17/2006
EMI Test Receiver	Rohde & Schwarz	20Hz~26.5GHz	ESMI	EC317	08/07/2006
Spectrum Analyzer	Rohde & Schwarz	9kHz~30GHz	FSP 30	EC353	07/24/2006
Spectrum Analyzer	Rohde & Schwarz	20Hz~40GHz	FSEK 30	EC365	11/01/2006
Horn Antenna	EMCO	1GHz~18GHz	3115	EC338	08/16/2007
Horn Antenna	SCHWARZBECK	14GHz~40GHz	BBHA 9170	EC351	07/08/2007
Bilog Antenna	SCHWARZBECK	25MHz~1.7GHz	VULB 9160	EC368	02/19/2007
Pre-Amplifier	MITEQ	100MHz~26.5GHz	919981	EC373	12/29/2007
Pre-Amplifier	MITEQ	26GHz~40GHz	828825	EC374	01/15/2008
Controller	HDGmbH	N/A	HD 100	EP317-1	N/A
Antenna Tower	HDGmbH	N/A	MA 240	EP317-2	N/A
Turn Table	HDGmbH	N/A	DS 420S	EP317-3	N/A
LISN	Rohde & Schwarz	9KHz~30MHz	ESH3-Z5	EC344	01/12/2007

Note: The above equipments are within the valid calibration period.

3. Radiated emission test FCC 15.249 (C)

3.1 Operating environment

Temperature:	23	°C
Relative Humidity:	56	%
Atmospheric Pressure:	1023	hPa

3.2 Test setup & procedure

The Diagram below shows the test setup, which is utilized to make these measurements.

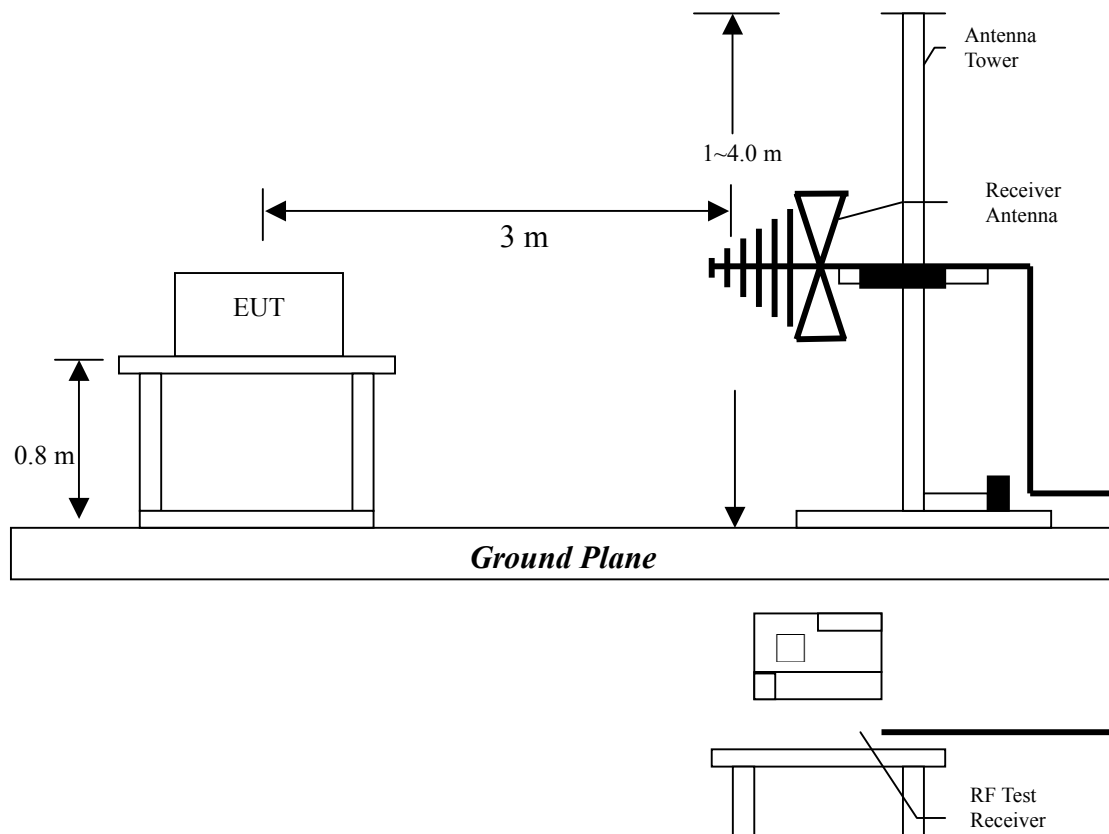

The signal is maximized through rotation and placement in the three orthogonal axes. Radiated emissions were investigated cover the frequency range from 30MHz to 1000MHz using a receiver RBW of 120kHz record QP reading, and the frequency over 1GHz using a spectrum analyzer RBW of 1MHz and 10Hz VBW record Average reading. (15.209 paragraph), the Peak reading (1MHz RBW/VBW) recorded also on the report. The EUT for testing is arranged on a wooden turntable. If some peripherals apply to the EUT, the peripherals will be connected to EUT and the whole system. During the test, all cables were arranged to produce worst-case emissions. The signal is maximized through rotation. The height of antenna and polarization is changing constantly for exploring for maximum signal level. The height of antenna can be up to 4 meters and down to 1 meter.

The measurement for radiated emission will be done at the distance of three meters unless the signal level is too low to measure at that distance. In the case of the reading under noise floor, a pre-amplifier is used and/or the test is conducted at a closer distance. And then all readings are extrapolated back to the equivalent three meter reading using inverse scaling with distance.

This test was verified at three orthogonal axes, and the test configuration was listed below:



After verifying three axes, the worst case was occurred at setup 3 configuration. The final test was executed under this configuration and recorded in this report.

The EUT configuration please refer to the “Spurious set-up photo.pdf”.

3.3 Emission limit

3.3.1 Fundamental and harmonics emission limits

Frequency (MHz)	Field Strength of Fundamental		Field Strength of Harmonics	
	(mV/m@3m)	(dBuV/m@3m)	(uV/m@3m)	(dBuV/m@3m)
2400-2483.5	50	94	500	54

3.3.2 General radiated emission limits

Emissions radiated outside of the specified frequency bands, except for harmonics, shall be attenuated by at least 50dB below the level of the fundamental or to the general radiated emission limits in paragraph 15.209, whichever is the lesser attenuation.

Frequency MHz	15.209 Limits (dB μ V/m@3m)
30-88	40
88-216	43.5
216-960	46
Above 960	54

Remark:

1. In the above table, the tighter limit applies at the band edges.
2. Distance refers to the distance in meters between the measuring instrument antenna and the closed point of any part of the device or system

Uncertainty was calculated in accordance with NAMAS NIS 81.

Expanded uncertainty (k=2) of radiated emission measurement is ± 4.98 dB.

3.4 Radiated spurious emission test data

3.4.1 Measurement results: frequencies equal to or less than 1 GHz

The test was performed on EUT under continuously transmitting mode. Channel 1, 40 were verified. The worst case occurred at Tx channel 1.

EUT : 36077
 Test Unit : Base
 Worst Case : Tx at channel 1

Frequency (MHz)	Spectrum Analyzer Detector	Antenna Polariz. (H/V)	Correction Factor (dB/m)	Reading (dBuV)	Corrected Level (dBuV/m)	Limit @ 3 m (dBuV/m)	Margin (dB)	Antenna high (cm)	Turn Table angle (degree)
43.5800	QP	V	12.38	25.88	38.26	40.00	-1.75	100	113
148.3400	QP	V	14.27	14.76	29.03	43.50	-14.47	100	302
165.8000	QP	V	15.70	17.18	32.88	43.50	-10.62	100	336
800.1800	QP	V	23.29	6.87	30.16	46.00	-15.84	241	258
43.580	QP	H	14.20	14.33	28.53	40.00	-11.47	400	115
107.600	QP	H	9.03	24.73	33.76	43.50	-9.75	400	185
165.800	QP	H	13.84	20.66	34.50	43.50	-9.01	400	233
303.540	QP	H	14.32	19.20	33.52	46.00	-12.49	221	68
800.180	QP	H	23.62	13.56	37.18	46.00	-8.82	124	40

Remark:

1. Corrected Level = Reading Level + Correction Factor
2. Correction Factor = Antenna Factor + Cable Loss

EUT : 36077
Test Unit : Handset
Test Condition : Tx at channel 1, 40

No Spurious emissions were found above the spectrum analyzer noise floor in the frequency range 30MHz to 1GHz.

3.5 Measurement results: frequency above 1GHz

EUT : 36077
 Test Unit : Base
 Test Condition : Tx at channel 1

Frequency (MHz)	Spectrum Analyzer Detector	Antenna Polariz. (H/V)	Preamp (dB)	Correction Factor (dB/m)	Reading (dBuV)	Corrected Level (dBuV)	Limit @ 3 m (dBuV)	Margin (dB)	Antenna high (cm)	Turn Table angle (degree)
2403.050	PK	H	35.76	30.31	68.63	63.18	114	-50.82	100	224
2403.050	AV	H	35.76	30.31	64.19	58.74	94	-35.26	100	224

Remark:

1. Corrected Level = Reading Level + Correction Factor – Preamp
2. Correction Factor = Antenna Factor + Cable Loss
3. The frequency measured ranges from 1GHz to 25GHz. The data value listed above which is higher than the noise floor, the others please refer to noise floor level.

Noise floor level is:

For PK:

1GHz-3GHz: 20dBuV
 3GHz-14GHz: 27dBuV
 14GHz-26.5GHz: 39dBuV

For AV:

1GHz-3GHz: 10dBuV
 3GHz-14GHz: 16dBuV
 14GHz-26.5GHz: 28dBuV

EUT : 36077
 Test Unit : Base
 Test Condition : Tx at channel 40

Frequency (MHz)	Spectrum Analyzer Detector	Antenna Polariz. (H/V)	Preamp (dB)	Correction Factor (dB/m)	Reading (dBuV)	Corrected Level (dBuV)	Limit @ 3 m (dBuV)	Margin (dB)	Antenna high (cm)	Turn Table angle (degree)
2405.000	PK	H	35.76	30.31	68.53	63.08	114	-50.92	100	12
2405.000	AV	H	35.76	30.31	63.25	57.8	94	-36.2	100	12

Remark:

1. Corrected Level = Reading Level + Correction Factor – Preamp
2. Correction Factor = Antenna Factor + Cable Loss
3. The frequency measured ranges from 1GHz to 25GHz. The data value listed above which is higher than the noise floor, the others please refer to noise floor level.

Noise floor level is:

For PK:

- 1GHz-3GHz: 20dBuV
- 3GHz-14GHz: 27dBuV
- 14GHz-26.5GHz: 39dBuV

For AV:

- 1GHz-3GHz: 10dBuV
- 3GHz-14GHz: 16dBuV
- 14GHz-26.5GHz: 28dBuV

EUT : 36077
 Test Unit : Handset
 Test Condition : Tx at channel 1

Frequency (MHz)	Spectrum Analyzer Detector	Antenna Polariz. (H/V)	Preamp (dB)	Correction Factor (dB/m)	Reading (dBuV)	Corrected Level (dBuV)	Limit @ 3 m (dBuV)	Margin (dB)	Antenna high (cm)	Turn Table angle (degree)
2474.000	PK	H	35.76	30.31	86.64	81.19	114	-32.81	100	209
2474.000	AV	H	35.76	30.31	86.01	80.56	94	-13.44	100	209

Remark:

1. Corrected Level = Reading Level + Correction Factor – Preamp
2. Correction Factor = Antenna Factor + Cable Loss
3. The frequency measured ranges from 1GHz to 25GHz. The data value listed above which is higher than the noise floor, the others please refer to noise floor level.

Noise floor level is:

For PK:

- 1GHz-3GHz: 20dBuV
- 3GHz-14GHz: 27dBuV
- 14GHz-26.5GHz: 39dBuV

For AV:

- 1GHz-3GHz: 10dBuV
- 3GHz-14GHz: 16dBuV
- 14GHz-26.5GHz: 28dBuV

EUT : 36077
 Test Unit : Handset
 Test Condition : Tx at channel 40

Frequency (MHz)	Spectrum Analyzer Detector	Antenna Polariz. (H/V)	Preamp (dB)	Correction Factor (dB/m)	Reading (dBuV)	Corrected Level (dBuV)	Limit @ 3 m (dBuV)	Margin (dB)	Antenna high (cm)	Turn Table angle (degree)
2475.950	PK	H	35.76	30.31	86.78	81.33	114	-32.67	100	187
2475.950	AV	H	35.76	30.31	86.17	80.72	94	-13.28	100	187

Remark:

1. Corrected Level = Reading Level + Correction Factor – Preamp
2. Correction Factor = Antenna Factor + Cable Loss
3. The frequency measured ranges from 1GHz to 25GHz. The data value listed above which is higher than the noise floor, the others please refer to noise floor level.

Noise floor level is:

For PK:

1GHz-3GHz: 20dBuV
 3GHz-14GHz: 27dBuV
 14GHz-26.5GHz: 39dBuV

For AV:

1GHz-3GHz: 10dBuV
 3GHz-14GHz: 16dBuV
 14GHz-26.5GHz: 28dBuV

4. Radiated emission on the band edge FCC 15.249(C)

Emissions radiated outside of the specified frequency bands, except for harmonics, shall be attenuated by at least 50 dB below the level of the fundamental (Base: 2403.05MHz ~ 2405.00MHz, Handset: 2474.00MHz ~ 2475.95MHz) or to the general radiated emission limits in §15.209, whichever is the lesser attenuation.

Please see the plot below.

Test Mode: Base

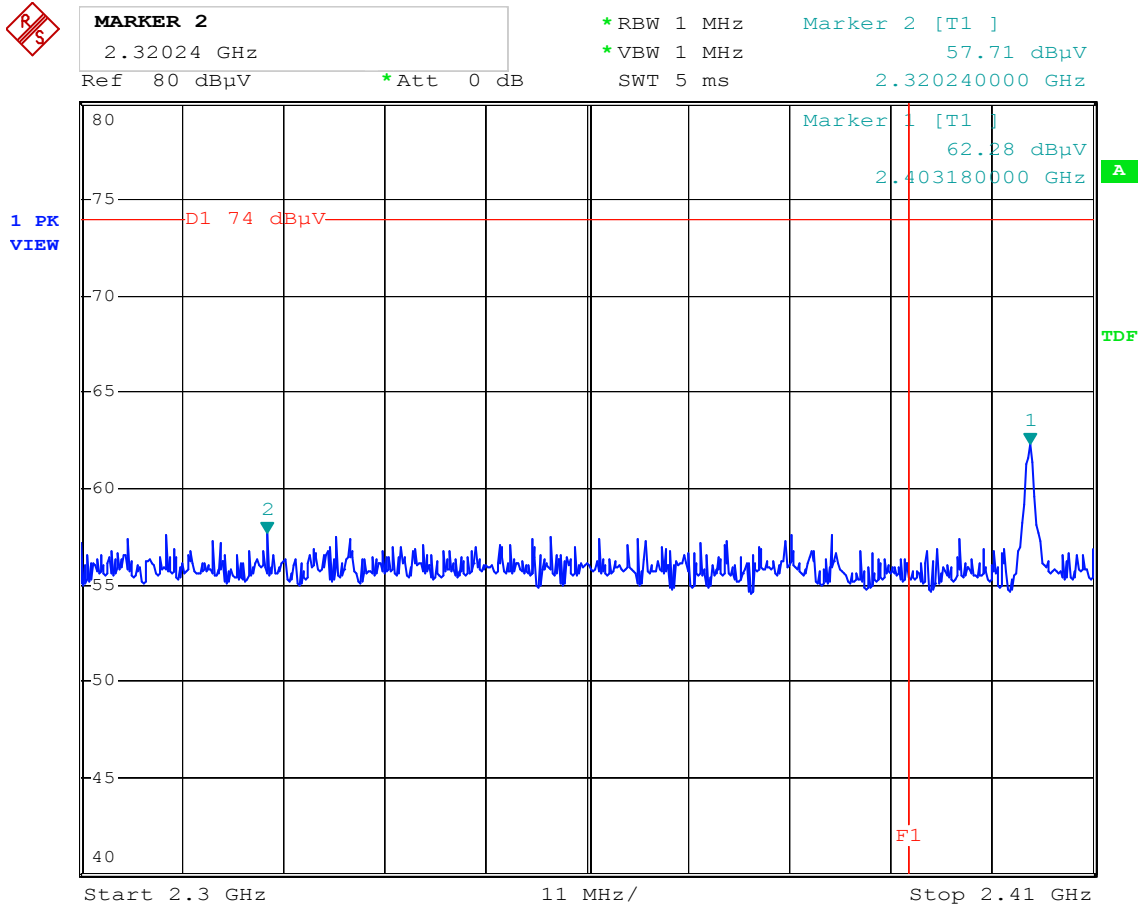

Comment: Band-edge at low ch
 Comment: 36077 Base PK F1=2390MHz
 Date: 20.MAR.2006 15:23:16

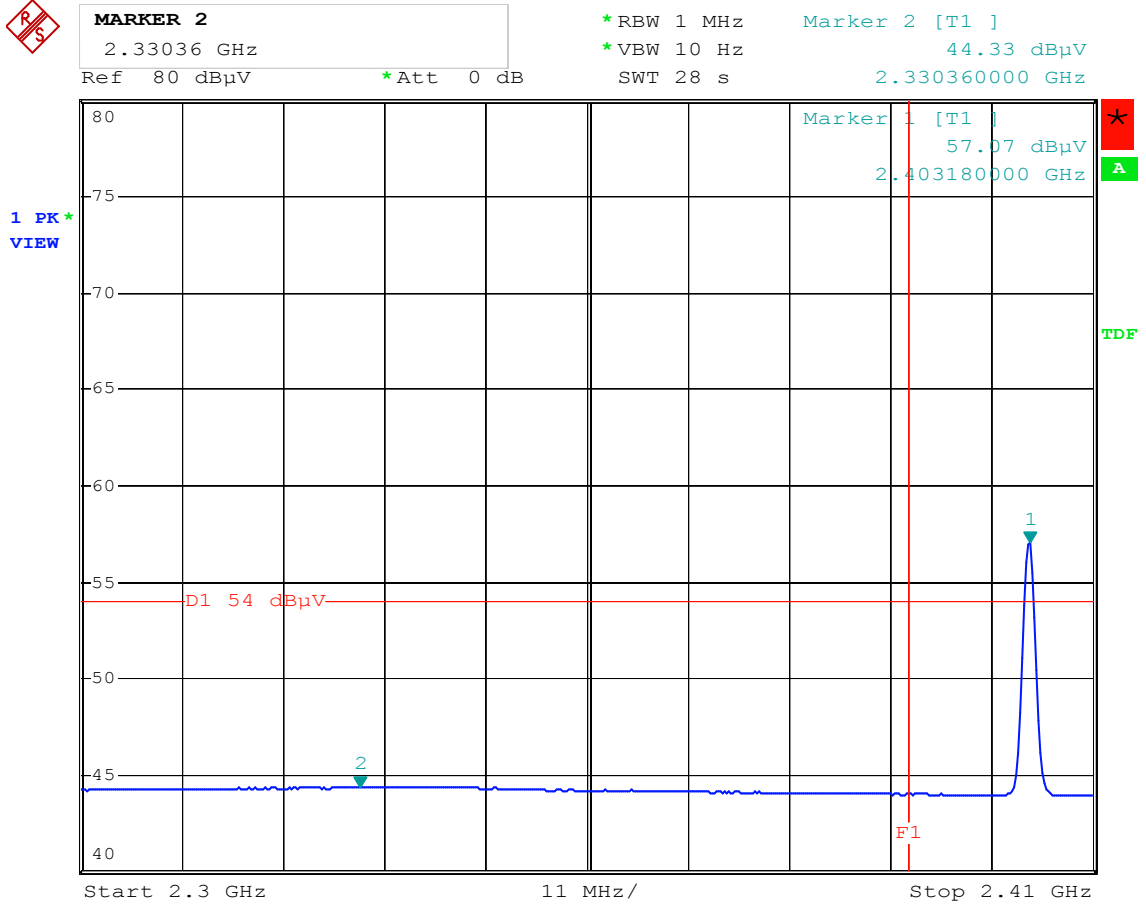

Comment: Band-edge at low ch
 Comment: 36077 Base AV F1=2390MHz
 Date: 20.MAR.2006 15:25:57

Test Mode: Handset

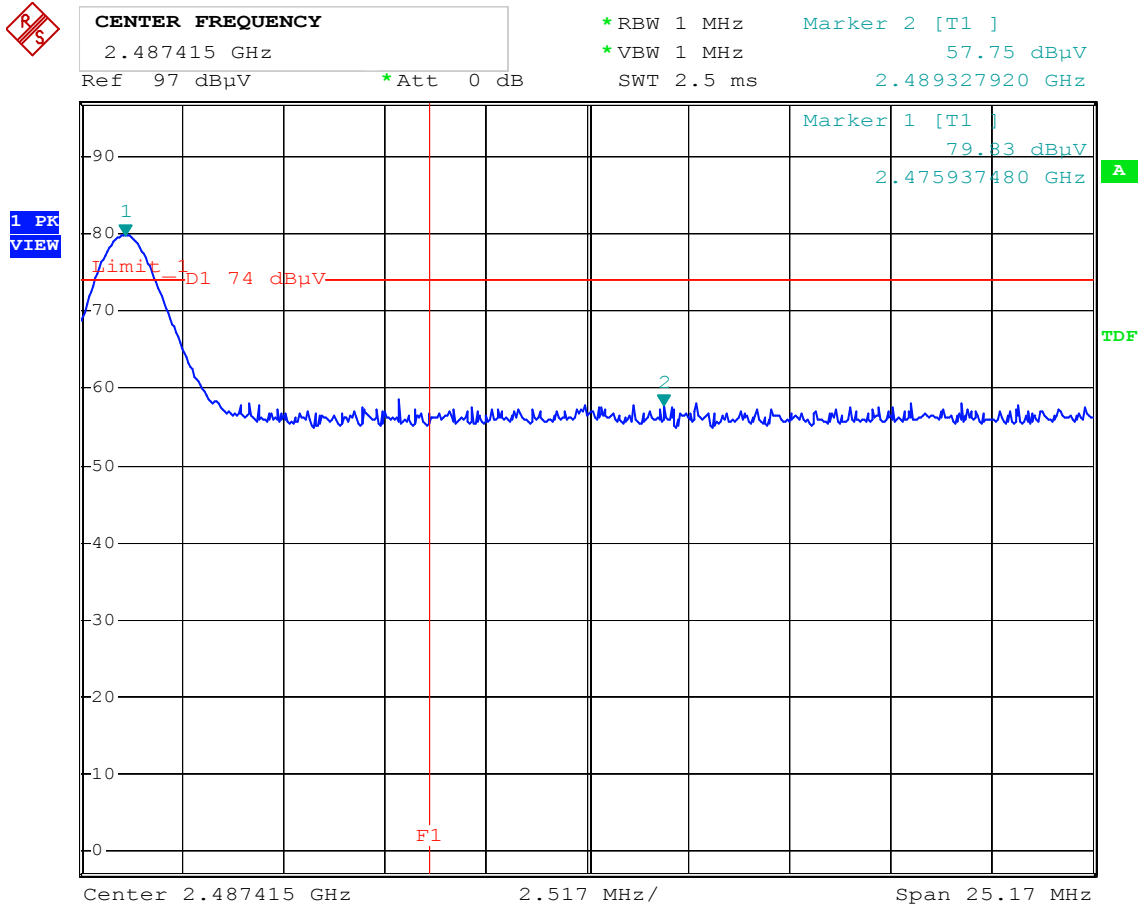

Comment: Band-edge at high ch
 Comment: Headset PK F1=2483.5MHz
 Date: 20.MAR.2006 16:16:27



MARKER 2 2.48605582 GHz Ref 97 dBµV *Att 0 dB	*RBW 1 MHz Marker 2 [T1] *VBW 10 Hz 46.09 dBµV SWT 6.4 s 2.486055820 GHz
---	--

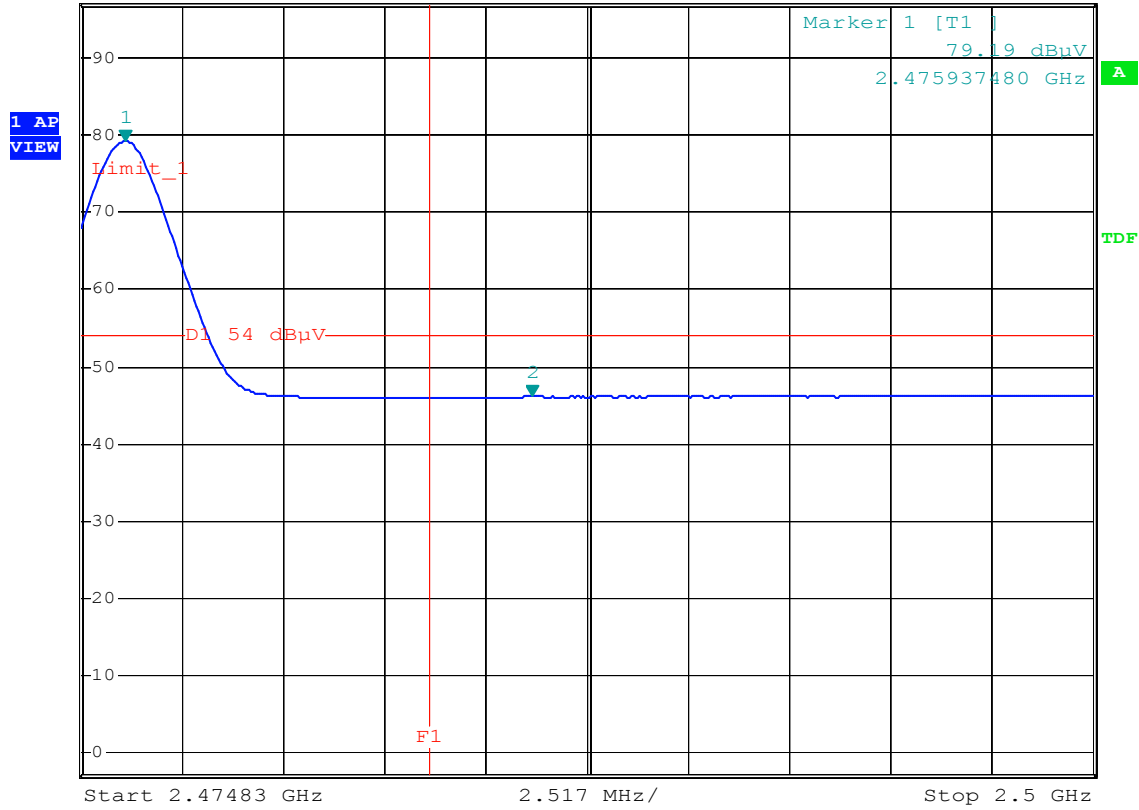

Comment: Band-edge at high ch
 Comment: Headset AV F1=2483.5MHz
 Date: 20.MAR.2006 16:18:37

5. Conducted emission test FCC 15.207

5.1 Operating environment

Temperature:	23	°C
Relative Humidity:	53	%
Atmospheric Pressure:	1023	hPa

5.2 Test setup & procedure

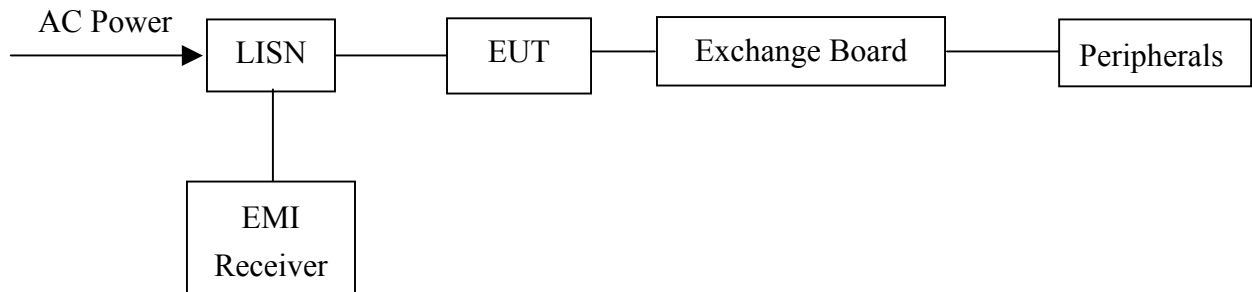

The EUT are connected to the main power through a line impedance stabilization network (LISN). This provides a 50 ohm/50uH coupling impedance for the measuring equipment. The peripheral devices are also connected to the main power through a LISN that provides a 50ohm/50uH coupling impedance with 50ohm termination.

Both sides (Line and Neutral) of AC line are checked for maximum conducted interference. In order to find the maximum emission, the relative positions of equipment and all of the interface cables must be changed according to ANSI C63.4/2003 on conducted measurement.

The bandwidth of the field strength meter (R & S Test Receiver ESCS 30) is set at 9kHz.

The EUT configuration please refer to the “Conducted set-up photo.pdf”.

5.3 Emission limit

Freq. (MHz)	Conducted Limit (dBuV)	
	Q.P.	Ave.
0.15~0.50	66 – 56*	56 – 46*
0.50~5.00	56	46
5.00~30.0	60	50

*Decreases with the logarithm of the frequency.

5.4 Uncertainty of Conducted Emission

Expanded uncertainty (k=2) of conducted emission measurement is ± 2.6 dB.

5.5 Power Line Conducted Emission test data

Phase : Line
EUT : 36077
Test Condition : Handset with Base

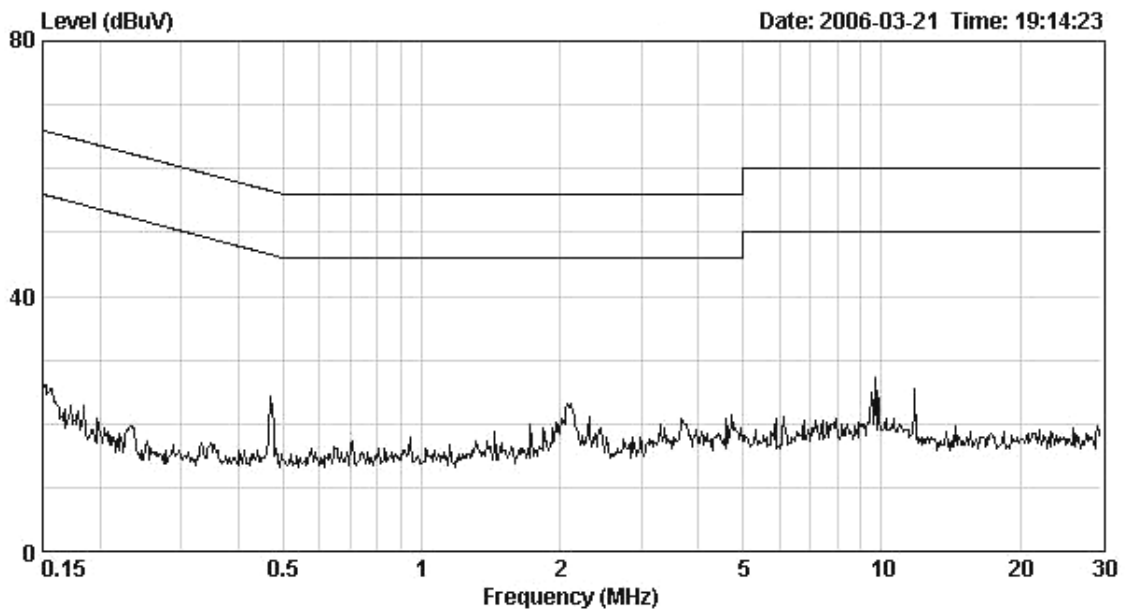

Test Result:

The power line conducted emission less than 20dB.

Phase : Neutral
EUT : 36077
Test Condition : Handset with Base

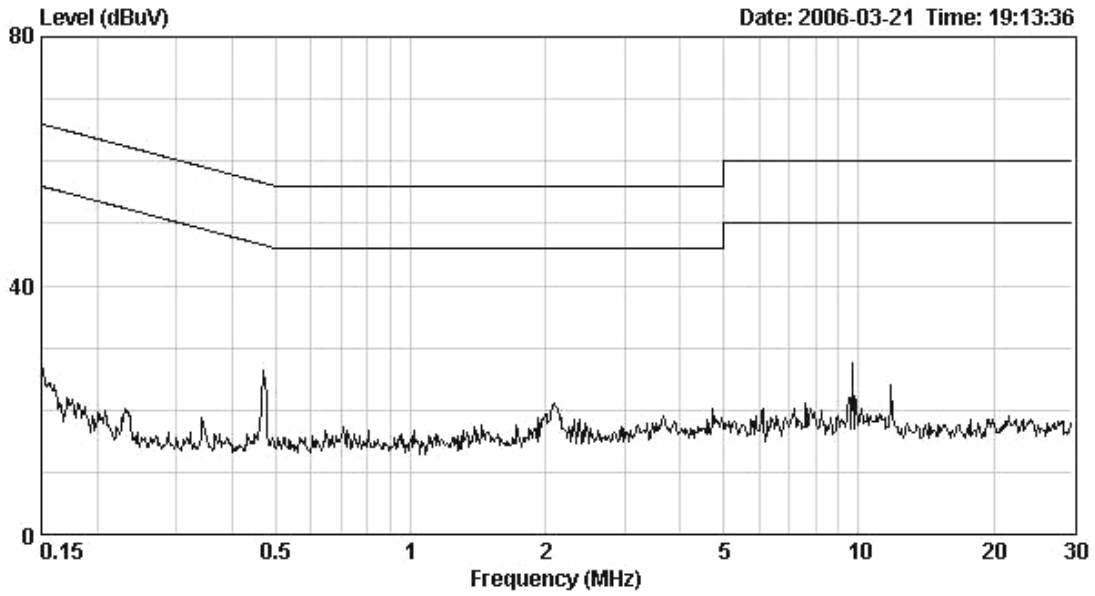

Test Result:

The power line conducted emission less than 20dB.