

TEST REPORT  
No.: 2-20542043b/02

for

GPRS/GSM 900/1800/1900 Module MC 45 +  
DSB 45 +  
Votronic Handset  
FCC ID: QIPMC45

**Applicant:** Siemens AG



TTI-P-G081/94

**FCC Registration  
No. 99538**

CETECOM - Certification and Testing in Communications GmbH  
Im Teelbruch 122  
D-45219 Essen  
Germany

Telephone: + 49 (0) 20 54 / 95 19 0  
Fax: + 49 (0) 2054 / 95 19 20

---

**Note:**

The test results relate only to the individual items which have been tested. This report shall not be reproduced in parts without the written approval of the testing laboratory

## Table of contents

<b>1. SUMMARY OF TEST RESULTS</b>	<b>3</b>
<b>2. ADMINISTRATIVE DATA</b>	<b>4</b>
2.1. IDENTIFICATION OF THE TESTING LABORATORY	4
2.2. TEST LOCATION	4
2.3. ORGANIZATIONAL ITEMS	4
2.4. APPLICANT'S DETAILS	4
2.5. MANUFACTURER'S DETAILS	4
<b>3. EQUIPMENT UNDER TEST (EUT)</b>	<b>5</b>
3.1. EUT: TYPE, S/N ETC. AND SHORT DESCRIPTIONS USED IN THIS TEST REPORT	5
3.2. AUXILIARY EQUIPMENT (AE): TYPE, S/N ETC. AND SHORT DESCRIPTIONS	5
3.3. EUT SET-UPS	6
3.4. EUT OPERATING MODES	6
<b>4. TEST SET-UPS</b>	<b>7</b>
4.1. TEST SET-UP 1 FOR CONDUCTED MEASUREMENTS	7
4.2. TEST SET-UP 2 FOR RADIATED MEASUREMENTS	8
4.3. PARAMETER SETTINGS ON MOBILE PHONE AND CMU	9
<b>5. MEASUREMENTS</b>	<b>10</b>
5.1. CALIBRATION OF ANECHOIC CHAMBER	10
5.2. RF POWER OUTPUT § 2.1046 CONDUCTED	11
5.3. RF POWER OUTPUT § 2.1046 RADIATED	12
5.4. OCCUPIED BANDWIDTH § 2.1049	13
5.5. SPURIOUS EMISSIONS AT ANTENNA TERMINALS § 2.1051	17
5.6. FIELD STRENGTH OF SPURIOUS RADIATION § 2.1053	26
5.7. FREQUENCY STABILITY / TEMPERATURE VARIATION § 2.1055	50
<b>6. INSTRUMENTS AND ANCILLARY EQUIPMENT „CTC“</b>	<b>53</b>
6.1. SINGLE INSTRUMENTS	53
6.2. TEST SYSTEMS	55
<b>7. PHOTOGRAPHS</b>	<b>56</b>
7.1. EXTERNAL PHOTOS OF EUT	56
7.2. INTERNAL PHOTOS OF EUT	57
7.3. PHOTOS OF TEST SET-UP	59

## 1. Summary of test results

### Modifications made during testing

The equipment passes without specific or special attributes.

### Deviations from the standard

No deviations were made from the requirements of the standard.

**Final Verdict: PASS**

FCC Rule	Industry Canada	Title	EUT set-up <sup>1</sup>	Result
§ 2.1046	RSS-133 §6.2	RF Output Power conducted	1	Complies
§ 2.1046 / § 24.232	RSS-133 §6.2	RF Output Power radiated, EIRP	2	Complies
§ 2.1049	--	Occupied bandwidth	1	Complies
§ 2.1051	RSS-133 §6.3	Spurious emissions at antenna terminals	1	Complies
§ 2.1053	RSS-133 §6.3	Field strength of spurious radiation	2	Complies
§ 2.1055	RSS-133 §7	Frequency Stability	1	Complies

FCC Rules Version July 2001

Responsible for testing laboratory



Responsible for test report

<sup>1</sup> for more details please see chapter "Equipment under test (EUT)".

## 2. Administrative Data

### 2.1. Identification of the testing laboratory

Company name:	CETECOM Certification and Testing in Communications GmbH
Address:	Im Teelbruch 122 D-45219 Essen - Kettwig Germany
Laboratory accreditation:	DAR-Registration No.: TTI-P-G081/94 FCC- Registration No.: 99538
Responsible for testing laboratory:	Dipl.-Ing. W. Richter
Deputies:	Dieter Franke Dipl.-Ing. Karin Silberhorn Dipl.-Ing. Heiko Strehlow

### 2.2. Test location

#### 2.2.1. Test laboratory "CTC"

Company name:	see chapter 2.1. Identification of the testing laboratory
---------------	---

### 2.3. Organizational items

Reference No.:	20542043
Order No.:	--
Responsible for test report and project leader:	Dipl.-Ing. V. Krueger
Receipt of EUT:	2002-07-17
Date(s) of test:	2002-07-17 – 2002-08-01
Date of report:	2002-08-19
Number of report pages:	65
Number of diagram pages (annex):	no diagrams
-----	
Version of template:	4.05

### 2.4. Applicant's details

Applicant's name:	Siemens AG
Address:	Siemensdamm 50 13629 Berlin Germany
Contact person:	Mr. Hussein Halawi; Tel. +49 30 38630211

### 2.5. Manufacturer's details

Manufacturer's name:	please see Applicant's details
Address:	please see Applicant's details

### 3. Equipment under test (EUT)

#### 3.1. EUT: Type, S/N etc. and short descriptions used in this test report

short description*)	EUT	Type	S/N serial number	HW hardware status	SW software status
EUT A	GPRS / GSM Module	MC 45	00499941137807 7	B 2.5	SW: 34
EUT B	Development support box	DSB 45	# 200	B 1.1	V 1.0
EUT C	Handset Votronic	HH-SI-30.3	Sample 2	V 1.1	--
EUT D					
EUT E					
EUT F					

\*) EUT short description is used to simplify the identification of the EUT in this test report.

#### Additional Information for EUT A

Frequency range: 1850.2 – 1909.8 MHz  
 Number of channels: 300  
 Nominal power supply voltage: 4,5 V (of module)  
 Power supply range: 3,3 – 4,5 V  
 Temperature range: -30°C - +60°C  
 Emission designator: 300KGXW  
 Antenna:  integral antenna       antenna connector       external antenna  
 Max. stated nominal output power: conducted 30,0 ±2 dBm, radiated 30,0 ±2 dBm EIRP  
 Max. measured output power: conducted 29,7 dBm, radiated 30,6 dBm EIRP

#### 3.2. Auxiliary Equipment (AE): Type, S/N etc. and short descriptions

AE short description*)	Auxiliary Equipment	Type	S/N serial number	HW Hardware status	SW software status
AE 1	RS 232 cable 1	for Com1 - Port	--	Length=1.81 meter	--
AE 2	RS 232 cable 2	for Com2 - Port	--	Length=1.81 meter	--
AE 3	AC/DC Adapter	MW 1000 GS	Sample 2	Input: 230 V AC, 50 Hz, 28 W Output: 3-6V 9-12 V DC, 1000 mA, 12 VA	--
AE 4	GSM Antenna	900/ 1800 MHz	# 1	0 dB Gain length=1 meter	--

\*) AE short description is used to simplify the identification of the auxiliary equipment in this test report.

### 3.3. EUT set-ups

EUT set-up no. *)	Combination of EUT and AE	Remarks
set. 1	EUT A + EUT B + EUT C + AE 1 + AE 2 + AE 3	Set-up for <b>conducted</b> measurements: MC 45 situated outside the DSB45 support-box com-1 cable and com-2 cable connected to DSB-Box but not terminated on the other side (open)
set. 2	EUT A + EUT B + EUT C + AE 1 + AE 2 + AE 3 + AE 4	Set-up for <b>radiated</b> measurements: MC 45 situated outside the DSB45 support-box com-1 cable and com-2 cable connected to DSB-Box but not terminated on the other side (open)
set. 3	--	--

\*) EUT set-up no. is used to simplify the identification of the EUT set-up in this test report.

### 3.4. EUT operating modes

EUT operating mode no. *)	Description of operating modes	Additional information
op. 1	<b>IDLE</b>	The mobile station is synchronized at the Broadcast Control Channel (BCCH) and listening to the Common Control Channel (CCCH), for details please see chapter: 4.3. Parameter settings on mobile phone and CMU.
op. 2	<b>TCH</b>	A communication link is established between the mobile station and the test simulator. The transmitter is operated at its maximum rated output power, for details please see chapter: 4.3. Parameter settings on mobile phone and CMU.

\*) EUT operating mode no. is used to simplify the test report.

## 4. Test Set-ups

### 4.1. Test Set-up 1 for Conducted measurements

The EUT's RF-signal is coupled out by the antenna connector which is supplied by the manufacturer. The signal is first 10 dB attenuated before it is 0° power divided (6 dB loss per branch). One of the signal path is connected to the communication base station CMU, the other one is connected to the spectrum – analyzer. The specific losses for both signal paths are first checked within a calibration, then the measurement readings on the CMU/ spectrum-analyzer are corrected by this specific test set-up loss. The attenuator, power divider, CMU and the spectrum-analyzer are impedance matched on 50 Ohm.

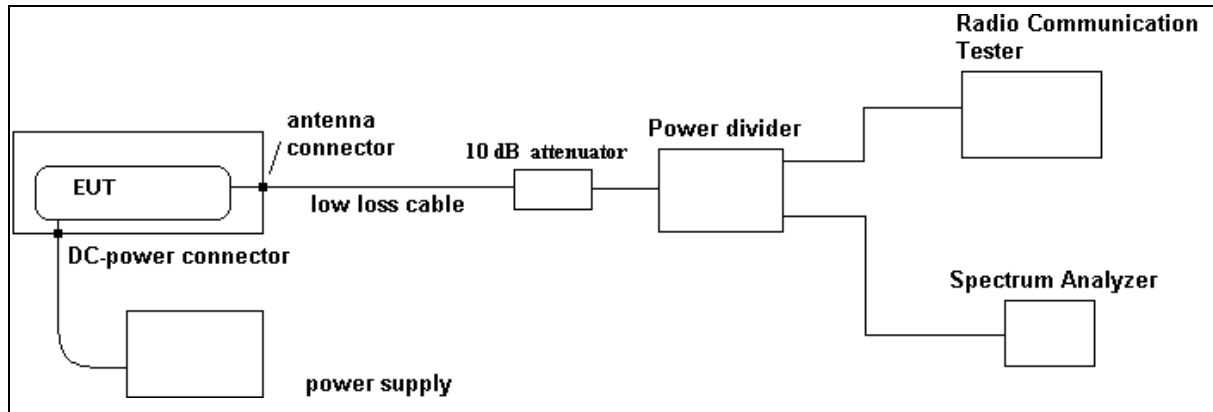

Block diagram: Test set-up 1

## 4.2. Test Set-up 2 for Radiated measurements

The radiated emissions from the test device are performed in a fully anechoic chamber. The EUT is placed on a non-conducting table of 1 meter high. The turntable and the position manipulator are commanded by an external control unit, so adjusting to all three orthogonal planes of the EUT are possible in order to maximize the radiated emissions. The measurements are performed in vertical and horizontal receiving antenna polarizations. The measuring distances are 3 meter for frequencies up to 1 GHz and 1 meter above 1 GHz. A biconilog antenna up to 1 GHz and Horn antennas for frequencies above 1 GHz are used.

The EUT is powered by an external DC-supply with nominal voltage, the signaling is performed from outside the chamber with a communication tester (CMU) by airlink (using a signaling antenna).

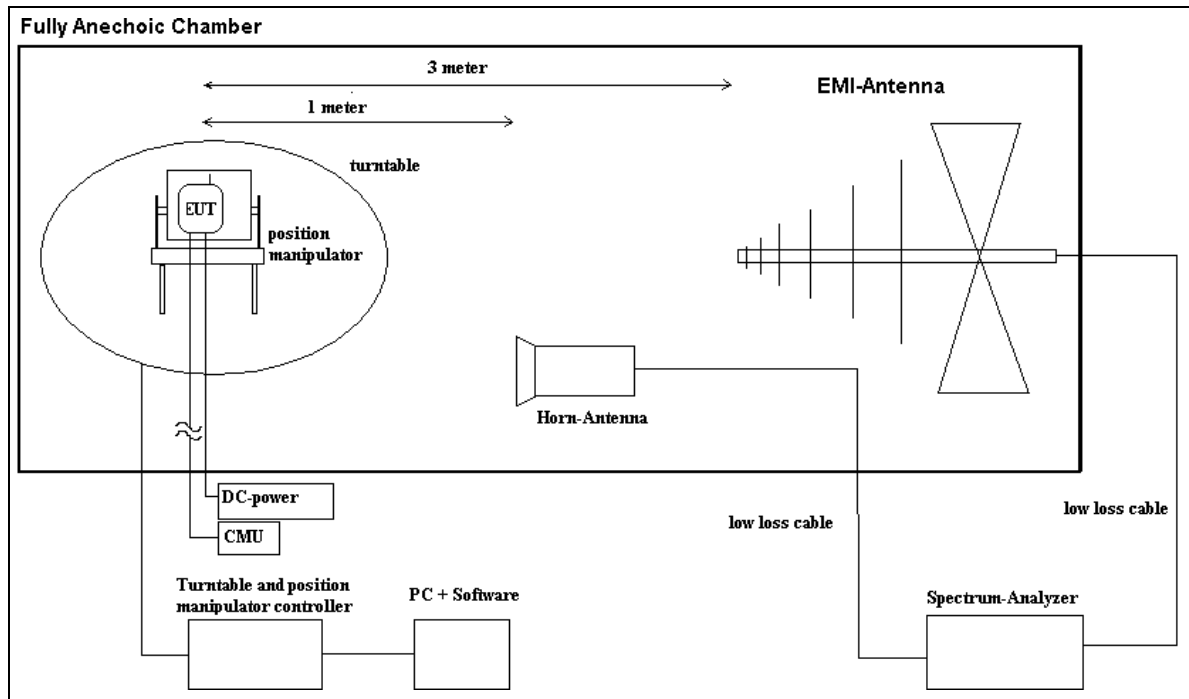

Block diagram: Test set-up 2



### 4.3. Parameter settings on mobile phone and CMU

Following settings are general for all measurements:

Parameter	Traffic Mode	Idle Mode
Traffic Channels mobile station	TCH MS = 512 / 681 / 810	--
maximum power step (PCL)	PCL = 0 (1 Watt)	--
Modulation	GMSK-Modulation	--
DTX	off	--
Bitstream	PRBS 2E9-1 (pseudo-random-sequence) – CCITT 0.153	
Timeslot	3	
Hopping	off	
Timeslot (slot mode)	single	
Maximum data transmission rate, single time slot	270.833 kBit/s	
Speech transcoding (Traffic Mode)	Full rate Version 1	
Mode	BCCH and TCH	
BCCH – base station (CMU, CMD)	Channel 530	530
TCH – base station (CMD, CMU)	auto	
Power level TCH – base station (used timeslot level)	- 70 dBm	
Power level BCCH – base station (control channel level)	- 80 dBm	
Burst shot	Single	
Display Mode	Maximum	
Statistic counts	200	
RF-maximum level	36 dBm	
RF Input / Output connector No.	No. 3	
P/PCL	3 channels	
BS AG BLKS RES	Not applicable	0
Paging re-organization		Off (0)
Signaling channel		SDCCH
Location Update		Auto
Cell access		Disabled (barred)

### Settings for CMU

Additional settings for § 2.1055

Repetition	Continuous	
Stop condition	None	
Display mode	Max./Min	
Statistic Count	1000 Bursts	
Decoder	Standard	

## 5. Measurements

### 5.1. Calibration of anechoic chamber

A pre-calibration method was used for determining the relevant radiated field-strength of radiated spurious in the fully anechoic chamber.

Generally a measured value is influenced by the characteristics of the used cables, filters, antennas and by the characteristics of the anechoic chamber.

By defining a **transducer** (TD) value, which include all characteristics of the signal propagation path (used equipment, cables, properties of anechoic chamber, etc.) from the source of radiation to the final reading equipment (spectrum-analyzer), the measured value can be corrected in order to get the real value of the device under test.

The method resumes as follows:

- 1.) determination of the path-loss of all cables used on the Tx- and Rx-side, which are used for the radiated measurement in the specific set-up for 1 meter and 3 meter distance.
- 2.) connection of the cables to the relevant antennas used for calibration.
- 3.) determination of the **space attenuation loss** ( $G$ ) in the anechoic-chamber for both horizontal and vertical antenna polarizations:

*A signal generator connected to the Tx-antenna sweeps the frequency range of interest (30 MHz to 20 GHz) with a CW-signal level of  $-30\text{dBm}$  - the readings on the Rx-side on the spectrum analyzer gives the space attenuation loss. The distance between Rx- and Tx-antenna is 3 meter for frequencies below 1 GHz, and 1 meter for frequencies above 1 GHz.*

- 4.) From the **space attenuation loss** mathematically the frequency dependant transducer values ( $\text{TD}_{H/V}$ ) can be evaluated:

$$\text{TD}_{H/V} = G_{H/V} + B_{H/V} - 10 \cdot \log_{10}(1.64) + D + E - F$$

#### ABBREVIATIONS:

$\text{TD}_{H/V}$  =  $\lambda/2$  transducer values horizontal / vertical  
 $G_{H/V}$  = space attenuation loss horiz./ vert.  
 $B_{H/V}$  = Gain of Tx-antenna -Dipole  
 $10 \cdot \text{Log}_{10}(1.64)$  = Gain in dB of  $\lambda/2$  Dipole relative to isotropic radiator  
 $D$  = insertion losses of Rx- and Tx-cables  
 $E$  = Loss of filters in signal path (not used for FCC measurements)  
 $F$  = Gain of pre-amplifiers in signal path (not used for FCC measurements)

- 5.) Definition of transducer tables which are programmed/ loaded in the spectrum analyzer. The readings on the spectrum-analyzer are automatically corrected by this values and can be compared directly with the limit lines. The limit is related to EIRP. EIRP can be calculated from ERP by adding the gain of the half-wave dipole:  $\text{EIRP} = \text{ERP} + 2.1\text{dBi}$

## 5.2. RF power output § 2.1046 conducted

### 5.2.1. Test equipment (for reference numbers please see chapter 'List of test equipment')

RF-equipment	Test site	Antenna	Spectrum Analyzer	GSM test system
249, 279	<input checked="" type="checkbox"/> radio lab	<input type="checkbox"/>	<input checked="" type="checkbox"/> 264 (FSEK 30)	<input checked="" type="checkbox"/> 298 (CMU 200)
	<input type="checkbox"/> anechoic chamber	<input type="checkbox"/>	<input type="checkbox"/> 120 (FSEM 30)	<input type="checkbox"/>
	<input type="checkbox"/>	<input type="checkbox"/>	<input type="checkbox"/>	<input type="checkbox"/>

### 5.2.2. Test condition and test set-up

T = 22°C, h = 66%, p = 1015 hPa

(a) For transmitters other than single sideband, independent sideband and controlled carrier radiotelephone, power output shall be measured at the RF output terminals when the transmitter is adjusted in accordance with the tune-up procedure to give the values of current and voltage on the circuit elements specified in § 2.1033(c)(8). The electrical characteristics of the radio frequency load attached to the output terminals when this test is made shall be stated.

(b) For single sideband, independent sideband, and single channel, controlled carrier radiotelephone transmitters the procedure specified in paragraph (a) of this section shall be employed and, in addition, the transmitter shall be modulated during the test as follows. In all tests, the input level of the modulating signal shall be such as to develop rated peak envelope power or carrier power, as appropriate, for the transmitter.

(c) For measurements conducted pursuant to paragraphs (a) and (b) of this section, all calculations and methods used by the applicant for determining carrier power or peak envelope power, as appropriate, on the basis of measured power in the radio frequency load attached to the transmitter output terminals shall be shown. Under the test conditions specified, no components of the emission spectrum shall exceed the limits specified in the applicable rule parts as necessary for meeting occupied bandwidth or emission limitations.

- 1) The measurements were made at the upper, center, and lower carrier traffic frequencies of the PCS band. Choosing three representative Tx-carrier frequencies of the mobile phone (1850.2 MHz, 1880 MHz and 1909.8 MHz) should be sufficient to demonstrate compliance.
- 2) The measurements were performed with the integrated power measurement function of the „radio communication tester CMU“ from Rohde & Schwarz. In this way spectrum analyzer instrument limitations can be avoided/minimized. Instead, CMU’s manufacturers calibration error can be assumed for this measurement.
- 3) The attenuations (insertion loss) at the RF Inputs/Outputs of CMU were set according the losses of the set-up, determined in a first step before starting the measurements. In this way the insertion loss is automatically considered for power readings.
- 4) The maximum power level of the GSM-Bursts were recorded: average and peak values

The configuration of the signaling unit is shown in chapter ‘Parameter settings on mobile phone’.

### 5.2.3. Results

The EUT is powered with nominal voltage.

EUT Type and S/N or EUT set-up no.		EUT set-up 1; op. 2 = TCH			
Channel:	Transducer factor [dB]	Average power [dBm]	Peak power [dBm]	Limit [dBm]	Verdict
512	16,2	29,5	29,6	30,0 ± 2dB	passed
661	16,2	29,4	29,5	30,0 ± 2dB	passed
810	16,5	29,5	29,7	30,0 ± 2dB	passed

### 5.3. RF power output § 2.1046 radiated

#### 5.3.1. Test equipment (for reference numbers please see chapter 'List of test equipment')

RF-equipment	Test site	Antenna	Spectrum Analyser	GSM test system
	<input type="checkbox"/> radio lab	<input checked="" type="checkbox"/> 48 bicon.-log.	<input checked="" type="checkbox"/> 264 (FSEK 30)	<input checked="" type="checkbox"/> 298 (CMU 200)
	<input checked="" type="checkbox"/> anechoic chamber	<input checked="" type="checkbox"/> 133 horn	<input type="checkbox"/> 120 (FSEM 30)	<input type="checkbox"/>
	<input type="checkbox"/>	<input checked="" type="checkbox"/> 302 horn	<input type="checkbox"/>	<input type="checkbox"/>

#### 5.3.2. Test condition and test set-up

T = 25°C, h = 65%, p = 1015 hPa

(a) For transmitters other than single sideband, independent sideband and controlled carrier radiotelephone, power output shall be measured at the RF output terminals when the transmitter is adjusted in accordance with the tune-up procedure to give the values of current and voltage on the circuit elements specified in § 2.1033(c)(8). The electrical characteristics of the radio frequency load attached to the output terminals when this test is made shall be stated.

(b) For single sideband, independent sideband, and single channel, controlled carrier radiotelephone transmitters the procedure specified in paragraph (a) of this section shall be employed and, in addition, the transmitter shall be modulated during the test as follows. In all tests, the input level of the modulating signal shall be such as to develop rated peak envelope power or carrier power, as appropriate, for the transmitter.

(c) For measurements conducted pursuant to paragraphs (a) and (b) of this section, all calculations and methods used by the applicant for determining carrier power or peak envelope power, as appropriate, on the basis of measured power in the radio frequency load attached to the transmitter output terminals shall be shown. Under the test conditions specified, no components of the emission spectrum shall exceed the limits specified in the applicable rule parts as necessary for meeting occupied bandwidth or emission limitations.

- 1.) The measurements were made at the upper, center, and lower carrier traffic frequencies of the PCS band. Choosing three representative Tx-carrier frequencies of the mobile phone (1850.2 MHz, 1880 MHz and 1909.8 MHz), should be sufficient to demonstrate compliance.
- 2.) The measurements were performed with the integrated power measurement function of the „radio communication tester CMU“ from Rohde & Schwarz. In this way spectrum analyzer instrument limitations can be avoided/minimized. Instead, CMU manufacturers calibration error can be assumed for this measurement.
- 3.) The transducer factors (determined within the anechoic-chamber calibration) corresponding to the carrier frequency were entered as RF Inputs/Outputs attenuation of the CMU. Therefore the levels measured are referred to the output level of the EUT and shifted to the actual level at the input connector of the CMU.
- 4.) During rotation of the EUT the maximum power levels of the GSM-Bursts were recorded: average and peak values. This was performed for both polarization's of the measuring antennas.

The configuration of the signaling unit is shown in chapter 'Parameter settings on mobile phone'.

#### 5.3.3. Results

The EUT is powered with nominal voltage.

EUT Type and S/N or EUT set-up no.		EUT set-up 2; op. 2 = TCH			
Channel:	Transducer factor [dB]	Average power EIRP [dBm]	Peak power EIRP [dBm]	Limit [dBm]	Verdict
512	30,7	29,3	30,1	33	passed
661	30,7	27,1	27,2	33	passed
810	30,7	30,4	30,6	33	passed

## 5.4. Occupied bandwidth § 2.1049

### 5.4.1. Test equipment (for reference numbers please see chapter 'List of test equipment')

RF-equipment	Test site	Antenna	Spectrum Analyser	GSM test system
249, 279	<input checked="" type="checkbox"/> radio lab	<input type="checkbox"/>	<input checked="" type="checkbox"/> 264 (FSEK 30)	<input checked="" type="checkbox"/> 298 (CMU 200)
	<input type="checkbox"/> anechoic chamber	<input type="checkbox"/>	<input type="checkbox"/> 120 (FSEM 30)	<input type="checkbox"/>
	<input type="checkbox"/>	<input type="checkbox"/>	<input type="checkbox"/>	<input type="checkbox"/>

### 5.4.2. Test condition and test set-up

T = 22°C, h = 60%, p = 1015hPa

„the occupied bandwidth, that is the frequency bandwidth, such that, below its lower and above its upper frequency limits, the mean powers radiated are each equal to 0.5 percent of the total mean power radiated by a given emission shall be measured under the following conditions as applicable“

(h) transmitters employing digital modulation techniques-when modulated by an input signal such that its amplitude and symbol rate represent the maximum rated conditions under which the equipment will operated. The signal shall be applied through any filter networks, pseudo-random generators or other devices required in normal service“

#### Settings of spectrum-analyzer

- ⇒ the Spectrum-Analyzer was fully-calibrated with the internal reference before starting the tests
- ⇒ Resolution Bandwidth: 1% from applicants stated/measured emission bandwidth
- ⇒ Span: 1 MHz
- ⇒ Video BW: 10 times the RBW
- ⇒ Detector: RMS
- ⇒ Sweep Time: according GSM dwell-time

The measurements were made at the upper, middle, and lower carrier traffic frequencies of the PCS band. Choosing three representative Tx-carrier frequencies of the mobile phone (1850.2 MHz, 1880 MHz and 1909.8 MHz), should be sufficient to demonstrate compliance.

Additionally the emission bandwidth (-26 dBc bandwidth) was recorded. The results were taken in order to determine according to §24.238 the resolution bandwidth, which should be at least 1% of the emission bandwidth.

The configuration of the signaling unit is shown in chapter ‘Parameter settings on mobile phone’.

### 5.4.3. Results

The EUT is powered with nominal voltage.

Channel	99% Occupied bandwidth		-26 dBc Emission bandwidth	
	Diagram No.	[kHz]	Diagram No.	[kHz]
512	13.01	244,49	13.04	316,63
661	13.02	244,49	13.05	312,63
810	13.03	246,49	13.06	312,63

Remarks: --

⇒ determined resolution bandwidth = >3kHz

5.4.4. Diagrams

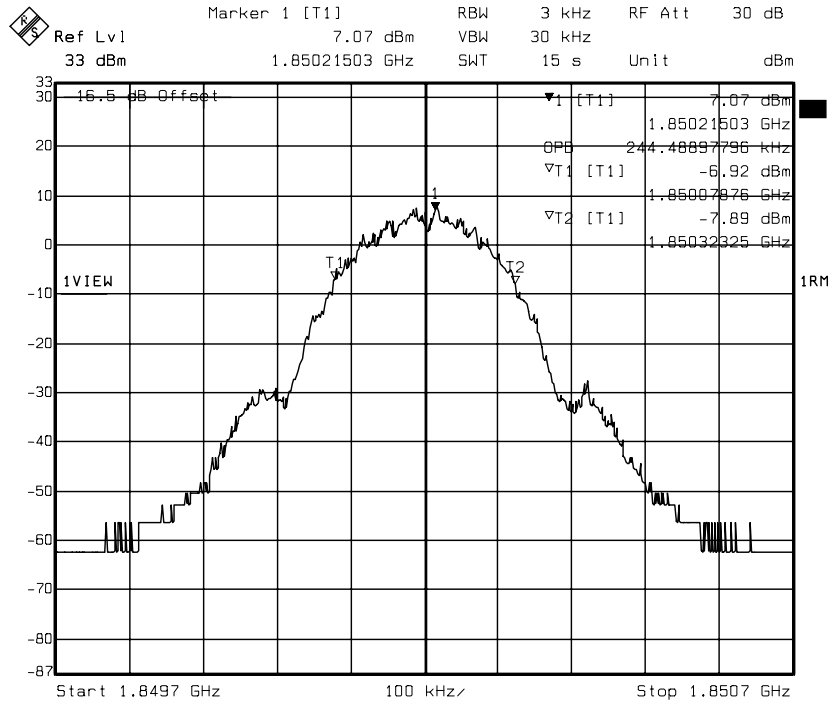

diagram 13.01

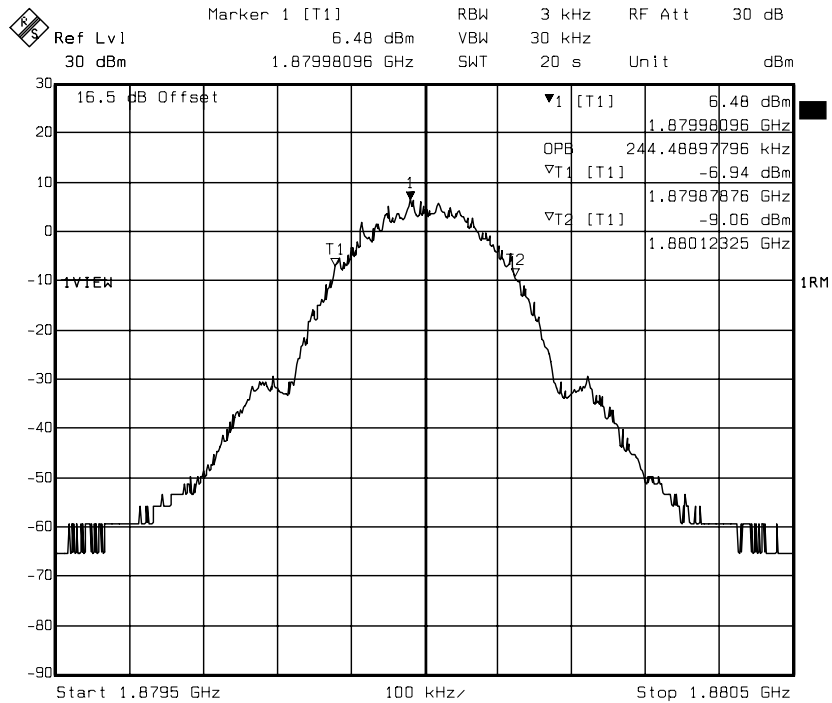

diagram 13.02

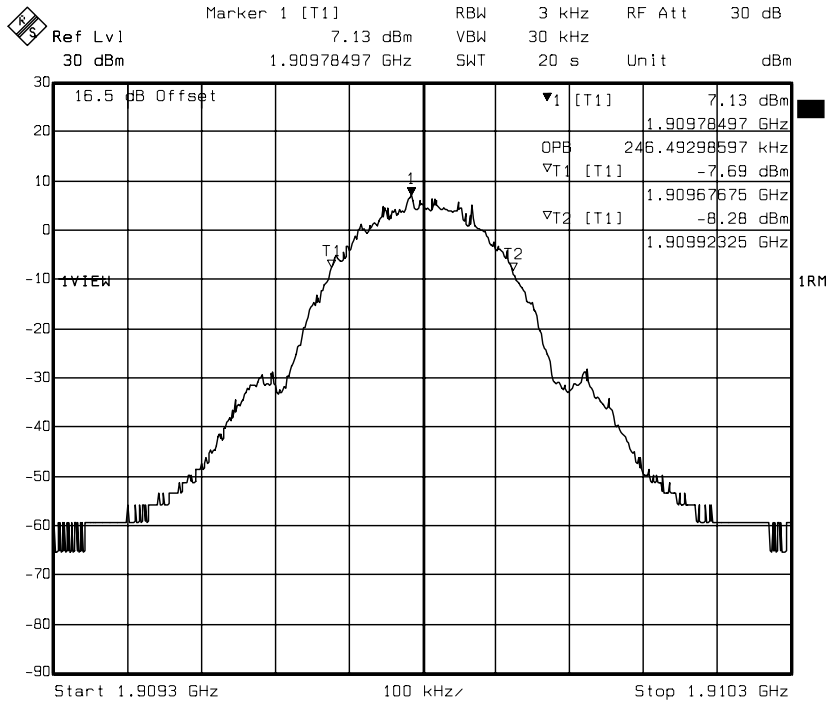

diagram 13.03

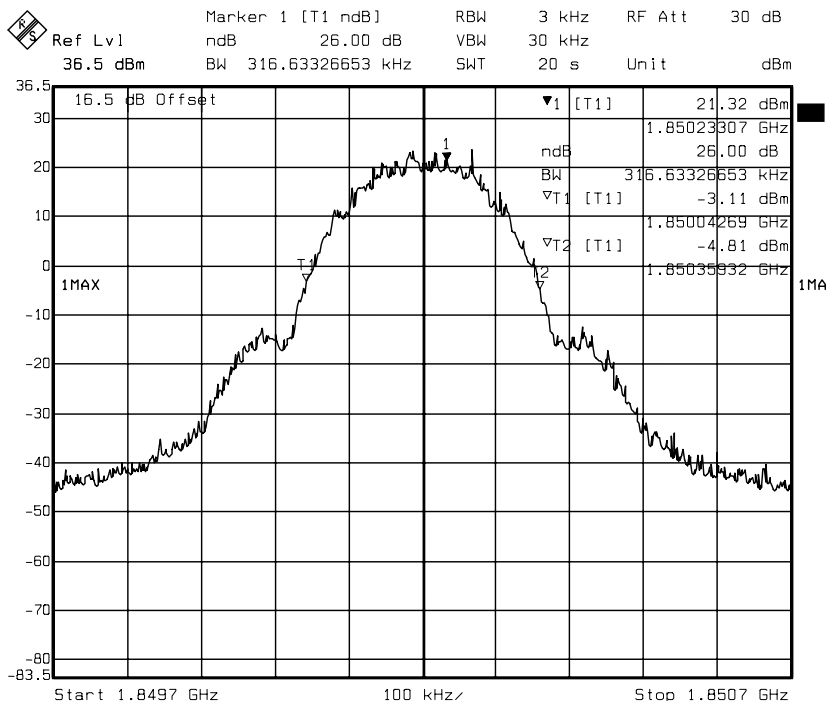

diagram 13.04

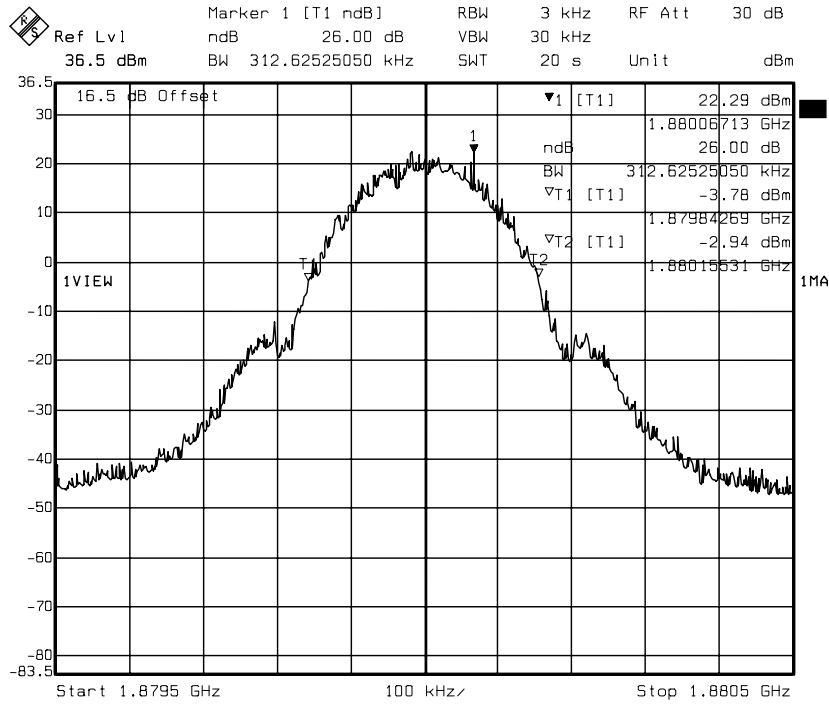

diagram 13.05

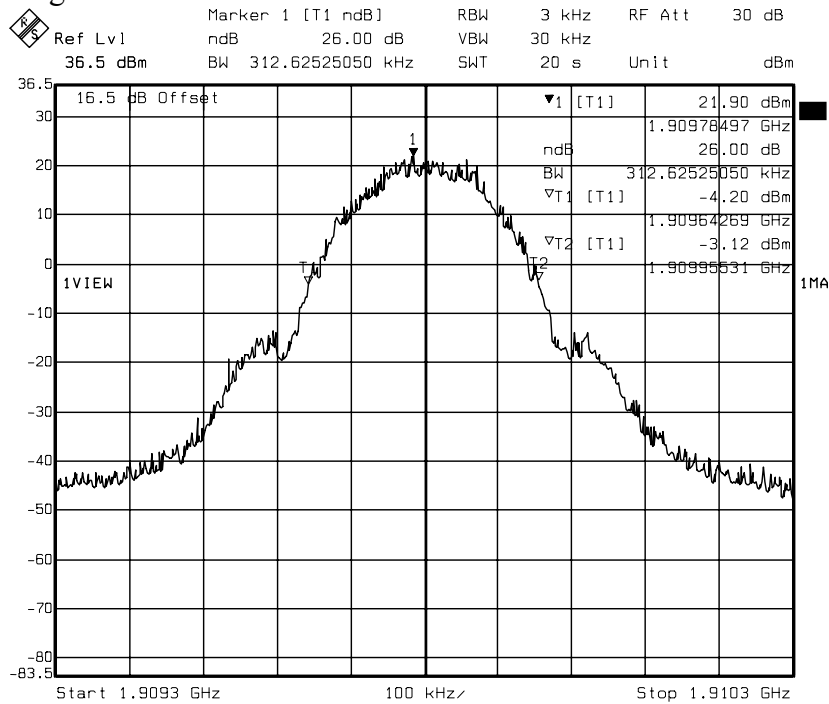

diagram 13.06



## 5.5. Spurious emissions at antenna terminals § 2.1051

### 5.5.1. Test equipment (for reference numbers please see chapter 'List of test equipment')

RF-equipment	Test site	Antenna	Spectrum Analyzer	GSM test system
249, 279	<input checked="" type="checkbox"/> radio lab	<input type="checkbox"/>	<input checked="" type="checkbox"/> 264 (FSEK 30)	<input checked="" type="checkbox"/> 298 (CMU 200)
	<input type="checkbox"/> anechoic chamber	<input type="checkbox"/>	<input type="checkbox"/> 120 (FSEM 30)	<input type="checkbox"/>
	<input type="checkbox"/>	<input type="checkbox"/>	<input type="checkbox"/>	<input type="checkbox"/>

### 5.5.2. Test condition and test set-up

T = 23°C, h = 60%, p = 1015 hPa

#### 24.238 (a)

„On any frequency outside a licensee’s frequency block (e.g. A, D, B, etc.) within the USPCS spectrum, the power of any emission shall be attenuated below the transmitter power (P, in Watts) by at least  $43+10\log(P)$  dB“

The spectrum was scanned from 1 MHz to the 10th harmonic of the highest frequency generated within the equipment. A stop frequency of 20 GHz is considered high enough to show compliance for the mobile phone. The specification that emissions shall be attenuated below the transmitter power (P) by at least  $43 + 10 \log (P)$  dB, translates in the relevant power range of the mobile phone (1 to 0.001 W) to a constant limit of -13 dBm.

Choosing three representative Tx-carrier frequencies of the mobile phone (1850.2 MHz, 1880 MHz and 1909.8 MHz), should be sufficient to demonstrate compliance.

- ⇒ The emissions were recorded using peak-detector and hold-max function of the spectrum-analyzer. Emissions more than 20 dB under the limit of -13 dBm are especially specified, otherwise the noise floor is recorded.
- ⇒ The reading on the spectrum-analyzer is automatically corrected by the transducer value (insertion loss)

### 5.5.3. Settings of spectrum analyzer

#### 24.238 (b)

„Compliance with these provisions is based on the use of measurement instrumentation employing a resolution bandwidth of 1 MHz or greater. However, in the 1 MHz bands immediately outside and adjacent to the frequency block a resolution bandwidth of at least one percent of the emission bandwidth of the fundamental emission of the transmitter may be employed. The emission bandwidth is defined as the width of the signal between two points, one below the carrier center frequency and one above the carrier center frequency, outside of which all emissions are attenuated at least 26 dB below the transmitter power“

Frequency range	RBW (resolution bandwidth)	VBW (video bandwidth)
1 MHz immediately outside and adjacent the frequency blocks	1% from applicants stated/measured emission bandwidth	10 times the RBW
More than 1 MHz outside and adjacent the frequency blocks	1 MHz	10 MHz

**RBW and VBW settings of spectrum analyzer**

The configuration of the signaling unit is shown in chapter 'Parameter settings on mobile phone'.

**5.5.4. Results**

EUT Type and S/N or EUT set-up no.		EUT set-up 1						
EUT-operation mode		Op. 2						
Diagram number	Start frequency (MHz)	Stop frequency (MHz)	Frequency of worst value (MHz)	Measured worst value (dBm)	Limit (dBm)	Margin	Remark	Verdict
Channel 512, 1850,2 MHz								
14.01	0,009	1835	62,52	-44,67	-13	31,67		passed
14.02	1835,0	2500,0	1933,61	-31,77	-13	18,77	*	passed
14.03	2500,0	20000,0	5551,10	-24,83	-13	11,83		passed
14.04	1849,0	1850,0	1849,98	-14,53	-13	1,53		passed
Channel 661, 1880,0 MHz								
14.05	0,009	1835	62,52	-46,29	-13	33,29		passed
14.06	1835,0	2500,0	1933,62	-31,72	-13	18,72	*	passed
14.07	2500,0	20000,0	5621,24	-26,35	-13	13,35		passed
14.08	1878,8	1879,8	1879,78	-14,82	-13	1,82		passed
14.09	1880,2	1881,2	1880,21	-14,02	-13	1,02		passed
Channel 810, 1909,80 MHz								
14.10	0,009	1835	62,52	-45,54	-13	32,54		passed
14.11	1835,0	2500,0	1933,61	-32,39	-13	19,39	*	passed
14.12	2500,0	20000,0	5726,45	-26,01	-13	13,01		passed
14.13	1910,0	1911,0	1910,0	-14,15	-13	1,15		passed

\*: Exclusion band from 1850 – 1990 MHz

### 5.5.5. Diagrams

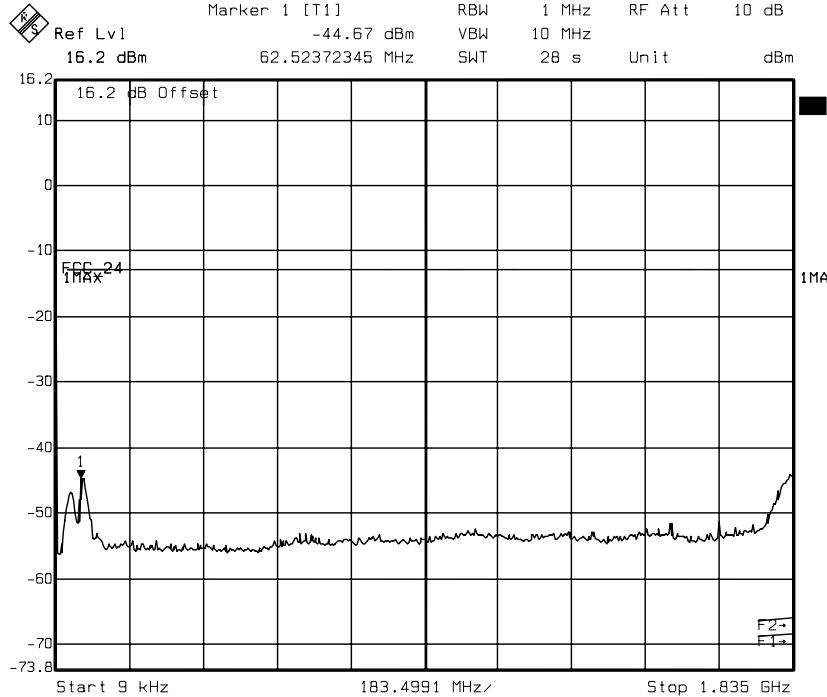

diagram 14.01: carrier on channel 512 (1850,2 MHz)

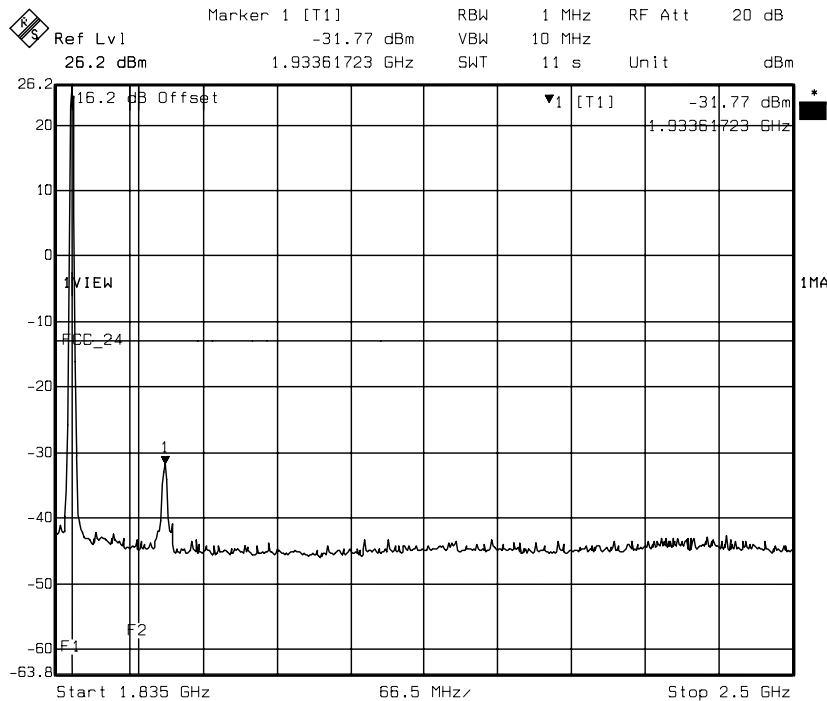
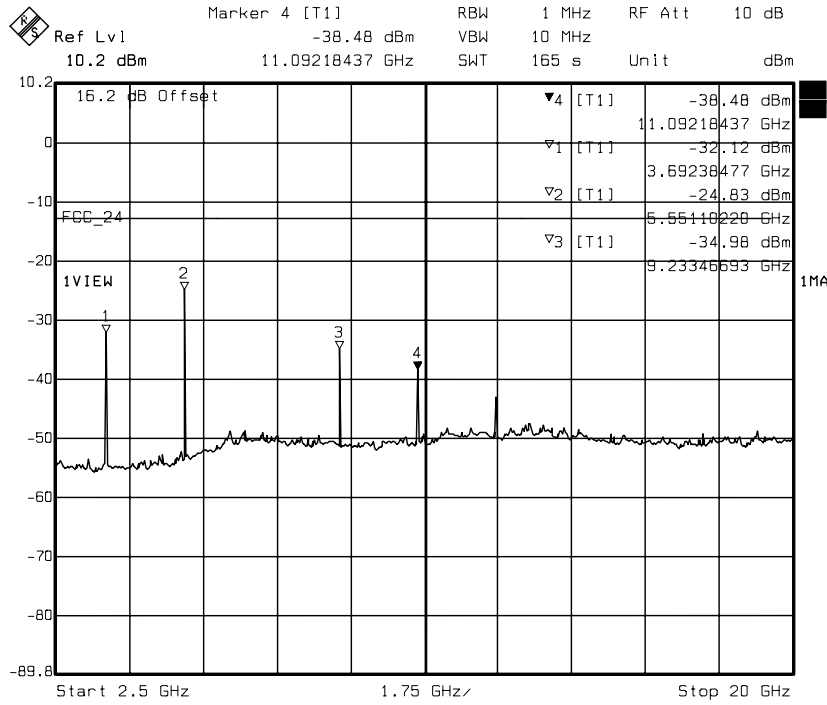
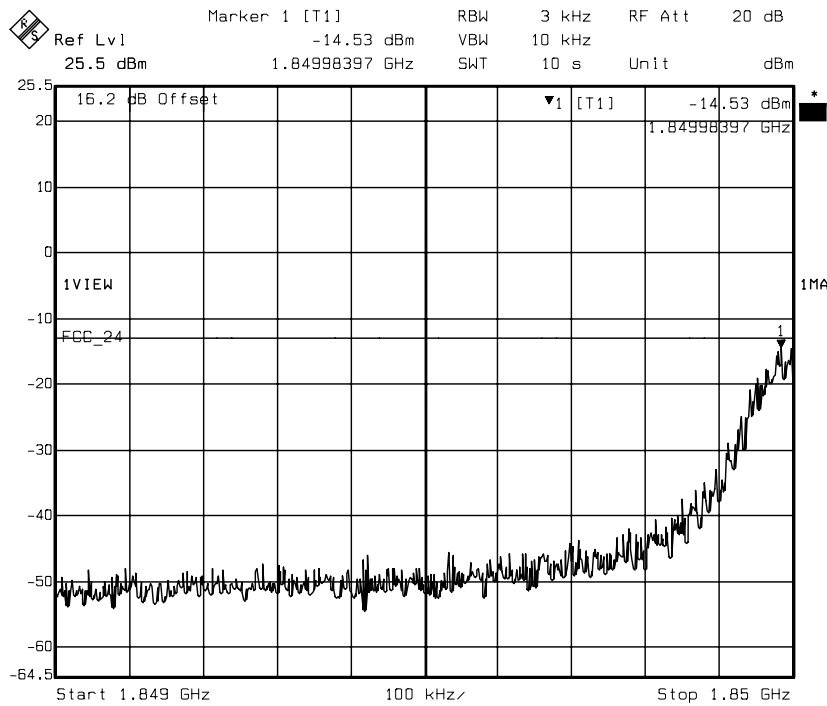

diagram 14.02: carrier on channel 512 (1850,2 MHz)



Title: FCC24 §2.1053, conducted measurement  
 Date: 24.JUL.2002 15:02:27

diagram 14.03: carrier on channel 512 (1850,2 MHz)



Title: FCC Part 24, §2.1053 conducted measurement  
 Date: 24.JUL.2002 15:05:10

diagram 14.04: carrier on channel 512 (1850,2 MHz)

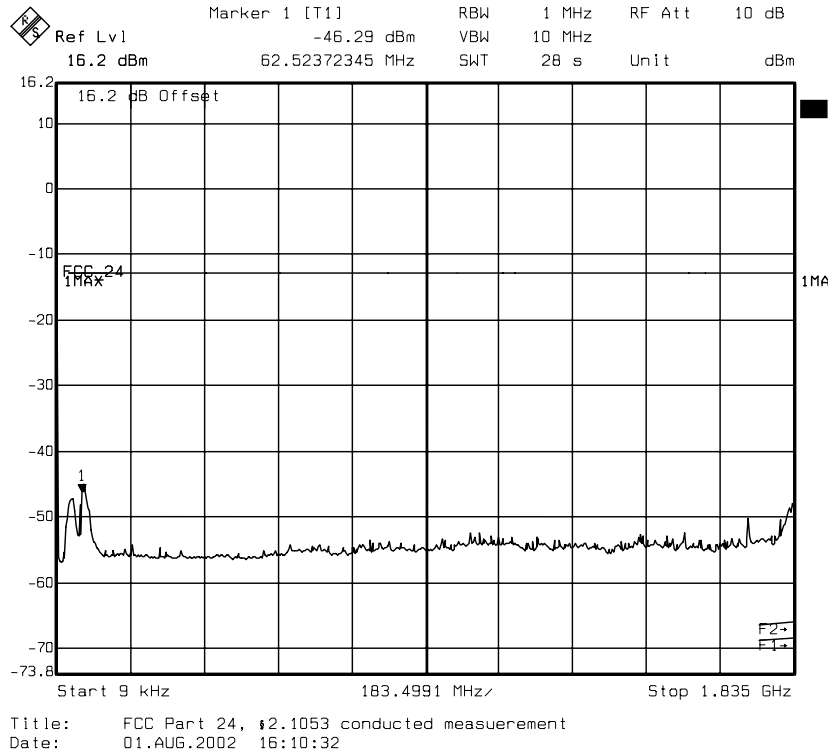

diagram 14.05: carrier on channel 661 (1880 MHz)

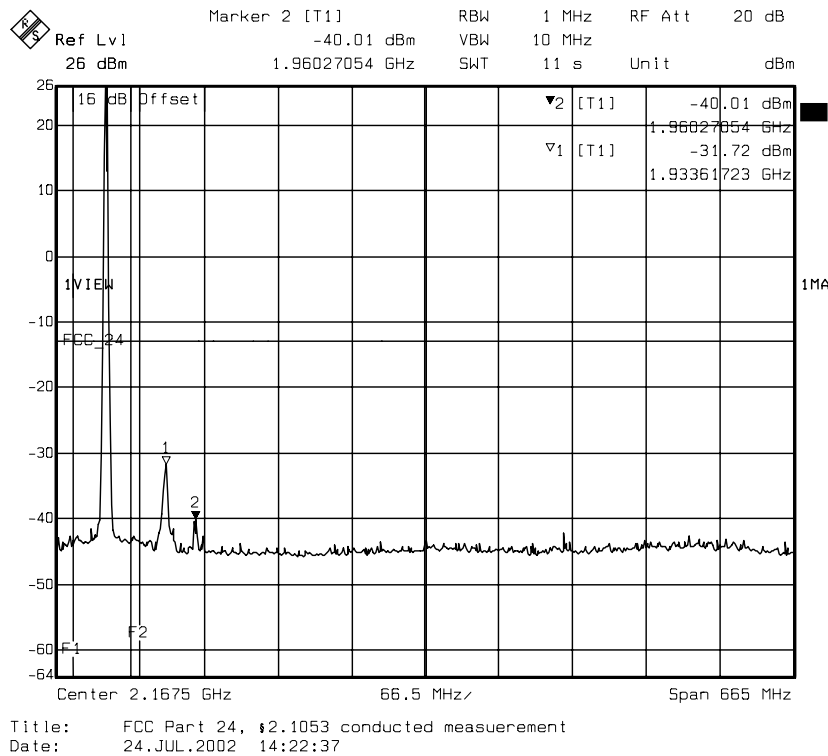
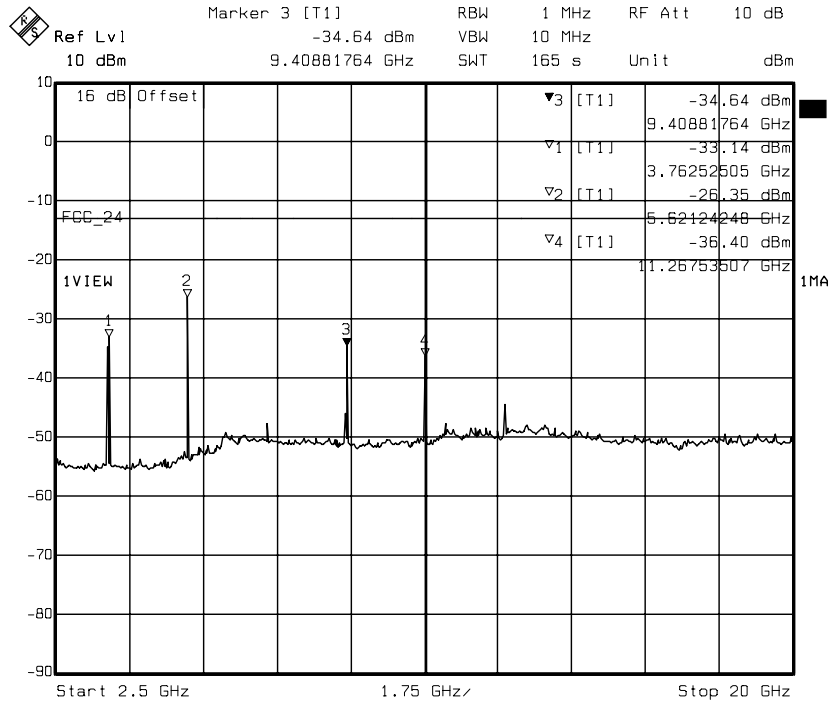
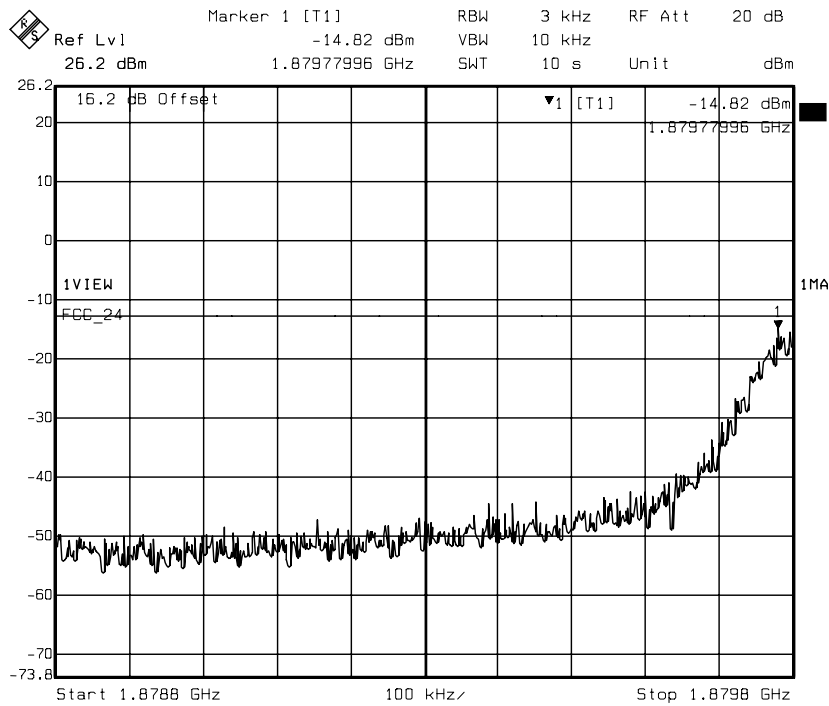

diagram 14.06: carrier on channel 661 (1880 MHz)



Title: FCC24 §2.1053, conducted measurement  
Date: 24.JUL.2002 14:30:24

diagram 14.07: carrier on channel 661 (1880 MHz)



Title: FCC Part 24, § 2.1053, conducted measurement  
Date: 24.JUL.2002 14:40:18

diagram 14.08: carrier on channel 661 (1880 MHz)

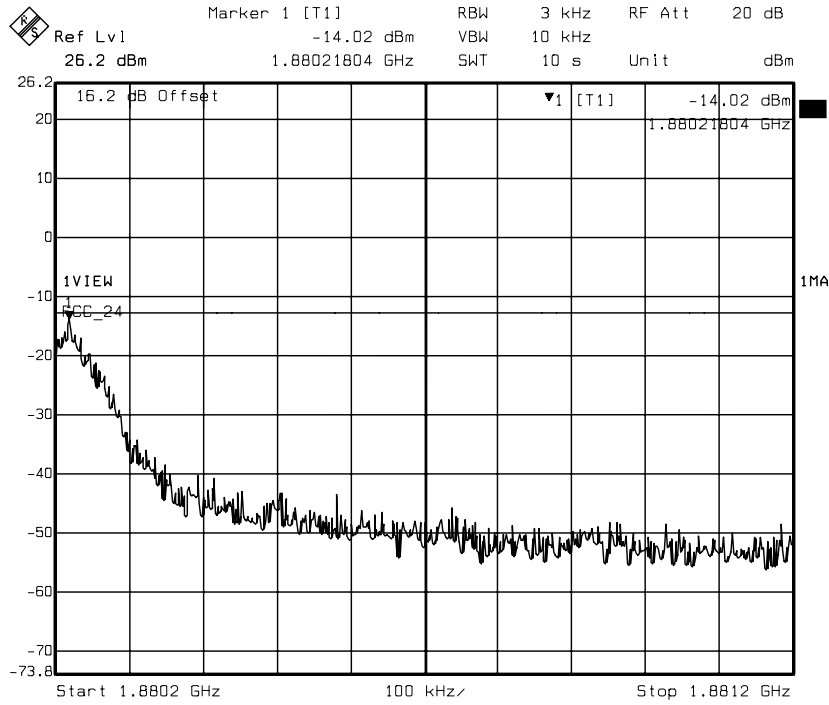

Title: FCC Part24, § 2.1053, conducted measurement  
 Date: 24.JUL.2002 14:42:47

diagram 14.09: carrier on channel 661 (1880 MHz)

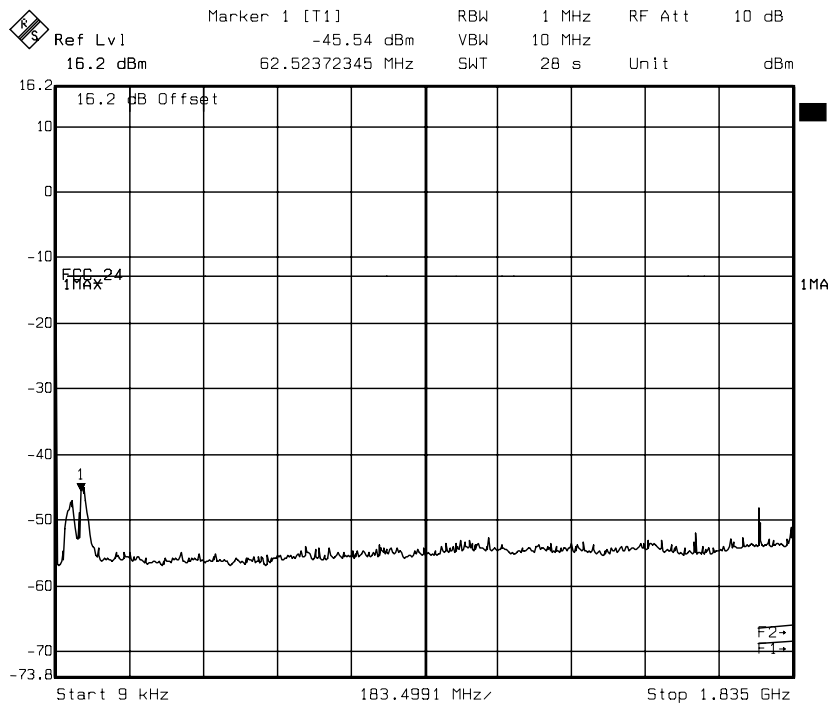

Title: FCC Part 24, §2.1053 conducted measurement  
 Date: 01.AUG.2002 16:11:42

diagram 14.10: carrier on channel 810 (1909.8 MHz)

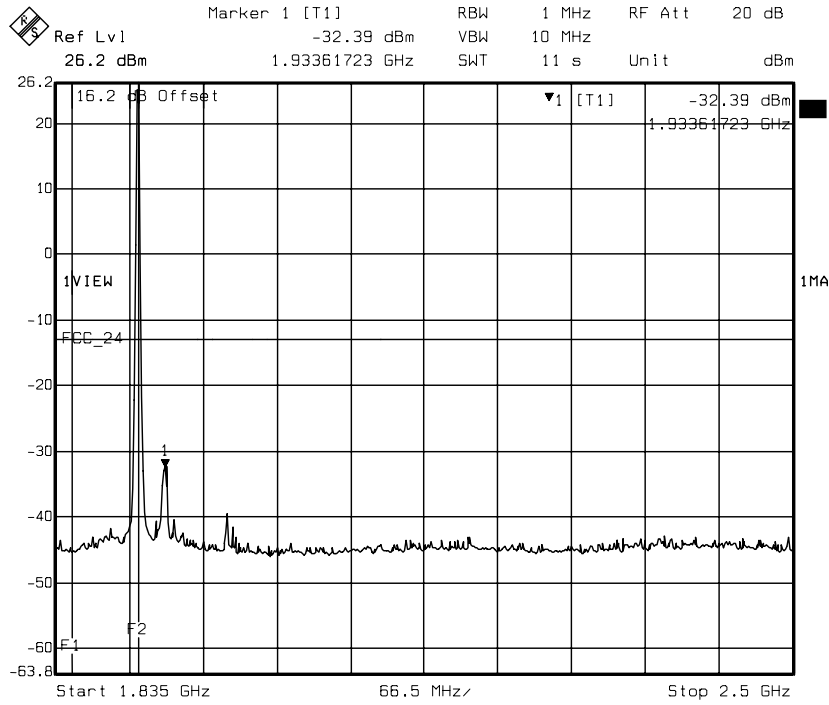

Title: FCC Part 24, §2.1053 conducted measurement  
 Date: 24.JUL.2002 15:10:03

diagram 14.11: carrier on channel 810 (1909.8 MHz)

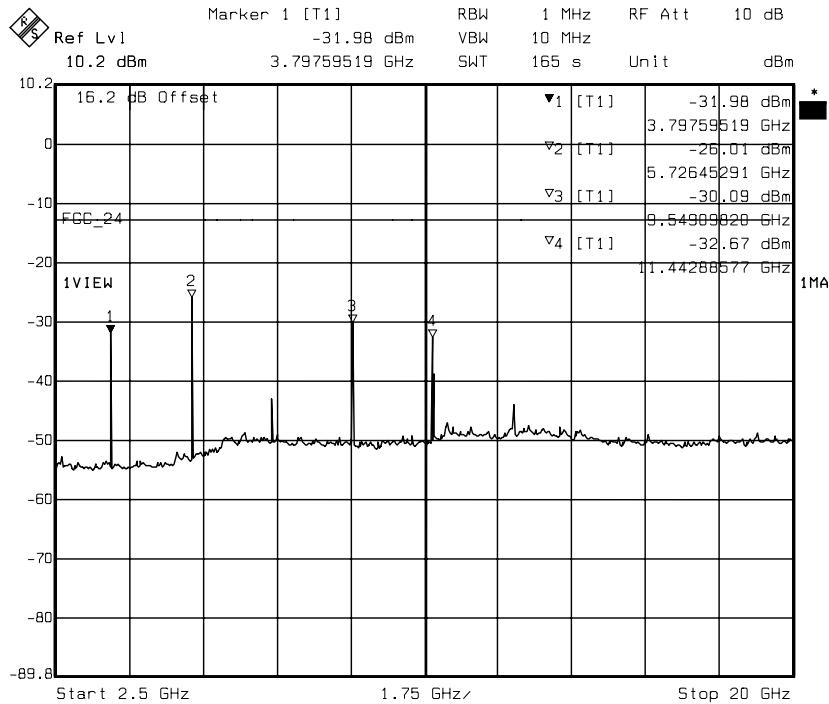

Title: FCC24 §2.1053, conducted measurement  
 Date: 24.JUL.2002 15:19:51

diagram 14.12: carrier on channel 810 (1909.8 MHz)



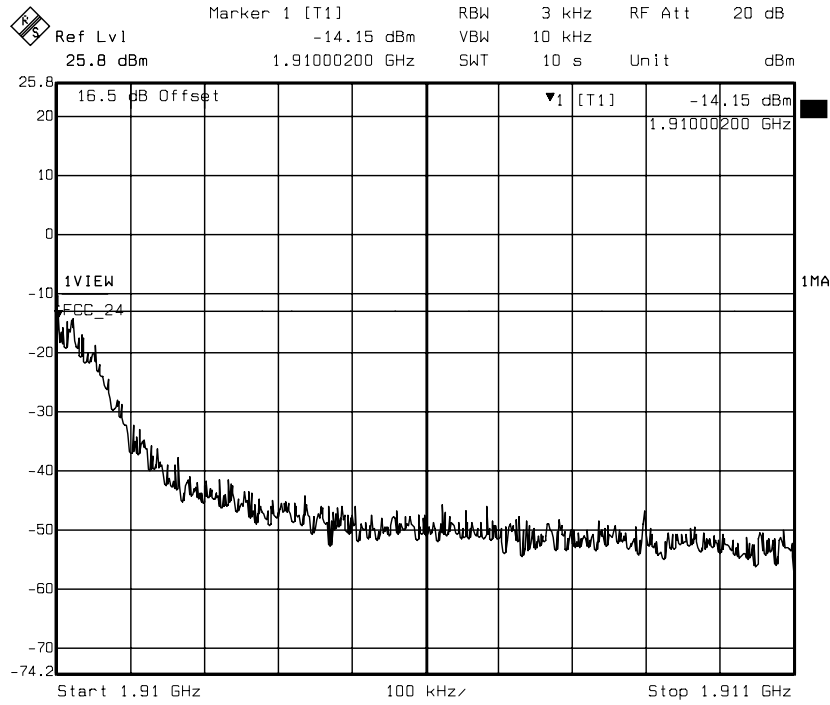

Title: FCC Part24, § 2.1053, conducted measurement  
Comment A: Channel 810  
Date: 24.JUL.2002 15:41:19

diagram 14.13: carrier on channel 810 (1909.8 MHz)

## 5.6. Field strength of spurious radiation § 2.1053

### 5.6.1. Test equipment (for reference numbers please see chapter 'List of test equipment')

RF-equipment	Test site	Antenna	Spectrum Analyser	GSM test system
254	<input type="checkbox"/> radio lab	<input checked="" type="checkbox"/> 48 bicon.-log.	<input checked="" type="checkbox"/> 264 (FSEK 30)	<input checked="" type="checkbox"/> 298 (CMU 200)
	<input checked="" type="checkbox"/> anechoic chamber	<input checked="" type="checkbox"/> 133 horn	<input type="checkbox"/> 120 (FSEM 30)	<input type="checkbox"/>
	<input type="checkbox"/>	<input checked="" type="checkbox"/> 302 horn	<input type="checkbox"/>	<input type="checkbox"/>

### 5.6.2. Test condition and test set-up

T = 26°C, h = 65%, p = 1014 hPa

#### 24.238 (a)

*„On any frequency outside a licensee’s frequency block (e.g. A, D, B, etc.) within the USPCS spectrum, the power of any emission shall be attenuated below the transmitter power (P, in Watts) by at least  $43+10\log(P)$  dB“*

The spectrum was scanned from 1 MHz to the 10th harmonic of the highest frequency generated within the equipment. A stop frequency of 20 GHz is considered high enough to show compliance for the mobile phone. The specification that emissions shall be attenuated below the transmitter power (P) by at least  $43 + 10 \log (P)$  dB, translates in the relevant power range of the mobile phone (1 to 0.001 W) to a constant limit of  $-13$  dBm.

- ⇒ By rotating the EUT, the emissions were recorded for each side of the EUT with peak-detector and max-hold function of the spectrum-analyser.
- ⇒ The frequency of interest is splitted in different defined frequency sweeps – please see diagrams and results.
- ⇒ A Pre-calibration method is used for the measurements, see chapter 5.1
- ⇒ Emissions more than 20 dB under the limit of  $-13$  dBm are especially specified, otherwise the noise floor is recorded.
- ⇒ The reading on the spectrum-analyser is automatically corrected by the transducer value (insertion loss).
- ⇒ The values are related to EIRP.

### 5.6.3. Settings of spectrum analyser

#### 24.238 (b)

*„Compliance with these provisions is based on the use of measurement instrumentation employing a resolution bandwidth of 1 MHz or greater. However, in the 1 MHz bands immediately outside and adjacent to the frequency block a resolution bandwidth of at least one percent of the emission bandwidth of the fundamental emission of the transmitter may be employed. The emission bandwidth is defined as the width of the signal between two points, one below the carrier centre frequency and one above the carrier centre frequency, outside of which all emissions are attenuated at least 26 dB below the transmitter power“*

Frequency range	RBW (resolution bandwidth)	VBW (video bandwidth)
1 MHz immediately outside and adjacent the frequency blocks	1% from applicants stated/measured emission bandwidth	10 times the RBW
More than 1 MHz outside and adjacent the frequency blocks	1 MHz	10 MHz

**RBW and VBW settings of spectrum analyzer**

The configuration of the signalling unit is shown in chapter ‘Parameter settings on mobile phone’.

**5.6.4. Results**

EUT Type and S/N or EUT set-up no.		EUT set-up 2						
EUT-operation mode		Op. 2; Rx-Antenna polarisation: horizontal						
Dia-gram number	Start frequency (MHz)	Stop frequency (MHz)	Frequency of worst value (MHz)	Measured worst value (dBm)	Limit (dBm)	Mar-gin	Remark	Verdict
Channel 512, 1850,2 MHz								
8.01	30	1000	1000	-23,1	-13	10,1		Passed
8.02	1000	2500		< -26,0	-13	> 13	*	Passed
8.03	2500	18000	1790,68	-21,39	-13	8,39		Passed
8.04	1849	1850	1849,98	-15,72	-13	2,72		Passed
8.05	18000	20000	19991,98	-26,49	-13	13,49		Passed
Channel 661 1880,0 MHz								
8.06	30	1000	998,06	-22,72	-13	9,72		Passed
8.07	1000	2500		< -25,0	-13	> 12	*	Passed
8.08	2500	18000	17937,,88	-21,50	-13	8,5		Passed
8.09	1878,8	1879,8	1879,80	-14,90	-13	1,9		Passed
8.10	1880,2	1881,2	1880,20	-14,92	-13	1,92		Passed
8.11	18000	20000	19983,97	-27,06	-13	14,06		Passed
Channel 810, 1909,80 MHz								
8.12	30	1000	994,17	-22,71	-13	9,71		Passed
8.13	1000	2500		< -26,0	-13	> 13	*	Passed
8.14	2500	18000	17534,07	-21,62	-13	8,62		Passed
8.15	1910	1911	1910,02	-14,46	-13	1,46		Passed
8.16	18000	20000	19963,93	-27,14	-13	14,14		Passed

\*: Exclusion band from 1850 – 1990 MHz

EUT Type and S/N or EUT set-up no.		EUT set-up 2						
EUT-operation mode		Op. 2; Rx-Antenna polarization: vertical						
Diagram number	Start frequency (MHz)	Stop frequency (MHz)	Frequency of worst value (MHz)	Measured worst value (dBm)	Limit (dBm)	Margin	Remark	Verdict
Channel 512, 1850,2 MHz								
8.17	30	1000	994,17	-21,07	-13	8,07		Passed
8.18	1000	2500		< -26,0	-13	> 13	*	Passed
8.19	2500	18000	17751,50	-22,07	-13	9,07		Passed
8.20	1849	1850	1849,99	-14,71	-13	1,71		Passed
8.21	18000	20000	19991,98	-26,63	-13	13,63		Passed
Channel 661, 1880,0 MHz								
8.22	30	1000	998,06	-20,65	-13	7,65		Passed
8.23	1000	2500		< -25,0	-13	> 12	*	Passed
8.24	2500	18000	17975,75	-22,53	-13	9,53		Passed
8.25	1878,8	1879,8	1879,79	-15,55	-13	2,55		Passed
8.26	1880,2	1881,2	1880,22	-15,26	-13	2,26		Passed
8.27	18000	20000	19983,97	-27,06	-13	14,06		Passed
Channel 810, 1909,80 MHz								
8.28	30	1000	996,11	-21,36	-13	8,36		Passed
8.29	1000	2500		< -25,0	-13	> 12	*	Passed
8.30	2500	18000	17844,69	-21,04	-13	8,04		Passed
8.31	1910	1911	1910,02	-14,30	-13	1,3		Passed
8.32	18000	20000	19899,80	-27,76	-13	14,76		Passed

\*: Exclusion band from 1850 – 1990 MHz

<b>EUT</b> Type and S/N or EUT set-up no.		EUT set-up 2						
<b>EUT-operation mode</b>		Op. 1; Rx-Antenna polarization: horizontal						
Dia-gram number	Start frequency (MHz)	Stop frequency (MHz)	Frequency of worst value (MHz)	Measured worst value (dBm)	Limit (dBm)	Mar-gin	Remark	Verdict
Channel 661, 1880,0 MHz								
8.33	30	1000	996,11	-31,15	-13	18,15		Passed
8.34	1000	2500	2433,87	-36,01	-13	23,01		Passed
8.35	2500	18000	17906,81	-20,63	-13	7,63		Passed
8.36	18000	20000	19983,97	-27,06	-13	14,06		Passed

<b>EUT</b> Type and S/N or EUT set-up no.		EUT set-up 2						
<b>EUT-operation mode</b>		Op. 1; Rx-Antenna polarization: vertical						
Dia-gram number	Start frequency (MHz)	Stop frequency (MHz)	Frequency of worst value (MHz)	Measured worst value (dBm)	Limit (dBm)	Mar-gin	Remark	Verdict
Channel 661, 1880,0 MHz								
8.37	30	1000	1000	-30,0	-13	17,00		Passed
8.38	1000	2500	2391,78	-35,40	-13	22,4		Passed
8.39	2500	18000	17813,63	-22,62	-13	9,62		Passed
8.40	18000	20000	19863,73	-27,63	-13	14,63		Passed

### 5.6.5. Diagrams

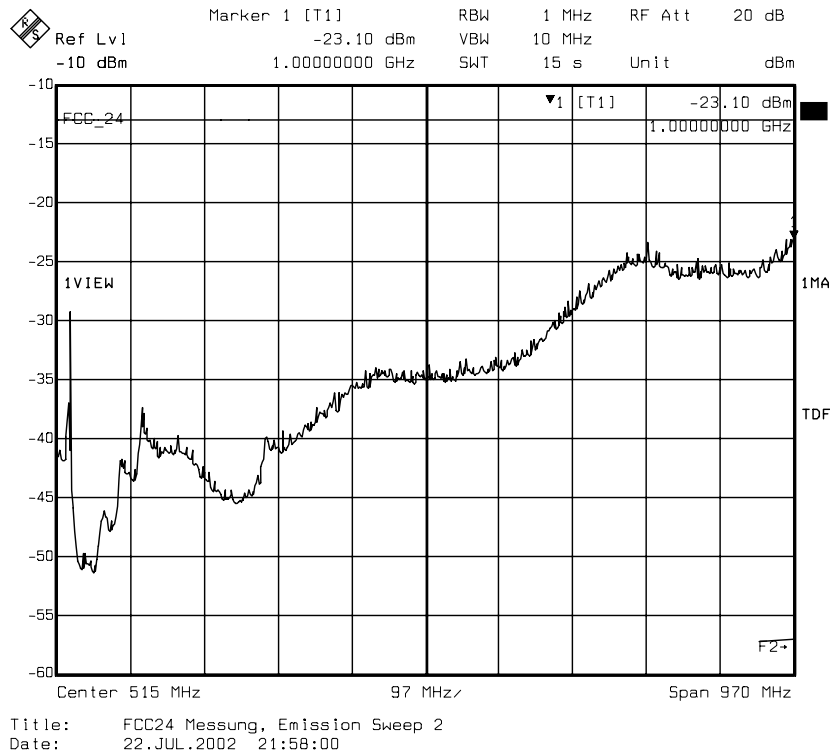

diagram 8.01: carrier on channel 512 (1850,2 MHz), TCH mode

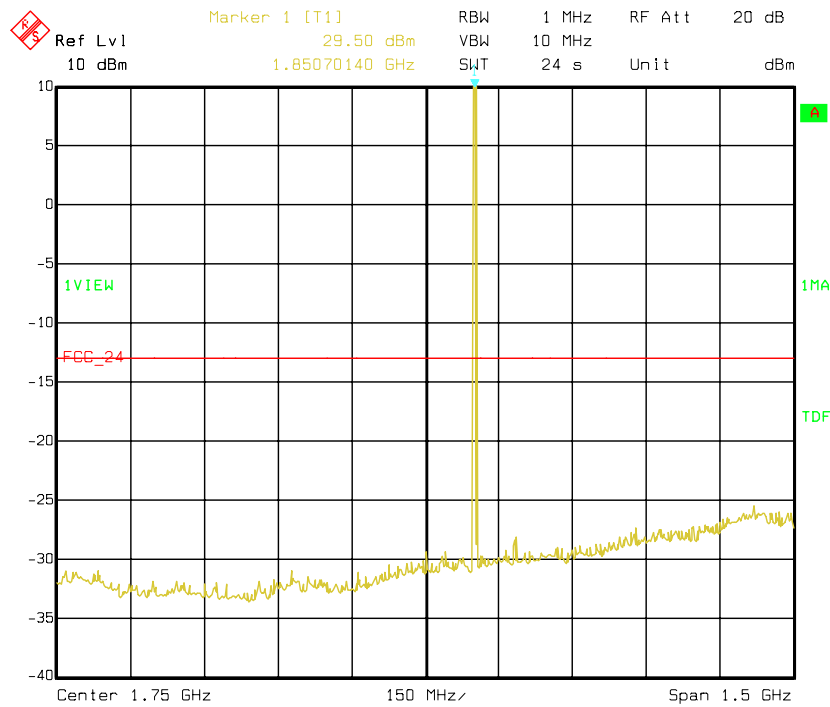
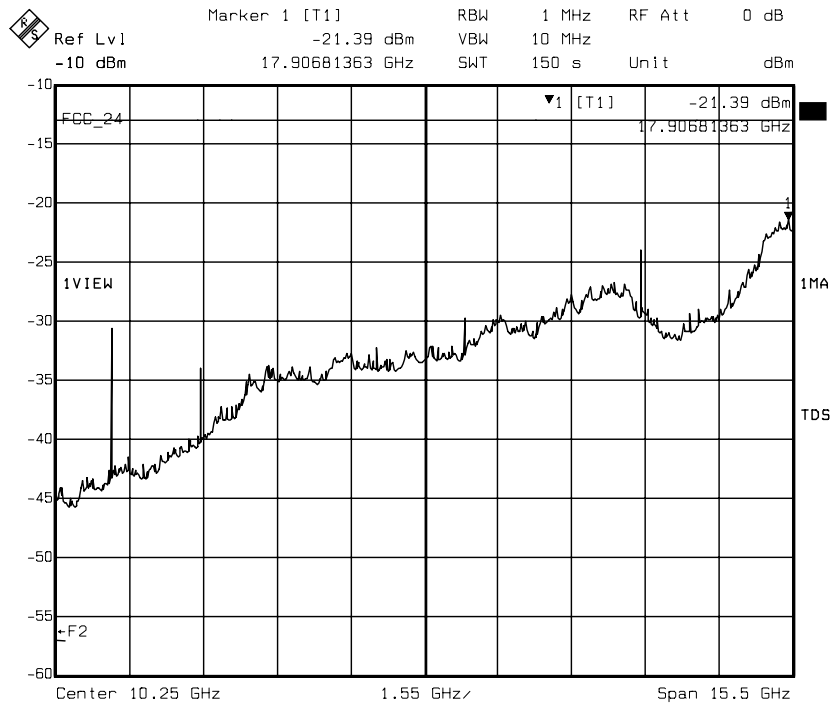

diagram 8.02: carrier on channel 512 (1850,2 MHz), TCH mode



Title: FCC24 Messung, Emission Sweep 2  
 Date: 22.JUL.2002 20:26:19

diagram 8.03: carrier on channel 512 (1850,2 MHz), TCH mode

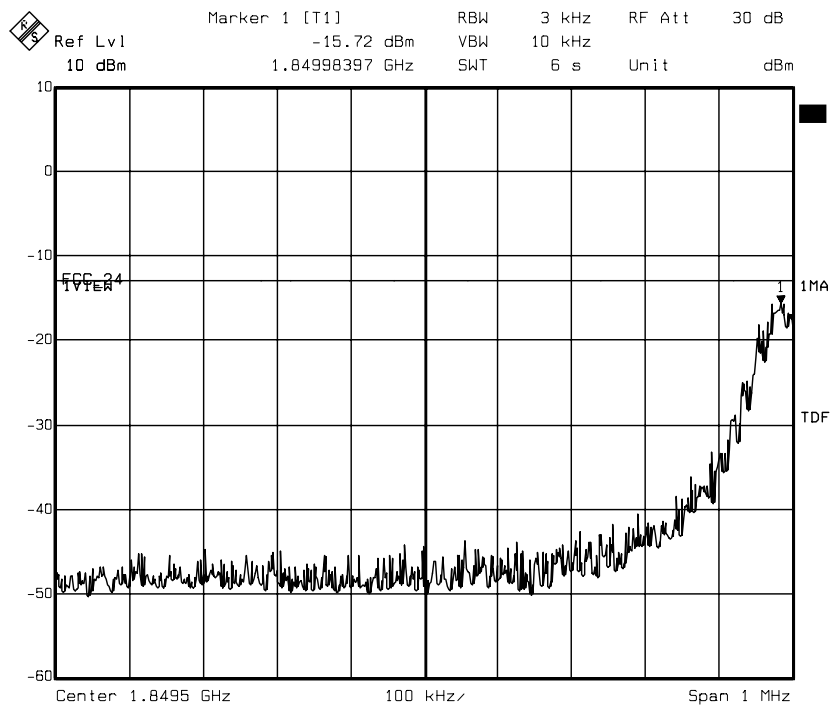
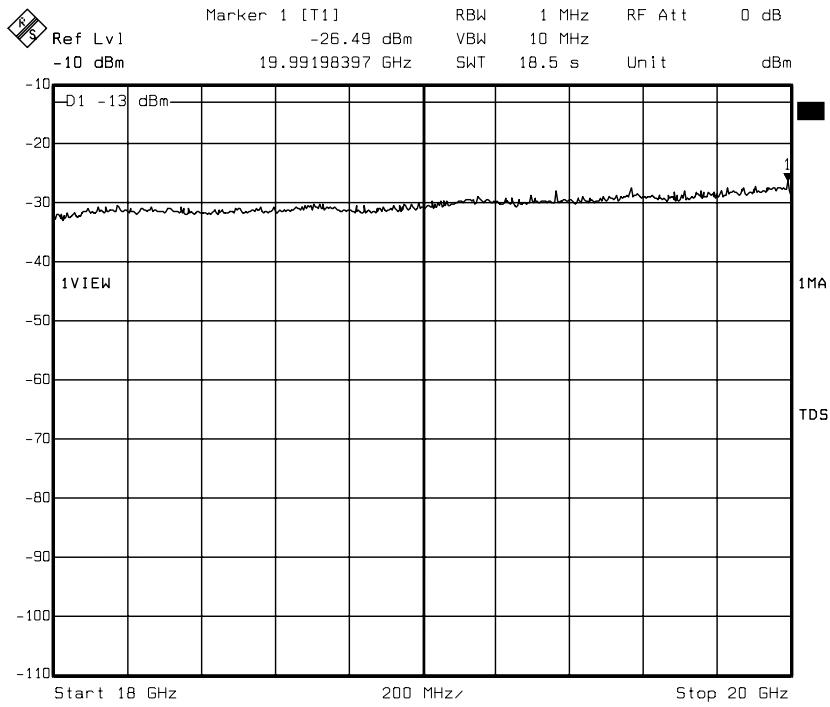
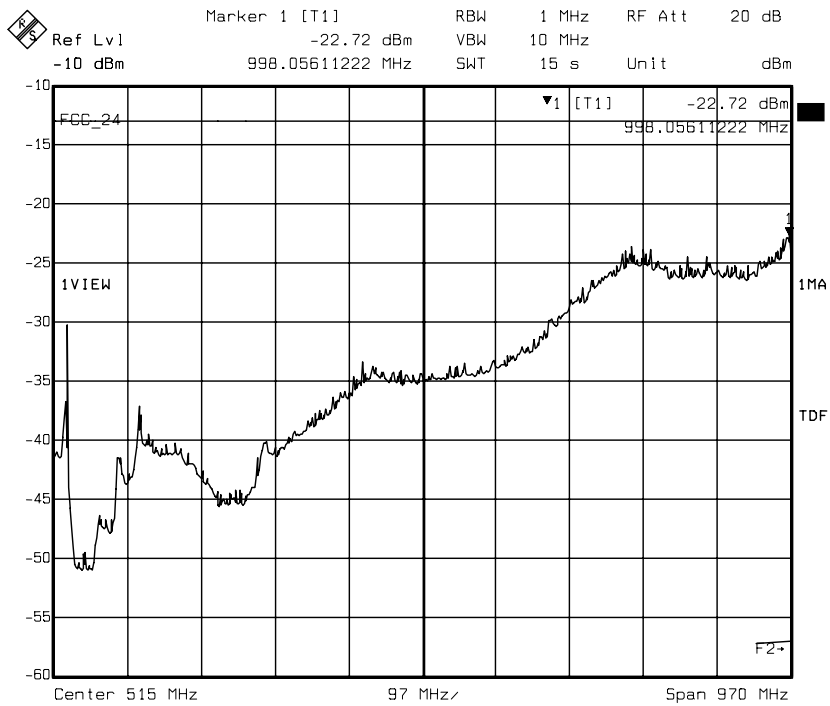

diagram 8.04: carrier on channel 512 (1850,2 MHz), TCH mode



Title: FCC Sweep 8 horizontal channel 512  
Date: 30.JUL.2002 13:21:06

diagram 8.05: carrier on channel 512 (1850,2 MHz), TCH mode



Title: FCC24 Messung, Emission Sweep 2  
Date: 22.JUL.2002 21:38:01

diagram 8.06: carrier on channel 661 (1880 MHz), TCH mode



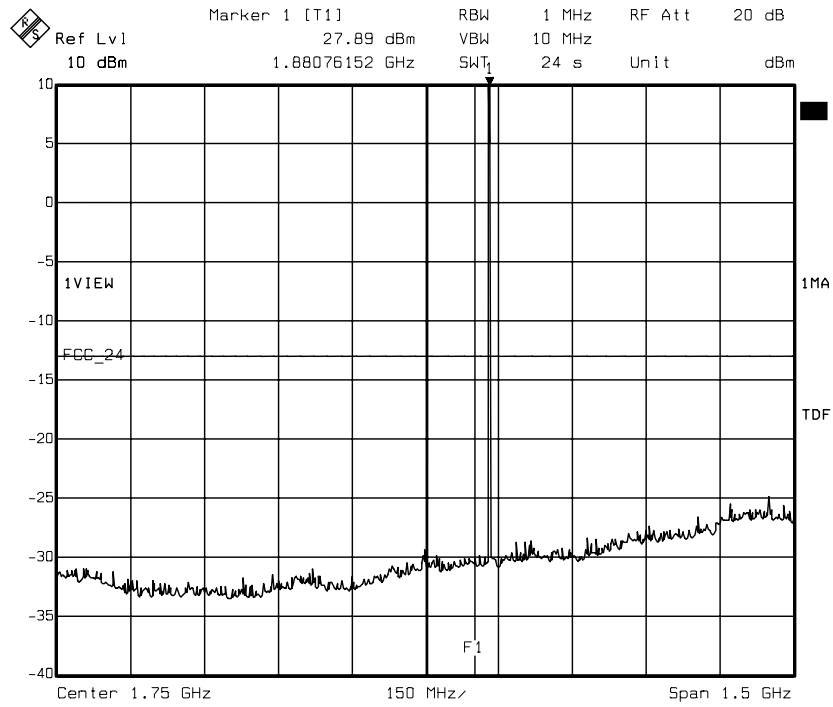

Title: FCC24 Messung, Emission Sweep 2  
 Date: 22.JUL.2002 15:51:01

diagram 8.07: carrier on channel 661 (1880 MHz), TCH mode

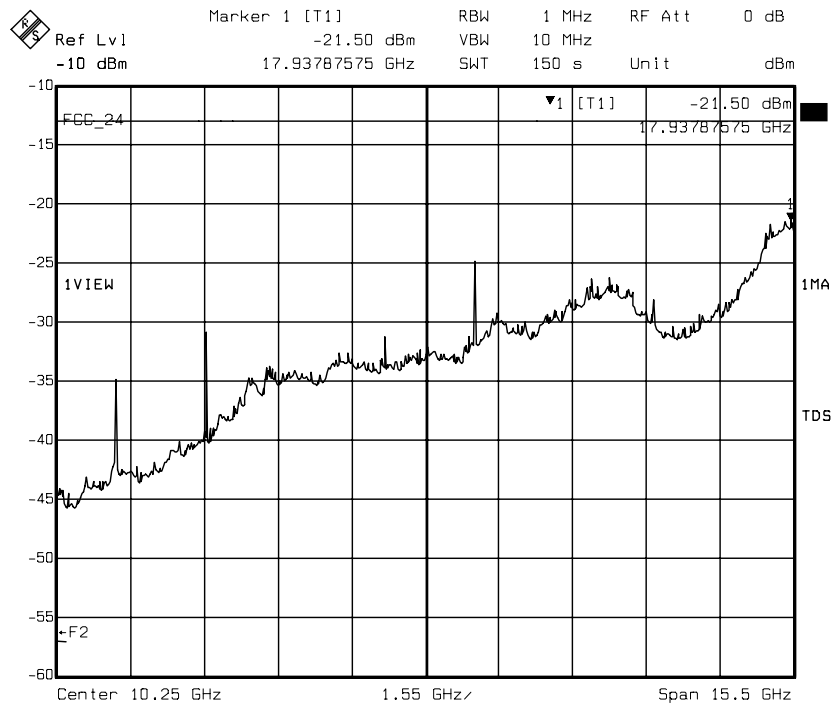

Title: FCC24 Messung, Emission Sweep 2  
 Date: 22.JUL.2002 20:48:41

diagram 8.08: carrier on channel 661 (1880 MHz), TCH mode

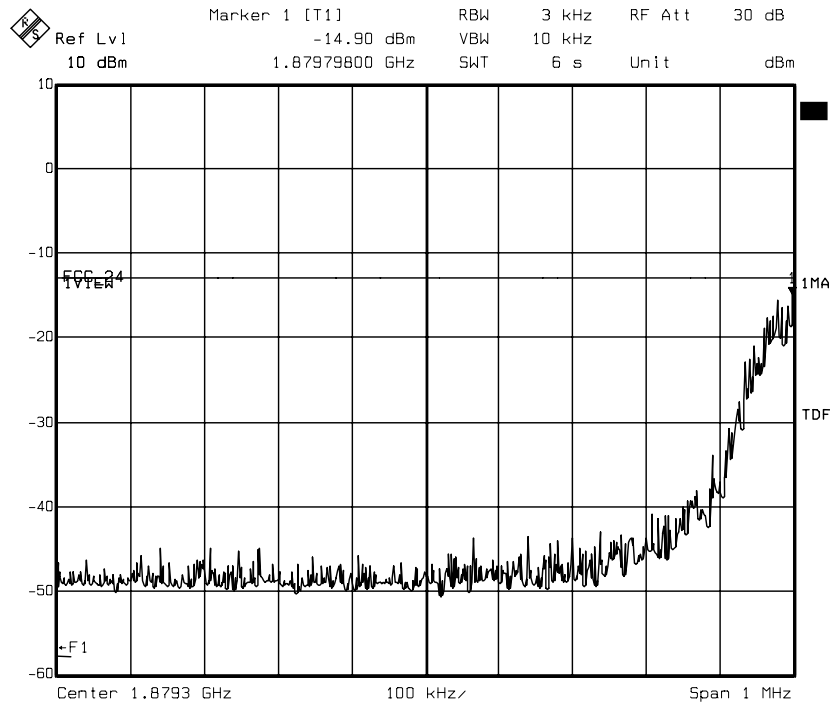

Title: FCC24 Messung, Emission Sweep 2  
Date: 22.JUL.2002 16:08:33

diagram 8.09: carrier on channel 661 (1880 MHz), TCH mode

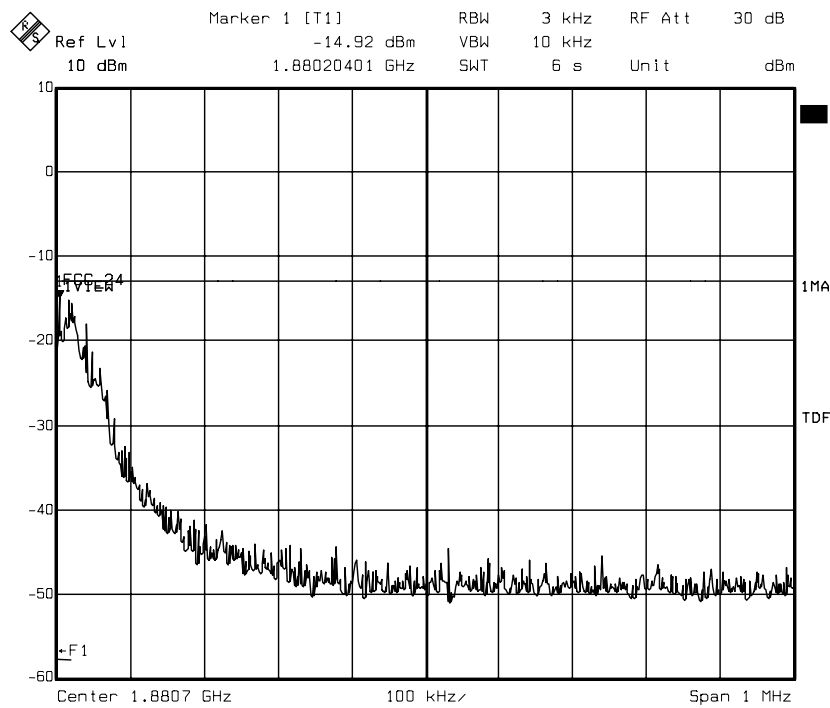

Title: FCC24 Messung, Emission Sweep 2  
Date: 22.JUL.2002 16:17:48

diagram 8.10: carrier on channel 661 (1880 MHz), TCH mode

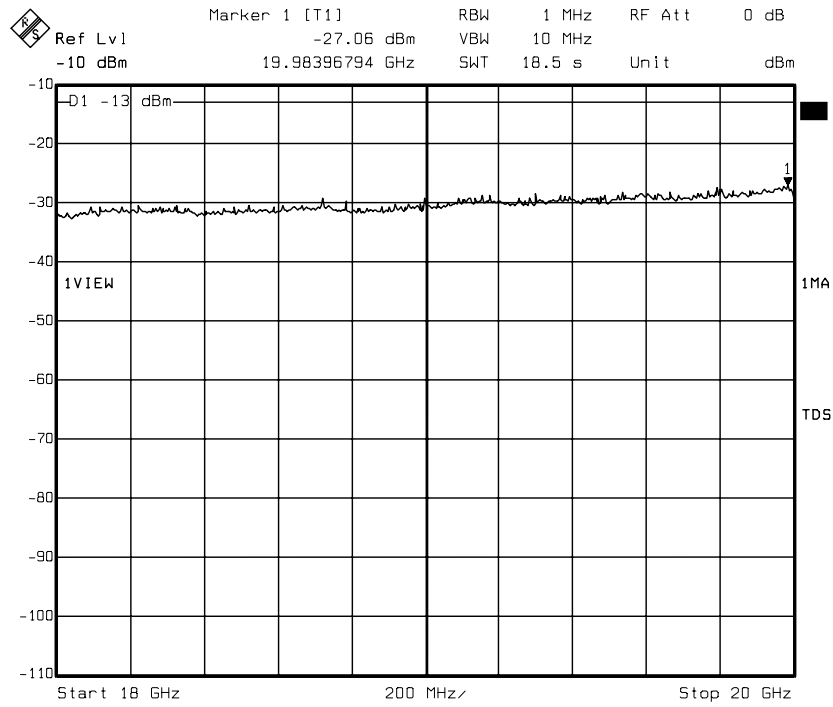

Title: FCC Sweep 8 horizontal channel 661  
Date: 30.JUL.2002 14:14:11

diagram 8.11: carrier on channel 661 (1880 MHz), TCH mode

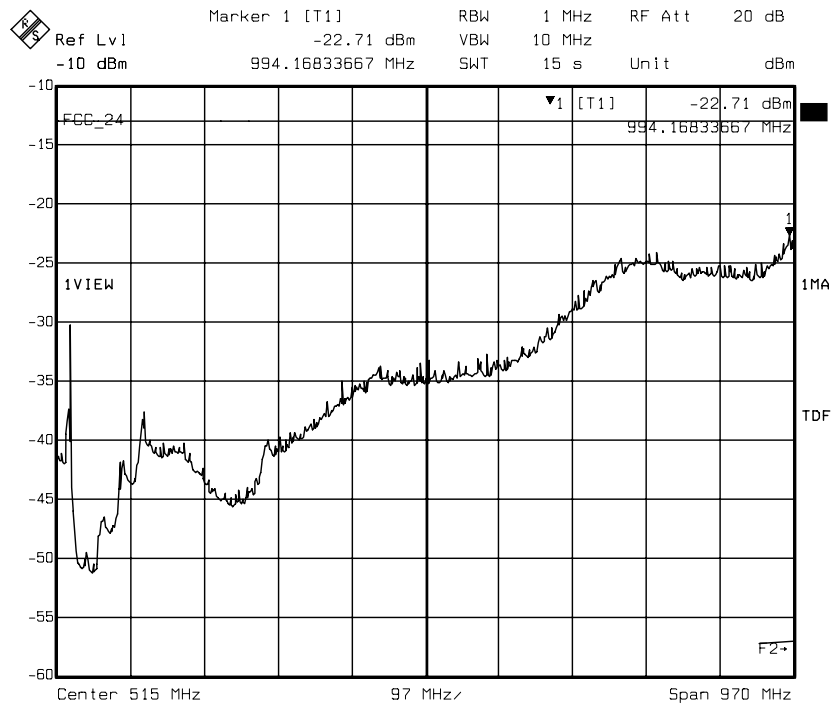

Title: FCC24 Messung, Emission Sweep 2  
Date: 22.JUL.2002 22:09:50

diagram 8.12: carrier on channel 810 (1909,8 MHz), TCH mode

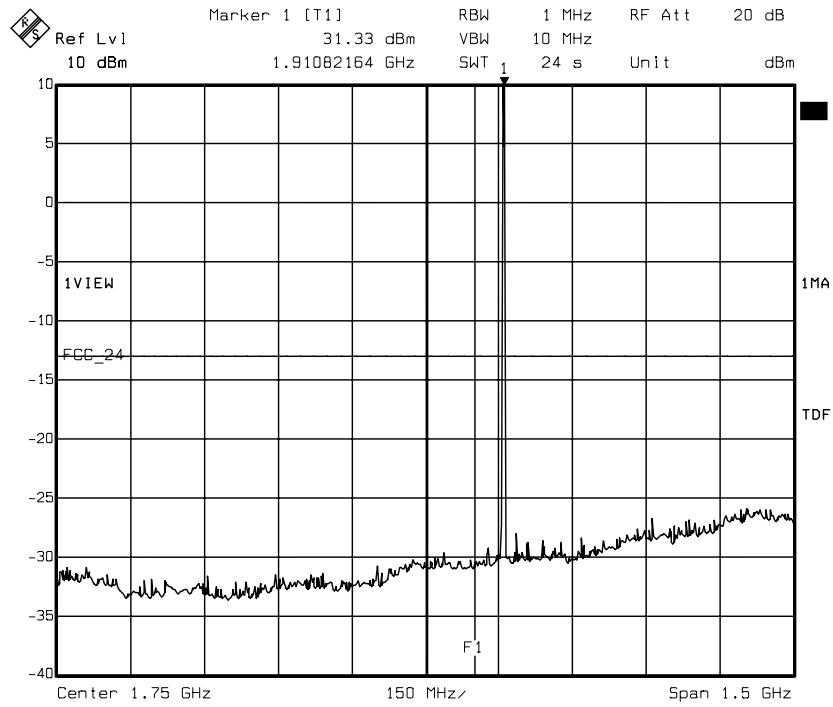

Title: FCC24 Messung, Emission Sweep 2  
Date: 22.JUL.2002 17:26:03

diagram 8.13: carrier on channel 810 (1909,8 MHz), TCH mode

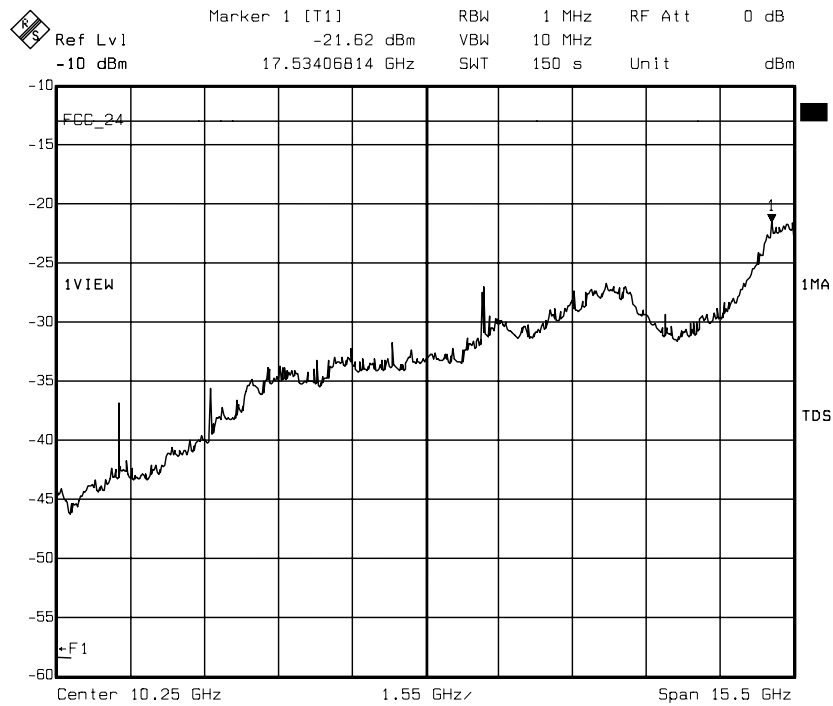

Title: FCC24 Messung, Emission Sweep 2  
Date: 22.JUL.2002 18:50:03

diagram 8.14: carrier on channel 810 (1909,8 MHz), TCH mode

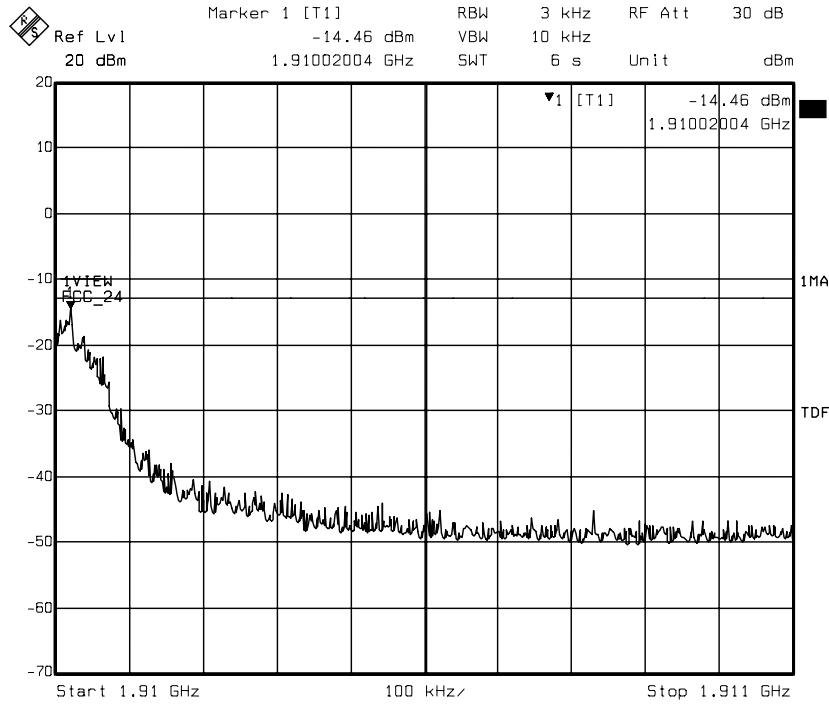

Date: 26.JUL.2002 15:15:39

diagram 8.15: carrier on channel 810 (1909,8 MHz), TCH mode

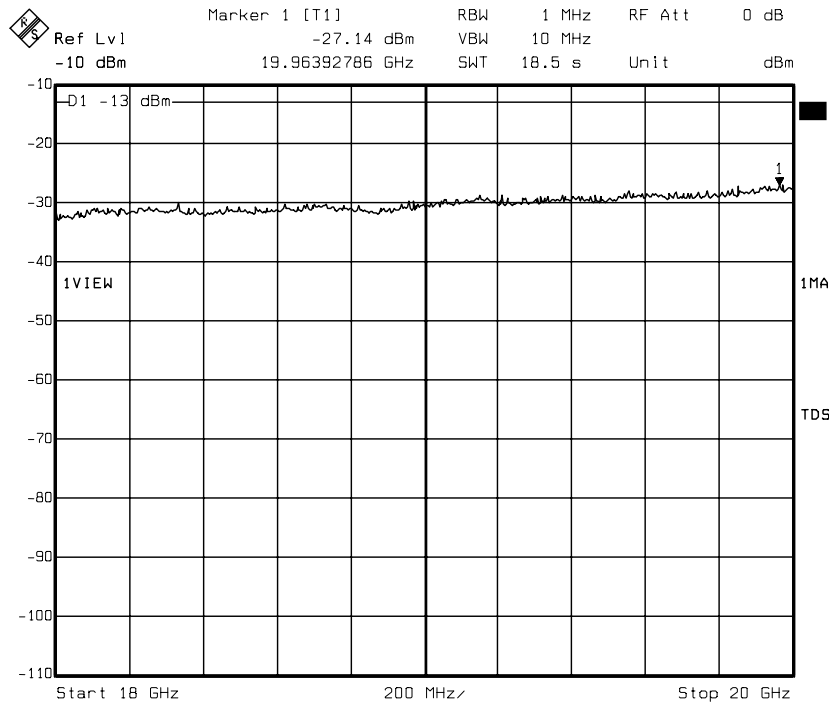

Title: FCC Sweep 8 horizontal channel 810  
Date: 30.JUL.2002 13:43:24

diagram 8.16: carrier on channel 810 (1909,8 MHz), TCH mode

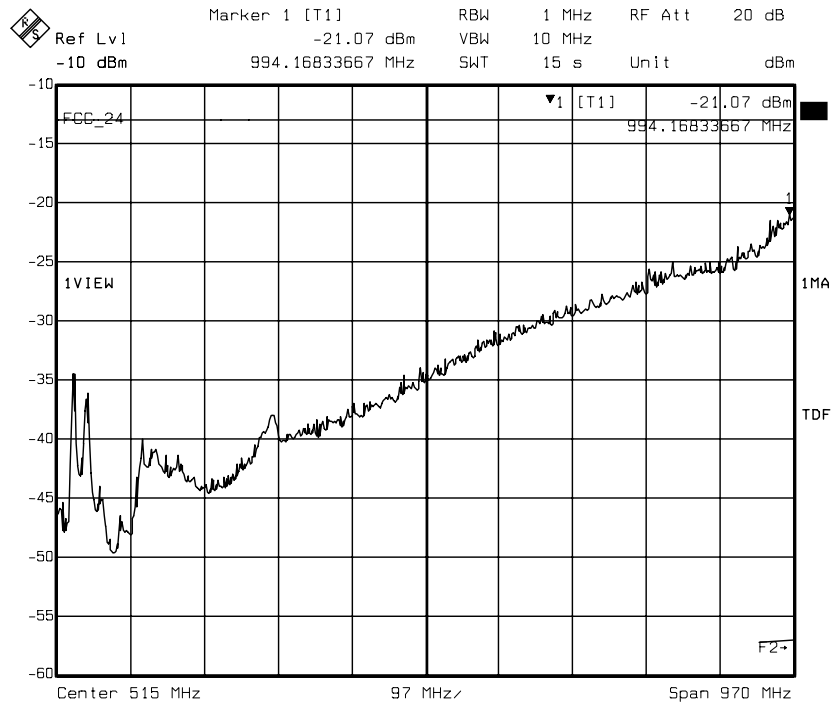

Title: FCC24 Messung, Emission Sweep 2  
 Date: 22.JUL.2002 22:02:42

diagram 8.17: carrier on channel 512 (1850,2 MHz), TCH mode

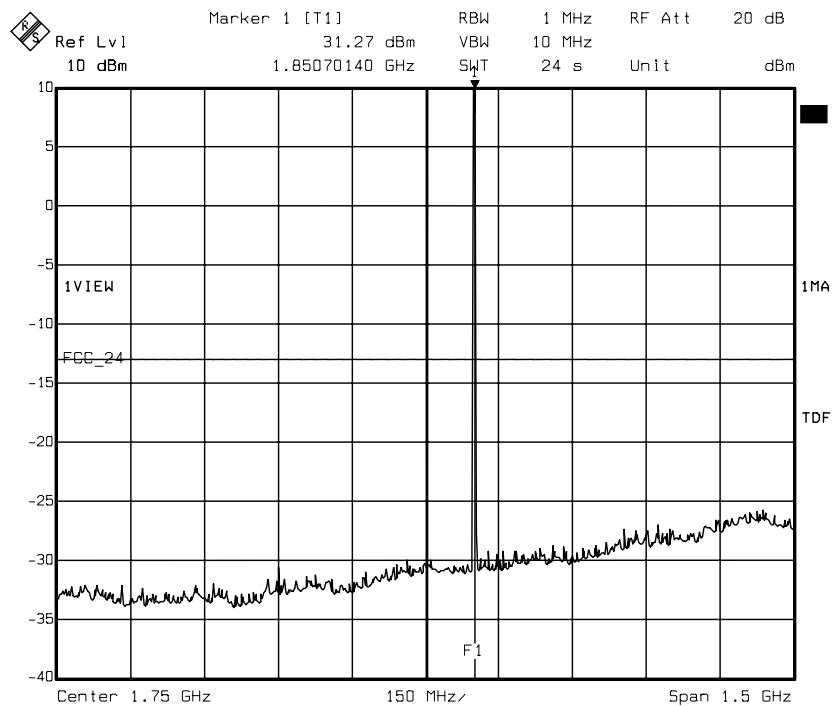

Title: FCC24 Messung, Emission Sweep 2  
 Date: 22.JUL.2002 16:53:36

diagram 8.18: carrier on channel 512 (1850,2 MHz), TCH mode

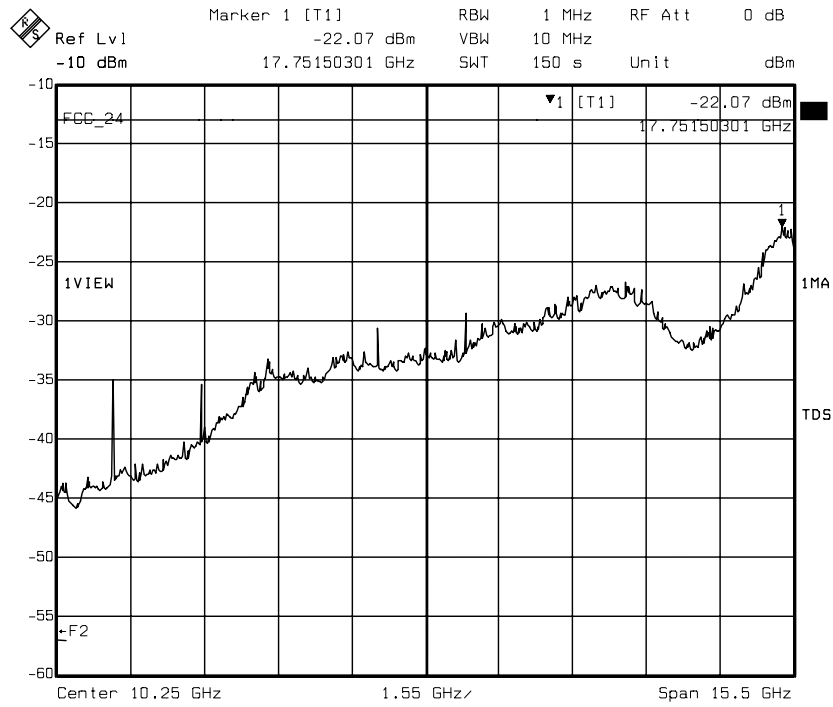

Title: FCC24 Messung, Emission Sweep 2  
 Date: 22.JUL.2002 20:06:40

diagram 8.19: carrier on channel 512 (1850,2 MHz), TCH mode

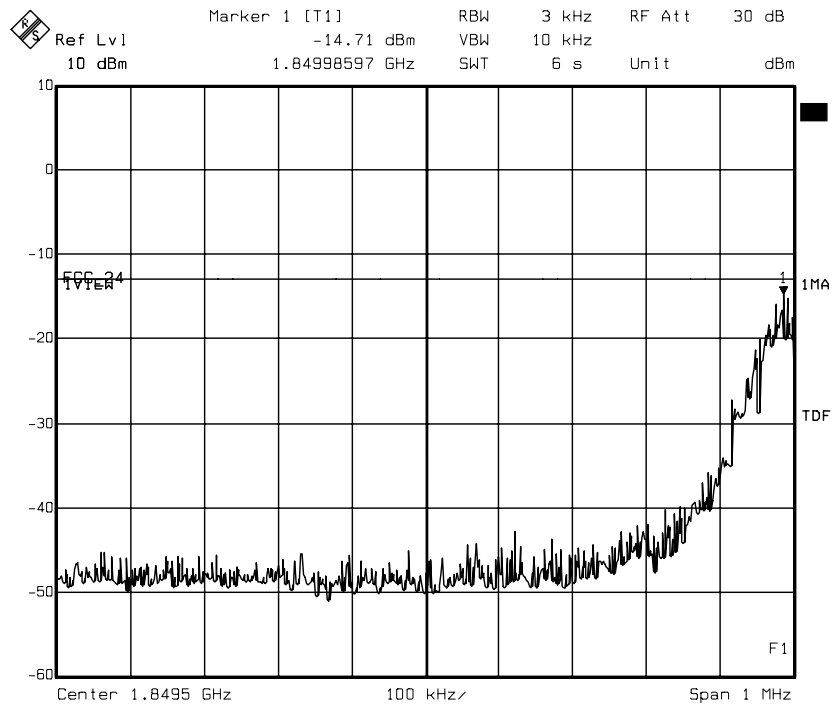

Title: FCC24 Messung, Emission Sweep 2  
 Date: 22.JUL.2002 16:58:11

diagram 8.20: carrier on channel 512 (1850,2 MHz), TCH mode

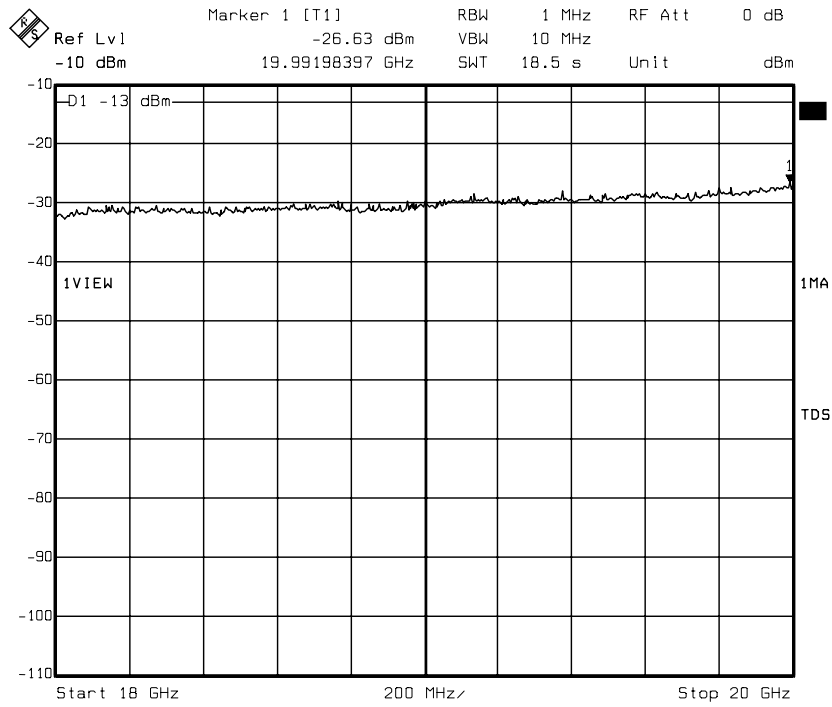

diagram 8.21: carrier on channel 512 (1850,2 MHz), TCH mode

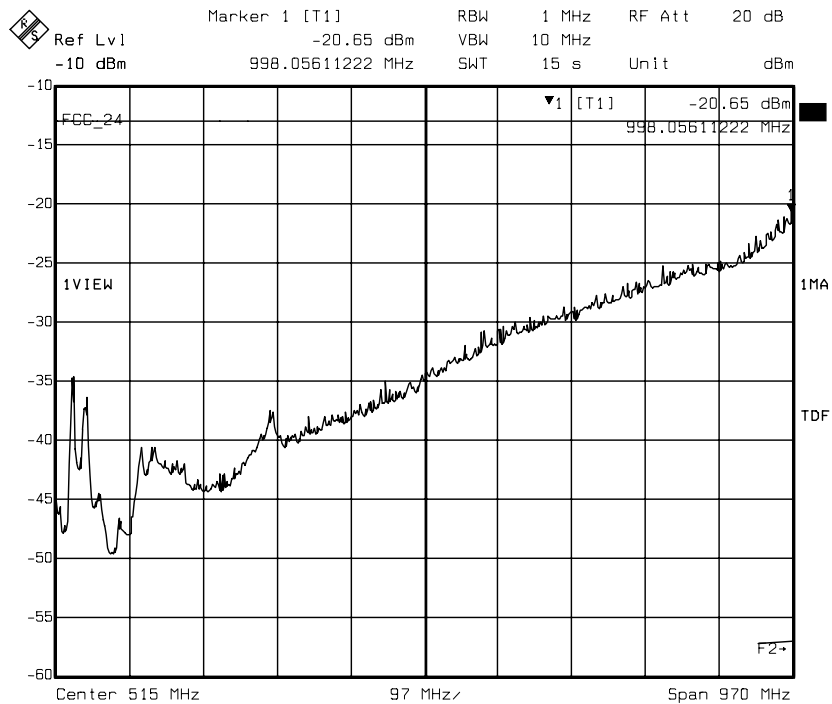
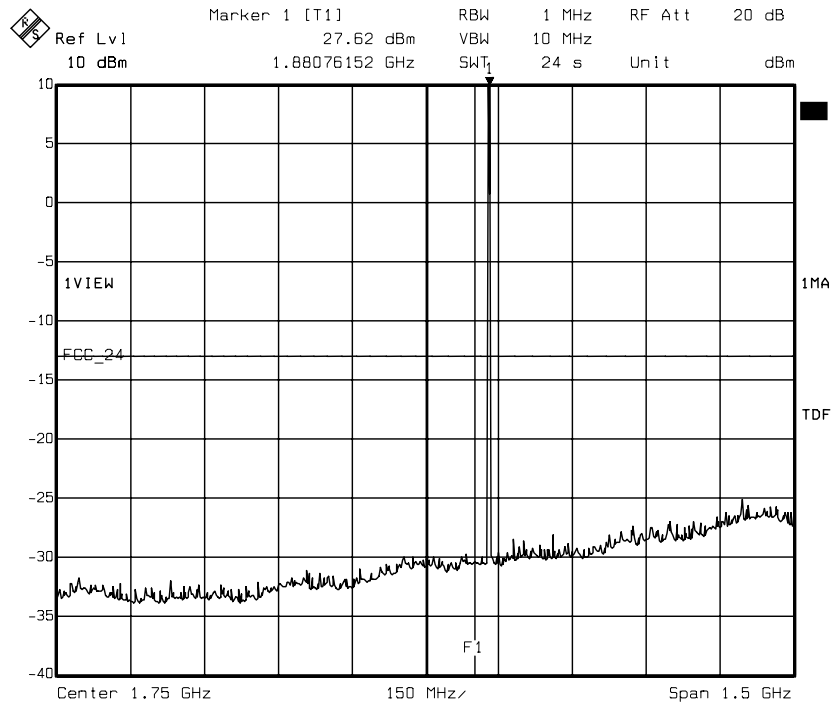

diagram 8.22: carrier on channel 661 (1880 MHz), TCH mode





Title: FCC24 Messung, Emission Sweep 2  
Date: 22.JUL.2002 16:33:17

diagram 8.23: carrier on channel 661 (1880 MHz), TCH mode

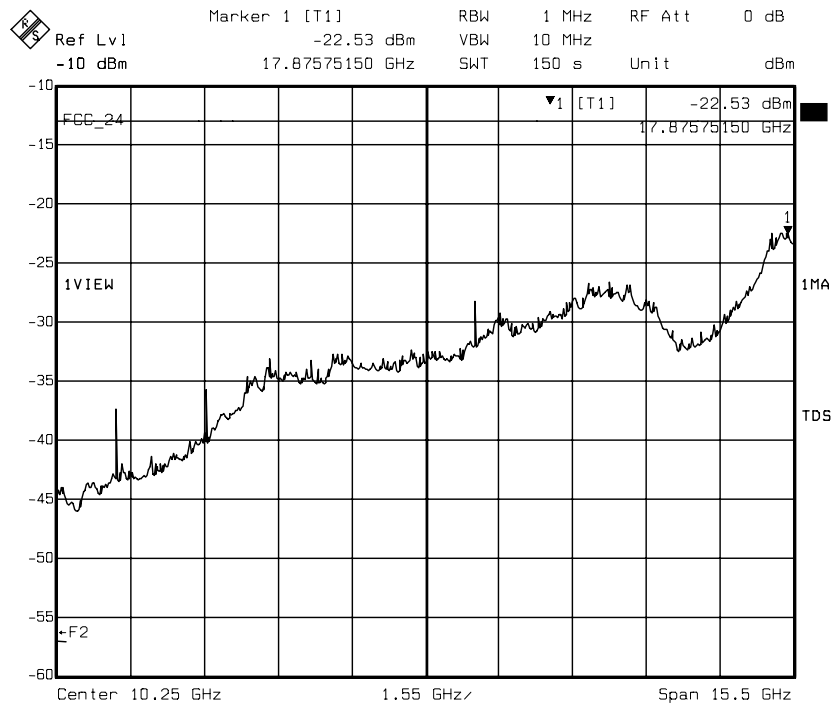

Title: FCC24 Messung, Emission Sweep 2  
Date: 22.JUL.2002 21:08:49

diagram 8.24: carrier on channel 661 (1880 MHz), TCH mode

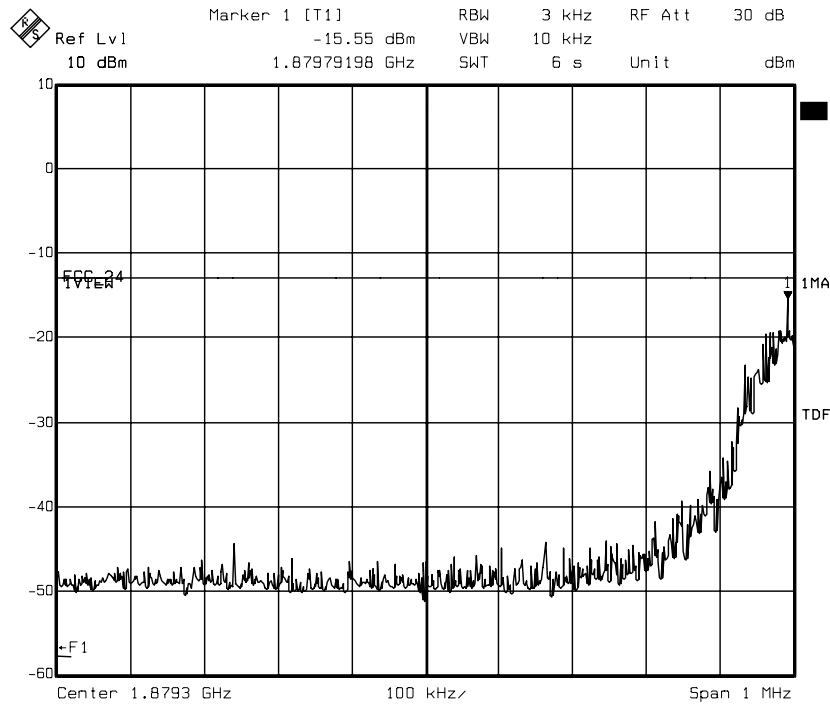

Title: FCC24 Messung, Emission Sweep 2  
Date: 22.JUL.2002 16:37:41

diagram 8.25: carrier on channel 661 (1880 MHz), TCH mode

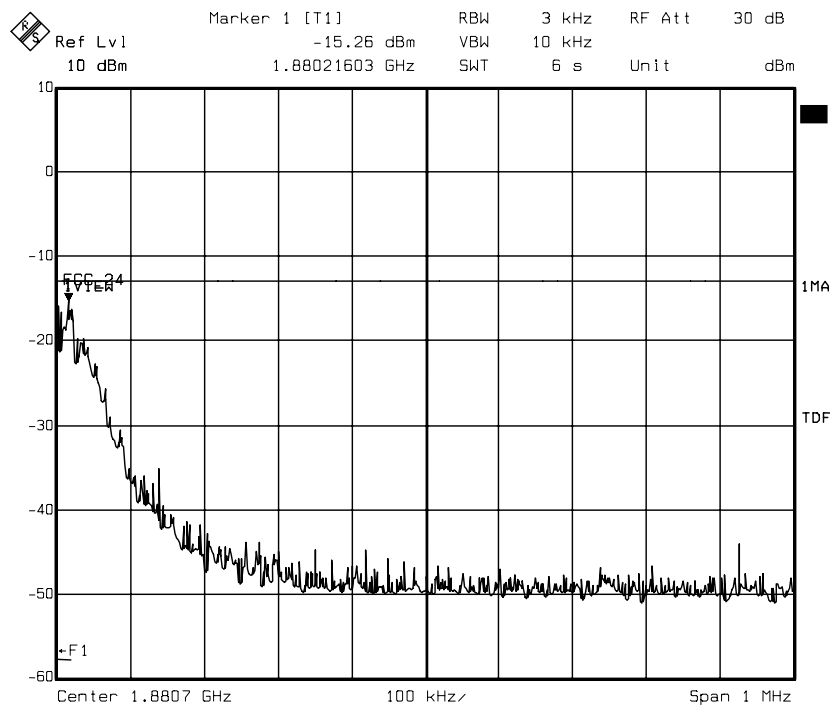

Title: FCC24 Messung, Emission Sweep 2  
Date: 22.JUL.2002 16:42:10

diagram 8.26: carrier on channel 661 (1880 MHz), TCH mode

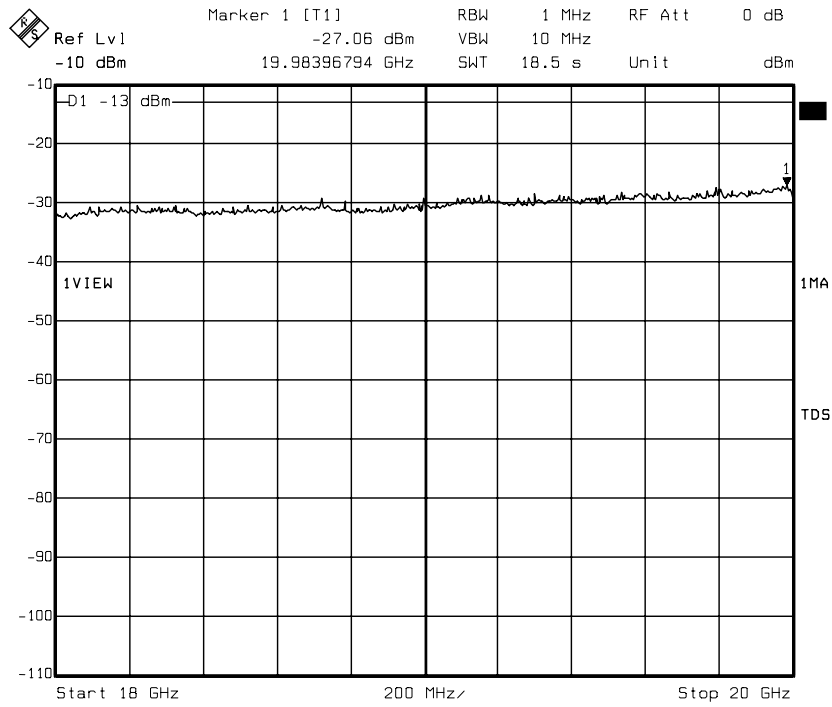

Title: FCC Sweep 8 horizontal channel 661  
Date: 30.JUL.2002 14:14:11

diagram 8.27: carrier on channel 661 (1880 MHz), TCH mode

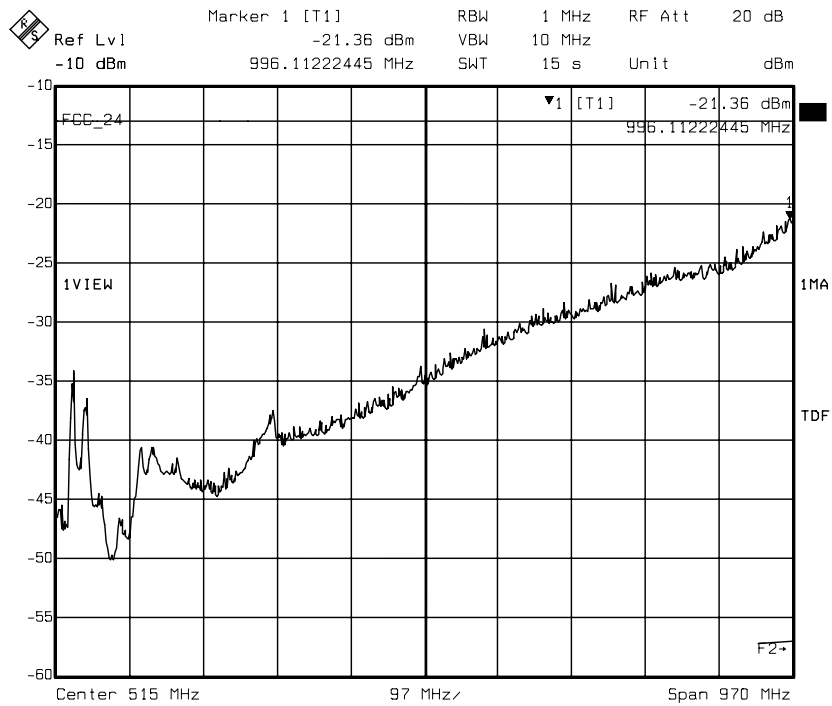

Title: FCC24 Messung, Emission Sweep 2  
Date: 22.JUL.2002 22:15:17

diagram 8.28: carrier on channel 810 (1909,8 MHz), TCH mode

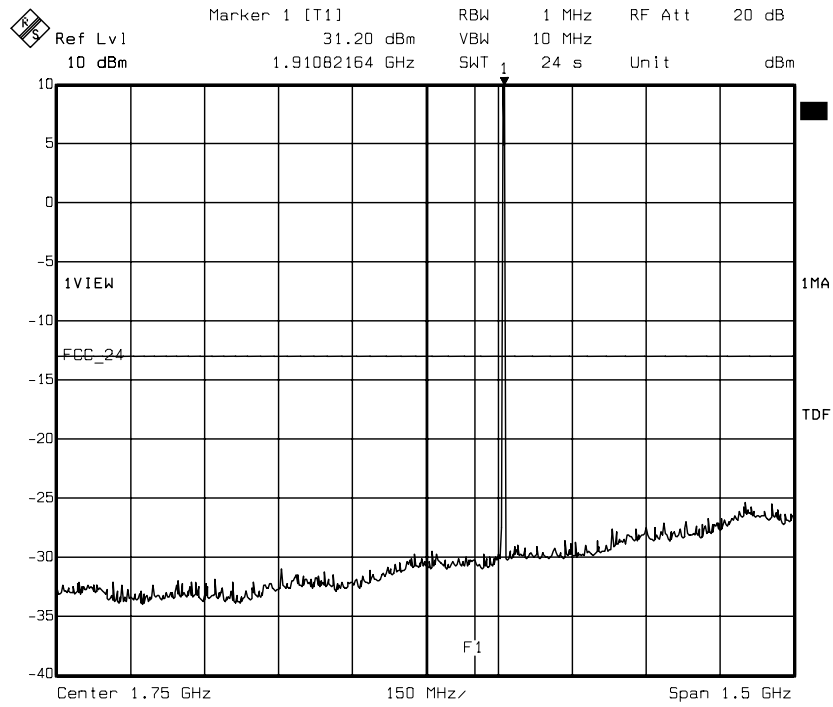

Title: FCC24 Messung, Emission Sweep 2  
Date: 22.JUL.2002 17:13:55

diagram 8.29: carrier on channel 810 (1909,8 MHz), TCH mode

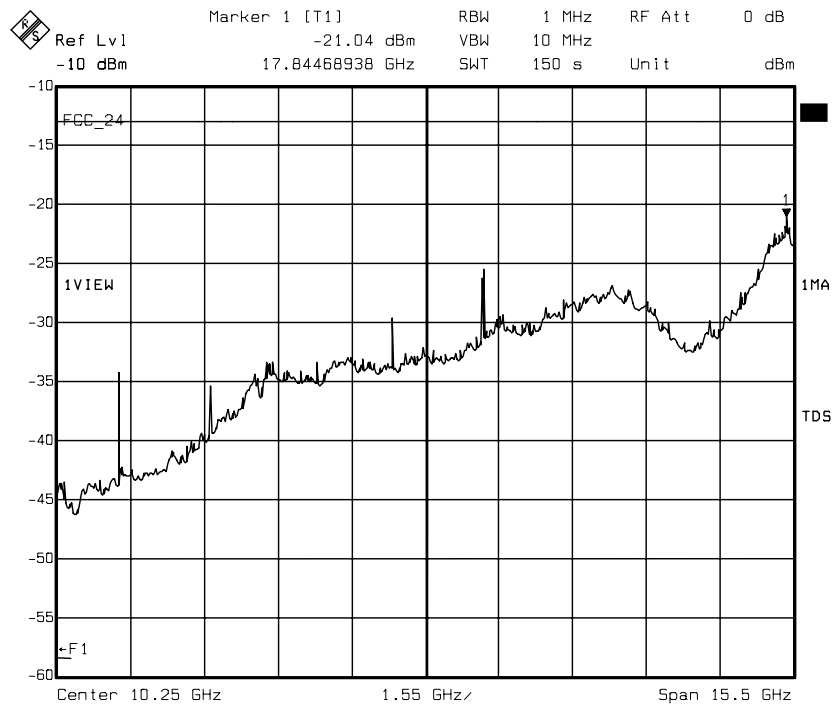

Title: FCC24 Messung, Emission Sweep 2  
Date: 22.JUL.2002 18:27:30

diagram 8.30: carrier on channel 810 (1909,8 MHz), TCH mode

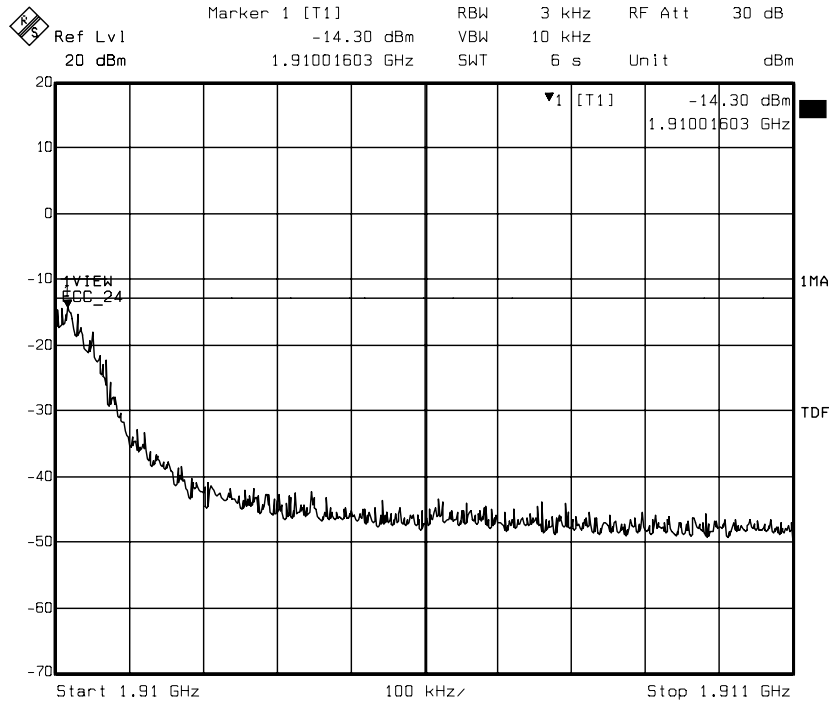

Date: 26.JUL.2002 14:58:14

diagram 8.31: carrier on channel 810 (1909,8 MHz), TCH mode

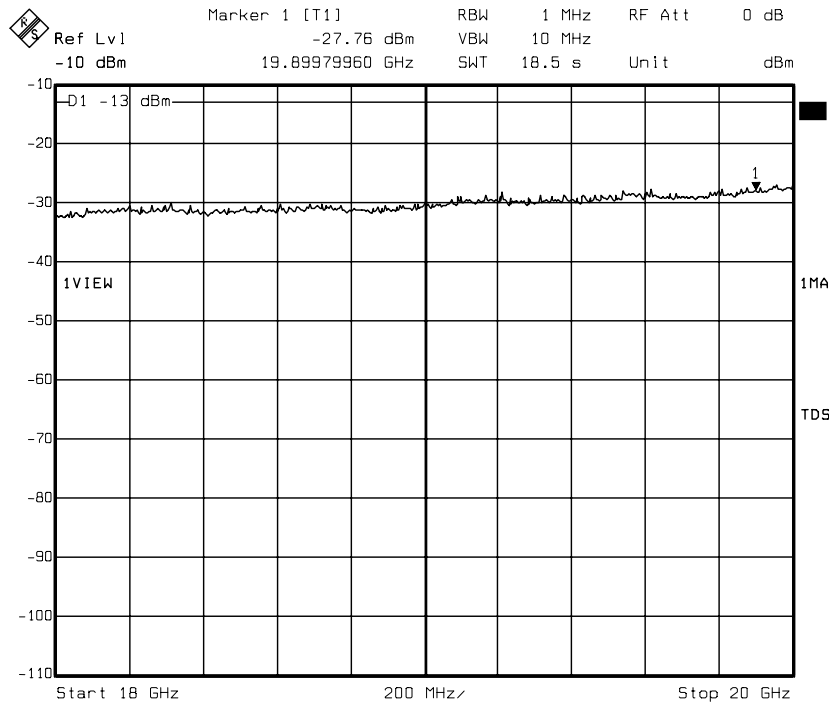

Title: FCC Sweep 8 vertical channel 810  
Date: 30.JUL.2002 13:55:42

diagram 8.32: carrier on channel 810 (1909,8 MHz), TCH mode

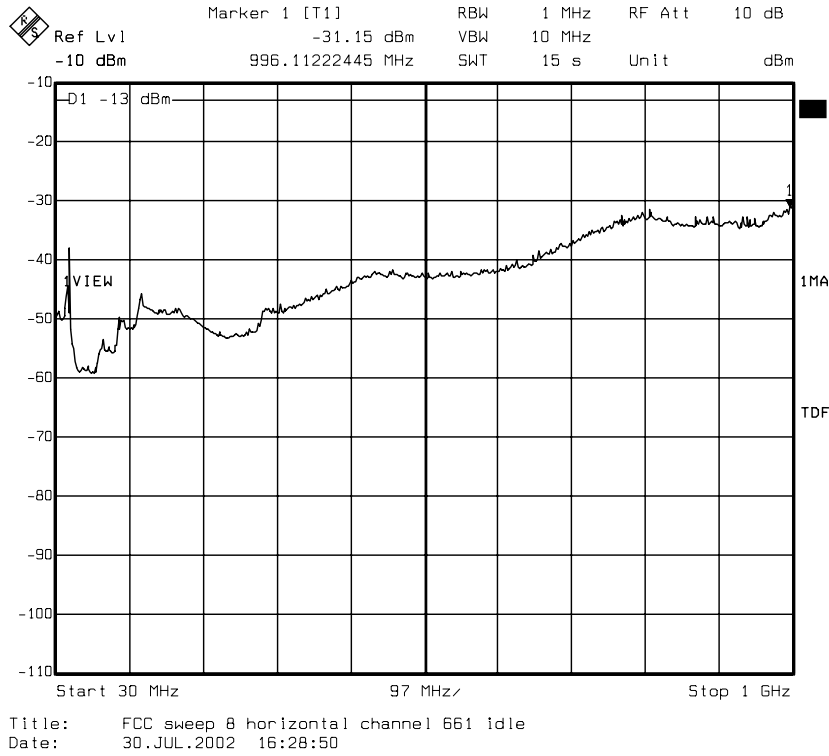

diagram 8.33: carrier on channel 661 (1880,0 MHz), IDLE mode

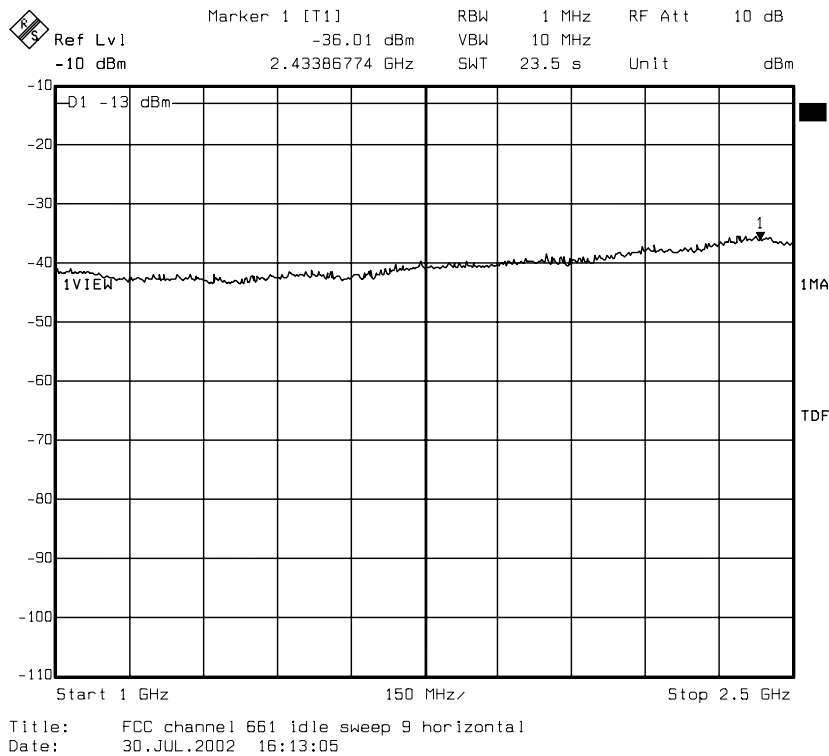
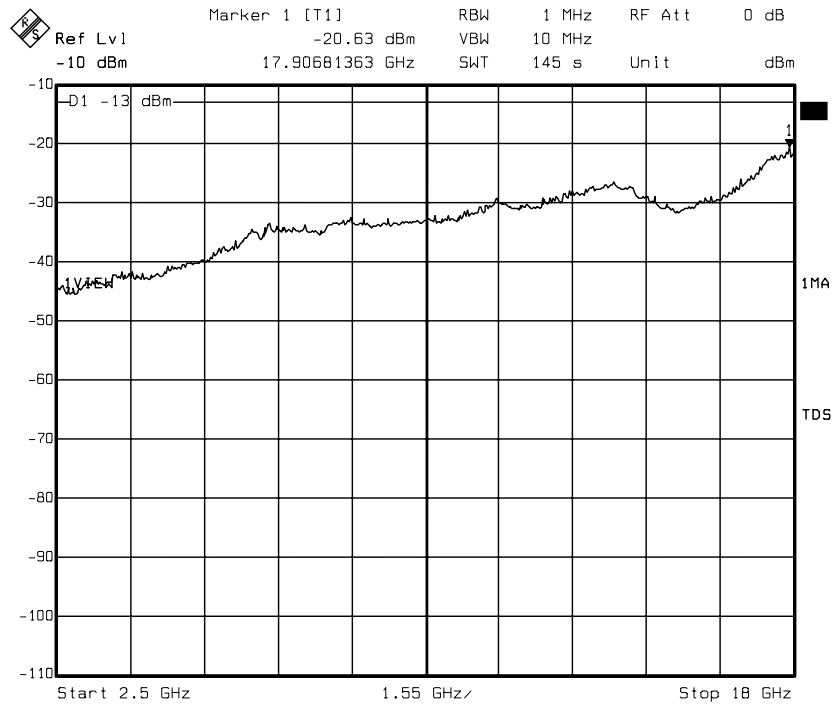
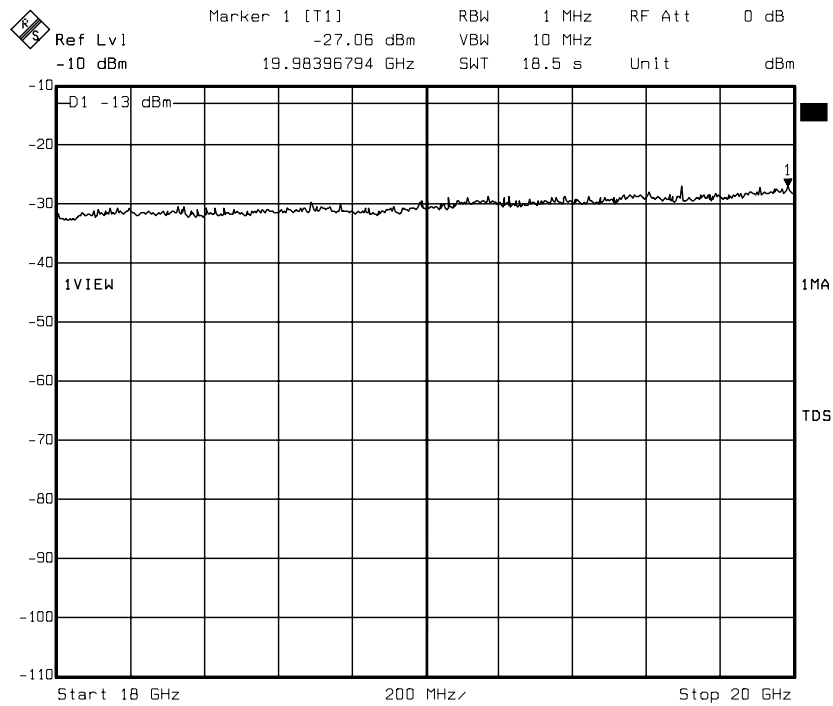

diagram 8.34: carrier on channel 661 (1880,0 MHz), IDLE mode



Title: FCC channel 661 idle sweep 10  
Date: 30.JUL.2002 15:17:43

diagram 8.35: carrier on channel 661 (1880,0 MHz), IDLE mode



Title: FCC Sweep 11 horizontal channel 661 idle  
Date: 30.JUL.2002 14:34:11

diagram 8.36: carrier on channel 661 (1880,0 MHz), IDLE mode

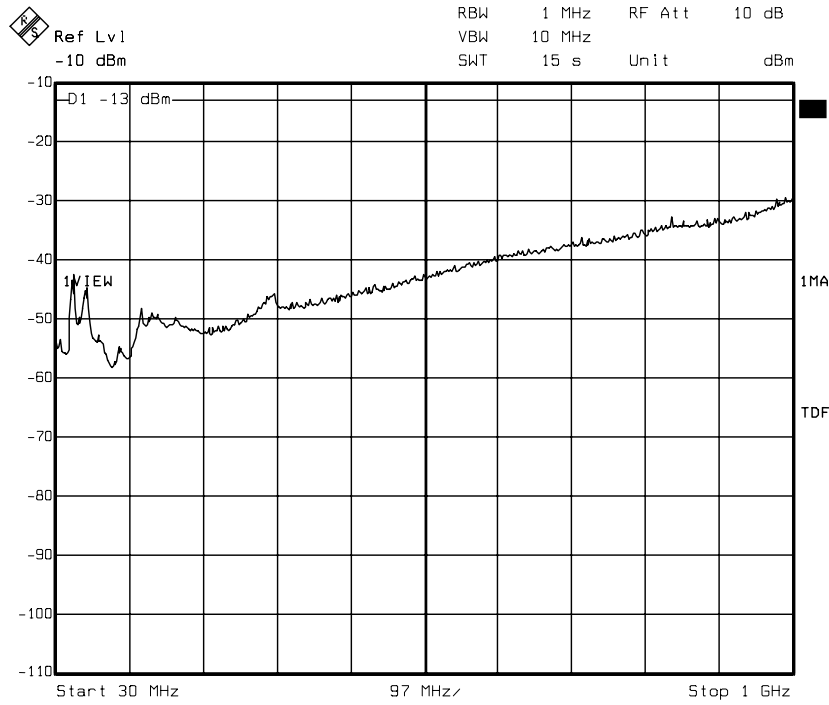

Title: FCC sweep 8 channel 661 idle vertical  
Date: 30.JUL.2002 16:36:33

diagram 8.37: carrier on channel 661 (1880,0 MHz), IDLE mode

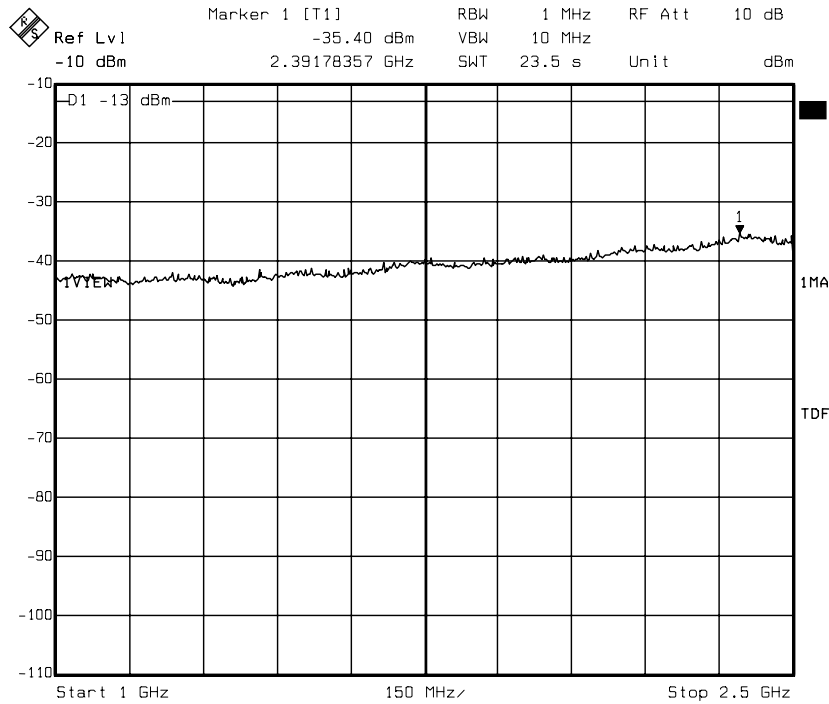

Title: FCC channel 661 idle sweep 9 vertical  
Date: 30.JUL.2002 16:03:22

diagram 8.38: carrier on channel 661 (1880,0 MHz), IDLE mode



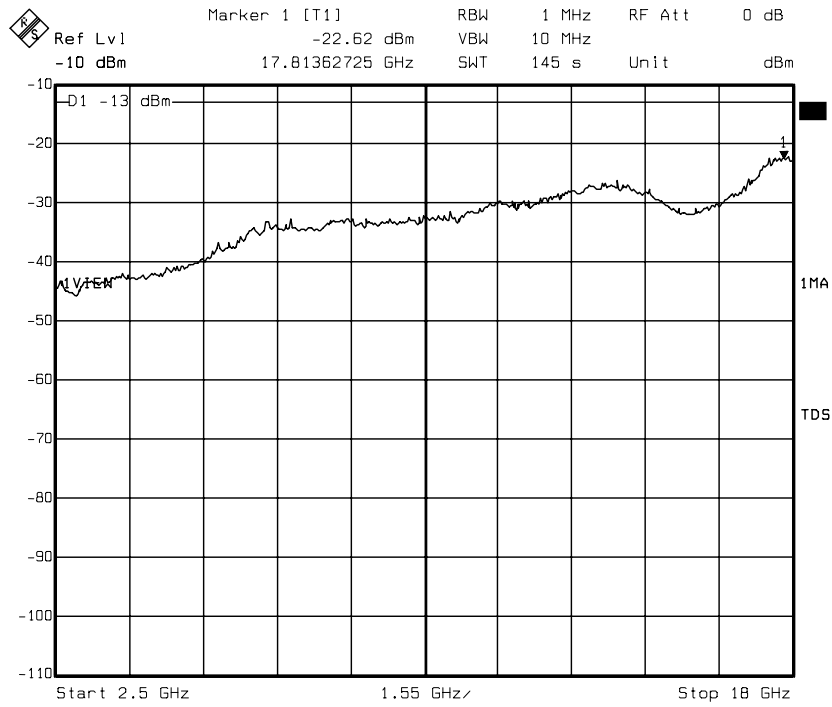

Title: FCC channel 661 idle sweep 10 vertical  
Date: 30.JUL.2002 15:51:30

diagram 8.39: carrier on channel 661 (1880,0 MHz), IDLE mode

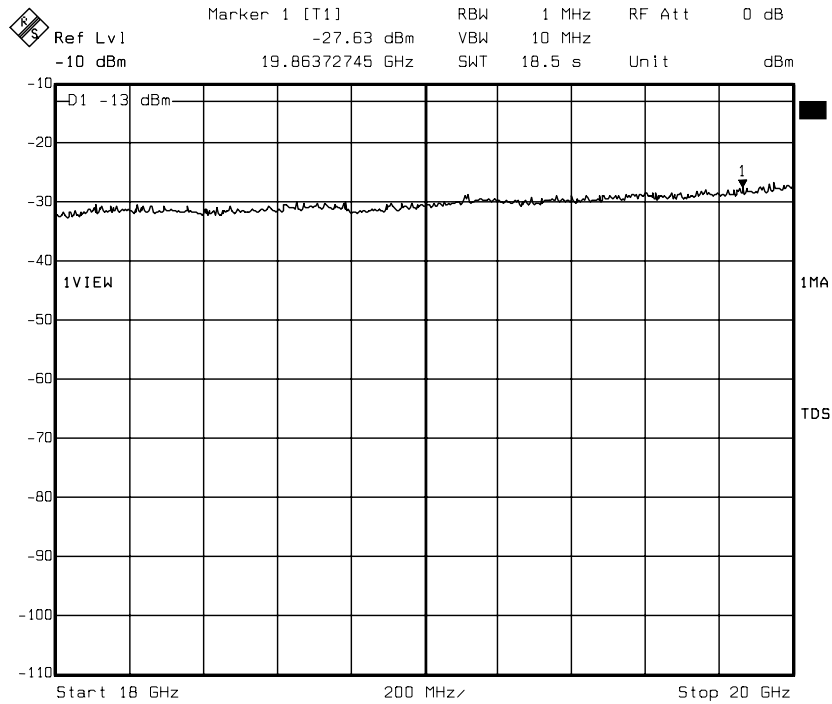

Title: FCC Sweep 11 vertical channel 661 idle  
Date: 30.JUL.2002 14:42:36

diagram 8.40: carrier on channel 661 (1880,0 MHz), IDLE mode

## 5.7. Frequency stability / temperature variation § 2.1055

### 5.7.1. Test equipment (for reference numbers please see chapter 'List of test equipment')

RF-equipment	Test site	Antenna	Spectrum Analyzer	GSM test system
249, 279, 325, 329	<input type="checkbox"/> radio lab	<input type="checkbox"/>	<input checked="" type="checkbox"/> 264 (FSEK 30)	<input checked="" type="checkbox"/> 298 (CMU 200)
	<input type="checkbox"/> anechoic chamber	<input type="checkbox"/>	<input type="checkbox"/> 120 (FSEM 30)	<input type="checkbox"/>
	<input checked="" type="checkbox"/> 331 clim. chamber	<input type="checkbox"/>	<input type="checkbox"/>	<input type="checkbox"/>

### 5.7.2. Test condition and test set-up

T = 20°C, h = 60%, p = 1016 hPa

#### §24.235

*„the frequency stability shall be sufficient to ensure that the fundamental emission stays within the authorized frequency block“*

#### § 2.1055

*(d) The frequency stability shall be measured with variation of primary supply voltage as follows:*

- (1) Vary primary supply voltage from 85 to 115 percent of the nominal value for other than hand carried battery equipment.*
- (2) For hand carried, battery powered equipment, reduce primary supply voltage to the battery operating end point which shall be specified by the manufacturer.*

- ⇒ According to the GSM 05.10 standard, the frequency stability of the EUT (MS) shall be within 0.1 ppm compared to signals to received from the base station. This accuracy is considered sufficient to meet Section 24.235, Frequency Stability and sufficient to ensure that the fundamental emission stays within the authorized frequency block.
- ⇒ in order to maintain the voltage constant over the time period of the tests, a dummy battery was connected to a laboratory power supply. The voltage range is considered according the applicants declared range of operation for the transceiver. If the declared voltage range is lower than the 85%..115% range, than applicants voltage range is taken for measurements.
- ⇒ see conducted measurement test set-up described in chapter Test Set-up.. The EUT was placed in an environmental climatic chamber
- ⇒ the mobiles power supply voltage was controlled and set by an external laboratory power supply, the power supply voltage was controlled on the input of the power supply terminals.
- ⇒ the integrated frequency measurement capability of the CMU was used for determining the frequency shift. The maximum shift in frequency was recorded for each channel during the transmission of 200 Bursts.

The measurements were made at the middle carrier traffic frequency of the PCS band.

#### Frequency shift against temperature at constant power supply voltage

Determine the carrier frequency for channels 661 at room temperature and nominal voltage [20°C] and expose the mobile station to -30°C. Perform all carrier frequencies measurements in 10°C increments from -30°C to +60°C. For about 1 hours at the specified temperature the mobile was powered-off. After powering-on, the measurements were made within 2 minute for the channel 512, in order to prevent self-warming of the mobile. Before changing to channel 810, the mobile was powered-off for about 10 minutes in order to avoid short term frequency transient effects.

### Frequency shift against voltage range at constant temperature of 20° Celsius

Determine the carrier frequency for channel 512 and nominal voltage. Apply  $V_{max}$  of the EUT and switch off the EUT for about 30 minutes. Record the carrier frequency within 2 minutes after powering-on the mobile.

Before proceeding with  $V_{min}$  switch off the EUT for about 30 minutes.

Record the carrier frequency within 2 minutes after powering-on the mobile. Before proceeding with  $V_{min}$  switch off the EUT for about 30 minutes

Following voltage range was checked according customers declaration of  $V_{min}$  and  $V_{max}$ .

The voltage was reduced to the lower end point of the battery, where the mobile phone stops working  $V_{end}$  (this shall be specified by the manufacturer) and the frequency was also recorded.

The configuration of the signaling unit is shown in chapter 'Parameter settings on mobile phone'.

### 5.7.3. Results

EUT Type and S/N or EUT set-up no.	EUT set-up 1, op. 2					
Frequency Error vs. Temperature [fix voltage of 4,5 V]						
Temperature [°C]	Frequency Error [Hz]	Frequency Error [%]	Frequency Error [ppm]	Limit [ppm]	Remark	Verdict
-30	72,0	0,0000038	0,0383	0,1		Passed
-20	55,0	0,0000029	0,0293	0,1		Passed
-10	59,0	0,0000031	0,0314	0,1		Passed
0	59,0	0,0000031	0,0314	0,1		Passed
10	57,0	0,0000030	0,0303	0,1		Passed
20	38,0	0,0000020	0,0202	0,1		Passed
30	61,0	0,0000032	0,0324	0,1		Passed
40	54,0	0,0000029	0,0287	0,1		Passed
50	68,0	0,0000036	0,0362	0,1		Passed
60	58,0	0,0000031	0,0309	0,1		Passed
Frequency error vs. Voltage [fix temperature of 20°C]						
Voltage [V]	Frequency Error [Hz]	Frequency Error [%]	Frequency Error [ppm]	Limit [ppm]	Remark	Verdict
$V_{max} = 4,5V$	38	0,0000020	0,0202	0,1		Passed
$V_{min} = 3,3V$	54	0,0000029	0,0287	0,1		Passed

Customer declaration: no other voltages are tunable in DSB 45

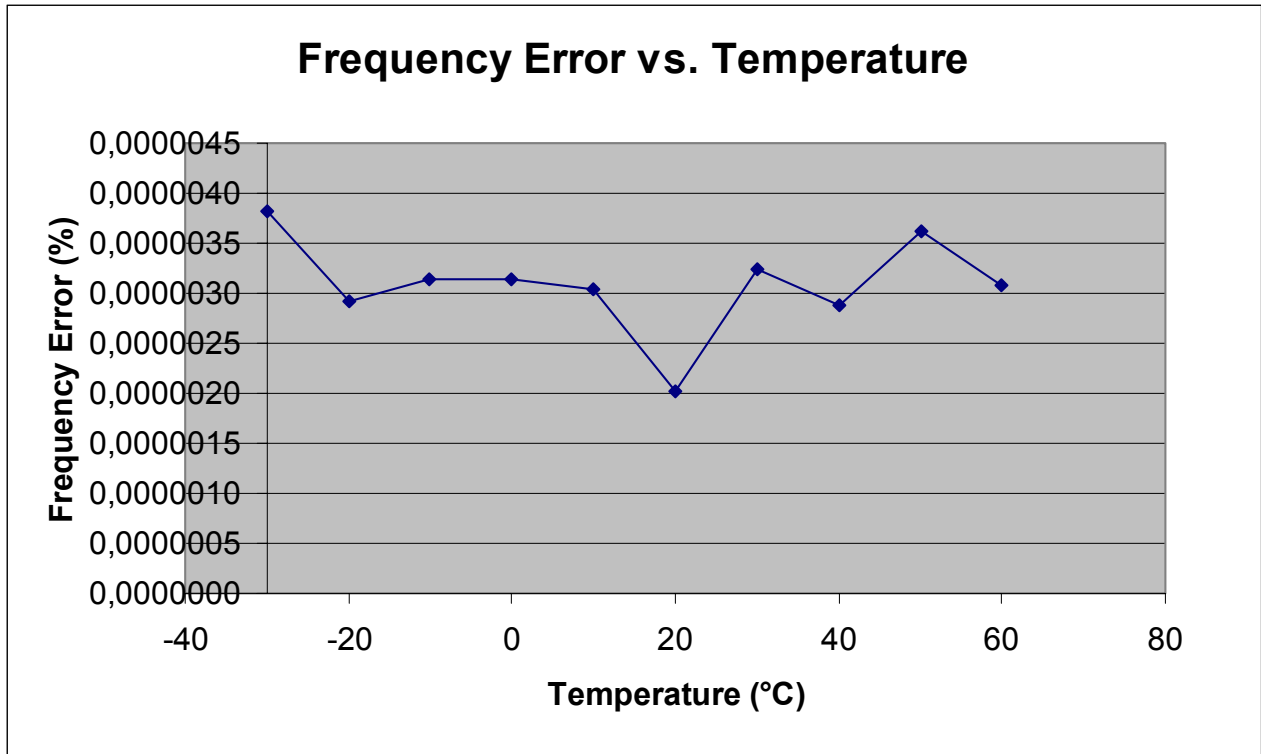

Diagram Frequency Error vs. Temperature

Remarks: --

## 6. Instruments and Ancillary Equipment „CTC“

### 6.1. Single instruments

Ref.-No.	Equipment	Type	Manufacturer	Serial-No.	Interval of calibration	Remark	Cal due
1	test receiver	ESS	Rohde & Schwarz	825132/017	12 M	-	31.03.2003
2	test receiver	ESVP	Rohde & Schwarz	879674/024	12 M	-	31.10.2002
3	spectrum monitor (EMI_Ltg)	EZM	Rohde & Schwarz	883580/001	12 M	-	31.10.2002
4	test receiver	ESH 3	Rohde & Schwarz	879599/005	12 M	-	31.10.2002
5	AC - LISN (50 Ohm/50μH, test site 1)	ESH2-Z5	Rohde & Schwarz	861 741/005	12 M	-	31.03.2003
7	DC - LISN (50 Ohm/5μH)	ESH3-Z6	Rohde & Schwarz	892563/002	12 M	-	31.03.2003
8	signal generator (EMS-Halle)	SMG	Rohde & Schwarz	863 991/021	12 M	-	31.03.2003
9	power meter (EMS-Halle)	NRV	Rohde & Schwarz	863056/017	12 M	-	31.03.2003
10	insertion unit (EMS-Halle)	URV5-Z2	Rohde & Schwarz	864169/001	12 M	-	31.03.2003
11	insertion unit (EMS-Halle)	URV5-Z2	Rohde & Schwarz	864169/004	12 M	-	31.03.2003
12	signal generator (HF_ unsym)	SMY 01	Rohde & Schwarz	839069/027	36 M	-	31.03.2003
13	power meter (HF_ unsym)	NRVD	Rohde & Schwarz	839111/003	12 M	-	31.03.2003
14	insertion unit (HF_ unsym)	URV5-Z2	Rohde & Schwarz	838519/029	12 M	-	31.03.2003
15	insertion unit (HF_ unsym)	URV5-Z4	Rohde & Schwarz	838570/024	12 M	-	31.03.2003
16	line impedance simulating network	Op. 24-D	Spitzenberger + Spies	B6366	24 M	-	31.10.2003
17	digital radiocommunication tester	CMD 65 (60)	Rohde & Schwarz	844365/014	12 M	-	31.03.2003
18	digital radiocommunication tester	CRTC 02 (analog unit)	Rohde & Schwarz	837488/007	-	3	
19	digital radiocommunication tester	CRTC 02 (digital unit)	Rohde & Schwarz	837949/008	-	3	
20	horn antenna (Subst 1)	3115	EMCO	9107-3699	12 M	-	31.10.2002
21	loop antenna	6502	EMCO	9206-2770	36 M	-	18.03.2003
22	audio measurement amplifier	2636C	B&K	1537643	12 M	-	31.03.2003
23	1000 Hz calibrator 94 dB SPL	4230	B&K	1594766	12 M	-	31.03.2003
24	Band pass filter 1 kHz	1625	B&K	1814825	pre-m	2	
25	Broadband field monitor display	model HI-4400	Holaday	60778	12 M	-	30.03.2003
26	isotropic electric field monitor	model HI-4421	Holaday	77591A000	12 M	-	30.03.2003
29	digital oscilloscope	TDS 784 A	Tektronix	B010268	12 M	-	07.06.2003
30	loop antenna	HFH-Z2	Rohde & Schwarz	879604/026	36 M	-	18.03.2003
31	absorbing clamp	MDS-21	Rohde & Schwarz	902068	24 M	-	31.10.2002
32	absorbing clamp	MDS-21	Rohde & Schwarz	841248	12 M	-	31.10.2002
33	RF-current probe (100kHz-30MHz)	ESH2-Z1	Rohde & Schwarz	911-5/18	12 M	-	31.10.2002
34	ESD-generator	ESD 30	EMTEST	ESD 30.0689-04	12 M	-	31.10.2002
35	air discharge modul	P 18	EMTEST	P 18-0689-04	12 M	-	31.10.2002
36	contact discharge modul	P 18	EMTEST	P 18-0392-55	12 M	-	31.10.2002
37	burst generator	EFT 5	EM TEST	0192-06	12 M	-	13.06.2003
38	hybrid generator (CWG)	CWG 4-104	HILO TEST	0594-08	12 M	-	13.06.2003
39	coupling decoupling network surge	CDN 104	HILO TEST	911393	12 M	-	13.06.2003
40	power fail simulator	PFS 16 A	EM TEST	10 91-04	12 M	-	14.06.2003
41	multimeter	E2373A	HP	-	-	3	
42	multimeter	8060 A	Fluke	4040321	24 M	-	31.10.2002
43	pulse limiter	ESH3-Z2	Rohde & Schwarz	4711	12 M	-	31.10.2002
44	pre-amplifier 100 MHz-26GHz	JS4-00102600-38-5P	Miteq	340123	12 M	-	31.10.2002
45	multimeter	B3220	Siemens	Q5-8710-0031	-	3	
46	multimeter	B3220	Siemens	Q5-8905-0012	-	3	
48	bicon. - log. Antenna (FAC)	3143	EMCO	1108	12 M	-	31.10.2002
49	current clamp (injection)	F-120-2	FCC	48	12 M	-	31.10.2002
50	3-phase coupling-decoupling-network (Burst)	CDN 300	Schaffner	176	12 M	-	13.06.2003
51	VHF-current probe 20-300 MHz	ESV-Z1	Rohde & Schwarz	872421	12 M	-	31.10.2002
52	notch filter DECT	WRCB1887,82/1889,55 SS	Wainwright Industries	12	12 M	-	31.03.2003
53	high pass filter,GSM1800,1900,DECT	230042	TRILITHIC	9642169	12 M	-	31.10.2002
57	relay-switch-unit (EMS system)	RSU	Rohde & Schwarz	494440/002	-	1a	
58	capacitive clamp (Burst)	IP 4	Hafely	99	-	3	
59	ferrite tube	FGZ 40 X 15 E	Lüthi	4225	-	3	
60	power amplifier (DC-2kHz)	Typ PAS 5000	Spitzenberger + Spies	B6363	-	3	
61	ferrite tube	FGZ 40 X 15 E	Lüthi	4250	-	3	
65	attenuator, 50 Ohm , 250W 6dB	AT 50-6-250	BNOS Electronics	521057	12 M	-	31.10.2002
66	power amplifier 10 kHz-220MHz	75A220MI	Amplifier Research	15860	-	1b	

67	coupling-decoupling-network	CDN801-M2/M3	Lüthi	272	12 M	-	31.10.2002
68	coupling-decoupling-network	CDN 801-M5	Lüthi	95226	12 M	-	31.10.2002
69	EM-clamp	EM101	Lüthi	9535159	12 M	-	31.10.2002
70	ferrite tube	FTC101	Lüthi	4199	12 M	-	31.10.2002
71	biconical antenna (Subst 1)	HUF-Z2	Rohde & Schwarz	863.029/010	12 M	-	31.10.2002
72	coupling-decoupling-network	CDN801-M2/M3	Lüthi	276	12 M	-	31.10.2002
77	2 wire T-network	T1-NNb	BOSSE Telefonbau	-	12 M	-	31.03.2003
78	2 wire T-network	T2-NNb	BOSSE Telefonbau	-	12 M	-	31.03.2003
79	4 wire T-network	EZ-10	Rohde & Schwarz	862 939 / 011	12 M	-	31.03.2003
80	power amplifier 10kHz-220MHz	AR 1000 L	Amplifier Research	10967	-	1a	
81	power amplifier 220-400MHz	AR 200 HA	Amplifier Research	11053	-	1a	
82	power amplifier 400-1000MHz	AR 100 HB	Amplifier Research	11134	-	1a	
83	AC - power supply, 9-10 A	EAC/MT 27010	EURO TEST	910502096	-	4	
84	AC - power supply, 0-5A	-	ELABO	-	-	4	
85	AC - power supply, 0-10A	R250	Schuntermann & Benningh.	-	-	4	
89	multimeter	Multavi 5	H&B	-	-	3	
92	log.-per.-ant. LP1 (20MHz-220 MHz)	LPD S12014/551	FSA	2300/1	-	1a	
93	log.-per.-ant. LP2 (220MHz-2000MHz)	LPD S23011/222	FSA	2300/2	-	1a	
94	artificial head (No.1)	4905	B&K	1566990	-	2	
96	artificial head (No.2)	4905	B&K	1536827	-	2	
99	passive voltage probe	ESH2-Z3	Rohde & Schwarz	299.7810.52	12 M	-	31.10.2002
100	passive voltage probe	Probe TK 9416	Schwarzbeck	keine	12 M	-	31.10.2002
104	directional coupler	DC5000	Amplifier Research	10714	-	1a	
105	directional coupler	DC6000	Amplifier Research	10846	-	1a	
106	EMC - control module	1037.2990.02	Rohde & Schwarz	****	-	1a	
119	RT harmonics analyser/dig. flickermeter	B10	BOCONSULT	G60547	24 M	-	31.10.2003
120	spectrum analyzer	FSEM 30	Rohde & Schwarz	845538/011	12 M	-	01.07.2003
121	notch filter GSM 1900	WRCB1879,5/1880,5EE	Wainwright Instr.	15	12 M	-	31.03.2003
122	notch filter GSM 1800	WRCB 1747/1748	Wainwright Instr.	12	12 M	-	31.03.2003
131	RF-Current Probe	F-52	FCC	19	12 M	-	31.10.2002
133	horn antenna (Meas 1)	3115	EMCO	9012-3629	12 M	-	31.10.2002
136	adjustable dipole antenna (Dipole 1)	3121C-DB4	EMCO	9105-0697	12 M	-	31.10.2002
138	spectrum analyzer, display unit	FSA-D	Rohde & Schwarz	863619/003	12 M	-	31.10.2002
139	spectrum analyzer, RF unit	FSBS-RF	Rohde & Schwarz	863373/003	12 M	-	31.10.2002
140	signal generator	SMHU	R & S	831314/006	24 M	-	31.10.2003
142	attenuator 6 dB 8 GHz 2 W	DGL N	Radiall	keine	12 M	-	31.10.2002
248	attenuator	SMA 6dB 2W	Radiall	-	pre-m	2	
249	attenuator	SMA 10dB 10W	Radiall	-	pre-m	2	
252	attenuator	N 6dB 12W	Radiall	-	pre-m	2	
254	high pass GSM1800/1900/DECT	5HC2600/12759-1.5KK	Trilithic	23042 / 9642169	12 M	-	31.03.2003
256	attenuator	SMA 3dB 2W	Radiall	pre-m	2		
257	hybrid	4031C	Narda	04491	pre-m	2	
259	adjustable notch filter	WRCD 1800/2100-10EEK	Wainwright	1	pre-m	2	
260	hybrid coupler	4032C	Narda	11342	pre-m	2	
261	thermal power sensor	NRV-Z55	R&S	825083/0008	24 M	-	31.10.2002
262	power meter	NRV-S	R&S	825770/0010	24 M	-	20.10.2002
263	signal generator	SMP 04	R&S	826190/0007	36 M	-	05.08.2004
264	spectrum analyser	FSEK 30	R&S	826939/005	12 M	-	31.10.2002
265	peak power sensor	NRV-Z33, Model 04	R&S	840414/009	24 M	-	31.10.2002
266	peak power sensor	NRV-Z31, Model 04	R&S	843383/016	24 M	-	31.10.2002
267	notch filter GSM 850	WRCA 800/960-6EEK	Wainwright	9	12 M	-	31.03.2003
268	AC/DC power supply	EA 3050	EA	9823636	-	4	
269	high pass filter Radio Lab HP2	4HC1600/12750-1.5-KK	Trilithic	9836064	pre-m	2	
270	termination	1418 N	Weinschel	BB6935	pre-m	2	
271	termination	1418 N	Weinschel	BE6384	pre-m	2	
272	attenuator 20 dB 50 W	Model 47	Weinschel	BF6239	pre-m	2	
273	attenuator (10 dB) 100 W	Model 48	Weinschel	BF9229	pre-m	2	
274	attenuator (10 dB) 50 W	Model 47 (10 dB) 50 W	Weinschel	BG0321	pre-m	2	
275	DC-Block	Model 7003 (N)	Weinschel	C5129	pre-m	2	
276	DC-Block	Model 7006 (SMA)	Weinschel	C7061	pre-m	2	
279	power divider	1515 (SMA)	Weinschel	LH855	pre-m	2	
284	coupling decoupling network	CDN M1	Lüthi	1661	12 M	-	31.10.2002
285	coupling decoupling network	CDN S1	Lüthi	1642	12 M	-	31.10.2002
287	pre-amplifier 25MHz - 4GHz	AMF-2D-100M4G-35-10P	Miteq	379418	12 M	-	31.10.2002
289	Bilconilog Antenna (OATS)	CBL 6141	Schaffner Chase	4107	12 M	-	31.10.2002

290	notch filter GSM 900	WRCA901,9/903,1ss	Wainwright	3RR	12 M	-	31.03.2003
291	high pass filter GSM 900	WHJ 2200-4EE	Wainwright	14	12 M	-	31.03.2003
295	Racal Digital Radio Test Set	Typ 6103	Racal	1572	-	3	
296	audio measurement amplifier	2636C	B&K	1537541	12 M	-	31.10.2002
298	Universal radio communication tester	CMU 200	R & S	832221/091	12 M	-	31.03.2003
299	Audio microphone	Typ 4134	B & K	-	pre-m	2	
300	AC LISN (50 Ohm/50µH , 1-phase)	ESH-3Z5	R&S	892 239/020	12 M	-	01.09.2002
301	attenuator 20dB 50W 18GHz	47-20-33	Lucas Weinschel	AW0272	pre-m	2	
302	Horn antenna 40 GHz (Meas 1)	BBHA9170	Schwarzbeck	155	24 M	-	31.12.2002
303	Horn antenna 40 GHz (Subst 1)	BBHA9179	Schwarzbeck	156	24 M	-	31.12.2002
304	fix dipole antenna 1,6 GHz	EMCO 3125-307	ETS	9907-1001	pre-m	2	
305	fix dipole antenna 1,8-2,0 GHz	EMCO 3125-306	ETS	9907-1007	pre-m	2	
306	fix dipole antenna 2,45 GHz	EMCO 3125-308	ETS	9907-1001	pre-m	2	
307	fix dipole antenna 3 GHz	EMCO 3125-309	ETS	9907-1001	pre-m	2	
312	Band pass filter 1kHz	EWR-BF 950-1050 Hz	IMD	keine	pre-m	2	
317	1000 Hz calibrator	4230 94dB	B&K	1542266	12 M	-	31.03.2003
323	Radio Comm.-Tester	CMD 55	R&S	825878/034	24 M	-	12.07.2003
325	Rubidium frequency standard	XSRM	R&S	862.715/001	36 M	-	31.10.2002
329	Frequency converter	XSRU-Z	R&S	862812/015	36 M	-	31.10.2002
331	Climatic test camber -40/+80 Grad	HC 4055	Heraeus Vötsch	43146	12 M	-	31.10.2002
332	high pass filter Radio Lab HP1	5HCC2700/12750-1.5-KK	Trilithic	9836065	pre-m	2	

## 6.2. Test systems

Ref.-No.	Test system	Manufacturer	Serial-No.	Interval of calibration	Remark	Cal due
a	EMS radiated anechoic chamber	Siemens/R&S	--	12 M	-	31.03.2003
b	EMS conducted	R&S	--	12 M	-	31.03.2003
c	Radiated spurious emission in anechoic chamber	Siemens/R&S	--	12 M	-	31.10.2002
d	EMI radiated anechoic chamber	Siemens/R&S	--	12 M	-	31.10.2002
e	EMI radiated OATS	HD GmbH	--	36 M	-	01.09.2002

Note / remarks

Calibrated during system calibration:

- 1a EMS radiated anechoic chamber
- 1b EMS conducted
- 1c Radiated spurious emission in anechoic chamber
- 1d EMI radiated anechoic chamber
- 1e EMI radiated OATS
- 2 calibration or equipment check immediately before measurement
- 3 Regulatory maintained equipment for functional check or support purpose, calibration of this equipment has no effect on measuring result
- 4 Ancillary equipment without calibration e.g. mechanical equipment or monitoring equipment

Interval of calibration

- 12 M 12 month
- 24 M 24 month
- 36 M 36 month
- Pre-m check before starting the measurement
- without calibration