



AEGIS LABS INC.



Class II Permissive Change
Test Report
And Application for Grant of Equipment Authorization

Pertaining To:

EUT	FCC ID:
Intel PRO/Wireless 2915ABG Network Connection, MN: WM3B2915ABG	PD9WM3B2915ABG

Configuration
802.11a / 802.11b / 802.11g with a set of Yokowo (Mint), Yokowo (Pumpkin), Fujitsu (Emilia), & Foxconn (Jakarta) Antennas

MEASUREMENTS PERFORMED IN ACCORDANCE WITH

Regulatory Standard(s)
47 CFR Part 15, Subpart C Section 15.247
<p>Test Method: ANSI C63.4: 2001 American National Standard for Methods of Measurement of Radio-Noise Emissions from Low-Voltage Electrical and Electronic Equipment in the Range of 9 kHz to 40 GHz</p>



Certificate Number: 1111.01

APPLICANT:

Intel Corporation
EC1-01 13280 Evening Creek Drive
San Diego, California 92128

Contact(s): Mr. Robert Paxman

PREPARED BY:

Aegis Labs, Inc.
22431 Antonio Parkway B160-417
Rancho S. Margarita, CA 92688

Agent(s): Mr. Steve Kuiper
Mr. Rick Candelas
Mr. Johnny Candelas

Test Report #: INTEL-040831F
Test Report Revision: None

	REPORT BODY	APPENDICES <i>A</i>	TOTAL PAGES
PAGES	18	119	137

The contents of this report shall not be reproduced except in full, without the written approval of Aegis Labs, Inc.

Page 1 of 18
Report Number: INTEL-040831F
FCC ID: PD9WM3B2915ABG



TABLE OF CONTENTS

SECTION	TITLE	PAGE
	COVER SHEET.....	01
	TABLE OF CONTENTS.....	02
1.0	CERTIFICATION OF TEST DATA.....	03
2.0	SUMMARY OF TEST RESULTS.....	06
3.0	ADMINISTRATIVE DATA AND TEST DESCRIPTION.....	07
4.0	DESCRIPTION OF EUT.....	08
4.1	EUT Description.....	08
4.1.1	Channel Number and Frequencies.....	09
4.2	EUT Configuration.....	10
4.3	List of EUT Sub-Assemblies and Host Equipment.....	11
4.4	I/O Cabling Diagram and Description.....	12
5.0	TEST EQUIPMENT AND TEST SETUPS.....	13
5.1	AC Power Line Conducted Emissions.....	13
5.2	Spurious Radiated Emissions.....	14
5.3	Conducted Emissions At The Antenna Port.....	14
5.4	Test and Measurement Equipment Used.....	15
6.0	SAMPLE CALCULATIONS.....	16
7.0	MODIFICATIONS AND RECOMMENDATIONS.....	18

APPENDICES

A	Test Data
----------	-----------



AEGIS LABS INC.

1.0 CERTIFICATION OF TEST DATA

Aegis Labs, Inc. operates as both a Nevada and California Corporation with no organizational or financial relationship with any company, institution, or private individual.

Testing and engineering functions provided by Aegis Labs are furnished through the use of part-time, full-time or consulting engineers with the appropriate qualifications to carry out their duties. The intended purpose of this test report is to describe the measurement procedure and to determine whether the equipment under test "EUT" complies with both the conducted and radiated limits. Limits for emissions testing are described under Subpart C of Part 15 of the FCC rules.

The data, data evaluation and equipment configuration represented herein are a true and accurate representation of the Equipment Under Test (EUT) under the requirements specified in the emissions standard as described below. The test results contained in this report are only representative of the test sample tested as described in Section 3.0 of this report. Certification of the EUT is required as a prerequisite to marketing as defined in Part 2 of the FCC Rules.

Prepared By:

09/20/04

Rick Candelas
Staff Engineer
Aegis Labs, Inc.

Date:

Report Approved By:

09/20/04

Steve J. Kuiper
Quality Assurance Manager
Aegis Labs, Inc.

Date:

Page 3 of 18

Report Number: INTEL-040831F

FCC ID: PD9WM3B2915ABG



AEGIS LABS INC.

2.0 SUMMARY OF TEST RESULTS

The test results provided within this report, indicate that the EUT has been found to be in **COMPLIANCE** with the test specifications based upon the following RF compliance standards:

Pass/Fail determination is based upon the nominal values of the test data.

802.11a Mode (5745-5825 MHz)

EMISSIONS STANDARD			
FCC Part 15 Section	Description	Results	Comments
15.247(a)(2)	The minimum 6dB bandwidth shall be at least 500 kHz.	PASSED	5745 MHz = 16.58 MHz 5785 MHz = 16.67 MHz 5825 MHz = 16.67 MHz <i>Per Original Filing</i>
15.247(b)(1)	The maximum peak output power of the intentional radiator shall not exceed 1 watt.	PASSED	5745 MHz = 22.80 dBm = 190.55 mW 5785 MHz = 22.90 dBm = 194.98 mW 5825 MHz = 23.30 dBm = 21.3.80 mW
15.247(b)(4)	The intentional radiator shall be operated in a manner that ensures that the public is not exposed to radio frequency energy levels in excess of the FCC guidelines per Section 1.1307(b)(1).	PASSED	Refer to MPE Calculations Exhibit
15.247(c)	In any 100 kHz bandwidth outside the frequency band in which the spread spectrum intentional radiator is operating, the radio frequency power that is produced by the intentional radiator shall be at least 20 dB below that in the 100 kHz bandwidth within the band that contains the highest level of the desired power.	PASSED	See Data Sheets
15.247(c)	Radiated emissions, which fall in the restricted bands, as defined in Sec. 15.205(a), must also comply with the radiated emission limits specified in Sec. 15.209(a). All others must be < -20dBc.	PASSED	See Data Sheets
15.247(d)	The peak power spectral density conducted from the intentional radiator to the antenna shall not be greater than 8 dBm in any 3 kHz band during any time interval of continuous transmission.	PASSED	5745 MHz = -10.50 dB 5785 MHz = -10.50 dB 5825 MHz = -9.83 dB <i>Per Original Filing</i>
15.207	AC Conducted Emissions	PASSED	<i>See Original Filing</i>
15.209	Radiated Emissions (30-1000 MHz)	PASSED	<i>See Original Filing</i>

Page 4 of 18

Report Number: INTEL-040831F

FCC ID: PD9WM3B2915ABG



AEGIS LABS INC.

2.0 Summary of Test Results (Continued)

The test results provided within this report, indicate that the EUT has been found to be in **COMPLIANCE** with the test specifications based upon the following RF compliance standards:

Pass/Fail determination is based upon the nominal values of the test data.

802.11b Mode (2412-2462 MHz)

EMISSIONS STANDARD			
FCC Part 15 Section	Description	Results	Comments
15.247(a)(2)	The minimum 6dB bandwidth shall be at least 500 kHz.	PASSED	2412 MHz = 7.75 MHz 2437 MHz = 7.83 MHz 2462 MHz = 7.75 MHz <i>Per Original Filing</i>
15.247(b)(1)	The maximum peak output power of the intentional radiator shall not exceed 1 watt.	PASSED	2412 MHz = 17.10 dBm = 51.29 mW 2437 MHz = 19.00 dBm = 79.43 mW 2462 MHz = 19.20 dBm = 83.18 mW
15.247(b)(4)	The intentional radiator shall be operated in a manner that ensures that the public is not exposed to radio frequency energy levels in excess of the FCC guidelines per Section 1.1307(b)(1).	PASSED	Refer to MPE Calculations Exhibit
15.247(c)	In any 100 kHz bandwidth outside the frequency band in which the spread spectrum intentional radiator is operating, the radio frequency power that is produced by the intentional radiator shall be at least 20 dB below that in the 100 kHz bandwidth within the band that contains the highest level of the desired power.	PASSED	See Data Sheets
15.247(c)	Radiated emissions, which fall in the restricted bands, as defined in Sec. 15.205(a), must also comply with the radiated emission limits specified in Sec. 15.209(a). All others must be < -20dBc.	PASSED	See Data Sheets
15.247(d)	The peak power spectral density conducted from the intentional radiator to the antenna shall not be greater than 8 dBm in any 3 kHz band during any time interval of continuous transmission.	PASSED	2412 MHz = -6.17 dB 2437 MHz = -6.67 dB 2462 MHz = -7.17 dB <i>Per Original Filing</i>
15.207	AC Conducted Emissions	PASSED	<i>See Original Filing</i>
15.209	Radiated Emissions (30-1000 MHz)	PASSED	<i>See Original Filing</i>

Page 5 of 18

Report Number: INTEL-040831F

FCC ID: PD9WM3B2915ABG



2.0 Summary of Test Results (Continued)

The test results provided within this report, indicate that the EUT has been found to be in **COMPLIANCE** with the test specifications based upon the following RF compliance standards:

Pass/Fail determination is based upon the nominal values of the test data.

802.11g Mode (2412-2462 MHz)

EMISSIONS STANDARD			
FCC Part 15 Section	Description	Results	Comments
15.247(a)(2)	The minimum 6dB bandwidth shall be at least 500 kHz.	PASSED	2412 MHz = 16.33 MHz 2437 MHz = 16.67 MHz 2462 MHz = 16.67 MHz <i>Per Original Filing</i>
15.247(b)(1)	The maximum peak output power of the intentional radiator shall not exceed 1 watt.	PASSED	2412 MHz = 24.10 dBm = 257.04 mW 2437 MHz = 24.00 dBm = 251.19 mW 2462 MHz = 23.90 dBm = 245.47 mW
15.247(b)(4)	The intentional radiator shall be operated in a manner that ensures that the public is not exposed to radio frequency energy levels in excess of the FCC guidelines per Section 1.1307(b)(1).	PASSED	Refer to MPE Calculations Exhibit
15.247(c)	In any 100 kHz bandwidth outside the frequency band in which the spread spectrum intentional radiator is operating, the radio frequency power that is produced by the intentional radiator shall be at least 20 dB below that in the 100 kHz bandwidth within the band that contains the highest level of the desired power.	PASSED	See Data Sheets
15.247(c)	Radiated emissions, which fall in the restricted bands, as defined in Sec. 15.205(a), must also comply with the radiated emission limits specified in Sec. 15.209(a). All others must be < -20dBc.	PASSED	See Data Sheets
15.247(d)	The peak power spectral density conducted from the intentional radiator to the antenna shall not be greater than 8 dBm in any 3 kHz band during any time interval of continuous transmission.	PASSED	2412 MHz = -11.33 dB 2437 MHz = -12.67 dB 2462 MHz = -11.17 dB <i>Per Original Filing</i>
15.207	AC Conducted Emissions	PASSED	<i>See Original Filing</i>
15.209	Radiated Emissions (30-1000 MHz)	PASSED	<i>See Original Filing</i>



AEGIS LABS INC.

3.0 ADMINISTRATIVE DATA AND TEST DESCRIPTION

DEVICE TESTED:	ITE Type: Intel PRO/Wireless 2915ABG Network Connection Model Number(s): WM3B2915ABG Serial Number: 344F96244ABC51962012 FCC ID: PD9WM3B2915ABG
TEST DATE(S):	August 31, 2004
DATE EUT RECEIVED:	July 28, 2004
ORIGIN OF TEST SAMPLE(S):	Production Unit
RESPONSIBLE PARTY:	Intel Corporation EC1-01 13280 Evening Creek Drive San Diego, California 92128
CLIENT CONTACT:	Mr. Robert Paxman
MANUFACTURER:	Intel Corporation
TEST LOCATION:	Aegis Labs, Inc. 32231 Trabuco Creek Road Trabuco Canyon, CA 92678 Conducted Site #2 Radiated Site #2
A2LA CERTIFICATE:	1111.01, Valid through February 28, 2006
PURPOSE OF TEST:	To demonstrate compliance with the relevant standards described in Section 2.0 of this report.
TEST(S) PERFORMED:	Refer to Table in Section 2.0 of this report.

All calibration vendors were responsible for certifying Aegis Labs, Inc. test equipment as per the manufacturer's specifications and that the equipment is calibrated using instruments and standards where the accuracy is traceable to the National Institute of Standards and Technology (NIST). Calibration of all test equipment conforms to ANSI/NCSL Z540-1 and ISO 10012-1 and/or ISO/IEC Guide 17025 compliance (Additionally, other pertinent test equipment will carry MIL-STD-45662A). All calibration documents are on file with Aegis Labs, Inc., with copies provided upon request.

Page 7 of 18
Report Number: INTEL-040831F
FCC ID: PD9WM3B2915ABG



4.0 DESCRIPTION OF EUT

4.1 EUT Description

Equipment Under Test (EUT)	
Trade Name:	Intel PRO/Wireless 2915ABG Network Connection
Model Number:	WM3B2915ABG
Frequency Range:	802.11a = 5745 – 5825 MHz 802.11b/g = 2412 – 2462MHz
Type of Transmission:	Direct Sequence Spread Spectrum
Transfer Rate:	1/5.5/11 Mbps for 802.11b mode 6/36/54 Mbps for 802.11g and 802.11a modes
Number of Channels:	802.11a mode (5725-5850 MHz) = 5 802.11b mode (2400-2483.5 MHz) = 11 802.11g mode (2400-2483.5 MHz)= 11
Modulation Type:	DBPSK, DQPSK, CCK, OFDM
Antenna Type:	Hirose U.FL-R-SMT mates with cable connector U.FL-LP-066
Antenna Gain (See Note 2):	Yokowo (Mint) = 1.45 dBi @ 5 GHz, 2.85 dBi @ 2.4 GHz Yokowo (Pumpkin) = 2.95 dBi @ 5 GHz, 2.31 dBi @ 2.4 GHz Fujitsu (Emilia) = 1.18 dBi @ 5 GHz, 1.06 dBi @ 2.4 GHz Foxconn (Jakarta) –1.05dBi @ 5 GHz, 2.51 dBi @ 2.4 GHz
Transmit Output Power:	23 dBm (Typical) for 802.11a mode 17 - 19 dBm (Typical) for 802.11b mode 24 dBm (Typical) for 802.11g mode Please see Appendix A (Data Sheets) for actual output power.
Power Supply:	3.3VDC from computer MPCPI slot.
Number of External Test Ports Exercised:	2 Antenna Ports (1 Main & 1 Auxiliary)

The Intel PRO/Wireless 2915ABG Network Connection is an embedded 2.4 and 5 GHz Wireless Local Area Network Mini-PCI adapter. The Mini-PCI Type 3B form factor is designed for notebook computer systems where overall thickness must be kept to an absolute minimum and connect to antennas internal to a notebook computer. It is capable of a data rate of up to 52 Mbps.

NOTE 1: For a more detailed description, please refer to the manufacture's specifications or User's Manual.

NOTE 2: The EUT was tested with a set of antennas. (Refer to the antenna specifications exhibits).



4.1.1 Channel Number and Frequencies

802.11a Mode		802.11b Mode		802.11g Mode	
Channel	Frequency (MHz)	Channel	Frequency (MHz)	Channel	Frequency (MHz)
149	5745	1	2412	1	2412
153	5765	2	2417	2	2417
157	5785	3	2422	3	2422
161	5805	4	2427	4	2427
165	5825	5	2432	5	2432
		6	2437	6	2437
		7	2442	7	2442
		8	2447	8	2447
		9	2452	9	2452
		10	2457	10	2457
		11	2462	11	2462



AEGIS LABS INC.

4.2 EUT Configuration

The EUT was tested installed in the Mini-PCI slot of the Hewlett Packard host computer as a modular device using a PCI extender board to extend the EUT outside the computer chassis. The EUT was then connected to a set of antennas via its Main and AUX antenna ports. Data for a set of Yokowo (Mint), Yokowo (Pumpkin), Fujitsu (Emilia), and Foxconn (Jakarta) antennas can be found in Appendix A (Data Sheets)

For conducted emissions at the AC mains port and radiated emissions, the Hewlett Packard host computer was connected to a Zoom modem, Hewlett Packard printer, Dell monitor, Hewlett Packard keyboard, and Hewlett Packard mouse via its serial, parallel, video, keyboard, and mouse ports respectively.

The low, middle, and high channels were tested in 802.11a, b, & g modes. Also, the EUT was tested once transmitting from the MAIN antenna port and once transmitting from the AUX antenna port. The EUT was placed in either continuous transmit or continuous receive mode by a program provided by the manufacturer (*CRTU Version 3.2.14.0000*).



4.3 List of EUT, Sub-Assemblies, and Host Equipment

LIST OF EUT AND SUB-ASSEMBLIES			
Equipment Name	Manufacturer	Model Number	Serial Number
Intel PRO/Wireless 2915ABG Network Connection	Intel Corporation	WM3B2915ABG	344F96244AB C51962012
EUT Sub-Assemblies			
Main Multi Band Antenna	Yokowo Co., Ltd.	YCE-5008 (Mint)	N/A
Auxiliary Multi Band Antenna	Yokowo Co.	YCE-5008 (Mint)	N/A
Main Multi Band Antenna	Yokowo Co.	YCE-5008 (Pumpkin)	N/A
Auxiliary Multi Band Antenna	Yokowo Co.	YCE-5008 (Pumpkin)	N/A
Main Multi Band Antenna	Fujitsu	CP115412-01 (Emilia)	N/A
Auxiliary Multi Band Antenna	Fujitsu	CP115412-01 (Emilia)	N/A
Main Multi Band Antenna	Foxconn	WDAN-Q1CT1001	N/A
Auxiliary Multi Band Antenna	Foxconn	WDAN-Q1CT1001	N/A

HOST EQUIPMENT LIST			
Equipment Name	Manufacturer	Model Number	Serial Number
Computer	Hewlett Packard	Pavillion a300n	MXK3391864
LCD Monitor	Dell	E151FPp	CN-06R644-47804-34R- LATL
Keyboard	Hewlett Packard	5183	BF33339165
Mouse	Hewlett Packard	M042KC	30870136

NOTE: All the power cords of the above support equipment are standard non-shielded, 1.8 meters long.



4.4 I/O Cabling Diagram and Description

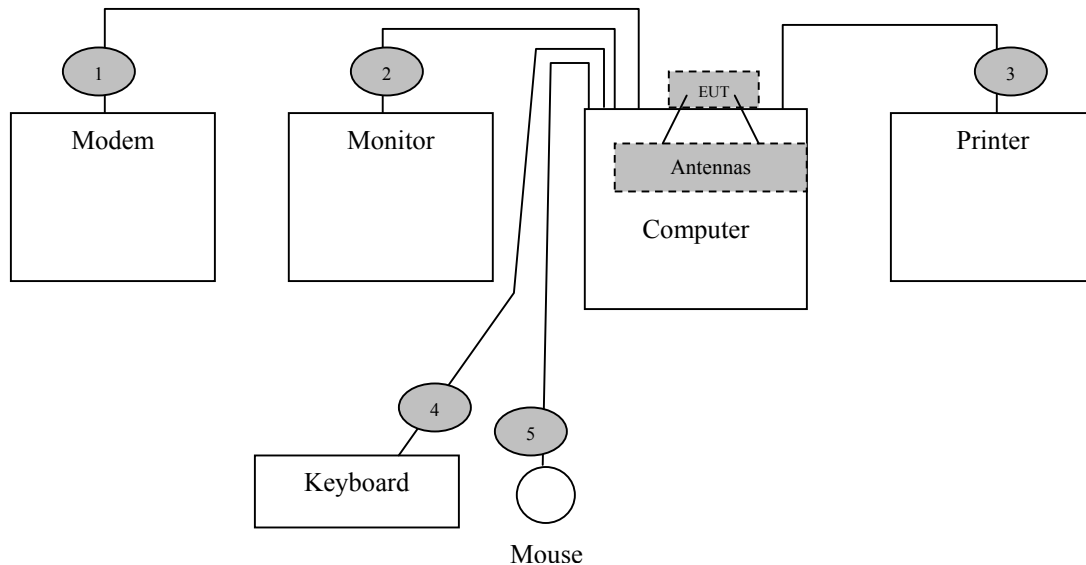

- Cable 1: This is a 6-foot braid and foil shielded round cable connecting the Hewlett Packard host computer with the Zoom modem. It has metallic DB-9 type connector at the computer end and a metallic DB-25 type connector at the modem end. The cable is bundled to a length of one meter and the shield of the cable is grounded to the chassis of both devices via the connector shells.
- Cable 2: This is a 6-foot braid and foil shielded round cable connecting the Hewlett Packard host computer with the Dell LCD monitor. It has metallic DB-15 type connector at the computer end and is hardwired to the monitor. The cable is bundled to a length of one meter and the shield of the cable is grounded to the chassis of both devices via the connector shells.
- Cable 3: This is a 6-foot braid and foil shielded round cable connecting the Hewlett Packard host computer to the Hewlett Packard printer. It has a metallic DB-25 type connector at the computer end and a metallic centronics type connector at the printer end. The cable is bundled to a length of one meter and the shield of the cable is grounded to the chassis of both devices via the connector shells.
- Cable 4: This is a 6-foot braid and foil shielded round cable connecting the Hewlett Packard host computer to the Hewlett Packard keyboard. It has a metallic 6-pin mini din type connector at the computer end and is hardwired to the keyboard. The shield of the cable is grounded to the chassis of the computer via the connector shell.
- Cable 5: This is a 6-foot braid and foil shielded round cable connecting the Hewlett Packard host computer to the Hewlett Packard mouse. It has a metallic 6-pin mini din type connector at the computer end and is hardwired to the mouse. The shield of the cable is grounded to the chassis of the computer via the connector shell.



5.0 TEST EQUIPMENT AND TEST SETUPS

The test equipment settings and functions are selected using the guidance of ANSI C63.4-1992. All test equipment setups and operations during conducted and radiated emissions testing are in accordance with this reference document.

5.1 AC Power Line Conducted Emissions

During conducted emissions measurements, a spectrum analyzer was used as the measuring instrument along with a preselector and quasi-peak detector. A 10 dB attenuation pad was used for the protection of the spectrum analyzer input stage. The conducted emissions from the EUT in the frequency range from 150 kHz to 30 MHz were captured for graphical display through the use of automated LABVIEW EMI measurement software. All graphical readings were measured in the “Peak” mode only to reduce testing time. Upon completion of the graphical scan, the test lab personnel performed the conducted measurement scan manually using the spectrum analyzer front panel keys. All peak measurements coming within 3 dB of the limit line were “Averaged” and/or “Quasi-Peaked” and denoted appropriately in the EXCEL spreadsheet.

The Equipment Under Test (EUT) was configured as a system with peripherals connected, so that at least one interface port of each type is connected to one external peripheral when tested for conducted emissions according to ANSI C63.4: 1992. Excess power cord length was wrapped in a bundle 30 to 40 centimeters in length near the center of the cord. The EUT was tested in a tabletop configuration.

The emission readings for Line 1 and Line 2 are highlighted on the data sheets in Appendix A. The graphical scans only reflect peak readings while the tabulated data sheets reflect peak, average, and/or quasi-peak readings which ever applies.



AEGIS LABS INC.

5.2 Spurious Radiated Emissions

A spectrum analyzer was used as the measuring instrumentation along with a preselector and quasi-peak-detector. The pre-amplifiers were used to increase the sensitivity of the instrument. The spectrum analyzer was used in the peak detector mode with the “max-hold” feature activated and in Positive Peak mode. In this mode, the spectrum analyzer records the highest measured reading over all the sweeps. The quasi-peak detector was used only for those readings, which are marked accordingly in the data sheet. The effective measurement bandwidth used for the radiated emissions test was 120 kHz for (30 MHz- 1000 MHz). The spectrum analyzer operated such that the modulation of the signal was filtered out to set the analyzer in linear mode. For testing beyond 1000 MHz a spectrum analyzer capable of taking reading above 1000 MHz was connected to the high frequency amplifier, where these measurement readings were taken with the transducer placed at a 3-meter test distance from the EUT.

The Open Area Test Sites (OATS) was used for radiated emission testing. These test sites are designed according to ANSI C63.4: 1992 and ANSI C63.7: 1992 guidelines. The Measurements were conducted in accordance with ANSI C63.4: 1992 and ANSI C63.7: 1992 requirements.

Broadband biconical, log periodic, and horn antennas were used as transducers during the measurement reading phase. The frequency spans were wide (30 MHz-88 MHz, 88 MHz- 216 MHz, 216 MHz- 300 MHz, and 300 MHz- 1000 MHz). After 1000 MHz the horn antenna was used to measure emissions. The emission readings in both horizontal and vertical polarities are highlighted on the data sheets in Appendix A.

5.3 Conducted Emissions at the Antenna Port

A spectrum analyzer or power meter was used as the measuring instrumentation along with an attenuator and/or filter connected to the EUT antenna port. The attenuator and filters are used to ensure that the front end of the measurement instrument is not overloaded by the fundamental transmission. . The instruments recorded the measured readings with the bandwidths (video and resolution) set in accordance with the FCC Rules and regulations.

For the power out measurements in 802.11b and 802.11g modes a peak power meter was used along with a peak power sensor with a wide enough bandwidth to capture the entire fundamental transmission. For 802.11a mode a spectrum analyzer with “Channel Power Measurement” function was used to measure the peak output power.

The measured readings are on the data sheets in Appendix A.

Page 14 of 18

Report Number: INTEL-040831F

FCC ID: PD9WM3B2915ABG



5.4 Test and Measurement Equipment Used

TEST EQUIPMENT USED					
Equipment Name	Manufacturer	Model Number	Serial Number	Calibration Due Date	Calibration Cycle
EMI Receiver - RF Section	Hewlett Packard	85462A	3325A00137	03/29/05	1 Year
EMI Receiver – RF Filter Section	Hewlett Packard	85460A	3330A00138	03/29/05	1 Year
Attenuator - 5W-10dB	Pasternack	PE7014-10	N/A	11/03/04	1 Year
LISN (EUT)	FCC	FCC-LISN-50-25-2	9931	02/06/05	1 Year
LISN (Access)	Com-Power	LI-200	12019	01/25/05	1 Year
LISN (Access)	Com-Power	LI-200	12018	01/25/05	1 Year
Spectrum Analyzer	Agilent	8564EC	4046A00387	02/06/06	2 Years
Preamplifier	Miteq	JS42-01001800-25-10P	815980 & 884968 & 885090	12/09/04	2 Years
2400-2483.5 MHz Notch Filter	Micro-Tronics	BRM50702-02	003	04/21/06	2 Years
5725-5850 MHz Notch Filter	Microwave Circuits, Inc.	N0257881	3173-01	06/27/05	2 Years
Antenna - Biconical	EMCO	3110	9108-1421	02/11/05	1 Year
Antenna - Log Periodic	EMCO	3148	4947	02/11/05	1 Year
1-18 GHz Antenna - Horn	Com-Power	AH-118	10069	12/09/04	2 Years
18-26.5 GHz Preamplified Antenna – Horn	Custom Microwave	H042	001	11/04/04	1 Year
26.5-40 GHz Preamplified Antenna – Horn	Custom Microwave	H028	GM1260-10	11/04/04	1 Year
Power Meter	Anritsu	ML2487A	6K00001785	04/05/05	2 Years
Wide Bandwidth Sensor	Anritsu	MA2491A	31193	04/05/05	2 Years



6.0 SAMPLE CALCULATIONS

If a preamplifier is used during the Radiated Emissions Testing, it is required that the amplifier gain be subtracted from the Spectrum Analyzer (Meter) Reading. In addition, a correction factor for the antenna, cable and a distance factor, if any, must be applied to the Meter Reading before a true field strength reading can be obtained. In the Automatic Mode of A.R.M.S. measurements, these considerations are automatically presented as a part of the printout. In the case of manual measurements and for greater efficiency and convenience, usage of the calibration correction factors in the Appendices is necessary to calculate the Corrected Meter Reading. These correlation factors for each meter reading, shall be modified to reflect these correlation factors at each frequency value so that the meter readings can be compared directly to the modified specification limit. This modified specification limit is referred to as the “Corrected Meter Reading Limit” (CML).

The equation shall be derived in the following manner:

$$\text{Corrected Meter Reading} = \text{Meter Reading} + F + C - G - D$$

Where, F = Antenna Factor

C = Cable Factor

G = Amplifier Gain

D = Distance Factor

Therefore, the equation for determining the Corrected Meter Reading Limit (CML) is:

$$\text{CML} = \text{Specification Limit} - F - C + G + D$$

For the manual mode of measurement, a table of corrected meter reading limits shall be used to permit immediate comparison of the meter reading to determine if the measured emission amplitude exceeded the specification limit at that specific frequency. There shall be two calculation sheets done, one for three meter and one for ten-meter measurement distances, where applicable. The correction factors for the antenna and the amplifier gain are attached in the Appendices.



AEGIS LABS INC.

6.0 Sample Calculations (Continued)

Peak Transmit Power Output:

A correction factor for the cable must be applied to the Conducted Power before a true power reading can be obtained. This is referred to as the “Corrected Power” (CP).

The equation shall be derived in the following manner:

$$\text{Corrected Power Reading} = \text{Conducted Power Reading} + C$$

Where, C = Cable Factor

The conducted power is taken in units of dBm. To obtain units of mW the following equation is used:

$$\text{mW} = 10^{(\text{dBm}/10)}$$



AEGIS LABS INC.

7.0 MODIFICATIONS AND RECOMMENDATIONS

No modifications were made to the EUT.

Page 18 of 18
Report Number: INTEL-040831F
FCC ID: PD9WM3B2915ABG



AEGIS LABS INC.

APPENDIX A

TEST DATA

Page 1 of 119 (Appendix A)
Report Number: INTEL-040831F
FCC ID: PD9WM3B2915ABG



AEGIS LABS INC.

Spurious Radiated Emissions Test Results (Continued)

CLIENT:	Intel Corporation	DATE:	08/03/04
EUT:	Intel PRO/Wireless 2915ABG Network Connection	PROJECT NUMBER:	INTEL-040803
MODEL NUMBER:	WM3B2915ABG	TEST ENGINEER:	JC
SERIAL NUMBER:	344F96244ABC51962012	SITE #:	2
CONFIGURATION:	Tested installed in the Hewlett Packard host computer's mini PCI slot in 802.11a (5745-5825 MHz) mode with the Yokowo (Pumpkin) antennas.	TEMPERATURE:	22 C
		HUMIDITY:	55% RH
		TIME:	10:15 AM

Standard:	FCC CFR 47, Part 15.247(c)
Description:	Radiated emissions, which fall in the restricted bands, as defined in Sec. 15.205(a), must also comply with the radiated emission limits specified in Sec. 15.209(a). All others must be < -20dBc.
Results:	Passes (See Data Sheets)

Unwanted Spurious Emissions Limits

Frequency (MHz)	Field Strength (uV/m)	Field Strength (dBuV/m) (Emissions in the restricted bands)	Field Strength (dBm/MHz) (Emissions outside the restricted bands)
Above 960	500	54.00 (Average) 74.00 (Peak)	< -20 dBc

Page 2 of 119 (Appendix A)
Report Number: INTEL-040831F
FCC ID: PD9WM3B2915ABG



Spurious Radiated Emissions Test Results (Continued)

*Fundamental Measurements in 802.11a mode (5745-5825 MHz)
Channels 149, 157, & 169
Continuous TX at MAIN Antenna port with Yokowo (Pumpkin) Antennas
Aegis Labs, Inc. File #: INTEL-040803-02*

RADIATED EMISSIONS - Horizontal Antenna Polarization											
<i>Freq. (MHz)</i>	<i>Meter Reading (dBuV)</i>	<i>Antenna Height (cm)</i>	<i>Azimuth (degrees)</i>	<i>Quasi pk or AVG (dBuV)</i>		<i>Preamp Factor (dB)</i>	<i>Cable Factor (dB)</i>	<i>Ant. Factor (dB)</i>	<i>Corrected Reading (dBuV)</i>	<i>Limits (dBuV)</i>	<i>Diff (dB) +=FAIL</i>
5745.00	65.50	100	225				5.25	34.85	105.59		
5745.00				55.36	A		5.25	34.85	95.45		
5785.00	64.17	100	225				5.27	34.87	104.31		
5785.00				54.41	A		5.27	34.87	94.55		
5825.00	64.67	100	225				5.30	34.90	104.87		
5825.00				54.98	A		5.30	34.90	95.18		

RADIATED EMISSIONS – Vertical Antenna Polarization											
<i>Freq. (MHz)</i>	<i>Meter Reading (dBuV)</i>	<i>Antenna Height (cm)</i>	<i>Azimuth (degrees)</i>	<i>Quasi pk or AVG (dBuV)</i>		<i>Preamp Factor (dB)</i>	<i>Cable Factor (dB)</i>	<i>Ant. Factor (dB)</i>	<i>Corrected Reading (dBuV)</i>	<i>Limits (dBuV)</i>	<i>Diff (dB) +=FAIL</i>
5745.00	65.17	100	270				5.25	34.85	105.26		
5745.00				55.23	A		5.25	34.85	95.32		
5785.00	64.50	100	270				5.27	34.87	104.64		
5785.00				54.19	A		5.27	34.87	94.33		
5825.00	64.00	100	270				5.30	34.90	104.20		
5825.00				54.71	A		5.30	34.90	94.91		



AEGIS LABS INC.

Spurious Radiated Emissions Test Results (Continued)

Band Edge Field Strength Measurements in 802.11a mode (5745-5825 MHz)
Channels 149, 157, & 169
Continuous TX at MAIN Antenna port with Yokowo (Pumpkin) Antennas
Aegis Labs, Inc. File #: INTEL-040803-02

RADIATED EMISSIONS - Horizontal Antenna Polarization

Freq. (MHz)	Meter Reading (dBuV)	Antenna Height (cm)	Azimuth (degrees)	Quasi pk or AVG (dBuV)	Preamp Factor (dB)	Cable Factor (dB)	Ant. Factor (dB)	Corrected Reading (dBuV)	Limits (dBuV)	Diff (dB) +=FAIL
5725.00	33.00	100	225			5.23	34.84	73.07	85.59	-12.53
5850.00	31.00	100	225			5.32	34.91	71.23	84.87	-13.64

RADIATED EMISSIONS - Vertical Antenna Polarization

Freq. (MHz)	Meter Reading (dBuV)	Antenna Height (cm)	Azimuth (degrees)	Quasi pk or AVG (dBuV)	Preamp Factor (dB)	Cable Factor (dB)	Ant. Factor (dB)	Corrected Reading (dBuV)	Limits (dBuV)	Diff (dB) +=FAIL
5725.00	33.50	100	270			5.23	34.84	73.57	85.26	-11.70
5850.00	30.83	100	270			5.32	34.91	71.06	84.20	-13.14

Page 4 of 119 (Appendix A)
Report Number: INTEL-040831F
FCC ID: PD9WM3B2915ABG



Spurious Radiated Emissions Test Results (Continued)

*Spurious Emissions Measurements in 802.11a mode (5745-5825 MHz)
Channels 149, 157, & 169
Continuous TX at MAIN Antenna port with Yokowo (Pumpkin) Antennas
Aegis Labs, Inc. File #: INTEL-040803-04*

RADIATED EMISSIONS - Horizontal Antenna Polarization											
<i>Freq. (MHz)</i>	<i>Meter Reading (dBuV)</i>	<i>Antenna Height (cm)</i>	<i>Azimuth (degrees)</i>	<i>Quasi pk or AVG (dBuV)</i>		<i>Preamp Factor (dB)</i>	<i>Cable Factor (dB)</i>	<i>Ant. Factor (dB)</i>	<i>Corrected Reading (dBuV)</i>	<i>Limits (dBuV)</i>	<i>Diff (dB) +=FAIL</i>
EUT in Continuous Transmit Mode on Channel 149 (5.745 GHz)											
3830.00	59.50	100	270			43.17	4.18	31.16	51.67	74.00	-22.33
3830.00				56.64	A	43.17	4.18	31.16	48.81	54.00	-5.19
7660.00	53.67	125	135			43.62	6.27	40.05	56.37	74.00	-17.63
7660.00				47.01	A	43.62	6.27	40.05	49.71	54.00	-4.29
11490.00	51.67	100	135			43.50	7.64	41.18	56.99	74.00	-17.01
11490.00				41.21	A	43.50	7.64	41.18	46.53	54.00	-7.47
15319.89	49.67	100	135			43.39	8.80	41.49	56.57	85.59	-29.02
EUT in Continuous Transmit Mode on Channel 157 (5.785 GHz)											
3856.66	58.00	100	270			43.17	4.21	31.23	50.26	74.00	-23.74
3856.66				54.69	A	43.17	4.21	31.23	46.95	54.00	-7.05
7713.33	55.17	125	135			43.60	6.29	40.20	58.06	74.00	-15.94
7713.33				48.37	A	43.60	6.29	40.20	51.26	54.00	-2.74
11569.98	50.83	100	135			43.48	7.66	41.38	56.40	74.00	-17.60
11569.98				40.28	A	43.48	7.66	41.38	45.85	54.00	-8.15
15426.58	49.33	100	135			43.35	8.80	41.56	56.34	74.00	-17.66
15426.58				37.96		43.35	8.80	41.56	44.97	54.00	-9.03
EUT in Continuous Transmit Mode on Channel 165 (5.825 GHz)											
3883.34	56.00	100	270			43.17	4.23	31.30	48.35	74.00	-25.65
3883.34				51.87	A	43.17	4.23	31.30	44.22	54.00	-9.78
7766.66	54.50	100	135			43.58	6.32	40.35	57.58	84.87	-27.29
11650.00	49.67	100	135			43.45	7.69	41.59	55.50	74.00	-18.50
11650.00				38.42	A	43.45	7.69	41.59	44.25	54.00	-9.75
15533.23	49.50	100	135			43.35	8.82	41.71	56.68	74.00	-17.32
15533.23				37.97	A	43.35	8.82	41.71	45.15	54.00	-8.85



Spurious Radiated Emissions Test Results (Continued)

RADIATED EMISSIONS - Vertical Antenna Polarization											
<i>Freq. (MHz)</i>	<i>Meter Reading (dBuV)</i>	<i>Antenna Height (cm)</i>	<i>Azimuth (degrees)</i>	<i>Quasi pk or AVG (dBuV)</i>		<i>Preamp Factor (dB)</i>	<i>Cable Factor (dB)</i>	<i>Ant. Factor (dB)</i>	<i>Corrected Reading (dBuV)</i>	<i>Limits (dBuV)</i>	<i>Diff (dB) +=FAIL</i>
EUT in Continuous Transmit Mode on Channel 149 (5.745 GHz)											
3830.00	59.33	100	270			43.17	4.18	31.09	51.44	74.00	-22.56
3830.00				56.49	A	43.17	4.18	31.09	48.60	54.00	-5.40
7660.00	50.33	100	135			43.62	6.27	40.11	53.10	74.00	-20.90
7660.00				40.35	A	43.62	6.27	40.11	43.12	54.00	-10.88
11490.00	49.83	100	135			43.50	7.64	41.66	55.63	74.00	-18.37
11490.00				38.96	A	43.50	7.64	41.66	44.76	54.00	-9.24
EUT in Continuous Transmit Mode on Channel 157 (5.785 GHz)											
3856.66	57.33	100	270			43.17	4.21	31.14	49.51	74.00	-24.49
3856.66				54.10	A	43.17	4.21	31.14	46.28	54.00	-7.72
7713.33	51.33	100	135			43.60	6.29	40.28	54.31	74.00	-19.69
7713.33				41.98	A	43.60	6.29	40.28	44.96	54.00	-9.04
11569.98	50.50	100	135			43.48	7.66	41.81	56.50	74.00	-17.50
11569.98				39.68	A	43.48	7.66	41.81	45.68	54.00	-8.32
EUT in Continuous Transmit Mode on Channel 165 (5.825 GHz)											
3883.33	55.83	100	270			43.17	4.23	31.19	48.08	74.00	-25.92
3883.33				51.12	A	43.17	4.23	31.19	43.37	54.00	-10.63
7766.66	53.83	100	135			43.58	6.32	40.45	57.02	84.20	-27.18
11650.00	49.67	100	135			43.45	7.69	41.94	55.85	74.00	-18.15
11650.00				38.29	A	43.45	7.69	41.94	44.47	54.00	-9.53



Spurious Radiated Emissions Test Results (Continued)

*Spurious Emissions Measurements in 802.11a mode (5745-5825 MHz)
Channels 149, 157, & 169
Continuous RX at MAIN Antenna port with Yokowo (Pumpkin) Antennas
Aegis Labs, Inc. File #: INTEL-040803-04*

RADIATED EMISSIONS - Horizontal Antenna Polarization											
<i>Freq. (MHz)</i>	<i>Meter Reading (dBuV)</i>	<i>Antenna Height (cm)</i>	<i>Azimuth (degrees)</i>	<i>Quasi pk or AVG (dBuV)</i>		<i>Preamp Factor (dB)</i>	<i>Cable Factor (dB)</i>	<i>Ant. Factor (dB)</i>	<i>Corrected Reading (dBuV)</i>	<i>Limits (dBuV)</i>	<i>Diff (dB) +=FAIL</i>
EUT in Continuous Receive Mode on Channel 149 (5.745 GHz)											
3830.00	50.17	100	135			43.17	4.18	31.16	42.34	80.00	-37.66
3830.00				39.76	A	43.17	4.18	31.16	31.93	60.00	-28.07
7660.00	53.67	100	135			43.62	6.27	40.05	56.37	80.00	-23.63
7660.00				47.84	A	43.62	6.27	40.05	50.54	60.00	-9.46
11489.92	51.17	100	135			43.50	7.64	41.18	56.49	80.00	-23.51
11489.92				41.58	A	43.50	7.64	41.18	46.90	60.00	-13.10
EUT in Continuous Receive Mode on Channel 157 (5.785 GHz)											
3856.62	51.33	100	135			43.17	4.21	31.23	43.59	80.00	-36.41
3856.62				42.02	A	43.17	4.21	31.23	34.28	60.00	-25.72
7713.32	54.83	100	135			43.60	6.29	40.20	57.72	80.00	-22.28
7713.32				49.37	A	43.60	6.29	40.20	52.26	60.00	-7.74
11569.92	51.17	100	135			43.48	7.66	41.38	56.74	80.00	-23.26
11569.92				40.81	A	43.48	7.66	41.38	46.38	60.00	-13.62
EUT in Continuous Receive Mode on Channel 165 (5.825 GHz)											
3883.34	51.50	100	135			43.17	4.23	31.30	43.85	80.00	-36.15
3883.34				43.29	A	43.17	4.23	31.30	35.64	60.00	-24.36
7766.62	54.00	100	135			43.58	6.32	40.35	57.08	80.00	-22.92
7766.62				48.21	A	43.58	6.32	40.35	51.29	60.00	-8.71
11649.94	50.17	100	135			43.45	7.69	41.59	56.00	80.00	-24.00
11649.94				39.09	A	43.45	7.69	41.59	44.92	60.00	-15.08



Spurious Radiated Emissions Test Results (Continued)

RADIATED EMISSIONS - Vertical Antenna Polarization											
<i>Freq. (MHz)</i>	<i>Meter Reading (dBuV)</i>	<i>Antenna Height (cm)</i>	<i>Azimuth (degrees)</i>	<i>Quasi pk or AVG (dBuV)</i>		<i>Preamp Factor (dB)</i>	<i>Cable Factor (dB)</i>	<i>Ant. Factor (dB)</i>	<i>Corrected Reading (dBuV)</i>	<i>Limits (dBuV)</i>	<i>Diff (dB) +=FAIL</i>
EUT in Continuous Receive Mode on Channel 149 (5.745 GHz)											
3830.00	51.17	100	135			43.17	4.18	31.09	43.28	80.00	-36.72
3830.00				42.32	A	43.17	4.18	31.09	34.43	60.00	-25.57
7660.00	50.17	100	135			43.62	6.27	40.11	52.94	80.00	-27.06
7660.00				38.96	A	43.62	6.27	40.11	41.73	60.00	-18.27
11489.96	50.83	100	135			43.50	7.64	41.66	56.63	80.00	-23.37
11489.96				40.01	A	43.50	7.64	41.66	45.81	60.00	-14.19
EUT in Continuous Receive Mode on Channel 157 (5.785 GHz)											
3856.65	51.50	100	135			43.17	4.21	31.14	43.68	80.00	-36.32
3856.65				42.89	A	43.17	4.21	31.14	35.07	60.00	-24.93
7713.29	50.33	100	135			43.60	6.29	40.28	53.31	80.00	-26.69
7713.29				39.39	A	43.60	6.29	40.28	42.37	60.00	-17.63
11569.91	50.50	100	135			43.48	7.66	41.81	56.50	80.00	-23.50
11569.91				39.86	A	43.48	7.66	41.81	45.86	60.00	-14.14
EUT in Continuous Receive Mode on Channel 165 (5.825 GHz)											
3883.35	51.17	100	135			43.17	4.23	31.19	43.42	80.00	-36.58
3883.35				43.01	A	43.17	4.23	31.19	35.26	60.00	-24.74
7766.63	50.33	100	135			43.58	6.32	40.45	53.52	80.00	-26.48
7766.63				40.17	A	43.58	6.32	40.45	43.36	60.00	-16.64
11649.97	51.00	100	135			43.45	7.69	41.94	57.18	80.00	-22.82
11649.97				41.86	A	43.45	7.69	41.94	48.04	60.00	-11.96



AEGIS LABS INC.

Spurious Radiated Emissions Test Results (Continued)

CLIENT:	Intel Corporation	DATE:	08/03/04
EUT:	Intel PRO/Wireless 2915ABG Network Connection	PROJECT NUMBER:	INTEL-040803
MODEL NUMBER:	WM3B2915ABG	TEST ENGINEER:	JC
SERIAL NUMBER:	344F96244ABC51962012	SITE #:	2
CONFIGURATION:	Tested installed in the Hewlett Packard host computer's mini PCI slot in 802.11b (2412-2462 MHz) mode with the Yokowo (Pumpkin) antennas.	TEMPERATURE:	22 C
		HUMIDITY:	55% RH
		TIME:	10:15 AM

Standard:	FCC CFR 47, Part 15.247(c)
Description:	Radiated emissions, which fall in the restricted bands, as defined in Sec. 15.205(a), must also comply with the radiated emission limits specified in Sec. 15.209(a). All others must be < -20dBc.
Results:	Passes (See Data Sheets)

Unwanted Spurious Emissions Limits

Frequency (MHz)	Field Strength (uV/m)	Field Strength (dBuV/m) (Emissions in the restricted bands)	Field Strength (dBm/MHz) (Emissions outside the restricted bands)
Above 960	500	54.00 (Average) 74.00 (Peak)	< -20 dBc

Page 11 of 119 (Appendix A)
Report Number: INTEL-040831F
FCC ID: PD9WM3B2915ABG



Spurious Radiated Emissions Test Results (Continued)

*Fundamental Measurements in 802.11b mode (2412-2462 MHz)
 Channels 1, 6, & 11
 Continuous TX at MAIN Antenna port with Yokowo (Pumpkin) Antennas
 Aegis Labs, Inc. File #: INTEL-040803-02*

RADIATED EMISSIONS - Horizontal Antenna Polarization											
<i>Freq. (MHz)</i>	<i>Meter Reading (dBuV)</i>	<i>Antenna Height (cm)</i>	<i>Azimuth (degrees)</i>	<i>Quasi pk or AVG (dBuV)</i>		<i>Preamp Factor (dB)</i>	<i>Cable Factor (dB)</i>	<i>Ant. Factor (dB)</i>	<i>Corrected Reading (dBuV)</i>	<i>Limits (dBuV)</i>	<i>Diff (dB) +=FAIL</i>
2412.00	69.83	100	315				3.30	31.11	104.24		
2412.00				65.91	A		3.30	31.11	100.32		
2437.00	72.33	100	315				3.32	31.05	106.70		
2437.00				68.98	A		3.32	31.05	103.35		
2462.00	71.83	100	315				3.34	30.99	106.16		
2462.00				68.36	A		3.34	30.99	102.69		

RADIATED EMISSIONS – Vertical Antenna Polarization											
<i>Freq. (MHz)</i>	<i>Meter Reading (dBuV)</i>	<i>Antenna Height (cm)</i>	<i>Azimuth (degrees)</i>	<i>Quasi pk or AVG (dBuV)</i>		<i>Preamp Factor (dB)</i>	<i>Cable Factor (dB)</i>	<i>Ant. Factor (dB)</i>	<i>Corrected Reading (dBuV)</i>	<i>Limits (dBuV)</i>	<i>Diff (dB) +=FAIL</i>
2412.00	70.67	100	270				3.30	31.24	105.21		
2412.00				67.24	A		3.30	31.24	101.78		
2437.00	73.33	100	270				3.32	31.20	107.85		
2437.00				70.10	A		3.32	31.20	104.62		
2462.00	72.67	100	270				3.34	31.16	107.17		
2462.00				69.48	A		3.34	31.16	103.98		

NOTE: Fundamental signals measured to calculate the band edge field strengths using the “Marker Delta Method”.



Spurious Radiated Emissions Test Results (Continued)

Band Edge Field Strength Measurements in 802.11b mode (2412-2462 MHz)
Channels 1, 6, & 11
Continuous TX at MAIN Antenna port with Yokowo (Pumpkin) Antennas
Aegis Labs, Inc. File #: INTEL-040803-02

RADIATED EMISSIONS - Horizontal Antenna Polarization										
Freq. (MHz)	Meter Reading (dBuV)	Antenna Height (cm)	Azimuth (degrees)	Quasi pk or AVG (dBuV)	Preamp Factor (dB)	Cable Factor (dB)	Ant. Factor (dB)	Corrected Reading (dBuV)	Limits (dBuV)	Diff (dB) +=FAIL
2390.00								50.07	74.00	-23.93
2390.00								37.98	54.00	-16.02
2359.80								52.41	74.00	-21.59
2359.80								38.98	54.00	-15.02
2400.00	36.67	100	315			3.29	31.14	71.10	84.24	-13.14
2483.50								51.66	74.00	-22.34
2483.50								40.36	54.00	-13.64
2520.70								52.50	74.00	-21.50
2520.70								41.19	54.00	-12.81
RADIATED EMISSIONS - Vertical Antenna Polarization										
Freq. (MHz)	Meter Reading (dBuV)	Antenna Height (cm)	Azimuth (degrees)	Quasi pk or AVG (dBuV)	Preamp Factor (dB)	Cable Factor (dB)	Ant. Factor (dB)	Corrected Reading (dBuV)	Limits (dBuV)	Diff (dB) +=FAIL
2390.00								51.04	74.00	-22.96
2390.00								39.44	54.00	-14.56
2359.80								53.38	74.00	-20.62
2359.80								40.44	54.00	-13.56
2400.00	38.83	100	270			3.29	31.26	73.38	85.21	-11.83
2483.50								52.67	74.00	-21.33
2483.50								41.65	54.00	-12.35
2520.70								53.51	74.00	-20.49
2520.70								42.48	54.00	-11.52

NOTE: The “Band Edge Field Strength” was calculated using the “Fundamental” and “Conducted Band Edge” measurements per the “Marker-Delta Method” with the following formula:

$$BE = Fm - \Delta m$$

Where

BE = Band Edge Field Strength

Fm = Measured Fundamental (Peak or Average)

Δm = Measured Conducted Band Edge Delta (Peak or Average)



Spurious Radiated Emissions Test Results (Continued)

Plots Showing Out-Of-Band Emissions (Peak RBW=VBW=1MHz; Average RBW = 1MHz, VBW = 10Hz)

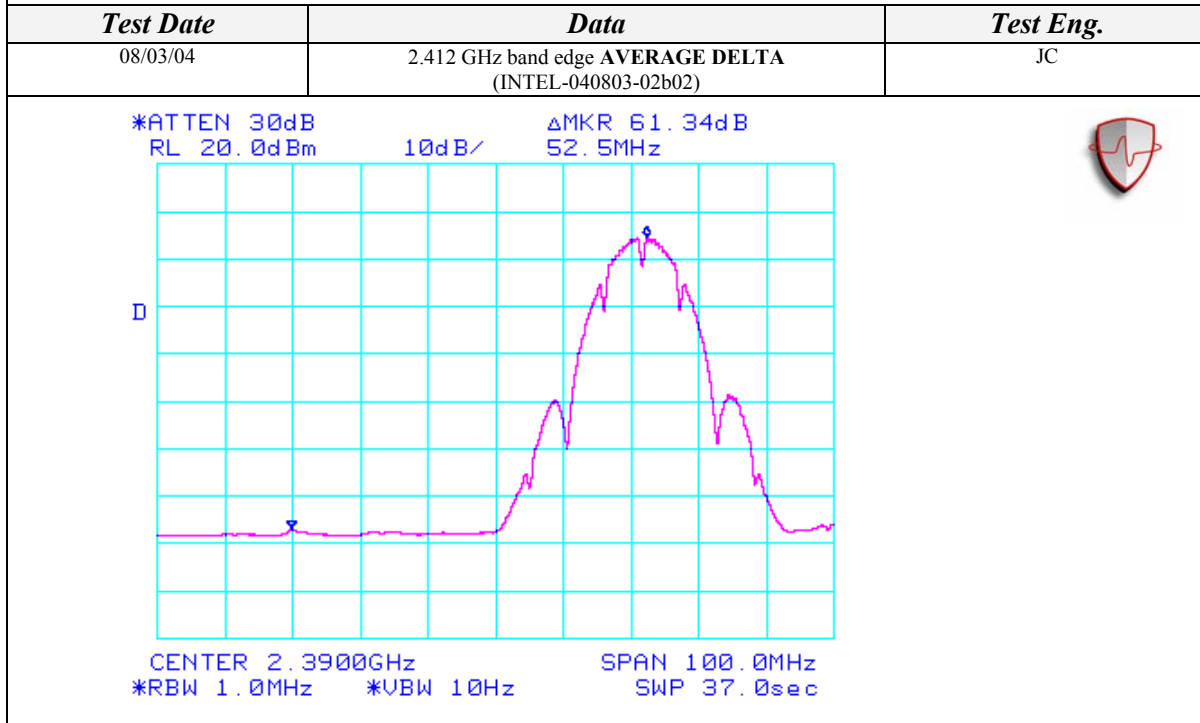
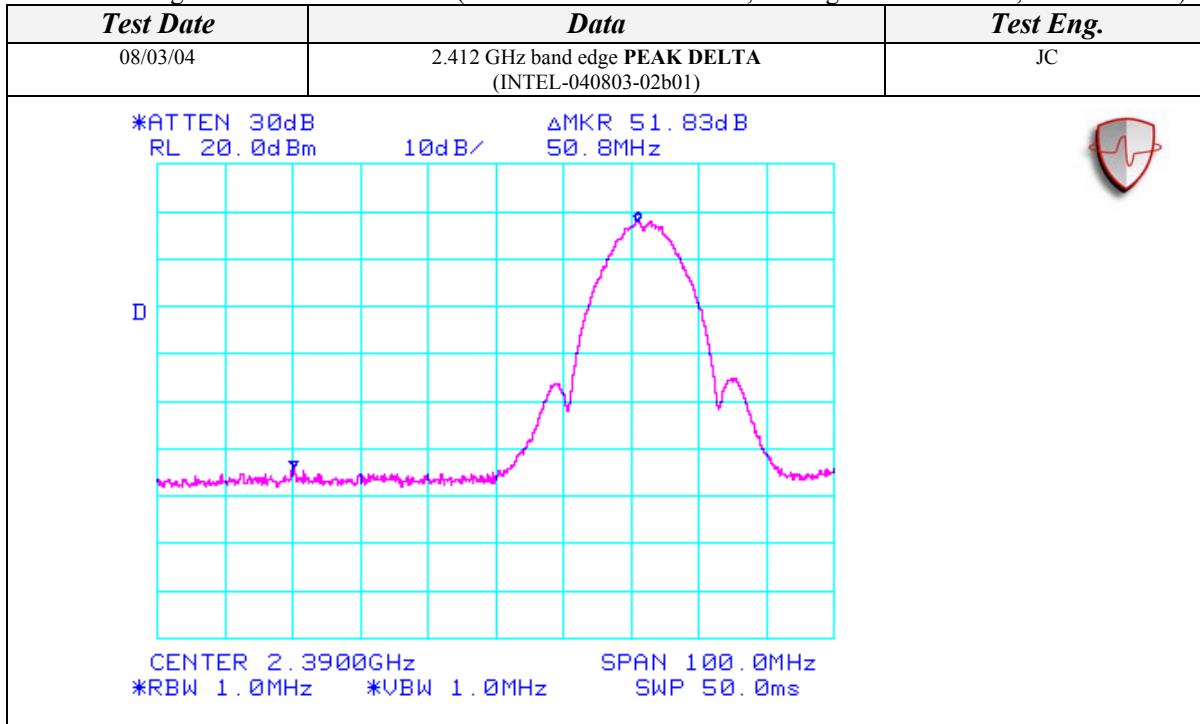



Spurious Radiated Emissions Test Results (Continued)

*Spurious Emissions Measurements in 802.11b mode (2412-2462 MHz)
Channels 1, 6, & 11
Continuous TX at MAIN Antenna port with Yokowo (Pumpkin) Antennas
Aegis Labs, Inc. File #: INTEL-040803-03*

RADIATED EMISSIONS - Horizontal Antenna Polarization											
Freq. (MHz)	Meter Reading (dBuV)	Antenna Height (cm)	Azimuth (degrees)	Quasi pk or AVG (dBuV)		1 Meter Distance Factor (dB)	Cable Factor (dB)	Ant. Factor (dB)	Corrected Reading (dBuV)	Limits (dBuV)	Diff (dB) +=FAIL
EUT in Continuous Transmit Mode on Channel 1 (2.412 GHz)											
2312.00	31.50	100	225			9.54	3.23	31.35	56.54	74.00	-17.46
2312.00				16.02	A	9.54	3.23	31.35	41.06	54.00	-12.94
EUT in Continuous Transmit Mode on Channel 6 (2.437 GHz)											
2336.00	33.00	100	225			9.54	3.25	31.29	58.00	74.00	-16.00
2336.00				21.09	A	9.54	3.25	31.29	46.09	54.00	-7.91
EUT in Continuous Transmit Mode on Channel 11 (2.462 GHz)											
2358.66	31.17	100	225			9.54	3.26	31.24	56.13	74.00	-17.87
2358.66				15.67	A	9.54	3.26	31.24	40.63	54.00	-13.37
RADIATED EMISSIONS - Vertical Antenna Polarization											
Freq. (MHz)	Meter Reading (dBuV)	Antenna Height (cm)	Azimuth (degrees)	Quasi pk or AVG (dBuV)		1 Meter Distance Factor (dB)	Cable Factor (dB)	Ant. Factor (dB)	Corrected Reading (dBuV)	Limits (dBuV)	Diff (dB) +=FAIL
EUT in Continuous Transmit Mode on Channel 1 (2.412 GHz)											
2312.00	30.83	100	225			9.54	3.23	31.40	55.92	74.00	-18.08
2312.00				15.81	A	9.54	3.23	31.40	40.90	54.00	-13.10
EUT in Continuous Transmit Mode on Channel 6 (2.437 GHz)											
2336.00	32.17	100	225			9.54	3.25	31.36	57.24	74.00	-16.76
2336.00				19.32	A	9.54	3.25	31.36	44.39	54.00	-9.61
EUT in Continuous Transmit Mode on Channel 11 (2.462 GHz)											
2358.66	30.67	100	225			9.54	3.26	31.33	55.72	74.00	-18.28
2358.66				15.10	A	9.54	3.26	31.33	40.15	54.00	-13.85

NOTE: These spurious emissions measurements were taken without a preamp at a distance on 1 meter to avoid saturating the preamp and analyzer because the signals were close to the fundamental frequency. The readings were extrapolated to 1 meter.



Spurious Radiated Emissions Test Results (Continued)

*Spurious Emissions Measurements in 802.11b mode (2412-2462 MHz)
Channels 1, 6, & 11
Continuous TX at MAIN Antenna port with Yokowo (Pumpkin) Antennas
Aegis Labs, Inc. File #: INTEL-040803-04*

RADIATED EMISSIONS - Horizontal Antenna Polarization											
<i>Freq. (MHz)</i>	<i>Meter Reading (dBuV)</i>	<i>Antenna Height (cm)</i>	<i>Azimuth (degrees)</i>	<i>Quasi pk or AVG (dBuV)</i>		<i>Preamp Factor (dB)</i>	<i>Cable Factor (dB)</i>	<i>Ant. Factor (dB)</i>	<i>Corrected Reading (dBuV)</i>	<i>Limits (dBuV)</i>	<i>Diff (dB) +=FAIL</i>
EUT in Continuous Transmit Mode on Channel 1 (2.412 GHz)											
3216.01	50.33	100	135			43.07	3.89	30.24	41.39	84.24	-42.85
4824.00	49.67	100	135			43.27	4.73	34.53	45.66	74.00	-28.34
4824.00				38.34	A	43.27	4.73	34.53	34.33	54.00	-19.67
6431.97	55.50	100	135			43.82	5.73	36.64	54.06	84.24	-30.18
9648.01	50.17	100	135			43.22	6.95	38.88	52.78	84.24	-31.46
12864.03	49.50	100	135			43.83	7.95	43.86	57.49	84.24	-26.75
EUT in Continuous Transmit Mode on Channel 6 (2.437 GHz)											
3249.32	50.00	100	135			43.08	3.91	30.25	41.07	86.70	-45.63
4873.99	48.50	100	135			43.29	4.77	34.72	44.70	74.00	-29.30
4873.99				36.89	A	43.29	4.77	34.72	33.09	54.00	-20.91
6498.69	55.67	100	135			43.84	5.78	36.90	54.50	86.70	-32.20
9747.96	49.50	100	135			43.25	6.99	39.00	52.23	86.70	-34.47
12997.37	50.33	100	135			43.83	8.02	44.29	58.81	86.70	-27.89
EUT in Continuous Transmit Mode on Channel 11 (2.462 GHz)											
3282.69	50.00	100	135			43.10	3.91	30.26	41.07	86.16	-45.09
4924.00	49.83	100	135			43.30	4.81	34.91	46.24	74.00	-27.76
4924.00				38.50	A	43.30	4.81	34.91	34.91	54.00	-19.09
6565.34	53.17	100	135			43.84	5.83	37.32	52.48	86.16	-33.68
9848.01	49.67	100	135			43.29	7.03	39.12	52.53	86.16	-33.63
13130.67	49.33	100	135			43.70	8.07	44.25	57.95	86.16	-28.21



Spurious Radiated Emissions Test Results (Continued)

RADIATED EMISSIONS - Vertical Antenna Polarization											
<i>Freq. (MHz)</i>	<i>Meter Reading (dBuV)</i>	<i>Antenna Height (cm)</i>	<i>Azimuth (degrees)</i>	<i>Quasi pk or AVG (dBuV)</i>		<i>Preamp Factor (dB)</i>	<i>Cable Factor (dB)</i>	<i>Ant. Factor (dB)</i>	<i>Corrected Reading (dBuV)</i>	<i>Limits (dBuV)</i>	<i>Diff (dB) +=FAIL</i>
EUT in Continuous Transmit Mode on Channel 1 (2.412 GHz)											
3216.00	49.83	100	135			43.07	3.89	30.44	41.09	85.21	-44.12
4823.96	49.17	100	135			43.27	4.73	34.53	45.16	74.00	-28.84
4823.96				37.79	A	43.27	4.73	34.53	33.78	54.00	-20.22
6431.95	53.33	100	135			43.82	5.73	36.64	51.89	85.21	-33.32
9647.97	49.67	100	135			43.22	6.95	38.97	52.37	85.21	-32.84
12864.01	49.33	100	135			43.83	7.95	44.23	57.68	85.21	-27.53
EUT in Continuous Transmit Mode on Channel 6 (2.437 GHz)											
3249.32	49.50	100	135			43.08	3.91	30.45	40.77	87.85	-47.08
4874.01	48.83	100	135			43.29	4.77	34.72	45.03	74.00	-28.97
4874.01				37.21	A	43.29	4.77	34.72	33.41	54.00	-20.59
6498.66	52.00	100	135			43.84	5.78	36.89	50.83	87.85	-37.02
9748.04	49.67	100	135			43.25	6.99	39.15	52.55	87.85	-35.30
12997.35	49.33	100	135			43.83	8.02	44.49	58.01	87.85	-29.84
EUT in Continuous Transmit Mode on Channel 11 (2.462 GHz)											
3282.66	49.50	100	135			43.10	3.91	30.46	40.77	87.17	-46.40
4924.00	49.00	100	135			43.30	4.81	34.91	45.41	74.00	-28.59
4924.00				37.97	A	43.30	4.81	34.91	34.38	54.00	-19.62
6565.32	51.67	100	135			43.84	5.83	37.38	51.04	87.17	-36.13
9847.96	49.50	100	135			43.29	7.03	39.33	52.57	87.17	-34.60
13130.63	49.17	100	135			43.70	8.07	44.45	57.99	87.17	-29.18



Spurious Radiated Emissions Test Results (Continued)

*Spurious Emissions Measurements in in802.11b mode (2412-2462 MHz)
 Channels 1, 6, & 11
 Continuous RX at MAIN Antenna port with Yokowo (Pumpkin) Antennas
 Aegis Labs, Inc. File #: INTEL-040803-04*

RADIATED EMISSIONS - Horizontal Antenna Polarization											
<i>Freq. (MHz)</i>	<i>Meter Reading (dBuV)</i>	<i>Antenna Height (cm)</i>	<i>Azimuth (degrees)</i>	<i>Quasi pk or AVG (dBuV)</i>		<i>Preamp Factor (dB)</i>	<i>Cable Factor (dB)</i>	<i>Ant. Factor (dB)</i>	<i>Corrected Reading (dBuV)</i>	<i>Limits (dBuV)</i>	<i>Diff (dB) +=FAIL</i>
EUT in Continuous Receive Mode on Channel 1 (2.412 GHz)											
3216.02	49.33	100	135			43.07	3.89	30.24	40.39	80.00	-39.61
3216.02				40.41	A	43.07	3.89	30.24	31.47	60.00	-28.53
6432.00	56.67	100	135			43.82	5.73	36.64	55.23	80.00	-24.77
6432.00				52.59	A	43.82	5.73	36.64	51.15	60.00	-8.85
9648.03	50.50	100	135			43.22	6.95	38.88	53.11	80.00	-26.89
9648.03				38.48	A	43.22	6.95	38.88	41.09	60.00	-18.91
EUT in Continuous Receive Mode on Channel 6 (2.437 GHz)											
3249.32	48.17	100	135			43.08	3.91	30.25	39.24	80.00	-40.76
3249.32				38.38	A	43.08	3.91	30.25	29.45	60.00	-30.55
6498.70	57.17	100	135			43.84	5.78	36.90	56.00	80.00	-24.00
6498.70				53.21	A	43.84	5.78	36.90	52.04	60.00	-7.96
9747.99	49.83	100	135			43.25	6.99	39.00	52.56	80.00	-27.44
9747.99				38.93	A	43.25	6.99	39.00	41.66	60.00	-18.34
EUT in Continuous Receive Mode on Channel 11 (2.462 GHz)											
3282.66	48.50	100	135			43.10	3.91	30.26	39.57	80.00	-40.43
3282.66				38.03	A	43.10	3.91	30.26	29.10	60.00	-30.90
6565.32	53.50	100	135			43.84	5.83	37.32	52.81	80.00	-27.19
6565.32				47.51	A	43.84	5.83	37.32	46.82	60.00	-13.18
9848.01	50.50	100	135			43.29	7.03	39.12	53.36	80.00	-26.64
9848.01				38.98	A	43.29	7.03	39.12	41.84	60.00	-18.16



Spurious Radiated Emissions Test Results (Continued)

RADIATED EMISSIONS - Vertical Antenna Polarization											
<i>Freq. (MHz)</i>	<i>Meter Reading (dBuV)</i>	<i>Antenna Height (cm)</i>	<i>Azimuth (degrees)</i>	<i>Quasi pk or AVG (dBuV)</i>		<i>Preamp Factor (dB)</i>	<i>Cable Factor (dB)</i>	<i>Ant. Factor (dB)</i>	<i>Corrected Reading (dBuV)</i>	<i>Limits (dBuV)</i>	<i>Diff (dB) +=FAIL</i>
EUT in Continuous Receive Mode on Channel 1 (2.412 GHz)											
3216.00	50.33	100	135			43.07	3.89	30.44	41.59	80.00	-38.41
3216.00				42.06	A	43.07	3.89	30.44	33.32	60.00	-26.68
6432.03	54.50	100	135			43.82	5.73	36.64	53.06	80.00	-26.94
6432.03				50.16	A	43.82	5.73	36.64	48.72	60.00	-11.28
9648.02	49.67	100	135			43.22	6.95	38.97	52.37	80.00	-27.63
9648.02				37.49	A	43.22	6.95	38.97	40.19	60.00	-19.81
EUT in Continuous Receive Mode on Channel 6 (2.437 GHz)											
3249.32	50.33	100	135			43.08	3.91	30.45	41.60	80.00	-38.40
3249.32				41.04	A	43.08	3.91	30.45	32.31	60.00	-27.69
6498.67	54.33	100	135			43.84	5.78	36.89	53.16	80.00	-26.84
6498.67				48.82	A	43.84	5.78	36.89	47.65	60.00	-12.35
9747.96	50.17	100	135			43.25	6.99	39.15	53.05	80.00	-26.95
9747.96				37.63	A	43.25	6.99	39.15	40.51	60.00	-19.49
EUT in Continuous Receive Mode on Channel 11 (2.462 GHz)											
3282.67	50.00	100	135			43.10	3.91	30.46	41.27	80.00	-38.73
3282.67				40.71	A	43.10	3.91	30.46	31.98	60.00	-28.02
6565.37	51.50	100	135			43.84	5.83	37.38	50.87	80.00	-29.13
6565.37				43.13	A	43.84	5.83	37.38	42.50	60.00	-17.50
9847.98	49.67	100	135			43.29	7.03	39.33	52.74	80.00	-27.26
9847.98				37.96	A	43.29	7.03	39.33	41.03	60.00	-18.97



AEGIS LABS INC.

Spurious Radiated Emissions Test Results (Continued)

CLIENT:	Intel Corporation	DATE:	08/03/04
EUT:	Intel PRO/Wireless 2915ABG Network Connection	PROJECT NUMBER:	INTEL-040803
MODEL NUMBER:	WM3B2915ABG	TEST ENGINEER:	JC
SERIAL NUMBER:	344F96244ABC51962012	SITE #:	2
CONFIGURATION:	Tested installed in the Hewlett Packard host computer's mini PCI slot in 802.11g (2412-2462 MHz) mode with the Yokowo (Pumpkin) antennas	TEMPERATURE:	22 C
		HUMIDITY:	55% RH
		TIME:	10:15 AM

Standard:	FCC CFR 47, Part 15.247(c)
Description:	Radiated emissions, which fall in the restricted bands, as defined in Sec. 15.205(a), must also comply with the radiated emission limits specified in Sec. 15.209(a). All others must be < -20dBc.
Results:	Passes (See Data Sheets)

Unwanted Spurious Emissions Limits

Frequency (MHz)	Field Strength (uV/m)	Field Strength (dBuV/m) (Emissions in the restricted bands)	Field Strength (dBm/MHz) (Emissions outside the restricted bands)
Above 960	500	54.00 (Average) 74.00 (Peak)	< -20 dBc

Page 21 of 119 (Appendix A)
Report Number: INTEL-040831F
FCC ID: PD9WM3B2915ABG



Spurious Radiated Emissions Test Results (Continued)

*Fundamental Measurements in 802.11g mode (2412-2462 MHz)
Channels 1, 6, & 11
Continuous TX at MAIN Antenna port with Yokowo (Pumpkin) Antennas
Aegis Labs, Inc. File #: INTEL-040803-02*

RADIATED EMISSIONS - Horizontal Antenna Polarization											
<i>Freq. (MHz)</i>	<i>Meter Reading (dBuV)</i>	<i>Antenna Height (cm)</i>	<i>Azimuth (degrees)</i>	<i>Quasi pk or AVG (dBuV)</i>		<i>Preamp Factor (dB)</i>	<i>Cable Factor (dB)</i>	<i>Ant. Factor (dB)</i>	<i>Corrected Reading (dBuV)</i>	<i>Limits (dBuV)</i>	<i>Diff (dB) +=FAIL</i>
2412.00	72.67	100	315				3.30	31.11	107.08		
2412.00				62.35	A		3.30	31.11	96.76		
2437.00	73.83	100	315				3.32	31.05	108.20		
2437.00				63.21	A		3.32	31.05	97.58		
2462.00	73.33	100	315				3.34	30.99	107.66		
2462.00				62.73	A		3.34	30.99	97.06		

RADIATED EMISSIONS – Vertical Antenna Polarization											
<i>Freq. (MHz)</i>	<i>Meter Reading (dBuV)</i>	<i>Antenna Height (cm)</i>	<i>Azimuth (degrees)</i>	<i>Quasi pk or AVG (dBuV)</i>		<i>Preamp Factor (dB)</i>	<i>Cable Factor (dB)</i>	<i>Ant. Factor (dB)</i>	<i>Corrected Reading (dBuV)</i>	<i>Limits (dBuV)</i>	<i>Diff (dB) +=FAIL</i>
2412.00	74.17	100	270				3.30	31.24	108.71		
2412.00				63.69	A		3.30	31.24	98.23		
2437.00	74.00	100	270				3.32	31.20	108.52		
2437.00				63.51	A		3.32	31.20	98.03		
2462.00	74.33	100	270				3.34	31.16	108.83		
2462.00				64.10	A		3.34	31.16	98.60		

NOTE: Fundamental signals measured to calculate the band edge field strengths using the “Marker Delta Method”.



Spurious Radiated Emissions Test Results (Continued)

*Band Edge Field Strength Measurements in 802.11g mode (2412-2462 MHz)
 Channels 1, 6, & 11
 Continuous TX at MAIN Antenna port with Yokowo (Pumpkin) Antennas
 Aegis Labs, Inc. File #: INTEL-040803-02*

RADIATED EMISSIONS - Horizontal Antenna Polarization										
<i>Freq. (MHz)</i>	<i>Meter Reading (dBuV)</i>	<i>Antenna Height (cm)</i>	<i>Azimuth (degrees)</i>	<i>Quasi pk or AVG (dBuV)</i>	<i>Preamp Factor (dB)</i>	<i>Cable Factor (dB)</i>	<i>Ant. Factor (dB)</i>	<i>Corrected Reading (dBuV)</i>	<i>Limits (dBuV)</i>	<i>Diff (dB) +=FAIL</i>
2390.00								60.74	74.00	-13.26
2390.00								46.09	54.00	-7.91
2400.00	49.17	100	315			3.29	31.14	83.60	87.08	-3.48
2483.50								63.16	74.00	-10.84
2483.50								46.06	54.00	-7.94

RADIATED EMISSIONS – Vertical Antenna Polarization										
<i>Freq. (MHz)</i>	<i>Meter Reading (dBuV)</i>	<i>Antenna Height (cm)</i>	<i>Azimuth (degrees)</i>	<i>Quasi pk or AVG (dBuV)</i>	<i>Preamp Factor (dB)</i>	<i>Cable Factor (dB)</i>	<i>Ant. Factor (dB)</i>	<i>Corrected Reading (dBuV)</i>	<i>Limits (dBuV)</i>	<i>Diff (dB) +=FAIL</i>
2390.00								62.37	74.00	-11.63
2390.00								47.56	54.00	-6.44
2400.00	50.50	100	270			3.29	31.26	85.05	88.71	-3.66
2483.50								64.33	74.00	-9.67
2483.50								47.60	54.00	-6.40

NOTE: The “Band Edge Field Strength” was calculated using the “Fundamental” and “Conducted Band Edge” measurements per the “Marker-Delta Method” with the following formula:

BE = Fm – Δm

Where

BE = Band Edge Field Strength

Fm = Measured Fundamental (Peak or Average)

Δm = Measured Conducted Band Edge Delta (Peak or Average)



Spurious Radiated Emissions Test Results (Continued)

*Spurious Emissions Measurements in 802.11g mode (2412-2462 MHz)
Channels 1, 6, & 11
Continuous TX at MAIN Antenna port with Yokowo (Pumpkin) Antennas
Aegis Labs, Inc. File #: INTEL-040803-03*

RADIATED EMISSIONS - Horizontal Antenna Polarization											
Freq. (MHz)	Meter Reading (dBuV)	Antenna Height (cm)	Azimuth (degrees)	Quasi pk or AVG (dBuV)		1 Meter Distance Factor (dB)	Cable Factor (dB)	Ant. Factor (dB)	Corrected Reading (dBuV)	Limits (dBuV)	Diff (dB) +=FAIL
EUT in Continuous Transmit Mode on Channel 1 (2.412 GHz)											
2312.00	32.67	100	225			9.54	3.23	31.35	57.71	74.00	-16.29
2312.00				20.98	A	9.54	3.23	31.35	46.02	54.00	-7.98
EUT in Continuous Transmit Mode on Channel 6 (2.437 GHz)											
2336.00	33.00	100	225			9.54	3.25	31.29	58.00	74.00	-16.00
2336.00				21.64	A	9.54	3.25	31.29	46.64	54.00	-7.36
EUT in Continuous Transmit Mode on Channel 11 (2.462 GHz)											
2358.68	31.83	100	225			9.54	3.26	31.24	56.79	74.00	-17.21
2358.68				17.46	A	9.54	3.26	31.24	42.42	54.00	-11.58
RADIATED EMISSIONS - Vertical Antenna Polarization											
Freq. (MHz)	Meter Reading (dBuV)	Antenna Height (cm)	Azimuth (degrees)	Quasi pk or AVG (dBuV)		1 Meter Distance Factor (dB)	Cable Factor (dB)	Ant. Factor (dB)	Corrected Reading (dBuV)	Limits (dBuV)	Diff (dB) +=FAIL
EUT in Continuous Transmit Mode on Channel 1 (2.412 GHz)											
2312.00	32.00	100	225			9.54	3.23	31.40	57.09	74.00	-16.91
2312.00				19.24	A	9.54	3.23	31.40	44.33	54.00	-9.67
EUT in Continuous Transmit Mode on Channel 6 (2.437 GHz)											
2336.00	32.33	100	225			9.54	3.25	31.36	57.40	74.00	-16.60
2336.00				19.89	A	9.54	3.25	31.36	44.96	54.00	-9.04
EUT in Continuous Transmit Mode on Channel 11 (2.462 GHz)											
2358.68	31.33	100	225			9.54	3.26	31.33	56.38	74.00	-17.62
2358.68				17.21	A	9.54	3.26	31.33	42.26	54.00	-11.74

NOTE: These spurious emissions measurements were taken without a preamp at a distance on 1 meter to avoid saturating the preamp and analyzer because the signals were close to the fundamental frequency. The readings were extrapolated to 1 meter.



Spurious Radiated Emissions Test Results (Continued)

*Spurious Emissions Measurements in 802.11g mode (2412-2462 MHz)
Channels 1, 6, & 11
Continuous TX at MAIN Antenna port with Yokowo (Pumpkin) Antennas
Aegis Labs, Inc. File #: INTEL-040803-04*

RADIATED EMISSIONS - Horizontal Antenna Polarization											
<i>Freq. (MHz)</i>	<i>Meter Reading (dBuV)</i>	<i>Antenna Height (cm)</i>	<i>Azimuth (degrees)</i>	<i>Quasi pk or AVG (dBuV)</i>		<i>Preamp Factor (dB)</i>	<i>Cable Factor (dB)</i>	<i>Ant. Factor (dB)</i>	<i>Corrected Reading (dBuV)</i>	<i>Limits (dBuV)</i>	<i>Diff (dB) +=FAIL</i>
EUT in Continuous Transmit Mode on Channel 1 (2.412 GHz)											
3216.00	49.83	100	135			43.07	3.89	30.24	40.89	87.08	-46.19
4824.20	48.33	100	135			43.27	4.73	34.53	44.33	74.00	-29.67
4824.20				35.56	A	43.27	4.73	34.53	31.56	54.00	-22.44
6432.05	56.33	100	135			43.82	5.73	36.64	54.89	87.08	-32.19
9647.97	50.00	100	135			43.22	6.95	38.88	52.61	87.08	-34.47
12864.05	49.50	100	135			43.83	7.95	43.86	57.49	87.08	-29.59
EUT in Continuous Transmit Mode on Channel 6 (2.437 GHz)											
3249.37	49.00	100	135			43.08	3.91	30.25	40.07	88.20	-48.13
4874.06	46.33	100	135			43.29	4.77	34.72	42.53	74.00	-31.47
4874.06				34.15	A	43.29	4.77	34.72	30.35	54.00	-23.65
6498.69	55.50	100	135			43.84	5.78	36.90	54.33	88.20	-33.87
9748.09	50.33	100	135			43.25	6.99	39.00	53.06	88.20	-35.14
12997.35	50.67	100	135			43.83	8.02	44.29	59.15	88.20	-29.05
EUT in Continuous Transmit Mode on Channel 11 (2.462 GHz)											
3282.68	49.17	100	135			43.10	3.91	30.26	40.24	87.66	-47.42
4923.82	49.00	100	135			43.30	4.81	34.91	45.41	74.00	-28.59
4923.82				35.49	A	43.30	4.81	34.91	31.90	54.00	-22.10
6565.42	52.67	100	135			43.84	5.83	37.32	51.98	87.66	-35.68
9847.97	50.00	100	135			43.29	7.03	39.12	52.86	87.66	-34.80
13130.70	49.50	100	135			43.70	8.07	44.25	58.12	87.66	-29.54



Spurious Radiated Emissions Test Results (Continued)

RADIATED EMISSIONS - Vertical Antenna Polarization											
<i>Freq. (MHz)</i>	<i>Meter Reading (dBuV)</i>	<i>Antenna Height (cm)</i>	<i>Azimuth (degrees)</i>	<i>Quasi pk or AVG (dBuV)</i>		<i>Preamp Factor (dB)</i>	<i>Cable Factor (dB)</i>	<i>Ant. Factor (dB)</i>	<i>Corrected Reading (dBuV)</i>	<i>Limits (dBuV)</i>	<i>Diff (dB) +=FAIL</i>
EUT in Continuous Transmit Mode on Channel 1 (2.412 GHz)											
3216.01	49.33	100	135			43.07	3.89	30.44	40.59	88.71	-48.12
4823.97	48.17	100	135			43.27	4.73	34.53	44.16	74.00	-29.84
4823.97				35.39	A	43.27	4.73	34.53	31.38	54.00	-22.62
6431.99	53.67	100	135			43.82	5.73	36.64	52.23	88.71	-36.48
9648.08	49.83	100	135			43.22	6.95	38.97	52.53	88.71	-36.18
12863.98	49.50	100	135			43.83	7.95	44.23	57.85	88.71	-30.86
EUT in Continuous Transmit Mode on Channel 6 (2.437 GHz)											
3249.35	49.50	100	135			43.08	3.91	30.45	40.77	88.52	-47.75
4874.03	45.83	100	135			43.29	4.77	34.72	42.03	74.00	-31.97
4874.03				33.90	A	43.29	4.77	34.72	30.10	54.00	-23.90
6498.67	52.33	100	135			43.84	5.78	36.89	51.16	88.52	-37.36
9748.00	49.67	100	135			43.25	6.99	39.15	52.55	88.52	-35.97
12997.35	50.67	100	135			43.83	8.02	44.49	59.35	88.52	-29.17
EUT in Continuous Transmit Mode on Channel 11 (2.462 GHz)											
3282.65	48.83	100	135			43.10	3.91	30.46	40.10	88.83	-48.73
4924.01	48.33	100	135			43.30	4.81	34.91	44.74	74.00	-29.26
4924.01				36.79	A	43.30	4.81	34.91	33.20	54.00	-20.80
6565.34	51.00	100	135			43.84	5.83	37.38	50.37	88.83	-38.46
9848.03	49.67	100	135			43.29	7.03	39.33	52.74	88.83	-36.09
13130.62	49.00	100	135			43.70	8.07	44.45	57.82	88.83	-31.01



Spurious Radiated Emissions Test Results (Continued)

*Spurious Emissions Measurements in 802.11g mode (2412-2462 MHz)
Channels 1, 6, & 11
Continuous RX at MAIN Antenna port with Yokowo (Pumpkin) Antennas
Aegis Labs, Inc. File #: INTEL-040803-02*

RADIATED EMISSIONS - Horizontal Antenna Polarization											
<i>Freq. (MHz)</i>	<i>Meter Reading (dBuV)</i>	<i>Antenna Height (cm)</i>	<i>Azimuth (degrees)</i>	<i>Quasi pk or AVG (dBuV)</i>		<i>Preamp Factor (dB)</i>	<i>Cable Factor (dB)</i>	<i>Ant. Factor (dB)</i>	<i>Corrected Reading (dBuV)</i>	<i>Limits (dBuV)</i>	<i>Diff (dB) +=FAIL</i>
EUT in Continuous Receive Mode on Channel 1 (2.412 GHz)											
3215.99	48.50	100	135			43.07	3.89	30.24	39.56	80.00	-40.44
3215.99				38.56	A	43.07	3.89	30.24	29.62	60.00	-30.38
6431.98	57.17	100	135			43.82	5.73	36.64	55.73	80.00	-24.27
6431.98				53.49	A	43.82	5.73	36.64	52.05	60.00	-7.95
9647.99	50.17	100	135			43.22	6.95	38.88	52.78	80.00	-27.22
9647.99				38.38	A	43.22	6.95	38.88	40.99	60.00	-19.01
EUT in Continuous Receive Mode on Channel 6 (2.437 GHz)											
3249.32	48.50	100	135			43.08	3.91	30.25	39.57	80.00	-40.43
3249.32				39.57	A	43.08	3.91	30.25	30.64	60.00	-29.36
6498.67	55.33	100	135			43.84	5.78	36.89	54.16	80.00	-25.84
6498.67				50.38	A	43.84	5.78	36.89	49.21	60.00	-10.79
9748.03	50.00	100	135			43.25	6.99	39.00	52.73	80.00	-27.27
9748.03				38.89	A	43.25	6.99	39.00	41.62	60.00	-18.38
EUT in Continuous Receive Mode on Channel 11 (2.462 GHz)											
3282.66	48.17	100	135			43.10	3.91	30.26	39.24	80.00	-40.76
3282.66				37.24	A	43.10	3.91	30.26	28.31	60.00	-31.69
6565.32	53.17	100	135			43.84	5.83	37.32	52.48	80.00	-27.52
6565.32				47.01	A	43.84	5.83	37.32	46.32	60.00	-13.68
9848.03	50.50	100	135			43.29	7.03	39.12	53.36	80.00	-26.64
9848.03				39.29	A	43.29	7.03	39.12	42.15	60.00	-17.85



Spurious Radiated Emissions Test Results (Continued)

RADIATED EMISSIONS - Vertical Antenna Polarization											
<i>Freq. (MHz)</i>	<i>Meter Reading (dBuV)</i>	<i>Antenna Height (cm)</i>	<i>Azimuth (degrees)</i>	<i>Quasi pk or AVG (dBuV)</i>		<i>Preamp Factor (dB)</i>	<i>Cable Factor (dB)</i>	<i>Ant. Factor (dB)</i>	<i>Corrected Reading (dBuV)</i>	<i>Limits (dBuV)</i>	<i>Diff (dB) +=FAIL</i>
EUT in Continuous Receive Mode on Channel 1 (2.412 GHz)											
3216.00	49.50	100	135			43.07	3.89	30.44	40.76	80.00	-39.24
3216.00				42.32	A	43.07	3.89	30.44	33.58	60.00	-26.42
6432.00	55.17	100	135			43.82	5.73	36.64	53.73	80.00	-26.27
6432.00				50.16	A	43.82	5.73	36.64	48.72	60.00	-11.28
9648.00	49.50	100	135			43.22	6.95	38.97	52.20	80.00	-27.80
9648.00				37.69	A	43.22	6.95	38.97	40.39	60.00	-19.61
EUT in Continuous Receive Mode on Channel 6 (2.437 GHz)											
3249.33	49.83	100	135			43.08	3.91	30.45	41.10	80.00	-38.90
3249.33				41.78	A	43.08	3.91	30.45	33.05	60.00	-26.95
6498.69	53.33	100	135			43.84	5.78	36.90	52.16	80.00	-27.84
6498.69				47.21	A	43.84	5.78	36.90	46.04	60.00	-13.96
9748.03	49.67	100	135			43.25	6.99	39.15	52.55	80.00	-27.45
9748.03				38.01	A	43.25	6.99	39.15	40.89	60.00	-19.11
EUT in Continuous Receive Mode on Channel 11 (2.462 GHz)											
3282.67	50.17	100	135			43.10	3.91	30.46	41.44	80.00	-38.56
3282.67				41.04	A	43.10	3.91	30.46	32.31	60.00	-27.69
6565.34	51.00	100	135			43.84	5.83	37.38	50.37	80.00	-29.63
6565.34				44.08	A	43.84	5.83	37.38	43.45	60.00	-16.55
9848.04	50.00	100	135			43.29	7.03	39.33	53.07	80.00	-26.93
9848.04				38.50	A	43.29	7.03	39.33	41.57	60.00	-18.43



AEGIS LABS INC.

Spurious Radiated Emissions Test Results (Continued)

CLIENT:	Intel Corporation	DATE:	08/05/04
EUT:	Intel PRO/Wireless 2915ABG Network Connection	PROJECT NUMBER:	INTEL-040803
MODEL NUMBER:	WM3B2915ABG	TEST ENGINEER:	JC
SERIAL NUMBER:	344F96244ABC51962012	SITE #:	2
CONFIGURATION:	Tested installed in the Hewlett Packard host computer's mini PCI slot in 802.11a (5745-5825 MHz) mode with the Yokowo (Mint) antennas.	TEMPERATURE:	31 C
		HUMIDITY:	36% RH
		TIME:	3:45 PM

Standard:	FCC CFR 47, Part 15.247(c)
Description:	Radiated emissions, which fall in the restricted bands, as defined in Sec. 15.205(a), must also comply with the radiated emission limits specified in Sec. 15.209(a). All others must be < -20dBc.
Results:	Passes (See Data Sheets)

Unwanted Spurious Emissions Limits

Frequency (MHz)	Field Strength (uV/m)	Field Strength (dBuV/m) (Emissions in the restricted bands)	Field Strength (dBm/MHz) (Emissions outside the restricted bands)
Above 960	500	54.00 (Average) 74.00 (Peak)	< -20 dBc

Page 31 of 119 (Appendix A)
Report Number: INTEL-040831F
FCC ID: PD9WM3B2915ABG



Spurious Radiated Emissions Test Results (Continued)

*Fundamental Measurements in 802.11a mode (5745-5825 MHz)
 Channels 149, 157, & 169
 Continuous TX at MAIN Antenna port with Yokowo (Mint) Antennas
 Aegis Labs, Inc. File #: INTEL-040803-06*

RADIATED EMISSIONS - Horizontal Antenna Polarization											
<i>Freq. (MHz)</i>	<i>Meter Reading (dBuV)</i>	<i>Antenna Height (cm)</i>	<i>Azimuth (degrees)</i>	<i>Quasi pk or AVG (dBuV)</i>		<i>Preamp Factor (dB)</i>	<i>Cable Factor (dB)</i>	<i>Ant. Factor (dB)</i>	<i>Corrected Reading (dBuV)</i>	<i>Limits (dBuV)</i>	<i>Diff (dB) +=FAIL</i>
5745.00	64.83	100	225				5.25	34.85	104.92		
5745.00				55.30	A		5.25	34.85	95.39		
5785.00	64.00	100	225				5.27	34.87	104.14		
5785.00				54.62	A		5.27	34.87	94.76		
5825.00	65.17	100	225				5.30	34.90	105.37		
5825.00				55.63	A		5.30	34.90	95.83		

RADIATED EMISSIONS – Vertical Antenna Polarization											
<i>Freq. (MHz)</i>	<i>Meter Reading (dBuV)</i>	<i>Antenna Height (cm)</i>	<i>Azimuth (degrees)</i>	<i>Quasi pk or AVG (dBuV)</i>		<i>Preamp Factor (dB)</i>	<i>Cable Factor (dB)</i>	<i>Ant. Factor (dB)</i>	<i>Corrected Reading (dBuV)</i>	<i>Limits (dBuV)</i>	<i>Diff (dB) +=FAIL</i>
5745.00	64.00	125	270				5.25	34.85	104.09		
5745.00				54.82	A		5.25	34.85	94.91		
5785.00	62.33	100	270				5.27	34.87	102.47		
5785.00				52.92	A		5.27	34.87	93.06		
5825.00	63.50	100	270				5.30	34.90	103.70		
5825.00				54.19	A		5.30	34.90	94.39		



Spurious Radiated Emissions Test Results (Continued)

*Band Edge Field Strength Measurements in 802.11a mode (5745-5825 MHz)
 Channels 149, 157, & 169
 Continuous TX at MAIN Antenna port with Yokowo (Mint) Antennas
 Aegis Labs, Inc. File #: INTEL-040803-06*

RADIATED EMISSIONS - Horizontal Antenna Polarization

<i>Freq. (MHz)</i>	<i>Meter Reading (dBuV)</i>	<i>Antenna Height (cm)</i>	<i>Azimuth (degrees)</i>	<i>Quasi pk or AVG (dBuV)</i>	<i>Preamp Factor (dB)</i>	<i>Cable Factor (dB)</i>	<i>Ant. Factor (dB)</i>	<i>Corrected Reading (dBuV)</i>	<i>Limits (dBuV)</i>	<i>Diff (dB) +=FAIL</i>	
5725.00	33.83	100	225				5.23	34.84	73.90	84.92	-11.03
5850.00	30.83	100	225				5.32	34.91	71.06	85.37	-14.31

RADIATED EMISSIONS – Vertical Antenna Polarization

<i>Freq. (MHz)</i>	<i>Meter Reading (dBuV)</i>	<i>Antenna Height (cm)</i>	<i>Azimuth (degrees)</i>	<i>Quasi pk or AVG (dBuV)</i>	<i>Preamp Factor (dB)</i>	<i>Cable Factor (dB)</i>	<i>Ant. Factor (dB)</i>	<i>Corrected Reading (dBuV)</i>	<i>Limits (dBuV)</i>	<i>Diff (dB) +=FAIL</i>	
5725.00	32.67	125	270				5.23	34.84	72.74	84.09	-11.36
5850.00	30.50	100	270				5.32	34.91	70.73	83.70	-12.97



Spurious Radiated Emissions Test Results (Continued)

Plots Showing Out-Of-Band Emissions (Peak RBW=VBW=1MHz; Average RBW = 1MHz, VBW = 10Hz)

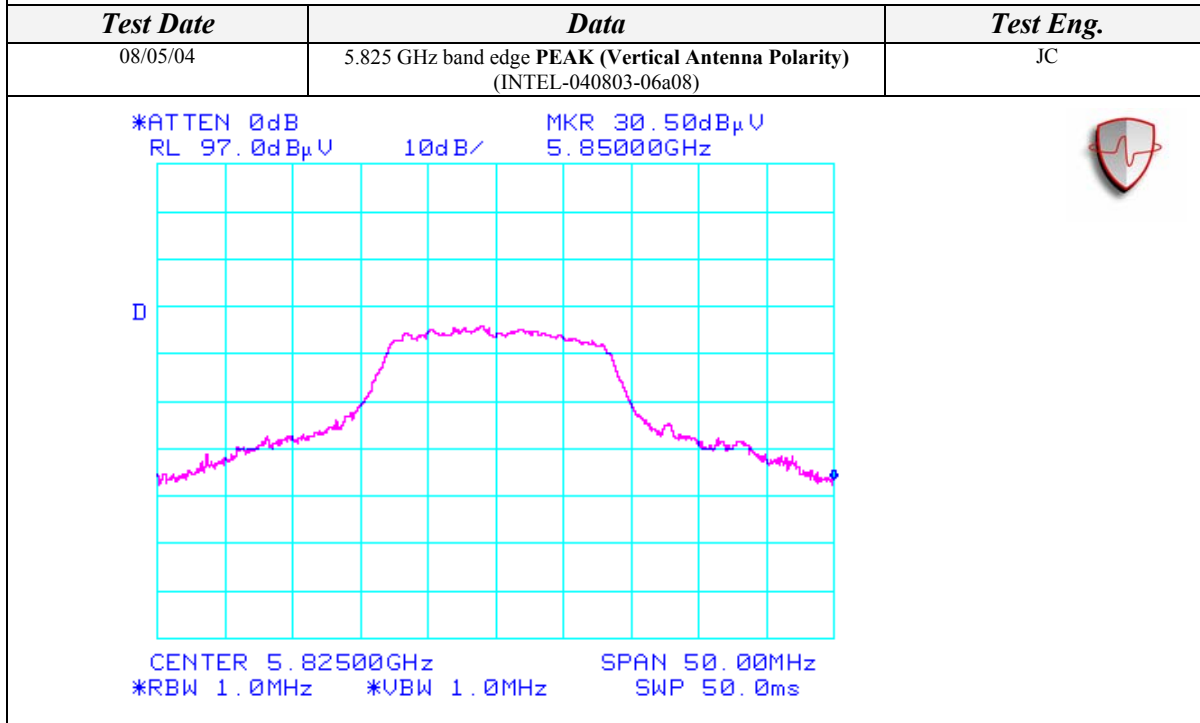
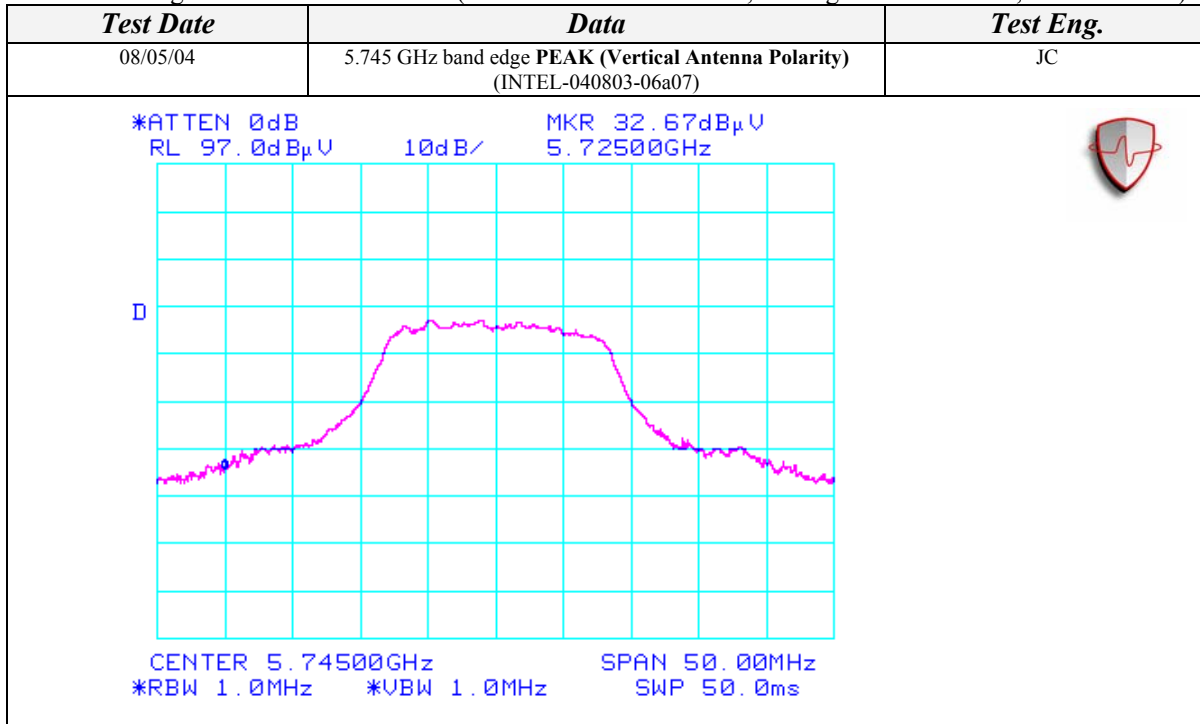



Spurious Radiated Emissions Test Results (Continued)

*Spurious Emissions Measurements in 802.11a mode (5745-5825 MHz)
 Channels 149, 157, & 169
 Continuous TX at MAIN Antenna port with Yokowo (Mint) Antennas
 Aegis Labs, Inc. File #: INTEL-040803-08*

RADIATED EMISSIONS - Horizontal Antenna Polarization											
<i>Freq. (MHz)</i>	<i>Meter Reading (dBuV)</i>	<i>Antenna Height (cm)</i>	<i>Azimuth (degrees)</i>	<i>Quasi pk or AVG (dBuV)</i>		<i>Preamp Factor (dB)</i>	<i>Cable Factor (dB)</i>	<i>Ant. Factor (dB)</i>	<i>Corrected Reading (dBuV)</i>	<i>Limits (dBuV)</i>	<i>Diff (dB) +=FAIL</i>
EUT in Continuous Transmit Mode on Channel 149 (5.745 GHz)											
3830.00	52.83	100	45			43.17	4.18	31.16	45.00	74.00	-29.00
3830.00				45.31	A	43.17	4.18	31.16	37.48	54.00	-16.52
7660.00	52.17	100	135			43.62	6.27	40.05	54.87	74.00	-19.13
7660.00				44.15	A	43.62	6.27	40.05	46.85	54.00	-7.15
11490.00	51.83	100	135			43.50	7.64	41.18	57.15	74.00	-16.85
11490.00				41.83	A	43.50	7.64	41.18	47.15	54.00	-6.85
15319.89	48.67	100	135			43.39	8.80	41.49	55.57	84.92	-29.35
EUT in Continuous Transmit Mode on Channel 157 (5.785 GHz)											
3856.66	54.83	100	270			43.17	4.21	31.23	47.09	74.00	-26.91
3856.66				48.97	A	43.17	4.21	31.23	41.23	54.00	-12.77
7713.33	53.83	100	135			43.60	6.29	40.20	56.72	74.00	-17.28
7713.33				47.37	A	43.60	6.29	40.20	50.26	54.00	-3.74
11569.98	50.50	100	135			43.48	7.66	41.38	56.07	74.00	-17.93
11569.98				39.19	A	43.48	7.66	41.38	44.76	54.00	-9.24
15426.58	50.00	100	135			43.35	8.80	41.56	57.01	74.00	-16.99
15426.58				37.70		43.35	8.80	41.56	44.71	54.00	-9.29
EUT in Continuous Transmit Mode on Channel 165 (5.825 GHz)											
3883.34	55.83	100	270			43.17	4.23	31.30	48.18	74.00	-25.82
3883.34				51.39	A	43.17	4.23	31.30	43.74	54.00	-10.26
7766.66	53.67	100	135			43.58	6.32	40.35	56.75	85.37	-28.62
11650.00	49.83	100	135			43.45	7.69	41.59	55.66	74.00	-18.34
11650.00				37.63	A	43.45	7.69	41.59	43.46	54.00	-10.54
15533.23	50.17	100	135			43.35	8.82	41.71	57.35	74.00	-16.65
15533.23				36.88	A	43.35	8.82	41.71	44.06	54.00	-9.94



Spurious Radiated Emissions Test Results (Continued)

RADIATED EMISSIONS - Vertical Antenna Polarization											
<i>Freq. (MHz)</i>	<i>Meter Reading (dBuV)</i>	<i>Antenna Height (cm)</i>	<i>Azimuth (degrees)</i>	<i>Quasi pk or AVG (dBuV)</i>		<i>Preamplifier Factor (dB)</i>	<i>Cable Factor (dB)</i>	<i>Ant. Factor (dB)</i>	<i>Corrected Reading (dBuV)</i>	<i>Limits (dBuV)</i>	<i>Diff (dB) +=FAIL</i>
EUT in Continuous Transmit Mode on Channel 149 (5.745 GHz)											
3830.00	53.50	100	270			43.17	4.18	31.09	45.61	74.00	-28.39
3830.00				46.05	A	43.17	4.18	31.09	38.16	54.00	-15.84
7660.00	50.50	100	135			43.62	6.27	40.11	53.27	74.00	-20.73
7660.00				41.09	A	43.62	6.27	40.11	43.86	54.00	-10.14
11490.00	51.17	100	135			43.50	7.64	41.66	56.97	74.00	-17.03
11490.00				40.86	A	43.50	7.64	41.66	46.66	54.00	-7.34
EUT in Continuous Transmit Mode on Channel 157 (5.785 GHz)											
3856.66	55.00	100	270			43.17	4.21	31.14	47.18	74.00	-26.82
3856.66				48.89	A	43.17	4.21	31.14	41.07	54.00	-12.93
7713.33	51.33	100	135			43.60	6.29	40.28	54.31	74.00	-19.69
7713.33				40.96	A	43.60	6.29	40.28	43.94	54.00	-10.06
11569.98	51.50	100	135			43.48	7.66	41.81	57.50	74.00	-16.50
11569.98				41.40	A	43.48	7.66	41.81	47.40	54.00	-6.60
EUT in Continuous Transmit Mode on Channel 165 (5.825 GHz)											
3883.33	54.67	100	270			43.17	4.23	31.19	46.92	74.00	-27.08
3883.33				48.14	A	43.17	4.23	31.19	40.39	54.00	-13.61
7766.66	52.50	100	135			43.58	6.32	40.45	55.69	83.70	-28.01
11650.00	49.50	100	135			43.45	7.69	41.94	55.68	74.00	-18.32
11650.00				37.02	A	43.45	7.69	41.94	43.20	54.00	-10.80



Spurious Radiated Emissions Test Results (Continued)

*Spurious Emissions Measurements in 802.11a mode (5745-5825 MHz)
 Channels 149, 157, & 169
 Continuous RX at MAIN Antenna port with Yokowo (Mint) Antennas
 Aegis Labs, Inc. File #: INTEL-040803-08*

RADIATED EMISSIONS - Horizontal Antenna Polarization											
<i>Freq. (MHz)</i>	<i>Meter Reading (dBuV)</i>	<i>Antenna Height (cm)</i>	<i>Azimuth (degrees)</i>	<i>Quasi pk or AVG (dBuV)</i>		<i>Preamp Factor (dB)</i>	<i>Cable Factor (dB)</i>	<i>Ant. Factor (dB)</i>	<i>Corrected Reading (dBuV)</i>	<i>Limits (dBuV)</i>	<i>Diff (dB) +=FAIL</i>
EUT in Continuous Receive Mode on Channel 149 (5.745 GHz)											
3830.00	49.17	100	225			43.17	4.18	31.16	41.34	80.00	-38.66
3830.00				36.79	A	43.17	4.18	31.16	28.96	60.00	-31.04
7660.00	50.17	100	135			43.62	6.27	40.05	52.87	80.00	-27.13
7660.00				39.53	A	43.62	6.27	40.05	42.23	60.00	-17.77
11489.92	49.67	100	135			43.50	7.64	41.18	54.99	80.00	-25.01
11489.92				36.55	A	43.50	7.64	41.18	41.87	60.00	-18.13
EUT in Continuous Receive Mode on Channel 157 (5.785 GHz)											
3856.62	50.17	100	135			43.17	4.21	31.23	42.43	80.00	-37.57
3856.62				40.59	A	43.17	4.21	31.23	32.85	60.00	-27.15
7713.32	50.17	100	135			43.60	6.29	40.20	53.06	80.00	-26.94
7713.32				39.22	A	43.60	6.29	40.20	42.11	60.00	-17.89
11569.92	49.33	100	135			43.48	7.66	41.38	54.90	80.00	-25.10
11569.92				38.75	A	43.48	7.66	41.38	44.32	60.00	-15.68
EUT in Continuous Receive Mode on Channel 165 (5.825 GHz)											
3883.34	49.83	100	135			43.17	4.23	31.30	42.18	80.00	-37.82
3883.34				38.13	A	43.17	4.23	31.30	30.48	60.00	-29.52
7766.62	50.00	100	135			43.58	6.32	40.35	53.08	80.00	-26.92
7766.62				37.96	A	43.58	6.32	40.35	41.04	60.00	-18.96
11649.94	48.83	100	135			43.45	7.69	41.59	54.66	80.00	-25.34
11649.94				36.39	A	43.45	7.69	41.59	42.22	60.00	-17.78



AEGIS LABS INC.

Spurious Radiated Emissions Test Results (Continued)

RADIATED EMISSIONS - Vertical Antenna Polarization											
<i>Freq. (MHz)</i>	<i>Meter Reading (dBuV)</i>	<i>Antenna Height (cm)</i>	<i>Azimuth (degrees)</i>	<i>Quasi pk or AVG (dBuV)</i>		<i>Preamp Factor (dB)</i>	<i>Cable Factor (dB)</i>	<i>Ant. Factor (dB)</i>	<i>Corrected Reading (dBuV)</i>	<i>Limits (dBuV)</i>	<i>Diff (dB) +=FAIL</i>
EUT in Continuous Receive Mode on Channel 149 (5.745 GHz)											
3830.00	50.50	100	135			43.17	4.18	31.09	42.61	80.00	-37.39
3830.00				41.59	A	43.17	4.18	31.09	33.70	60.00	-26.30
7660.00	49.67	100	135			43.62	6.27	40.11	52.44	80.00	-27.56
7660.00				36.76	A	43.62	6.27	40.11	39.53	60.00	-20.47
11489.96	49.33	100	135			43.50	7.64	41.66	55.13	80.00	-24.87
11489.96				36.63	A	43.50	7.64	41.66	42.43	60.00	-17.57
EUT in Continuous Receive Mode on Channel 157 (5.785 GHz)											
3856.65	51.17	100	135			43.17	4.21	31.14	43.35	80.00	-36.65
3856.65				41.83	A	43.17	4.21	31.14	34.01	60.00	-25.99
7713.29	50.67	100	135			43.60	6.29	40.28	53.65	80.00	-26.35
7713.29				39.86	A	43.60	6.29	40.28	42.84	60.00	-17.16
11569.91	51.00	100	135			43.48	7.66	41.81	57.00	80.00	-23.00
11569.91				39.24	A	43.48	7.66	41.81	45.24	60.00	-14.76
EUT in Continuous Receive Mode on Channel 165 (5.825 GHz)											
3883.35	50.83	100	135			43.17	4.23	31.19	43.08	80.00	-36.92
3883.35				42.19	A	43.17	4.23	31.19	34.44	60.00	-25.56
7766.63	49.50	100	135			43.58	6.32	40.45	52.69	80.00	-27.31
7766.63				36.98	A	43.58	6.32	40.45	40.17	60.00	-19.83
11649.97	49.00	100	135			43.45	7.69	41.94	55.18	80.00	-24.82
11649.97				36.56	A	43.45	7.69	41.94	42.74	60.00	-17.26



AEGIS LABS INC.

Spurious Radiated Emissions Test Results (Continued)

CLIENT:	Intel Corporation	DATE:	08/05/04
EUT:	Intel PRO/Wireless 2915ABG Network Connection	PROJECT NUMBER:	INTEL-040803
MODEL NUMBER:	WM3B2915ABG	TEST ENGINEER:	JC
SERIAL NUMBER:	344F96244ABC51962012	SITE #:	2
CONFIGURATION:	Tested installed in the Hewlett Packard host computer's mini PCI slot in 802.11b (2412-2462 MHz) mode with the Yokowo (Mint) antennas	TEMPERATURE:	31 C
		HUMIDITY:	36% RH
		TIME:	3:45 PM

Standard:	FCC CFR 47, Part 15.247(c)
Description:	Radiated emissions, which fall in the restricted bands, as defined in Sec. 15.205(a), must also comply with the radiated emission limits specified in Sec. 15.209(a). All others must be < -20dBc.
Results:	Passes (See Data Sheets)

Unwanted Spurious Emissions Limits

Frequency (MHz)	Field Strength (uV/m)	Field Strength (dBuV/m) (Emissions in the restricted bands)	Field Strength (dBm/MHz) (Emissions outside the restricted bands)
Above 960	500	54.00 (Average) 74.00 (Peak)	< -20 dBc

Page 40 of 119 (Appendix A)
Report Number: INTEL-040831F
FCC ID: PD9WM3B2915ABG



Spurious Radiated Emissions Test Results (Continued)

*Fundamental Measurements in 802.11b mode (2412-2462 MHz)
Channels 1, 6, & 11
Continuous TX at MAIN Antenna port with Yokowo (Mint) Antennas
Aegis Labs, Inc. File #: INTEL-040803-06*

RADIATED EMISSIONS - Horizontal Antenna Polarization											
<i>Freq. (MHz)</i>	<i>Meter Reading (dBuV)</i>	<i>Antenna Height (cm)</i>	<i>Azimuth (degrees)</i>	<i>Quasi pk or AVG (dBuV)</i>		<i>Preamp Factor (dB)</i>	<i>Cable Factor (dB)</i>	<i>Ant. Factor (dB)</i>	<i>Corrected Reading (dBuV)</i>	<i>Limits (dBuV)</i>	<i>Diff (dB) +=FAIL</i>
2412.00	68.67	100	315				3.30	31.11	103.08		
2412.00				64.71	A		3.30	31.11	99.12		
2437.00	71.67	100	225				3.32	31.05	106.04		
2437.00				68.46	A		3.32	31.05	102.83		
2462.00	71.50	100	225				3.34	30.99	105.83		
2462.00				68.01	A		3.34	30.99	102.34		

RADIATED EMISSIONS – Vertical Antenna Polarization											
<i>Freq. (MHz)</i>	<i>Meter Reading (dBuV)</i>	<i>Antenna Height (cm)</i>	<i>Azimuth (degrees)</i>	<i>Quasi pk or AVG (dBuV)</i>		<i>Preamp Factor (dB)</i>	<i>Cable Factor (dB)</i>	<i>Ant. Factor (dB)</i>	<i>Corrected Reading (dBuV)</i>	<i>Limits (dBuV)</i>	<i>Diff (dB) +=FAIL</i>
2412.00	69.33	125	270				3.30	31.24	103.87		
2412.00				65.47	A		3.30	31.24	100.01		
2437.00	72.83	125	270				3.32	31.20	107.35		
2437.00				69.69	A		3.32	31.20	104.21		
2462.00	72.00	125	270				3.34	31.16	106.50		
2462.00				68.58	A		3.34	31.16	103.08		

NOTE: Fundamental signals measured to calculate the band edge field strengths using the “Marker Delta Method”.



Spurious Radiated Emissions Test Results (Continued)

Band Edge Field Strength Measurements in 802.11b mode (2412-2462 MHz)
Channels 1, 6, & 11
Continuous TX at MAIN Antenna port with Yokowo (Mint) Antennas
Aegis Labs, Inc. File #: INTEL-040803-06

RADIATED EMISSIONS - Horizontal Antenna Polarization										
Freq. (MHz)	Meter Reading (dBuV)	Antenna Height (cm)	Azimuth (degrees)	Quasi pk or AVG (dBuV)	Preamp Factor (dB)	Cable Factor (dB)	Ant. Factor (dB)	Corrected Reading (dBuV)	Limits (dBuV)	Diff (dB) +=FAIL
2390.00								48.91	74.00	-25.09
2390.00								36.78	54.00	-17.22
2359.80								51.25	74.00	-22.75
2359.80								37.78	54.00	-16.22
2400.00	36.33	100	315			3.29	31.14	70.76	83.08	-12.32
2483.50								51.33	74.00	-22.67
2483.50								40.01	54.00	-13.99
2520.70								52.17	74.00	-21.83
2520.70								40.84	54.00	-13.16
RADIATED EMISSIONS - Vertical Antenna Polarization										
Freq. (MHz)	Meter Reading (dBuV)	Antenna Height (cm)	Azimuth (degrees)	Quasi pk or AVG (dBuV)	Preamp Factor (dB)	Cable Factor (dB)	Ant. Factor (dB)	Corrected Reading (dBuV)	Limits (dBuV)	Diff (dB) +=FAIL
2390.00								49.70	74.00	-24.30
2390.00								37.67	54.00	-16.33
2359.80								52.04	74.00	-21.96
2359.80								38.67	54.00	-15.33
2400.00	37.17	125	270			3.29	31.26	71.72	83.87	-12.15
2483.50								52.00	74.00	-22.00
2483.50								40.75	54.00	-13.25
2520.70								52.84	74.00	-21.16
2520.70								41.58	54.00	-12.42

NOTE: The “Band Edge Field Strength” was calculated using the “Fundamental” and “Conducted Band Edge” measurements per the “Marker-Delta Method” with the following formula:

$$BE = Fm - \Delta m$$

Where

BE = Band Edge Field Strength

Fm = Measured Fundamental (Peak or Average)

Δm = Measured Conducted Band Edge Delta (Peak or Average)



Spurious Radiated Emissions Test Results (Continued)

Plots Showing Out-Of-Band Emissions (Peak RBW=VBW=1MHz; Average RBW = 1MHz, VBW = 10Hz)

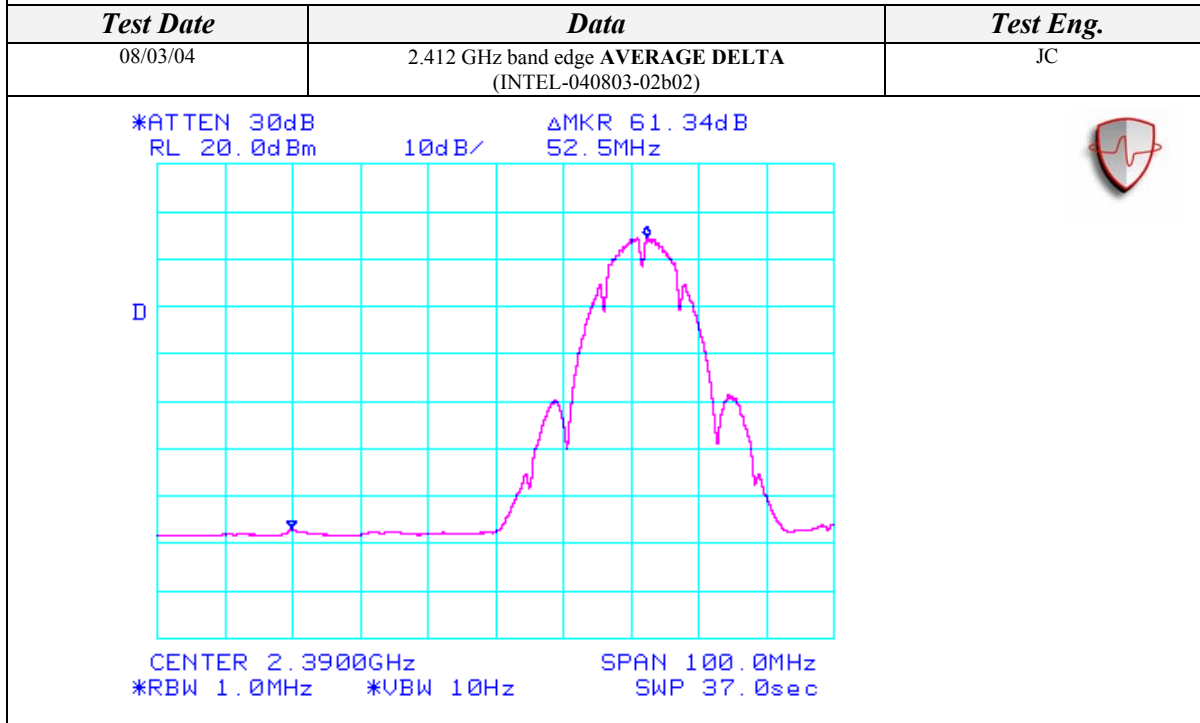
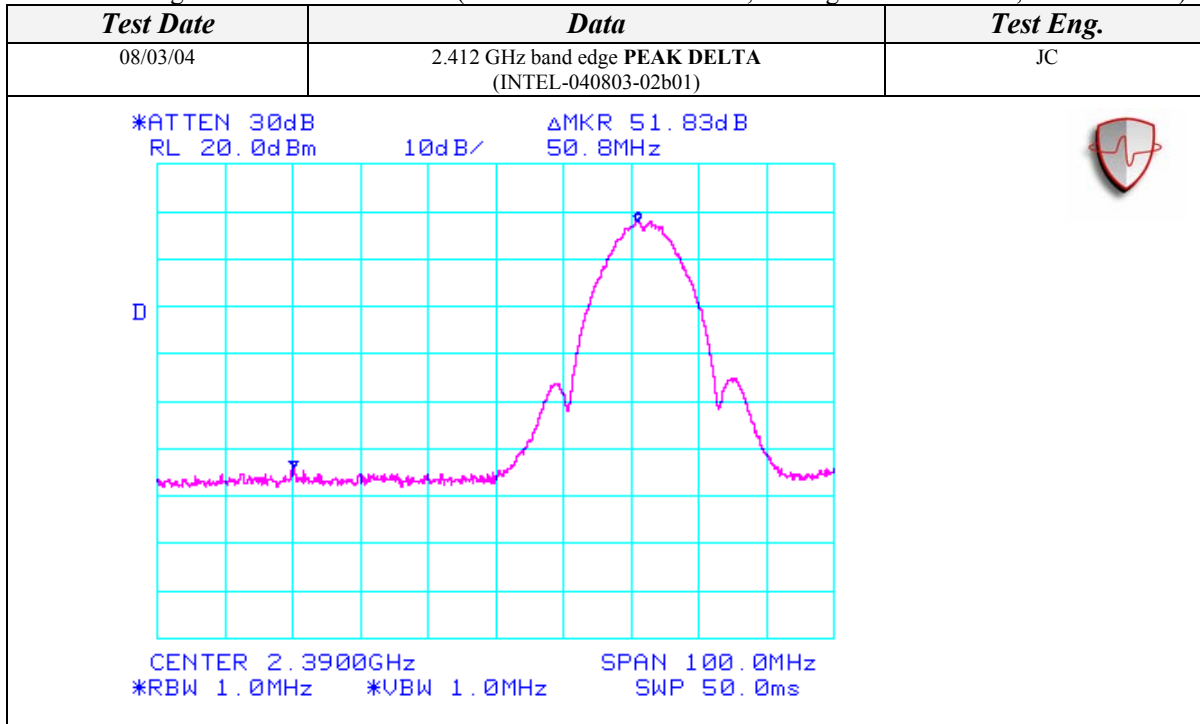



Spurious Radiated Emissions Test Results (Continued)

*Spurious Emissions Measurements in 802.11b mode (2412-2462 MHz)
Channels 1, 6, & 11
Continuous TX at MAIN Antenna port with Yokowo (Mint) Antennas
Aegis Labs, Inc. File #: INTEL-040803-07*

RADIATED EMISSIONS - Horizontal Antenna Polarization											
Freq. (MHz)	Meter Reading (dBuV)	Antenna Height (cm)	Azimuth (degrees)	Quasi pk or AVG (dBuV)		1 Meter Distance Factor (dB)	Cable Factor (dB)	Ant. Factor (dB)	Corrected Reading (dBuV)	Limits (dBuV)	Diff (dB) +=FAIL
EUT in Continuous Transmit Mode on Channel 1 (2.412 GHz)											
2312.00	31.67	100	225			9.54	3.23	31.35	56.71	74.00	-17.29
2312.00				17.24	A	9.54	3.23	31.35	42.28	54.00	-11.72
EUT in Continuous Transmit Mode on Channel 6 (2.437 GHz)											
2336.00	32.00	100	225			9.54	3.25	31.29	57.00	74.00	-17.00
2336.00				16.37	A	9.54	3.25	31.29	41.37	54.00	-12.63
EUT in Continuous Transmit Mode on Channel 11 (2.462 GHz)											
2358.66	31.83	100	225			9.54	3.26	31.24	56.79	74.00	-17.21
2358.66				15.68	A	9.54	3.26	31.24	40.64	54.00	-13.36
RADIATED EMISSIONS - Vertical Antenna Polarization											
Freq. (MHz)	Meter Reading (dBuV)	Antenna Height (cm)	Azimuth (degrees)	Quasi pk or AVG (dBuV)		1 Meter Distance Factor (dB)	Cable Factor (dB)	Ant. Factor (dB)	Corrected Reading (dBuV)	Limits (dBuV)	Diff (dB) +=FAIL
EUT in Continuous Transmit Mode on Channel 1 (2.412 GHz)											
2312.00	31.33	100	225			9.54	3.23	31.40	56.42	74.00	-17.58
2312.00				15.24	A	9.54	3.23	31.40	40.33	54.00	-13.67
EUT in Continuous Transmit Mode on Channel 6 (2.437 GHz)											
2336.00	31.83	100	225			9.54	3.25	31.36	56.90	74.00	-17.10
2336.00				15.74	A	9.54	3.25	31.36	40.81	54.00	-13.19
EUT in Continuous Transmit Mode on Channel 11 (2.462 GHz)											
2358.66	31.17	100	225			9.54	3.26	31.33	56.22	74.00	-17.78
2358.66				14.89	A	9.54	3.26	31.33	39.94	54.00	-14.06

NOTE: These spurious emissions measurements were taken without a preamp at a distance on 1 meter to avoid saturating the preamp and analyzer because the signals were close to the fundamental frequency. The readings were extrapolated to 1 meter.



Spurious Radiated Emissions Test Results (Continued)

*Spurious Emissions Measurements in 802.11b mode (2412-2462 MHz)
Channels 1, 6, & 11
Continuous TX at MAIN Antenna port with Yokowo (Mint) Antennas
Aegis Labs, Inc. File #: INTEL-040803-08*

RADIATED EMISSIONS - Horizontal Antenna Polarization											
<i>Freq. (MHz)</i>	<i>Meter Reading (dBuV)</i>	<i>Antenna Height (cm)</i>	<i>Azimuth (degrees)</i>	<i>Quasi pk or AVG (dBuV)</i>		<i>Preamp Factor (dB)</i>	<i>Cable Factor (dB)</i>	<i>Ant. Factor (dB)</i>	<i>Corrected Reading (dBuV)</i>	<i>Limits (dBuV)</i>	<i>Diff (dB) +=FAIL</i>
EUT in Continuous Transmit Mode on Channel 1 (2.412 GHz)											
3216.01	49.33	100	135			43.07	3.89	30.24	40.39	83.08	-42.69
4824.00	49.33	100	135			43.27	4.73	34.53	45.32	74.00	-28.68
4824.00				36.93	A	43.27	4.73	34.53	32.92	54.00	-21.08
6431.98	58.17	100	135			43.82	5.73	36.64	56.73	83.08	-26.35
9648.01	49.83	100	135			43.22	6.95	38.88	52.44	83.08	-30.64
12864.03	49.50	100	135			43.83	7.95	43.86	57.49	83.08	-25.59
EUT in Continuous Transmit Mode on Channel 6 (2.437 GHz)											
3249.32	48.83	100	135			43.08	3.91	30.25	39.90	86.04	-46.14
4873.99	53.67	100	135			43.29	4.77	34.72	49.87	74.00	-24.13
4873.99				48.98	A	43.29	4.77	34.72	45.18	54.00	-8.82
6498.69	58.50	100	135			43.84	5.78	36.90	57.33	86.04	-28.71
9747.96	50.33	100	135			43.25	6.99	39.00	53.06	86.04	-32.98
12997.37	50.00	100	135			43.83	8.02	44.29	58.48	86.04	-27.56
EUT in Continuous Transmit Mode on Channel 11 (2.462 GHz)											
3282.69	49.33	100	135			43.10	3.91	30.26	40.40	85.83	-45.43
4924.00	58.17	100	135			43.30	4.81	34.91	54.58	74.00	-19.42
4924.00				54.65	A	43.30	4.81	34.91	51.06	54.00	-2.94
6565.34	56.00	100	135			43.84	5.83	37.32	55.31	85.83	-30.52
9848.01	51.00	100	135			43.29	7.03	39.12	53.86	85.83	-31.97
13130.67	49.83	100	135			43.70	8.07	44.25	58.45	85.83	-27.38



Spurious Radiated Emissions Test Results (Continued)

RADIATED EMISSIONS - Vertical Antenna Polarization											
<i>Freq. (MHz)</i>	<i>Meter Reading (dBuV)</i>	<i>Antenna Height (cm)</i>	<i>Azimuth (degrees)</i>	<i>Quasi pk or AVG (dBuV)</i>		<i>Preamp Factor (dB)</i>	<i>Cable Factor (dB)</i>	<i>Ant. Factor (dB)</i>	<i>Corrected Reading (dBuV)</i>	<i>Limits (dBuV)</i>	<i>Diff (dB) +=FAIL</i>
EUT in Continuous Transmit Mode on Channel 1 (2.412 GHz)											
3216.00	48.17	100	135			43.07	3.89	30.44	39.43	83.87	-44.44
4823.96	48.67	100	135			43.27	4.73	34.53	44.66	74.00	-29.34
4823.96				37.36	A	43.27	4.73	34.53	33.35	54.00	-20.65
6431.95	53.50	100	135			43.82	5.73	36.64	52.06	83.87	-31.81
9647.97	49.67	100	135			43.22	6.95	38.97	52.37	83.87	-31.50
12864.01	49.33	100	135			43.83	7.95	44.23	57.68	83.87	-26.19
EUT in Continuous Transmit Mode on Channel 6 (2.437 GHz)											
3249.32	46.83	100	135			43.08	3.91	30.45	38.10	87.35	-49.25
4874.01	50.00	100	135			43.29	4.77	34.72	46.20	74.00	-27.80
4874.01				41.67	A	43.29	4.77	34.72	37.87	54.00	-16.13
6498.66	53.50	100	135			43.84	5.78	36.89	52.33	87.35	-35.02
9748.04	50.33	100	135			43.25	6.99	39.15	53.21	87.35	-34.14
12997.35	49.83	100	135			43.83	8.02	44.49	58.51	87.35	-28.84
EUT in Continuous Transmit Mode on Channel 11 (2.462 GHz)											
3282.66	48.67	100	135			43.10	3.91	30.46	39.94	86.50	-46.56
4924.00	56.50	100	135			43.30	4.81	34.91	52.91	74.00	-21.09
4924.00				50.80	A	43.30	4.81	34.91	47.21	54.00	-6.79
6565.32	51.83	100	135			43.84	5.83	37.38	51.20	86.50	-35.30
9847.96	51.50	100	135			43.29	7.03	39.33	54.57	86.50	-31.93
13130.63	49.00	100	135			43.70	8.07	44.45	57.82	86.50	-28.68



Spurious Radiated Emissions Test Results (Continued)

*Spurious Emissions Measurements in in802.11b mode (2412-2462 MHz)
 Channels 1, 6, & 11
 Continuous RX at MAIN Antenna port with Yokowo (Mint) Antennas
 Aegis Labs, Inc. File #: INTEL-040803-08*

RADIATED EMISSIONS - Horizontal Antenna Polarization											
<i>Freq. (MHz)</i>	<i>Meter Reading (dBuV)</i>	<i>Antenna Height (cm)</i>	<i>Azimuth (degrees)</i>	<i>Quasi pk or AVG (dBuV)</i>	<i>Preamp Factor (dB)</i>	<i>Cable Factor (dB)</i>	<i>Ant. Factor (dB)</i>	<i>Corrected Reading (dBuV)</i>	<i>Limits (dBuV)</i>	<i>Diff (dB) +=FAIL</i>	
EUT in Continuous Receive Mode on Channel 1 (2.412 GHz)											
3216.02	48.00	100	135			43.07	3.89	30.24	39.06	80.00	-40.94
3216.02				38.12	A	43.07	3.89	30.24	29.18	60.00	-30.82
6432.00	55.00	100	135			43.82	5.73	36.64	53.56	80.00	-26.44
6432.00				50.02	A	43.82	5.73	36.64	48.58	60.00	-11.42
9648.03	51.00	100	135			43.22	6.95	38.88	53.61	80.00	-26.39
9648.03				39.04	A	43.22	6.95	38.88	41.65	60.00	-18.35
EUT in Continuous Receive Mode on Channel 6 (2.437 GHz)											
3249.32	48.83	100	135			43.08	3.91	30.25	39.90	80.00	-40.10
3249.32				39.36	A	43.08	3.91	30.25	30.43	60.00	-29.57
6498.70	56.17	100	135			43.84	5.78	36.90	55.00	80.00	-25.00
6498.70				52.02	A	43.84	5.78	36.90	50.85	60.00	-9.15
9747.99	49.83	100	135			43.25	6.99	39.00	52.56	80.00	-27.44
9747.99				37.33	A	43.25	6.99	39.00	40.06	60.00	-19.94
EUT in Continuous Receive Mode on Channel 11 (2.462 GHz)											
3282.66	49.67	100	135			43.10	3.91	30.26	40.74	80.00	-39.26
3282.66				37.26	A	43.10	3.91	30.26	28.33	60.00	-31.67
6565.32	51.33	100	135			43.84	5.83	37.32	50.64	80.00	-29.36
6565.32				40.44	A	43.84	5.83	37.32	39.75	60.00	-20.25
9848.01	50.17	100	135			43.29	7.03	39.12	53.03	80.00	-26.97
9848.01				38.39	A	43.29	7.03	39.12	41.25	60.00	-18.75



Spurious Radiated Emissions Test Results (Continued)

RADIATED EMISSIONS - Vertical Antenna Polarization											
<i>Freq. (MHz)</i>	<i>Meter Reading (dBuV)</i>	<i>Antenna Height (cm)</i>	<i>Azimuth (degrees)</i>	<i>Quasi pk or AVG (dBuV)</i>		<i>Preamp Factor (dB)</i>	<i>Cable Factor (dB)</i>	<i>Ant. Factor (dB)</i>	<i>Corrected Reading (dBuV)</i>	<i>Limits (dBuV)</i>	<i>Diff (dB) +=FAIL</i>
EUT in Continuous Receive Mode on Channel 1 (2.412 GHz)											
3216.00	49.67	100	135			43.07	3.89	30.44	40.93	80.00	-39.07
3216.00				39.29	A	43.07	3.89	30.44	30.55	60.00	-29.45
6432.03	54.00	100	135			43.82	5.73	36.64	52.56	80.00	-27.44
6432.03				46.81	A	43.82	5.73	36.64	45.37	60.00	-14.63
9648.02	50.33	100	135			43.22	6.95	38.97	53.03	80.00	-26.97
9648.02				39.71	A	43.22	6.95	38.97	42.41	60.00	-17.59
EUT in Continuous Receive Mode on Channel 6 (2.437 GHz)											
3249.32	48.83	100	135			43.08	3.91	30.45	40.10	80.00	-39.90
3249.32				38.66	A	43.08	3.91	30.45	29.93	60.00	-30.07
6498.67	53.83	100	135			43.84	5.78	36.89	52.66	80.00	-27.34
6498.67				46.54	A	43.84	5.78	36.89	45.37	60.00	-14.63
9747.96	49.33	100	135			43.25	6.99	39.15	52.21	80.00	-27.79
9747.96				37.46	A	43.25	6.99	39.15	40.34	60.00	-19.66
EUT in Continuous Receive Mode on Channel 11 (2.462 GHz)											
3282.67	48.33	100	135			43.10	3.91	30.46	39.60	80.00	-40.40
3282.67				37.31	A	43.10	3.91	30.46	28.58	60.00	-31.42
6565.37	53.50	100	135			43.84	5.83	37.38	52.87	80.00	-27.13
6565.37				45.89	A	43.84	5.83	37.38	45.26	60.00	-14.74
9847.98	50.00	100	135			43.29	7.03	39.33	53.07	80.00	-26.93
9847.98				37.86	A	43.29	7.03	39.33	40.93	60.00	-19.07



AEGIS LABS INC.

Spurious Radiated Emissions Test Results (Continued)

CLIENT:	Intel Corporation	DATE:	08/05/04
EUT:	Intel PRO/Wireless 2915ABG Network Connection	PROJECT NUMBER:	INTEL-040803
MODEL NUMBER:	WM3B2915ABG	TEST ENGINEER:	JC
SERIAL NUMBER:	344F96244ABC51962012	SITE #:	2
CONFIGURATION:	Tested installed in the Hewlett Packard host computer's mini PCI slot in 802.11g (2412-2462 MHz) mode with the Yokowo (Mint) antennas.	TEMPERATURE:	31 C
		HUMIDITY:	36% RH
		TIME:	3:45 PM

Standard:	FCC CFR 47, Part 15.247(c)
Description:	Radiated emissions, which fall in the restricted bands, as defined in Sec. 15.205(a), must also comply with the radiated emission limits specified in Sec. 15.209(a). All others must be < -20dBc.
Results:	Passes (See Data Sheets)

Unwanted Spurious Emissions Limits			
Frequency (MHz)	Field Strength (uV/m)	Field Strength (dBuV/m) (Emissions in the restricted bands)	Field Strength (dBm/MHz) (Emissions outside the restricted bands)
Above 960	500	54.00 (Average) 74.00 (Peak)	< -20 dBc

Page 50 of 119 (Appendix A)
Report Number: INTEL-040831F
FCC ID: PD9WM3B2915ABG



Spurious Radiated Emissions Test Results (Continued)

*Fundamental Measurements in 802.11g mode (2412-2462 MHz)
Channels 1, 6, & 11
Continuous TX at MAIN Antenna port with Yokowo (Mint) Antennas
Aegis Labs, Inc. File #: INTEL-040803-06*

RADIATED EMISSIONS - Horizontal Antenna Polarization											
<i>Freq. (MHz)</i>	<i>Meter Reading (dBuV)</i>	<i>Antenna Height (cm)</i>	<i>Azimuth (degrees)</i>	<i>Quasi pk or AVG (dBuV)</i>		<i>Preamp Factor (dB)</i>	<i>Cable Factor (dB)</i>	<i>Ant. Factor (dB)</i>	<i>Corrected Reading (dBuV)</i>	<i>Limits (dBuV)</i>	<i>Diff (dB) +=FAIL</i>
2412.00	72.17	100	315				3.30	31.11	106.58		
2412.00				61.86	A		3.30	31.11	96.27		
2437.00	72.83	100	225				3.32	31.05	107.20		
2437.00				62.44	A		3.32	31.05	96.81		
2462.00	72.50	100	225				3.34	30.99	106.83		
2462.00				62.22	A		3.34	30.99	96.55		

RADIATED EMISSIONS – Vertical Antenna Polarization											
<i>Freq. (MHz)</i>	<i>Meter Reading (dBuV)</i>	<i>Antenna Height (cm)</i>	<i>Azimuth (degrees)</i>	<i>Quasi pk or AVG (dBuV)</i>		<i>Preamp Factor (dB)</i>	<i>Cable Factor (dB)</i>	<i>Ant. Factor (dB)</i>	<i>Corrected Reading (dBuV)</i>	<i>Limits (dBuV)</i>	<i>Diff (dB) +=FAIL</i>
2412.00	73.17	125	270				3.30	31.24	107.71		
2412.00				62.79	A		3.30	31.24	97.33		
2437.00	73.00	125	270				3.32	31.20	107.52		
2437.00				62.68	A		3.32	31.20	97.20		
2462.00	73.17	125	270				3.34	31.16	107.67		
2462.00				63.01	A		3.34	31.16	97.51		

NOTE: Fundamental signals measured to calculate the band edge field strengths using the “Marker Delta Method”.



Spurious Radiated Emissions Test Results (Continued)

*Band Edge Field Strength Measurements in 802.11g mode (2412-2462 MHz)
Channels 1, 6, & 11
Continuous TX at MAIN Antenna port with Yokowo (Mint) Antennas
Aegis Labs, Inc. File #: INTEL-040803-06*

RADIATED EMISSIONS - Horizontal Antenna Polarization										
<i>Freq. (MHz)</i>	<i>Meter Reading (dBuV)</i>	<i>Antenna Height (cm)</i>	<i>Azimuth (degrees)</i>	<i>Quasi pk or AVG (dBuV)</i>	<i>Preamp Factor (dB)</i>	<i>Cable Factor (dB)</i>	<i>Ant. Factor (dB)</i>	<i>Corrected Reading (dBuV)</i>	<i>Limits (dBuV)</i>	<i>Diff (dB) +=FAIL</i>
2390.00								60.24	74.00	-13.76
2390.00								45.60	54.00	-8.40
2400.00	48.17	100	315			3.29	31.14	82.60	86.58	-3.98
2483.50								62.33	74.00	-11.67
2483.50								45.55	54.00	-8.45

RADIATED EMISSIONS – Vertical Antenna Polarization										
<i>Freq. (MHz)</i>	<i>Meter Reading (dBuV)</i>	<i>Antenna Height (cm)</i>	<i>Azimuth (degrees)</i>	<i>Quasi pk or AVG (dBuV)</i>	<i>Preamp Factor (dB)</i>	<i>Cable Factor (dB)</i>	<i>Ant. Factor (dB)</i>	<i>Corrected Reading (dBuV)</i>	<i>Limits (dBuV)</i>	<i>Diff (dB) +=FAIL</i>
2390.00								61.37	74.00	-12.63
2390.00								46.66	54.00	-7.34
2400.00	49.33	125	270			3.29	31.26	83.88	87.71	-3.83
2483.50								63.17	74.00	-10.83
2483.50								46.51	54.00	-7.49

NOTE: The “Band Edge Field Strength” was calculated using the “Fundamental” and “Conducted Band Edge” measurements per the “Marker-Delta Method” with the following formula:

$$BE = Fm - \Delta m$$

Where

BE = Band Edge Field Strength

Fm = Measured Fundamental (Peak or Average)

Δm = Measured Conducted Band Edge Delta (Peak or Average)



AEGIS LABS INC.

Spurious Radiated Emissions Test Results (Continued)

Plots Showing Out-Of-Band Emissions (Peak RBW=VBW=1MHz; Average RBW = 1MHz, VBW = 10Hz)

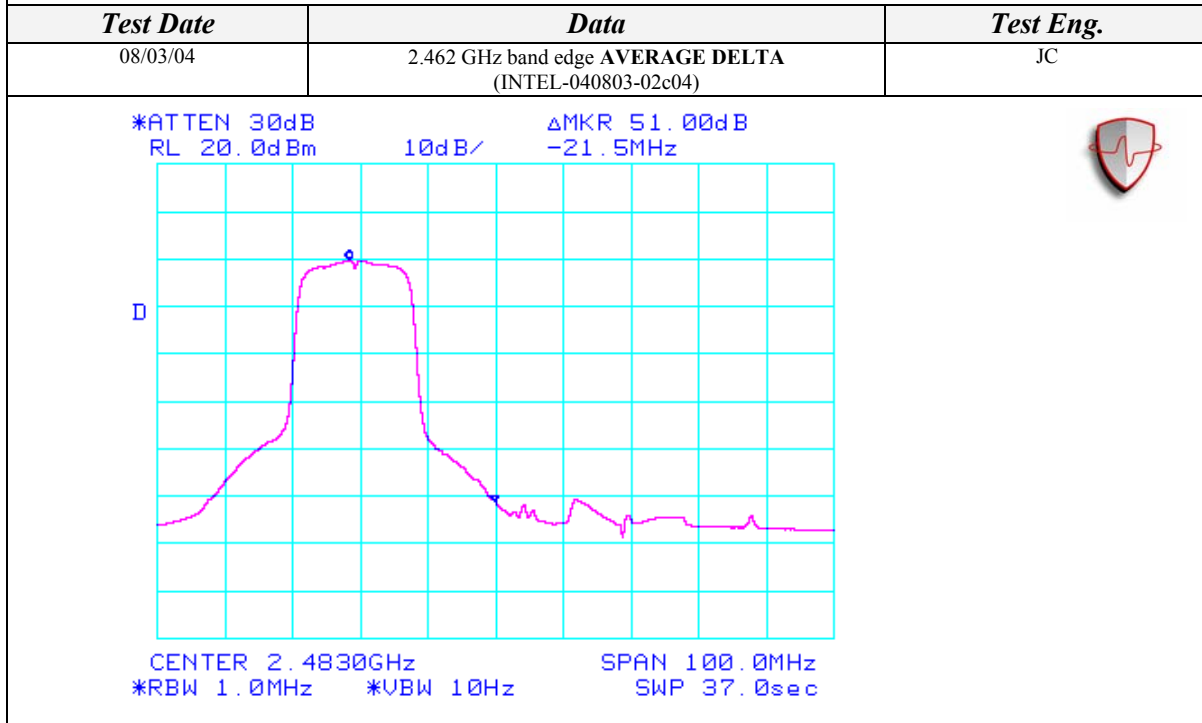
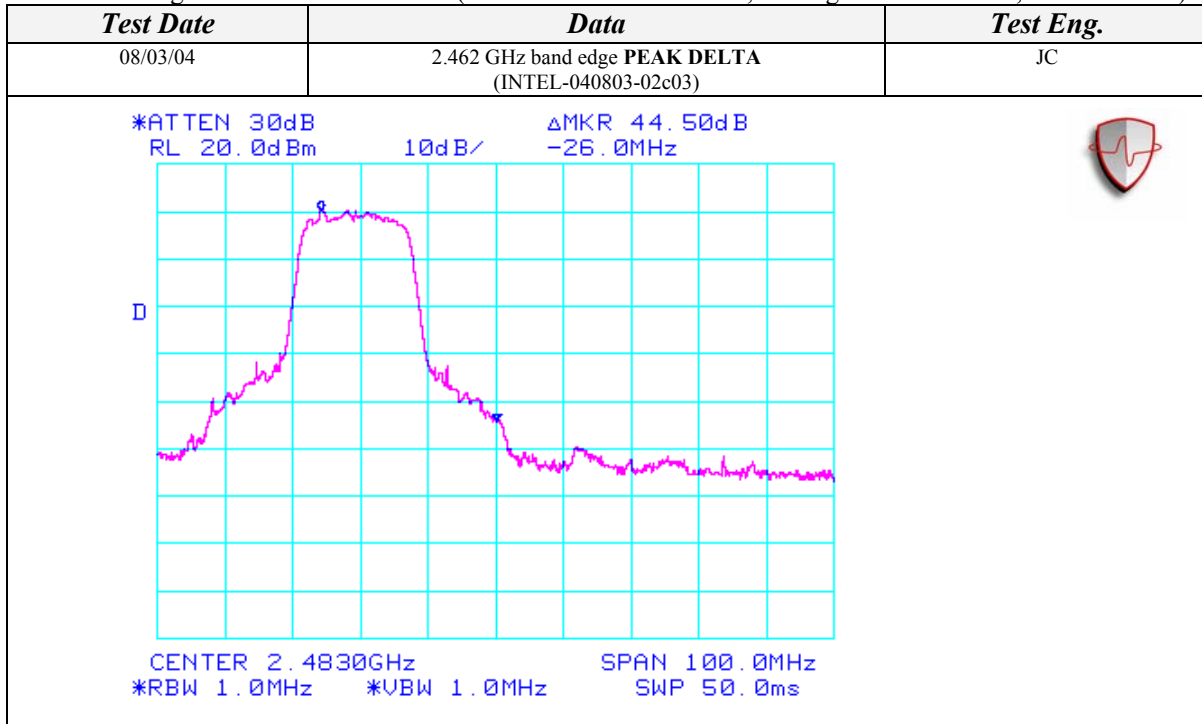

Page 54 of 119 (Appendix A)
Report Number: INTEL-040831F
FCC ID: PD9WM3B2915ABG



Spurious Radiated Emissions Test Results (Continued)

*Spurious Emissions Measurements in 802.11g mode (2412-2462 MHz)
Channels 1, 6, & 11
Continuous TX at MAIN Antenna port with Yokowo (Mint) Antennas
Aegis Labs, Inc. File #: INTEL-040803-07*

RADIATED EMISSIONS - Horizontal Antenna Polarization											
Freq. (MHz)	Meter Reading (dBuV)	Antenna Height (cm)	Azimuth (degrees)	Quasi pk or AVG (dBuV)		1 Meter Distance Factor (dB)	Cable Factor (dB)	Ant. Factor (dB)	Corrected Reading (dBuV)	Limits (dBuV)	Diff (dB) +=FAIL
EUT in Continuous Transmit Mode on Channel 1 (2.412 GHz)											
2312.00	34.00	100	225			9.54	3.23	31.35	59.04	74.00	-14.96
2312.00				24.00	A	9.54	3.23	31.35	49.04	54.00	-4.96
EUT in Continuous Transmit Mode on Channel 6 (2.437 GHz)											
2336.00	33.50	100	225			9.54	3.25	31.29	58.50	74.00	-15.50
2336.00				23.67	A	9.54	3.25	31.29	48.67	54.00	-5.33
EUT in Continuous Transmit Mode on Channel 11 (2.462 GHz)											
2358.68	32.33	100	225			9.54	3.26	31.24	57.29	74.00	-16.71
2358.68				20.39	A	9.54	3.26	31.24	45.35	54.00	-8.65
RADIATED EMISSIONS - Vertical Antenna Polarization											
Freq. (MHz)	Meter Reading (dBuV)	Antenna Height (cm)	Azimuth (degrees)	Quasi pk or AVG (dBuV)		1 Meter Distance Factor (dB)	Cable Factor (dB)	Ant. Factor (dB)	Corrected Reading (dBuV)	Limits (dBuV)	Diff (dB) +=FAIL
EUT in Continuous Transmit Mode on Channel 1 (2.412 GHz)											
2312.00	32.83	100	225			9.54	3.23	31.40	57.92	74.00	-16.08
2312.00				21.75	A	9.54	3.23	31.40	46.84	54.00	-7.16
EUT in Continuous Transmit Mode on Channel 6 (2.437 GHz)											
2336.00	33.50	100	225			9.54	3.25	31.36	58.57	74.00	-15.43
2336.00				22.59	A	9.54	3.25	31.36	47.66	54.00	-6.34
EUT in Continuous Transmit Mode on Channel 11 (2.462 GHz)											
2358.68	32.17	100	225			9.54	3.26	31.33	57.22	74.00	-16.78
2358.68				16.87	A	9.54	3.26	31.33	41.92	54.00	-12.08

NOTE: These spurious emissions measurements were taken without a preamp at a distance on 1 meter to avoid saturating the preamp and analyzer because the signals were close to the fundamental frequency. The readings were extrapolated to 1 meter.



Spurious Radiated Emissions Test Results (Continued)

*Spurious Emissions Measurements in 802.11g mode (2412-2462 MHz)
Channels 1, 6, & 11
Continuous TX at MAIN Antenna port with Yokowo (Mint) Antennas
Aegis Labs, Inc. File #: INTEL-040803-08*

RADIATED EMISSIONS - Horizontal Antenna Polarization											
<i>Freq. (MHz)</i>	<i>Meter Reading (dBuV)</i>	<i>Antenna Height (cm)</i>	<i>Azimuth (degrees)</i>	<i>Quasi pk or AVG (dBuV)</i>		<i>Preamp Factor (dB)</i>	<i>Cable Factor (dB)</i>	<i>Ant. Factor (dB)</i>	<i>Corrected Reading (dBuV)</i>	<i>Limits (dBuV)</i>	<i>Diff (dB) +=FAIL</i>
EUT in Continuous Transmit Mode on Channel 1 (2.412 GHz)											
3216.00	47.83	100	135			43.07	3.89	30.24	38.89	86.58	-47.69
4824.20	48.33	100	135			43.27	4.73	34.53	44.33	74.00	-29.67
4824.20				35.85	A	43.27	4.73	34.53	31.85	54.00	-22.15
6432.05	59.17	100	135			43.82	5.73	36.64	57.73	86.58	-28.85
9647.97	49.83	100	135			43.22	6.95	38.88	52.44	86.58	-34.14
12864.02	49.67	100	135			43.83	7.95	43.86	57.66	86.58	-28.92
EUT in Continuous Transmit Mode on Channel 6 (2.437 GHz)											
3249.37	48.83	100	135			43.08	3.91	30.25	39.90	87.20	-47.30
4874.06	50.33	100	135			43.29	4.77	34.72	46.53	74.00	-27.47
4874.06				35.89	A	43.29	4.77	34.72	32.09	54.00	-21.91
6498.69	58.17	100	135			43.84	5.78	36.90	57.00	87.20	-30.20
9748.09	50.00	100	135			43.25	6.99	39.00	52.73	87.20	-34.47
12997.35	49.83	100	135			43.83	8.02	44.29	58.31	87.20	-28.89
EUT in Continuous Transmit Mode on Channel 11 (2.462 GHz)											
3282.68	50.00	100	135			43.10	3.91	30.26	41.07	86.83	-45.76
4923.82	53.83	100	135			43.30	4.81	34.91	50.24	74.00	-23.76
4923.82				41.23	A	43.30	4.81	34.91	37.64	54.00	-16.36
6565.42	55.50	100	135			43.84	5.83	37.32	54.81	86.83	-32.02
9847.97	49.50	100	135			43.29	7.03	39.12	52.36	86.83	-34.47
13130.70	49.50	100	135			43.70	8.07	44.25	58.12	86.83	-28.71



Spurious Radiated Emissions Test Results (Continued)

RADIATED EMISSIONS - Vertical Antenna Polarization											
<i>Freq. (MHz)</i>	<i>Meter Reading (dBuV)</i>	<i>Antenna Height (cm)</i>	<i>Azimuth (degrees)</i>	<i>Quasi pk or AVG (dBuV)</i>		<i>Preamp Factor (dB)</i>	<i>Cable Factor (dB)</i>	<i>Ant. Factor (dB)</i>	<i>Corrected Reading (dBuV)</i>	<i>Limits (dBuV)</i>	<i>Diff (dB) +=FAIL</i>
EUT in Continuous Transmit Mode on Channel 1 (2.412 GHz)											
3216.01	47.50	100	135			43.07	3.89	30.44	38.76	87.71	-48.95
4823.97	48.00	100	135			43.27	4.73	34.53	43.99	74.00	-30.01
4823.97				35.19	A	43.27	4.73	34.53	31.18	54.00	-22.82
6432.01	55.00	100	135			43.82	5.73	36.64	53.56	87.71	-34.15
9648.03	50.33	100	135			43.22	6.95	38.97	53.03	87.71	-34.68
12863.98	49.50	100	135			43.83	7.95	44.23	57.85	87.71	-29.86
EUT in Continuous Transmit Mode on Channel 6 (2.437 GHz)											
3249.35	47.67	100	135			43.08	3.91	30.45	38.94	87.52	-48.58
4874.03	47.00	100	135			43.29	4.77	34.72	43.20	74.00	-30.80
4874.03				35.02	A	43.29	4.77	34.72	31.22	54.00	-22.78
6498.67	54.17	100	135			43.84	5.78	36.89	53.00	87.52	-34.52
9748.00	49.00	100	135			43.25	6.99	39.15	51.88	87.52	-35.64
12997.35	51.00	100	135			43.83	8.02	44.49	59.68	87.52	-27.84
EUT in Continuous Transmit Mode on Channel 11 (2.462 GHz)											
3282.65	47.33	100	135			43.10	3.91	30.46	38.60	87.67	-49.07
4924.01	50.33	100	135			43.30	4.81	34.91	46.74	74.00	-27.26
4924.01				36.89	A	43.30	4.81	34.91	33.30	54.00	-20.70
6565.34	51.33	100	135			43.84	5.83	37.38	50.70	87.67	-36.97
9848.03	49.33	100	135			43.29	7.03	39.33	52.40	87.67	-35.27
13130.62	49.67	100	135			43.70	8.07	44.45	58.49	87.67	-29.18



Spurious Radiated Emissions Test Results (Continued)

*Spurious Emissions Measurements in 802.11g mode (2412-2462 MHz)
Channels 1, 6, & 11
Continuous RX at MAIN Antenna port with Yokowo (Mint) Antennas
Aegis Labs, Inc. File #: INTEL-040803-06*

RADIATED EMISSIONS - Horizontal Antenna Polarization											
<i>Freq. (MHz)</i>	<i>Meter Reading (dBuV)</i>	<i>Antenna Height (cm)</i>	<i>Azimuth (degrees)</i>	<i>Quasi pk or AVG (dBuV)</i>		<i>Preamp Factor (dB)</i>	<i>Cable Factor (dB)</i>	<i>Ant. Factor (dB)</i>	<i>Corrected Reading (dBuV)</i>	<i>Limits (dBuV)</i>	<i>Diff (dB) +=FAIL</i>
EUT in Continuous Receive Mode on Channel 1 (2.412 GHz)											
3216.00	50.50	100	135			43.07	3.89	30.24	41.56	80.00	-38.44
3216.00				39.80	A	43.07	3.89	30.24	30.86	60.00	-29.14
6431.98	54.33	100	135			43.82	5.73	36.64	52.89	80.00	-27.11
6431.98				49.15	A	43.82	5.73	36.64	47.71	60.00	-12.29
9647.99	49.83	100	135			43.22	6.95	38.88	52.44	80.00	-27.56
9647.99				38.10	A	43.22	6.95	38.88	40.71	60.00	-19.29
EUT in Continuous Receive Mode on Channel 6 (2.437 GHz)											
3249.32	49.67	100	135			43.08	3.91	30.25	40.74	80.00	-39.26
3249.32				38.40	A	43.08	3.91	30.25	29.47	60.00	-30.53
6498.67	55.50	100	135			43.84	5.78	36.89	54.33	80.00	-25.67
6498.67				50.56	A	43.84	5.78	36.89	49.39	60.00	-10.61
9748.03	50.83	100	135			43.25	6.99	39.00	53.56	80.00	-26.44
9748.03				38.00	A	43.25	6.99	39.00	40.73	60.00	-19.27
EUT in Continuous Receive Mode on Channel 11 (2.462 GHz)											
3282.66	51.67	100	135			43.10	3.91	30.26	42.74	80.00	-37.26
3282.66				39.70	A	43.10	3.91	30.26	30.77	60.00	-29.23
6565.32	51.33	100	135			43.84	5.83	37.32	50.64	80.00	-29.36
6565.32				43.86	A	43.84	5.83	37.32	43.17	60.00	-16.83
9848.03	49.83	100	135			43.29	7.03	39.12	52.69	80.00	-27.31
9848.03				37.86	A	43.29	7.03	39.12	40.72	60.00	-19.28



Spurious Radiated Emissions Test Results (Continued)

RADIATED EMISSIONS - Vertical Antenna Polarization											
<i>Freq. (MHz)</i>	<i>Meter Reading (dBuV)</i>	<i>Antenna Height (cm)</i>	<i>Azimuth (degrees)</i>	<i>Quasi pk or AVG (dBuV)</i>		<i>Preamp Factor (dB)</i>	<i>Cable Factor (dB)</i>	<i>Ant. Factor (dB)</i>	<i>Corrected Reading (dBuV)</i>	<i>Limits (dBuV)</i>	<i>Diff (dB) +=FAIL</i>
EUT in Continuous Receive Mode on Channel 1 (2.412 GHz)											
3216.00	48.83	100	135			43.07	3.89	30.44	40.09	80.00	-39.91
3216.00				37.12	A	43.07	3.89	30.44	28.38	60.00	-31.62
6432.00	54.67	100	135			43.82	5.73	36.64	53.23	80.00	-26.77
6432.00				49.11	A	43.82	5.73	36.64	47.67	60.00	-12.33
9648.00	49.00	100	135			43.22	6.95	38.97	51.70	80.00	-28.30
9648.00				37.86	A	43.22	6.95	38.97	40.56	60.00	-19.44
EUT in Continuous Receive Mode on Channel 6 (2.437 GHz)											
3249.33	50.00	100	135			43.08	3.91	30.45	41.27	80.00	-38.73
3249.33				38.52	A	43.08	3.91	30.45	29.79	60.00	-30.21
6498.69	53.17	100	135			43.84	5.78	36.90	52.00	80.00	-28.00
6498.69				45.84	A	43.84	5.78	36.90	44.67	60.00	-15.33
9748.03	49.83	100	135			43.25	6.99	39.15	52.71	80.00	-27.29
9748.03				37.88	A	43.25	6.99	39.15	40.76	60.00	-19.24
EUT in Continuous Receive Mode on Channel 11 (2.462 GHz)											
3282.67	49.33	100	135			43.10	3.91	30.46	40.60	80.00	-39.40
3282.67				37.76	A	43.10	3.91	30.46	29.03	60.00	-30.97
6565.34	52.67	100	135			43.84	5.83	37.38	52.04	80.00	-27.96
6565.34				44.71	A	43.84	5.83	37.38	44.08	60.00	-15.92
9848.04	50.17	100	135			43.29	7.03	39.33	53.24	80.00	-26.76
9848.04				37.71	A	43.29	7.03	39.33	40.78	60.00	-19.22



AEGIS LABS INC.

Spurious Radiated Emissions Test Results (Continued)

CLIENT:	Intel Corporation	DATE:	08/06/04
EUT:	Intel PRO/Wireless 2915ABG Network Connection	PROJECT NUMBER:	INTEL-040803
MODEL NUMBER:	WM3B2915ABG	TEST ENGINEER:	JC
SERIAL NUMBER:	344F96244ABC51962012	SITE #:	2
CONFIGURATION:	Tested installed in the Hewlett Packard host computer's mini PCI slot in 802.11a (5745-5825 MHz) mode with the Fujitsu (Emilia) antennas.	TEMPERATURE:	29 C
		HUMIDITY:	33% RH
		TIME:	11:00 AM

Standard:	FCC CFR 47, Part 15.247(c)
Description:	Radiated emissions, which fall in the restricted bands, as defined in Sec. 15.205(a), must also comply with the radiated emission limits specified in Sec. 15.209(a). All others must be < -20dBc.
Results:	Passes (See Data Sheets)

Unwanted Spurious Emissions Limits

Frequency (MHz)	Field Strength (uV/m)	Field Strength (dBuV/m) (Emissions in the restricted bands)	Field Strength (dBm/MHz) (Emissions outside the restricted bands)
Above 960	500	54.00 (Average) 74.00 (Peak)	< -20 dBc

Page 60 of 119 (Appendix A)
Report Number: INTEL-040831F
FCC ID: PD9WM3B2915ABG



Spurious Radiated Emissions Test Results (Continued)

*Fundamental Measurements in 802.11a mode (5745-5825 MHz)
Channels 149, 157, & 169
Continuous TX at MAIN Antenna port with Fujitsu (Emilia) Antennas
Aegis Labs, Inc. File #: INTEL-040803-10*

RADIATED EMISSIONS - Horizontal Antenna Polarization											
<i>Freq. (MHz)</i>	<i>Meter Reading (dBuV)</i>	<i>Antenna Height (cm)</i>	<i>Azimuth (degrees)</i>	<i>Quasi pk or AVG (dBuV)</i>		<i>Preamp Factor (dB)</i>	<i>Cable Factor (dB)</i>	<i>Ant. Factor (dB)</i>	<i>Corrected Reading (dBuV)</i>	<i>Limits (dBuV)</i>	<i>Diff (dB) +=FAIL</i>
5745.00	61.67	100	135				5.25	34.85	101.76		
5745.00				51.88	A		5.25	34.85	91.97		
5785.00	59.67	100	135				5.27	34.87	99.81		
5785.00				50.13	A		5.27	34.87	90.27		
5825.00	61.50	100	45				5.30	34.90	101.70		
5825.00				52.27	A		5.30	34.90	92.47		

RADIATED EMISSIONS – Vertical Antenna Polarization											
<i>Freq. (MHz)</i>	<i>Meter Reading (dBuV)</i>	<i>Antenna Height (cm)</i>	<i>Azimuth (degrees)</i>	<i>Quasi pk or AVG (dBuV)</i>		<i>Preamp Factor (dB)</i>	<i>Cable Factor (dB)</i>	<i>Ant. Factor (dB)</i>	<i>Corrected Reading (dBuV)</i>	<i>Limits (dBuV)</i>	<i>Diff (dB) +=FAIL</i>
5745.00	63.17	125	45				5.25	34.85	103.26		
5745.00				53.21	A		5.25	34.85	93.30		
5785.00	61.17	125	45				5.27	34.87	101.31		
5785.00				51.15	A		5.27	34.87	91.29		
5825.00	60.83	100	135				5.30	34.90	101.03		
5825.00				51.67	A		5.30	34.90	91.87		



AEGIS LABS INC.

Spurious Radiated Emissions Test Results (Continued)

*Band Edge Field Strength Measurements in 802.11a mode (5745-5825 MHz)
Channels 149, 157, & 169
Continuous TX at MAIN Antenna port with Fujitsu (Emilia) Antennas
Aegis Labs, Inc. File #: INTEL-040803-10*

RADIATED EMISSIONS - Horizontal Antenna Polarization

<i>Freq. (MHz)</i>	<i>Meter Reading (dBuV)</i>	<i>Antenna Height (cm)</i>	<i>Azimuth (degrees)</i>	<i>Quasi pk or AVG (dBuV)</i>	<i>Preamp Factor (dB)</i>	<i>Cable Factor (dB)</i>	<i>Ant. Factor (dB)</i>	<i>Corrected Reading (dBuV)</i>	<i>Limits (dBuV)</i>	<i>Diff (dB) +=FAIL</i>
5725.00	33.17	100	135			5.23	34.84	73.24	81.76	-8.53
5850.00	30.50	100	45			5.32	34.91	70.73	81.70	-10.97

RADIATED EMISSIONS - Vertical Antenna Polarization

<i>Freq. (MHz)</i>	<i>Meter Reading (dBuV)</i>	<i>Antenna Height (cm)</i>	<i>Azimuth (degrees)</i>	<i>Quasi pk or AVG (dBuV)</i>	<i>Preamp Factor (dB)</i>	<i>Cable Factor (dB)</i>	<i>Ant. Factor (dB)</i>	<i>Corrected Reading (dBuV)</i>	<i>Limits (dBuV)</i>	<i>Diff (dB) +=FAIL</i>
5725.00	34.83	125	45			5.23	34.84	74.90	83.26	-8.37
5850.00	30.17	100	135			5.32	34.91	70.40	81.03	-10.63

Page 62 of 119 (Appendix A)
Report Number: INTEL-040831F
FCC ID: PD9WM3B2915ABG



Spurious Radiated Emissions Test Results (Continued)

*Spurious Emissions Measurements in 802.11a mode (5745-5825 MHz)
 Channels 149, 157, & 169
 Continuous TX at MAIN Antenna port with Fujitsu (Emilia) Antennas
 Aegis Labs, Inc. File #: INTEL-040803-12*

RADIATED EMISSIONS - Horizontal Antenna Polarization											
<i>Freq. (MHz)</i>	<i>Meter Reading (dBuV)</i>	<i>Antenna Height (cm)</i>	<i>Azimuth (degrees)</i>	<i>Quasi pk or AVG (dBuV)</i>		<i>Preamp Factor (dB)</i>	<i>Cable Factor (dB)</i>	<i>Ant. Factor (dB)</i>	<i>Corrected Reading (dBuV)</i>	<i>Limits (dBuV)</i>	<i>Diff (dB) +=FAIL</i>
EUT in Continuous Transmit Mode on Channel 149 (5.745 GHz)											
3830.00	54.00	100	225			43.17	4.18	31.16	46.17	74.00	-27.83
3830.00				47.89	A	43.17	4.18	31.16	40.06	54.00	-13.94
7660.00	51.50	100	135			43.62	6.27	40.05	54.20	74.00	-19.80
7660.00				44.10	A	43.62	6.27	40.05	46.80	54.00	-7.20
11490.00	50.50	100	135			43.50	7.64	41.18	55.82	74.00	-18.18
11490.00				39.26	A	43.50	7.64	41.18	44.58	54.00	-9.42
15319.89	49.67	100	135			43.39	8.80	41.49	56.57	81.76	-25.19
EUT in Continuous Transmit Mode on Channel 157 (5.785 GHz)											
3856.66	58.00	100	225			43.17	4.21	31.23	50.26	74.00	-23.74
3856.66				54.58	A	43.17	4.21	31.23	46.84	54.00	-7.16
7713.33	52.33	100	135			43.60	6.29	40.20	55.22	74.00	-18.78
7713.33				43.39	A	43.60	6.29	40.20	46.28	54.00	-7.72
11569.98	50.17	100	135			43.48	7.66	41.38	55.74	74.00	-18.26
11569.98				39.22	A	43.48	7.66	41.38	44.79	54.00	-9.21
15426.58	49.50	100	135			43.35	8.80	41.56	56.51	74.00	-17.49
15426.58				36.51		43.35	8.80	41.56	43.52	54.00	-10.48
EUT in Continuous Transmit Mode on Channel 165 (5.825 GHz)											
3883.34	59.50	100	315			43.17	4.23	31.30	51.85	74.00	-22.15
3883.34				56.73	A	43.17	4.23	31.30	49.08	54.00	-4.92
7766.66	53.33	100	135			43.58	6.32	40.35	56.41	81.70	-25.29
11650.00	49.17	100	135			43.45	7.69	41.59	55.00	74.00	-19.00
11650.00				38.24	A	43.45	7.69	41.59	44.07	54.00	-9.93
15533.23	50.00	100	135			43.35	8.82	41.71	57.18	74.00	-16.82
15533.23				37.54	A	43.35	8.82	41.71	44.72	54.00	-9.28



Spurious Radiated Emissions Test Results (Continued)

RADIATED EMISSIONS - Vertical Antenna Polarization											
<i>Freq. (MHz)</i>	<i>Meter Reading (dBuV)</i>	<i>Antenna Height (cm)</i>	<i>Azimuth (degrees)</i>	<i>Quasi pk or AVG (dBuV)</i>		<i>Preamplifier Factor (dB)</i>	<i>Cable Factor (dB)</i>	<i>Ant. Factor (dB)</i>	<i>Corrected Reading (dBuV)</i>	<i>Limits (dBuV)</i>	<i>Diff (dB) +=FAIL</i>
EUT in Continuous Transmit Mode on Channel 149 (5.745 GHz)											
3830.00	53.33	100	135			43.17	4.18	31.09	45.44	74.00	-28.56
3830.00				48.04	A	43.17	4.18	31.09	40.15	54.00	-13.85
7660.00	50.50	100	135			43.62	6.27	40.11	53.27	74.00	-20.73
7660.00				40.76	A	43.62	6.27	40.11	43.53	54.00	-10.47
11490.00	49.50	100	135			43.50	7.64	41.66	55.30	74.00	-18.70
11490.00				38.59	A	43.50	7.64	41.66	44.39	54.00	-9.61
EUT in Continuous Transmit Mode on Channel 157 (5.785 GHz)											
3856.66	56.50	100	135			43.17	4.21	31.14	48.68	74.00	-25.32
3856.66				52.22	A	43.17	4.21	31.14	44.40	54.00	-9.60
7713.33	51.00	100	135			43.60	6.29	40.28	53.98	74.00	-20.02
7713.33				40.38	A	43.60	6.29	40.28	43.36	54.00	-10.64
11569.98	50.33	100	135			43.48	7.66	41.81	56.33	74.00	-17.67
11569.98				40.03	A	43.48	7.66	41.81	46.03	54.00	-7.97
EUT in Continuous Transmit Mode on Channel 165 (5.825 GHz)											
3883.33	57.33	100	135			43.17	4.23	31.19	49.58	74.00	-24.42
3883.33				53.90	A	43.17	4.23	31.19	46.15	54.00	-7.85
7766.66	51.00	100	135			43.58	6.32	40.45	54.19	81.03	-26.84
11650.00	49.83	100	135			43.45	7.69	41.94	56.01	74.00	-17.99
11650.00				38.78	A	43.45	7.69	41.94	44.96	54.00	-9.04



Spurious Radiated Emissions Test Results (Continued)

*Spurious Emissions Measurements in 802.11a mode (5745-5825 MHz)
Channels 149, 157, & 169
Continuous RX at MAIN Antenna port with Fujitsu (Emilia) Antennas
Aegis Labs, Inc. File #: INTEL-040803-12*

RADIATED EMISSIONS - Horizontal Antenna Polarization											
<i>Freq. (MHz)</i>	<i>Meter Reading (dBuV)</i>	<i>Antenna Height (cm)</i>	<i>Azimuth (degrees)</i>	<i>Quasi pk or AVG (dBuV)</i>		<i>Preamp Factor (dB)</i>	<i>Cable Factor (dB)</i>	<i>Ant. Factor (dB)</i>	<i>Corrected Reading (dBuV)</i>	<i>Limits (dBuV)</i>	<i>Diff (dB) +=FAIL</i>
EUT in Continuous Receive Mode on Channel 149 (5.745 GHz)											
3830.00	50.67	100	135			43.17	4.18	31.16	42.84	80.00	-37.16
3830.00				40.98	A	43.17	4.18	31.16	33.15	60.00	-26.85
7660.00	52.67	100	135			43.62	6.27	40.05	55.37	80.00	-24.63
7660.00				45.22	A	43.62	6.27	40.05	47.92	60.00	-12.08
11489.92	50.17	100	135			43.50	7.64	41.18	55.49	80.00	-24.51
11489.92				39.25	A	43.50	7.64	41.18	44.57	60.00	-15.43
EUT in Continuous Receive Mode on Channel 157 (5.785 GHz)											
3856.62	51.00	100	135			43.17	4.21	31.23	43.26	80.00	-36.74
3856.62				41.07	A	43.17	4.21	31.23	33.33	60.00	-26.67
7713.32	52.83	100	135			43.60	6.29	40.20	55.72	80.00	-24.28
7713.32				44.62	A	43.60	6.29	40.20	47.51	60.00	-12.49
11569.92	50.83	100	135			43.48	7.66	41.38	56.40	80.00	-23.60
11569.92				38.67	A	43.48	7.66	41.38	44.24	60.00	-15.76
EUT in Continuous Receive Mode on Channel 165 (5.825 GHz)											
3883.34	51.50	100	135			43.17	4.23	31.30	43.85	80.00	-36.15
3883.34				42.24	A	43.17	4.23	31.30	34.59	60.00	-25.41
7766.62	53.33	100	135			43.58	6.32	40.35	56.41	80.00	-23.59
7766.62				47.06	A	43.58	6.32	40.35	50.14	60.00	-9.86
11649.94	50.17	100	135			43.45	7.69	41.59	56.00	80.00	-24.00
11649.94				38.86	A	43.45	7.69	41.59	44.69	60.00	-15.31



AEGIS LABS INC.

Spurious Radiated Emissions Test Results (Continued)

RADIATED EMISSIONS - Vertical Antenna Polarization											
<i>Freq. (MHz)</i>	<i>Meter Reading (dBuV)</i>	<i>Antenna Height (cm)</i>	<i>Azimuth (degrees)</i>	<i>Quasi pk or AVG (dBuV)</i>		<i>Preamp Factor (dB)</i>	<i>Cable Factor (dB)</i>	<i>Ant. Factor (dB)</i>	<i>Corrected Reading (dBuV)</i>	<i>Limits (dBuV)</i>	<i>Diff (dB) +=FAIL</i>
EUT in Continuous Receive Mode on Channel 149 (5.745 GHz)											
3830.00	50.17	100	135			43.17	4.18	31.09	42.28	80.00	-37.72
3830.00				40.53	A	43.17	4.18	31.09	32.64	60.00	-27.36
7660.00	50.17	100	135			43.62	6.27	40.11	52.94	80.00	-27.06
7660.00				37.34	A	43.62	6.27	40.11	40.11	60.00	-19.89
11489.96	49.67	100	135			43.50	7.64	41.66	55.47	80.00	-24.53
11489.96				36.59	A	43.50	7.64	41.66	42.39	60.00	-17.61
EUT in Continuous Receive Mode on Channel 157 (5.785 GHz)											
3856.65	50.50	100	135			43.17	4.21	31.14	42.68	80.00	-37.32
3856.65				41.71	A	43.17	4.21	31.14	33.89	60.00	-26.11
7713.29	50.00	100	135			43.60	6.29	40.28	52.98	80.00	-27.02
7713.29				39.84	A	43.60	6.29	40.28	42.82	60.00	-17.18
11569.91	49.50	100	135			43.48	7.66	41.81	55.50	80.00	-24.50
11569.91				38.98	A	43.48	7.66	41.81	44.98	60.00	-15.02
EUT in Continuous Receive Mode on Channel 165 (5.825 GHz)											
3883.35	51.17	100	135			43.17	4.23	31.19	43.42	80.00	-36.58
3883.35				42.54	A	43.17	4.23	31.19	34.79	60.00	-25.21
7766.63	50.00	100	135			43.58	6.32	40.45	53.19	80.00	-26.81
7766.63				39.29	A	43.58	6.32	40.45	42.48	60.00	-17.52
11649.97	50.33	100	135			43.45	7.69	41.94	56.51	80.00	-23.49
11649.97				39.46	A	43.45	7.69	41.94	45.64	60.00	-14.36



AEGIS LABS INC.

Spurious Radiated Emissions Test Results (Continued)

CLIENT:	Intel Corporation	DATE:	08/06/04
EUT:	Intel PRO/Wireless 2915ABG Network Connection	PROJECT NUMBER:	INTEL-040803
MODEL NUMBER:	WM3B2915ABG	TEST ENGINEER:	JC
SERIAL NUMBER:	344F96244ABC51962012	SITE #:	2
CONFIGURATION:	Tested installed in the Hewlett Packard host computer's mini PCI slot in 802.11b (2412-2462 MHz) mode with the Fujitsu (Emilia) antennas.	TEMPERATURE:	29 C
		HUMIDITY:	33% RH
		TIME:	11:00 AM

Standard:	FCC CFR 47, Part 15.247(c)
Description:	Radiated emissions, which fall in the restricted bands, as defined in Sec. 15.205(a), must also comply with the radiated emission limits specified in Sec. 15.209(a). All others must be < -20dBc.
Results:	Passes (See Data Sheets)

Unwanted Spurious Emissions Limits

Frequency (MHz)	Field Strength (uV/m)	Field Strength (dBuV/m) (Emissions in the restricted bands)	Field Strength (dBm/MHz) (Emissions outside the restricted bands)
Above 960	500	54.00 (Average) 74.00 (Peak)	< -20 dBc

Page 69 of 119 (Appendix A)
Report Number: INTEL-040831F
FCC ID: PD9WM3B2915ABG



Spurious Radiated Emissions Test Results (Continued)

*Fundamental Measurements in 802.11b mode (2412-2462 MHz)
 Channels 1, 6, & 11
 Continuous TX at MAIN Antenna port with Fujitsu (Emilia) Antennas
 Aegis Labs, Inc. File #: INTEL-040803-10*

RADIATED EMISSIONS - Horizontal Antenna Polarization											
<i>Freq. (MHz)</i>	<i>Meter Reading (dBuV)</i>	<i>Antenna Height (cm)</i>	<i>Azimuth (degrees)</i>	<i>Quasi pk or AVG (dBuV)</i>		<i>Preamp Factor (dB)</i>	<i>Cable Factor (dB)</i>	<i>Ant. Factor (dB)</i>	<i>Corrected Reading (dBuV)</i>	<i>Limits (dBuV)</i>	<i>Diff (dB) +=FAIL</i>
2412.00	70.17	100	225				3.30	31.11	104.58		
2412.00				66.30	A		3.30	31.11	100.71		
2437.00	73.17	100	225				3.32	31.05	107.54		
2437.00				69.60	A		3.32	31.05	103.97		
2462.00	71.50	100	225				3.34	30.99	105.83		
2462.00				67.84	A		3.34	30.99	102.17		

RADIATED EMISSIONS – Vertical Antenna Polarization											
<i>Freq. (MHz)</i>	<i>Meter Reading (dBuV)</i>	<i>Antenna Height (cm)</i>	<i>Azimuth (degrees)</i>	<i>Quasi pk or AVG (dBuV)</i>		<i>Preamp Factor (dB)</i>	<i>Cable Factor (dB)</i>	<i>Ant. Factor (dB)</i>	<i>Corrected Reading (dBuV)</i>	<i>Limits (dBuV)</i>	<i>Diff (dB) +=FAIL</i>
2412.00	67.00	125	315				3.30	31.24	101.54		
2412.00				63.03	A		3.30	31.24	97.57		
2437.00	70.50	125	270				3.32	31.20	105.02		
2437.00				67.15	A		3.32	31.20	101.67		
2462.00	71.00	125	270				3.34	31.16	105.50		
2462.00				67.46	A		3.34	31.16	101.96		

NOTE: Fundamental signals measured to calculate the band edge field strengths using the “Marker Delta Method”.



Spurious Radiated Emissions Test Results (Continued)

Band Edge Field Strength Measurements in 802.11b mode (2412-2462 MHz)
Channels 1, 6, & 11
Continuous TX at MAIN Antenna port with Fujitsu (Emilia) Antennas
Aegis Labs, Inc. File #: INTEL-040803-10

RADIATED EMISSIONS - Horizontal Antenna Polarization										
Freq. (MHz)	Meter Reading (dBuV)	Antenna Height (cm)	Azimuth (degrees)	Quasi pk or AVG (dBuV)	Preamp Factor (dB)	Cable Factor (dB)	Ant. Factor (dB)	Corrected Reading (dBuV)	Limits (dBuV)	Diff (dB) +=FAIL
2390.00								50.41	74.00	-23.59
2390.00								38.37	54.00	-15.63
2359.80								52.75	74.00	-21.25
2359.80								39.37	54.00	-14.63
2400.00	37.67	100	225			3.29	31.14	72.10	84.58	-12.48
2483.50								51.33	74.00	-22.67
2483.50								39.84	54.00	-14.16
2520.70								52.17	74.00	-21.83
2520.70								40.67	54.00	-13.33
RADIATED EMISSIONS - Vertical Antenna Polarization										
Freq. (MHz)	Meter Reading (dBuV)	Antenna Height (cm)	Azimuth (degrees)	Quasi pk or AVG (dBuV)	Preamp Factor (dB)	Cable Factor (dB)	Ant. Factor (dB)	Corrected Reading (dBuV)	Limits (dBuV)	Diff (dB) +=FAIL
2390.00								47.37	74.00	-26.63
2390.00								35.23	54.00	-18.77
2359.80								49.71	74.00	-24.29
2359.80								36.23	54.00	-17.77
2400.00	35.83	125	315			3.29	31.26	70.38	81.54	-11.16
2483.50								51.00	74.00	-23.00
2483.50								39.63	54.00	-14.37
2520.70								51.84	74.00	-22.16
2520.70								40.46	54.00	-13.54

NOTE: The "Band Edge Field Strength" was calculated using the "Fundamental" and "Conducted Band Edge" measurements per the "Marker-Delta Method" with the following formula:

$$BE = F_m - \Delta_m$$

Where

BE = Band Edge Field Strength

F_m = Measured Fundamental (Peak or Average)

Δ_m = Measured Conducted Band Edge Delta (Peak or Average)



Spurious Radiated Emissions Test Results (Continued)

Plots Showing Out-Of-Band Emissions (Peak RBW=VBW=1MHz; Average RBW = 1MHz, VBW = 10Hz)

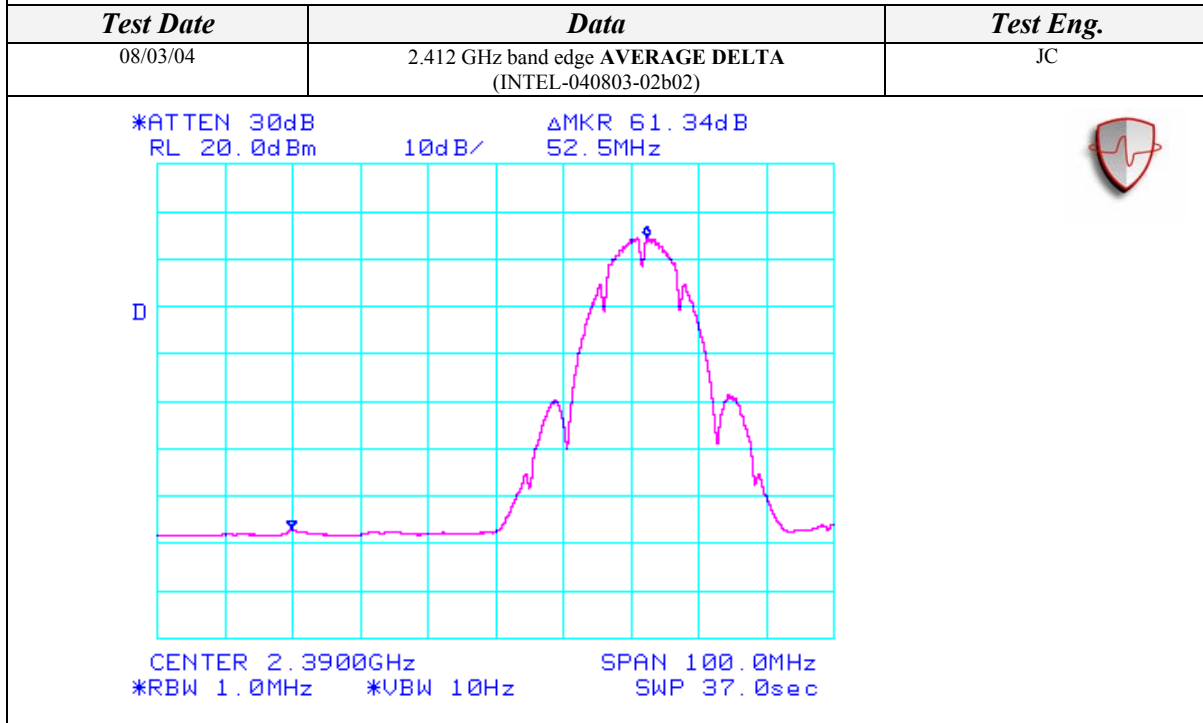
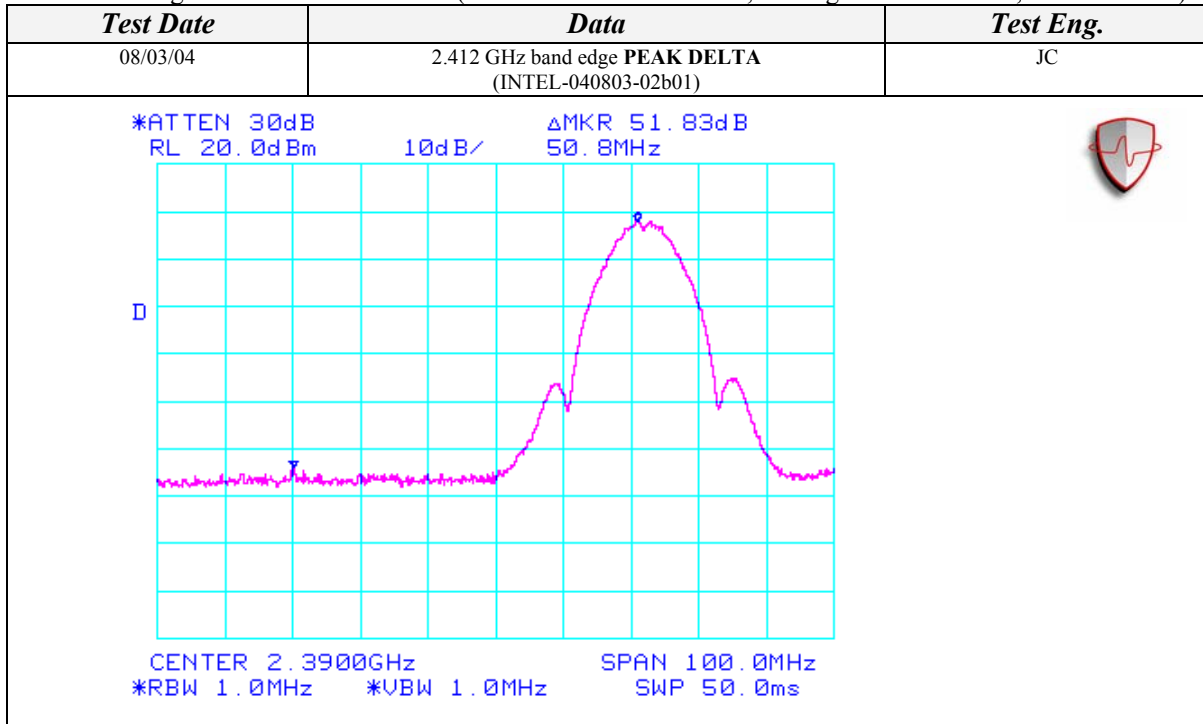



Spurious Radiated Emissions Test Results (Continued)

Plots Showing Out-Of-Band Emissions (Peak RBW=VBW=1MHz; Average RBW = 1MHz, VBW = 10Hz)

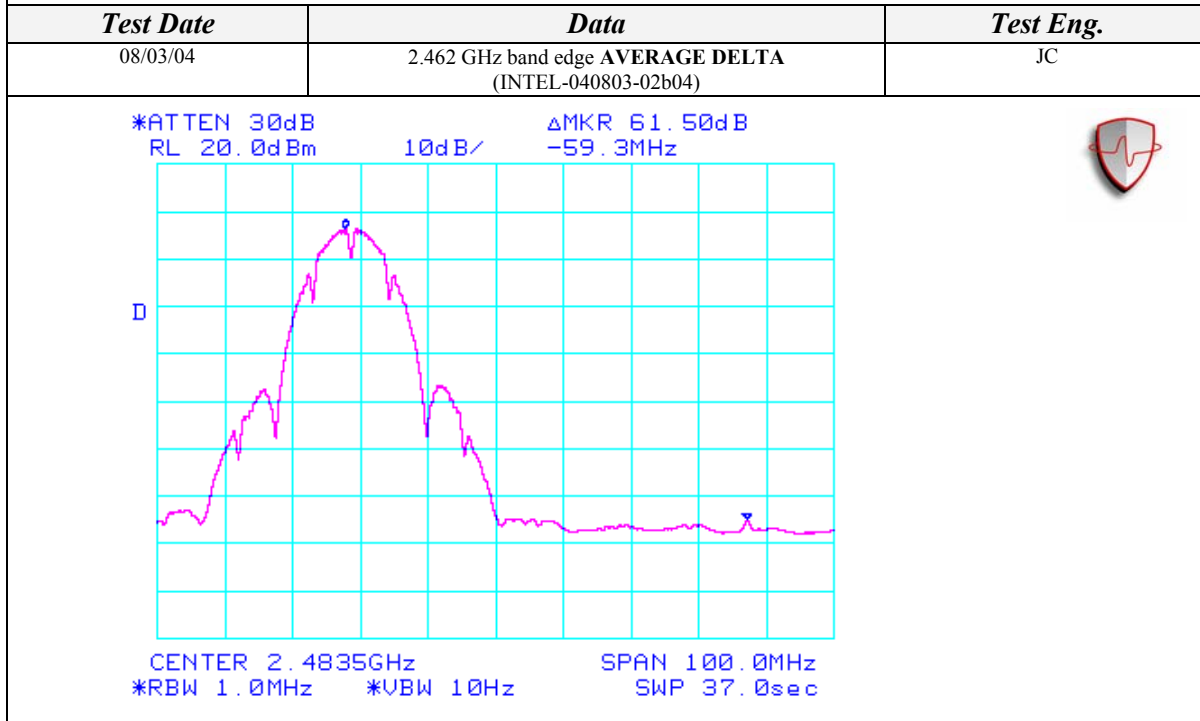
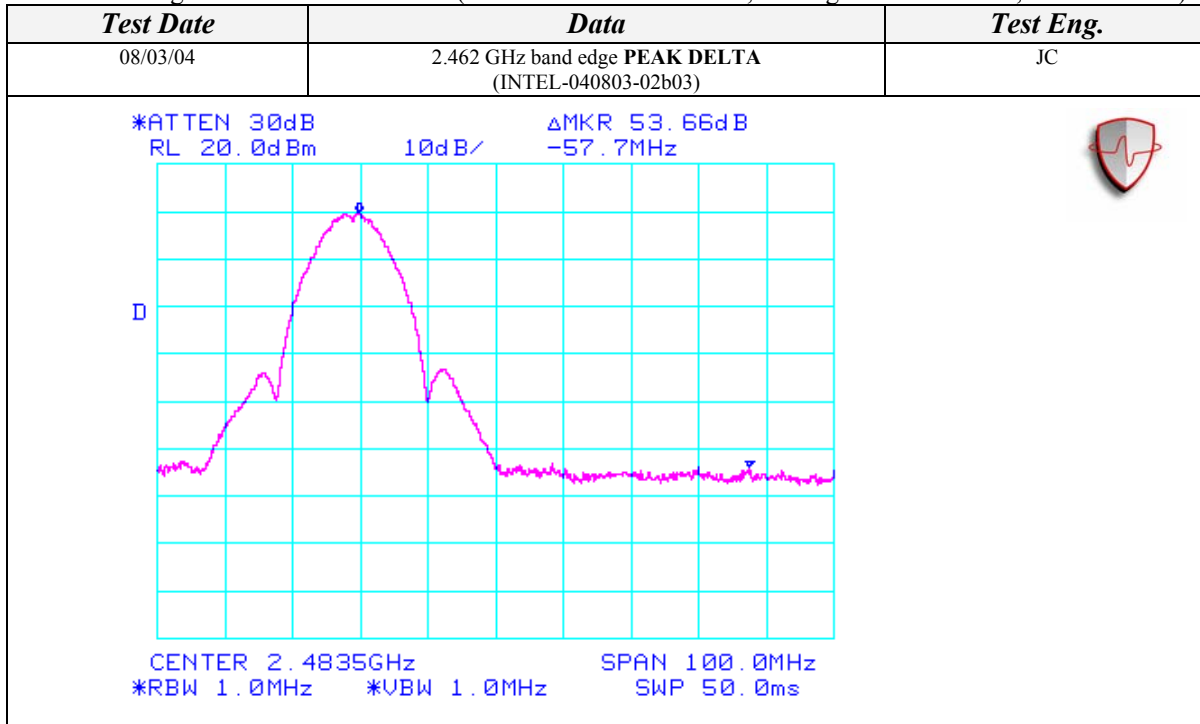



Spurious Radiated Emissions Test Results (Continued)

*Spurious Emissions Measurements in 802.11b mode (2412-2462 MHz)
Channels 1, 6, & 11
Continuous TX at MAIN Antenna port with Fujitsu (Emilia) Antennas
Aegis Labs, Inc. File #: INTEL-040803-11*

RADIATED EMISSIONS - Horizontal Antenna Polarization											
Freq. (MHz)	Meter Reading (dBuV)	Antenna Height (cm)	Azimuth (degrees)	Quasi pk or AVG (dBuV)		1 Meter Distance Factor (dB)	Cable Factor (dB)	Ant. Factor (dB)	Corrected Reading (dBuV)	Limits (dBuV)	Diff (dB) +=FAIL
EUT in Continuous Transmit Mode on Channel 1 (2.412 GHz)											
2312.00	31.67	100	225			9.54	3.23	31.35	56.71	74.00	-17.29
2312.00				14.32	A	9.54	3.23	31.35	39.36	54.00	-14.64
EUT in Continuous Transmit Mode on Channel 6 (2.437 GHz)											
2336.00	31.83	100	225			9.54	3.25	31.29	56.83	74.00	-17.17
2336.00				15.36	A	9.54	3.25	31.29	40.36	54.00	-13.64
EUT in Continuous Transmit Mode on Channel 11 (2.462 GHz)											
2358.66	31.33	100	225			9.54	3.26	31.24	56.29	74.00	-17.71
2358.66				15.86	A	9.54	3.26	31.24	40.82	54.00	-13.18
RADIATED EMISSIONS - Vertical Antenna Polarization											
Freq. (MHz)	Meter Reading (dBuV)	Antenna Height (cm)	Azimuth (degrees)	Quasi pk or AVG (dBuV)		1 Meter Distance Factor (dB)	Cable Factor (dB)	Ant. Factor (dB)	Corrected Reading (dBuV)	Limits (dBuV)	Diff (dB) +=FAIL
EUT in Continuous Transmit Mode on Channel 1 (2.412 GHz)											
2312.00	30.67	100	135			9.54	3.23	31.40	55.76	74.00	-18.24
2312.00				14.10	A	9.54	3.23	31.40	39.19	54.00	-14.81
EUT in Continuous Transmit Mode on Channel 6 (2.437 GHz)											
2336.00	31.83	100	135			9.54	3.25	31.36	56.90	74.00	-17.10
2336.00				14.84	A	9.54	3.25	31.36	39.91	54.00	-14.09
EUT in Continuous Transmit Mode on Channel 11 (2.462 GHz)											
2358.66	32.17	100	135			9.54	3.26	31.33	57.22	74.00	-16.78
2358.66				15.02	A	9.54	3.26	31.33	40.07	54.00	-13.93

NOTE: These spurious emissions measurements were taken without a preamp at a distance on 1 meter to avoid saturating the preamp and analyzer because the signals were close to the fundamental frequency. The readings were extrapolated to 1 meter.



Spurious Radiated Emissions Test Results (Continued)

*Spurious Emissions Measurements in 802.11b mode (2412-2462 MHz)
Channels 1, 6, & 11
Continuous TX at MAIN Antenna port with Fujitsu (Emilia) Antennas
Aegis Labs, Inc. File #: INTEL-040803-12*

RADIATED EMISSIONS - Horizontal Antenna Polarization											
<i>Freq. (MHz)</i>	<i>Meter Reading (dBuV)</i>	<i>Antenna Height (cm)</i>	<i>Azimuth (degrees)</i>	<i>Quasi pk or AVG (dBuV)</i>		<i>Preamp Factor (dB)</i>	<i>Cable Factor (dB)</i>	<i>Ant. Factor (dB)</i>	<i>Corrected Reading (dBuV)</i>	<i>Limits (dBuV)</i>	<i>Diff (dB) +=FAIL</i>
EUT in Continuous Transmit Mode on Channel 1 (2.412 GHz)											
3216.01	49.83	100	135			43.07	3.89	30.24	40.89	84.58	-43.69
4824.00	48.33	100	135			43.27	4.73	34.53	44.32	74.00	-29.68
4824.00				35.79	A	43.27	4.73	34.53	31.78	54.00	-22.22
6431.98	53.33	100	135			43.82	5.73	36.64	51.89	84.58	-32.69
9648.01	50.00	100	135			43.22	6.95	38.88	52.61	84.58	-31.97
12864.03	48.83	100	135			43.83	7.95	43.86	56.82	84.58	-27.76
EUT in Continuous Transmit Mode on Channel 6 (2.437 GHz)											
3249.32	49.50	100	135			43.08	3.91	30.25	40.57	87.54	-46.97
4873.99	48.67	100	135			43.29	4.77	34.72	44.87	74.00	-29.13
4873.99				36.03	A	43.29	4.77	34.72	32.23	54.00	-21.77
6498.69	60.50	100	135			43.84	5.78	36.90	59.33	87.54	-28.21
9747.96	50.17	100	135			43.25	6.99	39.00	52.90	87.54	-34.64
12997.37	49.67	100	135			43.83	8.02	44.29	58.15	87.54	-29.39
EUT in Continuous Transmit Mode on Channel 11 (2.462 GHz)											
3282.69	49.83	100	135			43.10	3.91	30.26	40.90	85.83	-44.93
4924.00	49.67	100	135			43.30	4.81	34.91	46.08	74.00	-27.92
4924.00				39.04	A	43.30	4.81	34.91	35.45	54.00	-18.55
6565.34	57.50	100	135			43.84	5.83	37.32	56.81	85.83	-29.02
9848.01	49.67	100	135			43.29	7.03	39.12	52.53	85.83	-33.30
13130.67	50.17	100	135			43.70	8.07	44.25	58.79	85.83	-27.04



Spurious Radiated Emissions Test Results (Continued)

RADIATED EMISSIONS - Vertical Antenna Polarization											
<i>Freq. (MHz)</i>	<i>Meter Reading (dBuV)</i>	<i>Antenna Height (cm)</i>	<i>Azimuth (degrees)</i>	<i>Quasi pk or AVG (dBuV)</i>		<i>Preamp Factor (dB)</i>	<i>Cable Factor (dB)</i>	<i>Ant. Factor (dB)</i>	<i>Corrected Reading (dBuV)</i>	<i>Limits (dBuV)</i>	<i>Diff (dB) +=FAIL</i>
EUT in Continuous Transmit Mode on Channel 1 (2.412 GHz)											
3216.00	48.50	100	135			43.07	3.89	30.44	39.76	81.54	-41.78
4823.96	49.50	100	135			43.27	4.73	34.53	45.49	74.00	-28.51
4823.96				37.39	A	43.27	4.73	34.53	33.38	54.00	-20.62
6431.95	55.83	100	135			43.82	5.73	36.64	54.39	81.54	-27.15
9647.98	50.17	100	135			43.22	6.95	38.97	52.87	81.54	-28.67
12864.01	49.33	100	135			43.83	7.95	44.23	57.68	81.54	-23.86
EUT in Continuous Transmit Mode on Channel 6 (2.437 GHz)											
3249.32	48.50	100	135			43.08	3.91	30.45	39.77	85.02	-45.25
4874.01	49.67	100	135			43.29	4.77	34.72	45.87	74.00	-28.13
4874.01				37.97	A	43.29	4.77	34.72	34.17	54.00	-19.83
6498.66	55.50	100	135			43.84	5.78	36.89	54.33	85.02	-30.69
9748.04	49.50	100	135			43.25	6.99	39.15	52.38	85.02	-32.64
12997.35	49.83	100	135			43.83	8.02	44.49	58.51	85.02	-26.51
EUT in Continuous Transmit Mode on Channel 11 (2.462 GHz)											
3282.66	50.33	100	135			43.10	3.91	30.46	41.60	85.50	-43.90
4924.00	49.50	100	135			43.30	4.81	34.91	45.91	74.00	-28.09
4924.00				37.28	A	43.30	4.81	34.91	33.69	54.00	-20.31
6565.32	52.83	100	135			43.84	5.83	37.38	52.20	85.50	-33.30
9847.96	49.50	100	135			43.29	7.03	39.33	52.57	85.50	-32.93
13130.63	49.83	100	135			43.70	8.07	44.45	58.65	85.50	-26.85



Spurious Radiated Emissions Test Results (Continued)

*Spurious Emissions Measurements in in802.11b mode (2412-2462 MHz)
 Channels 1, 6, & 11
 Continuous RX at MAIN Antenna port with Fujitsu (Emilia) Antennas
 Aegis Labs, Inc. File #: INTEL-040803-12*

RADIATED EMISSIONS - Horizontal Antenna Polarization											
<i>Freq. (MHz)</i>	<i>Meter Reading (dBuV)</i>	<i>Antenna Height (cm)</i>	<i>Azimuth (degrees)</i>	<i>Quasi pk or AVG (dBuV)</i>		<i>Preamp Factor (dB)</i>	<i>Cable Factor (dB)</i>	<i>Ant. Factor (dB)</i>	<i>Corrected Reading (dBuV)</i>	<i>Limits (dBuV)</i>	<i>Diff (dB) +=FAIL</i>
EUT in Continuous Receive Mode on Channel 1 (2.412 GHz)											
3216.02	49.33	100	225			43.07	3.89	30.24	40.39	80.00	-39.61
3216.02				42.42	A	43.07	3.89	30.24	33.48	60.00	-26.52
6432.00	52.17	100	135			43.82	5.73	36.64	50.73	80.00	-29.27
6432.00				45.04	A	43.82	5.73	36.64	43.60	60.00	-16.40
9648.01	50.33	100	135			43.22	6.95	38.88	52.94	80.00	-27.06
9648.01				38.40	A	43.22	6.95	38.88	41.01	60.00	-18.99
EUT in Continuous Receive Mode on Channel 6 (2.437 GHz)											
3249.32	49.17	100	225			43.08	3.91	30.25	40.24	80.00	-39.76
3249.32				42.19	A	43.08	3.91	30.25	33.26	60.00	-26.74
6498.70	60.33	100	135			43.84	5.78	36.90	59.16	80.00	-20.84
6498.70				57.76	A	43.84	5.78	36.90	56.59	60.00	-3.41
9747.99	49.67	100	135			43.25	6.99	39.00	52.40	80.00	-27.60
9747.99				38.13	A	43.25	6.99	39.00	40.86	60.00	-19.14
EUT in Continuous Receive Mode on Channel 11 (2.462 GHz)											
3282.66	49.00	100	225			43.10	3.91	30.26	40.07	80.00	-39.93
3282.66				41.59	A	43.10	3.91	30.26	32.66	60.00	-27.34
6565.32	57.17	100	135			43.84	5.83	37.32	56.48	80.00	-23.52
6565.32				54.07	A	43.84	5.83	37.32	53.38	60.00	-6.62
9848.01	49.33	100	135			43.29	7.03	39.12	52.19	80.00	-27.81
9848.01				37.50	A	43.29	7.03	39.12	40.36	60.00	-19.64



AEGIS LABS INC.

Spurious Radiated Emissions Test Results (Continued)

RADIATED EMISSIONS - Vertical Antenna Polarization											
<i>Freq. (MHz)</i>	<i>Meter Reading (dBuV)</i>	<i>Antenna Height (cm)</i>	<i>Azimuth (degrees)</i>	<i>Quasi pk or AVG (dBuV)</i>		<i>Preamp Factor (dB)</i>	<i>Cable Factor (dB)</i>	<i>Ant. Factor (dB)</i>	<i>Corrected Reading (dBuV)</i>	<i>Limits (dBuV)</i>	<i>Diff (dB) +=FAIL</i>
EUT in Continuous Receive Mode on Channel 1 (2.412 GHz)											
3216.00	50.00	100	135			43.07	3.89	30.44	41.26	80.00	-38.74
3216.00				42.34	A	43.07	3.89	30.44	33.60	60.00	-26.40
6432.03	57.17	100	135			43.82	5.73	36.64	55.73	80.00	-24.27
6432.03				53.46	A	43.82	5.73	36.64	52.02	60.00	-7.98
9648.02	50.00	100	135			43.22	6.95	38.97	52.70	80.00	-27.30
9648.02				37.63	A	43.22	6.95	38.97	40.33	60.00	-19.67
EUT in Continuous Receive Mode on Channel 6 (2.437 GHz)											
3249.32	48.83	100	135			43.08	3.91	30.45	40.10	80.00	-39.90
3249.32				40.22	A	43.08	3.91	30.45	31.49	60.00	-28.51
6498.67	56.67	100	135			43.84	5.78	36.89	55.50	80.00	-24.50
6498.67				52.49	A	43.84	5.78	36.89	51.32	60.00	-8.68
9748.00	49.50	100	135			43.25	6.99	39.15	52.38	80.00	-27.62
9748.00				37.36	A	43.25	6.99	39.15	40.24	60.00	-19.76
EUT in Continuous Receive Mode on Channel 11 (2.462 GHz)											
3282.67	49.33	100	135			43.10	3.91	30.46	40.60	80.00	-39.40
3282.67				40.89	A	43.10	3.91	30.46	32.16	60.00	-27.84
6565.37	53.00	100	135			43.84	5.83	37.38	52.37	80.00	-27.63
6565.37				47.28	A	43.84	5.83	37.38	46.65	60.00	-13.35
9847.98	49.17	100	135			43.29	7.03	39.33	52.24	80.00	-27.76
9847.98				37.10	A	43.29	7.03	39.33	40.17	60.00	-19.83



AEGIS LABS INC.

Spurious Radiated Emissions Test Results (Continued)

CLIENT:	Intel Corporation	DATE:	08/06/04
EUT:	Intel PRO/Wireless 2915ABG Network Connection	PROJECT NUMBER:	INTEL-040803
MODEL NUMBER:	WM3B2915ABG	TEST ENGINEER:	JC
SERIAL NUMBER:	344F96244ABC51962012	SITE #:	2
CONFIGURATION:	Tested installed in the Hewlett Packard host computer's mini PCI slot in 802.11g (2412-2462 MHz) mode with the Fujitsu (Emilia) antennas.	TEMPERATURE:	29 C
		HUMIDITY:	33% RH
		TIME:	11:00 AM

Standard:	FCC CFR 47, Part 15.247(c)
Description:	Radiated emissions, which fall in the restricted bands, as defined in Sec. 15.205(a), must also comply with the radiated emission limits specified in Sec. 15.209(a). All others must be < -20dBc.
Results:	Passes (See Data Sheets)

Unwanted Spurious Emissions Limits			
Frequency (MHz)	Field Strength (uV/m)	Field Strength (dBuV/m) (Emissions in the restricted bands)	Field Strength (dBm/MHz) (Emissions outside the restricted bands)
Above 960	500	54.00 (Average) 74.00 (Peak)	< -20 dBc

Page 79 of 119 (Appendix A)
Report Number: INTEL-040831F
FCC ID: PD9WM3B2915ABG



Spurious Radiated Emissions Test Results (Continued)

*Fundamental Measurements in 802.11g mode (2412-2462 MHz)
Channels 1, 6, & 11
Continuous TX at MAIN Antenna port with Fujitsu (Emilia) Antennas
Aegis Labs, Inc. File #: INTEL-040803-10*

RADIATED EMISSIONS - Horizontal Antenna Polarization											
<i>Freq. (MHz)</i>	<i>Meter Reading (dBuV)</i>	<i>Antenna Height (cm)</i>	<i>Azimuth (degrees)</i>	<i>Quasi pk or AVG (dBuV)</i>		<i>Preamp Factor (dB)</i>	<i>Cable Factor (dB)</i>	<i>Ant. Factor (dB)</i>	<i>Corrected Reading (dBuV)</i>	<i>Limits (dBuV)</i>	<i>Diff (dB) +=FAIL</i>
2412.00	73.50	100	225				3.30	31.11	107.91		
2412.00				63.10	A		3.30	31.11	97.51		
2437.00	74.83	100	225				3.32	31.05	109.20		
2437.00				64.17	A		3.32	31.05	98.54		
2462.00	72.83	100	225				3.34	30.99	107.16		
2462.00				62.44	A		3.34	30.99	96.77		

RADIATED EMISSIONS – Vertical Antenna Polarization											
<i>Freq. (MHz)</i>	<i>Meter Reading (dBuV)</i>	<i>Antenna Height (cm)</i>	<i>Azimuth (degrees)</i>	<i>Quasi pk or AVG (dBuV)</i>		<i>Preamp Factor (dB)</i>	<i>Cable Factor (dB)</i>	<i>Ant. Factor (dB)</i>	<i>Corrected Reading (dBuV)</i>	<i>Limits (dBuV)</i>	<i>Diff (dB) +=FAIL</i>
2412.00	72.50	125	270				3.30	31.24	107.04		
2412.00				62.22	A		3.30	31.24	96.76		
2437.00	72.00	125	270				3.32	31.20	106.52		
2437.00				61.69	A		3.32	31.20	96.21		
2462.00	72.33	125	270				3.34	31.16	106.83		
2462.00				61.75	A		3.34	31.16	96.25		

NOTE: Fundamental signals measured to calculate the band edge field strengths using the “Marker Delta Method”.



Spurious Radiated Emissions Test Results (Continued)

*Band Edge Field Strength Measurements in 802.11g mode (2412-2462 MHz)
 Channels 1, 6, & 11
 Continuous TX at MAIN Antenna port with Fujitsu (Emilia) Antennas
 Aegis Labs, Inc. File #: INTEL-040803-10*

RADIATED EMISSIONS - Horizontal Antenna Polarization										
Freq. (MHz)	Meter Reading (dBuV)	Antenna Height (cm)	Azimuth (degrees)	Quasi pk or AVG (dBuV)	Preamp Factor (dB)	Cable Factor (dB)	Ant. Factor (dB)	Corrected Reading (dBuV)	Limits (dBuV)	Diff (dB) +=FAIL
2390.00								61.57	74.00	-12.43
2390.00								46.84	54.00	-7.16
2400.00	50.00	100	225			3.29	31.14	84.43	87.91	-3.48
2483.50								62.66	74.00	-11.34
2483.50								45.77	54.00	-8.23

RADIATED EMISSIONS – Vertical Antenna Polarization										
Freq. (MHz)	Meter Reading (dBuV)	Antenna Height (cm)	Azimuth (degrees)	Quasi pk or AVG (dBuV)	Preamp Factor (dB)	Cable Factor (dB)	Ant. Factor (dB)	Corrected Reading (dBuV)	Limits (dBuV)	Diff (dB) +=FAIL
2390.00								60.70	74.00	-13.30
2390.00								46.09	54.00	-7.91
2400.00	48.67	125	270			3.29	31.26	83.22	87.04	-3.82
2483.50								62.33	74.00	-11.67
2483.50								45.25	54.00	-8.75

NOTE: The “Band Edge Field Strength” was calculated using the “Fundamental” and “Conducted Band Edge” measurements per the “Marker-Delta Method” with the following formula:

$$BE = Fm - \Delta m$$

Where

BE = Band Edge Field Strength

Fm = Measured Fundamental (Peak or Average)

Δm = Measured Conducted Band Edge Delta (Peak or Average)



Spurious Radiated Emissions Test Results (Continued)

Plots Showing Out-Of-Band Emissions (Peak RBW=VBW=1MHz; Average RBW = 1MHz, VBW = 10Hz)

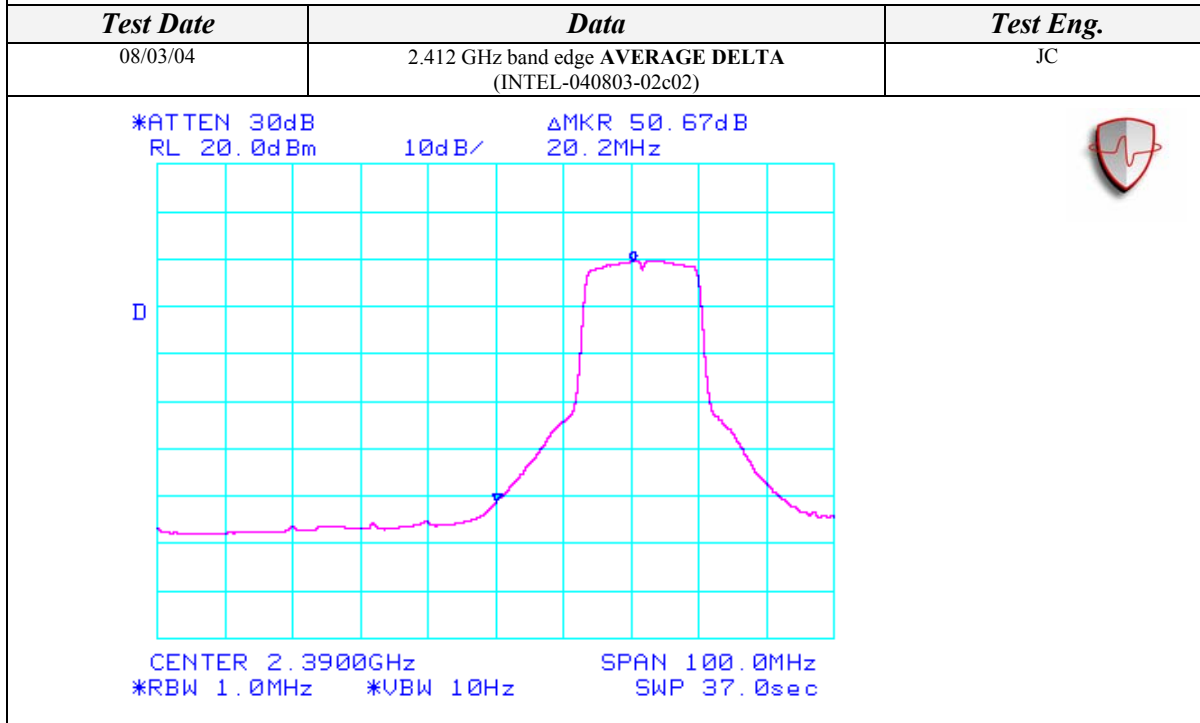
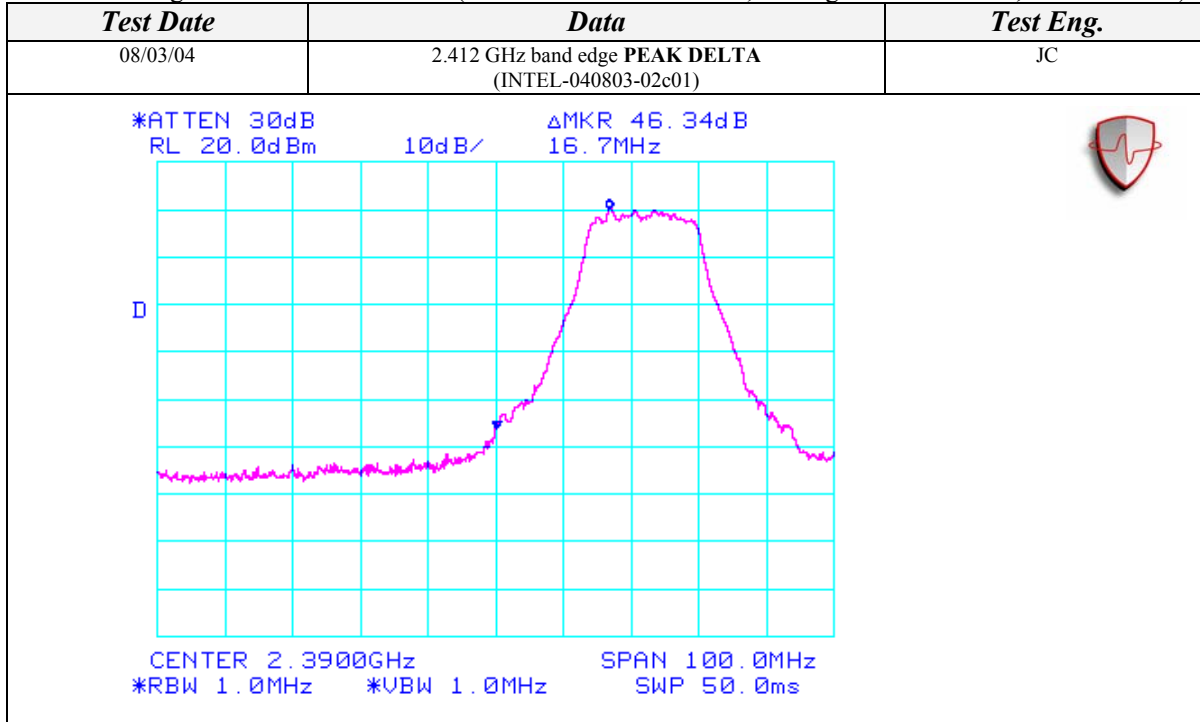



Spurious Radiated Emissions Test Results (Continued)

*Spurious Emissions Measurements in 802.11g mode (2412-2462 MHz)
Channels 1, 6, & 11
Continuous TX at MAIN Antenna port with Fujitsu (Emilia) Antennas
Aegis Labs, Inc. File #: INTEL-040803-11*

RADIATED EMISSIONS - Horizontal Antenna Polarization											
Freq. (MHz)	Meter Reading (dBuV)	Antenna Height (cm)	Azimuth (degrees)	Quasi pk or AVG (dBuV)		1 Meter Distance Factor (dB)	Cable Factor (dB)	Ant. Factor (dB)	Corrected Reading (dBuV)	Limits (dBuV)	Diff (dB) +=FAIL
EUT in Continuous Transmit Mode on Channel 1 (2.412 GHz)											
2312.00	31.50	100	225			9.54	3.23	31.35	56.54	74.00	-17.46
2312.00				16.38	A	9.54	3.23	31.35	41.42	54.00	-12.58
EUT in Continuous Transmit Mode on Channel 6 (2.437 GHz)											
2336.00	32.33	100	225			9.54	3.25	31.29	57.33	74.00	-16.67
2336.00				17.96	A	9.54	3.25	31.29	42.96	54.00	-11.04
EUT in Continuous Transmit Mode on Channel 11 (2.462 GHz)											
2358.66	32.00	100	225			9.54	3.26	31.24	56.96	74.00	-17.04
2358.66				17.24	A	9.54	3.26	31.24	42.20	54.00	-11.80
RADIATED EMISSIONS - Vertical Antenna Polarization											
Freq. (MHz)	Meter Reading (dBuV)	Antenna Height (cm)	Azimuth (degrees)	Quasi pk or AVG (dBuV)		1 Meter Distance Factor (dB)	Cable Factor (dB)	Ant. Factor (dB)	Corrected Reading (dBuV)	Limits (dBuV)	Diff (dB) +=FAIL
EUT in Continuous Transmit Mode on Channel 1 (2.412 GHz)											
2312.00	31.67	100	135			9.54	3.23	31.40	56.76	74.00	-17.24
2312.00				15.96	A	9.54	3.23	31.40	41.05	54.00	-12.95
EUT in Continuous Transmit Mode on Channel 6 (2.437 GHz)											
2336.00	31.83	100	135			9.54	3.25	31.36	56.90	74.00	-17.10
2336.00				16.26	A	9.54	3.25	31.36	41.33	54.00	-12.67
EUT in Continuous Transmit Mode on Channel 11 (2.462 GHz)											
2358.68	31.67	100	135			9.54	3.26	31.33	56.72	74.00	-17.28
2358.68				15.81	A	9.54	3.26	31.33	40.86	54.00	-13.14

NOTE: These spurious emissions measurements were taken without a preamp at a distance on 1 meter to avoid saturating the preamp and analyzer because the signals were close to the fundamental frequency. The readings were extrapolated to 1 meter.



Spurious Radiated Emissions Test Results (Continued)

*Spurious Emissions Measurements in 802.11g mode (2412-2462 MHz)
Channels 1, 6, & 11
Continuous TX at MAIN Antenna port with Fujitsu (Emilia) Antennas
Aegis Labs, Inc. File #: INTEL-040803-12*

RADIATED EMISSIONS - Horizontal Antenna Polarization											
<i>Freq. (MHz)</i>	<i>Meter Reading (dBuV)</i>	<i>Antenna Height (cm)</i>	<i>Azimuth (degrees)</i>	<i>Quasi pk or AVG (dBuV)</i>		<i>Preamp Factor (dB)</i>	<i>Cable Factor (dB)</i>	<i>Ant. Factor (dB)</i>	<i>Corrected Reading (dBuV)</i>	<i>Limits (dBuV)</i>	<i>Diff (dB) +=FAIL</i>
EUT in Continuous Transmit Mode on Channel 1 (2.412 GHz)											
3216.00	48.33	100	135			43.07	3.89	30.24	39.39	87.91	-48.52
4824.20	48.67	100	135			43.27	4.73	34.53	44.67	74.00	-29.33
4824.20				35.49	A	43.27	4.73	34.53	31.49	54.00	-22.51
6432.05	59.83	100	135			43.82	5.73	36.64	58.39	87.91	-29.52
9647.97	49.83	100	135			43.22	6.95	38.88	52.44	87.91	-35.47
12864.02	49.67	100	135			43.83	7.95	43.86	57.66	87.91	-30.25
EUT in Continuous Transmit Mode on Channel 6 (2.437 GHz)											
3249.37	49.17	100	135			43.08	3.91	30.25	40.24	89.20	-48.96
4874.06	48.00	100	135			43.29	4.77	34.72	44.20	74.00	-29.80
4874.06				35.98	A	43.29	4.77	34.72	32.18	54.00	-21.82
6498.69	59.67	100	135			43.84	5.78	36.90	58.50	89.20	-30.70
9748.09	49.67	100	135			43.25	6.99	39.00	52.40	89.20	-36.80
12997.35	49.83	100	135			43.83	8.02	44.29	58.31	89.20	-30.89
EUT in Continuous Transmit Mode on Channel 11 (2.462 GHz)											
3282.68	50.33	100	135			43.10	3.91	30.26	41.40	87.16	-45.76
4923.82	48.50	100	135			43.30	4.81	34.91	44.91	74.00	-29.09
4923.82				36.39	A	43.30	4.81	34.91	32.80	54.00	-21.20
6565.42	55.00	100	135			43.84	5.83	37.32	54.31	87.16	-32.85
9847.97	49.67	100	135			43.29	7.03	39.12	52.53	87.16	-34.63
13130.70	49.67	100	135			43.70	8.07	44.25	58.29	87.16	-28.87



Spurious Radiated Emissions Test Results (Continued)

RADIATED EMISSIONS - Vertical Antenna Polarization											
<i>Freq. (MHz)</i>	<i>Meter Reading (dBuV)</i>	<i>Antenna Height (cm)</i>	<i>Azimuth (degrees)</i>	<i>Quasi pk or AVG (dBuV)</i>		<i>Preamp Factor (dB)</i>	<i>Cable Factor (dB)</i>	<i>Ant. Factor (dB)</i>	<i>Corrected Reading (dBuV)</i>	<i>Limits (dBuV)</i>	<i>Diff (dB) +=FAIL</i>
EUT in Continuous Transmit Mode on Channel 1 (2.412 GHz)											
3216.01	49.50	100	135			43.07	3.89	30.44	40.76	87.04	-46.28
4823.97	48.33	100	135			43.27	4.73	34.53	44.32	74.00	-29.68
4823.97				36.29	A	43.27	4.73	34.53	32.28	54.00	-21.72
6432.01	56.17	100	135			43.82	5.73	36.64	54.73	87.04	-32.31
9648.03	49.67	100	135			43.22	6.95	38.97	52.37	87.04	-34.67
12863.98	49.00	100	135			43.83	7.95	44.23	57.35	87.04	-29.69
EUT in Continuous Transmit Mode on Channel 6 (2.437 GHz)											
3249.35	48.50	100	135			43.08	3.91	30.45	39.77	86.52	-46.75
4874.03	48.00	100	135			43.29	4.77	34.72	44.20	74.00	-29.80
4874.03				36.19	A	43.29	4.77	34.72	32.39	54.00	-21.61
6498.67	53.50	100	135			43.84	5.78	36.89	52.33	86.52	-34.19
9748.00	49.50	100	135			43.25	6.99	39.15	52.38	86.52	-34.14
12997.30	50.17	100	135			43.83	8.02	44.49	58.85	86.52	-27.67
EUT in Continuous Transmit Mode on Channel 11 (2.462 GHz)											
3282.65	49.50	100	135			43.10	3.91	30.46	40.77	86.83	-46.06
4924.01	48.50	100	135			43.30	4.81	34.91	44.91	74.00	-29.09
4924.01				36.59	A	43.30	4.81	34.91	33.00	54.00	-21.00
6565.34	53.67	100	135			43.84	5.83	37.38	53.04	86.83	-33.79
9848.02	49.33	100	135			43.29	7.03	39.33	52.40	86.83	-34.43
13130.62	49.50	100	135			43.70	8.07	44.45	58.32	86.83	-28.51



Spurious Radiated Emissions Test Results (Continued)

*Spurious Emissions Measurements in 802.11g mode (2412-2462 MHz)
Channels 1, 6, & 11
Continuous RX at MAIN Antenna port with Fujitsu (Emilia) Antennas
Aegis Labs, Inc. File #: INTEL-040803-12*

RADIATED EMISSIONS - Horizontal Antenna Polarization											
<i>Freq. (MHz)</i>	<i>Meter Reading (dBuV)</i>	<i>Antenna Height (cm)</i>	<i>Azimuth (degrees)</i>	<i>Quasi pk or AVG (dBuV)</i>		<i>Preamp Factor (dB)</i>	<i>Cable Factor (dB)</i>	<i>Ant. Factor (dB)</i>	<i>Corrected Reading (dBuV)</i>	<i>Limits (dBuV)</i>	<i>Diff (dB) +=FAIL</i>
EUT in Continuous Receive Mode on Channel 1 (2.412 GHz)											
3216.00	49.67	100	135			43.07	3.89	30.24	40.73	80.00	-39.27
3216.00				41.65	A	43.07	3.89	30.24	32.71	60.00	-27.29
6431.98	59.17	100	135			43.82	5.73	36.64	57.73	80.00	-22.27
6431.98				56.49	A	43.82	5.73	36.64	55.05	60.00	-4.95
9647.99	50.83	100	135			43.22	6.95	38.88	53.44	80.00	-26.56
9647.99				38.24	A	43.22	6.95	38.88	40.85	60.00	-19.15
EUT in Continuous Receive Mode on Channel 6 (2.437 GHz)											
3249.32	50.33	100	135			43.08	3.91	30.25	41.40	80.00	-38.60
3249.32				42.94	A	43.08	3.91	30.25	34.01	60.00	-25.99
6498.67	60.33	100	135			43.84	5.78	36.89	59.16	80.00	-20.84
6498.67				57.59	A	43.84	5.78	36.89	56.42	60.00	-3.58
9748.03	50.00	100	135			43.25	6.99	39.00	52.73	80.00	-27.27
9748.03				38.10	A	43.25	6.99	39.00	40.83	60.00	-19.17
EUT in Continuous Receive Mode on Channel 11 (2.462 GHz)											
3282.66	49.33	100	135			43.10	3.91	30.26	40.40	80.00	-39.60
3282.66				39.77	A	43.10	3.91	30.26	30.84	60.00	-29.16
6565.32	57.33	100	135			43.84	5.83	37.32	56.64	80.00	-23.36
6565.32				54.25	A	43.84	5.83	37.32	53.56	60.00	-6.44
9848.03	50.00	100	135			43.29	7.03	39.12	52.86	80.00	-27.14
9848.03				38.62	A	43.29	7.03	39.12	41.48	60.00	-18.52



Spurious Radiated Emissions Test Results (Continued)

RADIATED EMISSIONS - Vertical Antenna Polarization											
<i>Freq. (MHz)</i>	<i>Meter Reading (dBuV)</i>	<i>Antenna Height (cm)</i>	<i>Azimuth (degrees)</i>	<i>Quasi pk or AVG (dBuV)</i>		<i>Preamp Factor (dB)</i>	<i>Cable Factor (dB)</i>	<i>Ant. Factor (dB)</i>	<i>Corrected Reading (dBuV)</i>	<i>Limits (dBuV)</i>	<i>Diff (dB) +=FAIL</i>
EUT in Continuous Receive Mode on Channel 1 (2.412 GHz)											
3216.00	49.50	100	135			43.07	3.89	30.44	40.76	80.00	-39.24
3216.00				42.12	A	43.07	3.89	30.44	33.38	60.00	-26.62
6432.01	55.83	100	135			43.82	5.73	36.64	54.39	80.00	-25.61
6432.01				51.33	A	43.82	5.73	36.64	49.89	60.00	-10.11
9648.00	49.83	100	135			43.22	6.95	38.97	52.53	80.00	-27.47
9648.00				37.26	A	43.22	6.95	38.97	39.96	60.00	-20.04
EUT in Continuous Receive Mode on Channel 6 (2.437 GHz)											
3249.33	50.33	100	135			43.08	3.91	30.45	41.60	80.00	-38.40
3249.33				41.35	A	43.08	3.91	30.45	32.62	60.00	-27.38
6498.69	56.17	100	135			43.84	5.78	36.90	55.00	80.00	-25.00
6498.69				51.57	A	43.84	5.78	36.90	50.40	60.00	-9.60
9748.03	49.50	100	135			43.25	6.99	39.15	52.38	80.00	-27.62
9748.03				37.37	A	43.25	6.99	39.15	40.25	60.00	-19.75
EUT in Continuous Receive Mode on Channel 11 (2.462 GHz)											
3282.67	48.67	100	135			43.10	3.91	30.46	39.94	80.00	-40.06
3282.67				40.94	A	43.10	3.91	30.46	32.21	60.00	-27.79
6565.34	52.17	100	135			43.84	5.83	37.38	51.54	80.00	-28.46
6565.34				45.99	A	43.84	5.83	37.38	45.36	60.00	-14.64
9848.04	49.67	100	135			43.29	7.03	39.33	52.74	80.00	-27.26
9848.04				37.15	A	43.29	7.03	39.33	40.22	60.00	-19.78



AEGIS LABS INC.

Spurious Radiated Emissions Test Results (Continued)

CLIENT:	Intel Corporation	DATE:	08/31/04
EUT:	Intel PRO/Wireless 2915ABG Network Connection	PROJECT NUMBER:	INTEL-040831
MODEL NUMBER:	WM3B2915ABG	TEST ENGINEER:	JC
SERIAL NUMBER:	344F96244ABC51962012	SITE #:	2
CONFIGURATION:	Tested installed in the Hewlett Packard host computer's mini PCI slot in 802.11a (5745-5825 MHz) mode with the Foxconn (Jakarta) antennas.	TEMPERATURE:	33 C
		HUMIDITY:	27% RH
		TIME:	11:45 AM

Standard:	FCC CFR 47, Part 15.247(c)
Description:	Radiated emissions, which fall in the restricted bands, as defined in Sec. 15.205(a), must also comply with the radiated emission limits specified in Sec. 15.209(a). All others must be < -20dBc.
Results:	Passes (See Data Sheets)

Unwanted Spurious Emissions Limits

Frequency (MHz)	Field Strength (uV/m)	Field Strength (dBuV/m) (Emissions in the restricted bands)	Field Strength (dBm/MHz) (Emissions outside the restricted bands)
Above 960	500	54.00 (Average) 74.00 (Peak)	< -20 dBc

Page 89 of 119 (Appendix A)
Report Number: INTEL-040831F
FCC ID: PD9WM3B2915ABG



Spurious Radiated Emissions Test Results (Continued)

*Fundamental Measurements in 802.11a mode (5745-5825 MHz)
 Channels 149, 157, & 169
 Continuous TX at MAIN Antenna port with Foxconn (Jakarta) Antennas
 Aegis Labs, Inc. File #: INTEL-040831-02*

RADIATED EMISSIONS - Horizontal Antenna Polarization											
<i>Freq. (MHz)</i>	<i>Meter Reading (dBuV)</i>	<i>Antenna Height (cm)</i>	<i>Azimuth (degrees)</i>	<i>Quasi pk or AVG (dBuV)</i>		<i>Preamp Factor (dB)</i>	<i>Cable Factor (dB)</i>	<i>Ant. Factor (dB)</i>	<i>Corrected Reading (dBuV)</i>	<i>Limits (dBuV)</i>	<i>Diff (dB) +=FAIL</i>
5745.00	64.17	100	135				5.25	34.85	104.26		
5745.00				54.80	A		5.25	34.85	94.89		
5785.00	62.00	100	135				5.27	34.87	102.14		
5785.00				52.41	A		5.27	34.87	92.55		
5825.00	62.83	100	135				5.30	34.90	103.03		
5825.00				53.46	A		5.30	34.90	93.66		

RADIATED EMISSIONS – Vertical Antenna Polarization											
<i>Freq. (MHz)</i>	<i>Meter Reading (dBuV)</i>	<i>Antenna Height (cm)</i>	<i>Azimuth (degrees)</i>	<i>Quasi pk or AVG (dBuV)</i>		<i>Preamp Factor (dB)</i>	<i>Cable Factor (dB)</i>	<i>Ant. Factor (dB)</i>	<i>Corrected Reading (dBuV)</i>	<i>Limits (dBuV)</i>	<i>Diff (dB) +=FAIL</i>
5745.00	68.33	100	135				5.25	34.85	108.42		
5745.00				58.86	A		5.25	34.85	98.95		
5785.00	67.00	100	135				5.27	34.87	107.14		
5785.00				57.91	A		5.27	34.87	98.05		
5825.00	66.33	100	135				5.30	34.90	106.53		
5825.00				57.06	A		5.30	34.90	97.26		



Spurious Radiated Emissions Test Results (Continued)

*Band Edge Field Strength Measurements in 802.11a mode (5745-5825 MHz)
 Channels 149, 157, & 169
 Continuous TX at MAIN Antenna port with Foxconn (Jakarta) Antennas
 Aegis Labs, Inc. File #: INTEL-040831-02*

RADIATED EMISSIONS - Horizontal Antenna Polarization

<i>Freq. (MHz)</i>	<i>Meter Reading (dBuV)</i>	<i>Antenna Height (cm)</i>	<i>Azimuth (degrees)</i>	<i>Quasi pk or AVG (dBuV)</i>	<i>Preamp Factor (dB)</i>	<i>Cable Factor (dB)</i>	<i>Ant. Factor (dB)</i>	<i>Corrected Reading (dBuV)</i>	<i>Limits (dBuV)</i>	<i>Diff (dB) +=FAIL</i>
5725.00	35.83	100	135			5.23	34.84	75.90	84.26	-8.37
5850.00	30.67	100	135			5.32	34.91	70.90	83.03	-12.13

RADIATED EMISSIONS – Vertical Antenna Polarization

<i>Freq. (MHz)</i>	<i>Meter Reading (dBuV)</i>	<i>Antenna Height (cm)</i>	<i>Azimuth (degrees)</i>	<i>Quasi pk or AVG (dBuV)</i>	<i>Preamp Factor (dB)</i>	<i>Cable Factor (dB)</i>	<i>Ant. Factor (dB)</i>	<i>Corrected Reading (dBuV)</i>	<i>Limits (dBuV)</i>	<i>Diff (dB) +=FAIL</i>
5725.00	38.83	100	135			5.23	34.84	78.90	88.42	-9.53
5850.00	31.67	100	135			5.32	34.91	71.90	86.53	-14.63



Spurious Radiated Emissions Test Results (Continued)

Plots Showing Out-Of-Band Emissions (Peak RBW=VBW=1MHz; Average RBW = 1MHz, VBW = 10Hz)

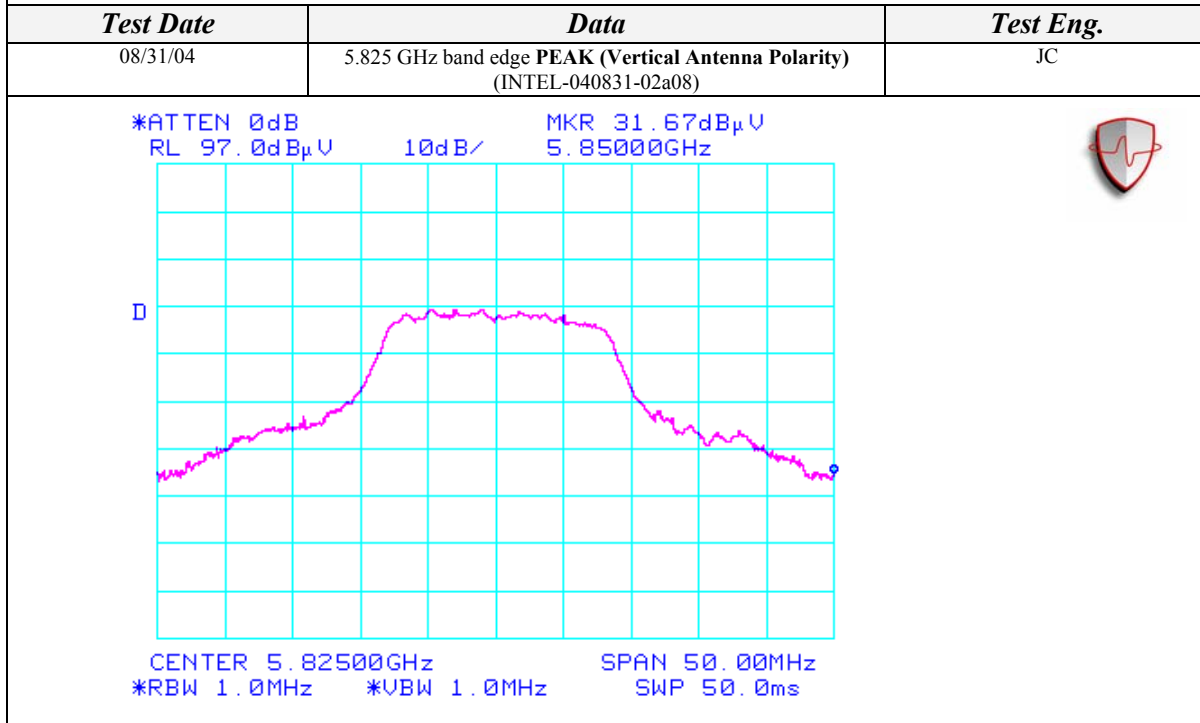
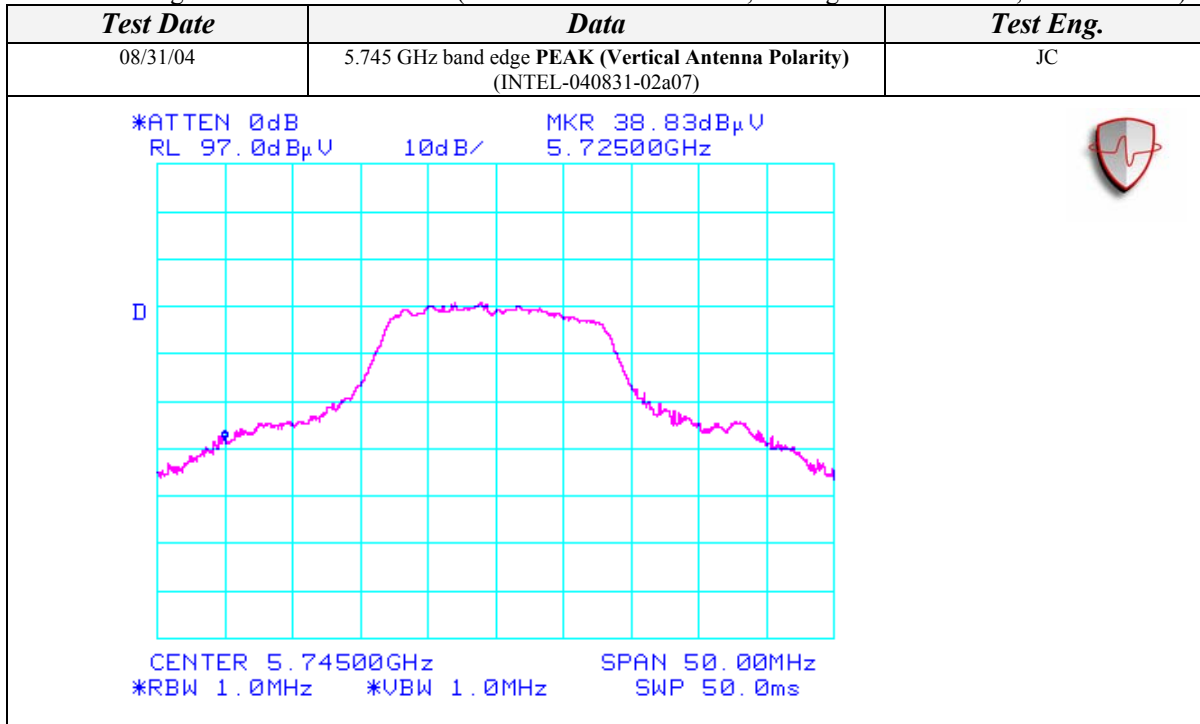



Spurious Radiated Emissions Test Results (Continued)

*Spurious Emissions Measurements in 802.11a mode (5745-5825 MHz)
Channels 149, 157, & 169
Continuous TX at MAIN Antenna port with Foxconn (Jakarta) Antennas
Aegis Labs, Inc. File #: INTEL-040831-04*

RADIATED EMISSIONS - Horizontal Antenna Polarization											
<i>Freq. (MHz)</i>	<i>Meter Reading (dBuV)</i>	<i>Antenna Height (cm)</i>	<i>Azimuth (degrees)</i>	<i>Quasi pk or AVG (dBuV)</i>		<i>Preamp Factor (dB)</i>	<i>Cable Factor (dB)</i>	<i>Ant. Factor (dB)</i>	<i>Corrected Reading (dBuV)</i>	<i>Limits (dBuV)</i>	<i>Diff (dB) +=FAIL</i>
EUT in Continuous Transmit Mode on Channel 149 (5.745 GHz)											
3830.00	56.50	100	225			43.17	4.18	31.16	48.67	74.00	-25.33
3830.00				52.41	A	43.17	4.18	31.16	44.58	54.00	-9.42
7660.00	52.17	100	135			43.62	6.27	40.05	54.87	74.00	-19.13
7660.00				43.59	A	43.62	6.27	40.05	46.29	54.00	-7.71
11490.00	50.33	100	135			43.50	7.64	41.18	55.65	74.00	-18.35
11490.00				39.86	A	43.50	7.64	41.18	45.18	54.00	-8.82
15320.00	48.83	100	135			43.39	8.80	41.49	55.73	84.26	-28.53
EUT in Continuous Transmit Mode on Channel 157 (5.785 GHz)											
3856.66	58.83	100	225			43.17	4.21	31.23	51.09	74.00	-22.91
3856.66				55.57	A	43.17	4.21	31.23	47.83	54.00	-6.17
7713.33	54.00	100	135			43.60	6.29	40.20	56.89	74.00	-17.11
7713.33				47.06	A	43.60	6.29	40.20	49.95	54.00	-4.05
11569.98	50.83	100	135			43.48	7.66	41.38	56.40	74.00	-17.60
11569.98				40.45	A	43.48	7.66	41.38	46.02	54.00	-7.98
15426.58	49.50	100	135			43.35	8.80	41.56	56.51	74.00	-17.49
15426.58				38.10		43.35	8.80	41.56	45.11	54.00	-8.89
EUT in Continuous Transmit Mode on Channel 165 (5.825 GHz)											
3883.34	61.83	100	225			43.17	4.23	31.30	54.18	74.00	-19.82
3883.34				59.43	A	43.17	4.23	31.30	51.78	54.00	-2.22
7766.66	53.83	100	135			43.58	6.32	40.35	56.91	83.03	-26.12
11650.00	49.83	100	135			43.45	7.69	41.59	55.66	74.00	-18.34
11650.00				38.96	A	43.45	7.69	41.59	44.79	54.00	-9.21
15533.23	49.50	100	135			43.35	8.82	41.71	56.68	74.00	-17.32
15533.23				37.89	A	43.35	8.82	41.71	45.07	54.00	-8.93



Spurious Radiated Emissions Test Results (Continued)

RADIATED EMISSIONS - Vertical Antenna Polarization											
<i>Freq. (MHz)</i>	<i>Meter Reading (dBuV)</i>	<i>Antenna Height (cm)</i>	<i>Azimuth (degrees)</i>	<i>Quasi pk or AVG (dBuV)</i>		<i>Preamp Factor (dB)</i>	<i>Cable Factor (dB)</i>	<i>Ant. Factor (dB)</i>	<i>Corrected Reading (dBuV)</i>	<i>Limits (dBuV)</i>	<i>Diff (dB) +=FAIL</i>
EUT in Continuous Transmit Mode on Channel 149 (5.745 GHz)											
3830.00	54.67	100	135			43.17	4.18	31.09	46.78	74.00	-27.22
3830.00				49.42	A	43.17	4.18	31.09	41.53	54.00	-12.47
7660.00	51.00	100	135			43.62	6.27	40.11	53.77	74.00	-20.23
7660.00				41.29	A	43.62	6.27	40.11	44.06	54.00	-9.94
11490.00	50.50	100	135			43.50	7.64	41.66	56.30	74.00	-17.70
11490.00				40.22	A	43.50	7.64	41.66	46.02	54.00	-7.98
EUT in Continuous Transmit Mode on Channel 157 (5.785 GHz)											
3856.66	57.17	100	135			43.17	4.21	31.14	49.35	74.00	-24.65
3856.66				53.58	A	43.17	4.21	31.14	45.76	54.00	-8.24
7713.33	52.33	100	135			43.60	6.29	40.28	55.31	74.00	-18.69
7713.33				43.83	A	43.60	6.29	40.28	46.81	54.00	-7.19
11569.98	49.33	100	135			43.48	7.66	41.81	55.33	74.00	-18.67
11569.98				38.89	A	43.48	7.66	41.81	44.89	54.00	-9.11
EUT in Continuous Transmit Mode on Channel 165 (5.825 GHz)											
3883.33	59.33	100	315			43.17	4.23	31.19	51.58	74.00	-22.42
3883.33				56.58	A	43.17	4.23	31.19	48.83	54.00	-5.17
7766.66	54.17	100	135			43.58	6.32	40.45	57.36	86.53	-29.17
11650.00	49.83	100	135			43.45	7.69	41.94	56.01	74.00	-17.99
11650.00				38.75	A	43.45	7.69	41.94	44.93	54.00	-9.07



Spurious Radiated Emissions Test Results (Continued)

*Spurious Emissions Measurements in 802.11a mode (5745-5825 MHz)
 Channels 149, 157, & 169
 Continuous RX at MAIN Antenna port with Foxconn (Jakarta) Antennas
 Aegis Labs, Inc. File #: INTEL-040831-04*

RADIATED EMISSIONS - Horizontal Antenna Polarization											
<i>Freq. (MHz)</i>	<i>Meter Reading (dBuV)</i>	<i>Antenna Height (cm)</i>	<i>Azimuth (degrees)</i>	<i>Quasi pk or AVG (dBuV)</i>		<i>Preamp Factor (dB)</i>	<i>Cable Factor (dB)</i>	<i>Ant. Factor (dB)</i>	<i>Corrected Reading (dBuV)</i>	<i>Limits (dBuV)</i>	<i>Diff (dB) +=FAIL</i>
EUT in Continuous Receive Mode on Channel 149 (5.745 GHz)											
3830.00	49.50	100	135			43.17	4.18	31.16	41.67	80.00	-38.33
3830.00				39.43	A	43.17	4.18	31.16	31.60	60.00	-28.40
7660.00	52.83	100	135			43.62	6.27	40.05	55.53	80.00	-24.47
7660.00				45.89	A	43.62	6.27	40.05	48.59	60.00	-11.41
11489.92	49.33	100	135			43.50	7.64	41.18	54.65	80.00	-25.35
11489.92				39.76	A	43.50	7.64	41.18	45.08	60.00	-14.92
EUT in Continuous Receive Mode on Channel 157 (5.785 GHz)											
3856.62	50.67	100	135			43.17	4.21	31.23	42.93	80.00	-37.07
3856.62				41.46	A	43.17	4.21	31.23	33.72	60.00	-26.28
7713.32	53.00	100	135			43.60	6.29	40.20	55.89	80.00	-24.11
7713.32				46.29	A	43.60	6.29	40.20	49.18	60.00	-10.82
11569.92	49.33	100	135			43.48	7.66	41.38	54.90	80.00	-25.10
11569.92				39.36	A	43.48	7.66	41.38	44.93	60.00	-15.07
EUT in Continuous Receive Mode on Channel 165 (5.825 GHz)											
3883.34	51.50	100	135			43.17	4.23	31.30	43.85	80.00	-36.15
3883.34				43.21	A	43.17	4.23	31.30	35.56	60.00	-24.44
7766.62	52.67	100	135			43.58	6.32	40.35	55.75	80.00	-24.25
7766.62				46.30	A	43.58	6.32	40.35	49.38	60.00	-10.62
11649.94	48.83	100	135			43.45	7.69	41.59	54.66	80.00	-25.34
11649.94				38.49	A	43.45	7.69	41.59	44.32	60.00	-15.68



Spurious Radiated Emissions Test Results (Continued)

RADIATED EMISSIONS - Vertical Antenna Polarization											
<i>Freq. (MHz)</i>	<i>Meter Reading (dBuV)</i>	<i>Antenna Height (cm)</i>	<i>Azimuth (degrees)</i>	<i>Quasi pk or AVG (dBuV)</i>		<i>Preamp Factor (dB)</i>	<i>Cable Factor (dB)</i>	<i>Ant. Factor (dB)</i>	<i>Corrected Reading (dBuV)</i>	<i>Limits (dBuV)</i>	<i>Diff (dB) +=FAIL</i>
EUT in Continuous Receive Mode on Channel 149 (5.745 GHz)											
3830.00	50.33	100	135			43.17	4.18	31.09	42.44	80.00	-37.56
3830.00				41.41	A	43.17	4.18	31.09	33.52	60.00	-26.48
7660.00	50.17	100	135			43.62	6.27	40.11	52.94	80.00	-27.06
7660.00				39.50	A	43.62	6.27	40.11	42.27	60.00	-17.73
11489.96	50.00	100	135			43.50	7.64	41.66	55.80	80.00	-24.20
11489.96				39.89	A	43.50	7.64	41.66	45.69	60.00	-14.31
EUT in Continuous Receive Mode on Channel 157 (5.785 GHz)											
3856.65	51.00	100	135			43.17	4.21	31.14	43.18	80.00	-36.82
3856.65				42.93	A	43.17	4.21	31.14	35.11	60.00	-24.89
7713.29	50.33	100	135			43.60	6.29	40.28	53.31	80.00	-26.69
7713.29				40.10	A	43.60	6.29	40.28	43.08	60.00	-16.92
11569.91	49.50	100	135			43.48	7.66	41.81	55.50	80.00	-24.50
11569.91				38.70	A	43.48	7.66	41.81	44.70	60.00	-15.30
EUT in Continuous Receive Mode on Channel 165 (5.825 GHz)											
3883.35	50.50	100	135			43.17	4.23	31.19	42.75	80.00	-37.25
3883.35				42.42	A	43.17	4.23	31.19	34.67	60.00	-25.33
7766.63	50.33	100	135			43.58	6.32	40.45	53.52	80.00	-26.48
7766.63				40.39	A	43.58	6.32	40.45	43.58	60.00	-16.42
11649.97	49.17	100	135			43.45	7.69	41.94	55.35	80.00	-24.65
11649.97				38.01	A	43.45	7.69	41.94	44.19	60.00	-15.81



AEGIS LABS INC.

Spurious Radiated Emissions Test Results (Continued)

CLIENT:	Intel Corporation	DATE:	08/31/04
EUT:	Intel PRO/Wireless 2915ABG Network Connection	PROJECT NUMBER:	INTEL-040831
MODEL NUMBER:	WM3B2915ABG	TEST ENGINEER:	JC
SERIAL NUMBER:	344F96244ABC51962012	SITE #:	2
CONFIGURATION:	Tested installed in the Hewlett Packard host computer's mini PCI slot in 802.11b (2412-2462 MHz) mode with the Foxconn (Jakarta) antennas.	TEMPERATURE:	33 C
		HUMIDITY:	27% RH
		TIME:	11:45 AM

Standard:	FCC CFR 47, Part 15.247(c)
Description:	Radiated emissions, which fall in the restricted bands, as defined in Sec. 15.205(a), must also comply with the radiated emission limits specified in Sec. 15.209(a). All others must be < -20dBc.
Results:	Passes (See Data Sheets)

Unwanted Spurious Emissions Limits

Frequency (MHz)	Field Strength (uV/m)	Field Strength (dBuV/m) (Emissions in the restricted bands)	Field Strength (dBm/MHz) (Emissions outside the restricted bands)
Above 960	500	54.00 (Average) 74.00 (Peak)	< -20 dBc

Page 98 of 119 (Appendix A)
Report Number: INTEL-040831F
FCC ID: PD9WM3B2915ABG



Spurious Radiated Emissions Test Results (Continued)

*Fundamental Measurements in 802.11b mode (2412-2462 MHz)
 Channels 1, 6, & 11
 Continuous TX at MAIN Antenna port with Foxconn (Jakarta) Antennas
 Aegis Labs, Inc. File #: INTEL-040831-02*

RADIATED EMISSIONS - Horizontal Antenna Polarization											
<i>Freq. (MHz)</i>	<i>Meter Reading (dBuV)</i>	<i>Antenna Height (cm)</i>	<i>Azimuth (degrees)</i>	<i>Quasi pk or AVG (dBuV)</i>		<i>Preamp Factor (dB)</i>	<i>Cable Factor (dB)</i>	<i>Ant. Factor (dB)</i>	<i>Corrected Reading (dBuV)</i>	<i>Limits (dBuV)</i>	<i>Diff (dB) +=FAIL</i>
2412.00	67.83	100	225				3.30	31.11	102.24		
2412.00				64.29	A		3.30	31.11	98.70		
2437.00	69.50	100	225				3.32	31.05	103.87		
2437.00				66.22	A		3.32	31.05	100.59		
2462.00	69.17	100	135				3.34	30.99	103.50		
2462.00				65.89	A		3.34	30.99	100.22		

RADIATED EMISSIONS – Vertical Antenna Polarization											
<i>Freq. (MHz)</i>	<i>Meter Reading (dBuV)</i>	<i>Antenna Height (cm)</i>	<i>Azimuth (degrees)</i>	<i>Quasi pk or AVG (dBuV)</i>		<i>Preamp Factor (dB)</i>	<i>Cable Factor (dB)</i>	<i>Ant. Factor (dB)</i>	<i>Corrected Reading (dBuV)</i>	<i>Limits (dBuV)</i>	<i>Diff (dB) +=FAIL</i>
2412.00	67.50	200	270				3.30	31.24	102.04		
2412.00				63.48	A		3.30	31.24	98.02		
2437.00	68.00	200	270				3.32	31.20	102.52		
2437.00				64.27	A		3.32	31.20	98.79		
2462.00	68.83	200	270				3.34	31.16	103.33		
2462.00				65.79	A		3.34	31.16	100.29		

NOTE: Fundamental signals measured to calculate the band edge field strengths using the “Marker Delta Method”.



Spurious Radiated Emissions Test Results (Continued)

Band Edge Field Strength Measurements in 802.11b mode (2412-2462 MHz)
Channels 1, 6, & 11
Continuous TX at MAIN Antenna port with Foxconn (Jakarta) Antennas
Aegis Labs, Inc. File #: INTEL-040803-14

RADIATED EMISSIONS - Horizontal Antenna Polarization										
<i>Freq. (MHz)</i>	<i>Meter Reading (dBuV)</i>	<i>Antenna Height (cm)</i>	<i>Azimuth (degrees)</i>	<i>Quasi pk or AVG (dBuV)</i>	<i>Preamp Factor (dB)</i>	<i>Cable Factor (dB)</i>	<i>Ant. Factor (dB)</i>	<i>Corrected Reading (dBuV)</i>	<i>Limits (dBuV)</i>	<i>Diff (dB) +=FAIL</i>
2390.00								48.07	74.00	-25.93
2390.00								36.36	54.00	-17.64
2359.80								50.41	74.00	-23.59
2359.80								37.36	54.00	-16.64
2400.00	36.50	100	225			3.29	31.14	70.93	82.24	-11.31
2483.50								49.00	74.00	-25.00
2483.50								37.89	54.00	-16.11
2520.70								49.84	74.00	-24.16
2520.70								38.72	54.00	-15.28

RADIATED EMISSIONS – Vertical Antenna Polarization										
<i>Freq. (MHz)</i>	<i>Meter Reading (dBuV)</i>	<i>Antenna Height (cm)</i>	<i>Azimuth (degrees)</i>	<i>Quasi pk or AVG (dBuV)</i>	<i>Preamp Factor (dB)</i>	<i>Cable Factor (dB)</i>	<i>Ant. Factor (dB)</i>	<i>Corrected Reading (dBuV)</i>	<i>Limits (dBuV)</i>	<i>Diff (dB) +=FAIL</i>
2390.00								47.87	74.00	-26.13
2390.00								35.68	54.00	-18.32
2359.80								50.21	74.00	-23.79
2359.80								36.68	54.00	-17.32
2400.00	36.50	200	270			3.29	31.26	71.05	82.04	-10.99
2483.50								48.83	74.00	-25.17
2483.50								37.96	54.00	-16.04
2520.70								49.67	74.00	-24.33
2520.70								38.79	54.00	-15.21

NOTE: The “Band Edge Field Strength” was calculated using the “Fundamental” and “Conducted Band Edge” measurements per the “Marker-Delta Method” with the following formula:

BE = Fm – Δm

Where

BE = Band Edge Field Strength

Fm = Measured Fundamental (Peak or Average)

Δm = Measured Conducted Band Edge Delta (Peak or Average)



Spurious Radiated Emissions Test Results (Continued)

Plots Showing Out-Of-Band Emissions (Peak RBW=VBW=1MHz; Average RBW = 1MHz, VBW = 10Hz)

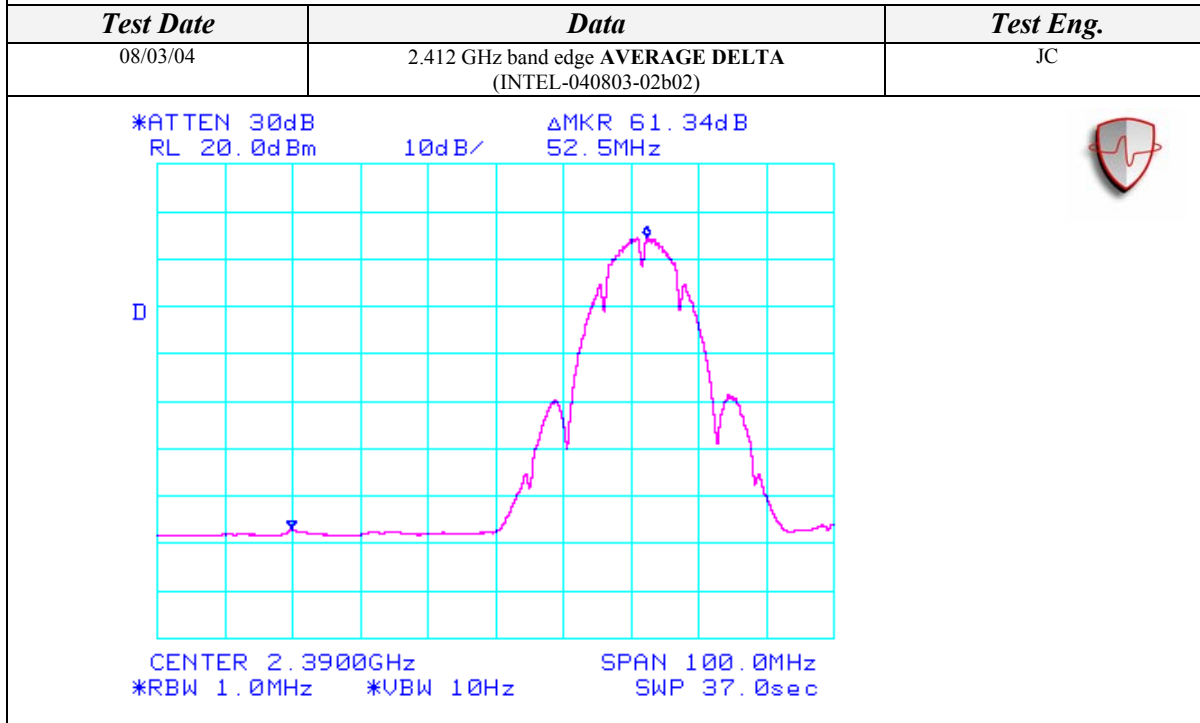
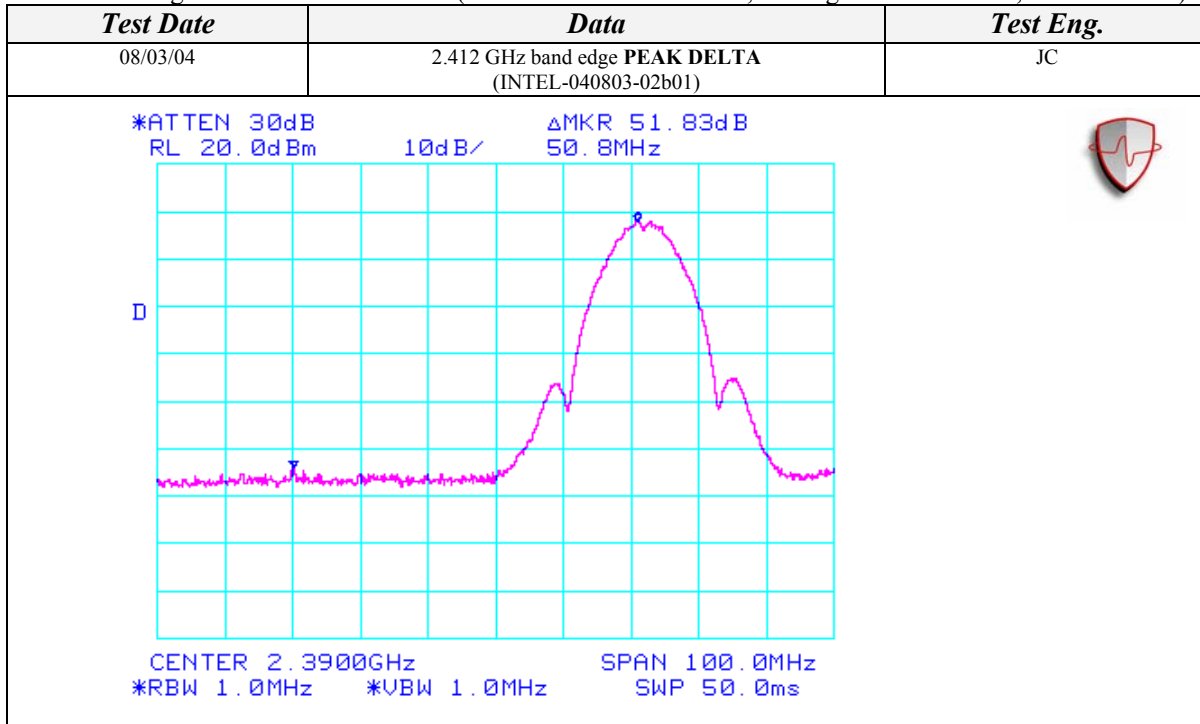



Spurious Radiated Emissions Test Results (Continued)

Plots Showing Out-Of-Band Emissions (Peak RBW=VBW=1MHz; Average RBW = 1MHz, VBW = 10Hz)

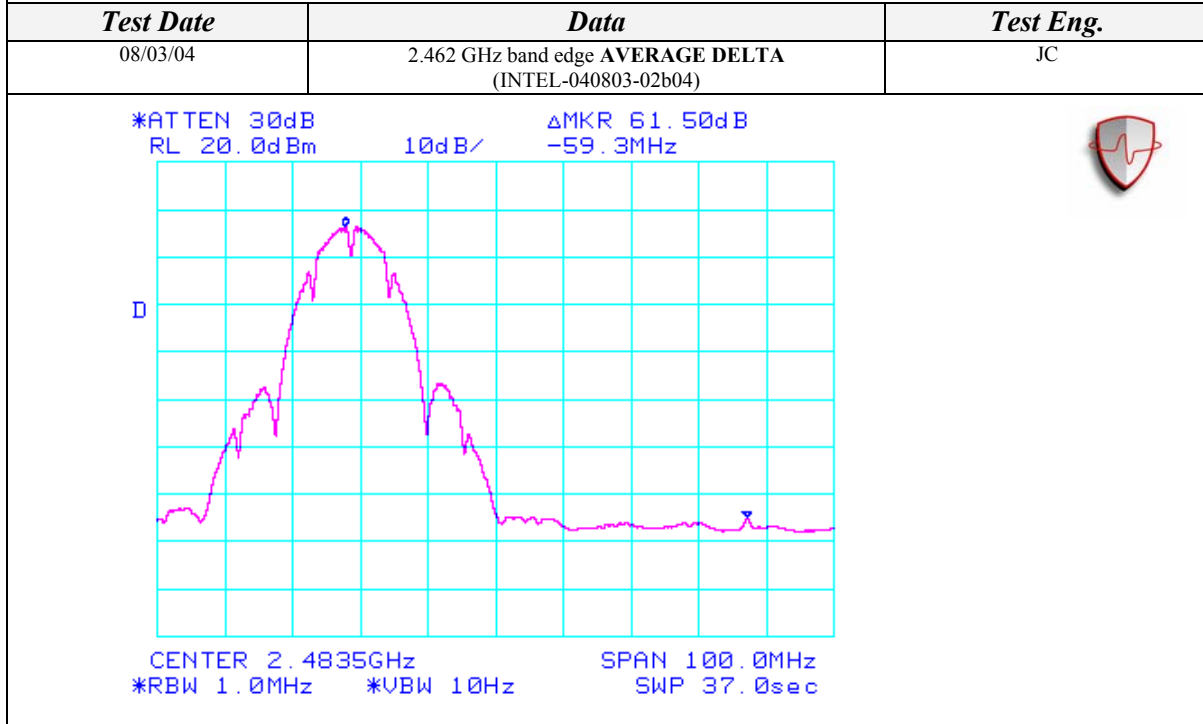
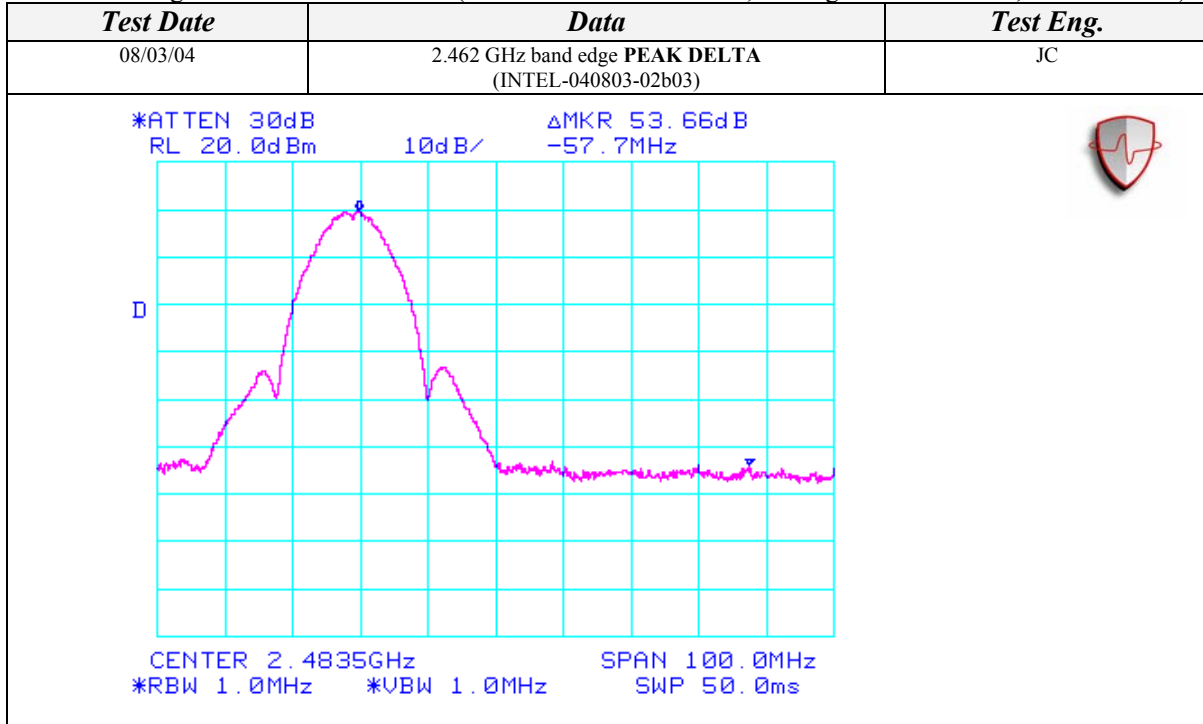



Spurious Radiated Emissions Test Results (Continued)

*Spurious Emissions Measurements in 802.11b mode (2412-2462 MHz)
Channels 1, 6, & 11
Continuous TX at MAIN Antenna port with Foxconn (Jakarta) Antennas
Aegis Labs, Inc. File #: INTEL-040831-03*

RADIATED EMISSIONS - Horizontal Antenna Polarization											
Freq. (MHz)	Meter Reading (dBuV)	Antenna Height (cm)	Azimuth (degrees)	Quasi pk or AVG (dBuV)		1 Meter Distance Factor (dB)	Cable Factor (dB)	Ant. Factor (dB)	Corrected Reading (dBuV)	Limits (dBuV)	Diff (dB) +=FAIL
EUT in Continuous Transmit Mode on Channel 1 (2.412 GHz)											
2312.00	31.00	100	180			9.54	3.23	31.35	56.04	74.00	-17.96
2312.00				15.20	A	9.54	3.23	31.35	40.24	54.00	-13.76
EUT in Continuous Transmit Mode on Channel 6 (2.437 GHz)											
2336.00	32.00	100	180			9.54	3.25	31.29	57.00	74.00	-17.00
2336.00				19.32	A	9.54	3.25	31.29	44.32	54.00	-9.68
EUT in Continuous Transmit Mode on Channel 11 (2.462 GHz)											
2358.66	31.17	100	225			9.54	3.26	31.24	56.13	74.00	-17.87
2358.66				15.87	A	9.54	3.26	31.24	40.83	54.00	-13.17
RADIATED EMISSIONS - Vertical Antenna Polarization											
Freq. (MHz)	Meter Reading (dBuV)	Antenna Height (cm)	Azimuth (degrees)	Quasi pk or AVG (dBuV)		1 Meter Distance Factor (dB)	Cable Factor (dB)	Ant. Factor (dB)	Corrected Reading (dBuV)	Limits (dBuV)	Diff (dB) +=FAIL
EUT in Continuous Transmit Mode on Channel 1 (2.412 GHz)											
2312.00	30.50	100	225			9.54	3.23	31.40	55.59	74.00	-18.41
2312.00				14.50	A	9.54	3.23	31.40	39.59	54.00	-14.41
EUT in Continuous Transmit Mode on Channel 6 (2.437 GHz)											
2336.00	31.50	100	225			9.54	3.25	31.36	56.57	74.00	-17.43
2336.00				17.41	A	9.54	3.25	31.36	42.48	54.00	-11.52
EUT in Continuous Transmit Mode on Channel 11 (2.462 GHz)											
2358.66	31.33	100	225			9.54	3.26	31.33	56.38	74.00	-17.62
2358.66				15.67	A	9.54	3.26	31.33	40.72	54.00	-13.28

NOTE: These spurious emissions measurements were taken without a preamp at a distance on 1 meter to avoid saturating the preamp and analyzer because the signals were close to the fundamental frequency. The readings were extrapolated to 1 meter.



Spurious Radiated Emissions Test Results (Continued)

*Spurious Emissions Measurements in 802.11b mode (2412-2462 MHz)
Channels 1, 6, & 11
Continuous TX at MAIN Antenna port with Foxconn (Jakarta) Antennas
Aegis Labs, Inc. File #: INTEL-040831-04*

RADIATED EMISSIONS - Horizontal Antenna Polarization											
<i>Freq. (MHz)</i>	<i>Meter Reading (dBuV)</i>	<i>Antenna Height (cm)</i>	<i>Azimuth (degrees)</i>	<i>Quasi pk or AVG (dBuV)</i>		<i>Preamp Factor (dB)</i>	<i>Cable Factor (dB)</i>	<i>Ant. Factor (dB)</i>	<i>Corrected Reading (dBuV)</i>	<i>Limits (dBuV)</i>	<i>Diff (dB) +=FAIL</i>
EUT in Continuous Transmit Mode on Channel 1 (2.412 GHz)											
3216.01	50.00	100	225			43.07	3.89	30.24	41.06	82.24	-41.18
4824.00	49.00	100	225			43.27	4.73	34.53	44.99	74.00	-29.01
4824.00				38.59	A	43.27	4.73	34.53	34.58	54.00	-19.42
6431.97	58.50	100	135			43.82	5.73	36.64	57.06	82.24	-25.18
9648.01	49.83	100	135			43.22	6.95	38.88	52.44	82.24	-29.80
12864.03	49.17	100	135			43.83	7.95	43.86	57.16	82.24	-25.08
EUT in Continuous Transmit Mode on Channel 6 (2.437 GHz)											
3249.32	51.00	100	225			43.08	3.91	30.25	42.07	83.87	-41.80
4873.99	49.50	100	225			43.29	4.77	34.72	45.70	74.00	-28.30
4873.99				41.01	A	43.29	4.77	34.72	37.21	54.00	-16.79
6498.69	59.33	100	135			43.84	5.78	36.90	58.16	83.87	-25.71
9747.96	49.67	100	135			43.25	6.99	39.00	52.40	83.87	-31.47
12997.37	50.00	100	135			43.83	8.02	44.29	58.48	83.87	-25.39
EUT in Continuous Transmit Mode on Channel 11 (2.462 GHz)											
3282.69	50.17	100	225			43.10	3.91	30.26	41.24	83.50	-42.26
4924.00	50.33	100	180			43.30	4.81	34.91	46.74	74.00	-27.26
4924.00				41.59	A	43.30	4.81	34.91	38.00	54.00	-16.00
6565.34	57.00	100	135			43.84	5.83	37.32	56.31	83.50	-27.19
9848.01	49.33	100	135			43.29	7.03	39.12	52.19	83.50	-31.31
13130.67	49.67	100	135			43.70	8.07	44.25	58.29	83.50	-25.21



Spurious Radiated Emissions Test Results (Continued)

RADIATED EMISSIONS - Vertical Antenna Polarization											
<i>Freq. (MHz)</i>	<i>Meter Reading (dBuV)</i>	<i>Antenna Height (cm)</i>	<i>Azimuth (degrees)</i>	<i>Quasi pk or AVG (dBuV)</i>		<i>Preamp Factor (dB)</i>	<i>Cable Factor (dB)</i>	<i>Ant. Factor (dB)</i>	<i>Corrected Reading (dBuV)</i>	<i>Limits (dBuV)</i>	<i>Diff (dB) +=FAIL</i>
EUT in Continuous Transmit Mode on Channel 1 (2.412 GHz)											
3216.00	49.00	100	135			43.07	3.89	30.44	40.26	82.04	-41.78
4823.96	50.83	100	180			43.27	4.73	34.53	46.82	74.00	-27.18
4823.96				43.65	A	43.27	4.73	34.53	39.64	54.00	-14.36
6431.95	56.50	100	135			43.82	5.73	36.64	55.06	82.04	-26.98
9647.97	49.67	100	135			43.22	6.95	38.97	52.37	82.04	-29.67
12864.01	48.33	100	135			43.83	7.95	44.23	56.68	82.04	-25.36
EUT in Continuous Transmit Mode on Channel 6 (2.437 GHz)											
3249.32	49.17	100	135			43.08	3.91	30.45	40.44	82.52	-42.08
4874.01	51.33	100	180			43.29	4.77	34.72	47.53	74.00	-26.47
4874.01				45.11	A	43.29	4.77	34.72	41.31	54.00	-12.69
6498.66	57.00	100	135			43.84	5.78	36.89	55.83	82.52	-26.69
9748.04	49.33	100	135			43.25	6.99	39.15	52.21	82.52	-30.31
12997.35	50.17	100	135			43.83	8.02	44.49	58.85	82.52	-23.67
EUT in Continuous Transmit Mode on Channel 11 (2.462 GHz)											
3282.66	49.33	100	135			43.10	3.91	30.46	40.60	83.33	-42.73
4924.00	53.33	100	180			43.30	4.81	34.91	49.74	74.00	-24.26
4924.00				47.01	A	43.30	4.81	34.91	43.42	54.00	-10.58
6565.32	54.50	100	135			43.84	5.83	37.38	53.87	83.33	-29.46
9847.96	49.17	100	135			43.29	7.03	39.33	52.24	83.33	-31.09
13130.63	49.67	100	135			43.70	8.07	44.45	58.49	83.33	-24.84



Spurious Radiated Emissions Test Results (Continued)

*Spurious Emissions Measurements in in802.11b mode (2412-2462 MHz)
Channels 1, 6, & 11
Continuous RX at MAIN Antenna port with Foxconn (Jakarta) Antennas
Aegis Labs, Inc. File #: INTEL-040831-04*

RADIATED EMISSIONS - Horizontal Antenna Polarization											
<i>Freq. (MHz)</i>	<i>Meter Reading (dBuV)</i>	<i>Antenna Height (cm)</i>	<i>Azimuth (degrees)</i>	<i>Quasi pk or AVG (dBuV)</i>		<i>Preamp Factor (dB)</i>	<i>Cable Factor (dB)</i>	<i>Ant. Factor (dB)</i>	<i>Corrected Reading (dBuV)</i>	<i>Limits (dBuV)</i>	<i>Diff (dB) +=FAIL</i>
EUT in Continuous Receive Mode on Channel 1 (2.412 GHz)											
3216.02	50.50	100	225			43.07	3.89	30.24	41.56	80.00	-38.44
3216.02				44.20	A	43.07	3.89	30.24	35.26	60.00	-24.74
6432.00	59.17	100	135			43.82	5.73	36.64	57.73	80.00	-22.27
6432.00				55.81	A	43.82	5.73	36.64	54.37	60.00	-5.63
9648.03	49.67	100	135			43.22	6.95	38.88	52.28	80.00	-27.72
9648.03				38.40	A	43.22	6.95	38.88	41.01	60.00	-18.99
EUT in Continuous Receive Mode on Channel 6 (2.437 GHz)											
3249.32	50.83	100	225			43.08	3.91	30.25	41.90	80.00	-38.10
3249.32				44.58	A	43.08	3.91	30.25	35.65	60.00	-24.35
6498.70	60.33	100	135			43.84	5.78	36.90	59.16	80.00	-20.84
6498.70				57.10	A	43.84	5.78	36.90	55.93	60.00	-4.07
9747.99	50.17	100	135			43.25	6.99	39.00	52.90	80.00	-27.10
9747.99				38.96	A	43.25	6.99	39.00	41.69	60.00	-18.31
EUT in Continuous Receive Mode on Channel 11 (2.462 GHz)											
3282.66	50.33	100	225			43.10	3.91	30.26	41.40	80.00	-38.60
3282.66				43.89	A	43.10	3.91	30.26	34.96	60.00	-25.04
6565.32	56.67	100	135			43.84	5.83	37.32	55.98	80.00	-24.02
6565.32				53.27	A	43.84	5.83	37.32	52.58	60.00	-7.42
9848.01	50.50	100	135			43.29	7.03	39.12	53.36	80.00	-26.64
9848.01				39.30	A	43.29	7.03	39.12	42.16	60.00	-17.84



Spurious Radiated Emissions Test Results (Continued)

RADIATED EMISSIONS - Vertical Antenna Polarization											
<i>Freq. (MHz)</i>	<i>Meter Reading (dBuV)</i>	<i>Antenna Height (cm)</i>	<i>Azimuth (degrees)</i>	<i>Quasi pk or AVG (dBuV)</i>		<i>Preamp Factor (dB)</i>	<i>Cable Factor (dB)</i>	<i>Ant. Factor (dB)</i>	<i>Corrected Reading (dBuV)</i>	<i>Limits (dBuV)</i>	<i>Diff (dB) +=FAIL</i>
EUT in Continuous Receive Mode on Channel 1 (2.412 GHz)											
3216.00	50.17	100	135			43.07	3.89	30.44	41.43	80.00	-38.57
3216.00				41.99	A	43.07	3.89	30.44	33.25	60.00	-26.75
6432.03	57.33	100	135			43.82	5.73	36.64	55.89	80.00	-24.11
6432.03				53.58	A	43.82	5.73	36.64	52.14	60.00	-7.86
9648.02	49.33	100	135			43.22	6.95	38.97	52.03	80.00	-27.97
9648.02				37.59	A	43.22	6.95	38.97	40.29	60.00	-19.71
EUT in Continuous Receive Mode on Channel 6 (2.437 GHz)											
3249.32	50.33	100	135			43.08	3.91	30.45	41.60	80.00	-38.40
3249.32				42.36	A	43.08	3.91	30.45	33.63	60.00	-26.37
6498.67	57.83	100	135			43.84	5.78	36.89	56.66	80.00	-23.34
6498.67				54.10	A	43.84	5.78	36.89	52.93	60.00	-7.07
9747.96	48.83	100	135			43.25	6.99	39.15	51.71	80.00	-28.29
9747.96				36.97	A	43.25	6.99	39.15	39.85	60.00	-20.15
EUT in Continuous Receive Mode on Channel 11 (2.462 GHz)											
3282.67	49.83	100	135			43.10	3.91	30.46	41.10	80.00	-38.90
3282.67				41.20	A	43.10	3.91	30.46	32.47	60.00	-27.53
6565.37	55.17	100	135			43.84	5.83	37.38	54.54	80.00	-25.46
6565.37				50.50	A	43.84	5.83	37.38	49.87	60.00	-10.13
9847.98	49.17	100	135			43.29	7.03	39.33	52.24	80.00	-27.76
9847.98				37.36	A	43.29	7.03	39.33	40.43	60.00	-19.57



AEGIS LABS INC.

Spurious Radiated Emissions Test Results (Continued)

CLIENT:	Intel Corporation	DATE:	08/31/04
EUT:	Intel PRO/Wireless 2915ABG Network Connection	PROJECT NUMBER:	INTEL-040831
MODEL NUMBER:	WM3B2915ABG	TEST ENGINEER:	JC
SERIAL NUMBER:	344F96244ABC51962012	SITE #:	2
CONFIGURATION:	Tested installed in the Hewlett Packard host computer's mini PCI slot in 802.11g (2412-2462 MHz) mode with the Foxconn (Jakarta) antennas.	TEMPERATURE:	33 C
		HUMIDITY:	27% RH
		TIME:	11:45 AM

Standard:	FCC CFR 47, Part 15.247(c)
Description:	Radiated emissions, which fall in the restricted bands, as defined in Sec. 15.205(a), must also comply with the radiated emission limits specified in Sec. 15.209(a). All others must be < -20dBc.
Results:	Passes (See Data Sheets)

Unwanted Spurious Emissions Limits

Frequency (MHz)	Field Strength (uV/m)	Field Strength (dBuV/m) (Emissions in the restricted bands)	Field Strength (dBm/MHz) (Emissions outside the restricted bands)
Above 960	500	54.00 (Average) 74.00 (Peak)	< -20 dBc

Page 108 of 119 (Appendix A)
Report Number: INTEL-040831F
FCC ID: PD9WM3B2915ABG



Spurious Radiated Emissions Test Results (Continued)

*Fundamental Measurements in 802.11g mode (2412-2462 MHz)
Channels 1, 6, & 11
Continuous TX at MAIN Antenna port with Foxconn (Jakarta) Antennas
Aegis Labs, Inc. File #: INTEL-040831-02*

RADIATED EMISSIONS - Horizontal Antenna Polarization											
Freq. (MHz)	Meter Reading (dBuV)	Antenna Height (cm)	Azimuth (degrees)	Quasi pk or AVG (dBuV)		Preamp Factor (dB)	Cable Factor (dB)	Ant. Factor (dB)	Corrected Reading (dBuV)	Limits (dBuV)	Diff (dB) +=FAIL
2412.00	71.67	100	225				3.30	31.11	106.08		
2412.00				61.43	A		3.30	31.11	95.84		
2437.00	71.00	100	225				3.32	31.05	105.37		
2437.00				60.69	A		3.32	31.05	95.06		
2462.00	71.00	100	135				3.34	30.99	105.33		
2462.00				60.62	A		3.34	30.99	94.95		

RADIATED EMISSIONS – Vertical Antenna Polarization											
Freq. (MHz)	Meter Reading (dBuV)	Antenna Height (cm)	Azimuth (degrees)	Quasi pk or AVG (dBuV)		Preamp Factor (dB)	Cable Factor (dB)	Ant. Factor (dB)	Corrected Reading (dBuV)	Limits (dBuV)	Diff (dB) +=FAIL
2412.00	70.67	200	270				3.30	31.24	105.21		
2412.00				60.30	A		3.30	31.24	94.84		
2437.00	70.50	200	270				3.32	31.20	105.02		
2437.00				60.02	A		3.32	31.20	94.54		
2462.00	70.17	200	270				3.34	31.16	104.67		
2462.00				59.87	A		3.34	31.16	94.37		

NOTE: Fundamental signals measured to calculate the band edge field strengths using the “Marker Delta Method”.



Spurious Radiated Emissions Test Results (Continued)

*Band Edge Field Strength Measurements in 802.11g mode (2412-2462 MHz)
Channels 1, 6, & 11
Continuous TX at MAIN Antenna port with Foxconn (Jakarta) Antennas
Aegis Labs, Inc. File #: INTEL-040831-02*

RADIATED EMISSIONS - Horizontal Antenna Polarization										
Freq. (MHz)	Meter Reading (dBuV)	Antenna Height (cm)	Azimuth (degrees)	Quasi pk or AVG (dBuV)	Preamp Factor (dB)	Cable Factor (dB)	Ant. Factor (dB)	Corrected Reading (dBuV)	Limits (dBuV)	Diff (dB) +=FAIL
2390.00								59.74	74.00	-14.26
2390.00								45.17	54.00	-8.83
2400.00	47.50	100	225			3.29	31.14	81.93	86.08	-4.15
2483.50								60.83	74.00	-13.17
2483.50								43.95	54.00	-10.05

RADIATED EMISSIONS – Vertical Antenna Polarization										
Freq. (MHz)	Meter Reading (dBuV)	Antenna Height (cm)	Azimuth (degrees)	Quasi pk or AVG (dBuV)	Preamp Factor (dB)	Cable Factor (dB)	Ant. Factor (dB)	Corrected Reading (dBuV)	Limits (dBuV)	Diff (dB) +=FAIL
2390.00								58.87	74.00	-15.13
2390.00								44.17	54.00	-9.83
2400.00	46.67	200	270			3.29	31.26	81.22	85.21	-3.99
2483.50								60.17	74.00	-13.83
2483.50								43.37	54.00	-10.63

NOTE: The “Band Edge Field Strength” was calculated using the “Fundamental” and “Conducted Band Edge” measurements per the “Marker-Delta Method” with the following formula:

$$BE = Fm - \Delta m$$

Where

BE = Band Edge Field Strength

Fm = Measured Fundamental (Peak or Average)

Δm = Measured Conducted Band Edge Delta (Peak or Average)



Spurious Radiated Emissions Test Results (Continued)

*Spurious Emissions Measurements in 802.11g mode (2412-2462 MHz)
Channels 1, 6, & 11
Continuous TX at MAIN Antenna port with Foxconn (Jakarta) Antennas
Aegis Labs, Inc. File #: INTEL-040831-03*

RADIATED EMISSIONS - Horizontal Antenna Polarization											
Freq. (MHz)	Meter Reading (dBuV)	Antenna Height (cm)	Azimuth (degrees)	Quasi pk or AVG (dBuV)		1 Meter Distance Factor (dB)	Cable Factor (dB)	Ant. Factor (dB)	Corrected Reading (dBuV)	Limits (dBuV)	Diff (dB) +=FAIL
EUT in Continuous Transmit Mode on Channel 1 (2.412 GHz)											
2312.00	32.00	100	225			9.54	3.23	31.35	57.04	74.00	-16.96
2312.00				19.39	A	9.54	3.23	31.35	44.43	54.00	-9.57
EUT in Continuous Transmit Mode on Channel 6 (2.437 GHz)											
2336.00	32.33	100	225			9.54	3.25	31.29	57.33	74.00	-16.67
2336.00				19.80	A	9.54	3.25	31.29	44.80	54.00	-9.20
EUT in Continuous Transmit Mode on Channel 11 (2.462 GHz)											
2358.66	31.33	100	225			9.54	3.26	31.24	56.29	74.00	-17.71
2358.66				17.03	A	9.54	3.26	31.24	41.99	54.00	-12.01
RADIATED EMISSIONS - Vertical Antenna Polarization											
Freq. (MHz)	Meter Reading (dBuV)	Antenna Height (cm)	Azimuth (degrees)	Quasi pk or AVG (dBuV)		1 Meter Distance Factor (dB)	Cable Factor (dB)	Ant. Factor (dB)	Corrected Reading (dBuV)	Limits (dBuV)	Diff (dB) +=FAIL
EUT in Continuous Transmit Mode on Channel 1 (2.412 GHz)											
2312.00	31.50	100	225			9.54	3.23	31.40	56.59	74.00	-17.41
2312.00				17.54	A	9.54	3.23	31.40	42.63	54.00	-11.37
EUT in Continuous Transmit Mode on Channel 6 (2.437 GHz)											
2336.00	31.67	100	225			9.54	3.25	31.36	56.74	74.00	-17.26
2336.00				17.71	A	9.54	3.25	31.36	42.78	54.00	-11.22
EUT in Continuous Transmit Mode on Channel 11 (2.462 GHz)											
2358.66	31.00	100	225			9.54	3.26	31.33	56.05	74.00	-17.95
2358.66				16.37	A	9.54	3.26	31.33	41.42	54.00	-12.58

NOTE: These spurious emissions measurements were taken without a preamp at a distance on 1 meter to avoid saturating the preamp and analyzer because the signals were close to the fundamental frequency. The readings were extrapolated to 1 meter.



Spurious Radiated Emissions Test Results (Continued)

*Spurious Emissions Measurements in 802.11g mode (2412-2462 MHz)
Channels 1, 6, & 11
Continuous TX at MAIN Antenna port with Foxconn (Jakarta) Antennas
Aegis Labs, Inc. File #: INTEL-040831-04*

RADIATED EMISSIONS - Horizontal Antenna Polarization											
<i>Freq. (MHz)</i>	<i>Meter Reading (dBuV)</i>	<i>Antenna Height (cm)</i>	<i>Azimuth (degrees)</i>	<i>Quasi pk or AVG (dBuV)</i>		<i>Preamp Factor (dB)</i>	<i>Cable Factor (dB)</i>	<i>Ant. Factor (dB)</i>	<i>Corrected Reading (dBuV)</i>	<i>Limits (dBuV)</i>	<i>Diff (dB) +=FAIL</i>
EUT in Continuous Transmit Mode on Channel 1 (2.412 GHz)											
3216.00	50.50	100	225			43.07	3.89	30.24	41.56	86.08	-44.52
4824.20	48.50	100	135			43.27	4.73	34.53	44.50	74.00	-29.50
4824.20				35.35	A	43.27	4.73	34.53	31.35	54.00	-22.65
6432.05	59.00	100	135			43.82	5.73	36.64	57.56	86.08	-28.52
9647.97	49.83	100	135			43.22	6.95	38.88	52.44	86.08	-33.64
12864.05	49.00	100	135			43.83	7.95	43.86	56.99	86.08	-29.09
EUT in Continuous Transmit Mode on Channel 6 (2.437 GHz)											
3249.37	51.17	100	225			43.08	3.91	30.25	42.24	85.37	-43.13
4874.06	47.67	100	135			43.29	4.77	34.72	43.87	74.00	-30.13
4874.06				34.41	A	43.29	4.77	34.72	30.61	54.00	-23.39
6498.69	57.67	100	135			43.84	5.78	36.90	56.50	85.37	-28.87
9748.09	49.83	100	135			43.25	6.99	39.00	52.56	85.37	-32.81
12997.35	50.17	100	135			43.83	8.02	44.29	58.65	85.37	-26.72
EUT in Continuous Transmit Mode on Channel 11 (2.462 GHz)											
3282.68	50.17	100	225			43.10	3.91	30.26	41.24	85.33	-44.09
4923.82	48.83	100	135			43.30	4.81	34.91	45.24	74.00	-28.76
4923.82				35.69	A	43.30	4.81	34.91	32.10	54.00	-21.90
6565.42	57.00	100	135			43.84	5.83	37.32	56.31	85.33	-29.02
9847.97	49.17	100	135			43.29	7.03	39.12	52.03	85.33	-33.30
13130.70	49.67	100	135			43.70	8.07	44.25	58.29	85.33	-27.04



Spurious Radiated Emissions Test Results (Continued)

RADIATED EMISSIONS - Vertical Antenna Polarization											
<i>Freq. (MHz)</i>	<i>Meter Reading (dBuV)</i>	<i>Antenna Height (cm)</i>	<i>Azimuth (degrees)</i>	<i>Quasi pk or AVG (dBuV)</i>		<i>Preamp Factor (dB)</i>	<i>Cable Factor (dB)</i>	<i>Ant. Factor (dB)</i>	<i>Corrected Reading (dBuV)</i>	<i>Limits (dBuV)</i>	<i>Diff (dB) +=FAIL</i>
EUT in Continuous Transmit Mode on Channel 1 (2.412 GHz)											
3216.01	49.00	100	180			43.07	3.89	30.44	40.26	85.21	-44.95
4823.97	49.83	100	135			43.27	4.73	34.53	45.82	74.00	-28.18
4823.97				37.63	A	43.27	4.73	34.53	33.62	54.00	-20.38
6431.99	57.00	100	135			43.82	5.73	36.64	55.56	85.21	-29.65
9648.08	49.33	100	135			43.22	6.95	38.97	52.03	85.21	-33.18
12863.98	49.00	100	135			43.83	7.95	44.23	57.35	85.21	-27.86
EUT in Continuous Transmit Mode on Channel 6 (2.437 GHz)											
3249.35	49.50	100	180			43.08	3.91	30.45	40.77	85.02	-44.25
4874.03	48.00	100	135			43.29	4.77	34.72	44.20	74.00	-29.80
4874.03				34.89	A	43.29	4.77	34.72	31.09	54.00	-22.91
6498.67	56.50	100	135			43.84	5.78	36.89	55.33	85.02	-29.69
9748.00	49.33	100	135			43.25	6.99	39.15	52.21	85.02	-32.81
12997.35	50.00	100	135			43.83	8.02	44.49	58.68	85.02	-26.34
EUT in Continuous Transmit Mode on Channel 11 (2.462 GHz)											
3282.65	49.00	100	180			43.10	3.91	30.46	40.27	84.67	-44.40
4924.01	48.33	100	135			43.30	4.81	34.91	44.74	74.00	-29.26
4924.01				35.46	A	43.30	4.81	34.91	31.87	54.00	-22.13
6565.34	54.33	100	135			43.84	5.83	37.38	53.70	84.67	-30.97
9848.03	49.50	100	135			43.29	7.03	39.33	52.57	84.67	-32.10
13130.62	49.00	100	135			43.70	8.07	44.45	57.82	84.67	-26.85



Spurious Radiated Emissions Test Results (Continued)

*Spurious Emissions Measurements in 802.11g mode (2412-2462 MHz)
Channels 1, 6, & 11
Continuous RX at MAIN Antenna port with Foxconn (Jakarta) Antennas
Aegis Labs, Inc. File #: INTEL-040831-04*

RADIATED EMISSIONS - Horizontal Antenna Polarization											
<i>Freq. (MHz)</i>	<i>Meter Reading (dBuV)</i>	<i>Antenna Height (cm)</i>	<i>Azimuth (degrees)</i>	<i>Quasi pk or AVG (dBuV)</i>		<i>Preamp Factor (dB)</i>	<i>Cable Factor (dB)</i>	<i>Ant. Factor (dB)</i>	<i>Corrected Reading (dBuV)</i>	<i>Limits (dBuV)</i>	<i>Diff (dB) +=FAIL</i>
EUT in Continuous Receive Mode on Channel 1 (2.412 GHz)											
3215.99	50.50	100	225			43.07	3.89	30.24	41.56	80.00	-38.44
3215.99				44.25	A	43.07	3.89	30.24	35.31	60.00	-24.69
6431.98	59.17	100	135			43.82	5.73	36.64	57.73	80.00	-22.27
6431.98				56.02	A	43.82	5.73	36.64	54.58	60.00	-5.42
9647.99	50.00	100	135			43.22	6.95	38.88	52.61	80.00	-27.39
9647.99				37.96	A	43.22	6.95	38.88	40.57	60.00	-19.43
EUT in Continuous Receive Mode on Channel 6 (2.437 GHz)											
3249.32	51.00	100	225			43.08	3.91	30.25	42.07	80.00	-37.93
3249.32				44.10	A	43.08	3.91	30.25	35.17	60.00	-24.83
6498.67	60.00	100	135			43.84	5.78	36.89	58.83	80.00	-21.17
6498.67				57.24	A	43.84	5.78	36.89	56.07	60.00	-3.93
9748.03	49.83	100	135			43.25	6.99	39.00	52.56	80.00	-27.44
9748.03				38.97	A	43.25	6.99	39.00	41.70	60.00	-18.30
EUT in Continuous Receive Mode on Channel 11 (2.462 GHz)											
3282.66	50.67	100	225			43.10	3.91	30.26	41.74	80.00	-38.26
3282.66				44.19	A	43.10	3.91	30.26	35.26	60.00	-24.74
6565.32	56.00	100	135			43.84	5.83	37.32	55.31	80.00	-24.69
6565.32				52.30	A	43.84	5.83	37.32	51.61	60.00	-8.39
9848.03	50.17	100	135			43.29	7.03	39.12	53.03	80.00	-26.97
9848.03				38.12	A	43.29	7.03	39.12	40.98	60.00	-19.02



Spurious Radiated Emissions Test Results (Continued)

RADIATED EMISSIONS - Vertical Antenna Polarization											
<i>Freq. (MHz)</i>	<i>Meter Reading (dBuV)</i>	<i>Antenna Height (cm)</i>	<i>Azimuth (degrees)</i>	<i>Quasi pk or AVG (dBuV)</i>		<i>Preamp Factor (dB)</i>	<i>Cable Factor (dB)</i>	<i>Ant. Factor (dB)</i>	<i>Corrected Reading (dBuV)</i>	<i>Limits (dBuV)</i>	<i>Diff (dB) +=FAIL</i>
EUT in Continuous Receive Mode on Channel 1 (2.412 GHz)											
3216.00	49.33	100	180			43.07	3.89	30.44	40.59	80.00	-39.41
3216.00				42.73	A	43.07	3.89	30.44	33.99	60.00	-26.01
6432.00	57.50	100	135			43.82	5.73	36.64	56.06	80.00	-23.94
6432.00				53.83	A	43.82	5.73	36.64	52.39	60.00	-7.61
9648.00	49.67	100	135			43.22	6.95	38.97	52.37	80.00	-27.63
9648.00				37.64	A	43.22	6.95	38.97	40.34	60.00	-19.66
EUT in Continuous Receive Mode on Channel 6 (2.437 GHz)											
3249.33	49.83	100	180			43.08	3.91	30.45	41.10	80.00	-38.90
3249.33				43.01	A	43.08	3.91	30.45	34.28	60.00	-25.72
6498.69	57.83	100	135			43.84	5.78	36.90	56.66	80.00	-23.34
6498.69				54.04	A	43.84	5.78	36.90	52.87	60.00	-7.13
9748.03	49.33	100	135			43.25	6.99	39.15	52.21	80.00	-27.79
9748.03				37.15	A	43.25	6.99	39.15	40.03	60.00	-19.97
EUT in Continuous Receive Mode on Channel 11 (2.462 GHz)											
3282.67	49.00	100	180			43.10	3.91	30.46	40.27	80.00	-39.73
3282.67				40.89	A	43.10	3.91	30.46	32.16	60.00	-27.84
6565.34	54.67	100	135			43.84	5.83	37.38	54.04	80.00	-25.96
6565.34				50.43	A	43.84	5.83	37.38	49.80	60.00	-10.20
9848.04	49.17	100	135			43.29	7.03	39.33	52.24	80.00	-27.76
9848.04				36.96	A	43.29	7.03	39.33	40.03	60.00	-19.97



AEGIS LABS INC.

PEAK TRANSMIT POWER

CLIENT:	Intel Corporation	DATE:	08/03/04
EUT:	Intel PRO/Wireless 2915ABG Network Connection	PROJECT NUMBER:	INTEL-040831-01
MODEL NUMBER:	WM3B2915ABG	TEST ENGINEER:	JC
SERIAL NUMBER:	344F96244ABC51962012	SITE #:	2
CONFIGURATION:	Tested installed in the Hewlett Packard host computer's mini PCI slot.	TEMPERATURE:	18 C
		HUMIDITY:	62% RH
		TIME:	9:15 AM

Standard:	FCC CFR 47, Part 15.247(b)(1)
Description:	The maximum peak output power of the intentional radiator shall not exceed 1 watt.
Results:	See Data Sheet

Peak Transmit Power Limits	
Frequency (MHz)	Output Power (W)
5725-5850	1
2412-2462	1

Page 118 of 119 (Appendix A)
Report Number: INTEL-040831F
FCC ID: PD9WM3B2915ABG



Peak Transmit Power (Continued)

Mode	Channel	Frequency (MHz)	Rate (Mbps)	Average Power (dBm)	Average Power (mW)	Peak Power (dBm)	Peak Power (mW)
802.11a	149	5745	6	17.20	52.48	22.80	190.55
802.11a	157	5785	6	17.25	53.09	22.90	194.98
802.11a	165	5825	6	17.15	51.88	23.30	213.80
802.11b	1	2412	1	15.00	31.62	17.10	51.29
802.11b	6	2437	1	16.90	48.98	19.00	79.43
802.11b	11	2462	1	17.00	50.12	19.20	83.18
802.11g	1	2412	6	15.35	34.28	24.10	257.04
802.11g	6	2437	6	15.30	33.88	24.00	251.19
802.11g	11	2462	6	15.20	33.11	23.90	245.47

NOTE: The output power measurement is conducted.