

# **Regulatory Antenna Information**

(English Required)

**Intel Corporation**

# Antenna Information

## I. Antenna Assembly Specifications

Antenna assembly overview: Peak Gain including cable loss.

Designator	Manufacture	Antenna type	Cable Assembly Info.	Peak Gain W/ Cable loss (dBi)
(P/N: DC330011800) Main antenna	Wistron NeWeb Corporation	PIFA	(P/N: 50.EBJ02.001 or 50.EBJ04.001) 50 ohm Coaxial. Length: 493 mm diameter: 1.13mm Connector: IPEX 20278-101R-13 or WNC connector	2400-2500MHz <b>0.66 dBi (peak)</b>
				5150-5350MHz <b>2.51 dBi (peak)</b>
				5470-5725MHz ... dBi (peak)
				5725-5850MHz ... dBi (peak)
(P/N: DC330011810) Auxiliary antenna	Wistron NeWeb Corporation	PIFA	(P/N: 50.EBJ01.001 or 50.EBJ03.001) 50 ohm Coaxial. Length: 628 mm diameter: 1.13mm Connector: IPEX 20278-101R-13 or WNC connector	2400-2500MHz <b>5.00 dBi (peak)</b>
				5150-5350MHz <b>2.48 dBi (peak)</b>
				5470-5725MHz ... dBi (peak)
				5725-5850MHz ... dBi (peak)

Antenna overview: Peak Gain not including cable loss.

Antenna Designator	Manufacture	Antenna type	Peak Gain w/o Cable Loss (dBi)
(P/N: DC330011800) Main antenna	Wistron NeWeb Corporation	PIFA	2400-2500MHz <b>2.90 dBi (peak)</b>
			5150-5350MHz <b>5.87 dBi (peak)</b>
			5470-5725MHz ... dBi (peak)
			5725-5850MHz ... dBi (peak)
(P/N: DC330011810) Auxiliary antenna	Wistron NeWeb Corporation	PIFA	2400-2500MHz <b>6.81 dBi (peak)</b>
			5150-5350MHz <b>5.20 dBi (peak)</b>
			5470-5725MHz ... dBi (peak)
			5725-5850MHz ... dBi (peak)

**Cable assembly overview: Cable loss (including connector).**

Designator	Manufacture	Cable type and length	VSWR	Cable Loss (dBi)
(P/N: 50.EBJ02.001) For use with the Main antenna	Well Shine Enterprises Co., Ltd	P/N: C.A WN-S-1.13W -628mm-(2-2-1) 50 ohm Coaxial. Length: 628 mm diameter: 1.13mm Connector: IPEX 20278-101R-13	2400-2500MHz <u>1.3</u> max	2400-2500MHz <u>2.24</u> dBi (peak)
			5150-5350MHz <u>1.4</u> max	5150-5350MHz <u>3.36</u> dBi (peak)
(P/N: 50.EBJ01.001) For use with the Auxiliary antenna	Well Shine Enterprises Co., Ltd	P/N: C.A WN-S-1.13B -493mm-(2-2-1) 50 ohm Coaxial. Length: 493 mm diameter: 1.13mm Connector: IPEX 20278-101R-13	2400-2500MHz <u>1.3</u> max	2400-2500MHz <u>1.81</u> dBi (peak)
			5150-5350MHz <u>1.4</u> max	5150-5350MHz <u>2.72</u> dBi (peak)

Designator	Manufacture	Cable type and length	VSWR	Cable Loss (dBi)
(P/N: 50.EBJ04.001) For use with the Main antenna	SPEED TECH CORP.	P/N: C.A ST-1W-1.13W -N-628mm-(2-2-1) 50 ohm Coaxial. Length: 628 mm diameter: 1.13mm Connector: WNC connector	2400-2500MHz <u>1.3</u> max	2400-2500MHz <u>2.24</u> dBi (peak)
			5150-5350MHz <u>1.4</u> max	5150-5350MHz <u>3.36</u> dBi (peak)
(P/N: 50.EBJ03.001) For use with the Auxiliary antenna	SPEED TECH CORP.	P/N: C.A ST-1W-1.13B -N-493mm-(2-2-1) 50 ohm Coaxial. Length: 493 mm diameter: 1.13mm Connector: WNC connector	2400-2500MHz <u>1.3</u> max	2400-2500MHz <u>1.81</u> dBi (peak)
			5150-5350MHz <u>1.4</u> max	5150-5350MHz <u>2.72</u> dBi (peak)

**NOTE:**

For Japan, Korea, and China the antenna data is the same as what this document requests:

• Please insert dimensioned photo or dimensioned drawing of main antenna here.

UNIT: MM

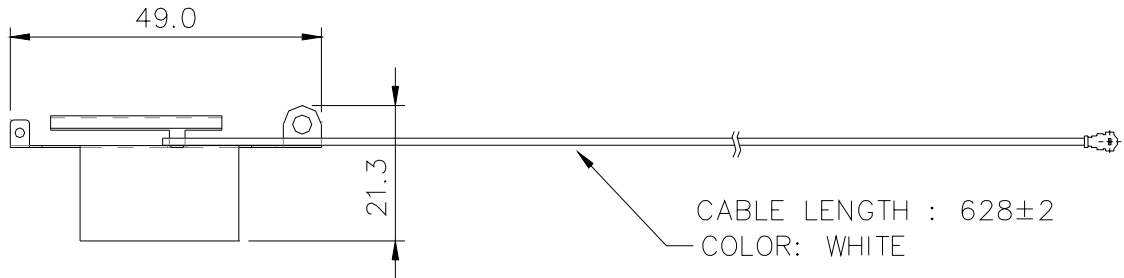

Please insert dimensioned photo or dimensioned drawing of aux antenna here.

UNIT: MM

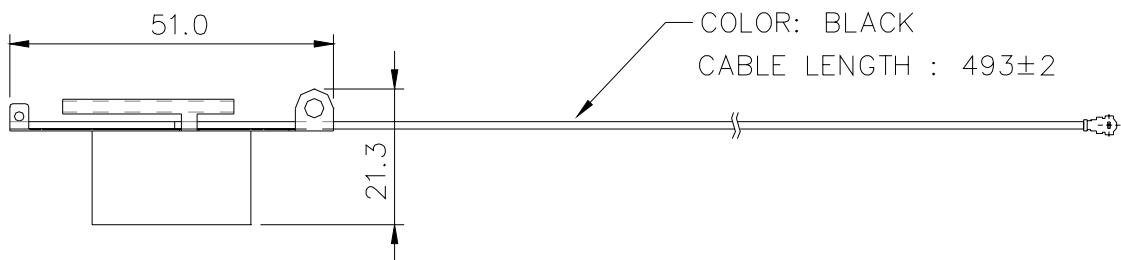

## Radiation characteristic of antennae Loaded (In Host System)

### 2400-2500MHz radiation characteristic

Main antenna: 2400 MHz

Main Antenna @ 2.40 GHz

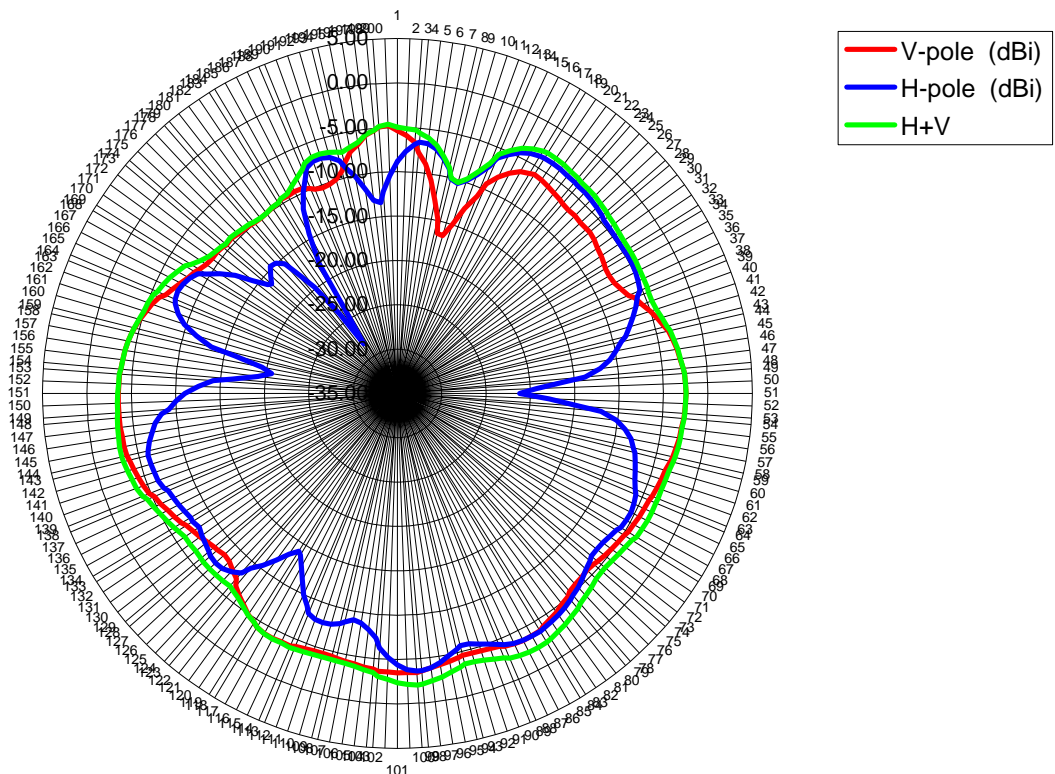

Center Frequency	<b>2400 MHz</b>
Horizontal (dBi) peak	<b>-2.46</b>
Vertical (dBi) peak	<b>-3.66</b>
Horz+Vert (dBi) peak	<b>-0.57</b>

Main antenna: 2450 MHz

Main Antenna @ 2.45 GHz

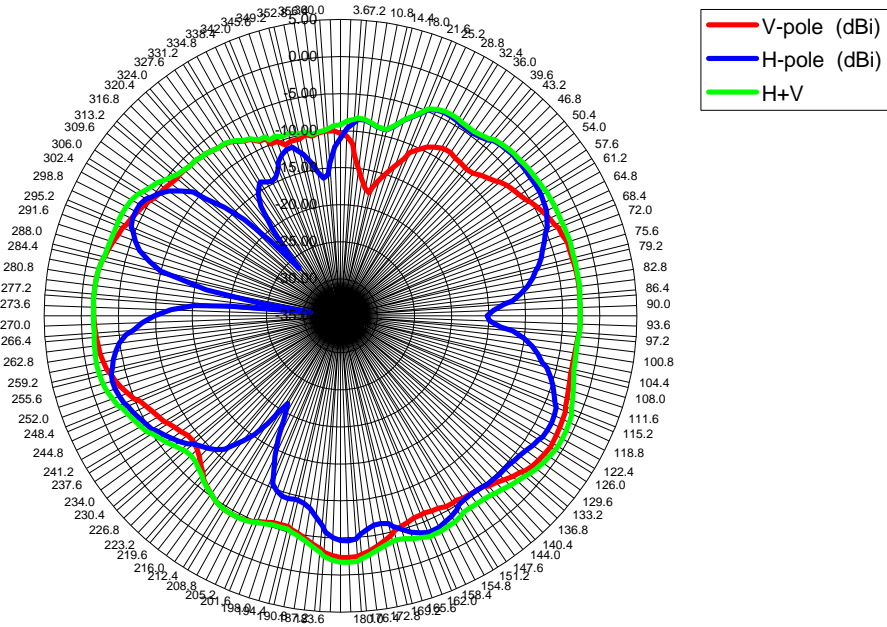

Center Frequency	<b>2450 MHz</b>
Horizontal (dBi) peak	<b>-1.58</b>
Vertical (dBi) peak	<b>-2.95</b>
Horz+Vert (dBi) peak	<b>0.66</b>

Main antenna: 2500 MHz

Main Antenna @ 2.50 GHz

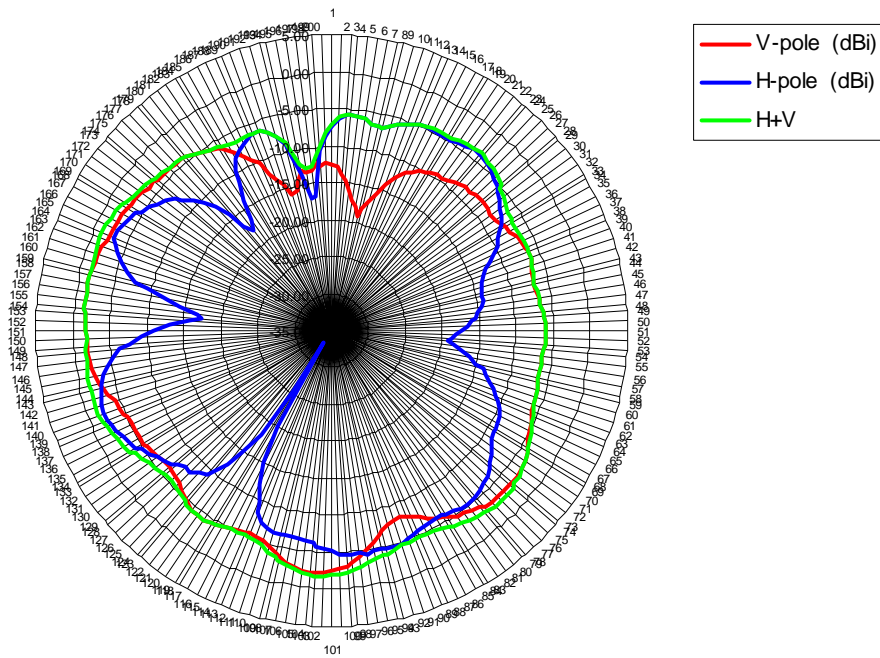

Center Frequency	<b>2500 MHz</b>
Horizontal (dBi) peak	<b>-1.40</b>
Vertical (dBi) peak	<b>-2.25</b>
Horz+Vert (dBi) peak	<b>0.27</b>

### Auxiliary antenna: 2400 MHz

Aux Antenna @ 2.40 GHz

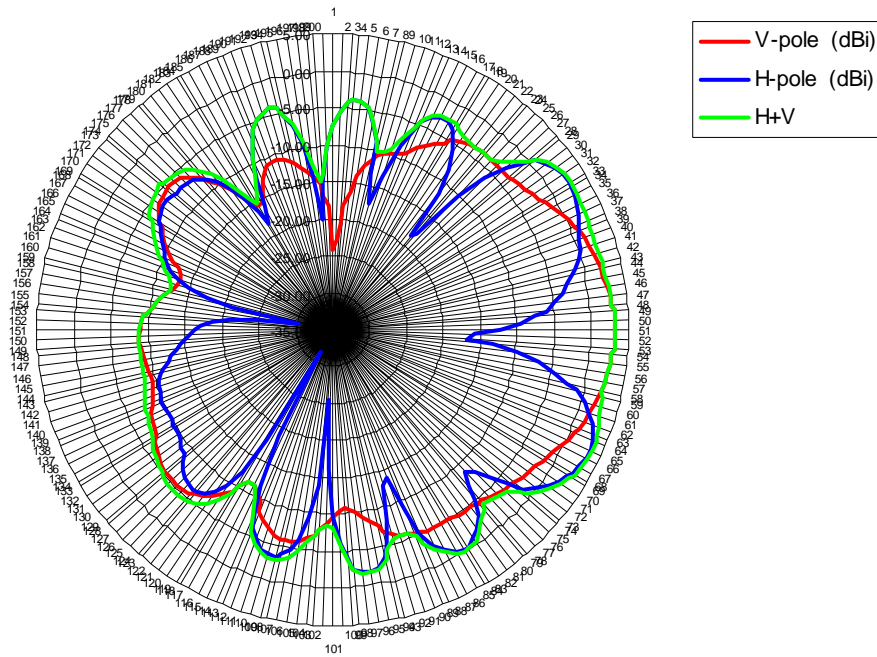

Center Frequency	<b>2400 MHz</b>
Horizontal (dBi) peak	<b>3.16</b>
Vertical (dBi) peak	<b>3.28</b>
Horz+Vert (dBi) peak	<b>5.00</b>



Auxiliary antenna: 2450 MHz

Aux Antenna @ 2.45 GHz

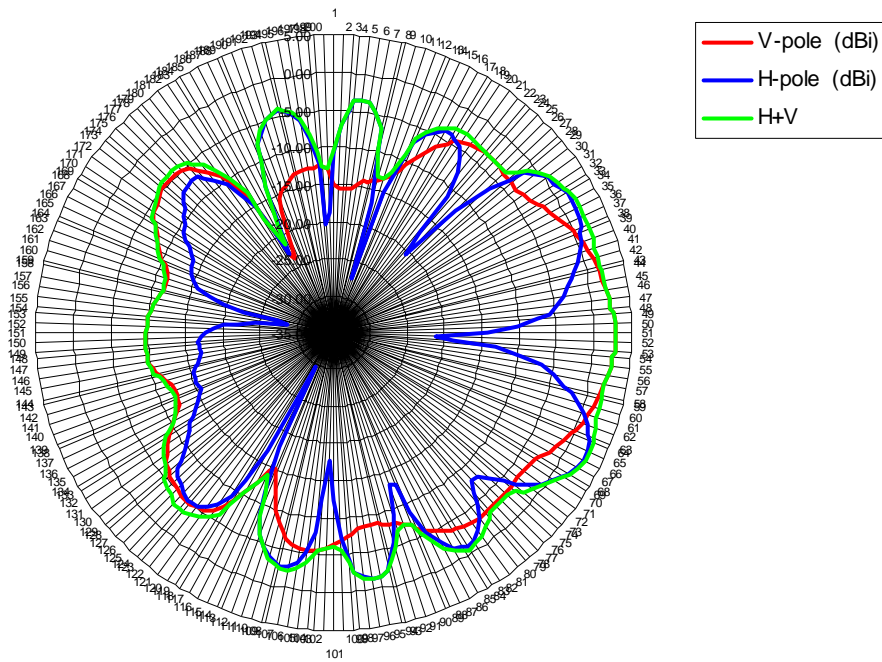

Center Frequency	<b>2450 MHz</b>
Horizontal (dBi) peak	<b>2.83</b>
Vertical (dBi) peak	<b>2.47</b>
Horz+Vert (dBi) peak	<b>4.17</b>

Auxiliary antenna: 2500 MHz

Aux Antenna @ 2.50 GHz

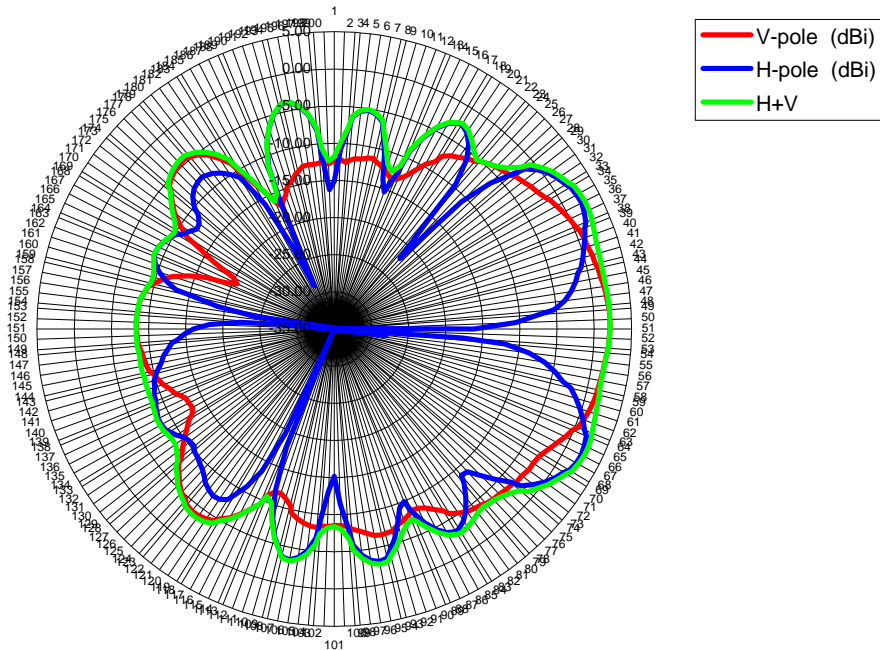

Center Frequency	<b>2500 MHz</b>
Horizontal (dBi) peak	<b>2.11</b>
Vertical (dBi) peak	<b>2.32</b>
Horz+Vert (dBi) peak	<b>4.17</b>

## 5150-5135 MHz radiation characteristic

### Main antenna: 5150 MHz

Main Antenna @ 5.15 GHz

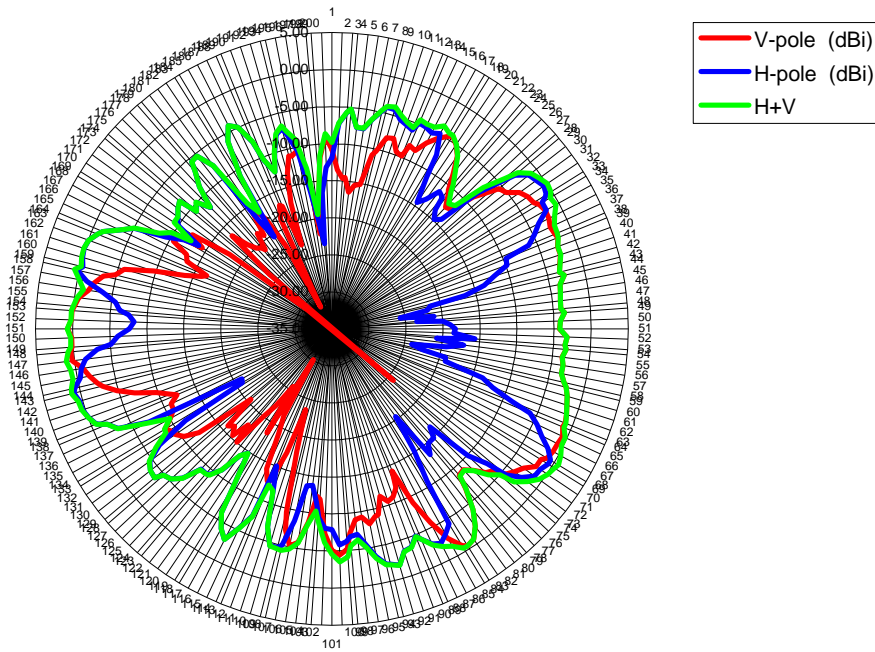

Center Frequency	<b>5150 MHz</b>
Horizontal (dBi) peak	<b>0.68</b>
Vertical (dBi) peak	<b>0.89</b>
Horz+Vert (dBi) peak	<b>2.51</b>

Main antenna: 5250 MHz

Main Antenna @ 5.25 GHz

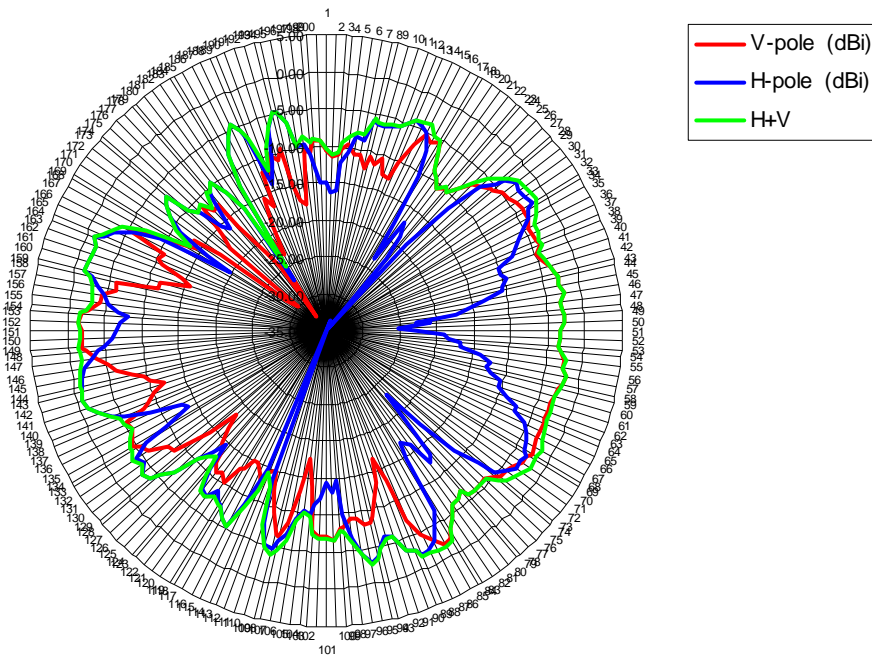

Center Frequency	<b>5250 MHz</b>
Horizontal (dBi) peak	<b>-1.55</b>
Vertical (dBi) peak	<b>-0.70</b>
Horz+Vert (dBi) peak	<b>0.08</b>

Main antenna: 5350 MHz

Main Antenna @ 5.35 GHz

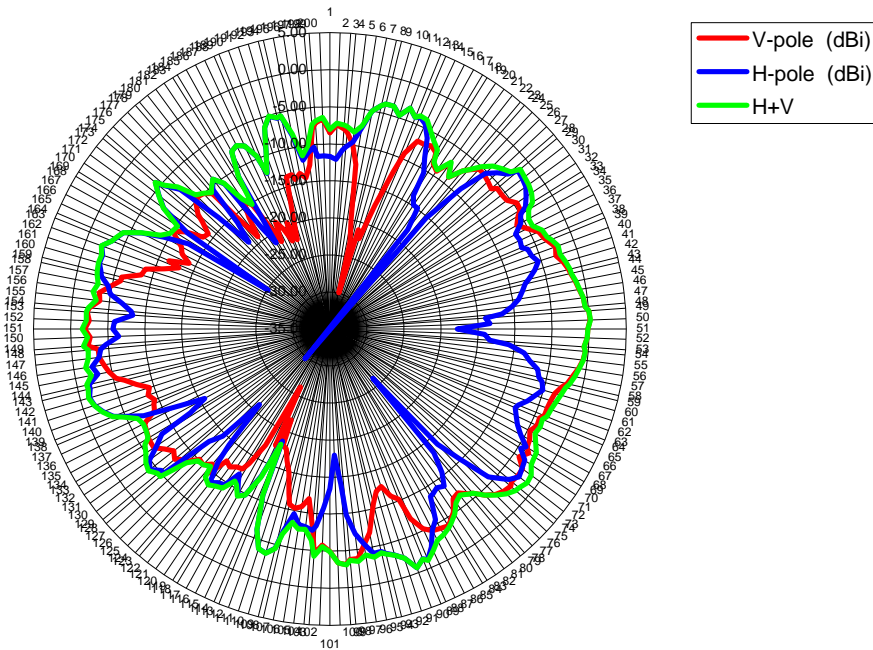

Center Frequency	<b>5350 MHz</b>
Horizontal (dBi) peak	<b>0.14</b>
Vertical (dBi) peak	<b>-0.71</b>
Horz+Vert (dBi) peak	<b>0.33</b>

### Auxiliary antenna: 5150 MHz

Aux Antenna @ 5.15 GHz

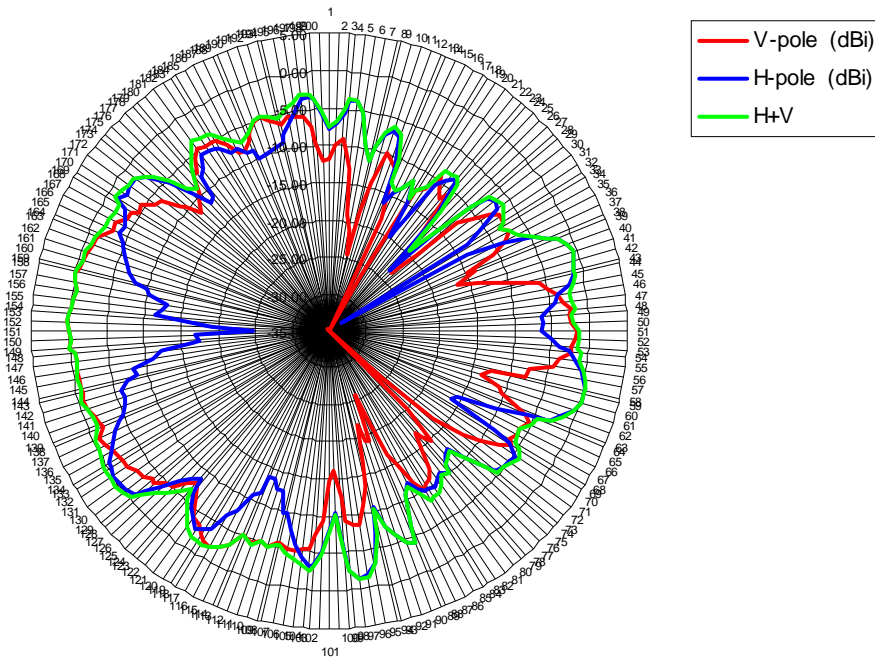

Center Frequency	<b>5150 MHz</b>
Horizontal (dBi) peak	<b>0.22</b>
Vertical (dBi) peak	<b>0.21</b>
Horz+Vert (dBi) peak	<b>1.89</b>

Auxiliary antenna: 5250 MHz

Aux Antenna @ 5.25 GHz

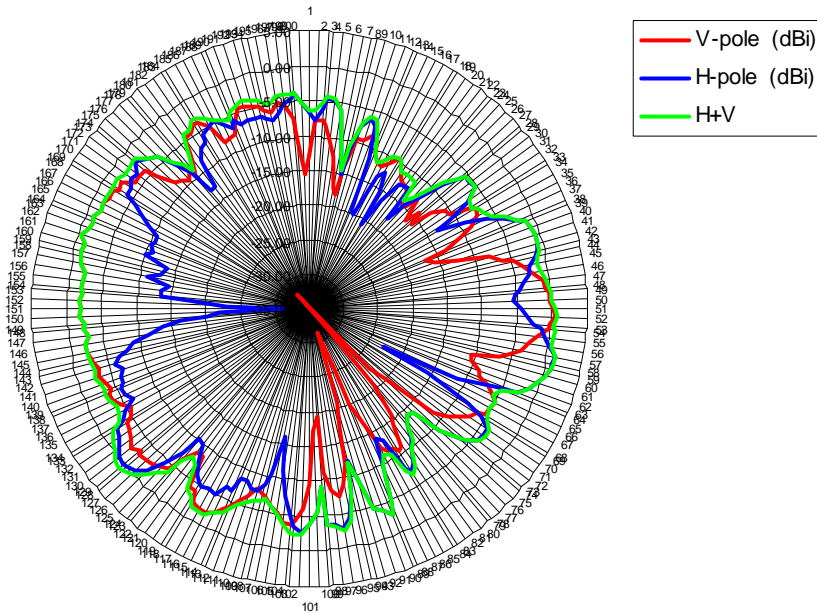

Center Frequency	<b>5250 MHz</b>
Horizontal (dBi) peak	<b>0.29</b>
Vertical (dBi) peak	<b>1.06</b>
Horz+Vert (dBi) peak	<b>2.08</b>

Auxiliary antenna: 5350 MHz

Aux Antenna @ 5.35 GHz

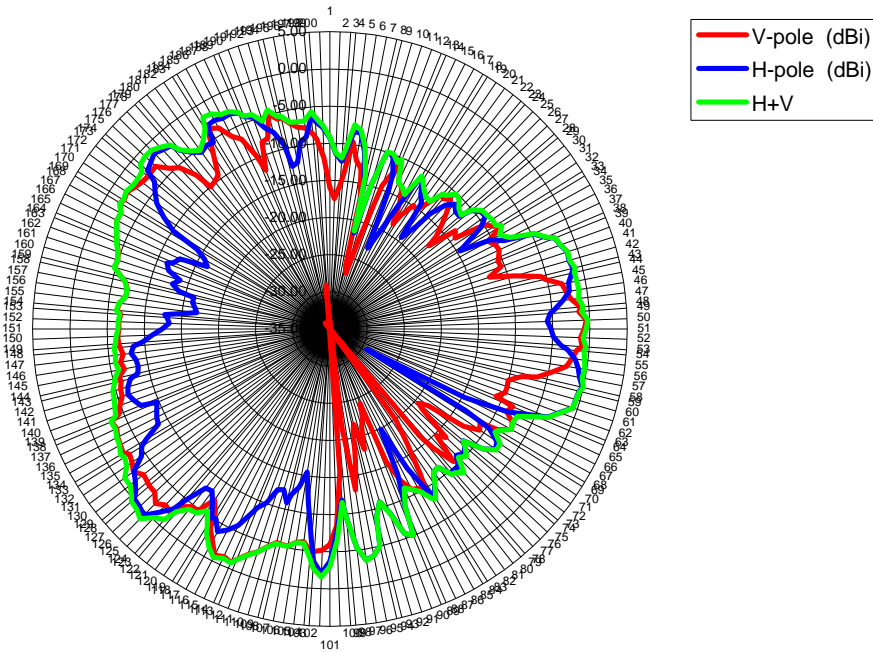

Center Frequency	<b>5350 MHz</b>
Horizontal (dBi) peak	<b>-0.49</b>
Vertical (dBi) peak	<b>0.45</b>
Horz+Vert (dBi) peak	<b>2.48</b>



## Host PC Information

Host model: TM290

Please insert dimensioned photos or dimensioned drawings of aux and main antenna placements.

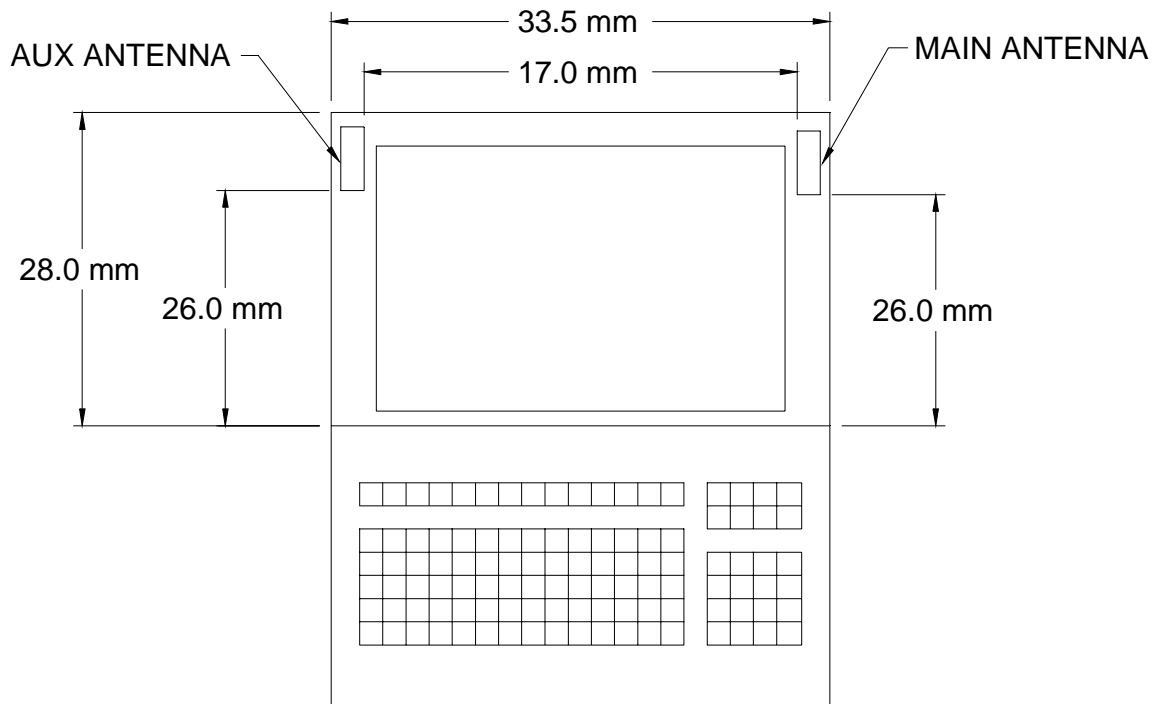

Please insert dimensioned photos or dimensioned drawings showing the distance (mm) between the transmit (main) antenna and the user (excluding hands, wrist, feet, and ankle)

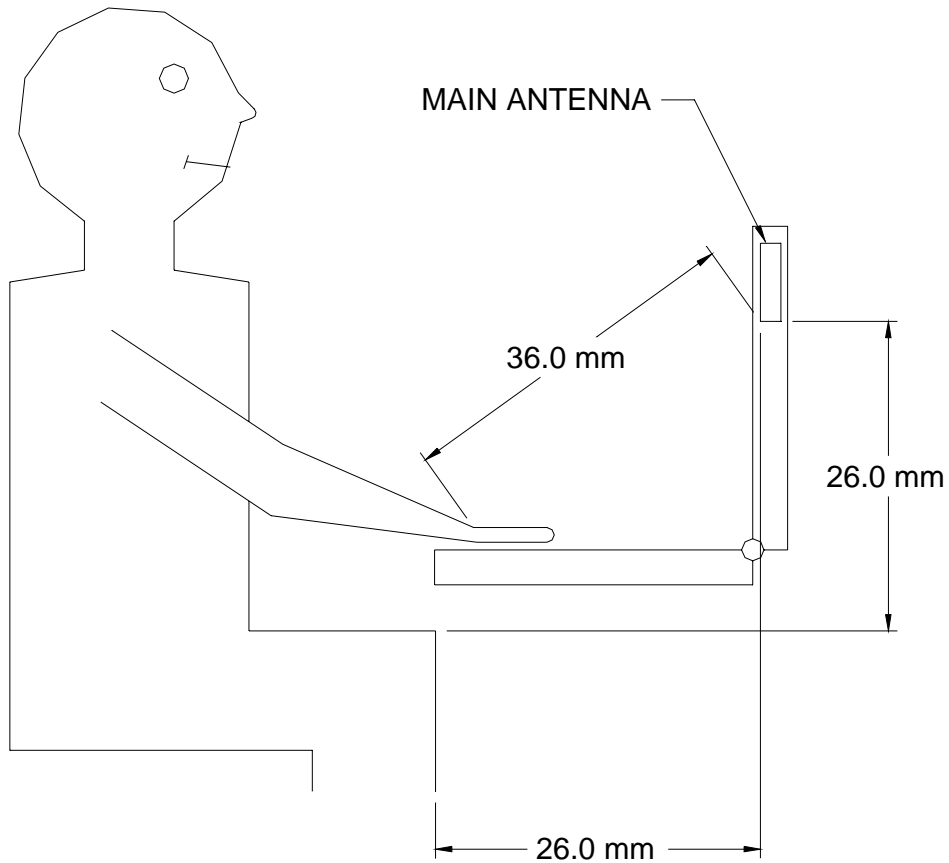

## Diagram Example of Co-Location Antenna Separation

Should indicate distance between WLAN module antennas and Bluetooth antenna element.

(Note: Due to the evolving rules regarding co-location each platform and/or system will need to be reviewed on a case by case basis)

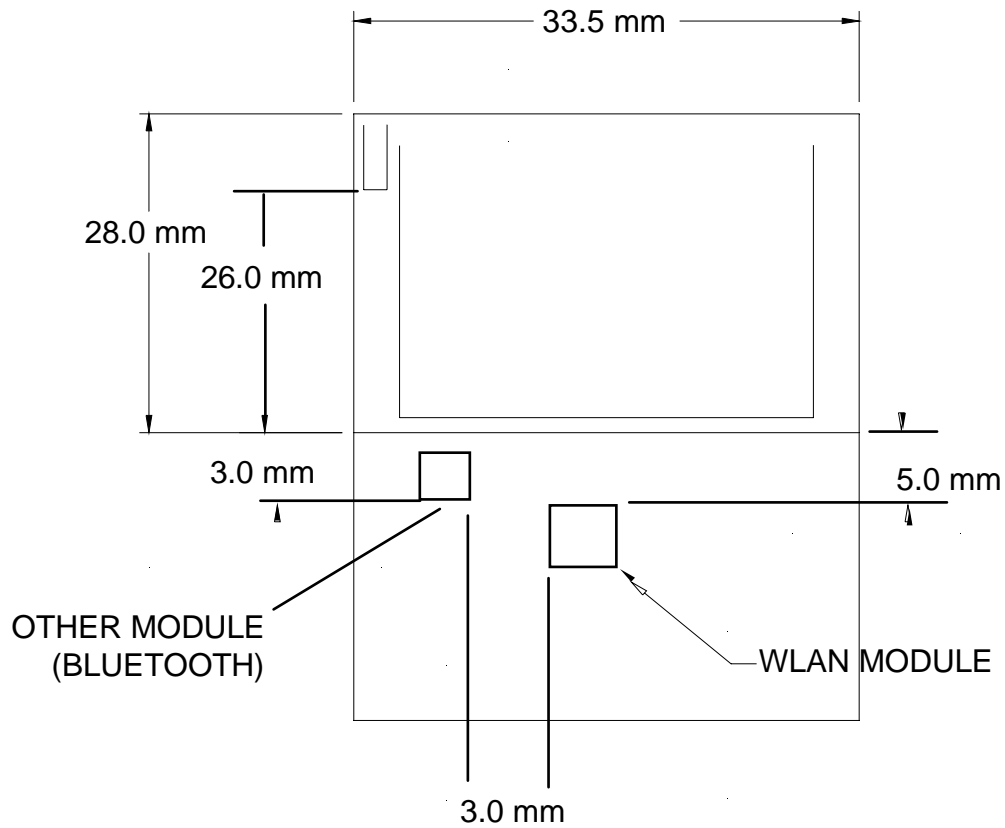

## APPENDIX I

### Intel's Antenna review process:

1. Regulatory Program Manager receives OEM antenna information.
2. Regulatory Program Manager will arrange an, Antenna information review. Provide feedback and request information not provided.
3. Then assign the OEMs a time line.
4. Check for the following below:
  - VSWR
  - Main & Aux antenna (Peak Gain W/ cable loss)
  - Main & Aux antenna (Peak Gain only)
  - Main & Aux antenna (Cable loss W/ connector)
  - Mechanical Drawings of Main & Aux. antenna
  - Radiation Characteristic of antenna Loaded (In a host system)
  - Max allowable input power
  - Manufacturer Name
  - Manufacturer Type

The information above is what this document is!

**INTEL OEM / ODM, ANTENNA REGULATORY INFORMATION CHECKLIST**

Description of Information Received	Received	Date
VSWR of cable including connector		
Main & Aux antenna (Peak Gain W/ cable loss)		
Main & Aux antenna (Peak Gain only)		
Main & Aux antenna (Cable loss W/ connector)		
Mechanical Drawings of Main & Aux. antenna		
Radiation Characteristic of antenna Loaded (In a host system)		
Max allowable input power		
Designator / Part number of antenna assembly		
Designator for Antenna only		
Manufacturer Name		
Manufacturer Type		