



**AEGIS LABS INC.**



Modular Approval  
Test Report  
And Application for Grant of Equipment Authorization

Pertaining To:

EUT	FCC ID:
<b>802.11b/g MiniPCI Type 3B Wireless Adapter, MN: WM3B2200BG</b>	<b>PD9WM3B2200BG</b>

Configuration
<b>802.11b / 802.11g</b>

*MEASUREMENTS PERFORMED IN ACCORDANCE WITH*

Regulatory Standard(s)
------------------------

**47 CFR Part 15, Subpart C Section 15.247**

Test Method:

ANSI C63.4: 1992 American National Standard for Methods of Measurement of Radio-Noise Emissions from Low-Voltage Electrical and Electronic Equipment in the Range of 9 kHz to 40 GHz



Certificate Number: 1111.01

**APPLICANT:**

Intel Corporation  
EC2-02 13280 Evening Creek Drive  
San Diego, California 92128

Contact(s): Mr. James K. Baer

**PREPARED BY:**

Aegis Labs, Inc.  
22431 Antonio Parkway B160-417  
Rancho S. Margarita, CA 92688

Agent(s): Mr. Steve Kuiper  
Mr. Rick Candelas

	REPORT BODY	APPENDICES	TOTAL PAGES
PAGES	15	A 81	96

Test Report #: INTEL-031111F  
Test Report Revision: Rev. C, 12-12-2003

The contents of this report shall not be reproduced except in full, without the written approval of Aegis Labs, Inc.

Page 1 of 15  
Report Number: INTEL-031111F  
FCC ID: PD9WM3B2200BG



# TABLE OF CONTENTS

SECTION	TITLE	PAGE
	<b>COVER SHEET.....</b>	<b>01</b>
	<b>TABLE OF CONTENTS.....</b>	<b>02</b>
<b>1.0</b>	<b>CERTIFICATION OF TEST DATA.....</b>	<b>03</b>
<b>2.0</b>	<b>SUMMARY OF TEST RESULTS.....</b>	<b>04</b>
<b>3.0</b>	<b>ADMINISTRATIVE DATA AND TEST DESCRIPTION.....</b>	<b>05</b>
<b>4.0</b>	<b>DESCRIPTION OF EUT.....</b>	<b>06</b>
4.1	EUT Description.....	06
4.1.1	Channel Number and Frequencies.....	07
4.2	EUT Configuration.....	08
4.3	List of EUT Sub-Assemblies and Host Equipment.....	09
4.4	I/O Cabling Diagram and Description.....	10
<b>5.0</b>	<b>TEST EQUIPMENT AND TEST SETUPS.....</b>	<b>11</b>
5.1	AC Power Line Conducted Emissions.....	11
5.2	Spurious Radiated Emissions.....	12
5.3	Conducted Emissions At The Antenna Port.....	12
5.4	Test and Measurement Equipment Used.....	13
<b>6.0</b>	<b>SAMPLE CALCULATIONS.....</b>	<b>14</b>
<b>7.0</b>	<b>MODIFICATIONS AND RECOMMENDATIONS.....</b>	<b>15</b>

## APPENDICES

<b>A</b>	Test Data
----------	-----------



AEGIS LABS INC.

## 1.0 CERTIFICATION OF TEST DATA

Aegis Labs, Inc. operates as both a Nevada and California Corporation with no organizational or financial relationship with any company, institution, or private individual.

Testing and engineering functions provided by Aegis Labs are furnished through the use of part-time, full-time or consulting engineers with the appropriate qualifications to carry out their duties. The intended purpose of this test report is to describe the measurement procedure and to determine whether the equipment under test "EUT" complies with both the conducted and radiated limits. Limits for emissions testing are described under Subpart C of Part 15 of the FCC rules.

The data, data evaluation and equipment configuration represented herein are a true and accurate representation of the Equipment Under Test (EUT) under the requirements specified in the emissions standard as described below. The test results contained in this report are only representative of the test sample tested as described in Section 3.0 of this report. Certification of the EUT is required as a prerequisite to marketing as defined in Part 2 of the FCC Rules.

**Prepared By:**

11/19/03

**Rick Candelas**  
**Staff Engineer**  
**Aegis Labs, Inc.**

**Date:**

**Report Approved By:**

11/19/03

**Steve J. Kuiper**  
**Quality Assurance Manager**  
**Aegis Labs, Inc.**

**Date:**

*Page 3 of 15*

*Report Number: INTEL-031111F*

*FCC ID: PD9WM3B2200BG*



AEGIS LABS INC.

## 2.0 SUMMARY OF TEST RESULTS

The test results provided within this report, indicate that the EUT has been found to be in **COMPLIANCE** with the test specifications based upon the following RF compliance standards:

Pass/Fail determination is based upon the nominal values of the test data.

EMISSIONS STANDARD			
FCC Part 15 Section	Description	Results	Comments
15.247(a)(2)	The minimum 6dB bandwidth shall be at least 500 kHz.	PASSED	See Data Sheets
15.247(b)(1)	The maximum peak output power of the intentional radiator shall not exceed 1 watt.	PASSED	See Data Sheets
15.247(b)(4)	The intentional radiator shall be operated in a manner that ensures that the public is not exposed to radio frequency energy levels in excess of the FCC guidelines per Section 1.1307(b)(1).	PASSED	Refer to MPE Calculations Exhibit
15.247(c)	In any 100 kHz bandwidth outside the frequency band in which the spread spectrum intentional radiator is operating, the radio frequency power that is produced by the intentional radiator shall be at least 20 dB below that in the 100 kHz bandwidth within the band that contains the highest level of the desired power.	PASSED	See Data Sheets
15.247(c)	Radiated emissions, which fall in the restricted bands, as defined in Sec. 15.205(a), must also comply with the radiated emission limits specified in Sec. 15.209(a). All others must be < -20dBc.	PASSED	See Data Sheets
15.247(d)	The peak power spectral density conducted from the intentional radiator to the antenna shall not be greater than 8 dBm in any 3 kHz band during any time interval of continuous transmission.	PASSED	See Data Sheets
15.207	AC Conducted Emissions	PASSED	See Data Sheets
15.209	Radiated Emissions (30-1000 MHz)	PASSED	See Data Sheets

Page 4 of 15

Report Number: INTEL-031111F

FCC ID: PD9WM3B2200BG



AEGIS LABS INC.

### 3.0 ADMINISTRATIVE DATA AND TEST DESCRIPTION

<b>DEVICE TESTED:</b>	ITE Type: 802.11b/g MiniPCI Type 3B Wireless Adapter Model Number(s): WM3B2200BG Serial Number: 000E35005267 FCC ID: PD9WM3B2200BG
<b>TEST DATE(S):</b>	November 11-18, 2003
<b>DATE EUT RECEIVED:</b>	November 11, 2003
<b>ORIGIN OF TEST SAMPLE(S):</b>	Pre-Production Unit
<b>RESPONSIBLE PARTY:</b>	Intel Corporation EC2-02 13280 Evening Creek Drive San Diego, California 92128
<b>CLIENT CONTACT:</b>	Mr. James K. Baer
<b>MANUFACTURER:</b>	Intel Corporation
<b>TEST LOCATION:</b>	Aegis Labs, Inc. 32231 Trabuco Creek Road Trabuco Canyon, CA 92678 Conducted Site #2 Radiated Site #2
<b>A2LA CERTIFICATE:</b>	1111.01, Valid through February 28, 2004
<b>PURPOSE OF TEST:</b>	To demonstrate compliance with the relevant standards described in Section 2.0 of this report.
<b>TEST(S) PERFORMED:</b>	Refer to Table in Section 2.0 of this report.

All calibration vendors were responsible for certifying Aegis Labs, Inc. test equipment as per the manufacturer's specifications and that the equipment is calibrated using instruments and standards where the accuracy is traceable to the National Institute of Standards and Technology (NIST). Calibration of all test equipment conforms to ANSI/NCSL Z540-1 and ISO 10012-1 and/or ISO/IEC Guide 17025 compliance (Additionally, other pertinent test equipment will carry MIL-STD-45662A). All calibration documents are on file with Aegis Labs, Inc., with copies provided upon request.

Page 5 of 15  
Report Number: INTEL-031111F  
FCC ID: PD9WM3B2200BG



## 4.0 DESCRIPTION OF EUT

### 4.1 EUT Description

<b>Equipment Under Test (EUT)</b>	
<b>Trade Name:</b>	802.11b/g MiniPCI Type 3B Wireless Adapter
<b>Model Number:</b>	WM3B2200BG
<b>Frequency Range:</b>	2.412 – 2.462 GHz
<b>Type of Transmission:</b>	Direct Sequence Spread Spectrum
<b>Transfer Rate:</b>	1/2/5.5/11 Mbps for 802.11b mode 6/36/54 Mbps for 802.11g mode
<b>Number of Channels:</b>	11
<b>Modulation Type:</b>	DBPSK, DQPSK, CCK
<b>Antenna Type:</b>	Hirose U.FL-R-SMT mates with cable connector U.FL-LP-066
<b>Antenna Gain (See Note 2):</b>	Hitachi Antenna = 1.67dBi Ethertronics Antenna = 2.00dBi
<b>Transmit Output Power:</b>	17 dBm (Typical) for 802.11b mode 16 dBm (Typical) for 802.11g mode Please see Appendix A (Data Sheets) for actual output power.
<b>Power Supply:</b>	3.3VDC from computer MPCPI slot.
<b>Number of External Test Ports Exercised:</b>	2 Antenna Ports (1 Main & 1 Auxiliary)

The 802.11b/g MiniPCI Type 3B Wireless Adapter is an embedded 2.4 GHz Wireless Local Area Network Mini-PCI adapter. The Mini-PCI Type 3B form factor is designed for notebook computer systems where overall thickness must be kept to an absolute minimum. It is capable of a data rate of up to 11 Mbps in 802.11b mode and 54 Mbps in 802.11g mode. Please refer to section 4.2 of this report for a further description.

**NOTE 1:** For a more detailed description, please refer to the manufacture's specifications or User's Manual.

**NOTE 2:** The EUT was tested separately with two different sets of antennas (Hitachi and Ethertronics). The "Hitachi Antenna Specification" list a 1.67dBi peak gain. The "Ethertronics Antenna Specification" list a 1.18dBi gain, which was measured with the cable installed at the main antenna port. (Refer to each antenna specifications).



**AEGIS LABS INC.**

#### 4.1.1 Channel Number and Frequencies

Eleven channels are provided for the EUT.

<b>Channel</b>	<b>Frequency (MHz)</b>
1	2412
2	2417
3	2422
4	2427
5	2432
6	2437
7	2442
8	2447
9	2452
10	2457
11	2462



AEGIS LABS INC.

## 4.2 EUT Configuration

The EUT was tested installed in the Mini-PCI slot of the Hewlett Packard host computer as a modular device using a PCI extender board to extend the EUT outside the computer chassis. The EUT was then connected to a set of antennas via its Main and AUX antenna ports. Data for a set of Hitachi and Ethertronics dual band antennas can be found in Appendix A (Data Sheets)

For conducted emissions at the AC mains port and radiated emissions, the Hewlett Packard host computer was connected to a Zoom modem, Canon printer, Dell monitor, Hewlett Packard keyboard, and Hewlett Packard mouse via its serial, parallel, video, keyboard, and mouse ports respectively.

The low (channel 1), middle (channel 6), and high (channel 11) were tested in 802.11b & g modes. Also, the EUT was tested once transmitting from the MAIN antenna port and once transmitting from the AUX antenna port. The EUT was transmitting and receiving on a continuous basis.

*Page 8 of 15*

*Report Number: INTEL-031111F*

*FCC ID: PD9WM3B2200BG*





#### 4.3 List of EUT, Sub-Assemblies, and Host Equipment

<b>LIST OF EUT AND SUB-ASSEMBLIES</b>			
<b>Equipment Name</b>	<b>Manufacturer</b>	<b>Model Number</b>	<b>Serial Number</b>
802.11b/g MiniPCI Type 3B Wireless Adapter	Intel Corporation	WM3B2200BG	000E35005267
<b>EUT Sub-Assemblies</b>			
Auxiliary Triple Band Antenna	Hitachi	None	N/A
Main Triple Band Antenna	Hitachi	None	N/A
Auxiliary Multi Band Antenna	Ethertronics	PCI01001	N/A
Main Multi Band Antenna	Ethertronics	PCI01001	N/A

<b>HOST EQUIPMENT LIST</b>			
<b>Equipment Name</b>	<b>Manufacturer</b>	<b>Model Number</b>	<b>Serial Number</b>
Computer	Hewlett Packard	Pavillion a300n	MXK3391864
LCD Monitor	Dell	E151FPp	CN-06R644-47804-34R-LATL
Keyboard	Hewlett Packard	5183	BF33339165
Mouse	Hewlett Packard	M042KC	30870136

NOTE: All the power cords of the above support equipment are standard non-shielded, 1.8 meters long.



#### 4.4 I/O Cabling Diagram and Description

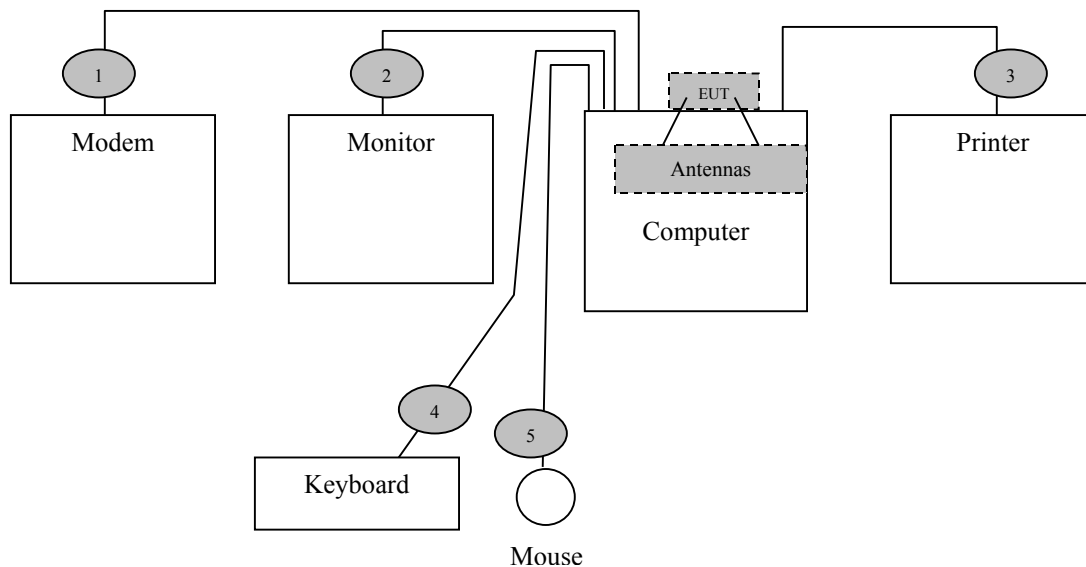

- Cable 1: This is a 6-foot braid and foil shielded round cable connecting the Hewlett Packard host computer with the Zoom modem. It has metallic DB-9 type connector at the computer end and a metallic DB-25 type connector at the modem end. The cable is bundled to a length of one meter and the shield of the cable is grounded to the chassis of both devices via the connector shells.
- Cable 2: This is a 6-foot braid and foil shielded round cable connecting the Hewlett Packard host computer with the Dell LCD monitor. It has metallic DB-15 type connector at the computer end and is hardwired to the monitor. The cable is bundled to a length of one meter and the shield of the cable is grounded to the chassis of both devices via the connector shells.
- Cable 3: This is a 6-foot braid and foil shielded round cable connecting the Hewlett Packard host computer to the Canon printer. It has a metallic DB-25 type connector at the computer end and a metallic centronics type connector at the printer end. The cable is bundled to a length of one meter and the shield of the cable is grounded to the chassis of both devices via the connector shells.
- Cable 4: This is a 6-foot braid and foil shielded round cable connecting the Hewlett Packard host computer to the Hewlett Packard keyboard. It has a metallic 6-pin mini din type connector at the computer end and is hardwired to the keyboard. The shield of the cable is grounded to the chassis of the computer via the connector shell.
- Cable 5: This is a 6-foot braid and foil shielded round cable connecting the Hewlett Packard host computer to the Hewlett Packard mouse. It has a metallic 6-pin mini din type connector at the computer end and is hardwired to the mouse. The shield of the cable is grounded to the chassis of the computer via the connector shell.



AEGIS LABS INC.

## 5.0 TEST EQUIPMENT AND TEST SETUPS

The test equipment settings and functions are selected using the guidance of ANSI C63.4-1992. All test equipment setups and operations during conducted and radiated emissions testing are in accordance with this reference document.

### 5.1 AC Power Line Conducted Emissions

During conducted emissions measurements, a spectrum analyzer was used as the measuring instrument along with a preselector and quasi-peak detector. A 10 dB attenuation pad was used for the protection of the spectrum analyzer input stage. The conducted emissions from the EUT in the frequency range from 150 kHz to 30 MHz were captured for graphical display through the use of automated LABVIEW EMI measurement software. All graphical readings were measured in the “Peak” mode only to reduce testing time. Upon completion of the graphical scan, the test lab personnel performed the conducted measurement scan manually using the spectrum analyzer front panel keys. All peak measurements coming within 3 dB of the limit line were “Averaged” and/or “Quasi-Peaked” and denoted appropriately in the EXCEL spreadsheet.

The Equipment Under Test (EUT) was configured as a system with peripherals connected, so that at least one interface port of each type is connected to one external peripheral when tested for conducted emissions according to ANSI C63.4: 1992. Excess power cord length was wrapped in a bundle 30 to 40 centimeters in length near the center of the cord. The EUT was tested in a tabletop configuration.

The emission readings for Line 1 and Line 2 are highlighted on the data sheets in Appendix A. The graphical scans only reflect peak readings while the tabulated data sheets reflect peak, average, and/or quasi-peak readings which ever applies.



AEGIS LABS INC.

## 5.2 Spurious Radiated Emissions

A spectrum analyzer was used as the measuring instrumentation along with a preselector and quasi-peak-detector. The pre-amplifiers were used to increase the sensitivity of the instrument. The spectrum analyzer was used in the peak detector mode with the “max-hold” feature activated and in Positive Peak mode. In this mode, the spectrum analyzer records the highest measured reading over all the sweeps. The quasi-peak detector was used only for those readings, which are marked accordingly in the data sheet. The effective measurement bandwidth used for the radiated emissions test was 120 kHz for (30 MHz- 1000 MHz). The spectrum analyzer operated such that the modulation of the signal was filtered out to set the analyzer in linear mode. For testing beyond 1000 MHz a spectrum analyzer capable of taking reading above 1000 MHz was connected to the high frequency amplifier, where these measurement readings were taken with the transducer placed at a 3-meter test distance from the EUT.

The Open Area Test Sites (OATS) was used for radiated emission testing. These test sites are designed according to ANSI C63.4: 1992 and ANSI C63.7: 1992 guidelines. The Measurements were conducted in accordance with ANSI C63.4: 1992 and ANSI C63.7: 1992 requirements.

Broadband biconical, log periodic, and horn antennas were used as transducers during the measurement reading phase. The frequency spans were wide (30 MHz-88 MHz, 88 MHz- 216 MHz, 216 MHz- 300 MHz, and 300 MHz- 1000 MHz). After 1000 MHz the horn antenna was used to measure emissions. The emission readings in both horizontal and vertical polarities are highlighted on the data sheets in Appendix A.

## 5.3 Conducted Emissions at the Antenna Port

A spectrum analyzer or power meter was used as the measuring instrumentation along with an attenuator and/or filter connected to the EUT antenna port. The attenuator and filters are used to ensure that the front end of the measurement instrument is not overloaded by the fundamental transmission. . The instruments recorded the measured readings with the bandwidths (video and resolution) set in accordance with the FCC Rules and regulations.

For the power out measurements an oscilloscope along with a schottkey detector diode, 12dB attenuator, and a signal generator were used to perform the measurements.

The measured readings are on the data sheets in Appendix A.

*Page 12 of 15*

*Report Number: INTEL-031111F*

*FCC ID: PD9WM3B2200BG*



AEGIS LABS INC.

## 5.4 Test and Measurement Equipment Used

TEST EQUIPMENT USED					
Equipment Name	Manufacturer	Model Number	Serial Number	Calibration Due Date	Calibration Cycle
EMI Receiver - RF Section	Hewlett Packard	85462A	3325A00137	12/16/03	1 Year
EMI Receiver - RF Filter Section	Hewlett Packard	85460A	3330A00138	12/16/03	1 Year
Attenuator - 5W-10dB	Pasternack	PE7014-10	N/A	11/03/04	1 Year
LISN (EUT)	FCC	FCC-LISN-50-25-2	9931	02/20/04	1 Year
LISN (Access)	Com-Power	LI-200	12019	01/25/04	1 Year
LISN (Access)	Com-Power	LI-200	12018	01/25/04	1 Year
Spectrum Analyzer	Agilent	8564EC	4046A00387	02/28/04	2 Years
Preamplifier	Agilent	8449B	3008A01573	04/29/04	2 Years
High Pass Filter	Microwave Circuits, Inc.	H3G020G2	0301DC0132	04/29/04	2 Years
Antenna - Biconical	EMCO	3110	9108-1421	02/11/04	1 Year
Antenna - Log Periodic	EMCO	3148	4947	02/11/04	1 Year
1-18 GHz Antenna - Horn	EMCO	3115	2230	09/14/04	2 Years
18-26.5 GHz Antenna – Horn	Custom Microwave	H042	001	05/09/04	1 Year
Power Meter	Rohde & Schwarz	NRVS	DE30863	07/21/05	2 Years
Power Sensor	Leistungsmesskoph	NRV-Z5	844855/012	07/21/05	2 Years
Oscilloscope	Tektronix	TDS3012B	B028086	08/21/04	1 Year
Schottkey Detector Diode	Narda	4503A	0209	None	None
12dB Attenuator	Narda	4779-12	0203	None	None
Signal Generator	Hewlett Packard	83752A	3610A01906	01/22/04	1 Year
Temperature/Humidity Monitor	Dickson	TH550	7255185	01/18/04	1 Year

Page 13 of 15

Report Number: INTEL-031111F

FCC ID: PD9WM3B2200BG



## 6.0 SAMPLE CALCULATIONS

If a preamplifier is used during the Radiated Emissions Testing, it is required that the amplifier gain be subtracted from the Spectrum Analyzer (Meter) Reading. In addition, a correction factor for the antenna, cable and a distance factor, if any, must be applied to the Meter Reading before a true field strength reading can be obtained. In the Automatic Mode of A.R.M.S. measurements, these considerations are automatically presented as a part of the printout. In the case of manual measurements and for greater efficiency and convenience, usage of the calibration correction factors in the Appendices is necessary to calculate the Corrected Meter Reading. These correlation factors for each meter reading, shall be modified to reflect these correlation factors at each frequency value so that the meter readings can be compared directly to the modified specification limit. This modified specification limit is referred to as the “Corrected Meter Reading Limit” (CML).

The equation shall be derived in the following manner:

$$\text{Corrected Meter Reading} = \text{Meter Reading} + F + C - G - D$$

Where, F = Antenna Factor

C = Cable Factor

G = Amplifier Gain

D = Distance Factor

Therefore, the equation for determining the Corrected Meter Reading Limit (CML) is:

$$\text{CML} = \text{Specification Limit} - F - C + G + D$$

For the manual mode of measurement, a table of corrected meter reading limits shall be used to permit immediate comparison of the meter reading to determine if the measured emission amplitude exceeded the specification limit at that specific frequency. There shall be two calculation sheets done, one for three meter and one for ten-meter measurement distances, where applicable. The correction factors for the antenna and the amplifier gain are attached in the Appendices.



**AEGIS LABS INC.**

## **7.0 MODIFICATIONS AND RECOMMENDATIONS**

No modifications were made to the EUT.

*Page 15 of 15*  
*Report Number: INTEL-031111F*  
*FCC ID: PD9WM3B2200BG*



**AEGIS LABS INC.**

## **APPENDIX A**

### ***TEST DATA***

*Page 1 of 81 (Appendix A)*  
*Report Number: INTEL-031111F*  
*FCC ID: PD9WM3B2200BG*





AEGIS LABS INC.

## AC POWER LINE CONDUCTED EMISSIONS TEST RESULTS

<b>CLIENT:</b>	Intel Corporation	<b>DATE:</b>	11/18/03
<b>EUT:</b>	802.11b/g MiniPCI Type 3B Wireless Adapter	<b>PROJECT NUMBER:</b>	INTEL-031111-11
<b>MODEL NUMBER:</b>	WM3B2200BG	<b>TEST ENGINEER:</b>	Rick Candelas
<b>SERIAL NUMBER:</b>	000E35005267	<b>SITE #:</b>	2
<b>CONFIGURATION:</b>	Tested installed in the Hewlett Packard host computer's mini PCI slot.	<b>TEMPERATURE:</b>	26 C
		<b>HUMIDITY:</b>	30% RH
		<b>TIME:</b>	3:00 PM

<b>Standard:</b>	FCC CFR 47, Part 15.207
<b>Description:</b>	AC Power Line Conducted Emissions
<b>Results:</b>	Passes the conducted limits by -3.70@ 0.8835 MHz

Conducted Limits		
Frequency (MHz)	Quasi-Peak Limit (dBuV)	Average Limit (dBuV)
0.15-0.5	66 to 56*	56 to 46*
0.5-5	56	46
5-30	60	50

\*Decreases with the logarithm of the frequency.

NOTE: During preliminary scans, there wasn't any difference which channel or data rate was used with the EUT; therefore only Channel 1 at a data rate of 1 Mbps was used for final testing. Also, the scan was only done with the Ethertronics set of antennas.

Page 2 of 81 (Appendix A)  
Report Number: INTEL-031111F  
FCC ID: PD9WM3B2200BG



AEGIS LABS INC.

AC Power Line Conducted Emissions Test Results (Continued)

CONDUCTED EMISSIONS – LINE 1						
Freq. (MHz)	Meter Reading (dBuV)	Detector (PK/QP/AV)	Average Limit (dBuV)	Average Delta(dB)	Quasi-Peak Limit (dBuV)	Quasi-Peak Delta(dB)
0.1629	49.90	PK	55.63	-5.73	65.63	-15.73
0.2427	42.80	PK	53.35	-10.55	63.35	-20.55
0.3975	41.50	PK	48.93	-7.43	58.93	-17.43
0.9483	39.40	PK	46.00	-6.60	56.00	-16.60
2.6400	38.90	PK	46.00	-7.10	56.00	-17.10
14.3050	38.90	PK	50.00	-11.10	60.00	-21.10

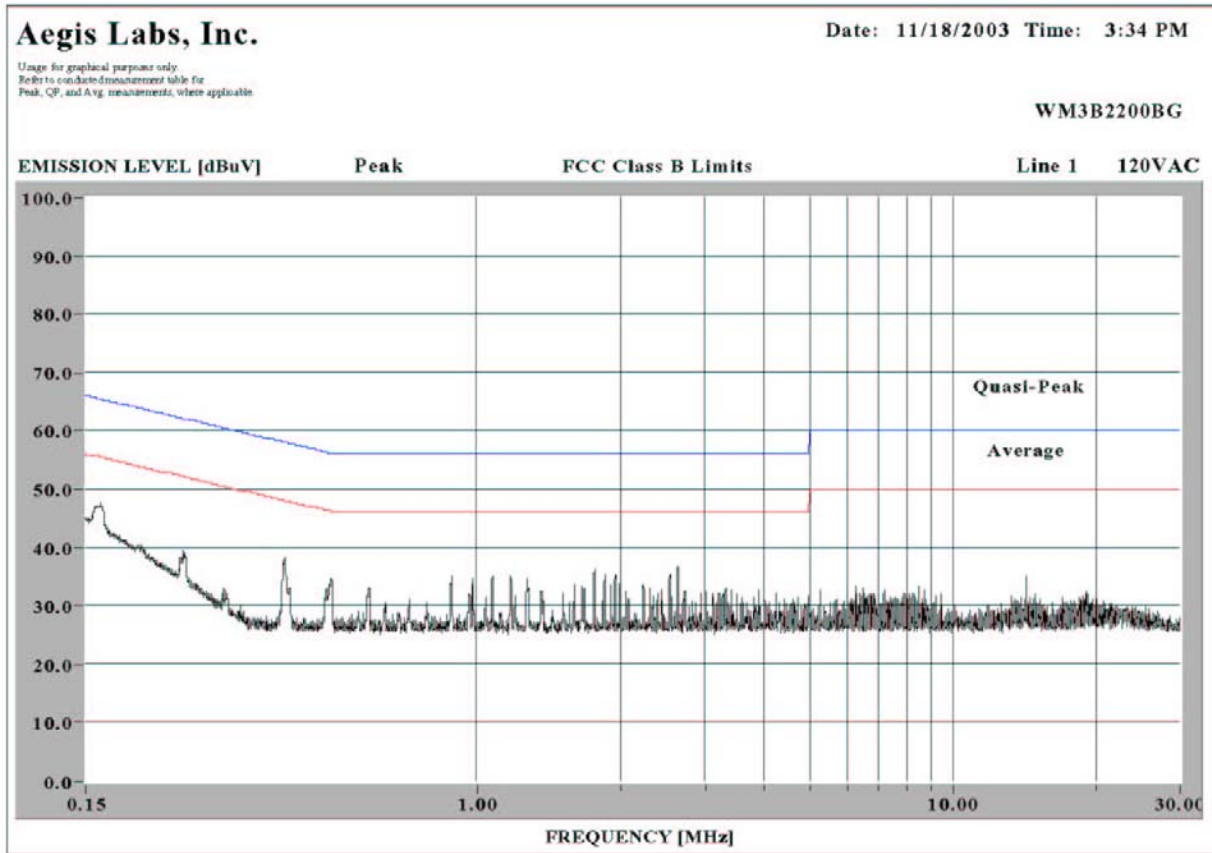

Page 3 of 81 (Appendix A)  
 Report Number: INTEL-031111F  
 FCC ID: PD9WM3B2200BG



AEGIS LABS INC.

AC Power Line Conducted Emissions Test Results (Continued)

CONDUCTED EMISSIONS - LINE 2						
Freq. (MHz)	Meter Reading (dBuV)	Detector (PK/QP/AV)	Average Limit (dBuV)	Average Delta(dB)	Quasi-Peak Limit (dBuV)	Quasi-Peak Delta(dB)
0.1629	51.30	PK	55.63	-4.33	65.63	-14.33
0.2421	44.20	PK	53.37	-9.17	63.37	-19.17
0.3978	44.70	PK	48.92	-4.22	58.92	-14.22
0.8835	42.30	PK	46.00	-3.70	56.00	-13.70
1.2700	40.40	PK	46.00	-5.60	56.00	-15.60
14.3050	38.10	PK	50.00	-11.90	60.00	-21.90

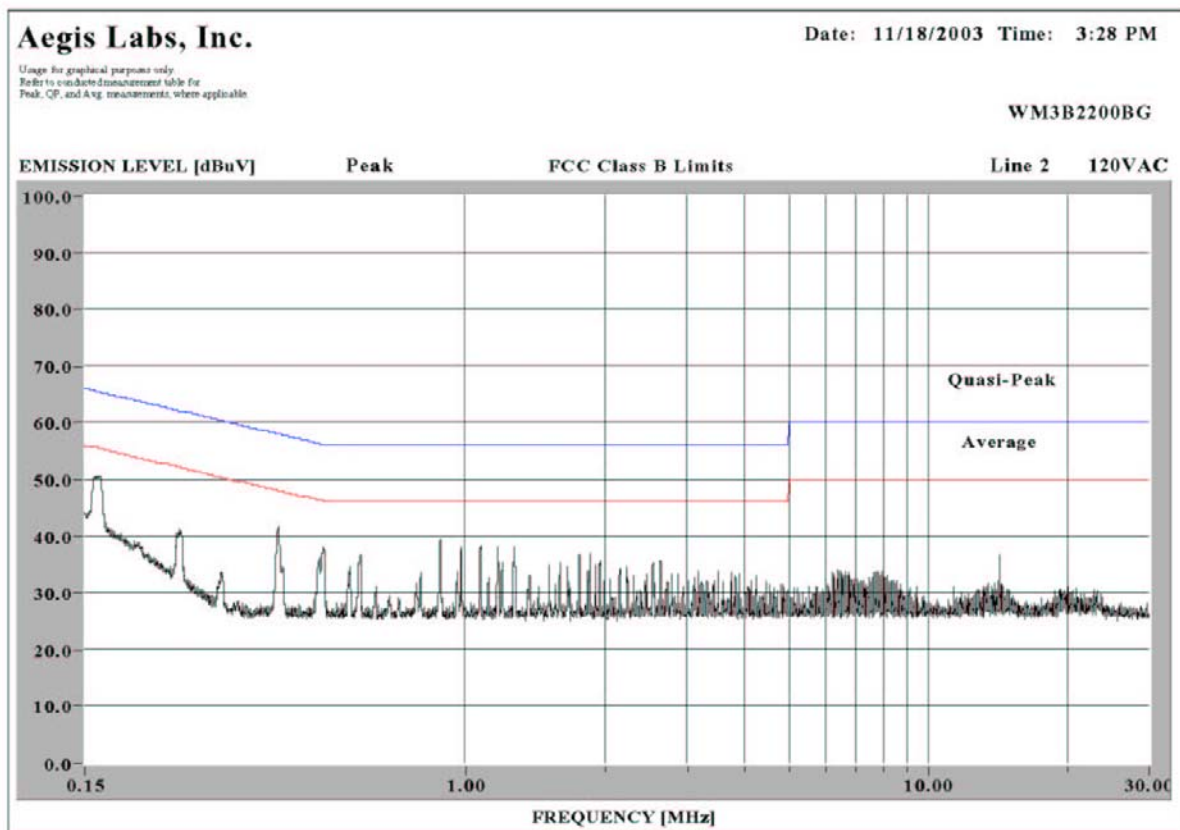

Page 4 of 81 (Appendix A)  
 Report Number: INTEL-031111F  
 FCC ID: PD9WM3B2200BG



AEGIS LABS INC.

## SPURIOUS RADIATED EMISSIONS TEST RESULTS

<b>CLIENT:</b>	Intel Corporation	<b>DATE:</b>	11/18/03
<b>EUT:</b>	802.11b/g MiniPCI Type 3B Wireless Adapter	<b>PROJECT NUMBER:</b>	INTEL-031111-10
<b>MODEL NUMBER:</b>	WM3B2200BG	<b>TEST ENGINEER:</b>	Rick Candelas
<b>SERIAL NUMBER:</b>	000E35005267	<b>SITE #:</b>	2
<b>CONFIGURATION:</b>	Tested installed in the Hewlett Packard host computer's mini PCI slot.	<b>TEMPERATURE:</b>	26 C
		<b>HUMIDITY:</b>	35% RH
		<b>TIME:</b>	1:00 PM

<b>Standard:</b>	FCC Pt. 15.209
<b>Description:</b>	Unwanted emissions below 1 GHz must comply with the general field strength limits set forth in Sec. 15.209.
<b>Results:</b>	Passes the radiated limits by $-3.40@$ 66.66 MHz (Vertical antenna polarization)

Radiated Limits	
Frequency (MHz)	Quasi-Peak Limit (dBuV)
30-88	40
88-216	43.52
216-960	46.02
960-1000	54

NOTE: During preliminary scans, there wasn't any difference which channel or data rate was used with the EUT; therefore only Channel 1 at a data rate of 1 Mbps was used for final testing. Also, the scan was only done with the Ethertronics set of antennas.

Page 5 of 81 (Appendix A)  
Report Number: INTEL-031111F  
FCC ID: PD9WM3B2200BG



Spurious Radiated Emissions Test Results (Continued)

**RADIATED EMISSIONS - Horizontal Antenna Polarization**

Freq. (MHz)	Meter Reading (dBuV)	Antenna Height (cm)	Azimuth (degrees)	Quasi pk or AVG (dBuV)	Preamp Factor (dB)	Cable Factor (dB)	Ant. Factor (dB)	10 Meter Distance Factor (dB)	Corrected Reading (dBuV)	Limits (dBuV)	Diff (dB) +=FAIL
33.34	36.70	300	225		34.42	0.97	17.90	10.46	31.60	40.00	-8.40
66.65	42.80	350	270		34.40	1.33	7.14	10.46	27.33	40.00	-12.67
86.00	36.00	400	180		34.41	1.56	7.58	10.46	21.19	40.00	-18.81
96.09	46.10	400	135		34.41	1.66	9.40	10.46	33.20	43.50	-10.30
99.54	46.10	400	135		34.41	1.70	10.02	10.46	33.86	43.50	-9.64
166.37	36.50	400	135		34.34	2.24	15.69	10.46	30.55	43.50	-12.95
233.14	37.00	400	180		34.24	2.63	17.50	10.46	33.35	46.00	-12.65
299.79	39.40	250	0		34.14	3.00	19.69	10.46	38.41	46.00	-7.59
329.37	41.70	300	0		34.11	3.18	14.99	10.46	36.22	46.00	-9.78
336.07	44.10	250	0		34.10	3.22	15.06	10.46	38.74	46.00	-7.26
343.19	40.60	250	0		34.09	3.26	15.13	10.46	35.36	46.00	-10.64
358.02	41.60	250	0		34.07	3.33	15.15	10.46	36.47	46.00	-9.53
366.50	45.10	200	45		34.06	3.37	15.10	10.46	39.97	46.00	-6.03
384.07	42.40	200	45		34.04	3.44	15.10	10.46	37.36	46.00	-8.64
430.43	38.10	200	90		33.96	3.62	16.23	10.46	34.45	46.00	-11.55

**RADIATED EMISSIONS - Vertical Antenna Polarization**

Freq. (MHz)	Meter Reading (dBuV)	Antenna Height (cm)	Azimuth (degrees)	Quasi pk or AVG (dBuV)	Preamp Factor (dB)	Cable Factor (dB)	Ant. Factor (dB)	10 Meter Distance Factor (dB)	Corrected Reading (dBuV)	Limits (dBuV)	Diff (dB) +=FAIL
33.34	40.10	100	315		34.42	0.97	17.46	10.46	34.57	40.00	-5.43
66.66	52.30	100	0		34.40	1.33	7.37	10.46	37.06	40.00	-2.94
85.97	44.80	100	90		34.41	1.56	7.90	10.46	30.31	40.00	-9.69
96.06	46.80	100	135		34.41	1.66	9.11	10.46	33.61	43.50	-9.89
99.58	50.90	100	90		34.41	1.70	9.46	10.46	38.10	43.50	-5.40
166.00	32.90	100	270		34.34	2.24	15.40	10.46	26.65	43.50	-16.85
232.57	34.90	100	180		34.24	2.63	18.19	10.46	31.94	46.00	-14.06
299.81	40.10	100	315		34.14	3.00	20.59	10.46	40.01	46.00	-5.99
329.38	34.50	100	90		34.11	3.18	15.61	10.46	29.64	46.00	-16.36
336.08	38.80	100	180		34.10	3.22	15.54	10.46	33.91	46.00	-12.09
366.48	42.00	100	0		34.06	3.37	15.33	10.46	37.10	46.00	-8.90
384.06	43.50	100	0		34.04	3.44	15.66	10.46	39.02	46.00	-6.98
431.87	40.50	100	225		33.96	3.63	16.72	10.46	37.35	46.00	-8.65
500.10	40.30	100	225		33.86	4.00	18.70	10.46	39.60	46.00	-6.40

NOTE: The measurements were taken at 10 meters and extrapolated to 3 meters.



AEGIS LABS INC.

## Spurious Radiated Emissions Test Results (Continued)

<b>CLIENT:</b>	Intel Corporation	<b>DATE:</b>	11/11/03
<b>EUT:</b>	802.11b/g MiniPCI Type 3B Wireless Adapter	<b>PROJECT NUMBER:</b>	INTEL-031111
<b>MODEL NUMBER:</b>	WM3B2200BG	<b>TEST ENGINEER:</b>	Rick Candelas
<b>SERIAL NUMBER:</b>	000E35005267	<b>SITE #:</b>	2
<b>CONFIGURATION:</b>	Tested installed in the Hewlett Packard host computer's mini PCI slot in 802.11b mode with the Hitachi antennas.	<b>TEMPERATURE:</b>	21 C
		<b>HUMIDITY:</b>	40% RH
		<b>TIME:</b>	10:00 AM

<b>Standard:</b>	FCC CFR 47, Part 15.247(c)
<b>Description:</b>	Radiated emissions, which fall in the restricted bands, as defined in Sec. 15.205(a), must also comply with the radiated emission limits specified in Sec. 15.209(a). All others must be < -20dBc.
<b>Results:</b>	Passes (See Data Sheets)

Unwanted Spurious Emissions Limits			
Frequency (MHz)	Field Strength (uV/m)	Field Strength (dBuV/m) (Emissions in the restricted bands)	Field Strength (dBm/MHz) (Emissions outside the restricted bands)
Above 960	500	54.00 (Average) 74.00 (Peak)	< -20 dBc

Page 7 of 81 (Appendix A)  
Report Number: INTEL-031111F  
FCC ID: PD9WM3B2200BG



Spurious Radiated Emissions Test Results (Continued)

*Fundamental Measurements in 802.11b mode  
Channels 1, 6, & 11  
Continuous TX at MAIN Antenna port with Hitachi Antennas  
Aegis Labs, Inc. File #: INTEL-031111-02*

<b>RADIATED EMISSIONS - Horizontal Antenna Polarization</b>											
<i>Freq. (MHz)</i>	<i>Meter Reading (dBuV)</i>	<i>Antenna Height (cm)</i>	<i>Azimuth (degrees)</i>	<i>Quasi pk or AVG (dBuV)</i>		<i>Preamp Factor (dB)</i>	<i>Cable Factor (dB)</i>	<i>Ant. Factor (dB)</i>	<i>Corrected Reading (dBuV)</i>	<i>Limits (dBuV)</i>	<i>Diff (dB) +=FAIL</i>
2412.00	73.67	125	225				2.99	29.22	105.88		
2412.00				66.83	A		2.99	29.22	99.04		
2437.00	71.83	100	180				3.05	29.27	104.15		
2437.00				64.83	A		3.05	29.27	97.15		
2462.00	71.33	100	180				3.11	29.32	103.76		
2462.00				64.00	A		3.11	29.32	96.43		

<b>RADIATED EMISSIONS – Vertical Antenna Polarization</b>											
<i>Freq. (MHz)</i>	<i>Meter Reading (dBuV)</i>	<i>Antenna Height (cm)</i>	<i>Azimuth (degrees)</i>	<i>Quasi pk or AVG (dBuV)</i>		<i>Preamp Factor (dB)</i>	<i>Cable Factor (dB)</i>	<i>Ant. Factor (dB)</i>	<i>Corrected Reading (dBuV)</i>	<i>Limits (dBuV)</i>	<i>Diff (dB) +=FAIL</i>
2412.00	75.50	125	270				2.99	29.42	107.91		
2412.00				68.17	A		2.99	29.42	100.58		
2437.00	73.17	100	270				3.05	29.47	105.69		
2437.00				65.50	A		3.05	29.47	98.02		
2462.00	72.33	125	270				3.11	29.52	104.96		
2462.00				65.50	A		3.11	29.52	98.13		



Spurious Radiated Emissions Test Results (Continued)

*Band Edge Field Strength Measurements in 802.11b mode  
Channels 1, 6, & 11  
Continuous TX at MAIN Antenna port with Hitachi Antennas  
Aegis Labs, Inc. File #: INTEL-031111-03*

<b>RADIATED EMISSIONS - Horizontal Antenna Polarization</b>											
<i>Freq. (MHz)</i>	<i>Meter Reading (dBuV)</i>	<i>Antenna Height (cm)</i>	<i>Azimuth (degrees)</i>	<i>Quasi pk or AVG (dBuV)</i>		<i>Preamp Factor (dB)</i>	<i>Cable Factor (dB)</i>	<i>Ant. Factor (dB)</i>	<i>Corrected Reading (dBuV)</i>	<i>Limits (dBuV)</i>	<i>Diff (dB) +=FAIL</i>
2386.27	63.67	125	225			36.44	2.93	29.17	59.33	74.00	-14.67
2385.07				52.83	A	36.43	2.92	29.17	48.49	54.00	-5.51
2390.00	59.00	125	225			36.45	2.94	29.18	54.67	74.00	-19.33
2390.00				47.83	A	36.45	2.94	29.18	43.50	54.00	-10.50
2400.00	75.00	125	225			36.47	2.96	29.20	70.69	85.88	-15.19
2490.03	60.50	100	180			36.70	3.18	29.38	56.36	74.00	-17.64
2489.23				51.83	A	36.69	3.17	29.38	47.69	54.00	-6.31
2483.50	59.00	100	180			36.68	3.16	29.37	54.85	74.00	-19.15
2483.50				48.50	A	36.68	3.16	29.37	44.35	54.00	-9.65

<b>RADIATED EMISSIONS – Vertical Antenna Polarization</b>											
<i>Freq. (MHz)</i>	<i>Meter Reading (dBuV)</i>	<i>Antenna Height (cm)</i>	<i>Azimuth (degrees)</i>	<i>Quasi pk or AVG (dBuV)</i>		<i>Preamp Factor (dB)</i>	<i>Cable Factor (dB)</i>	<i>Ant. Factor (dB)</i>	<i>Corrected Reading (dBuV)</i>	<i>Limits (dBuV)</i>	<i>Diff (dB) +=FAIL</i>
2386.93	63.50	200	270			36.44	2.93	29.37	59.36	74.00	-14.64
2385.07				52.17	A	36.43	2.92	29.37	48.03	54.00	-5.97
2390.00	60.17	200	270			36.45	2.94	29.38	56.04	74.00	-17.96
2390.00				48.00	A	36.45	2.94	29.38	43.87	54.00	-10.13
2400.00	75.67	200	270			36.47	2.96	29.40	71.56	87.91	-16.35
2489.50	60.00	200	270			36.69	3.17	29.58	56.06	74.00	-17.94
2489.10				50.33	A	36.69	3.17	29.58	46.39	54.00	-7.61
2483.50	58.67	200	270			36.68	3.16	29.57	54.72	74.00	-19.28
2483.50				48.00	A	36.68	3.16	29.57	44.05	54.00	-9.95





AEGIS LABS INC.

### Spurious Radiated Emissions Test Results (Continued)

Plots Showing Out-Of-Band Emissions (Peak RBW=VBW=1MHz; Average RBW = 1MHz, VBW = 10Hz)

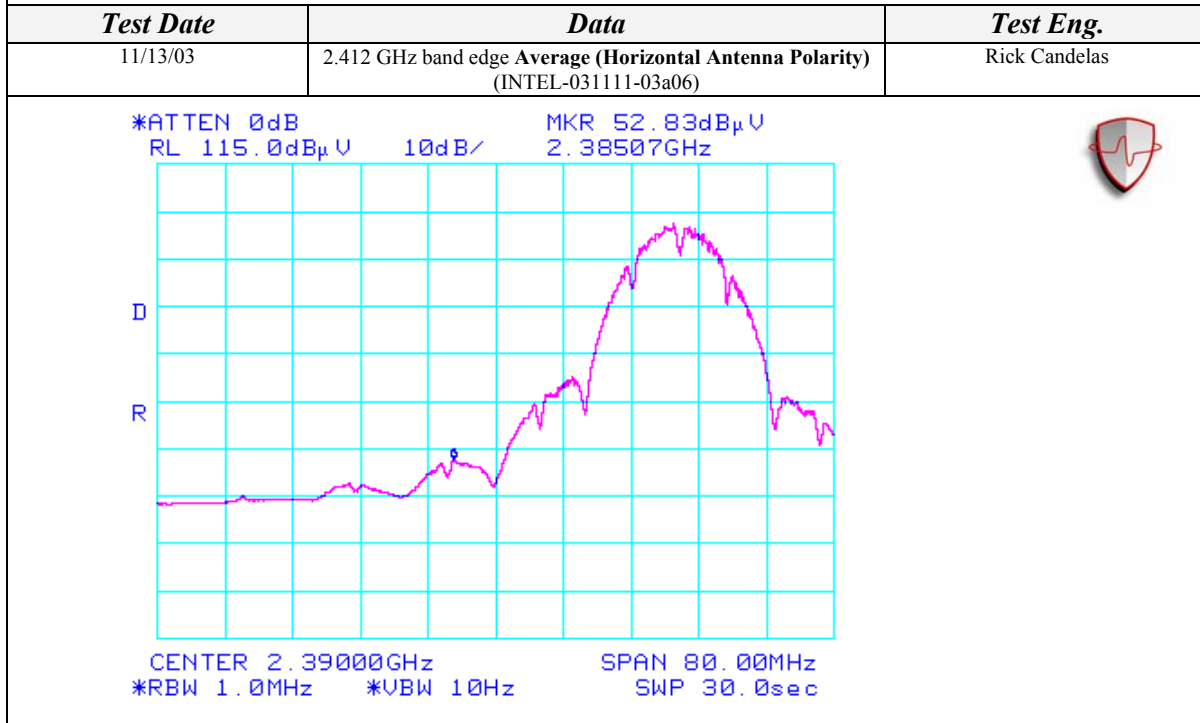
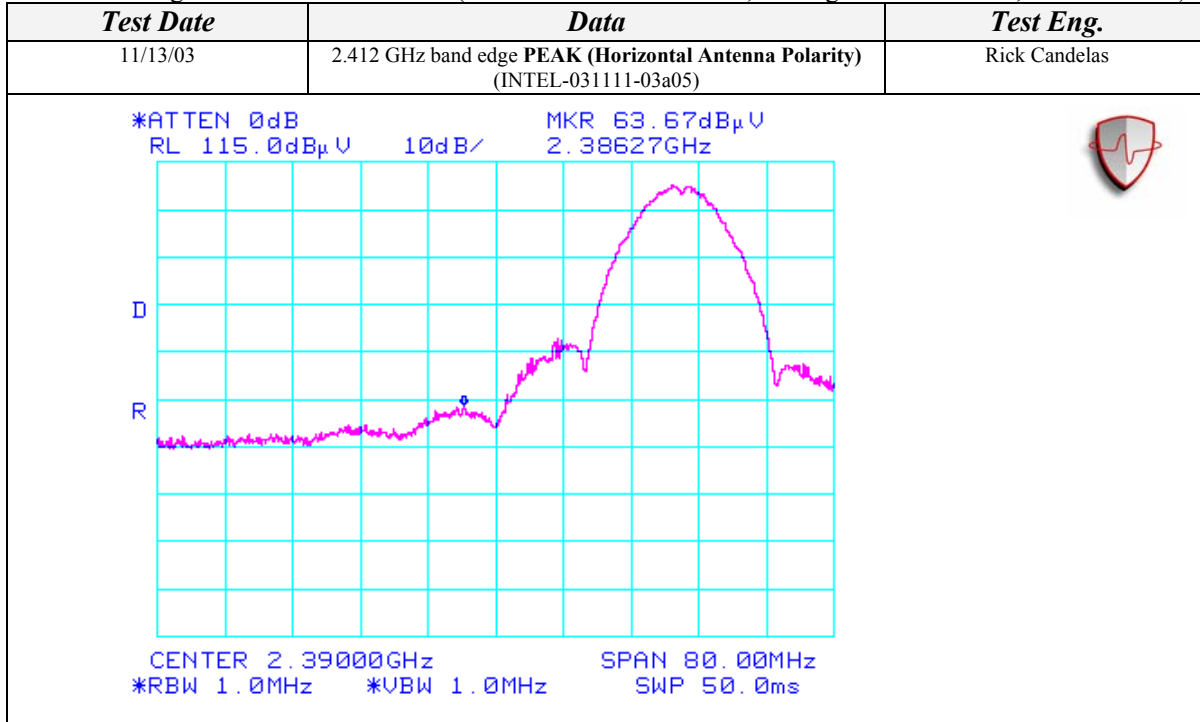

Page 10 of 81 (Appendix A)  
Report Number: INTEL-031111F  
FCC ID: PD9WM3B2200BG







AEGIS LABS INC.

## Spurious Radiated Emissions Test Results (Continued)

Plots Showing Out-Of-Band Emissions (Peak RBW=VBW=1MHz; Average RBW = 1MHz, VBW = 10Hz)

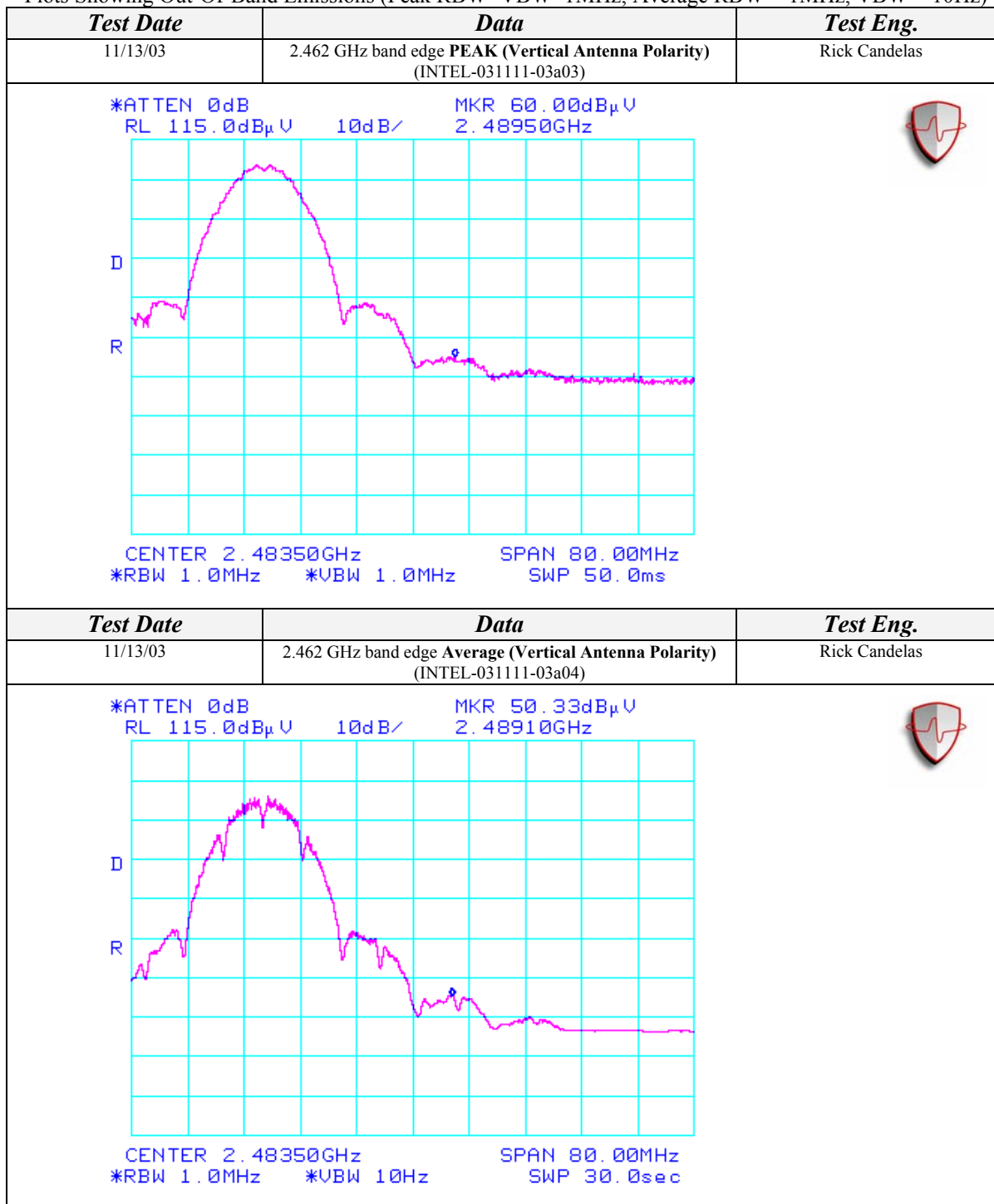

Page 13 of 81 (Appendix A)  
 Report Number: INTEL-031111F  
 FCC ID: PD9WM3B2200BG



Spurious Radiated Emissions Test Results (Continued)

*Spurious Emissions Measurements in 802.11b mode  
Channels 1, 6, & 11  
Continuous TX at MAIN Antenna port with Hitachi Antennas  
Aegis Labs, Inc. File #: INTEL-031111-12*

<b>RADIATED EMISSIONS - Horizontal Antenna Polarization</b>											
Freq. (MHz)	Meter Reading (dBuV)	Antenna Height (cm)	Azimuth (degrees)	Quasi pk or AVG (dBuV)		1 Meter Distance Factor (dB)	Cable Factor (dB)	Ant. Factor (dB)	Corrected Reading (dBuV)	Limits (dBuV)	Diff (dB) +=FAIL
<b>EUT in Continuous Transmit Mode on Channel 1 (2.412 GHz)</b>											
2312.00	33.50	100	225			9.54	2.75	28.62	55.33	74.00	-18.67
2312.00				22.00	A	9.54	2.75	28.62	43.83	54.00	-10.17
<b>EUT in Continuous Transmit Mode on Channel 6 (2.437 GHz)</b>											
2336.00	33.50	100	225			9.54	2.81	28.71	55.48	74.00	-18.52
2336.00				21.50	A	9.54	2.81	28.71	43.48	54.00	-10.52
<b>EUT in Continuous Transmit Mode on Channel 11 (2.462 GHz)</b>											
2360.00	33.00	100	225			9.54	2.86	28.80	55.12	74.00	-18.88
2360.00				20.33	A	9.54	2.86	28.80	42.45	54.00	-11.55
<b>RADIATED EMISSIONS - Vertical Antenna Polarization</b>											
Freq. (MHz)	Meter Reading (dBuV)	Antenna Height (cm)	Azimuth (degrees)	Quasi pk or AVG (dBuV)		1 Meter Distance Factor (dB)	Cable Factor (dB)	Ant. Factor (dB)	Corrected Reading (dBuV)	Limits (dBuV)	Diff (dB) +=FAIL
<b>EUT in Continuous Transmit Mode on Channel 1 (2.412 GHz)</b>											
2312.00	32.83	100	225			9.54	2.75	28.62	54.66	74.00	-19.34
2312.00				20.83	A	9.54	2.75	28.62	42.66	54.00	-11.34
<b>EUT in Continuous Transmit Mode on Channel 6 (2.437 GHz)</b>											
2336.00	32.50	100	225			9.54	2.81	28.71	54.48	74.00	-19.52
2336.00				20.67	A	9.54	2.81	28.71	42.65	54.00	-11.35
<b>EUT in Continuous Transmit Mode on Channel 11 (2.462 GHz)</b>											
2360.00	33.50	100	225			9.54	2.86	28.80	55.62	74.00	-18.38
2360.00				20.50	A	9.54	2.86	28.80	42.62	54.00	-11.38

NOTE: These spurious emissions measurements were taken without a preamp at a distance on 1 meter to avoid saturating the preamp and analyzer because the signals were close to the fundamental frequency. The readings were extrapolated to 1 meter.



Spurious Radiated Emissions Test Results (Continued)

*Spurious Emissions Measurements in 802.11b mode  
Channels 1, 6, & 11  
Continuous TX at MAIN Antenna port with Hitachi Antennas  
Aegis Labs, Inc. File #: INTEL-031111-03*

<b>RADIATED EMISSIONS - Horizontal Antenna Polarization</b>											
<i>Freq. (MHz)</i>	<i>Meter Reading (dBuV)</i>	<i>Antenna Height (cm)</i>	<i>Azimuth (degrees)</i>	<i>Quasi pk or AVG (dBuV)</i>		<i>Preamp Factor (dB)</i>	<i>Cable Factor (dB)</i>	<i>Ant. Factor (dB)</i>	<i>Corrected Reading (dBuV)</i>	<i>Limits (dBuV)</i>	<i>Diff (dB) +=FAIL</i>
<b>EUT in Continuous Transmit Mode on Channel 1 (2.412 GHz)</b>											
1008.00	62.83	100	315			37.24	1.62	24.93	52.13	74.00	-21.87
1008.00				50.67	A	37.24	1.62	24.93	39.97	54.00	-14.03
1097.80	63.67	100	180			36.90	1.70	25.25	53.72	74.00	-20.28
1097.80				48.00	A	36.90	1.70	25.25	38.05	54.00	-15.95
3215.99	50.00	100	135			36.33	3.37	30.98	48.02	85.88	-37.86
4823.95	51.33	100	180			36.16	4.06	34.10	53.33	74.00	-20.67
4823.99				46.50	A	36.16	4.06	34.10	48.50	54.00	-5.50
6432.01	57.50	100	135			36.39	4.67	35.37	61.16	85.88	-24.72
9648.04	53.33	100	225			36.98	5.99	38.11	60.44	85.88	-25.44
12062.23	47.00	100	180			36.00	7.04	39.66	57.70	74.00	-16.30
12062.23				36.17	A	36.00	7.04	39.66	46.87	54.00	-7.13
12863.92	46.83	100	180			34.94	7.23	40.27	59.39	85.88	-26.49
<b>EUT in Continuous Transmit Mode on Channel 6 (2.437 GHz)</b>											
1007.63	63.00	100	0			37.25	1.62	24.93	52.30	74.00	-21.70
1007.63				49.67	A	37.25	1.62	24.93	38.97	54.00	-15.03
1099.73	59.50	100	90			36.90	1.70	25.26	49.56	74.00	-24.44
1099.73				47.17	A	36.90	1.70	25.26	37.23	54.00	-16.77
3249.53	49.67	100	135			36.30	3.40	31.05	47.82	84.15	-36.33
4873.92	49.83	100	180			36.20	4.10	34.27	52.00	74.00	-22.00
4873.92				44.50	A	36.20	4.10	34.27	46.67	54.00	-7.33
6498.74	50.83	100	180			36.40	4.70	35.40	54.53	84.15	-29.62
9747.94	54.00	100	135			36.90	6.05	38.25	61.39	84.15	-22.76
12185.67	47.50	100	135			35.80	7.11	39.59	58.40	74.00	-15.60
12185.67				37.33	A	35.80	7.11	39.59	48.23	54.00	-5.77
12997.19	46.83	100	225			34.80	7.20	40.59	59.82	84.15	-24.33



Spurious Radiated Emissions Test Results (Continued)

<b>RADIATED EMISSIONS - Horizontal Antenna Polarization</b>										
<i>Freq. (MHz)</i>	<i>Meter Reading (dBuV)</i>	<i>Antenna Height (cm)</i>	<i>Azimuth (degrees)</i>	<i>Quasi pk or AVG (dBuV)</i>	<i>Preamp Factor (dB)</i>	<i>Cable Factor (dB)</i>	<i>Ant. Factor (dB)</i>	<i>Corrected Reading (dBuV)</i>	<i>Limits (dBuV)</i>	<i>Diff (dB) +=FAIL</i>

<b>EUT in Continuous Transmit Mode on Channel 11 (2.462 GHz)</b>											
1007.05	59.83	100	0			37.25	1.61	24.93	49.12	74.00	-24.88
1007.05				48.50	A	37.25	1.61	24.93	37.79	54.00	-16.21
1098.17	58.33	200	90			36.90	1.70	25.25	48.38	74.00	-25.62
1098.17				43.17	A	36.90	1.70	25.25	33.22	54.00	-20.78
3282.74	48.50	100	135			36.28	3.44	31.12	46.78	83.76	-36.98
4924.00	48.17	100	180			36.24	4.14	34.44	50.51	74.00	-23.49
4924.00				42.50	A	36.24	4.14	34.44	44.84	54.00	-9.16
6565.37	46.50	100	135			36.40	4.75	35.62	50.47	83.76	-33.29
9847.97	57.33	100	225			36.82	6.11	38.39	65.00	83.76	-18.76
12309.30	46.33	100	135			35.61	7.19	39.51	57.42	74.00	-16.58
12309.30				34.00	A	35.61	7.19	39.51	45.09	54.00	-8.91
13130.65	46.17	100	135			34.75	7.28	40.65	59.35	83.76	-24.41

<b>RADIATED EMISSIONS - Vertical Antenna Polarization</b>											
<i>Freq. (MHz)</i>	<i>Meter Reading (dBuV)</i>	<i>Antenna Height (cm)</i>	<i>Azimuth (degrees)</i>	<i>Quasi pk or AVG (dBuV)</i>	<i>Preamp Factor (dB)</i>	<i>Cable Factor (dB)</i>	<i>Ant. Factor (dB)</i>	<i>Corrected Reading (dBuV)</i>	<i>Limits (dBuV)</i>	<i>Diff (dB) +=FAIL</i>	
<b>EUT in Continuous Transmit Mode on Channel 1 (2.412 GHz)</b>											
1008.00	63.17	100	225			37.24	1.62	25.03	52.57	74.00	-21.43
1008.00				51.17	A	37.24	1.62	25.03	40.57	54.00	-13.43
1099.90	64.17	100	135			36.90	1.70	25.34	54.31	74.00	-19.69
1099.90				48.67	A	36.90	1.70	25.34	38.81	54.00	-15.19
3215.97	48.17	100	135			36.33	3.37	31.09	46.30	87.91	-41.61
4824.02	49.17	100	135			36.16	4.06	34.07	51.14	74.00	-22.86
4824.02				43.33	A	36.16	4.06	34.07	45.30	54.00	-8.70
6431.94	54.67	100	225			36.39	4.67	35.35	58.30	87.91	-29.61
9648.06	52.67	100	135			36.98	5.99	38.17	59.84	87.91	-28.07
12059.87	47.50	100	135			36.00	7.04	39.75	58.28	74.00	-15.72
12059.87				36.17	A	36.00	7.04	39.75	46.95	54.00	-7.05
12864.03	48.00	125	225			34.94	7.23	40.27	60.56	87.91	-27.35



Spurious Radiated Emissions Test Results (Continued)

<b>RADIATED EMISSIONS - Vertical Antenna Polarization</b>											
<i>Freq. (MHz)</i>	<i>Meter Reading (dBuV)</i>	<i>Antenna Height (cm)</i>	<i>Azimuth (degrees)</i>	<i>Quasi pk or AVG (dBuV)</i>		<i>Preamp Factor (dB)</i>	<i>Cable Factor (dB)</i>	<i>Ant. Factor (dB)</i>	<i>Corrected Reading (dBuV)</i>	<i>Limits (dBuV)</i>	<i>Diff (dB) +=FAIL</i>

<b>EUT in Continuous Transmit Mode on Channel 6 (2.437 GHz)</b>											
1009.30	62.33	200	135			37.24	1.62	25.03	51.74	74.00	-22.26
1009.30				50.17	A	37.24	1.62	25.03	39.58	54.00	-14.42
1099.92	61.67	100	180			36.90	1.70	25.34	51.81	74.00	-22.19
1099.92				48.33	A	36.90	1.70	25.34	38.47	54.00	-15.53
3249.23	47.33	100	135			36.30	3.40	31.15	45.58	85.69	-40.11
4873.96	47.33	100	135			36.20	4.10	34.22	49.45	74.00	-24.55
4873.96				41.67	A	36.20	4.10	34.22	43.79	54.00	-10.21
6498.71	49.83	125	135			36.40	4.70	35.40	53.53	85.69	-32.16
9747.95	53.17	100	135			36.90	6.05	38.35	60.66	85.69	-25.03
12188.17	47.00	100	135			35.80	7.11	39.65	57.96	74.00	-16.04
12188.17				34.67	A	35.80	7.11	39.65	45.63	54.00	-8.37
12997.21	48.33	100	225			34.80	7.20	40.59	61.32	85.69	-24.37

<b>EUT in Continuous Transmit Mode on Channel 11 (2.462 GHz)</b>											
1008.27	58.67	100	180			37.24	1.62	25.03	48.07	74.00	-25.93
1008.27				46.17	A	37.24	1.62	25.03	35.57	54.00	-18.43
1100.77	61.17	100	180			36.90	1.70	25.34	51.32	74.00	-22.68
1100.77				45.33	A	36.90	1.70	25.34	35.48	54.00	-18.52
3282.77	48.00	100	135			36.28	3.44	31.21	46.37	84.96	-38.59
4924.17	47.00	100	135			36.24	4.14	34.37	49.27	74.00	-24.73
4924.17				40.17	A	36.24	4.14	34.37	42.44	54.00	-11.56
6565.41	48.00	200	135			36.40	4.75	35.60	51.95	84.96	-33.01
9847.98	55.00	100	225			36.82	6.11	38.53	62.81	84.96	-22.15
12312.27	46.17	100	135			35.60	7.19	39.55	57.31	74.00	-16.69
12312.27				32.50	A	35.60	7.19	39.55	43.64	54.00	-10.36
13130.72	47.50	100	225			34.75	7.28	40.68	60.71	84.96	-24.25





## Spurious Radiated Emissions Test Results (Continued)

*Spurious Emissions Measurements in 802.11b mode  
Channels 1, 6, & 11  
Continuous RX at MAIN Antenna port with Hitachi Antennas  
Aegis Labs, Inc. File #: INTEL-031111-03*

**RADIATED EMISSIONS - Horizontal Antenna Polarization**

<i>Freq. (MHz)</i>	<i>Meter Reading (dBuV)</i>	<i>Antenna Height (cm)</i>	<i>Azimuth (degrees)</i>	<i>Quasi pk or AVG (dBuV)</i>		<i>Preamp Factor (dB)</i>	<i>Cable Factor (dB)</i>	<i>Ant. Factor (dB)</i>	<i>Corrected Reading (dBuV)</i>	<i>Limits (dBuV)</i>	<i>Diff (dB) +=FAIL</i>
<b>EUT in Continuous Receive Mode on Channel 1 (2.412 GHz)</b>											
1010.23	55.67	100	0			37.23	1.62	24.94	45.00	74.00	-29.00
1010.23				42.83	A	37.23	1.62	24.94	32.16	54.00	-21.84
1099.73	55.67	100	225			36.90	1.70	25.26	45.73	74.00	-28.27
1100.08				38.33	A	36.90	1.70	25.26	28.39	54.00	-25.61
3216.04	49.33	100	135			36.33	3.37	30.98	47.35	85.88	-38.53
6432.00	57.17	100	135			36.39	4.67	35.37	60.83	85.88	-25.05
<b>EUT in Continuous Receive Mode on Channel 6 (2.437 GHz)</b>											
1009.73	55.50	100	0			37.23	1.62	24.94	44.82	74.00	-29.18
1009.73				42.33	A	37.23	1.62	24.94	31.65	54.00	-22.35
1100.90	55.17	100	225			36.90	1.70	25.26	45.24	74.00	-28.76
1100.90				40.67	A	36.90	1.70	25.26	30.74	54.00	-23.26
3249.32	47.67	100	135			36.30	3.40	31.05	45.82	84.15	-38.33
6498.61	51.67	100	135			36.40	4.70	35.40	55.37	84.15	-28.78
<b>EUT in Continuous Receive Mode on Channel 11 (2.462 GHz)</b>											
1007.90	56.00	100	0			37.24	1.62	24.93	45.30	74.00	-28.70
1007.90				42.17	A	37.24	1.62	24.93	31.47	54.00	-22.53
1100.93	55.50	100	225			36.90	1.70	25.26	45.57	74.00	-28.43
1100.93				41.50	A	36.90	1.70	25.26	31.57	54.00	-22.43
3282.75	46.00	100	135			36.28	3.44	31.12	44.28	83.76	-39.48
6565.41	47.67	100	225			36.40	4.75	35.62	51.64	83.76	-32.12



Spurious Radiated Emissions Test Results (Continued)

<b>RADIATED EMISSIONS - Vertical Antenna Polarization</b>											
<i>Freq. (MHz)</i>	<i>Meter Reading (dBuV)</i>	<i>Antenna Height (cm)</i>	<i>Azimuth (degrees)</i>	<i>Quasi pk or AVG (dBuV)</i>		<i>Preamp Factor (dB)</i>	<i>Cable Factor (dB)</i>	<i>Ant. Factor (dB)</i>	<i>Corrected Reading (dBuV)</i>	<i>Limits (dBuV)</i>	<i>Diff (dB) +=FAIL</i>
<b>EUT in Continuous Receive Mode on Channel 1 (2.412 GHz)</b>											
1007.53	56.00	100	135			37.25	1.62	25.03	45.39	74.00	-28.61
1007.53				47.33	A	37.25	1.62	25.03	36.72	54.00	-17.28
1100.08	60.67	100	135			36.90	1.70	25.34	50.81	74.00	-23.19
1100.08				44.17	A	36.90	1.70	25.34	34.31	54.00	-19.69
3216.00	47.33	100	135			36.33	3.37	31.09	45.46	87.91	-42.45
6432.08	53.83	100	135			36.39	4.67	35.35	57.46	87.91	-30.45
<b>EUT in Continuous Receive Mode on Channel 6 (2.437 GHz)</b>											
1009.23	54.67	100	225			37.24	1.62	25.03	44.08	74.00	-29.92
1009.23				41.83	A	37.24	1.62	25.03	31.24	54.00	-22.76
1100.00	62.00	100	180			36.90	1.70	25.34	52.14	74.00	-21.86
1100.00				45.83	A	36.90	1.70	25.34	35.97	54.00	-18.03
3249.30	47.33	100	135			36.30	3.40	31.15	45.58	85.69	-40.11
6498.67	50.00	100	225			36.40	4.70	35.40	53.70	85.69	-31.99
<b>EUT in Continuous Receive Mode on Channel 11 (2.462 GHz)</b>											
1009.57	53.67	100	225			37.23	1.62	25.03	43.09	74.00	-30.91
1009.57				41.17	A	37.23	1.62	25.03	30.59	54.00	-23.41
1099.97	61.67	100	180			36.90	1.70	25.34	51.81	74.00	-22.19
1099.97				43.50	A	36.90	1.70	25.34	33.64	54.00	-20.36
3282.77	46.33	100	135			36.28	3.44	31.21	44.70	84.96	-40.26
6565.31	47.00	100	225			36.40	4.75	35.60	50.95	84.96	-34.01



AEGIS LABS INC.

## Spurious Radiated Emissions Test Results (Continued)

<b>CLIENT:</b>	Intel Corporation	<b>DATE:</b>	11/11/03
<b>EUT:</b>	802.11b/g MiniPCI Type 3B Wireless Adapter	<b>PROJECT NUMBER:</b>	INTEL-031111
<b>MODEL NUMBER:</b>	WM3B2200BG	<b>TEST ENGINEER:</b>	Rick Candelas
<b>SERIAL NUMBER:</b>	000E35005267	<b>SITE #:</b>	2
<b>CONFIGURATION:</b>	Tested installed in the Hewlett Packard host computer's mini PCI slot in 802.11g mode with the Hitachi antennas.	<b>TEMPERATURE:</b>	21 C
		<b>HUMIDITY:</b>	40% RH
		<b>TIME:</b>	10:00 AM

<b>Standard:</b>	FCC CFR 47, Part 15.247(c)
<b>Description:</b>	Radiated emissions, which fall in the restricted bands, as defined in Sec. 15.205(a), must also comply with the radiated emission limits specified in Sec. 15.209(a). All others must be < -20dBc.
<b>Results:</b>	Passes (See Data Sheets)

Unwanted Spurious Emissions Limits			
Frequency (MHz)	Field Strength (uV/m)	Field Strength (dBuV/m) (Emissions in the restricted bands)	Field Strength (dBm/MHz) (Emissions outside the restricted bands)
Above 960	500	54.00 (Average) 74.00 (Peak)	< -20 dBc

Page 20 of 81 (Appendix A)  
Report Number: INTEL-031111F  
FCC ID: PD9WM3B2200BG



Spurious Radiated Emissions Test Results (Continued)

*Fundamental Measurements in 802.11g mode  
Channels 1, 6, & 11  
Continuous TX at MAIN Antenna port with Hitachi Antennas  
Aegis Labs, Inc. File #: INTEL-031111-02*

<b>RADIATED EMISSIONS - Horizontal Antenna Polarization</b>											
<i>Freq. (MHz)</i>	<i>Meter Reading (dBuV)</i>	<i>Antenna Height (cm)</i>	<i>Azimuth (degrees)</i>	<i>Quasi pk or AVG (dBuV)</i>		<i>Preamp Factor (dB)</i>	<i>Cable Factor (dB)</i>	<i>Ant. Factor (dB)</i>	<i>Corrected Reading (dBuV)</i>	<i>Limits (dBuV)</i>	<i>Diff (dB) +=FAIL</i>
2412.00	72.17	100	225				2.99	29.22	104.38		
2412.00				46.67	A		2.99	29.22	78.88		
2437.00	71.33	100	180				3.05	29.27	103.65		
2437.00				45.50	A		3.05	29.27	77.82		
2462.00	70.33	100	180				3.11	29.32	102.76		
2462.00				45.33	A		3.11	29.32	77.76		

<b>RADIATED EMISSIONS – Vertical Antenna Polarization</b>											
<i>Freq. (MHz)</i>	<i>Meter Reading (dBuV)</i>	<i>Antenna Height (cm)</i>	<i>Azimuth (degrees)</i>	<i>Quasi pk or AVG (dBuV)</i>		<i>Preamp Factor (dB)</i>	<i>Cable Factor (dB)</i>	<i>Ant. Factor (dB)</i>	<i>Corrected Reading (dBuV)</i>	<i>Limits (dBuV)</i>	<i>Diff (dB) +=FAIL</i>
2412.00	74.67	100	270				2.99	29.42	107.08		
2412.00				47.83	A		2.99	29.42	80.24		
2437.00	74.33	125	270				3.05	29.47	106.85		
2437.00				47.67	A		3.05	29.47	80.19		
2462.00	71.17	125	270				3.11	29.52	103.80		
2462.00				46.00	A		3.11	29.52	78.63		



Spurious Radiated Emissions Test Results (Continued)

*Band Edge Field Strength Measurements in 802.11g mode  
Channels 1, 6, & 11  
Continuous TX at MAIN Antenna port with Hitachi Antennas  
Aegis Labs, Inc. File #: INTEL-031111-03*

<b>RADIATED EMISSIONS - Horizontal Antenna Polarization</b>											
<i>Freq. (MHz)</i>	<i>Meter Reading (dBuV)</i>	<i>Antenna Height (cm)</i>	<i>Azimuth (degrees)</i>	<i>Quasi pk or AVG (dBuV)</i>		<i>Preamp Factor (dB)</i>	<i>Cable Factor (dB)</i>	<i>Ant. Factor (dB)</i>	<i>Corrected Reading (dBuV)</i>	<i>Limits (dBuV)</i>	<i>Diff (dB) +=FAIL</i>
2390.00	72.83	125	225			36.45	2.94	29.18	68.50	74.00	-5.50
2390.00				49.67	A	36.45	2.94	29.18	45.34	54.00	-8.66
2400.00	85.67	125	225			36.47	2.96	29.20	81.36	84.38	-3.02
2483.50	70.83	100	180			36.68	3.16	29.37	66.68	74.00	-7.32
2483.50				49.83	A	36.68	3.16	29.37	45.68	54.00	-8.32

<b>RADIATED EMISSIONS - Vertical Antenna Polarization</b>											
<i>Freq. (MHz)</i>	<i>Meter Reading (dBuV)</i>	<i>Antenna Height (cm)</i>	<i>Azimuth (degrees)</i>	<i>Quasi pk or AVG (dBuV)</i>		<i>Preamp Factor (dB)</i>	<i>Cable Factor (dB)</i>	<i>Ant. Factor (dB)</i>	<i>Corrected Reading (dBuV)</i>	<i>Limits (dBuV)</i>	<i>Diff (dB) +=FAIL</i>
2390.00	73.83	100	270			36.45	2.94	29.38	69.70	74.00	-4.30
2390.00				48.83	A	36.45	2.94	29.38	44.70	54.00	-9.30
2400.00	87.33	100	270			36.47	2.96	29.40	83.22	87.08	-3.86
2483.50	70.83	175	270			36.68	3.16	29.57	66.88	74.00	-7.12
2483.50				49.50	A	36.68	3.16	29.57	45.55	54.00	-8.45



AEGIS LABS INC.

### Spurious Radiated Emissions Test Results (Continued)

Plots Showing Out-Of-Band Emissions (Peak RBW=VBW=1MHz; Average RBW = 1MHz, VBW = 10Hz)

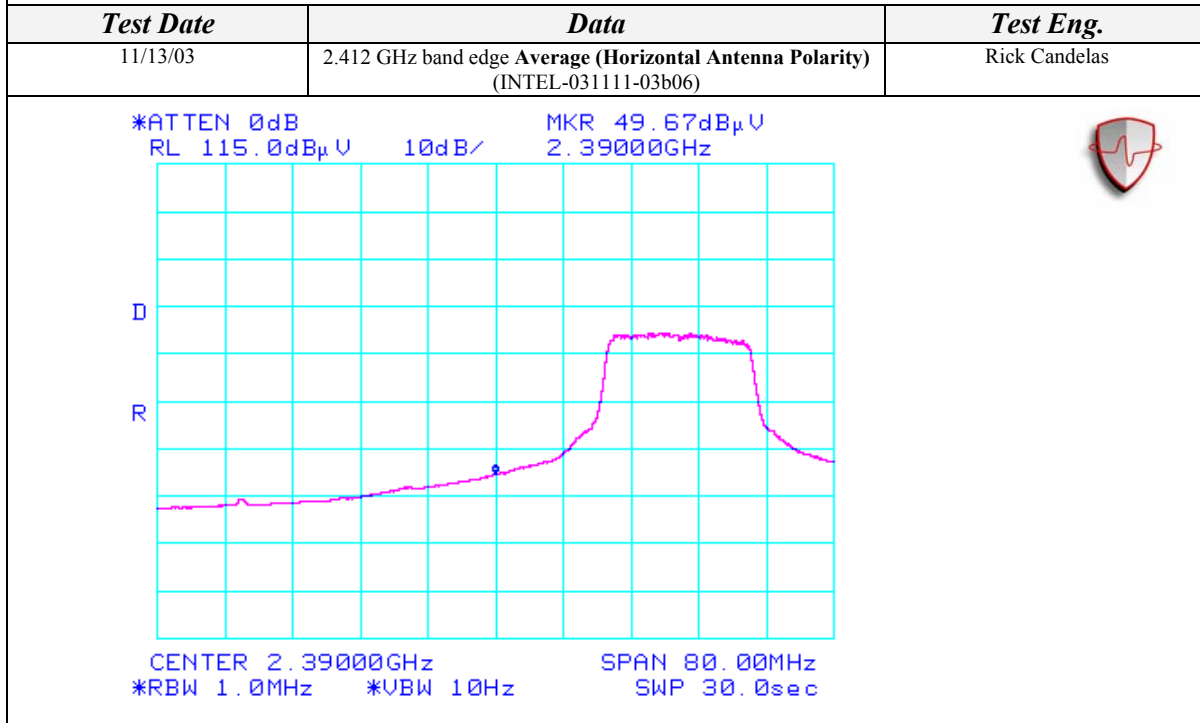
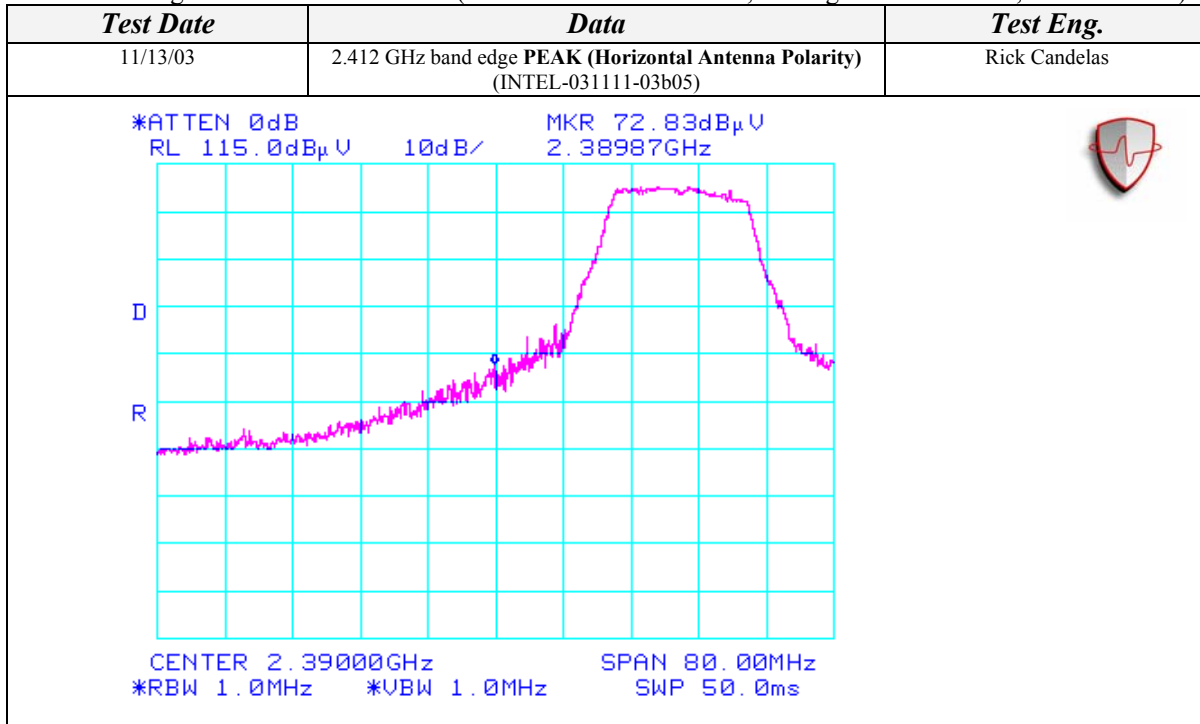

Page 23 of 81 (Appendix A)  
Report Number: INTEL-031111F  
FCC ID: PD9WM3B2200BG



### Spurious Radiated Emissions Test Results (Continued)

Plots Showing Out-Of-Band Emissions (Peak RBW=VBW=1MHz; Average RBW = 1MHz, VBW = 10Hz)

<b><i>Test Date</i></b>	<b><i>Data</i></b>	<b><i>Test Eng.</i></b>
11/13/03	2.462 GHz band edge <b>PEAK (Horizontal Antenna Polarity)</b> (INTEL-031111-03b07)	Rick Candelas
<p>*ATTEN 0dB                    MKR 70.83dBµV RL 115.0dBµV    10dB/     2.48377GHz</p> <p>CENTER 2.48350GHz                    SPAN 80.00MHz *RBW 1.0MHz    *VBW 1.0MHz                    SWP 50.0ms</p>		
<b><i>Test Date</i></b>	<b><i>Data</i></b>	<b><i>Test Eng.</i></b>
11/13/03	2.462 GHz band edge <b>Average (Horizontal Antenna Polarity)</b> (INTEL-031111-03b08)	Rick Candelas
<p>*ATTEN 0dB                    MKR 49.83dBµV RL 115.0dBµV    10dB/     2.48350GHz</p> <p>CENTER 2.48350GHz                    SPAN 80.00MHz *RBW 1.0MHz    *VBW 10Hz                    SWP 30.0sec</p>		



AEGIS LABS INC.

## Spurious Radiated Emissions Test Results (Continued)

Plots Showing Out-Of-Band Emissions (Peak RBW=VBW=1MHz; Average RBW = 1MHz, VBW = 10Hz)

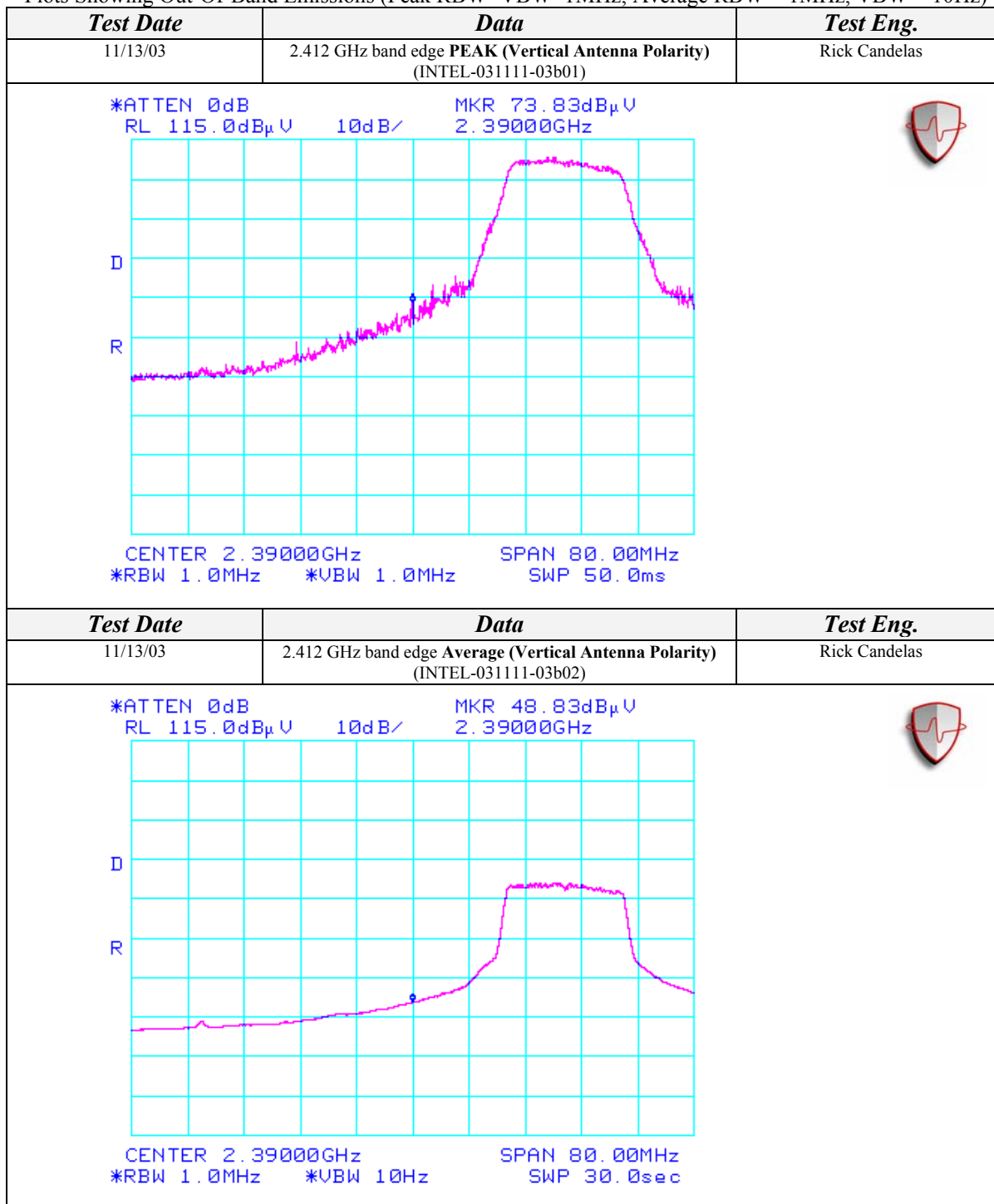

Page 25 of 81 (Appendix A)  
Report Number: INTEL-031111F  
FCC ID: PD9WM3B2200BG





## Spurious Radiated Emissions Test Results (Continued)

Plots Showing Out-Of-Band Emissions (Peak RBW=VBW=1MHz; Average RBW = 1MHz, VBW = 10Hz)

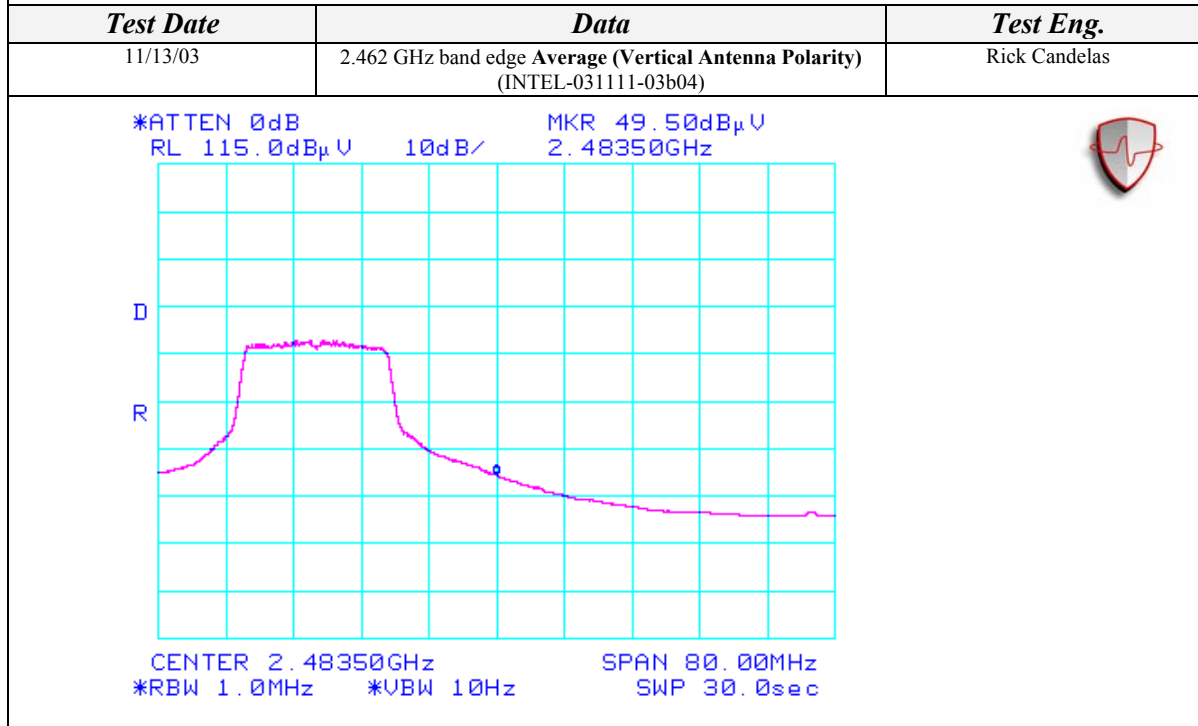
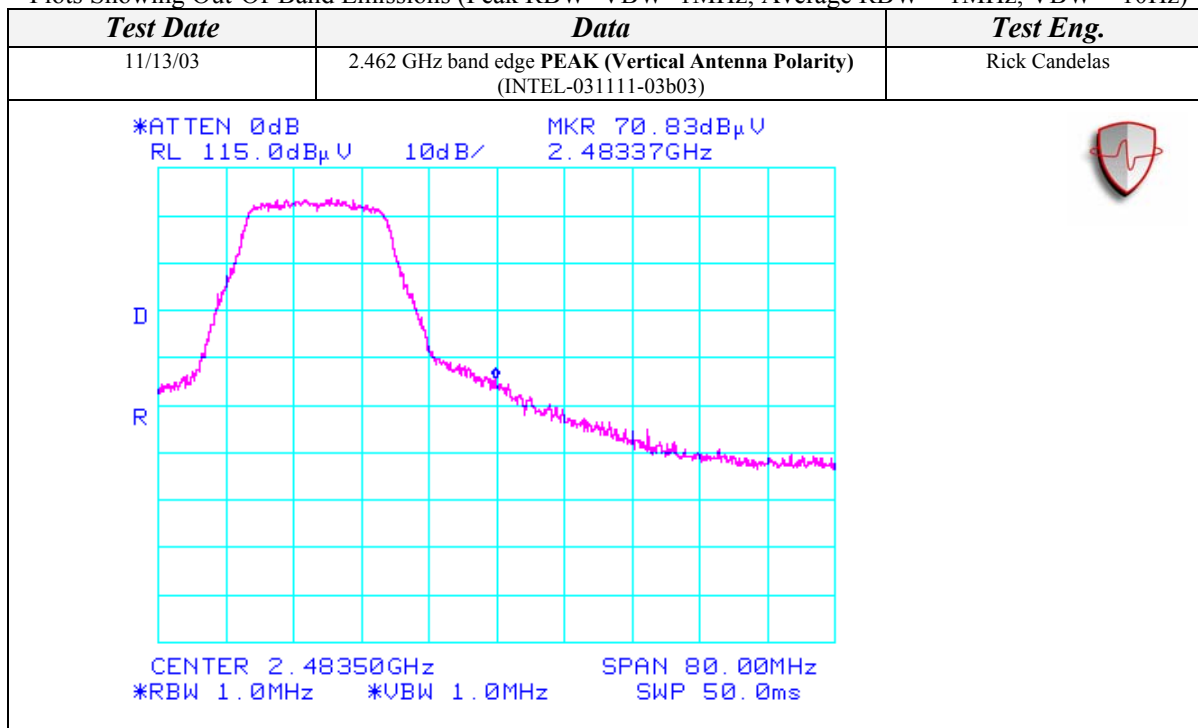



Spurious Radiated Emissions Test Results (Continued)

*Spurious Emissions Measurements in 802.11g mode  
Channels 1, 6, & 11  
Continuous TX at MAIN Antenna port with Hitachi Antennas  
Aegis Labs, Inc. File #: INTEL-031111-12*

<b>RADIATED EMISSIONS - Horizontal Antenna Polarization</b>											
Freq. (MHz)	Meter Reading (dBuV)	Antenna Height (cm)	Azimuth (degrees)	Quasi pk or AVG (dBuV)		1 Meter Distance Factor (dB)	Cable Factor (dB)	Ant. Factor (dB)	Corrected Reading (dBuV)	Limits (dBuV)	Diff (dB) +=FAIL
<b>EUT in Continuous Transmit Mode on Channel 1 (2.412 GHz)</b>											
2312.00	34.83	100	225			9.54	2.75	28.62	56.66	74.00	-17.34
2312.00				23.33	A	9.54	2.75	28.62	45.16	54.00	-8.84
<b>EUT in Continuous Transmit Mode on Channel 6 (2.437 GHz)</b>											
2336.00	35.00	100	225			9.54	2.81	28.71	56.98	74.00	-17.02
2336.00				22.50	A	9.54	2.81	28.71	44.48	54.00	-9.52
<b>EUT in Continuous Transmit Mode on Channel 11 (2.462 GHz)</b>											
2360.00	33.67	100	225			9.54	2.86	28.80	55.79	74.00	-18.21
2360.00				20.83	A	9.54	2.86	28.80	42.95	54.00	-11.05
<b>RADIATED EMISSIONS - Vertical Antenna Polarization</b>											
Freq. (MHz)	Meter Reading (dBuV)	Antenna Height (cm)	Azimuth (degrees)	Quasi pk or AVG (dBuV)		1 Meter Distance Factor (dB)	Cable Factor (dB)	Ant. Factor (dB)	Corrected Reading (dBuV)	Limits (dBuV)	Diff (dB) +=FAIL
<b>EUT in Continuous Transmit Mode on Channel 1 (2.412 GHz)</b>											
2312.00	33.83	100	225			9.54	2.75	28.62	55.66	74.00	-18.34
2312.00				22.33	A	9.54	2.75	28.62	44.16	54.00	-9.84
<b>EUT in Continuous Transmit Mode on Channel 6 (2.437 GHz)</b>											
2336.00	33.33	100	225			9.54	2.81	28.71	55.31	74.00	-18.69
2336.00				21.50	A	9.54	2.81	28.71	43.48	54.00	-10.52
<b>EUT in Continuous Transmit Mode on Channel 11 (2.462 GHz)</b>											
2360.00	33.33	100	225			9.54	2.86	28.80	55.45	74.00	-18.55
2360.00				20.67	A	9.54	2.86	28.80	42.79	54.00	-11.21

NOTE: These spurious emissions measurements were taken without a preamp at a distance on 1 meter to avoid saturating the preamp and analyzer because the signals were close to the fundamental frequency. The readings were extrapolated to 1 meter.



Spurious Radiated Emissions Test Results (Continued)

*Spurious Emissions Measurements in 802.11g mode  
Channels 1, 6, & 11  
Continuous TX at MAIN Antenna port with Hitachi Antennas  
Aegis Labs, Inc. File #: INTEL-031111-03*

<b>RADIATED EMISSIONS - Horizontal Antenna Polarization</b>											
<i>Freq. (MHz)</i>	<i>Meter Reading (dBuV)</i>	<i>Antenna Height (cm)</i>	<i>Azimuth (degrees)</i>	<i>Quasi pk or AVG (dBuV)</i>		<i>Preamp Factor (dB)</i>	<i>Cable Factor (dB)</i>	<i>Ant. Factor (dB)</i>	<i>Corrected Reading (dBuV)</i>	<i>Limits (dBuV)</i>	<i>Diff (dB) +=FAIL</i>
<b>EUT in Continuous Transmit Mode on Channel 1 (2.412 GHz)</b>											
1008.17	58.50	100	270			37.24	1.62	24.93	47.80	74.00	-26.20
1008.17				45.50	A	37.24	1.62	24.93	34.80	54.00	-19.20
1099.17	58.17	200	315			36.90	1.70	25.26	48.23	74.00	-25.77
1099.17				43.17	A	36.90	1.70	25.26	33.23	54.00	-20.77
3215.92	51.83	125	135			36.33	3.37	30.98	49.85	84.38	-34.53
4824.43	44.50	100	180			36.16	4.06	34.10	46.50	74.00	-27.50
4824.43				30.17	A	36.16	4.06	34.10	32.17	54.00	-21.83
6432.00	58.17	125	135			36.39	4.67	35.37	61.83	84.38	-22.55
9647.96	50.67	100	180			36.98	5.99	38.11	57.78	84.38	-26.60
12863.81	45.83	100	225			34.94	7.23	40.27	58.39	84.38	-25.99
<b>EUT in Continuous Transmit Mode on Channel 6 (2.437 GHz)</b>											
1007.90	59.17	100	270			37.24	1.62	24.93	48.47	74.00	-25.53
1007.90				47.00	A	37.24	1.62	24.93	36.30	54.00	-17.70
1096.20	58.17	100	270			36.91	1.70	25.25	48.21	74.00	-25.79
1096.20				42.33	A	36.91	1.70	25.25	32.37	54.00	-21.63
3249.27	50.33	100	135			36.30	3.40	31.05	48.48	83.65	-35.17
4873.74	41.33	100	180			36.20	4.10	34.27	43.50	74.00	-30.50
4873.74				27.83	A	36.20	4.10	34.27	30.00	54.00	-24.00
6498.65	51.33	100	90			36.40	4.70	35.40	55.03	83.65	-28.62
9748.04	53.67	100	225			36.90	6.05	38.25	61.06	83.65	-22.59
12997.67	46.67	100	180			34.80	7.20	40.59	59.66	83.65	-23.99



Spurious Radiated Emissions Test Results (Continued)

<b>RADIATED EMISSIONS - Horizontal Antenna Polarization</b>											
<i>Freq. (MHz)</i>	<i>Meter Reading (dBuV)</i>	<i>Antenna Height (cm)</i>	<i>Azimuth (degrees)</i>	<i>Quasi pk or AVG (dBuV)</i>		<i>Preamp Factor (dB)</i>	<i>Cable Factor (dB)</i>	<i>Ant. Factor (dB)</i>	<i>Corrected Reading (dBuV)</i>	<i>Limits (dBuV)</i>	<i>Diff (dB) +=FAIL</i>

<b>EUT in Continuous Transmit Mode on Channel 11 (2.462 GHz)</b>											
1008.58	58.17	100	270			37.24	1.62	24.93	47.48	74.00	-26.52
1008.58				46.17	A	37.24	1.62	24.93	35.48	54.00	-18.52
1099.73	57.50	175	225			36.90	1.70	25.26	47.56	74.00	-26.44
1099.73				43.17	A	36.90	1.70	25.26	33.23	54.00	-20.77
3282.65	48.50	100	135			36.28	3.44	31.12	46.78	82.76	-35.98
4923.82	41.83	100	135			36.24	4.14	34.44	44.17	74.00	-29.83
4923.82				28.33	A	36.24	4.14	34.44	30.67	54.00	-23.33
6565.33	46.83	100	270			36.40	4.75	35.62	50.80	82.76	-31.96
9847.94	53.83	100	225			36.82	6.11	38.39	61.50	82.76	-21.26
13130.48	45.67	100	135			34.75	7.28	40.65	58.85	82.76	-23.91

<b>RADIATED EMISSIONS - Vertical Antenna Polarization</b>											
<i>Freq. (MHz)</i>	<i>Meter Reading (dBuV)</i>	<i>Antenna Height (cm)</i>	<i>Azimuth (degrees)</i>	<i>Quasi pk or AVG (dBuV)</i>		<i>Preamp Factor (dB)</i>	<i>Cable Factor (dB)</i>	<i>Ant. Factor (dB)</i>	<i>Corrected Reading (dBuV)</i>	<i>Limits (dBuV)</i>	<i>Diff (dB) +=FAIL</i>
<b>EUT in Continuous Transmit Mode on Channel 1 (2.412 GHz)</b>											
1008.37	59.00	200	180			37.24	1.62	25.03	48.40	74.00	-25.60
1008.37				46.17	A	37.24	1.62	25.03	35.57	54.00	-18.43
1097.03	61.67	125	180			36.91	1.70	25.33	51.79	74.00	-22.21
1097.03				44.17	A	36.91	1.70	25.33	34.29	54.00	-19.71
3216.05	46.50	100	135			36.33	3.37	31.09	44.63	87.08	-42.45
4824.00	42.67	100	180			36.16	4.06	34.07	44.64	74.00	-29.36
4824.00				29.17	A	36.16	4.06	34.07	31.14	54.00	-22.86
6431.94	55.17	100	225			36.39	4.67	35.35	58.80	87.08	-28.28
9648.06	50.50	125	135			36.98	5.99	38.17	57.67	87.08	-29.41
12863.98	48.33	100	225			34.94	7.23	40.27	60.89	87.08	-26.19



AEGIS LABS INC.

Spurious Radiated Emissions Test Results (Continued)

RADIATED EMISSIONS - Vertical Antenna Polarization										
Freq. (MHz)	Meter Reading (dBuV)	Antenna Height (cm)	Azimuth (degrees)	Quasi pk or AVG (dBuV)	Preamp Factor (dB)	Cable Factor (dB)	Ant. Factor (dB)	Corrected Reading (dBuV)	Limits (dBuV)	Diff (dB) +=FAIL

EUT in Continuous Transmit Mode on Channel 6 (2.437 GHz)											
1008.40	58.83	100	180			37.24	1.62	25.03	48.23	74.00	-25.77
1008.40				46.83	A	37.24	1.62	25.03	36.23	54.00	-17.77
1097.73	61.83	100	225			36.90	1.70	25.33	51.96	74.00	-22.04
1097.73				44.33	A	36.90	1.70	25.33	34.46	54.00	-19.54
3249.39	48.67	100	135			36.30	3.40	31.15	46.92	86.85	-39.93
4873.79	41.33	100	135			36.20	4.10	34.22	43.45	74.00	-30.55
4873.79				27.83	A	36.20	4.10	34.22	29.95	54.00	-24.05
6498.62	50.50	100	225			36.40	4.70	35.40	54.20	86.85	-32.65
9748.07	50.83	100	180			36.90	6.05	38.35	58.32	86.85	-28.53
12997.40	48.83	125	225			34.80	7.20	40.59	61.82	86.85	-25.03
EUT in Continuous Transmit Mode on Channel 11 (2.462 GHz)											
1007.97	58.17	100	180			37.24	1.62	25.03	47.57	74.00	-26.43
1007.97				45.33	A	37.24	1.62	25.03	34.73	54.00	-19.27
1095.32	61.17	100	225			36.91	1.70	25.32	51.28	74.00	-22.72
1095.32				44.83	A	36.91	1.70	25.32	34.94	54.00	-19.06
3282.70	47.17	100	135			36.28	3.44	31.21	45.54	83.80	-38.26
4923.51	41.83	100	135			36.24	4.14	34.37	44.10	74.00	-29.90
4923.51				28.33	A	36.24	4.14	34.37	30.60	54.00	-23.40
6565.50	47.33	100	135			36.40	4.75	35.60	51.28	83.80	-32.52
9847.93	50.50	100	180			36.82	6.11	38.53	58.31	83.80	-25.49
13130.62	47.33	100	225			34.75	7.28	40.68	60.54	83.80	-23.26



Spurious Radiated Emissions Test Results (Continued)

*Spurious Emissions Measurements in 802.11g mode  
Channels 1, 6, & 11  
Continuous RX at MAIN Antenna port with Hitachi Antennas  
Aegis Labs, Inc. File #: INTEL-031111-03*

<b>RADIATED EMISSIONS - Horizontal Antenna Polarization</b>											
<i>Freq. (MHz)</i>	<i>Meter Reading (dBuV)</i>	<i>Antenna Height (cm)</i>	<i>Azimuth (degrees)</i>	<i>Quasi pk or AVG (dBuV)</i>		<i>Preamp Factor (dB)</i>	<i>Cable Factor (dB)</i>	<i>Ant. Factor (dB)</i>	<i>Corrected Reading (dBuV)</i>	<i>Limits (dBuV)</i>	<i>Diff (dB) +=FAIL</i>
<b>EUT in Continuous Receive Mode on Channel 1 (2.412 GHz)</b>											
1010.63	56.17	100	0			37.23	1.62	24.94	45.50	74.00	-28.50
1010.63				42.17	A	37.23	1.62	24.94	31.50	54.00	-22.50
1100.03	54.50	100	225			36.90	1.70	25.26	44.56	74.00	-29.44
1100.03				38.67	A	36.90	1.70	25.26	28.73	54.00	-25.27
3216.09	48.33	100	135			36.33	3.37	30.98	46.35	84.38	-38.03
6432.00	57.83	100	135			36.39	4.67	35.37	61.49	84.38	-22.89
<b>EUT in Continuous Receive Mode on Channel 6 (2.437 GHz)</b>											
1009.30	55.30	100	45			37.24	1.62	24.93	44.62	74.00	-29.38
1009.30				42.17	A	37.24	1.62	24.93	31.49	54.00	-22.51
1099.10	55.83	100	225			36.90	1.70	25.26	45.88	74.00	-28.12
1099.10				38.67	A	36.90	1.70	25.26	28.72	54.00	-25.28
3249.41	47.83	100	135			36.30	3.40	31.05	45.98	83.65	-37.67
6498.73	52.00	100	180			36.40	4.70	35.40	55.70	83.65	-27.95
<b>EUT in Continuous Receive Mode on Channel 11 (2.462 GHz)</b>											
1012.17	56.83	100	45			37.22	1.62	24.94	46.18	74.00	-27.82
1012.17				42.83	A	37.22	1.62	24.94	32.18	54.00	-21.82
1099.70	55.17	100	225			36.90	1.70	25.26	45.23	74.00	-28.77
1099.70				39.17	A	36.90	1.70	25.26	29.23	54.00	-24.77
3282.75	46.17	100	135			36.28	3.44	31.12	44.45	82.76	-38.31
6565.41	46.33	100	225			36.40	4.75	35.62	50.30	82.76	-32.46



Spurious Radiated Emissions Test Results (Continued)

<b>RADIATED EMISSIONS - Vertical Antenna Polarization</b>											
<i>Freq. (MHz)</i>	<i>Meter Reading (dBuV)</i>	<i>Antenna Height (cm)</i>	<i>Azimuth (degrees)</i>	<i>Quasi pk or AVG (dBuV)</i>		<i>Preamp Factor (dB)</i>	<i>Cable Factor (dB)</i>	<i>Ant. Factor (dB)</i>	<i>Corrected Reading (dBuV)</i>	<i>Limits (dBuV)</i>	<i>Diff (dB) +=FAIL</i>
<b>EUT in Continuous Receive Mode on Channel 1 (2.412 GHz)</b>											
1009.90	55.33	100	225			37.23	1.62	25.03	44.75	74.00	-29.25
1009.90				41.17	A	37.23	1.62	25.03	30.59	54.00	-23.41
1100.37	62.67	100	180			36.90	1.70	25.34	52.81	74.00	-21.19
1100.37				43.67	A	36.90	1.70	25.34	33.81	54.00	-20.19
3216.05	47.00	100	135			36.33	3.37	31.09	45.13	87.08	-41.95
6432.06	53.17	100	225			36.39	4.67	35.35	56.80	87.08	-30.28
<b>EUT in Continuous Receive Mode on Channel 6 (2.437 GHz)</b>											
1011.07	54.00	100	225			37.23	1.62	25.04	43.43	74.00	-30.57
1011.07				41.17	A	37.23	1.62	25.04	30.60	54.00	-23.40
1100.00	63.33	100	180			36.90	1.70	25.34	53.47	74.00	-20.53
1100.00				52.83	A	36.90	1.70	25.34	42.97	54.00	-11.03
3249.39	47.33	100	135			36.30	3.40	31.15	45.58	86.85	-41.27
6498.63	49.93	100	225			36.40	4.70	35.40	53.63	86.85	-33.22
<b>EUT in Continuous Receive Mode on Channel 11 (2.462 GHz)</b>											
1009.63	54.83	100	225			37.23	1.62	25.03	44.25	74.00	-29.75
1009.63				41.83	A	37.23	1.62	25.03	31.25	54.00	-22.75
1099.37	62.33	100	180			36.90	1.70	25.34	52.47	74.00	-21.53
1099.37				43.83	A	36.90	1.70	25.34	33.97	54.00	-20.03
3282.75	46.83	100	135			36.28	3.44	31.21	45.20	83.80	-38.60
6565.41	47.17	100	180			36.40	4.75	35.60	51.12	83.80	-32.68



AEGIS LABS INC.

## Spurious Radiated Emissions Test Results (Continued)

<b>CLIENT:</b>	Intel Corporation	<b>DATE:</b>	11/17/03
<b>EUT:</b>	802.11b/g MiniPCI Type 3B Wireless Adapter	<b>PROJECT NUMBER:</b>	INTEL-031111
<b>MODEL NUMBER:</b>	WM3B2200BG	<b>TEST ENGINEER:</b>	Rick Candelas
<b>SERIAL NUMBER:</b>	000E35005267	<b>SITE #:</b>	2
<b>CONFIGURATION:</b>	Tested installed in the Hewlett Packard host computer's mini PCI slot in 802.11b mode with the Ethertronics antennas.	<b>TEMPERATURE:</b>	18 C
		<b>HUMIDITY:</b>	46% RH
		<b>TIME:</b>	10:00 AM

<b>Standard:</b>	FCC CFR 47, Part 15.247(c)
<b>Description:</b>	Radiated emissions, which fall in the restricted bands, as defined in Sec. 15.205(a), must also comply with the radiated emission limits specified in Sec. 15.209(a). All others must be < -20dBc.
<b>Results:</b>	Passes (See Data Sheets)

Unwanted Spurious Emissions Limits			
Frequency (MHz)	Field Strength (uV/m)	Field Strength (dBuV/m) (Emissions in the restricted bands)	Field Strength (dBm/MHz) (Emissions outside the restricted bands)
Above 960	500	54.00 (Average) 74.00 (Peak)	< -20 dBc

Page 33 of 81 (Appendix A)  
Report Number: INTEL-031111F  
FCC ID: PD9WM3B2200BG





Spurious Radiated Emissions Test Results (Continued)

*Fundamental Measurements in 802.11b mode  
Channels 1, 6, & 11  
Continuous TX at MAIN Antenna port with Ethertronics Antennas  
Aegis Labs, Inc. File #: INTEL-031111-08*

<b>RADIATED EMISSIONS - Horizontal Antenna Polarization</b>											
<i>Freq. (MHz)</i>	<i>Meter Reading (dBuV)</i>	<i>Antenna Height (cm)</i>	<i>Azimuth (degrees)</i>	<i>Quasi pk or AVG (dBuV)</i>		<i>Preamp Factor (dB)</i>	<i>Cable Factor (dB)</i>	<i>Ant. Factor (dB)</i>	<i>Corrected Reading (dBuV)</i>	<i>Limits (dBuV)</i>	<i>Diff (dB) +=FAIL</i>
2412.00	78.00	100	225				2.99	29.22	110.21		
2412.00				70.67	A		2.99	29.22	102.88		
2437.00	79.50	100	135				3.05	29.27	111.82		
2437.00				71.83	A		3.05	29.27	104.15		
2462.00	79.00	100	135				3.11	29.32	111.43		
2462.00				71.50	A		3.11	29.32	103.93		

<b>RADIATED EMISSIONS – Vertical Antenna Polarization</b>											
<i>Freq. (MHz)</i>	<i>Meter Reading (dBuV)</i>	<i>Antenna Height (cm)</i>	<i>Azimuth (degrees)</i>	<i>Quasi pk or AVG (dBuV)</i>		<i>Preamp Factor (dB)</i>	<i>Cable Factor (dB)</i>	<i>Ant. Factor (dB)</i>	<i>Corrected Reading (dBuV)</i>	<i>Limits (dBuV)</i>	<i>Diff (dB) +=FAIL</i>
2412.00	77.00	100	90				2.99	29.42	109.41		
2412.00				70.00	A		2.99	29.42	102.41		
2437.00	72.33	100	225				3.05	29.47	104.85		
2437.00				65.50	A		3.05	29.47	98.02		
2462.00	74.50	100	90				3.11	29.52	107.13		
2462.00				66.83	A		3.11	29.52	99.46		



Spurious Radiated Emissions Test Results (Continued)

*Band Edge Field Strength Measurements in 802.11b mode  
Channels 1, 6, & 11  
Continuous TX at MAIN Antenna port with Ethertronics Antennas  
Aegis Labs, Inc. File #: INTEL-031111-09*

<b>RADIATED EMISSIONS - Horizontal Antenna Polarization</b>											
<i>Freq. (MHz)</i>	<i>Meter Reading (dBuV)</i>	<i>Antenna Height (cm)</i>	<i>Azimuth (degrees)</i>	<i>Quasi pk or AVG (dBuV)</i>		<i>Preamp Factor (dB)</i>	<i>Cable Factor (dB)</i>	<i>Ant. Factor (dB)</i>	<i>Corrected Reading (dBuV)</i>	<i>Limits (dBuV)</i>	<i>Diff (dB) +=FAIL</i>
2386.93	68.33	100	225			36.44	2.93	29.17	63.99	74.00	-10.01
2385.20				56.00	A	36.44	2.92	29.17	51.66	54.00	-2.34
2390.00	64.00	100	225			36.45	2.94	29.18	59.67	74.00	-14.33
2390.00				51.67	A	36.45	2.94	29.18	47.34	54.00	-6.66
2400.00	80.50	100	225			36.47	2.96	29.20	76.19	90.21	-14.02
2488.97	63.17	100	135			36.69	3.17	29.38	59.03	74.00	-14.97
2489.10				54.00	A	36.69	3.17	29.38	49.86	54.00	-4.14
2483.50	62.67	100	135			36.68	3.16	29.37	58.52	74.00	-15.48
2483.50				51.17	A	36.68	3.16	29.37	47.02	54.00	-6.98

<b>RADIATED EMISSIONS – Vertical Antenna Polarization</b>											
<i>Freq. (MHz)</i>	<i>Meter Reading (dBuV)</i>	<i>Antenna Height (cm)</i>	<i>Azimuth (degrees)</i>	<i>Quasi pk or AVG (dBuV)</i>		<i>Preamp Factor (dB)</i>	<i>Cable Factor (dB)</i>	<i>Ant. Factor (dB)</i>	<i>Corrected Reading (dBuV)</i>	<i>Limits (dBuV)</i>	<i>Diff (dB) +=FAIL</i>
2385.47	62.17	200	90			36.44	2.93	29.37	58.03	74.00	-15.97
2383.60				50.33	A	36.43	2.92	29.37	46.19	54.00	-7.81
2390.00	59.00	200	90			36.45	2.94	29.38	54.87	74.00	-19.13
2390.00				47.50	A	36.45	2.94	29.38	43.37	54.00	-10.63
2400.00	76.83	200	90			36.47	2.96	29.40	72.72	89.41	-16.69
2489.10	61.50	200	90			36.69	3.17	29.58	57.56	74.00	-16.44
2488.70				51.83	A	36.69	3.17	29.58	47.89	54.00	-6.11
2483.50	59.67	200	90			36.68	3.16	29.57	55.72	74.00	-18.28
2483.50				49.17	A	36.68	3.16	29.57	45.22	54.00	-8.78



AEGIS LABS INC.

### Spurious Radiated Emissions Test Results (Continued)

Plots Showing Out-Of-Band Emissions (Peak RBW=VBW=1MHz; Average RBW = 1MHz, VBW = 10Hz)

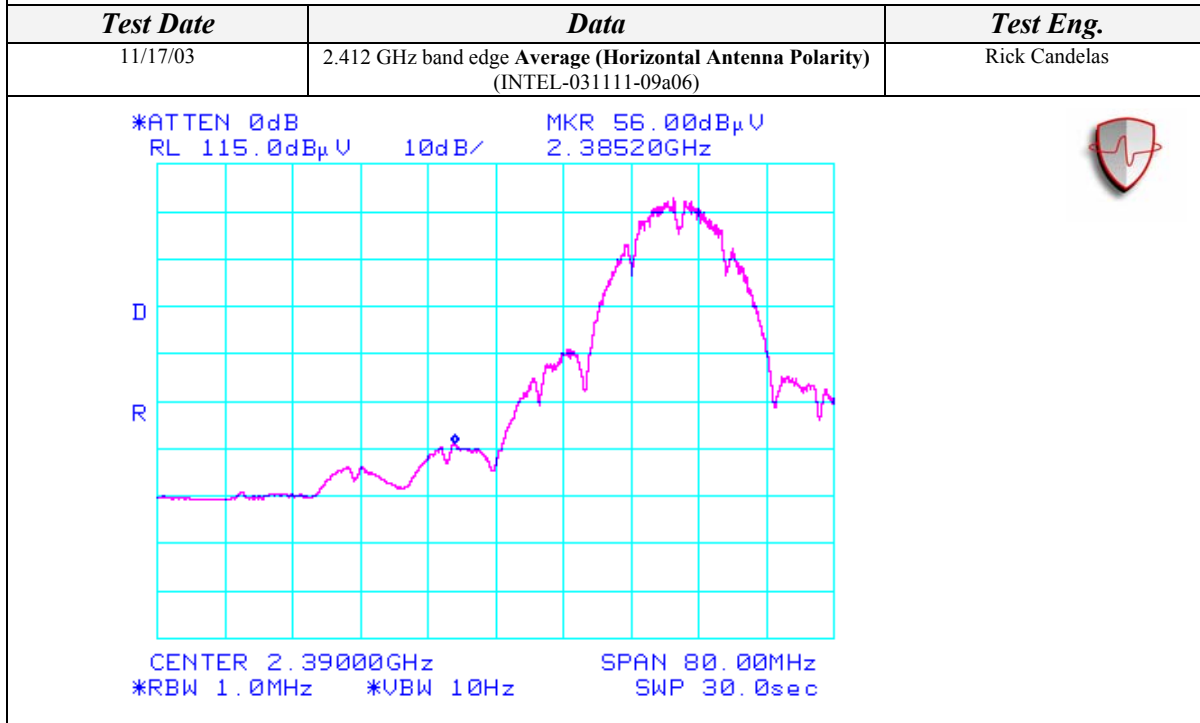
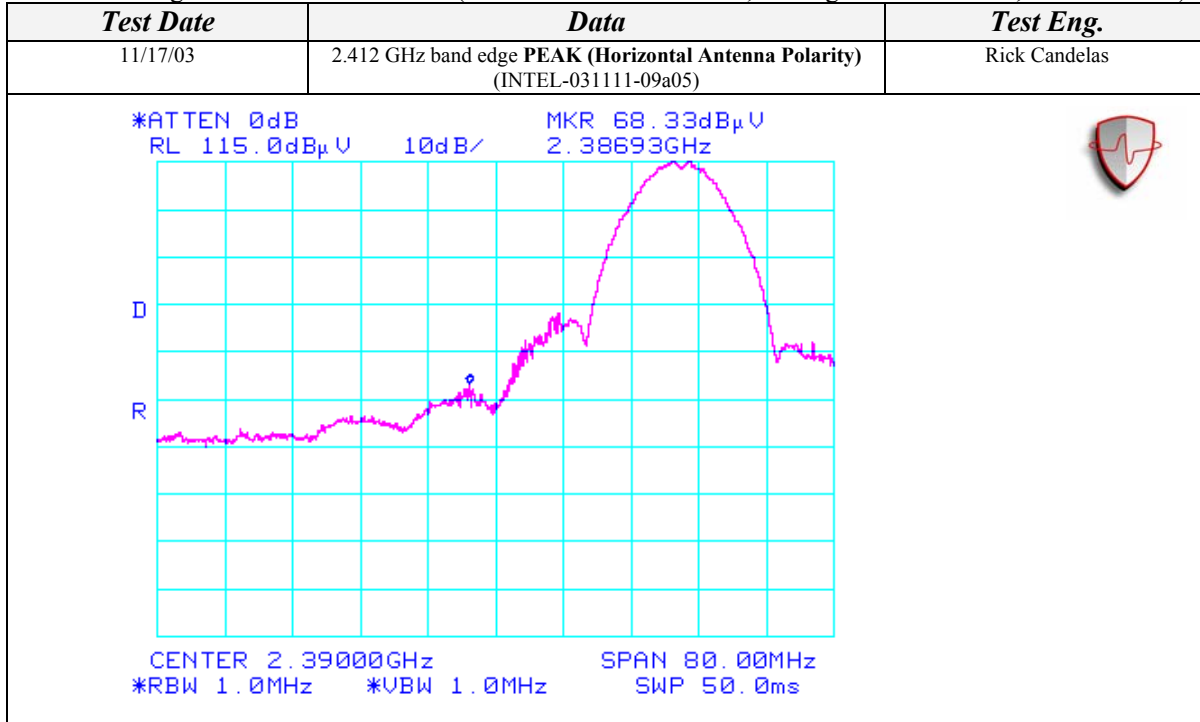

Page 36 of 81 (Appendix A)  
Report Number: INTEL-031111F  
FCC ID: PD9WM3B2200BG



AEGIS LABS INC.

### Spurious Radiated Emissions Test Results (Continued)

Plots Showing Out-Of-Band Emissions (Peak RBW=VBW=1MHz; Average RBW = 1MHz, VBW = 10Hz)

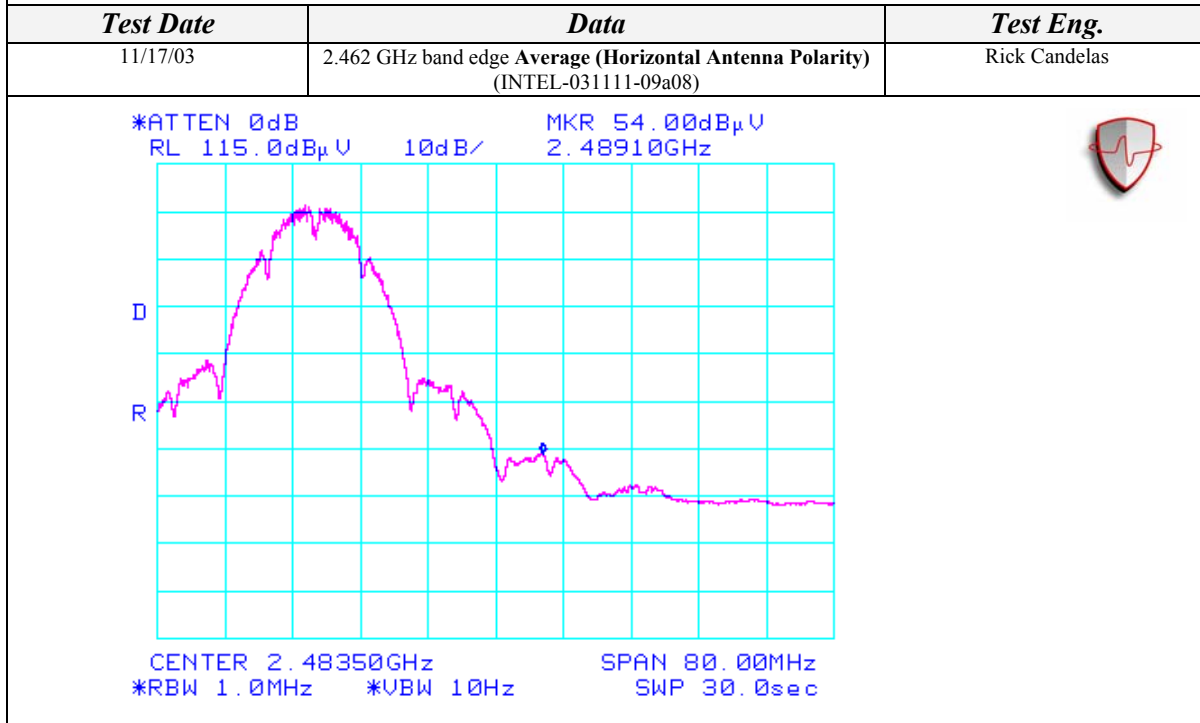
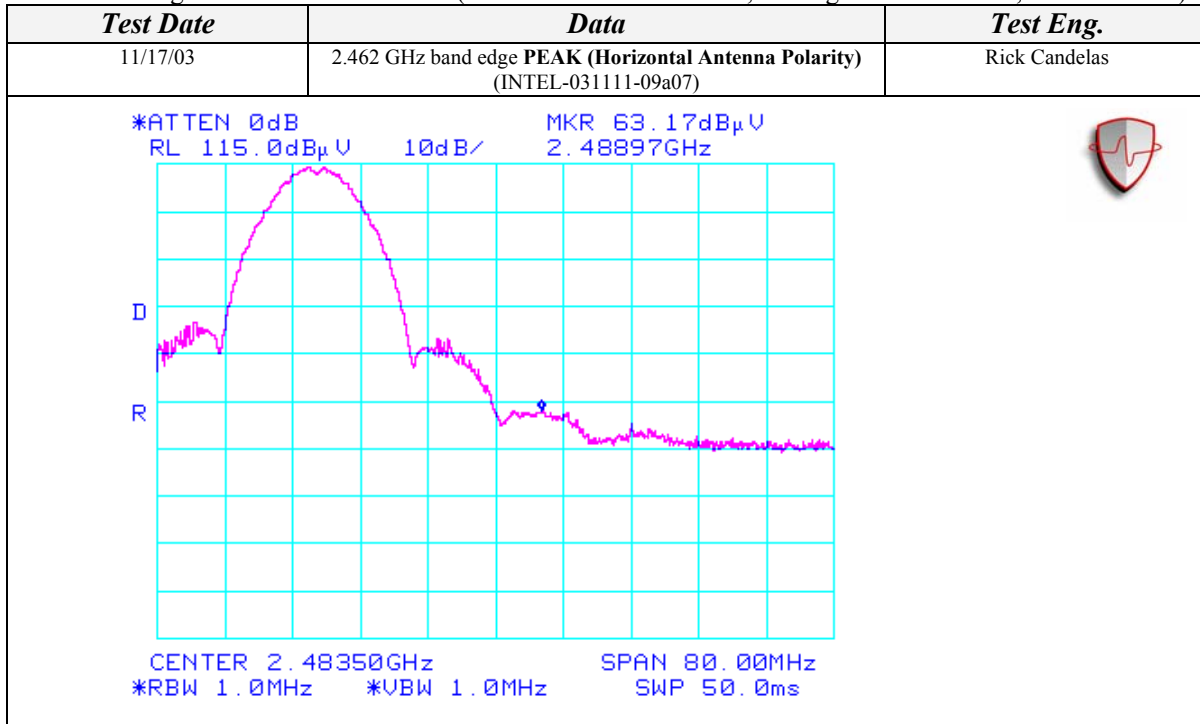

Page 37 of 81 (Appendix A)  
Report Number: INTEL-031111F  
FCC ID: PD9WM3B2200BG



AEGIS LABS INC.

### Spurious Radiated Emissions Test Results (Continued)

Plots Showing Out-Of-Band Emissions (Peak RBW=VBW=1MHz; Average RBW = 1MHz, VBW = 10Hz)

Test Date	Data	Test Eng.
11/17/03	2.412 GHz band edge <b>PEAK (Vertical Antenna Polarity)</b> (INTEL-031111-09a01)	Rick Candelas

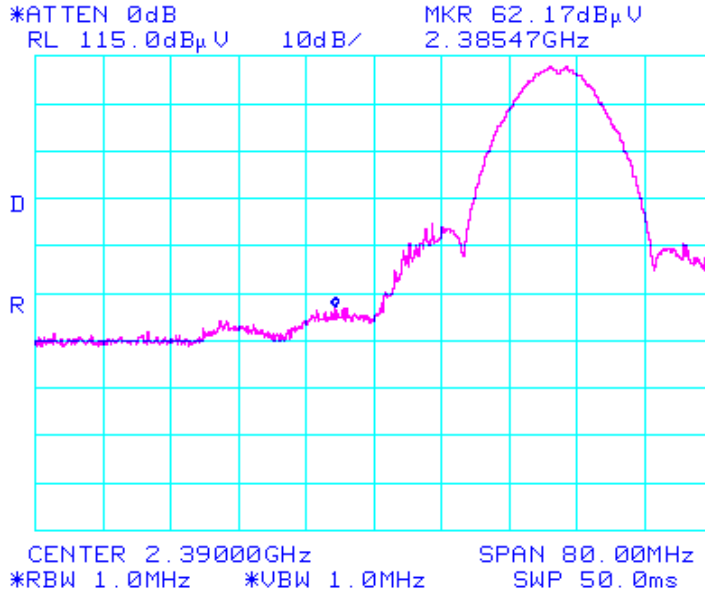

Test Date	Data	Test Eng.
11/17/03	2.412 GHz band edge <b>Average (Vertical Antenna Polarity)</b> (INTEL-031111-09a02)	Rick Candelas

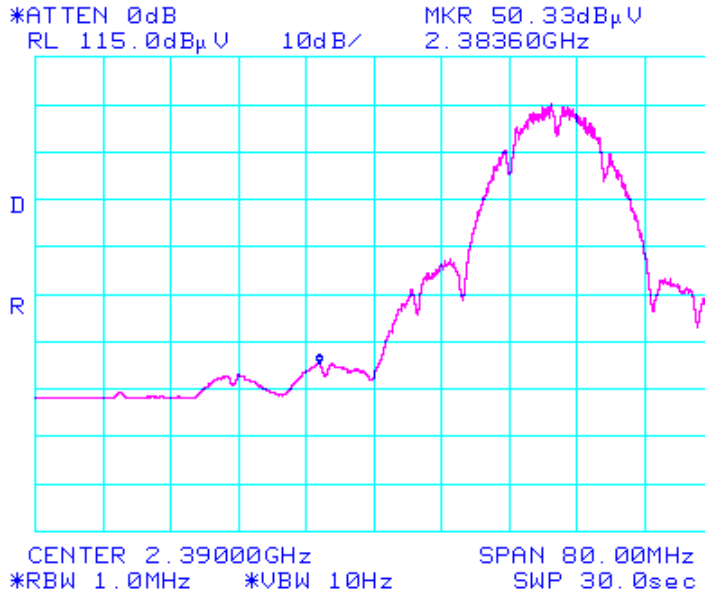

Page 38 of 81 (Appendix A)  
Report Number: INTEL-031111F  
FCC ID: PD9WM3B2200BG



AEGIS LABS INC.

### Spurious Radiated Emissions Test Results (Continued)

Plots Showing Out-Of-Band Emissions (Peak RBW=VBW=1MHz; Average RBW = 1MHz, VBW = 10Hz)

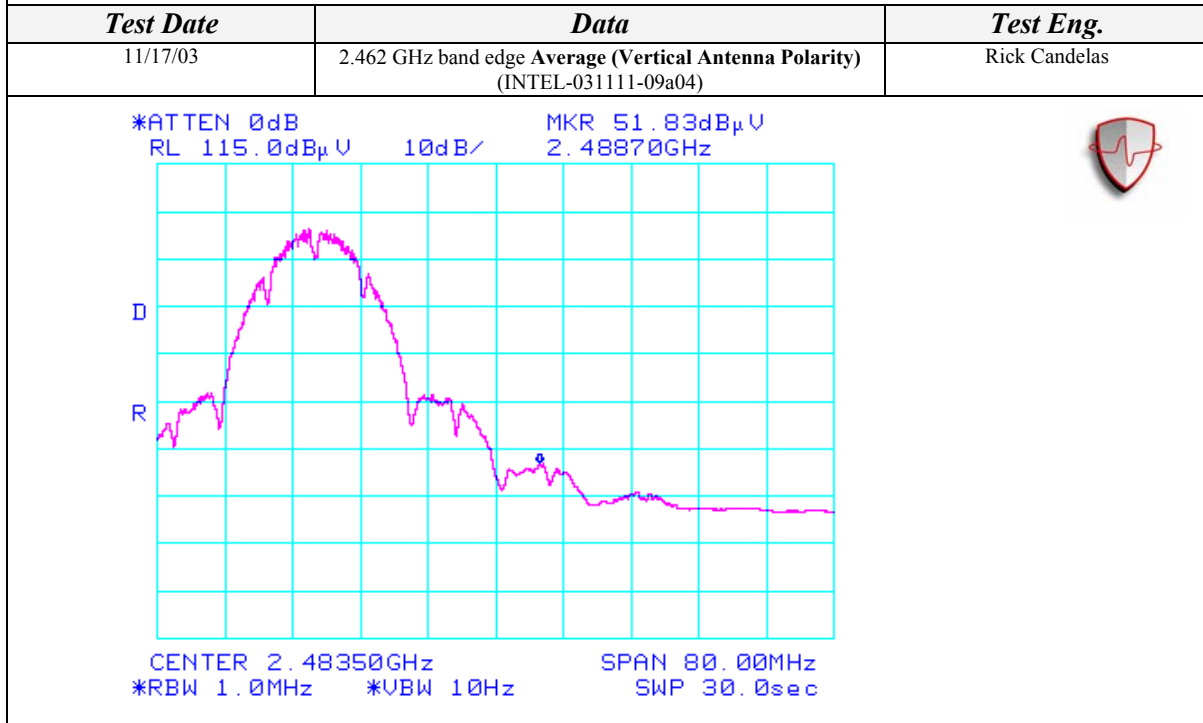
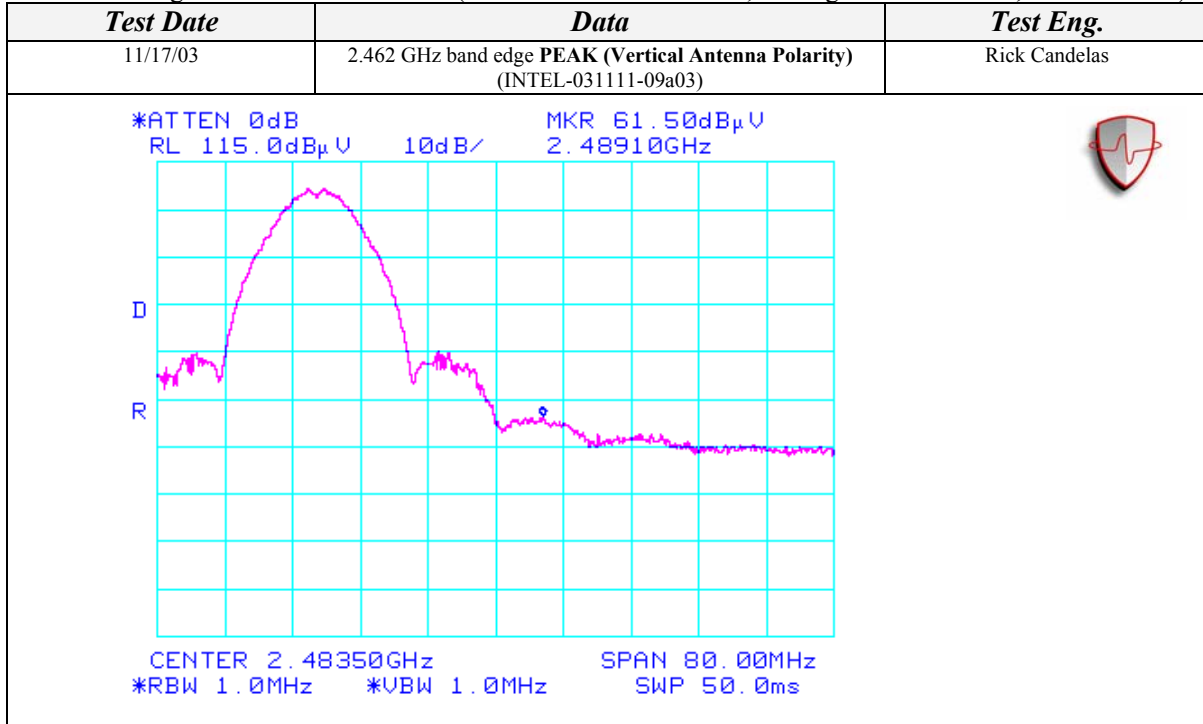

Page 39 of 81 (Appendix A)  
Report Number: INTEL-031111F  
FCC ID: PD9WM3B2200BG



Spurious Radiated Emissions Test Results (Continued)

*Spurious Emissions Measurements in 802.11b mode  
Channels 1, 6, & 11  
Continuous TX at MAIN Antenna port with Ethertronics Antennas  
Aegis Labs, Inc. File #: INTEL-031111-13*

<b>RADIATED EMISSIONS - Horizontal Antenna Polarization</b>											
Freq. (MHz)	Meter Reading (dBuV)	Antenna Height (cm)	Azimuth (degrees)	Quasi pk or AVG (dBuV)		1 Meter Distance Factor (dB)	Cable Factor (dB)	Ant. Factor (dB)	Corrected Reading (dBuV)	Limits (dBuV)	Diff (dB) +=FAIL
<b>EUT in Continuous Transmit Mode on Channel 1 (2.412 GHz)</b>											
2312.00	33.67	100	225			9.54	2.75	28.62	55.50	74.00	-18.50
2312.00				22.50	A	9.54	2.75	28.62	44.33	54.00	-9.67
<b>EUT in Continuous Transmit Mode on Channel 6 (2.437 GHz)</b>											
2336.00	32.83	100	225			9.54	2.81	28.71	54.81	74.00	-19.19
2336.00				21.83	A	9.54	2.81	28.71	43.81	54.00	-10.19
<b>EUT in Continuous Transmit Mode on Channel 11 (2.462 GHz)</b>											
2360.00	31.67	100	225			9.54	2.86	28.80	53.79	74.00	-20.21
2360.00				19.83	A	9.54	2.86	28.80	41.95	54.00	-12.05
<b>RADIATED EMISSIONS - Vertical Antenna Polarization</b>											
Freq. (MHz)	Meter Reading (dBuV)	Antenna Height (cm)	Azimuth (degrees)	Quasi pk or AVG (dBuV)		1 Meter Distance Factor (dB)	Cable Factor (dB)	Ant. Factor (dB)	Corrected Reading (dBuV)	Limits (dBuV)	Diff (dB) +=FAIL
<b>EUT in Continuous Transmit Mode on Channel 1 (2.412 GHz)</b>											
2312.00	33.17	100	225			9.54	2.75	28.62	55.00	74.00	-19.00
2312.00				20.17	A	9.54	2.75	28.62	42.00	54.00	-12.00
<b>EUT in Continuous Transmit Mode on Channel 6 (2.437 GHz)</b>											
2336.00	32.00	100	225			9.54	2.81	28.71	53.98	74.00	-20.02
2336.00				19.17	A	9.54	2.81	28.71	41.15	54.00	-12.85
<b>EUT in Continuous Transmit Mode on Channel 11 (2.462 GHz)</b>											
2360.00	32.33	100	225			9.54	2.86	28.80	54.45	74.00	-19.55
2360.00				19.17	A	9.54	2.86	28.80	41.29	54.00	-12.71

NOTE: These spurious emissions measurements were taken without a preamp at a distance on 1 meter to avoid saturating the preamp and analyzer because the signals were close to the fundamental frequency. The readings were extrapolated to 1 meter.



Spurious Radiated Emissions Test Results (Continued)

*Spurious Emissions Measurements in 802.11b mode  
Channels 1, 6, & 11  
Continuous TX at MAIN Antenna port with Ethertronics Antennas  
Aegis Labs, Inc. File #: INTEL-031111-09*

<b>RADIATED EMISSIONS - Horizontal Antenna Polarization</b>											
<i>Freq. (MHz)</i>	<i>Meter Reading (dBuV)</i>	<i>Antenna Height (cm)</i>	<i>Azimuth (degrees)</i>	<i>Quasi pk or AVG (dBuV)</i>		<i>Preamp Factor (dB)</i>	<i>Cable Factor (dB)</i>	<i>Ant. Factor (dB)</i>	<i>Corrected Reading (dBuV)</i>	<i>Limits (dBuV)</i>	<i>Diff (dB) +=FAIL</i>
<b>EUT in Continuous Transmit Mode on Channel 1 (2.412 GHz)</b>											
1008.00	59.17	100	0			37.24	1.62	24.93	48.47	74.00	-25.53
1008.00				48.33	A	37.24	1.62	24.93	37.63	54.00	-16.37
1099.97	59.50	100	180			36.90	1.70	25.26	49.56	74.00	-24.44
1099.70				43.50	A	36.90	1.70	25.26	33.56	54.00	-20.44
3215.97	50.00	125	135			36.33	3.37	30.98	48.02	90.21	-42.19
4823.97	51.50	100	180			36.16	4.06	34.10	53.50	74.00	-20.50
4823.97				46.50	A	36.16	4.06	34.10	48.50	54.00	-5.50
6432.04	57.67	100	135			36.39	4.67	35.37	61.33	90.21	-28.88
9647.90	52.33	100	135			36.98	5.99	38.11	59.44	90.21	-30.77
12059.50	48.17	100	180			36.00	7.04	39.66	58.87	74.00	-15.13
12059.50				37.83	A	36.00	7.04	39.66	48.53	54.00	-5.47
12864.03	45.67	100	180			34.94	7.23	40.27	58.23	90.21	-31.98
<b>EUT in Continuous Transmit Mode on Channel 6 (2.437 GHz)</b>											
1007.73	59.83	100	0			37.25	1.62	24.93	49.13	74.00	-24.87
1007.73				48.17	A	37.25	1.62	24.93	37.47	54.00	-16.53
1098.07	59.67	100	180			36.90	1.70	25.25	49.72	74.00	-24.28
1098.07				43.67	A	36.90	1.70	25.25	33.72	54.00	-20.28
3249.39	48.83	100	180			36.30	3.40	31.05	46.98	91.82	-44.84
4873.98	51.67	100	180			36.20	4.10	34.27	53.84	74.00	-20.16
4873.98				47.00	A	36.20	4.10	34.27	49.17	54.00	-4.83
6498.02	51.67	100	180			36.40	4.70	35.40	55.37	91.82	-36.45
9748.01	53.00	100	135			36.90	6.05	38.25	60.39	91.82	-31.43
12186.27	47.67	100	135			35.80	7.11	39.59	58.57	74.00	-15.43
12186.27				36.00	A	35.80	7.11	39.59	46.90	54.00	-7.10
12997.33	46.33	100	225			34.80	7.20	40.59	59.32	91.82	-32.50





Spurious Radiated Emissions Test Results (Continued)

<b>RADIATED EMISSIONS - Horizontal Antenna Polarization</b>										
<i>Freq. (MHz)</i>	<i>Meter Reading (dBuV)</i>	<i>Antenna Height (cm)</i>	<i>Azimuth (degrees)</i>	<i>Quasi pk or AVG (dBuV)</i>	<i>Preamp Factor (dB)</i>	<i>Cable Factor (dB)</i>	<i>Ant. Factor (dB)</i>	<i>Corrected Reading (dBuV)</i>	<i>Limits (dBuV)</i>	<i>Diff (dB) +=FAIL</i>

<b>EUT in Continuous Transmit Mode on Channel 11 (2.462 GHz)</b>											
1007.93	59.33	100	0			37.24	1.62	24.93	48.63	74.00	-25.37
1007.93				48.00	A	37.24	1.62	24.93	37.30	54.00	-16.70
1095.70	59.83	100	180			36.91	1.70	25.24	49.87	74.00	-24.13
1095.70				43.17	A	36.91	1.70	25.24	33.21	54.00	-20.79
3282.69	47.33	100	135			36.28	3.44	31.12	45.61	91.43	-45.82
4924.06	50.00	100	180			36.24	4.14	34.44	52.34	74.00	-21.66
4924.06				44.83	A	36.24	4.14	34.44	47.17	54.00	-6.83
6565.40	47.50	100	135			36.40	4.75	35.62	51.47	91.43	-39.96
9848.02	57.00	100	225			36.82	6.11	38.39	64.67	91.43	-26.76
12311.07	46.83	100	135			35.60	7.19	39.51	57.93	74.00	-16.07
12311.07				35.17	A	35.60	7.19	39.51	46.27	54.00	-7.73
13130.74	45.83	100	135			34.75	7.28	40.65	59.01	91.43	-32.42

<b>RADIATED EMISSIONS - Vertical Antenna Polarization</b>											
<i>Freq. (MHz)</i>	<i>Meter Reading (dBuV)</i>	<i>Antenna Height (cm)</i>	<i>Azimuth (degrees)</i>	<i>Quasi pk or AVG (dBuV)</i>	<i>Preamp Factor (dB)</i>	<i>Cable Factor (dB)</i>	<i>Ant. Factor (dB)</i>	<i>Corrected Reading (dBuV)</i>	<i>Limits (dBuV)</i>	<i>Diff (dB) +=FAIL</i>	
<b>EUT in Continuous Transmit Mode on Channel 1 (2.412 GHz)</b>											
1008.43	61.50	200	180			37.24	1.62	25.03	50.90	74.00	-23.10
1008.43				51.17	A	37.24	1.62	25.03	40.57	54.00	-13.43
1099.90	63.00	100	135			36.90	1.70	25.34	53.14	74.00	-20.86
1099.90				47.17	A	36.90	1.70	25.34	37.31	54.00	-16.69
3216.03	47.83	100	135			36.33	3.37	31.09	45.96	89.41	-43.45
4823.97	50.50	100	135			36.16	4.06	34.07	52.47	74.00	-21.53
4823.97				45.83	A	36.16	4.06	34.07	47.80	54.00	-6.20
6432.09	54.17	100	135			36.39	4.67	35.35	57.80	89.41	-31.61
9647.92	52.67	100	225			36.98	5.99	38.17	59.84	89.41	-29.57
12061.17	46.83	100	135			36.00	7.04	39.75	57.62	74.00	-16.38
12061.17				35.50	A	36.00	7.04	39.75	46.29	54.00	-7.71
12864.06	47.67	100	225			34.94	7.23	40.27	60.23	89.41	-29.18



AEGIS LABS INC.

Spurious Radiated Emissions Test Results (Continued)

<b>RADIATED EMISSIONS - Vertical Antenna Polarization</b>											
<i>Freq. (MHz)</i>	<i>Meter Reading (dBuV)</i>	<i>Antenna Height (cm)</i>	<i>Azimuth (degrees)</i>	<i>Quasi pk or AVG (dBuV)</i>		<i>Preamp Factor (dB)</i>	<i>Cable Factor (dB)</i>	<i>Ant. Factor (dB)</i>	<i>Corrected Reading (dBuV)</i>	<i>Limits (dBuV)</i>	<i>Diff (dB) +=FAIL</i>

<b>EUT in Continuous Transmit Mode on Channel 6 (2.437 GHz)</b>											
1008.37	61.00	200	180			37.24	1.62	25.03	50.40	74.00	-23.60
1008.37				50.83	A	37.24	1.62	25.03	40.23	54.00	-13.77
1099.33	62.17	100	135			36.90	1.70	25.34	52.31	74.00	-21.69
1099.33				45.83	A	36.90	1.70	25.34	35.97	54.00	-18.03
3249.36	48.50	100	135			36.30	3.40	31.15	46.75	84.85	-38.10
4874.04	49.67	100	135			36.20	4.10	34.22	51.79	74.00	-22.21
4874.04				44.67	A	36.20	4.10	34.22	46.79	54.00	-7.21
6498.67	50.33	100	135			36.40	4.70	35.40	54.03	84.85	-30.82
9747.93	53.67	100	135			36.90	6.05	38.35	61.16	84.85	-23.69
12183.03	46.50	100	225			35.81	7.11	39.65	57.46	74.00	-16.54
12183.03				33.50	A	35.81	7.11	39.65	44.46	54.00	-9.54
12997.47	47.50	100	225			34.80	7.20	40.59	60.49	84.85	-24.36

<b>EUT in Continuous Transmit Mode on Channel 11 (2.462 GHz)</b>											
1007.78	60.83	200	180			37.24	1.62	25.03	50.23	74.00	-23.77
1007.78				50.17	A	37.24	1.62	25.03	39.57	54.00	-14.43
1100.07	62.83	100	135			36.90	1.70	25.34	52.97	74.00	-21.03
1100.07				46.17	A	36.90	1.70	25.34	36.31	54.00	-17.69
3282.69	46.33	100	135			36.28	3.44	31.21	44.70	87.13	-42.43
4924.15	47.33	100	135			36.24	4.14	34.37	49.60	74.00	-24.40
4924.15				40.50	A	36.24	4.14	34.37	42.77	54.00	-11.23
6565.45	47.67	100	135			36.40	4.75	35.60	51.62	87.13	-35.51
9848.00	56.00	100	225			36.82	6.11	38.53	63.81	87.13	-23.32
12308.50	45.83	100	135			35.61	7.19	39.55	56.96	74.00	-17.04
12308.50				33.00	A	35.61	7.19	39.55	44.13	54.00	-9.87
13130.81	45.83	100	225			34.75	7.28	40.68	59.04	87.13	-28.09

Page 43 of 81 (Appendix A)  
 Report Number: INTEL-031111F  
 FCC ID: PD9WM3B2200BG



Spurious Radiated Emissions Test Results (Continued)

*Spurious Emissions Measurements in 802.11b mode  
Channels 1, 6, & 11  
Continuous RX at MAIN Antenna port with Ethertronics Antennas  
Aegis Labs, Inc. File #: INTEL-031111-09*

<b>RADIATED EMISSIONS - Horizontal Antenna Polarization</b>											
<i>Freq. (MHz)</i>	<i>Meter Reading (dBuV)</i>	<i>Antenna Height (cm)</i>	<i>Azimuth (degrees)</i>	<i>Quasi pk or AVG (dBuV)</i>		<i>Preamp Factor (dB)</i>	<i>Cable Factor (dB)</i>	<i>Ant. Factor (dB)</i>	<i>Corrected Reading (dBuV)</i>	<i>Limits (dBuV)</i>	<i>Diff (dB) +=FAIL</i>
<b>EUT in Continuous Receive Mode on Channel 1 (2.412 GHz)</b>											
1008.06	55.83	100	0			37.24	1.62	24.93	45.13	74.00	-28.87
1008.06				46.00	A	37.24	1.62	24.93	35.30	54.00	-18.70
1099.91	54.00	125	180			36.90	1.70	25.26	44.06	74.00	-29.94
1099.91				38.33	A	36.90	1.70	25.26	28.39	54.00	-25.61
3216.01	48.17	100	135			36.33	3.37	30.98	46.19	90.21	-44.02
6431.99	56.33	100	180			36.39	4.67	35.37	59.99	90.21	-30.22
<b>EUT in Continuous Receive Mode on Channel 6 (2.437 GHz)</b>											
1008.02	55.83	100	0			37.24	1.62	24.93	45.13	74.00	-28.87
1008.02				45.50	A	37.24	1.62	24.93	34.80	54.00	-19.20
1099.91	53.83	125	180			36.90	1.70	25.26	43.89	74.00	-30.11
1099.91				38.17	A	36.90	1.70	25.26	28.23	54.00	-25.77
3249.36	47.67	100	135			36.30	3.40	31.05	45.82	91.82	-46.00
6498.66	50.83	100	225			36.40	4.70	35.40	54.53	91.82	-37.29
<b>EUT in Continuous Receive Mode on Channel 11 (2.462 GHz)</b>											
1007.75	56.00	100	0			37.25	1.62	24.93	45.30	74.00	-28.70
1007.75				46.00	A	37.25	1.62	24.93	35.30	54.00	-18.70
1099.58	54.17	125	180			36.90	1.70	25.26	44.23	74.00	-29.77
1099.58				38.83	A	36.90	1.70	25.26	28.89	54.00	-25.11
3282.64	45.83	100	135			36.28	3.44	31.12	44.11	91.43	-47.32
6565.31	46.83	100	225			36.40	4.75	35.62	50.80	91.43	-40.63



Spurious Radiated Emissions Test Results (Continued)

<b>RADIATED EMISSIONS - Vertical Antenna Polarization</b>											
<i>Freq. (MHz)</i>	<i>Meter Reading (dBuV)</i>	<i>Antenna Height (cm)</i>	<i>Azimuth (degrees)</i>	<i>Quasi pk or AVG (dBuV)</i>		<i>Preamp Factor (dB)</i>	<i>Cable Factor (dB)</i>	<i>Ant. Factor (dB)</i>	<i>Corrected Reading (dBuV)</i>	<i>Limits (dBuV)</i>	<i>Diff (dB) +=FAIL</i>
<b>EUT in Continuous Receive Mode on Channel 1 (2.412 GHz)</b>											
1008.14	56.00	100	180			37.24	1.62	25.03	45.40	74.00	-28.60
1008.14				45.83	A	37.24	1.62	25.03	35.23	54.00	-18.77
1099.65	60.00	100	135			36.90	1.70	25.34	50.14	74.00	-23.86
1099.65				41.00	A	36.90	1.70	25.34	31.14	54.00	-22.86
3216.02	46.00	100	135			36.33	3.37	31.09	44.13	89.41	-45.28
6431.96	54.83	100	225			36.39	4.67	35.35	58.46	89.41	-30.95
<b>EUT in Continuous Receive Mode on Channel 6 (2.437 GHz)</b>											
1008.04	56.67	100	180			37.24	1.62	25.03	46.07	74.00	-27.93
1008.04				45.17	A	37.24	1.62	25.03	34.57	54.00	-19.43
1099.89	59.67	100	135			36.90	1.70	25.34	49.81	74.00	-24.19
1099.89				41.17	A	36.90	1.70	25.34	31.31	54.00	-22.69
3249.36	45.83	100	135			36.30	3.40	31.15	44.08	84.85	-40.77
6498.59	51.83	100	225			36.40	4.70	35.40	55.53	84.85	-29.32
<b>EUT in Continuous Receive Mode on Channel 11 (2.462 GHz)</b>											
1007.90	56.50	100	180			37.24	1.62	25.03	45.90	74.00	-28.10
1007.90				45.33	A	37.24	1.62	25.03	34.73	54.00	-19.27
1099.14	61.00	100	135			36.90	1.70	25.34	51.14	74.00	-22.86
1099.14				40.67	A	36.90	1.70	25.34	30.81	54.00	-23.19
3282.73	45.00	100	135			36.28	3.44	31.21	43.37	87.13	-43.76
6565.39	48.67	100	225			36.40	4.75	35.60	52.62	87.13	-34.51



AEGIS LABS INC.

## Spurious Radiated Emissions Test Results (Continued)

<b>CLIENT:</b>	Intel Corporation	<b>DATE:</b>	11/17/03
<b>EUT:</b>	802.11b/g MiniPCI Type 3B Wireless Adapter	<b>PROJECT NUMBER:</b>	INTEL-031111
<b>MODEL NUMBER:</b>	WM3B2200BG	<b>TEST ENGINEER:</b>	Rick Candelas
<b>SERIAL NUMBER:</b>	000E35005267	<b>SITE #:</b>	2
<b>CONFIGURATION:</b>	Tested installed in the Hewlett Packard host computer's mini PCI slot in 802.11g mode with the Ethertronics antennas.	<b>TEMPERATURE:</b>	18 C
		<b>HUMIDITY:</b>	46% RH
		<b>TIME:</b>	10:00 AM

<b>Standard:</b>	FCC CFR 47, Part 15.247(c)
<b>Description:</b>	Radiated emissions, which fall in the restricted bands, as defined in Sec. 15.205(a), must also comply with the radiated emission limits specified in Sec. 15.209(a). All others must be < -20dBc.
<b>Results:</b>	Passes (See Data Sheets)

Unwanted Spurious Emissions Limits			
Frequency (MHz)	Field Strength (uV/m)	Field Strength (dBuV/m) (Emissions in the restricted bands)	Field Strength (dBm/MHz) (Emissions outside the restricted bands)
Above 960	500	54.00 (Average) 74.00 (Peak)	< -20 dBc

Page 46 of 81 (Appendix A)  
Report Number: INTEL-031111F  
FCC ID: PD9WM3B2200BG



Spurious Radiated Emissions Test Results (Continued)

*Fundamental Measurements in 802.11g mode  
Channels 1, 6, & 11  
Continuous TX at MAIN Antenna port with Ethertronics Antennas  
Aegis Labs, Inc. File #: INTEL-031111-08*

<b>RADIATED EMISSIONS - Horizontal Antenna Polarization</b>											
<i>Freq. (MHz)</i>	<i>Meter Reading (dBuV)</i>	<i>Antenna Height (cm)</i>	<i>Azimuth (degrees)</i>	<i>Quasi pk or AVG (dBuV)</i>		<i>Preamp Factor (dB)</i>	<i>Cable Factor (dB)</i>	<i>Ant. Factor (dB)</i>	<i>Corrected Reading (dBuV)</i>	<i>Limits (dBuV)</i>	<i>Diff (dB) +=FAIL</i>
2412.00	78.67	100	225				2.99	29.22	110.88		
2412.00				50.33	A		2.99	29.22	82.54		
2437.00	79.67	100	135				3.05	29.27	111.99		
2437.00				51.17	A		3.05	29.27	83.49		
2462.00	78.17	100	135				3.11	29.32	110.60		
2462.00				50.50	A		3.11	29.32	82.93		

<b>RADIATED EMISSIONS – Vertical Antenna Polarization</b>											
<i>Freq. (MHz)</i>	<i>Meter Reading (dBuV)</i>	<i>Antenna Height (cm)</i>	<i>Azimuth (degrees)</i>	<i>Quasi pk or AVG (dBuV)</i>		<i>Preamp Factor (dB)</i>	<i>Cable Factor (dB)</i>	<i>Ant. Factor (dB)</i>	<i>Corrected Reading (dBuV)</i>	<i>Limits (dBuV)</i>	<i>Diff (dB) +=FAIL</i>
2412.00	77.83	100	90				2.99	29.42	110.24		
2412.00				49.67	A		2.99	29.42	82.08		
2437.00	77.00	100	90				3.05	29.47	109.52		
2437.00				49.33	A		3.05	29.47	81.85		
2462.00	74.67	100	90				3.11	29.52	107.30		
2462.00				47.83	A		3.11	29.52	80.46		



Spurious Radiated Emissions Test Results (Continued)

*Band Edge Field Strength Measurements in 802.11g mode  
Channels 1, 6, & 11  
Continuous TX at MAIN Antenna port with Ethertronics Antennas  
Aegis Labs, Inc. File #: INTEL-031111-09*

<b>RADIATED EMISSIONS - Horizontal Antenna Polarization</b>											
<i>Freq. (MHz)</i>	<i>Meter Reading (dBuV)</i>	<i>Antenna Height (cm)</i>	<i>Azimuth (degrees)</i>	<i>Quasi pk or AVG (dBuV)</i>		<i>Preamp Factor (dB)</i>	<i>Cable Factor (dB)</i>	<i>Ant. Factor (dB)</i>	<i>Corrected Reading (dBuV)</i>	<i>Limits (dBuV)</i>	<i>Diff (dB) +=FAIL</i>
2390.00	74.83	100	225			36.45	2.94	29.18	70.50	74.00	-3.50
2390.00				52.83	A	36.45	2.94	29.18	48.50	54.00	-5.50
2400.00	92.67	100	225			36.47	2.96	29.20	88.36	90.88	-2.52
2483.50	73.33	100	135			36.68	3.16	29.37	69.18	74.00	-4.82
2483.50				51.67	A	36.68	3.16	29.37	47.52	54.00	-6.48

<b>RADIATED EMISSIONS - Vertical Antenna Polarization</b>											
<i>Freq. (MHz)</i>	<i>Meter Reading (dBuV)</i>	<i>Antenna Height (cm)</i>	<i>Azimuth (degrees)</i>	<i>Quasi pk or AVG (dBuV)</i>		<i>Preamp Factor (dB)</i>	<i>Cable Factor (dB)</i>	<i>Ant. Factor (dB)</i>	<i>Corrected Reading (dBuV)</i>	<i>Limits (dBuV)</i>	<i>Diff (dB) +=FAIL</i>
2390.00	72.33	100	90			36.45	2.94	29.38	68.20	74.00	-5.80
2390.00				50.17	A	36.45	2.94	29.38	46.04	54.00	-7.96
2400.00	91.17	100	90			36.47	2.96	29.40	87.06	90.24	-3.18
2483.50	71.67	100	90			36.68	3.16	29.57	67.72	74.00	-6.28
2483.50				49.50	A	36.68	3.16	29.57	45.55	54.00	-8.45



AEGIS LABS INC.

### Spurious Radiated Emissions Test Results (Continued)

Plots Showing Out-Of-Band Emissions (Peak RBW=VBW=1MHz; Average RBW = 1MHz, VBW = 10Hz)

Test Date	Data	Test Eng.
11/17/03	2.412 GHz band edge <b>PEAK (Horizontal Antenna Polarity)</b> (INTEL-031111-09b05)	Rick Candelas

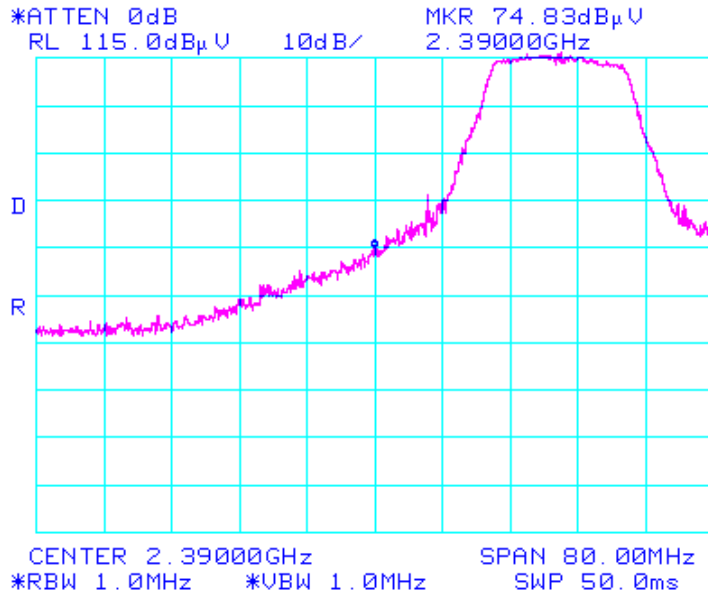

Test Date	Data	Test Eng.
11/17/03	2.412 GHz band edge <b>Average (Horizontal Antenna Polarity)</b> (INTEL-031111-09b06)	Rick Candelas

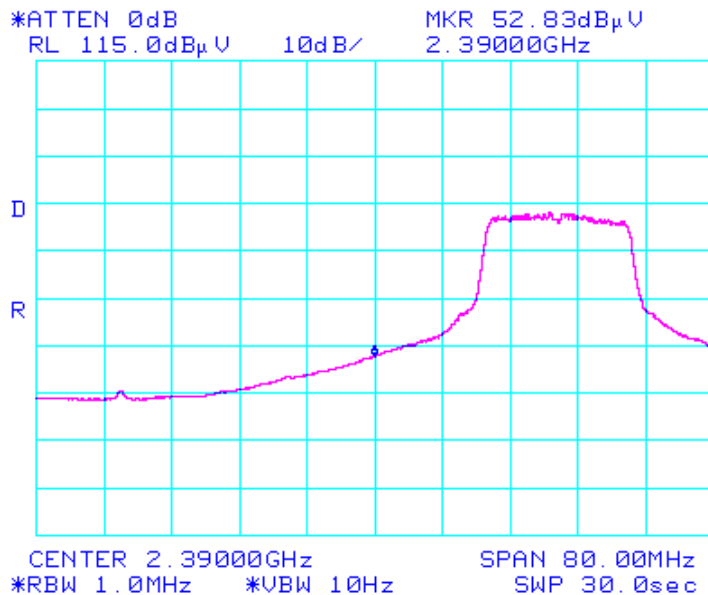

Page 49 of 81 (Appendix A)  
Report Number: INTEL-031111F  
FCC ID: PD9WM3B2200BG





AEGIS LABS INC.

Spurious Radiated Emissions Test Results (Continued)

Plots Showing Out-Of-Band Emissions (Peak RBW=VBW=1MHz; Average RBW = 1MHz, VBW = 10Hz)

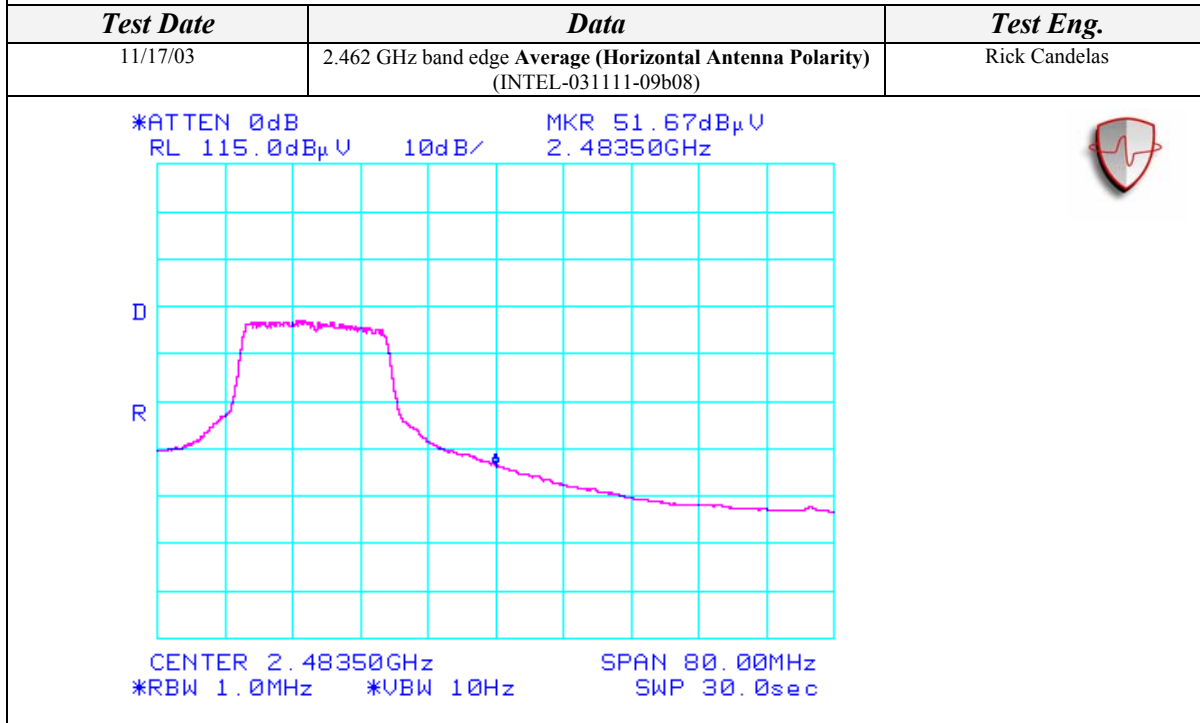
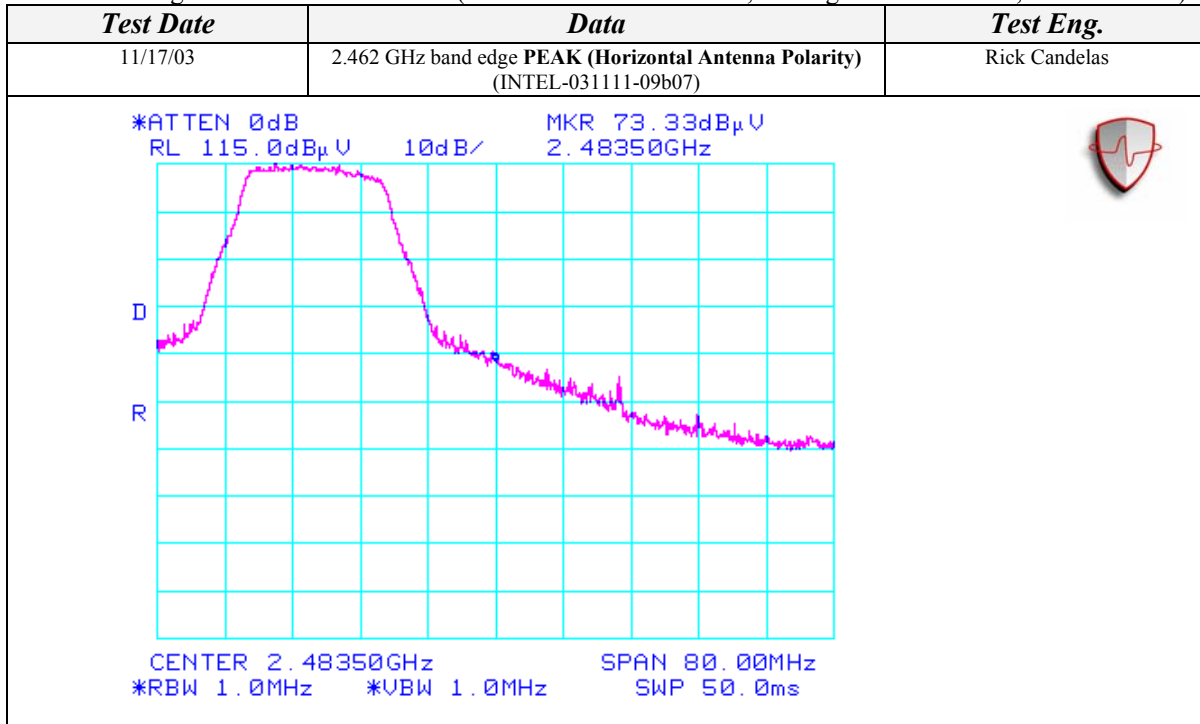

Page 50 of 81 (Appendix A)  
Report Number: INTEL-031111F  
FCC ID: PD9WM3B2200BG



AEGIS LABS INC.

### Spurious Radiated Emissions Test Results (Continued)

Plots Showing Out-Of-Band Emissions (Peak RBW=VBW=1MHz; Average RBW = 1MHz, VBW = 10Hz)

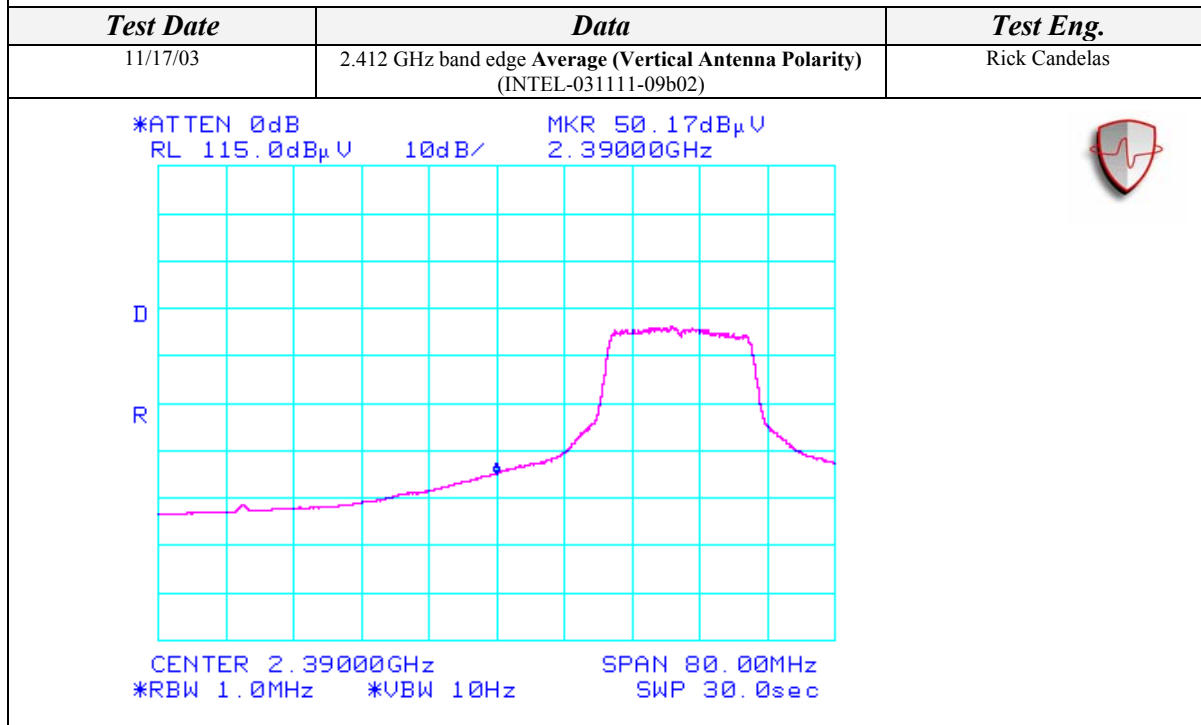
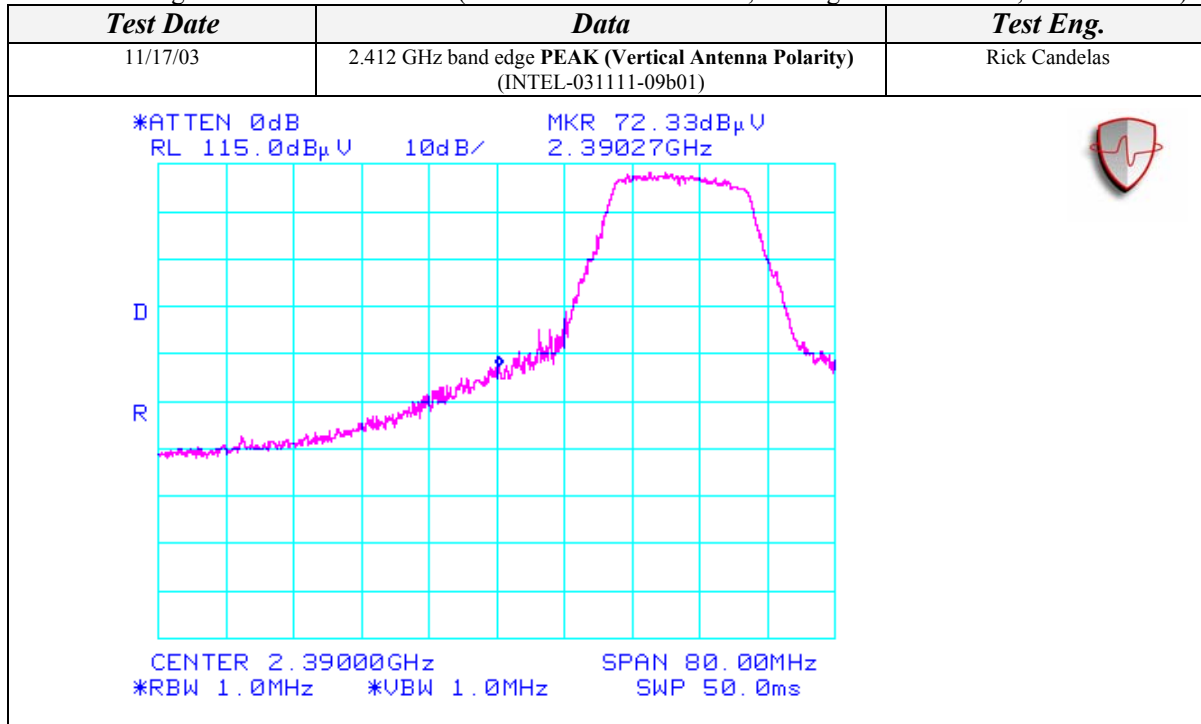

Page 51 of 81 (Appendix A)  
Report Number: INTEL-031111F  
FCC ID: PD9WM3B2200BG



AEGIS LABS INC.

### Spurious Radiated Emissions Test Results (Continued)

Plots Showing Out-Of-Band Emissions (Peak RBW=VBW=1MHz; Average RBW = 1MHz, VBW = 10Hz)

<b>Test Date</b>	<b>Data</b>	<b>Test Eng.</b>
11/17/03	2.462 GHz band edge <b>PEAK (Vertical Antenna Polarity)</b> (INTEL-031111-09b03)	Rick Candelas
<p>*ATTEN 0dB                                                  MKR 71.67dBµV  RL 115.0dBµV                  10dB/                  2.48350GHz</p> <p>CENTER 2.48350GHz                                  SPAN 80.00MHz  *RBW 1.0MHz                  *VBW 1.0MHz                  SWP 50.0ms</p>		
<b>Test Date</b>	<b>Data</b>	<b>Test Eng.</b>
11/17/03	2.462 GHz band edge <b>Average (Vertical Antenna Polarity)</b> (INTEL-031111-09b04)	Rick Candelas
<p>*ATTEN 0dB                                                  MKR 49.50dBµV  RL 115.0dBµV                  10dB/                  2.48350GHz</p> <p>CENTER 2.48350GHz                                  SPAN 80.00MHz  *RBW 1.0MHz                  *VBW 10Hz                  SWP 30.0sec</p>		

Page 52 of 81 (Appendix A)  
Report Number: INTEL-031111F  
FCC ID: PD9WM3B2200BG



Spurious Radiated Emissions Test Results (Continued)

*Spurious Emissions Measurements in 802.11g mode  
Channels 1, 6, & 11  
Continuous TX at MAIN Antenna port with Ethertronics Antennas  
Aegis Labs, Inc. File #: INTEL-031111-13*

<b>RADIATED EMISSIONS - Horizontal Antenna Polarization</b>											
Freq. (MHz)	Meter Reading (dBuV)	Antenna Height (cm)	Azimuth (degrees)	Quasi pk or AVG (dBuV)		1 Meter Distance Factor (dB)	Cable Factor (dB)	Ant. Factor (dB)	Corrected Reading (dBuV)	Limits (dBuV)	Diff (dB) +=FAIL
<b>EUT in Continuous Transmit Mode on Channel 1 (2.412 GHz)</b>											
2312.00	35.00	100	225			9.54	2.75	28.62	56.83	74.00	-17.17
2312.00				23.33	A	9.54	2.75	28.62	45.16	54.00	-8.84
<b>EUT in Continuous Transmit Mode on Channel 6 (2.437 GHz)</b>											
2336.00	35.50	100	225			9.54	2.81	28.71	57.48	74.00	-16.52
2336.00				22.83	A	9.54	2.81	28.71	44.81	54.00	-9.19
<b>EUT in Continuous Transmit Mode on Channel 11 (2.462 GHz)</b>											
2360.00	33.33	100	225			9.54	2.86	28.80	55.45	74.00	-18.55
2360.00				20.83	A	9.54	2.86	28.80	42.95	54.00	-11.05
<b>RADIATED EMISSIONS - Vertical Antenna Polarization</b>											
Freq. (MHz)	Meter Reading (dBuV)	Antenna Height (cm)	Azimuth (degrees)	Quasi pk or AVG (dBuV)		1 Meter Distance Factor (dB)	Cable Factor (dB)	Ant. Factor (dB)	Corrected Reading (dBuV)	Limits (dBuV)	Diff (dB) +=FAIL
<b>EUT in Continuous Transmit Mode on Channel 1 (2.412 GHz)</b>											
2312.00	33.17	100	225			9.54	2.75	28.62	55.00	74.00	-19.00
2312.00				20.67	A	9.54	2.75	28.62	42.50	54.00	-11.50
<b>EUT in Continuous Transmit Mode on Channel 6 (2.437 GHz)</b>											
2336.00	33.50	100	225			9.54	2.81	28.71	55.48	74.00	-18.52
2336.00				20.50	A	9.54	2.81	28.71	42.48	54.00	-11.52
<b>EUT in Continuous Transmit Mode on Channel 11 (2.462 GHz)</b>											
2360.00	33.33	100	225			9.54	2.86	28.80	55.45	74.00	-18.55
2360.00				19.50	A	9.54	2.86	28.80	41.62	54.00	-12.38

NOTE: These spurious emissions measurements were taken without a preamp at a distance on 1 meter to avoid saturating the preamp and analyzer because the signals were close to the fundamental frequency. The readings were extrapolated to 1 meter.



Spurious Radiated Emissions Test Results (Continued)

*Spurious Emissions Measurements in 802.11g mode  
Channels 1, 6, & 11  
Continuous TX at MAIN Antenna port with Ethertronics Antennas  
Aegis Labs, Inc. File #: INTEL-031111-09*

<b>RADIATED EMISSIONS - Horizontal Antenna Polarization</b>											
<i>Freq. (MHz)</i>	<i>Meter Reading (dBuV)</i>	<i>Antenna Height (cm)</i>	<i>Azimuth (degrees)</i>	<i>Quasi pk or AVG (dBuV)</i>		<i>Preamp Factor (dB)</i>	<i>Cable Factor (dB)</i>	<i>Ant. Factor (dB)</i>	<i>Corrected Reading (dBuV)</i>	<i>Limits (dBuV)</i>	<i>Diff (dB) +=FAIL</i>
<b>EUT in Continuous Transmit Mode on Channel 1 (2.412 GHz)</b>											
1008.07	60.67	100	0			37.24	1.62	24.93	49.97	74.00	-24.03
1008.07				48.00	A	37.24	1.62	24.93	37.30	54.00	-16.70
1095.67	60.33	100	180			36.91	1.70	25.24	50.37	74.00	-23.63
1095.67				43.50	A	36.91	1.70	25.24	33.54	54.00	-20.46
3216.05	49.50	100	135			36.33	3.37	30.98	47.52	90.88	-43.36
4824.70	45.67	100	135			36.16	4.06	34.10	47.67	74.00	-26.33
4824.70				30.33	A	36.16	4.06	34.10	32.33	54.00	-21.67
6431.98	58.00	100	135			36.39	4.67	35.37	61.66	90.88	-29.22
9648.01	50.67	100	180			36.98	5.99	38.11	57.78	90.88	-33.10
12863.95	46.33	100	225			34.94	7.23	40.27	58.89	90.88	-31.99
<b>EUT in Continuous Transmit Mode on Channel 6 (2.437 GHz)</b>											
1008.20	60.17	100	270			37.24	1.62	24.93	49.47	74.00	-24.53
1008.20				47.83	A	37.24	1.62	24.93	37.13	54.00	-16.87
1096.13	61.33	100	180			36.91	1.70	25.25	51.37	74.00	-22.63
1096.13				43.83	A	36.91	1.70	25.25	33.87	54.00	-20.13
3249.33	48.00	100	135			36.30	3.40	31.05	46.15	91.99	-45.84
4874.67	44.17	100	135			36.20	4.10	34.27	46.34	74.00	-27.66
4874.67				29.33	A	36.20	4.10	34.27	31.50	54.00	-22.50
6498.69	51.83	100	135			36.40	4.70	35.40	55.53	91.99	-36.46
9748.15	52.83	100	225			36.90	6.05	38.25	60.22	91.99	-31.77
12997.31	46.83	100	180			34.80	7.20	40.59	59.82	91.99	-32.17



Spurious Radiated Emissions Test Results (Continued)

<b>RADIATED EMISSIONS - Horizontal Antenna Polarization</b>										
<i>Freq. (MHz)</i>	<i>Meter Reading (dBuV)</i>	<i>Antenna Height (cm)</i>	<i>Azimuth (degrees)</i>	<i>Quasi pk or AVG (dBuV)</i>	<i>Preamp Factor (dB)</i>	<i>Cable Factor (dB)</i>	<i>Ant. Factor (dB)</i>	<i>Corrected Reading (dBuV)</i>	<i>Limits (dBuV)</i>	<i>Diff (dB) +=FAIL</i>

<b>EUT in Continuous Transmit Mode on Channel 11 (2.462 GHz)</b>											
1007.60	59.50	100	0			37.25	1.62	24.93	48.80	74.00	-25.20
1007.60				47.67	A	37.25	1.62	24.93	36.97	54.00	-17.03
1095.73	58.17	100	180			36.91	1.70	25.24	48.21	74.00	-25.79
1095.73				13.17	A	36.91	1.70	25.24	3.21	54.00	-50.79
3282.85	47.17	100	135			36.28	3.44	31.12	45.45	90.60	-45.15
4923.94	42.33	100	135			36.24	4.14	34.44	44.67	74.00	-29.33
4923.94				28.67	A	36.24	4.14	34.44	31.01	54.00	-22.99
6565.48	47.33	100	135			36.40	4.75	35.62	51.31	90.60	-39.29
9747.97	54.50	100	225			36.90	6.05	38.25	61.89	90.60	-28.71
13130.63	46.50	100	135			34.75	7.28	40.65	59.68	90.60	-30.92

<b>RADIATED EMISSIONS - Vertical Antenna Polarization</b>											
<i>Freq. (MHz)</i>	<i>Meter Reading (dBuV)</i>	<i>Antenna Height (cm)</i>	<i>Azimuth (degrees)</i>	<i>Quasi pk or AVG (dBuV)</i>	<i>Preamp Factor (dB)</i>	<i>Cable Factor (dB)</i>	<i>Ant. Factor (dB)</i>	<i>Corrected Reading (dBuV)</i>	<i>Limits (dBuV)</i>	<i>Diff (dB) +=FAIL</i>	
<b>EUT in Continuous Transmit Mode on Channel 1 (2.412 GHz)</b>											
1008.58	61.33	200	180			37.24	1.62	25.03	50.74	74.00	-23.26
1008.58				50.67	A	37.24	1.62	25.03	40.08	54.00	-13.92
1099.03	62.83	100	135			36.90	1.70	25.34	52.96	74.00	-21.04
1099.03				46.67	A	36.90	1.70	25.34	36.80	54.00	-17.20
3215.97	47.50	100	135			36.33	3.37	31.09	45.63	90.24	-44.61
4823.21	45.17	100	135			36.16	4.06	34.07	47.14	74.00	-26.86
4823.21				30.50	A	36.16	4.06	34.07	32.47	54.00	-21.53
6432.06	54.83	100	135			36.39	4.67	35.35	58.46	90.24	-31.78
9648.07	50.67	100	135			36.98	5.99	38.17	57.84	90.24	-32.40
12863.91	47.33	100	225			34.94	7.23	40.27	59.89	90.24	-30.35



Spurious Radiated Emissions Test Results (Continued)

<b>RADIATED EMISSIONS - Vertical Antenna Polarization</b>											
<i>Freq. (MHz)</i>	<i>Meter Reading (dBuV)</i>	<i>Antenna Height (cm)</i>	<i>Azimuth (degrees)</i>	<i>Quasi pk or AVG (dBuV)</i>		<i>Preamp Factor (dB)</i>	<i>Cable Factor (dB)</i>	<i>Ant. Factor (dB)</i>	<i>Corrected Reading (dBuV)</i>	<i>Limits (dBuV)</i>	<i>Diff (dB) +=FAIL</i>

**EUT in Continuous Transmit Mode on Channel 6 (2.437 GHz)**

1008.08	60.83	200	180			37.24	1.62	25.03	50.23	74.00	-23.77
1008.08				50.33	A	37.24	1.62	25.03	39.73	54.00	-14.27
1099.77	63.50	100	135			36.90	1.70	25.34	53.64	74.00	-20.36
1099.77				46.83	A	36.90	1.70	25.34	36.97	54.00	-17.03
3249.29	48.33	100	135			36.30	3.40	31.15	46.58	89.52	-42.94
4873.72	42.33	100	135			36.20	4.10	34.22	44.45	74.00	-29.55
4873.72				28.83	A	36.20	4.10	34.22	30.95	54.00	-23.05
6498.77	50.67	100	135			36.40	4.70	35.40	54.37	89.52	-35.15
9748.06	50.33	100	135			36.90	6.05	38.35	57.82	89.52	-31.70
12997.26	48.00	100	225			34.80	7.20	40.59	60.99	89.52	-28.53

**EUT in Continuous Transmit Mode on Channel 11 (2.462 GHz)**

1008.65	60.83	200	180			37.24	1.62	25.03	50.24	74.00	-23.76
1008.65				50.83	A	37.24	1.62	25.03	40.24	54.00	-13.76
1097.43	62.50	100	135			36.91	1.70	25.33	52.63	74.00	-21.37
1097.43				46.33	A	36.91	1.70	25.33	36.46	54.00	-17.54
3282.70	46.00	100	135			36.28	3.44	31.21	44.37	87.30	-42.93
4924.00	41.83	100	135			36.24	4.14	34.37	44.10	74.00	-29.90
4924.00				28.67	A	36.24	4.14	34.37	30.94	54.00	-23.06
6565.36	47.33	100	135			36.40	4.75	35.60	51.28	87.30	-36.02
9847.88	49.83	100	225			36.82	6.11	38.53	57.64	87.30	-29.66
13130.66	46.83	100	225			34.75	7.28	40.68	60.04	87.30	-27.26



Spurious Radiated Emissions Test Results (Continued)

*Spurious Emissions Measurements in 802.11g mode  
Channels 1, 6, & 11  
Continuous RX at MAIN Antenna port with Ethertronics Antennas  
Aegis Labs, Inc. File #: INTEL-031111-09*

<b>RADIATED EMISSIONS - Horizontal Antenna Polarization</b>											
<i>Freq. (MHz)</i>	<i>Meter Reading (dBuV)</i>	<i>Antenna Height (cm)</i>	<i>Azimuth (degrees)</i>	<i>Quasi pk or AVG (dBuV)</i>		<i>Preamp Factor (dB)</i>	<i>Cable Factor (dB)</i>	<i>Ant. Factor (dB)</i>	<i>Corrected Reading (dBuV)</i>	<i>Limits (dBuV)</i>	<i>Diff (dB) +=FAIL</i>
<b>EUT in Continuous Receive Mode on Channel 1 (2.412 GHz)</b>											
1007.99	55.83	100	0			37.24	1.62	24.93	45.13	74.00	-28.87
1007.99				46.17	A	37.24	1.62	24.93	35.47	54.00	-18.53
1100.01	54.17	125	180			36.90	1.70	25.26	44.23	74.00	-29.77
1100.01				38.33	A	36.90	1.70	25.26	28.39	54.00	-25.61
3216.01	48.00	100	135			36.33	3.37	30.98	46.02	90.88	-44.86
6432.00	56.00	100	135			36.39	4.67	35.37	59.66	90.88	-31.22
<b>EUT in Continuous Receive Mode on Channel 6 (2.437 GHz)</b>											
1008.00	56.33	100	0			37.24	1.62	24.93	45.63	74.00	-28.37
1008.00				46.67	A	37.24	1.62	24.93	35.97	54.00	-18.03
1098.67	54.83	125	180			36.90	1.70	25.26	44.88	74.00	-29.12
1098.67				38.50	A	36.90	1.70	25.26	28.55	54.00	-25.45
3249.32	47.33	100	135			36.30	3.40	31.05	45.48	91.99	-46.51
6498.73	51.50	100	225			36.40	4.70	35.40	55.20	91.99	-36.79
<b>EUT in Continuous Receive Mode on Channel 11 (2.462 GHz)</b>											
1007.92	55.83	100	0			37.24	1.62	24.93	45.13	74.00	-28.87
1007.92				45.83	A	37.24	1.62	24.93	35.13	54.00	-18.87
1099.98	53.83	125	180			36.90	1.70	25.26	43.89	74.00	-30.11
1099.98				38.33	A	36.90	1.70	25.26	28.39	54.00	-25.61
3282.63	45.67	100	135			36.28	3.44	31.12	43.95	90.60	-46.65
6565.29	46.67	100	225			36.40	4.75	35.62	50.64	90.60	-39.96





Spurious Radiated Emissions Test Results (Continued)

<b>RADIATED EMISSIONS - Vertical Antenna Polarization</b>											
<i>Freq. (MHz)</i>	<i>Meter Reading (dBuV)</i>	<i>Antenna Height (cm)</i>	<i>Azimuth (degrees)</i>	<i>Quasi pk or AVG (dBuV)</i>		<i>Preamp Factor (dB)</i>	<i>Cable Factor (dB)</i>	<i>Ant. Factor (dB)</i>	<i>Corrected Reading (dBuV)</i>	<i>Limits (dBuV)</i>	<i>Diff (dB) +=FAIL</i>
<b>EUT in Continuous Receive Mode on Channel 1 (2.412 GHz)</b>											
1007.99	55.83	100	180			37.24	1.62	25.03	45.23	74.00	-28.77
1007.99				45.00	A	37.24	1.62	25.03	34.40	54.00	-19.60
1000.08	59.33	100	135			37.29	1.60	25.00	48.64	74.00	-25.36
1000.08				40.83	A	37.29	1.60	25.00	30.14	54.00	-23.86
3216.00	46.00	100	135			36.33	3.37	31.09	44.13	90.24	-46.11
6431.95	55.00	100	225			36.39	4.67	35.35	58.63	90.24	-31.61
<b>EUT in Continuous Receive Mode on Channel 6 (2.437 GHz)</b>											
1007.70	56.33	100	180			37.25	1.62	25.03	45.73	74.00	-28.27
1007.70				45.17	A	37.25	1.62	25.03	34.57	54.00	-19.43
1099.04	60.00	100	135			36.90	1.70	25.34	50.13	74.00	-23.87
1099.04				41.17	A	36.90	1.70	25.34	31.30	54.00	-22.70
3249.35	46.83	100	135			36.30	3.40	31.15	45.08	89.52	-44.44
6498.70	51.00	100	225			36.40	4.70	35.40	54.70	89.52	-34.82
<b>EUT in Continuous Receive Mode on Channel 11 (2.462 GHz)</b>											
1008.01	55.67	100	180			37.24	1.62	25.03	45.07	74.00	-28.93
1008.01				45.67	A	37.24	1.62	25.03	35.07	54.00	-18.93
1099.94	59.33	100	135			36.90	1.70	25.34	49.47	74.00	-24.53
1099.94				41.00	A	36.90	1.70	25.34	31.14	54.00	-22.86
3282.70	44.67	100	135			36.28	3.44	31.21	43.04	87.30	-44.26
6565.46	49.17	100	225			36.40	4.75	35.60	53.12	87.30	-34.18



AEGIS LABS INC.

## PEAK TRANSMIT POWER

<b>CLIENT:</b>	Intel Corporation	<b>DATE:</b>	11/11/03
<b>EUT:</b>	802.11b/g MiniPCI Type 3B Wireless Adapter	<b>PROJECT NUMBER:</b>	INTEL-031111-01
<b>MODEL NUMBER:</b>	WM3B2200BG	<b>TEST ENGINEER:</b>	Rick Candelas
<b>SERIAL NUMBER:</b>	000E35005267	<b>SITE #:</b>	2
<b>CONFIGURATION:</b>	Tested installed in the Hewlett Packard host computer's mini PCI slot.	<b>TEMPERATURE:</b>	13 C
		<b>HUMIDITY:</b>	67% RH
		<b>TIME:</b>	8:30 AM

<b>Standard:</b>	FCC CFR 47, Part 15.247(b)(1)
<b>Description:</b>	The maximum peak output power of the intentional radiator shall not exceed 1 watt.
<b>Results:</b>	See Data Sheet

Peak Transmit Power Limits	
Frequency (MHz)	Output Power (W)
2412-2462	1

Page 59 of 81 (Appendix A)  
Report Number: INTEL-031111F  
FCC ID: PD9WM3B2200BG



Peak Transmit Power (Continued)

Mode	Channel	Frequency (MHz)	Rate (Mbps)	Conducted Power (dBm)	Cable Factor (dB)	Power Corrected (dBm)	Power (mW)
802.11b	1	2412	1	17.20	0.15	17.35	54.33
802.11b	1	2412	5.5	17.10	0.15	17.25	53.09
802.11b	1	2412	11	17.26	0.15	17.41	55.08
802.11b	6	2437	1	17.26	0.15	17.41	55.08
802.11b	6	2437	5.5	17.06	0.15	17.21	52.60
802.11b	6	2437	11	17.16	0.15	17.31	53.83
802.11b	11	2462	1	17.06	0.15	17.21	52.60
802.11b	11	2462	5.5	16.92	0.15	17.07	50.93
802.11b	11	2462	11	17.02	0.15	17.17	52.12
802.11g	1	2412	6	16.10	0.15	16.25	42.17
802.11g	1	2412	36	15.90	0.15	16.05	40.27
802.11g	1	2412	54	15.70	0.15	15.85	38.46
802.11g	6	2437	6	16.06	0.15	16.21	41.78
802.11g	6	2437	36	15.96	0.15	16.11	40.83
802.11g	6	2437	54	15.86	0.15	16.01	39.90
802.11g	11	2462	6	16.12	0.15	16.27	42.36
802.11g	11	2462	36	16.02	0.15	16.17	41.40
802.11g	11	2462	54	15.82	0.15	15.97	39.54

NOTE: The output power measurement is conducted.



AEGIS LABS INC.

## 6 dB EMISSIONS BANDWIDTH

<b>CLIENT:</b>	Intel Corporation	<b>DATE:</b>	11/14/03
<b>EUT:</b>	802.11b/g MiniPCI Type 3B Wireless Adapter	<b>PROJECT NUMBER:</b>	INTEL-031111
<b>MODEL NUMBER:</b>	WM3B2200BG	<b>TEST ENGINEER:</b>	Rick Candelas
<b>SERIAL NUMBER:</b>	000E35005267	<b>SITE #:</b>	2
<b>CONFIGURATION:</b>	Tested installed in the Hewlett Packard host computer's mini PCI slot.	<b>TEMPERATURE:</b>	22 C
		<b>HUMIDITY:</b>	39% RH
		<b>TIME:</b>	1:00 PM

<b>Standard:</b>	FCC CFR 47, Part 15.247(a)(2)
<b>Description:</b>	The minimum 6 dB bandwidth shall be at least 500 kHz.
<b>Results:</b>	See Data Sheets

Page 61 of 81 (Appendix A)  
Report Number: INTEL-031111F  
FCC ID: PD9WM3B2200BG



AEGIS LABS INC.

### 6 dB Emissions Bandwidth (Continued)

#### 802.11b Mode

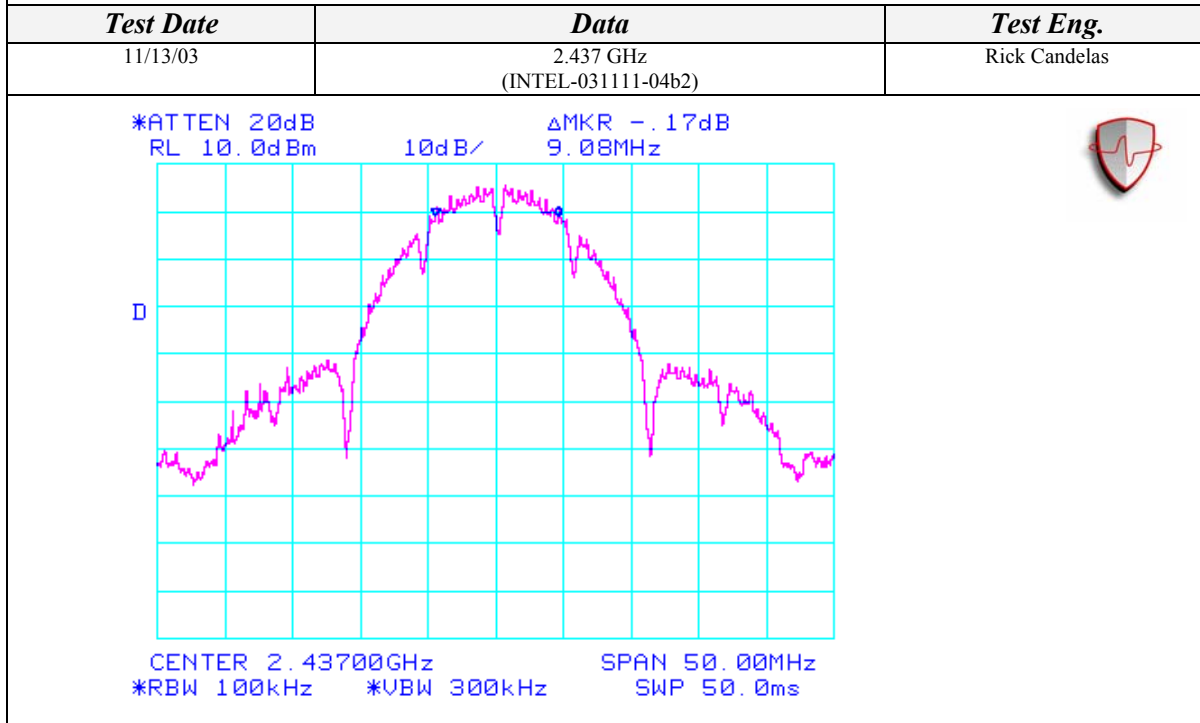
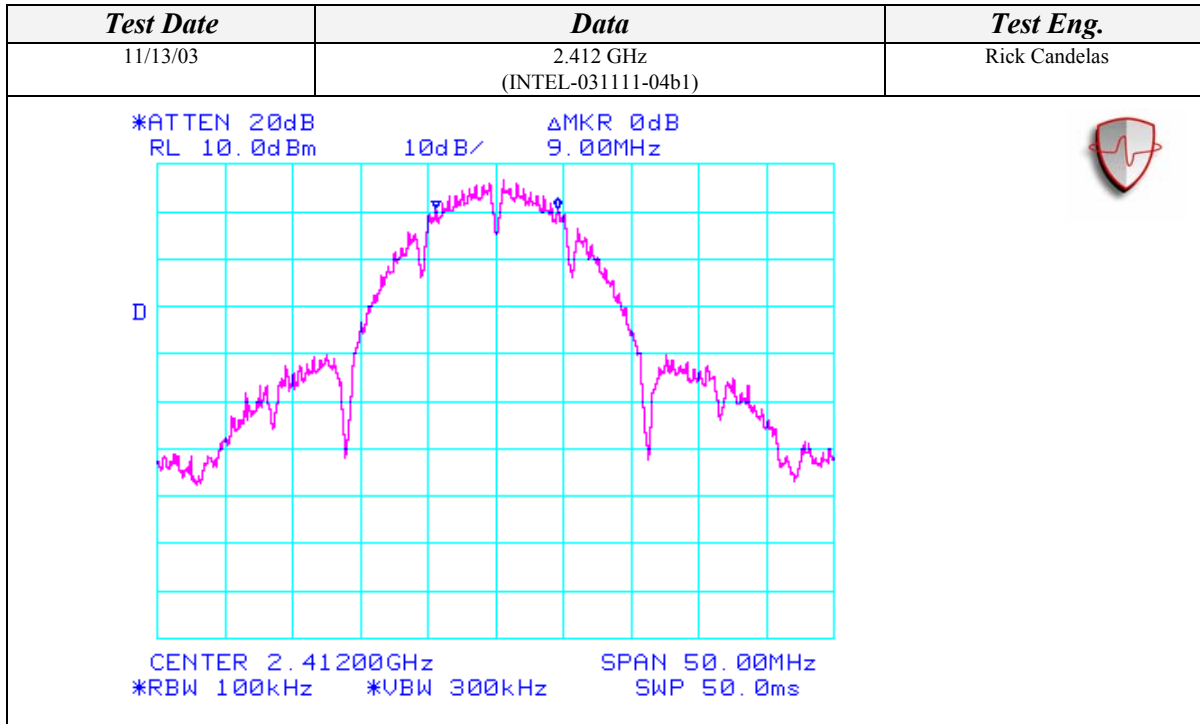

Page 62 of 81 (Appendix A)  
Report Number: INTEL-031111F  
FCC ID: PD9WM3B2200BG



AEGIS LABS INC.

### 6 dB Emissions Bandwidth (Continued)

#### 802.11b Mode

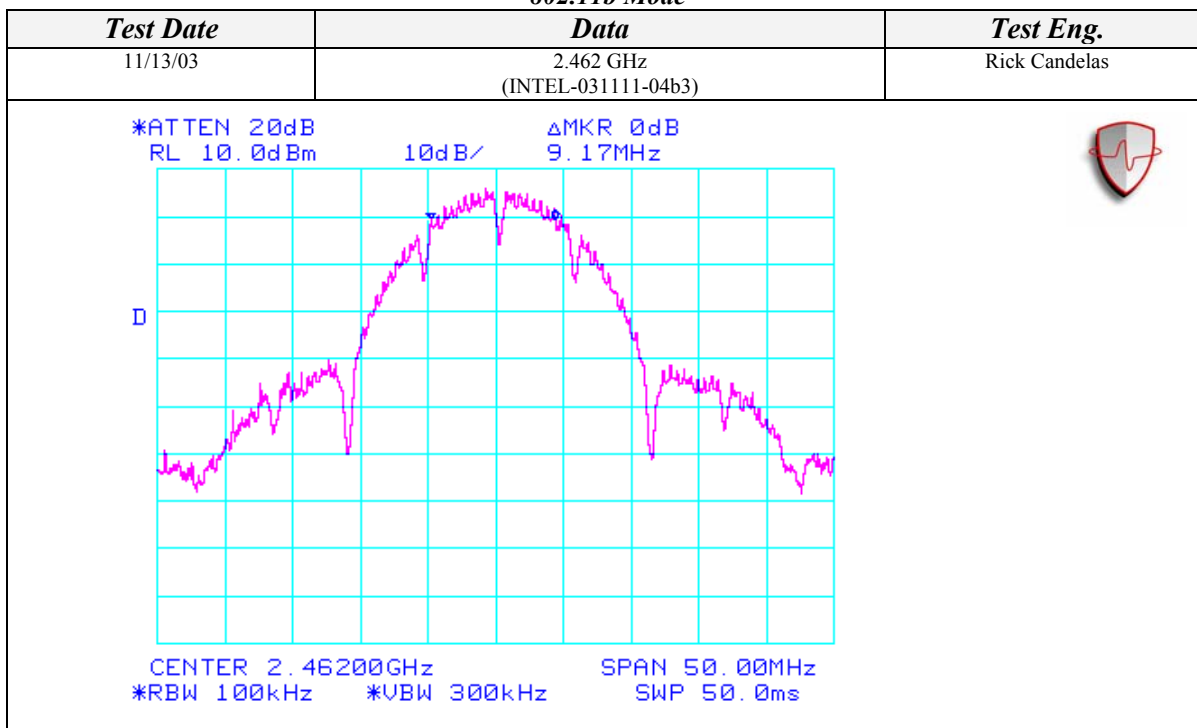

#### 802.11g Mode

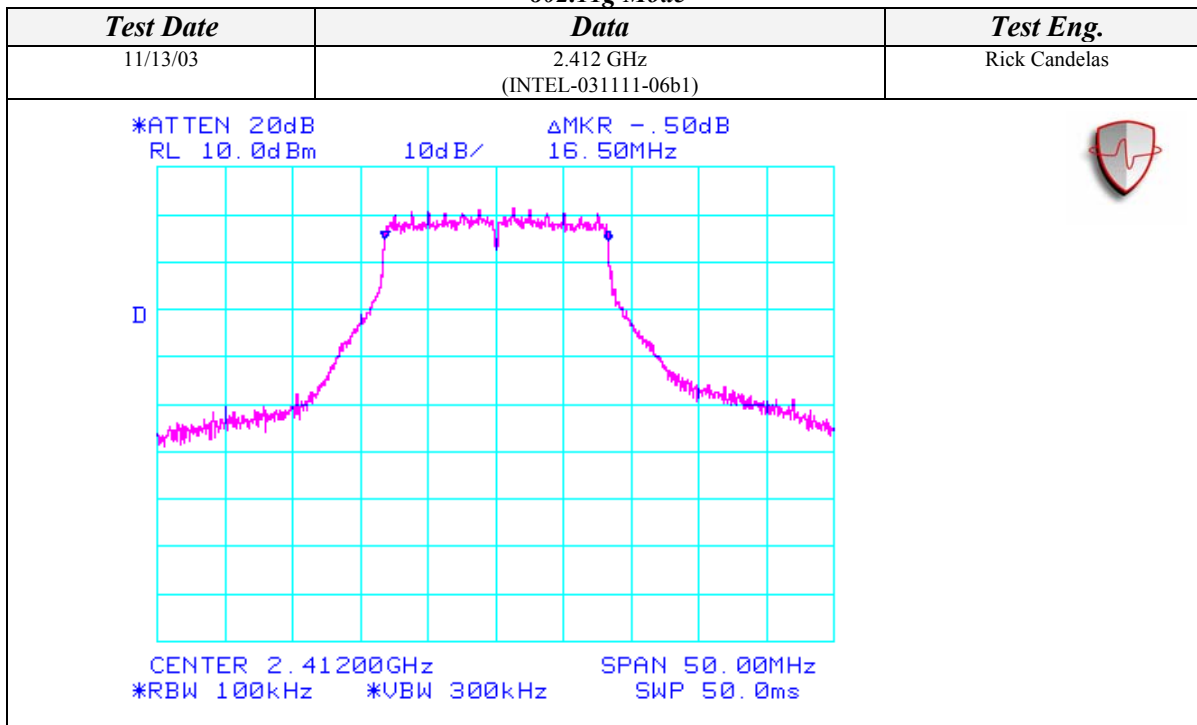

Page 63 of 81 (Appendix A)  
 Report Number: INTEL-031111F  
 FCC ID: PD9WM3B2200BG



AEGIS LABS INC.

### 6 dB Emissions Bandwidth (Continued)

#### 802.11g Mode

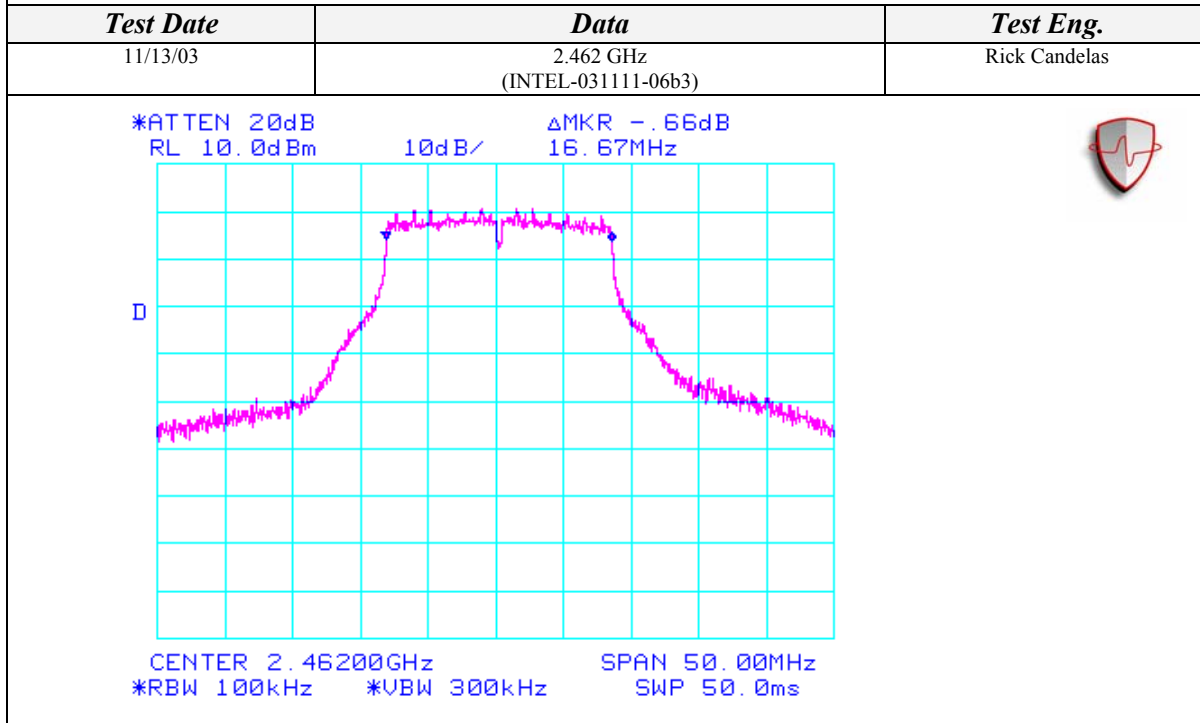
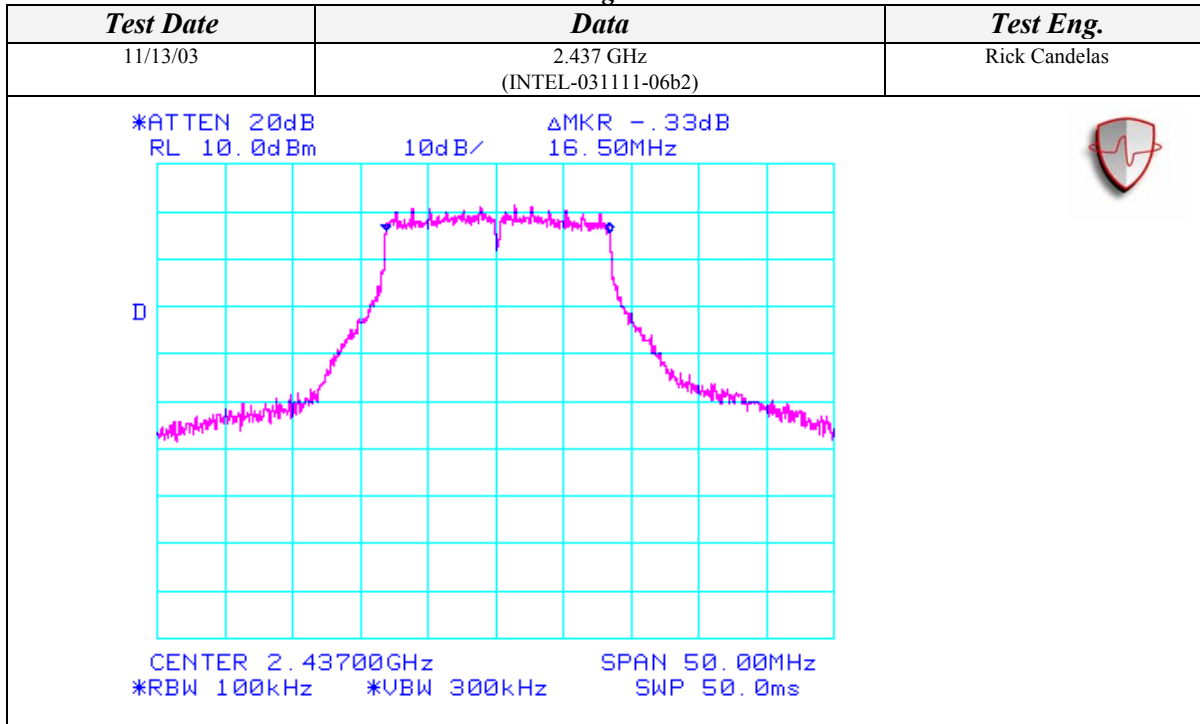

Page 64 of 81 (Appendix A)  
Report Number: INTEL-031111F  
FCC ID: PD9WM3B2200BG



AEGIS LABS INC.

## PEAK POWER SPECTRAL DENSITY

<b>CLIENT:</b>	Intel Corporation	<b>DATE:</b>	11/14/03
<b>EUT:</b>	802.11b/g MiniPCI Type 3B Wireless Adapter	<b>PROJECT NUMBER:</b>	INTEL-031111
<b>MODEL NUMBER:</b>	WM3B2200BG	<b>TEST ENGINEER:</b>	Rick Candelas
<b>SERIAL NUMBER:</b>	000E35005267	<b>SITE #:</b>	2
<b>CONFIGURATION:</b>	Tested installed in the Hewlett Packard host computer's mini PCI slot.	<b>TEMPERATURE:</b>	22 C
		<b>HUMIDITY:</b>	39% RH
		<b>TIME:</b>	1:00 PM

<b>Standard:</b>	FCC CFR 47, Part 15.247(d)
<b>Description:</b>	The peak power spectral density conducted from the intentional radiator to the antenna shall not be greater than 8 dBm in any 3 kHz band during any time interval of continuous transmission.
<b>Results:</b>	See Data Sheets

Peak Power Spectral Density Limits	
Frequency (MHz)	Limit (dBm)
2412-2462	8

Page 65 of 81 (Appendix A)  
Report Number: INTEL-031111F  
FCC ID: PD9WM3B2200BG





### Peak Power Spectral Density (Continued)

#### 802.11b Mode

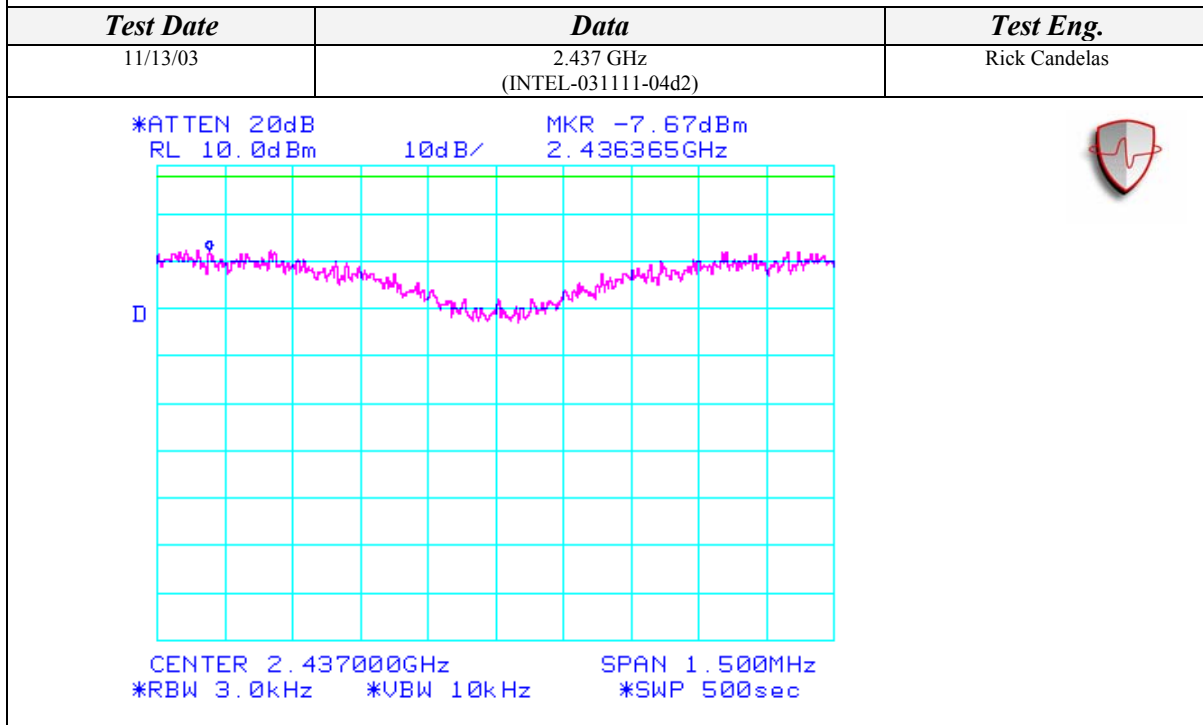
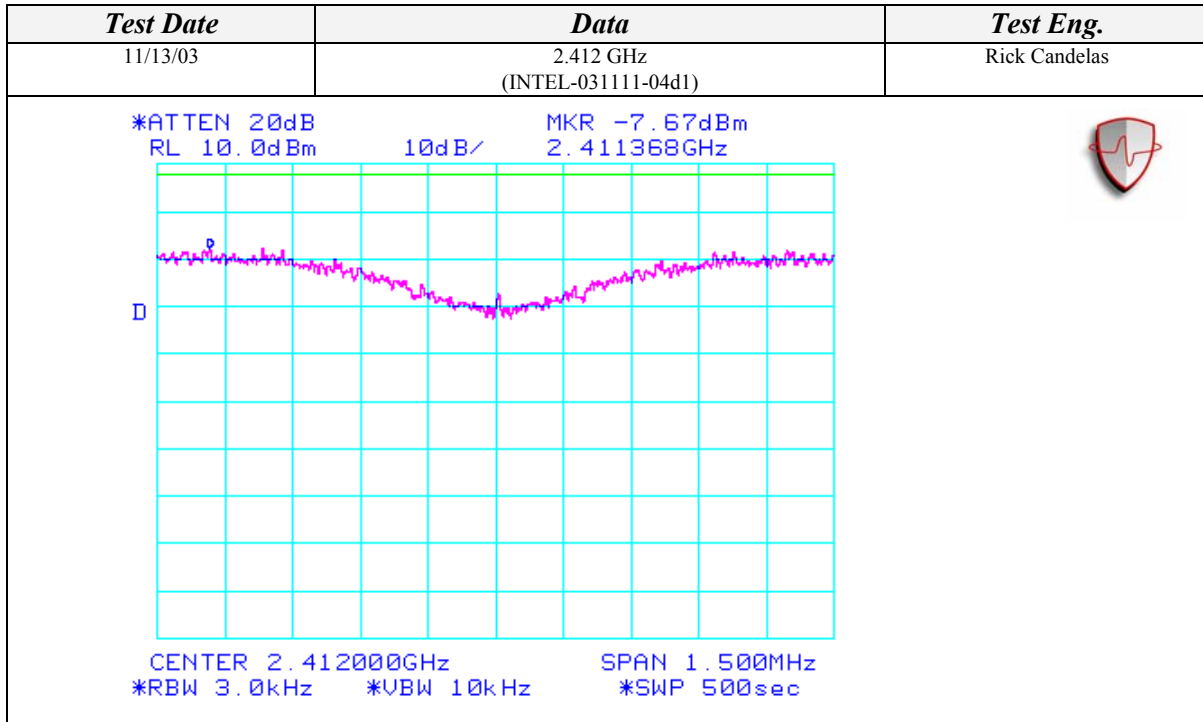



Peak Power Spectral Density (Continued)

802.11b Mode

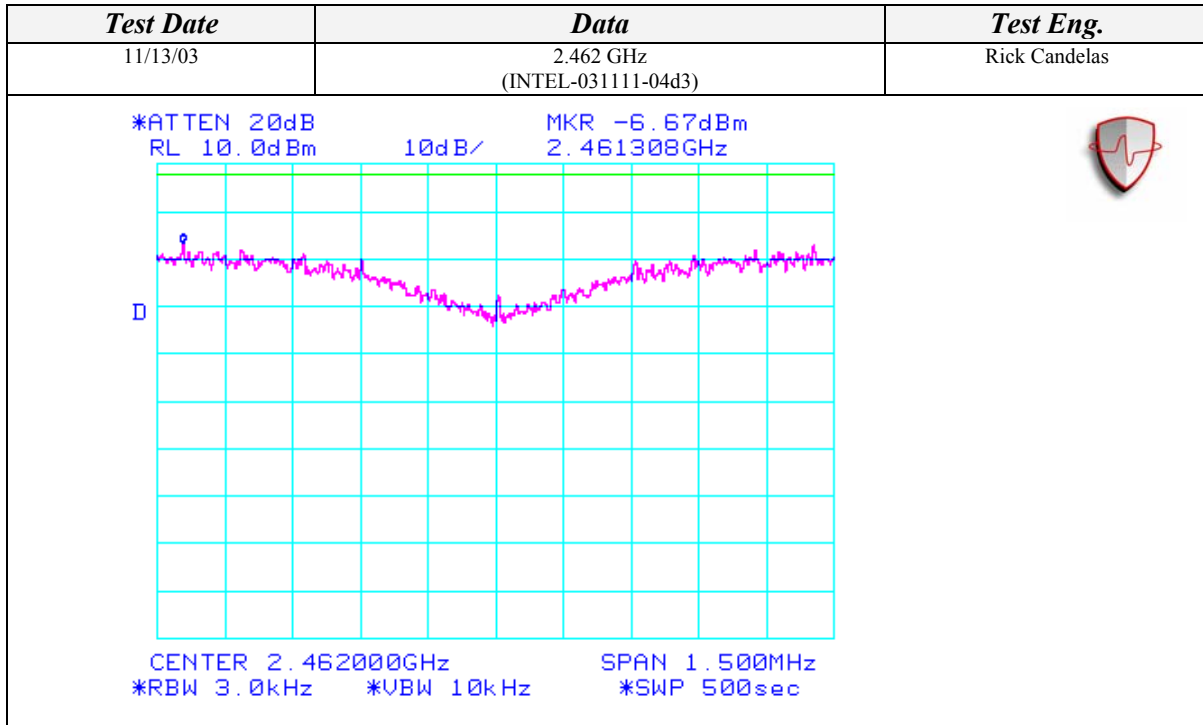

802.11g Mode

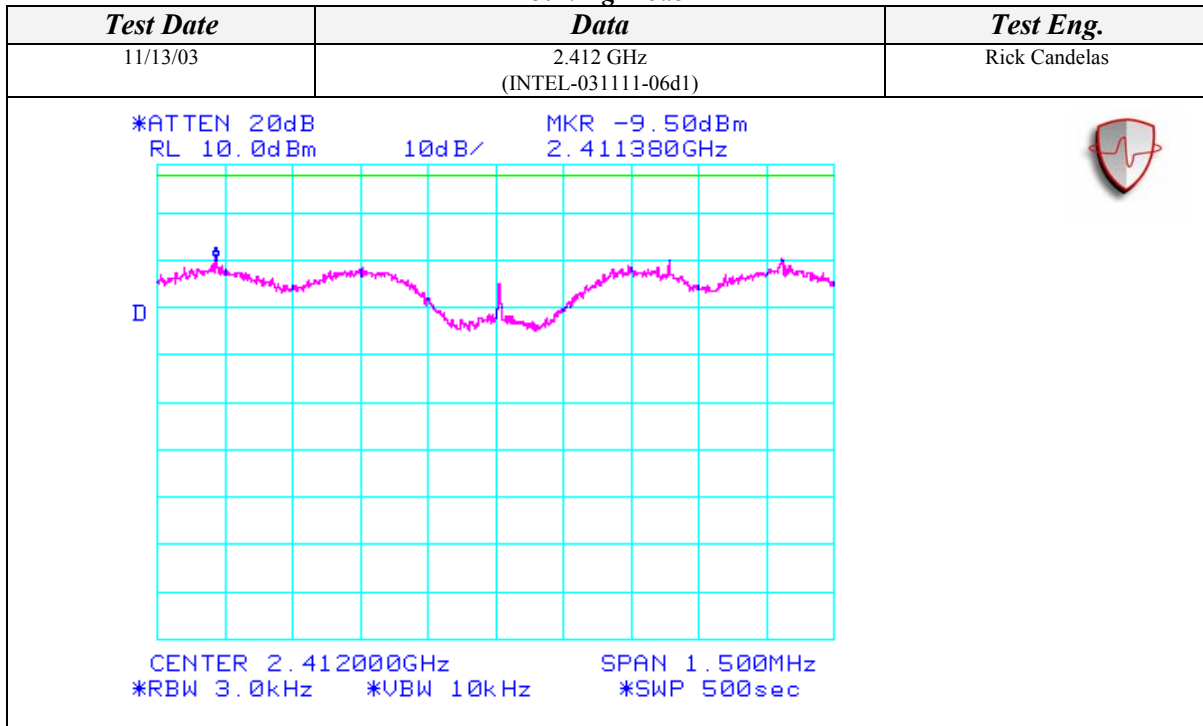



AEGIS LABS INC.

### Peak Power Spectral Density (Continued)

#### 802.11b Mode

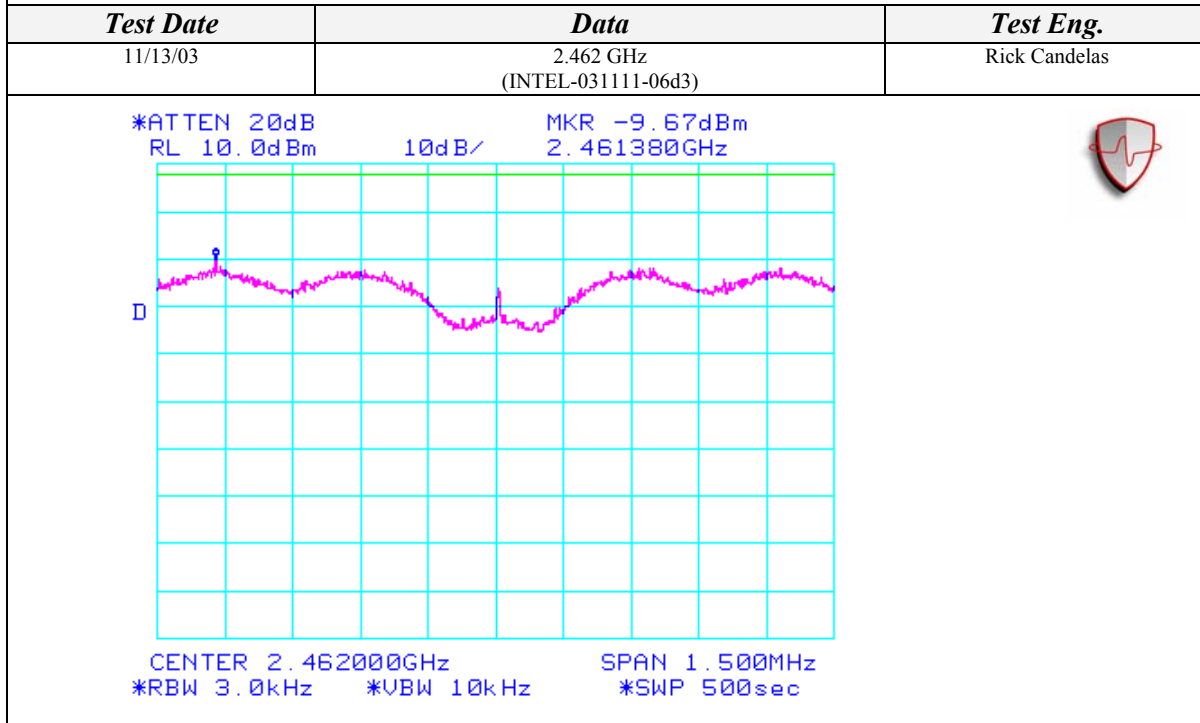
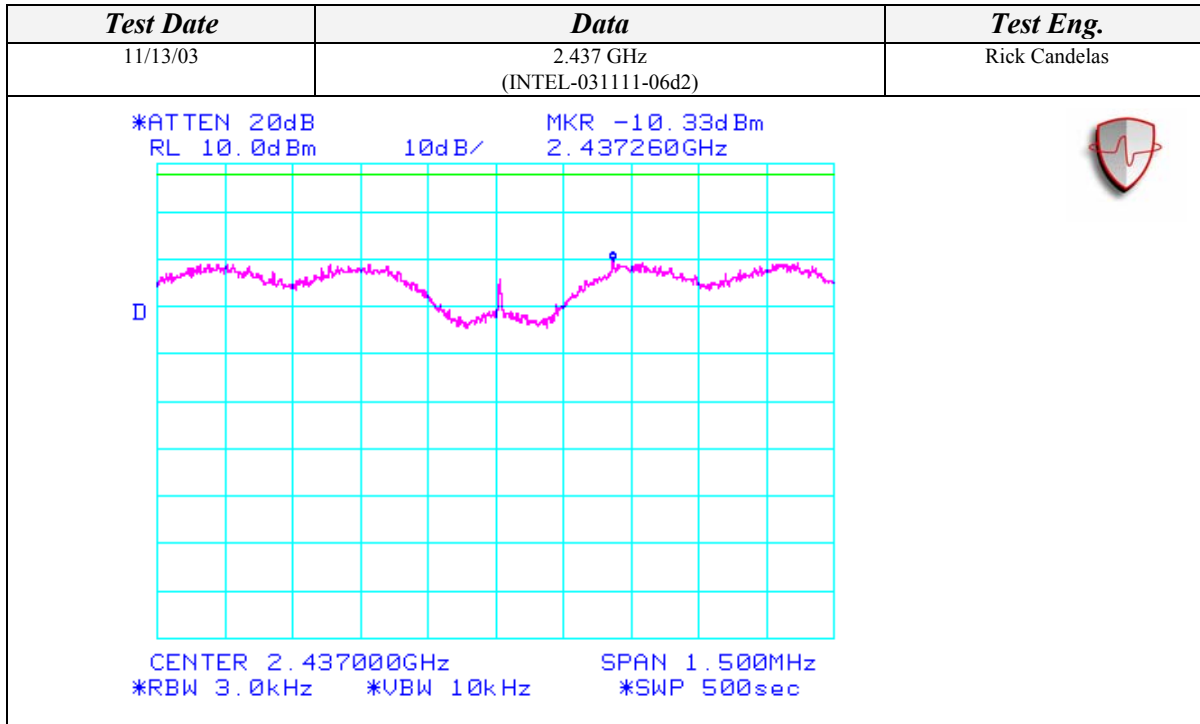

Page 68 of 81 (Appendix A)  
 Report Number: INTEL-031111F  
 FCC ID: PD9WM3B2200BG



AEGIS LABS INC.

## CONDUCTED OUT OF BAND EMISSIONS

<b>CLIENT:</b>	Intel Corporation	<b>DATE:</b>	11/13/03
<b>EUT:</b>	802.11b/g MiniPCI Type 3B Wireless Adapter	<b>PROJECT NUMBER:</b>	INTEL-031111-04
<b>MODEL NUMBER:</b>	WM3B2200BG	<b>TEST ENGINEER:</b>	Rick Candelas
<b>SERIAL NUMBER:</b>	000E35005267	<b>SITE #:</b>	2
<b>CONFIGURATION:</b>	Tested installed in the Hewlett Packard host computer's mini PCI slot.	<b>TEMPERATURE:</b>	20 C
		<b>HUMIDITY:</b>	60% RH
		<b>TIME:</b>	10:00 AM

<b>Standard:</b>	FCC CFR 47, Part 15.407(b)(1) and 15.407(b)(2)
<b>Description:</b>	In any 100 kHz bandwidth outside the frequency band in which the spread spectrum intentional radiator is operating, the radio frequency power that is produced by the intentional radiator shall be at least 20 dB below that in the 100 kHz bandwidth within the band that contains the highest level of the desired power.

Test Results Summary			
Plot	Channel Frequency (MHz)	Data	Results
INTEL-031111-04e01	2412	30MHz – 2GHz	See Plots
INTEL-031111-04e02		2GHz – 10GHz	See Plots
INTEL-031111-04e03		10GHz – 20GHz	See Plots
INTEL-031111-04e04		20GHz – 26.5GHz	See Plots
INTEL-031111-04e05	2437	30MHz – 2GHz	See Plots
INTEL-031111-04e06		2GHz – 10GHz	See Plots
INTEL-031111-04e07		10GHz – 20GHz	See Plots
INTEL-031111-04e08		20GHz – 26.5GHz	See Plots
INTEL-031111-04e09	2462	30MHz – 2GHz	See Plots
INTEL-031111-04e10		2GHz – 10GHz	See Plots
INTEL-031111-04e11		10GHz – 20GHz	See Plots
INTEL-031111-04e12		20GHz – 26.5GHz	See Plots

Page 69 of 81 (Appendix A)  
Report Number: INTEL-031111F  
FCC ID: PD9WM3B2200BG





Conducted Out Of Band Emissions (Continued)

**802.11b Mode**

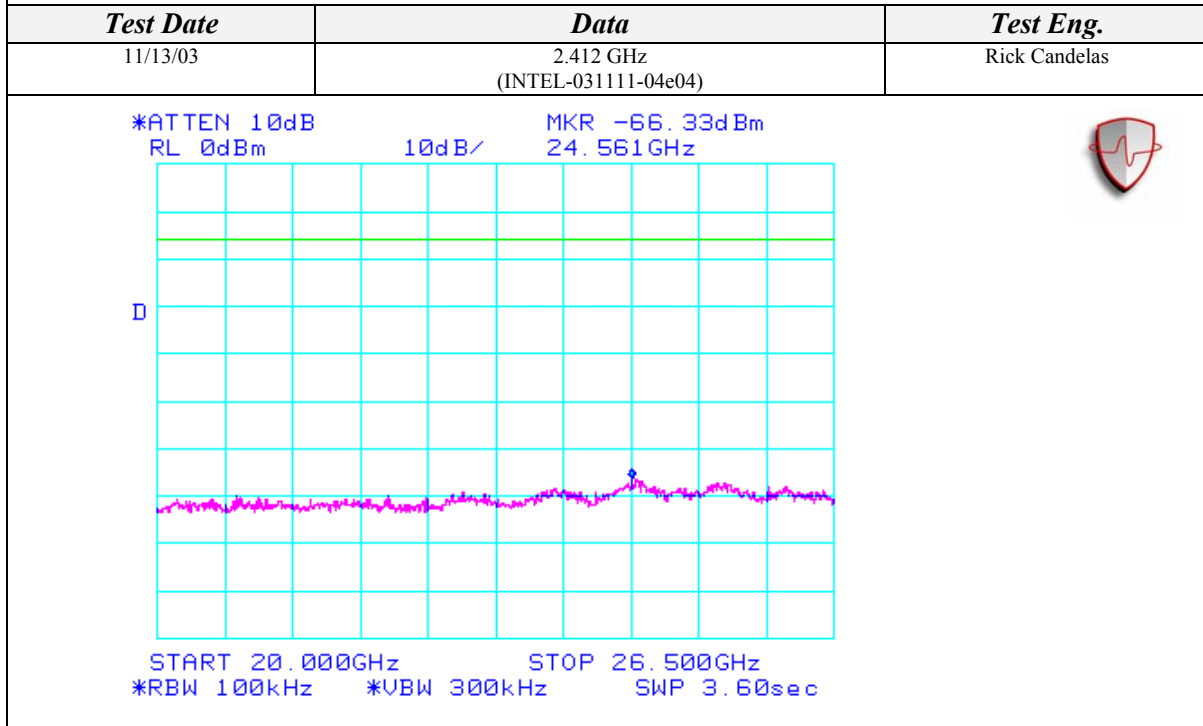
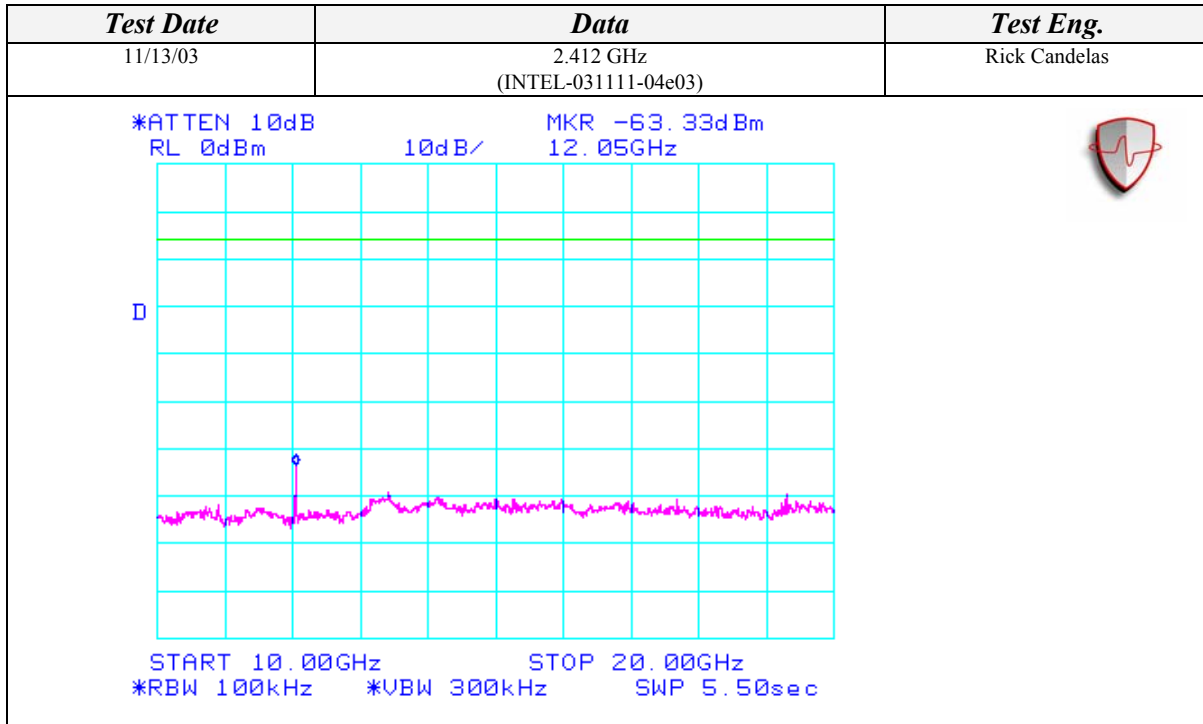



AEGIS LABS INC.

### Conducted Out Of Band Emissions (Continued)

#### 802.11b Mode

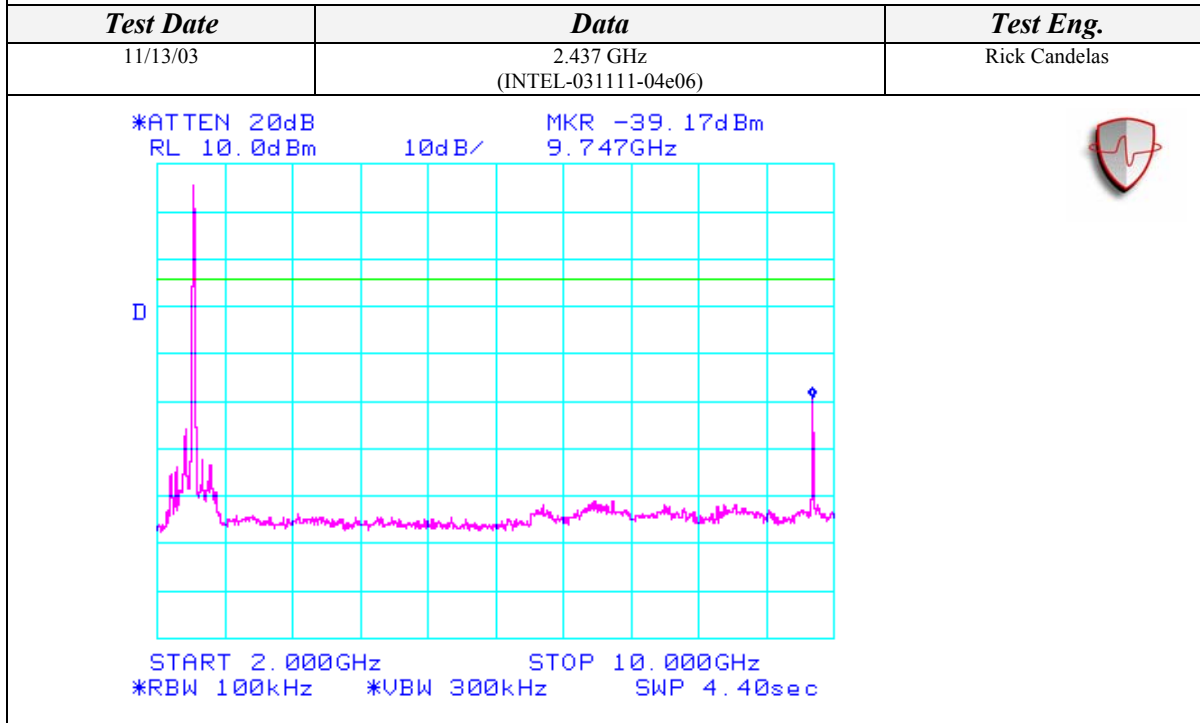
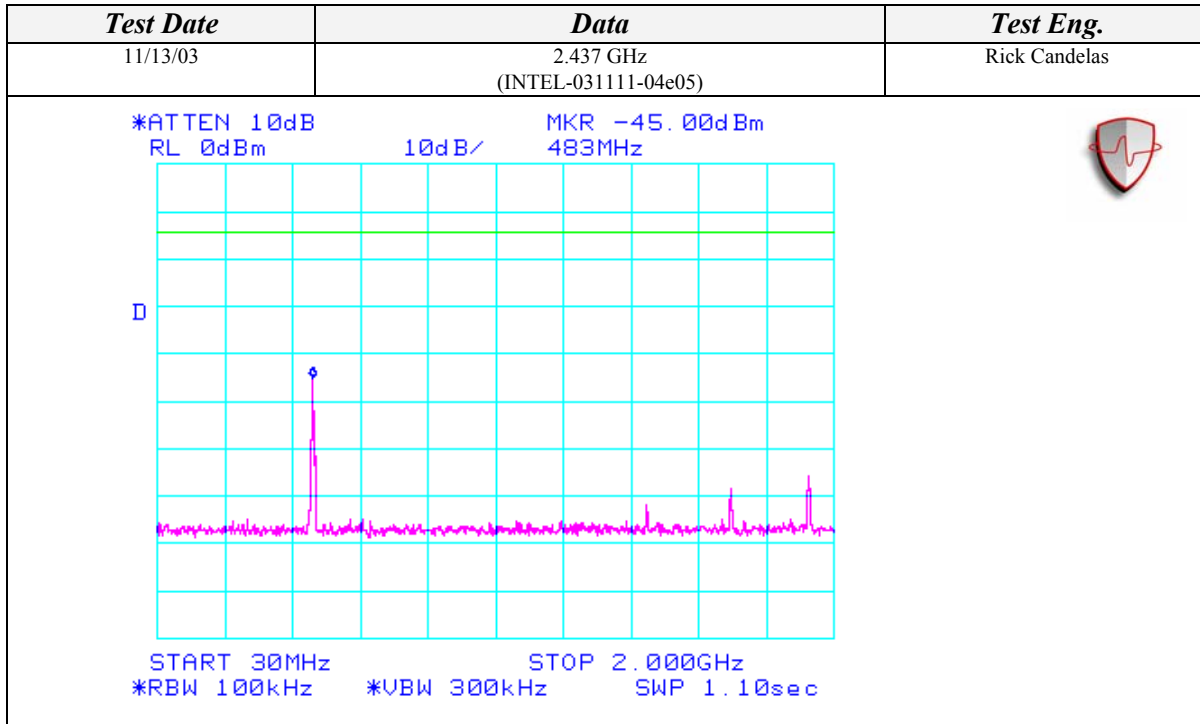

Page 72 of 81 (Appendix A)  
Report Number: INTEL-031111F  
FCC ID: PD9WM3B2200BG



AEGIS LABS INC.

Conducted Out Of Band Emissions (Continued)

**802.11b Mode**

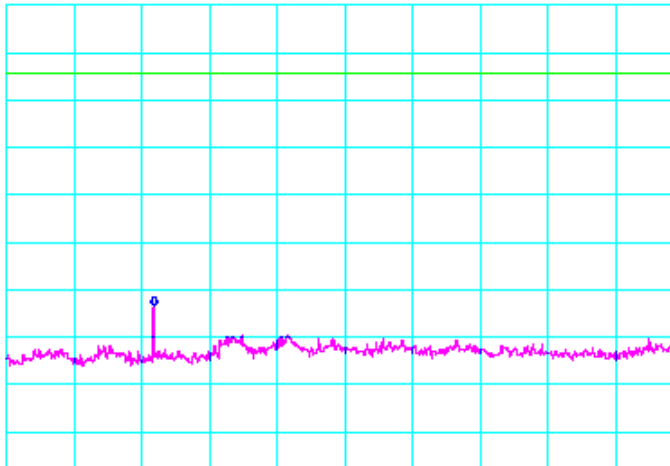
Test Date	Data	Test Eng.
11/13/03	2.437 GHz (INTEL-031111-04e07)	Rick Candelas
*ATTEN 10dB                      MKR -63.50dBm RL 0dBm                              10dB/                      12.18GHz  START 10.00GHz                      STOP 20.00GHz *RBW 100kHz                      *VBW 300kHz                      SWP 5.50sec		

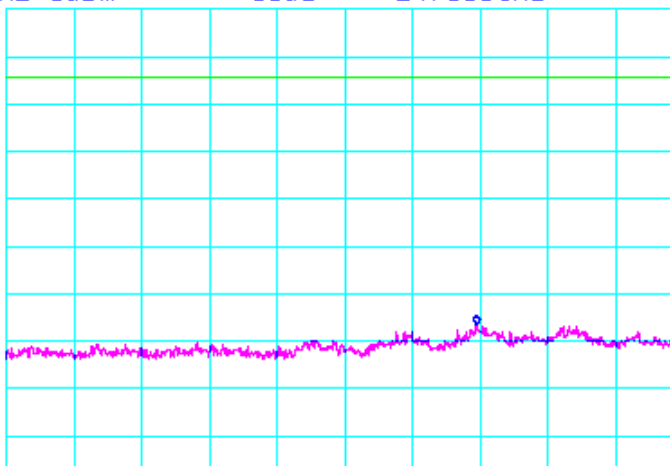

Test Date	Data	Test Eng.
11/13/03	2.437 GHz (INTEL-031111-04e08)	Rick Candelas
*ATTEN 10dB                      MKR -66.50dBm RL 0dBm                              10dB/                      24.518GHz  START 20.000GHz                      STOP 26.500GHz *RBW 100kHz                      *VBW 300kHz                      SWP 3.60sec		







Conducted Out Of Band Emissions (Continued)

802.11b Mode

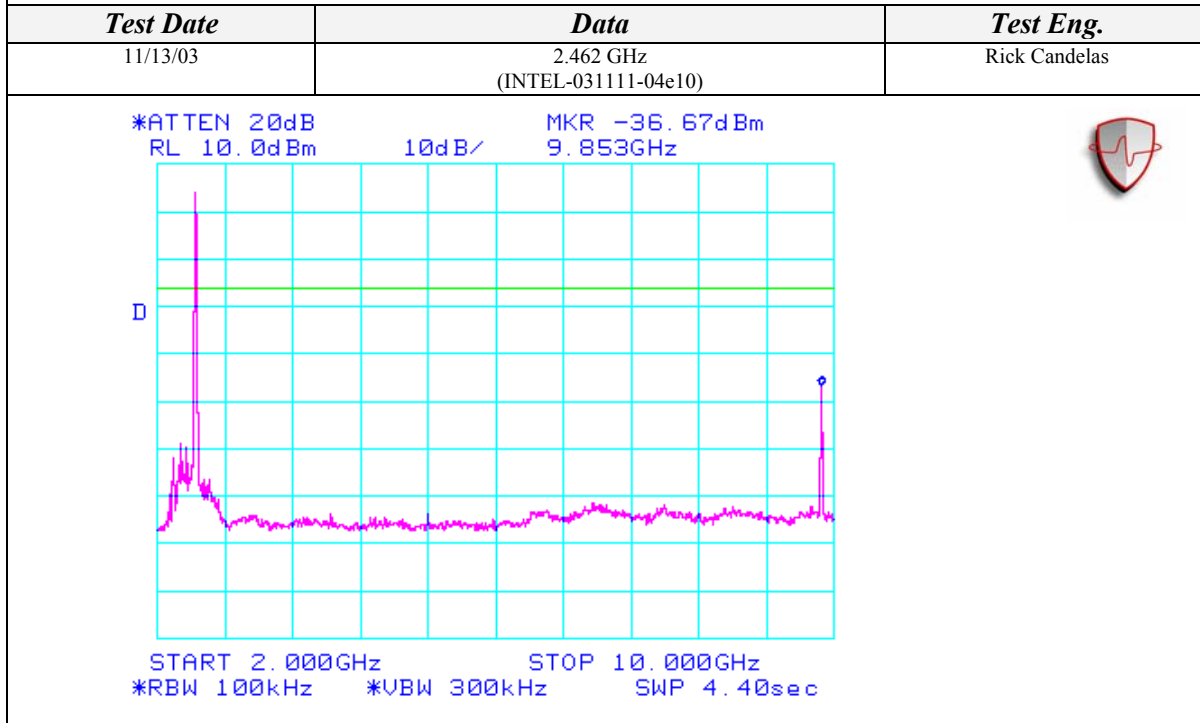
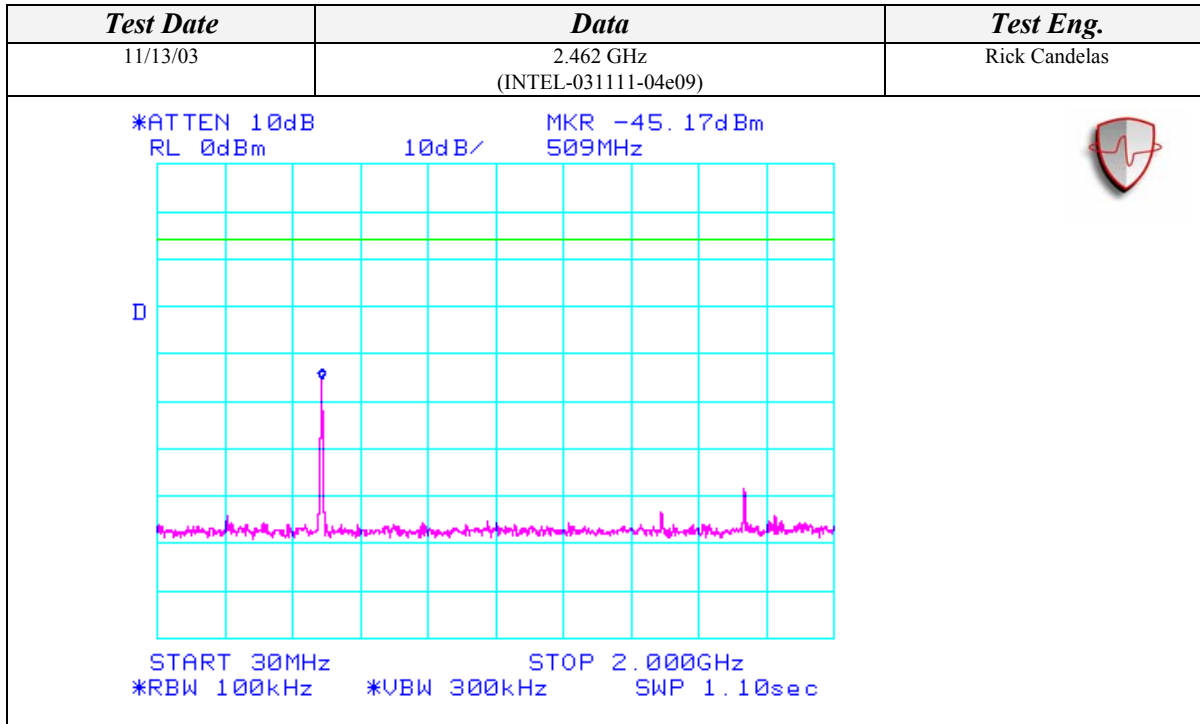



AEGIS LABS INC.

Conducted Out Of Band Emissions (Continued)

802.11b Mode

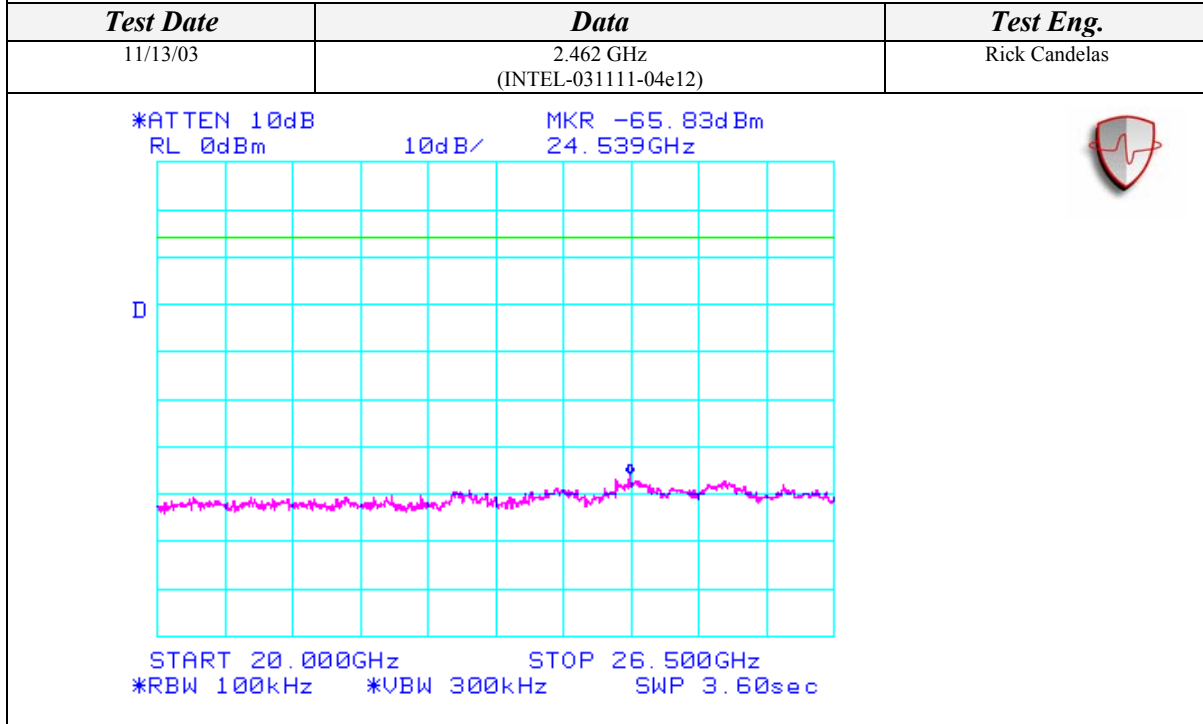
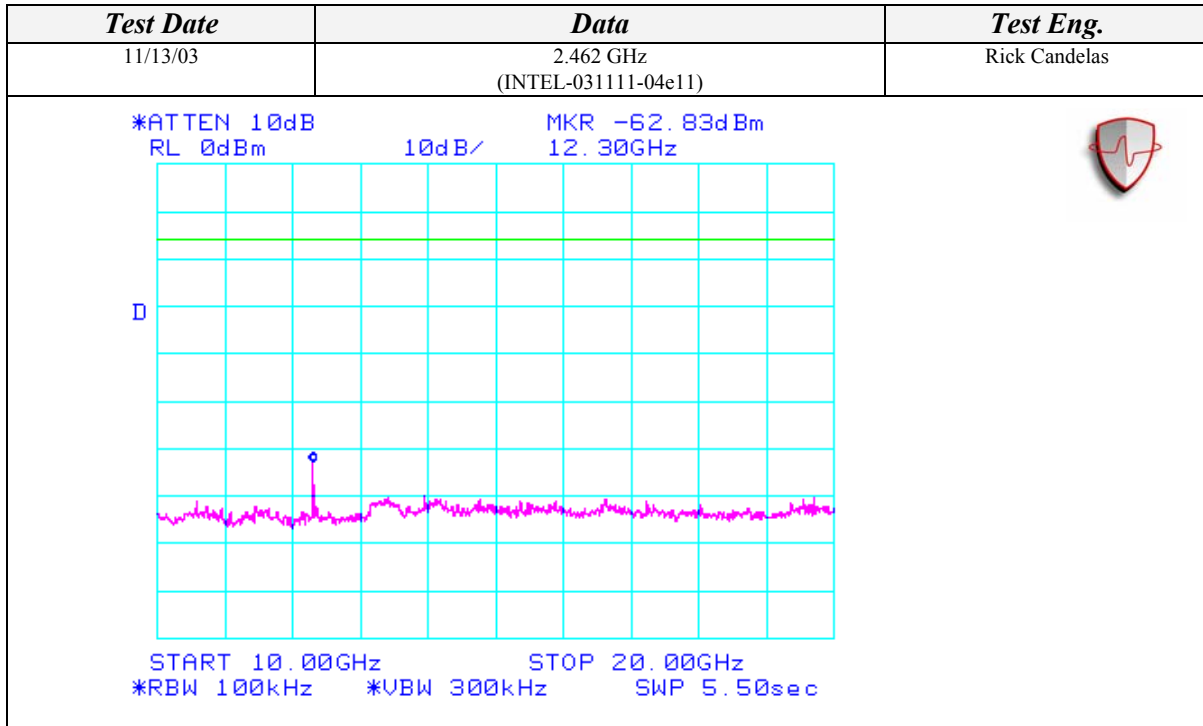



AEGIS LABS INC.

Conducted Out Of Band Emissions (Continued)

802.11b Mode

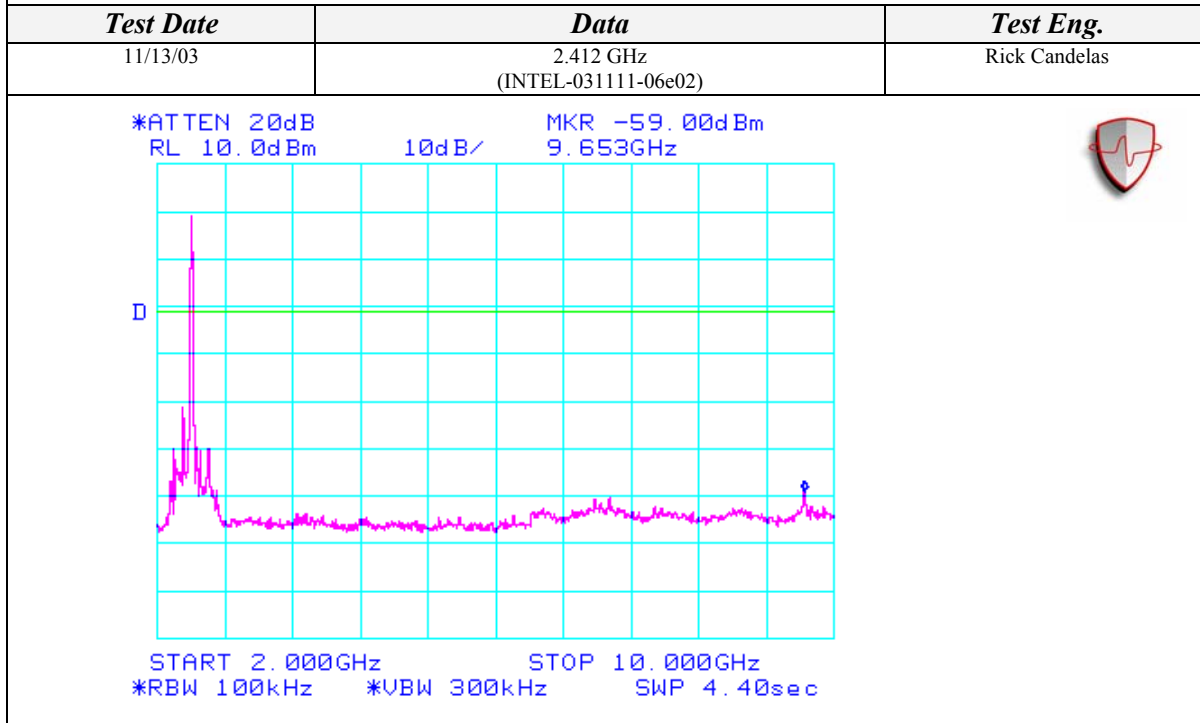
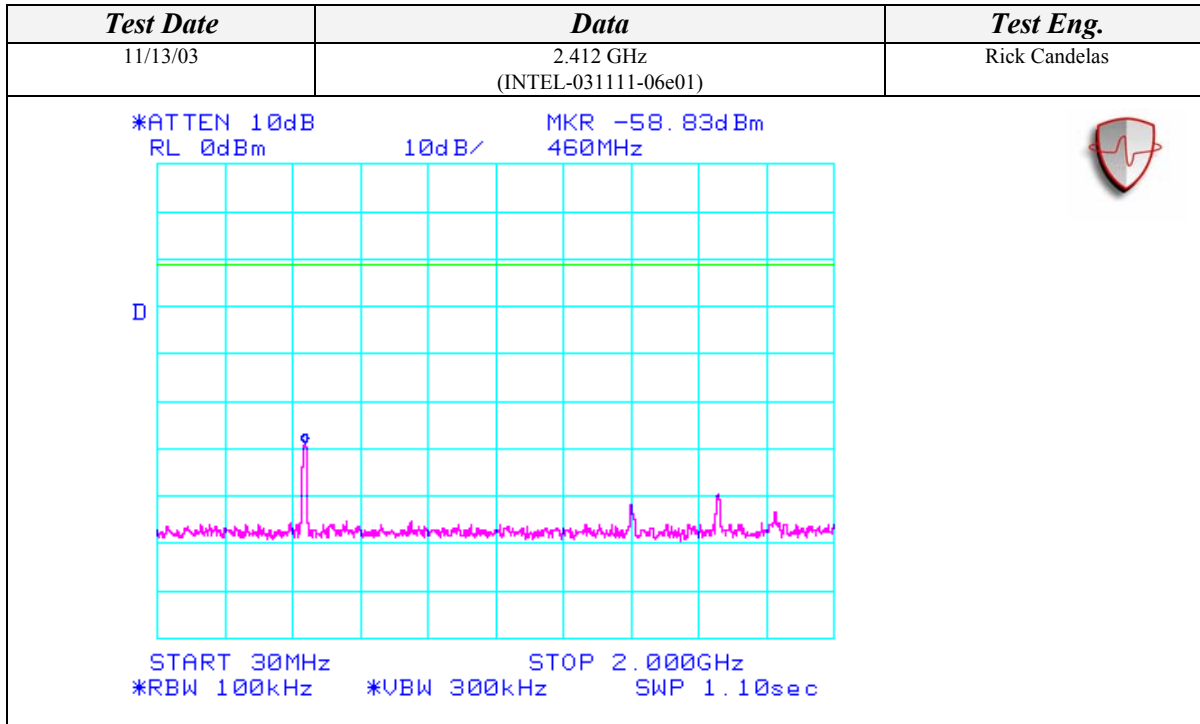

Page 76 of 81 (Appendix A)  
 Report Number: INTEL-031111F  
 FCC ID: PD9WM3B2200BG



AEGIS LABS INC.

Conducted Out Of Band Emissions (Continued)

082.11g Mode

<b>Test Date</b>	<b>Data</b>	<b>Test Eng.</b>
11/13/03	2.412 GHz (INTEL-031111-06e03)	Rick Candelas
<p>*ATTEN 10dB                      MKR -69.83dBm RL 0dBm                      10dB/                      15.68GHz</p> <p>START 10.00GHz                      STOP 20.00GHz *RBW 100kHz                      *VBW 300kHz                      SWP 5.50sec</p>		
<b>Test Date</b>	<b>Data</b>	<b>Test Eng.</b>
11/13/03	2.412 GHz (INTEL-031111-06e04)	Rick Candelas
<p>*ATTEN 10dB                      MKR -67.00dBm RL 0dBm                      10dB/                      24.528GHz</p> <p>START 20.000GHz                      STOP 26.500GHz *RBW 100kHz                      *VBW 300kHz                      SWP 3.60sec</p>		





Conducted Out Of Band Emissions (Continued)

**082.11g Mode**

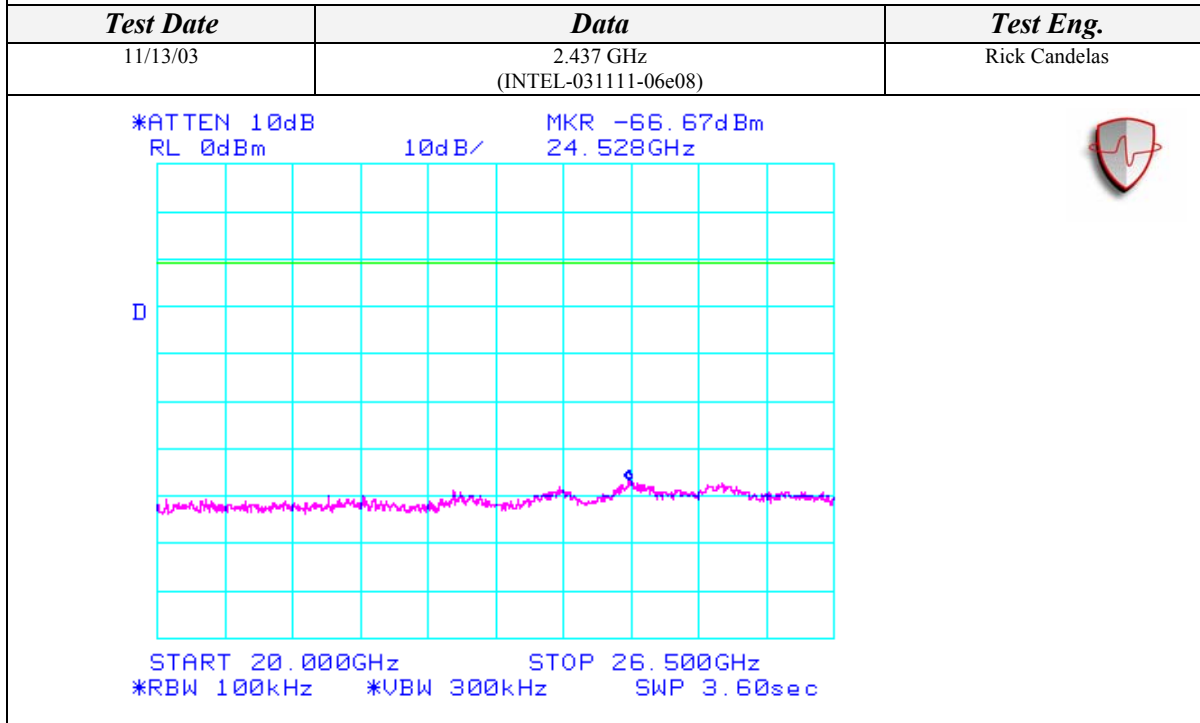
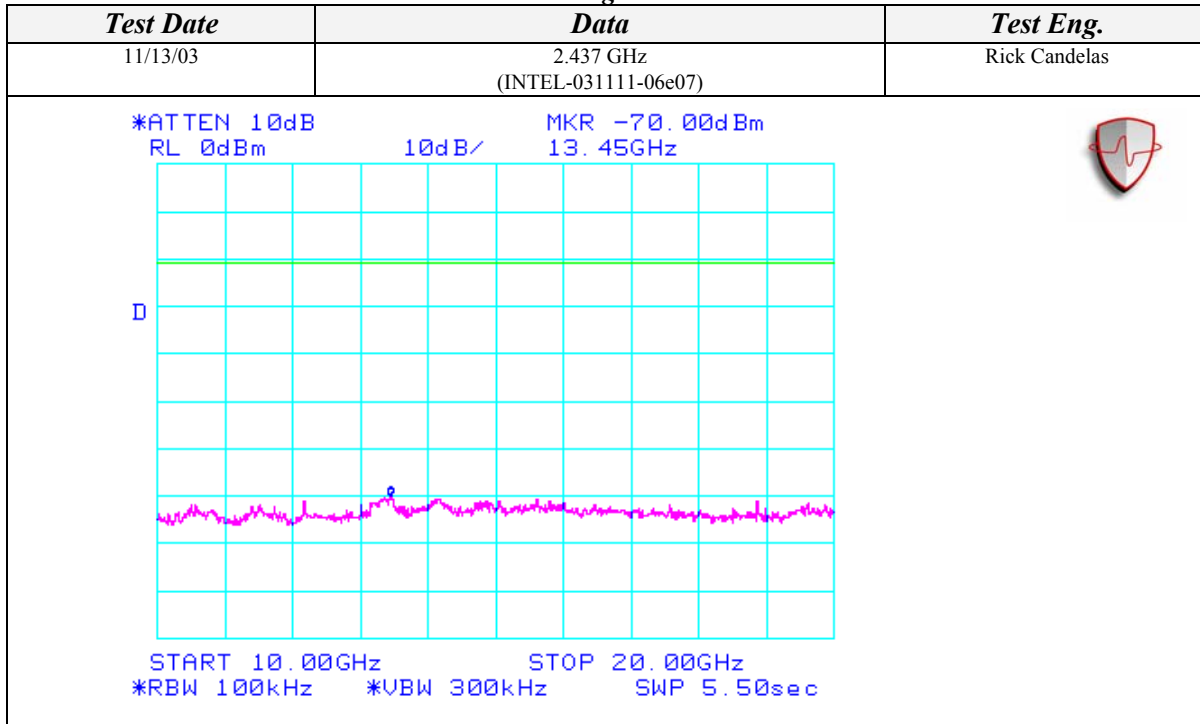



Conducted Out Of Band Emissions (Continued)

082.11g Mode

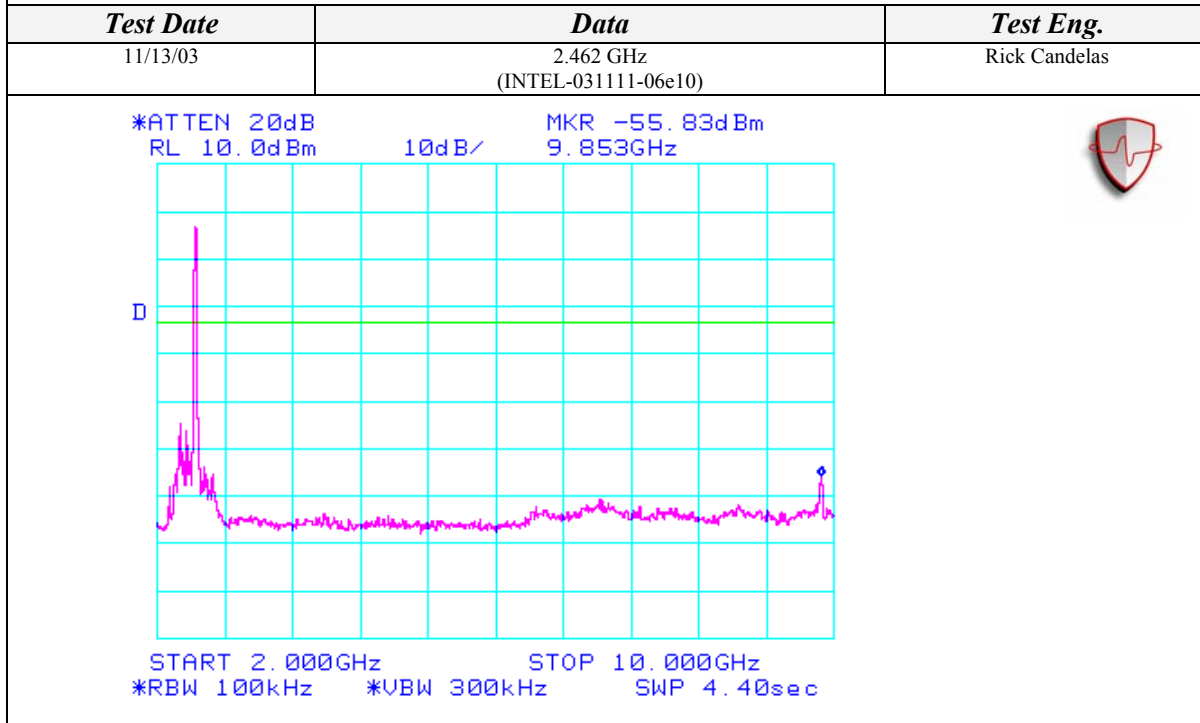
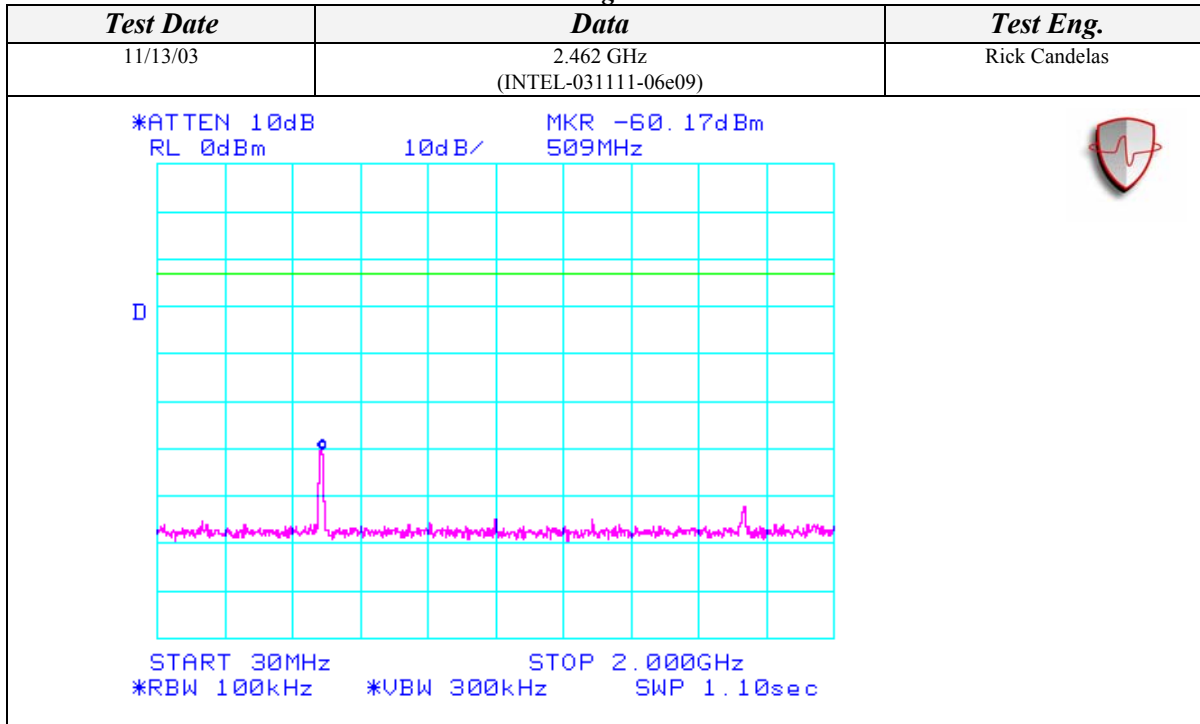





AEGIS LABS INC.

### Conducted Out Of Band Emissions (Continued)

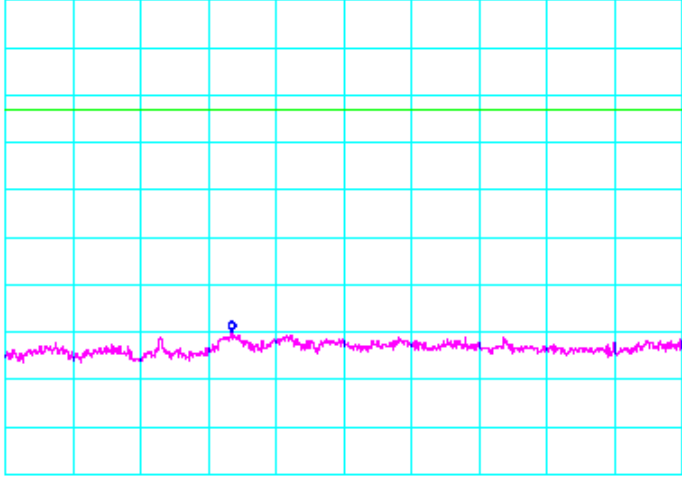
#### 082.11g Mode

Test Date	Data	Test Eng.
11/13/03	2.462 GHz (INTEL-031111-06e11)	Rick Candelas
<div style="text-align: right;">  </div> <p>*ATTEN 10dB                      MKR -69.67dBm            RL 0dBm                         10dB/                      13.35GHz</p>  <p>START 10.00GHz                      STOP 20.00GHz            *RBW 100kHz                      *VBW 300kHz                      SWP 5.50sec</p>		

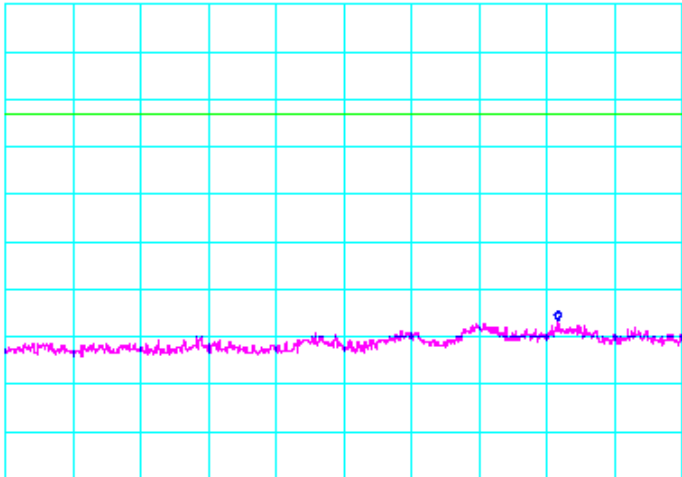
Test Date	Data	Test Eng.
11/13/03	2.462 GHz (INTEL-031111-06e12)	Rick Candelas
<div style="text-align: right;">  </div> <p>*ATTEN 10dB                      MKR -66.50dBm            RL 0dBm                         10dB/                      25.308GHz</p>  <p>START 20.000GHz                      STOP 26.500GHz            *RBW 100kHz                      *VBW 300kHz                      SWP 3.60sec</p>		