



AEGIS LABS INC.



Modular Approval
Test Report
And Application for Grant of Equipment Authorization

Pertaining To:

Equipment Under Test	FCC ID:
Intel PRO/Wireless 2915ABG Network Connection, MN: WM3A2915ABG	PD9WM3A2915ABG

Configuration
802.11a with a set of Ethertronics Antennas

MEASUREMENTS PERFORMED IN ACCORDANCE WITH

Regulatory Standard(s)
47 CFR Part 15, Subpart E Section 15.407 (UNII Devices)
<p>Test Method: ANSI C63.4: 1992 American National Standard for Methods of Measurement of Radio-Noise Emissions from Low-Voltage Electrical and Electronic Equipment in the Range of 9 kHz to 40 GHz</p>



Certificate Number: 1111.01

APPLICANT:

Intel Corporation
EC2-02 13280 Evening Creek Drive
San Diego, CA 92128

Contact(s): Mr. Robert Paxman

PREPARED BY:

Aegis Labs, Inc.
22431 Antonio Parkway B160-417
Rancho S. Margarita, CA 92688

Agent(s): Mr. Steve Kuiper
Mr. Rick Candelas
Mr. Johnny Candelas

Test Report #: INTEL-040615F
Test Report Revision: None

	REPORT BODY	APPENDICES	TOTAL PAGES
		<i>A</i>	
PAGES	16	38	54

The contents of this report shall not be reproduced except in full, without the written approval of Aegis Labs, Inc.

Page 1 of 16
Report Number: INTEL-040615F
FCC ID: PD9WM3A2915ABG



TABLE OF CONTENTS

SECTION	TITLE	PAGE
	COVER SHEET.....	01
	TABLE OF CONTENTS.....	02
1.0	CERTIFICATION OF TEST DATA.....	03
2.0	SUMMARY OF TEST RESULTS.....	04
3.0	ADMINISTRATIVE DATA AND TEST DESCRIPTION.....	05
4.0	DESCRIPTION OF EUT.....	07
4.1	EUT Description.....	07
4.2	EUT Configuration.....	08
4.3	List of EUT Sub-Assemblies and Host Equipment.....	09
4.4	I/O Cabling Diagram and Description.....	10
5.0	TEST EQUIPMENT AND TEST SETUPS.....	11
5.1	AC Power Line Conducted Emissions.....	11
5.2	Spurious Radiated Emissions.....	12
5.3	Conducted Emissions At The Antenna Port.....	12
5.4	Test and Measurement Equipment Used.....	13
6.0	SAMPLE CALCULATIONS.....	14
7.0	MODIFICATIONS AND RECOMMENDATIONS.....	16

APPENDICES

A	Test Data
---	-----------



AEGIS LABS INC.

1.0 CERTIFICATION OF TEST DATA

Aegis Labs, Inc. operates as both a Nevada and California Corporation with no organizational or financial relationship with any company, institution, or private individual.

Testing and engineering functions provided by Aegis Labs are furnished through the use of part-time, full-time or consulting engineers with the appropriate qualifications to carry out their duties. The intended purpose of this test report is to describe the measurement procedure and to determine whether the equipment under test "EUT" complies with both the conducted and radiated limits. Limits for emissions testing are described under Subpart E of Part 15 of the FCC rules for Unlicensed National Information Infrastructure (UNII) Devices.

The data, data evaluation and equipment configuration represented herein are a true and accurate representation of the Equipment Under Test (EUT) under the requirements specified in the emissions standard as described below. The test results contained in this report are only representative of the test sample tested as described in Section 3.0 of this report. Certification of the EUT is required as a prerequisite to marketing as defined in Part 2 of the FCC Rules.

Prepared By:

06/30/04

Rick Candelas
Staff Engineer
Aegis Labs, Inc.

Date:

Report Approved By:

06/30/04

Steve J. Kuiper
Quality Assurance Manager
Aegis Labs, Inc.

Date:

Page 3 of 16

Report Number: INTEL-040615F

FCC ID: PD9WM3A2915ABG



2.0 SUMMARY OF TEST RESULTS

The test results provided within this report, indicate that the EUT has been found to be in **COMPLIANCE** with the test specifications based upon the following RF compliance standards:

Pass/Fail determination is based upon the nominal values of the test data.

EMISSIONS STANDARD			
FCC Part 15 Section	Description	Results	Comments
Operation in the 5.15-5.25 GHz Band			
15.407(d)	Any UNII device shall use a transmitting antenna that is an integral part of the device.	PASSED	The antenna will be integral when installed in a notebook computer
15.407(e)	UNII devices will be restricted to indoor operations.	PASSED	Refer to "User's Manual" Exhibit
15.407(a)(1)	26dB emissions bandwidth in MHz.	N/A	5.18 GHz = 23.92 MHz
15.407(a)(1)	Peak transmit power shall not exceed the lesser of 50mW or 4dBm+10logB (where B = 26dB emissions bandwidth).	PASSED	5.18 GHz = 16.80dBm (47.86mW) 5.24 GHz = 16.90dBm (48.98mW)
15.407(a)(1)	The peak power spectral density shall not exceed 4dBm in any 1MHz band.	PASSED	5.18 GHz = 1.00dBm
15.407(a)(1)	Peak transmit power and the peak power spectral density shall be reduced by the amount in dB that the transmitting antenna exceeds 6dBi.	N/A	5 GHz antenna gain = 5.0dBi
15.407(b)(5) / 15.209	Unwanted emissions below 1 GHz must comply with the general field strength limits set forth in Section 15.209.	PASSED	See Data Sheets
15.407(b)(1)	All emissions outside of the 5.15-5.35 GHz band shall not exceed an EIRP of -27dBm/MHz.	PASSED	See Data Sheets
Operation in the 5.25-5.35 GHz Band			
15.407(a)(2)	26dB emissions bandwidth in MHz.	N/A	5.26 GHz = 27.42 MHz 5.32 GHz = 29.42 MHz
15.407(a)(2)	Peak transmit power shall not exceed the lesser of 250mW or 11dBm+10logB (where B = 26dB emissions bandwidth).	PASSED	5.26 GHz = 20.60dBm (114.82mW) 5.32 GHz = 20.70dBm (117.49mW)
15.407(a)(2)	The peak power spectral density shall not exceed 11dBm in any 1MHz band.	PASSED	5.26 GHz = 5.50dBm 5.32 GHz = 6.17dBm
15.407(a)(2)	Peak transmit power and the peak power spectral density shall be reduced by the amount in dB that the transmitting antenna exceeds 6dBi.	N/A	5 GHz antenna gain = 5.0dBi
15.407(b)(5) / 15.209	Unwanted emissions below 1 GHz must comply with the general field strength limits set forth in Section 15.209.	PASSED	See Data Sheets
15.407(b)(2)	All emissions outside of the 5.15-5.35 GHz band shall not exceed an EIRP of -27dBm/MHz. Must meet all applicable technical requirements for operating in the 5.15-5.25 GHz band.	PASSED	See Data Sheets



AEGIS LABS INC.

2.0 SUMMARY OF TEST RESULTS (Continued)

EMISSIONS STANDARD			
FCC Part 15 Section	Description	Results	Comments
General Requirements For All Bands			
15.407(a)(6)	The ratio of the peak excursion of the modulation envelope to the peak transmit power shall not exceed 13dB across any 1 MHz bandwidth or the emissions bandwidth whichever is less.	PASSED	5.18 GHz = 5.50 dB 5.26 GHz = 5.67 dB 5.32 GHz = 6.00 dB
15.407(f)	Radio frequency radiation exposure requirement.	PASSED	Refer to MPE Calculations Exhibit
15.407(b) / 15.207	UNII devices using AC power line are required to comply with the conducted limits set forth in Section 15.207.	PASSED	See Data Sheets

Page 5 of 16
Report Number: INTEL-040615F
FCC ID: PD9WM3A2915ABG



AEGIS LABS INC.

3.0 ADMINISTRATIVE DATA AND TEST DESCRIPTION

DEVICE TESTED:	ITE Type: Intel PRO/Wireless 2915ABG Network Connection Model Number(s): WM3A2915ABG Serial Number: 000E35344011 FCC ID: PD9WM3A2915ABG
TEST DATE(S):	June 14-21, 2004
DATE EUT RECEIVED:	June 14, 2004
ORIGIN OF TEST SAMPLE(S):	Pre-Production Unit
RESPONSIBLE PARTY:	Intel Corporation EC2-02 13280 Evening Creek Drive San Diego, CA 92128
CLIENT CONTACT:	Mr. Robert Paxman
MANUFACTURER:	Intel Corporation
TEST LOCATION:	Aegis Labs, Inc. 32231 Trabuco Creek Road Trabuco Canyon, CA 92678 Conducted Site #2 Radiated Site #2
A2LA CERTIFICATE:	1111.01, Valid through February 28, 2006
PURPOSE OF TEST:	To demonstrate compliance with the relevant standards described in Section 2.0 of this report.
TEST(S) PERFORMED:	Refer to Table in Section 2.0 of this report.

All calibration vendors were responsible for certifying Aegis Labs, Inc. test equipment as per the manufacturer's specifications and that the equipment is calibrated using instruments and standards where the accuracy is traceable to the National Institute of Standards and Technology (NIST). Calibration of all test equipment conforms to ANSI/NCSL Z540-1 and ISO 10012-1 and/or ISO/IEC Guide 17025 compliance (Additionally, other pertinent test equipment will carry MIL-STD-45662A). All calibration documents are on file with Aegis Labs, Inc., with copies provided upon request.

Page 6 of 16
Report Number: INTEL-040615F
FCC ID: PD9WM3A2915ABG



4.0 DESCRIPTION OF EUT

4.1 EUT Description

Equipment Under Test (EUT)	
Trade Name:	Intel PRO/Wireless 2915ABG Network Connection
Model Number:	WM3A2915ABG
Frequency Range:	5.15-5.35 GHz
Enclosure:	The EUT contains it's own shield made of aluminum approximately 3.5cm wide by 3.5cm deep by 2mm high.
Transfer Rate:	6/36/52 Mbps
Antenna Type:	Hirose U.FL-R-SMT mates with cable connector U.FL-LP-066
Antenna Gain (See Note 2):	Ethertronics Antenna @ 5 GHz = 5.00 dBi
Transmit Output Power:	17 dBm (Typical) for 5.15-5.25 GHz 21 dBm (Typical) for 5.25-5.35 GHz Please see Appendix A (Data Sheets) for actual output power.
Power Supply:	3.3VDC from computer MPCPI slot.
Number of External Test Ports Exercised:	2 Antenna Ports (1 Main & 1 Auxiliary)

The Intel PRO/Wireless 2915ABG Network Connection is an embedded 2.4 and 5 GHz Wireless Local Area Network Mini-PCI adapter. The Mini-PCI Type 3B form factor is designed for notebook computer systems where overall thickness must be kept to an absolute minimum and connect to antennas internal to a notebook computer. It is capable of a data rate of up to 52 Mbps.

NOTE 1: For a more detailed description, please refer to the manufacture's specifications or User's Manual.

NOTE 2: Refer to the antenna specifications for a further description of the antennas. Antennas will be professionally installed inside the laptop computer by the laptop vendor.



AEGIS LABS INC.

4.2 EUT Configuration

The EUT was tested installed in the Mini-PCI slot of the Hewlett Packard host computer as a modular device using a PCI extender board to extend the EUT outside the computer chassis. The EUT was then connected to a set of antennas via its Main and AUX antenna ports. Data for a set of Ethertronics antennas can be found in Appendix A (Data Sheets)

For conducted emissions at the AC mains port and radiated emissions, the Hewlett Packard host computer was connected to a Zoom modem, Hewlett Packard printer, Dell monitor, Hewlett Packard keyboard, and Hewlett Packard mouse via its serial, parallel, video, keyboard, and mouse ports respectively.

The low, middle, and high channels were tested in 802.11a, b, & g modes. Also, the EUT was tested once transmitting from the MAIN antenna port and once transmitting from the AUX antenna port. The EUT was placed in either continuous transmit or continuous receive mode by a program provided by the manufacturer (*CRTU Version 3.2.11.0000*).



AEGIS LABS INC.

4.3 List of EUT, Sub-Assemblies, and Host Equipment

LIST OF EUT AND SUB-ASSEMBLIES			
Equipment Name	Manufacturer	Model Number	Serial Number
Intel PRO/Wireless 2915ABG Network Connection	Intel Corporation	WM3A2915ABG	000E35344011
EUT Sub-Assemblies			
Main Multi Band Antenna	Ethertronics	MPCI01001	N/A
Auxiliary Multi Band Antenna	Ethertronics	MPCI01001	N/A

HOST EQUIPMENT LIST			
Equipment Name	Manufacturer	Model Number	Serial Number
Computer	Hewlett Packard	Pavillion a300n	MXK3391864
LCD Monitor	Dell	E151FPp	CN-06R644-47804-34R- LATL
Keyboard	Hewlett Packard	5183	BF33339165
Mouse	Hewlett Packard	M042KC	30870136

NOTE: All the power cords of the above support equipment are standard non-shielded, 1.8 meters long.



4.4 I/O Cabling Diagram and Description

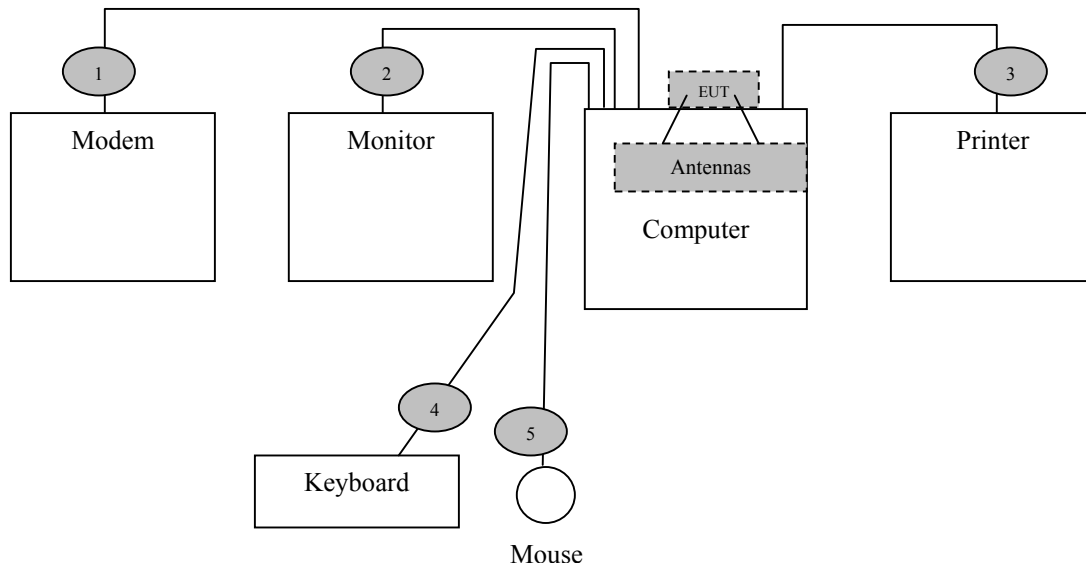

- Cable 1: This is a 6-foot braid and foil shielded round cable connecting the Hewlett Packard host computer with the Zoom modem. It has metallic DB-9 type connector at the computer end and a metallic DB-25 type connector at the modem end. The cable is bundled to a length of one meter and the shield of the cable is grounded to the chassis of both devices via the connector shells.
- Cable 2: This is a 6-foot braid and foil shielded round cable connecting the Hewlett Packard host computer with the Dell LCD monitor. It has metallic DB-15 type connector at the computer end and is hardwired to the monitor. The cable is bundled to a length of one meter and the shield of the cable is grounded to the chassis of both devices via the connector shells.
- Cable 3: This is a 6-foot braid and foil shielded round cable connecting the Hewlett Packard host computer to the Hewlett Packard printer. It has a metallic DB-25 type connector at the computer end and a metallic centronics type connector at the printer end. The cable is bundled to a length of one meter and the shield of the cable is grounded to the chassis of both devices via the connector shells.
- Cable 4: This is a 6-foot braid and foil shielded round cable connecting the Hewlett Packard host computer to the Hewlett Packard keyboard. It has a metallic 6-pin mini din type connector at the computer end and is hardwired to the keyboard. The shield of the cable is grounded to the chassis of the computer via the connector shell.
- Cable 5: This is a 6-foot braid and foil shielded round cable connecting the Hewlett Packard host computer to the Hewlett Packard mouse. It has a metallic 6-pin mini din type connector at the computer end and is hardwired to the mouse. The shield of the cable is grounded to the chassis of the computer via the connector shell.



AEGIS LABS INC.

5.0 TEST EQUIPMENT AND TEST SETUPS

The test equipment settings and functions are selected using the guidance of ANSI C63.4-1992. All test equipment setups and operations during conducted and radiated emissions testing are in accordance with this reference document.

5.1 AC Power Line Conducted Emissions

During conducted emissions measurements, a spectrum analyzer was used as the measuring instrument along with a preselector and quasi-peak detector. A 10 dB attenuation pad was used for the protection of the spectrum analyzer input stage. The conducted emissions from the EUT in the frequency range from 150 kHz to 30 MHz were captured for graphical display through the use of automated LABVIEW EMI measurement software. All graphical readings were measured in the “Peak” mode only to reduce testing time. Upon completion of the graphical scan, the test lab personnel performed the conducted measurement scan manually using the spectrum analyzer front panel keys. All peak measurements coming within 3 dB of the limit line were “Averaged” and/or “Quasi-Peaked” and denoted appropriately in the EXCEL spreadsheet.

The Equipment Under Test (EUT) was configured as a system with peripherals connected, so that at least one interface port of each type is connected to one external peripheral when tested for conducted emissions according to ANSI C63.4: 1992. Excess power cord length was wrapped in a bundle 30 to 40 centimeters in length near the center of the cord. The EUT was tested in a tabletop configuration.

The emission readings for Line 1 and Line 2 are highlighted on the data sheets in Appendix A. The graphical scans only reflect peak readings while the tabulated data sheets reflect peak, average, and/or quasi-peak readings which ever applies.



AEGIS LABS INC.

5.2 Spurious Radiated Emissions

A spectrum analyzer was used as the measuring instrumentation along with a preselector and quasi-peak-detector. The pre-amplifiers were used to increase the sensitivity of the instrument. The spectrum analyzer was used in the peak detector mode with the “max-hold” feature activated and in Positive Peak mode. In this mode, the spectrum analyzer records the highest measured reading over all the sweeps. The quasi-peak detector was used only for those readings, which are marked accordingly in the data sheet. The effective measurement bandwidth used for the radiated emissions test was 120 kHz for (30 MHz- 1000 MHz). The spectrum analyzer operated such that the modulation of the signal was filtered out to set the analyzer in linear mode. For testing beyond 1000 MHz a spectrum analyzer capable of taking reading above 1000 MHz was connected to the high frequency amplifier, where these measurement readings were taken with the transducer placed at a 3-meter test distance from the EUT.

The Open Area Test Sites (OATS) was used for radiated emission testing. These test sites are designed according to ANSI C63.4: 1992 and ANSI C63.7: 1992 guidelines. The Measurements were conducted in accordance with ANSI C63.4: 1992 and ANSI C63.7: 1992 requirements.

Broadband biconical, log periodic, and horn antennas were used as transducers during the measurement reading phase. The frequency spans were wide (30 MHz-88 MHz, 88 MHz- 216 MHz, 216 MHz- 300 MHz, and 300 MHz- 1000 MHz). After 1000 MHz the horn antenna was used to measure emissions. The emission readings in both horizontal and vertical polarities are highlighted on the data sheets in Appendix A.

5.3 Conducted Emissions at the Antenna Port

A spectrum analyzer or power meter was used as the measuring instrumentation along with an attenuator and/or filter connected to the EUT antenna port. The attenuator and filters are used to ensure that the front end of the measurement instrument is not overloaded by the fundamental transmission. . The instruments recorded the measured readings with the bandwidths (video and resolution) set in accordance with the FCC Rules and regulations.

The measured readings are on the data sheets in Appendix A.

Page 12 of 16

Report Number: INTEL-040615F

FCC ID: PD9WM3A2915ABG



AEGIS LABS INC.

5.4 Test and Measurement Equipment Used

TEST EQUIPMENT USED					
Equipment Name	Manufacturer	Model Number	Serial Number	Calibration Due Date	Calibration Cycle
EMI Receiver - RF Section	Hewlett Packard	85462A	3325A00137	03/29/05	1 Year
EMI Receiver – RF Filter Section	Hewlett Packard	85460A	3330A00138	03/29/05	1 Year
Attenuator - 5W-10dB	Pasternack	PE7014-10	N/A	11/03/04	1 Year
LISN (EUT)	FCC	FCC-LISN-50-25-2	9931	02/06/05	1 Year
LISN (Access)	Com-Power	LI-200	12019	01/25/05	1 Year
LISN (Access)	Com-Power	LI-200	12018	01/25/05	1 Year
Spectrum Analyzer	Agilent	8564EC	4046A00387	02/06/06	2 Years
Preamplifier	Miteq	JS42-01001800-25-10P	815980 & 884968 & 885090	12/09/04	2 Years
2400-2483.5 MHz Notch Filter	Micro-Tronics	BRM50702-02	003	04/21/06	2 Years
5725-5850 MHz Notch Filter	Microwave Circuits, Inc.	N0257881	3173-01	06/27/05	2 Years
Antenna - Biconical	EMCO	3110	9108-1421	02/11/05	1 Year
Antenna - Log Periodic	EMCO	3148	4947	02/11/05	1 Year
1-18 GHz Antenna - Horn	Com-Power	AH-118	10069	12/09/04	2 Years
18-26.5 GHz Preamplified Antenna – Horn	Custom Microwave	H042	001	11/04/04	1 Year
Power Meter	Anritsu	ML2487A	6K00001785	04/05/05	2 Years
Wide Bandwidth Sensor	Anritsu	MA2491A	31193	04/05/05	2 Years
Temperature/Humidity Monitor	Dickson	TH550	7255185	01/18/05	1 Year

Page 13 of 16

Report Number: INTEL-040615F

FCC ID: PD9WM3A2915ABG



6.0 SAMPLE CALCULATIONS

If a preamplifier is used during the Radiated Emissions Testing, it is required that the amplifier gain be subtracted from the Spectrum Analyzer (Meter) Reading. In addition, a correction factor for the antenna, cable and a distance factor, if any, must be applied to the Meter Reading before a true field strength reading can be obtained. In the Automatic Mode of A.R.M.S. measurements, these considerations are automatically presented as a part of the printout. In the case of manual measurements and for greater efficiency and convenience, usage of the calibration correction factors in the Appendices is necessary to calculate the Corrected Meter Reading. These correlation factors for each meter reading, shall be modified to reflect these correlation factors at each frequency value so that the meter readings can be compared directly to the modified specification limit. This modified specification limit is referred to as the “Corrected Meter Reading Limit” (CML).

The equation shall be derived in the following manner:

$$\text{Corrected Meter Reading} = \text{Meter Reading} + F + C - G - D$$

Where, F = Antenna Factor

C = Cable Factor

G = Amplifier Gain

D = Distance Factor

Therefore, the equation for determining the Corrected Meter Reading Limit (CML) is:

$$\text{CML} = \text{Specification Limit} - F - C + G + D$$

For the manual mode of measurement, a table of corrected meter reading limits shall be used to permit immediate comparison of the meter reading to determine if the measured emission amplitude exceeded the specification limit at that specific frequency. There shall be two calculation sheets done, one for three meter and one for ten-meter measurement distances, where applicable. The correction factors for the antenna and the amplifier gain are attached in the Appendices.



AEGIS LABS INC.

6.0 Sample Calculations (Continued)

Peak Transmit Power Output:

A correction factor for the cable must be applied to the Conducted Power before a true power reading can be obtained. This is referred to as the “Corrected Power” (CP).

The equation shall be derived in the following manner:

$$\text{Corrected Power Reading} = \text{Conducted Power Reading} + C$$

Where, C = Cable Factor

The conducted power is taken in units of dBm. To obtain units of mW the following equation is used:

$$\text{mW} = 10^{(\text{dBm}/10)}$$



AEGIS LABS INC.

7.0 MODIFICATIONS AND RECOMMENDATIONS

No modifications were made to the EUT.

Page 16 of 16
Report Number: INTEL-040615F
FCC ID: PD9WM3A2915ABG



AEGIS LABS INC.

APPENDIX A

TEST DATA

Page 1 of 36 (Appendix A)
Report Number: INTEL-040615F
FCC ID: PD9WM3A2915ABG



AEGIS LABS INC.

AC POWER LINE CONDUCTED EMISSIONS TEST RESULTS

CLIENT:	Intel Corporation	DATE:	06/21/04
EUT:	Intel PRO/Wireless 2915ABG Network Connection	PROJECT NUMBER:	INTEL-040614-19
MODEL NUMBER:	WM3A2915ABG	TEST ENGINEER:	JC
SERIAL NUMBER:	000E35344011	SITE #:	2
CONFIGURATION:	Tested installed in the Hewlett Packard host computer's mini PCI slot.	TEMPERATURE:	22 C
		HUMIDITY:	64% RH
		TIME:	2:00 PM

Standard:	FCC CFR 47, Part 15.407(b)(5)
Description:	U-NII devices using an AC power line are required to comply with the conducted limits set forth in Sec. 15.207.
Results:	Passes the conducted limits by -3.96@ 0.1653 MHz

Conducted Limits		
Frequency (MHz)	Quasi-Peak Limit (dBuV)	Average Limit (dBuV)
0.15-0.5	66 to 56*	56 to 46*
0.5-5	56	46
5-30	60	50

*Decreases with the logarithm of the frequency.

NOTE: During preliminary scans, there wasn't any difference which channel or data rate was used with the EUT; therefore the final testing was made with the EUT at the low channel and a data rate of 6 Mbps.

Page 2 of 36 (Appendix A)
Report Number: INTEL-040615F
FCC ID: PD9WM3A2915ABG



AC Power Line Conducted Emissions Test Results (Continued)

CONDUCTED EMISSIONS – LINE 1						
Freq. (MHz)	Meter Reading (dBuV)	Detector (PK/QP/AV)	Average Limit (dBuV)	Average Delta(dB)	Quasi-Peak Limit (dBuV)	Quasi-Peak Delta(dB)
0.1674	50.20	PK	55.50	-5.30	65.50	-15.30
0.2487	42.50	PK	53.18	-10.68	63.18	-20.68
0.4008	42.20	PK	48.83	-6.63	58.83	-16.63
0.8901	40.10	PK	46.00	-5.90	56.00	-15.90
1.8550	39.10	PK	46.00	-6.90	56.00	-16.90
15.8150	39.40	PK	50.00	-10.60	60.00	-20.60

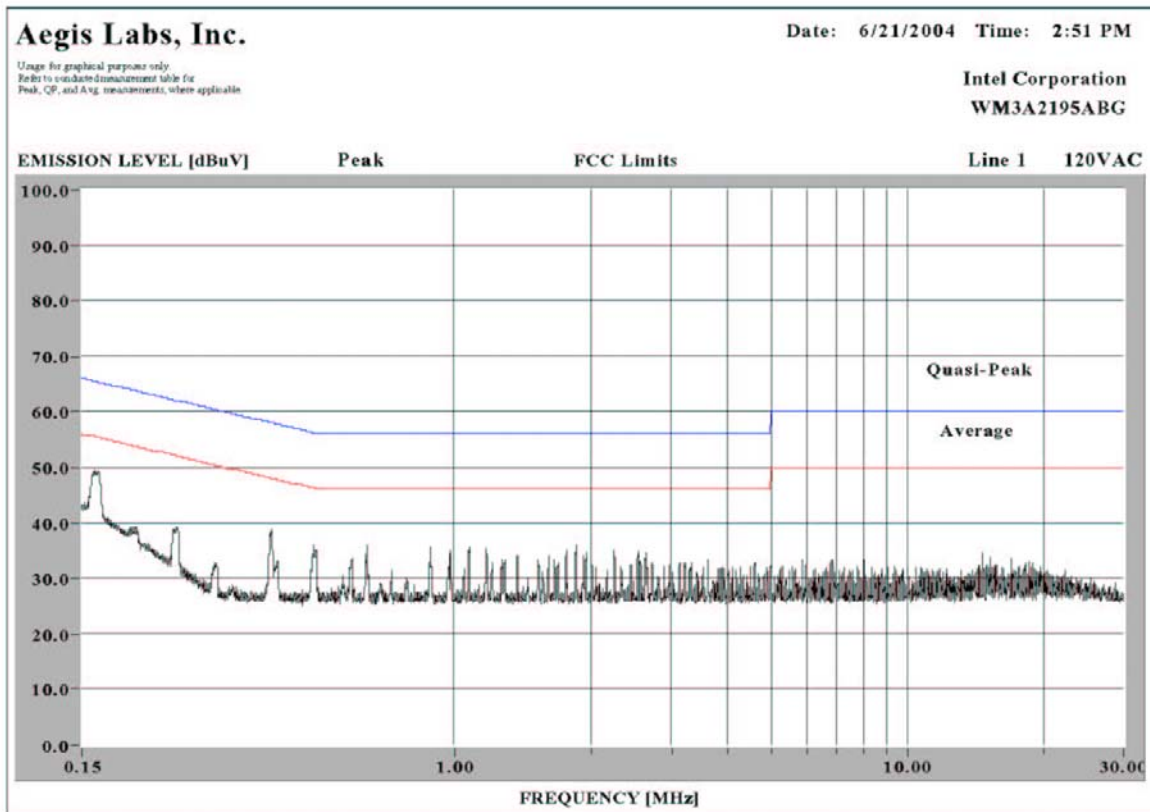



AEGIS LABS INC.

AC Power Line Conducted Emissions Test Results (Continued)

CONDUCTED EMISSIONS - LINE 2						
Freq. (MHz)	Meter Reading (dBuV)	Detector (PK/QP/AV)	Average Limit (dBuV)	Average Delta(dB)	Quasi-Peak Limit (dBuV)	Quasi-Peak Delta(dB)
0.1653	51.60	PK	55.56	-3.96	65.56	-13.96
0.2478	44.00	PK	53.20	-9.20	63.20	-19.20
0.4005	42.50	PK	48.84	-6.34	58.84	-16.34
0.4914	41.60	PK	46.24	-4.64	56.24	-14.64
1.6700	39.20	PK	46.00	-6.80	56.00	-16.80
14.9250	40.30	PK	50.00	-9.70	60.00	-19.70

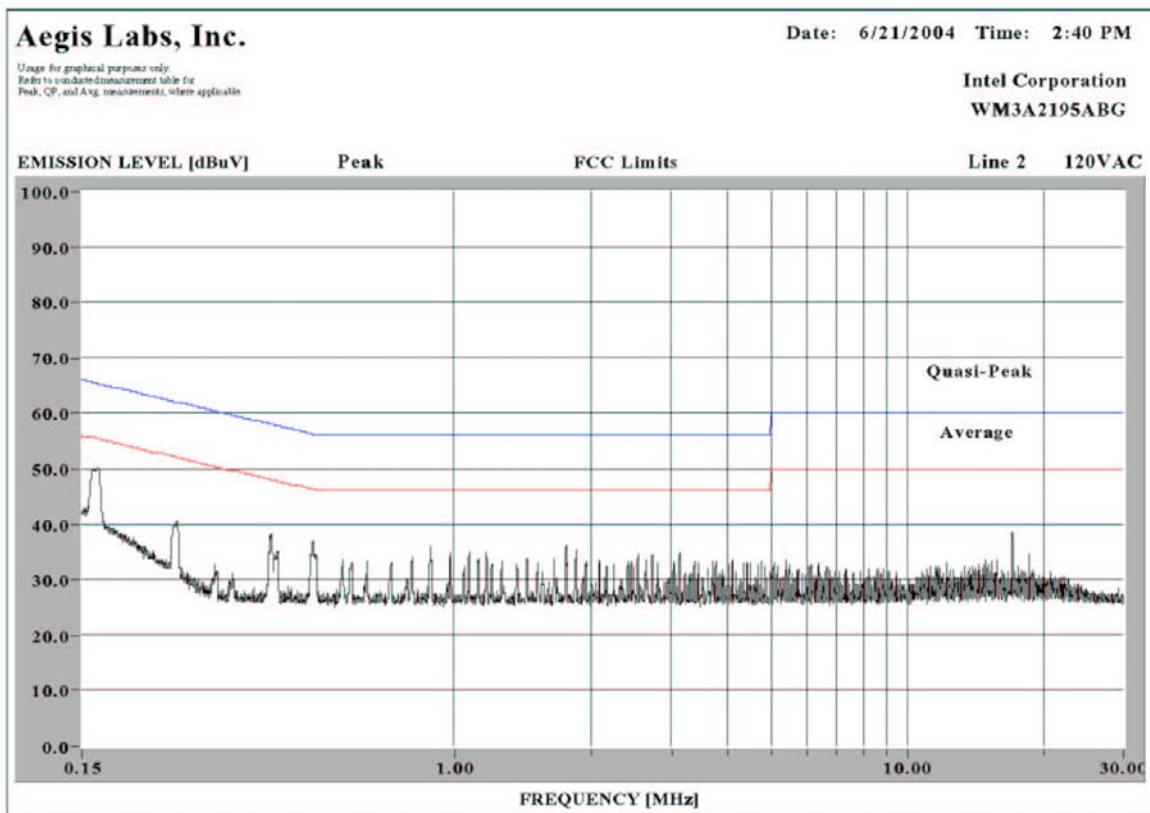

Page 4 of 36 (Appendix A)
 Report Number: INTEL-040615F
 FCC ID: PD9WM3A2915ABG



AEGIS LABS INC.

SPURIOUS RADIATED EMISSIONS TEST RESULTS

CLIENT:	Intel Corporation	DATE:	06/21/04
EUT:	Intel PRO/Wireless 2915ABG Network Connection	PROJECT NUMBER:	INTEL-040614-20
MODEL NUMBER:	WM3A2915ABG	TEST ENGINEER:	JC
SERIAL NUMBER:	000E35344011	SITE #:	2
CONFIGURATION:	Tested installed in the Hewlett Packard host computer's mini PCI slot.	TEMPERATURE:	26 C
		HUMIDITY:	52% RH
		TIME:	4:00 PM

Standard:	FCC CFR 47, Part 15.407(b)(5)
Description:	Unwanted emissions below 1 GHz must comply with the general field strength limits set forth in Sec. 15.209. (Using CISPR22 Class B Limits)
Results:	Passes the radiated limits by -3.71 @ 366.73 MHz (Vertical antenna polarization)

Radiated Limits	
Frequency (MHz)	Quasi-Peak Limit (dBuV) @ 10m
30-230	30
230-1000	37

NOTE: During preliminary scans, there wasn't any difference which channel or data rate was used with the EUT; therefore the final testing was made with the EUT at the low channel and a data rate of 6 Mbps

Page 5 of 36 (Appendix A)
Report Number: INTEL-040615F
FCC ID: PD9WM3A2915ABG



AEGIS LABS INC.

Spurious Radiated Emissions Test Results (Continued)

RADIATED EMISSIONS - Horizontal Antenna Polarization												
Freq. (MHz)	Meter Reading (dBuV)	Antenna Height (cm)	Azimuth (degrees)	Quasi pk or AVG (dBuV)		Preamp Factor (dB)	Cable Factor (dB)	Ant. Factor (dB)	10 Meter Distance Factor (dB)	Corrected Reading (dBuV)	Limits (dBuV)	Diff (dB) +/- FAIL
33.38	39.90	400	270			34.42	0.97	17.88	10.46	34.79	40.00	-5.21
66.62	42.20	400	270			34.40	1.33	7.14	10.46	26.74	40.00	-13.26
85.95	50.30	400	135			34.41	1.56	7.57	10.46	35.48	40.00	-4.52
133.29	39.60	400	315			34.34	1.95	14.43	10.46	32.10	43.50	-11.40
166.60	40.70	400	135			34.34	2.24	15.70	10.46	34.75	43.50	-8.75
200.30	38.20	350	270			34.31	2.40	17.00	10.46	33.76	43.50	-9.74
233.05	38.00	400	270			34.24	2.63	17.50	10.46	34.35	46.00	-11.65
266.99	39.70	350	45			34.21	2.84	18.58	10.46	37.37	46.00	-8.63
299.97	42.80	350	135			34.14	3.00	19.70	10.46	41.82	46.00	-4.18
329.30	41.60	300	225			34.11	3.18	14.99	10.46	36.12	46.00	-9.88
335.97	45.60	250	90			34.10	3.22	15.06	10.46	40.23	46.00	-5.77
343.43	39.10	300	45			34.09	3.26	15.13	10.46	33.86	46.00	-12.14
357.91	41.10	250	0			34.08	3.33	15.15	10.46	35.97	46.00	-10.03
366.73	49.30	300	45	47.96	Q	34.06	3.37	15.10	10.46	42.83	46.00	-3.17
384.08	49.20	250	270	47.55	Q	34.04	3.44	15.10	10.46	42.51	46.00	-3.49
430.30	41.20	200	270			33.96	3.62	16.23	10.46	37.55	46.00	-8.45
500.25	40.60	200	90			33.86	4.00	18.80	10.46	40.00	46.00	-6.00

NOTE: The measurements were taken at 10 meters and extrapolated to 3 meters.

Page 6 of 36 (Appendix A)
Report Number: INTEL-040615F
FCC ID: PD9WM3A2915ABG



Spurious Radiated Emissions Test Results (Continued)

RADIATED EMISSIONS - Vertical Antenna Polarization												
Freq. (MHz)	Meter Reading (dBuV)	Antenna Height (cm)	Azimuth (degrees)	Quasi pk or AVG (dBuV)		Preamp Factor (dB)	Cable Factor (dB)	Ant. Factor (dB)	10 Meter Distance Factor (dB)	Corrected Reading (dBuV)	Limits (dBuV)	Diff (dB) +/- FAIL
33.40	39.10	100	0			34.42	0.97	17.44	10.46	33.55	40.00	-6.45
66.63	49.20	100	45			34.40	1.33	7.37	10.46	33.97	40.00	-6.03
85.95	43.60	100	315			34.41	1.56	7.89	10.46	29.10	40.00	-10.90
133.28	42.70	100	90			34.34	1.95	13.06	10.46	33.83	43.50	-9.67
166.62	42.60	100	270			34.34	2.24	15.40	10.46	36.36	43.50	-7.14
199.97	39.76	100	0			34.31	2.40	17.10	10.46	35.41	43.50	-8.09
233.03	38.50	100	315			34.24	2.63	18.22	10.46	35.57	46.00	-10.43
266.88	39.70	100	0			34.21	2.84	19.24	10.46	38.02	46.00	-7.98
299.96	44.90	100	135	42.76	Q	34.14	3.00	20.60	10.46	42.67	46.00	-3.33
329.29	39.80	100	225			34.11	3.18	15.61	10.46	34.94	46.00	-11.06
336.01	43.50	100	315			34.10	3.22	15.54	10.46	38.61	46.00	-7.39
366.73	45.90	100	45			34.06	3.37	15.33	10.46	41.00	46.00	-5.00
383.93	46.00	100	45			34.04	3.44	15.66	10.46	41.52	46.00	-4.48
433.10	43.40	100	180			33.95	3.63	16.73	10.46	40.27	46.00	-5.73
499.97	42.10	100	135			33.86	4.00	18.70	10.46	41.40	46.00	-4.60

NOTE: The measurements were taken at 10 meters and extrapolated to 3 meters.



AEGIS LABS INC.

Spurious Radiated Emissions Test Results (Continued)

CLIENT:	Intel Corporation	DATE:	06/16/04
EUT:	Intel PRO/Wireless 2915ABG Network Connection	PROJECT NUMBER:	INTEL-040614
MODEL NUMBER:	WM3A2915ABG	TEST ENGINEER:	JC
SERIAL NUMBER:	000E35344011	SITE #:	2
CONFIGURATION:	Tested installed in the Hewlett Packard host computer's mini PCI slot in 802.11a (5150-5350 MHz) mode with the Ethertronics antennas.	TEMPERATURE:	17 C
		HUMIDITY:	61% RH
		TIME:	9:30 AM

Standard:	FCC CFR 47, Part 15.407(b)(6)
Description:	The provisions of Sec. 15.205 apply to intentional radiators operating under this section.
Results:	Passes (See Data Sheets)

Unwanted Spurious Emissions Limits

Frequency (MHz)	Field Strength (uV/m)	Field Strength (dBuV/m) (Emissions in the restricted bands)	Field Strength (dBm/MHz) (Emissions outside the restricted bands)
Above 960	500	54.00 (Average) 74.00 (Peak)	EIRP < -27dBm/MHz (68.3dBuV/m)

Page 8 of 36 (Appendix A)
Report Number: INTEL-040615F
FCC ID: PD9WM3A2915ABG



Spurious Radiated Emissions Test Results (Continued)

*Fundamental Measurements in 802.11a mode (5150-5350 MHz)
Channels 32, 56, & 64
Continuous TX at MAIN Antenna port with Ethertronics Antennas
Aegis Labs, Inc. File #: INTEL-040614-12*

RADIATED EMISSIONS - Horizontal Antenna Polarization											
<i>Freq. (MHz)</i>	<i>Meter Reading (dBuV)</i>	<i>Antenna Height (cm)</i>	<i>Azimuth (degrees)</i>	<i>Quasi pk or AVG (dBuV)</i>		<i>Preamp Factor (dB)</i>	<i>Cable Factor (dB)</i>	<i>Ant. Factor (dB)</i>	<i>Corrected Reading (dBuV)</i>	<i>Limits (dBuV)</i>	<i>Diff (dB) +=FAIL</i>
5180.00	62.50	100	225				4.94	35.02	102.46		
5180.00				50.69	A		4.94	35.02	90.65		
5240.00	60.50	100	225				4.97	34.96	100.43		
5240.00				51.69	A		4.97	34.96	91.62		
5260.00	65.17	100	225				4.97	34.94	105.08		
5260.00				55.03	A		4.97	34.94	94.94		
5320.00	65.83	100	225				5.00	34.88	105.71		
5320.00				57.19	A		5.00	34.88	97.07		

RADIATED EMISSIONS – Vertical Antenna Polarization											
<i>Freq. (MHz)</i>	<i>Meter Reading (dBuV)</i>	<i>Antenna Height (cm)</i>	<i>Azimuth (degrees)</i>	<i>Quasi pk or AVG (dBuV)</i>		<i>Preamp Factor (dB)</i>	<i>Cable Factor (dB)</i>	<i>Ant. Factor (dB)</i>	<i>Corrected Reading (dBuV)</i>	<i>Limits (dBuV)</i>	<i>Diff (dB) +=FAIL</i>
5180.00	61.17	200	135				4.94	35.02	101.13		
5180.00				50.83	A		4.94	35.02	90.79		
5240.00	59.33	200	135				4.97	34.96	99.26		
5240.00				50.44	A		4.97	34.96	90.37		
5260.00	65.50	200	225				4.97	34.94	105.41		
5260.00				56.49	A		4.97	34.94	96.40		
5320.00	67.33	200	135				5.00	34.88	107.21		
5320.00				58.59	A		5.00	34.88	98.47		

NOTE: Fundamental signals measured to calculate the band edge field strengths using the “Marker Delta Method”.



Spurious Radiated Emissions Test Results (Continued)

*Band Edge Field Strength Calculations in 802.11a mode (5150-5350 MHz)
Channels 32, 56, & 64
Continuous TX at MAIN Antenna port with Ethertronics Antennas
Aegis Labs, Inc. File #: INTEL-040614-12*

RADIATED EMISSIONS - Horizontal Antenna Polarization											
<i>Freq. (MHz)</i>	<i>Meter Reading (dBuV)</i>	<i>Antenna Height (cm)</i>	<i>Azimuth (degrees)</i>	<i>Quasi pk or AVG (dBuV)</i>		<i>Preamp Factor (dB)</i>	<i>Cable Factor (dB)</i>	<i>Ant. Factor (dB)</i>	<i>Corrected Reading (dBuV)</i>	<i>Limits (dBuV)</i>	<i>Diff (dB) +=FAIL</i>
5150.00									46.63	74.00	-27.37
5150.00					A				34.31	54.00	-19.69
5120.20									49.29	74.00	-24.71
5120.20					A				35.15	54.00	-18.85
5350.00									58.88	74.00	-15.12
5350.00					A				44.57	54.00	-9.43
5363.80									56.04	74.00	-17.96
5363.80					A				41.24	54.00	-12.76
RADIATED EMISSIONS – Vertical Antenna Polarization											
<i>Freq. (MHz)</i>	<i>Meter Reading (dBuV)</i>	<i>Antenna Height (cm)</i>	<i>Azimuth (degrees)</i>	<i>Quasi pk or AVG (dBuV)</i>		<i>Preamp Factor (dB)</i>	<i>Cable Factor (dB)</i>	<i>Ant. Factor (dB)</i>	<i>Corrected Reading (dBuV)</i>	<i>Limits (dBuV)</i>	<i>Diff (dB) +=FAIL</i>
5150.00									45.30	74.00	-28.70
5150.00					A				34.45	54.00	-19.55
5120.20									47.96	74.00	-26.04
5120.20					A				35.29	54.00	-18.71
5350.00									60.38	74.00	-13.62
5350.00					A				45.97	54.00	-8.03
5363.80									57.54	74.00	-16.46
5363.80					A				42.64	54.00	-11.36

NOTE: The “Band Edge Field Strength” was calculated using the “Fundamental” and “Conducted Band Edge” measurements per the “Marker-Delta Method” with the following formula:

$$BE = Fm - \Delta m$$

12

Where

BE = Band Edge Field Strength

Fm = Measured Fundamental (Peak or Average)

Δm = Measured Conducted Band Edge Delta (Peak or Average)



AEGIS LABS INC.

Spurious Radiated Emissions Test Results (Continued)

Plots Showing Out-Of-Band Emissions (Peak RBW=VBW=1MHz; Average RBW = 1MHz, VBW = 10Hz)

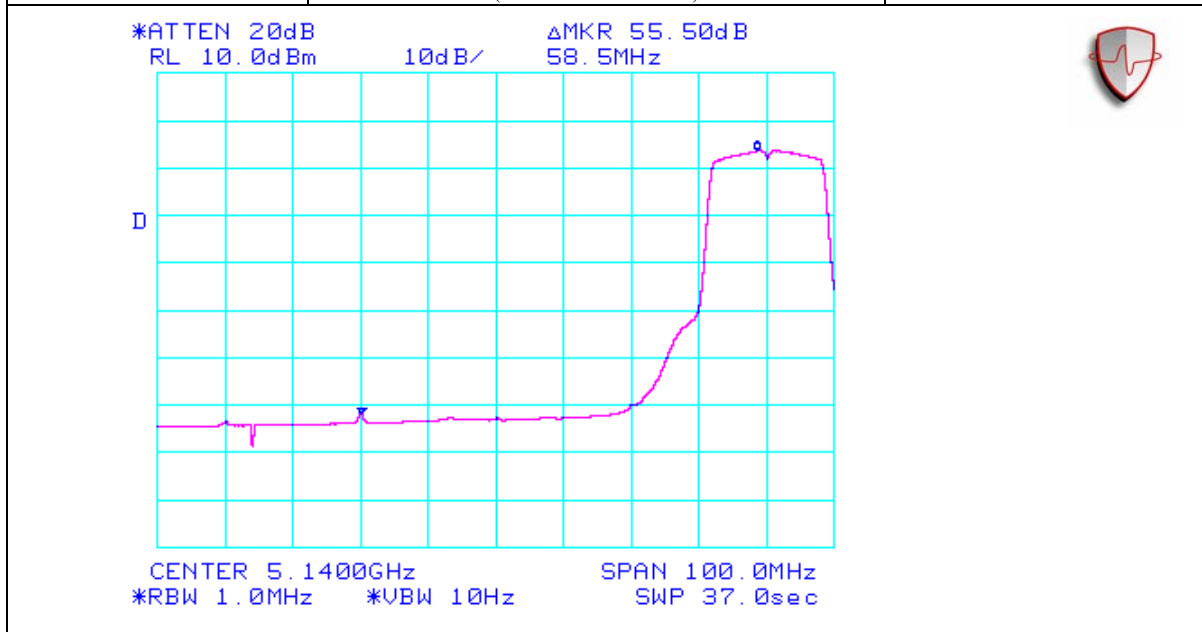
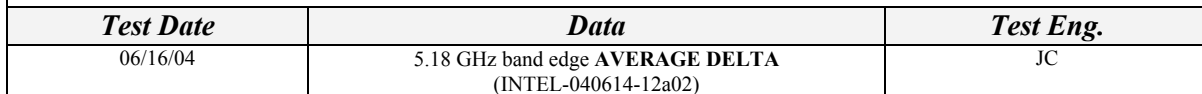
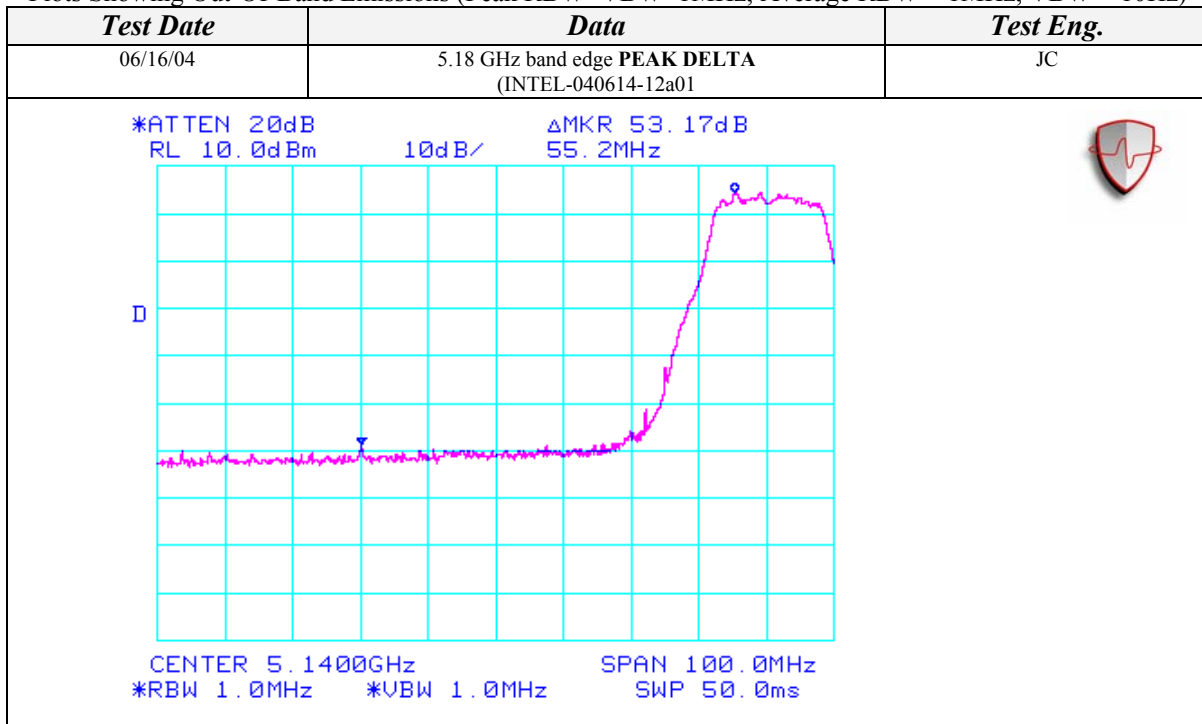



Spurious Radiated Emissions Test Results (Continued)

Plots Showing Out-Of-Band Emissions (Peak RBW=VBW=1MHz; Average RBW = 1MHz, VBW = 10Hz)

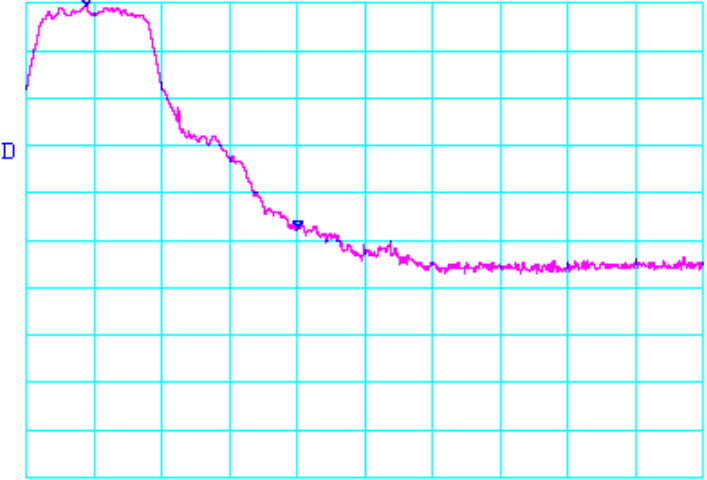
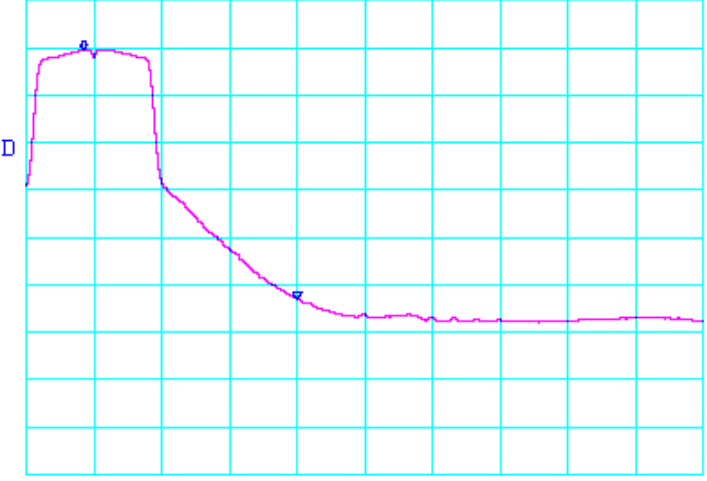
Test Date	Data	Test Eng.
06/16/04	5.32 GHz band edge PEAK DELTA (INTEL-040614-12a03)	JC
<div style="display: flex; justify-content: space-between;"> <div data-bbox="337 457 954 506"> <p>*ATTEN 20dB RL 10.0dBm 10dB/</p> </div> <div data-bbox="743 457 954 506"> <p>ΔMKR 46.83dB -31.3MHz</p> </div> <div data-bbox="1289 464 1365 541"> </div> </div> <div style="text-align: center; margin: 10px 0;">  </div> <div style="display: flex; justify-content: space-around; margin-top: 10px;"> <div data-bbox="337 993 760 1041"> <p>CENTER 5.3600GHz *RBW 1.0MHz *VBW 1.0MHz</p> </div> <div data-bbox="800 993 1019 1041"> <p>SPAN 100.0MHz SWP 50.0ms</p> </div> </div>		
Test Date	Data	Test Eng.
06/16/04	5.32 GHz band edge AVERAGE DELTA (INTEL-040614-12a04)	JC
<div style="display: flex; justify-content: space-between;"> <div data-bbox="337 1180 695 1228"> <p>*ATTEN 20dB RL 10.0dBm 10dB/</p> </div> <div data-bbox="743 1180 954 1228"> <p>ΔMKR 52.50dB -31.5MHz</p> </div> <div data-bbox="1289 1186 1365 1264"> </div> </div> <div style="text-align: center; margin: 10px 0;">  </div> <div style="display: flex; justify-content: space-around; margin-top: 10px;"> <div data-bbox="337 1715 727 1764"> <p>CENTER 5.3600GHz *RBW 1.0MHz *VBW 10Hz</p> </div> <div data-bbox="800 1715 1019 1764"> <p>SPAN 100.0MHz SWP 37.0sec</p> </div> </div>		



Spurious Radiated Emissions Test Results (Continued)

*Spurious Emissions Measurements in 802.11a mode (5150-5350 MHz)
Channels 32, 56, & 64
Continuous TX at MAIN Antenna port with Ethertronics Antennas
Aegis Labs, Inc. File #: INTEL-040614-14*

RADIATED EMISSIONS - Horizontal Antenna Polarization											
<i>Freq. (MHz)</i>	<i>Meter Reading (dBuV)</i>	<i>Antenna Height (cm)</i>	<i>Azimuth (degrees)</i>	<i>Quasi pk or AVG (dBuV)</i>	<i>Preamp Factor (dB)</i>	<i>Cable Factor (dB)</i>	<i>Ant. Factor (dB)</i>	<i>Corrected Reading (dBuV)</i>	<i>Limits (dBuV)</i>	<i>Diff (dB) +=FAIL</i>	
EUT in Continuous Transmit Mode on Channel 36 (5.18 GHz)											
3453.29	52.83	100	135			43.15	3.93	30.29	43.90	68.00	-24.10
6906.54	53.17	100	135			43.84	6.10	39.50	54.93	68.00	-13.07
10360.01	51.00	100	135			43.46	7.37	39.44	54.36	68.00	-13.64
13813.36	50.50	100	135			43.65	8.28	45.23	60.35	68.00	-7.65
EUT in Continuous Transmit Mode on Channel 52 (5.26 GHz)											
3506.72	54.33	100	135			43.17	3.94	30.32	45.42	68.00	-22.58
7013.26	52.17	100	135			43.84	6.17	40.09	54.59	68.00	-13.41
10519.88	50.33	100	135			43.51	7.49	39.53	53.84	68.00	-14.16
14026.62	49.67	100	135			43.86	8.33	45.81	59.96	68.00	-8.04
EUT in Continuous Transmit Mode on Channel 64 (5.32 GHz)											
3546.66	55.17	100	135			43.17	3.97	30.42	46.39	68.00	-21.61
7093.33	52.83	100	135			43.81	6.18	40.01	55.20	68.00	-12.80
10639.98	49.83	100	135			43.55	7.52	39.70	53.49	74.00	-20.51
10639.98				39.22	A	43.55	7.52	39.70	42.88	54.00	-11.12
14186.58	50.83	100	135			43.96	8.41	45.30	60.58	68.00	-7.42



AEGIS LABS INC.

Spurious Radiated Emissions Test Results (Continued)

RADIATED EMISSIONS - Vertical Antenna Polarization											
<i>Freq. (MHz)</i>	<i>Meter Reading (dBuV)</i>	<i>Antenna Height (cm)</i>	<i>Azimuth (degrees)</i>	<i>Quasi pk or AVG (dBuV)</i>		<i>Preamp Factor (dB)</i>	<i>Cable Factor (dB)</i>	<i>Ant. Factor (dB)</i>	<i>Corrected Reading (dBuV)</i>	<i>Limits (dBuV)</i>	<i>Diff (dB) +=FAIL</i>
EUT in Continuous Transmit Mode on Channel 36 (5.18 GHz)											
3453.29	52.17	100	135			43.15	3.93	30.49	43.44	68.00	-24.56
6906.59	53.50	100	135			43.84	6.10	39.91	55.67	68.00	-12.33
10359.93	49.83	100	135			43.46	7.37	39.96	53.71	68.00	-14.29
EUT in Continuous Transmit Mode on Channel 52 (5.26 GHz)											
3506.72	53.33	100	135			43.17	3.94	30.51	44.62	68.00	-23.38
7013.29	52.17	100	135			43.84	6.17	40.57	55.08	68.00	-12.92
10519.92	50.50	100	135			43.51	7.49	40.08	54.56	68.00	-13.44
EUT in Continuous Transmit Mode on Channel 64 (5.32 GHz)											
3546.66	53.00	100	135			43.17	3.97	30.58	44.39	68.00	-23.61
7093.33	51.83	100	135			43.81	6.18	40.41	54.61	68.00	-13.39
10639.98	49.50	100	135			43.55	7.52	39.99	53.46	74.00	-20.54
10639.98				39.01	A	43.55	7.52	39.99	42.97	54.00	-11.03

Page 14 of 36 (Appendix A)
Report Number: INTEL-040615F
FCC ID: PD9WM3A2915ABG



Spurious Radiated Emissions Test Results (Continued)

*Spurious Emissions Measurements in 802.11a mode (5150-5350 MHz)
 Channels 32, 56, & 64
 Continuous RX at MAIN Antenna port with Ethertronics Antennas
 Aegis Labs, Inc. File #: INTEL-040614-138*

RADIATED EMISSIONS - Horizontal Antenna Polarization											
<i>Freq. (MHz)</i>	<i>Meter Reading (dBuV)</i>	<i>Antenna Height (cm)</i>	<i>Azimuth (degrees)</i>	<i>Quasi pk or AVG (dBuV)</i>		<i>Preamp Factor (dB)</i>	<i>Cable Factor (dB)</i>	<i>Ant. Factor (dB)</i>	<i>Corrected Reading (dBuV)</i>	<i>Limits (dBuV)</i>	<i>Diff (dB) +=FAIL</i>
EUT in Continuous Transmit Mode on Channel 36 (5.18 GHz)											
3453.31	53.83	100	225			43.15	3.93	30.29	44.90	80.00	-35.10
3453.31				44.89	A	43.15	3.93	30.29	35.96	60.00	-24.04
6906.66	53.00	125	135			43.84	6.10	39.50	54.76	80.00	-25.24
6906.66				44.23	A	43.84	6.10	39.50	45.99	60.00	-14.01
10359.95	52.83	100	135			43.46	7.37	39.44	56.19	80.00	-23.81
10359.95				44.01	A	43.46	7.37	39.44	47.37	60.00	-12.63
13813.25	50.17	100	135			43.65	8.28	45.23	60.02	80.00	-19.98
13813.25				39.22	A	43.65	8.28	45.23	49.07	60.00	-10.93
EUT in Continuous Transmit Mode on Channel 52 (5.26 GHz)											
3506.66	54.17	100	135			43.17	3.94	30.32	45.26	80.00	-34.74
3506.66				47.19	A	43.17	3.94	30.32	38.28	60.00	-21.72
7013.33	52.00	125	135			43.84	6.17	40.09	54.42	80.00	-25.58
7013.33				41.97	A	43.84	6.17	40.09	44.39	60.00	-15.61
10519.94	51.50	100	135			43.51	7.49	39.53	55.01	80.00	-24.99
10519.94				41.81	A	43.51	7.49	39.53	45.32	60.00	-14.68
14026.53	49.17	100	135			43.86	8.33	45.82	59.46	80.00	-20.54
14026.53				37.46	A	43.86	8.33	45.82	47.75	60.00	-12.25
EUT in Continuous Transmit Mode on Channel 64 (5.32 GHz)											
3546.72	54.67	100	135			43.17	3.97	30.42	45.90	80.00	-34.10
3546.72				48.63	A	43.17	3.97	30.42	39.86	60.00	-20.14
7093.27	52.33	100	135			43.81	6.18	40.01	54.70	80.00	-25.30
7093.27				43.86	A	43.81	6.18	40.01	46.23	60.00	-13.77
10639.92	50.17	100	135			43.55	7.52	39.70	53.83	80.00	-26.17
10639.92				39.63	A	43.55	7.52	39.70	43.29	60.00	-16.71
14186.64	49.67	100	135			43.96	8.41	45.30	59.42	80.00	-20.58
14186.64				38.17	A	43.96	8.41	45.30	47.92	60.00	-12.08



Spurious Radiated Emissions Test Results (Continued)

RADIATED EMISSIONS - Vertical Antenna Polarization											
<i>Freq. (MHz)</i>	<i>Meter Reading (dBuV)</i>	<i>Antenna Height (cm)</i>	<i>Azimuth (degrees)</i>	<i>Quasi pk or AVG (dBuV)</i>		<i>Preamp Factor (dB)</i>	<i>Cable Factor (dB)</i>	<i>Ant. Factor (dB)</i>	<i>Corrected Reading (dBuV)</i>	<i>Limits (dBuV)</i>	<i>Diff (dB) +=FAIL</i>
EUT in Continuous Transmit Mode on Channel 36 (5.18 GHz)											
3453.30	50.83	100	135			43.15	3.93	30.49	42.10	80.00	-37.90
3453.30				40.74	A	43.15	3.93	30.49	32.01	60.00	-27.99
6906.67	53.67	100	135			43.84	6.10	39.91	55.84	80.00	-24.16
6906.67				44.04	A	43.84	6.10	39.91	46.21	60.00	-13.79
10359.98	52.83	125	135			43.46	7.37	39.96	56.71	80.00	-23.29
10359.98				42.64	A	43.46	7.37	39.96	46.52	60.00	-13.48
EUT in Continuous Transmit Mode on Channel 52 (5.26 GHz)											
3506.68	52.33	100	135			43.17	3.94	30.51	43.62	80.00	-36.38
3506.68				44.02	A	43.17	3.94	30.51	35.31	60.00	-24.69
7013.36	50.67	100	135			43.84	6.17	40.57	53.58	80.00	-26.42
7013.36				39.98	A	43.84	6.17	40.57	42.89	60.00	-17.11
10519.91	50.50	100	135			43.51	7.49	40.08	54.56	80.00	-25.44
10519.95				39.36	A	43.51	7.49	40.08	43.42	60.00	-16.58
EUT in Continuous Transmit Mode on Channel 64 (5.32 GHz)											
3546.66	53.17	100	135			43.17	3.97	30.58	44.56	80.00	-35.44
3546.66				45.57	A	43.17	3.97	30.58	36.96	60.00	-23.04
7093.33	50.83	125	135			43.81	6.18	40.41	53.61	80.00	-26.39
7093.33				40.42	A	43.81	6.18	40.41	43.20	60.00	-16.80
10639.97	50.17	100	135			43.55	7.52	39.99	54.13	80.00	-25.87
10639.97				39.74	A	43.55	7.52	39.99	43.70	60.00	-16.30



AEGIS LABS INC.

PEAK TRANSMIT POWER

CLIENT:	Intel Corporation	DATE:	06/16/04
EUT:	Intel PRO/Wireless 2915ABG Network Connection	PROJECT NUMBER:	INTEL-040614-11
MODEL NUMBER:	WM3A2915ABG	TEST ENGINEER:	JC
SERIAL NUMBER:	000E35344011	SITE #:	2
CONFIGURATION:	Tested installed in the Hewlett Packard host computer's mini PCI slot.	TEMPERATURE:	16 C
		HUMIDITY:	60% RH
		TIME:	8:45 AM

Standard:	FCC CFR 47, Part 15.407(a)(1) & 15.407(a)(2)
Description:	For the band 5.15-5.25 GHz, the peak transmit power over the frequency band of operation shall not exceed the lesser of 50 mW or 4 dBm + 10logB, where B is the 26-dB emission bandwidth in MHz. For the band 5.25-5.35 GHz, the peak transmit power over the frequency band of operation shall not exceed the lesser of 250 mW or 11 dBm + 10logB, where B is the 26-dB emission bandwidth in MHz.
Results:	See Data Sheet

Peak Transmit Power Limits		
Frequency (MHz)	Output Power (mW)	Output Power (Note 1)
5150-5250	50 (17 dBm)	4 dBm + 10logB = 17.68 dBm @ 5180 MHz
5250-5350	250 (24 dBm)	11 dBm + 10logB = 26.86 dBm @ 5260 MHz 11 dBm + 10logB = 27.00 dBm @ 5320 MHz

Note 1: Calculated using the 26-dB emissions bandwidth measurements.

Page 17 of 36 (Appendix A)
Report Number: INTEL-040615F
FCC ID: PD9WM3A2915ABG



AEGIS LABS INC.

Peak Transmit Power (Continued)

Mode	Channel	Frequency (MHz)	Rate (Mbps)	Average Power (dBm)	Average Power (mW)	Peak Power (dBm)	Peak Power (mW)
802.11a	36	5180	6	11.15	13.03	16.80	47.86
802.11a	51	5240	6	11.00	12.59	16.90	48.98
802.11a	52	5260	6	16.00	39.81	20.60	114.82
802.11a	64	5320	6	16.10	40.74	20.70	117.49

Page 18 of 36 (Appendix A)
Report Number: INTEL-040615F
FCC ID: PD9WM3A2915ABG



AEGIS LABS INC.

CONDCUTED BAND EDGE EMISSIONS TEST RESULTS

CLIENT:	Intel Corporation	DATE:	07/29/04
EUT:	Intel PRO/Wireless 2915ABG Network Connection	PROJECT NUMBER:	INTEL-040614-21
MODEL NUMBER:	WM3A2915ABG	TEST ENGINEER:	JC
SERIAL NUMBER:	000E35344011	SITE #:	2
CONFIGURATION:	Tested installed in the Hewlett Packard host computer's mini PCI slot.	TEMPERATURE:	25 C
		HUMIDITY:	40% RH
		TIME:	10:30 AM

Standard:	FCC CFR 47, Part 15.407(b)(2)
Description:	For transmitters operating in the 5.25-5.35 GHz band: all emissions outside of the 5.15-5.35 GHz band shall not exceed an EIRP of -27 dBm/MHz. Devices operating in the 5.25-5.35 GHz band that generate emissions in the 5.15-5.25 GHz band must meet all applicable technical requirements for operation in the 5.15-5.25 GHz band (including indoor use) or alternatively meet an out-of-band emission EIRP limit of -27 dBm/MHz in the 5.15-5.25 GHz band.
Results:	Passes (See Data Sheets)

Unwanted Spurious Emissions Limits	
Frequency (MHz)	Field Strength (dBm/MHz) (Emissions outside the restricted bands)
5250-5350	EIRP < -27dBm/MHz (68.3dBuV/m)

Freq. (MHz)	Power Spec Den. Reading (dBm/MHz)	Antenna Gain (dBi)	Corrected Reading (dBm/MHz)	Limits (dBm/MHz)	Diff (dB) +=FAIL	Comments
5250.00	-58.80	5.00	-53.80	-27.00	-26.80	Tx @ 5240 MHz
5250.00	-53.60	5.00	-48.60	-27.00	-21.60	Tx @ 5260 MHz

Page 19 of 36 (Appendix A)
 Report Number: INTEL-040615F
 FCC ID: PD9WM3A2915ABG



Conducted Band Edge Emissions Test Results (Continued)

Plots Showing Power Spectral Densities

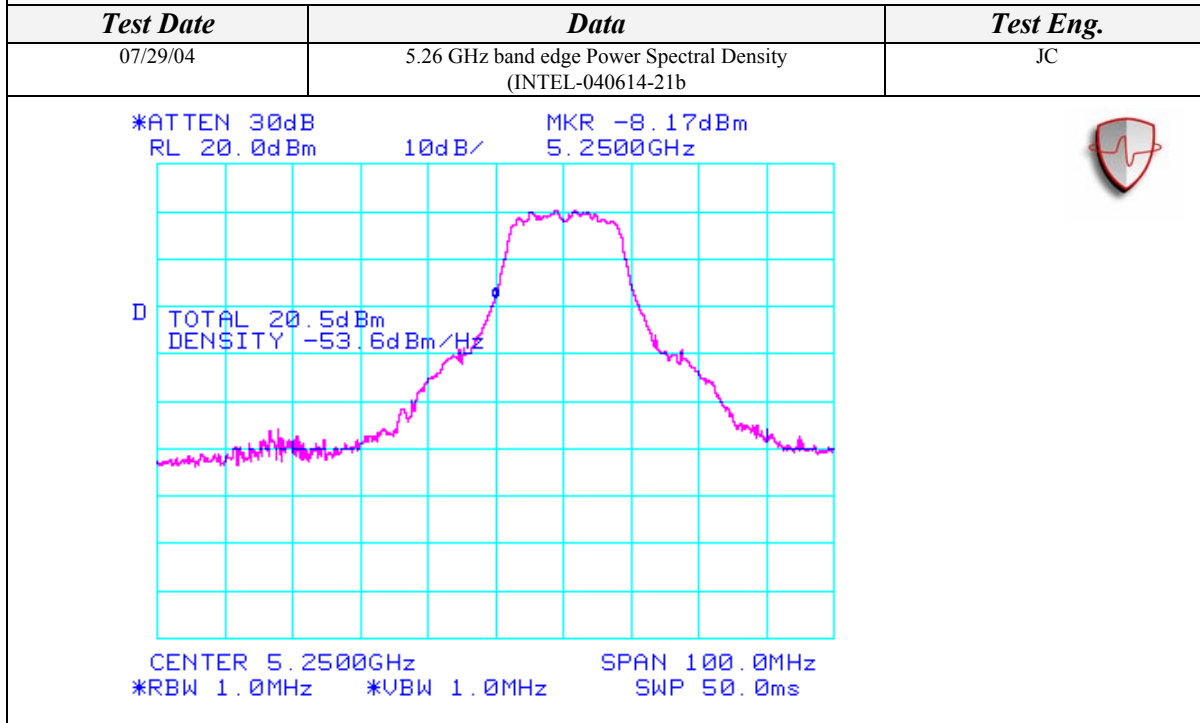
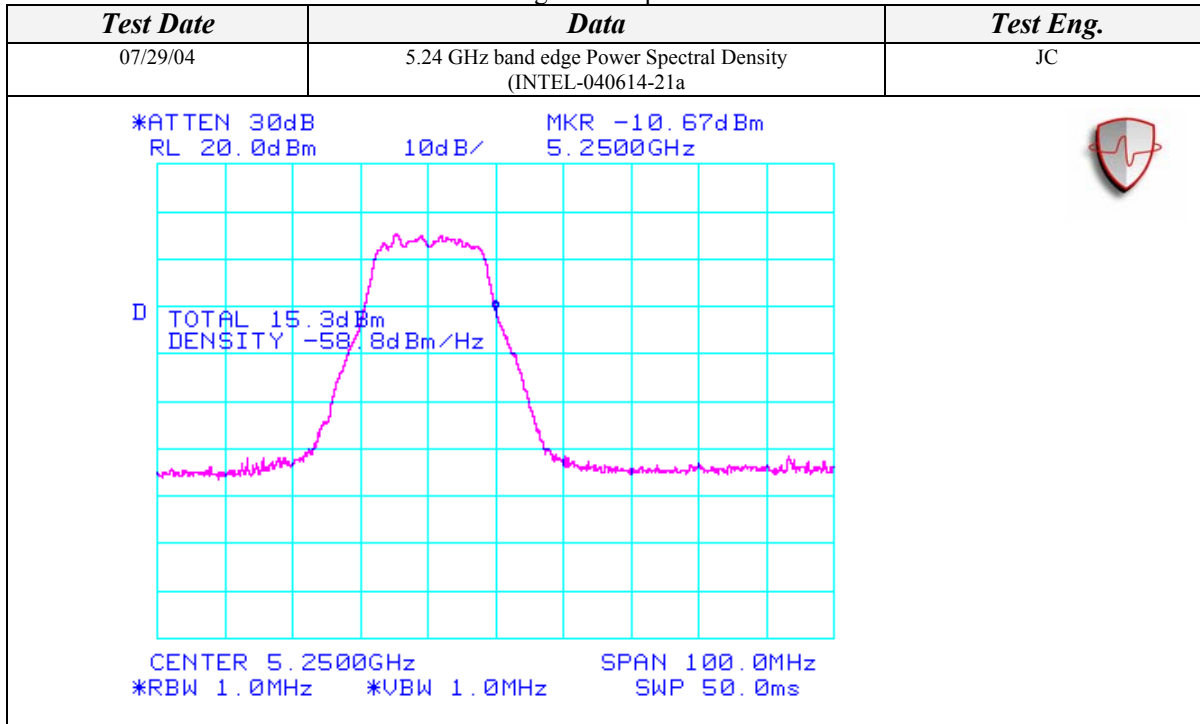



AEGIS LABS INC.

26-dB EMISSIONS BANDWIDTH

CLIENT:	Intel Corporation	DATE:	06/18/04
EUT:	Intel PRO/Wireless 2915ABG Network Connection	PROJECT NUMBER:	INTEL-040614
MODEL NUMBER:	WM3A2915ABG	TEST ENGINEER:	JC
SERIAL NUMBER:	000E35344011	SITE #:	2
CONFIGURATION:	Tested installed in the Hewlett Packard host computer's mini PCI slot.	TEMPERATURE:	23 C
		HUMIDITY:	53% RH
		TIME:	10:30 AM

Standard:	FCC CFR 47, Part 15.407(a)(1) & 15.407(a)(2)
Description:	26-dB emission bandwidth in MHz
Results:	See Data Sheets

Page 21 of 36 (Appendix A)
Report Number: INTEL-040615F
FCC ID: PD9WM3A2915ABG



AEGIS LABS INC.

26-dB Emissions Bandwidth (Continued)

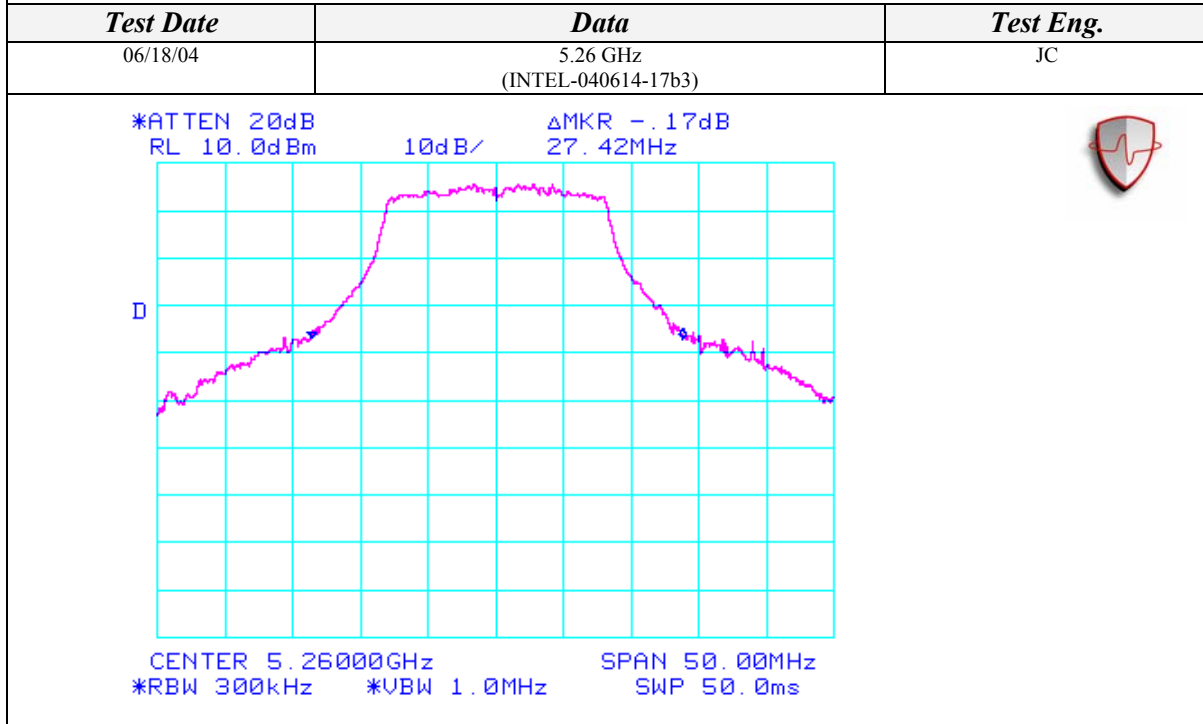
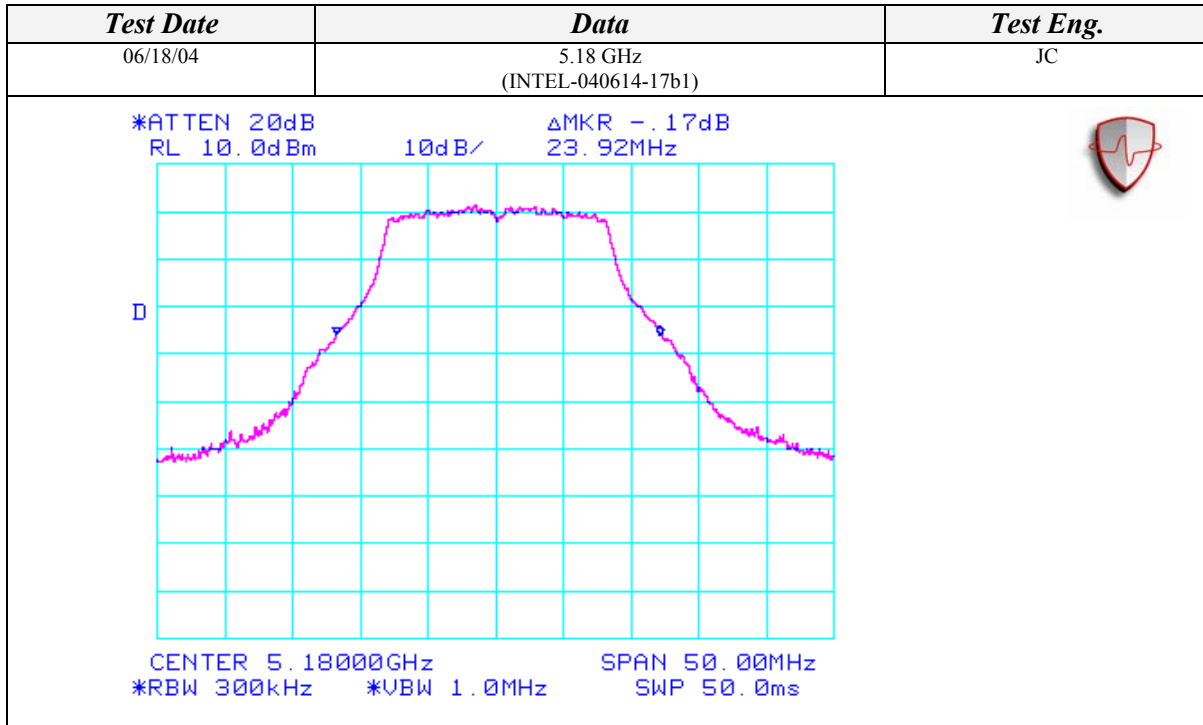



AEGIS LABS INC.

26-dB Emissions Bandwidth (Continued)

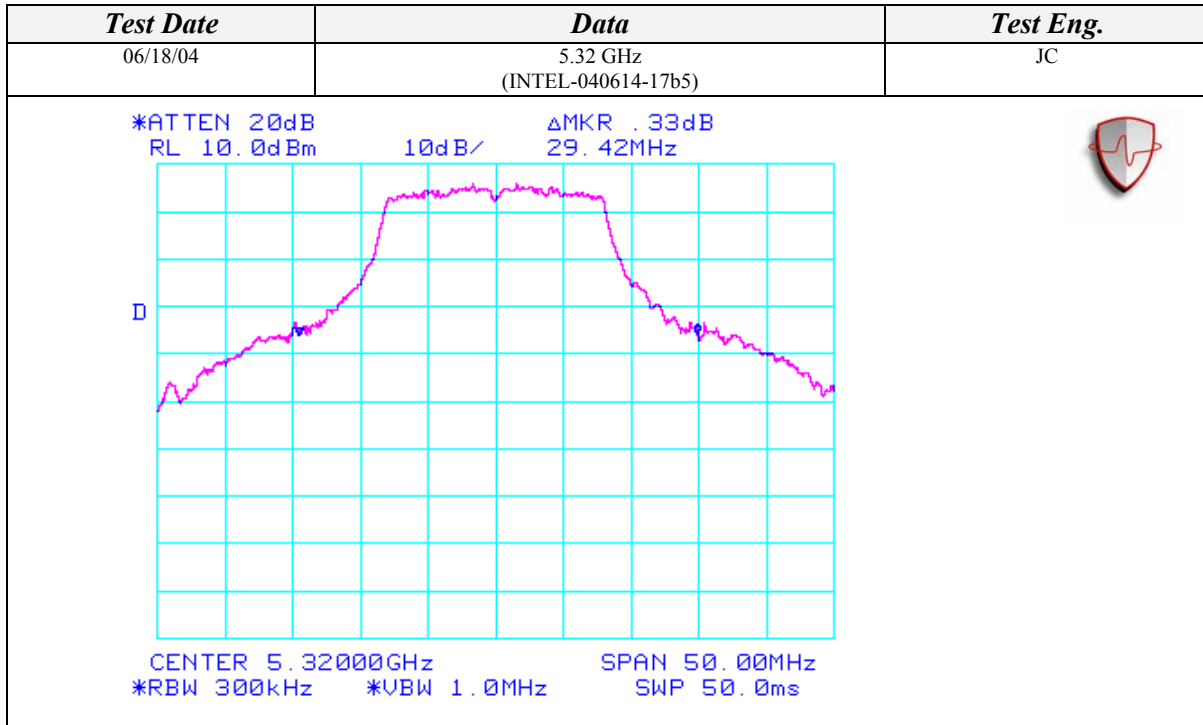



AEGIS LABS INC.

PEAK POWER SPECTRAL DENSITY

CLIENT:	Intel Corporation	DATE:	06/18/04
EUT:	Intel PRO/Wireless 2915ABG Network Connection	PROJECT NUMBER:	INTEL-040614
MODEL NUMBER:	WM3A2915ABG	TEST ENGINEER:	JC
SERIAL NUMBER:	000E35344011	SITE #:	2
CONFIGURATION:	Tested installed in the Hewlett Packard host computer's mini PCI slot.	TEMPERATURE:	23 C
		HUMIDITY:	53% RH
		TIME:	10:30 AM

Standard:	FCC CFR 47, Part 15.407(a)(1) & 15.407(a)(2)
Description:	For the band 5.15-5.25 GHz, the peak power spectral density shall not exceed 4 dBm in any 1-MHz band
	For the band 5.2 5-5.35 GHz, the peak power spectral density shall not exceed 11 dBm in any 1-MHz band
Results:	See Data Sheets

Peak Power Spectral Density Limits	
Frequency (MHz)	Limit (dBm)
5150-5250	4
5250-5350	11

Page 24 of 36 (Appendix A)
Report Number: INTEL-040615F
FCC ID: PD9WM3A2915ABG



AEGIS LABS INC.

Peak Power Spectral Density (Continued)

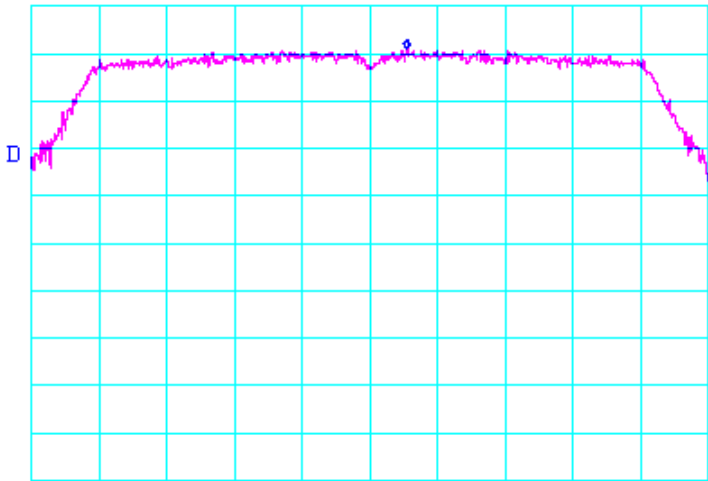
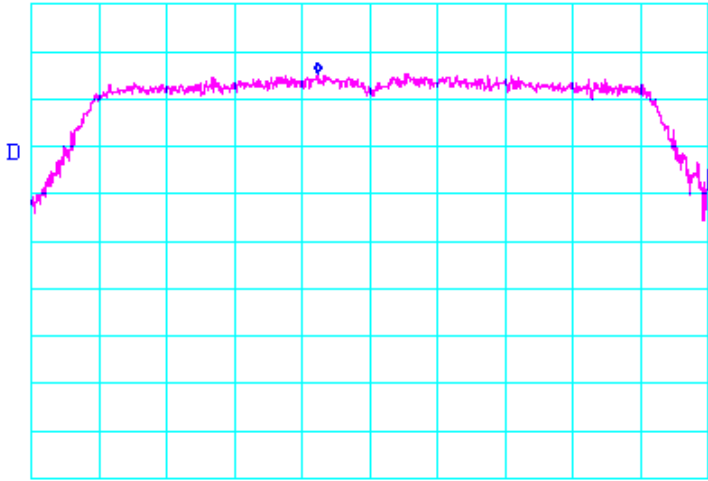
Test Date	Data	Test Eng.
06/18/04	5.18 GHz (INTEL-040614-17a1)	JC
<p>*ATTEN 20dB VAUG 100 MKR 1.00dBm RL 10.0dBm 10dB/ 5.18120GHz</p>  <p>CENTER 5.18010GHz SPAN 20.00MHz *RBW 1.0MHz *VBW 3.0MHz SWP 50.0ms</p>		
Test Date	Data	Test Eng.
06/18/04	5.26 GHz (INTEL-040614-17a3)	JC
<p>*ATTEN 30dB VAUG 100 MKR 5.50dBm RL 20.0dBm 10dB/ 5.25847GHz</p>  <p>CENTER 5.26000GHz SPAN 20.00MHz *RBW 1.0MHz *VBW 3.0MHz SWP 50.0ms</p>		



AEGIS LABS INC.

Peak Power Spectral Density (Continued)

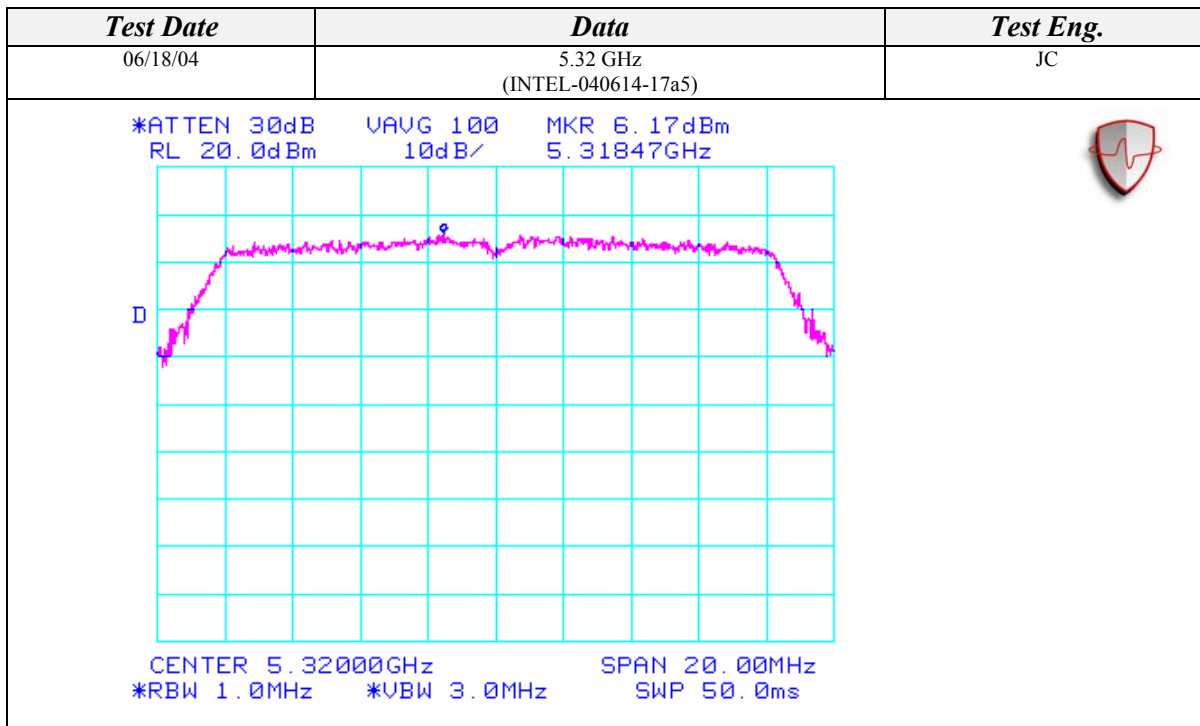



AEGIS LABS INC.

PEAK EXCURSION

CLIENT:	Intel Corporation	DATE:	06/18/04
EUT:	Intel PRO/Wireless 2915ABG Network Connection	PROJECT NUMBER:	INTEL-040614
MODEL NUMBER:	WM3A2915ABG	TEST ENGINEER:	JC
SERIAL NUMBER:	000E35344011	SITE #:	2
CONFIGURATION:	Tested installed in the Hewlett Packard host computer's mini PCI slot.	TEMPERATURE:	23 C
		HUMIDITY:	53% RH
		TIME:	10:30 AM

Standard:	FCC CFR 47, Part 15.407(a)(6)
Description:	The ratio of the peak excursion of the modulation envelope (measured using a peak hold function) to the peak transmit power shall not exceed 13 dB across any 1 MHz bandwidth or the emission bandwidth whichever is less.
Results:	See Data Sheets

Peak Excursion Limits	
Frequency (MHz)	Limit (dB)
5150-5350	13

Page 27 of 36 (Appendix A)
Report Number: INTEL-040615F
FCC ID: PD9WM3A2915ABG



AEGIS LABS INC.

Peak Excursion (Continued)

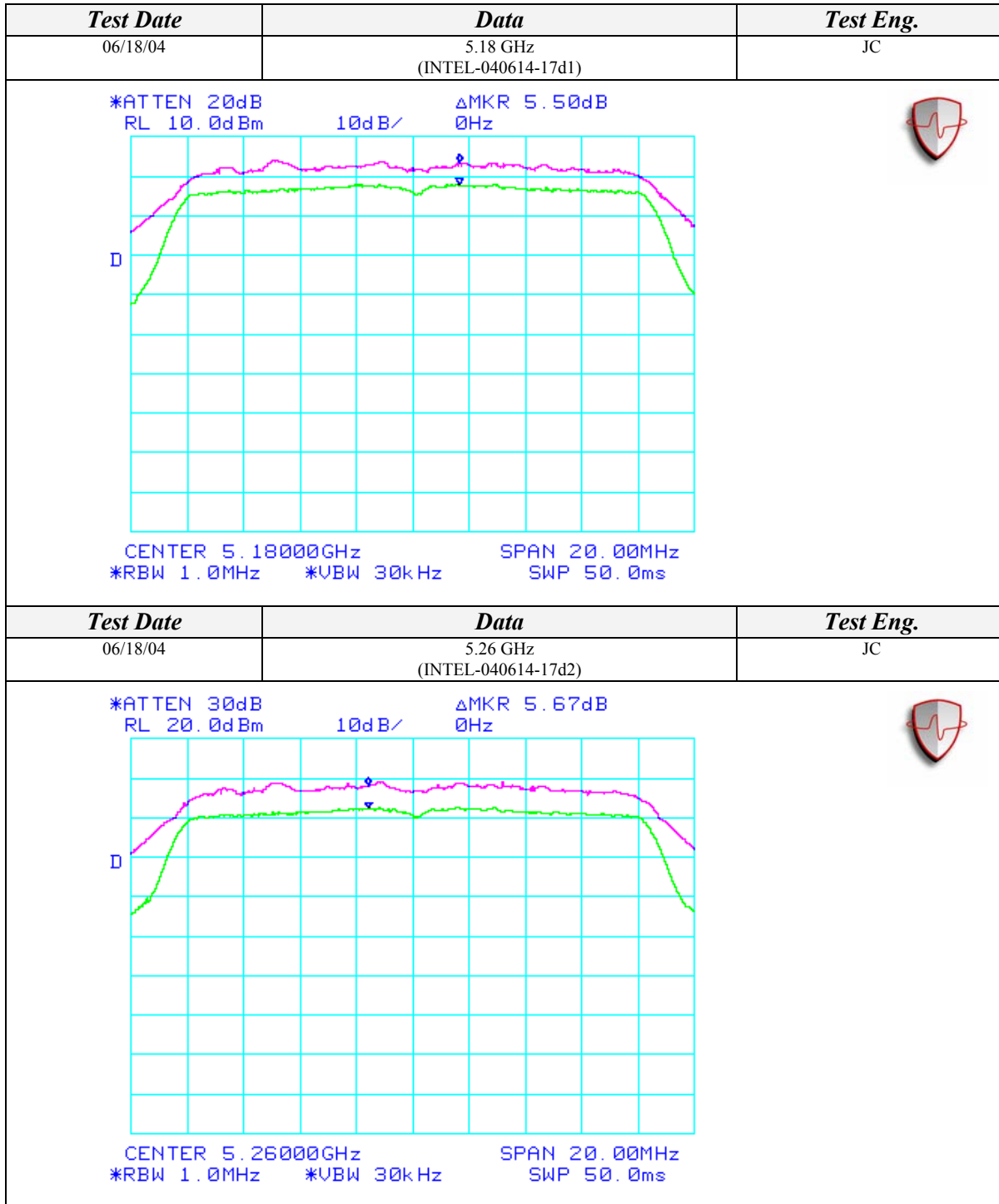

Page 28 of 36 (Appendix A)
Report Number: INTEL-040615F
FCC ID: PD9WM3A2915ABG



AEGIS LABS INC.

Peak Excursion (Continued)

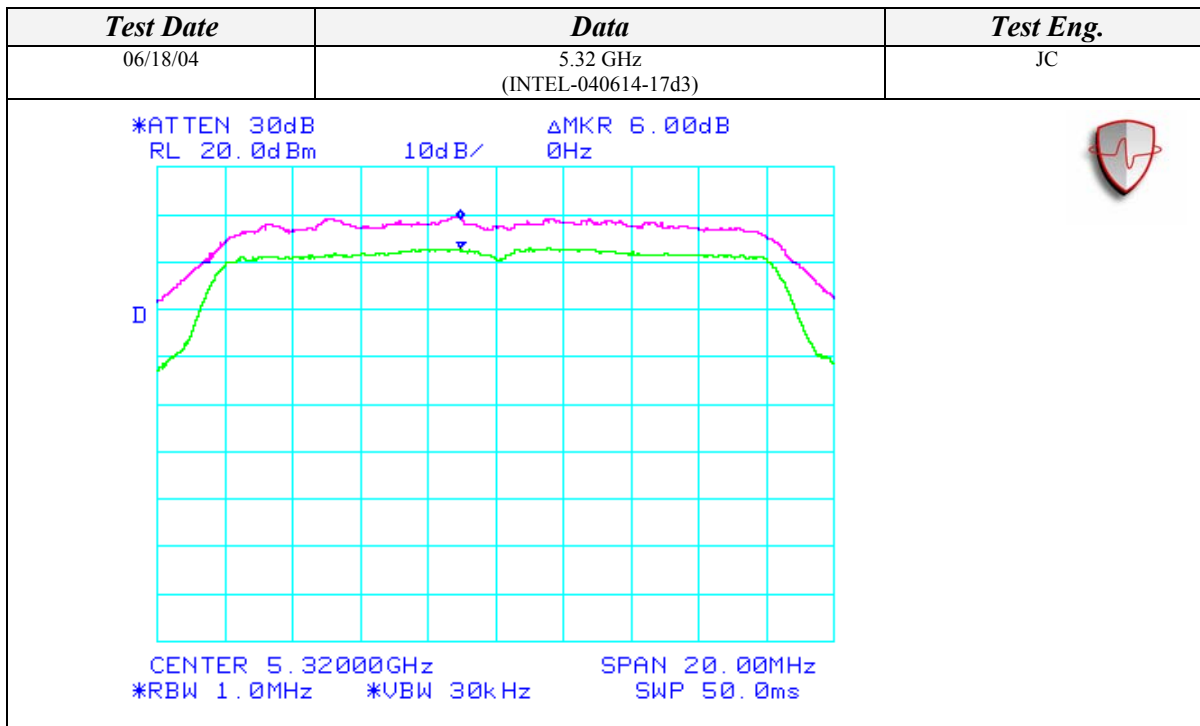

Page 29 of 36 (Appendix A)
Report Number: INTEL-040615F
FCC ID: PD9WM3A2915ABG



AEGIS LABS INC.

CONDUCTED OUT OF BAND EMISSIONS

CLIENT:	Intel Corporation	DATE:	06/18/04
EUT:	Intel PRO/Wireless 2915ABG Network Connection	PROJECT NUMBER:	INTEL-040614
MODEL NUMBER:	WM3A2915ABG	TEST ENGINEER:	JC
SERIAL NUMBER:	000E35344011	SITE #:	2
CONFIGURATION:	Tested installed in the Hewlett Packard host computer's mini PCI slot.	TEMPERATURE:	23 C
		HUMIDITY:	53% RH
		TIME:	10:30 AM

Standard:	FCC CFR 47, Part 15.407(b)(1) and 15.407(b)(2)
Description:	For transmitters operating in the 5.15-5.25 GHz band: all emissions outside of the 5.15-5.35 GHz band shall not exceed an EIRP of -27 dBm/MHz.
	For transmitters operating in the 5.25-5.35 GHz band: all emissions outside of the 5.15-5.35 GHz band shall not exceed an EIRP of -27 dBm/MHz. Devices operating in the 5.25-5.35 GHz band that generate emissions in the 5.15-5.25 GHz band must meet all applicable technical requirements for operation in the 5.15-5.25 GHz band (including indoor use) or alternatively meet an out-of-band emission EIRP limit of -27 dBm/MHz in the 5.15-5.25 GHz band.

Page 30 of 36 (Appendix A)
Report Number: INTEL-040615F
FCC ID: PD9WM3A2915ABG



AEGIS LABS INC.

Conducted Out Of Band Emissions (Continued)

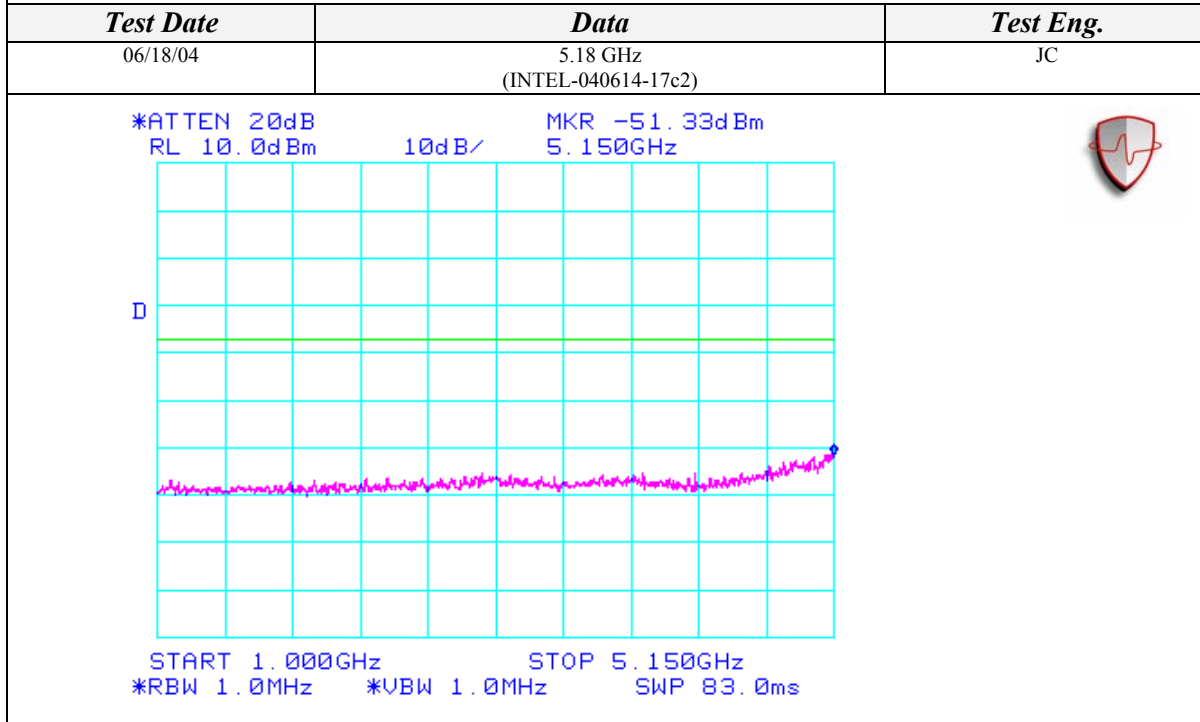
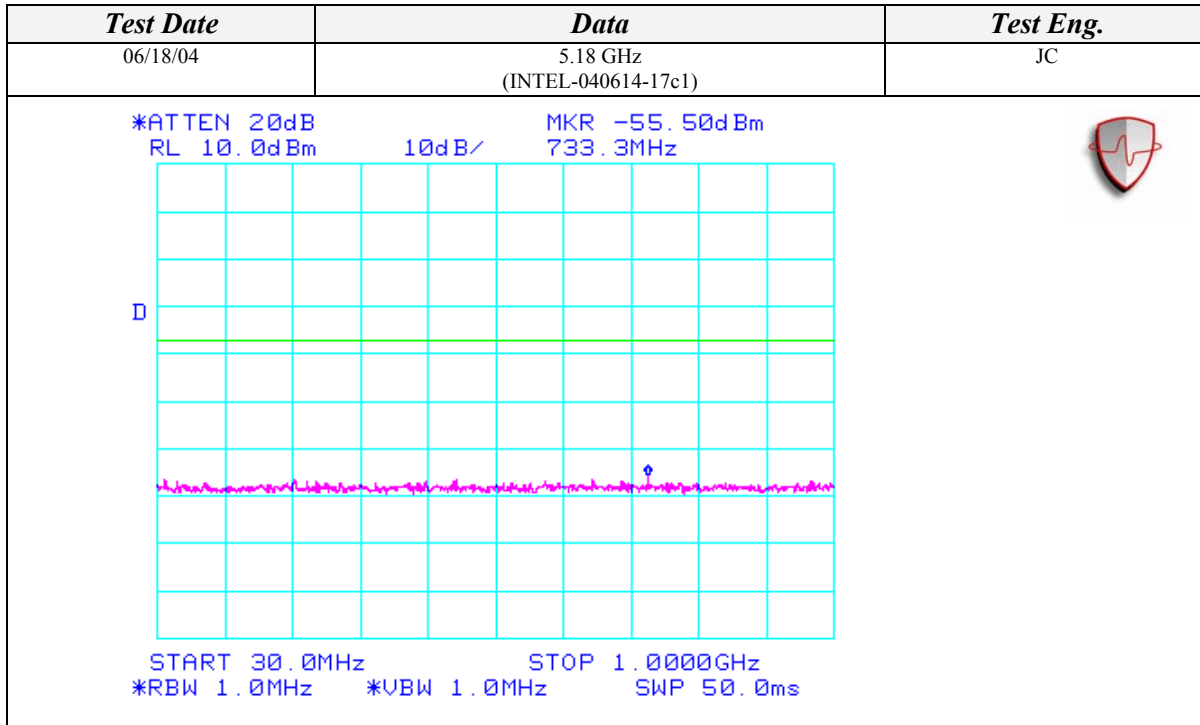



Conducted Out Of Band Emissions (Continued)

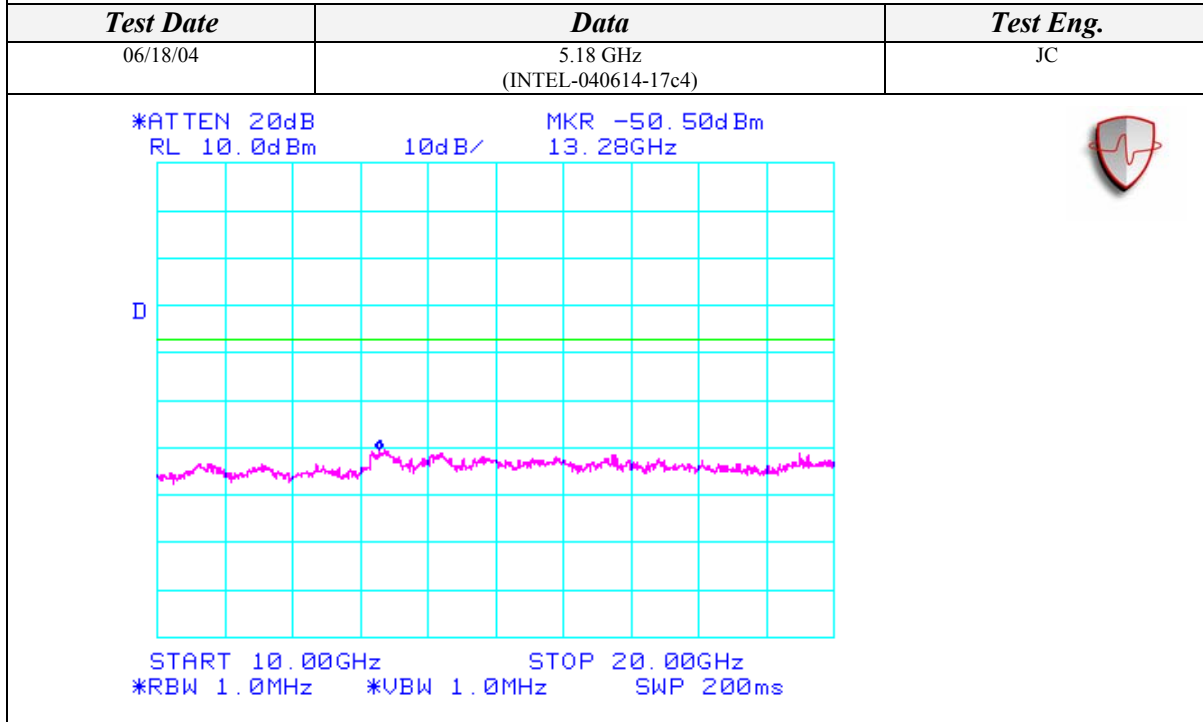
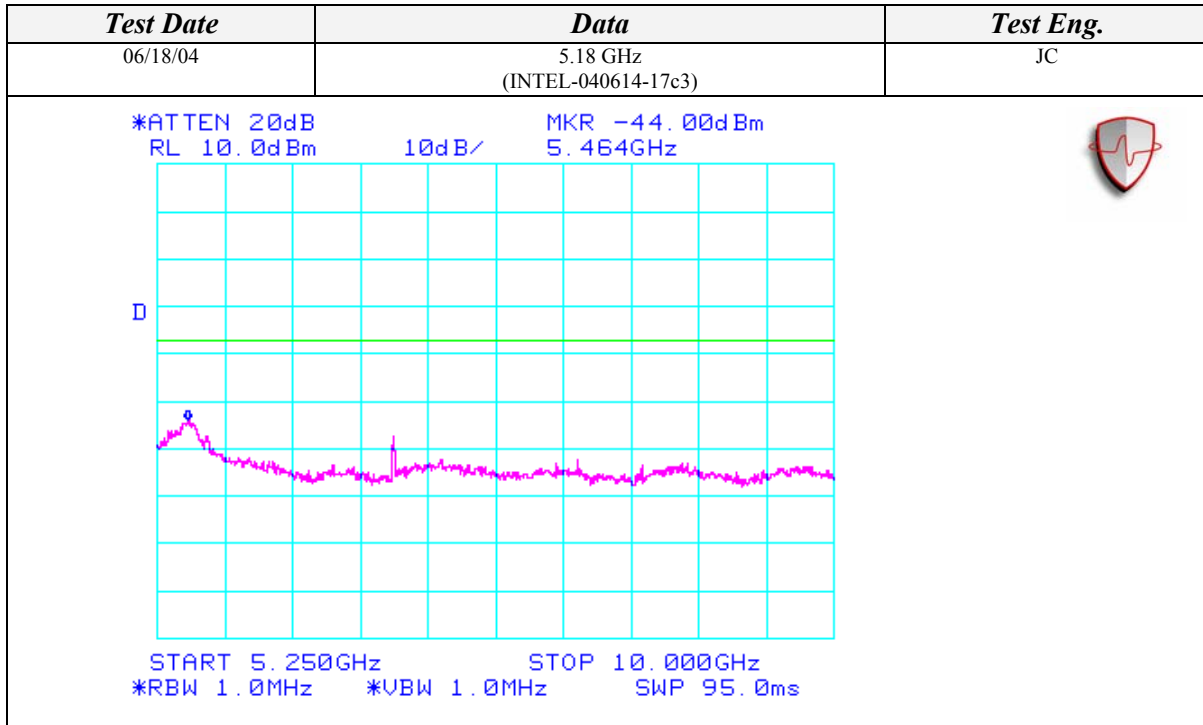



Conducted Out Of Band Emissions (Continued)

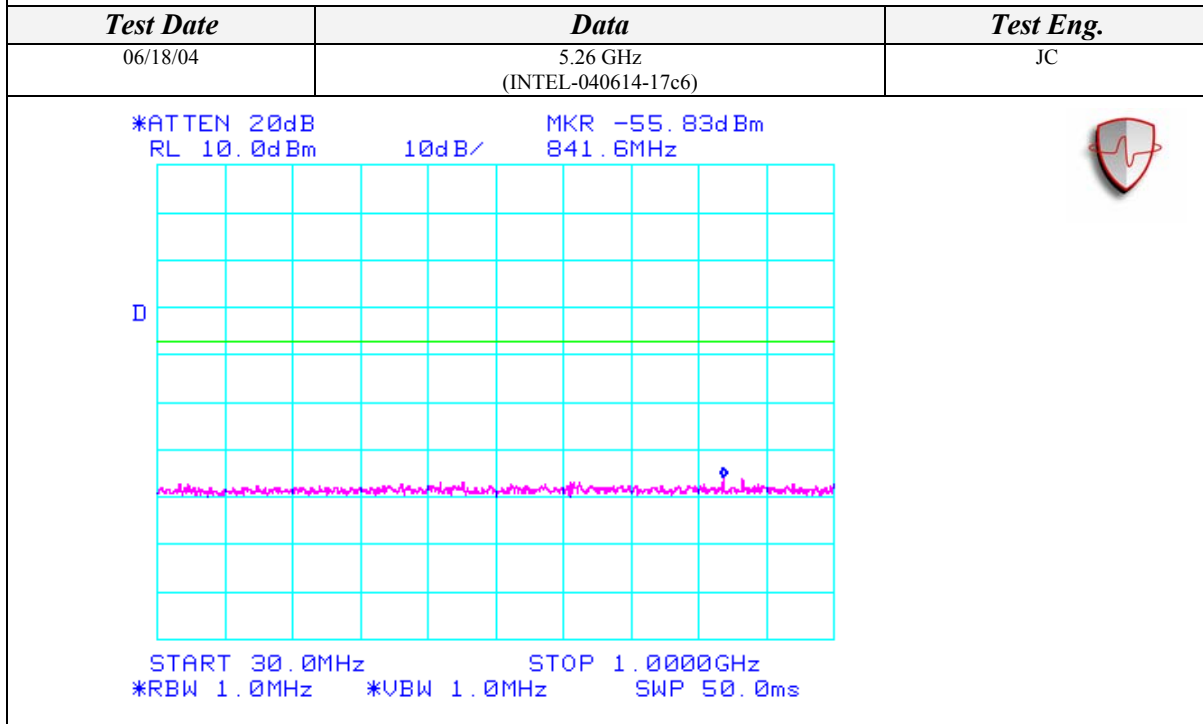
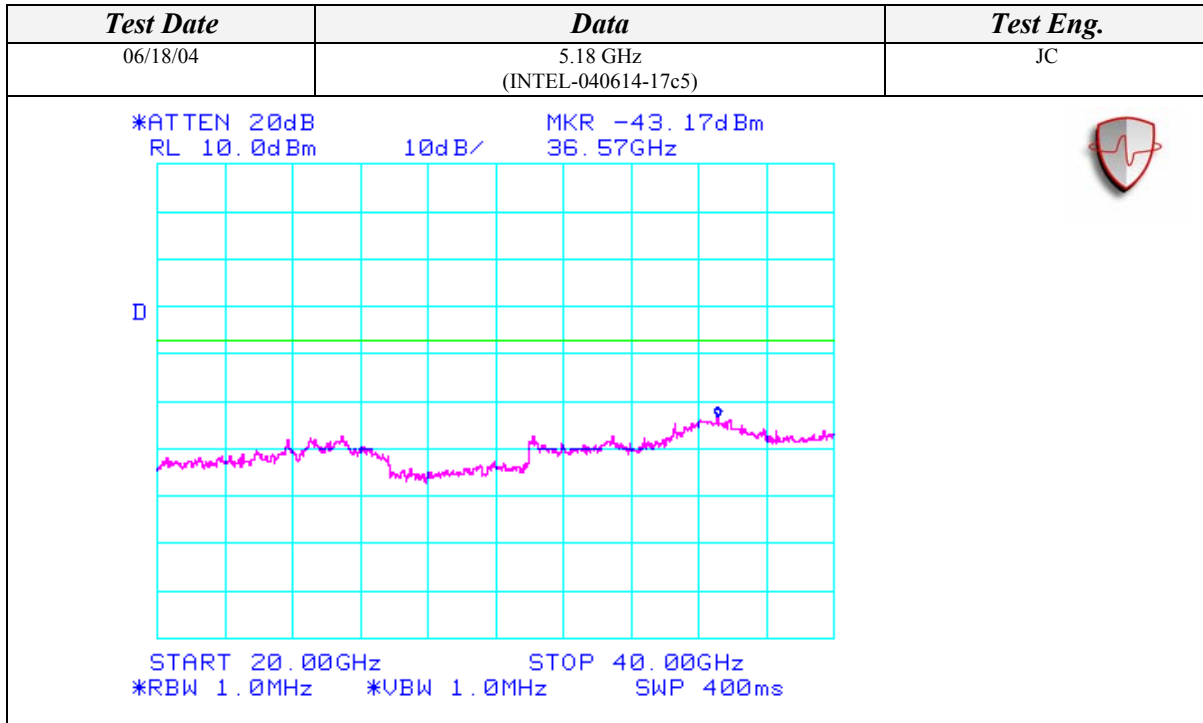



Conducted Out Of Band Emissions (Continued)

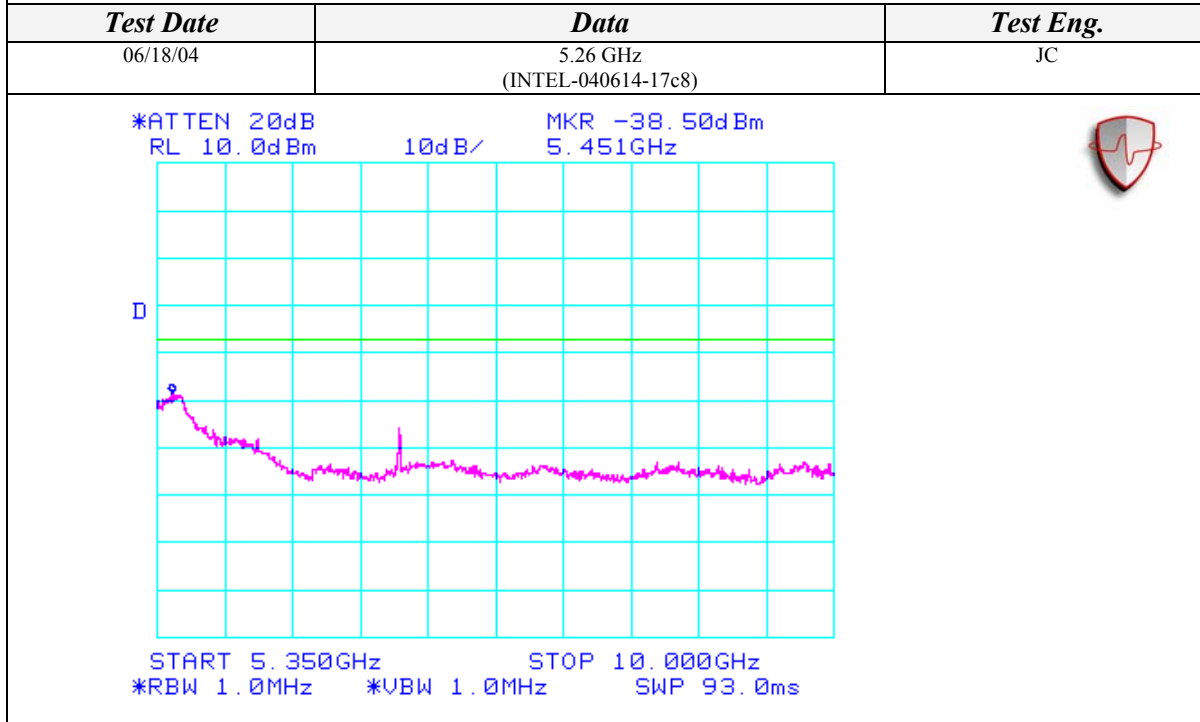
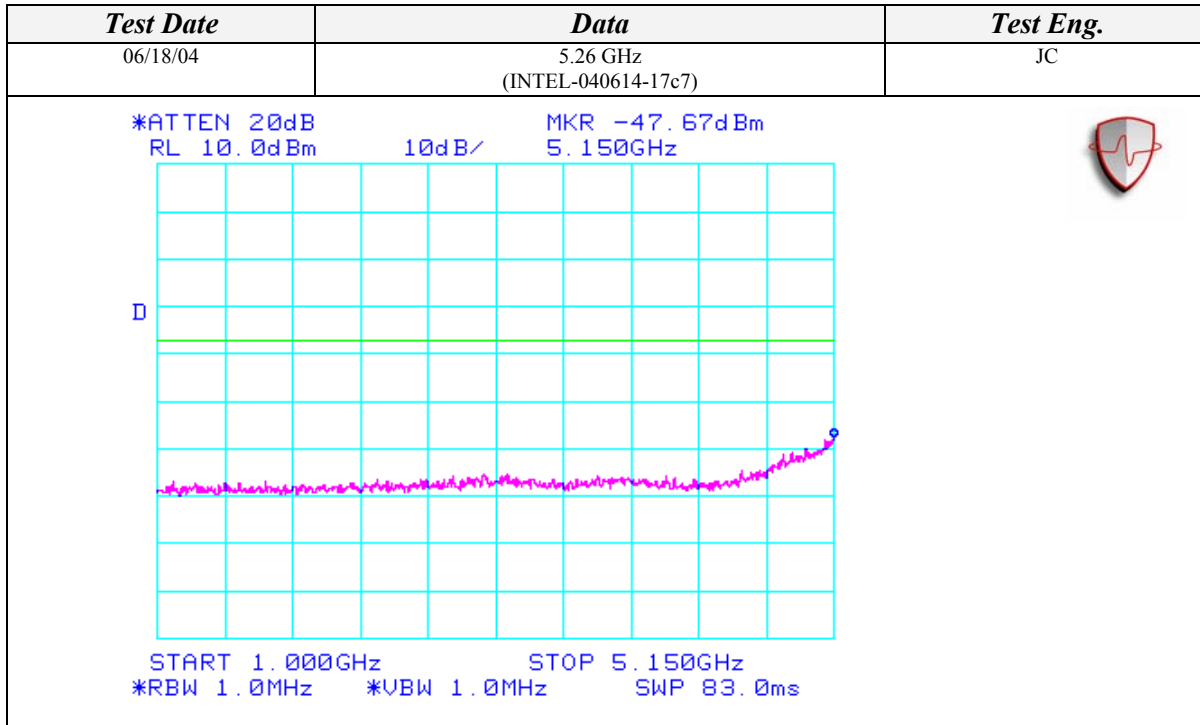

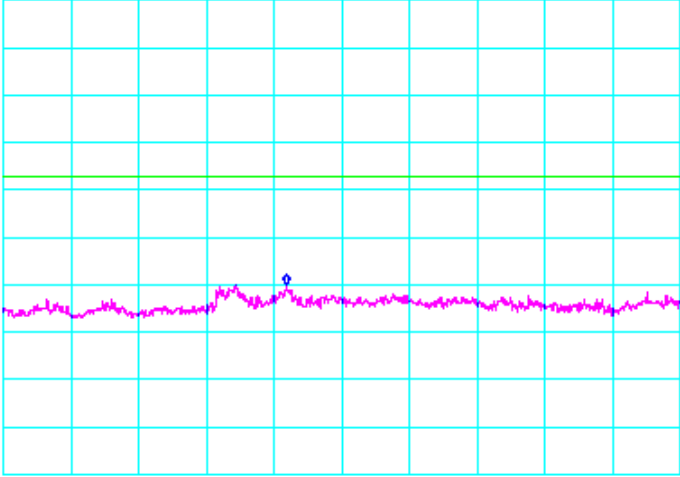
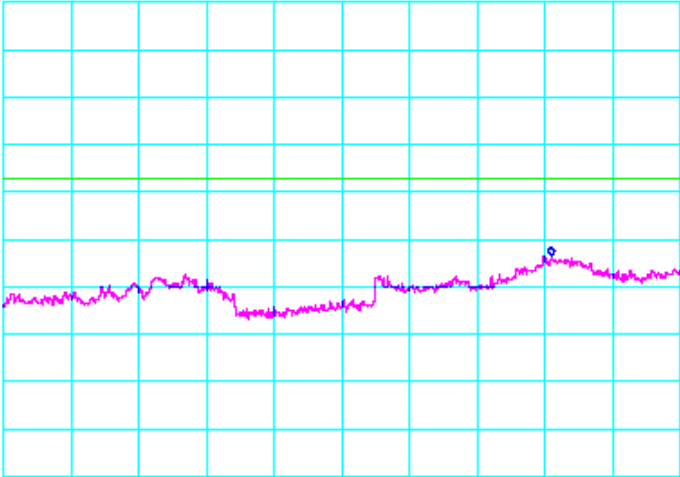

Conducted Out Of Band Emissions (Continued)

<i>Test Date</i>	<i>Data</i>	<i>Test Eng.</i>
06/18/04	5.26 GHz (INTEL-040614-17c9)	JC
<p data-bbox="332 426 967 478">*ATTEN 20dB MKR -49.83dBm RL 10.0dBm 10dB/ 14.18GHz</p>  <p data-bbox="332 959 987 1012">START 10.00GHz STOP 20.00GHz *RBW 1.0MHz *VBW 1.0MHz SWP 200ms</p>		
<i>Test Date</i>	<i>Data</i>	<i>Test Eng.</i>
06/18/04	5.26 GHz (INTEL-040614-17c10)	JC
<p data-bbox="332 1142 967 1194">*ATTEN 20dB MKR -43.50dBm RL 10.0dBm 10dB/ 36.20GHz</p>  <p data-bbox="332 1675 987 1728">START 20.00GHz STOP 40.00GHz *RBW 1.0MHz *VBW 1.0MHz SWP 400ms</p>		



Conducted Out Of Band Emissions (Continued)

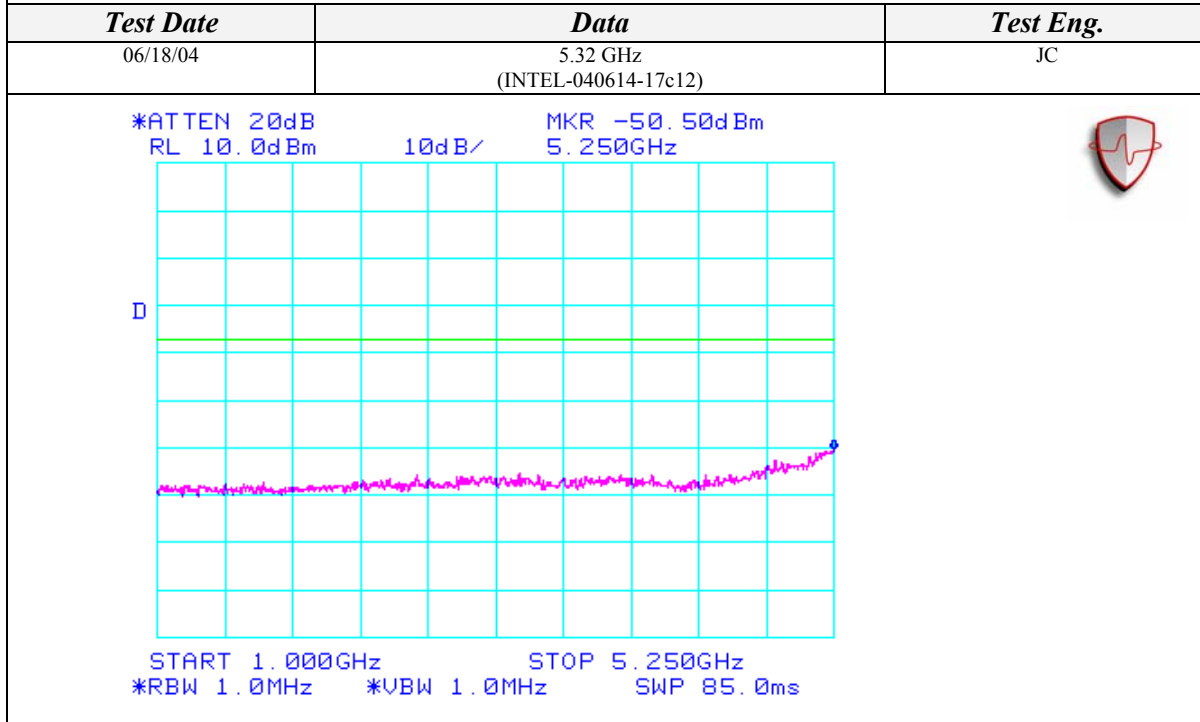
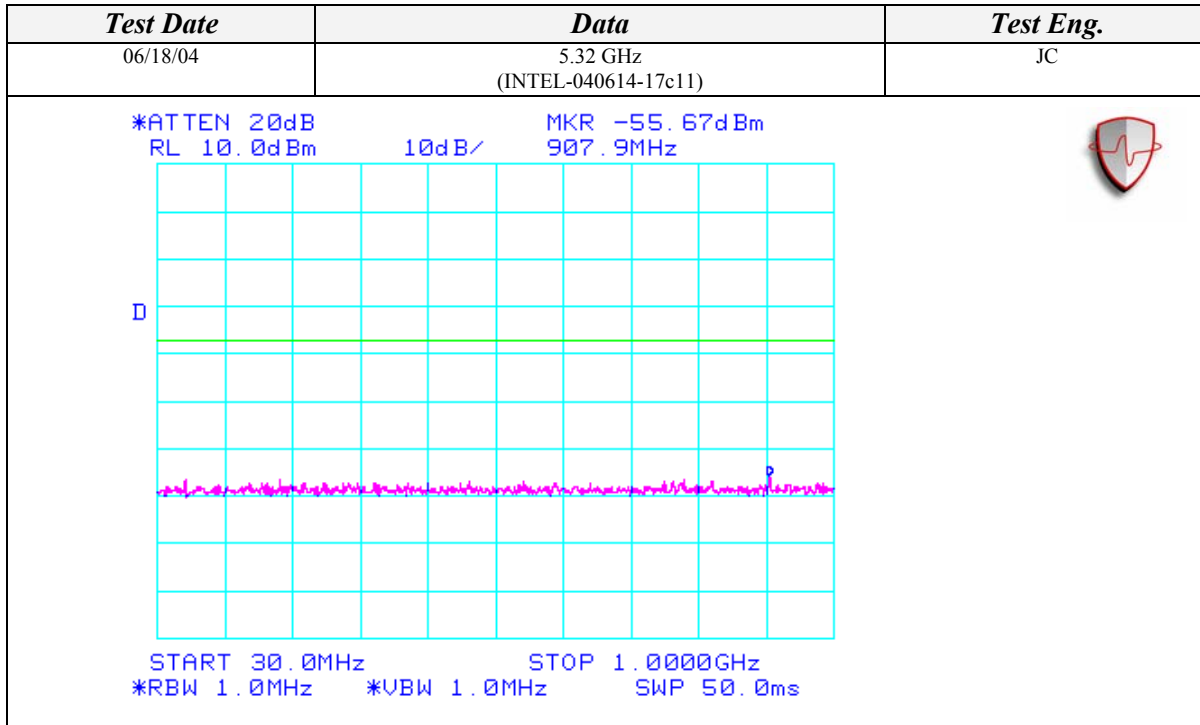



AEGIS LABS INC.

Conducted Out Of Band Emissions (Continued)

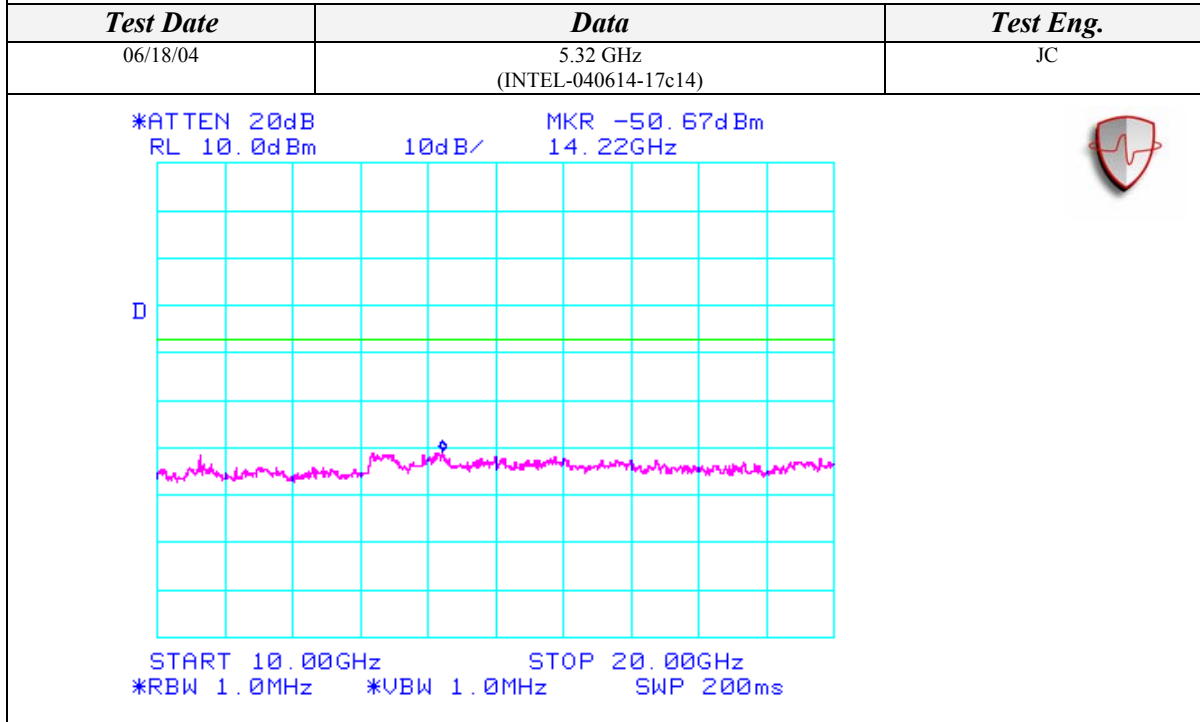
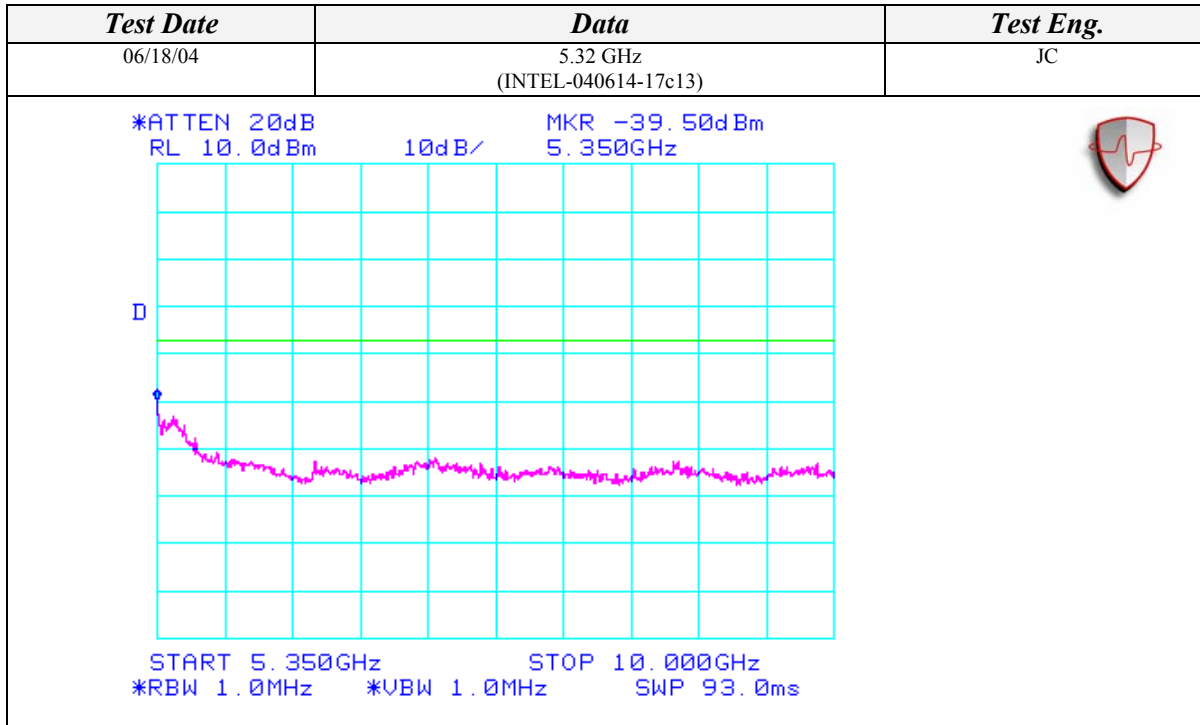

Page 37 of 36 (Appendix A)
Report Number: INTEL-040615F
FCC ID: PD9WM3A2915ABG



AEGIS LABS INC.

Conducted Out Of Band Emissions (Continued)

