



AEGIS LABS INC.



Limited Modular Approval
Test Report
And Application for Grant of Equipment Authorization

Pertaining To:

EUT	FCC ID:
Intel PRO/Wireless 2200BG Network Connection, MN: WM3A2200BG	PD9WM3A2200BG

Configuration
Tested with in 802.11b / 802.11g With a set of Wistron NeWeb Corp. and Hitachi Antennas

MEASUREMENTS PERFORMED IN ACCORDANCE WITH

Regulatory Standard(s)
47 CFR Part 15, Subpart C Section 15.247
Test Method: ANSI C63.4: 1992 American National Standard for Methods of Measurement of Radio-Noise Emissions from Low-Voltage Electrical and Electronic Equipment in the Range of 9 kHz to 40 GHz



Certificate Number: 1111.01

APPLICANT:

Intel Corporation
EC2-02 13280 Evening Creek Drive
San Diego, California 92128

Contact(s): Mr. James K. Baer

PREPARED BY:

Aegis Labs, Inc.
22431 Antonio Parkway B160-417
Rancho S. Margarita, CA 92688

Agent(s): Mr. Steve Kuiper
Mr. Rick Candelas

	REPORT BODY	APPENDICES	TOTAL PAGES
PAGES	16	A 69	85

Test Report #: INTEL-031126F
Test Report Revision: None

The contents of this report shall not be reproduced except in full, without the written approval of Aegis Labs, Inc.

Page 1 of 16
Report Number: INTEL-031126F
FCC ID: PD9WM3A2200BG



TABLE OF CONTENTS

SECTION	TITLE	PAGE
	COVER SHEET.....	01
	TABLE OF CONTENTS.....	02
1.0	CERTIFICATION OF TEST DATA.....	03
2.0	SUMMARY OF TEST RESULTS.....	04
3.0	ADMINISTRATIVE DATA AND TEST DESCRIPTION.....	05
4.0	DESCRIPTION OF EUT.....	06
4.1	EUT Description.....	06
4.1.1	Channel Number and Frequencies.....	07
4.2	EUT Configuration.....	08
4.3	List of EUT Sub-Assemblies and Host Equipment.....	09
4.4	I/O Cabling Diagram and Description.....	10
5.0	TEST EQUIPMENT AND TEST SETUPS.....	11
5.1	AC Power Line Conducted Emissions.....	11
5.2	Spurious Radiated Emissions.....	12
5.3	Conducted Emissions At The Antenna Port.....	12
5.4	Test and Measurement Equipment Used.....	13
6.0	SAMPLE CALCULATIONS.....	14
7.0	MODIFICATIONS AND RECOMMENDATIONS.....	16

APPENDICES

A	Test Data
---	-----------



AEGIS LABS INC.

1.0 CERTIFICATION OF TEST DATA

Aegis Labs, Inc. operates as both a Nevada and California Corporation with no organizational or financial relationship with any company, institution, or private individual.

Testing and engineering functions provided by Aegis Labs are furnished through the use of part-time, full-time or consulting engineers with the appropriate qualifications to carry out their duties. The intended purpose of this test report is to describe the measurement procedure and to determine whether the equipment under test "EUT" complies with both the conducted and radiated limits. Limits for emissions testing are described under Subpart C of Part 15 of the FCC rules.

The data, data evaluation and equipment configuration represented herein are a true and accurate representation of the Equipment Under Test (EUT) under the requirements specified in the emissions standard as described below. The test results contained in this report are only representative of the test sample tested as described in Section 3.0 of this report. Certification of the EUT is required as a prerequisite to marketing as defined in Part 2 of the FCC Rules.

Prepared By:

01/28/04

Rick Candelas
Staff Engineer
Aegis Labs, Inc.

Date:

Report Approved By:

01/28/04

Steve J. Kuiper
Quality Assurance Manager
Aegis Labs, Inc.

Date:

Page 3 of 16

Report Number: INTEL-031126F

FCC ID: PD9WM3A2200BG



2.0 SUMMARY OF TEST RESULTS

The test results provided within this report, indicate that the EUT has been found to be in **COMPLIANCE** with the test specifications based upon the following RF compliance standards:

Pass/Fail determination is based upon the nominal values of the test data.

EMISSIONS STANDARD			
FCC Part 15 Section	Description	Results	Comments
15.247(a)(2)	The minimum 6dB bandwidth shall be at least 500 kHz.	PASSED	See Data Sheets
15.247(b)(1)	The maximum peak output power of the intentional radiator shall not exceed 1 watt.	PASSED	See Data Sheets
15.247(b)(4)	The intentional radiator shall be operated in a manner that ensures that the public is not exposed to radio frequency energy levels in excess of the FCC guidelines per Section 1.1307(b)(1).	PASSED	Refer to SAR Test Reports
15.247(c)	In any 100 kHz bandwidth outside the frequency band in which the spread spectrum intentional radiator is operating, the radio frequency power that is produced by the intentional radiator shall be at least 20 dB below that in the 100 kHz bandwidth within the band that contains the highest level of the desired power.	PASSED	See Data Sheets
15.247(c)	Radiated emissions, which fall in the restricted bands, as defined in Sec. 15.205(a), must also comply with the radiated emission limits specified in Sec. 15.209(a). All others must be < -20dBc.	PASSED	See Data Sheets
15.247(d)	The peak power spectral density conducted from the intentional radiator to the antenna shall not be greater than 8 dBm in any 3 kHz band during any time interval of continuous transmission.	PASSED	See Data Sheets
15.207	AC Conducted Emissions	PASSED	See Data Sheets
15.209	Radiated Emissions (30-1000 MHz)	PASSED	See Data Sheets



AEGIS LABS INC.

3.0 ADMINISTRATIVE DATA AND TEST DESCRIPTION

DEVICE TESTED:	ITE Type: Intel PRO/Wireless 2200BG Network Connection Model Number(s): WM3A2200BG Serial Number: 0058AAA463ADC54980203 FCC ID: PD9WM3A2200BG
TEST DATE(S):	November 25-December 17, 2003
DATE EUT RECEIVED:	November 19, 2003
ORIGIN OF TEST SAMPLE(S):	Production Unit
RESPONSIBLE PARTY:	Intel Corporation EC2-02 13280 Evening Creek Drive San Diego, California 92128
CLIENT CONTACT:	Mr. James K. Baer
MANUFACTURER:	Intel Corporation
TEST LOCATION:	Aegis Labs, Inc. 32231 Trabuco Creek Road Trabuco Canyon, CA 92678 Conducted Site #2 Radiated Site #2
A2LA CERTIFICATE:	1111.01, Valid through February 28, 2004
PURPOSE OF TEST:	To demonstrate compliance with the relevant standards described in Section 2.0 of this report.
TEST(S) PERFORMED:	Refer to Table in Section 2.0 of this report.

All calibration vendors were responsible for certifying Aegis Labs, Inc. test equipment as per the manufacturer's specifications and that the equipment is calibrated using instruments and standards where the accuracy is traceable to the National Institute of Standards and Technology (NIST). Calibration of all test equipment conforms to ANSI/NCSL Z540-1 and ISO 10012-1 and/or ISO/IEC Guide 17025 compliance (Additionally, other pertinent test equipment will carry MIL-STD-45662A). All calibration documents are on file with Aegis Labs, Inc., with copies provided upon request.

Page 5 of 16
Report Number: INTEL-031126F
FCC ID: PD9WM3A2200BG



4.0 DESCRIPTION OF EUT

4.1 EUT Description

Equipment Under Test (EUT)	
Trade Name:	Intel PRO/Wireless 2200BG Network Connection
Model Number:	WM3A2200BG
Frequency Range:	2.412 – 2.462 GHz
Type of Transmission:	Direct Sequence Spread Spectrum
Transfer Rate:	1/2/5.5/11 Mbps for 802.11b mode 6/36/54 Mbps for 802.11g mode
Number of Channels:	11
Modulation Type:	DBPSK, DQPSK, CCK
Antenna Type (See Note 1):	<u>Wistron:</u> PCB IFA (Main), TIFA (Aux) <u>Hitachi:</u> Monopole Type – MFJ (Multi Frame Joiner)
Antenna Gain (See Note 2):	<u>Wistron:</u> Main = 1.87dBi – 0.80dB = 1.07dBi Aux = 2.09dBi – 1.39dB = 0.70dBi <u>Hitachi:</u> Main = 1.20dBi – 0.60dB = 0.60dBi Aux = 0.90dBi – 1.30dB = -0.40dBi
Transmit Output Power:	17 dBm (Typical) for 802.11b mode 16 dBm (Typical) for 802.11g mode Please see Appendix A (Data Sheets) for actual output power.
Power Supply:	3.3VDC from computer MPCPI slot.
Number of External Test Ports Exercised:	2 Antenna Ports (1 Main & 1 Auxiliary)

The Intel PRO/Wireless 2200BG Network Connection MN: WM3A2200BG was tested installed in the Mini PCI slot of a Dell notebook computer as an embedded 2.4 GHz Wireless Local Area Network Mini-PCI adapter. The Mini-PCI Type 3A form factor is designed for notebook computer systems where overall thickness must be kept to an absolute minimum and connect to antennas internal to the notebook computer. It is capable of a data rate of up to 11 Mbps in 802.11b mode and 54Mbps in 802.11g mode. Please refer to section 4.2 of this report for a further description.

NOTE 1: For a more detailed description, please refer to the manufacture's specifications or User's Manual.

NOTE 2: Refer to the antenna specifications for a further description of the antennas. Antennas will be professionally installed inside the laptop computer by the laptop vendor. The antenna gain was subtracted from the antenna cable loss to come up with the total antenna gain.



AEGIS LABS INC.

4.1.1 Channel Number and Frequencies

Eleven channels are provided for the EUT.

Channel	Frequency (MHz)
1	2412
2	2417
3	2422
4	2427
5	2432
6	2437
7	2442
8	2447
9	2452
10	2457
11	2462



AEGIS LABS INC.

4.2 EUT Configuration

The EUT was tested installed in the mini PCI slot of a Dell notebook computer and was connected to a set of Wistron NeWeb Corp. triple band antennas via its main and auxiliary antenna ports. Data can be found in Appendix A. Also a set of Hitachi Multi band antennas were tested for and the data can also be found in Appendix A

For conducted emissions at the AC mains port and radiated emissions, the EUT was connected to a Zoom modem, Canon printer, Dell monitor, and Logitech mouse via its serial, parallel, video, and USB ports respectively.

The low (channel 1), middle (channel 6), and high (channel 11) were tested in 802.11b & g modes. Also, the EUT was tested once transmitting from the MAIN antenna port and once transmitting from the AUX antenna port. The EUT was transmitting and receiving on a continuous basis.

Page 8 of 16

Report Number: INTEL-031126F

FCC ID: PD9WM3A2200BG



AEGIS LABS INC.

4.3 List of EUT, Sub-Assemblies, and Host Equipment

LIST OF EUT AND SUB-ASSEMBLIES			
Equipment Name	Manufacturer	Model Number	Serial Number
Intel PRO/Wireless 2200BG Network Connection	Intel Corporation	WM3A2200BG	0058AA463ADC 54980203
EUT Sub-Assemblies			
Notebook Computer	Dell Computer Corporation	PP05L	CN-0C3038- 48643-3AD-9430
Auxiliary Triple Band Antenna	Winstron NeWeb Corp.	CA5-Q	N/A
Main Triple Band Antenna	Winstron NeWeb Corp.	CA5-Q	N/A
Auxiliary Multi Band Antenna	Hitachi	HFT01-DL01	N/A
Main Multi Band Antenna	Hitachi	HFT01-DL01	N/A

HOST EQUIPMENT LIST			
Equipment Name	Manufacturer	Model Number	Serial Number
LCD Monitor	Dell	E151FPp	CN-06R644-47804-34R- LATL
Mouse	Logitech	M-BJ58	LNA22802012
Printer	Canon	S400	0A28A
Modem	Zoom	2498	0623-2948-00-02C-0249

NOTE: All the power cords of the above support equipment are standard non-shielded, 1.8 meters long.

Page 9 of 16
Report Number: INTEL-031126F
FCC ID: PD9WM3A2200BG



4.4 I/O Cabling Diagram and Description

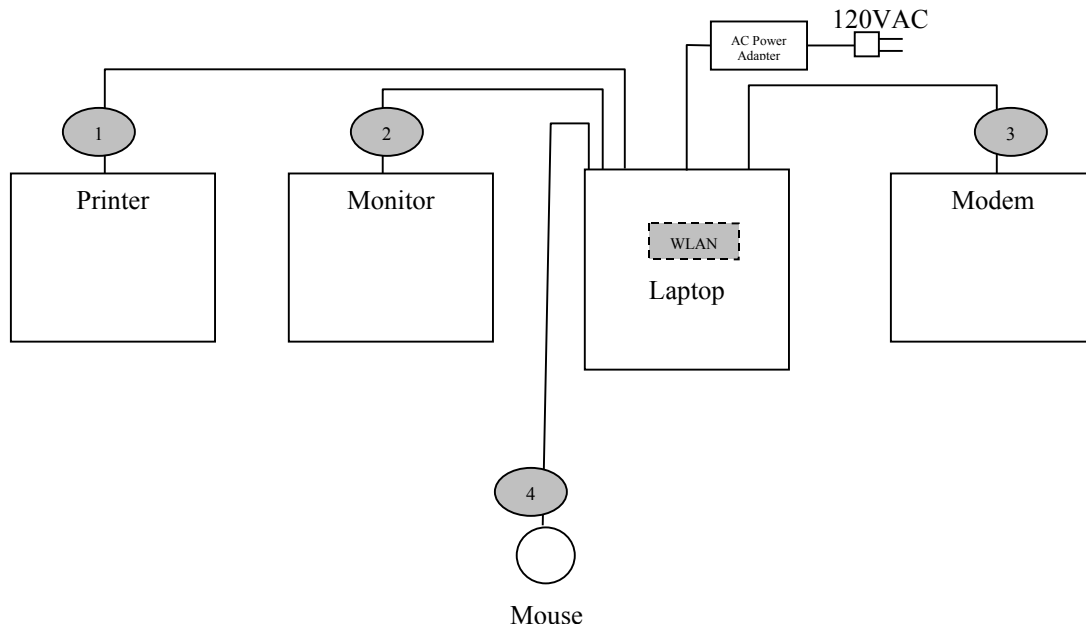

- Cable 1: This is a 6-foot braid and foil shielded round cable connecting the Dell Computer Corporation notebook computer to the Canon Printer. It has a metallic DB-25 type connector at the computer end and a metallic centronics type connector at the printer end. The cable is bundled to a length of one meter and the shield of the cable is grounded to the chassis of both devices via the connector shells.
- Cable 2: This is a 6-foot braid and foil shielded round cable connecting the Dell Computer Corporation notebook computer with the Dell LCD monitor. It has metallic DB-15 type connector at the computer end and is hardwired to the monitor. The cable is bundled to a length of one meter and the shield of the cable is grounded to the chassis of both devices via the connector shells.
- Cable 3: This is a 6-foot braid and foil shielded round cable connecting the Dell Computer Corporation notebook computer with the Zoom modem. It has metallic DB-9 type connector at the computer end and a metallic DB-25 type connector at the modem end. The cable is bundled to a length of one meter and the shield of the cable is grounded to the chassis of both devices via the connector shells.
- Cable 4: This is a 6-foot braid and foil shielded round cable connecting the Dell Computer Corporation notebook computer to the Logitech mouse. It has a metallic USB-B type connector at the computer end and is hardwired to the mouse. The shield of the cable is grounded to the chassis of the computer via the connector shell.



AEGIS LABS INC.

5.0 TEST EQUIPMENT AND TEST SETUPS

The test equipment settings and functions are selected using the guidance of ANSI C63.4-1992. All test equipment setups and operations during conducted and radiated emissions testing are in accordance with this reference document.

5.1 AC Power Line Conducted Emissions

During conducted emissions measurements, a spectrum analyzer was used as the measuring instrument along with a preselector and quasi-peak detector. A 10 dB attenuation pad was used for the protection of the spectrum analyzer input stage. The conducted emissions from the EUT in the frequency range from 150 kHz to 30 MHz were captured for graphical display through the use of automated LABVIEW EMI measurement software. All graphical readings were measured in the “Peak” mode only to reduce testing time. Upon completion of the graphical scan, the test lab personnel performed the conducted measurement scan manually using the spectrum analyzer front panel keys. The spectrum analyzer bandwidth settings for measuring “Peak”, “Average”, and/or “Quasi-Peak” conducted emissions were set at 9 kHz. The Frequency Span was set at 300 kHz, Resolution Bandwidth = 100 kHz, Video Bandwidth = 100 kHz, Sweep Time = 200msec with a reference level set at 97.0 dBuV. Attenuation was set at 10dB, Positive Peak. All peak measurements coming within 3 dB of the limit line were “Averaged” and/or “Quasi-Peaked” and denoted appropriately in the EXCEL spreadsheet.

The Equipment Under Test (EUT) was configured as a system with peripherals connected, so that at least one interface port of each type is connected to one external peripheral when tested for conducted emissions according to ANSI C63.4: 1992. Excess power cord length was wrapped in a bundle 30 to 40 centimeters in length near the center of the cord. The EUT was tested in a tabletop configuration.

The emission readings for Line 1 and Line 2 are highlighted on the data sheets in Appendix A. The graphical scans only reflect peak readings while the tabulated data sheets reflect peak, average, and/or quasi-peak readings which ever applies.

Page 11 of 16

Report Number: INTEL-031126F

FCC ID: PD9WM3A2200BG



AEGIS LABS INC.

5.2 Spurious Radiated Emissions

A spectrum analyzer was used as the measuring instrumentation along with a preselector and quasi-peak-detector. The pre-amplifiers were used to increase the sensitivity of the instrument. The spectrum analyzer was used in the peak detector mode with the “max-hold” feature activated and in Positive Peak mode. In this mode, the spectrum analyzer records the highest measured reading over all the sweeps. The quasi-peak detector was used only for those readings, which are marked accordingly in the data sheet. The effective measurement bandwidth used for the radiated emissions test was 120 kHz for (30 MHz- 1000 MHz). The Frequency Span was set at 1 MHz Resolution Bandwidth = 1MHz, Video Bandwidth = 1 MHz, Sweep Time = 20msec with a reference level set at 97.0 dBuV. Attenuation was set at 0dB, Positive Peak. The spectrum analyzer operated such that the modulation of the signal was filtered out to set the analyzer in linear mode. For testing beyond 1000 MHz a spectrum analyzer capable of taking reading above 1000 MHz was connected to the high frequency amplifier, where these measurement readings were taken with the transducer placed at a 3-meter test distance from the EUT. The spectrum analyzer settings for testing beyond 1000 MHz included Resolution and Video Bandwidths set at 1 MHz, Sweep Time = 50 msec.

The Open Area Test Sites (OATS) was used for radiated emission testing. These test sites are designed according to ANSI C63.4: 1992 and ANSI C63.7: 1992 guidelines. The Measurements were conducted in accordance with ANSI C63.4: 1992 and ANSI C63.7: 1992 requirements.

Broadband biconical, log periodic, and horn antennas were used as transducers during the measurement reading phase. The frequency spans were wide (30 MHz-88 MHz, 88 MHz- 216 MHz, 216 MHz- 300 MHz, and 300 MHz- 1000 MHz). After 1000 MHz the horn antenna was used to measure emissions. The emission readings in both horizontal and vertical polarities are highlighted on the data sheets in Appendix A.

5.3 Conducted Emissions at the Antenna Port

A spectrum analyzer or power meter was used as the measuring instrumentation along with an attenuator and/or filter connected to the EUT antenna port. The attenuator and filters are used to ensure that the front end of the measurement instrument is not overloaded by the fundamental transmission. . The instruments recorded the measured readings with the bandwidths (video and resolution) set in accordance with the FCC Rules and regulations.

For the power out measurements an oscilloscope along with a schottkey detector diode, 12dB attenuator, and a signal generator were used to perform the measurements.

The measured readings are on the data sheets in Appendix A.

Page 12 of 16

Report Number: INTEL-031126F

FCC ID: PD9WM3A2200BG



AEGIS LABS INC.

5.4 Test and Measurement Equipment Used

TEST EQUIPMENT USED					
Equipment Name	Manufacturer	Model Number	Serial Number	Calibration Due Date	Calibration Cycle
EMI Receiver - RF Section	Hewlett Packard	85462A	3325A00137	12/12/04	1 Year
EMI Receiver - RF Filter Section	Hewlett Packard	85460A	3330A00138	12/12/04	1 Year
Attenuator - 5W-10dB	Pasternack	PE7014-10	N/A	03/30/04	1 Year
LISN (EUT)	FCC	FCC-LISN-50-25-2	9931	02/20/04	1 Year
LISN (Access)	Com-Power	LI-200	12019	01/25/04	1 Year
LISN (Access)	Com-Power	LI-200	12018	01/25/04	1 Year
Spectrum Analyzer	Agilent	8564EC	4046A00387	02/28/04	2 Years
Preamplifier	Miteq	JS42-01001800-25-10P	815980 - 884968 - 885090	12/09/04	2 Years
High Pass Filter	Microwave Circuits, Inc.	H3G020G2	0301DC0132	04/29/04	2 Years
Antenna - Biconical	EMCO	3110	9108-1421	02/11/04	1 Year
Antenna - Log Periodic	EMCO	3148	4947	02/11/04	1 Year
1-18 GHz Antenna - Horn	Com-Power	AH-118	10069	12/09/04	2 Years
18-26.5 GHz Antenna – Horn	Custom Microwave	H042	001	05/09/04	1 Year
Power Meter	Rohde & Schwarz	NRVS	DE30863	07/21/05	2 Years
Power Sensor	Leistungsmesskoph	NRV-Z5	844855/012	07/21/05	2 Years
Oscilloscope	Tektronix	TDS3012B	B028086	08/21/04	1 Year
Schottkey Detector Diode	Narda	4503A	0209	None	None
12dB Attenuator	Narda	4779-12	0203	None	None
Signal Generator	Hewlett Packard	83752A	3610A01906	01/22/04	1 Year
Temperature/Humidity Monitor	Dickson	TH550	7255185	01/18/04	1 Year



6.0 SAMPLE CALCULATIONS

If a preamplifier is used during the Radiated Emissions Testing, it is required that the amplifier gain be subtracted from the Spectrum Analyzer (Meter) Reading. In addition, a correction factor for the antenna, cable and a distance factor, if any, must be applied to the Meter Reading before a true field strength reading can be obtained. In the case of manual measurements and for greater efficiency and convenience, usage of the calibration correction factors is necessary to calculate the Corrected Meter Reading. These correlation factors for each meter reading, shall be modified to reflect these correlation factors at each frequency value so that the meter readings can be compared directly to the modified specification limit. This modified specification limit is referred to as the “Corrected Meter Reading Limit” (CML).

The equation shall be derived in the following manner:

$$\text{Corrected Meter Reading} = \text{Meter Reading} + F + C - G - D$$

Where, F = Antenna Factor

C = Cable Factor

G = Amplifier Gain

D = Distance Factor

Therefore, the equation for determining the Corrected Meter Reading Limit (CML) is:

$$\text{CML} = \text{Specification Limit} - F - C + G + D$$

For the manual mode of measurement, a table of corrected meter reading limits shall be used to permit immediate comparison of the meter reading to determine if the measured emission amplitude exceeded the specification limit at that specific frequency. There shall be two calculation sheets done, one for three meter and one for ten-meter measurement distances, where applicable.



AEGIS LABS INC.

6.0 Sample Calculations (Continued)

Peak Transmit Power Output:

A correction factor for the cable must be applied to the Conducted Power before a true power reading can be obtained. This is referred to as the “Corrected Power” (CP).

The equation shall be derived in the following manner:

$$\text{Corrected Power Reading} = \text{Conducted Power Reading} + C$$

Where, C = Cable Factor

The conducted power is taken in units of dBm. To obtain units of mW the following equation is used:

$$\text{mW} = 10^{(\text{dBm}/10)}$$



AEGIS LABS INC.

7.0 MODIFICATIONS AND RECOMMENDATIONS

No modifications were made to the EUT.

Page 16 of 16
Report Number: INTEL-031126F
FCC ID: PD9WM3A2200BG



AEGIS LABS INC.

APPENDIX A

TEST DATA

Page 1 of 69 (Appendix A)
Report Number: INTEL-031126F
FCC ID: PD9WM3A2200BG



AEGIS LABS INC.

AC POWER LINE CONDUCTED EMISSIONS TEST RESULTS

CLIENT:	Intel Corporation	DATE:	12/02/03
EUT:	Intel PRO/Wireless 2200BG Network Connection	PROJECT NUMBER:	INTEL-031125-09
MODEL NUMBER:	WM3A2200BG	TEST ENGINEER:	Rick Candelas
SERIAL NUMBER:	0058AAA463ADC54980203	SITE #:	2
CONFIGURATION:	Tested installed in the Dell notebook computer's mini PCI slot.	TEMPERATURE:	18 C
		HUMIDITY:	35% RH
		TIME:	3:00 PM

Standard:	FCC CFR 47, Part 15.207
Description:	AC Power Line Conducted Emissions
Results:	Passes the conducted limits by -3.17@ 0.1650 MHz

Conducted Limits		
Frequency (MHz)	Quasi-Peak Limit (dBuV)	Average Limit (dBuV)
0.15-0.5	66 to 56*	56 to 46*
0.5-5	56	46
5-30	60	50

*Decreases with the logarithm of the frequency.

NOTE: During preliminary scans, there wasn't any difference which channel or data rate was used with the EUT; therefore only Channel 1 at a data rate of 1 Mbps was used for final testing. Also, the scan was only done with the Wistron set of antennas.

Page 2 of 69 (Appendix A)
Report Number: INTEL-031126F
FCC ID: PD9WM3A2200BG



AEGIS LABS INC.

AC Power Line Conducted Emissions Test Results (Continued)

CONDUCTED EMISSIONS – LINE 1						
Freq. (MHz)	Meter Reading (dBuV)	Detector (PK/QP/AV)	Average Limit (dBuV)	Average Delta(dB)	Quasi-Peak Limit (dBuV)	Quasi-Peak Delta(dB)
0.1650	52.40	PK	55.57	-3.17	65.57	-13.17
0.2397	49.90	PK	53.44	-3.54	63.44	-13.54
0.3165	43.90	PK	51.24	-7.34	61.24	-17.34
0.4815	41.50	PK	46.53	-5.03	56.53	-15.03
2.2300	40.40	PK	46.00	-5.60	56.00	-15.60
4.9550	39.40	PK	46.00	-6.60	56.00	-16.60

Aegis Labs, Inc.

Date: 12/2/2003 Time: 3:02 PM

Usage for graphical purposes only.
Refer to conducted measurement table for Peak, QP, and Avg. measurements, where applicable.

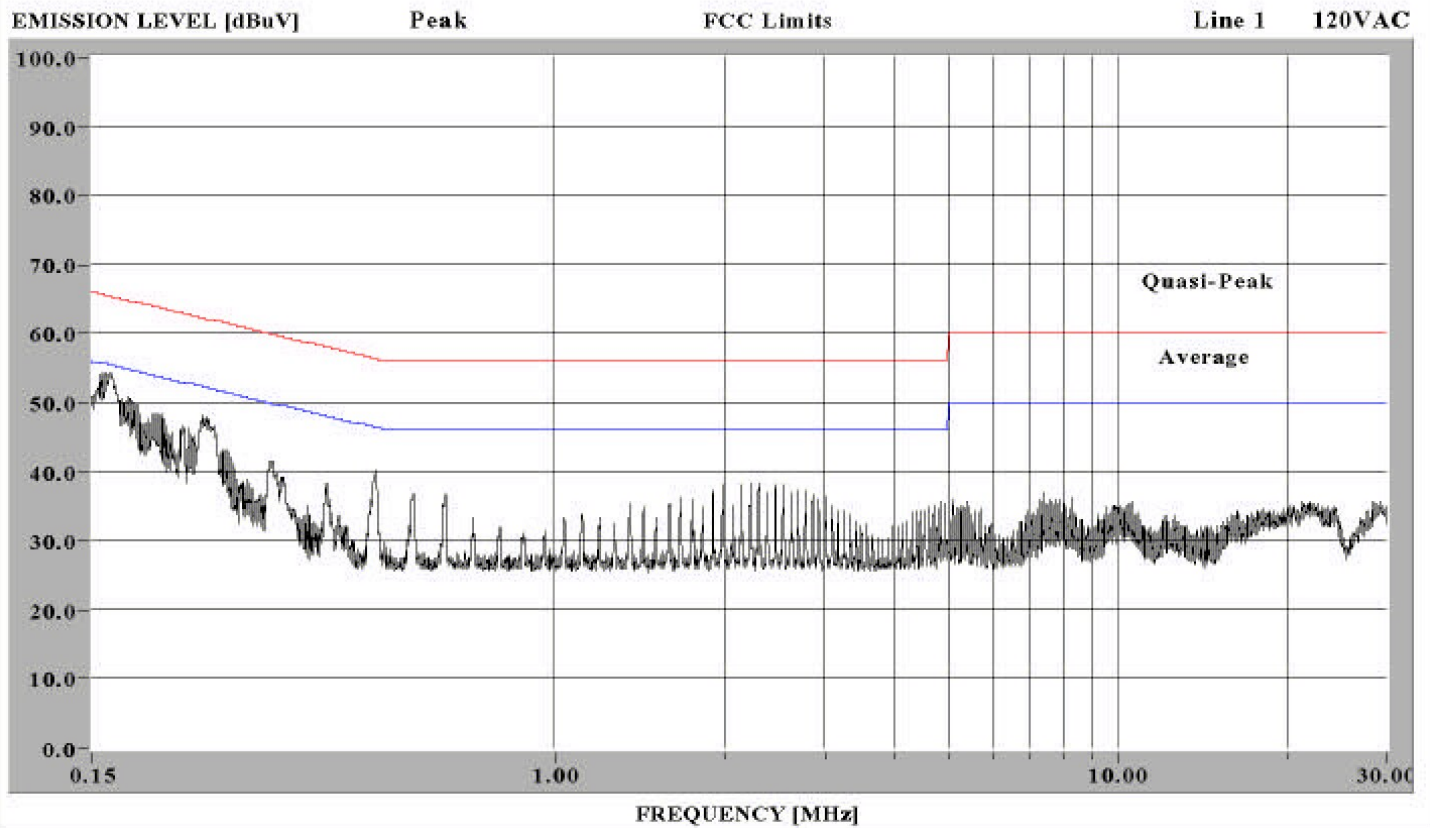

RBW = 100 kHz, VBW = 100 kHz

Page 3 of 69 (Appendix A)
Report Number: INTEL-031126F
FCC ID: PD9WM3A2200BG



AEGIS LABS INC.

AC Power Line Conducted Emissions Test Results (Continued)

CONDUCTED EMISSIONS - LINE 2						
Freq. (MHz)	Meter Reading (dBuV)	Detector (PK/QP/AV)	Average Limit (dBuV)	Average Delta(dB)	Quasi-Peak Limit (dBuV)	Quasi-Peak Delta(dB)
0.1551	51.50	PK	55.85	-4.35	65.85	-14.35
0.2421	49.90	PK	53.37	-3.47	63.37	-13.47
0.3165	44.10	PK	51.24	-7.14	61.24	-17.14
0.4023	45.50	PK	48.79	-3.29	58.79	-13.29
2.1550	41.40	PK	46.00	-4.60	56.00	-14.60
5.0350	40.90	PK	50.00	-9.10	60.00	-19.10

Aegis Labs, Inc.

Date: 12/2/2003 Time: 3:13 PM

Usage for graphical purposes only
Refer to conducted measurement table for
Peak, QP, and Avg. measurements, where applicable.

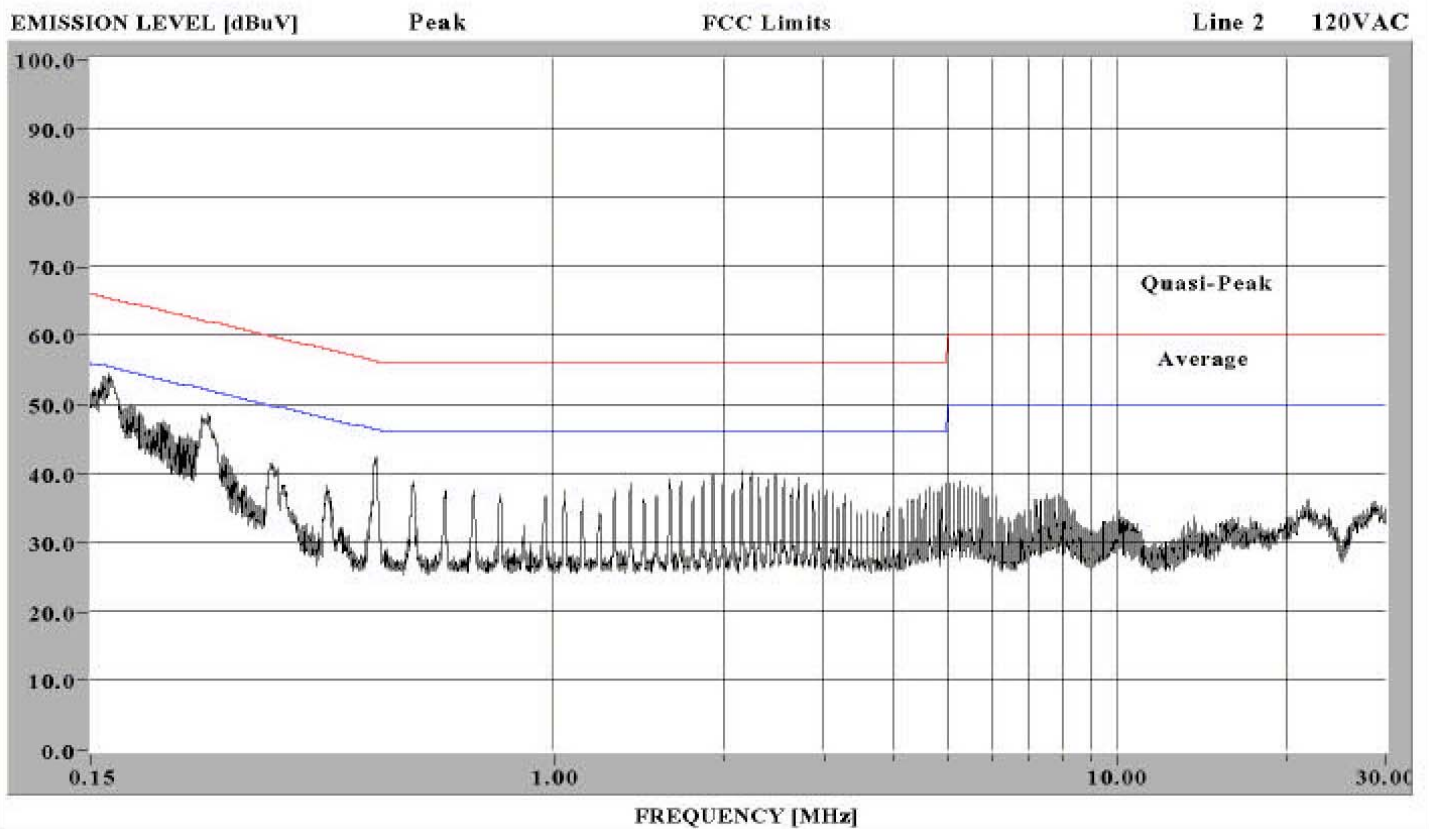

RBW = 100 kHz, VBW = 100 kHz

Page 4 of 69 (Appendix A)
Report Number: INTEL-031126F
FCC ID: PD9WM3A2200BG



AEGIS LABS INC.

SPURIOUS RADIATED EMISSIONS TEST RESULTS

CLIENT:	Intel Corporation	DATE:	12/02/03
EUT:	Intel PRO/Wireless 2200BG Network Connection	PROJECT NUMBER:	INTEL-031125-08
MODEL NUMBER:	WM3A2200BG	TEST ENGINEER:	Rick Candelas
SERIAL NUMBER:	0058AAA463ADC54980203	SITE #:	2
CONFIGURATION:	Tested installed in the Dell notebook computer's mini PCI slot.	TEMPERATURE:	21 C
		HUMIDITY:	44% RH
		TIME:	1:00 PM

Standard:	FCC Pt. 15.209
Description:	Unwanted emissions below 1 GHz must comply with the general field strength limits set forth in Sec. 15.209.
Results:	Passes the radiated limits by $-5.53@ 65.53$ MHz (Vertical antenna polarization)

Radiated Limits	
Frequency (MHz)	Quasi-Peak Limit (dBuV) @ 10m
30-230	30
230-1000	37

NOTE 1: During preliminary scans, there wasn't any difference which channel or data rate was used with the EUT; therefore only Channel 1 at a data rate of 1 Mbps was used for final testing. Also, the scan was only done with the Wistron set of antennas.

NOTE 2: RBW/VBW = 1 MHz

Page 5 of 69 (Appendix A)
Report Number: INTEL-031126F
FCC ID: PD9WM3A2200BG



Spurious Radiated Emissions Test Results (Continued)

RADIATED EMISSIONS - Horizontal Antenna Polarization

Freq. (MHz)	Meter Reading (dBuV)	Antenna Height (cm)	Azimuth (degrees)	Peak, Quasi pk or AVG (dBuV)	Preamp Factor (dB)	Cable Factor (dB)	Ant. Factor (dB)	10 Meter Distance Factor (dB)	Corrected Reading (dBuV)	Limits (dBuV)	Diff (dB) +=FAIL
54.50	32.10	300	270	PK	34.40	1.15	10.22	10.46	19.52	40.00	-20.48
66.51	36.80	350	180	PK	34.40	1.33	7.16	10.46	21.36	40.00	-18.64
119.80	37.60	400	180	PK	34.39	1.80	13.37	10.46	28.84	43.50	-14.66
231.97	36.00	400	180	PK	34.24	2.63	17.48	10.46	32.33	46.00	-13.67
315.60	35.60	300	180	PK	34.12	3.09	14.37	10.46	29.40	46.00	-16.60
322.07	43.40	300	180	PK	34.11	3.13	14.77	10.46	37.65	46.00	-8.35
331.95	33.70	300	225	PK	34.10	3.19	15.02	10.46	28.27	46.00	-17.73

RADIATED EMISSIONS - Vertical Antenna Polarization

Freq. (MHz)	Meter Reading (dBuV)	Antenna Height (cm)	Azimuth (degrees)	Peak, Quasi pk or AVG (dBuV)	Preamp Factor (dB)	Cable Factor (dB)	Ant. Factor (dB)	10 Meter Distance Factor (dB)	Corrected Reading (dBuV)	Limits (dBuV)	Diff (dB) +=FAIL
58.60	47.20	100	180	PK	34.40	1.19	9.02	10.46	33.47	40.00	-6.53
65.53	49.50	100	270	PK	34.40	1.31	7.59	10.46	34.47	40.00	-5.53
119.66	42.20	100	270	PK	34.39	1.80	11.86	10.46	31.92	43.50	-11.58
250.08	37.20	100	180	PK	34.22	2.70	19.10	10.46	35.24	46.00	-10.76
313.15	37.30	100	180	PK	34.13	3.08	14.77	10.46	31.49	46.00	-14.51
321.30	40.70	100	180	PK	34.12	3.13	15.38	10.46	35.55	46.00	-10.45
333.04	37.50	100	315	PK	34.10	3.20	15.57	10.46	32.62	46.00	-13.38

NOTE 1: The measurements were taken at 10 meters and extrapolated to 3 meters.

NOTE 2: The measurements are Peak readings unless otherwise specified.



AEGIS LABS INC.

Spurious Radiated Emissions Test Results (Continued)

CLIENT:	Intel Corporation	DATE:	11/26/03
EUT:	Intel PRO/Wireless 2200BG Network Connection	PROJECT NUMBER:	INTEL-031125
MODEL NUMBER:	WM3A2200BG	TEST ENGINEER:	Rick Candelas
SERIAL NUMBER:	0058AAA463ADC54980203	SITE #:	2
CONFIGURATION:	Tested installed in the Dell notebook computer's mini PCI slot Wistron antennas in 802.11b mode.	TEMPERATURE:	11 C
		HUMIDITY:	63% RH
		TIME:	11:00 AM

Standard:	FCC CFR 47, Part 15.247(c)
Description:	Radiated emissions, which fall in the restricted bands, as defined in Sec. 15.205(a), must also comply with the radiated emission limits specified in Sec. 15.209(a). All others must be < -20dBc.
Results:	Passes (See Data Sheets)

Unwanted Spurious Emissions Limits			
Frequency (MHz)	Field Strength (uV/m)	Field Strength (dBuV/m) (Emissions in the restricted bands)	Field Strength (dBm/MHz) (Emissions outside the restricted bands)
Above 960	500	54.00 (Average) 74.00 (Peak)	< -20 dBc

NOTE 1: RBW/VBW = 1 MHz

Page 7 of 69 (Appendix A)
Report Number: INTEL-031126F
FCC ID: PD9WM3A2200BG



Spurious Radiated Emissions Test Results (Continued)

*Fundamental Measurements in 802.11b mode
Channels 1, 6, & 11
Continuous TX at MAIN Antenna port with Wistron Antennas
Aegis Labs, Inc. File #: INTEL-031125-14*

RADIATED EMISSIONS - Horizontal Antenna Polarization											
<i>Freq. (MHz)</i>	<i>Meter Reading (dBuV)</i>	<i>Antenna Height (cm)</i>	<i>Azimuth (degrees)</i>	<i>Quasi pk or AVG (dBuV)</i>		<i>Preamp Factor (dB)</i>	<i>Cable Factor (dB)</i>	<i>Ant. Factor (dB)</i>	<i>Corrected Reading (dBuV)</i>	<i>Limits (dBuV)</i>	<i>Diff (dB) +=FAIL</i>
2412.00	71.83	100	225				3.30	31.11	106.24		
2412.00				66.50	A		3.30	31.11	100.91		
2437.00	73.00	100	225				3.32	31.05	107.37		
2437.00				67.67	A		3.32	31.05	102.04		
2462.00	70.00	100	225				3.34	30.99	104.33		
2462.00				64.67	A		3.34	30.99	99.00		

RADIATED EMISSIONS – Vertical Antenna Polarization											
<i>Freq. (MHz)</i>	<i>Meter Reading (dBuV)</i>	<i>Antenna Height (cm)</i>	<i>Azimuth (degrees)</i>	<i>Quasi pk or AVG (dBuV)</i>		<i>Preamp Factor (dB)</i>	<i>Cable Factor (dB)</i>	<i>Ant. Factor (dB)</i>	<i>Corrected Reading (dBuV)</i>	<i>Limits (dBuV)</i>	<i>Diff (dB) +=FAIL</i>
2412.00	74.83	100	0				3.30	31.24	109.37		
2412.00				69.17	A		3.30	31.24	103.71		
2437.00	74.33	100	0				3.32	31.20	108.85		
2437.00				68.00	A		3.32	31.20	102.52		
2462.00	71.33	100	180				3.34	31.16	105.83		
2462.00				65.83	A		3.34	31.16	100.33		



Spurious Radiated Emissions Test Results (Continued)

*Band Edge Field Strength Measurements in 802.11b mode
Channels 1, 6, & 11
Continuous TX at MAIN Antenna port with Wistron Antennas
Aegis Labs, Inc. File #: INTEL-031125-14*

RADIATED EMISSIONS - Horizontal Antenna Polarization										
Freq. (MHz)	Meter Reading (dBuV)	Antenna Height (cm)	Azimuth (degrees)	Quasi pk or AVG (dBuV)	Preamp Factor (dB)	Cable Factor (dB)	Ant. Factor (dB)	Corrected Reading (dBuV)	Limits (dBuV)	Diff (dB) +=FAIL
2390.00								53.07	74.00	-20.93
2390.00					A			42.41	54.00	-11.59
2385.20								56.41	74.00	-17.59
2385.20					A			48.08	54.00	-5.92
2400.00	38.13	100	270			3.29	31.14	72.56	86.24	-13.68
2483.50								51.33	74.00	-22.67
2483.50					A			41.50	54.00	-12.50
2487.36								53.16	74.00	-20.84
2487.36					A			45.00	54.00	-9.00
RADIATED EMISSIONS - Vertical Antenna Polarization										
Freq. (MHz)	Meter Reading (dBuV)	Antenna Height (cm)	Azimuth (degrees)	Quasi pk or AVG (dBuV)	Preamp Factor (dB)	Cable Factor (dB)	Ant. Factor (dB)	Corrected Reading (dBuV)	Limits (dBuV)	Diff (dB) +=FAIL
2390.00								56.20	74.00	-17.80
2390.00					A			45.21	54.00	-8.79
2385.20								59.54	74.00	-14.46
2385.20					A			50.88	54.00	-3.12
2400.00	40.00	100	0			3.29	31.26	74.55	89.37	-14.82
2483.50								52.83	74.00	-21.17
2483.50					A			42.83	54.00	-11.17
2487.36								54.66	74.00	-19.34
2487.36					A			46.33	54.00	-7.67

NOTE: The "Band Edge Field Strength" was calculated using the "Fundamental" and "Conducted Band Edge" measurements per the "Marker-Delta Method" with the following formula:

$$BE = F_m - \Delta m$$

Where

BE = Band Edge Field Strength

F_m = Measured Fundamental (Peak or Average)

Δ_m = Measured Conducted Band Edge Delta (Peak or Average)



AEGIS LABS INC.

Spurious Radiated Emissions Test Results (Continued)
 (Marker Delta Conducted Band Edge Plots)

Plots Showing Out-Of-Band Emissions (Peak RBW=VBW=1MHz; Average RBW = 1MHz, VBW = 10Hz)

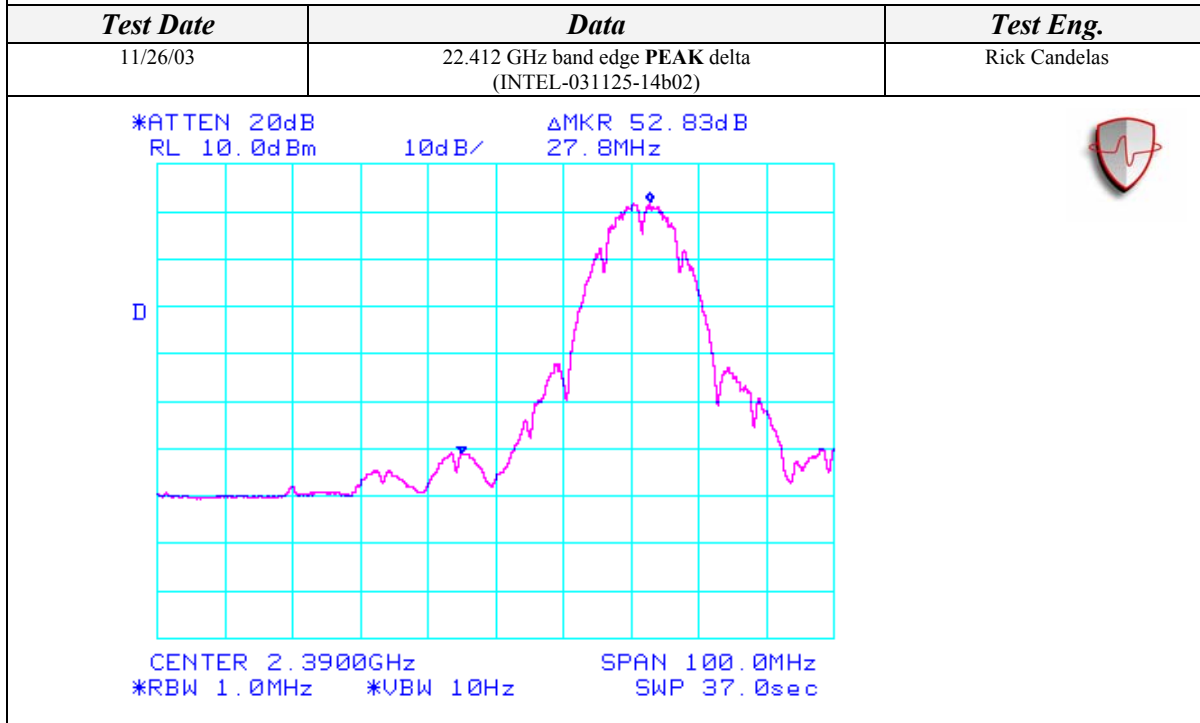
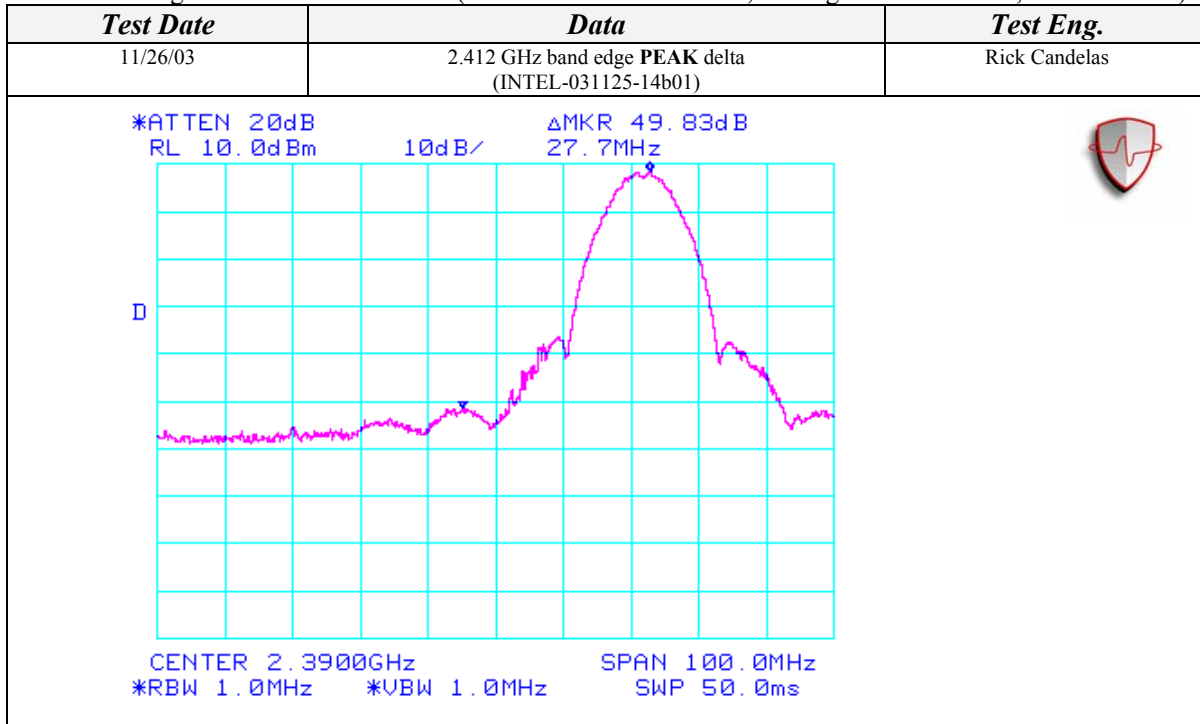

Page 10 of 69 (Appendix A)
 Report Number: INTEL-031126F
 FCC ID: PD9WM3A2200BG



AEGIS LABS INC.

Spurious Radiated Emissions Test Results (Continued)
 (Marker Delta Conducted Band Edge Plots)

Plots Showing Out-Of-Band Emissions (Peak RBW=VBW=1MHz; Average RBW = 1MHz, VBW = 10Hz)

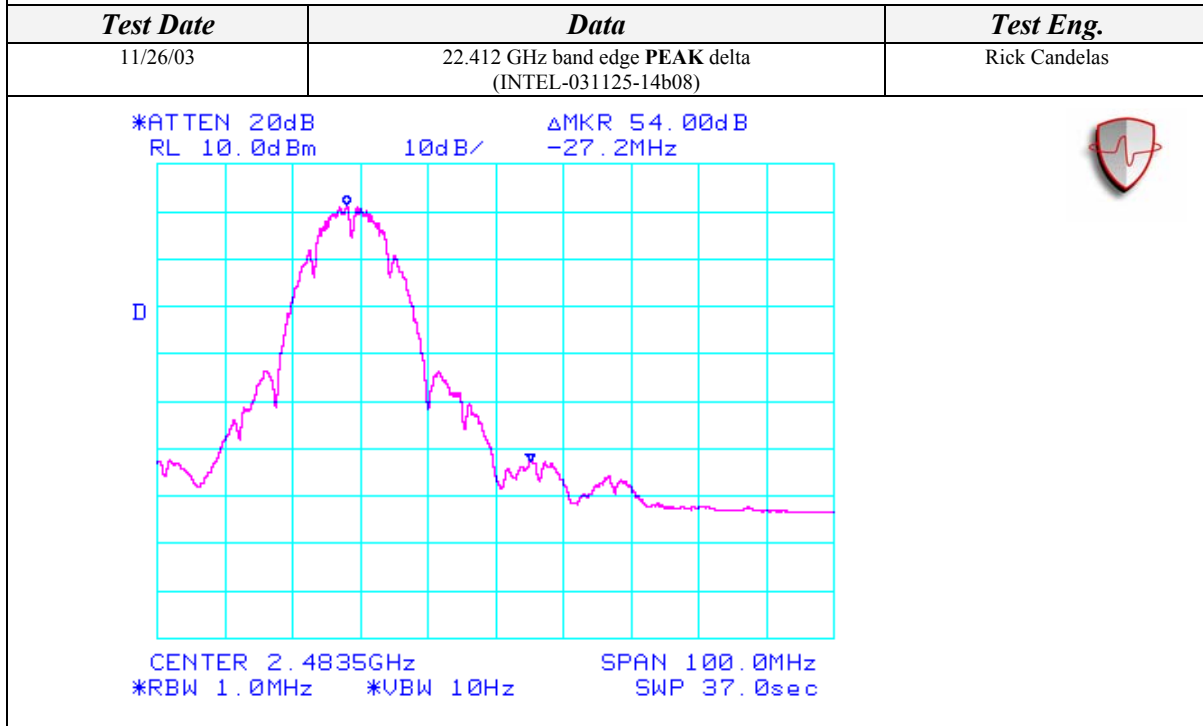
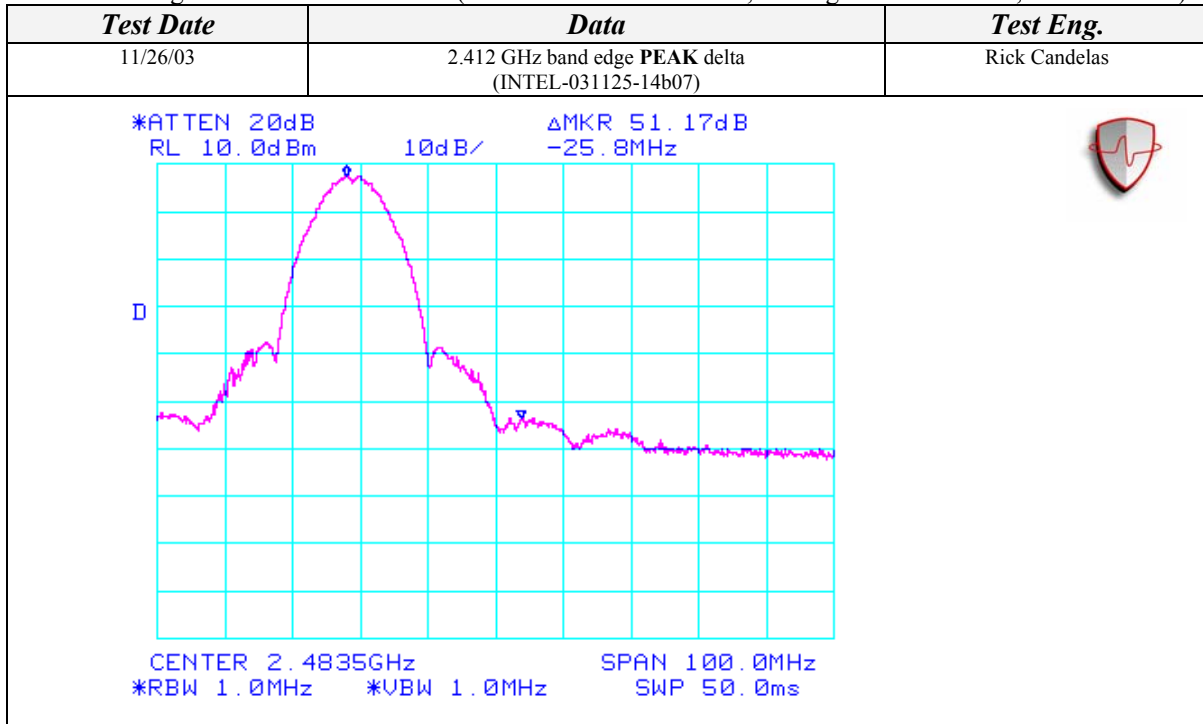



Spurious Radiated Emissions Test Results (Continued)

*Spurious Emissions Measurements in 802.11b mode
Channels 1, 6, & 11
Continuous TX at MAIN Antenna port with Wistron Antennas
Aegis Labs, Inc. File #: INTEL-031125-12*

RADIATED EMISSIONS - Horizontal Antenna Polarization											
Freq. (MHz)	Meter Reading (dBuV)	Antenna Height (cm)	Azimuth (degrees)	Quasi pk or AVG (dBuV)		1 Meter Distance Factor (dB)	Cable Factor (dB)	Ant. Factor (dB)	Corrected Reading (dBuV)	Limits (dBuV)	Diff (dB) +=FAIL
EUT in Continuous Transmit Mode on Channel 1 (2.412 GHz)											
2312.00	32.17	100	225			9.54	3.23	31.35	57.21	74.00	-16.79
2312.00				20.17	A	9.54	3.23	31.35	45.21	54.00	-8.79
EUT in Continuous Transmit Mode on Channel 6 (2.437 GHz)											
2336.00	33.33	100	225			9.54	3.25	31.29	58.33	74.00	-15.67
2336.00				21.00	A	9.54	3.25	31.29	46.00	54.00	-8.00
EUT in Continuous Transmit Mode on Channel 11 (2.462 GHz)											
2360.00	32.33	100	225			9.54	3.26	31.24	57.29	74.00	-16.71
2360.00				19.83	A	9.54	3.26	31.24	44.79	54.00	-9.21
RADIATED EMISSIONS - Vertical Antenna Polarization											
Freq. (MHz)	Meter Reading (dBuV)	Antenna Height (cm)	Azimuth (degrees)	Quasi pk or AVG (dBuV)		1 Meter Distance Factor (dB)	Cable Factor (dB)	Ant. Factor (dB)	Corrected Reading (dBuV)	Limits (dBuV)	Diff (dB) +=FAIL
EUT in Continuous Transmit Mode on Channel 1 (2.412 GHz)											
2312.00	32.17	100	0			9.54	3.23	31.40	57.26	74.00	-16.74
2312.00				20.67	A	9.54	3.23	31.40	45.76	54.00	-8.24
EUT in Continuous Transmit Mode on Channel 6 (2.437 GHz)											
2336.00	32.67	100	0			9.54	3.25	31.36	57.74	74.00	-16.26
2336.00				21.67	A	9.54	3.25	31.36	46.74	54.00	-7.26
EUT in Continuous Transmit Mode on Channel 11 (2.462 GHz)											
2360.00	32.50	100	0			9.54	3.26	31.32	57.55	74.00	-16.45
2360.00				21.00	A	9.54	3.26	31.32	46.05	54.00	-7.95

NOTE: These spurious emissions measurements were taken without a preamp at a distance on 1 meter to avoid saturating the preamp and analyzer because the signals were close to the fundamental frequency. The readings were extrapolated to 1 meter.



Spurious Radiated Emissions Test Results (Continued)

Spurious Emissions Measurements in 802.11b mode
Channels 1, 6, & 11
Continuous TX at MAIN Antenna port with Wistron Antennas
Aegis Labs, Inc. File #: INTEL-031125-07

Table with 12 columns: Freq. (MHz), Meter Reading (dBuV), Antenna Height (cm), Azimuth (degrees), Quasi pk or AVG (dBuV), Preamp Factor (dB), Cable Factor (dB), Ant. Factor (dB), Corrected Reading (dBuV), Limits (dBuV), Diff (dB) +/- FAIL. It contains three sections of data for Channels 1, 6, and 11.



Spurious Radiated Emissions Test Results (Continued)

RADIATED EMISSIONS - Vertical Antenna Polarization											
<i>Freq. (MHz)</i>	<i>Meter Reading (dBuV)</i>	<i>Antenna Height (cm)</i>	<i>Azimuth (degrees)</i>	<i>Quasi pk or AVG (dBuV)</i>		<i>Preamp Factor (dB)</i>	<i>Cable Factor (dB)</i>	<i>Ant. Factor (dB)</i>	<i>Corrected Reading (dBuV)</i>	<i>Limits (dBuV)</i>	<i>Diff (dB) +=FAIL</i>
EUT in Continuous Transmit Mode on Channel 1 (2.412 GHz)											
1000.00	59.67	100	225			42.66	2.07	25.70	44.78	74.00	-29.22
1000.00				43.00	A	42.66	2.07	25.70	28.11	54.00	-25.89
1217.53	54.33	100	45			42.59	2.38	27.01	41.12	74.00	-32.88
1217.53				39.33	A	42.59	2.38	27.01	26.12	54.00	-27.88
3215.80	51.00	100	45			43.07	3.89	30.44	42.26	89.37	-47.11
4824.20	51.33	100	270			43.27	4.73	34.53	47.33	74.00	-26.67
4824.20				42.33	A	43.27	4.73	34.53	38.33	54.00	-15.67
6431.89	54.50	100	225			43.82	5.73	36.64	53.06	89.37	-36.31
9648.00	56.00	100	225			43.22	6.95	38.97	58.70	89.37	-30.67
EUT in Continuous Transmit Mode on Channel 6 (2.437 GHz)											
1000.00	58.67	100	180			42.66	2.07	25.70	43.78	74.00	-30.22
1000.00				42.83	A	42.66	2.07	25.70	27.94	54.00	-26.06
1217.73	55.17	100	0			42.59	2.38	27.01	41.97	74.00	-32.03
1217.73				40.33	A	42.59	2.38	27.01	27.13	54.00	-26.87
3249.23	50.83	100	270			43.08	3.91	30.45	42.10	88.85	-46.75
4874.00	48.67	100	270			43.29	4.77	34.72	44.87	74.00	-29.13
4874.00				36.83	A	43.29	4.77	34.72	33.03	54.00	-20.97
6498.65	55.83	100	135			43.84	5.78	36.89	54.66	88.85	-34.19
9748.03	54.83	100	180			43.25	6.99	39.15	57.71	88.85	-31.14
EUT in Continuous Transmit Mode on Channel 11 (2.462 GHz)											
1000.00	59.67	100	180			42.66	2.07	25.70	44.78	74.00	-29.22
1000.00				42.17	A	42.66	2.07	25.70	27.28	54.00	-26.72
1217.60	55.17	100	45			42.59	2.38	27.01	41.96	74.00	-32.04
1217.60				39.50	A	42.59	2.38	27.01	26.29	54.00	-27.71
3282.77	50.67	100	225			43.10	3.91	30.46	41.94	85.83	-43.89
4923.95	49.17	100	225			43.30	4.81	34.91	45.58	74.00	-28.42
4923.95				35.17	A	43.30	4.81	34.91	31.58	54.00	-22.42
6565.35	55.00	100	225			43.84	5.83	37.38	54.37	85.83	-31.46
9848.05	55.33	100	225			43.29	7.03	39.33	58.40	85.83	-27.43



Spurious Radiated Emissions Test Results (Continued)

Spurious Emissions Measurements in 802.11b mode
Channels 1, 6, & 11
Continuous RX at MAIN Antenna port with Wistron Antennas
Aegis Labs, Inc. File #: INTEL-031125-07

RADIATED EMISSIONS - Horizontal Antenna Polarization											
<i>Freq. (MHz)</i>	<i>Meter Reading (dBuV)</i>	<i>Antenna Height (cm)</i>	<i>Azimuth (degrees)</i>	<i>Quasi pk or AVG (dBuV)</i>		<i>Preamp Factor (dB)</i>	<i>Cable Factor (dB)</i>	<i>Ant. Factor (dB)</i>	<i>Corrected Reading (dBuV)</i>	<i>Limits (dBuV)</i>	<i>Diff (dB) +=FAIL</i>
EUT in Continuous Receive Mode on Channel 1 (2.412 GHz)											
1000.00	57.83	100	0			42.66	2.07	25.50	42.74	74.00	-31.26
1000.00				42.00	A	42.66	2.07	25.50	26.91	54.00	-27.09
1215.83	53.30	100	135			42.59	2.38	26.84	39.92	74.00	-34.08
1215.83				41.83	A	42.59	2.38	26.84	28.45	54.00	-25.55
3215.93	49.50	100	135			43.07	3.89	30.24	40.56	80.00	-39.44
3215.93				41.50	A	43.07	3.89	30.24	32.56	60.00	-27.44
6431.93	51.50	100	225			43.82	5.73	36.64	50.06	80.00	-29.94
6431.93				43.17	A	43.82	5.73	36.64	41.73	60.00	-18.27
EUT in Continuous Receive Mode on Channel 6 (2.437 GHz)											
1000.00	59.33	100	45			42.66	2.07	25.50	44.24	74.00	-29.76
1000.00				42.83	A	42.66	2.07	25.50	27.74	54.00	-26.26
1217.77	53.67	100	135			42.59	2.38	26.85	40.31	74.00	-33.69
1217.77				41.83	A	42.59	2.38	26.85	28.47	54.00	-25.53
3249.23	50.50	100	270			43.08	3.91	30.25	41.57	80.00	-38.43
3249.23				42.00	A	43.08	3.91	30.25	33.07	60.00	-26.93
6498.54	52.67	100	225			43.84	5.78	36.89	51.50	80.00	-28.50
6498.54				43.00	A	43.84	5.78	36.89	41.83	60.00	-18.17
EUT in Continuous Receive Mode on Channel 11 (2.462 GHz)											
1000.00	59.67	100	0			42.66	2.07	25.50	44.58	74.00	-29.42
1000.00				42.67	A	42.66	2.07	25.50	27.58	54.00	-26.42
1217.20	54.50	100	135			42.59	2.38	26.85	41.13	74.00	-32.87
1217.20				41.67	A	42.59	2.38	26.85	28.30	54.00	-25.70
3282.75	50.83	100	270			43.10	3.91	30.26	41.90	80.00	-38.10
3282.75				41.87	A	43.10	3.91	30.26	32.94	60.00	-27.06
6565.39	52.00	100	225			43.84	5.83	37.32	51.31	80.00	-28.69
6565.39				43.17	A	43.84	5.83	37.32	42.48	60.00	-17.52



Spurious Radiated Emissions Test Results (Continued)

RADIATED EMISSIONS - Vertical Antenna Polarization											
<i>Freq. (MHz)</i>	<i>Meter Reading (dBuV)</i>	<i>Antenna Height (cm)</i>	<i>Azimuth (degrees)</i>	<i>Quasi pk or AVG (dBuV)</i>	<i>Preamp Factor (dB)</i>	<i>Cable Factor (dB)</i>	<i>Ant. Factor (dB)</i>	<i>Corrected Reading (dBuV)</i>	<i>Limits (dBuV)</i>	<i>Diff (dB) +=FAIL</i>	
EUT in Continuous Receive Mode on Channel 1 (2.412 GHz)											
1000.00	61.83	100	0			42.66	2.07	25.70	46.94	74.00	-27.06
1000.00				45.17	A	42.66	2.07	25.70	30.28	54.00	-23.72
1217.87	58.17	100	180			42.59	2.38	27.01	44.97	74.00	-29.03
1217.87				42.33	A	42.59	2.38	27.01	29.13	54.00	-24.87
3215.94	51.17	100	270			43.07	3.89	30.44	42.43	80.00	-37.57
3215.94				42.00	A	43.07	3.89	30.44	33.26	60.00	-26.74
6431.90	54.17	100	225			43.82	5.73	36.64	52.73	80.00	-27.27
6431.90				43.33	A	43.82	5.73	36.64	41.89	60.00	-18.11
EUT in Continuous Receive Mode on Channel 6 (2.437 GHz)											
1000.00	60.50	100	0			42.66	2.07	25.70	45.61	74.00	-28.39
1000.00				44.33	A	42.66	2.07	25.70	29.44	54.00	-24.56
1217.43	56.83	100	180			42.59	2.38	27.00	43.62	74.00	-30.38
1217.43				41.83	A	42.59	2.38	27.00	28.62	54.00	-25.38
3249.39	52.00	100	270			43.08	3.91	30.45	43.27	80.00	-36.73
3249.39				42.17	A	43.08	3.91	30.45	33.44	60.00	-26.56
6498.65	54.83	100	225			43.84	5.78	36.89	53.66	80.00	-26.34
6498.65				42.87	A	43.84	5.78	36.89	41.70	60.00	-18.30
EUT in Continuous Receive Mode on Channel 11 (2.462 GHz)											
1000.00	61.00	100	0			42.66	2.07	25.70	46.11	74.00	-27.89
1000.00				44.00	A	42.66	2.07	25.70	29.11	54.00	-24.89
1212.77	57.33	100	180			42.59	2.37	26.98	44.09	74.00	-29.91
1212.77				41.17	A	42.59	2.37	26.98	27.93	54.00	-26.07
3282.63	51.00	100	270			43.10	3.91	30.46	42.27	80.00	-37.73
3282.63				40.00	A	43.10	3.91	30.46	31.27	60.00	-28.73
6565.34	53.83	100	225			43.84	5.83	37.38	53.20	80.00	-26.80
6565.34				42.54	A	43.84	5.83	37.38	41.91	60.00	-18.09



AEGIS LABS INC.

Spurious Radiated Emissions Test Results (Continued)

CLIENT:	Intel Corporation	DATE:	12/02/03
EUT:	Intel PRO/Wireless 2200BG Network Connection	PROJECT NUMBER:	INTEL-031125
MODEL NUMBER:	WM3A2200BG	TEST ENGINEER:	Rick Candelas
SERIAL NUMBER:	0058AAA463ADC54980203	SITE #:	2
CONFIGURATION:	Tested installed in the Dell notebook computer's mini PCI slot using the Wistron antennas in 802.11g mode.	TEMPERATURE:	15 C
		HUMIDITY:	53% RH
		TIME:	9:00 AM

Standard:	FCC CFR 47, Part 15.247(c)
Description:	Radiated emissions, which fall in the restricted bands, as defined in Sec. 15.205(a), must also comply with the radiated emission limits specified in Sec. 15.209(a). All others must be < -20dBc.
Results:	Passes (See Data Sheets)

Unwanted Spurious Emissions Limits			
Frequency (MHz)	Field Strength (uV/m)	Field Strength (dBuV/m) (Emissions in the restricted bands)	Field Strength (dBm/MHz) (Emissions outside the restricted bands)
Above 960	500	54.00 (Average) 74.00 (Peak)	< -20 dBc

NOTE 1: RBW/VBW = 1 MHz

Page 17 of 69 (Appendix A)
Report Number: INTEL-031126F
FCC ID: PD9WM3A2200BG



Spurious Radiated Emissions Test Results (Continued)

*Fundamental Measurements in 802.11g mode
Channels 1, 6, & 11
Continuous TX at MAIN Antenna port with Wistron Antennas
Aegis Labs, Inc. File #: INTEL-031125-14*

RADIATED EMISSIONS - Horizontal Antenna Polarization											
<i>Freq. (MHz)</i>	<i>Meter Reading (dBuV)</i>	<i>Antenna Height (cm)</i>	<i>Azimuth (degrees)</i>	<i>Quasi pk or AVG (dBuV)</i>		<i>Preamp Factor (dB)</i>	<i>Cable Factor (dB)</i>	<i>Ant. Factor (dB)</i>	<i>Corrected Reading (dBuV)</i>	<i>Limits (dBuV)</i>	<i>Diff (dB) +=FAIL</i>
2412.00	73.17	100	225				3.30	31.11	107.58		
2412.00				59.50	A		3.30	31.11	93.91		
2437.00	72.33	100	225				3.32	31.05	106.70		
2437.00				59.17	A		3.32	31.05	93.54		
2462.00	71.83	100	225				3.34	30.99	106.16		
2462.00				58.67	A		3.34	30.99	93.00		

RADIATED EMISSIONS – Vertical Antenna Polarization											
<i>Freq. (MHz)</i>	<i>Meter Reading (dBuV)</i>	<i>Antenna Height (cm)</i>	<i>Azimuth (degrees)</i>	<i>Quasi pk or AVG (dBuV)</i>		<i>Preamp Factor (dB)</i>	<i>Cable Factor (dB)</i>	<i>Ant. Factor (dB)</i>	<i>Corrected Reading (dBuV)</i>	<i>Limits (dBuV)</i>	<i>Diff (dB) +=FAIL</i>
2412.00	74.67	100	0				3.30	31.24	109.21		
2412.00				61.00	A		3.30	31.24	95.54		
2437.00	73.33	100	180				3.32	31.20	107.85		
2437.00				59.83	A		3.32	31.20	94.35		
2462.00	72.83	100	180				3.34	31.16	107.33		
2462.00				59.00	A		3.34	31.16	93.50		



Spurious Radiated Emissions Test Results (Continued)

*Band Edge Field Strength Measurements in 802.11g mode
Channels 1, 6, & 11
Continuous TX at MAIN Antenna port with Wistron Antennas
Aegis Labs, Inc. File #: INTEL-031125-14*

RADIATED EMISSIONS - Horizontal Antenna Polarization											
<i>Freq. (MHz)</i>	<i>Meter Reading (dBuV)</i>	<i>Antenna Height (cm)</i>	<i>Azimuth (degrees)</i>	<i>Quasi pk or AVG (dBuV)</i>		<i>Preamp Factor (dB)</i>	<i>Cable Factor (dB)</i>	<i>Ant. Factor (dB)</i>	<i>Corrected Reading (dBuV)</i>	<i>Limits (dBuV)</i>	<i>Diff (dB) +=FAIL</i>
2390.00									66.58	74.00	-7.42
2390.00					A				50.91	54.00	-3.09
2400.00	49.33	100	270				3.29	31.14	83.76	87.58	-3.82
2483.50									69.66	74.00	-4.34
2483.50					A				52.50	54.00	-1.50
RADIATED EMISSIONS – Vertical Antenna Polarization											
<i>Freq. (MHz)</i>	<i>Meter Reading (dBuV)</i>	<i>Antenna Height (cm)</i>	<i>Azimuth (degrees)</i>	<i>Quasi pk or AVG (dBuV)</i>		<i>Preamp Factor (dB)</i>	<i>Cable Factor (dB)</i>	<i>Ant. Factor (dB)</i>	<i>Corrected Reading (dBuV)</i>	<i>Limits (dBuV)</i>	<i>Diff (dB) +=FAIL</i>
2390.00									68.21	74.00	-5.79
2390.00					A				52.54	54.00	-1.46
2400.00	49.83	100	0				3.29	31.26	84.38	89.21	-4.83
2483.50									70.83	74.00	-3.17
2483.50					A				53.00	54.00	-1.00

NOTE: The “Band Edge Field Strength” was calculated using the “Fundamental” and “Conducted Band Edge” measurements per the “Marker-Delta Method” with the following formula:

$$BE = Fm - \Delta m$$

Where

BE = Band Edge Field Strength

Fm = Measured Fundamental (Peak or Average)

Δm = Measured Conducted Band Edge Delta (Peak or Average)



AEGIS LABS INC.

Spurious Radiated Emissions Test Results (Continued) (Marker Delta Conducted Band Edge Plots)

Plots Showing Out-Of-Band Emissions (Peak RBW=VBW=1MHz; Average RBW = 1MHz, VBW = 10Hz)

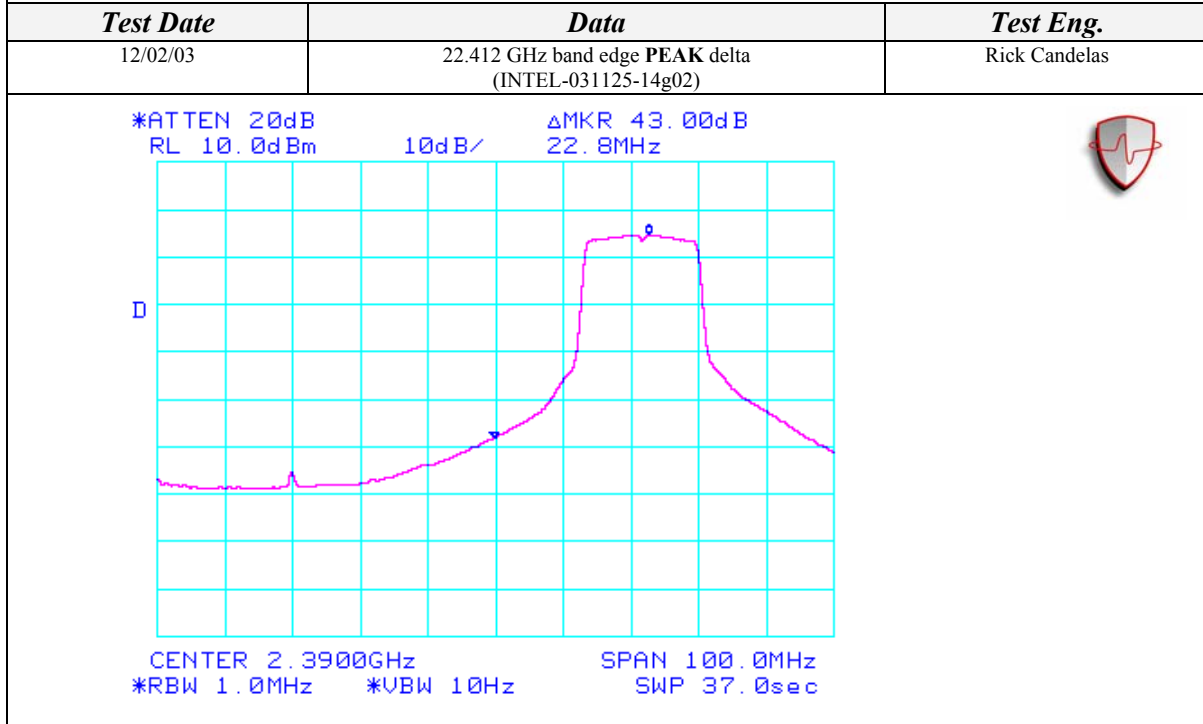
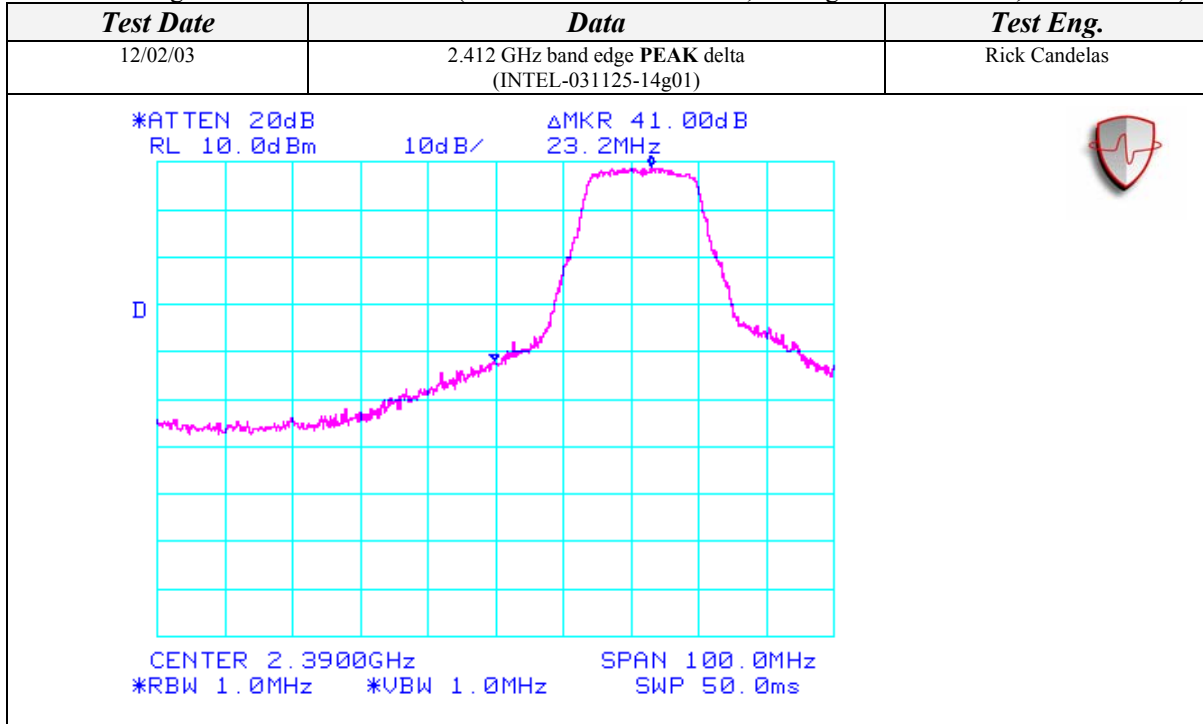

Page 20 of 69 (Appendix A)
Report Number: INTEL-031126F
FCC ID: PD9WM3A2200BG



AEGIS LABS INC.

Spurious Radiated Emissions Test Results (Continued) (Marker Delta Conducted Band Edge Plots)

Plots Showing Out-Of-Band Emissions (Peak RBW=VBW=1MHz; Average RBW = 1MHz, VBW = 10Hz)

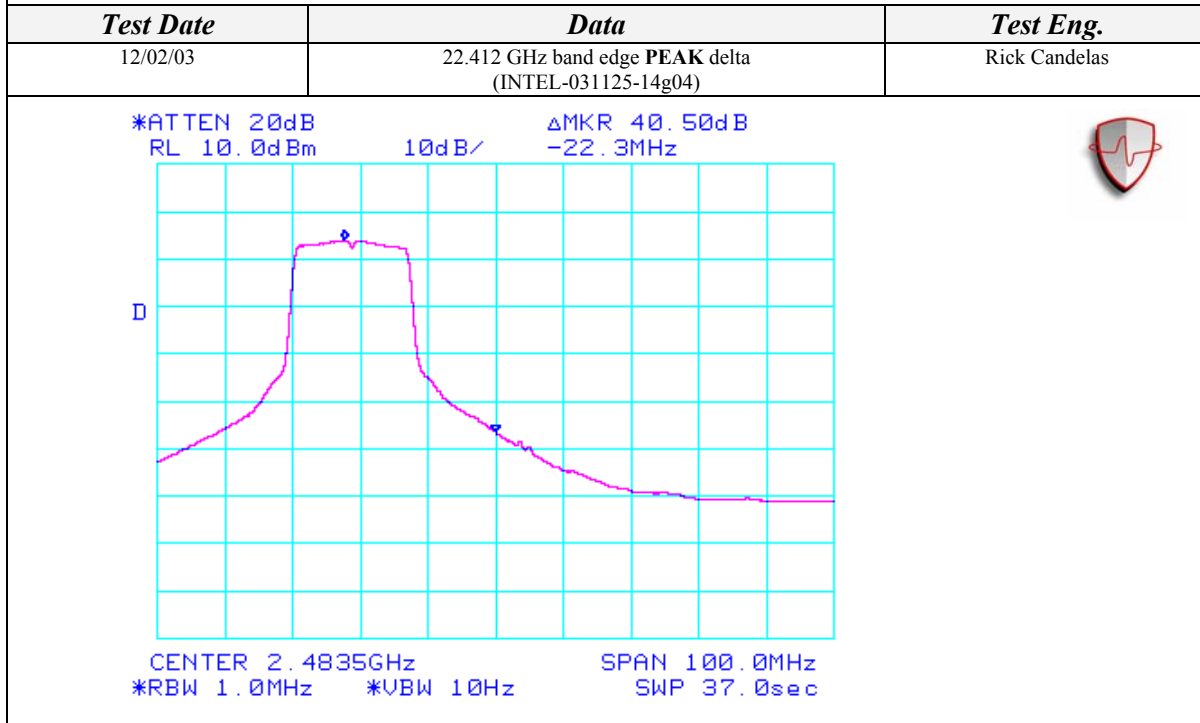
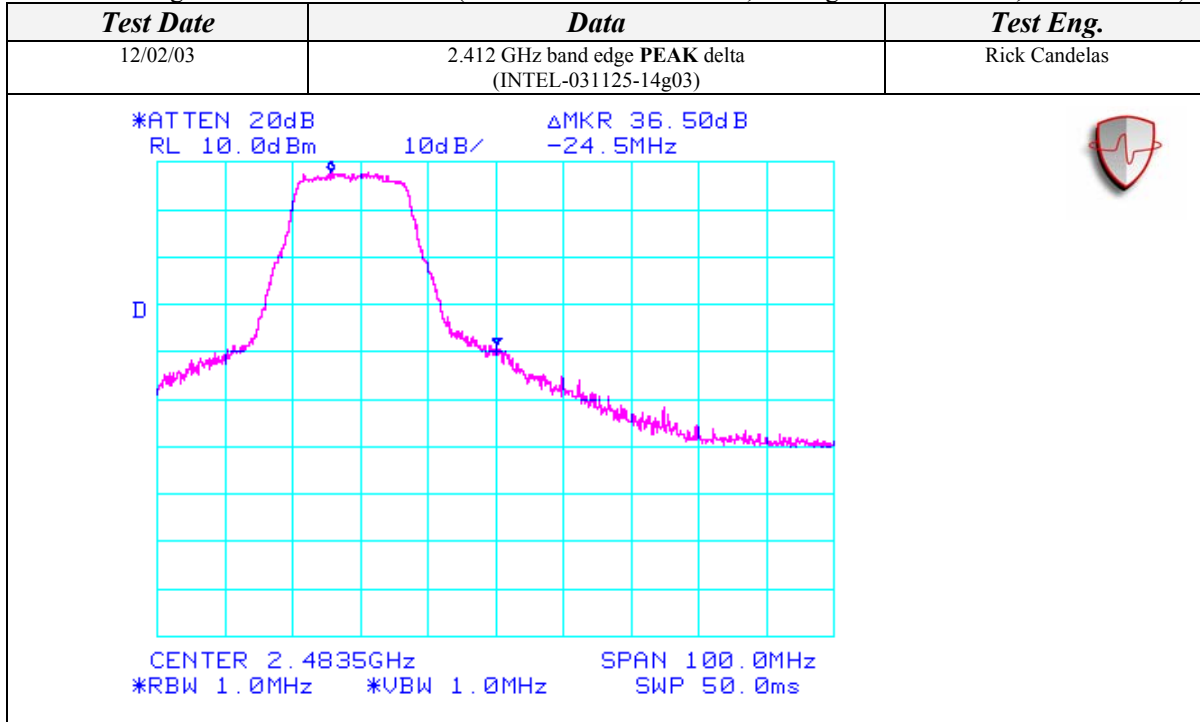



Spurious Radiated Emissions Test Results (Continued)

*Spurious Emissions Measurements in 802.11g mode
Channels 1, 6, & 11
Continuous TX at MAIN Antenna port with Wistron Antennas
Aegis Labs, Inc. File #: INTEL-031125-12*

RADIATED EMISSIONS - Horizontal Antenna Polarization											
Freq. (MHz)	Meter Reading (dBuV)	Antenna Height (cm)	Azimuth (degrees)	Quasi pk or AVG (dBuV)		1 Meter Distance Factor (dB)	Cable Factor (dB)	Ant. Factor (dB)	Corrected Reading (dBuV)	Limits (dBuV)	Diff (dB) +=FAIL
EUT in Continuous Transmit Mode on Channel 1 (2.412 GHz)											
2312.00	34.33	100	225			9.54	3.23	31.35	59.37	74.00	-14.63
2312.00				24.50	A	9.54	3.23	31.35	49.54	54.00	-4.46
EUT in Continuous Transmit Mode on Channel 6 (2.437 GHz)											
2336.00	34.50	100	225			9.54	3.25	31.29	59.50	74.00	-14.50
2336.00				24.67	A	9.54	3.25	31.29	49.67	54.00	-4.33
EUT in Continuous Transmit Mode on Channel 11 (2.462 GHz)											
2360.00	33.83	100	225			9.54	3.26	31.24	58.79	74.00	-15.21
2360.00				22.17	A	9.54	3.26	31.24	47.13	54.00	-6.87
RADIATED EMISSIONS - Vertical Antenna Polarization											
Freq. (MHz)	Meter Reading (dBuV)	Antenna Height (cm)	Azimuth (degrees)	Quasi pk or AVG (dBuV)		1 Meter Distance Factor (dB)	Cable Factor (dB)	Ant. Factor (dB)	Corrected Reading (dBuV)	Limits (dBuV)	Diff (dB) +=FAIL
EUT in Continuous Transmit Mode on Channel 1 (2.412 GHz)											
2312.00	34.50	100	0			9.54	3.23	31.40	59.59	74.00	-14.41
2312.00				24.83	A	9.54	3.23	31.40	49.92	54.00	-4.08
EUT in Continuous Transmit Mode on Channel 6 (2.437 GHz)											
2336.00	35.17	100	0			9.54	3.25	31.36	60.24	74.00	-13.76
2336.00				25.83	A	9.54	3.25	31.36	50.90	54.00	-3.10
EUT in Continuous Transmit Mode on Channel 11 (2.462 GHz)											
2360.00	34.50	100	0			9.54	3.26	31.32	59.55	74.00	-14.45
2360.00				25.00	A	9.54	3.26	31.32	50.05	54.00	-3.95

NOTE: These spurious emissions measurements were taken without a preamp at a distance on 1 meter to avoid saturating the preamp and analyzer because the signals were close to the fundamental frequency. The readings were extrapolated to 1 meter.



Spurious Radiated Emissions Test Results (Continued)

Spurious Emissions Measurements in 802.11g mode
Channels 1, 6, & 11
Continuous TX at MAIN Antenna port with Wistron Antennas
Aegis Labs, Inc. File #: INTEL-031125-07

RADIATED EMISSIONS - Horizontal Antenna Polarization

Table with 12 columns: Freq. (MHz), Meter Reading (dBuV), Antenna Height (cm), Azimuth (degrees), Quasi pk or AVG (dBuV), Preamp Factor (dB), Cable Factor (dB), Ant. Factor (dB), Corrected Reading (dBuV), Limits (dBuV), Diff (dB) +/- FAIL. It contains three sub-tables for Channels 1, 6, and 11.



Spurious Radiated Emissions Test Results (Continued)

RADIATED EMISSIONS - Vertical Antenna Polarization											
<i>Freq. (MHz)</i>	<i>Meter Reading (dBuV)</i>	<i>Antenna Height (cm)</i>	<i>Azimuth (degrees)</i>	<i>Quasi pk or AVG (dBuV)</i>		<i>Preamp Factor (dB)</i>	<i>Cable Factor (dB)</i>	<i>Ant. Factor (dB)</i>	<i>Corrected Reading (dBuV)</i>	<i>Limits (dBuV)</i>	<i>Diff (dB) +=FAIL</i>
EUT in Continuous Transmit Mode on Channel 1 (2.412 GHz)											
1000.00	59.17	100	225			42.66	2.07	25.70	44.28	74.00	-29.72
1000.00				41.83	A	42.66	2.07	25.70	26.94	54.00	-27.06
1212.83	55.67	100	45			42.59	2.37	26.98	42.43	74.00	-31.57
1212.83				40.50	A	42.59	2.37	26.98	27.26	54.00	-26.74
3216.10	50.00	100	270			43.07	3.89	30.44	41.26	89.21	-47.95
4824.00	47.50	100	180			43.27	4.73	34.53	43.49	74.00	-30.51
4824.00				34.33	A	43.27	4.73	34.53	30.32	54.00	-23.68
6431.94	54.83	100	135			43.82	5.73	36.64	53.39	89.21	-35.82
9648.06	52.67	100	270			43.22	6.95	38.97	55.37	89.21	-33.84
EUT in Continuous Transmit Mode on Channel 6 (2.437 GHz)											
1000.00	59.33	100	180			42.66	2.07	25.70	44.44	74.00	-29.56
1000.00				42.83	A	42.66	2.07	25.70	27.94	54.00	-26.06
1217.67	55.00	100	0			42.59	2.38	27.01	41.80	74.00	-32.20
1217.67				41.50	A	42.59	2.38	27.01	28.30	54.00	-25.70
3249.39	51.50	100	225			43.08	3.91	30.45	42.77	87.85	-45.08
4873.79	48.00	100	180			43.29	4.77	34.72	44.20	74.00	-29.80
4873.79				33.67	A	43.29	4.77	34.72	29.87	54.00	-24.13
6498.75	55.83	100	225			43.84	5.78	36.90	54.66	87.85	-33.19
9748.07	52.83	100	135			43.25	6.99	39.15	55.71	87.85	-32.14
EUT in Continuous Transmit Mode on Channel 11 (2.462 GHz)											
1000.00	59.00	100	180			42.66	2.07	25.70	44.11	74.00	-29.89
1000.00				43.17	A	42.66	2.07	25.70	28.28	54.00	-25.72
1217.47	54.67	100	45			42.59	2.38	27.00	41.46	74.00	-32.54
1217.47				38.83	A	42.59	2.38	27.00	25.62	54.00	-28.38
3282.53	50.67	100	270			43.10	3.91	30.46	41.94	87.33	-45.39
4824.46	48.33	100	135			43.27	4.73	34.53	44.33	74.00	-29.67
4824.46				34.17	A	43.27	4.73	34.53	30.17	54.00	-23.83
6565.38	55.50	100	225			43.84	5.83	37.38	54.87	87.33	-32.46
9848.08	51.83	100	225			43.29	7.03	39.33	54.90	87.33	-32.43



Spurious Radiated Emissions Test Results (Continued)

*Spurious Emissions Measurements in 802.11g mode
Channels 1, 6, & 11
Continuous RX at MAIN Antenna port with Wistron Antennas
Aegis Labs, Inc. File #: INTEL-031125-07*

RADIATED EMISSIONS - Horizontal Antenna Polarization											
<i>Freq. (MHz)</i>	<i>Meter Reading (dBuV)</i>	<i>Antenna Height (cm)</i>	<i>Azimuth (degrees)</i>	<i>Quasi pk or AVG (dBuV)</i>		<i>Preamp Factor (dB)</i>	<i>Cable Factor (dB)</i>	<i>Ant. Factor (dB)</i>	<i>Corrected Reading (dBuV)</i>	<i>Limits (dBuV)</i>	<i>Diff (dB) +=FAIL</i>
EUT in Continuous Receive Mode on Channel 1 (2.412 GHz)											
1000.00	58.67	100	225			42.66	2.07	25.50	43.58	74.00	-30.42
1000.00				42.83	A	42.66	2.07	25.50	27.74	54.00	-26.26
1217.43	55.00	100	0			42.59	2.38	26.85	41.64	74.00	-32.36
1217.43				39.17	A	42.59	2.38	26.85	25.81	54.00	-28.19
3216.09	48.17	100	225			43.07	3.89	30.24	39.23	80.00	-40.77
3216.09				39.17	A	43.07	3.89	30.24	30.23	60.00	-29.77
6432.00	51.00	100	225			43.82	5.73	36.64	49.56	80.00	-30.44
6432.00				42.33	A	43.82	5.73	36.64	40.89	60.00	-19.11
EUT in Continuous Receive Mode on Channel 6 (2.437 GHz)											
1000.00	58.17	100	180			42.66	2.07	25.50	43.08	74.00	-30.92
1000.00				42.17	A	42.66	2.07	25.50	27.08	54.00	-26.92
1214.97	54.50	100	45			42.59	2.38	26.83	41.12	74.00	-32.88
1214.97				39.00	A	42.59	2.38	26.83	25.62	54.00	-28.38
3249.41	49.33	100	270			43.08	3.91	30.25	40.40	80.00	-39.60
3249.41				39.33	A	43.08	3.91	30.25	30.40	60.00	-29.60
6498.59	53.00	100	225			43.84	5.78	36.89	51.83	80.00	-28.17
6498.59				42.87	A	43.84	5.78	36.89	41.70	60.00	-18.30
EUT in Continuous Receive Mode on Channel 11 (2.462 GHz)											
1000.00	59.33	100	180			42.66	2.07	25.50	44.24	74.00	-29.76
1000.00				42.67	A	42.66	2.07	25.50	27.58	54.00	-26.42
1217.85	54.33	100	45			42.59	2.38	26.85	40.97	74.00	-33.03
1217.85				39.33	A	42.59	2.38	26.85	25.97	54.00	-28.03
3282.76	50.00	100	225			43.10	3.91	30.26	41.07	80.00	-38.93
3282.76				41.00	A	43.10	3.91	30.26	32.07	60.00	-27.93
6565.10	51.33	100	225			43.84	5.83	37.32	50.64	80.00	-29.36
6565.10				42.17	A	43.84	5.83	37.32	41.48	60.00	-18.52



Spurious Radiated Emissions Test Results (Continued)

RADIATED EMISSIONS - Vertical Antenna Polarization											
<i>Freq. (MHz)</i>	<i>Meter Reading (dBuV)</i>	<i>Antenna Height (cm)</i>	<i>Azimuth (degrees)</i>	<i>Quasi pk or AVG (dBuV)</i>	<i>Preamp Factor (dB)</i>	<i>Cable Factor (dB)</i>	<i>Ant. Factor (dB)</i>	<i>Corrected Reading (dBuV)</i>	<i>Limits (dBuV)</i>	<i>Diff (dB) +=FAIL</i>	
EUT in Continuous Receive Mode on Channel 1 (2.412 GHz)											
1000.00	62.50	100	0			42.66	2.07	25.70	47.61	74.00	-26.39
1000.00				45.33	A	42.66	2.07	25.70	30.44	54.00	-23.56
1217.40	56.33	100	315			42.59	2.38	27.00	43.12	74.00	-30.88
1217.40				41.17	A	42.59	2.38	27.00	27.96	54.00	-26.04
3216.05	50.17	100	270			43.07	3.89	30.44	41.43	80.00	-38.57
3216.05				39.00	A	43.07	3.89	30.44	30.26	60.00	-29.74
6432.06	53.67	100	225			43.82	5.73	36.64	52.23	80.00	-27.77
6432.06				41.17	A	43.82	5.73	36.64	39.73	60.00	-20.27
EUT in Continuous Receive Mode on Channel 6 (2.437 GHz)											
1000.00	62.33	100	0			42.66	2.07	25.70	47.44	74.00	-26.56
1000.00				45.00	A	42.66	2.07	25.70	30.11	54.00	-23.89
1217.20	56.83	100	0			42.59	2.38	27.00	43.62	74.00	-30.38
1217.20				41.00	A	42.59	2.38	27.00	27.79	54.00	-26.21
3249.39	50.33	100	225			43.08	3.91	30.45	41.60	80.00	-38.40
3249.39				41.17	A	43.08	3.91	30.45	32.44	60.00	-27.56
6498.55	54.67	100	225			43.84	5.78	36.89	53.50	80.00	-26.50
6498.55				42.00	A	43.84	5.78	36.89	40.83	60.00	-19.17
EUT in Continuous Receive Mode on Channel 11 (2.462 GHz)											
1000.00	62.00	100	45			42.66	2.07	25.70	47.11	74.00	-26.89
1000.00				45.33	A	42.66	2.07	25.70	30.44	54.00	-23.56
1217.27	57.33	100	0			42.59	2.38	27.00	44.12	74.00	-29.88
1217.27				41.33	A	42.59	2.38	27.00	28.12	54.00	-25.88
3282.68	51.00	100	225			43.10	3.91	30.46	42.27	80.00	-37.73
3282.68				40.00	A	43.10	3.91	30.46	31.27	60.00	-28.73
6565.34	54.33	100	225			43.84	5.83	37.38	53.70	80.00	-26.30
6565.34				42.00	A	43.84	5.83	37.38	41.37	60.00	-18.63



AEGIS LABS INC.

Spurious Radiated Emissions Test Results (Continued)

CLIENT:	Intel Corporation	DATE:	12/16/03
EUT:	Intel PRO/Wireless 2200BG Network Connection	PROJECT NUMBER:	INTEL-031216
MODEL NUMBER:	WM3A2200BG	TEST ENGINEER:	Rick Candelas
SERIAL NUMBER:	0058AAA463ADC54980203	SITE #:	2
CONFIGURATION:	Tested installed in the Dell notebook computer's mini PCI slot using the Hitachi antennas in 802.11b mode.	TEMPERATURE:	21 C
		HUMIDITY:	18% RH
		TIME:	2:30 PM

Standard:	FCC CFR 47, Part 15.247(c)
Description:	Radiated emissions, which fall in the restricted bands, as defined in Sec. 15.205(a), must also comply with the radiated emission limits specified in Sec. 15.209(a). All others must be < -20dBc.
Results:	Passes (See Data Sheets)

Unwanted Spurious Emissions Limits			
Frequency (MHz)	Field Strength (uV/m)	Field Strength (dBuV/m) (Emissions in the restricted bands)	Field Strength (dBm/MHz) (Emissions outside the restricted bands)
Above 960	500	54.00 (Average) 74.00 (Peak)	< -20 dBc

NOTE 1: RBW/VBW = 1 MHz

Page 27 of 69 (Appendix A)
Report Number: INTEL-031126F
FCC ID: PD9WM3A2200BG



Spurious Radiated Emissions Test Results (Continued)

*Fundamental Measurements in 802.11b mode
Channels 1, 6, & 11
Continuous TX at MAIN Antenna port with Hitachi Antennas
Aegis Labs, Inc. File #: INTEL-031216-02*

RADIATED EMISSIONS - Horizontal Antenna Polarization											
<i>Freq. (MHz)</i>	<i>Meter Reading (dBuV)</i>	<i>Antenna Height (cm)</i>	<i>Azimuth (degrees)</i>	<i>Quasi pk or AVG (dBuV)</i>		<i>Preamp Factor (dB)</i>	<i>Cable Factor (dB)</i>	<i>Ant. Factor (dB)</i>	<i>Corrected Reading (dBuV)</i>	<i>Limits (dBuV)</i>	<i>Diff (dB) +=FAIL</i>
2412.00	66.50	100	225				3.30	31.11	100.91		
2412.00				61.17	A		3.30	31.11	95.58		
2437.00	69.00	100	225				3.32	31.05	103.37		
2437.00				62.67	A		3.32	31.05	97.04		
2462.00	68.50	100	225				3.34	30.99	102.83		
2462.00				62.83	A		3.34	30.99	97.16		

RADIATED EMISSIONS – Vertical Antenna Polarization											
<i>Freq. (MHz)</i>	<i>Meter Reading (dBuV)</i>	<i>Antenna Height (cm)</i>	<i>Azimuth (degrees)</i>	<i>Quasi pk or AVG (dBuV)</i>		<i>Preamp Factor (dB)</i>	<i>Cable Factor (dB)</i>	<i>Ant. Factor (dB)</i>	<i>Corrected Reading (dBuV)</i>	<i>Limits (dBuV)</i>	<i>Diff (dB) +=FAIL</i>
2412.00	74.67	100	0				3.30	31.24	109.21		
2412.00				69.17	A		3.30	31.24	103.71		
2437.00	74.00	100	0				3.32	31.20	108.52		
2437.00				68.33	A		3.32	31.20	102.85		
2462.00	72.17	100	0				3.34	31.16	106.67		
2462.00				67.33	A		3.34	31.16	101.83		



Spurious Radiated Emissions Test Results (Continued)

*Band Edge Field Strength Measurements in 802.11b mode
Channels 1, 6, & 11
Continuous TX at MAIN Antenna port with Hitachi Antennas
Aegis Labs, Inc. File #: INTEL-031216-02*

RADIATED EMISSIONS - Horizontal Antenna Polarization											
Freq. (MHz)	Meter Reading (dBuV)	Antenna Height (cm)	Azimuth (degrees)	Quasi pk or AVG (dBuV)		Preamp Factor (dB)	Cable Factor (dB)	Ant. Factor (dB)	Corrected Reading (dBuV)	Limits (dBuV)	Diff (dB) +=FAIL
2390.00									46.91	74.00	-27.09
2390.00					A				36.91	54.00	-17.09
2385.20									51.75	74.00	-22.25
2385.20					A				44.74	54.00	-9.26
2400.00	34.17	100	225				3.29	31.14	68.60	80.91	-12.31
2483.50									50.50	74.00	-23.50
2483.50					A				39.16	54.00	-14.84
2488.00									52.83	74.00	-21.17
2488.00					A				45.83	54.00	-8.17
RADIATED EMISSIONS - Vertical Antenna Polarization											
Freq. (MHz)	Meter Reading (dBuV)	Antenna Height (cm)	Azimuth (degrees)	Quasi pk or AVG (dBuV)		Preamp Factor (dB)	Cable Factor (dB)	Ant. Factor (dB)	Corrected Reading (dBuV)	Limits (dBuV)	Diff (dB) +=FAIL
2390.00									55.21	74.00	-18.79
2390.00					A				45.04	54.00	-8.96
2385.20									60.05	74.00	-13.95
2385.20					A				52.87	54.00	-1.13
2400.00	39.67	100	0				3.29	31.26	74.22	89.21	-14.99
2483.50									54.34	74.00	-19.66
2483.50					A				43.83	54.00	-10.17
2488.00									56.67	74.00	-17.33
2488.00					A				50.50	54.00	-3.50

NOTE: The "Band Edge Field Strength" was calculated using the "Fundamental" and "Conducted Band Edge" measurements per the "Marker-Delta Method" with the following formula:

$$BE = F_m - \Delta m$$

Where

BE = Band Edge Field Strength

F_m = Measured Fundamental (Peak or Average)

Δ_m = Measured Conducted Band Edge Delta (Peak or Average)



AEGIS LABS INC.

Spurious Radiated Emissions Test Results (Continued) (Marker Delta Conducted Band Edge Plots)

Plots Showing Out-Of-Band Emissions (Peak RBW=VBW=1MHz; Average RBW = 1MHz, VBW = 10Hz)

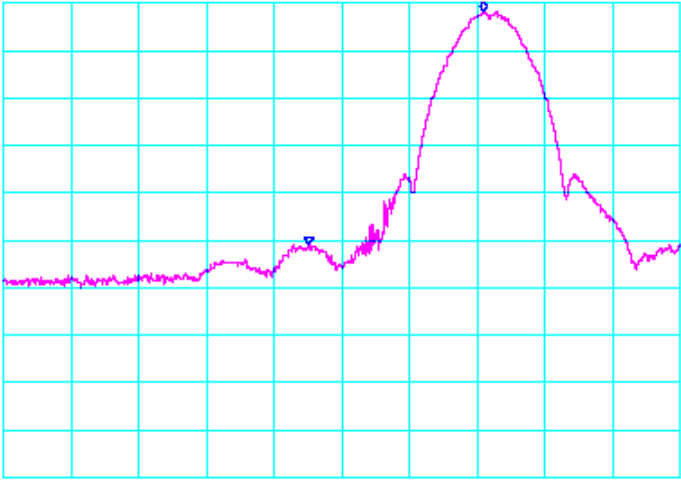
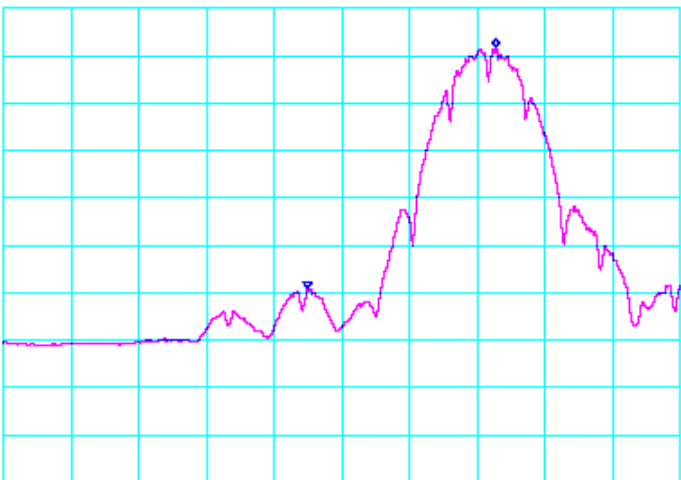
Test Date	Data	Test Eng.
12/16/03	2.412 GHz band edge PEAK delta (INTEL-031216-02b01)	Rick Candelas
<p>*ATTEN 20dB ΔMKR 49.16dB RL 10.0dBm 10dB/ 25.8MHz</p>  <p>CENTER 2.3900GHz SPAN 100.0MHz *RBW 1.0MHz *VBW 1.0MHz SWP 50.0ms</p>		
Test Date	Data	Test Eng.
12/16/03	22.412 GHz band edge PEAK delta (INTEL-031216-02b02)	Rick Candelas
<p>*ATTEN 20dB ΔMKR 50.84dB RL 10.0dBm 10dB/ 27.8MHz</p>  <p>CENTER 2.3900GHz SPAN 100.0MHz *RBW 1.0MHz *VBW 10Hz SWP 37.0sec</p>		

Page 30 of 69 (Appendix A)
 Report Number: INTEL-031126F
 FCC ID: PD9WM3A2200BG



AEGIS LABS INC.

Spurious Radiated Emissions Test Results (Continued) (Marker Delta Conducted Band Edge Plots)

Plots Showing Out-Of-Band Emissions (Peak RBW=VBW=1MHz; Average RBW = 1MHz, VBW = 10Hz)

Test Date	Data	Test Eng.
12/16/03	2.412 GHz band edge PEAK delta (INTEL-031216-02b07)	Rick Candelas
<p>*ATTEN 20dB ΔMKR 50.00dB RL 10.0dBm 10dB/ -25.3MHz</p> <p>CENTER 2.4835GHz SPAN 100.0MHz *RBW 1.0MHz *VBW 1.0MHz SWP 50.0ms</p>		
Test Date	Data	Test Eng.
12/16/03	22.412 GHz band edge PEAK delta (INTEL-031216-02b08)	Rick Candelas
<p>*ATTEN 20dB ΔMKR 51.33dB RL 10.0dBm 10dB/ -29.3MHz</p> <p>CENTER 2.4835GHz SPAN 100.0MHz *RBW 1.0MHz *VBW 10Hz SWP 37.0sec</p>		

Page 31 of 69 (Appendix A)
Report Number: INTEL-031126F
FCC ID: PD9WM3A2200BG



Spurious Radiated Emissions Test Results (Continued)

*Spurious Emissions Measurements in 802.11b mode
Channels 1, 6, & 11
Continuous TX at MAIN Antenna port with Hitachi Antennas
Aegis Labs, Inc. File #: INTEL-031216-03*

RADIATED EMISSIONS - Horizontal Antenna Polarization											
Freq. (MHz)	Meter Reading (dBuV)	Antenna Height (cm)	Azimuth (degrees)	Quasi pk or AVG (dBuV)		1 Meter Distance Factor (dB)	Cable Factor (dB)	Ant. Factor (dB)	Corrected Reading (dBuV)	Limits (dBuV)	Diff (dB) +=FAIL
EUT in Continuous Transmit Mode on Channel 1 (2.412 GHz)											
2312.00	31.83	100	225			9.54	3.23	31.35	56.87	74.00	-17.13
2312.00				19.50	A	9.54	3.23	31.35	44.54	54.00	-9.46
EUT in Continuous Transmit Mode on Channel 6 (2.437 GHz)											
2336.00	32.50	100	225			9.54	3.25	31.29	57.50	74.00	-16.50
2336.00				20.83	A	9.54	3.25	31.29	45.83	54.00	-8.17
EUT in Continuous Transmit Mode on Channel 11 (2.462 GHz)											
2360.00	32.17	100	225			9.54	3.26	31.24	57.13	74.00	-16.87
2360.00				19.00	A	9.54	3.26	31.24	43.96	54.00	-10.04
RADIATED EMISSIONS - Vertical Antenna Polarization											
Freq. (MHz)	Meter Reading (dBuV)	Antenna Height (cm)	Azimuth (degrees)	Quasi pk or AVG (dBuV)		1 Meter Distance Factor (dB)	Cable Factor (dB)	Ant. Factor (dB)	Corrected Reading (dBuV)	Limits (dBuV)	Diff (dB) +=FAIL
EUT in Continuous Transmit Mode on Channel 1 (2.412 GHz)											
2312.00	33.67	100	225			9.54	3.23	31.40	58.76	74.00	-15.24
2312.00				22.17	A	9.54	3.23	31.40	47.26	54.00	-6.74
EUT in Continuous Transmit Mode on Channel 6 (2.437 GHz)											
2336.00	35.33	100	225			9.54	3.25	31.36	60.40	74.00	-13.60
2336.00				25.33	A	9.54	3.25	31.36	50.40	54.00	-3.60
EUT in Continuous Transmit Mode on Channel 11 (2.462 GHz)											
2360.00	33.33	100	225			9.54	3.26	31.32	58.38	74.00	-15.62
2360.00				22.00	A	9.54	3.26	31.32	47.05	54.00	-6.95

NOTE: These spurious emissions measurements were taken without a preamp at a distance on 1 meter to avoid saturating the preamp and analyzer because the signals were close to the fundamental frequency. The readings were extrapolated to 1 meter.



Spurious Radiated Emissions Test Results (Continued)

Spurious Emissions Measurements in 802.11b mode
Channels 1, 6, & 11
Continuous TX at MAIN Antenna port with Hitachi Antennas
Aegis Labs, Inc. File #: INTEL-031216-04

RADIATED EMISSIONS - Horizontal Antenna Polarization

Table with 11 columns: Freq. (MHz), Meter Reading (dBuV), Antenna Height (cm), Azimuth (degrees), Quasi pk or AVG (dBuV), Preamp Factor (dB), Cable Factor (dB), Ant. Factor (dB), Corrected Reading (dBuV), Limits (dBuV), Diff (dB) +/- FAIL

EUT in Continuous Transmit Mode on Channel 1 (2.412 GHz)

Table with 11 columns: Freq. (MHz), Meter Reading (dBuV), Antenna Height (cm), Azimuth (degrees), Quasi pk or AVG (dBuV), Preamp Factor (dB), Cable Factor (dB), Ant. Factor (dB), Corrected Reading (dBuV), Limits (dBuV), Diff (dB) +/- FAIL. Data for Channel 1.

EUT in Continuous Transmit Mode on Channel 6 (2.437 GHz)

Table with 11 columns: Freq. (MHz), Meter Reading (dBuV), Antenna Height (cm), Azimuth (degrees), Quasi pk or AVG (dBuV), Preamp Factor (dB), Cable Factor (dB), Ant. Factor (dB), Corrected Reading (dBuV), Limits (dBuV), Diff (dB) +/- FAIL. Data for Channel 6.

EUT in Continuous Transmit Mode on Channel 11 (2.462 GHz)

Table with 11 columns: Freq. (MHz), Meter Reading (dBuV), Antenna Height (cm), Azimuth (degrees), Quasi pk or AVG (dBuV), Preamp Factor (dB), Cable Factor (dB), Ant. Factor (dB), Corrected Reading (dBuV), Limits (dBuV), Diff (dB) +/- FAIL. Data for Channel 11.



Spurious Radiated Emissions Test Results (Continued)

RADIATED EMISSIONS - Vertical Antenna Polarization											
<i>Freq. (MHz)</i>	<i>Meter Reading (dBuV)</i>	<i>Antenna Height (cm)</i>	<i>Azimuth (degrees)</i>	<i>Quasi pk or AVG (dBuV)</i>		<i>Preamp Factor (dB)</i>	<i>Cable Factor (dB)</i>	<i>Ant. Factor (dB)</i>	<i>Corrected Reading (dBuV)</i>	<i>Limits (dBuV)</i>	<i>Diff (dB) +=FAIL</i>
EUT in Continuous Transmit Mode on Channel 1 (2.412 GHz)											
1000.00	53.83	100	0			36.20	2.07	25.70	45.40	74.00	-28.60
1000.00				37.67	A	36.20	2.07	25.70	29.24	54.00	-24.76
1206.00	52.50	100	225			35.88	2.36	26.94	45.92	74.00	-28.08
1206.00				39.83	A	35.88	2.36	26.94	33.25	54.00	-20.75
3216.20	46.67	100	135			35.78	3.89	30.44	45.23	89.21	-43.98
4823.86	46.17	100	225			36.14	4.73	34.53	49.30	74.00	-24.70
4823.86				33.50	A	36.14	4.73	34.53	36.63	54.00	-17.37
6432.03	49.17	100	225			36.18	5.73	36.64	55.36	89.21	-33.85
9648.00	50.67	100	270			36.79	6.95	38.97	59.80	89.21	-29.41
EUT in Continuous Transmit Mode on Channel 6 (2.437 GHz)											
1000.00	51.67	100	45			36.20	2.07	25.70	43.24	74.00	-30.76
1000.00				36.67	A	36.20	2.07	25.70	28.24	54.00	-25.76
1208.83	53.00	100	0			35.87	2.37	26.95	46.44	74.00	-27.56
1208.83				39.00	A	35.87	2.37	26.95	32.44	54.00	-21.56
3249.23	45.17	100	225			35.84	3.91	30.45	43.69	88.52	-44.83
4874.00	44.83	100	180			36.26	4.77	34.72	48.06	74.00	-25.94
4874.00				31.83	A	36.26	4.77	34.72	35.06	54.00	-18.94
6498.78	50.00	100	225			36.18	5.78	36.90	56.49	88.52	-32.03
9748.03	51.83	100	225			36.75	6.99	39.15	61.21	88.52	-27.31
EUT in Continuous Transmit Mode on Channel 11 (2.462 GHz)											
1000.00	52.17	100	45			36.20	2.07	25.70	43.74	74.00	-30.26
1000.00				36.50	A	36.20	2.07	25.70	28.07	54.00	-25.93
1217.60	52.67	100	45			35.86	2.38	27.01	46.19	74.00	-27.81
1217.60				38.33	A	35.86	2.38	27.01	31.85	54.00	-22.15
3282.64	44.33	100	180			35.90	3.91	30.46	42.80	86.67	-43.87
4923.95	43.83	100	180			36.39	4.81	34.91	47.16	74.00	-26.84
4923.95				31.50	A	36.39	4.81	34.91	34.83	54.00	-19.17
6565.57	48.50	100	225			36.14	5.83	37.39	55.58	86.67	-31.09
9848.06	51.17	100	225			36.71	7.03	39.33	60.81	86.67	-25.86



Spurious Radiated Emissions Test Results (Continued)

Spurious Emissions Measurements in 802.11b mode
Channels 1, 6, & 11
Continuous RX at MAIN Antenna port with Hitachi Antennas
Aegis Labs, Inc. File #: INTEL-031216-04

RADIATED EMISSIONS - Horizontal Antenna Polarization

<i>Freq. (MHz)</i>	<i>Meter Reading (dBuV)</i>	<i>Antenna Height (cm)</i>	<i>Azimuth (degrees)</i>	<i>Quasi pk or AVG (dBuV)</i>		<i>Preamp Factor (dB)</i>	<i>Cable Factor (dB)</i>	<i>Ant. Factor (dB)</i>	<i>Corrected Reading (dBuV)</i>	<i>Limits (dBuV)</i>	<i>Diff (dB) +=FAIL</i>
EUT in Continuous Receive Mode on Channel 1 (2.412 GHz)											
1000.00	54.00	100	0			36.20	2.07	25.50	45.37	74.00	-28.63
1000.00				38.00	A	36.20	2.07	25.50	29.37	54.00	-24.63
1204.00	49.50	100	135			35.88	2.36	26.76	42.74	74.00	-31.26
1204.00				37.83	A	35.88	2.36	26.76	31.07	54.00	-22.93
3216.01	44.17	100	180			35.77	3.89	30.24	42.53	80.00	-37.47
3216.01				31.67	A	35.77	3.89	30.24	30.03	60.00	-29.97
6431.95	46.33	100	180			36.18	5.73	36.64	52.52	80.00	-27.48
6431.95				37.00	A	36.18	5.73	36.64	43.19	60.00	-16.81
EUT in Continuous Receive Mode on Channel 6 (2.437 GHz)											
1000.00	51.83	100	0			36.20	2.07	25.50	43.20	74.00	-30.80
1000.00				36.67	A	36.20	2.07	25.50	28.04	54.00	-25.96
1208.42	49.67	100	135			35.87	2.37	26.79	42.95	74.00	-31.05
1208.42				37.67	A	35.87	2.37	26.79	30.95	54.00	-23.05
3249.30	43.17	100	180			35.84	3.91	30.25	41.49	80.00	-38.51
3249.30				31.50	A	35.84	3.91	30.25	29.82	60.00	-30.18
6498.65	46.33	100	180			36.18	5.78	36.89	52.82	80.00	-27.18
6498.65				37.50	A	36.18	5.78	36.89	43.99	60.00	-16.01
EUT in Continuous Receive Mode on Channel 11 (2.462 GHz)											
1000.00	51.67	100	0			36.20	2.07	25.50	43.04	74.00	-30.96
1000.00				36.83	A	36.20	2.07	25.50	28.20	54.00	-25.80
1206.50	48.83	100	135			35.88	2.36	26.78	42.09	74.00	-31.91
1206.50				38.00	A	35.88	2.36	26.78	31.26	54.00	-22.74
3282.75	41.83	100	180			35.90	3.91	30.26	40.10	80.00	-39.90
3282.75				30.33	A	35.90	3.91	30.26	28.60	60.00	-31.40
6565.37	44.50	100	180			36.14	5.83	37.32	51.51	80.00	-28.49
6565.37				43.17	A	36.14	5.83	37.32	50.18	60.00	-9.82



Spurious Radiated Emissions Test Results (Continued)

RADIATED EMISSIONS - Vertical Antenna Polarization											
<i>Freq. (MHz)</i>	<i>Meter Reading (dBuV)</i>	<i>Antenna Height (cm)</i>	<i>Azimuth (degrees)</i>	<i>Quasi pk or AVG (dBuV)</i>		<i>Preamp Factor (dB)</i>	<i>Cable Factor (dB)</i>	<i>Ant. Factor (dB)</i>	<i>Corrected Reading (dBuV)</i>	<i>Limits (dBuV)</i>	<i>Diff (dB) +=FAIL</i>
EUT in Continuous Receive Mode on Channel 1 (2.412 GHz)											
1000.00	55.17	100	0			36.20	2.07	25.70	46.74	74.00	-27.26
1000.00				38.33	A	36.20	2.07	25.70	29.90	54.00	-24.10
1203.58	52.50	100	90			35.88	2.36	26.92	45.90	74.00	-28.10
1203.58				38.33	A	35.88	2.36	26.92	31.73	54.00	-22.27
3216.05	44.50	100	270			35.77	3.89	30.44	43.06	80.00	-36.94
3216.05				32.83	A	35.77	3.89	30.44	31.39	60.00	-28.61
6431.95	50.83	100	225			36.18	5.73	36.64	57.02	80.00	-22.98
6431.95				46.33	A	36.18	5.73	36.64	52.52	60.00	-7.48
EUT in Continuous Receive Mode on Channel 6 (2.437 GHz)											
1000.00	53.50	100	0			36.20	2.07	25.70	45.07	74.00	-28.93
1000.00				36.00	A	36.20	2.07	25.70	27.57	54.00	-26.43
1200.00	53.00	100	90			35.89	2.35	26.90	46.36	74.00	-27.64
1200.00				37.00	A	35.89	2.35	26.90	30.36	54.00	-23.64
3249.31	42.83	100	270			35.84	3.91	30.45	41.35	80.00	-38.65
3249.31				31.50	A	35.84	3.91	30.45	30.02	60.00	-29.98
6498.73	50.50	100	225			36.18	5.78	36.90	56.99	80.00	-23.01
6498.73				46.33	A	36.18	5.78	36.90	52.82	60.00	-7.18
EUT in Continuous Receive Mode on Channel 11 (2.462 GHz)											
1000.00	53.00	100	0			36.20	2.07	25.70	44.57	74.00	-29.43
1000.00				36.67	A	36.20	2.07	25.70	28.24	54.00	-25.76
1199.08	53.17	100	90			35.89	2.35	26.89	46.53	74.00	-27.47
1199.08				37.17	A	35.89	2.35	26.89	30.53	54.00	-23.47
3282.68	41.83	100	225			35.90	3.91	30.46	40.30	80.00	-39.70
3282.68				30.67	A	35.90	3.91	30.46	29.14	60.00	-30.86
6565.33	48.67	100	225			36.14	5.83	37.38	55.75	80.00	-24.25
6565.33				43.33	A	36.14	5.83	37.38	50.41	60.00	-9.59



AEGIS LABS INC.

Spurious Radiated Emissions Test Results (Continued)

CLIENT:	Intel Corporation	DATE:	12/17/03
EUT:	Intel PRO/Wireless 2200BG Network Connection	PROJECT NUMBER:	INTEL-031216
MODEL NUMBER:	WM3A2200BG	TEST ENGINEER:	Rick Candelas
SERIAL NUMBER:	0058AAA463ADC54980203	SITE #:	2
CONFIGURATION:	Tested installed in the Dell notebook computer's mini PCI slot using the Hitachi antennas in 802.11g mode.	TEMPERATURE:	25 C
		HUMIDITY:	63% RH
		TIME:	8:00 AM

Standard:	FCC CFR 47, Part 15.247(c)
Description:	Radiated emissions, which fall in the restricted bands, as defined in Sec. 15.205(a), must also comply with the radiated emission limits specified in Sec. 15.209(a). All others must be < -20dBc.
Results:	Passes (See Data Sheets)

Unwanted Spurious Emissions Limits			
Frequency (MHz)	Field Strength (uV/m)	Field Strength (dBuV/m) (Emissions in the restricted bands)	Field Strength (dBm/MHz) (Emissions outside the restricted bands)
Above 960	500	54.00 (Average) 74.00 (Peak)	< -20 dBc

NOTE 1: RBW/VBW = 1 MHz

Page 37 of 69 (Appendix A)
Report Number: INTEL-031126F
FCC ID: PD9WM3A2200BG



Spurious Radiated Emissions Test Results (Continued)

*Fundamental Measurements in 802.11g mode
Channels 1, 6, & 11
Continuous TX at MAIN Antenna port with Hitachi Antennas
Aegis Labs, Inc. File #: INTEL-031216-02*

RADIATED EMISSIONS - Horizontal Antenna Polarization											
<i>Freq. (MHz)</i>	<i>Meter Reading (dBuV)</i>	<i>Antenna Height (cm)</i>	<i>Azimuth (degrees)</i>	<i>Quasi pk or AVG (dBuV)</i>		<i>Preamp Factor (dB)</i>	<i>Cable Factor (dB)</i>	<i>Ant. Factor (dB)</i>	<i>Corrected Reading (dBuV)</i>	<i>Limits (dBuV)</i>	<i>Diff (dB) +=FAIL</i>
2412.00	67.00	100	225				3.30	31.11	101.41		
2412.00				54.00	A		3.30	31.11	88.41		
2437.00	67.50	100	225				3.32	31.05	101.87		
2437.00				54.83	A		3.32	31.05	89.20		
2462.00	67.83	100	225				3.34	30.99	102.16		
2462.00				54.67	A		3.34	30.99	89.00		

RADIATED EMISSIONS – Vertical Antenna Polarization											
<i>Freq. (MHz)</i>	<i>Meter Reading (dBuV)</i>	<i>Antenna Height (cm)</i>	<i>Azimuth (degrees)</i>	<i>Quasi pk or AVG (dBuV)</i>		<i>Preamp Factor (dB)</i>	<i>Cable Factor (dB)</i>	<i>Ant. Factor (dB)</i>	<i>Corrected Reading (dBuV)</i>	<i>Limits (dBuV)</i>	<i>Diff (dB) +=FAIL</i>
2412.00	74.00	100	0				3.30	31.24	108.54		
2412.00				60.17	A		3.30	31.24	94.71		
2437.00	74.00	100	0				3.32	31.20	108.52		
2437.00				60.17	A		3.32	31.20	94.69		
2462.00	71.67	100	0				3.34	31.16	106.17		
2462.00				58.33	A		3.34	31.16	92.83		



Spurious Radiated Emissions Test Results (Continued)

*Band Edge Field Strength Measurements in 802.11g mode
Channels 1, 6, & 11
Continuous TX at MAIN Antenna port with Hitachi Antennas
Aegis Labs, Inc. File #: INTEL-031125-14*

RADIATED EMISSIONS - Horizontal Antenna Polarization										
<i>Freq. (MHz)</i>	<i>Meter Reading (dBuV)</i>	<i>Antenna Height (cm)</i>	<i>Azimuth (degrees)</i>	<i>Quasi pk or AVG (dBuV)</i>	<i>Preamp Factor (dB)</i>	<i>Cable Factor (dB)</i>	<i>Ant. Factor (dB)</i>	<i>Corrected Reading (dBuV)</i>	<i>Limits (dBuV)</i>	<i>Diff (dB) +=FAIL</i>
2390.00								61.08	74.00	-12.92
2390.00					A			46.07	54.00	-7.93
2400.00	42.33	100	225			3.29	31.14	76.76	81.41	-4.65
2483.50								64.83	74.00	-9.17
2483.50					A			48.83	54.00	-5.17
RADIATED EMISSIONS – Vertical Antenna Polarization										
<i>Freq. (MHz)</i>	<i>Meter Reading (dBuV)</i>	<i>Antenna Height (cm)</i>	<i>Azimuth (degrees)</i>	<i>Quasi pk or AVG (dBuV)</i>	<i>Preamp Factor (dB)</i>	<i>Cable Factor (dB)</i>	<i>Ant. Factor (dB)</i>	<i>Corrected Reading (dBuV)</i>	<i>Limits (dBuV)</i>	<i>Diff (dB) +=FAIL</i>
2390.00								68.21	74.00	-5.79
2390.00					A			52.37	54.00	-1.63
2400.00	49.00	100	0			3.29	31.26	83.55	88.54	-4.99
2483.50								68.84	74.00	-5.16
2483.50					A			52.66	54.00	-1.34

NOTE: The “Band Edge Field Strength” was calculated using the “Fundamental” and “Conducted Band Edge” measurements per the “Marker-Delta Method” with the following formula:

$$BE = Fm - \Delta m$$

Where

BE = Band Edge Field Strength

Fm = Measured Fundamental (Peak or Average)

Δm = Measured Conducted Band Edge Delta (Peak or Average)



AEGIS LABS INC.

Spurious Radiated Emissions Test Results (Continued) (Marker Delta Conducted Band Edge Plots)

Plots Showing Out-Of-Band Emissions (Peak RBW=VBW=1MHz; Average RBW = 1MHz, VBW = 10Hz)

Test Date	Data	Test Eng.
12/17/03	2.412 GHz band edge PEAK delta (INTEL-031216-02g01)	Rick Candelas
<p>*ATTEN 20dB ΔMKR 40.33dB RL 10.0dBm 10dB/ 25.2MHz</p> <p>CENTER 2.3900GHz SPAN 100.0MHz *RBW 1.0MHz *VBW 1.0MHz SWP 50.0ms</p>		
Test Date	Data	Test Eng.
12/17/03	22.412 GHz band edge PEAK delta (INTEL-031216-02g02)	Rick Candelas
<p>*ATTEN 20dB ΔMKR 42.34dB RL 10.0dBm 10dB/ 19.3MHz</p> <p>CENTER 2.3900GHz SPAN 100.0MHz *RBW 1.0MHz *VBW 10Hz SWP 37.0sec</p>		



AEGIS LABS INC.

Spurious Radiated Emissions Test Results (Continued) (Marker Delta Conducted Band Edge Plots)

Plots Showing Out-Of-Band Emissions (Peak RBW=VBW=1MHz; Average RBW = 1MHz, VBW = 10Hz)

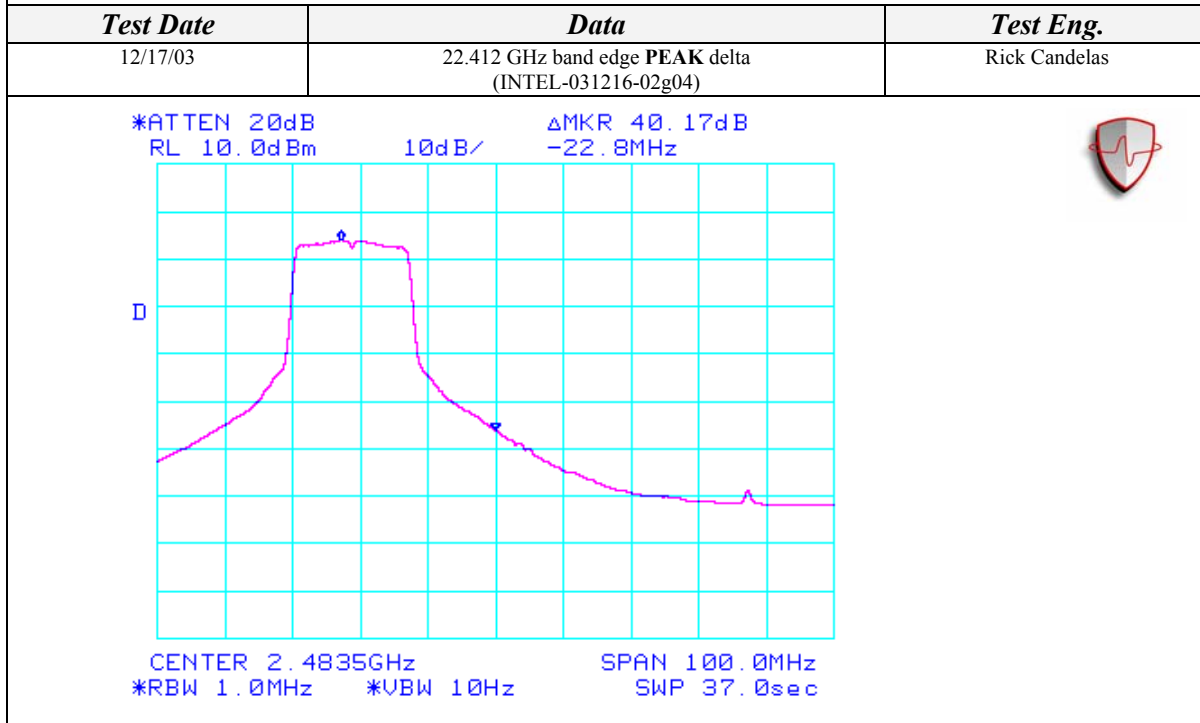
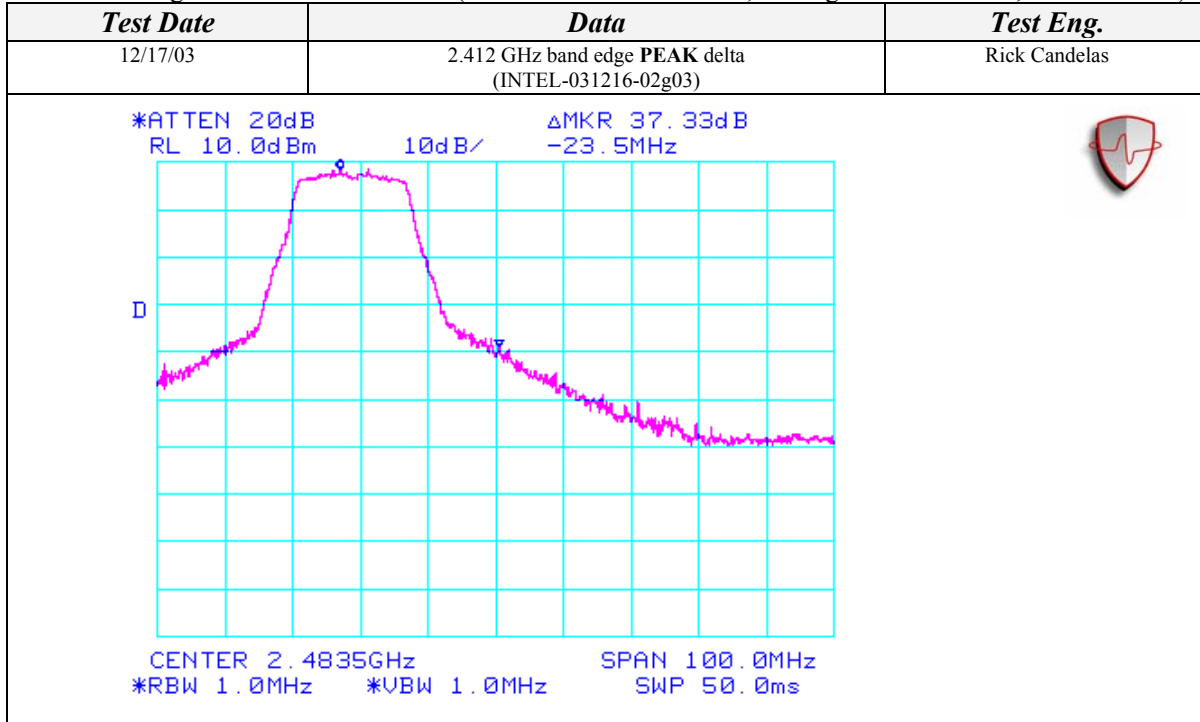

Page 41 of 69 (Appendix A)
Report Number: INTEL-031126F
FCC ID: PD9WM3A2200BG



Spurious Radiated Emissions Test Results (Continued)

*Spurious Emissions Measurements in 802.11g mode
Channels 1, 6, & 11
Continuous TX at MAIN Antenna port with Hitachi Antennas
Aegis Labs, Inc. File #: INTEL-031216-03*

RADIATED EMISSIONS - Horizontal Antenna Polarization											
Freq. (MHz)	Meter Reading (dBuV)	Antenna Height (cm)	Azimuth (degrees)	Quasi pk or AVG (dBuV)		1 Meter Distance Factor (dB)	Cable Factor (dB)	Ant. Factor (dB)	Corrected Reading (dBuV)	Limits (dBuV)	Diff (dB) +=FAIL
EUT in Continuous Transmit Mode on Channel 1 (2.412 GHz)											
2312.00	33.67	100	225			9.54	3.23	31.35	58.71	74.00	-15.29
2312.00				22.50	A	9.54	3.23	31.35	47.54	54.00	-6.46
EUT in Continuous Transmit Mode on Channel 6 (2.437 GHz)											
2336.00	33.83	100	225			9.54	3.25	31.29	58.83	74.00	-15.17
2336.00				23.50	A	9.54	3.25	31.29	48.50	54.00	-5.50
EUT in Continuous Transmit Mode on Channel 11 (2.462 GHz)											
2360.00	32.17	100	225			9.54	3.26	31.24	57.13	74.00	-16.87
2360.00				19.83	A	9.54	3.26	31.24	44.79	54.00	-9.21
RADIATED EMISSIONS - Vertical Antenna Polarization											
Freq. (MHz)	Meter Reading (dBuV)	Antenna Height (cm)	Azimuth (degrees)	Quasi pk or AVG (dBuV)		1 Meter Distance Factor (dB)	Cable Factor (dB)	Ant. Factor (dB)	Corrected Reading (dBuV)	Limits (dBuV)	Diff (dB) +=FAIL
EUT in Continuous Transmit Mode on Channel 1 (2.412 GHz)											
2312.00	35.67	100	225			9.54	3.23	31.40	60.76	74.00	-13.24
2312.00				27.67	A	9.54	3.23	31.40	52.76	54.00	-1.24
EUT in Continuous Transmit Mode on Channel 6 (2.437 GHz)											
2336.00	36.83	100	225			9.54	3.25	31.36	61.90	74.00	-12.10
2336.00				27.67	A	9.54	3.25	31.36	52.74	54.00	-1.26
EUT in Continuous Transmit Mode on Channel 11 (2.462 GHz)											
2360.00	34.50	100	225			9.54	3.26	31.32	59.55	74.00	-14.45
2360.00				25.33	A	9.54	3.26	31.32	50.38	54.00	-3.62

NOTE: These spurious emissions measurements were taken without a preamp at a distance on 1 meter to avoid saturating the preamp and analyzer because the signals were close to the fundamental frequency. The readings were extrapolated to 1 meter.



Spurious Radiated Emissions Test Results (Continued)

Spurious Emissions Measurements in 802.11g mode
Channels 1, 6, & 11
Continuous TX at MAIN Antenna port with Hitachi Antennas
Aegis Labs, Inc. File #: INTEL-031216-04

RADIATED EMISSIONS - Horizontal Antenna Polarization

Table with 11 columns: Freq. (MHz), Meter Reading (dBuV), Antenna Height (cm), Azimuth (degrees), Quasi pk or AVG (dBuV), Preamp Factor (dB), Cable Factor (dB), Ant. Factor (dB), Corrected Reading (dBuV), Limits (dBuV), Diff (dB) +/- FAIL

EUT in Continuous Transmit Mode on Channel 1 (2.412 GHz)

Table with 11 columns: Freq. (MHz), Meter Reading (dBuV), Antenna Height (cm), Azimuth (degrees), Quasi pk or AVG (dBuV), Preamp Factor (dB), Cable Factor (dB), Ant. Factor (dB), Corrected Reading (dBuV), Limits (dBuV), Diff (dB) +/- FAIL. Contains 10 rows of data for Channel 1.

EUT in Continuous Transmit Mode on Channel 6 (2.437 GHz)

Table with 11 columns: Freq. (MHz), Meter Reading (dBuV), Antenna Height (cm), Azimuth (degrees), Quasi pk or AVG (dBuV), Preamp Factor (dB), Cable Factor (dB), Ant. Factor (dB), Corrected Reading (dBuV), Limits (dBuV), Diff (dB) +/- FAIL. Contains 10 rows of data for Channel 6.

EUT in Continuous Transmit Mode on Channel 11 (2.462 GHz)

Table with 11 columns: Freq. (MHz), Meter Reading (dBuV), Antenna Height (cm), Azimuth (degrees), Quasi pk or AVG (dBuV), Preamp Factor (dB), Cable Factor (dB), Ant. Factor (dB), Corrected Reading (dBuV), Limits (dBuV), Diff (dB) +/- FAIL. Contains 10 rows of data for Channel 11.



Spurious Radiated Emissions Test Results (Continued)

RADIATED EMISSIONS - Vertical Antenna Polarization											
<i>Freq. (MHz)</i>	<i>Meter Reading (dBuV)</i>	<i>Antenna Height (cm)</i>	<i>Azimuth (degrees)</i>	<i>Quasi pk or AVG (dBuV)</i>		<i>Preamp Factor (dB)</i>	<i>Cable Factor (dB)</i>	<i>Ant. Factor (dB)</i>	<i>Corrected Reading (dBuV)</i>	<i>Limits (dBuV)</i>	<i>Diff (dB) +=FAIL</i>
EUT in Continuous Transmit Mode on Channel 1 (2.412 GHz)											
1000.00	51.83	100	0			36.20	2.07	25.70	43.40	74.00	-30.60
1000.00				36.50	A	36.20	2.07	25.70	28.07	54.00	-25.93
1200.00	52.00	100	180			35.89	2.35	26.90	45.36	74.00	-28.64
1200.00				38.33	A	35.89	2.35	26.90	31.69	54.00	-22.31
3216.01	46.50	100	225			35.77	3.89	30.44	45.06	88.54	-43.48
4824.00	44.50	100	180			36.14	4.73	34.53	47.63	74.00	-26.37
4824.00				31.83	A	36.14	4.73	34.53	34.96	54.00	-19.04
6431.94	49.00	100	225			36.18	5.73	36.64	55.19	88.54	-33.35
9648.06	50.33	100	270			36.79	6.95	38.97	59.46	88.54	-29.08
EUT in Continuous Transmit Mode on Channel 6 (2.437 GHz)											
1000.00	52.00	100	0			36.20	2.07	25.70	43.57	74.00	-30.43
1000.00				36.00	A	36.20	2.07	25.70	27.57	54.00	-26.43
1198.42	51.67	100	180			35.89	2.35	26.89	45.02	74.00	-28.98
1198.42				39.00	A	35.89	2.35	26.89	32.35	54.00	-21.65
3249.33	44.33	100	225			35.84	3.91	30.45	42.85	88.52	-45.67
4873.79	45.00	100	180			36.26	4.77	34.72	48.23	74.00	-25.77
4873.79				31.33	A	36.26	4.77	34.72	34.56	54.00	-19.44
6498.61	49.83	100	225			36.18	5.78	36.89	56.32	88.52	-32.20
9747.87	48.83	100	225			36.75	6.99	39.15	58.21	88.52	-30.31
EUT in Continuous Transmit Mode on Channel 11 (2.462 GHz)											
1000.00	51.33	100	45			36.20	2.07	25.70	42.90	74.00	-31.10
1000.00				36.33	A	36.20	2.07	25.70	27.90	54.00	-26.10
1201.67	51.17	100	225			35.89	2.35	26.91	44.55	74.00	-29.45
1201.67				38.00	A	35.89	2.35	26.91	31.38	54.00	-22.62
3282.68	45.17	100	225			35.90	3.91	30.46	43.64	86.17	-42.53
4824.46	44.67	100	135			36.14	4.73	34.53	47.80	74.00	-26.20
4824.46				31.33	A	36.14	4.73	34.53	34.46	54.00	-19.54
6565.25	48.17	100	225			36.14	5.83	37.38	55.25	86.17	-30.92
9847.95	49.33	100	225			36.71	7.03	39.33	58.97	86.17	-27.20



Spurious Radiated Emissions Test Results (Continued)

*Spurious Emissions Measurements in 802.11g mode
Channels 1, 6, & 11
Continuous RX at MAIN Antenna port with Hitachi Antennas
Aegis Labs, Inc. File #: INTEL-031216-04*

RADIATED EMISSIONS - Horizontal Antenna Polarization											
<i>Freq. (MHz)</i>	<i>Meter Reading (dBuV)</i>	<i>Antenna Height (cm)</i>	<i>Azimuth (degrees)</i>	<i>Quasi pk or AVG (dBuV)</i>		<i>Preamp Factor (dB)</i>	<i>Cable Factor (dB)</i>	<i>Ant. Factor (dB)</i>	<i>Corrected Reading (dBuV)</i>	<i>Limits (dBuV)</i>	<i>Diff (dB) +=FAIL</i>
EUT in Continuous Receive Mode on Channel 1 (2.412 GHz)											
1000.00	52.33	100	0			36.20	2.07	25.50	43.70	74.00	-30.30
1000.00				36.33	A	36.20	2.07	25.50	27.70	54.00	-26.30
1210.58	50.50	100	135			35.87	2.37	26.81	43.80	74.00	-30.20
1210.58				37.50	A	35.87	2.37	26.81	30.80	54.00	-23.20
3215.98	44.50	100	180			35.77	3.89	30.24	42.86	80.00	-37.14
3215.98				31.83	A	35.77	3.89	30.24	30.19	60.00	-29.81
6432.00	46.00	100	180			36.18	5.73	36.64	52.19	80.00	-27.81
6432.00				35.83	A	36.18	5.73	36.64	42.02	60.00	-17.98
EUT in Continuous Receive Mode on Channel 6 (2.437 GHz)											
1000.00	51.67	100	0			36.20	2.07	25.50	43.04	74.00	-30.96
1000.00				36.67	A	36.20	2.07	25.50	28.04	54.00	-25.96
1204.00	49.17	100	135			35.88	2.36	26.76	42.41	74.00	-31.59
1204.00				37.83	A	35.88	2.36	26.76	31.07	54.00	-22.93
3249.32	44.33	100	180			35.84	3.91	30.25	42.65	80.00	-37.35
3249.32				31.50	A	35.84	3.91	30.25	29.82	60.00	-30.18
6598.63	45.83	100	180			36.12	5.86	37.53	53.10	80.00	-26.90
6498.63				36.67	A	36.18	5.78	36.89	43.16	60.00	-16.84
EUT in Continuous Receive Mode on Channel 11 (2.462 GHz)											
1000.00	51.17	100	0			36.20	2.07	25.50	42.54	74.00	-31.46
1000.00				36.83	A	36.20	2.07	25.50	28.20	54.00	-25.80
1206.58	50.00	100	135			35.88	2.36	26.78	43.27	74.00	-30.73
1206.58				37.50	A	35.88	2.36	26.78	30.77	54.00	-23.23
3282.76	41.67	100	180			35.90	3.91	30.26	39.94	80.00	-40.06
3282.76				30.50	A	35.90	3.91	30.26	28.77	60.00	-31.23
6565.10	45.50	100	180			36.14	5.83	37.32	52.51	80.00	-27.49
6565.10				34.17	A	36.14	5.83	37.32	41.18	60.00	-18.82



Spurious Radiated Emissions Test Results (Continued)

RADIATED EMISSIONS - Vertical Antenna Polarization											
<i>Freq. (MHz)</i>	<i>Meter Reading (dBuV)</i>	<i>Antenna Height (cm)</i>	<i>Azimuth (degrees)</i>	<i>Quasi pk or AVG (dBuV)</i>		<i>Preamp Factor (dB)</i>	<i>Cable Factor (dB)</i>	<i>Ant. Factor (dB)</i>	<i>Corrected Reading (dBuV)</i>	<i>Limits (dBuV)</i>	<i>Diff (dB) +=FAIL</i>
EUT in Continuous Receive Mode on Channel 1 (2.412 GHz)											
1000.00	53.33	100	0			36.20	2.07	25.70	44.90	74.00	-29.10
1000.00				36.67	A	36.20	2.07	25.70	28.24	54.00	-25.76
1198.08	52.67	100	90			35.89	2.35	26.89	46.02	74.00	-27.98
1198.08				37.00	A	35.89	2.35	26.89	30.35	54.00	-23.65
3216.03	42.67	100	270			35.77	3.89	30.44	41.23	80.00	-38.77
3216.03				32.17	A	35.77	3.89	30.44	30.73	60.00	-29.27
6432.08	50.17	100	225			36.18	5.73	36.64	56.36	80.00	-23.64
6432.08				45.33	A	36.18	5.73	36.64	51.52	60.00	-8.48
EUT in Continuous Receive Mode on Channel 6 (2.437 GHz)											
1000.00	52.67	100	0			36.20	2.07	25.70	44.24	74.00	-29.76
1000.00				37.00	A	36.20	2.07	25.70	28.57	54.00	-25.43
1201.00	53.00	100	90			35.89	2.35	26.91	46.37	74.00	-27.63
1201.00				37.17	A	35.89	2.35	26.91	30.54	54.00	-23.46
3249.33	44.50	100	270			35.84	3.91	30.45	43.02	80.00	-36.98
3249.33				32.67	A	35.84	3.91	30.45	31.19	60.00	-28.81
6498.55	50.67	100	225			36.18	5.78	36.89	57.16	80.00	-22.84
6498.55				45.00	A	36.18	5.78	36.89	51.49	60.00	-8.51
EUT in Continuous Receive Mode on Channel 11 (2.462 GHz)											
1000.00	52.50	100	0			36.20	2.07	25.70	44.07	74.00	-29.93
1000.00				36.50	A	36.20	2.07	25.70	28.07	54.00	-25.93
1203.75	51.17	100	90			35.88	2.36	26.92	44.57	74.00	-29.43
1203.75				37.33	A	35.88	2.36	26.92	30.73	54.00	-23.27
3282.71	43.00	100	225			35.90	3.91	30.46	41.47	80.00	-38.53
3282.71				31.00	A	35.90	3.91	30.46	29.47	60.00	-30.53
6565.22	49.00	100	225			36.14	5.83	37.38	56.08	80.00	-23.92
6565.22				43.00	A	36.14	5.83	37.38	50.08	60.00	-9.92



AEGIS LABS INC.

PEAK TRANSMIT POWER

CLIENT:	Intel Corporation	DATE:	11/25/03
EUT:	Intel PRO/Wireless 2200BG Network Connection	PROJECT NUMBER:	INTEL-031125-13
MODEL NUMBER:	WM3A2200BG	TEST ENGINEER:	Rick Candelas
SERIAL NUMBER:	0058AAA463ADC54980203	SITE #:	2
CONFIGURATION:	Tested installed in the Dell notebook computer's mini PCI slot.	TEMPERATURE:	16 C
		HUMIDITY:	62% RH
		TIME:	7:00 PM

Standard:	FCC CFR 47, Part 15.247(b)(1)
Description:	The maximum peak output power of the intentional radiator shall not exceed 1 watt.
Results:	See Data Sheet

Peak Transmit Power Limits	
Frequency (MHz)	Output Power (W)
2412-2462	1

NOTE: Channels 1 and 11 were set at approximately 16dBm and Channels 2-10 were set at approximately 17dBm in 802.11b mode. In 802.11g mode Channels 1-11 were set to approximately 16dBm.

Page 47 of 69 (Appendix A)
Report Number: INTEL-031126F
FCC ID: PD9WM3A2200BG



Peak Transmit Power (Continued)

Mode	Channel	Frequency (MHz)	Rate (Mbps)	Conducted Power (dBm)	Cable Factor (dB)	Power Corrected (dBm)	Power (mW)
802.11b	1	2412	1	16.30	0.15	16.45	44.16
802.11b	1	2412	5.5	15.25	0.15	15.40	34.67
802.11b	1	2412	11	15.20	0.15	15.35	34.28
802.11b	2	2417	1	17.35	0.15	17.50	56.23
802.11b	2	2417	5.5	16.40	0.15	16.55	45.19
802.11b	2	2417	11	16.34	0.15	16.49	44.57
802.11b	6	2437	1	17.00	0.15	17.15	51.88
802.11b	6	2437	5.5	15.80	0.15	15.95	39.36
802.11b	6	2437	11	15.86	0.15	16.01	39.90
802.11b	10	2457	1	16.60	0.15	16.75	47.32
802.11b	10	2457	5.5	15.50	0.15	15.65	36.73
802.11b	10	2457	11	15.35	0.15	15.50	35.48
802.11b	11	2462	1	16.00	0.15	16.15	41.21
802.11b	11	2462	5.5	15.21	0.15	15.36	34.36
802.11b	11	2462	11	15.15	0.15	15.30	33.88
802.11g	1	2412	6	16.29	0.15	16.44	44.06
802.11g	1	2412	36	16.10	0.15	16.25	42.17
802.11g	1	2412	54	15.75	0.15	15.90	38.90
802.11g	6	2437	6	15.95	0.15	16.10	40.74
802.11g	6	2437	36	15.70	0.15	15.85	38.46
802.11g	6	2437	54	15.35	0.15	15.50	35.48
802.11g	11	2462	6	15.70	0.15	15.85	38.46
802.11g	11	2462	36	15.40	0.15	15.55	35.89
802.11g	11	2462	54	15.01	0.15	15.16	32.81

NOTE: The output power measurement is conducted.



AEGIS LABS INC.

6 dB EMISSIONS BANDWIDTH

CLIENT:	Intel Corporation	DATE:	11/25/03
EUT:	Intel PRO/Wireless 2200BG Network Connection	PROJECT NUMBER:	INTEL-031125
MODEL NUMBER:	WM3A2200BG	TEST ENGINEER:	Rick Candelas
SERIAL NUMBER:	0058AAA463ADC54980203	SITE #:	2
CONFIGURATION:	Tested with an Intel PRO/Wireless 2200BG Network Connection installed in its mini PCI slot.	TEMPERATURE:	17 C
		HUMIDITY:	40% RH
		TIME:	9:30 AM

Standard:	FCC CFR 47, Part 15.247(a)(2)
Description:	The minimum 6dB bandwidth shall be at least 500 kHz.
Results:	See Data Sheets

Page 49 of 69 (Appendix A)
Report Number: INTEL-031126F
FCC ID: PD9WM3A2200BG



AEGIS LABS INC.

6 dB Emissions Bandwidth (Continued)

802.11b Mode

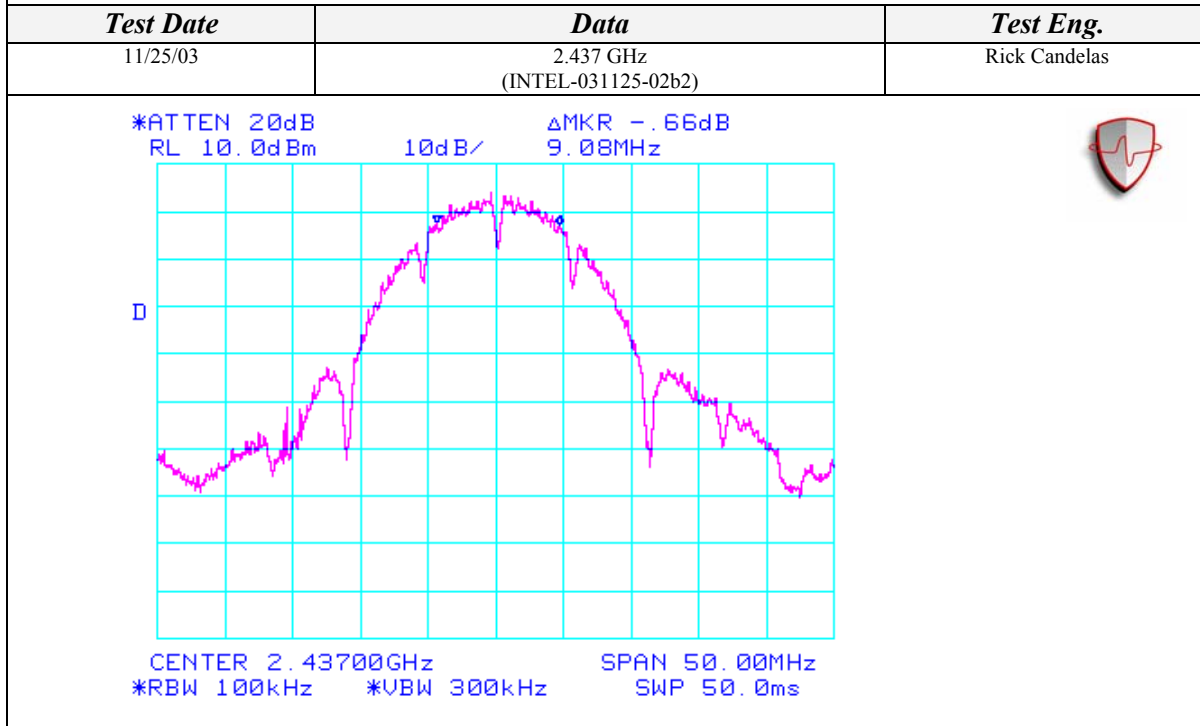
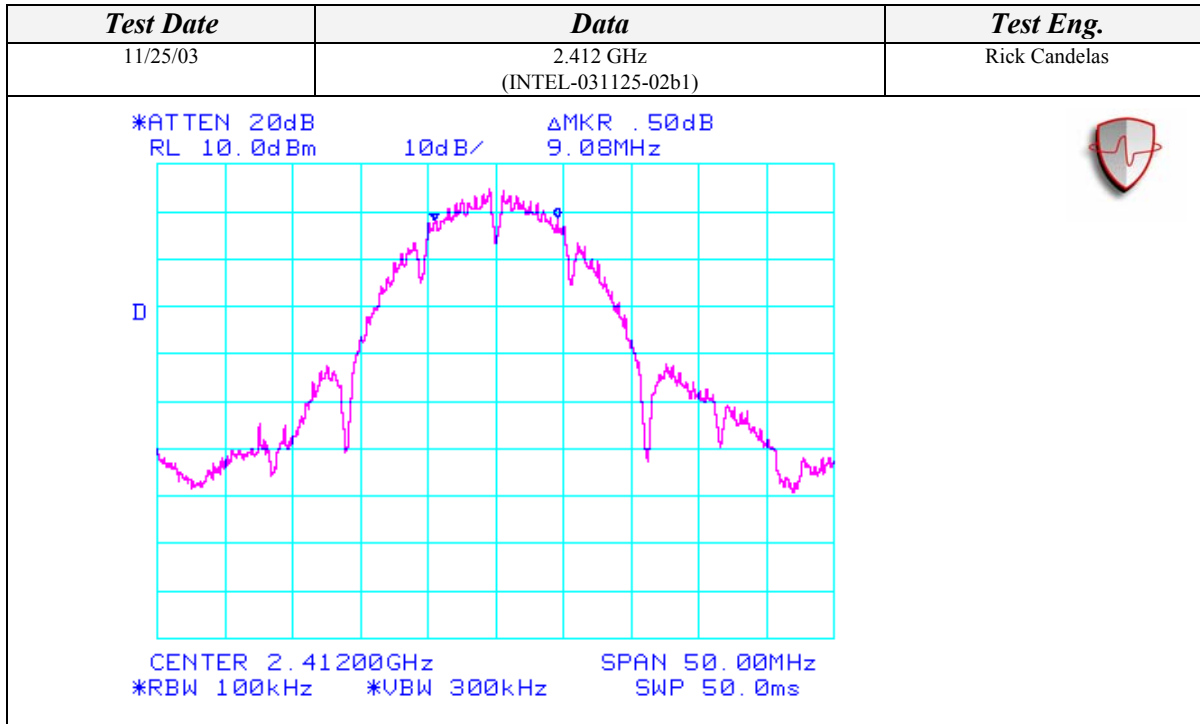

Page 50 of 69 (Appendix A)
Report Number: INTEL-031126F
FCC ID: PD9WM3A2200BG



AEGIS LABS INC.

6 dB Emissions Bandwidth (Continued)

802.11b Mode

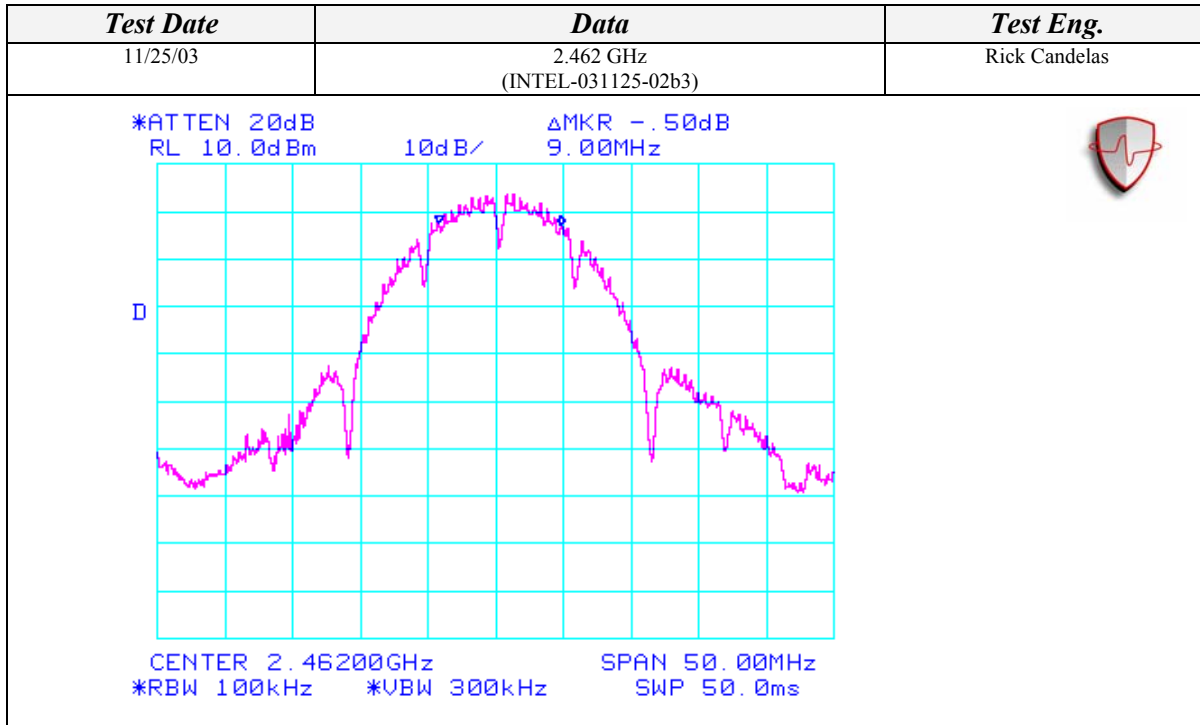

802.11g Mode

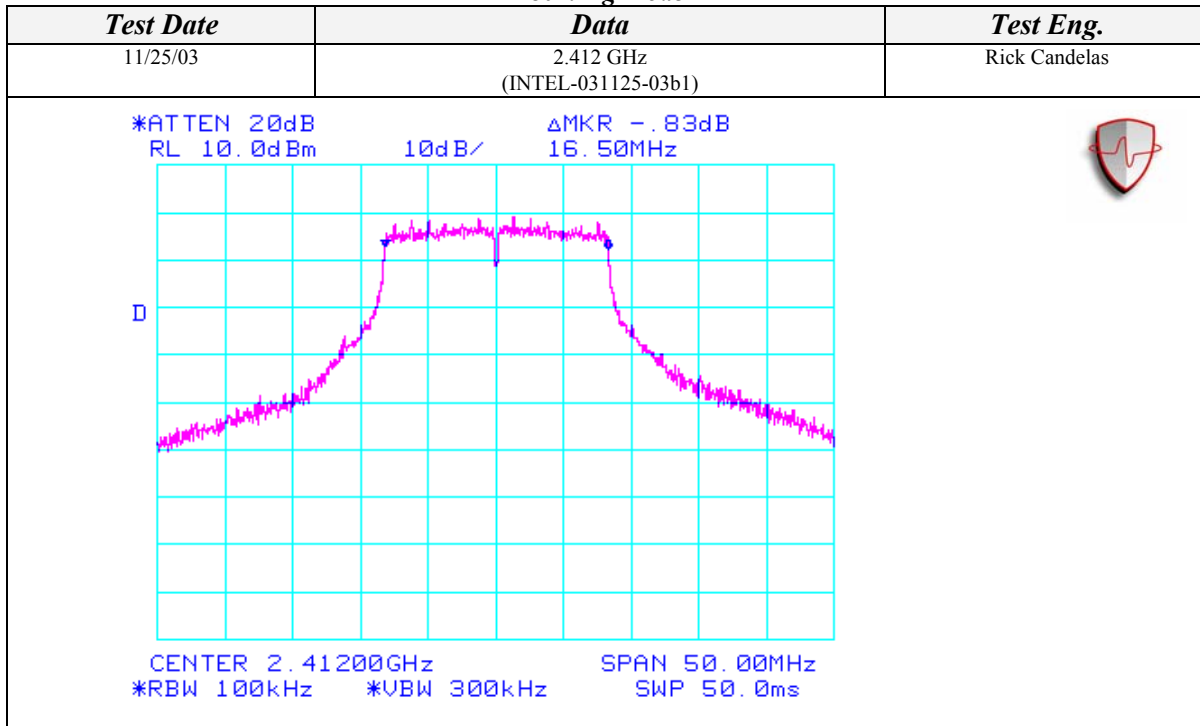

Page 51 of 69 (Appendix A)
Report Number: INTEL-031126F
FCC ID: PD9WM3A2200BG



AEGIS LABS INC.

6 dB Emissions Bandwidth (Continued)

802.11g Mode

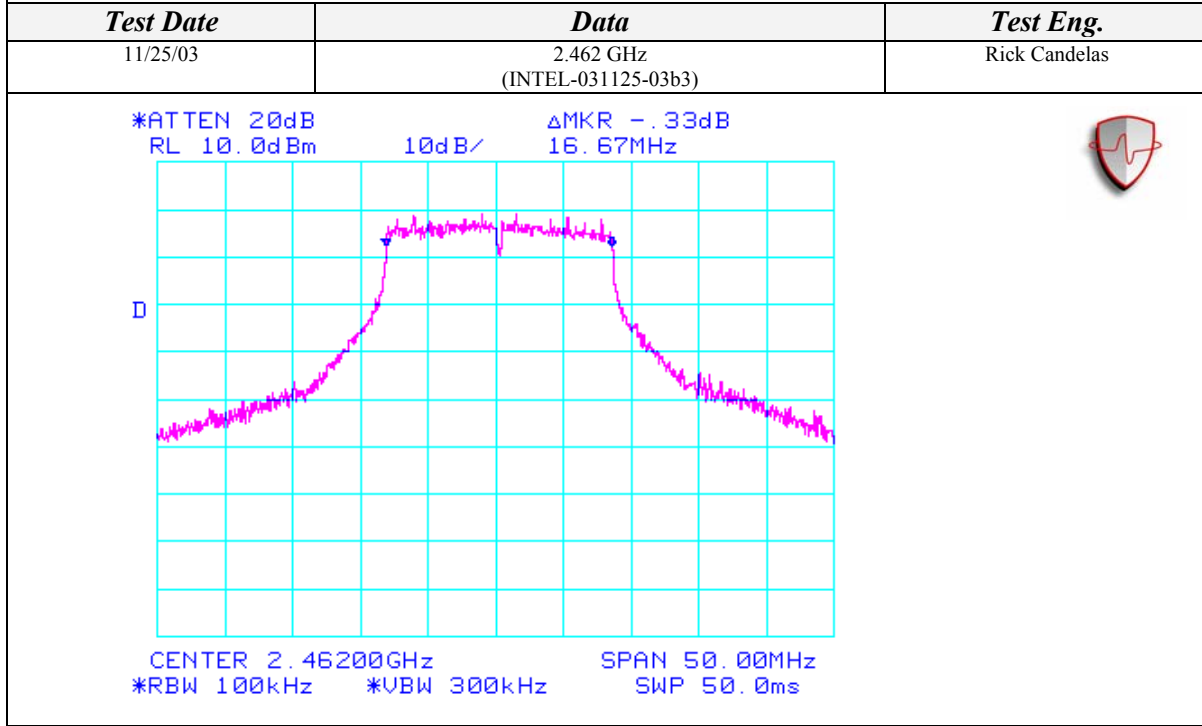
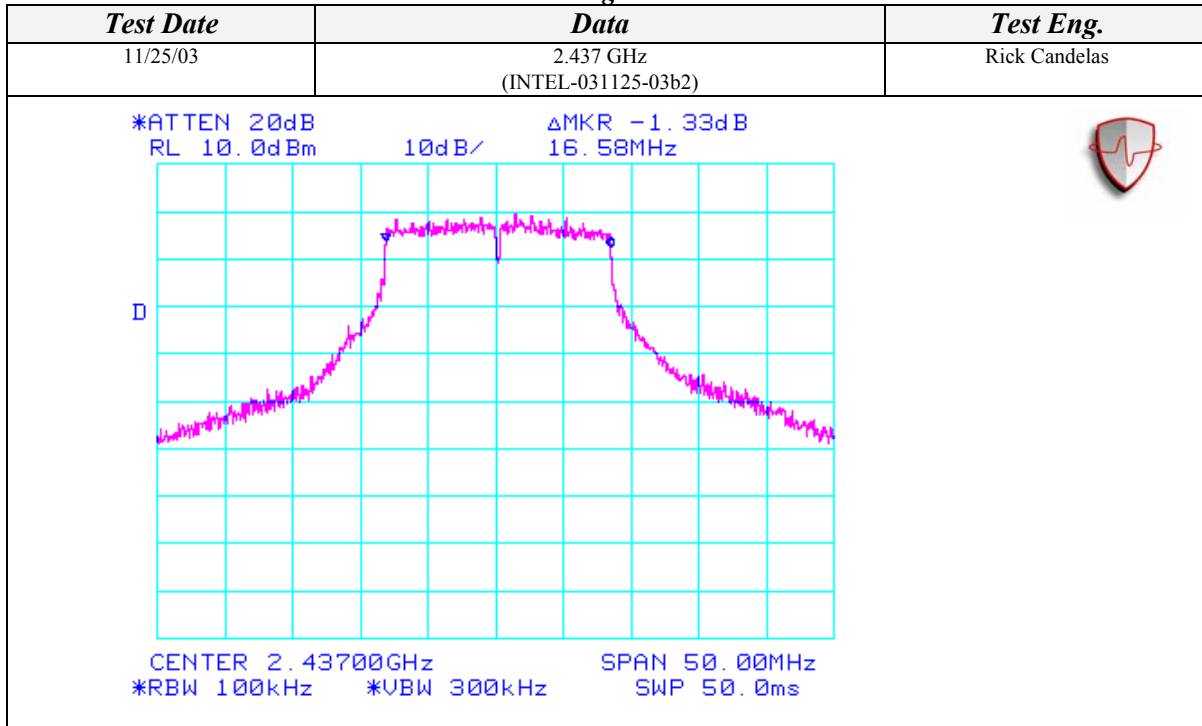

Page 52 of 69 (Appendix A)
Report Number: INTEL-031126F
FCC ID: PD9WM3A2200BG



AEGIS LABS INC.

PEAK POWER SPECTRAL DENSITY

CLIENT:	Intel Corporation	DATE:	11/25/03
EUT:	Intel PRO/Wireless 2200BG Network Connection	PROJECT NUMBER:	INTEL-031125
MODEL NUMBER:	WM3A2200BG	TEST ENGINEER:	Rick Candelas
SERIAL NUMBER:	0058AAA463ADC54980203	SITE #:	2
CONFIGURATION:	Tested installed in the Dell notebook computer's mini PCI slot.	TEMPERATURE:	17 C
		HUMIDITY:	40% RH
		TIME:	9:30 AM

Standard:	FCC CFR 47, Part 15.247(d)
Description:	The peak power spectral density conducted from the intentional radiator to the antenna shall not be greater than 8dBm in any 3 kHz band during any time interval of continuous transmission.
Results:	See Data Sheets

Peak Power Spectral Density Limits	
Frequency (MHz)	Limit (dBm)
2412-2462	8

Page 53 of 69 (Appendix A)
Report Number: INTEL-031126F
FCC ID: PD9WM3A2200BG



Peak Power Spectral Density (Continued)

802.11b Mode

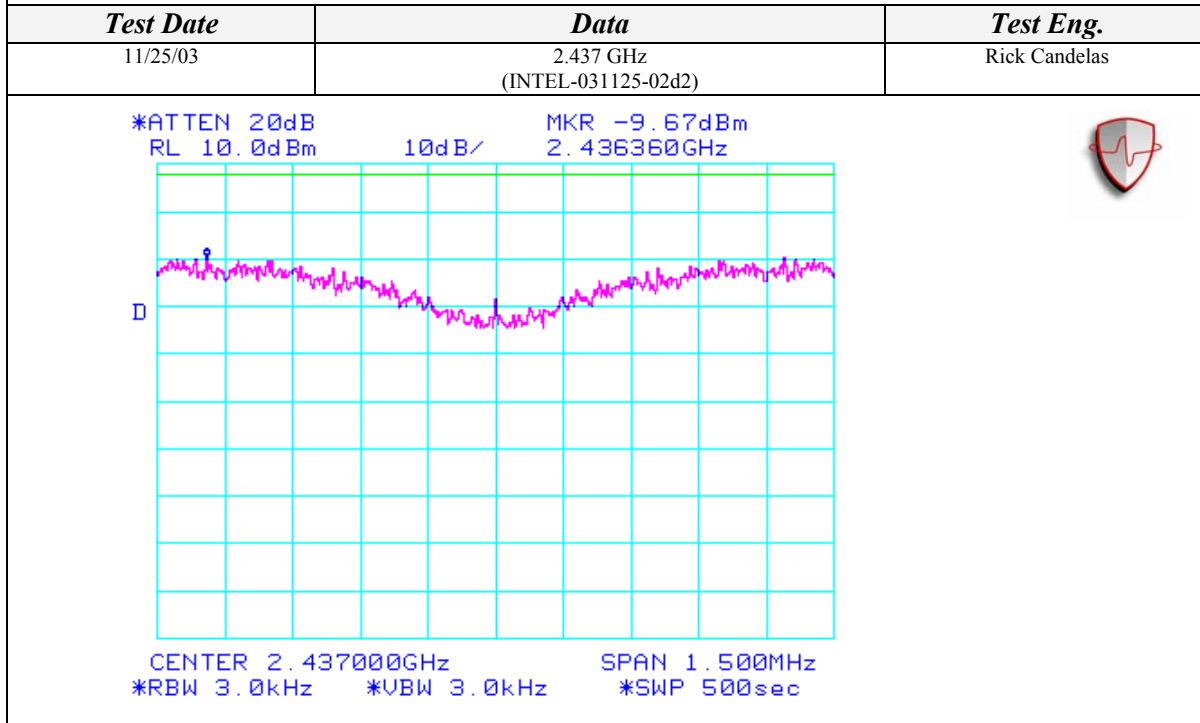
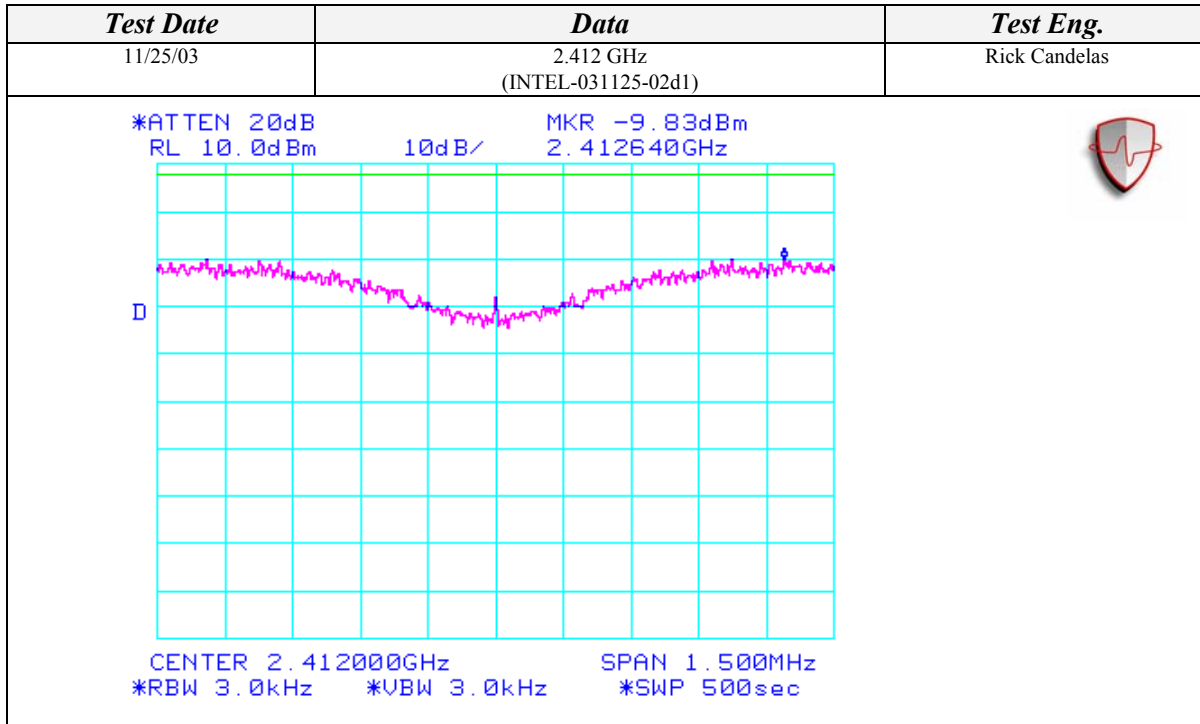



Peak Power Spectral Density (Continued)

802.11g Mode

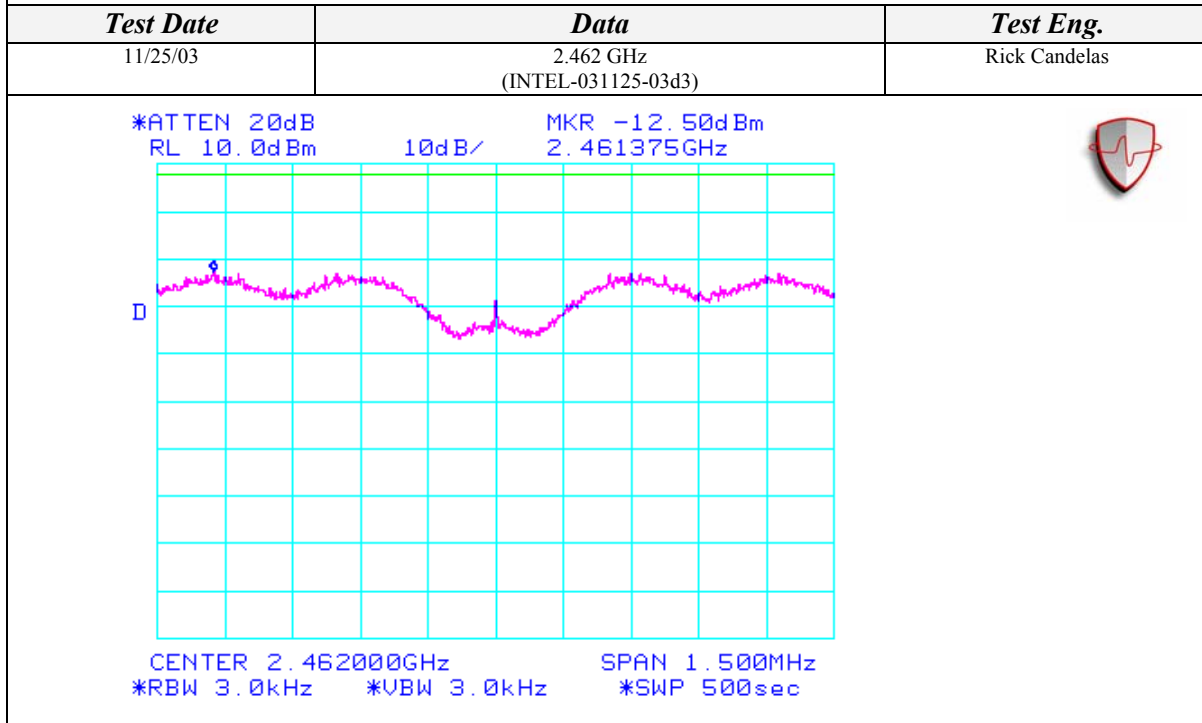
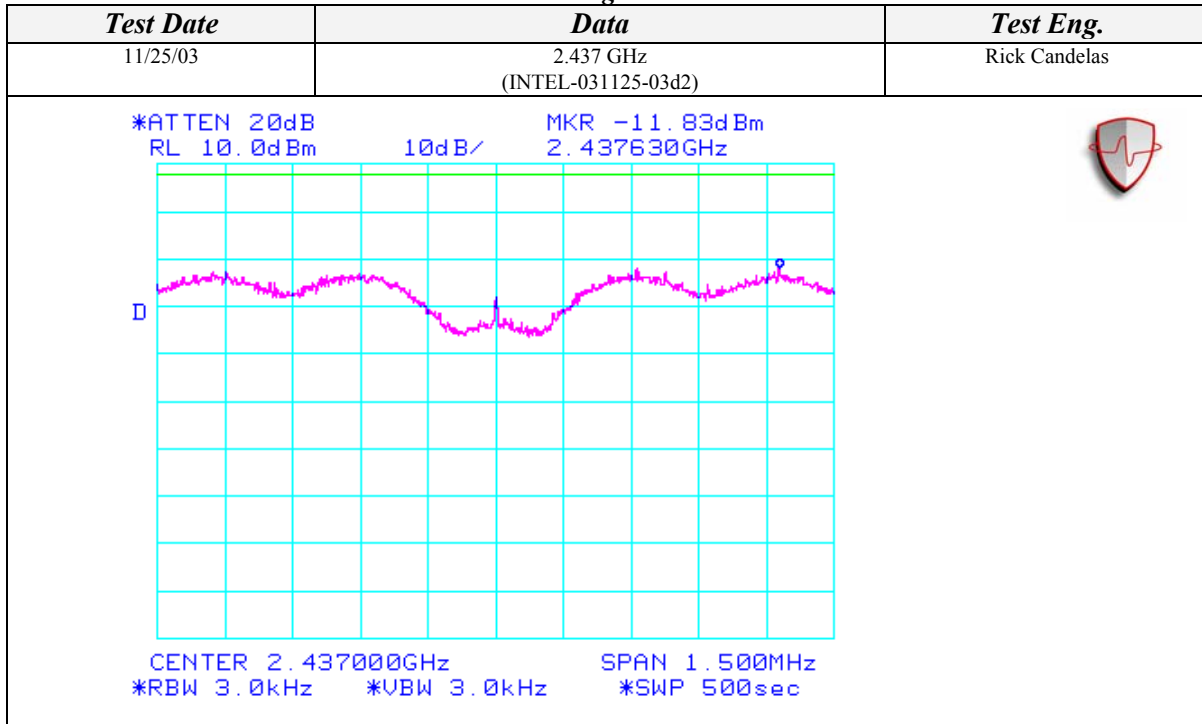



AEGIS LABS INC.

CONDUCTED OUT OF BAND EMISSIONS

CLIENT:	Intel Corporation	DATE:	11/25/03
EUT:	Intel PRO/Wireless 2200BG Network Connection	PROJECT NUMBER:	INTEL-031125
MODEL NUMBER:	WM3A2200BG	TEST ENGINEER:	Rick Candelas
SERIAL NUMBER:	0058AAA463ADC54980203	SITE #:	2
CONFIGURATION:	Tested installed in the Dell notebook computer's mini PCI slot.	TEMPERATURE:	17 C
		HUMIDITY:	40% RH
		TIME:	9:30 AM

Standard:	FCC CFR 47, Part 15.407(b)(1) and 15.407(b)(2)
Description:	In any 100 kHz bandwidth outside the frequency band in which the spread spectrum intentional radiator is operating, the radio frequency power that is produced by the intentional radiator shall be at least 20 dB below that in the 100 kHz bandwidth within the band that contains the highest level of the desired power.

Test Results Summary			
Plot	Channel Frequency (MHz)	Data	Results
INTEL-031125-e01	2412	30MHz – 2GHz	See Plots
INTEL-031125-e02		2GHz – 10GHz	See Plots
INTEL-031125-e03		10GHz – 20GHz	See Plots
INTEL-031125-e04		20GHz – 26.5GHz	See Plots
INTEL-031125-e05	2437	30MHz – 2GHz	See Plots
INTEL-031125-e06		2GHz – 10GHz	See Plots
INTEL-031125-e07		10GHz – 20GHz	See Plots
INTEL-031125-e08		20GHz – 26.5GHz	See Plots
INTEL-031125-e09	2462	30MHz – 2GHz	See Plots
INTEL-031125-e10		2GHz – 10GHz	See Plots
INTEL-031125-e11		10GHz – 20GHz	See Plots
INTEL-031125-e12		20GHz – 26.5GHz	See Plots

Page 57 of 69 (Appendix A)
Report Number: INTEL-031126F
FCC ID: PD9WM3A2200BG



AEGIS LABS INC.

Conducted Out Of Band Emissions (Continued)

802.11b Mode

<i>Test Date</i>	<i>Data</i>	<i>Test Eng.</i>
11/25/03	2.412 GHz (INTEL-031125-02e01)	Rick Candelas

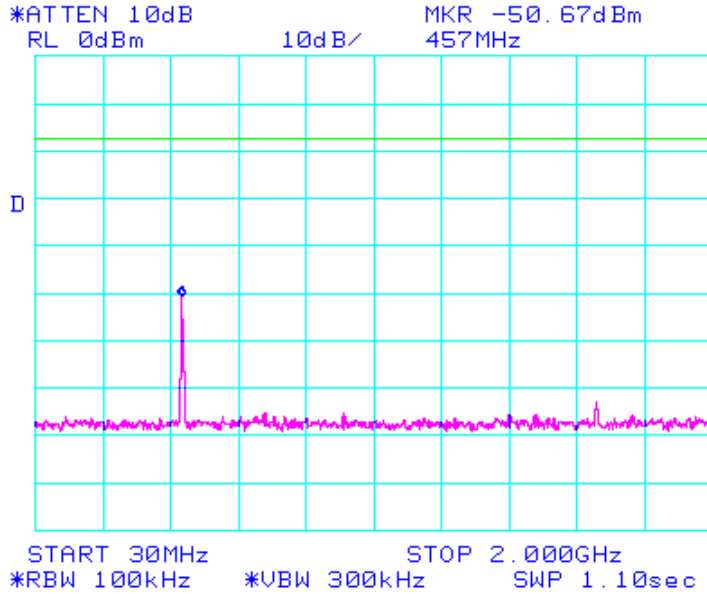

<i>Test Date</i>	<i>Data</i>	<i>Test Eng.</i>
11/25/03	2.412 GHz (INTEL-031125-02e02)	Rick Candelas

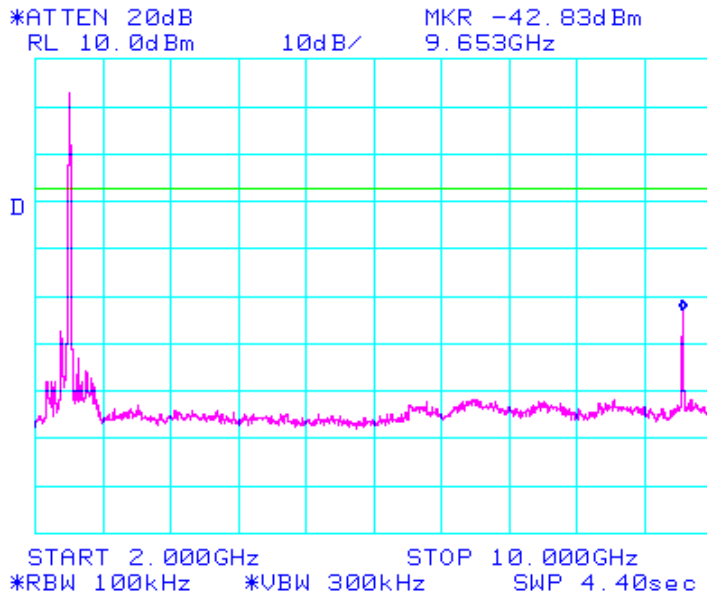

Page 58 of 69 (Appendix A)
Report Number: INTEL-031126F
FCC ID: PD9WM3A2200BG



Conducted Out Of Band Emissions (Continued)

802.11b Mode

Test Date	Data	Test Eng.
11/25/03	2.412 GHz (INTEL-031125-02e03)	Rick Candelas

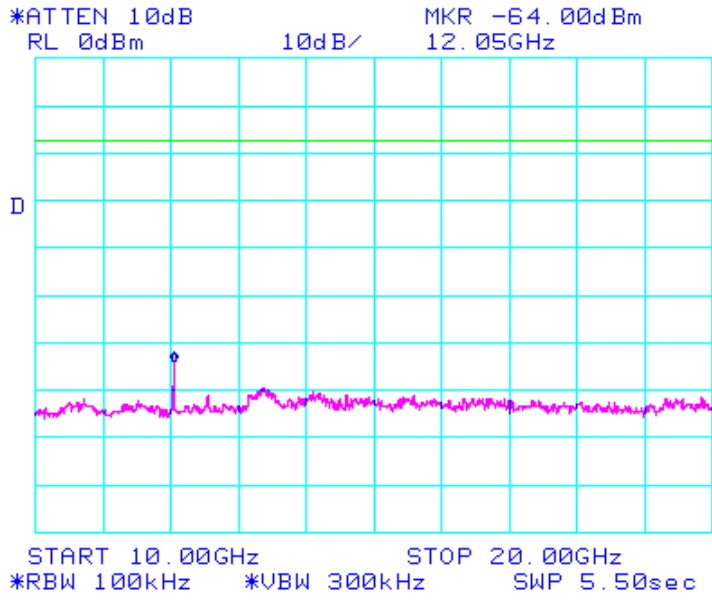

Test Date	Data	Test Eng.
11/25/03	2.412 GHz (INTEL-031125-02e04)	Rick Candelas

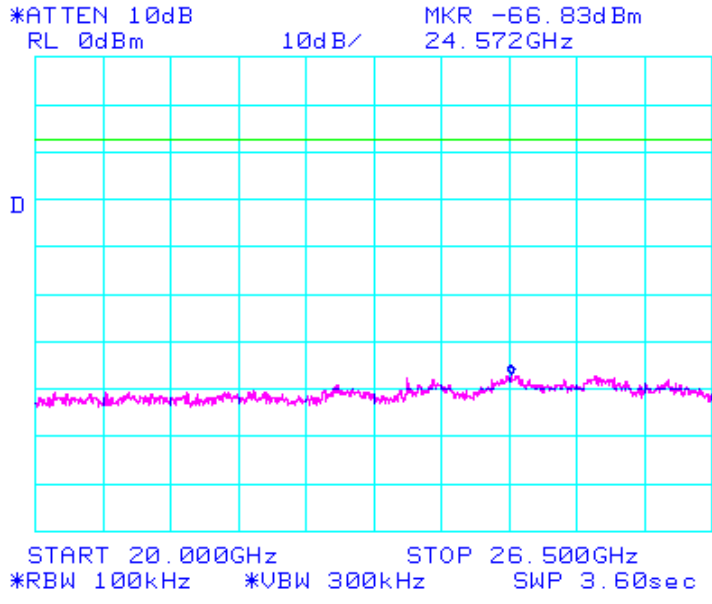



Conducted Out Of Band Emissions (Continued)

802.11b Mode

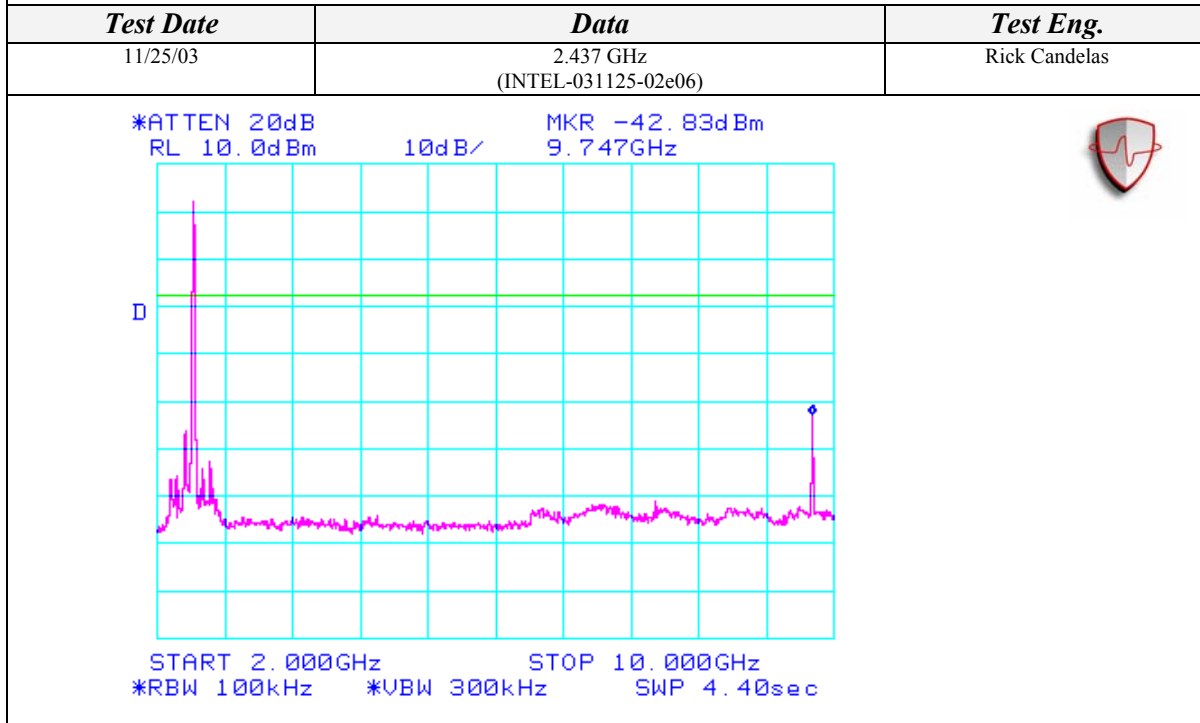
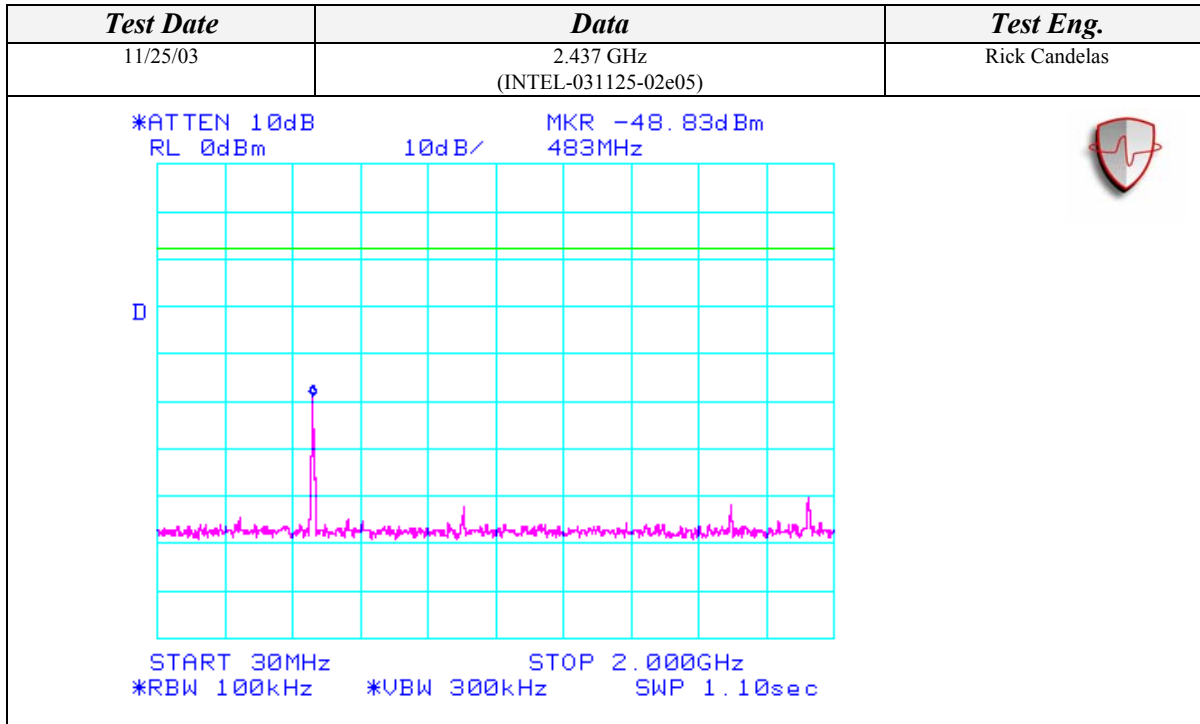



AEGIS LABS INC.

Conducted Out Of Band Emissions (Continued)

802.11b Mode

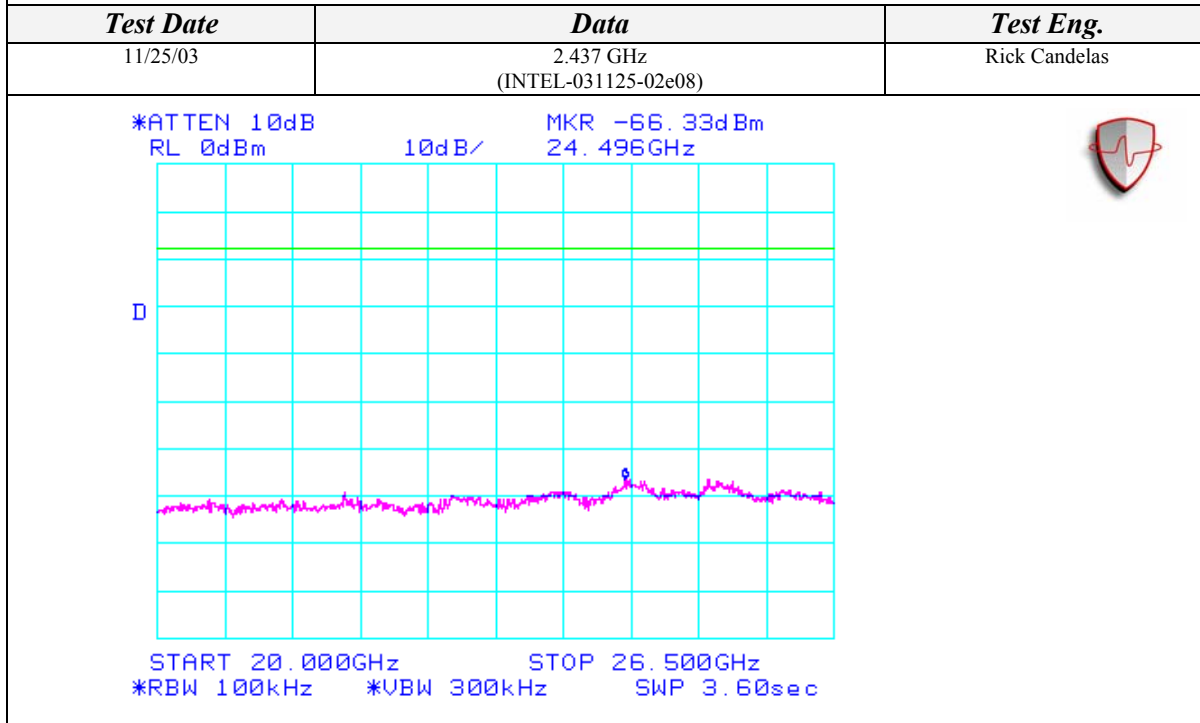
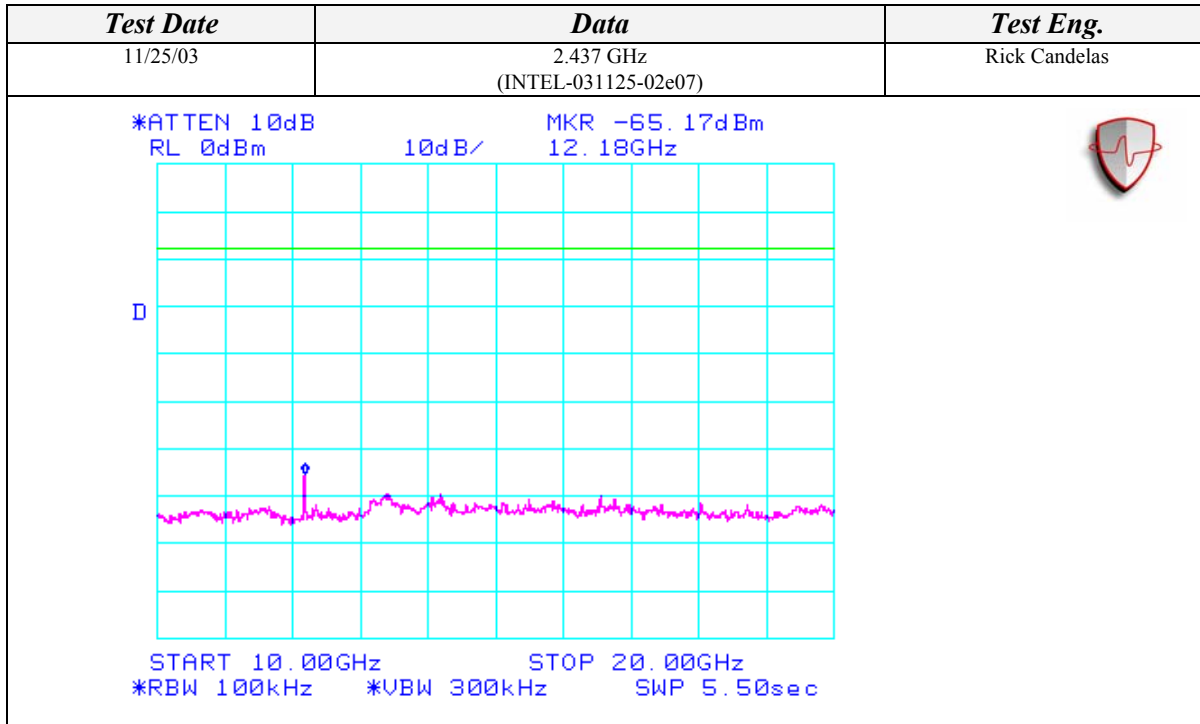

Page 61 of 69 (Appendix A)
Report Number: INTEL-031126F
FCC ID: PD9WM3A2200BG



Conducted Out Of Band Emissions (Continued)

802.11b Mode

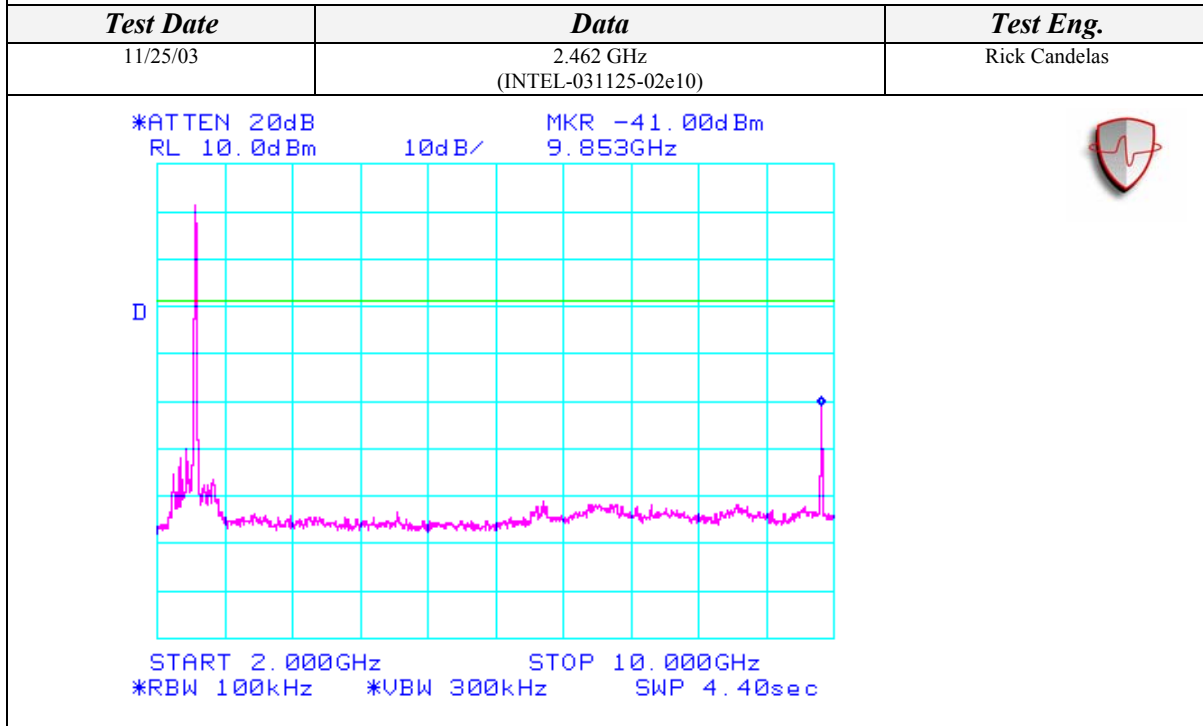
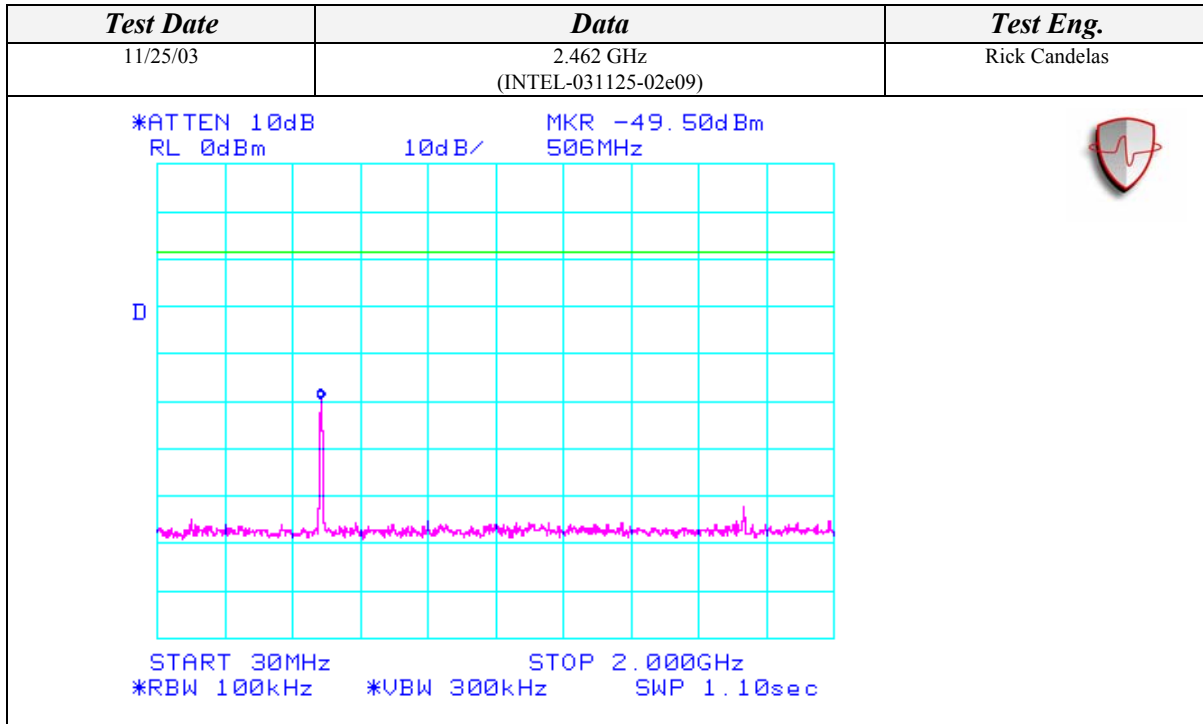



AEGIS LABS INC.

Conducted Out Of Band Emissions (Continued)

802.11b Mode

Test Date	Data	Test Eng.
11/25/03	2.462 GHz (INTEL-031125-02e11)	Rick Candelas
<p>*ATTEN 10dB MKR -64.83dBm RL 0dBm 10dB/ 12.30GHz</p> <p>START 10.00GHz STOP 20.00GHz *RBW 100kHz *VBW 300kHz SWP 5.50sec</p>		



Test Date	Data	Test Eng.
11/25/03	2.462 GHz (INTEL-031125-02e12)	Rick Candelas
<p>*ATTEN 10dB MKR -66.83dBm RL 0dBm 10dB/ 24.702GHz</p> <p>START 20.000GHz STOP 26.500GHz *RBW 100kHz *VBW 300kHz SWP 3.60sec</p>		





AEGIS LABS INC.

Conducted Out Of Band Emissions (Continued)

802.11g Mode

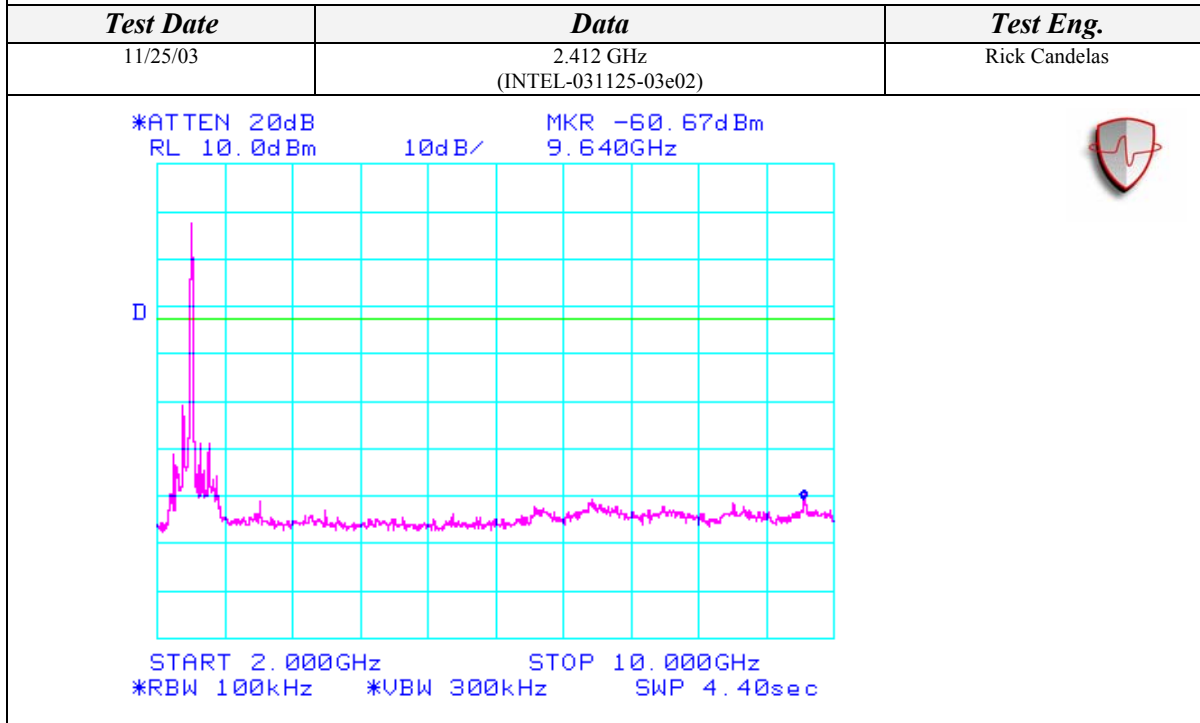
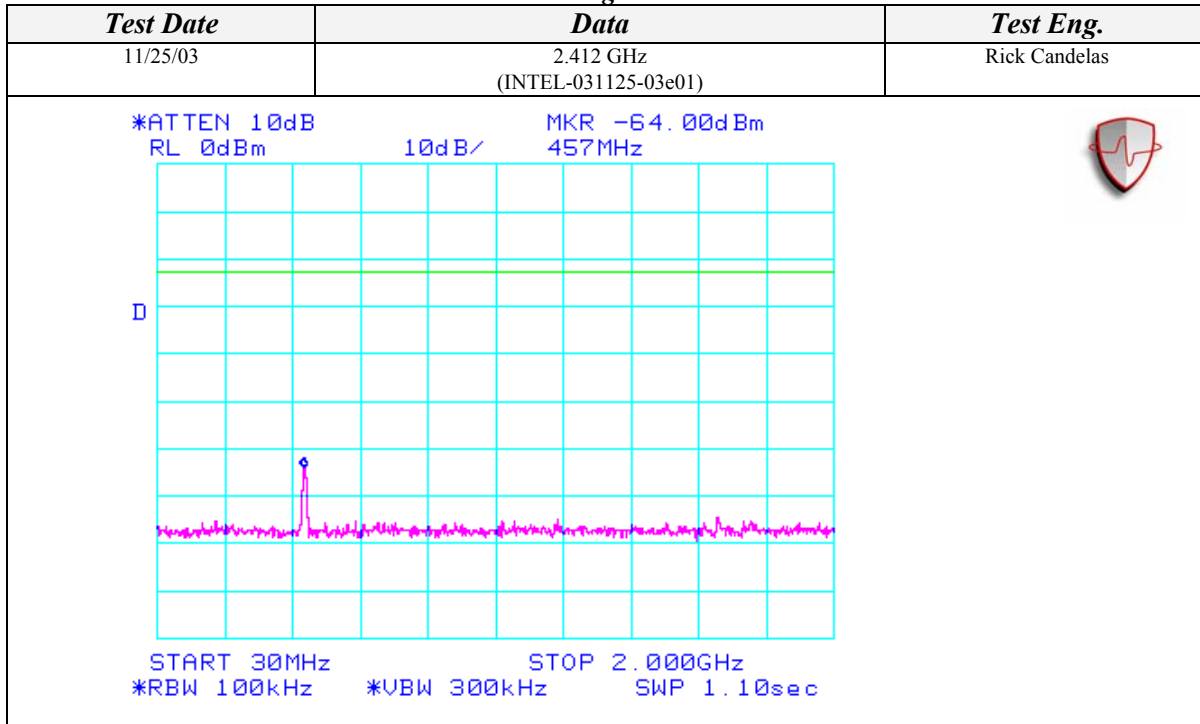

Page 64 of 69 (Appendix A)
 Report Number: INTEL-031126F
 FCC ID: PD9WM3A2200BG



AEGIS LABS INC.

Conducted Out Of Band Emissions (Continued)

802.11g Mode

<i>Test Date</i>	<i>Data</i>	<i>Test Eng.</i>
11/25/03	2.412 GHz (INTEL-031125-03e03)	Rick Candelas
<p>*ATTEN 10dB MKR -69.67dBm RL 0dBm 10dB/ 13.20GHz</p> <p>D</p> <p>START 10.00GHz STOP 20.00GHz *RBW 100kHz *VBW 300kHz SWP 5.50sec</p>		
<i>Test Date</i>	<i>Data</i>	<i>Test Eng.</i>
11/25/03	2.412 GHz (INTEL-031125-03e04)	Rick Candelas
<p>*ATTEN 10dB MKR -66.50dBm RL 0dBm 10dB/ 24.583GHz</p> <p>D</p> <p>START 20.000GHz STOP 26.500GHz *RBW 100kHz *VBW 300kHz SWP 3.60sec</p>		

Page 65 of 69 (Appendix A)
Report Number: INTEL-031126F
FCC ID: PD9WM3A2200BG



AEGIS LABS INC.

Conducted Out Of Band Emissions (Continued)

802.11g Mode

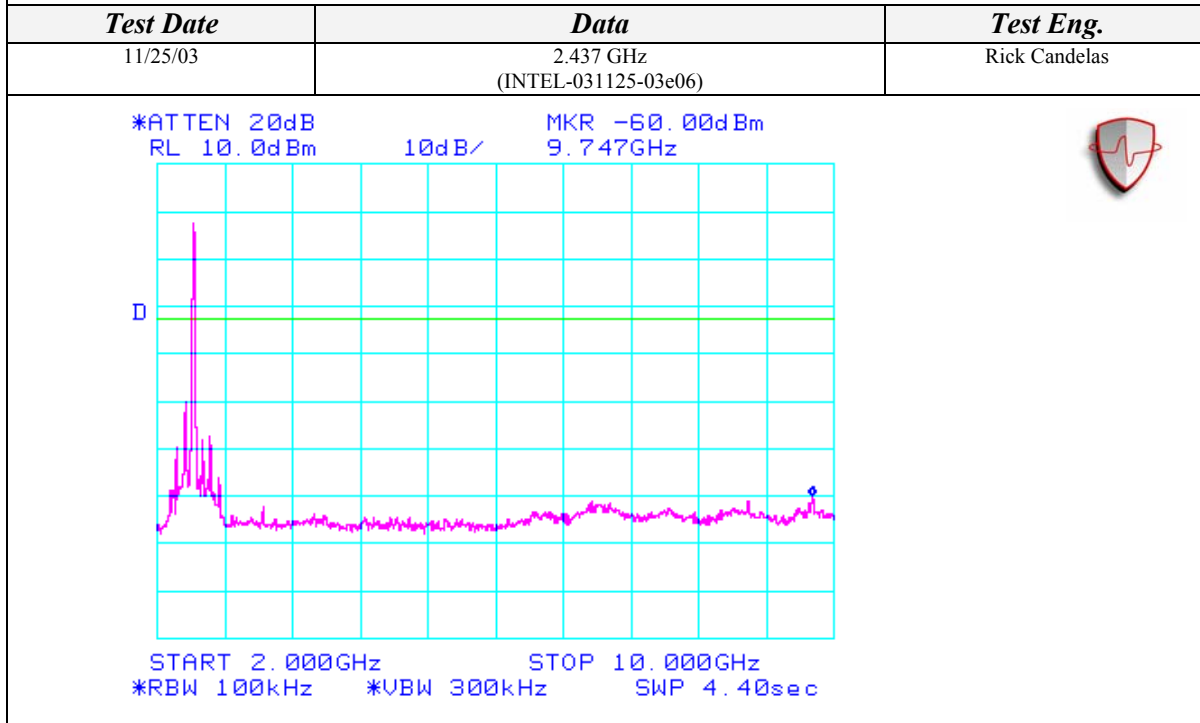
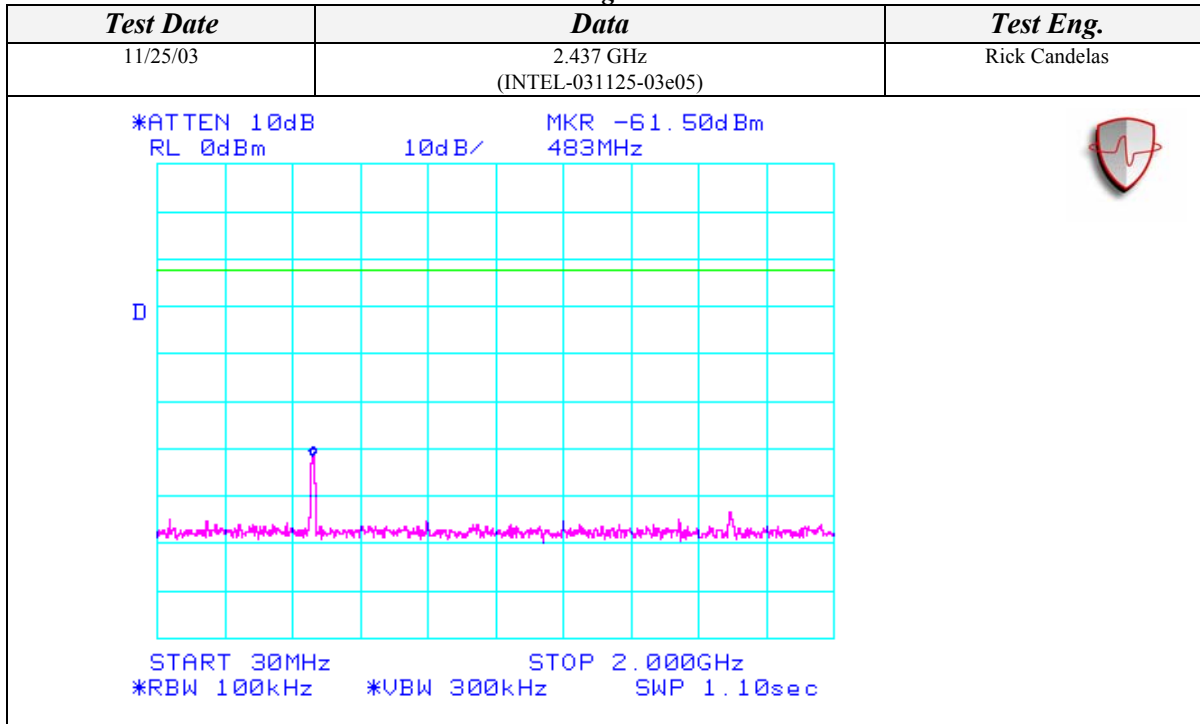

Page 66 of 69 (Appendix A)
Report Number: INTEL-031126F
FCC ID: PD9WM3A2200BG



AEGIS LABS INC.

Conducted Out Of Band Emissions (Continued)

802.11g Mode

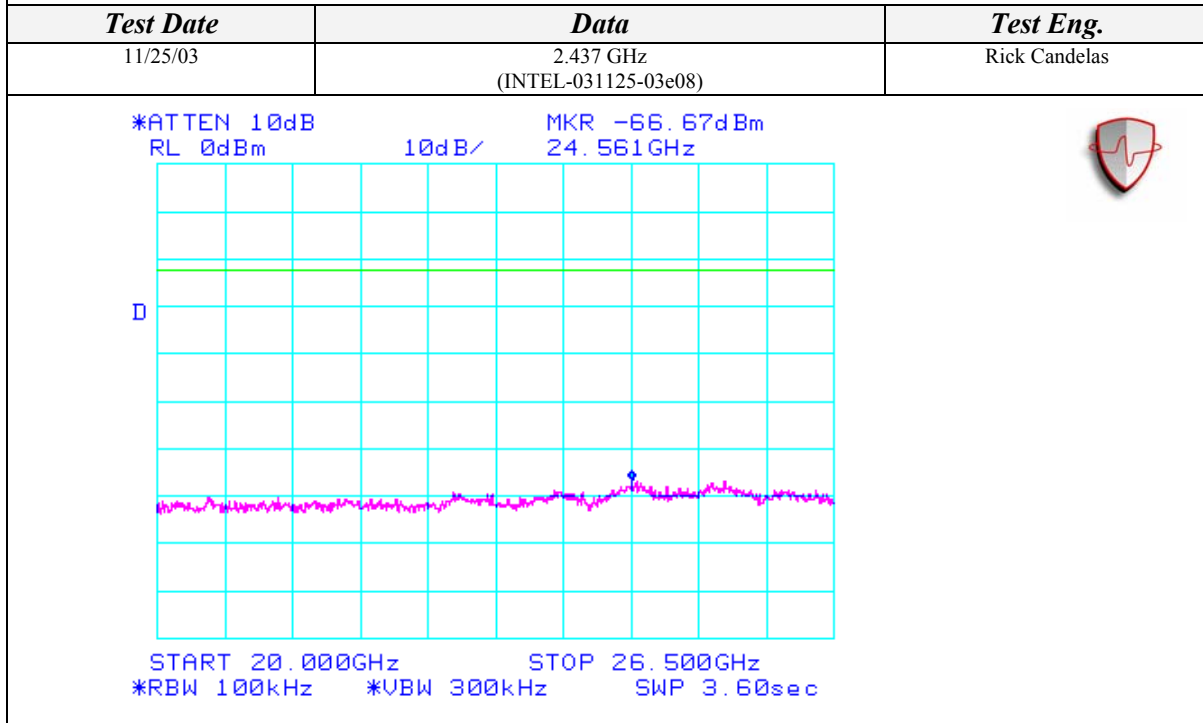
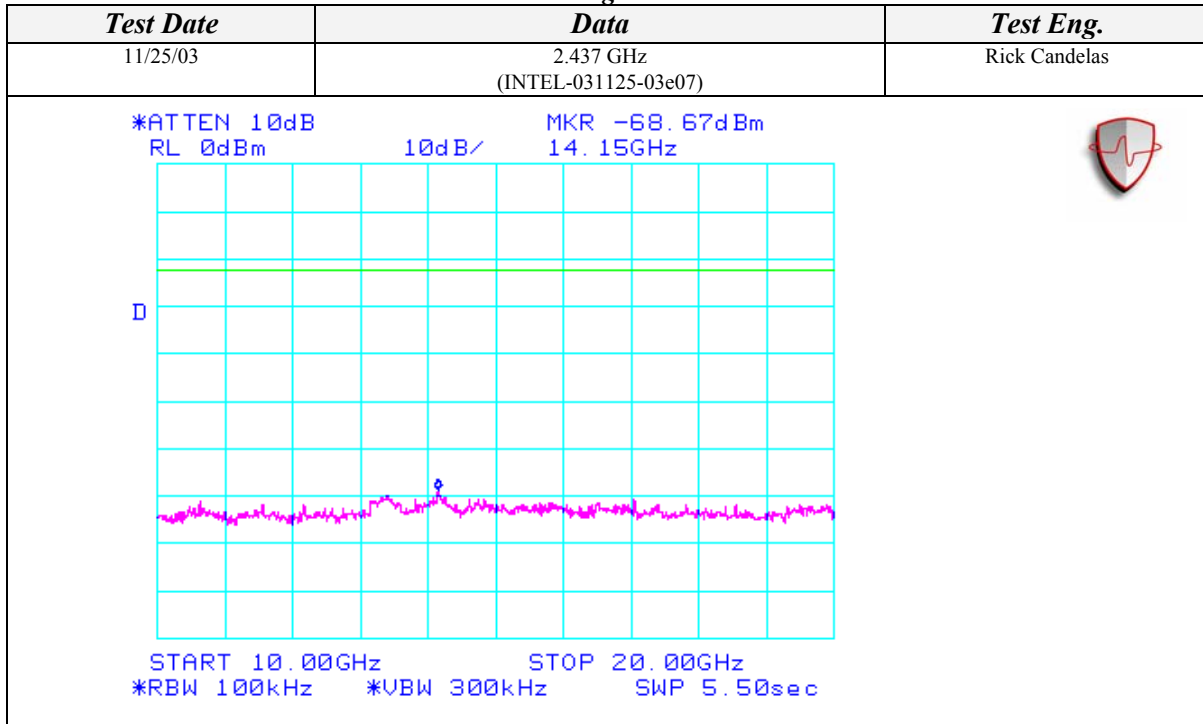



Conducted Out Of Band Emissions (Continued)

802.11g Mode

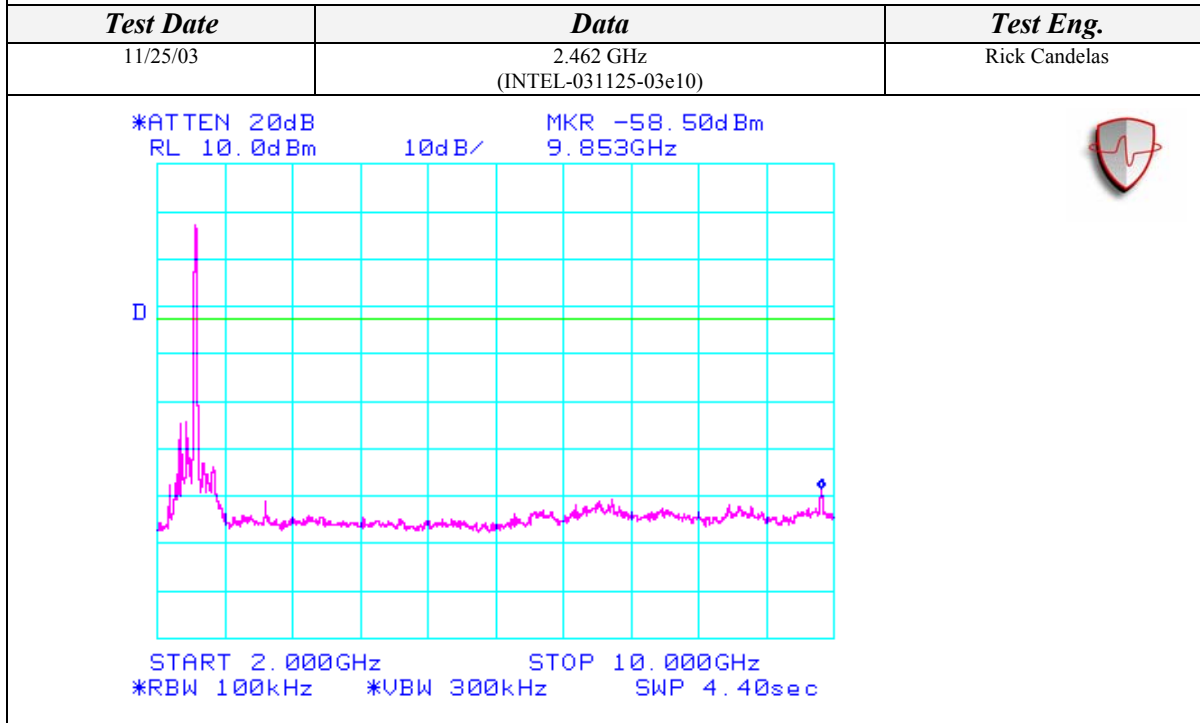
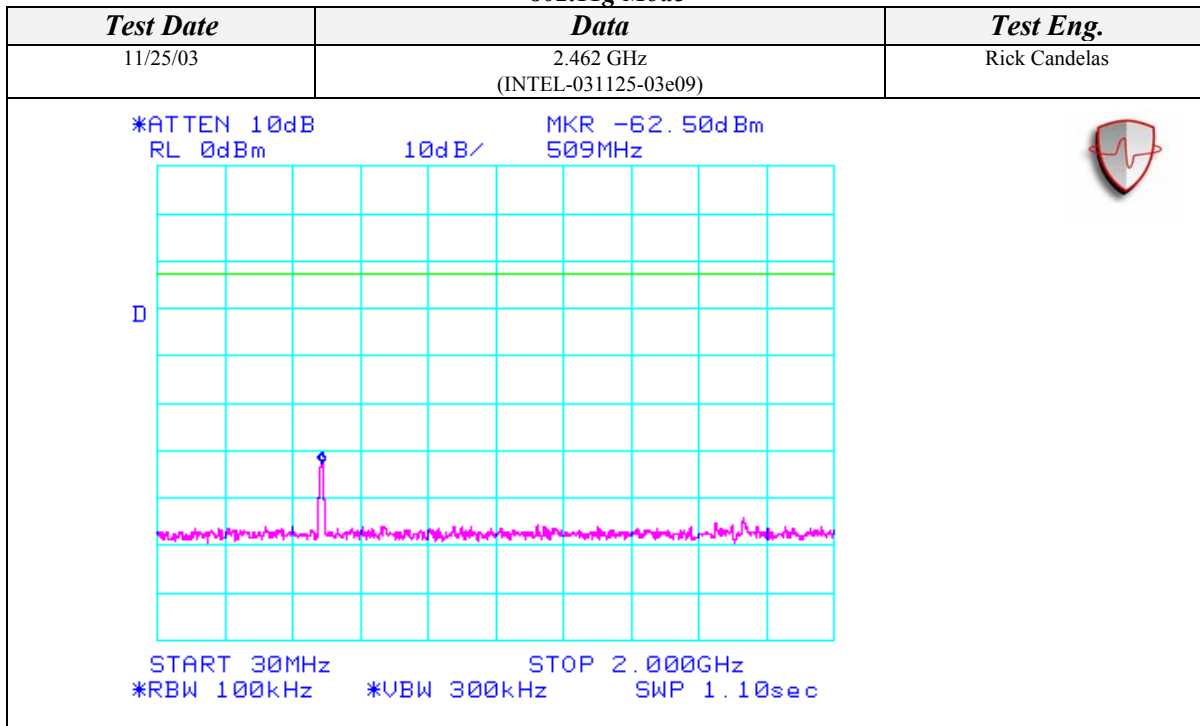



Conducted Out Of Band Emissions (Continued)

802.11g Mode

<i>Test Date</i>	<i>Data</i>	<i>Test Eng.</i>
11/25/03	2.462 GHz (INTEL-031125-03e11)	Rick Candelas
<p>*ATTEN 10dB MKR -69.17dBm RL 0dBm 10dB/ 13.22GHz</p> <p>START 10.00GHz STOP 20.00GHz *RBW 100kHz *VBW 300kHz SWP 5.50sec</p>		



<i>Test Date</i>	<i>Data</i>	<i>Test Eng.</i>
11/25/03	2.462 GHz (INTEL-031125-03e12)	Rick Candelas
<p>*ATTEN 10dB MKR -66.17dBm RL 0dBm 10dB/ 25.319GHz</p> <p>START 20.000GHz STOP 26.500GHz *RBW 100kHz *VBW 300kHz SWP 3.60sec</p>		

