

Latest Regulator Information for Bondi - Hitachi

29-Nov-02

Antenna Type	Monopole Type - MFJ (Multi Frame Joiner)		
Antenna Model Number	Main Antenna	HFT01-DL01(Main)	
	Aux Antenna	HFT01-DL01(Aux)	
Peak Gain	Main Antenna	2GHz	1.2dBi
		5GHz	5.6dBi
	Aux Antenna	2GHz	0.9dBi
		5GHz	4.9dBi
Manufacturing Info	Hitachi Cable, Ltd. Takasago Works, 880 Isagozawa-cho Hitachi-shi, Ibaraki-ken, 319-1418 Japan http://www.hitachi-cable.co.jp/		
Antenna Dimension(Mechanical Drawing)	Main Antenna	EH3848238	
	Aux Antenna	EH3848239	
Cable Length	Main Antenna	141mm	
	Aux Antenna	349mm	
Cable Loss(including connector)	Cable Length 141mm	2GHz	0.6dB
		5GHz	1.2dB
	Cable Length 349mm	2GHz	1.3dB
		5GHz	2.2dB
Antenna Material	Antenna Element	MFJ	
	Cable	Coaxial Cable	
	Connector	I-PEX20308-111R-13	
Connector Info(general description)	Micro Coaxial Connector		

Pictures of Antennas

Main Antenna

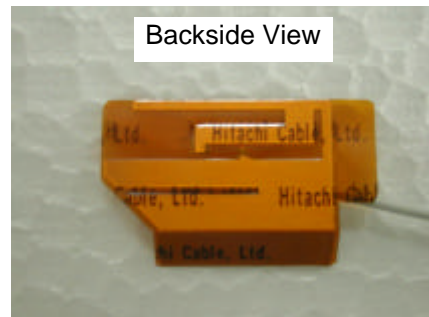
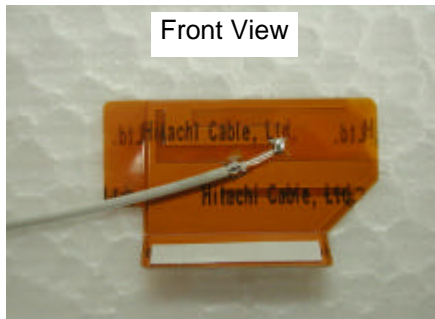

Aux Antenna

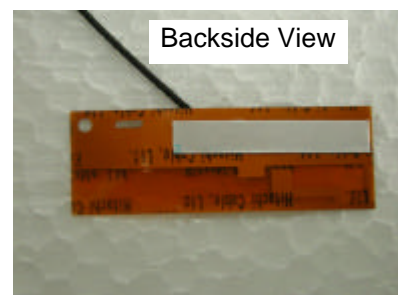
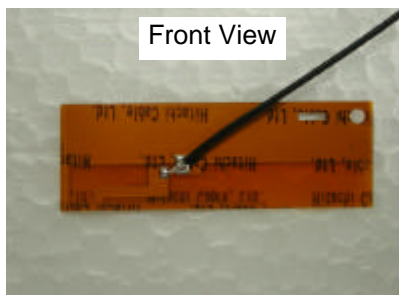

MAIN ANTENNA DRAWING

EH3848238

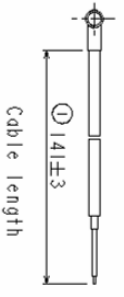
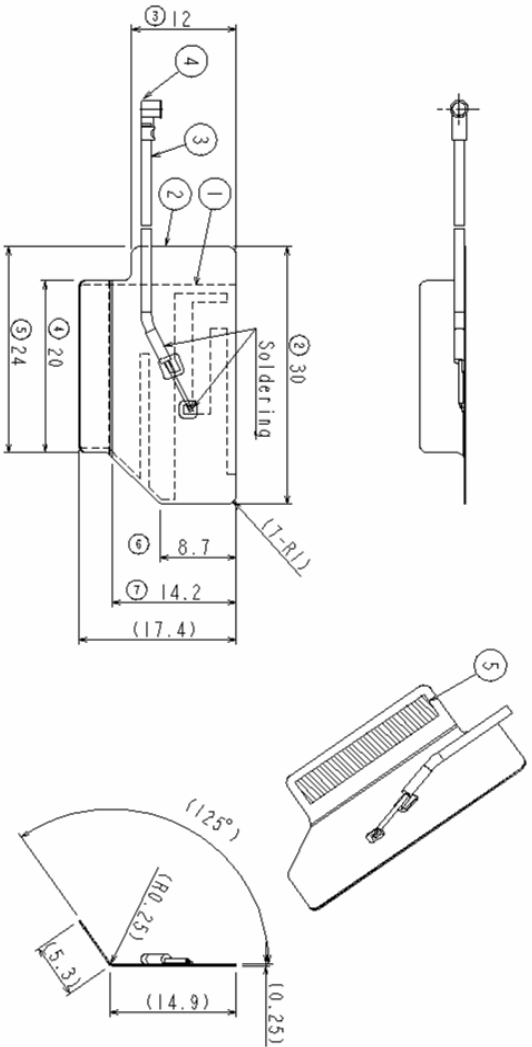

Note
1. means couple-face adhesive tape.
2. The dimensions on this drawing are numbered 1-7.

TOLERANCES OF DIMENSIONS		Tolerance	
Dimension		±0.1	
6	- 6	±0.2	
30	-	±0.3	

No.	Description
①	Conductor
②	Insulating Film
③	Coaxial Cable (φ1.13)
④	Connector I-PEX20308-111R-13
⑤	Adhesive Tape

MARK	REVISION	DATE	NAME	CHKD.
F	dimension changed.	02.11.27	K. ENDO	R. SATO
G	Slope changed.	02.11.27	K. ENDO	R. SATO

Customer P/N		D0670025C203	
DWN.	K. ENDO	02.11.27	TITLE
CHKD.	R. SATO	REGD. PROJ.	HF T01-DL01-MAIN
APPD.	H. TATE		ASSY
SCALE	N.T.S		
Hitachi Cable, Ltd.			
Hitaka Works			
EH3848238			

CADDBG: EH3848238R6 CADDBG: MAIN-HOLE22ALAS 7/19/97: ASSEM

AUX ANTENNA DRAWING

EH3848239

MARK	REVISION	DATE NAME	CHKD.
D	Cable length and dimension number added.	R2.11.28	K. ENDO S. SATO
E	Shape changed.	R2.11.28	K. ENDO R. SATO

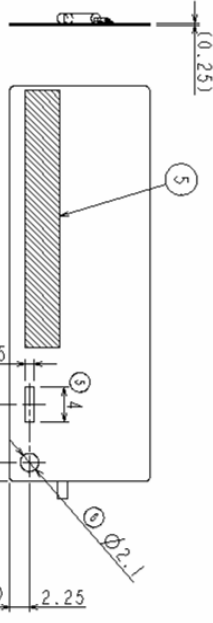
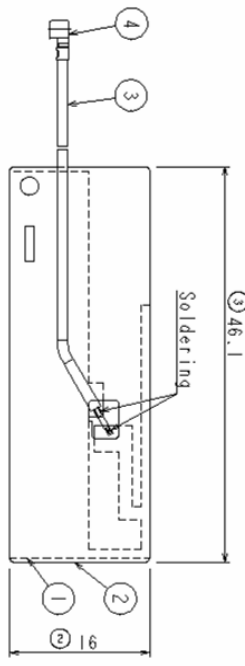
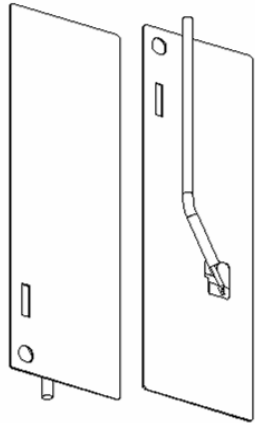

Note
 1. means couple-face adhesive tape.
 2. The dimensions on this drawing are numbered 1-9.

No.	Description
1	Conductor
2	Insulating Film
3	Coaxial Cable (φ1.13)
4	Connector I-PEX20308-1111R-13
5	Adhesive Tape

TOLERANCES OF DIMENSIONS		
Dimension	Tolerance	
6	- 6	±0.1
30	- 30	±0.3

Customer P/N		DQ617005C201	
DWN.	K. ENDO	02.11.28	TITLE
CHKD.	R. SATO	REGD. PROJ.	HFT01-DL01-AUX
APPD.	H. TATE		ASSY
SCALE	N.T.S.		
Hitachi Cable, Ltd.		EH3848239	
Hitaka Works			

CAD005: EH3848239RE CAD005: AUX06ALAS EMI/917: ASSEM

