



TEST REPORT

EUT Description	WLAN and BT, 2x2 PCIe M.2 1625 adapter card
Brand Name	Intel® Wi-Fi 6E AX411
Model Name	AX411E2W
FCC ID	PD9AX411E2
Date of Test Start/End	2021-07-18 / 2021-09-02
Features	802.11ax, Tri Band, 2x2 Wi-Fi 6E + Bluetooth® 5.2 + CDB (Concurrent Dual Band simultaneous wi-fi connection) (see section 5)

Applicant	Intel Mobile Communications
Address	100 Center Point Circle, Suite 200 Columbia, South Carolina 29210 USA
Contact Person	Steven Hackett
Telephone/Fax/ Email	steven.c.hackett@intel.com

Reference Standards	FCC CFR Title 47 Part 15 E (see section 1)
---------------------	---

Test Report identification	210611-03.TR42
Revision Control	Rev. 00 This test report revision replaces any previous test report revision (see section 8)

The test results relate only to the samples tested.
Reference to accreditation shall be used only by full reproduction of test report.

Issued by _____ Reviewed by _____

Cedric REQUIN
(Test Engineer Lead)

Ines KHARRAT
(Technical Officer)

Intel Corporation S.A.S – WRF Lab
425 rue de Goa – Le Cargo B6 - 06600, Antibes, France
Tel. +33493001400 / Fax +33493001401

Table of Contents

1. Standards, reference documents and applicable test methods	3
2. General conditions, competences and guarantees	3
3. Environmental Conditions	3
4. Test samples	4
5. EUT Features	5
6. Remarks and comments	6
7. Test Verdicts summary	7
7.1. 802.11 A/N/AC/AX – U-NII- 4	7
8. Document Revision History	7
Annex A. Test & System Description	8
A.1 MEASUREMENT SYSTEM.....	8
A.2 TEST EQUIPMENT LIST	10
A.3 MEASUREMENT UNCERTAINTY EVALUATION	12
Annex B. Test Results U-NII-4.....	13
B.1 TEST CONDITIONS.....	13
B.2 TEST RESULTS TABLES	14
B.2.1 6dB & 99% Bandwidth	14
B.2.2 Maximum output power & Maximum power spectral Density	16
B.2.3 Undesirable emission limits : out of band (Conducted).....	22
B.2.4 Radiated spurious emission.....	23
B.3 TEST RESULTS SCREENSHOT	45
B.3.1 6dB Bandwidth	45
B.3.2 99% Bandwidth.....	49
B.3.3 Maximum output power	54
B.3.4 Maximum Power Spectral Density (PSD).....	59
B.3.5 Undesirable emission limits : out of band (Conducted).....	63
Annex C. Photographs	85
C.1 TEST SETUP	85
C.2 TEST SAMPLE	87

1. Standards, reference documents and applicable test methods

FCC	<ol style="list-style-type: none"> 1. FCC Title 47 CFR part 15 – Subpart E – Unlicensed National Information Infrastructure Devices. 2021-05-03 online Edition 2. FCC Title 47 CFR part 15 – Subpart C – §15.209 Radiated emission limits; general requirements. 2019-10-01 Edition 3. FCC OET KDB 662911 D01 v02r01 - Emissions Testing of Transmitters with Multiple Outputs in the Same Band. 4. FCC OET KDB 789033 D02 v02r01 - Guidelines for compliance testing of unlicensed national information infrastructure (U-NII) devices part 15, subpart E 5. ANSI C63.10-2013 American National Standard of Procedures for Compliance Testing of Unlicensed Wireless Devices. 6. FCC OET KDB 291074 D01 v01 - General Requirements 7. FCC OET KDB 291074 D02 v01 - EMC Measurement 8. FCC OET KDB 291074 D03 v01 - QA General Questions and Answers
-----	--

2. General conditions, competences and guarantees

- ✓ Tests performed under FCC standards identified in section 1 are covered by A2LA accreditation.
- ✓ Intel Corporation SAS Wireless RF Lab (Intel WRF Lab) is an ISO/IEC 17025:2017 laboratory accredited by the American Association for Laboratory Accreditation (A2LA) with the certificate number 3478.01.
- ✓ Intel Corporation SAS Wireless RF Lab (Intel WRF Lab) is an Accredited Test Firm recognized by the FCC, with Designation Number FR0011.
- ✓ Intel WRF Lab only provides testing services and is committed to providing reliable, unbiased test results and interpretations.
- ✓ Intel WRF Lab is liable to the client for the maintenance of the confidentiality of all information related to the item under test and the results of the test.
- ✓ Intel WRF Lab has developed calibration and proficiency programs for its measurement equipment to ensure correlated and reliable results to its customers.
- ✓ This report is only referred to the item that has undergone the test.
- ✓ This report does not imply an approval of the product by the Certification Bodies or competent Authorities.

3. Environmental Conditions

- ✓ At the site where the measurements were performed the following limits were not exceeded during the tests:

Temperature	22.4 °C ±1 °C
Humidity	49.6% ±4.5%

4. Test samples

Sample	Control #	Description	Model	Serial #	Date of receipt	Note
#1	210611-03.S04	WiFi 6E Module	AX411E2W	WM:3413E8F0D1BA	2021-07-05	RF Conducted
	170000-01.S02	Laptop	Latitude E5470	21HTPF2	2017-03-28	
	191003-02.S06	Extender	PCB00651_01	6513519-009	2019-10-29	
	210611-03.S24	Socket (GfP4 SD1625)	AX411E2W	-	2021-07-22	
#2	210611-03.S01	WiFi 6E Module	AX411E2W	WM:3413E8F0D70A	2021-07-05	Used for 30MHz-1GHz and 9.5-18GHz Radiated Spurious Emissions tests
	210611-03.S25	Socket	Adaptor 1625	-	2021-07-16	
	200102-01.S03	Extender	ADEXELEC	-	2020-01-02	
	210611-02.S15	Adaptor	PowerBy SNJ A4	-	2021-07-02	
	200602-03.S06	Absorber	MCS0	-	2020-07-03	
	170801-01.S10	Laptop	Latitude E7470	7KNOXF2	2017-09-08	
	210611-02.S13	Antenna 1	SkyCross	-	2021-07-02	
	210611-02.S14	Antenna 2	SkyCross	-	2021-07-02	
#3	210611-03.S02	WiFi 6E Module	AX411E2W	WM:3413E8F0DA75	2021-07-05	Used for 1GHz-9.5GHz Radiated Spurious Emissions tests
	210611-03.S26	Socket	Adaptor 1625	-	2021-07-16	
	200611-03.S26	Extender	ADEXELEC	-	2020-07-01	
	210611-02.S16	Adaptor	PowerBy SNJ A4	-	2021-07-02	
	200602-03.S06	Absorber	MCS0	-	2020-07-03	
	170000-01.S01	Laptop	Latitude E5470	DBPLMC2	2017-03-28	
	210611-02.S11	Antenna 1	SkyCross	-	2021-07-02	
	210611-02.S12	Antenna 2	SkyCross	-	2021-07-02	
#4	210611-03.S01	WiFi 6E Module	AX411E2W	WM:3413E8F0D70A	2021-07-05	Used for 18GHz - 40GHz Radiated Spurious Emissions tests
	210611-03.S25	Socket	Adaptor 1625	-	2021-07-16	
	200611-03.S26	Extender	ADEXELEC	-	2020-07-01	
	210611-02.S15	Adaptor	PowerBy SNJ A4	-	2021-07-02	
	200602-03.S06	Absorber	MCS0	-	2020-07-03	
	170000-01.S01	Laptop	Latitude E5470	DBPLMC2	2017-03-28	
	210611-02.S11	Antenna 1	SkyCross	-	2021-07-02	
	210611-02.S12	Antenna 2	SkyCross	-	2021-07-02	

5. EUT Features

The herein information is provided by the customer

Brand Name	Intel® Wi-Fi 6E AX411		
Model Name	AX411E2W		
Software Version	DRTU Version: 99.2100.64.0-OEM.DRTU.12485 DRTU Version: 99.2100.66.0-OEM.DRTU.12712*		
Driver Version	99.0.63.5 99.0.66.4*		
Prototype / Production	Production		
Supported Radios	802.11b/g/n/ax 802.11a/n/ac/ax 802.11ax Bluetooth 5.2	2.4 GHz (2400.0 – 2483.5 MHz) 5.2 GHz (5150.0 – 5350.0 MHz) 5.6 GHz (5470.0 – 5725.0 MHz) 5.8 GHz (5725.0 – 5895.0 MHz) 5.9 GHz (5850.0 – 5895.0 MHz) 6.0 GHz (5925.0 - 7125.0MHz)	
Antenna Information	Transmitter	Chain 1 (A)	Chain 2 (B)
	Manufacturer	SkyCross	Skycross
	Antenna type	PIFA antenna	PIFA antenna
	Part number	N/A	N/A
	Declared antenna gain (dBi)	+5	+5
Additional information	The EUT is a WiFi module supporting concurrent dual band (CDB) transmission modes		
	Mode	Chain 2 (B)	Chain 1 (A)
	CDB Mode + Co-run BT:		
	BT Co-run – CDB SISO	WLAN 2.4GHz + WLAN 5GHz	BT
		WLAN 2.4GHz + WLAN 6GHz	BT
	CDB only SISO	WLAN 2.4GHz + WLAN 5GHz	-
		WLAN 2.4GHz + WLAN 6GHz	-
	CDB only MIMO	-	WLAN 2.4GHz + WLAN 5GHz
		-	WLAN 2.4GHz + WLAN 6GHz
	BT Co-run (CDB SISO)	WLAN 2.4GHz + WLAN 5GHz	WLAN 2.4GHz + WLAN 5GHz
WLAN 2.4GHz + WLAN 6GHz		WLAN 2.4GHz + WLAN 6GHz	
BT Co-run (CDB SISO)	WLAN 2.4GHz	WLAN 5GHz + BT	
	WLAN 2.4GHz	WLAN 6GHz + BT	

*Note 1: The following test cases used DRTU Version: 99.2100.66.0.12712 and driver 99.0.66.4

Mode	Rate	Channel	Freq [MHz]	Antenna
802.11n40	HT8	167	5835	MIMO A
				MIMO B
802.11ax40	MCS0	167	5835	MIMO A
				MIMO B

6. Remarks and comments

1. No deviations were made from the test methods listed in section 1 of this report.
2. Only the worst-case plot per 802.11 mode and test case measurements have been reported excepted for band edge measurements where all plots are reported
3. Tests have been performed with the KDB draft. No deviation between the KDB draft and the KDB has been identified.

7. Test Verdicts summary

The statement of conformity to applicable standards in the table below are based on the measured values, without taking into account the measurement uncertainties.

7.1. 802.11 a/n/ac/ax – U-NII- 4

FCC part	Test name	Verdict
15.407 (e)	6dB Bandwidth	P
15.407 (a) (3)	Power Limits. Maximum output power	P
15.407 (a) (3)	Power spectral density	P
15.407 (b) (5)	Undesirable emissions limits: out of band (conducted)	P
15.407 (b) (5) 15.209	Undesirable emissions limits: Spurious emissions (radiated)	P

P: Pass

F: Fail

NM: Not Measured

NA: Not Applicable

8. Document Revision History

Revision #	Modified by	Revision Details
Rev. 00	N.Bui	First Issue

Annex A. Test & System Description

A.1 Measurement System

Measurements were performed using the following setups, made in accordance to the general provisions of ANSI C63.10 2013.

The DUT was installed in a test fixture and this test fixture is connected to a laptop computer and AC/DC power adapter. The laptop computer was used to configure the EUT to continuously transmit at a specified output power using all different modes and modulation schemes, using the Intel proprietary tool DRTU.

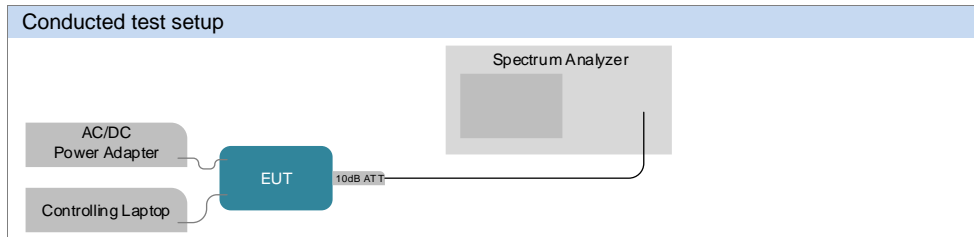

Radiated test setup

Radiated Setup 30 MHz - 1 GHz (Transmitter tests)

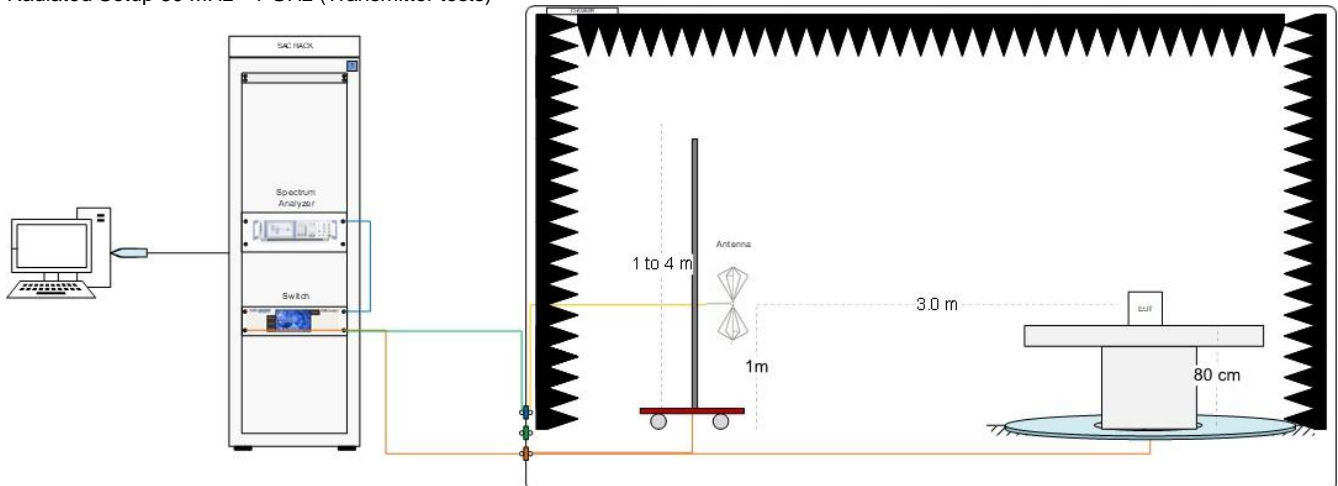

Radiated Setup 1 GHz - 9.5 GHz (Transmitter tests)

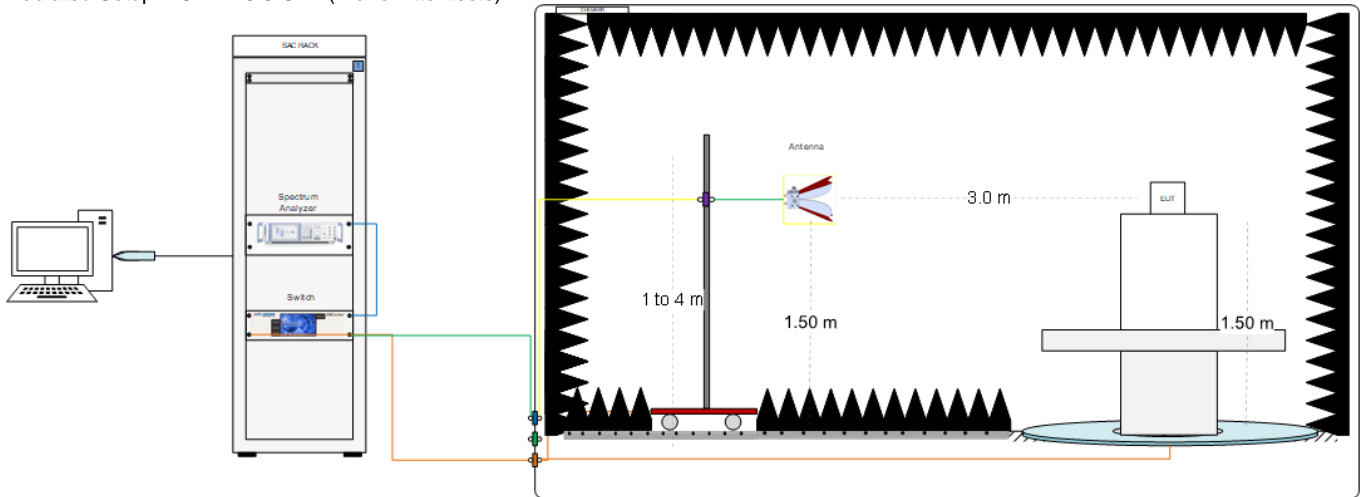

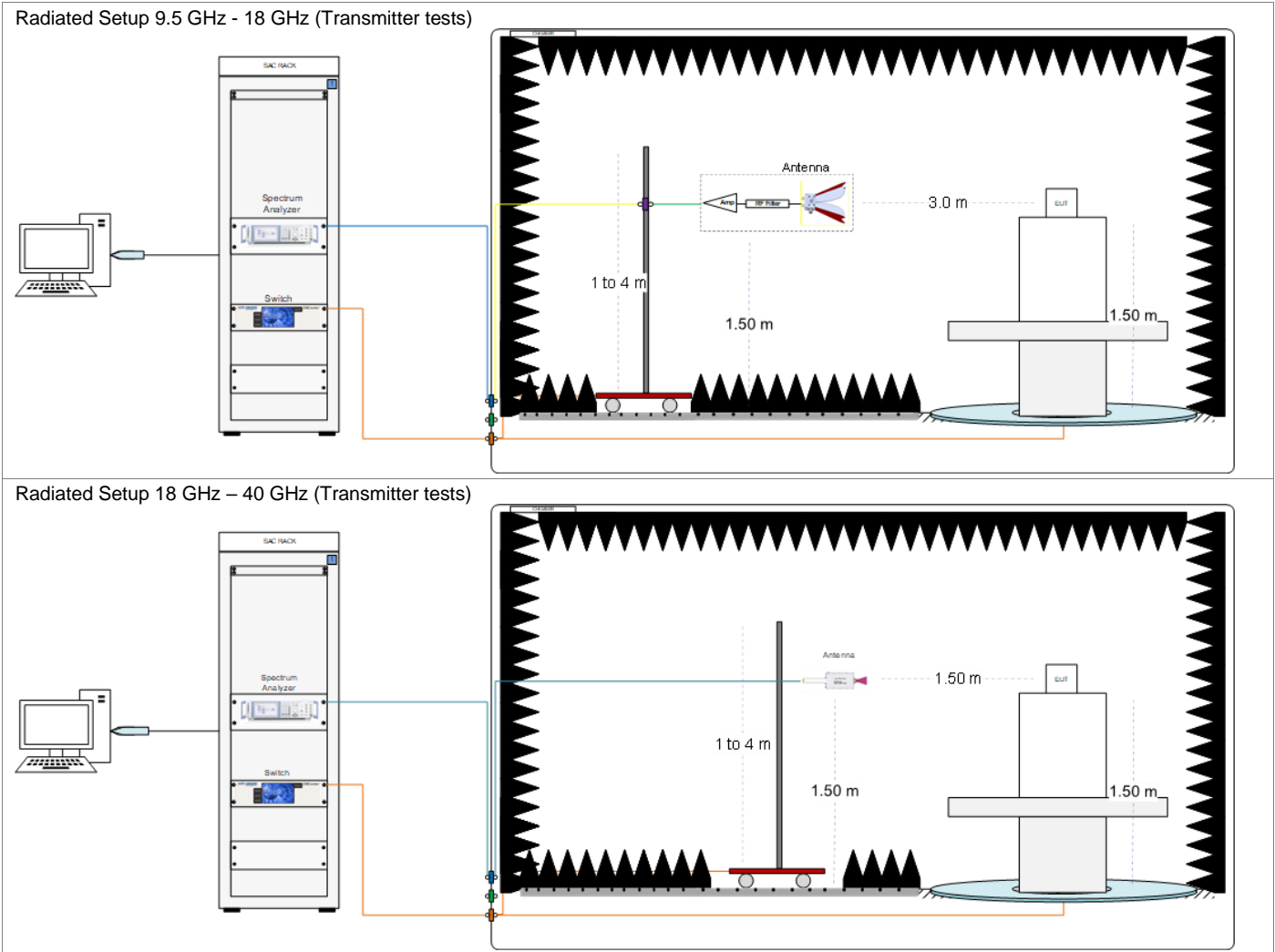

Sample Calculation

The spurious received voltage $V(\text{dB}\mu\text{V})$ in the spectrum Analyzer is converted to Electric field strength using the transducer factor F corresponding to the Rx path Loss:

$$F \text{ (dB/m)} = \text{Rx Antenna Factor (dB/m)} + \text{Cable losses (dB)} - \text{Amplifiers Gain (dBi)}$$

$$E \text{ (dB}\mu\text{V/m)} = V(\text{dB}\mu\text{V}) + F \text{ (dB/m)}$$

For field strength measurements made at other than the distance at which the applicable limit is specified, the field strength of the emission at the distance specified by the limit is deduced as follows:

$$E_{\text{SpecLimit}} = E_{\text{Meas}} + 20 \cdot \log(D_{\text{Meas}}/D_{\text{SpecLimit}})$$

where

$E_{\text{SpecLimit}}$ is the field strength of the emission at the distance specified by the limit, in $\text{dB}\mu\text{V/m}$

E_{Meas} is the field strength of the emission at the measurement distance, in $\text{dB}\mu\text{V/m}$

D_{Meas} is the measurement distance, in m

$D_{\text{SpecLimit}}$ is the distance specified by the limit, in m

A.2 Test Equipment List

Conducted setup

ID#	Device	Type/Model	Serial #	Manufacturer	Cal. Date	Cal. Due Date
273-000*	Spectrum Analyzer	FSV30	103309	Rohde & Schwarz	2019-09-02	2021-09-02
018-003*	RF cable 50cm	PE360-50CM	N/A	PASTERNAK	2021-02-23	2022-02-23
018-001*	10dB Attenuator + MH4	N/A	N/A	N/A	2021-02-23	2022-02-23
408-000	Temp & Humidity Logger	RA12E-TH1-RAS	RA12-E21FC8	AVTECH	2021-06-03	2023-06-03
413-000	Measurement SW v1.5.4.2	Octopi	N/A	Step AT	N/A	N/A

N/A: Not Applicable

*Items not used during out of calibration period

Radiated Setup #1

ID#	Device	Type/Model	Serial #	Manufacturer	Cal. Date	Cal. Due Date
006-000	Anechoic Chamber	FACT3	5720	ETS-Lindgren	2020-07-06	2022-01-07
006-001	Turn Table	ETS	-	ETS-Lindgren	N/A	N/A
006-002	Switch Positioning & systems	EMC Center	00159757	ETS-Lindgren	N/A	N/A
006-008	Measurement SW	EMC32, v10.40.10	100623	Rohde & Schwarz	N/A	N/A
006-011	Boresight antenna mast	BAM 4.0-P	P/278/2890.01	Maturo	N/A	N/A
006-019	Biconical antenna 30 MHz – 1 GHz	UBAA9115 + BBVU9135 + DGA9552N	0286 + CH 9044	Schwarzbeck	2019-11-22	2021-11-22
147-000	Spectrum analyzer	FSW43	101847	Rohde & Schwarz	2020-11-02	2022-11-02
006-020*	Horn antenna 3117	3117	00157734	ETS-Lindgren	2019-08-12	2021-08-12
057-000	Horn Antenna 3117 + Amplifier + HPF9.5	3117	00167062+00169546	ETS-Lindgren	2020-06-15	2022-06-15
007-008*	Double Horn Ridged antenna	3116C-PA	00169308bis + 00196308	ETS-Lindgren	2019-07-24	2021-07-24
006-039*	Cable 2.5m - 30MHz to 18GHz	0500990992500KE	19.23.395	Radiall	2021-02-23	2021-08-23
006-030*	Cable 1.2m – 18 to 40 GHz	UFA147A-0-0480-200200	MFR 64639223720-003	Micro-coax	2021-02-14	2021-08-14
006-034*	Cable 1m - 1GHz to 18GHz	UFA147A	-	Utilflex	2021-02-18	2021-08-18
006-036*	Cable 1m – 30 MHz - 18GHz	UFB311A-0-0590-50U50U	MFR 64639 223230-001	Micro-coax	2021-02-23	2021-08-23
006-052*	RF Cable 7.5m	0501051057000GX	19.35.850	Radiall	2021-02-23	2021-08-23
006-038*	Cable 7m - 18GHz to 40GHz	R286304009	-	Radiall	2021-02-14	2021-08-14
006-051*	RF Cable 1.0m	CBL-1.5M-SMSM+	202879	Mini-Circuits	2021-02-23	2021-08-23
365-000	Temperature & Humidity logger	RA12E-TH1-RAS	00-80-A3-E1-6E-55	Avtech	2021-03-08	2023-03-08

N/A: Not Applicable

The equipment were not used during out of calibration period

Test Report N° 210611-03.TR42

Radiated Setup #2

ID#	Device	Type/Model	Serial #	Manufacturer	Cal. Date	Cal. Due Date
007-000	Anechoic chamber	RFD-FA-100	5996	ETS Lindgren	2020-07-06	2022-07-06
007-002	Turntable	-	-	ETS Lindgren	N/A	N/A
007-003	Antenna Tower	2171B-3.0M	00150123	ETS Lindgren	N/A	N/A
007-006	Switch & Positioner	EMCenter	00151232	ETS Lindgren	N/A	N/A
007-005	Measurement SW	EMC32, V11.20.00	100401	Rohde & Schwarz	N/A	N/A
127-000	Spectrum Analyzer	FSV40	101358	Rohde & Schwarz	2021-01-15	2023-01-15
007-007	Double Ridge Horn (1- 18GHz)	3117	00152266	ETS Lindgren	2020-03-18	2022-03-18
057-000	Horn Antenna 3117 + Amplifier + HPF9.5	3117	00167062+00169546	ETS-Lindgren	2020-06-15	2022-06-15
007-008*	Double Horn Ridged antenna	3116C-PA	00169308bis 00196308	ETS-Lindgren	2019-07-24	2021-07-24
007-022*	RF Cable 1-18GHz, 1.5m	0501050991200GX	19.23.493	Radiall	2021-02-14	2021-08-14
007-020*	RF Cable 1-18GHz, 1.2 m	2301761761200PJ	12.22.1104	Radiall	2021-02-14	2021-08-14
007-011*	RF Cable 1-18GHz - 6.5m	140-8500-11-51	001	Spectrum	2021-02-14	2021-08-14
007-015*	RF Cable 1GHz-18GHz 1.5m	-	-	Spirent	2021-02-15	2021-08-15
007-014*	RF Cable 18-40 GHz 6m	R286304009	1747364	Radiall	2021-02-14	2021-08-14
007-023*	RF Cable 1m DC-40GHz	PE360-100CM	-	Pasternack	2021-02-16	2021-08-16
007-018*	RF Cable 1-9.5GHz 1.2m	0500990991200KE	-	Radiall	2021-02-15	2021-08-15
145-000	Temp & Humidity Logger	RA12E-TH1-RAS	RA12-B89BE3	Avtech	2020-01-22	2022-01-22

N/A: Not Applicable

The equipment were not used during out of calibration period

Shared Radiated Equipment

ID#	Device	Type/Model	Serial #	Manufacturer	Cal. Date	Cal. Due Date
412-000	DRTU Power finder V2.0	-	-	Intel	NA	NA
139-000	Power Sensor	NRP-Z81	104383	Rohde & Schwarz	2021-04-07	2023-04-07
140-000	Power Sensor	NRP-Z81	104382	Rohde & Schwarz	2020-04-08	2022-04-08

A.3 Measurement Uncertainty Evaluation

The system uncertainty evaluation is shown in the table below with a coverage factor of $k = 2$ to indicate a 95% level of confidence:

Measurement type	Uncertainty	Unit
Timing	± 0.12	%
Power Spectral density	± 1.47	dB
Occupied bandwidth	± 2.07	%
Conducted Power	± 1.03	dB
Conducted Out of band Emission <7 GHz	± 1.67	dB
Radiated tests <1GHz	± 5.99	dB
Radiated tests 1GHz – 40 GHz	± 5.85	dB

Annex B. Test Results U-NII-4

The herein test results were performed by:

Test case measurement	Test Personnel
6dB and 99% Bandwidth	C.Requin . Y Haddad
Maximum output power & Maximum PSD	C.Requin . Y Haddad
Undesirable emission limits: out of band	C.Requin . Y Haddad
Radiated spurious emissions	A.Lounes, N.Bui

B.1 Test Conditions

For 802.11a mode the EUT can transmit at both CHAIN A and CHAIN B RF outputs individually, but not simultaneously.

For 802.11n20 & 802.11ax20 (20 MHz channel bandwidth), 802.11n40 & 802.11ax40 (40MHz channel bandwidth), 802.11ac80 & 802.11ax80 (80MHz channel bandwidth) and 802.11ac160 & 802.11ax160 (160MHz channel bandwidth) modes the EUT can transmit at both CHAIN A and CHAIN B RF outputs individually, and also simultaneously.

The following data rates were selected based on preliminary testing that identified those rates as the worst cases for output power and spurious levels at the band edges:

Transmission	Mode	Bandwidth (MHz)	Worst Case Data Rate
SISO	802.11a	20	6Mbps
	802.11n	20	HT0
		40	HT0
	802.11ac	80/160	VHT0
	802.11ax	20/40/80/160	HE0
MIMO	802.11n	20/40	HT8
	802.11ac	80/160	VHT0
	802.11ax	20/40/80/160	HE0

B.2 Test Results Tables

B.2.1 6dB & 99% Bandwidth

Test limits

FCC part	Limits
15.407 (e)	For equipment operating in the band 5725-5895 MHz, the minimum 6 dB bandwidth shall be at least 500 kHz.

Test procedure

The conducted setup shown in section *Test & System Description* was used to measure the 6dB & 99% Bandwidth. The antenna terminal of the EUT is connected to the spectrum analyzer through an attenuator, and the spectrum analyzer reading is compensated to include the RF path loss.

Results tables

Mode	Rate	Antenna	Channel	Freq [MHz]	6dB BW [MHz]	99% BW [MHz]
802.11a	6Mbps	SISO A	169	5845	15.06	16.80
			173	5865	14.64	16.60
			177	5885	15.12	16.56
		SISO B	169	5845	15.09	16.68
			173	5865	15.07	16.72
			177	5885	15.03	16.72
802.11n20	HT0	SISO A	169	5845	15.03	17.72
			173	5865	15.06	17.80
			177	5885	15.11	17.76
		SISO B	169	5845	15.11	17.72
			173	5865	15.07	17.80
			177	5885	15.07	17.72
	HT8	MIMO A	169	5845	15.01	17.76
			173	5865	13.85	17.96
			177	5885	15.09	17.76
		MIMO B	169	5845	15.70	17.76
			173	5865	15.68	17.76
			177	5885	15.62	17.72
802.11n40	HT0	SISO A	167	5835	35.09	36.24
			175	5875	33.79	36.08
		SISO B	167	5835	35.08	36.24
			175	5875	33.81	36.24
			167	5835	33.83	36.08
	HT8	MIMO A	175	5875	34.98	36.08
			167	5835	35.01	36.00
		MIMO B	167	5835	35.01	36.00
			175	5875	35.00	35.92
			175	5875	35.00	35.92
802.11ac80	VHT0	SISO A	171	5855	70.08	75.36
		SISO B			72.64	75.04
		MIMO A			72.64	75.04
		MIMO B			72.64	75.04
802.11ac160	VHT0	SISO A	163	5815	145.13	152.96
		SISO B			136.33	153.28
		MIMO A			152.58	153.28
		MIMO B			145.13	152.96

Max Value

Mode	Rate	Antenna	Channel	Freq [MHz]	6dB BW [MHz]	99% BW [MHz]
802.11ax20	HE0	SISO A	169	5845	17.60	18.88
					173	18.96
					177	18.92
		SISO B	169	5845	16.32	18.88
					173	18.96
					177	18.92
		MIMO A	169	5845	15.46	18.92
					173	18.88
					177	19.00
		MIMO B	169	5845	15.10	18.92
					173	18.92
					177	18.88
802.11ax40	HE0	SISO A	167	5835	34.99	37.76
					175	37.60
		SISO B	167	5835	35.06	37.68
					175	37.52
		MIMO A	167	5835	35.07	37.36
					175	37.60
		MIMO B	167	5835	34.96	37.60
					175	37.44
802.11ax80	HE0	SISO A	171	5855	72.69	76.80
		SISO B			75.15	76.80
		MIMO A			73.92	76.64
		MIMO B			70.19	76.48
802.11ax160	HE0	SISO A	163	5815	152.58	155.20
		SISO B			151.43	155.20
		MIMO A			151.43	154.56
		MIMO B			152.68	154.88

Max Value

See Section B.3.1, B.3.2 for the screenshot results.

B.2.2 Maximum output power & Maximum power spectral Density

Test limits

FCC part	Limits
15.407 (a) (3) (iii)	For client devices operating under the control of an indoor access point in the 5.850-5.895 GHz band, the maximum power spectral density must not exceed 14 dBm e.i.r.p. in any 1-megahertz band, and the maximum e.i.r.p. over the frequency band of operation must not exceed 30 dBm. Client devices operating on a channel that spans the 5.725-5.850 GHz and 5.850-5.895 GHz bands must not exceed an e.i.r.p. of 30 dBm.
15.407 (a) (12)	Power spectral density measurement: The maximum power spectral density is measured as a conducted emission by direct connection of a calibrated test instrument to the equipment under test. Measurements in the 5.725-5.895 GHz band are made over a reference bandwidth of 500 kHz or the 26 dB emission bandwidth of the device, whichever is less.

Test procedure

The Maximum Conducted Output Power was measured using the channel integration method over the entire 99% occupied bandwidth according to section E) 2) d) (Method SA-2) of KDB 789033

The maximum power spectral density (PSD) was measured using the method according to section F) of KDB 789033.

In the measure-and-sum approach for MIMO mode, the conducted emission level (e.g., transmit power or power in specified bandwidth) is measured at each antenna port. The measured results at the various antenna ports are then summed mathematically in linear power units to determine the total emission level from the device.

The EIRP power (dBm) is calculated by adding the declared maximum antenna gain to the measured conducted power.

The conducted setup shown in section *Test & System Description* was used to measure the maximum conducted output power and power spectral density. The antenna terminal of the EUT is connected to the spectrum analyser through an attenuator, and the spectrum analyzer reading is compensated to include the RF path loss.

Results tables
Duty cycle

Mode	Rate	Antenna	Duty Cycle [%]
802.11a	6Mbps	SISO A	97.37
		SISO B	97.37
802.11n20	HT0	SISO A	98.36
		SISO B	98.36
	HT8	MIMO A	98.26
		MIMO B	98.26
802.11ax20	HE0	SISO A	98.12
		SISO B	98.12
		MIMO A	98.31
		MIMO B	98.31
802.11n40	HT0	SISO A	98.33
		SISO B	98.33
	HT8	MIMO A	98.03
		MIMO B	98.03
802.11ax40	HE0	SISO A	98.12
		SISO B	98.12
		MIMO A	98.86
		MIMO B	98.86
802.11ac80	VHT0	SISO A	99.04
		SISO B	98.05
		MIMO A	97.98
		MIMO B	97.98
802.11ax80	HE0	SISO A	97.88
		SISO B	97.88
		MIMO A	97.9
		MIMO B	97.9
802.11ac160	VTH0	SISO A	97.86
		SISO B	97.86
		MIMO A	97.5
		MIMO B	97.5
802.11ax160	HE0	SISO A	98.38
		SISO B	98.38
		MIMO A	97.0
		MIMO B	97.0

Maximum output power – U-NII-4 Channels

Mode	Rate	Channel	Freq [MHz]	Antenna	Average Conducted Output Power [dBm]	Avg Max* Conducted Output Power [dBm]	Avg Max*. EIRP [dBm]	Avg Max* Conducted Output Power [mW]	
802.11a	6Mbps	169	5845	SISO A	18.19	18.31	23.31	67.70	
				SISO B	18.05	18.17	23.17	65.55	
		173	5865	SISO A	17.18	17.30	22.30	53.65	
				SISO B	17.07	17.19	22.19	52.31	
		177	5885	SISO A	17.61	17.73	22.73	59.23	
				SISO B	17.11	17.23	22.23	52.79	
802.11n20	HT0	169	5845	SISO A	18.29	18.29	23.29	67.45	
				SISO B	18.16	18.16	23.16	65.46	
		173	5865	SISO A	17.09	17.09	22.09	51.17	
				SISO B	17.25	17.25	22.25	53.09	
		177	5885	SISO A	17.34	17.34	22.34	54.20	
				SISO B	17.21	17.21	22.21	52.60	
	HT8	169	5845	MIMO A	15.55	15.55	20.55	35.89	
				MIMO B	15.70	15.70	20.70	37.15	
				Combined A+B	18.64	18.64	23.64	73.05	
		173	5865	MIMO A	15.00	15.00	20.00	31.62	
				MIMO B	15.06	15.06	20.06	32.06	
				Combined A+B	18.04	18.04	23.04	63.69	
	177	5885	MIMO A	14.85	14.85	19.85	30.55		
			MIMO B	15.08	15.08	20.08	32.21		
			Combined A+B	17.98	17.98	22.98	62.76		
	802.11n40	HT0	167	5835	SISO A	20.87	20.87	25.87	122.18
					SISO B	20.64	20.64	25.64	115.88
			175	5875	SISO A	20.09	20.09	25.09	102.09
SISO B					20.11	20.11	25.11	102.57	
HT8		167	5835	MIMO A	19.70	19.70	24.70	93.33	
				MIMO B	19.53	19.53	24.53	89.74	
				Combined A+B	22.63	22.63	27.63	183.07	
				MIMO A	17.31	17.31	22.31	53.83	
		175	5875	MIMO B	17.12	17.12	22.12	51.52	
				Combined A+B	20.23	20.23	25.23	105.35	
				SISO A	20.78	20.78	25.78	119.67	
				SISO B	20.03	20.03	25.03	100.69	
802.11ac80	VHT0	171	5855	MIMO A	18.53	18.62	23.62	72.75	
				MIMO B	18.61	18.70	23.70	74.11	
				Combined A+B	21.58	21.67	26.67	146.86	
				SISO A	15.60	15.69	20.69	37.10	
802.11ac160	VHT0	163	5815	SISO B	17.06	17.15	22.15	51.93	
				MIMO A	14.69	14.80	19.80	30.20	
				MIMO B	14.89	15.00	20.00	31.62	
				Combined A+B	17.80	17.91	22.91	61.82	

* Maximum values are the duty cycle compensated values calculated from the average (measured)

Max Value

Min Value

Mode	Rate	Channel	Freq [MHz]	Antenna	Average Conducted Ouput Power [dBm]	Avg Max* Conducted Ouput Power [dBm]	Avg Max*. EIRP [dBm]	Avg Max* Conducted Ouput Power [mW]
802.11ax20	HE0	169	5845	SISO A	17.91	17.91	22.91	61.80
				SISO B	17.99	17.99	22.99	62.95
				MIMO A	15.22	15.22	20.22	33.27
		MIMO B	15.59	15.59	20.59	36.22		
		Combined A+B	18.42	18.42	23.42	69.49		
		173	5865	SISO A	17.20	17.20	22.20	52.48
	SISO B			17.12	17.12	22.12	51.52	
	MIMO A			15.03	15.03	20.03	31.84	
	MIMO B	15.17	15.17	20.17	32.89			
	Combined A+B	18.11	18.11	23.11	64.73			
	177	5885	SISO A	18.15	18.15	23.15	65.31	
			SISO B	17.02	17.02	22.02	50.35	
MIMO A			15.12	15.12	20.12	32.51		
MIMO B	15.20	15.20	20.20	33.11				
Combined A+B	18.17	18.17	23.17	65.62				
802.11ax40	HE0	167	5835	SISO A	20.82	20.82	25.82	120.78
				SISO B	20.76	20.76	25.76	119.12
				MIMO A	19.50	19.50	24.50	89.13
		MIMO B	19.44	19.44	24.44	87.90		
		Combined A+B	22.48	22.48	27.48	177.03		
	175	5875	SISO A	19.98	19.98	24.98	99.54	
			SISO B	19.96	19.96	24.96	99.08	
			MIMO A	17.09	17.09	22.09	51.17	
			MIMO B	17.08	17.08	22.08	51.05	
Combined A+B	20.10	20.10	25.10	102.22				
802.1ax80	HE0	171	5855	SISO A	20.31	20.40	25.40	109.73
				SISO B	19.92	20.01	25.01	100.30
				MIMO A	18.49	18.58	23.58	72.15
				MIMO B	18.56	18.65	23.65	73.32
				Combined A+B	21.54	21.63	26.63	145.47
802.11ax160	HE0	163	5815	SISO A	15.70	15.70	20.70	37.15
				SISO B	16.85	16.85	21.85	48.42
				MIMO A	14.68	14.81	19.81	30.29
				MIMO B	14.89	15.02	20.02	31.79
				Combined A+B	17.80	17.93	22.93	62.07

* Maximum values are the duty cycle compensated values calculated from the average (measured)

Max Value

Min Value

See Section B.3.3 for the screenshot results

Maximum Power Spectral Density (PSD) – U-NII-4 channels

Mode	Rate	Channel	Freq [MHz]	Antenna	Average conducted PSD [dBm/500kHz]	Max.* conducted PSD [dBm/500kHz]	Max.* conducted PSD [dBm/MHz]	EIRP PSD* [dBm/MHz]	
802.11a	6Mbps	169	5845	SISO A	4.23	4.35	7.36	12.36	
				SISO B	4.14	4.26	7.27	12.27	
		173	5865	SISO A	3.21	3.33	6.34	11.34	
				SISO B	3.17	3.29	6.30	11.30	
		177	5885	SISO A	3.68	3.80	6.81	11.81	
				SISO B	3.16	3.28	6.29	11.29	
802.11n20	HT0	169	5845	SISO A	4.15	4.15	7.16	12.16	
				SISO B	4.03	4.03	7.04	12.04	
		173	5865	SISO A	2.87	2.87	5.88	10.88	
				SISO B	3.14	3.14	6.15	11.15	
		177	5885	SISO A	3.26	3.26	6.27	11.27	
				SISO B	3.06	3.06	6.07	11.07	
	HT8	169	5845	MIMO A	1.37	1.37	4.38	9.38	
				MIMO B	1.6	1.60	4.61	9.61	
				Combined A+B	4.50	4.50	7.51	12.51	
		173	5865	MIMO A	0.88	0.88	3.89	8.89	
				MIMO B	0.95	0.95	3.96	8.96	
				Combined A+B	3.925	3.93	6.94	11.94	
	177	5885	MIMO A	0.87	0.87	3.88	8.88		
			MIMO B	0.96	0.96	3.97	8.97		
			Combined A+B	3.93	3.93	6.94	11.94		
	802.11n40	HT0	167	5835	SISO A	3.34	3.34	6.35	11.35
					SISO B	3.08	3.08	6.09	11.09
			175	5875	SISO A	2.5	2.50	5.51	10.51
SISO B					2.52	2.52	5.53	10.53	
HT8		167	5835	MIMO A	2.04	2.04	5.05	10.05	
				MIMO B	1.81	1.81	4.82	9.82	
				Combined A+B	4.93	4.94	7.95	12.95	
		175	5875	MIMO A	-0.3	-0.30	2.71	7.71	
				MIMO B	-0.39	-0.39	2.62	7.62	
Combined A+B	2.66	2.67	5.68	10.68					
802.11ac80	VHT0	171	5855	SISO A	0.16	0.16	3.17	8.17	
				SISO B	-0.62	-0.62	2.39	7.39	
				MIMO A	-2.08	-1.99	1.02	6.02	
				MIMO B	-2.05	-1.96	1.05	6.05	
				Combined A+B	0.94	1.03	4.04	9.04	
802.11ac160	VHT0	163	5815	SISO A	-7.84	-7.75	-4.74	0.26	
				SISO B	-6.31	-6.22	-3.21	1.79	
				MIMO A	-8.64	-8.53	-5.52	-0.52	
				MIMO B	-8.43	-8.32	-5.31	-0.31	
				Combined A+B	-5.52	-5.41	-2.40	2.60	

* Maximum values are the duty cycle compensated values calculated from the average (measured)

Max Value

Min Value

Mode	Rate	Channel	Freq [MHz]	Antenna	Average conducted PSD [dBm/500kHz]	Max.* conducted PSD [dBm/500kHz]	Max.* conducted PSD [dBm/MHz]	EIRP PSD* [dBm/MHz]
802.11ax20	HE0	169	5845	SISO A	3.57	3.57	6.58	11.58
				SISO B	3.7	3.70	6.71	11.71
				MIMO A	0.85	0.85	3.86	8.86
				MIMO B	1.3	1.30	4.31	9.31
				Combined A+B	4.09	4.09	7.10	12.10
		173	5865	SISO A	2.86	2.86	5.87	10.87
				SISO B	2.73	2.73	5.74	10.74
				MIMO A	0.66	0.66	3.67	8.67
				MIMO B	0.86	0.86	3.87	8.87
				Combined A+B	3.77	3.77	6.78	11.78
		177	5885	SISO A	3.74	3.74	6.75	11.75
				SISO B	2.71	2.71	5.72	10.72
MIMO A	0.87			0.87	3.88	8.88		
MIMO B	0.86			0.86	3.87	8.87		
Combined A+B	3.88			3.88	6.89	11.89		
802.11ax40	HE0	167	5835	SISO A	3.07	3.07	6.08	11.08
				SISO B	3.02	3.02	6.03	11.03
				MIMO A	1.57	1.57	4.58	9.58
				MIMO B	1.5	1.50	4.51	9.51
				Combined A+B	4.55	4.55	7.56	12.56
		175	5875	SISO A	2.26	2.26	5.27	10.27
				SISO B	2.22	2.22	5.23	10.23
				MIMO A	-0.63	-0.63	2.38	7.38
				MIMO B	-0.6	-0.60	2.41	7.41
				Combined A+B	2.39	2.40	5.41	10.41
802.1axc80	HE0	171	5855	SISO A	-0.49	-0.40	2.61	7.61
				SISO B	-0.81	-0.72	2.29	7.29
				MIMO A	-2.27	-2.18	0.83	5.83
				MIMO B	-2.23	-2.14	0.87	5.87
				Combined A+B	0.76	0.85	3.86	8.86
802.11ax160	HE0	163	5815	SISO A	-7.91	-7.91	-4.90	0.10
				SISO B	-6.71	-6.71	-3.70	1.30
				MIMO A	-8.63	-8.50	-5.49	-0.49
				MIMO B	-8.57	-8.44	-5.43	-0.43
				Combined A+B	-5.59	-5.46	-2.45	2.55

* Maximum values are the duty cycle compensated values calculated from the average (measured)

Max Value

Min Value

Note :PSD [dBm/500KHz] corresponds to the measurement done using RBW = 500KHz. To obtain the PSD [dBm/1MHz] a correction factor is applied: $10\log\left(\frac{1MHz}{500kHz}\right) = +3.01dB$

See Section B.3.4. for the screenshot results

B.2.3 Undesirable emission limits : out of band (Conducted)Test limits

FCC part	Limits
15.407 (b) (4)	All emissions below 5.725 GHz shall not exceed an e.i.r.p of -27 dBm/MHz at 5.65GHz increasing linearly to 10dBm/MHz at 5.7 GHz, and from 5.7GHz increasing linearly to a level of 15.6 dBm/MHz at 5.72GHz, and from 5.72 GHz increasing linearly to a level of 27dBm/MHz at 5.725GHz.
15.407 (b) (5) (ii)	All emissions at or above 5.895GHz shall not exceed an e.i.r.p of -5dBm/MHz and shall decrease linearly to an e.i.r.p of -27dBm/MHz at or above 5.925GHz.

Test procedure

The conducted setup shown in section *Test & System Description* was used to measure undesirable emissions on the Band Edge domain. The antenna terminal of the EUT is connected to the spectrum analyzer through an attenuator, and the spectrum analyzer reading is compensated to include the RF path loss and the declared antenna gain.

For lower OOBE, Peak detector is used according to FCC OET KDB 789033 D02 v02r01.

For upper OOBE, RMS detector is used according to FCC OET KDB 291074 D01 v01.

See Section B.3.5 for the screenshot results.

B.2.4 Radiated spurious emission

Standard references

FCC part	Limits																				
15.407 (b) (5) (ii)	For transmitters operating solely in the 5.850-5.895 GHz band or operating on a channel that spans across 5.725-5.895 GHz: For a client device, all emissions at or above 5.895 GHz shall not exceed an e.i.r.p. of -5 dBm/MHz and shall decrease linearly to an e.i.r.p. of -27 dBm/MHz at or above 5.925 GHz.																				
15.407 (b) (5) (iii)	For a client device or indoor access point or subordinate device, all emissions below 5.725 GHz shall not exceed an e.i.r.p. of -27 dBm/MHz at 5.65 GHz increasing linearly to 10 dBm/MHz at 5.7 GHz, and from 5.7 GHz increasing linearly to a level of 15.6 dBm/MHz at 5.72 GHz, and from 5.72 GHz increasing linearly to a level of 27 dBm/MHz at 5.725 GHz.																				
15.209	Radiated emissions which fall in the restricted bands, as defined in §15.205(a), must also comply with the radiated emission limits specified in §15.209(a):																				
	<table border="1"> <thead> <tr> <th>Freq Range (MHz)</th> <th>Field Strength (μV/m)</th> <th>Field Strength (dBμV/m)</th> <th>Meas. Distance (m)</th> </tr> </thead> <tbody> <tr> <td>30-88</td> <td>100</td> <td>40</td> <td>3</td> </tr> <tr> <td>88-216</td> <td>150</td> <td>43.5</td> <td>3</td> </tr> <tr> <td>216-960</td> <td>200</td> <td>46</td> <td>3</td> </tr> <tr> <td>Above 960</td> <td>500</td> <td>54</td> <td>3</td> </tr> </tbody> </table>	Freq Range (MHz)	Field Strength (μV/m)	Field Strength (dBμV/m)	Meas. Distance (m)	30-88	100	40	3	88-216	150	43.5	3	216-960	200	46	3	Above 960	500	54	3
	Freq Range (MHz)	Field Strength (μV/m)	Field Strength (dBμV/m)	Meas. Distance (m)																	
	30-88	100	40	3																	
	88-216	150	43.5	3																	
216-960	200	46	3																		
Above 960	500	54	3																		
The emission limits shown in the above table are based on measurements employing CISPR quasi-peak detector except for the frequency bands 9-90 kHz, 110-490 kHz and above 1000 MHz. Radiated emission limits in these three bands are based on measurements employing an average detector.																					
For average radiated emission measurements above 1000 MHz, there is also a limit specified when measuring with peak detector function, corresponding to 20 dB above the indicated values in the table.																					

Test procedure

The radiated setups shown in section *Test & System Description* were used to measure the radiated spurious emissions.

Depending of the frequency range and bands being tested, different antennas and filters were used.

The final measurement is done by varying the antenna height, the EUT azimuth over 360° and for both Vertical and Horizontal polarizations.

The radiated spurious emission was measured on the worst case configuration selected from the chapter B.1 and using the low, middle and high channels.

Test Results

30 MHz – 1 GHz, Radiated spurious emissions**Radiated Spurious – All modes**

Frequency	Level	Detector	Limit	Margin	Polar
MHz	dB μ V/m	---	dB μ V/m	dB μ V/m	---
117.2	13.3	Quasi-Peak	43.5	30.2	V
533.2	36.8	Quasi-Peak	46.0	9.2	V
891.7	31.1	Quasi-Peak	46.0	14.9	H

Note 1: The detected spurious signals do not depend on either the operating channel or the modulation mode.

Radiated spurious – 1 GHz to 40 GHz[802.11a](#)**802.11a, 6Mbps, Chain A****CH169**

Frequency	Level	Detector	Limit	Margin	Polar
MHz	dB μ V/m	---	dB μ V/m	dB	---
3379.5	46.5	RMS	68.2	21.6	V
3382.0	57.9	Peak	88.2	30.3	V
11690.2	42.0	Average	54.0	12.0	V
11693.0	50.9	Peak	74.0	23.1	V
23380.0	47.5	Peak	88.2	40.7	V
23380.0	40.3	RMS	68.2	27.9	V

CH173

Frequency	Level	Detector	Limit	Margin	Polar
MHz	dB μ V/m	---	dB μ V/m	dB	---
3374.0	59.0	Peak	88.2	29.2	H
3376.0	46.9	RMS	68.2	21.4	V
11729.4	42.7	Average	54.0	11.3	V
11730.3	51.8	Peak	74.0	22.2	V
23459.8	46.2	Peak	88.2	42.0	V
23459.8	39.6	RMS	68.2	28.6	V

CH177

Frequency	Level	Detector	Limit	Margin	Polar
MHz	dBμV/m	---	dBμV/m	dB	---
3374.0	46.8	RMS	68.2	21.4	V
3374.5	58.9	Peak	88.2	29.3	V
11770.0	42.5	Average	54.0	11.5	V
11774.2	51.8	Peak	74.0	22.2	V
23540.1	47.1	Peak	88.2	41.1	H
23540.1	42.4	RMS	68.2	25.8	H

802.11a, 6Mbps, Chain B

CH169

Frequency	Level	Detector	Limit	Margin	Polar
MHz	dBμV/m	---	dBμV/m	dB	---
3377.5	58.8	Peak	88.2	29.4	V
3378.5	46.6	RMS	68.2	21.6	H
11686.4	61.5	Peak	74.0	12.5	V
11689.7	51.0	Average	54.0	3.0	V
23378.6	53.0	Peak	88.2	35.2	H
23378.6	44.1	RMS	68.2	24.1	H

CH173

Frequency	Level	Detector	Limit	Margin	Polar
MHz	dBμV/m	---	dBμV/m	dB	---
3374.0	46.7	RMS	68.2	21.5	V
3375.5	58.3	Peak	88.2	29.9	V
11721.3	55.6	Peak	74.0	18.4	V
11733.1	44.1	Average	54.0	9.9	V
23460.3	49.8	Peak	88.2	38.4	H
23460.3	42.5	RMS	68.2	25.7	V

CH177

Frequency	Level	Detector	Limit	Margin	Polar
MHz	dB μ V/m	---	dB μ V/m	dB	---
3391.0	58.1	Peak	88.2	30.1	H
3393.0	46.2	RMS	68.2	22.0	V
11769.5	55.3	Peak	74.0	18.7	V
11772.3	44.7	Average	54.0	9.3	V
23540.1	47.5	Peak	88.2	40.7	V
23540.1	40.9	RMS	68.2	27.3	V

802.11n**802.11n20, HT0, Chain A****CH169**

Frequency	Level	Detector	Limit	Margin	Polar
MHz	dB μ V/m	---	dB μ V/m	dB	---
3376.0	46.8	RMS	68.2	21.4	H
3376.5	58.9	Peak	88.2	29.3	H
11689.7	51.9	Peak	74.0	22.1	V
11690.2	41.6	Average	54.0	12.4	V
23380.0	47.1	Peak	88.2	41.1	H
23380.0	40.6	RMS	68.2	27.6	H

CH173

Frequency	Level	Detector	Limit	Margin	Polar
MHz	dB μ V/m	---	dB μ V/m	dB	---
3394.0	59.6	Peak	88.2	28.6	V
3394.5	46.1	RMS	68.2	22.1	V
11729.4	40.9	Average	54.0	13.1	V
11734.6	52.4	Peak	74.0	21.6	V
23460.3	47.1	Peak	88.2	41.1	V
23460.3	41.0	RMS	68.2	27.2	H

CH177

Frequency	Level	Detector	Limit	Margin	Polar
MHz	dBµV/m	---	dBµV/m	dB	---
3383.0	46.3	RMS	68.2	21.9	V
3383.0	59.5	Peak	88.2	28.7	H
11769.5	51.3	Peak	74.0	22.7	V
11770.0	42.1	Average	54.0	11.9	V
23540.1	47.9	Peak	88.2	40.3	V
23540.1	39.4	RMS	68.2	28.8	H

802.11n20, HT0, Chain B

CH169

Frequency	Level	Detector	Limit	Margin	Polar
MHz	dBµV/m	---	dBµV/m	dB	---
3390.5	57.9	Peak	88.2	30.3	H
3391.0	46.2	RMS	68.2	22.0	H
11682.1	59.7	Peak	74.0	14.3	V
11690.6	50.3	Average	54.0	3.7	V
23378.1	42.5	RMS	68.2	25.7	H
23378.1	53.1	Peak	88.2	35.1	H

CH173

Frequency	Level	Detector	Limit	Margin	Polar
MHz	dBµV/m	---	dBµV/m	dB	---
3392.0	57.0	Peak	88.2	31.2	V
3395.0	46.2	RMS	68.2	22.0	V
11727.0	53.5	Peak	74.0	20.5	V
11727.5	42.9	Average	54.0	11.2	V
17590.6	62.7	Peak	88.2	25.5	H
23457.5	39.8	RMS	68.2	28.4	V
23457.5	50.8	Peak	88.2	37.4	V

CH177

Frequency	Level	Detector	Limit	Margin	Polar
MHz	dBμV/m	---	dBμV/m	dB	---
3371.5	58.5	Peak	88.2	29.7	V
3376.5	46.8	RMS	68.2	21.4	V
11770.0	42.6	Average	54.0	11.4	V
11772.3	53.2	Peak	74.0	20.8	V
23540.1	48.6	Peak	88.2	39.6	H
23540.1	42.9	RMS	68.2	25.3	H

802.11n20, HT8, Chain A+B**CH169**

Frequency	Level	Detector	Limit	Margin	Polar
MHz	dBμV/m	---	dBμV/m	dB	---
3396.0	46.0	RMS	68.2	22.2	H
3399.0	59.0	Peak	88.2	29.2	H
11685.0	48.9	Average	54.0	5.1	V
11685.4	59.2	Peak	74.0	14.8	V
23374.8	39.9	RMS	68.2	28.3	H
23374.8	52.6	Peak	88.2	35.6	V

CH173

Frequency	Level	Detector	Limit	Margin	Polar
MHz	dBμV/m	---	dBμV/m	dB	---
3386.0	46.5	RMS	68.2	21.7	V
3386.5	58.3	Peak	88.2	29.9	V
11729.8	54.2	Peak	74.0	19.8	V
11729.8	43.5	Average	54.0	10.5	V
23460.3	48.1	Peak	88.2	40.1	V
23460.3	41.6	RMS	68.2	26.6	H

CH177

Frequency	Level	Detector	Limit	Margin	Polar
MHz	dB μ V/m	---	dB μ V/m	dB	---
3392.0	46.3	RMS	68.2	21.9	V
3392.0	58.0	Peak	88.2	30.2	V
11766.7	53.3	Peak	74.0	20.7	V
11768.1	43.0	Average	54.0	11.0	V
17655.3	52.2	RMS	68.2	16.0	V
17656.7	63.6	Peak	88.2	24.6	V
23540.1	47.9	Peak	88.2	40.3	H
23540.1	39.2	RMS	68.2	29.0	H

802.11n40, HT0, Chain A**CH167**

Frequency	Level	Detector	Limit	Margin	Polar
MHz	dB μ V/m	---	dB μ V/m	dB	---
3393.0	46.2	RMS	68.2	22.0	H
3394.0	58.1	Peak	88.2	30.1	H
11669.9	41.2	Average	54.0	12.8	V
11669.9	50.2	Peak	74.0	23.8	V
23339.9	46.9	Peak	88.2	41.3	H
23339.9	40.7	RMS	68.2	27.5	V

CH175

Frequency	Level	Detector	Limit	Margin	Polar
MHz	dB μ V/m	---	dB μ V/m	dB	---
3396.0	46.1	RMS	68.2	22.1	H
3400.0	58.9	Peak	88.2	29.3	H
11749.2	50.0	Peak	74.0	24.0	V
11750.1	40.6	Average	54.0	13.4	V
23500.4	46.1	Peak	88.2	42.1	H
23500.4	40.5	RMS	68.2	27.7	H

802.11n40, HT0, Chain B

CH167

Frequency	Level	Detector	Limit	Margin	Polar
MHz	dB μ V/m	---	dB μ V/m	dB	---
3393.5	46.1	RMS	68.2	22.1	H
3396.0	59.2	Peak	88.2	29.0	V
11650.0	57.9	Peak	74.0	16.1	V
11668.9	47.9	Average	54.0	6.1	V
17511.2	50.1	RMS	68.2	18.1	V
17516.9	60.5	Peak	88.2	27.7	H
23339.9	42.1	RMS	68.2	26.1	H
23339.9	49.1	Peak	88.2	39.1	H

CH175

Frequency	Level	Detector	Limit	Margin	Polar
MHz	dB μ V/m	---	dB μ V/m	dB	---
3377.0	58.3	Peak	88.2	29.9	V
3378.0	46.7	RMS	68.2	21.5	V
11735.5	39.2	Average	54.0	14.8	V
11774.2	50.9	Peak	74.0	23.1	V
23500.0	47.9	Peak	88.2	40.3	H
23500.0	43.0	RMS	68.2	25.2	H

802.11n40, HT8, Chain A+B

CH167

Frequency	Level	Detector	Limit	Margin	Polar
MHz	dB μ V/m	---	dB μ V/m	dB	---
3386.5	46.2	RMS	68.2	22.0	H
3390.5	57.6	Peak	88.2	30.6	H
11659.0	47.3	Average	54.0	6.7	V
11666.1	57.8	Peak	74.0	16.2	V
17513.1	57.4	Peak	88.2	30.8	V
17517.9	46.5	RMS	68.2	21.7	V
23349.3	37.4	RMS	68.2	30.8	H
23349.3	49.6	Peak	88.2	38.6	H

CH175

Frequency	Level	Detector	Limit	Margin	Polar
MHz	dB μ V/m	---	dB μ V/m	dB	---
3387.0	46.3	RMS	68.2	21.9	H
3387.0	58.3	Peak	88.2	29.9	V
11748.7	51.5	Peak	74.0	22.5	V
11749.7	40.6	Average	54.0	13.4	V
23500.0	47.4	Peak	88.2	40.8	V
23500.0	41.5	RMS	68.2	26.7	H

802.11ax

802.11ax20, HE0, Chain A**CH169**

Frequency	Level	Detector	Limit	Margin	Polar
MHz	dB μ V/m	---	dB μ V/m	dB	---
3386.5	59.5	Peak	88.2	28.8	H
3387.5	46.3	RMS	68.2	21.9	V
11672.7	52.5	Peak	74.0	21.5	V
11673.2	45.3	Average	54.0	8.7	V
23346.0	47.7	Peak	88.2	40.5	V
23346.0	39.1	RMS	68.2	29.1	H
23380.0	47.9	Peak	88.2	40.3	H
23380.0	40.0	RMS	68.2	28.2	H

CH173

Frequency	Level	Detector	Limit	Margin	Polar
MHz	dB μ V/m	---	dB μ V/m	dB	---
3389.5	58.9	Peak	88.2	29.3	V
3392.5	46.3	RMS	68.2	21.9	V
11712.8	55.6	Peak	74.0	18.4	V
11712.8	49.4	Average	54.0	4.6	V
23426.8	46.8	Peak	88.2	41.4	V
23426.8	37.9	RMS	68.2	30.3	H
23460.3	39.6	RMS	68.2	28.6	V
23460.3	47.3	Peak	88.2	40.9	H

CH177

Frequency	Level	Detector	Limit	Margin	Polar
MHz	dB μ V/m	---	dB μ V/m	dB	---
3396.0	58.3	Peak	88.2	29.9	V
3396.5	46.2	RMS	68.2	22.0	H
11752.5	54.2	Peak	74.0	19.8	V
11753.0	47.6	Average	54.0	6.4	V
23540.1	47.3	Peak	88.2	40.9	H
23540.1	41.7	RMS	68.2	26.5	H

802.11ax20, HE0, Chain B**CH169**

Frequency	Level	Detector	Limit	Margin	Polar
MHz	dB μ V/m	---	dB μ V/m	dB	---
3397.5	46.1	RMS	68.2	22.1	V
3399.5	58.5	Peak	88.2	29.7	H
17798.8	53.1	Peak	74.0	20.9	V
17813.9	42.0	Average	54.0	12.1	V
23348.9	43.0	RMS	68.2	25.2	H
23348.9	64.9	Peak	88.2	23.3	V
23380.0	47.9	Peak	88.2	40.3	H
23380.0	42.7	RMS	68.2	25.5	H

CH173

Frequency	Level	Detector	Limit	Margin	Polar
MHz	dB μ V/m	---	dB μ V/m	dB	---
3392.5	46.2	RMS	68.2	22.0	H
3394.0	57.6	Peak	88.2	30.6	H
11713.3	51.1	Peak	74.0	22.9	V
11713.3	43.2	Average	54.0	10.8	V
17570.8	51.6	Peak	88.2	36.6	V
17570.8	41.6	RMS	68.2	26.6	V
23426.8	56.9	Peak	88.2	31.3	V
23426.8	46.8	RMS	68.2	21.4	V
23460.3	41.0	RMS	68.2	27.2	V
23460.3	48.0	Peak	88.2	40.2	H

CH177

Frequency	Level	Detector	Limit	Margin	Polar
MHz	dB μ V/m	---	dB μ V/m	dB	---
3385.0	58.2	Peak	88.2	30.0	V
3385.5	46.3	RMS	68.2	21.9	V
11752.0	54.1	Peak	74.0	19.9	V
11752.5	47.5	Average	54.0	6.5	V
23507.1	40.5	RMS	68.2	27.7	V
23507.1	51.1	Peak	88.2	37.1	H
23540.1	47.8	Peak	88.2	40.4	H
23540.1	43.9	RMS	68.2	24.3	H

802.11ax20, HE0, Chain A+B

CH169

Frequency	Level	Detector	Limit	Margin	Polar
MHz	dBμV/m	---	dBμV/m	dB	---
3390.0	58.2	Peak	88.2	30.0	V
3391.5	46.1	RMS	68.2	22.1	H
11685.0	48.0	Peak	74.0	25.9	V
11690.2	39.0	Average	54.0	15.0	V
23345.6	56.5	Peak	88.2	31.7	H
23346.0	48.3	RMS	68.2	19.9	H
23380.0	47.4	Peak	88.2	40.9	H
23380.0	40.3	RMS	68.2	27.9	H

CH173

Frequency	Level	Detector	Limit	Margin	Polar
MHz	dBμV/m	---	dBμV/m	dB	---
3372.0	59.3	Peak	88.2	28.9	V
3373.0	46.8	RMS	68.2	21.4	H
11712.8	49.8	Average	54.0	4.2	V
11713.3	58.5	Peak	74.0	15.6	V
17568.4	53.3	Peak	88.2	34.9	V
17569.3	42.9	RMS	68.2	25.3	V
23426.8	43.8	RMS	68.2	24.4	V
23426.8	53.9	Peak	88.2	34.3	V
23460.3	47.7	Peak	88.2	40.5	H
23460.3	40.5	RMS	68.2	27.7	H

CH177

Frequency	Level	Detector	Limit	Margin	Polar
MHz	dBµV/m	---	dBµV/m	dB	---
3395.0	46.2	RMS	68.2	22.0	V
3398.5	57.8	Peak	88.2	30.4	V
11753.0	45.4	Average	54.0	8.6	V
11753.9	52.2	Peak	74.0	21.8	V
23506.6	48.0	Peak	88.2	40.2	V
23506.6	38.5	RMS	68.2	29.8	V
23540.1	40.8	RMS	68.2	27.4	H
23540.1	46.7	Peak	88.2	41.5	H

802.11ax40, HE0, Chain A

CH167

Frequency	Level	Detector	Limit	Margin	Polar
MHz	dBµV/m	---	dBµV/m	dB	---
3394.0	57.8	Peak	88.2	30.4	V
3394.5	46.2	RMS	68.2	22.0	H
11676.9	46.8	Average	54.0	7.2	V
11677.4	55.3	Peak	74.0	18.7	V
23340.4	46.5	Peak	88.2	41.7	V
23340.4	41.1	RMS	68.2	27.1	H
23354.1	40.5	RMS	68.2	27.6	H
23354.5	49.9	Peak	88.2	38.3	V

CH175

Frequency	Level	Detector	Limit	Margin	Polar
MHz	dBµV/m	---	dBµV/m	dB	---
3397.0	46.2	RMS	68.2	22.0	V
3397.0	57.9	Peak	88.2	30.3	V
11756.3	56.2	Peak	74.0	17.8	V
11756.3	47.9	Average	54.0	6.2	V
23500.0	47.2	Peak	88.2	40.9	H
23500.0	39.7	RMS	68.2	28.5	H

802.11ax40, HE0, Chain B

CH167

Frequency	Level	Detector	Limit	Margin	Polar
MHz	dB μ V/m	---	dB μ V/m	dB	---
3393.0	46.2	RMS	68.2	22.0	H
3396.0	58.3	Peak	88.2	29.9	V
11675.1	48.6	Peak	74.0	25.4	V
11676.9	38.2	Average	54.0	15.8	V
23355.0	45.7	RMS	68.2	22.5	V
23355.0	64.8	Peak	88.2	23.4	V

CH175

Frequency	Level	Detector	Limit	Margin	Polar
MHz	dB μ V/m	---	dB μ V/m	dB	---
3389.0	46.4	RMS	68.2	21.8	H
3390.0	57.3	Peak	88.2	30.9	H
11755.3	53.3	Peak	74.0	20.7	V
11756.3	47.7	Average	54.0	6.3	V
23500.0	41.9	RMS	68.2	26.3	H
23500.0	48.9	Peak	88.2	39.3	V
23514.6	40.6	RMS	68.2	27.6	V
23514.6	54.2	Peak	88.2	34.0	V

802.11ax40, HE0, Chain A+B

CH167

Frequency	Level	Detector	Limit	Margin	Polar
MHz	dB μ V/m	---	dB μ V/m	dB	---
3381.0	58.9	Peak	88.2	29.3	H
3384.0	46.4	RMS	68.2	21.8	H
11669.9	39.1	Average	54.0	14.9	V
11675.5	49.4	Peak	74.0	24.6	V
23353.6	56.8	Peak	88.2	31.4	H
23353.6	47.2	RMS	68.2	21.0	V

CH175

Frequency	Level	Detector	Limit	Margin	Polar
MHz	dBµV/m	---	dBµV/m	dB	---
3382.0	58.9	Peak	88.2	29.3	H
3384.5	46.6	RMS	68.2	21.6	H
11755.3	52.3	Peak	74.0	21.7	V
11756.3	43.4	Average	54.0	10.7	V
23500.0	45.8	Peak	88.2	42.4	V
23500.0	40.0	RMS	68.2	28.2	H
23513.7	39.3	RMS	68.2	28.9	V
23513.7	49.6	Peak	88.2	38.6	V

802.11ax80, HE0, Chain A**CH171**

Frequency	Level	Detector	Limit	Margin	Polar
MHz	dBµV/m	---	dBµV/m	dB	---
3394.0	46.3	RMS	68.2	21.9	V
3394.0	58.0	Peak	88.2	30.2	V
11718.5	49.4	Average	54.0	4.6	V
11719.4	56.9	Peak	74.0	17.1	V
23419.7	48.2	Peak	88.2	40.0	H
23419.7	39.4	RMS	68.2	28.8	H
23439.1	37.0	RMS	68.2	31.2	V
23439.1	49.9	Peak	88.2	38.3	V

802.11ax80, HE0, Chain B

CH171

Frequency	Level	Detector	Limit	Margin	Polar
MHz	dBμV/m	---	dBμV/m	dB	---
3372.0	46.8	RMS	68.2	21.4	H
3372.0	59.4	Peak	88.2	28.8	V
11718.0	50.3	Average	54.0	3.7	V
11718.5	61.4	Peak	74.0	12.7	V
17577.4	53.7	Peak	88.2	34.5	H
17578.8	44.3	RMS	68.2	23.9	V
23420.2	43.0	RMS	68.2	25.2	H
23420.2	48.4	Peak	88.2	39.8	H
23436.2	43.3	RMS	68.2	24.9	V
23436.2	56.9	Peak	88.2	31.3	V

802.11ax80, HE0, Chain A+B

CH171

Frequency	Level	Detector	Limit	Margin	Polar
MHz	dBμV/m	---	dBμV/m	dB	---
3375.0	46.6	RMS	68.2	21.6	H
3378.0	58.5	Peak	88.2	29.8	H
11718.5	52.2	Peak	74.0	21.8	V
11719.0	43.0	Average	54.0	11.0	V
23420.2	46.2	Peak	88.2	42.0	V
23420.2	40.1	RMS	68.2	28.1	V
23436.2	41.1	RMS	68.2	27.1	H
23436.2	55.1	Peak	88.2	33.1	H

802.11ax160, HE0, Chain A

CH163

Frequency	Level	Detector	Limit	Margin	Polar
MHz	dBμV/m	---	dBμV/m	dB	---
3365.5	59.1	Peak	88.2	29.1	V
3368.0	46.9	RMS	68.2	21.3	V
11628.3	48.2	Peak	74.0	25.8	H
11629.7	40.8	Average	54.0	13.2	V
23202.5	42.6	RMS	68.2	25.6	H
23202.5	50.8	Peak	88.2	37.4	H
23260.1	47.4	Peak	88.2	40.8	V
23260.1	40.7	RMS	68.2	27.5	H

802.11ax160, HE0, Chain B

CH163

Frequency	Level	Detector	Limit	Margin	Polar
MHz	dBμV/m	---	dBμV/m	dB	---
3382.5	46.5	RMS	68.2	21.7	H
3384.0	58.7	Peak	88.2	29.5	V
11600.9	62.8	Peak	74.0	11.2	V
11600.9	52.6	Average	54.0	1.4	V
23202.0	55.3	Peak	88.2	32.9	V
23202.0	45.5	RMS	68.2	22.6	H
23230.3	37.6	RMS	68.2	30.6	V
23230.3	45.6	Peak	88.2	42.6	V
23260.1	47.5	Peak	88.2	40.7	H
23260.1	42.8	RMS	68.2	25.4	H

802.11ax160, HE0, Chain A+B

CH163

Frequency	Level	Detector	Limit	Margin	Polar
MHz	dB μ V/m	---	dB μ V/m	dB	---
3367.5	46.9	RMS	68.2	21.3	H
3368.5	58.2	Peak	88.2	30.0	H
11600.9	47.4	Average	54.0	6.6	V
11601.4	57.6	Peak	74.0	16.4	V
23202.5	55.9	Peak	88.2	32.3	V
23202.5	45.2	RMS	68.2	23.0	V
23260.1	47.5	Peak	88.2	40.7	V
23260.1	41.5	RMS	68.2	26.7	V

802.11ac

802.11ac80, VHT0, Chain A

CH171

Frequency	Level	Detector	Limit	Margin	Polar
MHz	dB μ V/m	---	dB μ V/m	dB	---
3385.0	46.3	RMS	68.2	21.9	H
3385.0	58.8	Peak	88.2	29.4	V
11703.9	49.2	Peak	74.0	24.8	V
11710.0	40.5	Average	54.0	13.5	V
23420.2	47.1	Peak	88.2	41.1	H
23420.2	40.4	RMS	68.2	27.8	H

802.11ac80, VHT0, Chain B

CH171

Frequency	Level	Detector	Limit	Margin	Polar
MHz	dBμV/m	---	dBμV/m	dB	---
3377.0	59.8	Peak	88.2	28.4	H
3378.5	46.5	RMS	68.2	21.6	V
11666.6	42.8	Average	54.0	11.2	V
11704.8	53.6	Peak	74.0	20.4	V
23420.2	48.9	Peak	88.2	39.3	V
23420.2	43.0	RMS	68.2	25.2	H

802.11ac80, VHT0, Chain A+B

CH171

Frequency	Level	Detector	Limit	Margin	Polar
MHz	dBμV/m	---	dBμV/m	dB	---
3395.0	58.1	Peak	88.2	30.1	V
3396.0	46.5	RMS	68.2	21.7	V
11668.4	52.9	Peak	74.0	21.1	V
11693.9	41.4	Average	54.0	12.6	V
17557.5	46.3	RMS	68.2	21.9	H
17566.0	57.9	Peak	88.2	30.3	H
22274.6	46.2	Peak	74.0	27.8	H
22274.6	38.3	Average	54.0	15.7	H
23420.2	46.9	Peak	88.2	41.3	H
23420.2	39.9	RMS	68.2	28.3	V

802.11ac160, VHT0, Chain A**CH163**

Frequency	Level	Detector	Limit	Margin	Polar
MHz	dB μ V/m	---	dB μ V/m	dB	---
3371.5	46.8	RMS	68.2	21.4	H
3372.0	58.7	Peak	88.2	29.5	V
11626.4	49.3	Peak	74.0	24.7	H
11629.7	41.2	Average	54.0	12.8	V
23260.1	47.8	Peak	88.2	40.4	V
23260.1	41.7	RMS	68.2	26.5	V

802.11ac160, VHT0, Chain B**CH163**

Frequency	Level	Detector	Limit	Margin	Polar
MHz	dB μ V/m	---	dB μ V/m	dB	---
3383.5	46.4	RMS	68.2	21.8	H
3385.0	58.1	Peak	88.2	30.1	V
11552.8	53.8	Peak	74.0	20.2	V
11598.6	43.2	Average	54.0	10.8	V
23260.1	48.4	Peak	88.2	39.8	V
23260.1	42.8	RMS	68.2	25.4	V

802.11ac160, VHT0, Chain A+B**CH163**

Frequency	Level	Detector	Limit	Margin	Polar
MHz	dBμV/m	---	dBμV/m	dB	---
3369.0	46.9	RMS	68.2	21.4	H
3371.0	57.9	Peak	88.2	30.3	H
11135.3	49.8	Peak	74.0	24.2	V
11135.3	44.1	Average	54.0	9.9	V
11596.2	42.5	Average	54.0	11.5	V
11646.7	55.6	Peak	74.0	18.4	V
22280.7	46.1	Peak	74.0	27.9	H
22280.7	37.8	Average	54.0	16.2	H
23260.1	47.1	Peak	88.2	41.1	V
23260.1	41.2	RMS	68.2	27.0	V

B.3 Test Results Screenshot

B.3.1 6dB Bandwidth

SISO-A, 802.11a, 6Mbps-CH177

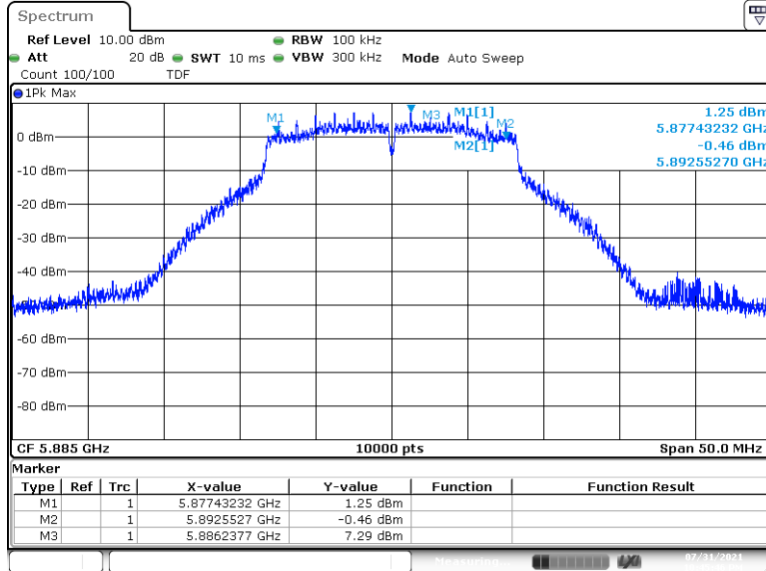

MIMO-B, 802.11n20, HT0-CH169

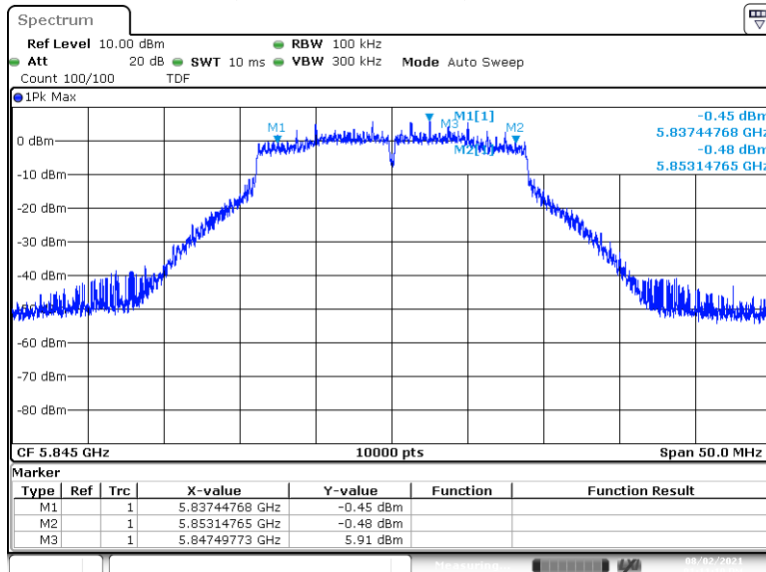

SISO-A, 802.11n40, HT0-CH167

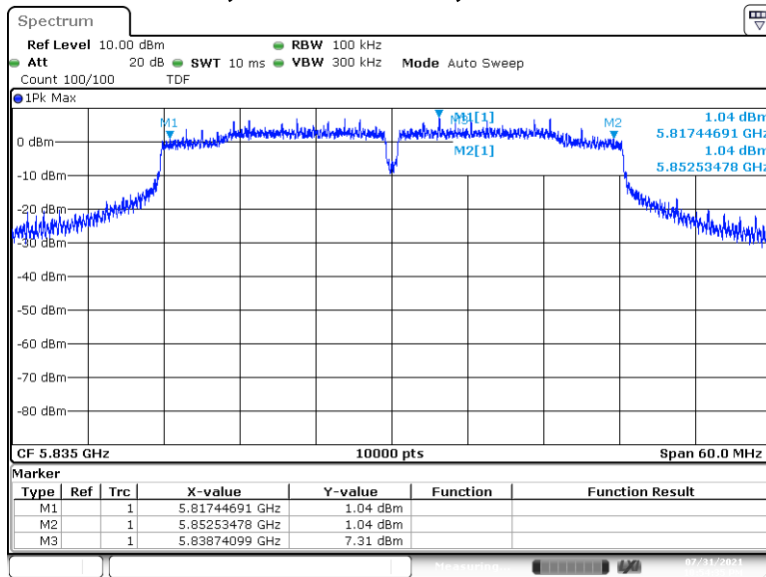

SISO-B, 802.11ac80, VHT0-CH171

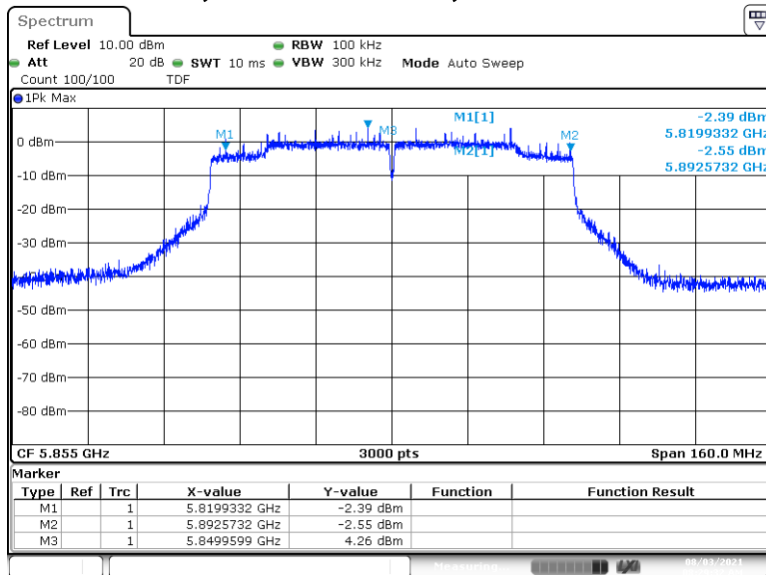

MIMO-A, 802.11ac160, VHT0-CH163

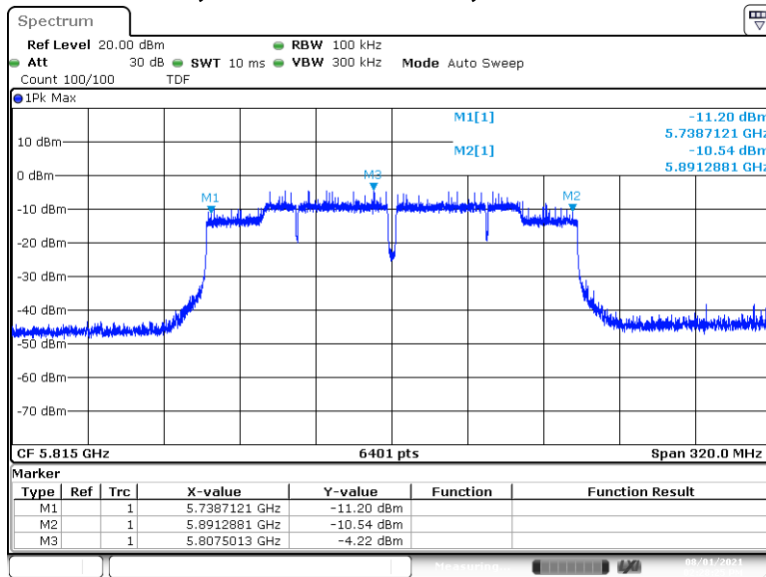

SISO-A, 802.11ax20, HE0-CH169

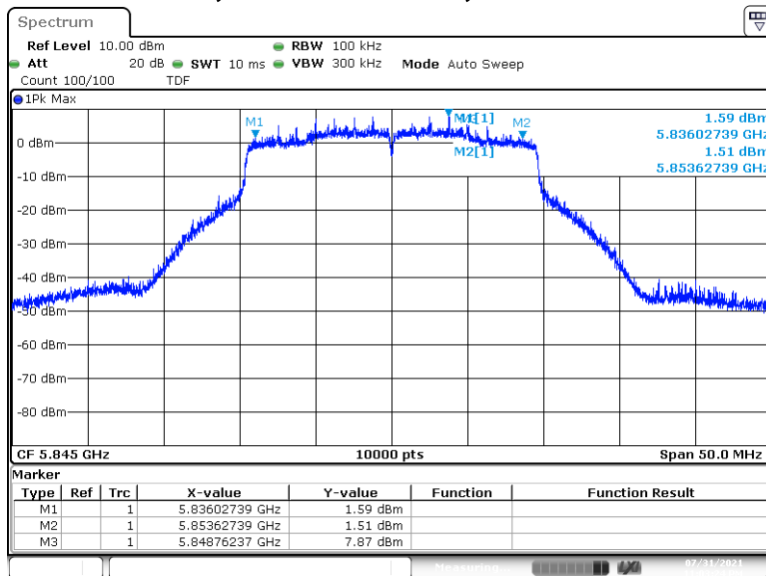

MIMO-A, 802.11ax40, HE0-CH175

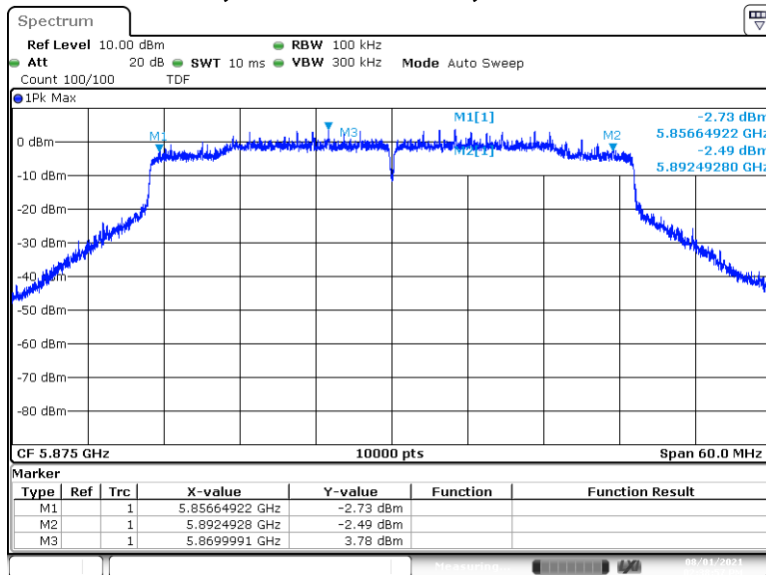

SISO-B, 802.11ax80, HE0-CH171

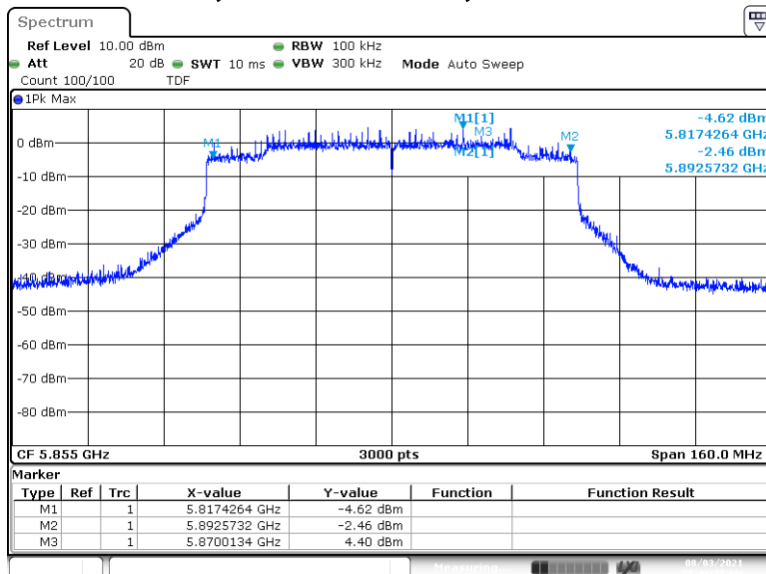

MIMO-B, 802.11ax160, HE0-CH163

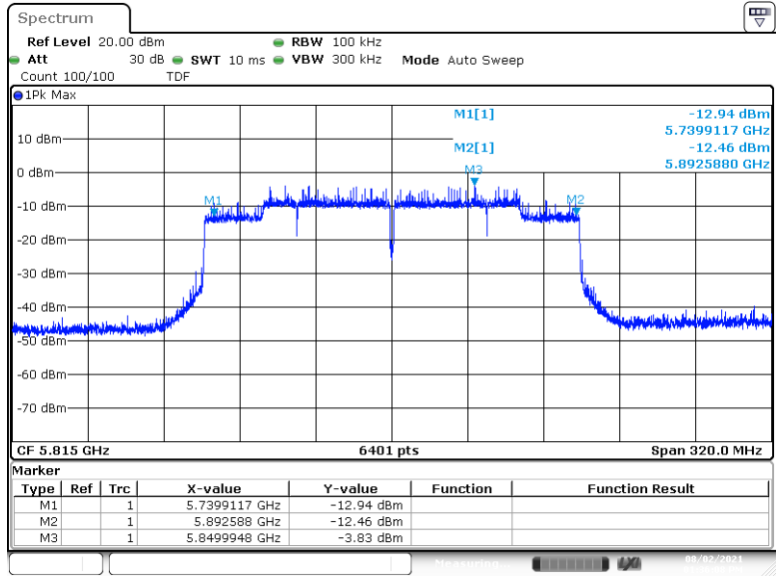

B.3.2 99% Bandwidth

SISO-A, 802.11a, 6Mbps-CH169

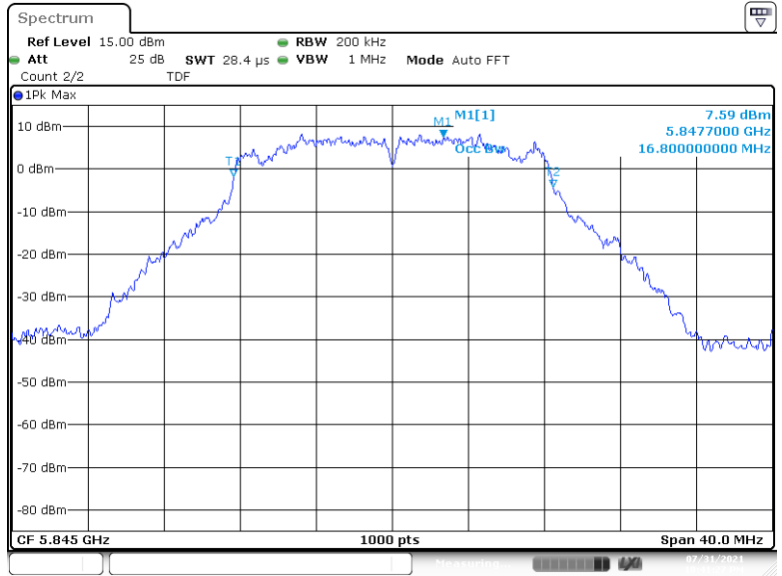

MIMO-A, 802.11n20, HT0-CH173

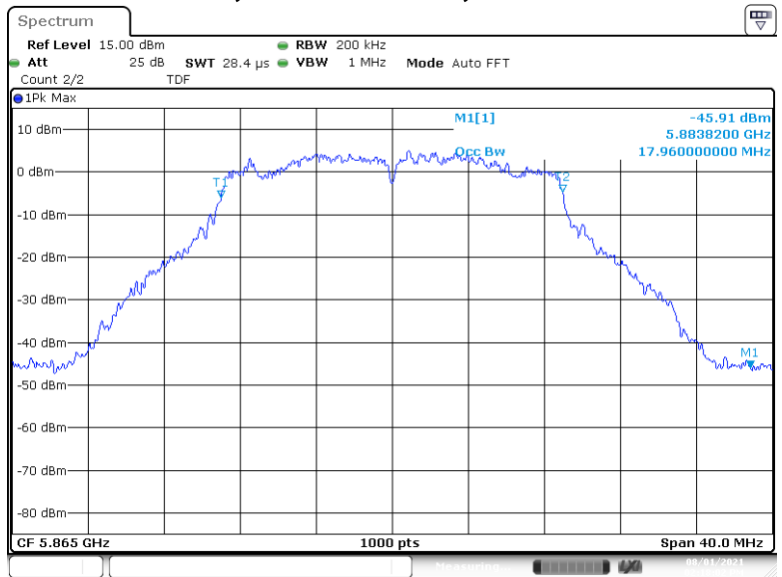

SISO-A, 802.11n40, HT0-CH167

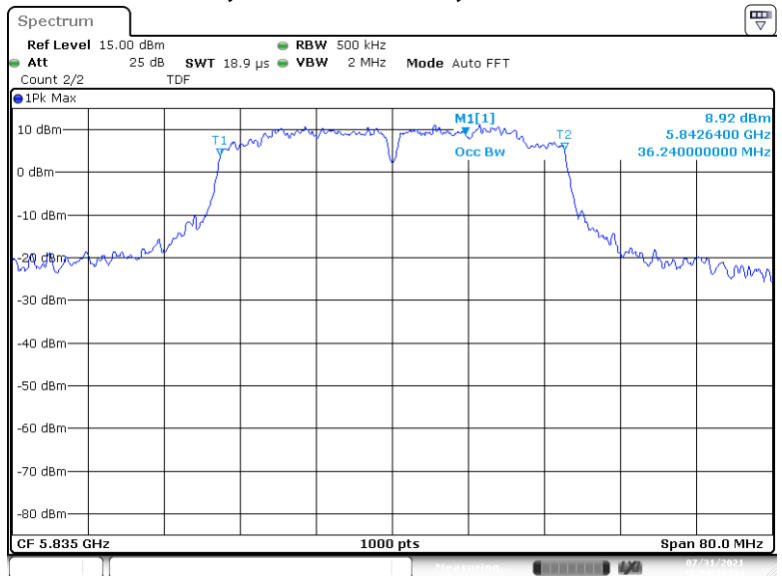

SISO-A, 802.11ac80, VHT0-CH171

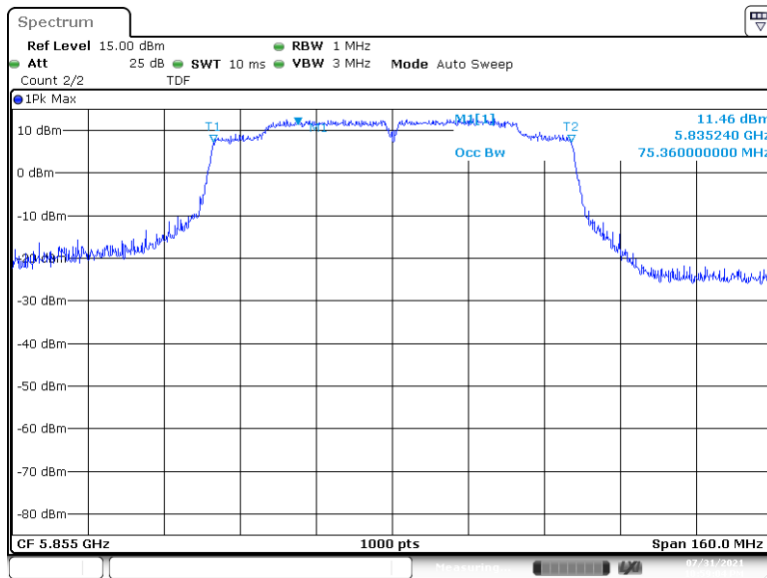

SISO-B, 802.11ac160, VHT0-CH163

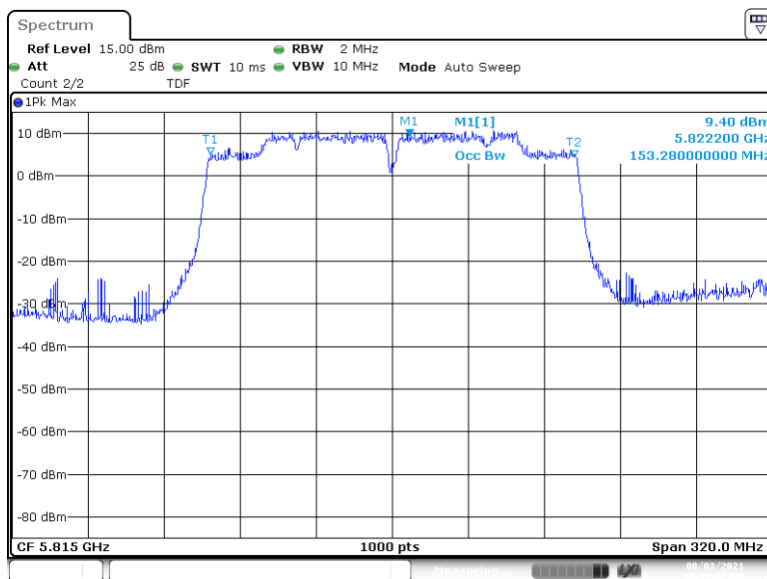

MIMO-A, 802.11ax20, HE0-CH177

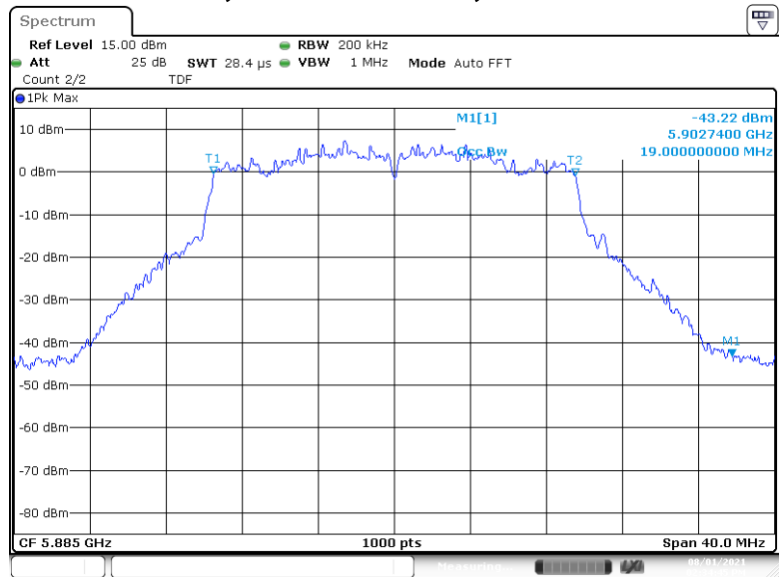

SISO-A, 802.11ax40, HE0-CH167

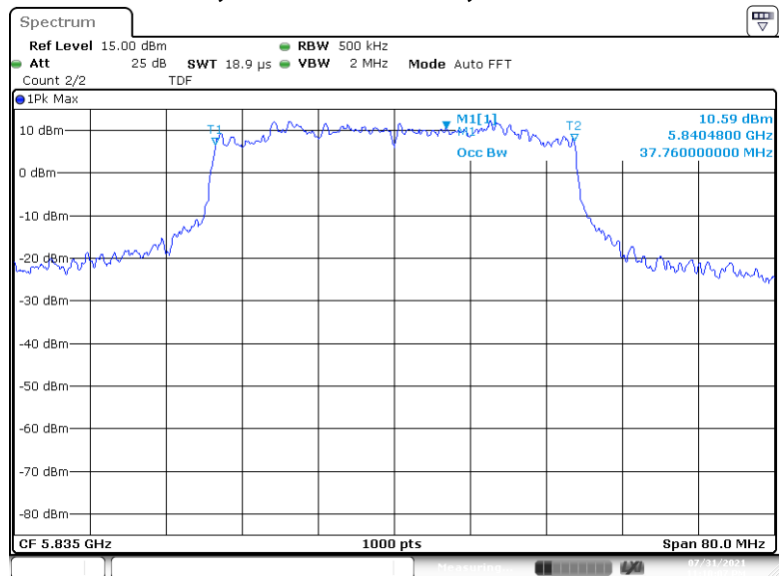

SISO-A, 802.11ax80, HE0-CH171

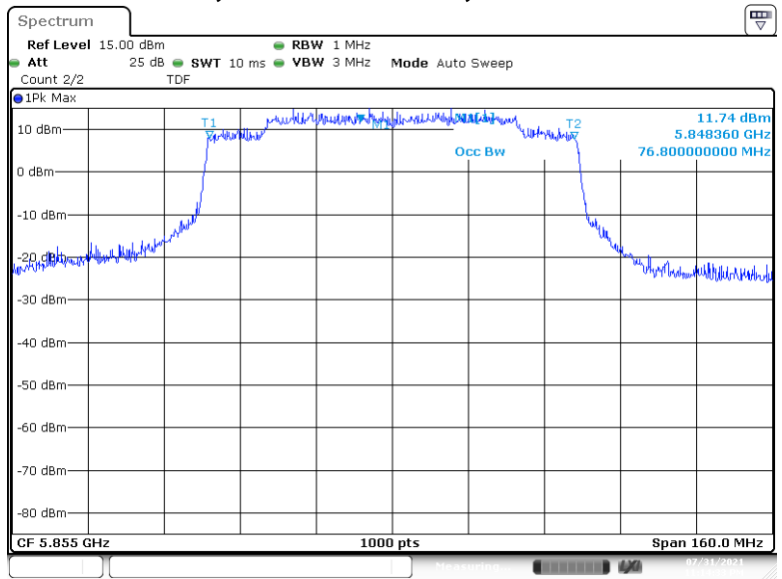

SISO-B, 802.11ax160, HE0-CH163

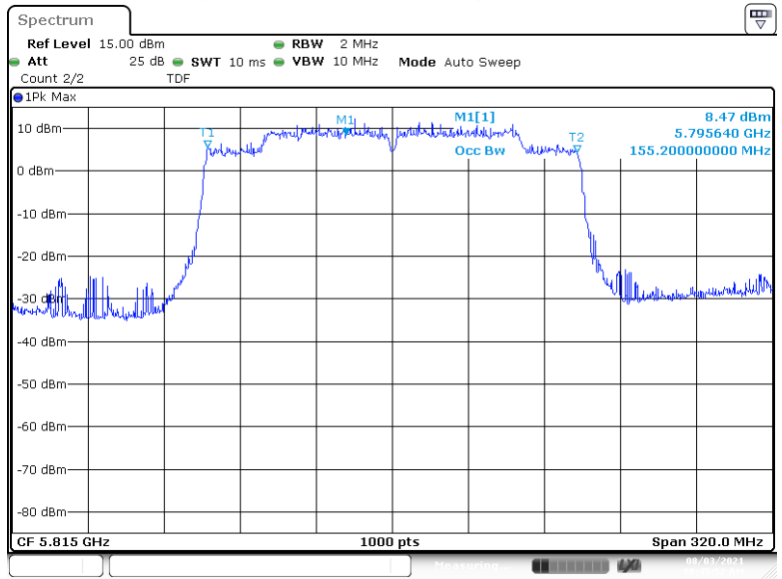

B.3.3 Maximum output power

SISO-A, 802.11a, 6Mbps-CH-169

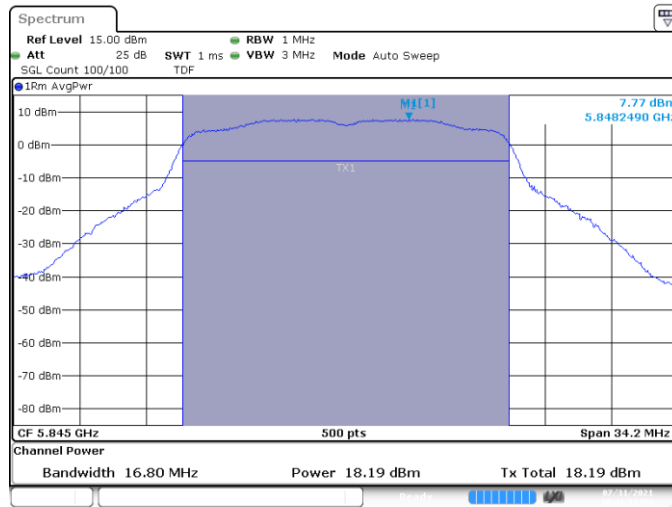

MIMO-A, 802.11n20, HT8-CH-169

MIMO-B, 802.11n20, HT8-CH-169

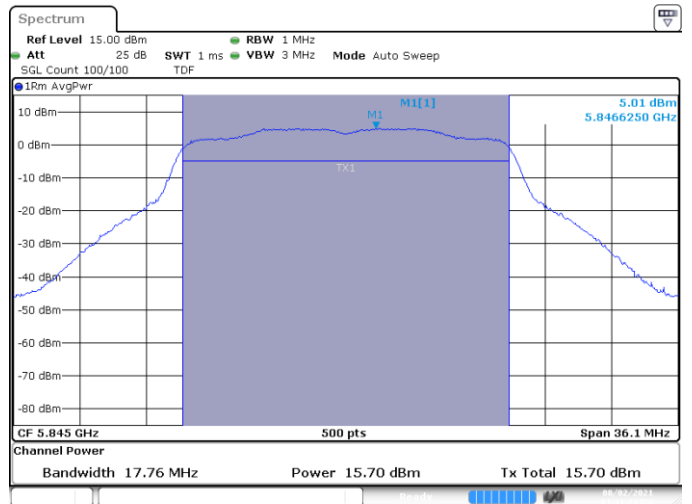
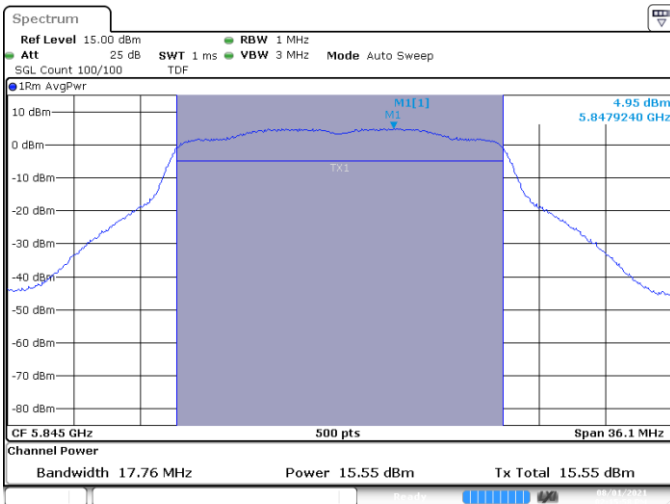

MIMO-A, 802.11n40, HT8-CH-167

MIMO-B, 802.11n40, HT8-CH-167

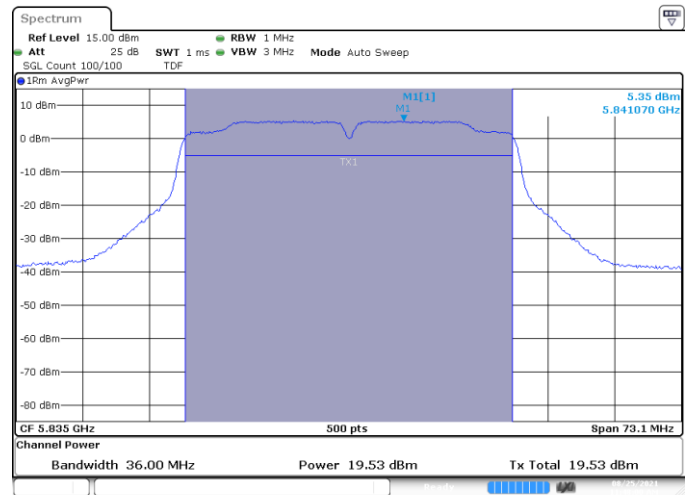
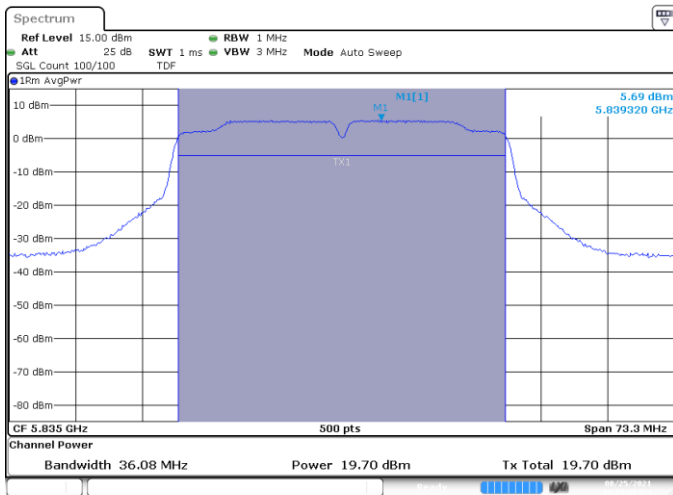

MIMO-A, 802.11ac80, VHT0-CH171

MIMO-B, 802.11ac80, VHT0-CH171

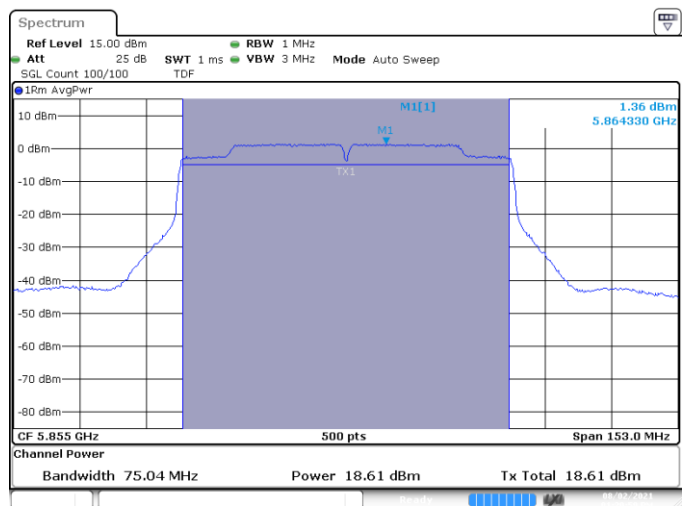
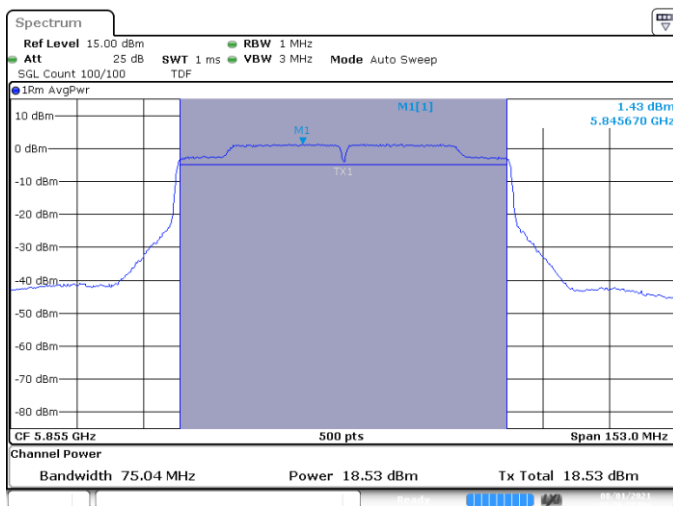

MIMO-A,802.11ac160,VHT0-CH163 MIMO-B,802.11ac160,VHT0-CH163

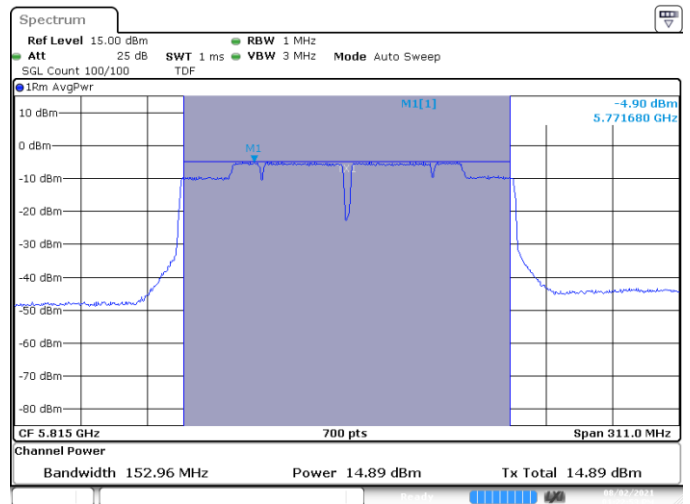
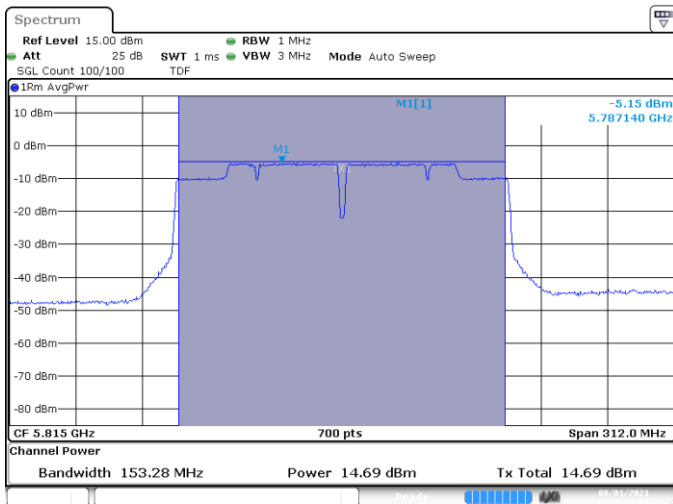

MIMO-A, 802.11ax20, HE0-CH-169

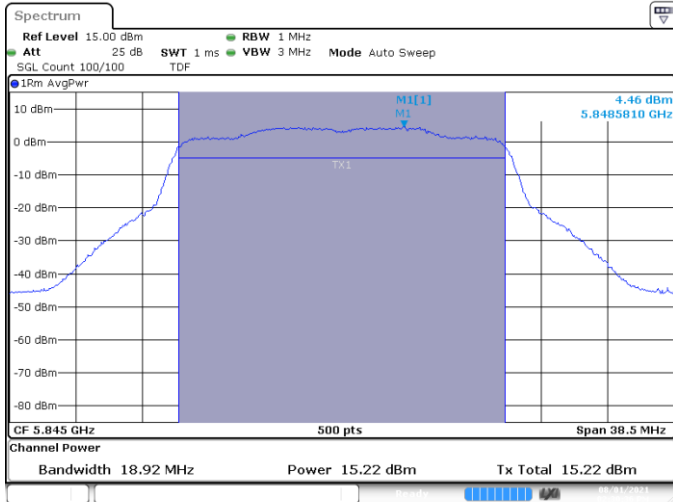

MIMO-B, 802.11ax20, HE0-CH-169

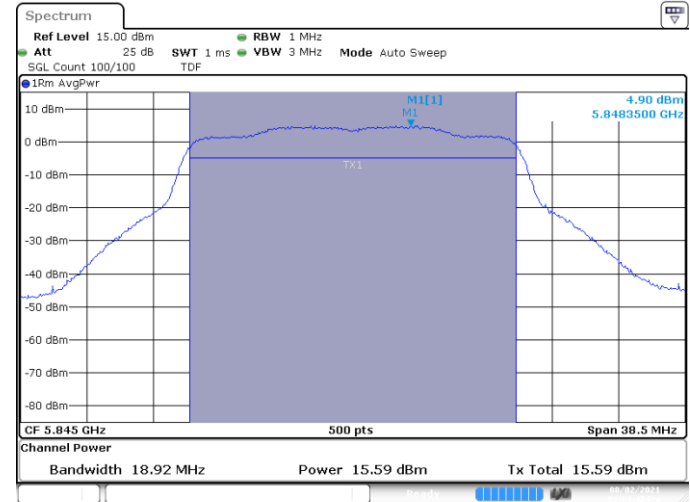

MIMO-A, 802.11ax40, HE0-CH-167

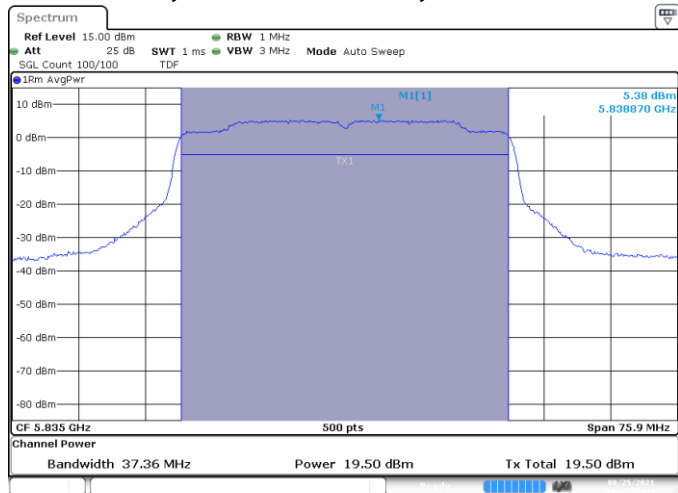

MIMO-B, 802.11ax40, HE0-CH-167

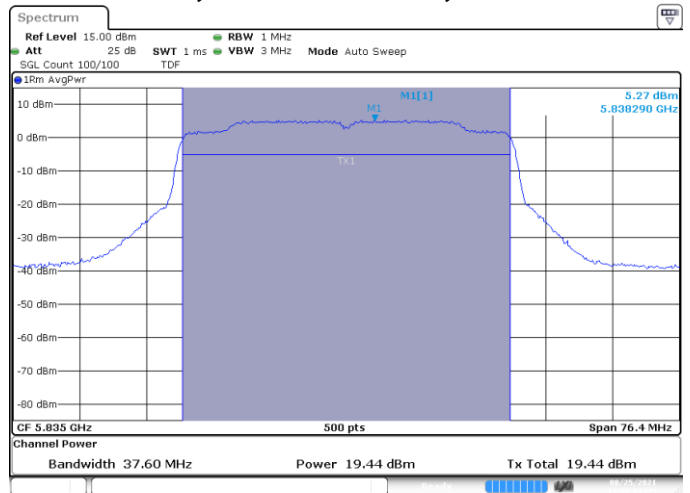

MIMO-A, 802.11ax80, HE0-CH171

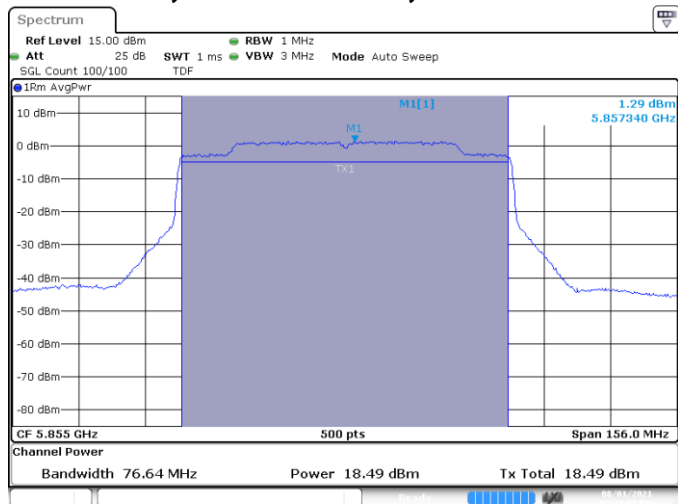

MIMO-B, 802.11ax80, HE0-CH171

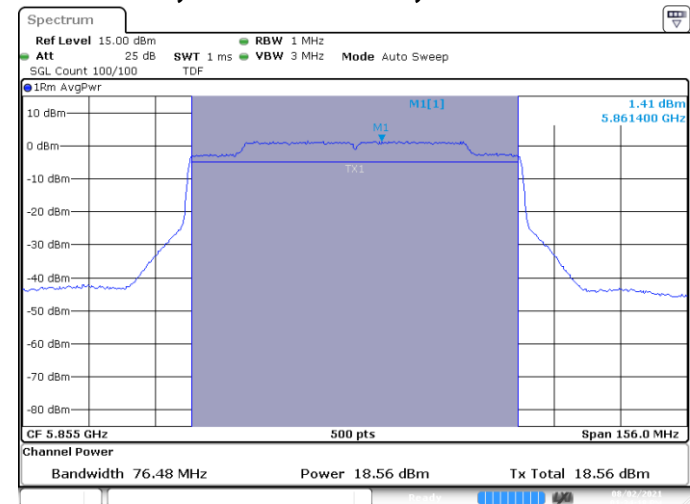

MIMO-A,802.11ax160,HE0-CH163 MIMO-B,802.11ax160,HE0-CH163

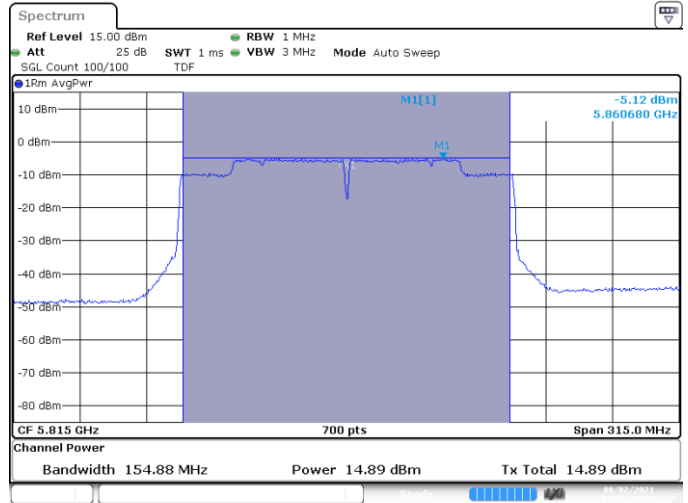
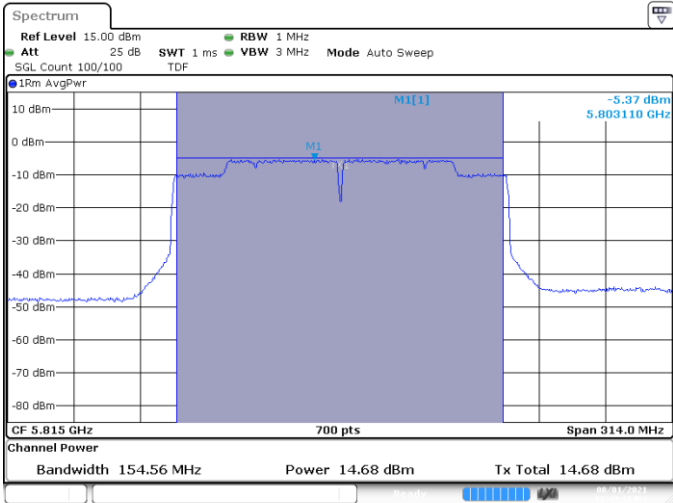

B.3.4 Maximum Power Spectral Density (PSD)

SISO-A, 802.11a, 6Mbps-CH-169

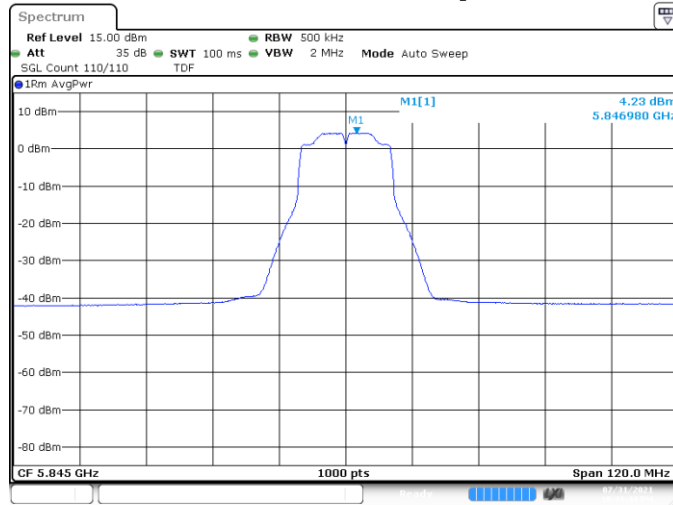

MIMO-A, 802.11n20, HT8-CH-169 MIMO-B, 802.11n20, HT8-CH-169

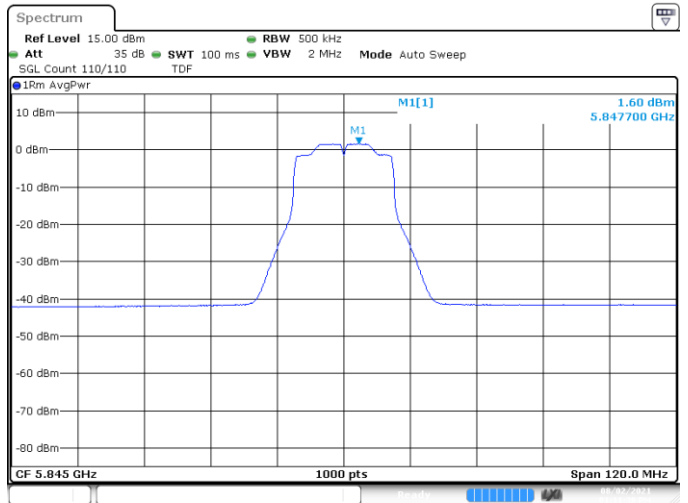
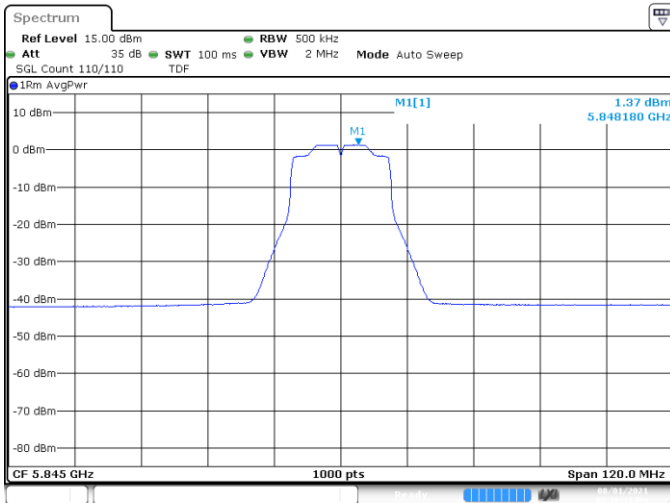

MIMO-A, 802.11n40, HT8-CH-167

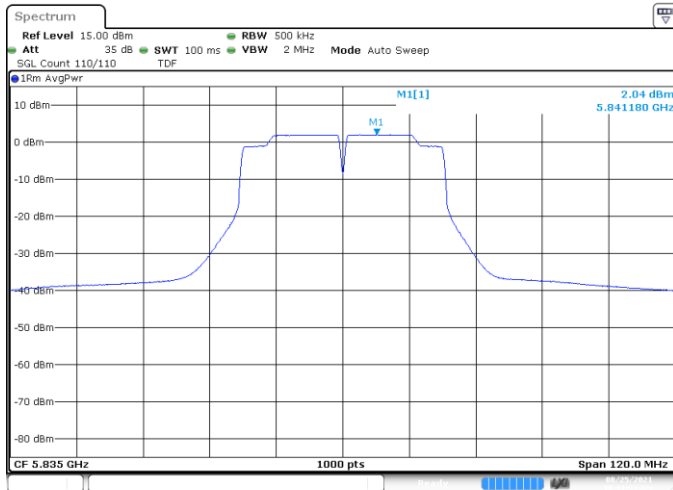

MIMO-B, 802.11n40, HT8-CH-167

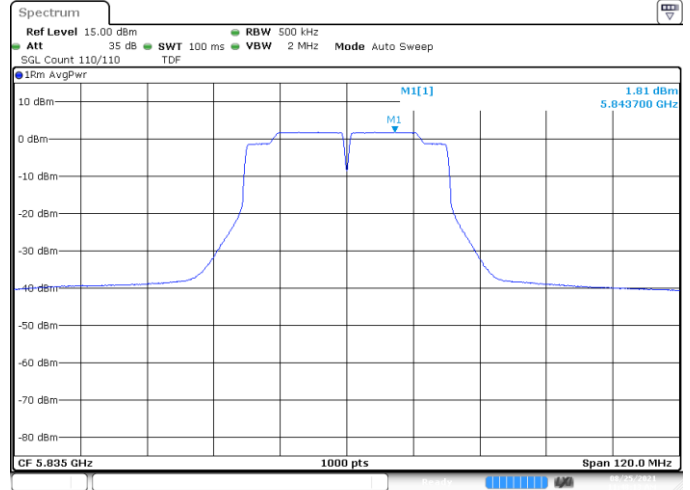

MIMO-A, 802.11ac80, VHT0-CH171

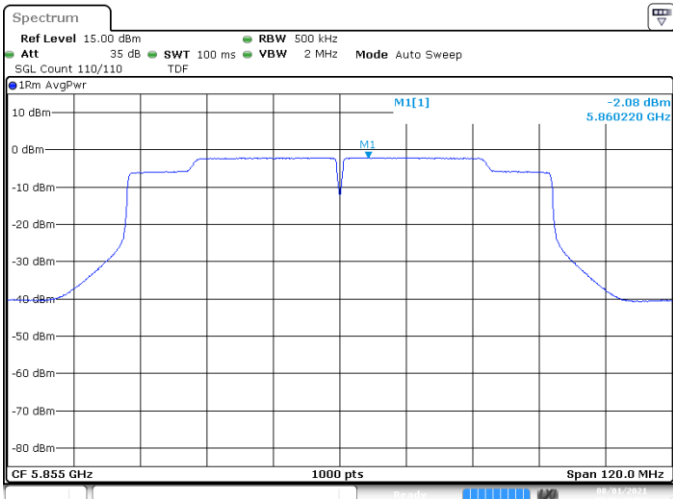

MIMO-B, 802.11ac80, VHT0-CH171

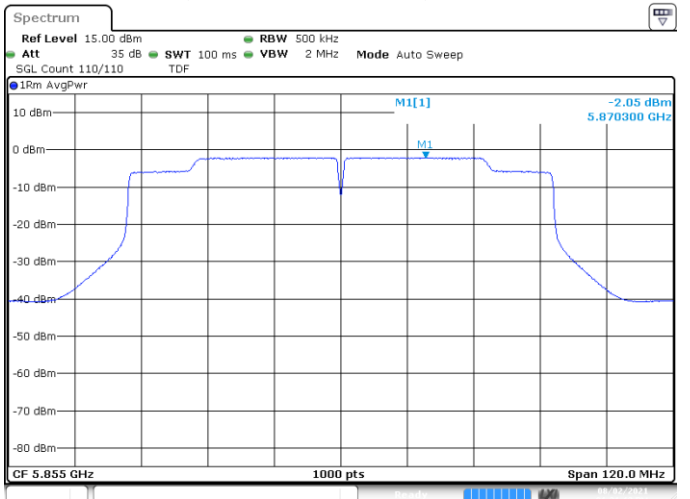

MIMO-A,802.11ac160,VHT0-CH163 MIMO-B,802.11ac160,VHT0-CH163

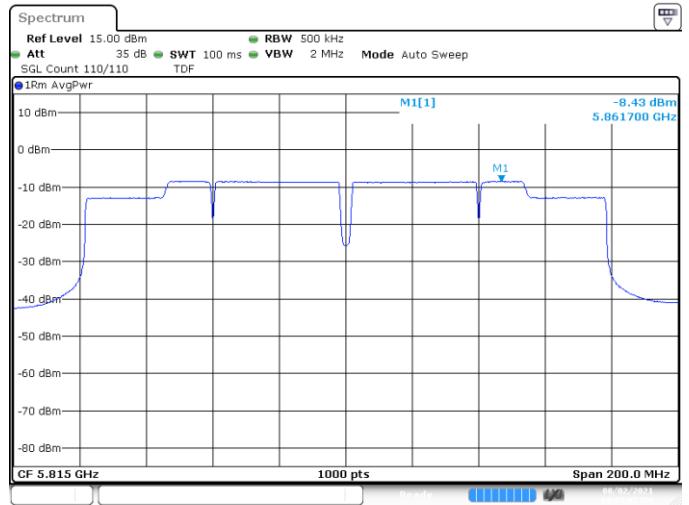
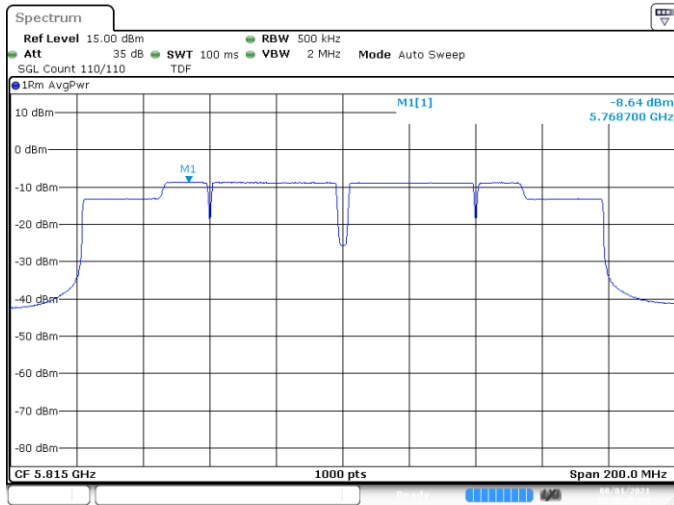

MIMO-A, 802.11ax20, HE0-CH-169 MIMO-B, 802.11ax20, HE0-CH-169

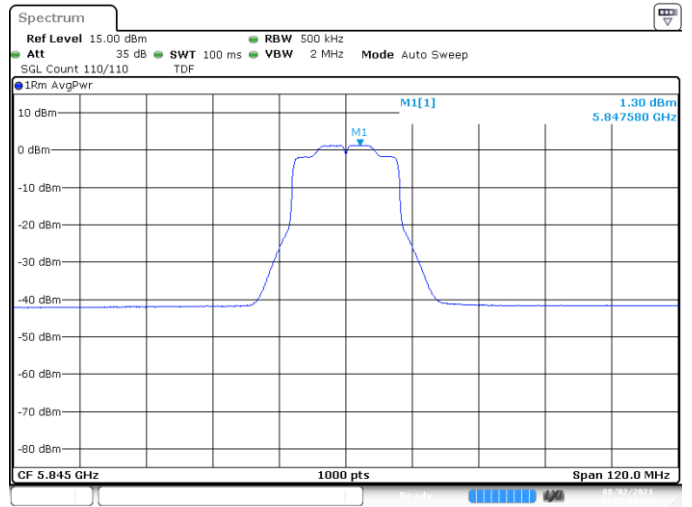
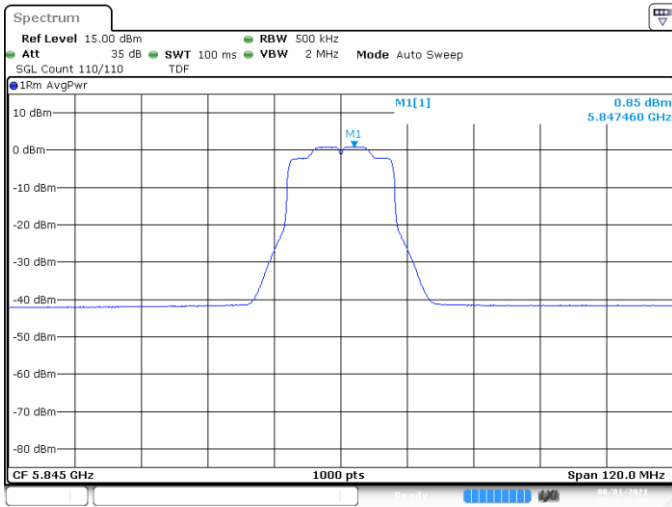

MIMO-A, 802.11ax40, HE0-CH-167

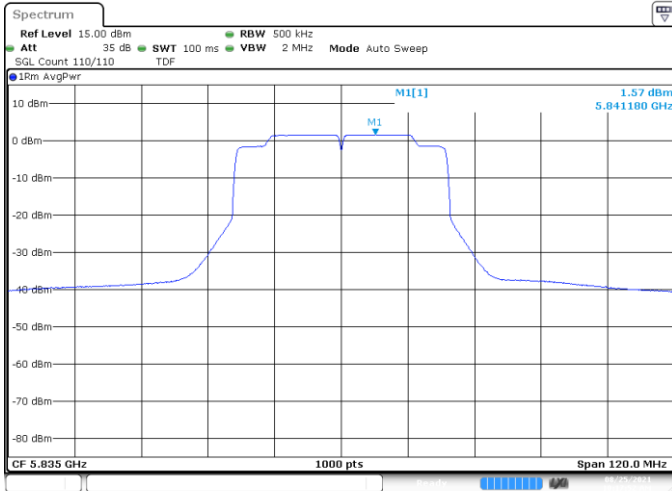

MIMO-B, 802.11ax40, HE0-CH-175

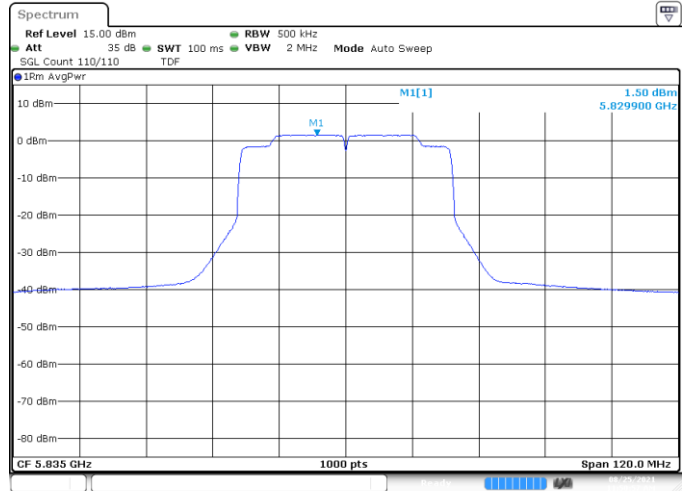

MIMO-A,802.11ax80,HE0-CH171

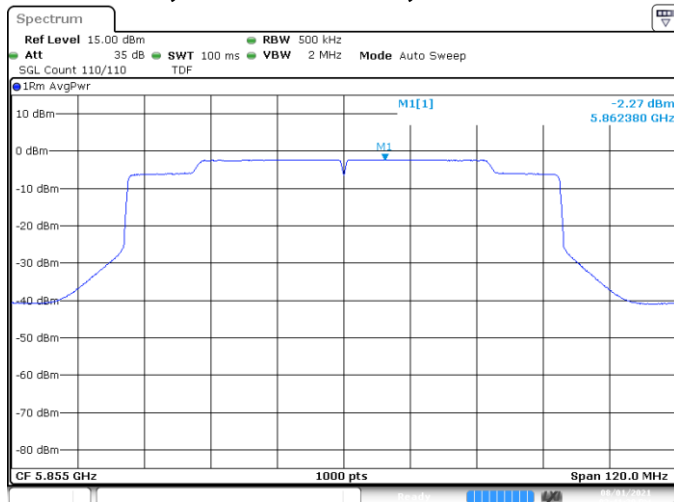

MIMO-B,802.11ax80,HE0-CH171

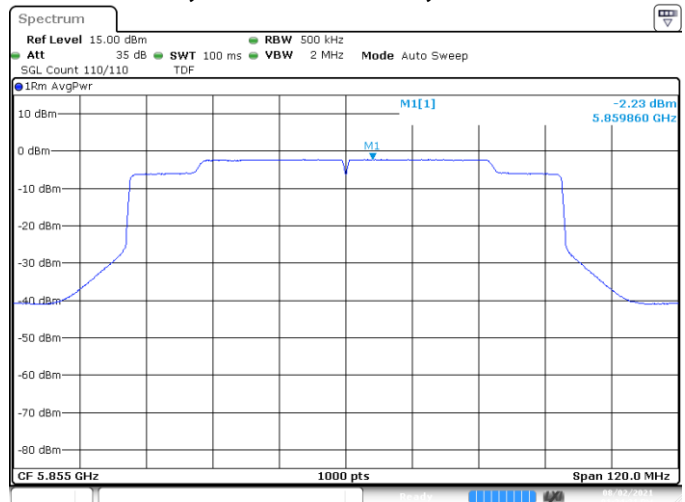

MIMO-A,802.11ax160,HE0-CH163

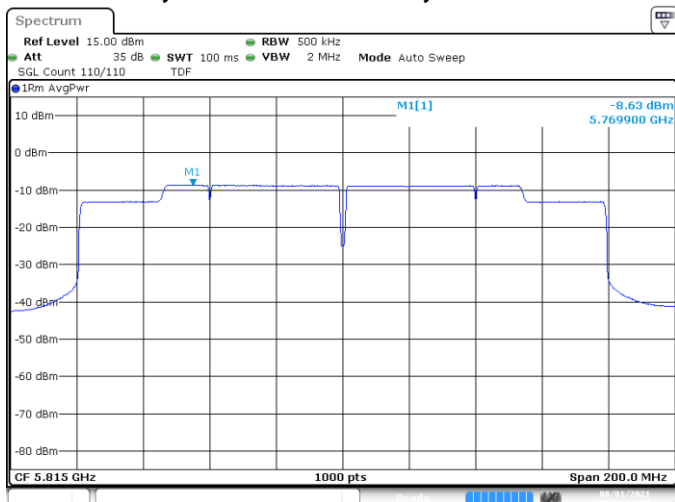

MIMO-B,802.11ax160,HE0-CH163

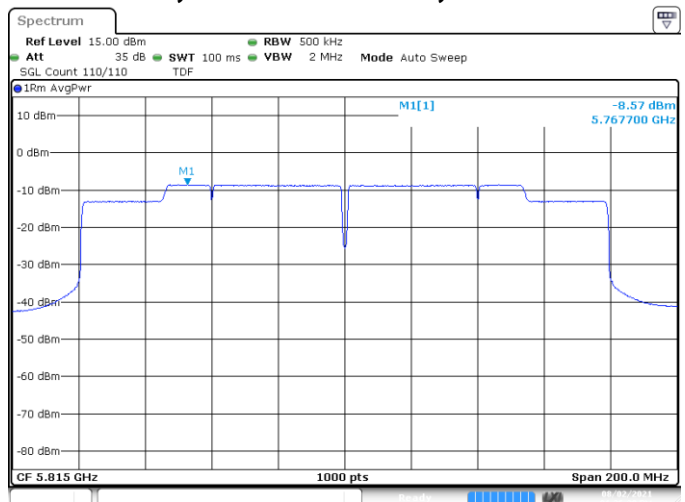

B.3.5 Undesirable emission limits : out of band (Conducted)

SISO-A

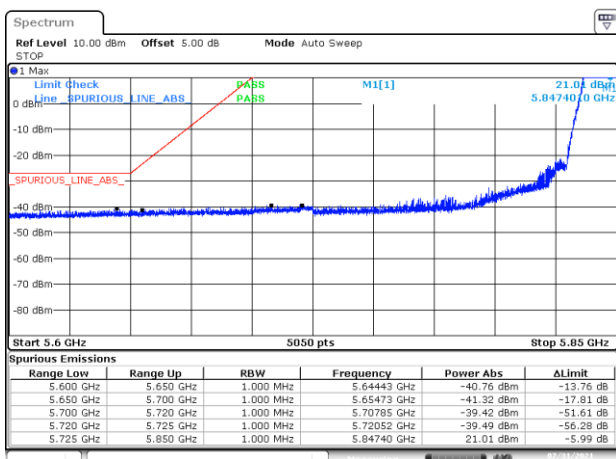

BE-NR-LOW, SISO-A, 802.11a20-6Mbps, Ch169

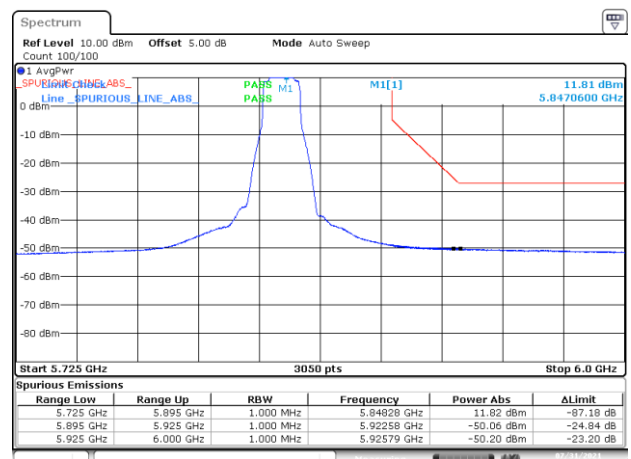

BE-NR-HIGH, SISO-A, 802.11a20-6Mbps, Ch169

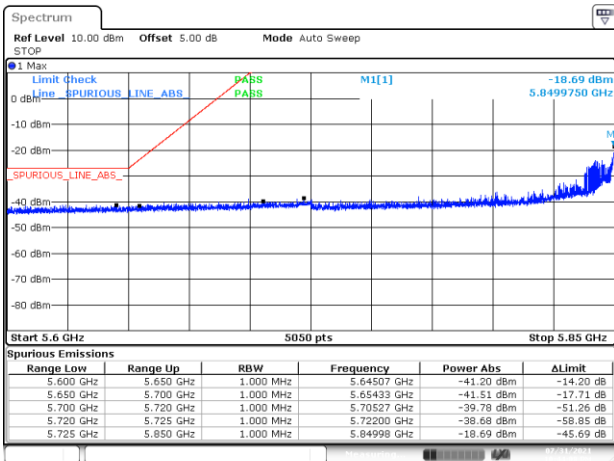

BE-NR-LOW, SISO-A, 802.11a20-6Mbps, Ch173

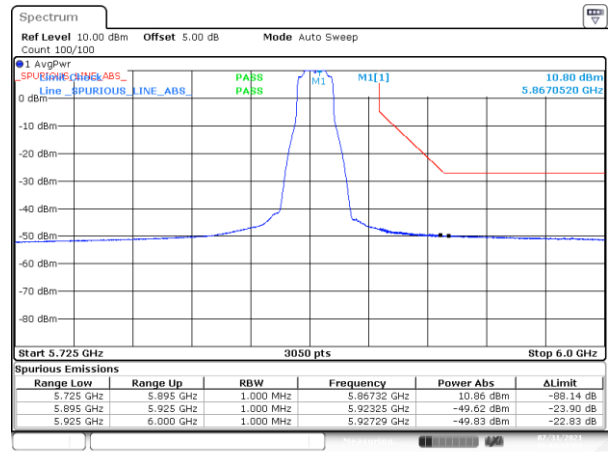

BE-NR-HIGH, SISO-A, 802.11a20-6Mbps, Ch173

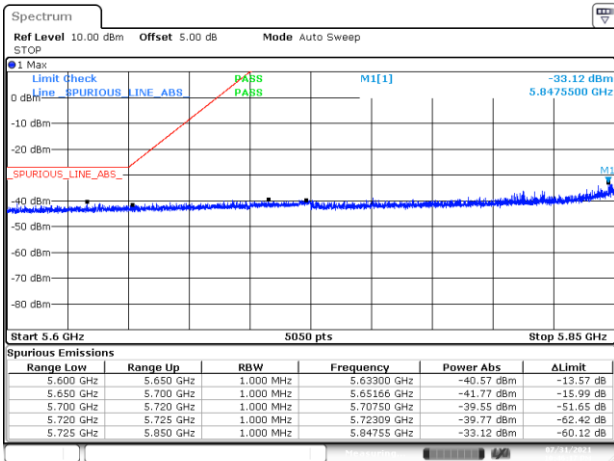

BE-NR-LOW, SISO-A, 802.11a20-6Mbps, Ch177

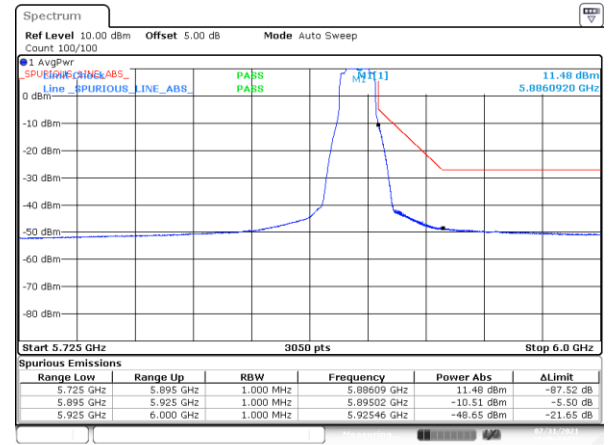

BE-NR-HIGH, SISO-A, 802.11a20-6Mbps, Ch177

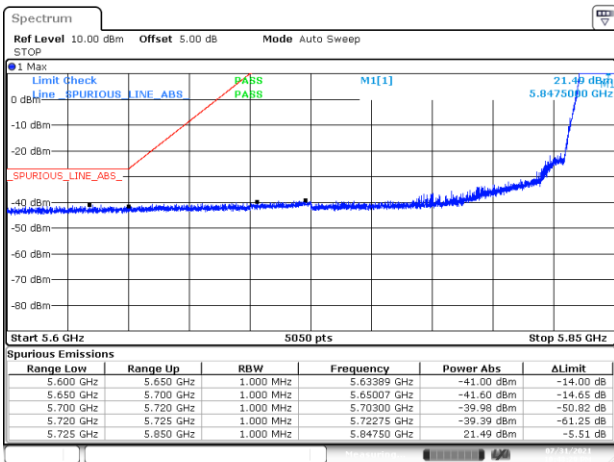

BE-NR-LOW, SISO-A, 802.11n20-HT0, Ch169

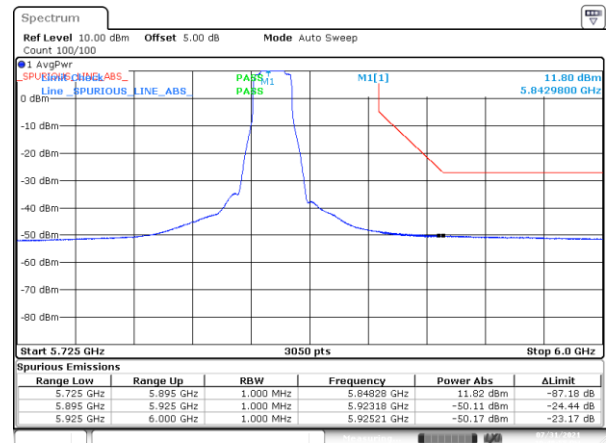

BE-NR-HIGH, SISO-A, 802.11n20-HT0, Ch169

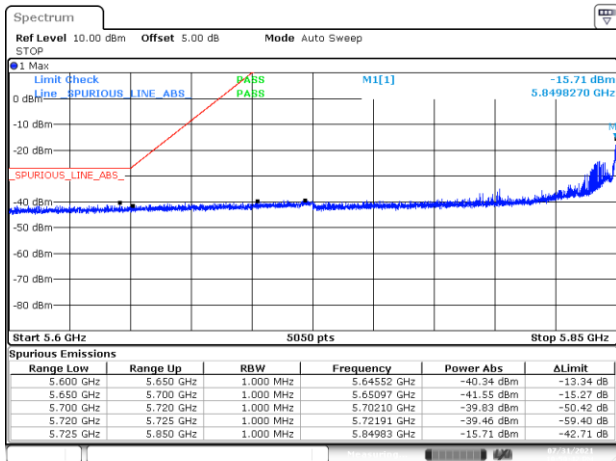

BE-NR-LOW, SISO-A, 802.11n20-HT0, Ch173

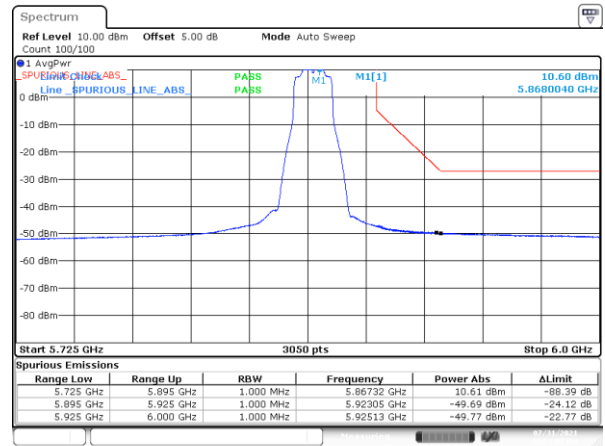

BE-NR-HIGH, SISO-A, 802.11n20-HT0, Ch173

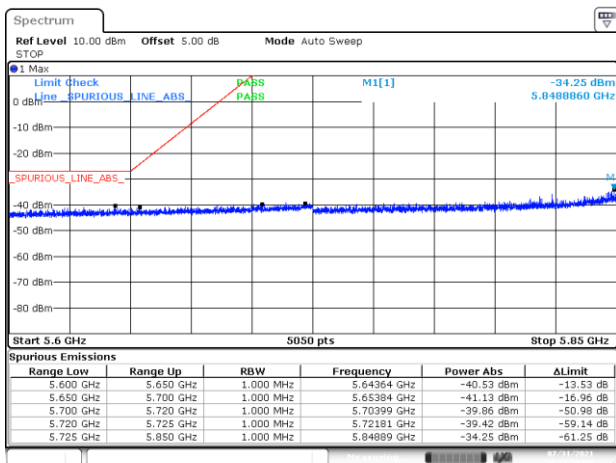

BE-NR-LOW, SISO-A, 802.11n20-HT0, Ch177

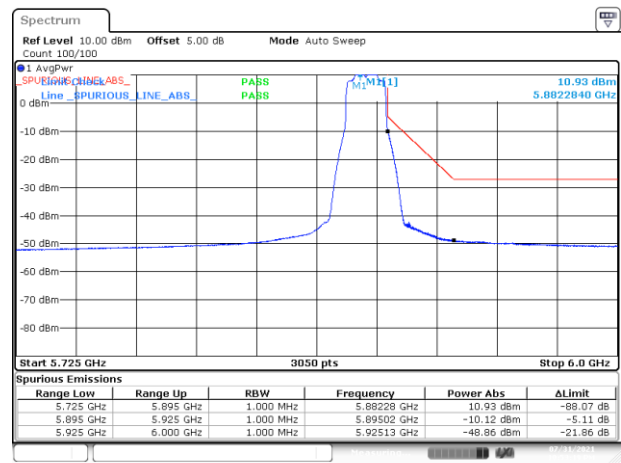

BE-NR-HIGH, SISO-A, 802.11n20-HT0, Ch177

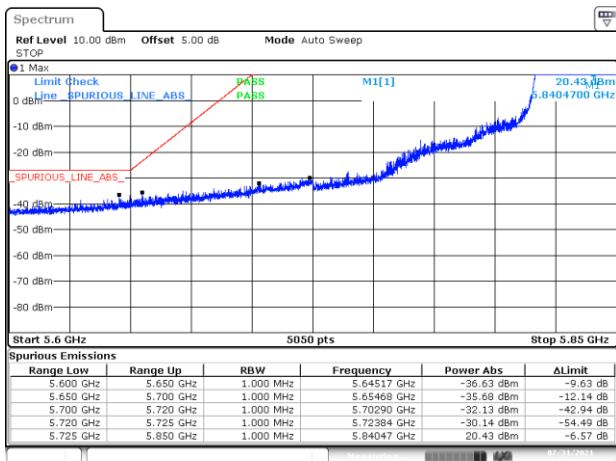

BE-NR-LOW, SISO-A, 802.11n40-HT0, Ch167

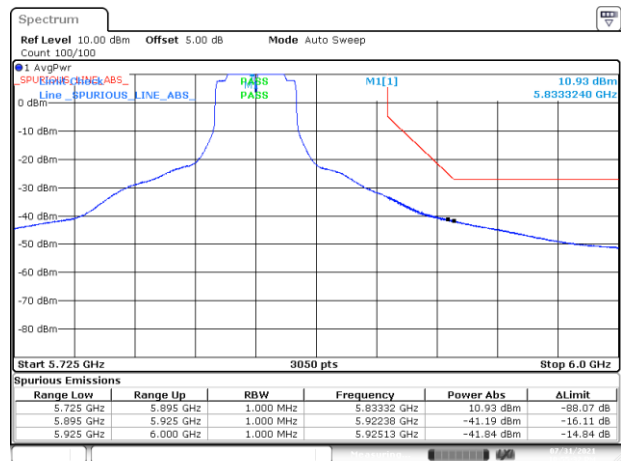

BE-NR-HIGH, SISO-A, 802.11n40-HT0, Ch167

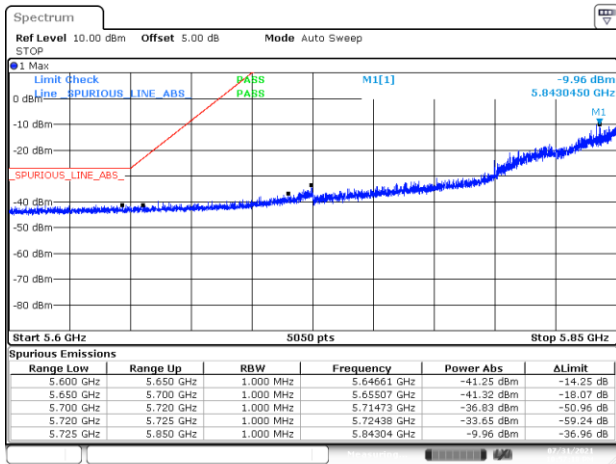

BE-NR-LOW, SISO-A, 802.11n40-HT0, Ch175

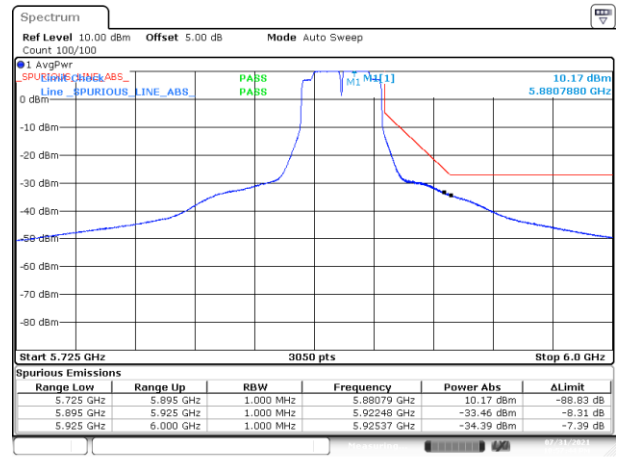

BE-NR-HIGH, SISO-A, 802.11n40-HT0, Ch175

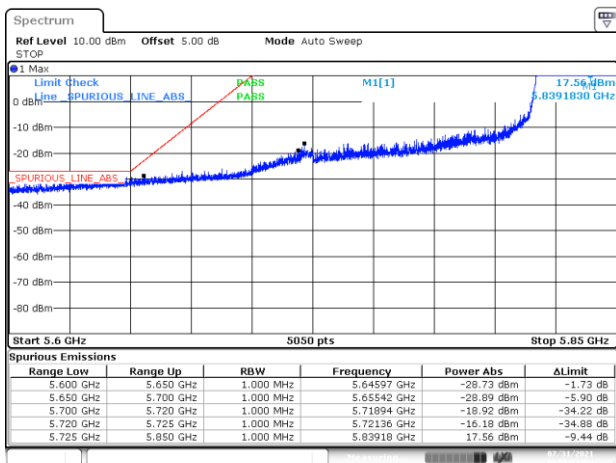

BE-NR-LOW, SISO-A, 802.11ac80-VHT0, Ch171

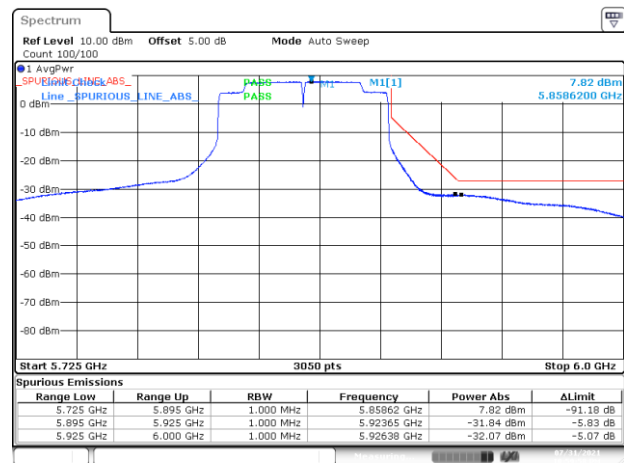

BE-NR-HIGH, SISO-A, 802.11ac80-VHT0, Ch171

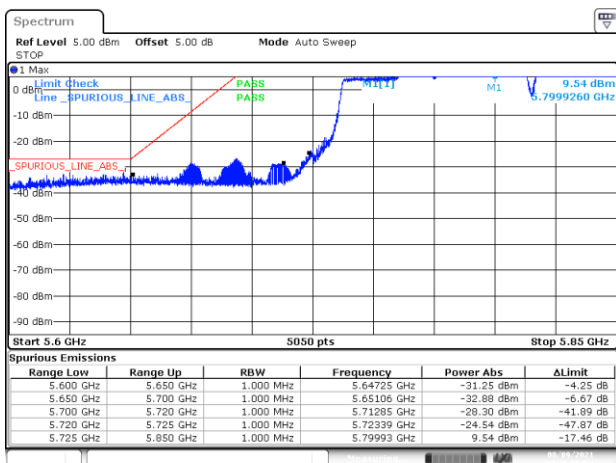

BE-NR-LOW, SISO-A, 802.11ac160-VHT0, Ch163

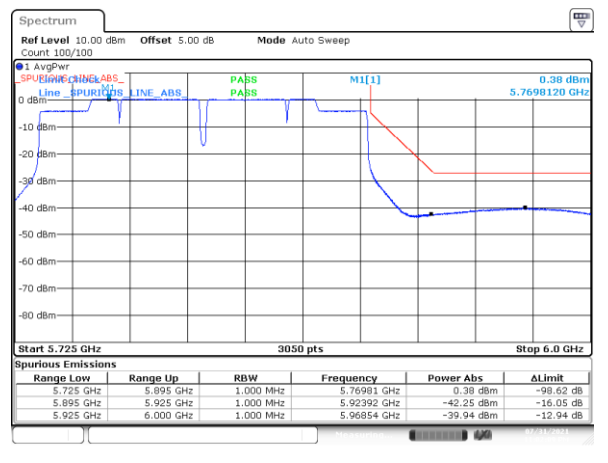

BE-NR-HIGH, SISO-A, 802.11ac160-VHT0, Ch163