

# ANTENNA INFORMATION

OEM	DELL
ODM	Compal Electronics, Inc.
Platform model name	P184G
Intel platform (ex: Yes, No or NA)	Yes
Platform type (ex: regular NB, convertible PC, AIO...etc)	Regular NB
SAR minimum separation (mm)	3.35mm (w/bumper) 1.25mm (w/o bumper)

Antenna manufacturer	<b>Hong Bo Co., Ltd..</b>		
Address	4F., No.143, Sinhu 1st Rd., Neihu Dist., Taipei City, 11494 Taiwan		
Antenna Part number	Main: Antenna PN: 330-24043 Compal PN: DC33002TV1L	Aux: Antenna PN: 330-24043 Compal PN: DC33002TV1L	
Antenna type (ex: PIFA, Dipole...etc)	Monopole		

Antenna Peak gain w/ cable loss (dBi)*										
	2.4GHz 2400-2483.5 MHz	5.2GHz 5150-5250MHz	5.3GHz 5250-5350MHz	5.6GHz 5470-5725MHz	5.8GHz 5725-5850MHz	5.9GHz 5850-5895MHz	6.2GHz 5925-6425MHz	6.5GHz 6425-6525MHz	6.7GHz 6525-6875MHz	7.0 GHz 6875-7125MHz
Main	2.63	1.96	1.81	2.30	2.30	1.73	1.83	1.65	2.36	3.04
Aux	1.08	1.11	1.4	2.53	1.35	1.00	2.48	2.06	1.95	1.95

Cable Assembly Part Number and Information					
	Cable PN	Cable length(mm)	Cable diameter(mm)	Impedance(ohm)	Connector type
Main	White 1.13SLLS SY113L/50-143	23.5	1.13	50 ohm	i-PEX MHF-4L (20565-001R-13)
Aux	Black 1.13SLLS SY113L/50-118	30	1.13	50 ohm	i-PEX MHF-4L (20565-001R-13)

\* 3D Antenna Peak Gain required being test in system basis.

# Table of Contents

<b>Cover page.....</b>	<b>1</b>
<b>1. Intel Reference Gain and Type.....</b>	<b>3</b>
<b>2. Document Revision History.....</b>	<b>3</b>
<b>3. Test &amp; System Description</b>	
3.1 Measurement Method and System.....	4
3.2 Test setup.....	4
3.3 Equipment list.....	5
<b>4. Radiation characteristics of antenna loaded in Host Platform.....</b>	<b>6</b>

## 1. Intel Reference Gain and Type

Antenna Peak gain w/ cable loss (dBi)											
Band/Frequency		2.4GHz 2400-2483.5 MHz	5.2GHz 5150-5250MHz	5.3GHz 5250-5350MHz	5.6GHz 5470-5725MHz	5.8GHz 5725-5850MHz	5.9GHz 5850-5895MHz	6.2GHz 5925-6425MHz	6.5GHz 6425-6525MHz	6.7GHz 6525-6875MHz	7.0 GHz 6875-7125MHz
Design	EU/UK	3.00	5.00	5.00	5.00	5.00	5.00	5.00	5.00	5.00	5.00
PIFA	For WiFi 6E and earlier	3.24	3.64	3.73	4.77	4.97	4.72	4.83	4.30	5.37	5.59
	From WiFi 7	2.95	5.11	4.55	5.15	5.13	4.45	5.02	5.02	4.96	4.96
Dipole	For WiFi 6E and earlier	2.89	2.92	3.19	4.41	4.22	4.22	4.83	4.30	4.49	5.34
	From WiFi 7	2.95	4.03	4.11	5.15	5.13	4.45	5.02	4.71	4.49	4.96

### 3D Peak Antenna gain should be equal or greater than -2 dBi

If a host integrator plans to use a lower gain antenna of the same type, additional CBP(FCC)/EDT(EU) testing need to be performed while the module is installed in the host.

## 2. Document Revision History

Revision #	Revision Details	Issued Date
Rev. 00	First Issue	2023.06.20

### 3. Test & System Description

#### 3.1 Measurement Method and System

<insert test description here for test method>

[example] This test report is prepared for host antenna testing under a Full Anechoic Chamber.

#### 3.2 Test setup

<insert test diagram here for test site utilized>

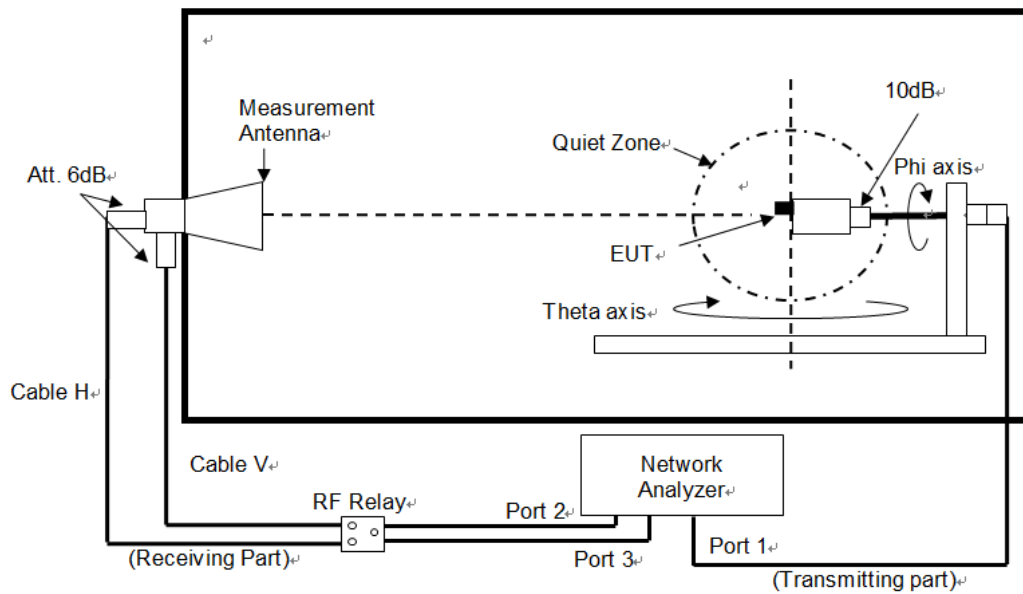

### 3.3 Equipment list

<insert test diagram here for test site utilized>

Huaya-Sporton OTA03					
Name	Manufacturer	Type/Model	Serial Number	Calibration	
				Last Cal.	Due Date
ENA Series Network Analyzer	Keysight	E5080B	MY59101211	2022/5/23	2024/5/23
RF Switch	Keysight	3499A	MY42000955	NCR	NCR
Multi-Axis Positioner Controller	ETS-Lindgren	2090	N/A	NCR	NCR
Medium-Duty Positioner	ETS-Lindgren	2015	N/A	NCR	NCR
Measurement Horn Antenna	EMCO	3164-08	00086722	NCR	NCR
Anechoic chamber	ETS-Lindgren	AMS-8500	N/A	2022/1/6	2024/1/6
12GHz SMA(M)-SMA(M)+20core for 60cm RG316DS Cable Assembly	Woken Technology Inc.	RG316DS	N/A	N/A	N/A
12GHz SMA(M)-SMA(M)+30core for 300cm RG316DS Cable Assembly	Woken Technology Inc.	RG316DS	N/A	N/A	N/A
Note: Chamber calibration included full set of implement.					

#### 4. Radiation characteristics of antenna loaded in Host Platform

##### Main Antenna

Max Antenna 3D Radiation Pattern 2400 – 2483.5 MHz

Frequency (MHz)	Peak Gain w/ Cable Loss (dBi)
2400-2483.5	2.63

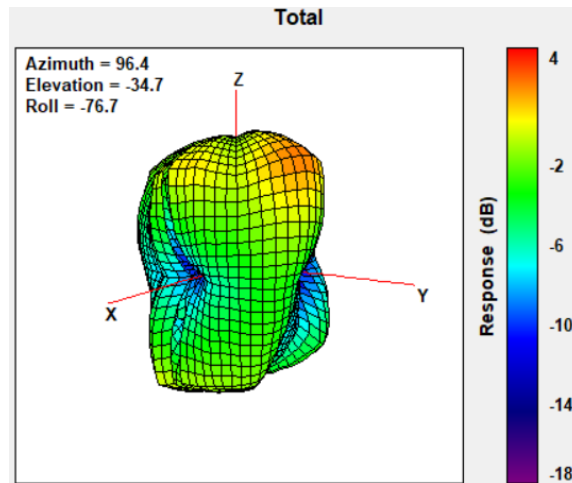

Max Antenna 3D Radiation Pattern 5150-5250 MHz

Frequency (MHz)	Peak Gain w/ Cable Loss (dBi)
5150-5250	1.96

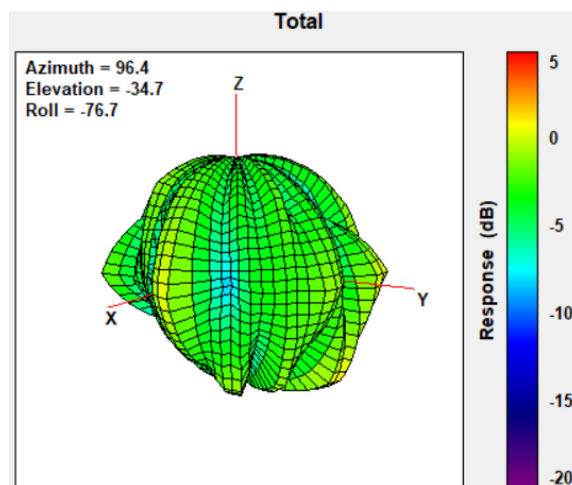

Max Antenna 3D Radiation Pattern 5250-5350 MHz

Frequency (MHz)	Peak Gain w/ Cable Loss (dBi)
5250-5350	1.81

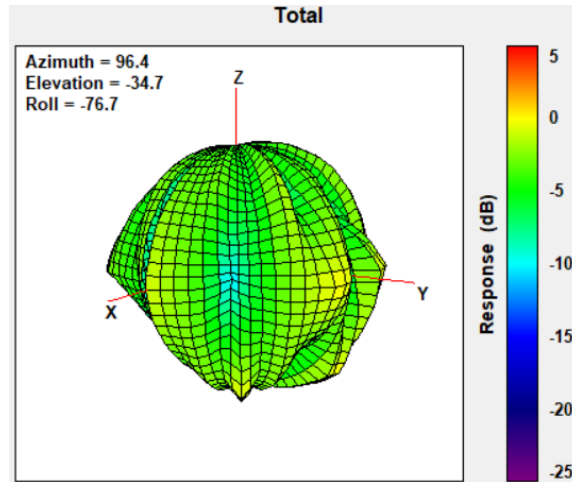

Max Antenna 3D Radiation Pattern 5470-5725 MHz

Frequency (MHz)	Peak Gain w/ Cable Loss (dBi)
5470-5725	2.30

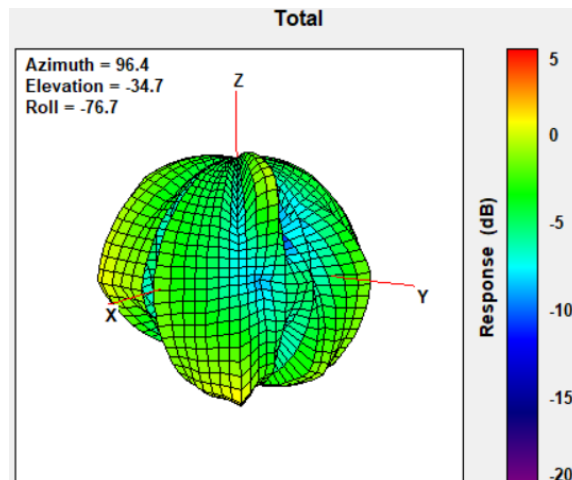

### Max Antenna 3D Radiation Pattern 5725-5850 MHz

Frequency (MHz)	Peak Gain w/ Cable Loss (dBi)
5725-5850	2.30

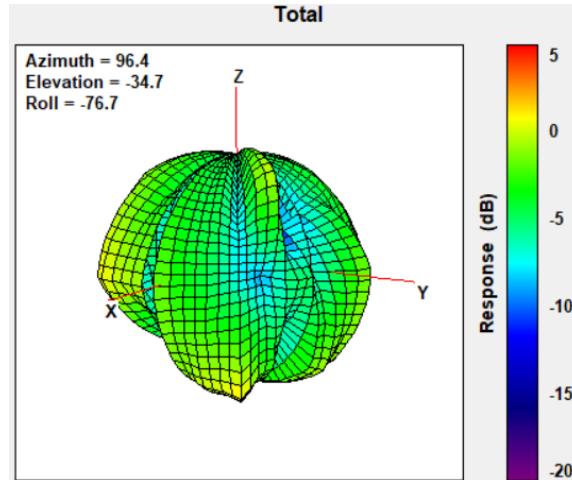

### Max Antenna 3D Radiation Pattern 5850-5895 MHz

Frequency (MHz)	Peak Gain w/ Cable Loss (dBi)
5850-5895	1.73

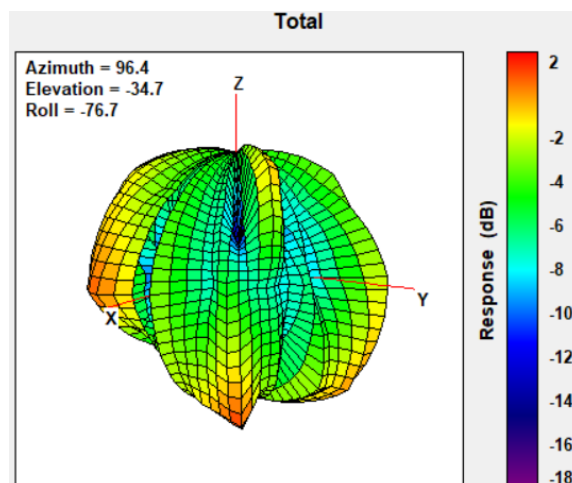



### Max Antenna 3D Radiation Pattern 5925-6425 MHz

Frequency (MHz)	Peak Gain w/ Cable Loss (dBi)
5925-6425	1.83

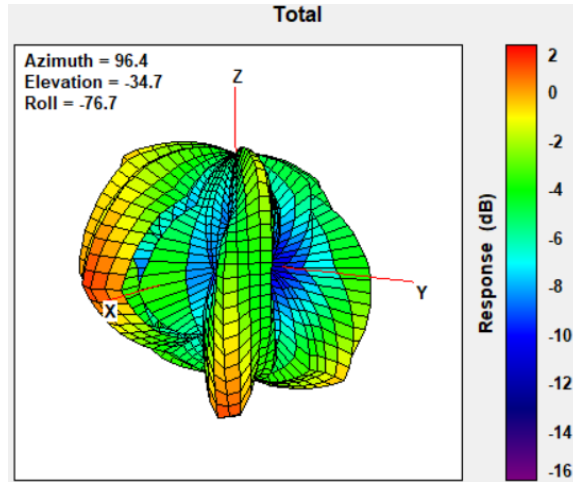

### Max Antenna 3D Radiation Pattern 6425-6525 MHz

Frequency (MHz)	Peak Gain w/ Cable Loss (dBi)
6425-6525	1.65

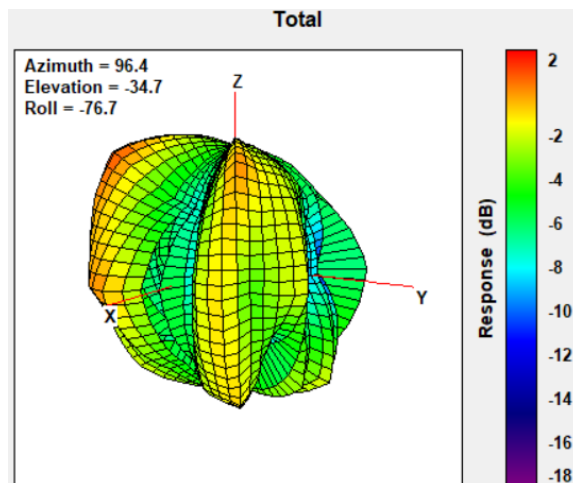

Max Antenna 3D Radiation Pattern 6525-6875 MHz

Frequency (MHz)	Peak Gain w/ Cable Loss (dBi)
6525-6875	2.36

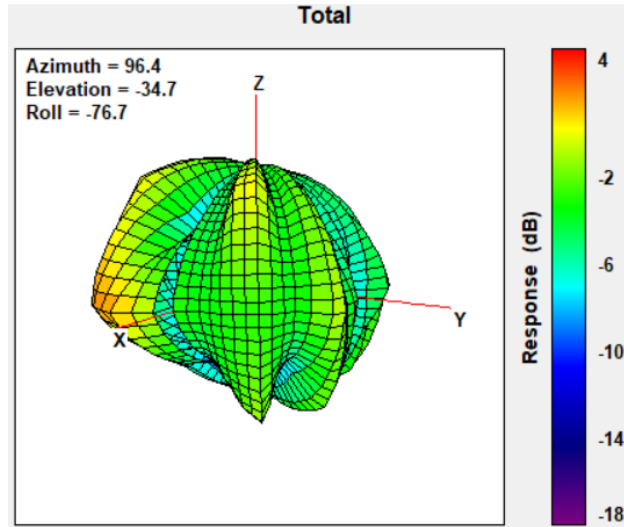

Max Antenna 3D Radiation Pattern 6875-7125 MHz

Frequency (MHz)	Peak Gain w/ Cable Loss (dBi)
6875-7125	3.04

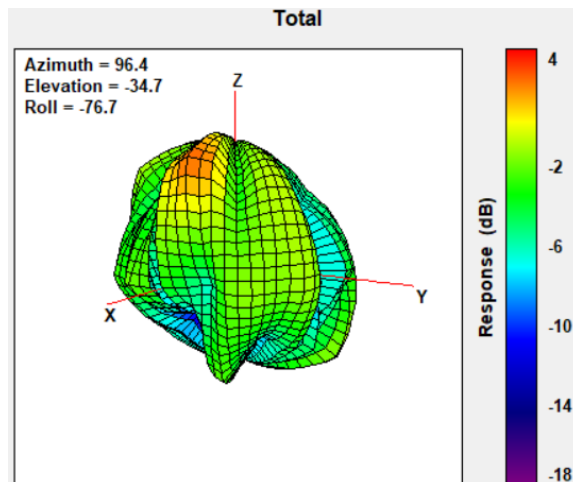

### Auxiliary Antenna

#### Max Antenna 3D Radiation Pattern 2400 – 2483.5 MHz

Frequency (MHz)	Peak Gain w/ Cable Loss (dBi)
2400-2483.5	1.08

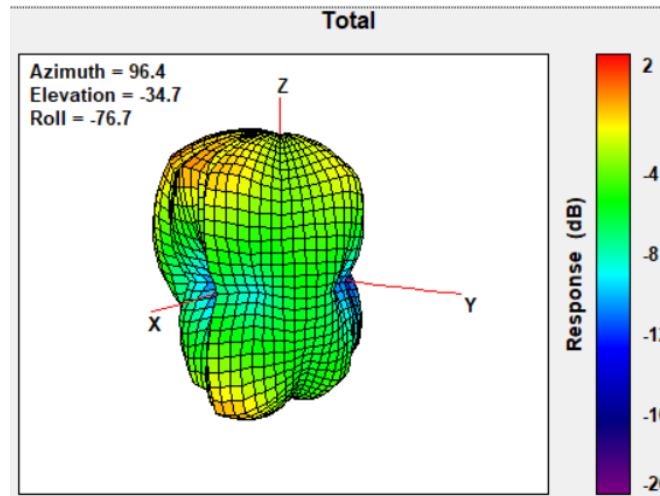

#### Max Antenna 3D Radiation Pattern 5150-5250 MHz

Frequency (MHz)	Peak Gain w/ Cable Loss (dBi)
5150-5250	1.11

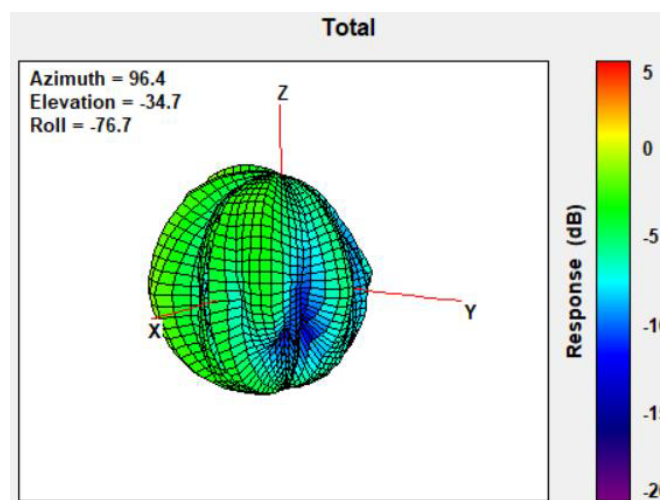

### Max Antenna 3D Radiation Pattern 5250-5350 MHz

Frequency (MHz)	Peak Gain w/ Cable Loss (dBi)
5250-5350	1.40

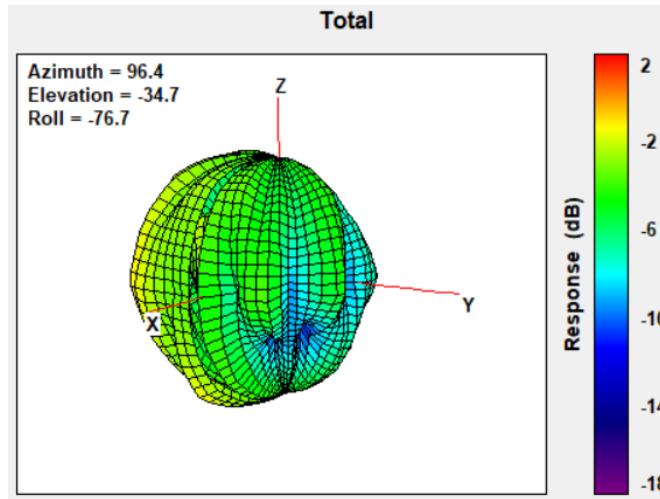

### Max Antenna 3D Radiation Pattern 5470-5725 MHz

Frequency (MHz)	Peak Gain w/ Cable Loss (dBi)
5470-5725	2.53

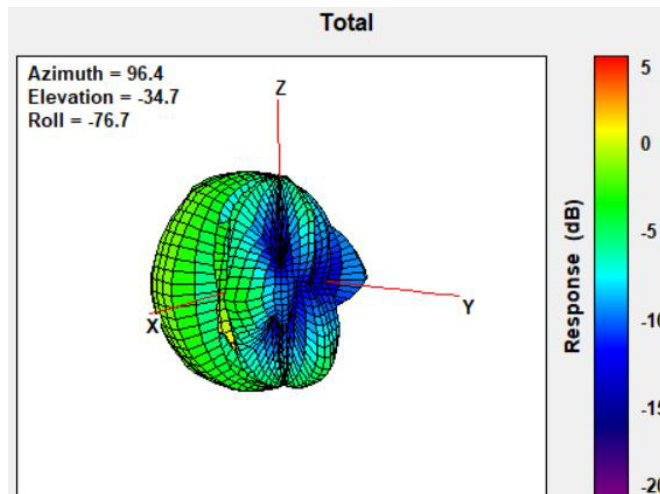

### Max Antenna 3D Radiation Pattern 5725-5850 MHz

Frequency (MHz)	Peak Gain w/ Cable Loss (dBi)
5725-5850	1.35

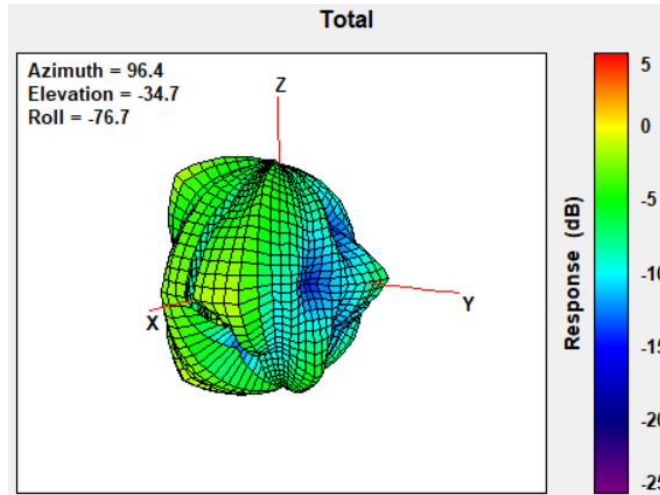

### Max Antenna 3D Radiation Pattern 5850-5895 MHz

Frequency (MHz)	Peak Gain w/ Cable Loss (dBi)
5850-5895	1.00

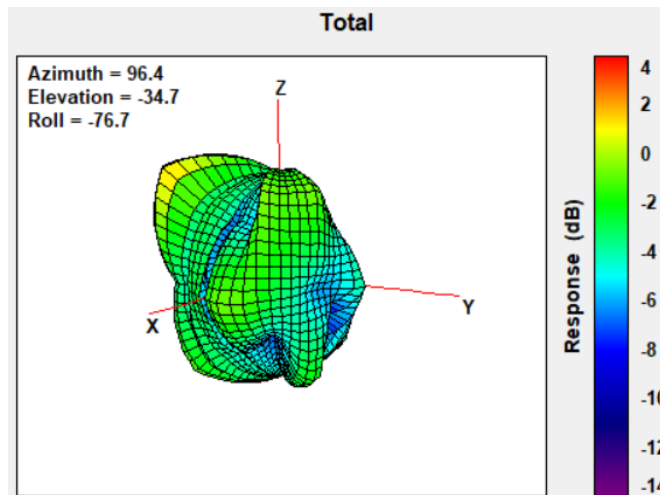

Max Antenna 3D Radiation Pattern 5925-6425 MHz

Frequency (MHz)	Peak Gain w/ Cable Loss (dBi)
5925-6425	2.48

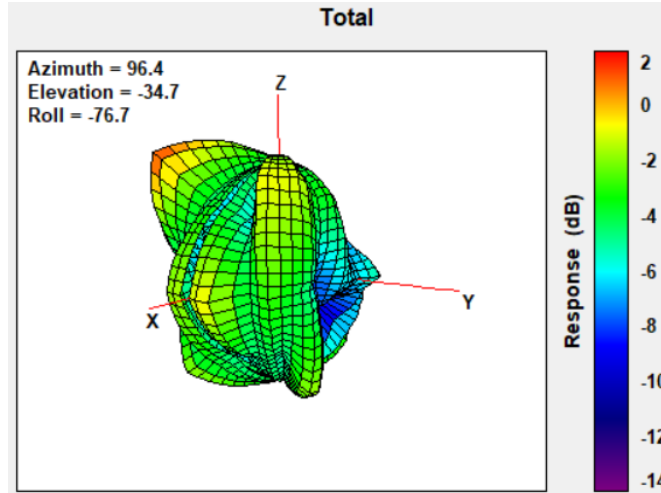

Max Antenna 3D Radiation Pattern 6425-6525 MHz

Frequency (MHz)	Peak Gain w/ Cable Loss (dBi)
6425-6525	2.06

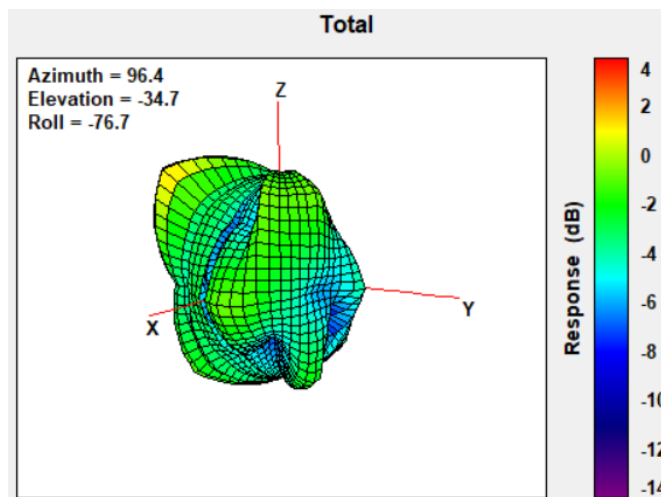

### Max Antenna 3D Radiation Pattern 6525-6875 MHz

Frequency (MHz)	Peak Gain w/ Cable Loss (dBi)
6525-6875	1.95

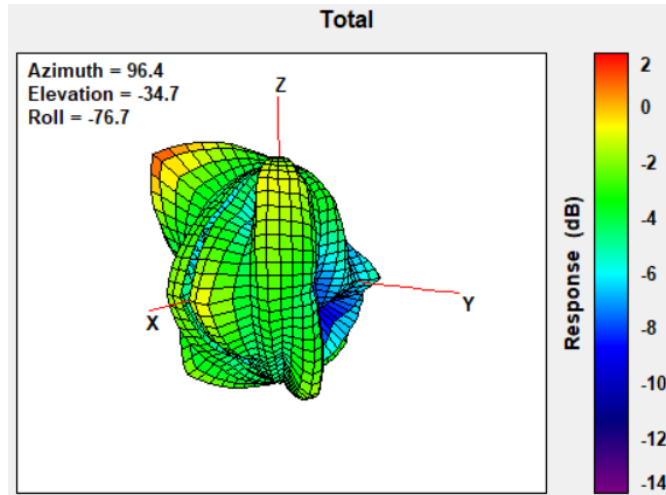

### Max Antenna 3D Radiation Pattern 6875-7125 MHz

Frequency (MHz)	Peak Gain w/ Cable Loss (dBi)
6875-7125	1.95

