



TEST REPORT

EUT Description	Wireless Module installed in Convertible PC
Brand Name	Intel® Wi-Fi 6E AX210
Model Name	AX210NGW
FCC/IC ID	PD9AX210NG ; 1000M-AX210NG
Date of Test Start/End	2022-03-28 / 2022-04-11
Features	802.11ax, Dual Band, 2x2 Wi-Fi + Bluetooth® 5.0 (see section 5)
Description	Platform: P159G + WNC antenna

Applicant	Intel Mobile Communications
Address	100 Center Point Circle, Suite 200 / Columbia, SC 29210 / United States
Contact Person	Steven Hackett
Telephone/Fax/ Email	steven.c.hackett@intel.com

Reference Standards	FCC 47 CFR Part §2.1093 RSS-102, issue 5 (See section 1)	
RF Exposure Environment	Portable devices - General population/uncontrolled exposure	
Exposure Conditions	Body worn	
	SAR Result	SAR Limit
Maximum SAR Result & Limit	1.06 W/kg (1g)	1.6 W/kg (1g)
Min. test separation distance	0mm to phantom, 3.09 mm to antenna edge	

Test Report identification	211213-02.TR01
Revision Control	Rev. 00 This test report revision replaces any previous test report revision (See section 8)

The test results relate only to the samples tested.
Reference to accreditation shall be used only by full reproduction of test report.

_____ Issued by _____ Reviewed by _____

Adel LOUNES
(Test Engineer Lead)

Zayd OUACHICHA
(Technical Manager)

Intel Corporation S.A.S – WRF Lab
425 rue de Goa – Le Cargo B6 - 06600 Antibes, France
Tel. +33493001400 / Fax +33493001401

Table of Contents

1. Standards, reference documents and applicable test methods	4
2. General conditions, competences and guarantees	4
3. Environmental Conditions	5
4. Test samples	5
5. EUT Features	6
6. Remarks and comments	9
7. Test Verdicts summary	9
8. Document Revision History	9
Annex A. Test & System Description	10
A.1 SAR DEFINITION.....	10
A.2 SPEAG SAR MEASUREMENT SYSTEM	11
A.2.1 SAR Measurement Setup.....	11
A.2.2 E-Field Measurement Probe.....	12
A.2.3 SAM Phantom	12
A.2.4 Flat Phantom	12
A.2.5 Device Positioner.....	13
A.3 DATA EVALUATION	14
A.4 SYSTEM AND LIQUID CHECK	16
A.4.1 System Check	16
A.4.2 Liquid Check.....	17
A.5 TEST EQUIPMENT LIST	18
A.5.1 Tissue Simulant Liquid	18
A.6 MEASUREMENT UNCERTAINTY EVALUATION	19
A.7 RF EXPOSURE LIMITS	20
Annex B. Test Results	21
B.1 TEST CONDITIONS.....	21
B.1.1 Test SAR Test positions relative to the phantom.....	21
B.1.2 Test signal, Output power and Test Frequencies	21
B.1.3 Evaluation Exclusion and Test Reductions.....	22
B.2 CONDUCTED POWER MEASUREMENTS.....	24
B.2.1 WLAN 2.4GHz.....	24
B.2.2 WLAN 5GHz (U-NII).....	25
B.2.3 Bluetooth	31
B.3 TISSUE PARAMETERS MEASUREMENT	32
B.4 SYSTEM CHECK MEASUREMENTS	32
B.5 SAR TEST RESULTS	33
B.5.1 802.11b/g/n/ax – 2.4GHz – DTS.....	33
B.5.2 802.11a/n/ac/ax – 5.3 GHz – U-NII-2A.....	33
B.5.3 802.11a/n/ac/ax – 5.6 GHz – U-NII-2C.....	33
B.5.4 802.11a/n/ac/ax – 5.8 GHz – U-NII-3	33
B.5.5 SAR Measurement Variability.....	35
B.5.6 Simultaneous Transmission SAR Evaluation.....	36
Annex C. Test System Plots.....	38
Annex D. TSL Dielectric Parameters.....	47
D.1 BODY 5200MHZ-5800MHZ	48
Annex E. Calibration Certificates	49

Annex F. Photographs 51

F.1 TEST SAMPLE 51

F.2 TEST POSITION 52

F.3 ANTENNA HOST PLATFORM LOCATION AND ADJACENT EDGE POSITIONS RELATIVE TO THE BODY 54

F.4 PHANTOM LIQUID LEVEL DURING MEASUREMENTS 55

1. Standards, reference documents and applicable test methods

FCC	<ol style="list-style-type: none"> 1. FCC Title 47 CFR Part §2.1093 – Radiofrequency radiation exposure evaluation: portable devices. 2019-10-01 Edition 2. FCC OET KDB 248227 D01 v02r02 – SAR guidance for IEEE 802.11 (Wi-Fi) transmitters. 3. FCC OET KDB 447498 D01 v06 –RF Exposure Procedures and Equipment Authorization Policies for Mobile and Portable Devices. 4. FCC OET KDB 616217 D04 v01r02 – SAR Evaluation Considerations for Laptop, Notebook, Netbook and Tablet Computers. 5. FCC OET KDB 865664 D01 v01r04 – SAR Measurement Requirements for 100 MHz to 6 GHz. 6. FCC OET KDB 865664 D02 v01r02 – RF Exposure Compliance Reporting and Documentation Considerations. 7. IEEE Std 1528-2013 – IEEE Recommended Practice Determining the Peak Spatial-Average Specific Absorption Rate (SAR) in the Human Head from Wireless Communication Devices: Measurement Techniques...
ISED	<ol style="list-style-type: none"> 1. ISED RSS 102, Issue 5 – Radio Frequency (RF) Exposure Compliance of Radio communication Apparatus (All Frequency Bands) 2. ISED RSS-102 Supplementary Procedures SPR-001 SAR testing requirements with regard to bystanders for laptop type computers with antennas built-in on display screen (Laptop Mode / Tablet Mode) 3. ISED Notice 2020-DRS0020 - Applicability of IEC/IEEE 62209-1528 and IEC 62209-3 Standard 4. ISED Notice 2016-DRS001 – Applicability of latest FCC RF Exposure KDB Procedures and Other Procedures. 5. ISED Notice 2012-DRS0529 – SAR correction for measured conductivity and relative permittivity based on IEC 62209-2 standard. 6. FCC OET KDB 248227 D01 v02r02 – SAR guidance for IEEE 802.11 (Wi-Fi) transmitters. 7. FCC OET KDB 447498 D01 v06 –RF Exposure Procedures and Equipment Authorization Policies for Mobile and Portable Devices. 8. FCC OET KDB 616217 D04 v01r02– SAR Evaluation Considerations for Laptop, Notebook, Netbook and Tablet Computers. 9. IEC/IEEE 62209-1528:2020 Measurement procedure for the assessment of specific absorption rate of human exposure to radio frequency fields from hand-held and body-mounted wireless communication devices – Part 1528: Human models, instrumentation, and procedures (Frequency range of 4 MHz to 10 GHz).

2. General conditions, competences and guarantees

- ✓ Tests performed under FCC standards identified in section 1 are covered by A2LA accreditation.
- ✓ Tests performed under ISED standards identified in section 1 are covered by Cofrac accreditation.
- ✓ Intel Corporation SAS Wireless RF Lab (Intel WRF Lab) is an ISO/IEC 17025:2017 laboratory accredited by the American Association for Laboratory Accreditation (A2LA) with the certificate number 3478.01.
- ✓ Intel Corporation SAS Wireless RF Lab (Intel WRF Lab) is an Accredited Test Firm recognized by the FCC, with Designation Number FR0011.
- ✓ Intel Corporation SAS Wireless RF Lab (Intel WRF Lab) is an ISO/IEC 17025:2017 testing laboratory accredited by the French Committee for Accreditation (Cofrac) with the certificate number 1-6736.
- ✓ Intel Corporation SAS Wireless RF Lab (Intel WRF Lab) is a Registered Test Site listed by ISED, with ISED #1000Y.
- ✓ Intel WRF Lab declines any responsibility with respect to the identified information provided by the customer and that may affect the validity of results.
- ✓ Intel WRF Lab only provides testing services and is committed to providing reliable, unbiased test results and interpretations.
- ✓ Intel WRF Lab is liable to the client for the maintenance of the confidentiality of all information related to the item under test and the results of the test.
- ✓ Intel WRF Lab has developed calibration and proficiency programs for its measurement equipment to ensure correlated and reliable results to its customers.
- ✓ This report is only referred to the item that has undergone the test.
- ✓ This report does not imply an approval of the product by the Certification Bodies or competent Authorities.

3. Environmental Conditions

✓ At the site where the measurements were performed the following limits were not exceeded during the tests:

Temperature	22.5°C ± 1°C
Humidity	40% ± 10%
Liquid Temperature	21°C ± 1°C

4. Test samples

Sample	Control #	Description	Model	Serial #	Date of receipt	Note
#01	211213-02.S01	Wireless Module installed in Convertible PC	P159G	2021101234154	06-01-2022	WNC antenna

5. EUT Features

The herein information is provided by the customer

Brand Name	Intel® Wi-Fi 6E AX210														
Model Name	AX210NGW														
Software Version	22.21070.0.0-OEM.DRTU.12463														
Driver Version	20.70.0.6														
Prototype / Production	Production														
Host Identification	P159G														
Supported Radios	802.11b/g/n/ax	2.4GHz (2400.0 – 2483.5 MHz)													
	802.11a/n/ac/ax	5.2GHz (5150.0 – 5250.0 MHz) 5.3GHz (5250.0 – 5350.0 MHz) 5.6GHz (5470.0 – 5725.0 MHz) 5.8GHz (5725.0 – 5850.0 MHz)													
Antenna Information	802.11ax	6.0GHz (5925.0 - 7125.0 MHz)*													
	<table border="1"> <thead> <tr> <th>Transmitter</th> <th>Main</th> <th>Aux</th> </tr> </thead> <tbody> <tr> <td>Manufacturer</td> <td>WNC</td> <td>WNC</td> </tr> <tr> <td>Antenna type</td> <td>PIFA</td> <td>PIFA</td> </tr> <tr> <td>Part number</td> <td>81EABJ15.G27</td> <td>81EABJ15.G28</td> </tr> </tbody> </table>			Transmitter	Main	Aux	Manufacturer	WNC	WNC	Antenna type	PIFA	PIFA	Part number	81EABJ15.G27	81EABJ15.G28
	Transmitter	Main	Aux												
	Manufacturer	WNC	WNC												
	Antenna type	PIFA	PIFA												
Part number	81EABJ15.G27	81EABJ15.G28													
See Annex F for more details on antennas location.															
Simultaneous Transmission Configurations	WLAN 2.4GHz Main + BT Aux														
	WLAN 2.4GHz Main + WLAN 2.4GHz Aux														
	WLAN 5GHz Main + BT Aux														
	WLAN 5GHz Main + WLAN 5GHz Aux														
	WLAN 5GHz Main + WLAN 5GHz Aux + BT Aux														
	WLAN 6GHz Main + BT Aux *														
WLAN 6GHz Main + WLAN 6GHz Aux *															
WLAN 6GHz Main + WLAN 6GHz Aux + BT Aux *															
Additional Information	No WWAN transmitter is considered in this report														
	5.60-5.65 GHz band (TDWR) is supported by the device														
	Band gap is supported by the device														

*For WiFi 6E band refer to the: 211213-02.TR02_SAR_PD_WiFi_6E_Dell P159G_AX210NGW

Supported Radios

Mode	Duty Cycle	Modulation	Band	UL Freq Range (MHz)	Measured Max. Conducted Power (dBm)
802.11b/g/n	100%	BPSK QPSK 16QAM 64QAM	2.4GHz	2400-2483.5	16.95
802.11a/n/ac	100%	BPSK QPSK 16QAM 64QAM 256QAM	5.2GHz	5150-5250	NM
			5.3GHz	5250-5350	11.88
			5.6GHz	5475-5725	11.91
			5.8GHz	5725-5850	11.77
BDR/EDR v5.2	77%	GFSK $\pi/4$ DQPSK 8DPSK	2.4GHz	2400-2483.5	11.42
Bluetooth LE	33%	GFSK	2.4GHz	2400-2483.5	NM

NM: Not Measured

Maximum Output power specification + Tune up tolerance limit			SISO mode	
Equipment Class	Mode	BW (MHz)	Aux Chain A (dBm)	Main Chain B (dBm)
DTS	802.11b	20	17.00	17.00
	802.11g	20	17.00	17.00
	802.11n20	20	17.00	17.00
	802.11ax20	20	17.00	17.00
	802.11n40	40	17.00	17.00
	802.11ax40	40	17.00	17.00
U-NII-1	802.11a	20	12.00	12.00
	802.11n20	20	12.00	12.00
	802.11ax20	20	12.00	12.00
	802.11n40	40	12.00	12.00
	802.11ax40	40	12.00	12.00
	802.11ac80	80	12.00	12.00
U-NII-2A	802.11a	20	12.00	12.00
	802.11n20	20	12.00	12.00
	802.11ax20	20	12.00	12.00
	802.11n40	40	12.00	12.00
	802.11ax40	40	12.00	12.00
	802.11ac80	80	12.00	12.00
	802.11ax80	80	12.00	12.00
	802.11ac160	160	12.00	12.00
U-NII-2C	802.11a	20	12.00	12.00
	802.11n20	20	12.00	12.00
	802.11ax20	20	12.00	12.00
	802.11n40	40	12.00	12.00
	802.11ax40	40	12.00	12.00
	802.11ac80	80	12.00	12.00
	802.11ax80	80	12.00	12.00
	802.11ac160	160	12.00	12.00
U-NII-3	802.11a	20	12.00	12.00
	802.11n20	20	12.00	12.00
	802.11ax20	20	12.00	12.00
	802.11n40	40	12.00	12.00
	802.11ax40	40	12.00	12.00
	802.11ac80	80	12.00	12.00
BT	Bluetooth v5.0 BDR	1	11.50	
	Bluetooth v5.0 EDR2	1	11.00	
	Bluetooth v5.0 EDR3	1	11.00	
	BLE	2	10.00	

6. Remarks and comments

1. The conducted values are obtained by applying the BIOS SAR power values to the AX210NGW Intel module installed in the P159G identified in this report, as requested by the customer
2. Variability and simultaneous transmission results shown in this report are based on the highest SAR value obtained among all antenna manufacturers.
3. Only the plots for the test positions with the highest measured SAR per band/mode are included in Annex C as required per FCC OET KDB 865664 D02, paragraph 2.3.8.

7. Test Verdicts summary

The statement of conformity to applicable standards in the table below are based on the measured values, without taking into account the measurement uncertainties.

Standard	Band	Highest Reported SAR (1g) (W/kg)	Verdict
802.11b/g/n/ax	2.4GHz	0.67	P
802.11a/n/ac/ax	5.2GHz	NM	NA
	5.3GHz	1.06	P
	5.6GHz	0.62	P
	5.8GHz	0.79	P
Bluetooth	2.4GHz	0.17	P

P: Pass
 F: Fail
 NM: Not Measured
 NA: Not Applicable

According to the FCC OET KDB 690783 D01, this is the summary of the values for the Grant Listing:

Exposure Condition	Highest Reported SAR (1g) (W/kg)		
	Equipment Class		
	DTS	DSS	U-NII
Body Worn	0.67	0.17	1.06
Simultaneous Tx	Sum-SAR: 1.07 SPLSR : NR	Sum-SAR: 1.80 SPLSR : 0.01	Sum-SAR: 1.80 SPLSR : 0.01

Considering the results of the performed test according to FCC 47CFR Part 2.1093 and ISED RSS 102, Issue 5 the item under test is IN COMPLIANCE with the requested specifications specified in Section1. Standards, reference documents and applicable test methods

8. Document Revision History

Revision #	Modified by	Revision Details
Rev. 00	A.LOUNES	First Issue

Annex A. Test & System Description

A.1 SAR Definition

Specific Absorption rate is defined as the time derivative of the incremental energy (dW) absorbed by (dissipated in) and incremental mass (dm) contained in a volume element (dV) of a given density (ρ).

$$SAR = \frac{d}{dt} \cdot \left(\frac{dW}{dm} \right) = \frac{d}{dt} \cdot \left(\frac{dW}{\rho \cdot dV} \right)$$

SAR is expressed in units of watts per kilogram (W/kg). SAR can be related to the electric field at a point by

$$SAR = \frac{\sigma |E|^2}{\rho}$$

Where:

σ = Conductivity of the tissue (S/m)

ρ = Mass density of the tissue (kg/m³)

E = RMS electric field strength (V/m)

A.2 SPEAG SAR Measurement System

A.2.1 SAR Measurement Setup

The DASY6 system for performing compliance tests consists of the following items:

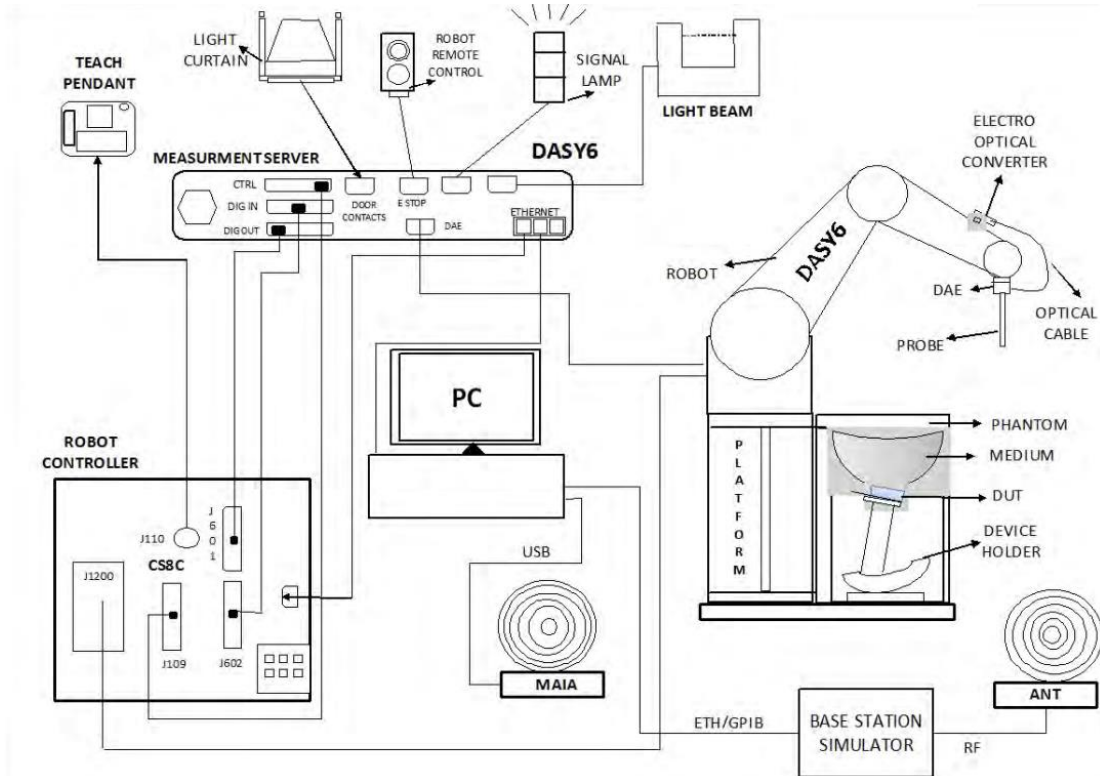

- ✓ A standard high precision 6-axis robot (Stäubli TX/RX family) with controller, teach pendant and software. It includes an arm extension for accommodating the data acquisition electronics (DAE)
- ✓ An isotropic field probe optimized and calibrated for the targeted measurements.
- ✓ A data acquisition electronics (DAE) which performs the signal amplification, signal multiplexing, AD-conversion, offset measurements, mechanical surface detection, collision detection, etc. The unit is battery powered with standard or rechargeable batteries. The signal is optically transmitted to the EOC.
- ✓ The Electro-optical Converter (EOC) performs the conversion from optical to electrical signals for the digital communication to the DAE. The EOC signal is transmitted to the measurement server.
- ✓ The function of the measurement server is to perform the time critical tasks such as signal filtering, control of the robot operation and fast movements interrupts.
- ✓ The Light Beam used is for probe alignment. This improves the (absolute) accuracy of the probe positioning.
- ✓ A computer running Win7 professional operating system and the DASY6 software.
- ✓ Remote control and teach pendant as well as additional circuitry for robot safety such as warning lamps, etc.
- ✓ The phantom, the device holder and other accessories according to the targeted measurement.
- ✓ MAIA is a hardware interface (Antenna) used to evaluate the modulation and audio interference characteristics of RF signals.
- ✓ ANT is an ultra-wideband antenna for use with the base station simulators over 698 MHz to 6GHz.
- ✓ The base station simulator is an equipment used for SAR cellular tests in order to emulate the cellular signals characteristics and behavior between a regular base station and the equipment under test.
- ✓ Tissue simulating liquid.
- ✓ System Validation dipoles.
- ✓ Network emulator or RF test tool.

A.2.2 E-Field Measurement Probe

The probe is constructed using three orthogonal dipole sensors arranged on an interlocking, triangular prism core. The probe has built-in shielding against static charges and is contained within a PEEK cylindrical enclosure material at the tip.

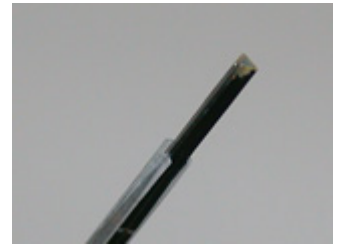

The probe's characteristics are:

Frequency Range	30MHz – 6GHz
Length	337 mm
Probe tip external diameter	2.5 mm
Typical distance between dipoles and the probe tip	1 mm
Axial Isotropy (in human-equivalent liquids)	±0.3 dB
Hemispherical Isotropy (in human-equivalent liquids)	±0.5 dB
Linearity	±0.2 dB
Maximum operating SAR	100 W/kg
Lower SAR detection threshold	0.001 W/kg

A.2.3 Flat Phantom

Phantom for compliance testing of handheld and body-mounted wireless devices in the frequency range of 30 MHz to 6 GHz. ELI is fully compatible with the IEC 62209-2 standard and all known tissue simulating liquids. ELI has been optimized regarding its performance and can be integrated into our standard phantom tables. A cover prevents evaporation of the liquid. Reference markings on the phantom allow installation of the complete setup, including all predefined phantom positions and measurement grids, by teaching three points. The phantom is compatible with all SPEAG dosimetric probes and dipoles.

The phantom's characteristics are:

Material	Vinylester, glass fiber reinforced (VE-GF)
Shell thickness	2 mm ± 0.2 mm
Filling volume	30 Liters approx.
Dimensions	Major axis: 600mm / Minor axis: 400mm

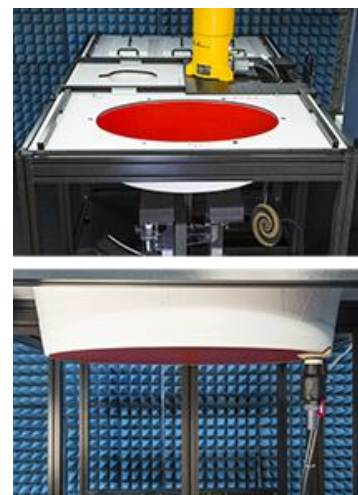

A.2.4 Device Positioner

The SAR in the phantom is approximately inversely proportional to the square of the distance between the source and the liquid surface. For a source at 5 mm distance, a positioning uncertainty of 0.5 mm would produce a SAR uncertainty of 20%. Accurate device positioning is therefore crucial for accurate and repeatable measurements. The positions in which the devices must be measured are defined by the standards.



The DASY device holder is designed to cope with the different positions given in the standard. It has two scales for device rotation (with respect to the body axis) and device inclination (with respect to the line between the ear reference points). The rotation center for both scales is the ear reference point (ERP). Thus the device needs no repositioning when changing the angles.

The DASY device holder is constructed of low-loss POM material having the following dielectric parameters: relative permittivity $\epsilon=3$ and loss tangent $\delta=0.02$. The amount of dielectric material has been reduced in the closest vicinity of the device, since measurements have suggested that the influence of the clamp on the test results could thus be lowered.

A simple but effective and easy-to-use extension for the Mounting Device; facilitates testing of larger devices according to IEC 62209-2 (e.g., laptops, cameras, etc.); lightweight and fits easily on the upper part of the Mounting Device in place of the phone positioner. The extension is fully compatible with the Twin SAM, ELI and other Flat Phantoms.



A.3 Data Evaluation

- **Power Reference measurement**

The robot measures the E field in a specified reference position that can be either the selected section's grid reference point or a user point in this section at 4mm of the inner surface of the phantom, 2mm for frequencies above 3GHz.

- **Area Scan**

Measurement procedures for evaluating SAR from wireless handsets typically start with a coarse measurement grid to determine the approximate location of the local peak SAR values. This is known as the area-scan procedure. The SAR distribution is scanned along the inside surface of one side of the phantom head, at least for an area larger than the projection of the handset and antenna. The distance between the measured points and phantom surface should be less than 8 mm, and should remain constant (with variation less than ± 1 mm) during the entire scan in order to determine the locations of the local peak SAR with sufficient accuracy. The angle between the probe axis and the surface normal line is recommended but not required to be less than 30° . If this angle is larger than 30° and the closest point on the probe-tip housing to the phantom surface is closer than a probe diameter, the boundary effect may become larger and polarization dependent. This additional uncertainty needs to be analyzed and accounted for. To achieve this, modified test procedures and additional uncertainty analyses not described in this recommended practice may be required. The measurement and interpolation point spacing should be chosen such as to allow identification of the local peak locations to within one-half of the linear dimension of a side of the zoom-scan volume. Because a local peak having specific amplitude and steep gradients may produce a lower peak spatial-average SAR compared to peaks with slightly lower amplitude and less steep gradients, it is necessary to evaluate these other peaks as well. However, since the spatial gradients of local SAR peaks are a function of the wavelength inside the tissue-equivalent liquid and the incident magnetic field strength, it is not necessary to evaluate local peaks that are less than 2 dB or more below the global maximum peak. Two-dimensional spline algorithms (Brishoual et al. 2001; Press et al., 1996) are typically used to determine the peaks and gradients within the scanned area. If a peak is found at a distance from the scan border of less than one-half the edge dimension of the desired 1 g or 10 g cube, the measurement area should be enlarged if possible.

- **Zoom Scan**

To evaluate the peak spatial-average SAR values for 1 g or 10 g cubes, fine resolution volume scans, called zoom scans, are performed at the peak SAR locations identified during the area scan. The minimum zoom scan volume size should extend at least 1.5 times the edge dimension of a 1 g cube in all directions from the center of the scan volume, for both 1 g and 10 g peak spatial-average SAR evaluations. Along the phantom curved surfaces, the front face of the volume facing the tissue/liquid interface conforms to the curved boundary, to ensure that all SAR peaks are captured. The back face should be equally distorted to maintain the correct averaging mass. The flatness and orientation of the four side faces are unchanged from that of a cube whose orientation is within $\pm 30^\circ$ of the line normal to the phantom at the center of the cube face next to the phantom surface. The peak local SAR locations that were determined in the area scan (interpolated values) should be used for the centers of the zoom scans. If a scan volume cannot be centered due to proximity of a phantom shape feature, the probe should be tilted to allow scan volume enlargement. If probe tilt is not feasible, the zoom-scan origin may be shifted, but not by more than half of the 1 g or 10 g cube edge dimension.

After the zoom-scan measurement, extrapolations from the closest measured points to the surface, for example along lines parallel to the zoom-scan centerline, and interpolations to a finer resolution between all measured and extrapolated points are performed. Extrapolation algorithm considerations are described in 6.5.3, and 3-D spline methods (Brishoual et al., 2001; Kreyszig, 1983; Press et al., 1996) can be used for interpolation. The peak spatial-average SAR is finally determined by a numerical averaging of the local SAR values in the interpolation grid, using for example a trapezoidal algorithm for the integration (averaging).

In some areas of the phantom, such as the jaw and upper head regions, the angle of the probe with respect to the line normal to the surface may be relatively large, e.g., greater than $\pm 30^\circ$, which could increase the boundary effect error to a larger level. In these cases, during the zoom scan a change in the orientation of the probe, the phantom, or both is recommended but not required for the duration of the zoom scan, so that the angle between the probe axis and the line normal to the surface is within 30° for all measurement points.

- **Power Drift measurement**

The robot re-measures the E-Field in the same reference location measured at the Power Reference. The drift measurement gives the field difference in dB from the first to the last reference reading. This allows a user to monitor the power drift of the device under test that must remain within a maximum variation of $\pm 5\%$.

- **Post-processing**

The procedure for spatial peak SAR evaluation has been implemented according to the IEEE1528 and IEC 62209-1/2 standards. It can be conducted for 1g and 10g.

The software allows evaluations that combine measured data and robot positions, such as:

- ✓ Maximum search
- ✓ Extrapolation
- ✓ Boundary correction
- ✓ Peak search for averaged SAR

Interpolation between the measured points is performed when the resolution of the grid is not fine enough to compute the average SAR over a given mass.

Extrapolation routines are used to obtain SAR values between the lowest measurement points and the inner phantom surface. The extrapolation is determined by the surface detection distance and the probe sensor offset. Several measurements at different distances are necessary for the extrapolation.

A.4 System and Liquid Check

A.4.1 System Check

The system performance check verifies that the system operates within its specifications. System and operator errors can be detected and corrected. It is recommended that the system performance check be performed prior to any usage of the system in order to guarantee reproducible results.

The system performance check uses normal SAR measurements in a simplified setup with a well characterized source. This setup was selected to give a high sensitivity to all parameters that might fail or vary over time. The system check does not intend to replace the calibration of the components, but indicates situations where the system uncertainty is exceeded due to drift or failure.

In the simplified setup for system check, the EUT is replaced by a calibrated dipole and the power source is replaced by a controlled continuous wave generated by a signal generator. The calibrated dipole must be placed beneath the flat phantom section of the phantom at the correct distance.

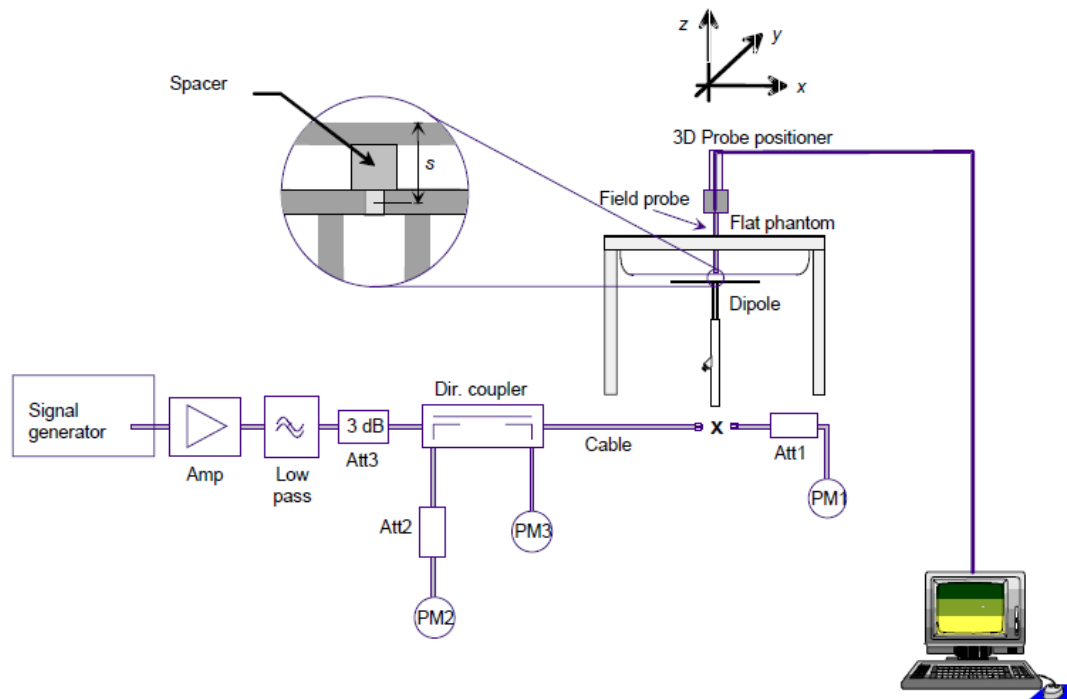

The equipment setup is shown below:

- ✓ Signal Generator
- ✓ Amplifier
- ✓ Directional coupler
- ✓ Power meter
- ✓ Calibrated dipole

First, the power meter PM1 (including attenuator Att1) is connected to the cable to measure the forward power at the location of the connector (x) to the system check source. The signal generator is adjusted for the desired forward power at the connector as read by power meter PM1 after attenuation Att1 and also as coupled through Att2 to PM2. After connecting the cable to the source, the signal generator is readjusted for the same reading at power meter PM2.

SAR results are normalized to a forward power of 1W to compare the values with the calibration reports results as described at IEEE 1528 and IEC 62209 standards.

A.4.2 Liquid Check

The dielectric parameters check is done prior to the use of the tissue simulating liquid. The verification is made by comparing the relative permittivity and conductivity to the values recommended by the applicable standards.

The liquid verification was performed using the following test setup:

- ✓ VNA (Vector Network Analyzer)
- ✓ Open-Short-Load calibration kit
- ✓ RF Cable
- ✓ Open-Ended Coaxial probe
- ✓ DAK software tool
- ✓ SAR Liquid
- ✓ De-ionized water
- ✓ Thermometer

These are the target dielectric properties of the tissue-equivalent liquid material as defined in FCC OET KDB 865664 D01.

Frequency (MHz)	Body SAR	
	ϵ_r (F/m)	σ (S/m)
150	61.9	0.80
300	58.2	0.92
450	56.7	0.94
835	55.2	0.97
900	55.0	1.05
1450	54.0	1.30
1800-2000	53.3	1.52
2450	52.7	1.95
3000	52.0	2.73
5800	48.2	6.00

(ϵ_r = relative permittivity, σ = conductivity and ρ = 1000 kg/m³)

The measurement system implement a SAR error compensation algorithm as documented in IEEE Std 1528-2013 (equivalent to draft standard IEEE P1528-2011) to automatically compensate the measured SAR results for deviations between the measured and required tissue dielectric parameters (applied to only scale up the measured SAR, and not downward) so, according to FCC OET KDB 865664 D01, the tolerance for ϵ_r and σ may be relaxed to $\pm 10\%$.

A.5 Test Equipment List

SAR system #2

ID #	Device	Type/Model	Serial Number	Manufacturer	Cal. Date	Cal. Due Date
002-000	6-Axis Robot	TX60 Lspeag	F16/55FXA1/A/01	STAÜBLI	NA	NA
002-001	Robot Controller	CS8C	F16/55FXA1/C/01	STAÜBLI	NA	NA
002-002	Measurement Server	DASY6	1489	SPEAG	NA	NA
002-003	Electro Optical Converter	EOC60	1098	SPEAG	NA	NA
002-004	Light Beam Unit	SE UKS 030 AA	N/A	Di-soric	NA	NA
002-005	Oval Flat Phantom	ELI V8.0	2048	SPEAG	NA	NA
002-006	Laptop Holder		N/A	SPEAG	NA	NA
002-007	Measurement Software	DASY6 v6.14	9-5DEE27C2	SPEAG	NA	NA
002-008	Data Acquisition Electronics	DAE4	1429	SPEAG	2021-05-11	2022-05-11
002-009	Dosimetric E-Field probe	EX3DV4	3978	SPEAG	2021-05-21	2022-05-21
002-010	MAIA Antenna	MAIA	1249	SPEAG	NA	NA

Shared equipment

ID #	Device	Type/Model	Serial Number	Manufacturer	Cal. Date	Cal. Due Date
123-000	USB Power Sensor	NRP-Z81	102278	R&S	2021-04-13	2023-04-13
124-000	USB Power Sensor	NRP-Z81	102279	R&S	2021-04-13	2023-04-13
126-000	Vector Signal Generator	ESG E4438C	MY45092885	Agilent	2021-05-27	2023-05-27
451-000	Vector Reflectometer	R140	21190006	Copper Mountain	2021-11-09	2023-11-09
099-000	Liquid measurement SW	DAK-3.5 V3.0.2.3	9-2687B491	SPEAG	NA	NA
069-000	Dielectric Probe Kit	DAK-3.5	1309	SPEAG	2021-03-10	2023-03-10
078-000	RF Cable	ST-18/SMAm/SMAm/48	1158830	Huber & Suhner	2022-02-01	2022-08-01
079-000	RF Cable	ST-18/SMAm/SMAm/48	1158831	Huber & Suhner	2022-02-01	2022-08-01
077-000	Coupler	CD0.5-8-20-30	1251-002	Amd-group	2022-02-01	2022-08-01
384-000	0.1-6GHz RF amplifier	AMT-A0328	1818	Agile Microwave Technology	2022-02-01	2022-08-01
141-000	USB Power Sensor	NRP-Z81	104381	R&S	2020-06-03	2022-06-03
070-000	2.45GHz System Validation Dipole	D2450V2	937	SPEAG	2020-05-12	2022-05-12
068-000	5GHz System Validation Dipole	D5GHzv2	1164	SPEAG	2021-05-18	2023-05-18
398-000	Thermometer	TESTO 922	33622932/208	TESTO	2021-11-09	2023-11-09
327-000	Temp & Humidity Logger	RA32E-TH1-RAS	RA32-F0DEF9	AVTECH	2021-03-09	2023-03-09

A.5.1 Tissue Simulant Liquid

TSL	Manufacturer / Model	Freq Range (MHz)	Main Ingredients
Body WideBand	SPEAG MBBL600-6000V6 Batch 160603-1	600-6000	Ethanediol, Sodium petroleum sulfonate, Hexylene Glycol / 2-Methyl-pentane-2.4-diol, Alkoxyated alcohol

A.6 Measurement Uncertainty Evaluation

The system uncertainty evaluation is shown in the table below with a coverage factor of $k = 2$ to indicate a 95% level of confidence:

SPEAG DASY6 Uncertainty Budget								
According to IEC/IEEE 62209-1528 (4 MHz - 6 GHz)								
including IEEE 1528-2013 and IEC 62209-1/2016, IEC 62209-2/2010								
Symbol	Error Description	Uncert. Value	Prob. Dist.	Div.	(ci) 1g	(ci) 10g	Std. Unc. (1g)	Std. Unc. (10g)
Measurement System Errors								
CF	Probe Calibration	±14.0 %	N	2	1	1	±7.0 %	±7.0 %
CF _{drift}	Probe Calibration Drift	±1.0 %	N	1	1	1	±1.0 %	±1.0 %
LIN	Probe Linearity	±4.7 %	R	√3	1	1	±2.7 %	±2.7 %
BBS	Broadband Signal	±3.0 %	N	2	1	1	±1.5 %	±1.5 %
ISO	Axial Isotropy	±4.7 %	R	√3	0.5	0.5	±1.4 %	±1.4 %
ISO	Hemispherical Isotropy	±9.6 %	R	√3	0.5	0.5	±2.8 %	±2.8 %
DAE	Data Acquisition	±0.3 %	N	1	1	1	±0.3 %	±0.3 %
AMB	RF Ambient	±1.8 %	N	1	1	1	±1.8 %	±1.8 %
Δ _{sys}	Probe Positioning	±0.2 %	N	1	0.33	0.33	±0.1 %	±0.1 %
DAT	Data Processing	±2.3 %	N	1	1	1	±2.3 %	±2.3 %
Phantom and Device Errors								
LIQ(σ)	Conductivity (meas.) _{DAK}	±2.5 %	N	1	0.78	0.71	±2.0 %	±1.8 %
LIQ(T _σ)	Conductivity (temp.) _{BB}	±3.4 %	R	√3	0.78	0.71	±1.5 %	±1.4 %
EPS	Phantom Permittivity	±14.0 %	R	√3	0.25	0.25	±2.0 %	±2.0 %
DAS	Distance DUT - TSL	±2.0 %	N	1	2	2	±4.0 %	±4.0 %
H	Device Holder	±3.6 %	N	1	1	1	±3.6 %	±3.6 %
MOD	DUT Modulation _m	±2.4 %	R	√3	1	1	±1.4 %	±1.4 %
TAS	Time-average SAR	±2.6 %	R	√3	1	1	±1.5 %	±1.5 %
RF _{drift}	DUT drift	±5.0 %	N	1	1	1	±2.9 %	±2.9 %
Correction to the SAR results								
C(ε, σ)	Deviation to Target	±1.9 %	N	1	1	0.84	±1.9 %	±1.6 %
Combined Std. Uncertainty							±11.5 %	±11.4 %
Expanded STD Uncertainty							±23.1 %	±22.9 %

A.7 RF Exposure Limits

SAR assessments have been made in line with the requirements of FCC 47CFR Part 2.1093 and ISED RSS 102 issue 5 on the limitation of exposure of the general population / uncontrolled exposure for portable devices.

Exposure Type	General Population / Uncontrolled Environment
Peak spatial-average SAR (averaged over any 1 gram of tissue)	1.6 W/kg
Whole body average SAR	0.08 W/kg
Peak spatial-average SAR (extremities) (averaged over any 10 grams of tissue)	4.0 W/kg

Annex B. Test Results

The herein test results were performed by:

Test case measurement	Test Personnel
Conducted measurement	F. Heurtematte
SAR measurement	A.Lounes

B.1 Test Conditions

B.1.1 Test SAR Test positions relative to the phantom

The device under test was an Intel® Wi-Fi 6E AX210 card inside a Convertible PC host platform (P159G) using a set of PIFA antenna. The card was operated utilizing proprietary software (DRTU version 22.21070.0.0-OEM.DRTU.12463) and each channel was measured using a broadband power meter to determine the maximum average power.

According to FCC OET KDB 616217 D04, laptop position should be tested for SAR compliance with the display screen opened at an angle of 90° to the keyboard compartment and the notebook bottom surface must be touching the phantom.

The closest distance from the antenna to an adjacent tablet edge is used to determine if SAR testing is required for the adjacent edges, with the adjacent edge positioned against the phantom and the edge containing the antenna positioned perpendicular to the phantom.

Considering the antenna location diagrams in Annex F and the test exclusions described before, the surfaces/edges to be measured for each antenna are:

Antenna	Main	Aux
Position	<ul style="list-style-type: none"> • Laptop • Back Face • Left Edge 	<ul style="list-style-type: none"> • Laptop • Back Face • Right Edge

See B.1.3.1 for a more detailed list of the applied reductions.

See F.2 Test position section for more information on the tested positions.

B.1.2 Test signal, Output power and Test Frequencies

For 802.11 transmission modes the device was put into operation by using an own control software to program the test mode required to select the continuous transmission with 100% duty cycle.

The output power of the device was set to transmit at maximum power for all tests.

B.1.3 Evaluation Exclusion and Test Reductions

B.1.3.1 SAR evaluation exclusion

The SAR Test Exclusion Threshold in FCC OET KDB 447498 D01 v06 can be applied to determine SAR test exclusion for adjacent edge configurations. For 100MHz to 6GHz and test separation distances ≤50mm, the 1-g and 10-g SAR test exclusion thresholds are determined by the following formula:

$$[(\text{max. power of channel, including tune – up tolerance, mW}) / (\text{min. test separation distance, mm})] \cdot \sqrt{f_{(\text{GHz})}} \leq 3.0 \text{ for } 1\text{g SAR, and } \leq 7.5 \text{ for } 10\text{g extremity SAR} \quad (1)$$

Where:

- f(GHz) is the RF channel transmit frequency in GHz
- Power and distance are rounded to the nearest mW and mm before calculation
- The result is rounded to one decimal place for comparison
- The values 3.0 and 7.5 are referred to as numeric thresholds

The test exclusions are applicable only when the minimum test separation distance is ≤ 50 mm, and for transmission frequencies between 100 MHz and 6 GHz. When the minimum test separation distance is < 5 mm, a distance of 5 mm is applied to determine SAR test exclusion.

For test separation distances > 50 mm, the 1-g and 10-g SAR test exclusion thresholds are determined using the following formulas:

$$((\text{Power allowed at numeric threshold for } 50 \text{ mm in (1)}) + (\text{test separation distance} - 50 \text{ mm}) \cdot (f_{\text{MHz}}/150))\text{mW, for } 100\text{MHz to } 1500\text{MHz} \quad (2)$$

$$((\text{Power allowed at numeric threshold for } 50 \text{ mm in (1)}) + (\text{test separation distance} - 50 \text{ mm}) \cdot 10)\text{mW, for } 1500\text{MHz and } \leq 6\text{GHz} \quad (3)$$

LAN Antenna	Band Name	Output power		Laptop	Top Edge	Bottom Edge	Back Face	Left Edge	Right Edge	Laptop	Top Edge	Bottom Edge	Back Face	Left Edge	Right Edge
		dBm	mW												
WLAN Main	DTS	17.00	50.12	<50	>50	>50	<50	<50	>50	T	R	R	T	T	R
	U-NII-1	12.00	15.85	<50	>50	>50	<50	<50	>50	R	R	R	R	R	R
	U-NII-2A	12.00	15.85	<50	>50	>50	<50	<50	>50	T	R	R	T	T	R
	U-NII-2C	12.00	15.85	<50	>50	>50	<50	<50	>50	T	R	R	T	T	R
	U-NII-3	12.00	15.85	<50	>50	>50	<50	<50	>50	T	R	R	T	T	R
WLAN Aux	DTS	17.00	50.12	<50	>50	>50	<50	>50	<50	T	R	R	T	T	T
	U-NII-1	12.00	15.85	<50	>50	>50	<50	>50	<50	R	R	R	R	R	R
	U-NII-2A	12.00	15.85	<50	>50	>50	<50	>50	<50	T	R	R	T	T	T
	U-NII-2C	12.00	15.85	<50	>50	>50	<50	>50	<50	T	R	R	T	T	T
	U-NII-3	12.00	15.85	<50	>50	>50	<50	>50	<50	T	R	R	T	T	T
	BT	11.50	14.12	<50	>50	>50	<50	>50	<50	T	R	R	T	T	T

T: Tested position
R: Reduced

See Annex F for a more detailed explanation of the separation distance related to the platform.

B.1.3.2 General SAR test reduction

According to FCC OET KDB 447498 D01, testing of other required channels within the operating mode of a frequency band is not required when the reported 1-g or 10-g SAR for the mid-band or highest output power channel is:

- ≤ 0.8 W/kg or 2.0 W/kg, for 1-g or 10-g respectively, when the transmission band is ≤ 100 MHz
- ≤ 0.6 W/kg or 1.5 W/kg, for 1-g or 10-g respectively, when the transmission band is between 100 MHz and 200 MHz
- ≤ 0.4 W/kg or 1.0 W/kg, for 1-g or 10-g respectively, when the transmission band is ≥ 200 MHz

WLAN SAR Test reduction

Transmission Mode	SAR test exclusion/reduction
DSSS	<p>According to FCC OET KDB 248227 D01, SAR is measured for 2.4 GHz 802.11b, SAR test reduction is determined according to the following:</p> <ul style="list-style-type: none"> ▪ When the reported SAR of the highest measured maximum output power channel for the exposure configuration is ≤ 0.8 W/kg, no further SAR testing is required for 802.11b DSSS in that exposure configuration. ▪ When the reported SAR is > 0.8 W/kg, SAR is required for that exposure configuration using the next highest measured output power channel. When any reported SAR is > 1.2 W/kg, SAR is required for the third channel. <p>According to FCC OET KDB 248227 D01, SAR is not required for 2.4 GHz OFDM conditions when the highest reported SAR for DSSS is adjusted by the ratio of OFDM to DSSS specified maximum output power and the adjusted SAR is ≤ 1.2 W/kg.</p>
OFDM	<p>According to FCC OET KDB 248227 D01, 802.11a/g/n/ac modes have the same specified maximum output power, largest channel bandwidth, lowest order modulation and lowest data rate, the lowest order 802.11 mode is selected; i.e., 802.11a is chosen over 802.11n then 802.11ac or 802.11g is chosen over 802.11n.</p> <p>According to FCC OET KDB 248227 D01, an <i>initial test configuration</i> is determined for OFDM and DSSS transmission modes according to the channel bandwidth, modulation and data rate combination(s) with the highest maximum output power specified for production units in each standalone and aggregated frequency band. SAR is measured using the highest measured maximum output power channel. SAR test reduction for subsequent highest output test channels is determined according to reported SAR of the initial test configuration.</p> <p>The <i>initial test configuration</i> for 5 GHz OFDM transmission modes is determined by the 802.11 configuration with the highest maximum output power specified for production units, including tune-up tolerance, in each standalone and aggregated frequency band. SAR for the initial test configuration is measured using the highest maximum output power channel determined by the default power measurement procedures.</p> <p>According to FCC OET KDB 248227 D01, when the reported SAR of the initial test configuration is > 0.8 W/kg, SAR measurement is required for subsequent next highest measured output power channel(s) in the initial test configuration until reported SAR is ≤ 1.2 W/kg or all required channels are tested.</p>

B.2 Conducted Power Measurements

B.2.1 WLAN 2.4GHz

Band	Mode	BW(MHz)	Rate (Mbps)	Ch	Frequency (MHz)	Average power (dBm)				SAR Test?
						Main transmitter		Aux transmitter		
						HB	Tune-up Power	HB	Tune-up Power	
2.4GHz(DTS)	802.11b	20	1	1	2412	16.88	17.00	16.55	17.00	No
				6	2437	16.87	17.00	16.95	17.00	
				11	2462	16.84	17.00	16.78	17.00	
	802.11g		6	1	2412	NR	17.00	NR	17.00	No ^{4,5,6}
				6	2437	NR	17.00	NR	17.00	
				11	2462	NR	17.00	NR	17.00	
	802.11 n20		HT0	1	2412	NR	17.00	NR	17.00	
				6	2437	NR	17.00	NR	17.00	
				11	2462	NR	17.00	NR	17.00	
	802.11 ax20	HE0	1	2412	NR	17.00	NR	17.00		
			6	2437	NR	17.00	NR	17.00		
			11	2462	NR	17.00	NR	17.00		
	802.11 n40	HT0	40	3	2422	NR	17.00	NR	17.00	
				6	2437	NR	17.00	NR	17.00	
				9	2452	NR	17.00	NR	17.00	
802.11 ax40	HE0	3		2422	NR	17.00	NR	17.00		
		6		2437	NR	17.00	NR	17.00		
		9		2452	NR	17.00	NR	17.00		

Initial test configuration

- NR: Not Required
- When band gap channels between U-NII-2C and U-NII-3 band are supported channels in U-NII-2C band below 5.65 GHz are considered as one band and channels above 5.65 GHz, together with channels in 5.8 GHz U-NII-3 or §15.247 band, are considered as a separate band
- Additional conducted power measurement is required when reported SAR is > 1.2W/kg. In case the subsequent test configuration and the channel bandwidth is smaller than the initial test configuration, all channels that overlap with the larger channel bandwidth in the initial configuration should be tested
- The initial test configuration for 2.4 GHz and 5 GHz OFDM transmission modes is determined by the 802.11 configuration with the highest maximum output power specified for production units, including tune-up tolerance, in each standalone and aggregated frequency band. SAR for the initial test configuration is measured using the highest maximum output power channel determined by the default power measurement procedures. When multiple transmission modes (802.11a/g/n/ac) have the same specified maximum output power, largest channel bandwidth, lowest order modulation and lowest data rate, lowest order 802.11 mode is selected (i.e. a, g, n, ac then ax)
- When the reported SAR of the initial test configuration is > 0.8W/kg, SAR measurement is required for the subsequent next highest measured output power channel(s) in the initial test configuration until reported SAR is ≤1.2W/kg or all required channels are tested.
- When the highest reported SAR for the initial test configuration (when applicable, include subsequent highest output channels), according to the initial test position or fixed exposure requirements, is adjusted by the ratio of the subsequent test configuration to the initial test configuration specified maximum output power and the adjusted SAR is ≤1.2 W/Kg, SAR is not required for that subsequent test configuration.
- SAR for subsequent highest measured maximum output power channels in the subsequent test configuration is required only when the reported SAR of the preceding higher maximum output power channel(s) in the subsequent test configuration is >1.2 W/Kg or until all required channels are tested.

B.2.2 WLAN 5GHz (U-NII)

B.2.2.1 5.2GHz and 5.3GHz (U-NII-1 and U-NII-2A)

Band	Mode	BW(MHz)	Rate (Mbps)	Ch	Frequency (MHz)	Average power (dBm)				SAR Test?
						Main transmitter		Aux transmitter		
						HB	Tune-up Power	HB	Tune-up Power	
5.2GHz (U-NII-1)	802.11a	20	6	36	5180	NR	12.00	NR	12.00	No ^{4,5,6}
				40	5200	NR	12.00	NR	12.00	
				44	5220	NR	12.00	NR	12.00	
				48	5240	NR	12.00	NR	12.00	
	802.11n20		HT0	36	5180	NR	12.00	NR	12.00	
				40	5200	NR	12.00	NR	12.00	
				44	5220	NR	12.00	NR	12.00	
				48	5240	NR	12.00	NR	12.00	
	802.11ax20	HE0	36	5180	NR	12.00	NR	12.00		
			40	5200	NR	12.00	NR	12.00		
			44	5220	NR	12.00	NR	12.00		
			48	5240	NR	12.00	NR	12.00		
	802.11n40	HT0	40	38	5190	NR	12.00	NR	12.00	
				46	5230	NR	12.00	NR	12.00	
	802.11ax40	HE0		38	5190	NR	12.00	NR	12.00	
				46	5230	NR	12.00	NR	12.00	
802.11ac80	VHT0	80		42	5210	NR	12.00	NR	12.00	
802.11ax80				HE0		NR	12.00	NR	12.00	

Initial test configuration

1. NR: Not Required
2. When the same maximum output power is specified for both bands, begin SAR measurement in U-NII-2A band by applying the OFDM SAR requirements. If the highest reported SAR for a test configuration is ≤ 1.2 W/kg, SAR is not required for U-NII-1 band (see §B.5.2 in this document).
3. Additional conducted power measurement is required when reported SAR is > 1.2 W/kg. In case the subsequent test configuration and the channel bandwidth is smaller than the initial test configuration, all channels that overlap with the larger channel bandwidth in the initial configuration should be tested.
4. The initial test configuration for 2.4 GHz and 5 GHz OFDM transmission modes is determined by the 802.11 configuration with the highest maximum output power specified for production units, including tune-up tolerance, in each standalone and aggregated frequency band. SAR for the initial test configuration is measured using the highest maximum output power channel determined by the default power measurement procedures. When multiple transmission modes (802.11a/g/n/ac) have the same specified maximum output power, largest channel bandwidth, lowest order modulation and lowest data rate, lowest order 802.11 mode is selected (i.e. a, g, n, ac then ax)
5. When the reported SAR of the initial test configuration is > 0.8 W/kg, SAR measurement is required for the subsequent next highest measured output power channel(s) in the initial test configuration until reported SAR is $=1.2$ W/kg or all required channels are tested.
6. When the highest reported SAR for the initial test configuration (when applicable, include subsequent highest output channels), according to the initial test position or fixed exposure requirements, is adjusted by the ratio of the subsequent test configuration to the initial test configuration specified maximum output power and the adjusted SAR is ≤ 1.2 W/Kg, SAR is not required for that subsequent test configuration
7. SAR for subsequent highest measured maximum output power channels in the subsequent test configuration is required only when the reported SAR of the preceding higher maximum output power channel(s) in the subsequent test configuration is >1.2 W/Kg or until all required channels are tested.

Band	Mode	BW(MHz)	Rate (Mbps)	Ch	Frequency (MHz)	Average power (dBm)				SAR Test?
						Main transmitter		Aux transmitter		
						HB	Tune-up Power	HB	Tune-up Power	
5.3GHz (U-NII-2A)	802.11a	20	6	52	5260	NR	12.00	NR	12.00	No ^{4,5,6}
				56	5280	NR	12.00	NR	12.00	
				60	5300	NR	12.00	NR	12.00	
				64	5320	NR	12.00	NR	12.00	
	802.11n20		HT0	52	5260	NR	12.00	NR	12.00	
				56	5280	NR	12.00	NR	12.00	
				60	5300	NR	12.00	NR	12.00	
				64	5320	NR	12.00	NR	12.00	
	802.11ax20	HE0	52	5260	NR	12.00	NR	12.00		
			56	5280	NR	12.00	NR	12.00		
			60	5300	NR	12.00	NR	12.00		
			64	5320	NR	12.00	NR	12.00		
	802.11n40	40	HT0	54	5270	NR	12.00	NR	12.00	
				62	5310	NR	12.00	NR	12.00	
	802.11ax40		HE0	54	5270	NR	12.00	NR	12.00	
				62	5310	NR	12.00	NR	12.00	
802.11ac80	80	VHT0	58	5290	NR	12.00	NR	12.00		
802.11ax80		HE0			NR	12.00	NR	12.00		
802.11ac160	160	VHT0	50	5250	11.88	12.00	11.59	12.00	Yes	
802.11ax160		HE0			NR	12.00	NR	12.00	No ^{4,5,6}	

Initial test configuration

1. NR: Not Required
2. The initial test configuration for 2.4 GHz and 5 GHz OFDM transmission modes is determined by the 802.11 configuration with the highest maximum output power specified for production units, including tune-up tolerance, in each standalone and aggregated frequency band. SAR for the initial test configuration is measured using the highest maximum output power channel determined by the default power measurement procedures. When multiple transmission modes (802.11a/g/n/ac) have the same specified maximum output power, largest channel bandwidth, lowest order modulation and lowest data rate, lowest order 802.11 mode is selected (i.e. a, g, n, ac then ax)
3. Additional conducted power measurement is required when reported SAR is > 1.2W/kg. In case the subsequent test configuration and the channel bandwidth is smaller than the initial test configuration, all channels that overlap with the larger channel bandwidth in the initial configuration should be tested.
4. When the reported SAR of the initial test configuration is > 0.8W/kg, SAR measurement is required for the subsequent next highest measured output power channel(s) in the initial test configuration until reported SAR is ≤1.2W/kg or all required channels are tested.
5. When the highest reported SAR for the initial test configuration (when applicable, include subsequent highest output channels), according to the initial test position or fixed exposure requirements, is adjusted by the ratio of the subsequent test configuration to the initial test configuration specified maximum output power and the adjusted SAR is ≤1.2 W/Kg, SAR is not required for that subsequent test configuration.
6. SAR for subsequent highest measured maximum output power channels in the subsequent test configuration is required only when the reported SAR of the preceding higher maximum output power channel(s) in the subsequent test configuration is >1.2 W/Kg or until all required channels are tested.

B.2.2.2 5.6 (U-NII-2C)

Band	Mode	BW(MHz)	Rate (Mbps)	Ch	Frequency (MHz)	Average power (dBm)				SAR Test?
						Main transmitter		Aux transmitter		
						HB	Tune-up Power	HB	Tune-up Power	
5.6GHz (U-NII-2C)	802.11a	20	6	100	5500	NR	12.00	NR	12.00	No ^{4,5,6}
				104	5520	NR	12.00	NR	12.00	
				108	5540	NR	12.00	NR	12.00	
				112	5560	NR	12.00	NR	12.00	
				116	5580	NR	12.00	NR	12.00	
				120	5600	NR	12.00	NR	12.00	
				124	5620	NR	12.00	NR	12.00	
				128	5640	NR	12.00	NR	12.00	
	802.11n20		HT0	100	5500	NR	12.00	NR	12.00	
				104	5520	NR	12.00	NR	12.00	
				108	5540	NR	12.00	NR	12.00	
				112	5560	NR	12.00	NR	12.00	
				116	5580	NR	12.00	NR	12.00	
				120	5600	NR	12.00	NR	12.00	
				124	5620	NR	12.00	NR	12.00	
				128	5640	NR	12.00	NR	12.00	
	802.11ax20		HE0	100	5500	NR	12.00	NR	12.00	
				104	5520	NR	12.00	NR	12.00	
				108	5540	NR	12.00	NR	12.00	
				112	5560	NR	12.00	NR	12.00	
				116	5580	NR	12.00	NR	12.00	
				120	5600	NR	12.00	NR	12.00	
				124	5620	NR	12.00	NR	12.00	
				128	5640	NR	12.00	NR	12.00	
	802.11n40	HT0	102	5510	NR	12.00	NR	12.00		
			110	5550	NR	12.00	NR	12.00		
			118	5590	NR	12.00	NR	12.00		
			126	5630	NR	12.00	NR	12.00		
	802.11ax40	HE0	102	5510	NR	12.00	NR	12.00		
			110	5550	NR	12.00	NR	12.00		
			118	5590	NR	12.00	NR	12.00		
			126	5630	NR	12.00	NR	12.00		
	802.11ac80	VHT0	106	5530	NR	12.00	NR	12.00		
			122	5610	NR	12.00	NR	12.00		
	802.11ax80	HE0	106	5530	NR	12.00	NR	12.00		
			122	5610	NR	12.00	NR	12.00		
802.11ac160	160	VHT0	114	5570	11.66	12.00	11.91	12.00	Yes	
802.11ax160		HE0			NR	12.00	NR	12.00	No	

Initial test configuration

8. NR: Not Required
9. When band gap channels between U-NII-2C and U-NII-3 band are supported channels in U-NII-2C band below 5.65 GHz are considered as one band and channels above 5.65 GHz, together with channels in 5.8 GHz U-NII-3 or §15.247 band, are considered as a separate band
10. Additional conducted power measurement is required when reported SAR is $> 1.2\text{W/kg}$. In case the subsequent test configuration and the channel bandwidth is smaller than the initial test configuration, all channels that overlap with the larger channel bandwidth in the initial configuration should be tested
11. The initial test configuration for 2.4 GHz and 5 GHz OFDM transmission modes is determined by the 802.11 configuration with the highest maximum output power specified for production units, including tune-up tolerance, in each standalone and aggregated frequency band. SAR for the initial test configuration is measured using the highest maximum output power channel determined by the default power measurement procedures. When multiple transmission modes (802.11a/g/n/ac) have the same specified maximum output power, largest channel bandwidth, lowest order modulation and lowest data rate, lowest order 802.11 mode is selected (i.e. a, g, n, ac then ax)
12. When the reported SAR of the initial test configuration is $> 0.8\text{W/kg}$, SAR measurement is required for the subsequent next highest measured output power channel(s) in the initial test configuration until reported SAR is $\leq 1.2\text{W/kg}$ or all required channels are tested.
13. When the highest reported SAR for the initial test configuration (when applicable, include subsequent highest output channels), according to the initial test position or fixed exposure requirements, is adjusted by the ratio of the subsequent test configuration to the initial test configuration specified maximum output power and the adjusted SAR is $\leq 1.2\text{ W/Kg}$, SAR is not required for that subsequent test configuration.
14. SAR for subsequent highest measured maximum output power channels in the subsequent test configuration is required only when the reported SAR of the preceding higher maximum output power channel(s) in the subsequent test configuration is $> 1.2\text{ W/Kg}$ or until all required channels are tested.

B.2.2.3 5.8GHz (U-NII-3)

Band	Mode	BW(MHz)	Rate (Mbps)	Ch	Frequency (MHz)	Average power (dBm)				SAR Test?	
						Main transmitter		Aux transmitter			
						HB	Tune-up Power	HB	Tune-up Power		
5.6/5.8GHz (U-NII-3)	802.11a	20	6	132	5660	NR	12.00	NR	12.00	No ^{4,5,6}	
				136	5680	NR	12.00	NR	12.00		
				140	5700	NR	12.00	NR	12.00		
				149	5745	NR	12.00	NR	12.00		
				153	5765	NR	12.00	NR	12.00		
				157	5785	NR	12.00	NR	12.00		
				161	5805	NR	12.00	NR	12.00		
				165	5825	NR	12.00	NR	12.00		
	802.11n20	20	HT0	132	5660	NR	12.00	NR	12.00		
				136	5680	NR	12.00	NR	12.00		
				140	5700	NR	12.00	NR	12.00		
				149	5745	NR	12.00	NR	12.00		
				153	5765	NR	12.00	NR	12.00		
				157	5785	NR	12.00	NR	12.00		
				161	5805	NR	12.00	NR	12.00		
				165	5825	NR	12.00	NR	12.00		
	802.11 ax20	20	HE0	132	5660	NR	12.00	NR	12.00		
				136	5680	NR	12.00	NR	12.00		
				140	5700	NR	12.00	NR	12.00		
				149	5745	NR	12.00	NR	12.00		
				153	5765	NR	12.00	NR	12.00		
				157	5785	NR	12.00	NR	12.00		
				161	5805	NR	12.00	NR	12.00		
				165	5825	NR	12.00	NR	12.00		
	802.11 n40	40	HT0	134	5670	NR	12.00	NR	12.00		
				142	5710	NR	12.00	NR	12.00		
				151	5755	NR	12.00	NR	12.00		
				159	5795	NR	12.00	NR	12.00		
	802.11ax40	40	HE0	134	5670	NR	12.00	NR	12.00		
				142	5710	NR	12.00	NR	12.00		
				151	5755	NR	12.00	NR	12.00		
				159	5795	NR	12.00	NR	12.00		
	802.11ac80	80	VHT0	138	5690	11.76	12.00	11.62	12.00		Yes
				155	5775	11.77	12.00	11.55	12.00		
	802.11ax80	80	HE0	138	5690	NR	12.00	NR	12.00		No ^{4,5,6}
				155	5775	NR	12.00	NR	12.00		

Initial test configuration

1. NR: Not Required
2. When band gap channels between U-NII-2C and U-NII-3 band are supported channels in U-NII-2C band below 5.65 GHz are considered as one band and channels above 5.65 GHz, together with channels in 5.8 GHz U-NII-3 or §15.247 band, are considered as a separate band
3. Additional conducted power measurement is required when reported SAR is $> 1.2\text{W/kg}$. In case the subsequent test configuration and the channel bandwidth is smaller than the initial test configuration, all channels that overlap with the larger channel bandwidth in the initial configuration should be tested
4. The initial test configuration for 2.4 GHz and 5 GHz OFDM transmission modes is determined by the 802.11 configuration with the highest maximum output power specified for production units, including tune-up tolerance, in each standalone and aggregated frequency band. SAR for the initial test configuration is measured using the highest maximum output power channel determined by the default power measurement procedures. When multiple transmission modes (802.11a/g/n/ac) have the same specified maximum output power, largest channel bandwidth, lowest order modulation and lowest data rate, lowest order 802.11 mode is selected (i.e. a, g, n, ac then ax)
5. When the reported SAR of the initial test configuration is $> 0.8\text{W/kg}$, SAR measurement is required for the subsequent next highest measured output power channel(s) in the initial test configuration until reported SAR is $\leq 1.2\text{W/kg}$ or all required channels are tested.
6. When the highest reported SAR for the initial test configuration (when applicable, include subsequent highest output channels), according to the initial test position or fixed exposure requirements, is adjusted by the ratio of the subsequent test configuration to the initial test configuration specified maximum output power and the adjusted SAR is $\leq 1.2\text{ W/Kg}$, SAR is not required for that subsequent test configuration.
7. SAR for subsequent highest measured maximum output power channels in the subsequent test configuration is required only when the reported SAR of the preceding higher maximum output power channel(s) in the subsequent test configuration is $> 1.2\text{ W/Kg}$ or until all required channels are tested.

B.2.3 Bluetooth

Band	Mode	Data Rate	Channel	Frequency (MHz)	Antenna	Average power (dBm)		SAR Test?
						Aux transmitter		
						HB	Tune-up Pwr (dBm)	
2.4GHz	Bluetooth v5.2	Basic rate GFSK	0	2402	Aux	11.16	11.50	No
			39	2441		11.42	11.50	Yes
			78	2480		9.93	11.50	No
	Bluetooth v5.2	Basic rate $\pi/4$ DQPSK	0	2402		NR ¹	11.00	No
			39	2441			11.00	
			78	2480			11.00	
	Bluetooth v5.2	Basic rate 8-DPSK	0	2402			11.00	
			39	2441			11.00	
			78	2480			11.00	
	BLE	Low energy GFSK	0	2412			10.00	
			20	2442			10.00	
			39	2480			10.00	

Initial test configuration

1. NR: Not Required

B.3 Tissue Parameters Measurement

Body TSL

Freq.(MHz)	Target Parameters		Measured TSL Parameters		Deviation (%)		Date
	ϵ' (F/m)	σ (S/m)	ϵ' (F/m)	σ (S/m)	Deviation ϵ'	Deviation σ	
5800	48.20	6.00	48.49	6.23	0.60	3.83	2022-04-07
2450	52.70	1.95	50.79	1.92	-3.62	-1.54	2022-04-11
5200	49.01	5.30	46.18	5.18	-5.77	-2.26	
5300	48.88	5.42	46.01	5.34	-5.87	-1.48	
5500	48.61	5.65	45.74	5.60	-5.90	-0.88	
5600	48.47	5.77	45.62	5.72	-5.88	-0.87	

See 1 for more details.

B.4 System Check Measurements

Body Measurements

Frequency (MHz)	Average	Target SAR (W/kg)	Measured SAR (W/kg)	Deviation to target (%)	Limit (%)	Date
2450	1g	48.60	50.80	4.53	± 10	2022-04-11
	10g	23.00	24.20	5.22		2022-04-11
5300	1g	71.70	67.60	-5.72		2022-04-11
	10g	20.00	20.20	1.00		2022-04-11
5600	1g	76.50	79.80	4.31		2022-04-11
	10g	21.20	22.80	7.55		2022-04-11
5800	1g	73.40	69.60	-5.18		2022-04-08
	10g	20.00	20.20	1.00		2022-04-08

See Annex C for more details.

B.5 SAR Test Results

B.5.1 802.11b/g/n/ax – 2.4GHz – DTS and BT

Antenna Manufacturer	Mode	Data rate	BW (MHz)	Channel Number	Freq (MHz)	Test position mode	Antenna	Scaling Factor (dB)	Measured SAR 1g (W/kg)	Reported SAR 1g (W/kg)	Plot #
WNC	802.15	DH5	1	39	2441	Back Face	Aux	0.08	0.13	0.13	
						Laptop	Aux	0.08	0.04	0.04	
						Right Edge	Aux	0.08	0.09	0.09	
	802.11b	1Mbps	20	1	2412	Back Face	Main	0.12	0.43	0.44	
						Laptop	Main	0.12	0.28	0.29	
						Left Edge	Main	0.12	0.03	0.03	
				6	2437	Back Face	Aux	0.05	0.38	0.38	
						Laptop	Aux	0.05	0.27	0.27	
						Right Edge	Aux	0.05	0.66	0.67	1

B.5.2 802.11a/n/ac/ax – 5.3 GHz – U-NII-2A

Antenna Manufacturer	Mode	Data rate	BW (MHz)	Channel Number	Freq (MHz)	Test position mode	Antenna	Scaling Factor (dB)	Measured SAR 1g (W/kg)	Reported SAR 1g (W/kg)	Plot #
WNC	802.11ac	VHT0	160	50	5250	Back Face	Aux	0.41	0.80	0.88	
						Laptop	Aux	0.41	0.14	0.15	
						Right Edge	Aux	0.41	0.96	1.06	2
						Back Face	Main	0.12	0.29	0.30	
						Laptop	Main	0.12	0.17	0.18	
						Left Edge	Main	0.12	0.38	0.39	

B.5.3 802.11a/n/ac/ax – 5.6 GHz – U-NII-2C

Antenna Manufacturer	Mode	Data rate	BW (MHz)	Channel Number	Freq (MHz)	Test position mode	Antenna	Scaling Factor (dB)	Measured SAR 1g (W/kg)	Reported SAR 1g (W/kg)	Plot #
WNC	802.11ac	VHT0	160	114	5570	Back Face	Aux	0.09	0.45	0.46	
						Laptop	Aux	0.09	0.09	0.09	
						Right Edge	Aux	0.09	0.53	0.54	
						Back Face	Main	0.34	0.54	0.58	
						Laptop	Main	0.34	0.17	0.18	
						Left Edge	Main	0.34	0.57	0.62	3

B.5.4 802.11a/n/ac/ax – 5.8 GHz – U-NII-3

Antenna Manufacturer	Mode	Data rate	BW (MHz)	Channel Number	Freq (MHz)	Test position mode	Antenna	Scaling Factor (dB)	Measured SAR 1g (W/kg)	Reported SAR 1g (W/kg)	Plot #
WNC	802.11ac	VHT0	80	138	5690	Back Face	Aux	0.38	0.52	0.56	
						Laptop	Aux	0.38	0.10	0.10	
						Right Edge	Aux	0.38	0.54	0.59	
				155	5775	Back Face	Main	0.23	0.75	0.79	4
						Laptop	Main	0.23	0.16	0.17	
						Left Edge	Main	0.23	0.46	0.48	

B.5.5 SAR Measurement Variability

According to FCC OET KDB 865664, SAR Measurement variability is assessed when the maximum initial measured SAR is ≥ 0.8 W/kg for a certain band/mode. If the measured SAR value of the initial repeated measurement is < 1.45 W/kg with $< 20\%$ variation, only one repeated measurement is required to confirm that the results are not expected to have substantial variations.

A second repeated measurement is required only if the measured results for the initial repeated measurement are within 10% of the SAR limit or vary by more than 20%.

A third repeated measurement is required only if the original, first or second repeated measurement ≥ 1.5 W/Kg and the ratio of largest to smallest SAR for the original, first and second repeated measurement is > 1.2 .

Band / Mode	Position	Ch #	Freq. (MHz)	Measured SAR 1g (W/kg)	1 st Repeated SAR 1g (W/Kg)	2 nd Repeated SAR 1g (W/Kg)	Highest Ratio
UNII-2A / 802.11ac - 160 MHz	Right Edge	50	5250	0.96	0.94		1.03

B.5.6 Simultaneous Transmission SAR Evaluation

According to FCC OET KDB 447498 D01, when the sum of 1g SAR for all simultaneously transmitting antennas in an operating mode and exposure condition combination is within the SAR limit, SAR test exclusion applies to that simultaneous transmission configuration.

All the values stated in the table below are the worst case found for standalone measurement with disregard of the transmission mode or channel where the worst case was found

Antenna	Position	Highest Reported SAR (1g) (W/kg)		
		WLAN 2.4GHz	WLAN 5GHz	Bluetooth
Main	Laptop	0.29	0.18	
	Back Face	0.44	0.79	
	Left Edge	0.03	0.62	
	Right Edge	0.40*	0.40*	
Aux	Laptop	0.27	0.15	0.04
	Back Face	0.38	0.88	0.13
	Left Edge	0.40*	0.40*	0.40*
	Right Edge	0.67	1.06	0.09

* According to FCC OET KDB 447498 D01, when standalone test exclusion is applied to an antenna that transmits simultaneously with other antennas, the standalone SAR must be estimated to 0.4 W/Kg for 1-g SAR when the test separation is > 50mm in order to determine simultaneous transmission test exclusion.

Position	Simultaneous Tx Antenna Combination		Σ SAR 1g (W/kg)	Limit (W/kg)
	Main Antenna	Aux Antenna		
Laptop	WLAN 5GHz	WLAN 5GHz	0.33	1.6
	WLAN 5GHz	WLAN 5GHz + BT	0.37	
	WLAN 5GHz	BT	0.22	
	WLAN 2.4GHz	WLAN 2.4GHz	0.56	
	WLAN 2.4GHz	BT	0.36	
Back Face	WLAN 5GHz	WLAN 5GHz	1.67	
	WLAN 5GHz	WLAN 5GHz + BT	1.80	
	WLAN 5GHz	BT	0.92	
	WLAN 2.4GHz	WLAN 2.4GHz	0.82	
	WLAN 2.4GHz	BT	0.57	
Left Edge	WLAN 5GHz	WLAN 5GHz	1.02	
	WLAN 5GHz	WLAN 5GHz + BT	1.42	
	WLAN 5GHz	BT	1.02	
	WLAN 2.4GHz	WLAN 2.4GHz	0.43	
	WLAN 2.4GHz	BT	0.43	
Right Edge	WLAN 5GHz	WLAN 5GHz	1.46	
	WLAN 5GHz	WLAN 5GHz + BT	1.55	
	WLAN 5GHz	BT	1.15	
	WLAN 2.4GHz	WLAN 2.4GHz	1.07	
	WLAN 2.4GHz	BT	0.57	

In case the sum of SAR is larger than the limit, SAR test exclusion is determined by the SAR to peak location separation ratio:

Position	Antenna	Reported SAR 1g (W/kg)	Σ SAR 1g (W/Kg)	Peak Location (mm) (x,y,z)	SAR to peak location separation ratio	Limit
Back Face	Main WLAN 5GHz	0.79	1.67	(44.7 ;135.7 ;-177)	0.01	0.04
	Aux WLAN 5GHz	0.88		(41.3 ;-154.3 ;-177)		
	Main WLAN 5GHz	0.78	1.80	(44.7 ;135.7 ;-177)	0.01	
	Aux WLAN 5GHz + BT	1.01		(41.3 ;-154.3 ;-177)		

Considering the results described above and according to the simultaneous transmission evaluation exclusions described in FCC OET KDB 447498 D01, no enlarged zoom scan measurements are required

Annex C. Test System Plots

1. DTS - 802.11b20, CH6, Aux Antenna - Right Edge - WNC.....	39
2. UNII-2A - 802.11ac160, CH50, Aux Antenna - Right Edge - WNC.....	40
3. UNII-2C - 802.11ac160, CH114, Main Antenna - Left Edge - WNC.....	41
4. UNII-3 - 802.11ac80, CH155, Aux Antenna - Back Face - Hong-Bo.....	42
5. System Check Body Liquid 2450.0MHz.....	43
6. System Check Body Liquid 5300.0MHz.....	44
7. System Check Body Liquid 5600.0MHz.....	45
8. System Check Body Liquid 5800.0MHz.....	46

1. DTS - 802.11b20, CH6, Aux Antenna - Right Edge - WNC

Device under Test Properties

Name, Manufacturer	Dimensions [mm]	SN	DUT Type
P159 , DELL	305.0 x 205.0 x 15.0	2021101234154	Convertible PC

Exposure Conditions

Phantom Section, TSL	Position, Test Distance [mm]	Band	Group, UID	Frequency [MHz], Channel Number	Conversion Factor	TSL Conductivity [S/m]	TSL Permittivity
Flat MSL	EDGE RIGHT 0.00	WLAN 2.4GHz	WLAN,10415,AAA	2437.0, 6	7.32	1.91	50.8

Hardware Setup

Phantom	TSL, Measured Date	Probe, Calibration Date	DAE, Calibration Date
ELI V8.0 (20deg probe tilt) - xxxx	MBBL-600-6000 , 2022-Apr-11	EX3DV4 - SN3978, 2021-05-21	DAE4 Sn1429, 2021-05-11

Scan Setup

	Area Scan	Zoom Scan
Grid Extents [mm]	100.0 x 120.0	30.0 x 30.0 x 30.0
Grid Steps [mm]	10.0 x 10.0	4.5 x 4.5 x 1.5
Sensor Surface [mm]	3.0	1.4
Graded Grid	Yes	Yes
Grading Ratio	1.5	1.5
MAIA	Confirmed by MAIA	Confirmed by MAIA
Surface Detection	Yes	Yes
Scan Method	Measured	Measured

Measurement Results

	Area Scan	Zoom Scan
Date	2022-04-11, 10:57	2022-04-11, 11:07
SAR1g [W/Kg]	0.634	0.663
SAR10g [W/Kg]	0.231	0.234
Power Drift [dB]	-0.01	-0.04
Power Scaling	Disabled	Disabled
Scaling Factor [dB]		
TSL Correction	Positive Only	Positive Only

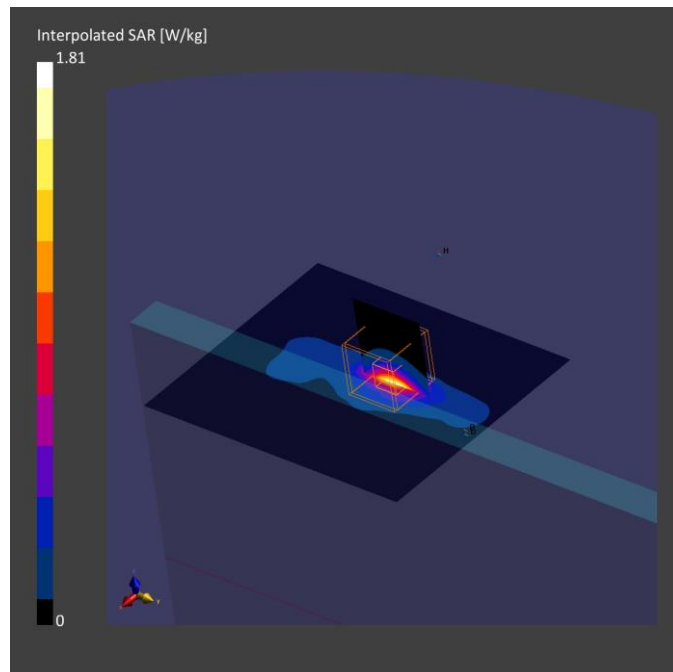

2. UNII-2A - 802.11ac160, CH50, Aux Antenna - Right Edge - WNC

Device under Test Properties

Name, Manufacturer	Dimensions [mm]	SN	DUT Type
P159 , DELL	305.0 x 205.0 x 15.0	2021101234154	Convertible PC

Exposure Conditions

Phantom Section, TSL	Position, Test Distance [mm]	Band	Group, UID	Frequency [MHz], Channel Number	Conversion Factor	TSL Conductivity [S/m]	TSL Permittivity
Flat MSL	EDGE RIGHT 0.00	WLAN 5GHz	WLAN,10456,AAC	5250.0, 50	4.19	5.26	46.1

Hardware Setup

Phantom	TSL, Measured Date	Probe, Calibration Date	DAE, Calibration Date
ELI V8.0 (20deg probe tilt) - xxxx	MBBL-600-6000 , 2022-Apr-11	EX3DV4 - SN3978, 2021-05-21	DAE4 Sn1429, 2021-05-11

Scan Setup

	Area Scan	Zoom Scan
Grid Extents [mm]	100.0 x 120.0	22.0 x 22.0 x 22.0
Grid Steps [mm]	10.0 x 10.0	4.0 x 4.0 x 1.4
Sensor Surface [mm]	3.0	1.4
Graded Grid	Yes	Yes
Grading Ratio	1.5	1.4
MAIA	Confirmed by MAIA	Confirmed by MAIA
Surface Detection	Yes	Yes
Scan Method	Measured	Measured

Measurement Results

	Area Scan	Zoom Scan
Date	2022-04-11, 13:30	2022-04-11, 12:36
SAR1g [W/Kg]	0.	0.964
SAR10g [W/Kg]	0.	0.
Power Drift [dB]	0.07	-0.00
Power Scaling	Disabled	Disabled
Scaling Factor		
TSL Correction	Positive Only	Positive Only

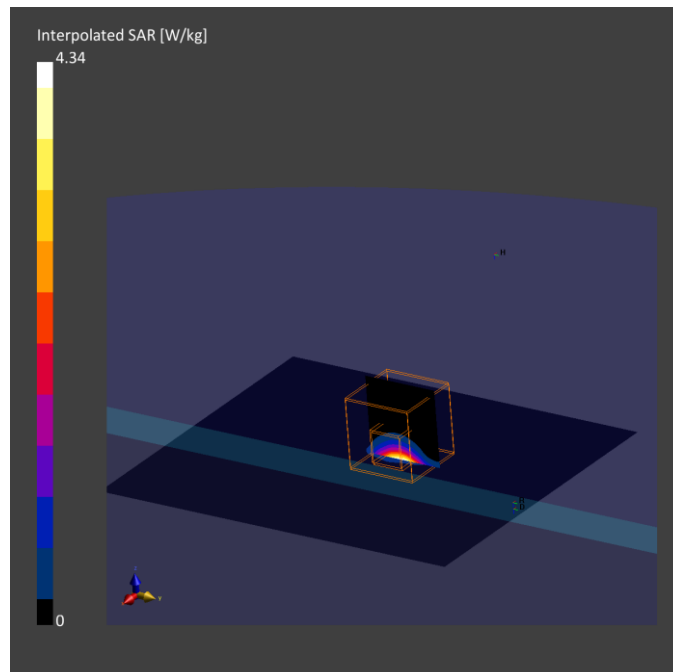

3. UNII-2C - 802.11ac160, CH114, Main Antenna - Left Edge - WNC

Device under Test Properties

Name, Manufacturer	Dimensions [mm]	SN	DUT Type
P159 , DELL	305.0 x 205.0 x 15.0	2021101234154	Convertible PC

Exposure Conditions

Phantom Section, TSL	Position, Test Distance [mm]	Band	Group, UID	Frequency [MHz], Channel Number	Conversion Factor	TSL Conductivity [S/m]	TSL Permittivity
Flat MSL	EDGE LEFT 0.00	WLAN 5GHz	WLAN,10456,AAC	5570.0, 114	3.73	5.68	45.7

Hardware Setup

Phantom	TSL, Measured Date	Probe, Calibration Date	DAE, Calibration Date
ELI V8.0 (20deg probe tilt) - xxxx	MBBL-600-6000 , 2022-Apr-11	EX3DV4 - SN3978, 2021-05-21	DAE4 Sn1429, 2021-05-11

Scan Setup

	Area Scan	Zoom Scan
Grid Extents [mm]	100.0 x 140.0	22.0 x 22.0 x 22.0
Grid Steps [mm]	10.0 x 10.0	4.0 x 4.0 x 1.4
Sensor Surface [mm]	3.0	1.4
Graded Grid	Yes	Yes
Grading Ratio	1.5	1.4
MAIA	Confirmed by MAIA	Confirmed by MAIA
Surface Detection	Yes	Yes
Scan Method	Measured	Measured

Measurement Results

	Area Scan	Zoom Scan
Date	2022-04-11, 10:14	2022-04-11, 10:23
SAR1g [W/Kg]	0.371	0.575
SAR10g [W/Kg]	0.112	0.115
Power Drift [dB]	0.18	-0.20
Power Scaling	Disabled	Disabled
Scaling Factor [dB]		
TSL Correction	Positive Only	Positive Only

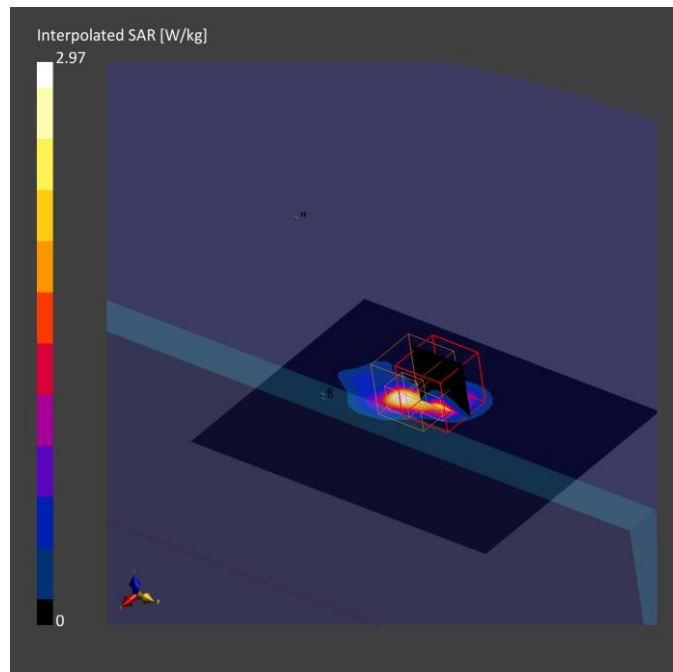

4. UNII-3 - 802.11ac80, CH155, Aux Antenna - Back Face - WNC

Device under Test Properties

Name, Manufacturer	Dimensions [mm]	SN	DUT Type
P159 , DELL	305.0 x 205.0 x 15.0	2021101234154	Convertible PC

Exposure Conditions

Phantom Section, TSL	Position, Test Distance [mm]	Band	Group, UID	Frequency [MHz], Channel Number	Conversion Factor	TSL Conductivity [S/m]	TSL Permittivity
Flat MSL	BACK 0.00	WLAN 5GHz	WLAN,10402,AAE	5775.0, 155	3.76	6.20	48.6

Hardware Setup

Phantom	TSL, Measured Date	Probe, Calibration Date	DAE, Calibration Date
ELI V8.0 (20deg probe tilt) - xxxx	MBBL-600-6000 , 2022-Apr-07	EX3DV4 - SN3978, 2021-05-21	DAE4 Sn1429, 2021-05-11

Scan Setup

	Area Scan	Zoom Scan
Grid Extents [mm]	120.0 x 160.0	22.0 x 22.0 x 22.0
Grid Steps [mm]	10.0 x 10.0	2.7 x 2.7 x 1.2
Sensor Surface [mm]	3.0	1.4
Graded Grid	Yes	Yes
Grading Ratio	1.5	1.2
MAIA	Confirmed by MAIA	Confirmed by MAIA
Surface Detection	Yes	Yes
Scan Method	Measured	Measured

Measurement Results

	Area Scan	Zoom Scan
Date	2022-04-08, 20:35	2022-04-08, 20:53
SAR1g [W/Kg]	0.435	0.748
SAR10g [W/Kg]	0.152	0.226
Power Drift [dB]	-0.11	0.01
Power Scaling	Disabled	Disabled
Scaling Factor [dB]		
TSL Correction	Positive Only	Positive Only

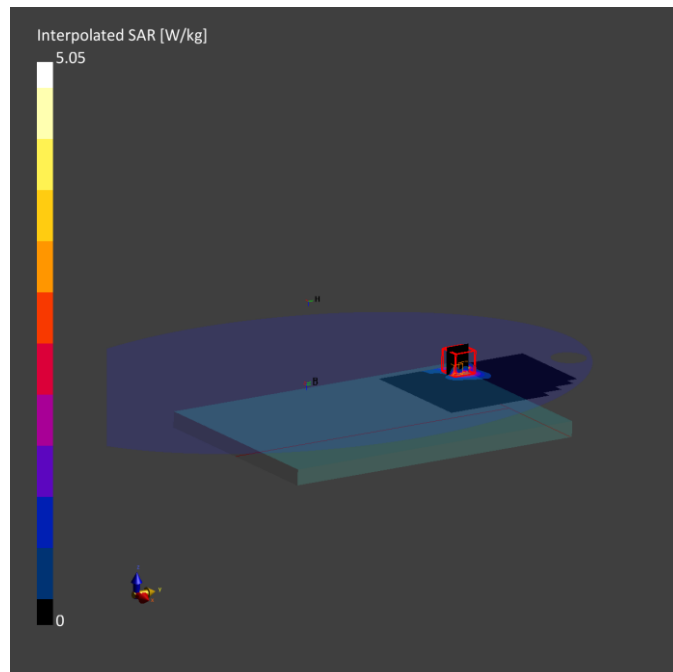

5. System Check Body Liquid 2450.0MHz

Device under Test Properties

Name, Manufacturer	Dimensions [mm]	Serial Number	DUT Type
D2.45GHzV2, SPEAG	50.0 x 10.0 x 8.0	937	Validation Dipole

Exposure Conditions

Phantom Section, TSL	Position, Test Distance [mm]	Band	Group, UID	Frequency [MHz], Channel Number	Conversion Factor	TSL Conductivity [S/m]	TSL Permittivity
Flat MSL			,	2450.0	7.32	1.92	50.8

Hardware Setup

Phantom	TSL, Measured Date	Probe, Calibration Date	DAE, Calibration Date
ELI V8.0 (20deg probe tilt) - xxxx	MBBL-600-6000 , 2022-Apr-11	EX3DV4 - SN3978, 2021-05-21	DAE4 Sn1429, 2021-05-11

Scan Setup

	Area Scan	Zoom Scan
Grid Extents [mm]	40.0 x 80.0	30.0 x 30.0 x 30.0
Grid Steps [mm]	10.0 x 10.0	5.0 x 5.0 x 1.5
Sensor [mm]	Surface 3.0	1.4
Graded Grid	Yes	Yes
Grading Ratio	1.5	1.5
MAIA	Confirmed by MAIA	Confirmed by MAIA
Surface Detection	Yes	Yes
Scan Method	Measured	Measured

Measurement Results

	Area Scan	Zoom Scan
Date	2022-04-11, 14:03	2022-04-11, 14:10
psSAR1g [W/Kg]	2.66	2.54
psSAR10g [W/Kg]	1.21	1.21
Power Drift [dB]	-0.01	0.01
Power Scaling	Disabled	Disabled
Scaling Factor		
TSL Correction	Positive Only	Positive Only

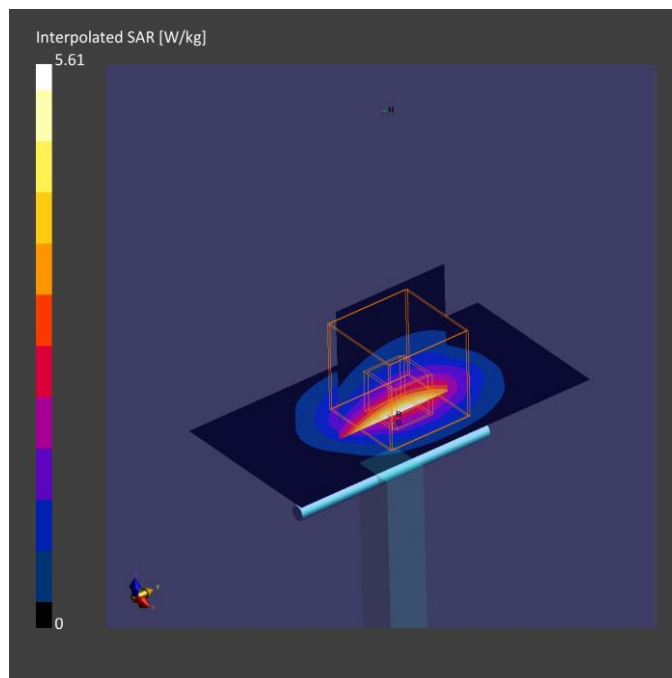

6. System Check Body Liquid 5300.0MHz

Device under Test Properties

Name, Manufacturer	Dimensions [mm]	Serial Number	DUT Type
D5.0GHzV2, SPEAG	50.0 x 10.0 x 8.0	1164	Validation Dipole

Exposure Conditions

Phantom Section, TSL	Position, Test Distance [mm]	Band	Group, UID	Frequency [MHz], Channel Number	Conversion Factor	TSL Conductivity [S/m]	TSL Permittivity
Flat MSL			,	5300.0	4.11	5.34	46.0

Hardware Setup

Phantom	TSL, Measured Date	Probe, Calibration Date	DAE, Calibration Date
ELI V8.0 (20deg probe tilt) - xxxx	MABL-600-6000 , 2022-Apr-11	EX3DV4 - SN3978, 2021-05-21	DAE4 Sn1429, 2021-05-11

Scan Setup

	Area Scan	Zoom Scan
Grid Extents [mm]	40.0 x 80.0	22.0 x 22.0 x 22.0
Grid Steps [mm]	10.0 x 10.0	4.0 x 4.0 x 1.4
Sensor Surface [mm]	3.0	1.4
Graded Grid	Yes	Yes
Grading Ratio	1.5	1.4
MAIA	Confirmed by MAIA	Confirmed by MAIA
Surface Detection	Yes	Yes
Scan Method	Measured	Measured

Measurement Results

	Area Scan	Zoom Scan
Date	2022-04-11, 14:55	2022-04-11, 15:01
psSAR1g [W/Kg]	3.01	3.38
psSAR10g [W/Kg]	0.967	1.01
Power Drift [dB]	0.01	-0.03
Power Scaling	Disabled	Disabled
Scaling Factor		
TSL Correction	Positive Only	Positive Only

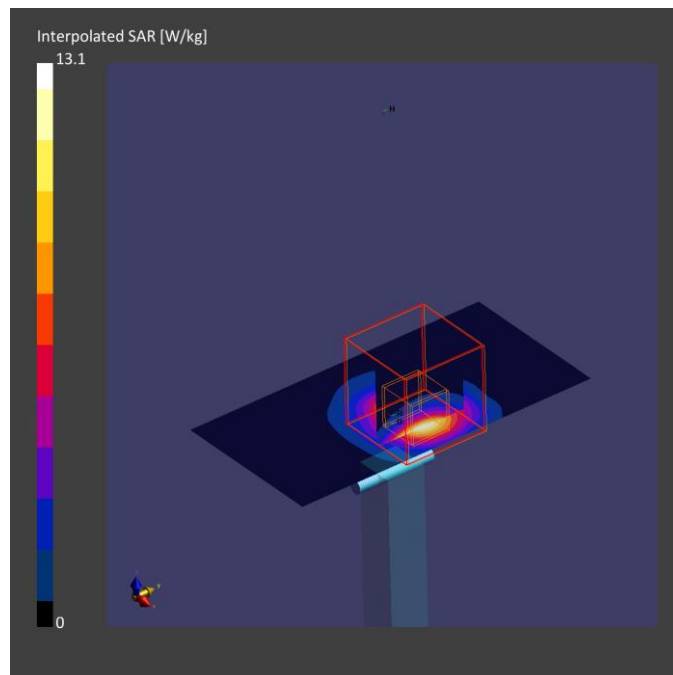

7. System Check Body Liquid 5600.0MHz

Device under Test Properties

Name, Manufacturer	Dimensions [mm]	Serial Number	DUT Type
D5.0GHzV2, SPEAG	50.0 x 10.0 x 8.0	1164	Validation Dipole

Exposure Conditions

Phantom Section, TSL	Position, Test Distance [mm]	Band	Group, UID	Frequency [MHz], Channel Number	Conversion Factor	TSL Conductivity [S/m]	TSL Permittivity
Flat MSL			,	5600.0	3.73	5.72	45.6

Hardware Setup

Phantom	TSL, Measured Date	Probe, Calibration Date	DAE, Calibration Date
ELI V8.0 (20deg probe tilt) - xxxx	MBBL-600-6000 , 2022-Apr-11	EX3DV4 - SN3978, 2021-05-21	DAE4 Sn1429, 2021-05-11

Scan Setup

	Area Scan	Zoom Scan
Grid Extents [mm]	40.0 x 80.0	22.0 x 22.0 x 22.0
Grid Steps [mm]	10.0 x 10.0	4.0 x 4.0 x 1.4
Sensor Surface [mm]	3.0	1.4
Graded Grid	Yes	Yes
Grading Ratio	1.5	1.4
MAIA	Confirmed by MAIA	Confirmed by MAIA
Surface Detection	Yes	Yes
Scan Method	Measured	Measured

Measurement Results

	Area Scan	Zoom Scan
Date	2022-04-11, 16:03	2022-04-11, 16:10
psSAR1g [W/Kg]	3.44	3.99
psSAR10g [W/Kg]	1.11	1.14
Power Drift [dB]	-0.03	-0.05
Power Scaling	Disabled	Disabled
Scaling Factor [dB]		
TSL Correction	Positive Only	Positive Only

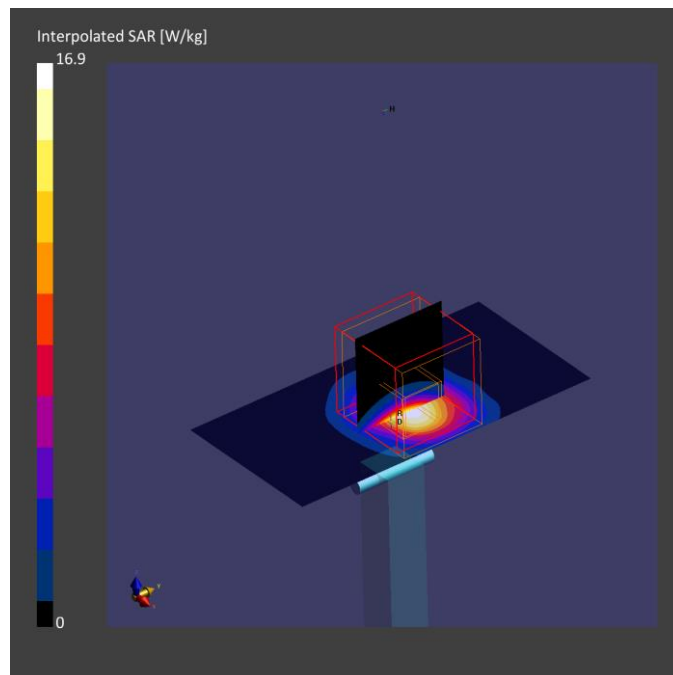

8. System Check Body Liquid 5800.0MHz

Device under Test Properties

Name, Manufacturer	Dimensions [mm]	Serial Number	DUT Type
D5.0GHzV2, SPEAG	50.0 x 10.0 x 8.0	1164	Validation Dipole

Exposure Conditions

Phantom Section, TSL	Position, Test Distance [mm]	Band	Group, UID	Frequency [MHz], Channel Number	Conversion Factor	TSL Conductivity [S/m]	TSL Permittivity
Flat MSL			,	5800.0	3.76	6.23	48.5

Hardware Setup

Phantom	TSL, Measured Date	Probe, Calibration Date	DAE, Calibration Date
ELI V8.0 (20deg probe tilt) - xxxx	MABL-600-6000 , 2022-Apr-07	EX3DV4 - SN3978, 2021-05-21	DAE4 Sn1429, 2021-05-11

Scan Setup

	Area Scan	Zoom Scan
Grid Extents [mm]	40.0 x 80.0	22.0 x 22.0 x 22.0
Grid Steps [mm]	10.0 x 10.0	4.0 x 4.0 x 1.4
Sensor Surface [mm]	3.0	1.4
Graded Grid	Yes	Yes
Grading Ratio	1.5	1.4
MAIA	Confirmed by MAIA	Confirmed by MAIA
Surface Detection	Yes	Yes
Scan Method	Measured	Measured

Measurement Results

	Area Scan	Zoom Scan
Date	2022-04-08, 14:59	2022-04-08, 15:05
psSAR1g [W/Kg]	2.97	3.48
psSAR10g [W/Kg]	0.932	1.01
Power Drift [dB]	-0.12	-0.10
Power Scaling	Disabled	Disabled
Scaling Factor [dB]		
TSL Correction	Positive Only	Positive Only

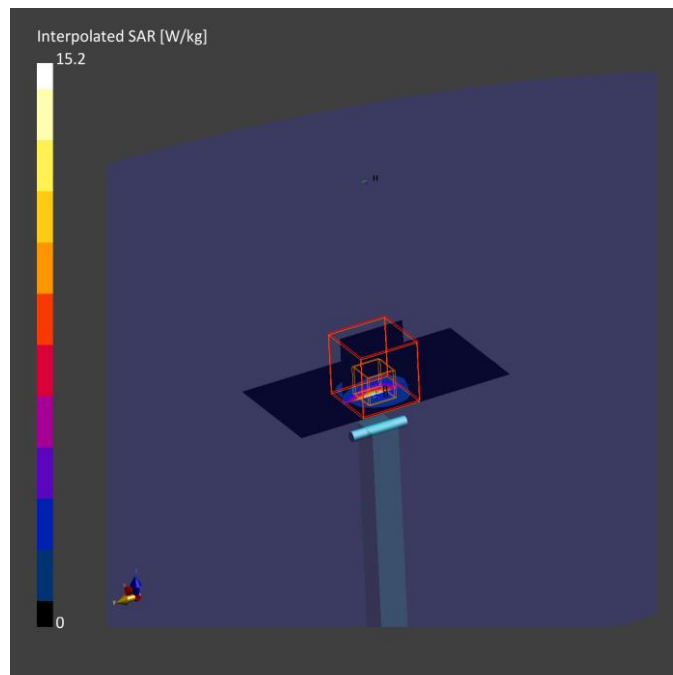

Annex D. TSL Dielectric Parameters

Freq.(MHz)	Target		Measured 2022-04-11	
	ϵ' (F/m)	σ (S/m)	ϵ' (F/m)	σ (S/m)
2400	52.77	1.90	50.84	1.87
2450	52.70	1.95	50.79	1.92
2500	52.64	2.02	50.74	1.96

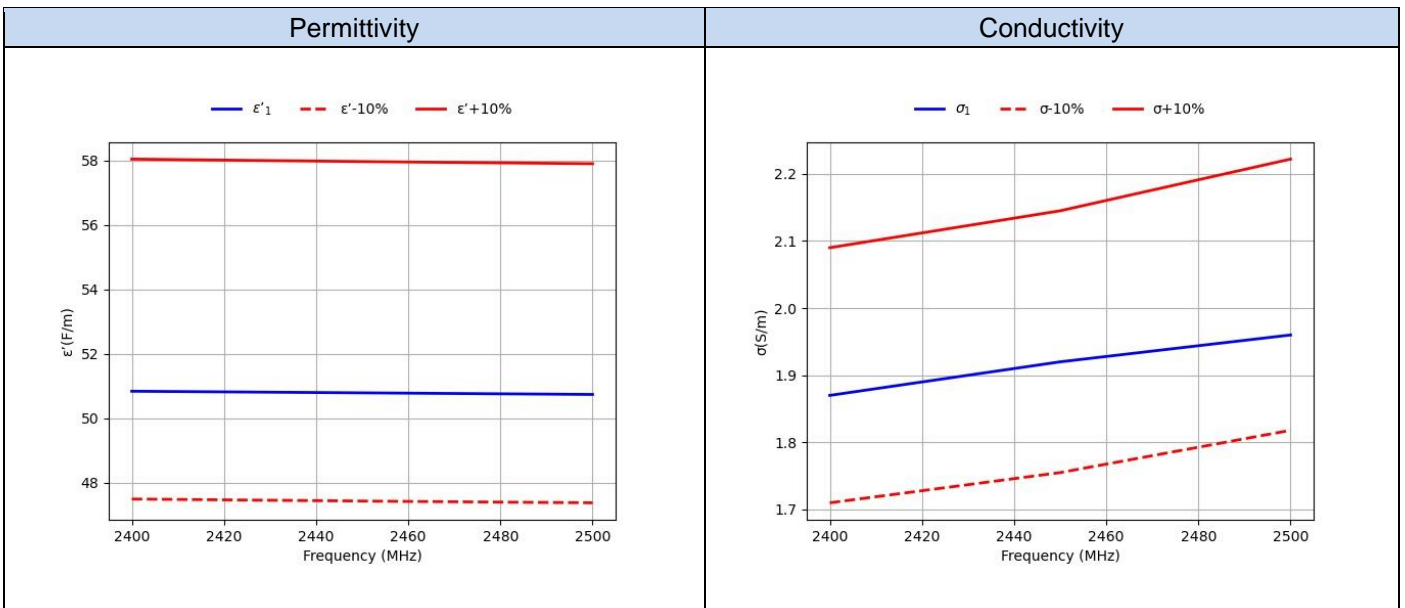

D.1 Body 5200MHz-5800MHz

Freq.(MHz)	Target		Measured 2022-04-11		Measured 2022-04-07	
	ϵ' (F/m)	σ (S/m)	$\epsilon'1$ (F/m)	$\sigma1$ (S/m)	$\epsilon'2$ (F/m)	$\sigma2$ (S/m)
5100	49.15	5.18	46.39	5.03	49.77	5.19
5150	49.08	5.24	46.27	5.10	49.69	5.27
5200	49.01	5.30	46.18	5.18	49.60	5.35
5250	48.95	5.36	46.09	5.26	49.52	5.43
5300	48.88	5.42	46.01	5.34	49.45	5.52
5350	48.81	5.47	45.94	5.41	49.37	5.59
5400	48.74	5.53	45.86	5.48	49.30	5.67
5450	48.67	5.59	45.80	5.54	49.22	5.74
5500	48.61	5.65	45.74	5.60	49.15	5.80
5550	48.54	5.71	45.69	5.66	49.08	5.87
5600	48.47	5.77	45.62	5.72	48.98	5.94
5650	48.40	5.82	45.54	5.80	48.87	6.02
5700	48.34	5.88	45.44	5.87	48.75	6.09
5750	48.27	5.94	45.34	5.94	48.61	6.16
5800	48.20	6.00	45.24	6.01	48.49	6.23
5850	48.13	6.06	45.12	6.08	48.36	6.30
5900	48.06	6.12	45.00	6.16	48.23	6.37

