

# TEST REPORT

EUT Description	<b>WLAN and BT, 2x2 PCIe M.2 2230 adapter card</b>
Brand Name	<b>Intel® Wi-Fi 6 AX204</b>
Model Name	<b>AX204NGW</b>
FCC ID / IC ID	<b>FCC ID:PD9AX204NG ; IC ID: 1000M-AX204NG</b>
Date of Test Start/End	<b>2022-03-05 / 2022-03-15</b>
Features	<b>802.11ax R2, Dual Band, 2x2 Wi-Fi 6 + Bluetooth® 5.2</b> (see section 5)

Applicant	<b>Intel Mobile Communications</b>
Address	<b>100 Center Point Circle, Suite 200 Columbia, South Carolina 29210 USA</b>
Contact Person	<b>Steven Hackett</b>
Telephone/Fax/ Email	<b>steven.c.hackett@intel.com</b>

Reference Standards	<b>FCC CFR Title 47 Part 15 E RSS-247 issue 2, RSS-Gen issue 5 - A1</b> (see section 1)
---------------------	--

Test Report identification	<b>220225-01.TR03</b>
Revision Control	<b>Rev. 00 This test report revision replaces any previous test report revision</b> (see section 8)

The test results relate only to the samples tested.  
Reference to accreditation shall be used only by full reproduction of test report.

Issued by

Reviewed by

Khodor RIDA  
(Test Engineer Lead)

Zayd OUACHICHA  
(Technical Manager Deputy)

**Intel Corporation S.A.S – WRF Lab**  
**425 rue de Goa – Le Cargo B6 - 06600, Antibes, France**  
**Tel. +33493001400 / Fax +33493001401**

# Table of Contents

---

<b>1. Standards, reference documents and applicable test methods .....</b>	<b>3</b>
<b>2. General conditions, competences and guarantees .....</b>	<b>3</b>
<b>3. Environmental Conditions .....</b>	<b>3</b>
<b>4. Test samples .....</b>	<b>4</b>
<b>5. EUT Features .....</b>	<b>5</b>
<b>6. Remarks and comments .....</b>	<b>6</b>
<b>7. Test Verdicts summary .....</b>	<b>6</b>
7.1. 802.11 A/N/AC/AX – U-NII- 3 .....	6
<b>8. Document Revision History .....</b>	<b>6</b>
<b>Annex A. Test &amp; System Description .....</b>	<b>7</b>
A.1 MEASUREMENT SYSTEM.....	7
A.2 TEST EQUIPMENT LIST .....	9
A.3 MEASUREMENT UNCERTAINTY EVALUATION .....	11
<b>Annex B. Test Results U-NII-3.....</b>	<b>12</b>
B.1 TEST CONDITIONS.....	12
B.2 TEST RESULTS TABLES .....	13
B.2.1 6dB & 99% Bandwidth .....	13
B.2.2 Power Limits. Maximum output power & Maximum power spectral Density.....	16
B.2.3 Undesirable emission limits : out of band (Conducted).....	24
B.2.4 Radiated spurious emission.....	25
B.3 TEST RESULTS SCREENSHOT .....	43
B.3.1 6dB Bandwidth .....	43
B.3.2 99% Bandwidth.....	47
B.3.3 Maximum output power .....	51
B.3.4 Undesirable emission limits : out of band (Conducted).....	58
<b>Annex C. Photographs .....</b>	<b>67</b>
C.1 TEST SETUP .....	67
C.2 TEST SAMPLE .....	69

## 1. Standards, reference documents and applicable test methods

FCC	<ol style="list-style-type: none"> <li>1. FCC Title 47 CFR part 15 – Subpart E – Unlicensed National Information Infrastructure Devices. 2019-10-01 Edition</li> <li>2. FCC Title 47 CFR part 15 – Subpart C – §15.209 Radiated emission limits; general requirements. 2019-10-01 Edition</li> <li>3. FCC OET KDB 789033 D02 v02r01 - General U-NII Test Procedures New Rules – Guidelines for compliance testing of Unlicensed National Information Infrastructure (U-NII) Devices (Part 15, Subpart E)</li> <li>4. FCC OET KDB 662911 D01 v02r01 - Emissions Testing of Transmitters with Multiple Outputs in the Same Band.</li> <li>5. ANSI C63.10-2013 American National Standard of Procedures for Compliance Testing of Unlicensed Wireless Devices.</li> </ol>
ISED	<ol style="list-style-type: none"> <li>1. RSS-Gen Issue 5 Amendment 1 - General Requirements for Compliance of Radio Apparatus.</li> <li>2. RSS-247 Issue 2 - Digital Transmission Systems (DTSs), Frequency Hopping Systems (FHSs) and License-Exempt Local Area Network (LE-LAN) Devices.</li> <li>3. FCC OET KDB 789033 D02 v02r01 - General U-NII Test Procedures New Rules – Guidelines for compliance testing of Unlicensed National Information Infrastructure (U-NII) Devices (Part 15, Subpart E)</li> <li>4. FCC OET KDB 662911 D01 v02r01 - Emissions Testing of Transmitters with Multiple Outputs in the Same Band.</li> <li>5. ANSI C63.10-2013 American National Standard of Procedures for Compliance Testing of Unlicensed Wireless Devices</li> </ol>

## 2. General conditions, competences and guarantees

- ✓ Tests performed under FCC standards identified in section 1 are covered by A2LA accreditation.
- ✓ Tests performed under ISED standards identified in section 1 are covered by Cofrac accreditation.
- ✓ Intel Corporation SAS Wireless RF Lab (Intel WRF Lab) is an ISO/IEC 17025:2017 laboratory accredited by the American Association for Laboratory Accreditation (A2LA) with the certificate number 3478.01.
- ✓ Intel Corporation SAS Wireless RF Lab (Intel WRF Lab) is an Accredited Test Firm recognized by the FCC, with Designation Number FR0011.
- ✓ Intel Corporation SAS Wireless RF Lab (Intel WRF Lab) is an ISO/IEC 17025:2017 testing laboratory accredited by the French Committee for Accreditation (Cofrac) with the certificate number 1-6736.
- ✓ Intel Corporation SAS Wireless RF Lab (Intel WRF Lab) is a Registered Test Site listed by ISED, with ISED #1000Y.
- ✓ Intel WRF Lab declines any responsibility with respect to the identified information provided by the customer and that may affect the validity of results.
- ✓ Intel WRF Lab only provides testing services and is committed to providing reliable, unbiased test results and interpretations.
- ✓ Intel WRF Lab is liable to the client for the maintenance of the confidentiality of all information related to the item under test and the results of the test.
- ✓ Intel WRF Lab has developed calibration and proficiency programs for its measurement equipment to ensure correlated and reliable results to its customers.
- ✓ This report is only referred to the item that has undergone the test.
- ✓ This report does not imply an approval of the product by the Certification Bodies or competent Authorities.

## 3. Environmental Conditions

- ✓ At the site where the measurements were performed the following limits were not exceeded during the tests:

Temperature	22.0°C ± 2.1°C
Humidity	44.0% ± 16.0%

#### 4. Test samples

Sample	Control #	Description	Model	Serial #	Date of receipt	Note
#01	220225-01.S01	WiFi Module	AX204NGW	C8CB9E88AA68	2022-03-04	Used for 30 MHz-1 GHz and 18-40 GHz Spurious Emissions tests
	200611-01.S09	Adaptor	PowerBy SNJ A4	-	2020-11-30	
	200602-03.S06	Absorber	-	-	2020-07-03	
	200611-03.S31	Extender	ADEXELEC	-	2020-08-19	
	200615-05.S09	Laptop	Latitude 5401	GVGLK13	2020-06-12	
	210611-02.S13	Main Antenna	SkyCross	-	2021-07-02	
	210611-02.S14	Aux Antenna	SkyCross	-	2021-07-02	
#02	220225-01.S02	WiFi Module	AX204NGW	C8CB9E8A9BE	2022-03-04	Used for 1 GHz-18 GHz Spurious Emission tests
	210611-02.S17	Adaptor	PowerBy SNJ A4	-	2021-07-02	
	200602-03.S06	Absorber	-	-	2020-07-03	
	200611-03.S26	Extender	ADEXELEC	-	2020-07-01	
	170000-01.S01	Laptop	Latitude E5470	DBPLMC2	2017-03-28	
	210611-02.S11	Main Antenna	SkyCross	-	2021-07-02	
	210611-02.S12	Aux Antenna	SkyCross	-	2021-07-02	
#03	220225-01.S05	WiFi Module	AX204NGW	C8CB9E88A93C	2022-03-04	RF Conducted
	170000-01.S02	Laptop	Latitude E5470	21HTPF2	2017-03-28	
	200611-01.S12	Extender	XVT EXTENDER SNJ A4	-	2020-11-30	

## 5. EUT Features

The herein information is provided by the customer

Brand Name	Intel® Wi-Fi 6 AX204		
Model Name	AX204NGW		
Software Version	DRTU_01188_99.0.69C		
Driver Version	99.0.70.4		
Prototype / Production	Production		
Supported Radios	802.11b/g/n/ax	2.4GHz (2400.0 – 2483.5 MHz)	
	802.11a/n/ac/ax	5.2GHz (5150.0 – 5350.0 MHz) 5.6GHz (5470.0 – 5725.0 MHz) 5.8GHz (5725.0 – 5895.0 MHz)	
Antenna Information	Bluetooth 5.2	2.4GHz (2400.0 – 2483.5 MHz)	
	Transmitter	Chain 1 (A) / Aux	Chain 2 (B) / Main
	Manufacturer	SkyCross	SkyCross
	Antenna type	PIFA Antenna	PIFA Antenna
	Part number	NA	NA
	Declared antenna gain (dBi)	+5 dBi	+5 dBi

## 6. Remarks and comments

1. No deviations were made from the test methods listed in section 1 of this report
2. Only the worst-case plot per 802.11 mode and test case measurements have been reported excepted for band edge measurements where all plots are reported

## 7. Test Verdicts summary

The statement of conformity to applicable standards in the table below are based on the measured values, without taking into account the measurement uncertainties.

### 7.1. 802.11 a/n/ac/ax – U-NII- 3

FCC part	RSS clause	Test name	Verdict
15.407 (a) (3)	RSS-247 Clause 6.2.4.1	Maximum output power	P
15.407 (a) (3)	RSS-247 Clause 6.2.4.1	Power spectral density	P
15.407 (b) (3)	RSS-247 Clause 6.2.4.2	Undesirable emissions limits: out of band (conducted)	P
15.407 (b) (3) 15.209	RSS-247 Clause 6.2.4.2 RSS-GEN A1 Clause 8.9	Undesirable emissions limits: Spurious emissions (radiated)	P

## 8. Document Revision History

Revision #	Modified by	Revision Details
Rev. 00	N.Bui, V.Kaculini	First Issue

# Annex A. Test & System Description

## A.1 Measurement System

Measurements were performed using the following setups, made in accordance to the general provisions of FCC KDB 789033 D02 General UNII Test Procedures.

The DUT was installed in a test fixture and this test fixture is connected to a laptop computer and AC/DC power adapter. The laptop computer was used to configure the EUT to continuously transmit at a specified output power using all different modes and modulation schemes, using the Intel proprietary tool DRTU.

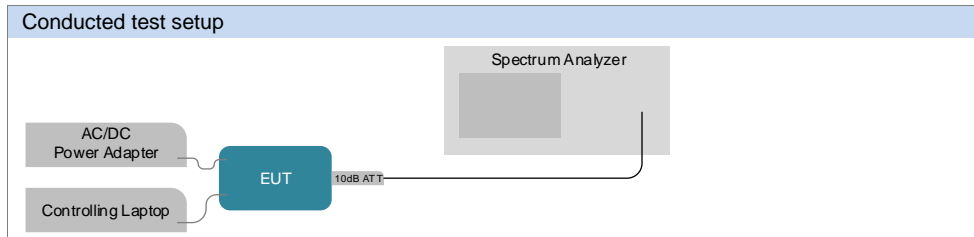

### Radiated test setup

#### Radiated Setup 30 MHz - 1 GHz (Transmitter tests)

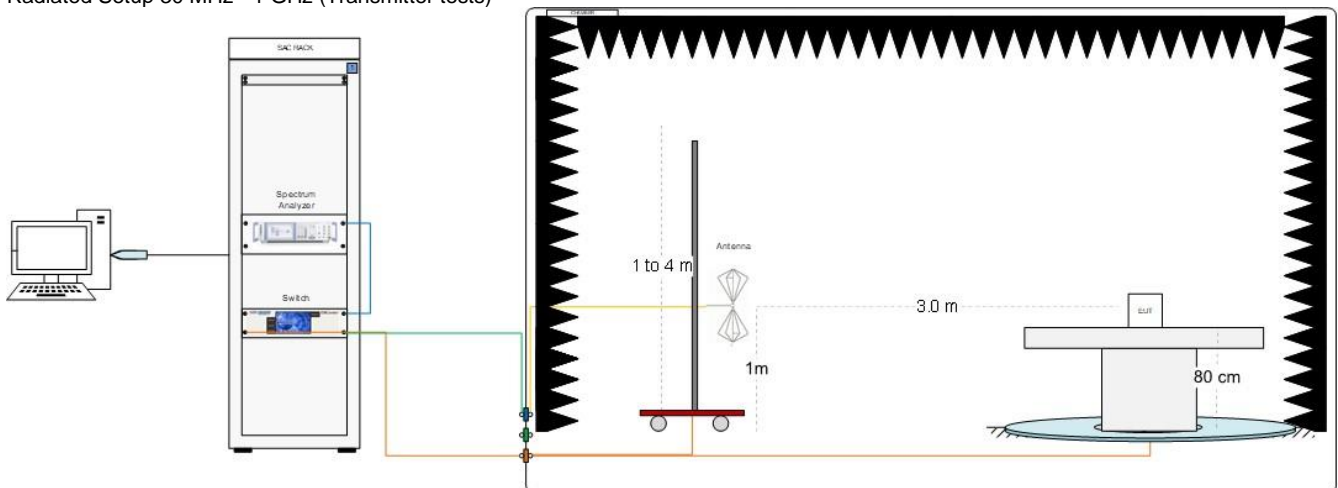

#### Radiated Setup 1 GHz - 9.5 GHz (Transmitter tests)

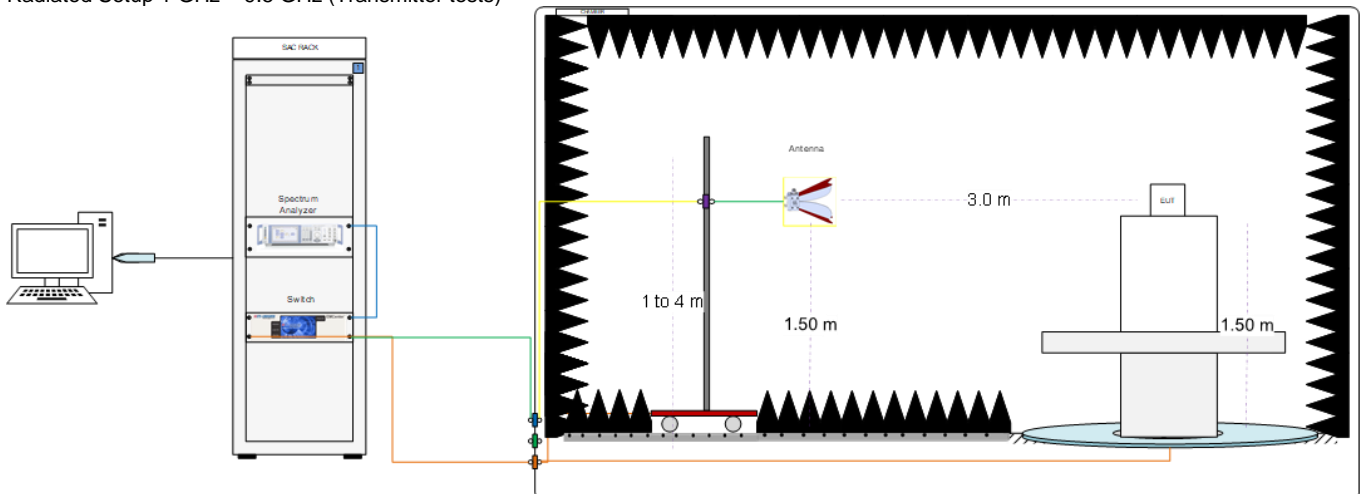

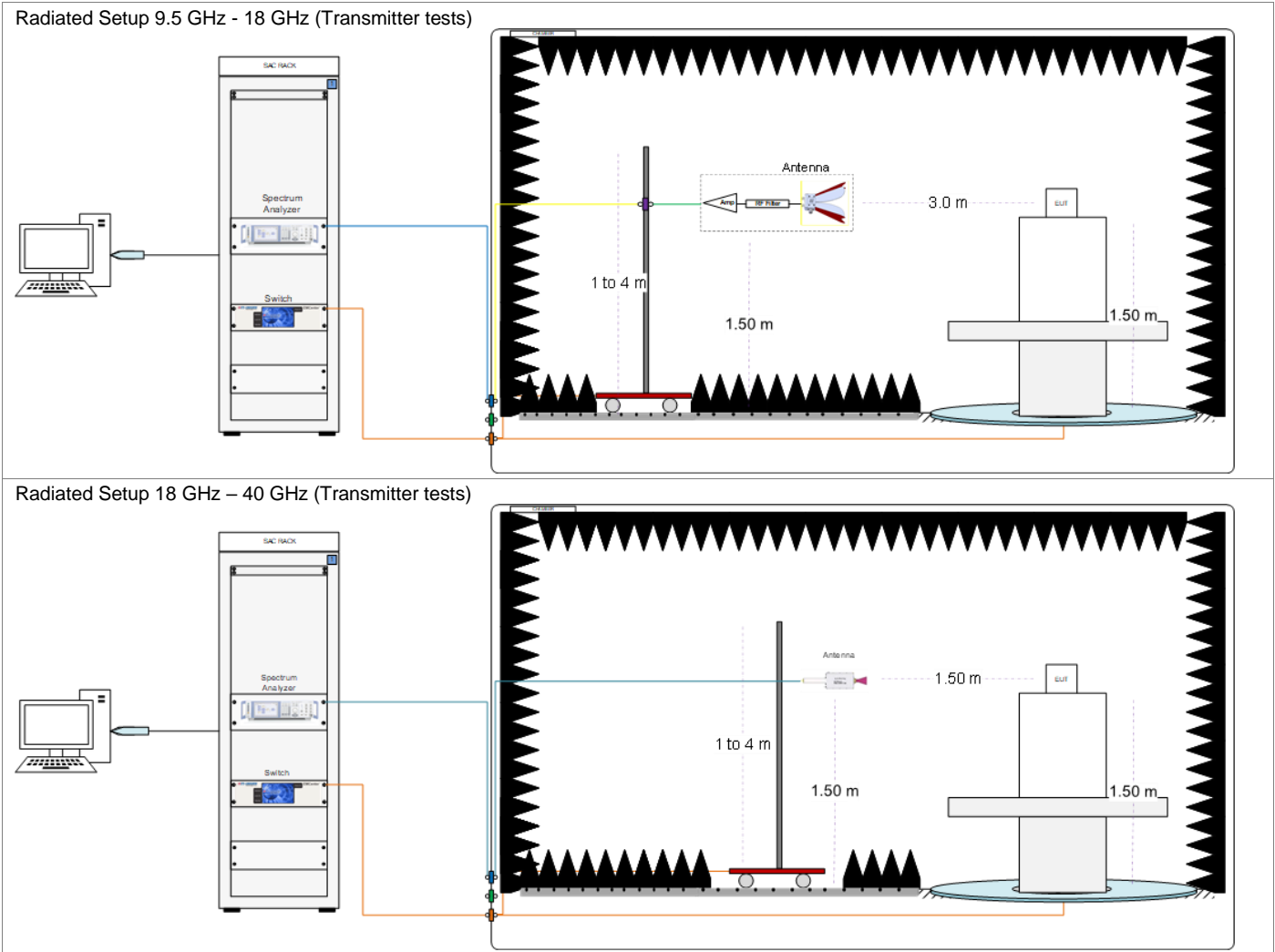

Sample Calculation

The spurious received voltage  $V(\text{dB}\mu\text{V})$  in the spectrum Analyzer is converted to Electric field strength using the transducer factor  $F$  corresponding to the Rx path Loss:

$$F \text{ (dB/m)} = \text{Rx Antenna Factor (dB/m)} + \text{Cable losses (dB)} - \text{Amplifiers Gain (dBi)}$$

$$E \text{ (dB}\mu\text{V/m)} = V(\text{dB}\mu\text{V}) + F \text{ (dB/m)}$$

For field strength measurements made at other than the distance at which the applicable limit is specified, the field strength of the emission at the distance specified by the limit is deduced as follows:

$$E_{\text{SpecLimit}} = E_{\text{Meas}} + 20 \cdot \log(D_{\text{Meas}}/D_{\text{SpecLimit}})$$

where

$E_{\text{SpecLimit}}$  is the field strength of the emission at the distance specified by the limit, in  $\text{dB}\mu\text{V/m}$

$E_{\text{Meas}}$  is the field strength of the emission at the measurement distance, in  $\text{dB}\mu\text{V/m}$

$D_{\text{Meas}}$  is the measurement distance, in  $m$

$D_{\text{SpecLimit}}$  is the distance specified by the limit, in  $m$



## A.2 Test Equipment List

### Conducted setup

ID#	Device	Type/Model	Serial #	Manufacturer	Cal. Date	Cal. Due Date
265-000	Spectrum Analyzer	FSV30	101318	Rohde & Schwarz	2020-05-28	2022-05-28
019-000	RF cable 100cm	PE360-100CM	N/A	PASTERNAK	2022-02-04	2022-08-04
019-002	10dB Attenuator + MH4	N/A	N/A	N/A	2022-02-04	2022-08-04
322-000	Temp & Humidity Logger	RA12E-TH1-RAS	RA12-B89702	AVTECH	2021-09-02	2023-09-02
413-000	Measurement SW v1.5.4.2	Octopi	N/A	Step AT	N/A	N/A

### Radiated Setup #1

ID#	Device	Type/Model	Serial #	Manufacturer	Cal. Date	Cal. Due Date
006-000	Anechoic chamber	FACT 3	5720	ETS Lindgren	2022-01-21	2024-01-21
006-001	Turntable	-	-	ETS Lindgren	N/A	N/A
006-008	Measurement Software v11.30.00	EMC32	100623	Rohde & Schwarz	N/A	N/A
147-000	Spectrum analyzer	FSW43	101847	Rohde & Schwarz	2020-11-02	2022-11-02
006-002	Switch & Positioning	EMC center	00159757	ETS Lindgren	N/A	N/A
006-011	Boresight antenna mast	BAM4.0-P	P/278/2890.01	Maturo	N/A	N/A
006-019	Biconical antenna 30 MHz – 1 GHz	UBAA9115 + BBVU9135 + DGA9552N	0286 + CH 9044	Schwarzbeck	2022-02-01	2024-02-01
006-020	Double Ridged Horn Antenna 1 GHz – 18 GHz	3117	00157734	ETS Lindgren	2021-08-05	2023-08-05
057-000	Horn Antenna 3117 + Amplifier + HPF9.5	3117	00167062+00169546	ETS-Lindgren	2020-06-15	2022-06-15
007-008	Double Horn Ridged antenna+Amplifier	3116C-PA	00169308bis + 00196308	ETS-Lindgren	2021-08-05	2023-08-05
006-059	RF Cable 7.0m	R286304174	20.46.369	Radiall	2022-03-04	2022-09-04
006-051	RF Cable 1.0m	CBL-1.5M-SMSM+	202879	Mini-Circuits	2022-02-02	2022-08-02
006-030	RF Cable 1.2m	UFA147A-0-0480-200200	MFR 64639223720-003	Micro-coax	2022-02-02	2022-08-02
006-034	RF Cable 1.0m	UFA147A	-	Utilflex	2022-02-02	2022-08-02
006-036	RF Cable 1.0m	UFB311A-0-0590-50U50U	MFR 64639 223230-001	Micro-coax	2022-02-02	2022-08-02
006-038	RF Cable 7.0m	R286304009	-	Radiall	2022-02-02	2022-08-02
006-039	RF Cable 2.5m	0500990992500KE	19.23.395	Radiall	2022-02-02	2022-08-02
365-000	Temperature & Humidity logger	RA12E-TH1-RAS	00-80-A3-E1-6E-55	Avtech	2021-03-08	2023-03-08

N/A: Not Applicable

Radiated Setup #2

ID#	Device	Type/Model	Serial #	Manufacturer	Cal. Date	Cal. Due Date
007-000	Anechoic chamber	RFD-FA-100	5996	ETS Lindgren	2021-09-14	2023-09-14
007-002	Turntable	-	-	ETS Lindgren	N/A	N/A
007-003	Antenna Tower	2171B-3.0M	00150123	ETS Lindgren	N/A	N/A
007-006	Switch & Positioner	EMCenter	00151232	ETS Lindgren	N/A	N/A
007-005	Measurement SW, V11.20.00	EMC32	100401	Rohde & Schwarz	N/A	N/A
127-000	Spectrum Analyzer	FSV40	101358	Rohde & Schwarz	2021-01-15	2023-01-15
007-007	Double Ridge Horn (1-18GHz)	3117	00152266	ETS Lindgren	2020-03-18	2022-03-18
057-000	Horn Antenna 3117 + Amplifier + HPF9.5	3117	00167062+00169546	ETS-Lindgren	2020-06-15	2022-06-15
007-008	Double Horn Ridged antenna+Amplifier	3116C-PA	00169308bis 00196308	ETS-Lindgren	2021-08-05	2023-08-05
007-022	RF Cable 1-18GHz, 1.5m	0501050991200GX	19.23.493	Radiall	2022-02-03	2022-08-03
007-020	RF Cable 1-18GHz, 1.2 m	2301761761200PJ	12.22.1104	Radiall	2022-02-03	2022-08-03
007-011	RF Cable 1-18GHz - 6.5m	140-8500-11-51	001	Spectrum	2022-02-03	2022-08-03
007-015	RF Cable 1GHz-18GHz 1.5m	-	-	Spirent	2022-02-03	2022-08-03
007-014	RF Cable 18-40 GHz 6m	R286304009	1747364	Radiall	2022-02-03	2022-08-03
007-023	RF Cable 1m DC-40GHz	PE360-100CM	-	Pasternack	2022-02-03	2022-08-03
007-018	RF Cable 1-9.5GHz 1.2m	0500990991200KE	-	Radiall	2022-02-03	2022-08-03
325-000	Temp & Humidity Logger	RA12E-TH1-RAS	RA12-B9B7C6	Avtech	2022-01-17	2024-01-17

N/A: Not Applicable

Shared Radiated Equipment

ID#	Device	Type/Model	Serial #	Manufacturer	Cal. Date	Cal. Due Date
412-000	DRTU Power finder V2.0	-	-	Intel	NA	NA
139-000	Power Sensor	NRP-Z81	104383	Rohde & Schwarz	2021-04-07	2023-04-07
140-000	Power Sensor	NRP-Z81	104382	Rohde & Schwarz	2020-04-08	2022-04-08

### A.3 Measurement Uncertainty Evaluation

The system uncertainty evaluation is shown in the table below with a coverage factor of  $k = 2$  to indicate a 95% level of confidence:

Measurement type	Uncertainty	Unit
Timing	$\pm 0.12$	%
Power Spectral density	$\pm 1.47$	dB
Occupied bandwidth	$\pm 2.07$	%
Conducted Power	$\pm 1.03$	dB
Conducted Spurious Emission <40 GHz	$\pm 3.45$	dB
Radiated tests <1GHz	$\pm 6.07$	dB
Radiated tests 1GHz – 40 GHz	$\pm 6.04$	dB

# Annex B. Test Results U-NII-3

The herein test results were performed by:

Test case measurement	Test Personnel
6dB and 99% Bandwidth	C.Requin, V.Kaculini
Maximum output power & Maximum PSD	C.Requin, V.Kaculini
Undesirable emission limits: out of band	C.Requin, V.Kaculini
Radiated spurious emissions	K.Khatib, R.Simonini

## B.1 Test Conditions

For 802.11a mode the EUT can transmit at both CHAIN A and CHAIN B RF outputs individually, but not simultaneously.

For 802.11n20 & 802.11ax20 (20 MHz channel bandwidth), 802.11n40 and 802.11ax40 (40MHz channel bandwidth) 802.11ac80 & 802.11ax80 (80MHz channel bandwidth) modes the EUT can transmit at both CHAIN A and CHAIN B RF outputs individually, and also simultaneously.

The conducted RF output power at each chain was adjusted according to the client's supplied target values (see following table) using the Intel DRTU tool and measuring the power by using a spectrum analyser with the channel integration method according to section II) E) 2) e) (Method SA-2 Alternative) of Guidance FCC KDB 789033 D02 Measured values for adjustment were within +/- 0.25 dB from the declared target values..

The following data rates were selected based on preliminary testing that identified those rates as the worst cases for output power and spurious levels at the band edges:

Transmission	Mode	Bandwidth (MHz)	Worst Case Data Rate
SISO	802.11a	20	6Mbps
	802.11n	20	HT0
		40	HT0
	802.11ac	80	VHT0
	802.11ax	20	HE0
		40	HE0
80		HE0	
MIMO	802.11n	20/40	HT8
	802.11ac	80	VHT0
	802.11ax	20/40/80	HE0

## B.2 Test Results Tables

### B.2.1 6dB & 99% Bandwidth

#### Test limits

FCC part	RSS clause	Limits
15.407 (e)	RSS-247 Clause 6.2.4.1	For equipment operating in the band 5725-5850 MHz, the minimum 6 dB bandwidth shall be at least 500 kHz.

#### Test procedure

The conducted setup shown in section *Test & System Description* was used to measure the 6dB & 99% Bandwidth. The antenna terminal of the EUT is connected to the spectrum analyzer through an attenuator, and the spectrum analyzer reading is compensated to include the RF path loss.

For the overlapped channels between U-NII-2C and U-NII-3 bands, and according to FCC KDB 789033 D02, the boundary frequency between the bands is used as one edge for defining the portion of the 6dB bandwidth that falls within a particular U-NII band. This rule is only applicable for the 6dB bandwidth and for those channels marked as overlapped.

#### Results tables

##### U-NII-3 channels

Mode	Rate	Antenna	Channel	Freq [MHz]	6dB BW [MHz]	99% BW [MHz]
802.11a	6Mbps	SISO A	149	5745	15.29	16.72
			157	5785	15.13	16.84
			165	5825	15.07	16.64
		SISO B	149	5745	15.09	16.76
			157	5785	15.11	16.72
			165	5825	15.07	16.60
802.11n20	HT0	SISO A	149	5745	14.98	17.80
			157	5785	15.10	17.88
			165	5825	15.40	17.72
		SISO B	149	5745	13.83	17.80
			157	5785	15.02	17.84
			165	5825	15.93	17.80
	HT8	MIMO A	149	5745	15.08	17.76
			157	5785	15.91	17.76
			165	5825	15.03	17.76
		MIMO B	149	5745	15.28	17.80
			157	5785	16.66	17.76
			165	5825	16.27	17.80
802.11n40	HT0	SISO A	151	5755	35.07	36.16
			159	5795	33.87	36.00
		SISO B	151	5755	35.08	36.08
			159	5795	34.10	36.16
	HT8	MIMO A	151	5755	35.02	36.32
			159	5795	35.07	36.08
		MIMO B	151	5755	34.78	36.08
			159	5795	35.01	36.16
			159	5795	35.01	36.16
802.11ac80	VHT0	SISO A	155	5775	75.09	75.04
		SISO B			73.87	75.04
		MIMO A			73.92	75.20
		MIMO B			70.19	75.04
					70.19	75.04

Max Value

Mode	Rate	Antenna	Channel	Freq [MHz]	RU config.	6dB BW [MHz]	99% BW [MHz]
802.11ax20	HE0	SISO A	149	5745	Full	17.61	18.88
					26/0	1.99	18.40
					52/37	16.98	18.52
			157	5785	106/53	17.10	18.44
					Full	15.52	18.88
					Full	15.42	18.92
		SISO B	149	5745	Full	17.25	19.04
					26/0	2.09	18.56
					52/37	17.01	18.36
			157	5785	106/53	17.06	18.28
					Full	14.96	18.92
					Full	15.03	18.92
		MIMO A	149	5745	Full	16.97	18.88
					26/0	2.04	18.64
					52/37	17.01	18.40
			157	5785	106/53	17.06	18.28
					Full	17.80	18.92
					Full	16.86	18.92
		MIMO B	149	5745	Full	14.94	18.92
					26/0	16.98	18.64
					52/37	17.01	18.32
			157	5785	106/53	17.10	18.16
					Full	13.79	18.88
					Full	15.07	18.84
802.11ax40	HE0	SISO A	151	5755	Full	35.50	37.52
					242/61	15.18	18.80
			159	5795	Full	35.03	37.60
					Full	35.94	37.52
		SISO B	151	5755	242/61	16.32	18.72
					Full	35.71	37.36
			159	5795	Full	35.02	37.52
					242/61	16.02	18.80
		MIMO A	151	5755	Full	34.16	37.60
					242/61	17.95	18.80
			159	5795	Full	35.12	37.44
					242/61	17.95	18.80
MIMO B	151	5755	Full	35.07	37.36		
			242/61	17.95	18.80		
	159	5795	Full	35.07	37.36		
			242/61	17.95	18.80		
802.11ax80	HE0	SISO A	155	5775	Full	68.91	76.80
					484/65	36.21	37.44
		SISO B			Full	71.41	76.96
					484/65	34.35	37.28
		MIMO A	Full	73.81	76.80		
			484/65	35.09	37.28		
		MIMO B	Full	68.91	76.80		
			484/65	36.75	37.28		

Max Value

**Overlapped channels between U-NII-2C and U-NII-3**

Mode	Channel	Frequency (MHz)	Antenna	Chain	6dB BW [MHz]	26dB BW UNII-3 [MHz]
802.11n20	144	5720	SISO	A	3.38	6.98
				B	3.38	6.78
			MIMO	A	3.49	6.83
				B	3.35	6.53
802.11n40	142	5710	SISO	A	4.07	5.93
				B	4.04	5.48
			MIMO	A	3.19	6.56
				B	3.16	5.65
802.11ac80	138	5690	SISO	A	4.06	6.71
				B	4.06	6.71
			MIMO	A	4.06	6.33
				B	4.05	6.52
802.11ax20	144	5720	SISO	A	4.17	6.38
				B	3.40	6.68
			MIMO	A	3.38	6.53
				B	3.38	6.33
802.11ax40	142	5710	SISO	A	4.03	6.02
				B	4.03	5.93
			MIMO	A	4.01	6.02
				B	4.09	6.02
802.11ax80	138	5690	SISO	A	4.08	6.33
				B	4.06	6.52
			MIMO	A	4.06	6.71
				B	4.11	5.95

Note, the 26dB bandwidth of the overlapped channels falling in U-NII-3 band is shown in the above table. These values were used to measure the maximum output power in the U-NII-3 band as specified in chapter B.2.2.

**See Section B.3.1 and B.3.2 for the screenshot results.**

## B.2.2 Maximum output power & Maximum power spectral Density

### Test limits

FCC part	RSS clause	Limits
15.407 (a) (3)	RSS-247 Clause 6.2.4.1	For the band 5.725-5.85 GHz, the maximum conducted output power over the frequency band of operation shall not exceed 1 W. In addition, the maximum power spectral density shall not exceed 30 dBm in any 500-kHz band

### Test procedure

The Maximum Conducted Output Power was measured using the channel integration method according to section E) 2) e) (Method SA-2) of FCC KDB 789033 D02

The maximum power spectral density (PSD) was measured using the method according to section F) (Method SA-2) of FCC KDB 789033 D02

In the measure-and-sum approach for MIMO mode, the conducted emission level (e.g., transmit power or power in specified bandwidth) is measured at each antenna port. The measured results at the various antenna ports are then summed mathematically in linear power units to determine the total emission level from the device.

The EIRP power (dBm) is calculated by adding the declared maximum antenna gain to the measured conducted power.

The conducted setup shown in section *Test & System Description* was used to measure the maximum conducted output power and power spectral density. The antenna terminal of the EUT is connected to the spectrum analyser through an attenuator, and the spectrum analyzer reading is compensated to include the RF path loss.

For the overlapped channels between U-NII-2C and U-NII-3, and according to FCC KDB 789033 D02, the power is computed based on the portion of the emission bandwidth (26dB) contained within that band. This rule is only applicable for those channels marked as overlapped.



Results tables
Duty cycle

Mode	Rate	Antenna	Duty Cycle [%]
802.11a	6Mbps	SISO A	97.9
		SISO B	97.9
802.11n20	HT0	SISO A	98.9
		SISO B	98.9
	HT8	MIMO A	98.9
		MIMO B	98.9
802.11ax20	HE0	SISO A	98.8
		SISO B	98.8
		MIMO A	99.3
		MIMO B	99.3
802.11n40	HT0	SISO A	98.9
		SISO B	98.9
	HT8	MIMO A	98.9
		MIMO B	98.9
802.11ax40	HE0	SISO A	98.8
		SISO B	98.8
		MIMO A	99.3
		MIMO B	99.3
802.11ac80	VHT0	SISO A	98.9
		SISO B	98.9
		MIMO A	99.4
		MIMO B	99.4
802.11ax80	HE0	SISO A	98.7
		SISO B	98.7
		MIMO A	99.2
		MIMO B	99.2

Maximum output power – U-NII-3 Channels

Mode	Rate	Channel	Freq [MHz]	Antenna	Average Conducted Output Power [dBm]	Avg Max* Conducted Output Power [dBm]	Avg Max* EIRP [dBm]	Avg Max* Conducted Power [mW]
802.11a	6Mbps	149	5745	SISO A	21.00	21.09	26.09	128.59
				SISO B	20.70	20.79	25.79	120.01
		157	5785	SISO A	21.03	21.12	26.12	129.48
				SISO B	20.90	20.99	25.99	125.67
		165	5825	SISO A	20.96	21.05	26.05	127.41
SISO B	20.89			20.98	25.98	125.38		
802.11n20	HT0	149	5745	SISO A	20.98	20.98	25.98	125.31
				SISO B	20.94	20.94	25.94	124.17
		157	5785	SISO A	20.98	20.98	25.98	125.31
				SISO B	20.85	20.85	25.85	121.62
		165	5825	SISO A	20.87	20.87	25.87	122.18
				SISO B	20.82	20.82	25.82	120.78
	HT8	149	5745	MIMO A	20.85	20.85	25.85	121.62
				MIMO B	20.87	20.87	25.87	122.18
				Combined A+B	23.87	23.87	28.87	243.80
		157	5785	MIMO A	20.82	20.82	25.82	120.78
				MIMO B	20.97	20.97	25.97	125.03
				Combined A+B	23.91	23.91	28.91	245.81
		165	5825	MIMO A	20.79	20.79	25.79	119.95
				MIMO B	20.94	20.94	25.94	124.17
				Combined A+B	23.88	23.88	28.88	244.12
802.11n40	HT0	151	5755	SISO A	20.87	20.87	25.87	122.18
				SISO B	20.80	20.80	25.80	120.23
		159	5795	SISO A	20.84	20.84	25.84	121.34
				SISO B	20.88	20.88	25.88	122.46
	HT8	151	5755	MIMO A	20.80	20.80	25.80	120.23
				MIMO B	20.52	20.52	25.52	112.72
				Combined A+B	23.67	23.67	28.67	232.95
		159	5795	MIMO A	20.84	20.84	25.84	121.34
				MIMO B	20.85	20.85	25.85	121.62
Combined A+B	23.86	23.86	28.86	242.96				
802.11ac80	VHT0	155	5775	SISO A	20.13	20.13	25.13	103.04
				SISO B	19.88	19.88	24.88	97.27
				MIMO A	18.32	18.32	23.32	67.92
				MIMO B	18.32	18.32	23.32	67.92
				Combined A+B	21.33	21.33	26.33	135.84

\* Maximum values are the duty cycle compensated values calculated from the average (measured)

Max Value

Min Value

Mode	Rate	Channel	Freq [MHz]	Antenna	RU config.	Average Conducted Ouput Power [dBm]	Avg Max* Conducted Ouput Power [dBm]	Avg Max*. EIRP [dBm]	Avg Max* Conducted Power [mW]		
802.11ax20	HE0	149	5745	SISO A	Full	20.85	20.85	25.85	121.62		
					26/0	21.15	21.15	26.15	130.32		
					52/37	20.88	20.88	25.88	122.46		
					106/53	20.94	20.94	25.94	124.17		
				SISO B	Full	20.80	20.80	25.80	120.23		
					26/0	20.97	20.97	25.97	125.03		
					52/37	20.78	20.78	25.78	119.67		
					106/53	21.00	21.00	26.00	125.89		
				MIMO A	Full	20.93	20.93	25.93	123.88		
					26/0	17.96	17.96	22.96	62.52		
					52/37	13.99	13.99	18.99	25.06		
					106/53	17.94	17.94	22.94	62.23		
		MIMO B	Full	20.99	20.99	25.99	125.60				
			26/0	18.19	18.19	23.19	65.92				
			52/37	14.08	14.08	19.08	25.59				
			106/53	18.02	18.02	23.02	63.39				
		Combined A+B	Full	23.97	23.97	28.97	249.48				
			26/0	21.09	21.09	26.09	128.43				
			52/37	17.05	17.05	22.05	50.65				
			106/53	20.99	20.99	25.99	125.62				
		157	5785	SISO A	Full	20.85	20.85	25.85	121.62		
				SISO B	Full	20.70	20.70	25.70	117.49		
				MIMO A	Full	20.92	20.92	25.92	123.59		
				MIMO B	Full	20.86	20.86	25.86	121.90		
				Combined A+B	Full	23.90	23.90	28.90	245.49		
		165	5825	SISO A	Full	20.79	20.79	25.79	119.95		
				SISO B	Full	20.94	20.94	25.94	124.17		
				MIMO A	Full	20.87	20.87	25.87	122.18		
				MIMO B	Full	20.84	20.84	25.84	121.34		
				Combined A+B	Full	23.87	23.87	28.87	243.52		
		802.11ax40	HE0	151	5755	SISO A	Full	20.80	20.80	25.80	120.23
							242/61	20.97	20.97	25.97	125.03
						SISO B	Full	20.97	20.97	25.97	125.03
							242/61	21.00	21.00	26.00	125.89
						MIMO A	Full	20.15	20.15	25.15	103.51
							242/61	20.81	20.81	25.81	120.50
MIMO B	Full			20.14	20.14	25.14	103.28				
	242/61			20.89	20.89	25.89	122.74				
Combined A+B	Full			23.16	23.16	28.16	206.79				
	242/61			23.86	23.86	28.86	243.25				
159	5795			SISO A	Full	20.79	20.79	25.79	119.95		
				SISO B	Full	20.78	20.78	25.78	119.67		
				MIMO A	Full	20.88	20.88	25.88	122.46		
				MIMO B	Full	20.55	20.55	25.55	113.50		
		Combined A+B	Full	23.73	23.73	28.73	235.96				
802.11ax80	HE0	155	5775	SISO A	Full	19.82	19.82	24.82	95.94		
					484/65	20.38	20.38	25.38	109.14		
				SISO B	Full	19.84	19.84	24.84	96.38		
					484/65	20.48	20.48	25.48	111.69		
				MIMO A	Full	17.99	17.99	22.99	62.95		
					484/65	20.43	20.43	25.43	110.41		
				MIMO B	Full	18.24	18.24	23.24	66.68		
					484/65	20.32	20.32	25.32	107.65		
				Combined A+B	Full	21.13	21.13	26.13	129.63		
					484/65	23.39	23.39	28.39	218.05		

\* Maximum values are the duty cycle compensated values calculated from the average (measured)

Max Value

Min Value

Maximum output power – Overlapped channels between U-NII-2C and U-NII-3

Mode	Channel	Freq (MHz)	Antenna	Chain	Average Cond. Output Power UNII-3 [dBm]	Max.* Cond. Output Power UNII-3 [dBm]	Max.* EIRP UNII-3 [dBm]	Max.* Cond. Output Power UNII-3 [mW]
802.11n20	144	5720	SISO	A	12.84	12.84	17.84	19.23
				B	13.10	13.10	18.10	20.42
			MIMO	A	10.68	10.68	15.68	11.69
				B	10.51	10.51	15.51	11.25
			Combined	A+B	13.61	13.61	18.61	22.94
802.11n40	142	5710	SISO	A	8.84	8.84	13.84	7.66
				B	8.69	8.69	13.69	7.40
			MIMO	A	8.10	8.10	13.10	6.46
				B	7.88	7.88	12.88	6.14
			Combined	A+B	11.00	11.00	16.00	12.59
802.11ac80	138	5690	SISO	A	5.46	5.46	10.46	3.52
				B	5.25	5.25	10.25	3.35
			MIMO	A	5.26	5.26	10.26	3.36
				B	5.17	5.17	10.17	3.29
			Combined	A+B	8.23	8.23	13.23	6.65
802.11ax20	144	5720	SISO	A	13.08	13.08	18.08	20.32
				B	13.46	13.46	18.46	22.18
			MIMO	A	10.93	10.93	15.93	12.39
				B	10.76	10.76	15.76	11.91
			Combined	A+B	13.86	13.86	18.86	24.30
802.11ax40	142	5710	SISO	A	8.84	8.84	13.84	7.66
				B	8.73	8.73	13.73	7.46
			MIMO	A	8.70	8.70	13.70	7.41
				B	8.47	8.47	13.47	7.03
			Combined	A+B	11.60	11.60	16.60	14.44
802.11ax80	138	5690	SISO	A	5.46	5.46	10.46	3.52
				B	5.23	5.23	10.23	3.33
			MIMO	A	5.16	5.16	10.16	3.28
				B	5.17	5.17	10.17	3.29
			Combined	A+B	8.18	8.18	13.18	6.57

\* Maximum values are the duty cycle compensated values calculated from the average (measured)

Max Value

Min Value

**See Section B.3.3 for the screenshot results**

Maximum Power Spectral Density (PSD) – U-NII-3 channels

Mode	Rate	Channel	Freq [MHz]	Antenna	Average conducted PSD [dBm/500kHz]	Max.* conducted PSD [dBm/500kHz]	
802.11a	6Mbps	149	5745	SISO A	7.24	7.33	
				SISO B	6.96	7.05	
		157	5785	SISO A	7.06	7.15	
				SISO B	6.94	7.03	
		165	5825	SISO A	7.08	7.17	
				SISO B	7.05	7.14	
802.11n20	HT0	149	5745	SISO A	6.99	6.99	
				SISO B	6.90	6.90	
		157	5785	SISO A	6.80	6.80	
				SISO B	6.68	6.68	
		165	5825	SISO A	6.82	6.82	
				SISO B	6.73	6.73	
	HT8	149	5745	MIMO A	6.86	6.86	
				MIMO B	6.89	6.89	
				Combined A+B	9.89	9.89	
		157	5785	MIMO A	6.66	6.66	
				MIMO B	6.85	6.85	
				Combined A+B	9.77	9.77	
	165	5825	MIMO A	6.72	6.72		
			MIMO B	6.90	6.90		
			Combined A+B	9.82	9.82		
	802.11n40	HT0	151	5755	SISO A	3.44	3.44
					SISO B	3.37	3.37
			159	5795	SISO A	3.33	3.33
SISO B					3.33	3.33	
HT8		151	5755	MIMO A	3.37	3.37	
				MIMO B	3.13	3.13	
		159	5795	Combined A+B	6.26	6.26	
				MIMO A	3.23	3.23	
					MIMO B	3.29	3.29
					Combined A+B	6.27	6.27
					SISO A	-0.42	-0.42
					SISO B	-0.71	-0.71
802.11ac80	VHT0	155	5775	MIMO A	-2.21	-2.21	
				MIMO B	-2.16	-2.16	
				Combined A+B	0.83	0.83	

Mode	Rate	Channel	Freq [MHz]	Antenna	RU config.	Average conducted PSD [dBm/500kHz]	Max.* conducted PSD [dBm/500kHz]			
802.11ax20	HE0	149	5745	SISO A	Full	6.66	6.66			
					26/0	15.41	15.41			
					52/37	12.04	12.04			
				SISO B	106/53	9.14	9.14			
					Full	6.61	6.61			
					26/0	15.03	15.03			
				MIMO A	52/37	12.14	12.14			
					106/53	9.25	9.25			
					Full	6.76	6.76			
				MIMO B	26/0	12.24	12.24			
					52/37	5.39	5.39			
		106/53	6.11		6.11					
		Combined A+B	Full	6.82	6.82					
			26/0	12.19	12.19					
			52/37	5.44	5.44					
		157	5785	SISO A	5825	106/53	6.22	6.22		
						Full	9.80	9.80		
						26/0	15.23	15.23		
				SISO B	52/37	8.43	8.43			
					106/53	9.18	9.18			
					Full	6.52	6.52			
		165	5825	MIMO A	5785	Full	6.37	6.37		
						Full	6.57	6.57		
						Full	6.57	6.57		
				MIMO B	Full	6.57	6.57			
					Full	9.58	9.58			
					Full	9.58	9.58			
		151	5755	SISO A	5795	Full	6.53	6.53		
						Full	6.67	6.67		
Full	6.62					6.62				
SISO B	Full			6.60		6.60				
	Full			6.60		6.60				
	Full			9.62		9.62				
802.11ax40	HE0	151	5755	SISO A	Full	3.20	3.20			
					242/61	6.75	6.75			
				SISO B	Full	3.33	3.33			
					242/61	6.75	6.75			
				MIMO A	Full	2.54	2.54			
					242/61	6.58	6.58			
		MIMO B	Full	2.51	2.51					
			242/61	6.68	6.68					
		Combined A+B	Full	5.54	5.54					
			242/61	9.64	9.64					
		159	5795	SISO A	5775	Full	3.07	3.07		
						Full	3.04	3.04		
MIMO A	Full			3.14		3.14				
	Full			3.20		3.20				
MIMO B	Full			3.20		3.20				
	Full			6.18		6.18				
802.11ax80	HE0	155	5775	SISO A	Full	-0.83	-0.83			
					484/65	2.68	2.68			
				SISO B	Full	-0.86	-0.86			
					484/65	2.73	2.73			
				MIMO A	Full	-2.63	-2.63			
					484/65	2.81	2.81			
				MIMO B	Full	-2.40	-2.40			
					484/65	2.59	2.59			
				Combined A+B	Full	0.50	0.50			
					484/65	5.71	5.71			

Maximum Power Spectral Density (PSD) – Overlapped channels between U-NII-2C and U-NII-3

Mode	Channel	Freq (MHz)	Antenna	Chain	Average conducted PSD UNII-3 [dBm/MHz]	Maximum* conducted PSD UNII-3 [dBm/MHz]
802.11n20	144	5720	SISO	A	5.74	5.74
				B	5.91	5.91
			MIMO	A	3.57	3.57
				B	3.32	3.32
			Combined	A+B	6.46	6.46
			802.11n40	142	5710	SISO
B	0.03	0.03				
MIMO	A	0.28				0.28
	B	0.06				0.06
Combined	A+B	3.18				3.18
802.11ac80	138	5690				SISO
			B	-3.39	-3.39	
			MIMO	A	-3.42	-3.42
				B	-3.47	-3.47
			Combined	A+B	-0.43	-0.43
			802.11ax20	144	5720	SISO
B	5.72	5.72				
MIMO	A	3.20				3.20
	B	3.00				3.00
Combined	A+B	6.11				6.11
802.11ax40	142	5710				SISO
			B	0.14	0.14	
			MIMO	A	0.06	0.06
				B	-0.18	-0.18
			Combined	A+B	2.95	2.95
			802.11ax80	138	5690	SISO
B	-3.43	-3.43				
MIMO	A	-3.49				-3.49
	B	-3.45				-3.45
Combined	A+B	-0.46				-0.46

### B.2.3 Undesirable emission limits : out of band (Conducted)

#### Test limits

FCC part	RSS clause	Limits
15.407 (b) (4)	RSS-247 Clause 6.2.4.2	For transmitters operating in the 5.725-5.85 GHz band: All emissions shall be limited to a level of -27 dBm/MHz at 75 MHz or more above or below the band edge increasing linearly to 10 dBm/MHz at 25 MHz above or below the band edge, and from 25 MHz above or below the band edge increasing linearly to a level of 15.6 dBm/MHz at 5 MHz above or below the band edge, and from 5 MHz above or below the band edge increasing linearly to a level of 27 dBm/MHz at the band edge.

#### Test procedure

The conducted setup shown in section *Test & System Description* was used to measure undesirable emissions on the Band Edge domain. The antenna terminal of the EUT is connected to the spectrum analyzer through an attenuator, and the spectrum analyzer reading is compensated to include the RF path loss and the declared antenna gain.

**See Section B.3.4 for the screenshot results.**



## B.2.4 Radiated spurious emission

### Standard references

FCC part	RSS clause	Limits																				
15.407 (b) (4)	RSS-247 Clause 6.2.4.2	For transmitters operating in the 5.725-5.85 GHz band: All emissions shall be limited to a level of -27 dBm/MHz at 75 MHz or more above or below the band edge increasing linearly to 10 dBm/MHz at 25 MHz above or below the band edge, and from 25 MHz above or below the band edge increasing linearly to a level of 15.6 dBm/MHz at 5 MHz above or below the band edge, and from 5 MHz above or below the band edge increasing linearly to a level of 27 dBm/MHz at the band edge.																				
15.209	RSS-GEN A1, Clause 8.9	<p>Radiated emissions which fall in the restricted bands, as defined in §15.205(a), must also comply with the radiated emission limits specified in §15.209(a):</p> <table border="1"> <thead> <tr> <th>Freq Range (MHz)</th> <th>Field Strength (µV/m)</th> <th>Field Strength (dBµV/m)</th> <th>Meas. Distance (m)</th> </tr> </thead> <tbody> <tr> <td>30-88</td> <td>100</td> <td>40</td> <td>3</td> </tr> <tr> <td>88-216</td> <td>150</td> <td>43.5</td> <td>3</td> </tr> <tr> <td>216-960</td> <td>200</td> <td>46</td> <td>3</td> </tr> <tr> <td>Above 960</td> <td>500</td> <td>54</td> <td>3</td> </tr> </tbody> </table> <p>The emission limits shown in the above table are based on measurements employing CISPR quasi-peak detector except for the frequency bands 9-90 kHz, 110-490 kHz and above 1000 MHz. Radiated emission limits in these three bands are based on measurements employing an average detector.</p> <p>For average radiated emission measurements above 1000 MHz, there is also a limit specified when measuring with peak detector function, corresponding to 20 dB above the indicated values in the table.</p>	Freq Range (MHz)	Field Strength (µV/m)	Field Strength (dBµV/m)	Meas. Distance (m)	30-88	100	40	3	88-216	150	43.5	3	216-960	200	46	3	Above 960	500	54	3
Freq Range (MHz)	Field Strength (µV/m)	Field Strength (dBµV/m)	Meas. Distance (m)																			
30-88	100	40	3																			
88-216	150	43.5	3																			
216-960	200	46	3																			
Above 960	500	54	3																			

### Test procedure

The radiated setups shown in section *Test & System Description* were used to measure the radiated spurious emissions.

Depending of the frequency range and bands being tested, different antennas and filters were used.

The final measurement is done by varying the antenna height, the EUT azimuth over 360° and for both Vertical and Horizontal polarizations.

The radiated spurious emission was measured on the worst case configuration selected from the chapter B.1 and using the low, middle and high channels.

Test Results

**Radiated spurious - 30 MHz to 1 GHz**

**All modes**

Frequency	Level	Detector	Limit	Margin	Polar
MHz	dBµV/m	---	dBµV/m	dB	---
73.1	33.0	Quasi-Peak	40.0	7.0	V
840.2	31.1	Quasi-Peak	46.0	14.9	V

Note 1: The spurious signals detected do not depend on either the operating channel or the modulation mode.

**Radiated spurious - 1 GHz to 40 GHz**

802.11a

**802.11a, 6Mbps, Chain A**

**CH149**

Frequency	Level	Detector	Limit	Margin	Polar
MHz	dBµV/m	---	dBµV/m	dB	---
1596.4	48.4	Peak	74.0	25.6	H
1596.4	33.2	Average	54.0	20.8	H
3085.8	49.8	Peak	68.2	18.4	H
12193.6	38.1	Average	54.0	15.9	V
12194.0	47.8	Peak	74.0	26.2	H
28724.3	52.0	Peak	68.2	16.2	V

**CH157**

Frequency	Level	Detector	Limit	Margin	Polar
MHz	dBµV/m	---	dBµV/m	dB	---
1595.0	32.5	Average	54.0	21.5	H
1597.4	48.9	Peak	74.0	25.1	H
15758.4	39.5	Average	54.0	14.6	H
15760.2	49.6	Peak	74.0	24.4	H
28914.4	53.5	Peak	68.2	14.7	V

**CH165**

Frequency	Level	Detector	Limit	Margin	Polar
MHz	dBμV/m	---	dBμV/m	dB	---
1597.4	32.9	Average	54.0	21.1	H
1597.4	48.3	Peak	74.0	25.7	H
17800.7	51.7	Peak	74.0	22.3	V
17800.7	41.3	Average	54.0	12.7	H
29124.7	54.1	Peak	68.2	14.1	V

**802.11a, 6Mbps, Chain B****CH149**

Frequency	Level	Detector	Limit	Margin	Polar
MHz	dBμV/m	---	dBμV/m	dB	---
1592.6	32.0	Average	54.0	22.0	H
1594.5	48.4	Peak	74.0	25.6	H
17796.9	50.9	Peak	74.0	23.1	H
17797.4	40.8	Average	54.0	13.2	V
39618.2	57.7	Peak	74.0	16.3	V
39622.6	47.6	Average	54.0	<b>6.4</b>	V

**CH157**

Frequency	Level	Detector	Limit	Margin	Polar
MHz	dBμV/m	---	dBμV/m	dB	---
1598.8	32.8	Average	54.0	21.2	H
1599.7	48.3	Peak	74.0	25.7	H
11899.8	38.1	Average	54.0	15.9	H
11902.2	49.4	Peak	74.0	24.6	V
39649.0	57.4	Peak	74.0	16.6	H
39653.9	47.4	Average	54.0	6.6	H

**CH165**

Frequency	Level	Detector	Limit	Margin	Polar
MHz	dBµV/m	---	dBµV/m	dB	---
1597.4	33.1	Average	54.0	20.9	H
1597.4	46.2	Peak	74.0	27.8	H
17808.3	51.4	Peak	74.0	22.6	V
17808.3	41.4	Average	54.0	12.6	V
39515.0	56.6	Peak	74.0	17.4	H
39636.3	47.6	Average	54.0	6.4	V

802.11n**802.11n20, HT0, Chain A****CH149**

Frequency	Level	Detector	Limit	Margin	Polar
MHz	dBµV/m	---	dBµV/m	dB	---
1597.4	34.1	Average	54.0	19.9	H
1597.4	47.5	Peak	74.0	26.4	H
17804.0	50.8	Peak	74.0	23.2	H
17804.0	41.4	Average	54.0	12.6	H
28717.9	51.9	Peak	68.2	16.3	V

**CH157**

Frequency	Level	Detector	Limit	Margin	Polar
MHz	dBµV/m	---	dBµV/m	dB	---
1592.6	31.6	Average	54.0	22.4	H
1592.6	47.1	Peak	74.0	26.9	H
15678.6	40.0	Average	54.0	14.0	H
15679.0	49.0	Peak	74.0	25.1	H
17800.2	41.1	Average	54.0	12.9	V
17800.7	51.4	Peak	74.0	22.6	V
28926.7	52.2	Peak	68.2	16.0	V

**CH165**

Frequency	Level	Detector	Limit	Margin	Polar
MHz	dBµV/m	---	dBµV/m	dB	---
1595.0	34.9	Average	54.0	19.1	H
1595.0	48.1	Peak	74.0	25.9	H
12367.3	48.1	Peak	74.0	25.9	H
12367.3	38.5	Average	54.0	15.5	V
29126.1	54.0	Peak	68.2	14.2	V

**802.11n20, HT0, Chain B****CH149**

Frequency	Level	Detector	Limit	Margin	Polar
MHz	dBµV/m	---	dBµV/m	dB	---
1597.8	34.0	Average	54.0	19.9	H
1597.8	48.2	Peak	74.0	25.8	H
17814.9	51.0	Peak	74.0	23.0	H
17814.9	41.2	Average	54.0	12.8	H
39626.5	57.5	Peak	74.0	16.5	H
39628.4	47.0	Average	54.0	7.0	V

**CH157**

Frequency	Level	Detector	Limit	Margin	Polar
MHz	dBµV/m	---	dBµV/m	dB	---
1593.1	48.6	Peak	74.0	25.4	H
1593.6	32.5	Average	54.0	21.5	H
12665.8	48.0	Peak	74.0	26.0	H
12665.8	38.9	Average	54.0	15.1	H
16070.0	51.0	Peak	74.0	22.9	V
16073.8	39.8	Average	54.0	14.2	V
39570.3	56.5	Peak	74.0	17.5	H
39643.1	47.6	Average	54.0	6.4	V

## CH165

Frequency	Level	Detector	Limit	Margin	Polar
MHz	dBµV/m	---	dBµV/m	dB	---
1596.4	47.9	Peak	74.0	26.1	H
1596.9	33.7	Average	54.0	20.3	H
17799.8	51.9	Peak	74.0	22.1	V
17801.2	41.1	Average	54.0	12.9	V
39648.5	48.0	Average	54.0	6.0	H
39651.4	57.6	Peak	74.0	16.4	H

## 802.11n20, HT8, Chain A+B

## CH149

Frequency	Level	Detector	Limit	Margin	Polar
MHz	dBµV/m	---	dBµV/m	dB	---
1597.4	33.8	Average	54.0	20.2	H
1597.4	48.6	Peak	74.0	25.4	H
17804.0	50.9	Peak	74.0	23.1	H
17804.0	41.0	Average	54.0	13.0	H
28728.7	52.4	Peak	68.2	15.8	V

## CH157

Frequency	Level	Detector	Limit	Margin	Polar
MHz	dBµV/m	---	dBµV/m	dB	---
1594.5	32.8	Average	54.0	21.2	H
1597.8	46.9	Peak	74.0	27.1	H
17804.0	51.2	Peak	74.0	22.8	H
17805.0	41.0	Average	54.0	12.9	V
28919.3	53.2	Peak	68.2	15.0	V

**CH165**

Frequency	Level	Detector	Limit	Margin	Polar
MHz	dB $\mu$ V/m	---	dB $\mu$ V/m	dB	---
1595.5	33.5	Average	54.0	20.5	H
1595.5	49.3	Peak	74.0	24.7	H
17820.1	41.1	Average	54.0	12.9	H
17820.6	50.7	Peak	74.0	23.3	H
29122.2	53.5	Peak	68.2	14.7	V

**802.11n40, HT0, Chain A****CH151**

Frequency	Level	Detector	Limit	Margin	Polar
MHz	dB $\mu$ V/m	---	dB $\mu$ V/m	dB	---
1592.2	46.1	Peak	74.0	27.9	H
1594.5	32.6	Average	54.0	21.4	H
17791.3	51.5	Peak	74.0	22.5	V
17792.2	41.1	Average	54.0	12.9	V
39658.8	58.0	Peak	74.0	16.0	H
39662.7	47.4	Average	54.0	6.6	V

**CH159**

Frequency	Level	Detector	Limit	Margin	Polar
MHz	dB $\mu$ V/m	---	dB $\mu$ V/m	dB	---
1595.9	49.0	Peak	74.0	25.0	H
1596.4	31.7	Average	54.0	22.3	H
17795.5	51.1	Peak	74.0	22.9	V
17796.9	41.1	Average	54.0	12.9	V
39604.0	57.3	Peak	74.0	16.7	H
39612.8	46.9	Average	54.0	7.1	H

## 802.11n40, HT0, Chain B

### CH151

Frequency	Level	Detector	Limit	Margin	Polar
MHz	dB $\mu$ V/m	---	dB $\mu$ V/m	dB	---
1594.1	31.2	Average	54.0	22.8	H
1594.1	45.5	Peak	74.0	28.5	H
17801.2	52.1	Peak	74.0	21.9	H
17801.2	41.0	Average	54.0	13.0	V
39932.5	57.9	Peak	74.0	16.1	V
39937.9	46.6	Average	54.0	7.3	V

### CH159

Frequency	Level	Detector	Limit	Margin	Polar
MHz	dB $\mu$ V/m	---	dB $\mu$ V/m	dB	---
1594.5	47.4	Peak	74.0	26.6	H
1595.0	31.1	Average	54.0	22.9	H
17808.8	51.0	Peak	74.0	23.0	H
17808.8	41.2	Average	54.0	12.8	H
39665.1	47.7	Average	54.0	6.3	V
39709.6	57.1	Peak	74.0	16.9	H

## 802.11n40, HT8, Chain A+B

### CH151

Frequency	Level	Detector	Limit	Margin	Polar
MHz	dB $\mu$ V/m	---	dB $\mu$ V/m	dB	---
1596.9	33.2	Average	54.0	20.8	H
1596.9	48.6	Peak	74.0	25.4	H
17803.6	51.2	Peak	74.0	22.8	H
17803.6	41.3	Average	54.0	12.7	V
39677.3	47.4	Average	54.0	6.6	H
39678.3	57.3	Peak	74.0	16.7	H



## CH159

Frequency	Level	Detector	Limit	Margin	Polar
MHz	dBµV/m	---	dBµV/m	dB	---
1597.8	32.0	Average	54.0	22.0	H
1598.3	45.6	Peak	74.0	28.4	H
17817.7	51.0	Peak	74.0	23.0	H
17817.7	41.0	Average	54.0	12.9	H
39640.7	47.3	Average	54.0	6.8	V
39637.2	57.3	Peak	74.0	16.7	V

## 802.11ac

## 802.11ac80, VHT0, Chain A

## CH155

Frequency	Level	Detector	Limit	Margin	Polar
MHz	dBµV/m	---	dBµV/m	dB	---
1595.9	32.7	Average	54.0	21.3	H
1595.9	45.2	Peak	74.0	28.8	H
12090.1	47.1	Peak	74.0	26.9	V
12090.1	38.2	Average	54.0	15.8	V
17810.6	41.4	Average	54.0	12.6	V
17811.6	50.9	Peak	74.0	23.1	H
39656.3	47.5	Average	54.0	6.5	H
39678.8	57.6	Peak	74.0	16.4	V

### 802.11ac80, VHT0, Chain B

#### CH155

Frequency	Level	Detector	Limit	Margin	Polar
MHz	dB $\mu$ V/m	---	dB $\mu$ V/m	dB	---
1595.0	47.3	Peak	74.0	26.7	H
1595.9	31.9	Average	54.0	22.1	H
13749.1	53.8	Peak	68.2	14.4	V
17802.6	51.8	Peak	74.0	22.2	H
17804.0	40.9	Average	54.0	13.1	V
39636.3	57.3	Peak	74.0	16.7	V
39688.1	47.4	Average	54.0	6.6	V

### 802.11ac80, VHT0, Chain A+B

#### CH155

Frequency	Level	Detector	Limit	Margin	Polar
MHz	dB $\mu$ V/m	---	dB $\mu$ V/m	dB	---
1596.9	32.9	Average	54.0	21.1	H
1596.9	47.5	Peak	74.0	26.6	H
10966.2	37.3	Average	54.0	16.7	V
10966.7	46.8	Peak	74.0	27.2	H
17802.6	51.3	Peak	74.0	22.7	H
17804.0	41.4	Average	54.0	12.6	H
39628.0	46.5	Average	54.0	7.5	V
39630.9	56.5	Peak	74.0	17.5	V

## 802.11ax

**802.11ax20, HE0, Chain A****CH149**

Frequency	Level	Detector	Limit	Margin	Polar
MHz	dBµV/m	---	dBµV/m	dB	---
1597.4	46.3	Peak	74.0	27.7	H
1598.8	32.9	Average	54.0	21.1	H
5256.6	52.7	Peak	68.2	15.5	H
11473.4	37.4	Average	54.0	16.6	H
11473.9	46.9	Peak	74.0	27.1	H
28685.2	60.4	Peak	68.2	7.8	V

**CH157**

Frequency	Level	Detector	Limit	Margin	Polar
MHz	dBµV/m	---	dBµV/m	dB	---
1594.5	47.8	Peak	74.0	26.2	H
1595.0	31.2	Average	54.0	22.8	H
5296.3	53.4	Peak	68.2	14.8	H
17802.1	52.0	Peak	74.0	22.0	H
17803.6	41.1	Average	54.0	12.9	V
28880.2	64.0	Peak	68.2	<b>4.2</b>	V

**CH165**

Frequency	Level	Detector	Limit	Margin	Polar
MHz	dBµV/m	---	dBµV/m	dB	---
1598.3	33.2	Average	54.0	20.8	H
1598.3	48.4	Peak	74.0	25.6	H
5336.4	52.6	Peak	68.2	15.6	V
5576.8	53.6	Peak	68.2	14.6	V
14403.6	49.4	Peak	68.2	18.8	H
29083.6	61.2	Peak	68.2	7.0	V
29134.4	54.1	Peak	68.2	14.1	V

## 802.11ax20, HE0, Chain B

### CH149

Frequency	Level	Detector	Limit	Margin	Polar
MHz	dBμV/m	---	dBμV/m	dB	---
1594.1	32.8	Average	54.0	21.2	H
1594.1	46.8	Peak	74.0	27.2	H
5255.7	52.9	Peak	68.2	15.3	V
5617.4	53.0	Peak	68.2	15.2	V
17804.5	52.0	Peak	74.0	22.0	H
17804.5	41.2	Average	54.0	12.8	V
28682.7	51.8	Peak	68.2	16.4	V

### CH157

Frequency	Level	Detector	Limit	Margin	Polar
MHz	dBμV/m	---	dBμV/m	dB	---
1593.6	33.0	Average	54.0	21.0	H
1593.6	46.8	Peak	74.0	27.2	H
5296.3	52.5	Peak	68.2	15.7	H
13387.8	48.8	Peak	74.0	25.2	V
13389.7	38.4	Average	54.0	15.6	H
17329.4	49.5	Peak	68.2	18.7	V
28883.6	53.5	Peak	68.2	14.7	V

### CH165

Frequency	Level	Detector	Limit	Margin	Polar
MHz	dBμV/m	---	dBμV/m	dB	---
1595.0	32.6	Average	54.0	21.4	H
1595.0	47.4	Peak	74.0	26.6	H
5337.4	53.5	Peak	68.2	14.7	V
5493.7	52.4	Peak	68.2	15.8	H
17817.2	41.1	Average	54.0	12.9	H
17817.7	50.9	Peak	74.0	23.1	V
29081.6	53.6	Peak	68.2	14.6	V

## 802.11ax20, HE0, Chain A+B

### CH149

Frequency	Level	Detector	Limit	Margin	Polar
MHz	dB $\mu$ V/m	---	dB $\mu$ V/m	dB	---
1593.1	32.9	Average	54.0	21.1	H
1593.6	46.2	Peak	74.0	27.8	H
5255.7	53.7	Peak	68.2	14.5	H
17798.4	51.0	Peak	74.0	23.0	V
17798.8	41.0	Average	54.0	13.0	V
28681.7	58.2	Peak	68.2	10.0	V

### CH157

Frequency	Level	Detector	Limit	Margin	Polar
MHz	dB $\mu$ V/m	---	dB $\mu$ V/m	dB	---
1597.4	31.6	Average	54.0	22.4	H
1597.8	46.4	Peak	74.0	27.6	H
5296.3	52.3	Peak	68.2	15.9	H
17801.7	41.1	Average	54.0	12.9	H
17802.1	50.6	Peak	74.0	23.4	V
28883.2	64.0	Peak	68.2	4.2	V

### CH165

Frequency	Level	Detector	Limit	Margin	Polar
MHz	dB $\mu$ V/m	---	dB $\mu$ V/m	dB	---
1596.4	33.0	Average	54.0	21.0	H
1596.4	49.4	Peak	74.0	24.6	H
5336.4	54.0	Peak	68.2	14.2	H
15847.1	39.5	Average	54.0	14.5	V
15848.1	49.9	Peak	74.0	24.1	V
29082.1	61.2	Peak	68.2	7.0	V

## 802.11ax40, HE0, Chain A

### CH151

Frequency	Level	Detector	Limit	Margin	Polar
MHz	dB $\mu$ V/m	---	dB $\mu$ V/m	dB	---
1597.8	31.2	Average	54.0	22.8	H
1597.8	47.7	Peak	74.0	26.3	H
5273.1	51.7	Peak	68.2	16.5	H
5501.7	52.6	Peak	68.2	15.6	V
5624.9	54.5	Peak	68.2	13.7	V
11490.4	46.4	Peak	74.0	27.6	H
11490.4	37.5	Average	54.0	16.5	H
28724.8	57.1	Peak	68.2	11.1	V

### CH159

Frequency	Level	Detector	Limit	Margin	Polar
MHz	dB $\mu$ V/m	---	dB $\mu$ V/m	dB	---
1596.9	32.0	Average	54.0	21.9	H
1596.9	47.9	Peak	74.0	26.1	H
5305.2	53.2	Peak	68.2	15.0	H
5546.1	53.8	Peak	68.2	14.4	V
13691.4	53.5	Peak	68.2	14.7	V
28929.6	62.9	Peak	68.2	5.3	V

## 802.11ax40, HE0, Chain B

### CH151

Frequency	Level	Detector	Limit	Margin	Polar
MHz	dB $\mu$ V/m	---	dB $\mu$ V/m	dB	---
1592.2	49.3	Peak	74.0	24.7	H
1593.1	32.8	Average	54.0	21.2	H
5266.1	52.2	Peak	68.2	16.0	V
13556.4	47.4	Peak	68.2	20.8	H
28724.8	50.7	Peak	68.2	17.5	V

## CH159

Frequency	Level	Detector	Limit	Margin	Polar
MHz	dB $\mu$ V/m	---	dB $\mu$ V/m	dB	---
1594.5	31.6	Average	54.0	22.4	H
1594.5	47.0	Peak	74.0	27.0	H
5306.2	52.8	Peak	68.2	15.4	H
17803.1	51.4	Peak	74.0	22.6	H
17803.1	41.1	Average	54.0	12.9	H
39638.2	57.7	Peak	74.0	16.3	H
39639.7	47.7	Average	54.0	6.3	V

## 802.11ax40, HE0, Chain A+B

### CH151

Frequency	Level	Detector	Limit	Margin	Polar
MHz	dB $\mu$ V/m	---	dB $\mu$ V/m	dB	---
1597.4	33.5	Average	54.0	20.5	H
1597.4	48.8	Peak	74.0	25.2	H
5263.7	52.7	Peak	68.2	15.5	H
5505.9	53.0	Peak	68.2	15.2	H
17818.2	40.9	Average	54.0	13.1	H
17819.6	51.7	Peak	74.0	22.3	V
28726.7	57.2	Peak	68.2	11.0	V

### CH159

Frequency	Level	Detector	Limit	Margin	Polar
MHz	dB $\mu$ V/m	---	dB $\mu$ V/m	dB	---
1595.5	31.6	Average	54.0	22.4	H
1595.5	48.3	Peak	74.0	25.7	H
5304.8	54.2	Peak	68.2	13.9	V
5545.1	53.8	Peak	68.2	14.4	V
11299.6	47.7	Peak	74.0	26.3	V
11300.1	37.9	Average	54.0	16.1	V
13352.9	47.6	Peak	74.0	26.4	V
13352.9	38.3	Average	54.0	15.7	V
28927.2	58.0	Peak	68.2	10.2	V



## 802.11ax80, HE0, Chain A

### CH155

Frequency	Level	Detector	Limit	Margin	Polar
MHz	dB $\mu$ V/m	---	dB $\mu$ V/m	dB	---
1596.4	31.9	Average	54.0	22.1	H
1596.4	48.2	Peak	74.0	25.8	H
5274.1	52.1	Peak	68.2	16.1	V
11507.4	46.8	Peak	74.0	27.2	H
11507.4	37.7	Average	54.0	16.3	H
28731.1	50.3	Peak	68.2	17.9	V
28769.2	56.2	Peak	68.2	12.0	V

## 802.11ax80, HE0, Chain B

### CH155

Frequency	Level	Detector	Limit	Margin	Polar
MHz	dB $\mu$ V/m	---	dB $\mu$ V/m	dB	---
1594.1	33.2	Average	54.0	20.8	H
1594.1	49.1	Peak	74.0	24.9	H
5273.1	52.6	Peak	68.2	15.6	H
5444.1	52.0	Peak	74.0	21.9	H
5444.1	42.5	Average	54.0	11.5	H
17800.7	41.3	Average	54.0	12.7	H
17801.7	51.6	Peak	74.0	22.4	V
28767.3	50.4	Peak	68.2	17.8	V

**802.11ax80, HE0, Chain A+B****CH155**

Frequency	Level	Detector	Limit	Margin	Polar
MHz	dB $\mu$ V/m	---	dB $\mu$ V/m	dB	---
1594.1	48.0	Peak	74.0	26.0	H
1595.0	33.5	Average	54.0	20.5	H
5274.1	53.2	Peak	68.2	15.0	H
5442.2	53.3	Peak	74.0	20.7	V
5443.6	43.6	Average	54.0	<b>10.4</b>	V
11507.4	37.5	Average	54.0	16.5	V
11507.9	47.8	Peak	74.0	26.2	H
28767.8	56.9	Peak	68.2	11.3	V

### B.3 Test Results Screenshot

#### B.3.1 6dB Bandwidth

## SISO-A, 802.11a, 6Mbps

Channel 149

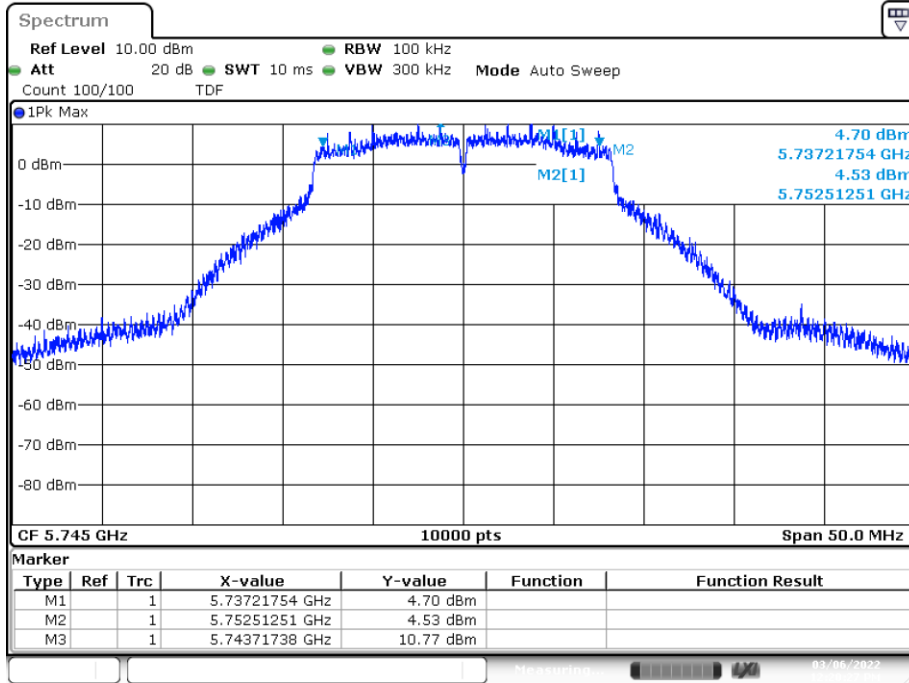

## MIMO-B, 802.11n20, HT8

Channel 157

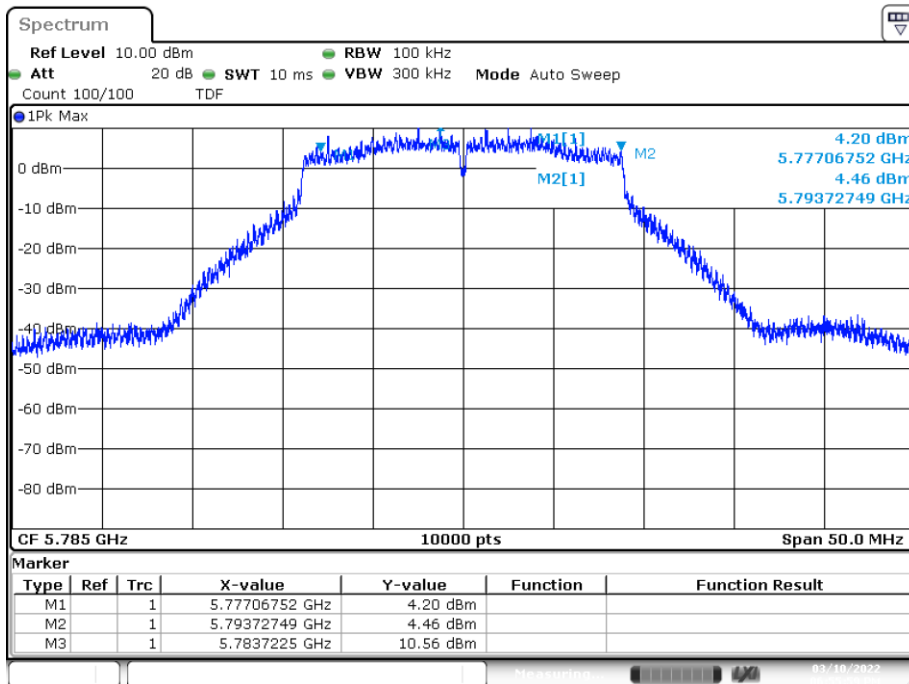

# SISO-B, 802.11n40, HT0

Channel 151

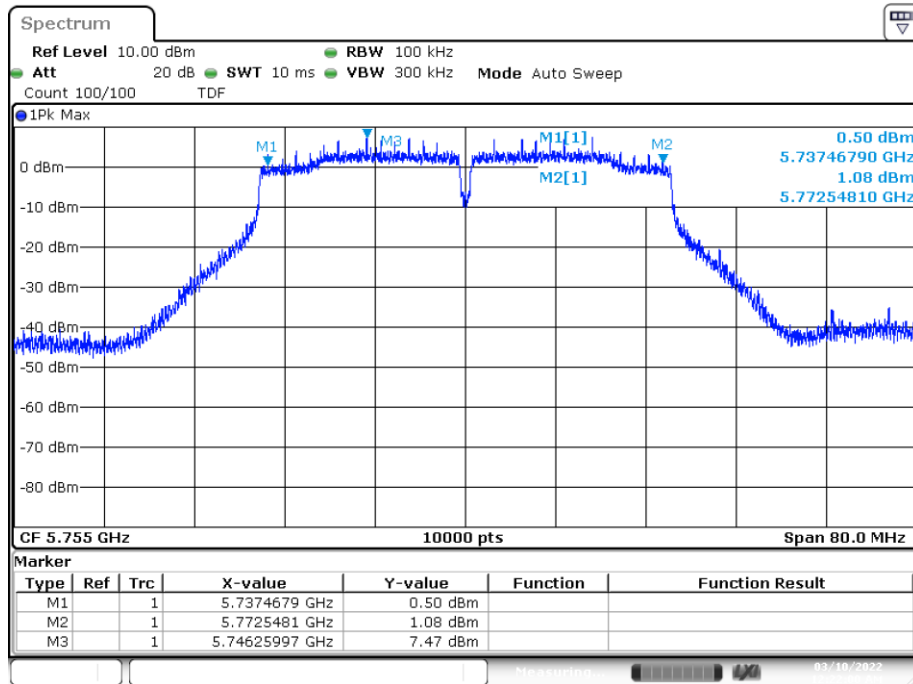

# SISO-A, 802.11ac80, VHT0

Channel 155

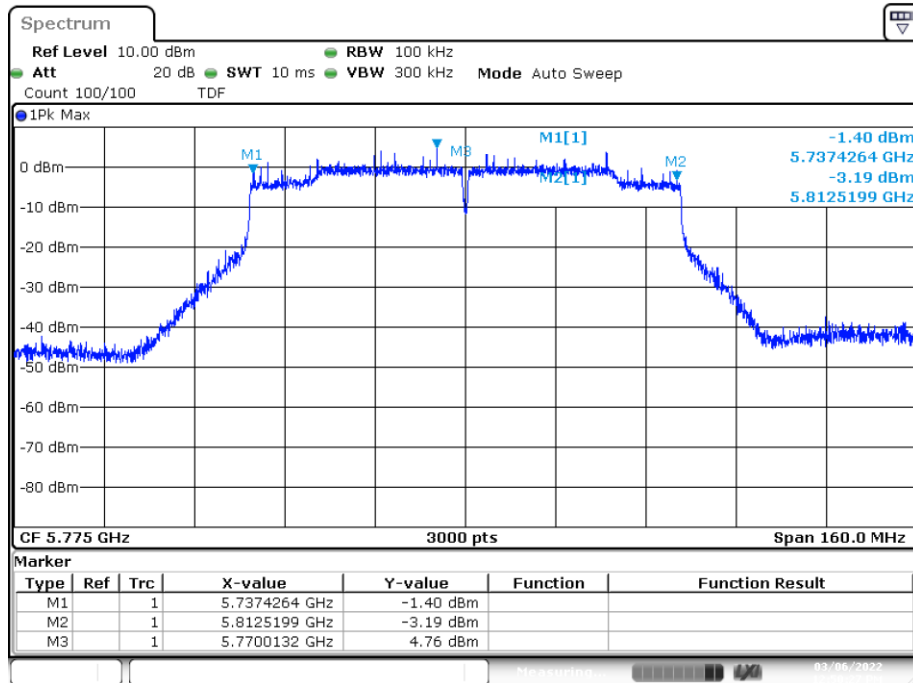

# MIMO-A, 802.11ax20, HE0

Channel 157

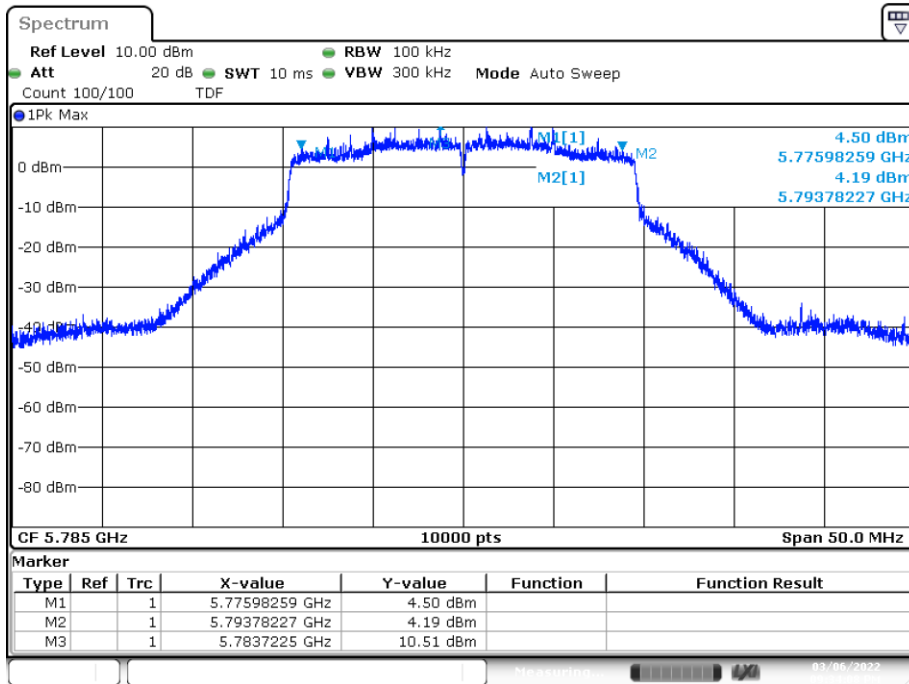

# SISO-B, 802.11ax40, HE0

Channel 151

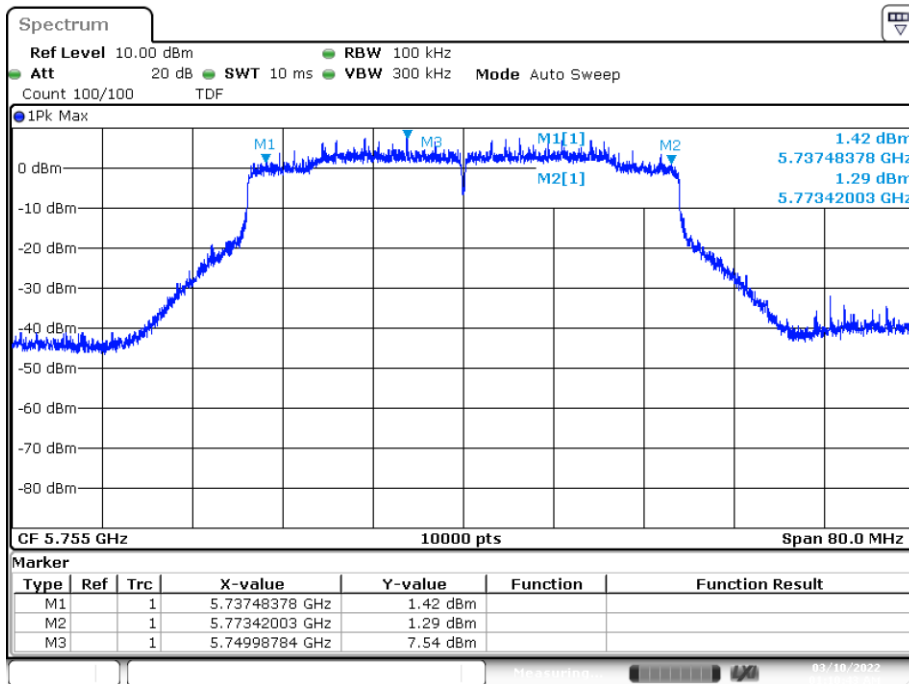

# MIMO-A, 802.11ax80, HE0

Channel 155

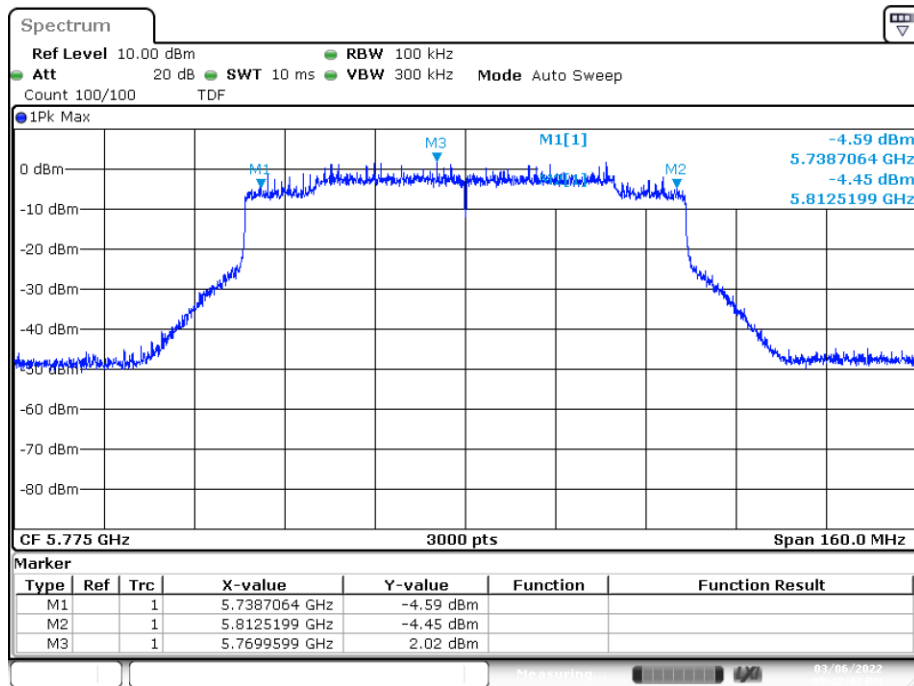

### B.3.2 99% Bandwidth

## SISO-A, 802.11a, 6Mbps

Channel 157

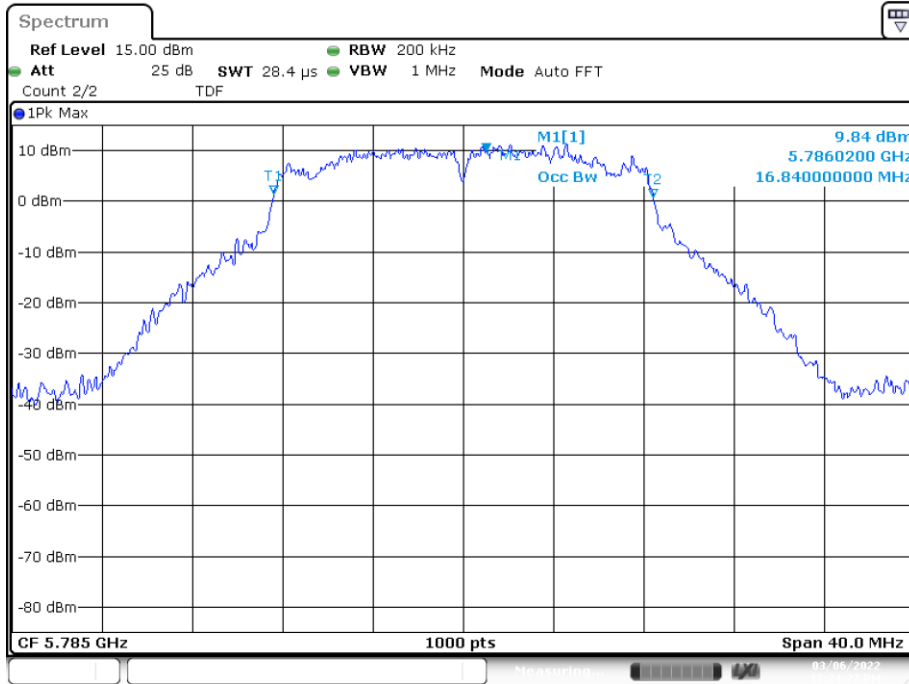

## SISO-A, 802.11n20, HT0

Channel 157

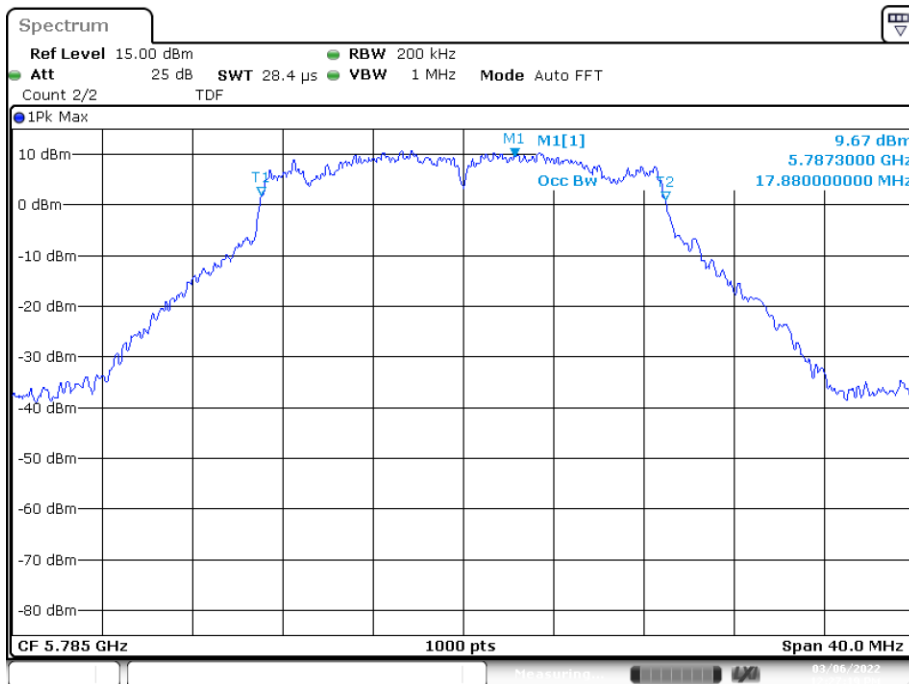

# MIMO-A, 802.11n40, HT8

Channel 151

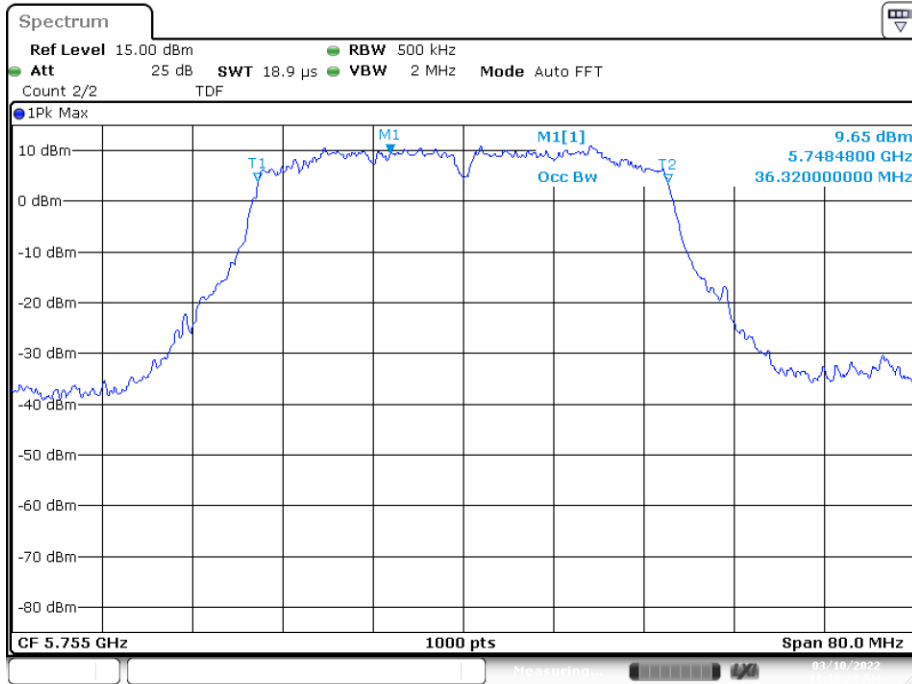

# MIMO-A, 802.11ac80, VHT0

Channel 155

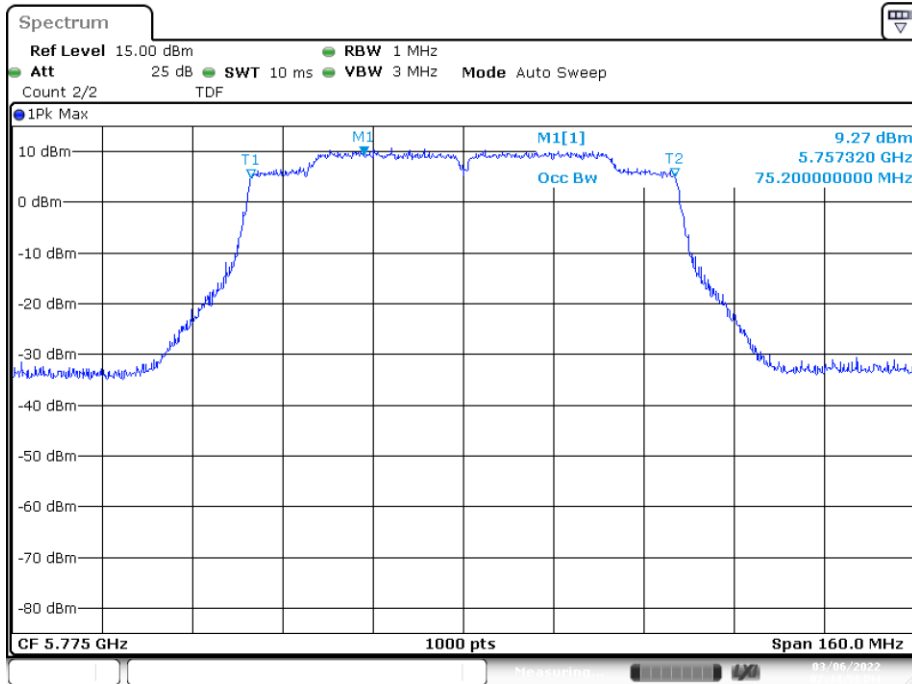



# SISO-B, 802.11ax20, HE0

Channel 149

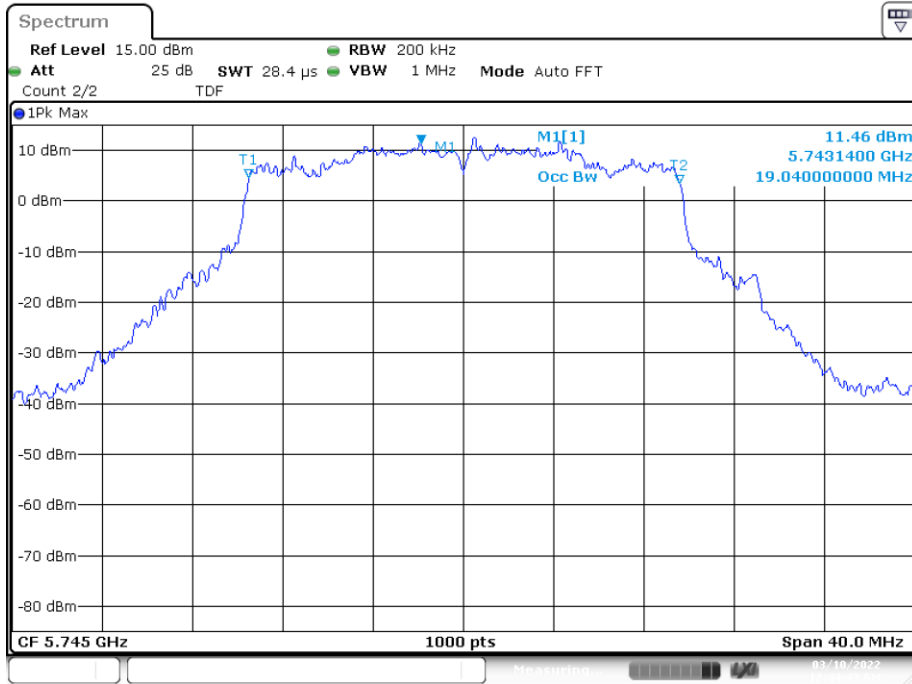

# SISO-A, 802.11ax40, HE0

Channel 159

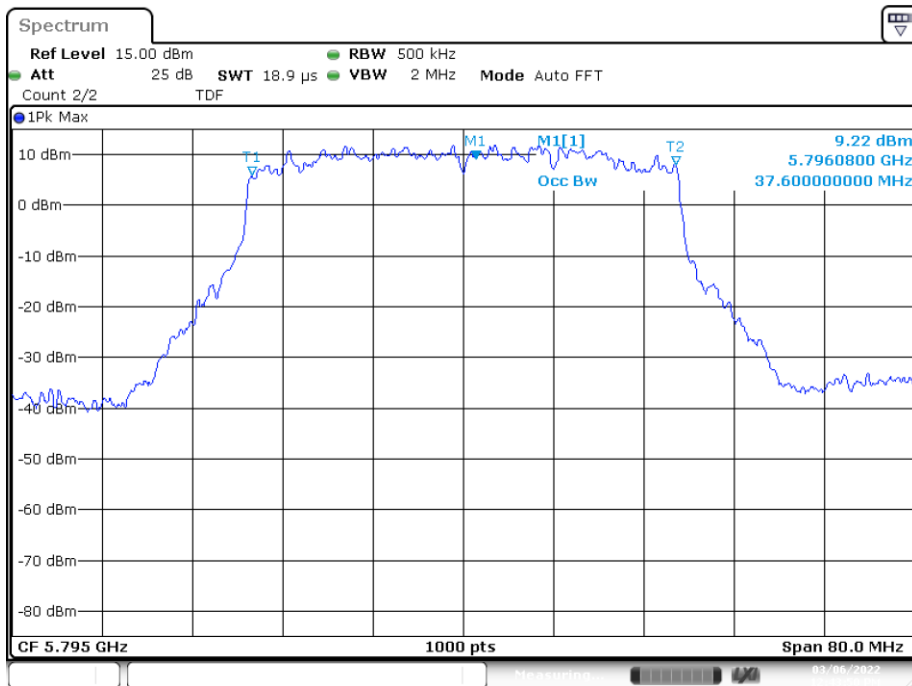

# SISO-B, 802.11ax80, HE0

Channel 155

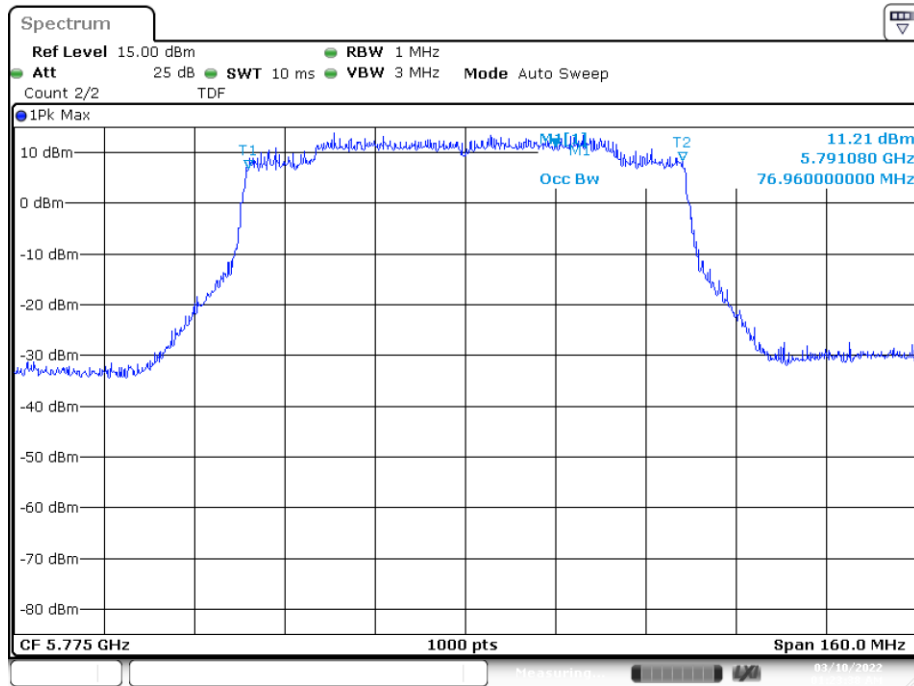

### B.3.3 Maximum output power

## SISO-A, 802.11a, 6Mbps

Channel 157

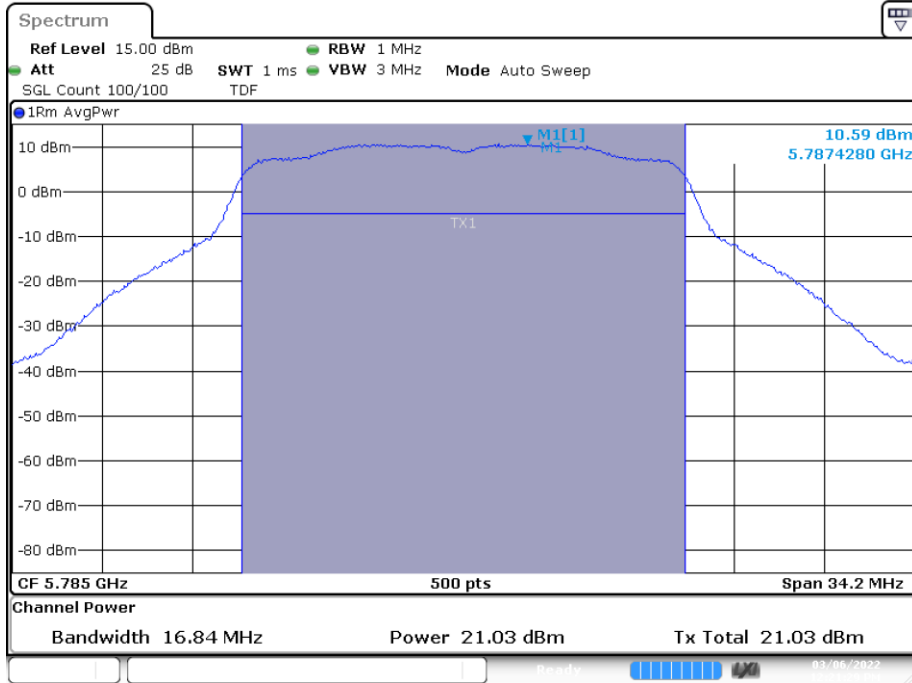

# MIMO-A, 802.11n20, HT8

Channel 157

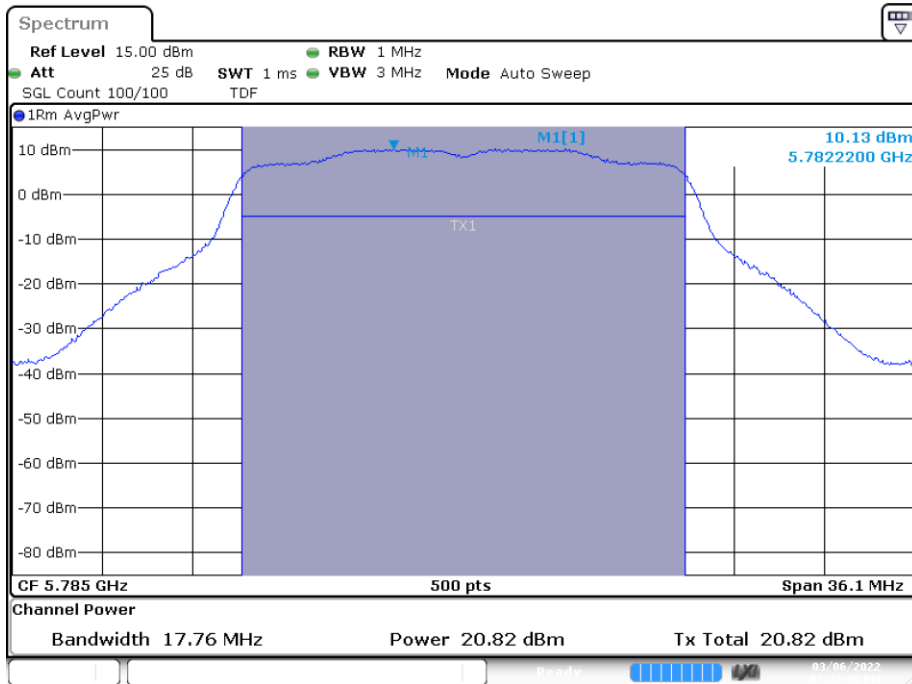

# MIMO-B, 802.11n20, HT8

Channel 157

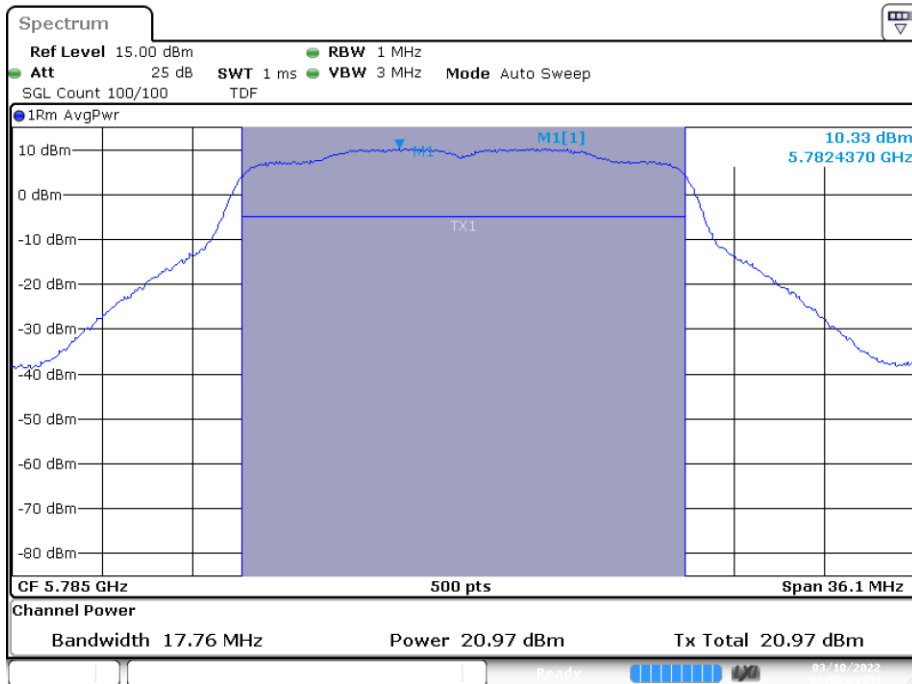

# MIMO-A, 802.11n40, HT8

Channel 159

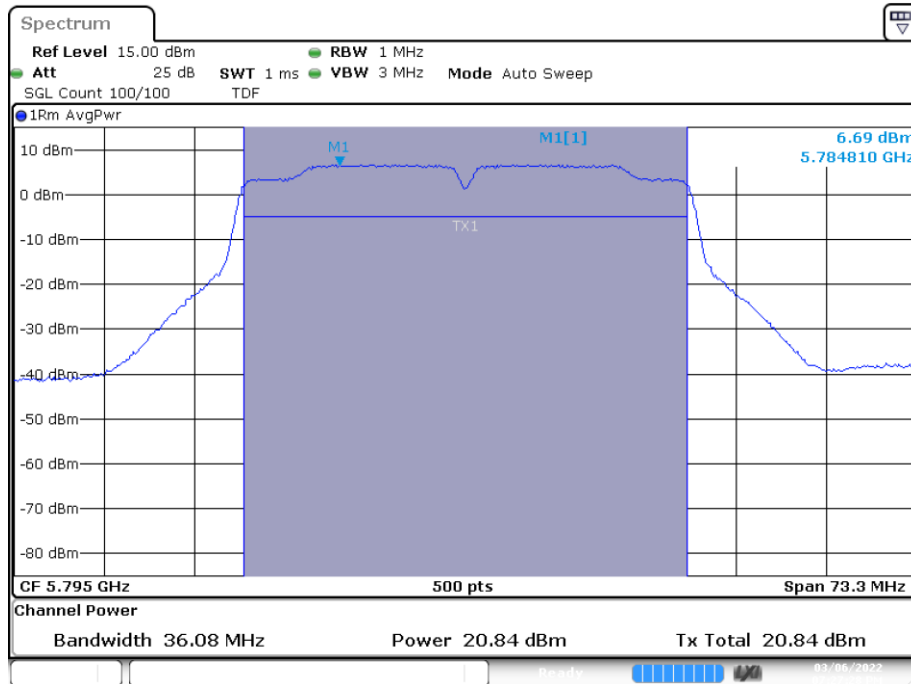

# MIMO-B, 802.11n40, HT8

Channel 159

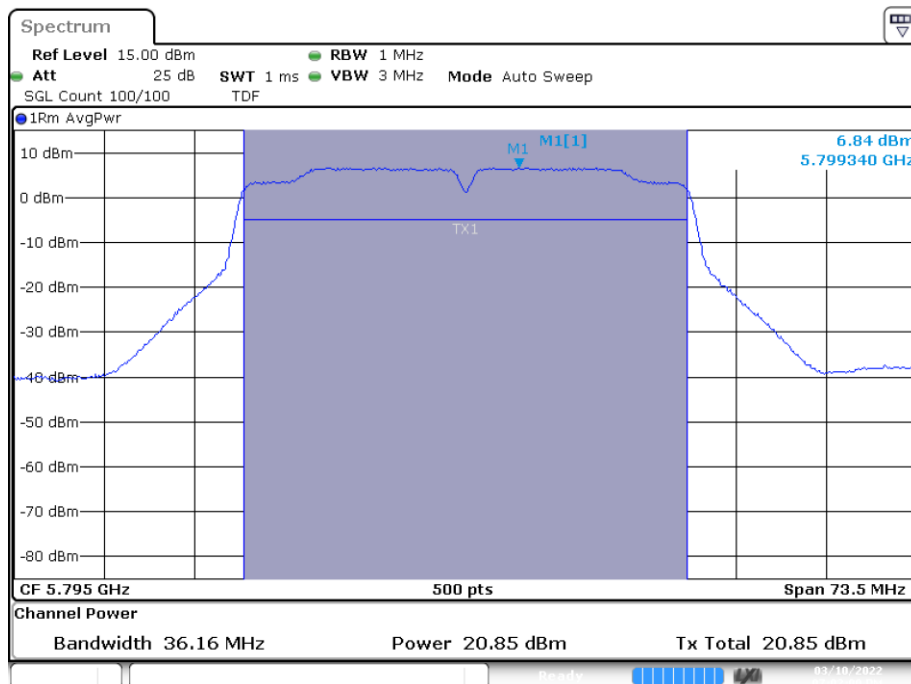

# MIMO-A, 802.11ac80, VHT0

Channel 155

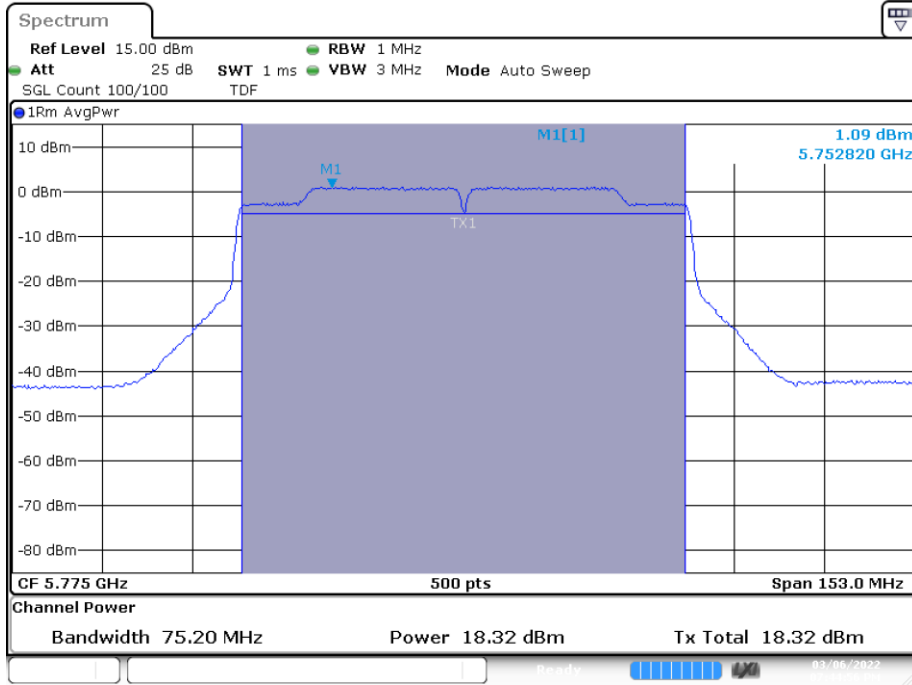

# MIMO-B, 802.11ac80, VHT0

Channel 155

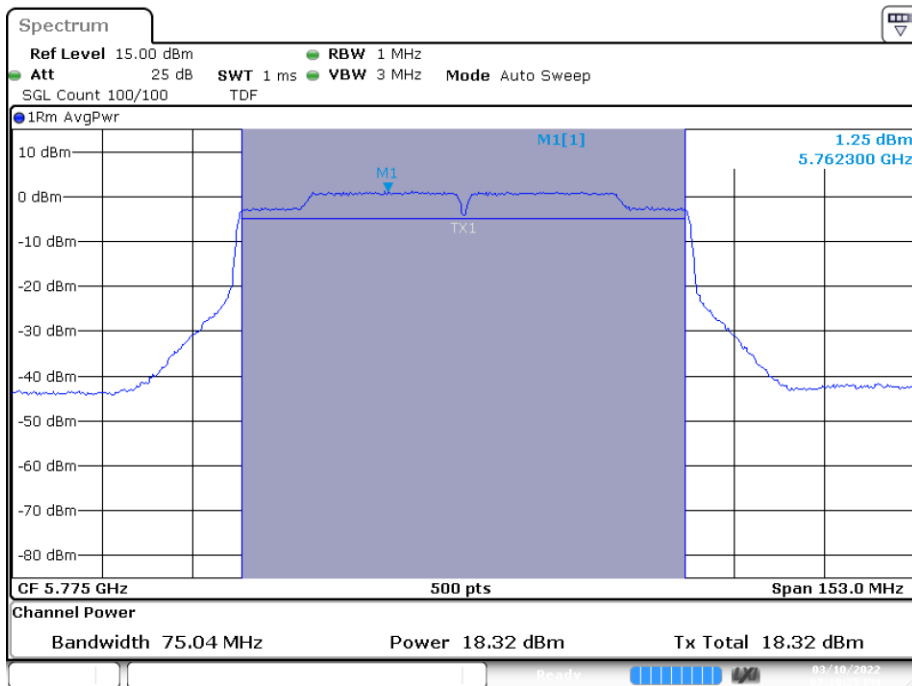

# MIMO-A, 802.11ax20, HE0

Channel 149

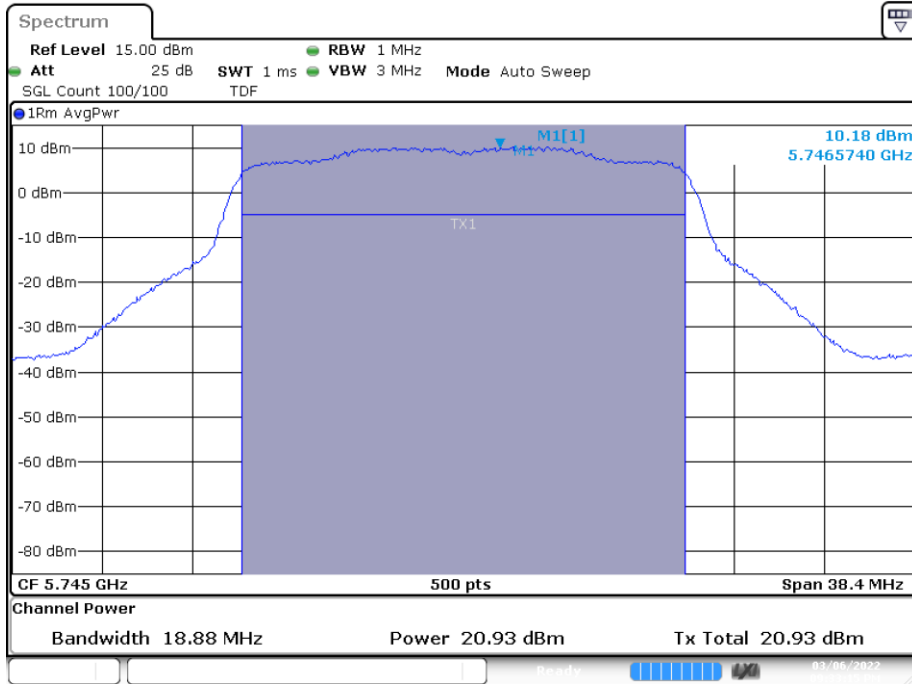

# MIMO-B, 802.11ax20, HE0

Channel 149

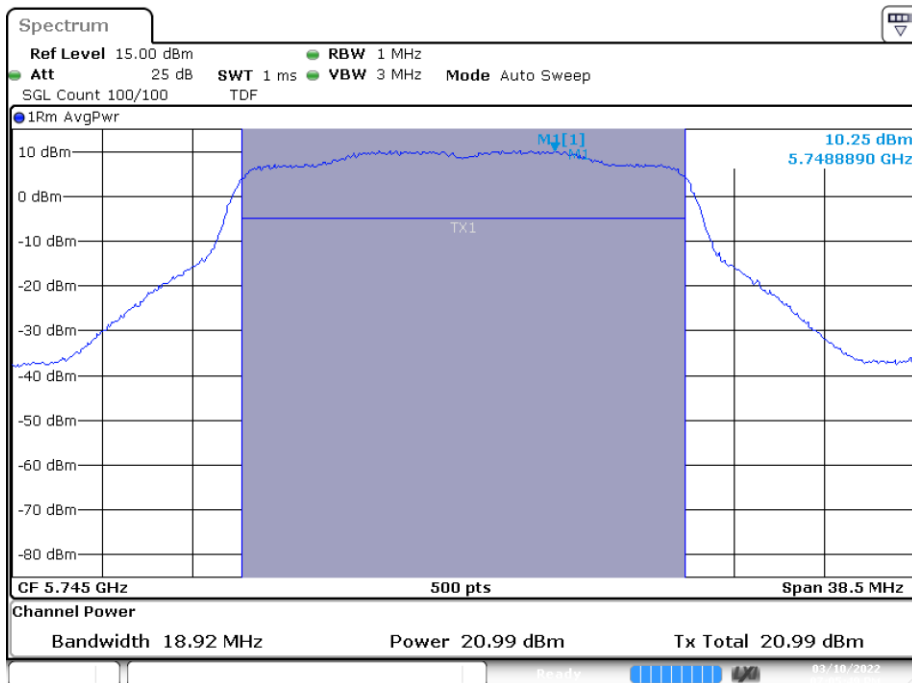

# MIMO-A, 802.11ax40, 242/61, HE0

Channel 151

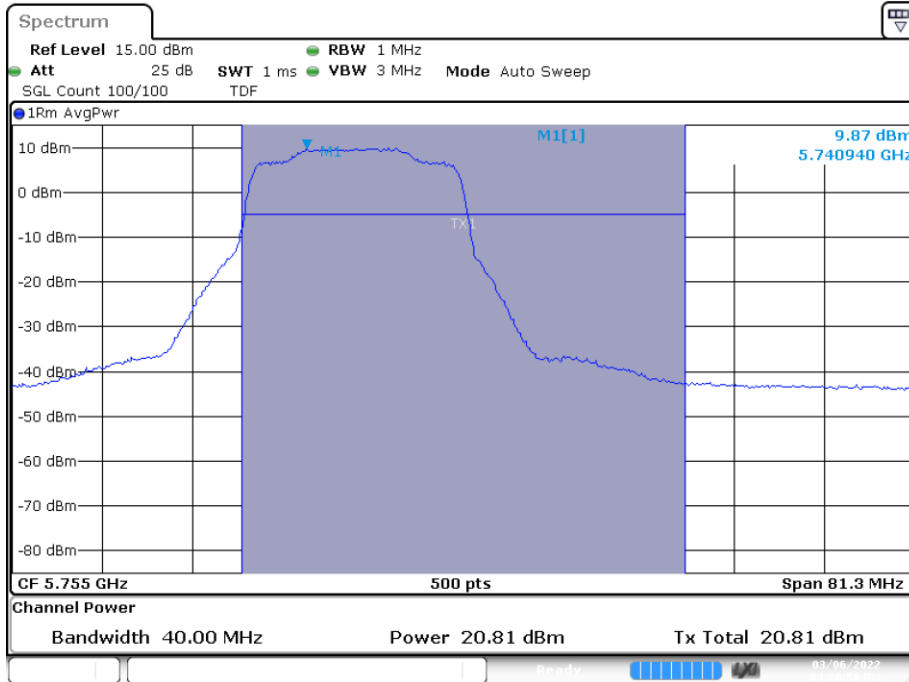

# MIMO-B, 802.11ax40, 242/61, HE0

Channel 151

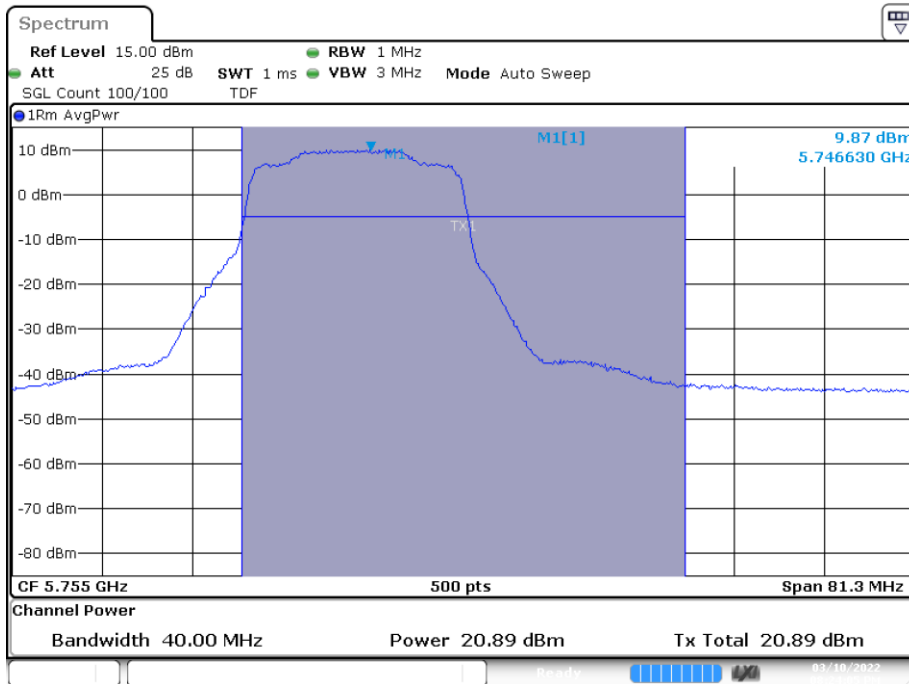



# MIMO-A, 802.11ax80, 484/65, HE0

Channel 155

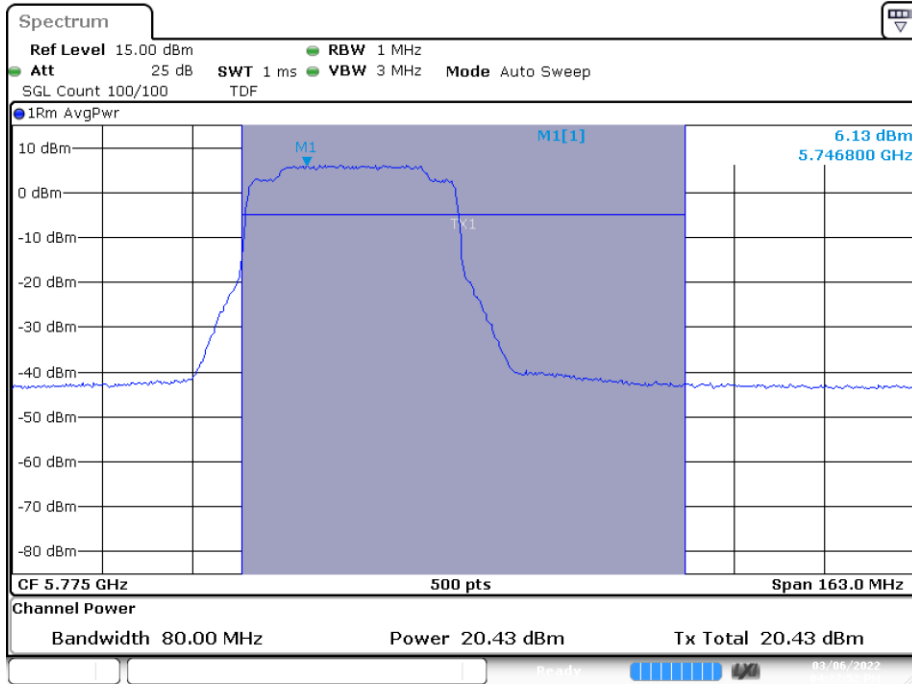

# MIMO-B, 802.11ax80, 484/65, HE0

Channel 155

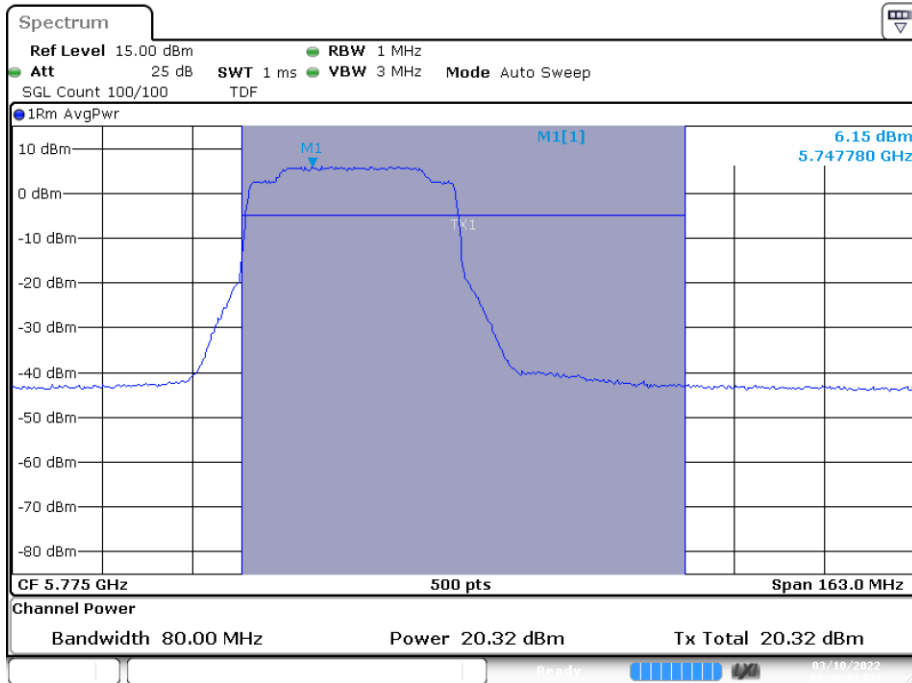

### B.3.4 Undesirable emission limits : out of band (Conducted)

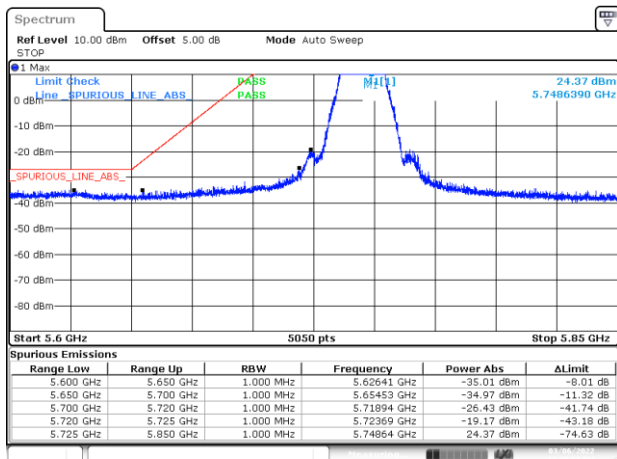

BE-NR-LOW, SISO-A, 802.11a-6Mbps, Ch149

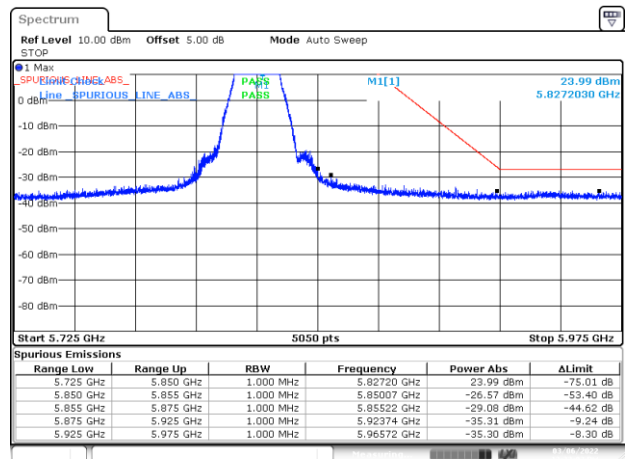

BE-NR-HIGH, SISO-A, 802.11a-6Mbps, Ch165

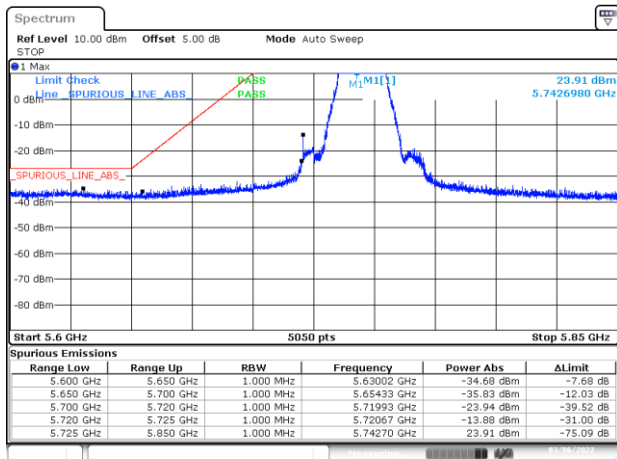

BE-NR-LOW, SISO-A, 802.11n20-HT0, Ch149

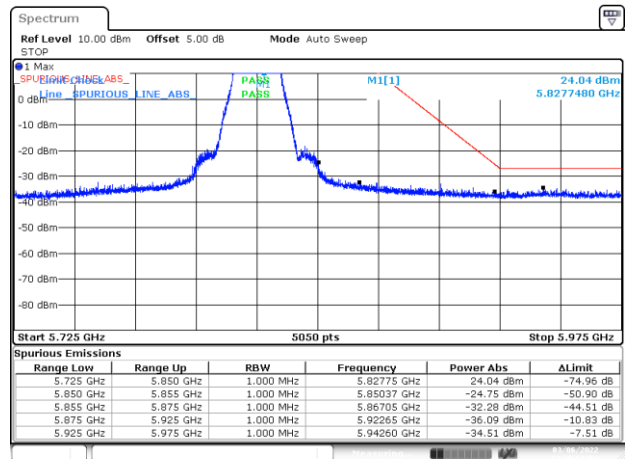

BE-NR-HIGH, SISO-A, 802.11n20-HT0, Ch165

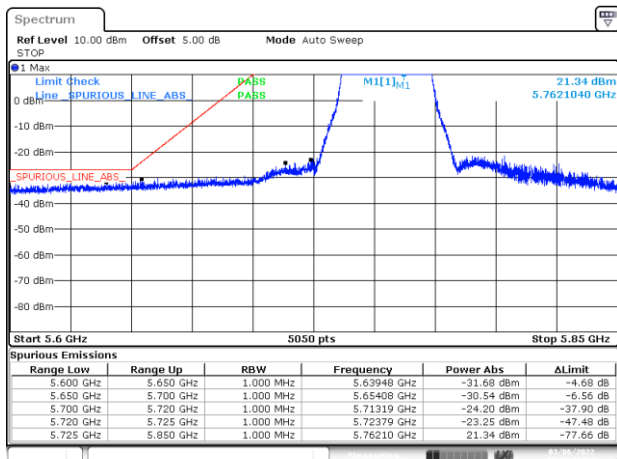

BE-NR-LOW, SISO-A, 802.11n40-HT0, Ch151

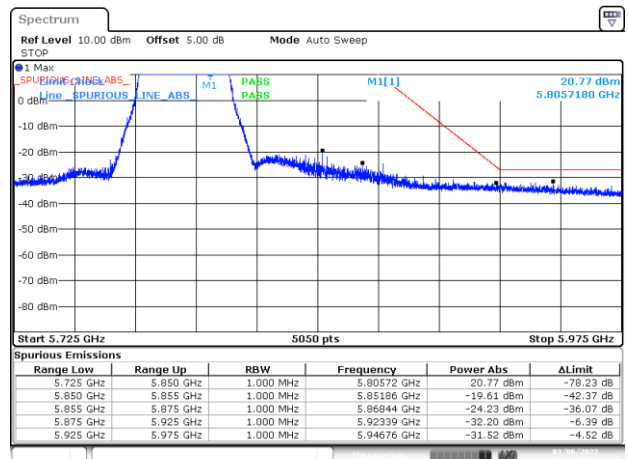

BE-NR-HIGH, SISO-A, 802.11n40-HT0, Ch159

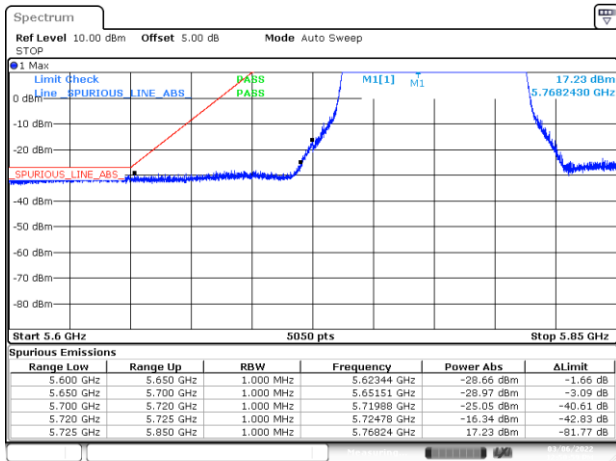

BE-NR-LOW, SISO-A, 802.11ac80-VHT0, Ch155

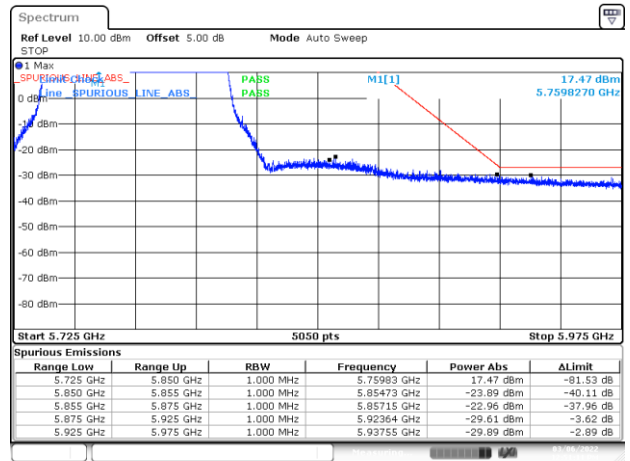

BE-NR-HIGH, SISO-A, 802.11ac80-VHT0, Ch155

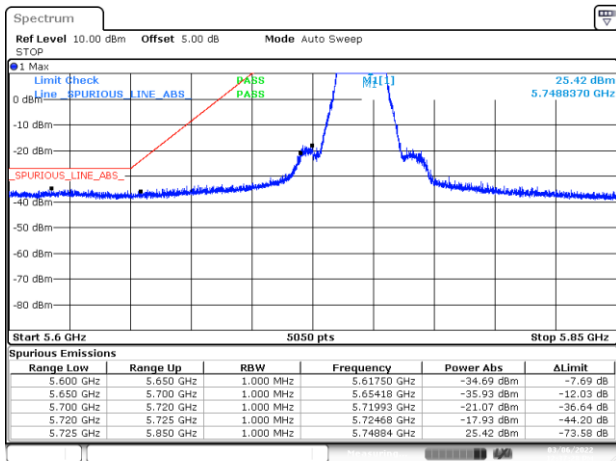

BE-NR-LOW, SISO-A, 802.11ax20-HE0, Ch149

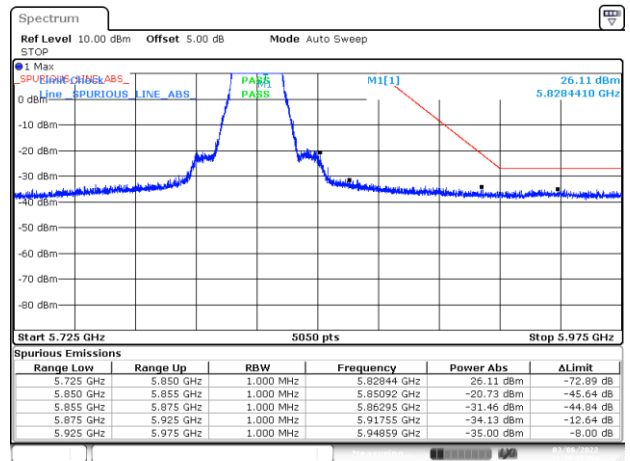

BE-NR-HIGH, SISO-A, 802.11ax20-HE0, Ch165

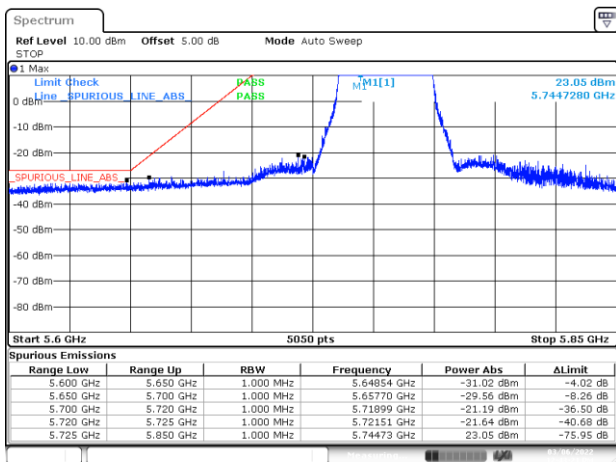

BE-NR-LOW, SISO-A, 802.11ax40-HE0, Ch151

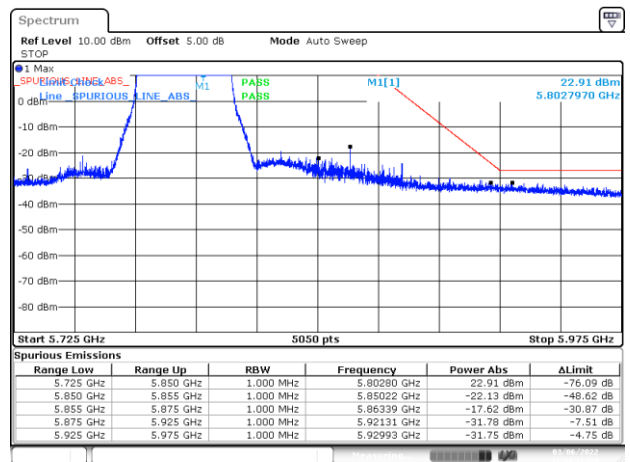

BE-NR-HIGH, SISO-A, 802.11ax40-HE0, Ch159

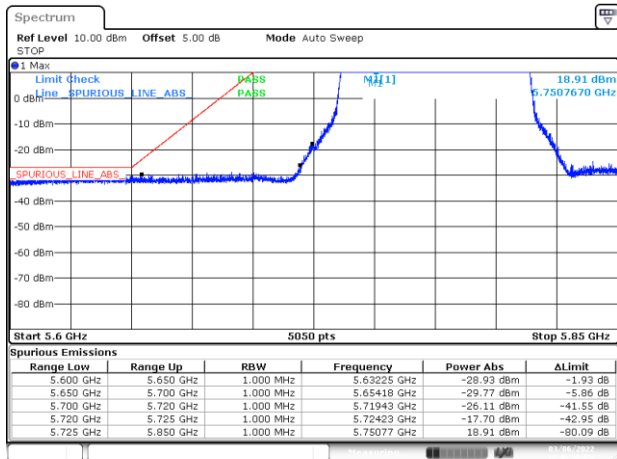

BE-NR-LOW, SISO-A, 802.11ax80-HE0, Ch155

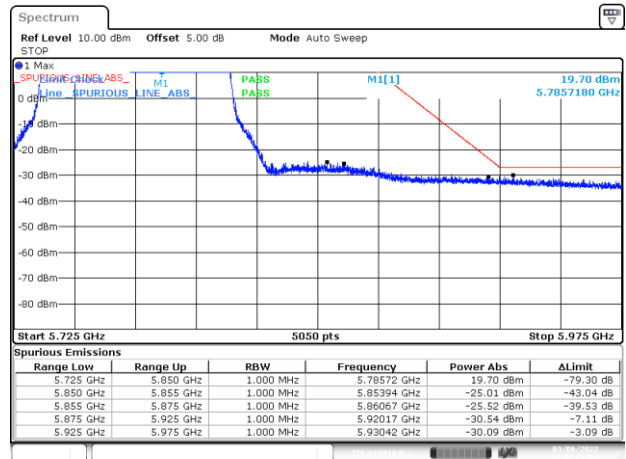

BE-NR-HIGH, SISO-A, 802.11ax80-HE0, Ch155

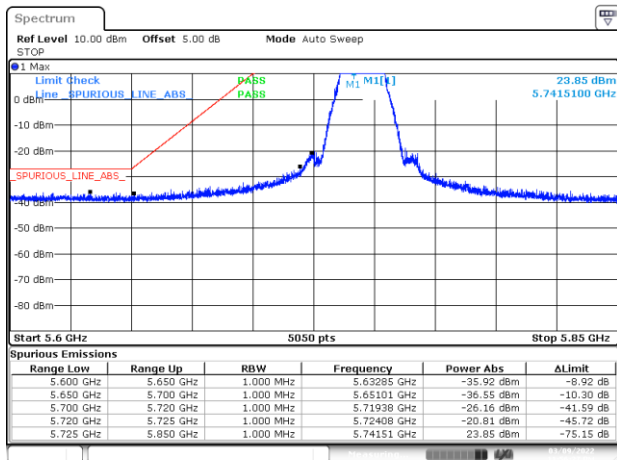

BE-NR-LOW, SISO-B, 802.11a-6Mbps, Ch149

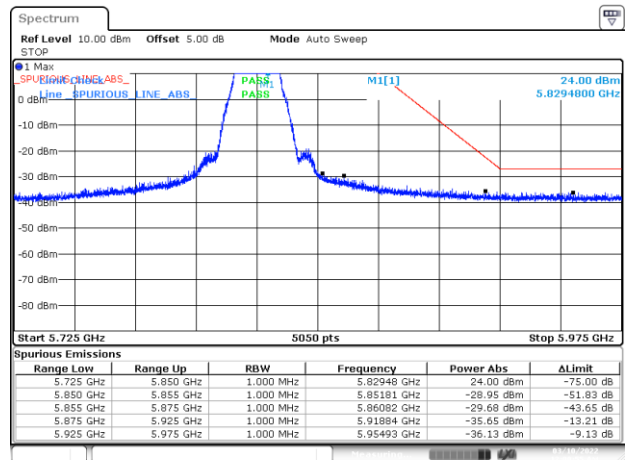

BE-NR-HIGH, SISO-B, 802.11a-6Mbps, Ch165

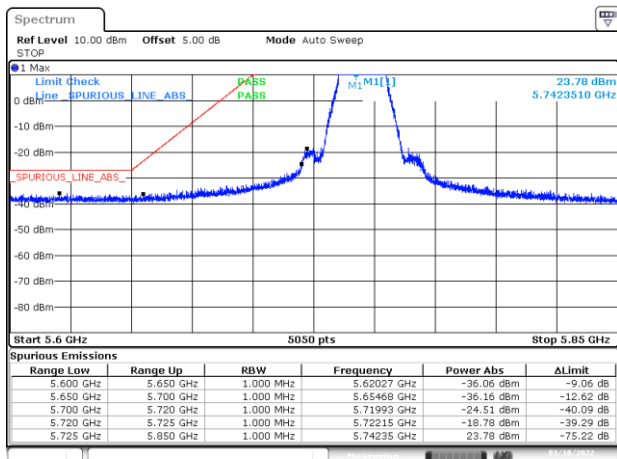

BE-NR-LOW, SISO-B, 802.11n20-HT0, Ch149

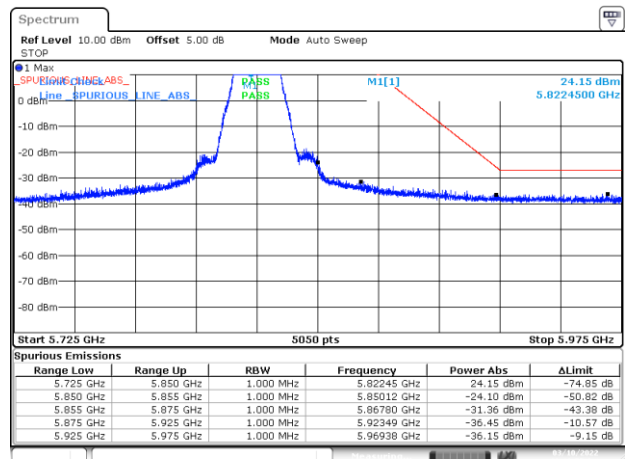

BE-NR-HIGH, SISO-B, 802.11n20-HT0, Ch165

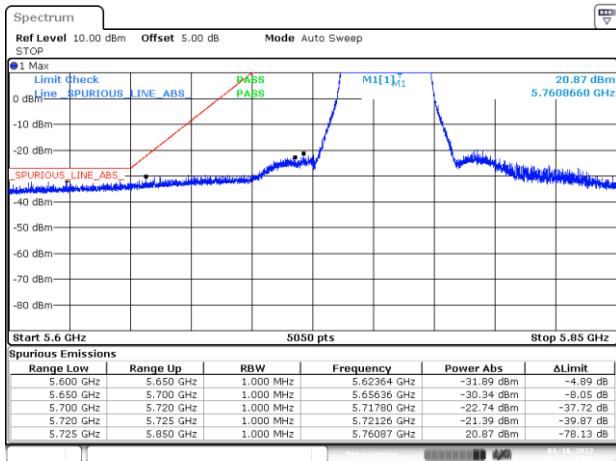

BE-NR-LOW, SISO-B, 802.11n40-HT0, Ch151

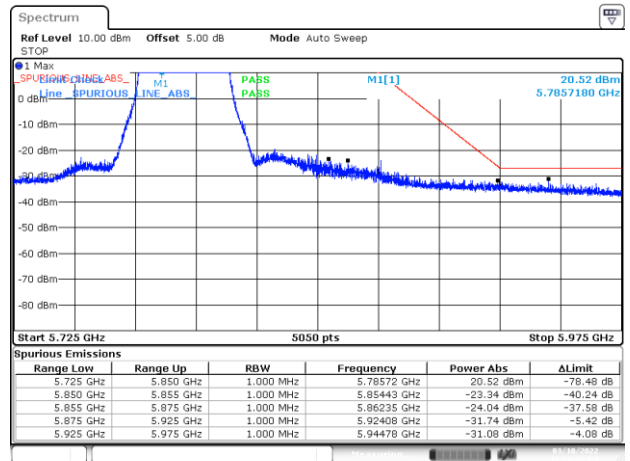

BE-NR-HIGH, SISO-B, 802.11n40-HT0, Ch159

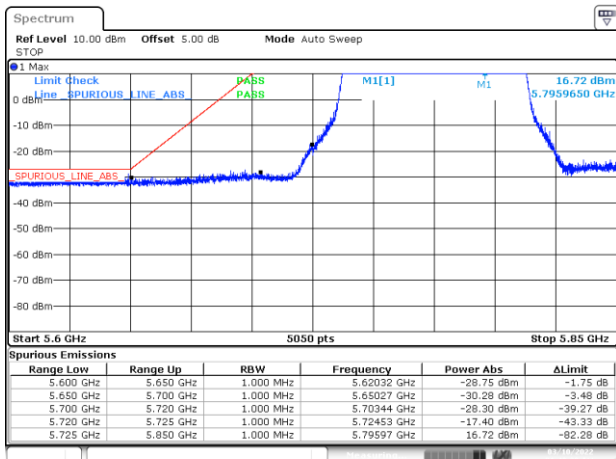

BE-NR-LOW, SISO-B, 802.11ac80-VHT0, Ch155

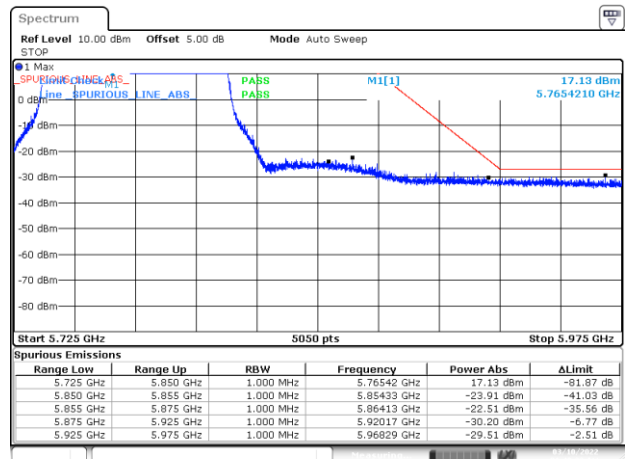

BE-NR-HIGH, SISO-B, 802.11ac80-VHT0, Ch155

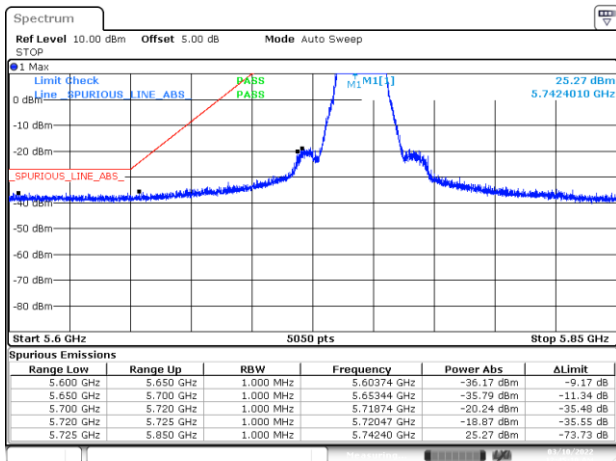

BE-NR-LOW, SISO-B, 802.11ax20-HE0, Ch149

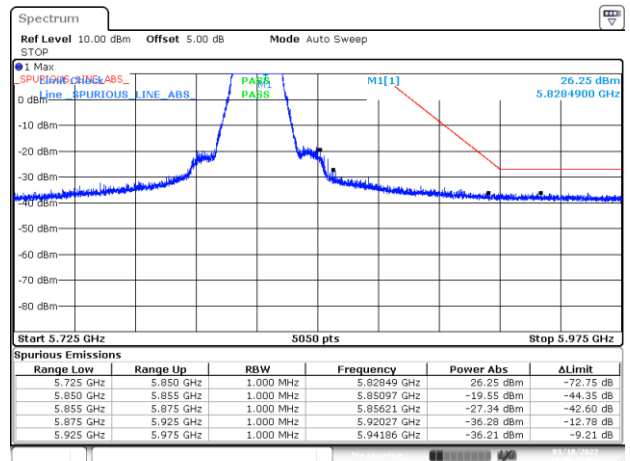

BE-NR-HIGH, SISO-B, 802.11ax20-HE0, Ch165

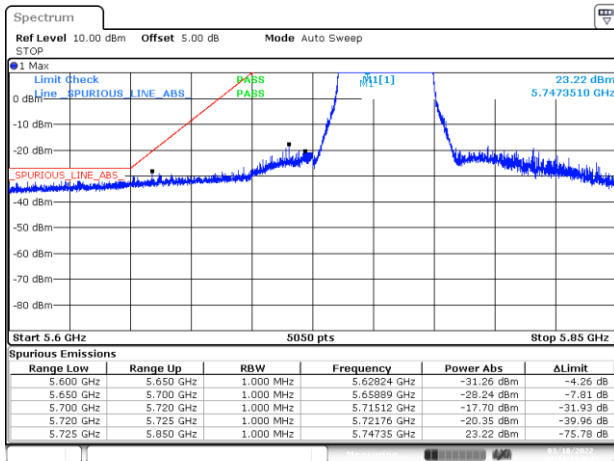

BE-NR-LOW, SISO-B, 802.11ax40-HE0, Ch151

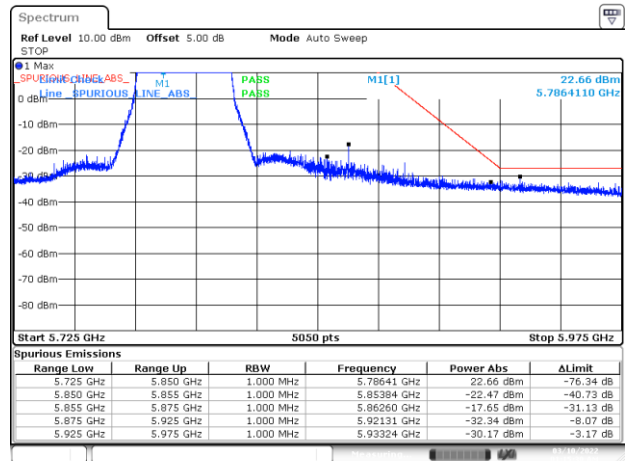

BE-NR-HIGH, SISO-B, 802.11ax40-HE0, Ch159

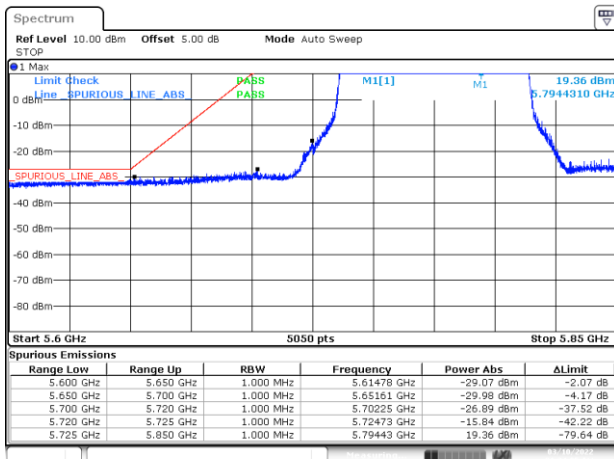

BE-NR-LOW, SISO-B, 802.11ax80-HE0, Ch155

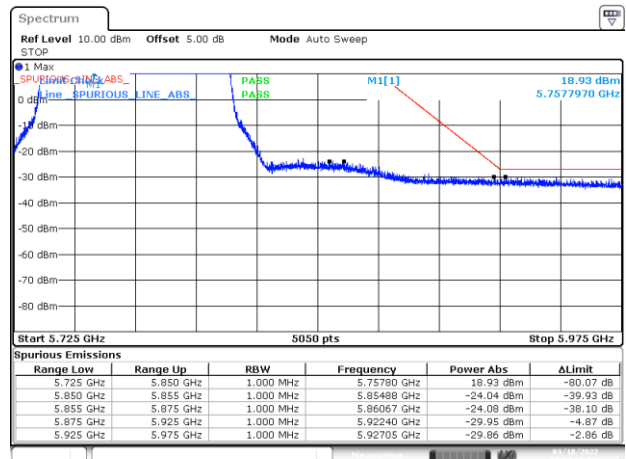

BE-NR-HIGH, SISO-B, 802.11ax80-HE0, Ch155

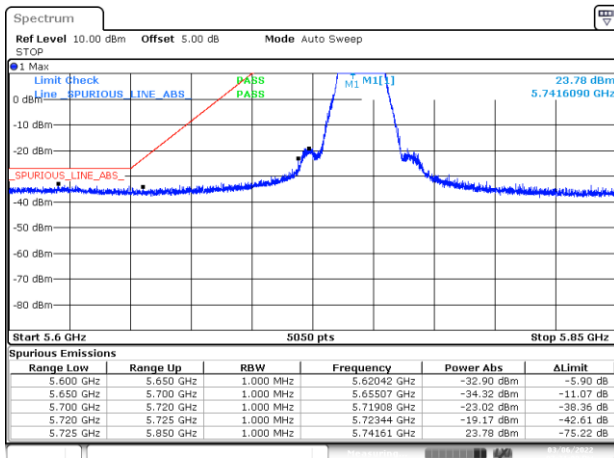

BE-NR-LOW, MIMO-A, 802.11n20-HT8, Ch149

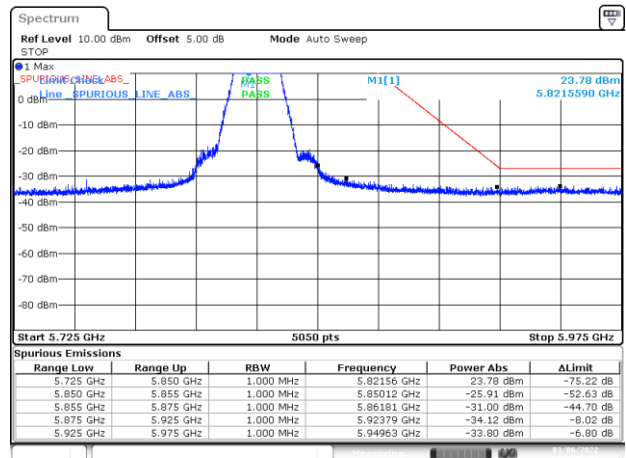

BE-NR-HIGH, MIMO-A, 802.11n20-HT8, Ch165

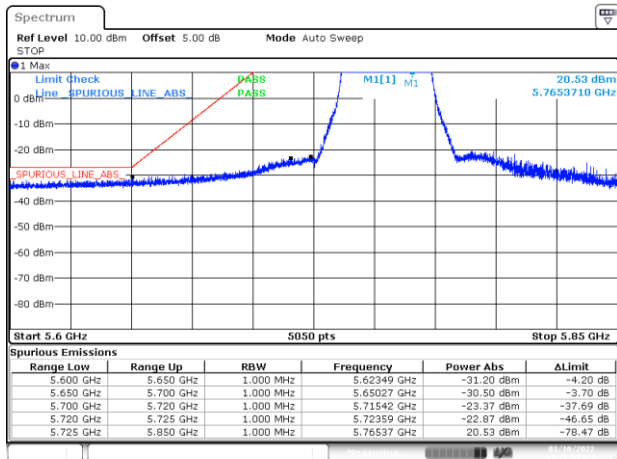

BE-NR-LOW, MIMO-A, 802.11n40-HT8, Ch151

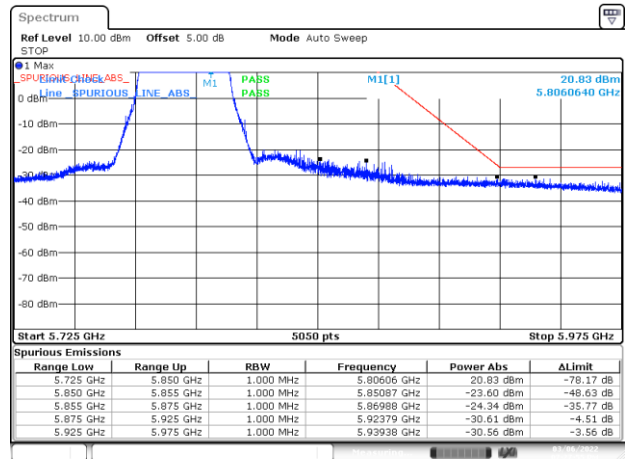

BE-NR-HIGH, MIMO-A, 802.11n40-HT8, Ch159

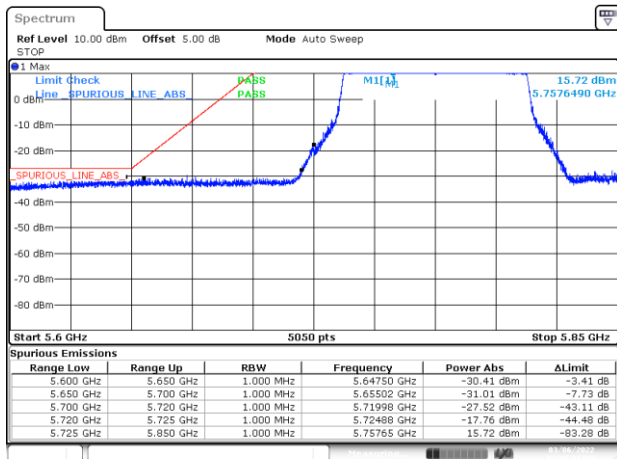

BE-NR-LOW, MIMO-A, 802.11ac80-VHT0, Ch155

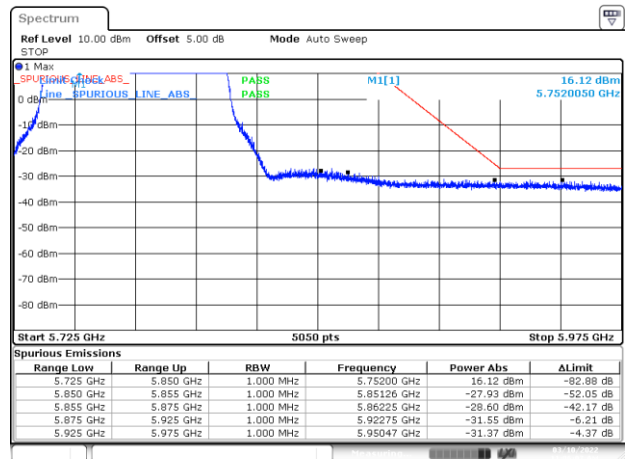

BE-NR-HIGH, MIMO-A, 802.11ac80-VHT0, Ch155

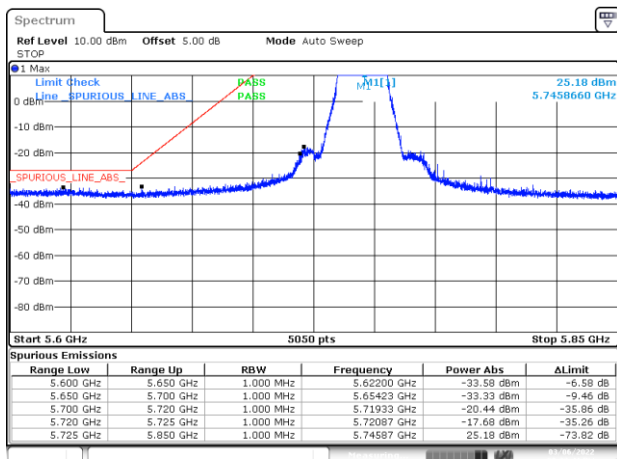

BE-NR-LOW, MIMO-A, 802.11ax20-HE0, Ch149

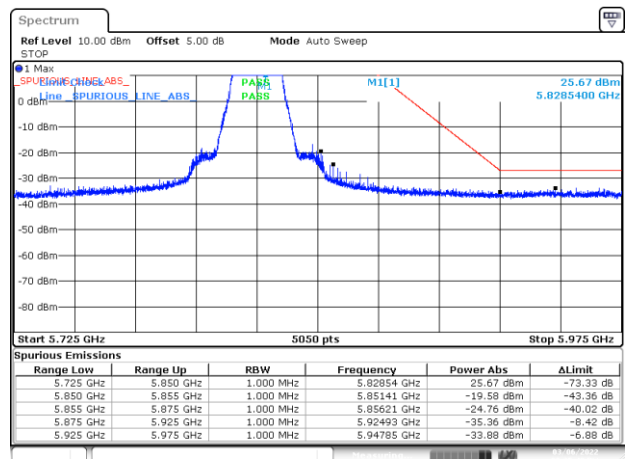

BE-NR-HIGH, MIMO-A, 802.11ax20-HE0, Ch165

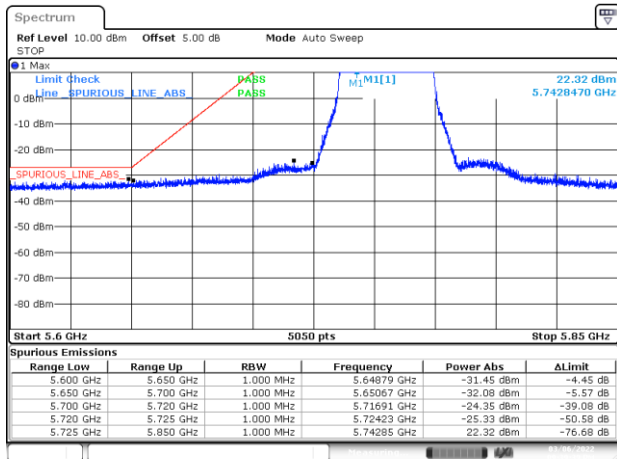

BE-NR-LOW, MIMO-A, 802.11ax40-HE0, Ch151

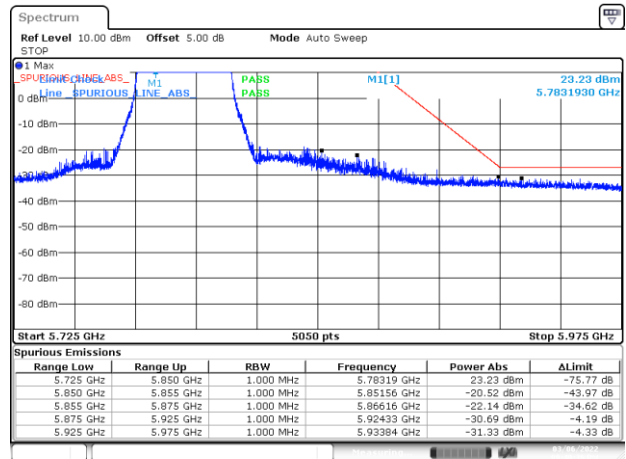

BE-NR-HIGH, MIMO-A, 802.11ax40-HE0, Ch159

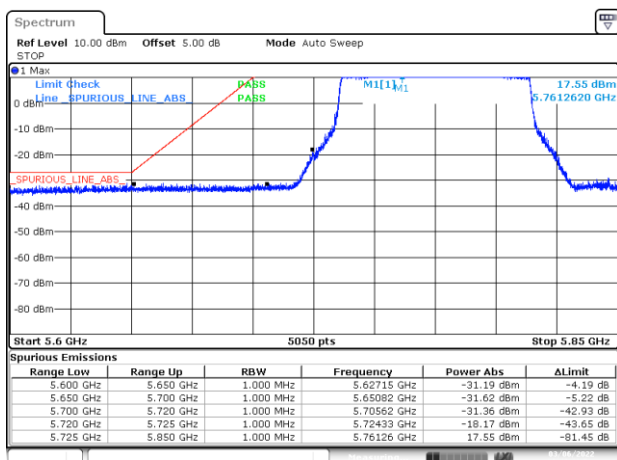

BE-NR-LOW, MIMO-A, 802.11ax80-HE0, Ch155

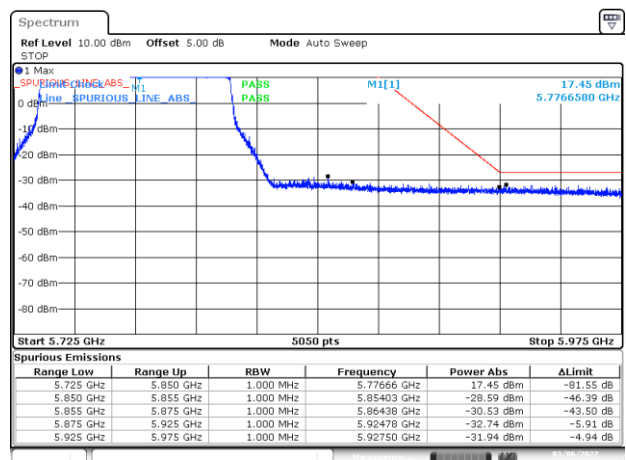

BE-NR-HIGH, MIMO-A, 802.11ax80-HE0, Ch155

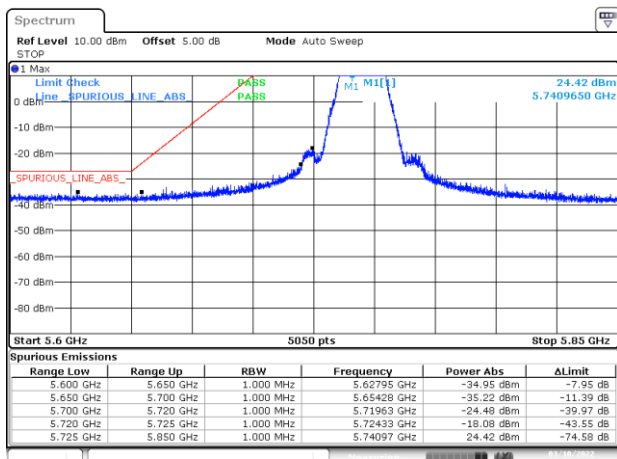

BE-NR-LOW, MIMO-B, 802.11n20-HT8, Ch149

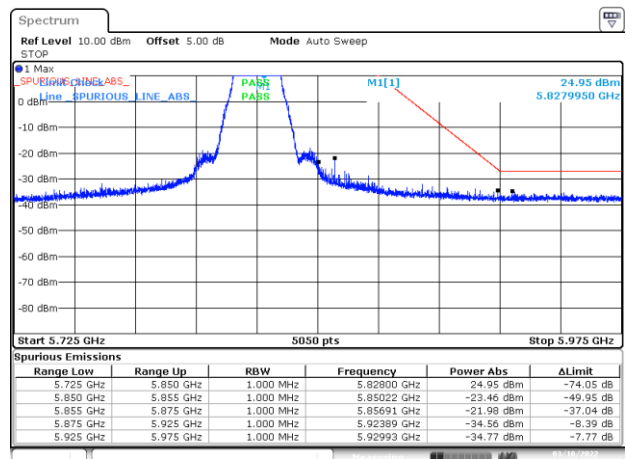

BE-NR-HIGH, MIMO-B, 802.11n20-HT8, Ch165



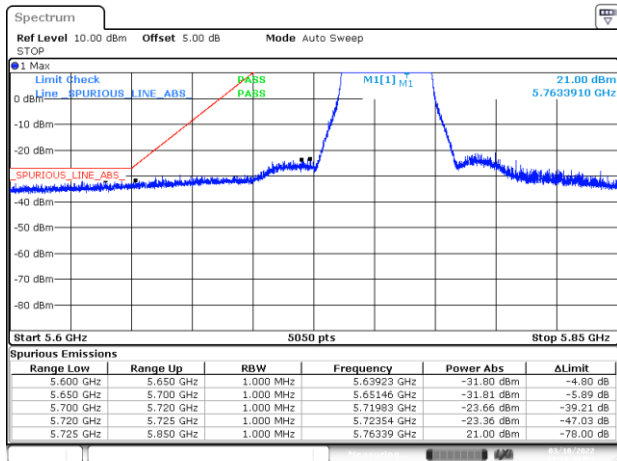

BE-NR-LOW, MIMO-B, 802.11n40-HT8, Ch151

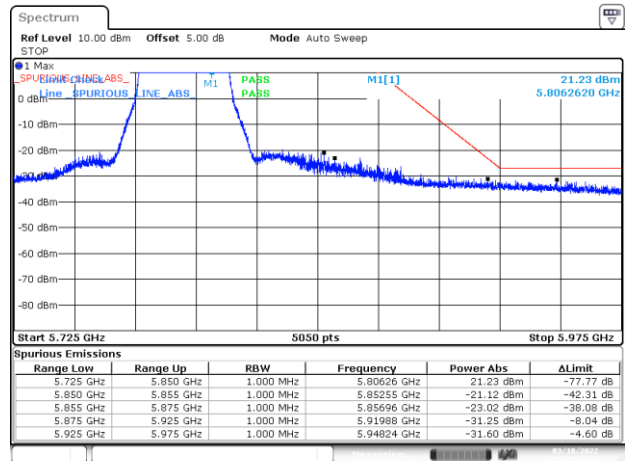

BE-NR-HIGH, MIMO-B, 802.11n40-HT8, Ch159

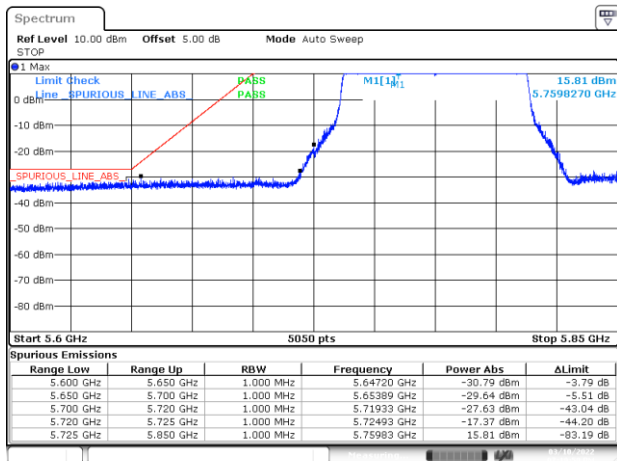

BE-NR-LOW, MIMO-B, 802.11ac80-VHT0, Ch155

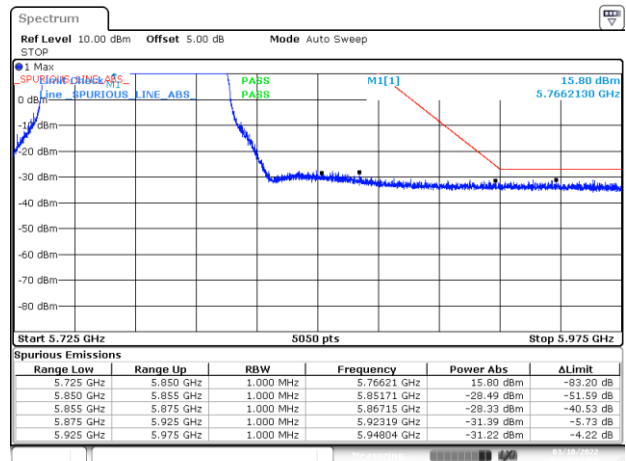

BE-NR-HIGH, MIMO-B, 802.11ac80-VHT0, Ch155

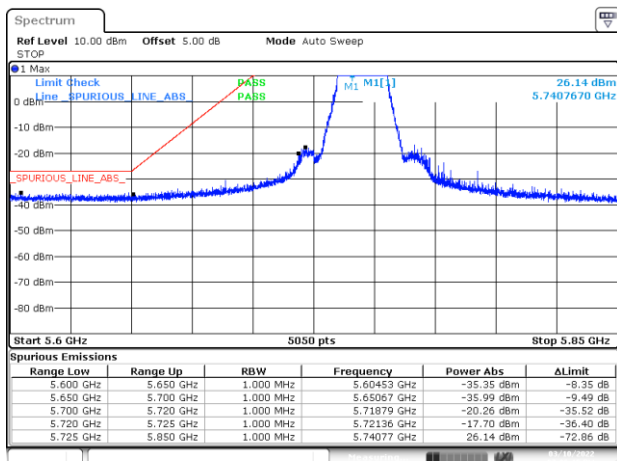

BE-NR-LOW, MIMO-B, 802.11ax20-HE0, Ch149

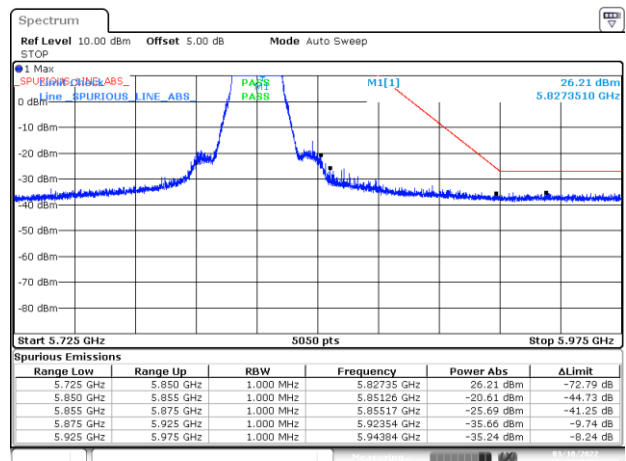

BE-NR-HIGH, MIMO-B, 802.11ax20-HE0, Ch165

Test Report N° 220225-01.TR03

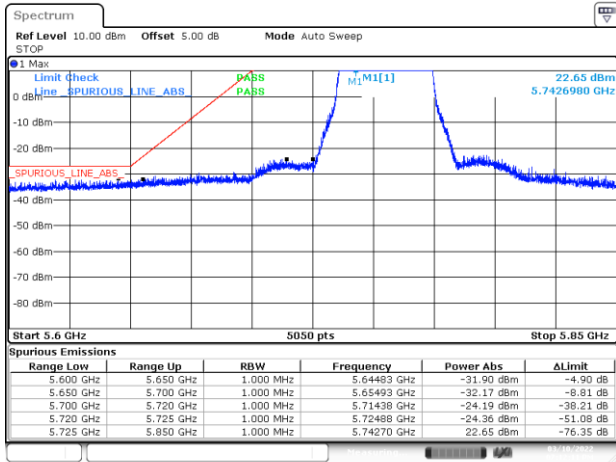

BE-NR-LOW, MIMO-B, 802.11ax40-HE0, Ch151

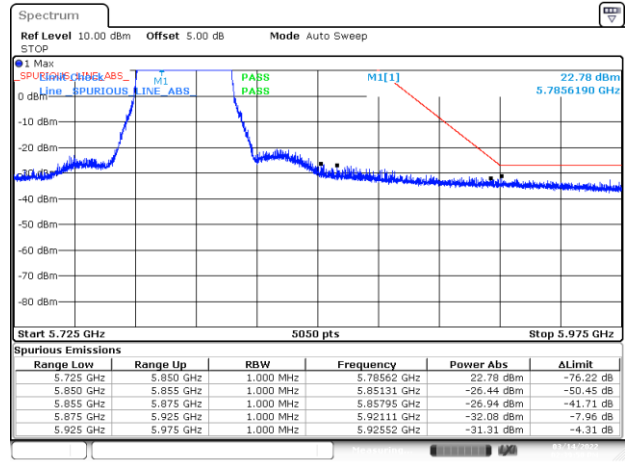

Date: 14 MAR 2022 14:39:49

BE-NR-HIGH, MIMO-B, 802.11ax40-HE0, Ch159

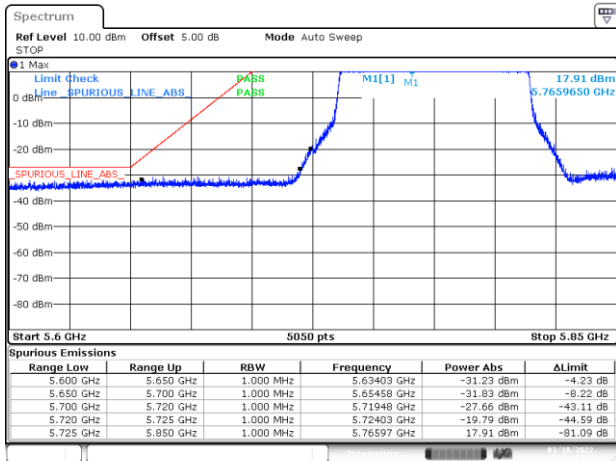

BE-NR-LOW, MIMO-B, 802.11ax80-HE0, Ch155



BE-NR-HIGH, MIMO-B, 802.11ax80-HE0, Ch155