

TEST REPORT

EUT Description	WLAN and BT, 2x2 PCIe M.2 2230 adapter card
Brand Name	Intel® Wi-Fi 6 AX204
Model Name	AX204NGW
FCC/IC ID	FCC ID: PD9AX204NG ; IC ID 1000M-AX204NG
Date of Test Start/End	2022-03-08 / 2022-03-17
Features	802.11ax R2, Dual Band, 2x2 Wi-Fi 6 + Bluetooth® 5.2 (see section 5)

Applicant	Intel Mobile Communications
Address	100 Center Point Circle, Suite 200 Columbia, South Carolina 29210 USA
Contact Person	Steven Hackett
Telephone/Fax/ Email	steven.c.hackett@intel.com

Reference Standards	FCC CFR Title 47 Part 15 C RSS-247 issue 2, RSS-Gen issue 5 A1 (see section 1)
---------------------	--

Test Report identification	220225-01.TR63
Revision Control	Rev. 00 This test report revision replaces any previous test report revision (see section 8)

The test results relate only to the samples tested.
Reference to accreditation shall be used only by full reproduction of test report.

Issued by _____ Reviewed by _____

Khodor RIDA
(Test Engineer)

Zayd OUACHICHA
(Technical Manager Deputy)

Intel Corporation S.A.S – WRF Lab
425 rue de Goa – Le Cargo B6 - 06600, Antibes, France
Tel. +33493001400 / Fax +33493001401

Table of Contents

1. Standards, reference documents and applicable test methods	3
2. General conditions, competences and guarantees	3
3. Environmental Conditions	3
4. Test samples	4
5. EUT Features	5
6. Remarks and comments	6
7. Test Verdicts summary	6
7.1. BLE	6
8. Document Revision History	6
Annex A. Test & System Description	7
A.1 MEASUREMENT SYSTEM.....	7
A.2 TEST EQUIPMENT LIST	10
A.3 MEASUREMENT UNCERTAINTY EVALUATION	12
Annex B. Test Results	13
B.1 TEST RESULTS	13
B.1.1 6dB & 99% Bandwidth.....	13
B.1.2 Maximum Output Power and antenna gain.....	17
B.1.3 Power Spectral Density	22
B.1.4 Out-of-band emission (Conducted).....	23
B.1.5 Radiated spurious emission.....	26
Annex C. Photographs	29
C.1 TEST SETUP	29
C.2 TEST SAMPLE	31

1. Standards, reference documents and applicable test methods

FCC	<ol style="list-style-type: none"> 1. FCC Title 47 CFR part 15 - Subpart C – §15.247 Operation within the bands 902-928 MHz, 2400-2483.5 MHz, and 5725-5850 MHz. 2019-10-01 Edition 2. FCC Title 47 CFR part 15 - Subpart C – §15.209 Radiated emission limits; general requirements. 2019-10-01 Edition 3. FCC OET KDB 558074 D01 v05r02 - Guidance for compliance measurements on digital transmission system, frequency hopping spread spectrum system, and hybrid system devices operating under section 15.247 of the FCC rules. 4. FCC OET KDB 662911 D01 v02r01 - Emissions Testing of Transmitters with Multiple Outputs in the Same Band. 5. ANSI C63.10-2013 - American National Standard of Procedures for Compliance Testing of Unlicensed Wireless Devices
ISED	<ol style="list-style-type: none"> 1. RSS-247 Issue 2 - Digital Transmission Systems (DTSs), Frequency Hopping Systems (FHSs) and License-Exempt Local Area Network (LE-LAN) Devices. 2. RSS-Gen Issue 5 A1- General Requirements for Compliance of Radio Apparatus. 3. FCC OET KDB 558074 D01 v05r02 - Guidance for compliance measurements on digital transmission system, frequency hopping spread spectrum system, and hybrid system devices operating under section 15.247 of the FCC rules. 4. FCC OET KDB 662911 D01 v02r01 - Emissions Testing of Transmitters with Multiple Outputs in the Same Band. 5. ANSI C63.10-2013 - American National Standard of Procedures for Compliance Testing of Unlicensed Wireless Devices

2. General conditions, competences and guarantees

- ✓ Tests performed under FCC standards identified in section 1 are covered by A2LA accreditation.
- ✓ Tests performed under ISED standards identified in section 1 are covered by Cofrac accreditation.
- ✓ Intel Corporation SAS Wireless RF Lab (Intel WRF Lab) is an ISO/IEC 17025:2017 laboratory accredited by the American Association for Laboratory Accreditation (A2LA) with the certificate number 3478.01.
- ✓ Intel Corporation SAS Wireless RF Lab (Intel WRF Lab) is an Accredited Test Firm recognized by the FCC, with Designation Number FR0011.
- ✓ Intel Corporation SAS Wireless RF Lab (Intel WRF Lab) is an ISO/IEC 17025:2017 testing laboratory accredited by the French Committee for Accreditation (Cofrac) with the certificate number 1-6736.
- ✓ Intel Corporation SAS Wireless RF Lab (Intel WRF Lab) is a Registered Test Site listed by ISED, with ISED #1000Y.
- ✓ Intel WRF Lab declines any responsibility with respect to the identified information provided by the customer and that may affect the validity of results.
- ✓ Intel WRF Lab only provides testing services and is committed to providing reliable, unbiased test results and interpretations.
- ✓ Intel WRF Lab is liable to the client for the maintenance of the confidentiality of all information related to the item under test and the results of the test.
- ✓ Intel WRF Lab has developed calibration and proficiency programs for its measurement equipment to ensure correlated and reliable results to its customers.
- ✓ This report is only referred to the item that has undergone the test.
- ✓ This report does not imply an approval of the product by the Certification Bodies or competent Authorities.

3. Environmental Conditions

- ✓ At the site where the measurements were performed the following limits were not exceeded during the tests:

Temperature	21.0°C ± 1.2°C
Humidity	43.0% ± 17.0%

4. Test samples

Sample	Control #	Description	Model	Serial #	Date of receipt	Note
#01	220225-01.S01	WiFi Module	AX204NGW	C8CB9E88AA68	2022-03-04	Used for 30 MHz-1 GHz Spurious Emissions tests
	200611-01.S09	Adaptor	PowerBy SNJ A4	-	2020-11-30	
	200602-03.S06	Absorber	-	-	2020-07-03	
	200611-03.S31	Extender	ADEXELEC	-	2020-08-19	
	200615-05.S09	Laptop	Latitude 5401	GVGLK13	2020-06-12	
	210611-02.S13	Main Antenna	SkyCross	-	2021-07-02	
	210611-02.S14	Aux Antenna	SkyCross	-	2021-07-02	
#02	220225-01.S02	WiFi Module	AX204NGW	C8CB9E8A9BE	2022-03-04	Used for 1 GHz-26 GHz Spurious Emission tests
	210611-02.S17	Adaptor	PowerBy SNJ A4	-	2021-07-02	
	200602-03.S06	Absorber	-	-	2020-07-03	
	200611-03.S26	Extender	ADEXELEC	-	2020-07-01	
	170000-01.S01	Laptop	Latitude E5470	DBPLMC2	2017-03-28	
	210611-02.S11	Main Antenna	SkyCross	-	2021-07-02	
	210611-02.S12	Aux Antenna	SkyCross	-	2021-07-02	
#03	220225-01.S05	WiFi Module	AX204NGW	C8CB9E88A93C	2022-03-04	RF Conducted
	170000-01.S02	Laptop	Latitude E5470	21HTPF2	2017-03-28	
	200611-01.S12	Extender	XVT EXTENDER SNJ A4	-	2020-11-30	

5. EUT Features

The herein information is provided by the customer

Brand Name	Intel® Wi-Fi 6 AX204		
Model Name	AX204NGW		
Software Version	DRTU_01188_99.0.69C		
Driver Version	WiFi: 99.0.70.4 BT: 22.140.22111.51677		
Prototype / Production	Production		
Supported Radios	802.11b/g/n/ax	2.4GHz (2400.0 – 2483.5 MHz)	
	802.11a/n/ac/ax	5.2GHz (5150.0 – 5350.0 MHz)	
		5.6GHz (5470.0 – 5725.0 MHz)	
		5.8GHz (5725.0 – 5895.0 MHz)	
	Bluetooth 5.2	2.4GHz (2400.0 – 2483.5 MHz)	
Antenna Information	Transmitter	Chain 1 (A) / Aux	Chain 2 (B) / Main
	Manufacturer	SkyCross	Skycross
	Antenna type	PIFA antenna	PIFA antenna
	Part number	N/A	N/A
	Declared antenna gain (dBi)	+3.24	+3.24

6. Remarks and comments

1. No deviations were made from the test methods listed in section 1 of this report

7. Test Verdicts summary

The statement of conformity to applicable standards in the table below are based on the measured values, without taking into account the measurement uncertainties.

7.1. BLE

FCC part	RSS part	Test name	Verdict
15.247 (a) (2)	RSS-247 Clause 5.2 (a)	6dB Bandwidth	P
15.247 (b) (3)	RSS-247 Clause 5.4 (d)	Maximum output power and E.I.R.P.	P
15.247 (e)	RSS-247 Clause 5.2 (b)	Power spectral density	P
15.247 (d) 15.209	RSS-247 Clause 5.5 RSS-Gen A1 Clause 8.9	Out-of-band Emissions (conducted)	P
15.247 (d) 15.209	RSS-247 Clause 5.5 RSS-Gen A1 Clause 8.9	Spurious Emissions (radiated)	P

P: Pass
 F: Fail
 NM: Not Measured
 NA: Not Applicable

8. Document Revision History

Revision #	Modified by	Revision Details
Rev. 00	N.Bui V.Kaculini	First Issue

Annex A. Test & System Description

A.1 Measurement System

Measurements were performed using the following setups, made in accordance to the general provisions of FCC OET KDB 558074 D01 DTS Meas Guidance.

The DUT was installed in a test fixture and this test fixture is connected to a laptop computer and AC/DC power adapter. The laptop computer was used to configure the EUT to continuously transmit at a specified output power using all different modes and modulation schemes, using the Intel proprietary tool DRTU.

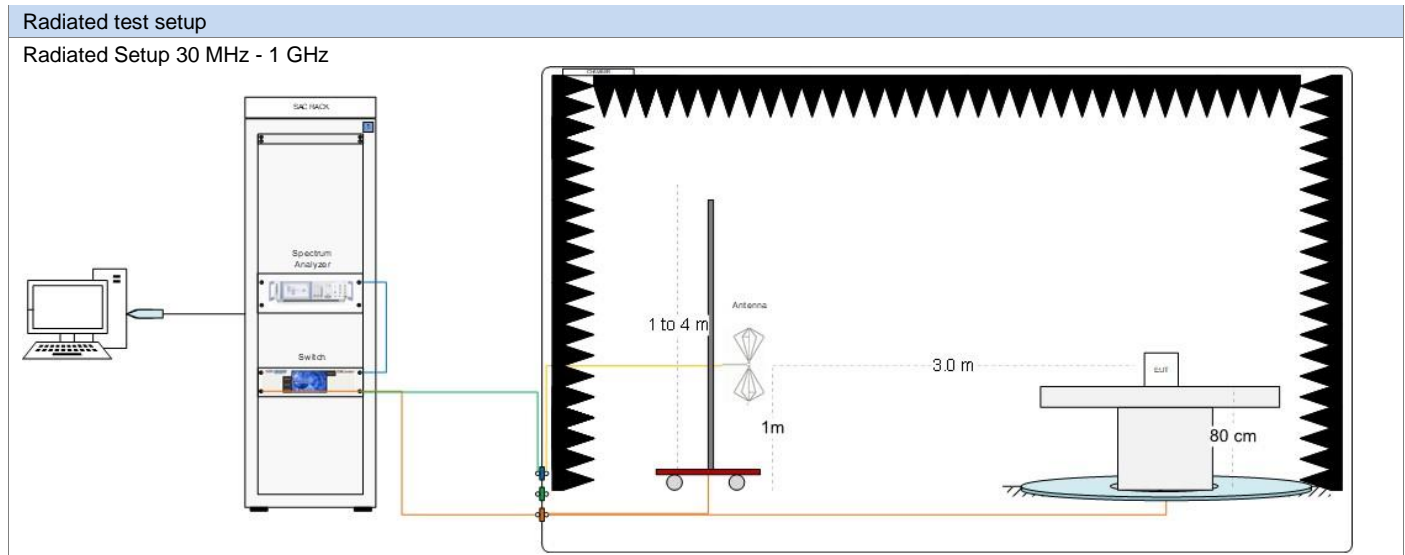
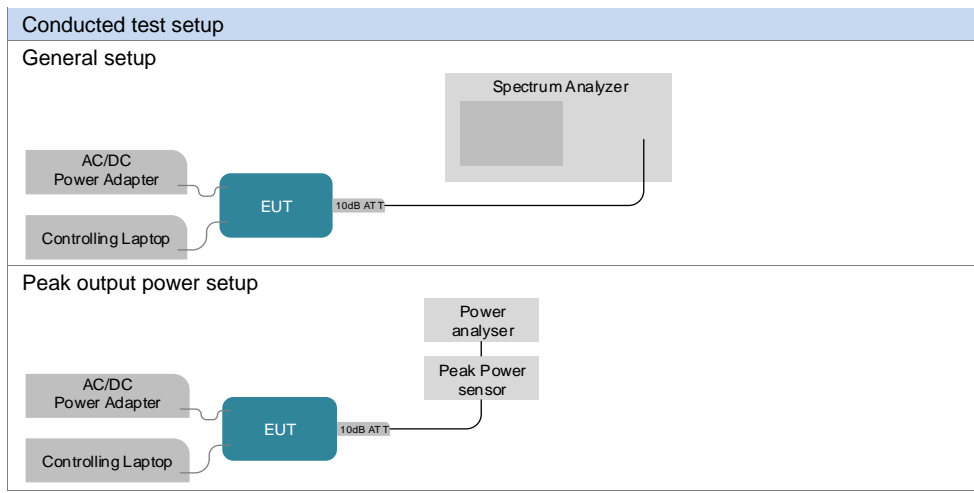

Radiated Setup 1 GHz – 9.5 GHz

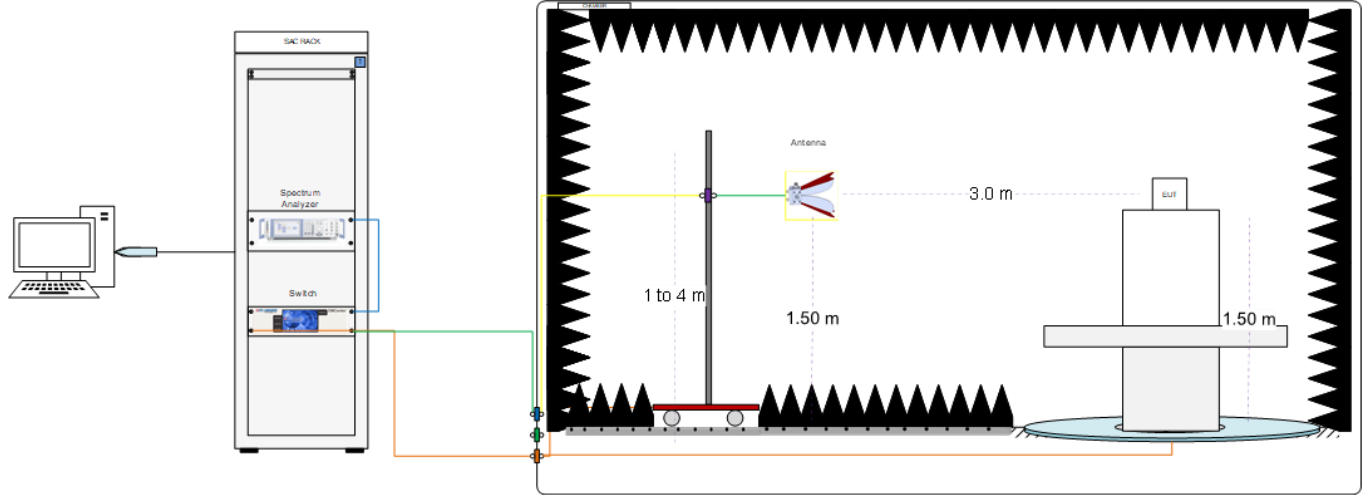

Radiated Setup 9.5 GHz - 18 GHz

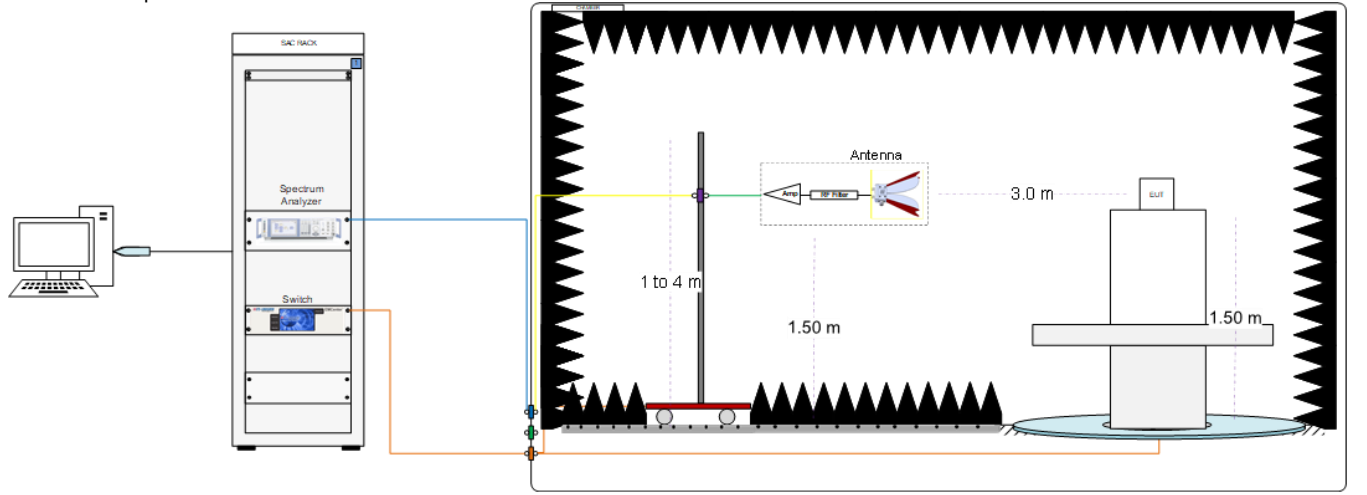

Radiated Setup 18 GHz – 26 GHz

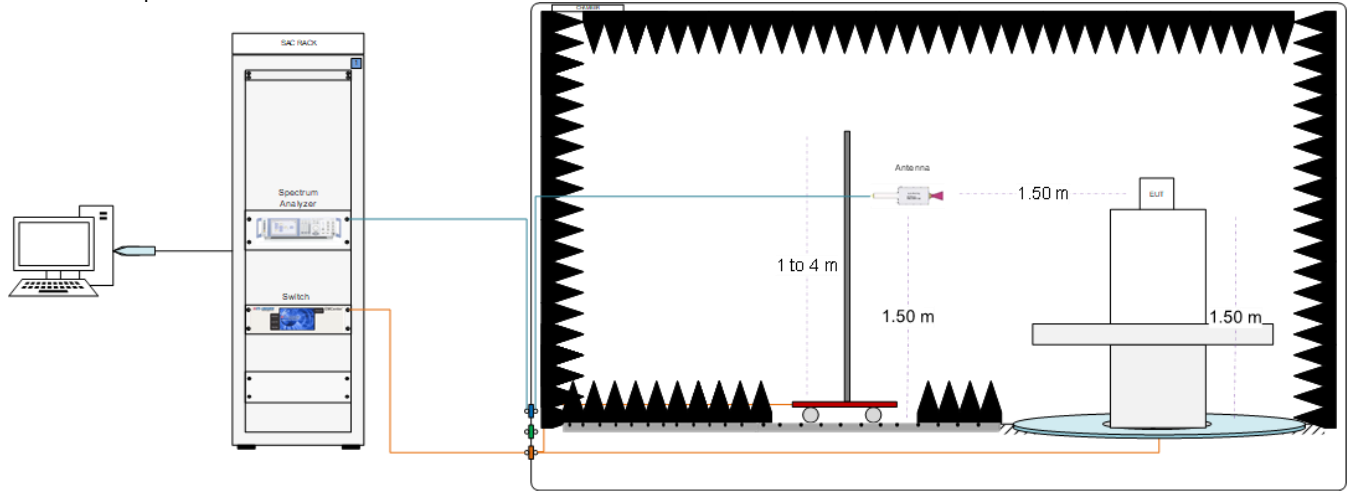

Sample Calculation

The spurious received voltage V (dB μ V) in the spectrum Analyzer is converted to Electric field strength using the transducer factor F corresponding to the Rx path Loss:

$$\mathbf{F \text{ (dB/m)} = Rx \text{ Antenna Factor (dB/m) + Cable losses (dB) - Amplifiers Gain (dBi)}$$
$$\mathbf{E \text{ (dB}\mu\mathbf{V)} = V \text{ (dB}\mu\mathbf{V)} + F \text{ (dB/m)}$$

For field strength measurements made at other than the distance at which the applicable limit is specified, the field strength of the emission at the distance specified by the limit is deduced as follows:

$$\mathbf{E_{SpecLimit} = E_{Meas} + 20 \cdot \log(D_{Meas}/D_{SpecLimit})}$$

where

E_{SpecLimit} is the field strength of the emission at the distance specified by the limit, in dB μ V/m

E_{Meas} is the field strength of the emission at the measurement distance, in dB μ V/m

D_{Meas} is the measurement distance, in m

D_{SpecLimit} is the distance specified by the limit, in m

A.2 Test Equipment List

Conducted setup

ID#	Device	Type/Model	Serial #	Manufacturer	Cal. Date	Cal. Due Date
265-000	Spectrum Analyzer	FSV30	101318	Rohde & Schwarz	2020-05-28	2022-05-28
019-000	RF cable 100cm	PE360-100CM	N/A	PASTERNAK	2022-02-04	2022-08-04
019-002	10dB Attenuator + MH4	N/A	N/A	N/A	2022-02-04	2022-08-04
322-000	Temp & Humidity Logger	RA12E-TH1-RAS	RA12-B89702	AVTECH	2021-09-02	2023-09-02
413-000	Measurement SW v1.5.4.2	Octopi	N/A	Step AT	N/A	N/A

Radiated Setup #1

ID#	Device	Type/Model	Serial #	Manufacturer	Cal. Date	Cal. Due Date
006-000	Anechoic chamber	FACT 3	5720	ETS Lindgren	2022-01-21	2024-01-21
006-001	Turntable	-	-	ETS Lindgren	N/A	N/A
006-008	Measurement Software v11.30.00	EMC32	100623	Rohde & Schwarz	N/A	N/A
147-000	Spectrum analyzer	FSW43	101847	Rohde & Schwarz	2020-11-02	2022-11-02
006-002	Switch & Positioning	EMC center	00159757	ETS Lindgren	N/A	N/A
006-011	Boresight antenna mast	BAM4.0-P	P/278/2890.01	Maturo	N/A	N/A
006-019	Biconical antenna 30 MHz – 1 GHz	UBAA9115 + BBVU9135 + DGA9552N	0286 + CH 9044	Schwarzbeck	2022-02-01	2024-02-01
006-020	Double Ridged Horn Antenna 1 GHz – 18 GHz	3117	00157734	ETS Lindgren	2021-08-05	2023-08-05
057-000	Horn Antenna 3117 + Amplifier + HPF9.5	3117	00167062+00169546	ETS-Lindgren	2020-06-15	2022-06-15
007-008	Double Horn Ridged antenna+Amplifier	3116C-PA	00169308bis + 00196308	ETS-Lindgren	2021-08-05	2023-08-05
006-059	RF Cable 7.0m	R286304174	20.46.369	Radiall	2022-03-04	2022-09-04
006-051	RF Cable 1.0m	CBL-1.5M-SMSM+	202879	Mini-Circuits	2022-02-02	2022-08-02
006-030	RF Cable 1.2m	UFA147A-0-0480-200200	MFR 64639223720-003	Micro-coax	2022-02-02	2022-08-02
006-034	RF Cable 1.0m	UFA147A	-	Utiliflex	2022-02-02	2022-08-02
006-036	RF Cable 1.0m	UFB311A-0-0590-50U50U	MFR 64639 223230-001	Micro-coax	2022-02-02	2022-08-02
006-038	RF Cable 7.0m	R286304009	-	Radiall	2022-02-02	2022-08-02
006-039	RF Cable 2.5m	0500990992500KE	19.23.395	Radiall	2022-02-02	2022-08-02
365-000	Temperature & Humidity logger	RA12E-TH1-RAS	00-80-A3-E1-6E-55	Avtech	2021-03-08	2023-03-08

N/A: Not Applicable

Radiated Setup #2

ID#	Device	Type/Model	Serial #	Manufacturer	Cal. Date	Cal. Due Date
007-000	Anechoic chamber	RFD-FA-100	5996	ETS Lindgren	2021-09-14	2023-09-14
007-002	Turntable	-	-	ETS Lindgren	N/A	N/A
007-003	Antenna Tower	2171B-3.0M	00150123	ETS Lindgren	N/A	N/A
007-006	Switch & Positioner	EMCenter	00151232	ETS Lindgren	N/A	N/A
007-005	Measurement SW, V11.20.00	EMC32	100401	Rohde & Schwarz	N/A	N/A
127-000	Spectrum Analyzer	FSV40	101358	Rohde & Schwarz	2021-01-15	2023-01-15
007-007	Double Ridge Horn (1-18GHz)	3117	00152266	ETS Lindgren	2020-03-18	2022-03-18
057-000	Horn Antenna 3117 + Amplifier + HPF9.5	3117	00167062+00169546	ETS-Lindgren	2020-06-15	2022-06-15
007-008	Double Horn Ridged antenna+Amplifier	3116C-PA	00169308bis 00196308	ETS-Lindgren	2021-08-05	2023-08-05
007-022	RF Cable 1-18GHz, 1.5m	0501050991200GX	19.23.493	Radiall	2022-02-03	2022-08-03
007-020	RF Cable 1-18GHz, 1.2 m	2301761761200PJ	12.22.1104	Radiall	2022-02-03	2022-08-03
007-011	RF Cable 1-18GHz – 6.5m	140-8500-11-51	001	Spectrum	2022-02-03	2022-08-03
007-015	RF Cable 1GHz-18GHz 1.5m	-	-	Spirent	2022-02-03	2022-08-03
007-014	RF Cable 18-40 GHz 6m	R286304009	1747364	Radiall	2022-02-03	2022-08-03
007-023	RF Cable 1m DC-40GHz	PE360-100CM	-	Pasternack	2022-02-03	2022-08-03
007-018	RF Cable 1-9.5GHz 1.2m	0500990991200KE	-	Radiall	2022-02-03	2022-08-03
325-000	Temp & Humidity Logger	RA12E-TH1-RAS	RA12-B9B7C6	Avtech	2022-01-17	2024-01-17

N/A: Not Applicable

Shared Radiated Equipment

ID#	Device	Type/Model	Serial #	Manufacturer	Cal. Date	Cal. Due Date
412-000	DRTU Power finder V2.0	-	-	Intel	NA	NA
139-000	Power Sensor	NRP-Z81	104383	Rohde & Schwarz	2021-04-07	2023-04-07
140-000	Power Sensor	NRP-Z81	104382	Rohde & Schwarz	2020-04-08	2022-04-08

A.3 Measurement Uncertainty Evaluation

The system uncertainty evaluation is shown in the table below with a coverage factor of $k = 2$ to indicate a 95% level of confidence:

Measurement type	Uncertainty	Unit
Timing	± 0.12	%
Power Spectral density	± 1.47	dB
Occupied bandwidth	± 2.07	%
Conducted Power	± 1.03	dB
Conducted Spurious Emission <26.5 GHz	± 2.93	dB
Radiated tests <1GHz	± 6.07	dB
Radiated tests 1GHz – 26.5 GHz	± 5.92	dB

Annex B. Test Results

The herein test results were performed by:

Test case measurement	Test Personnel
6dB Bandwidth	C. Requin
Maximum output power and E.I.R.P.	C. Requin
Power spectral density	C. Requin
Out-of-band Emissions (conducted)	C. Requin
Out-of-band Emissions (radiated)	K.Khatib, R.Simonini

B.1 Test Results

B.1.1 6dB & 99% Bandwidth

Test limits

FCC part	RSS part	Limits
15.247 (a) (2)	RSS-247 Clause 5.2 (a)	Systems using digital modulation techniques may operate in the 902-928 MHz, 2400-2483.5 MHz, and 5725-5850 MHz bands. The minimum 6 dB bandwidth shall be at least 500 kHz.

Test procedure

The conducted setup shown in section *Test & System Description* was used to measure the 6dB & 99% Bandwidth. The antenna terminal of the EUT is connected to the spectrum through an attenuator, and the spectrum analyzer reading is compensated to include the RF path loss.

Results tables

Mode	Frequency [MHz]	6dB BW [MHz]	99% BW [MHz]
BLE	2402	1.16	2.046
	2440	1.17	2.046
	2480	1.16	2.046

Results screenshot

BLE

6dB BW – 2402 MHz

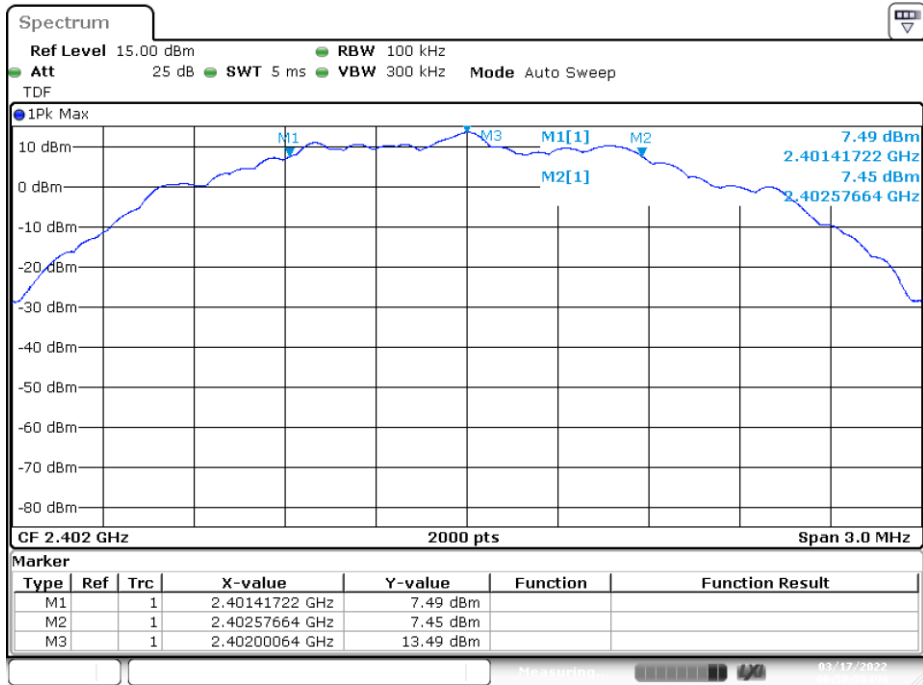

99% BW – 2402 MHz

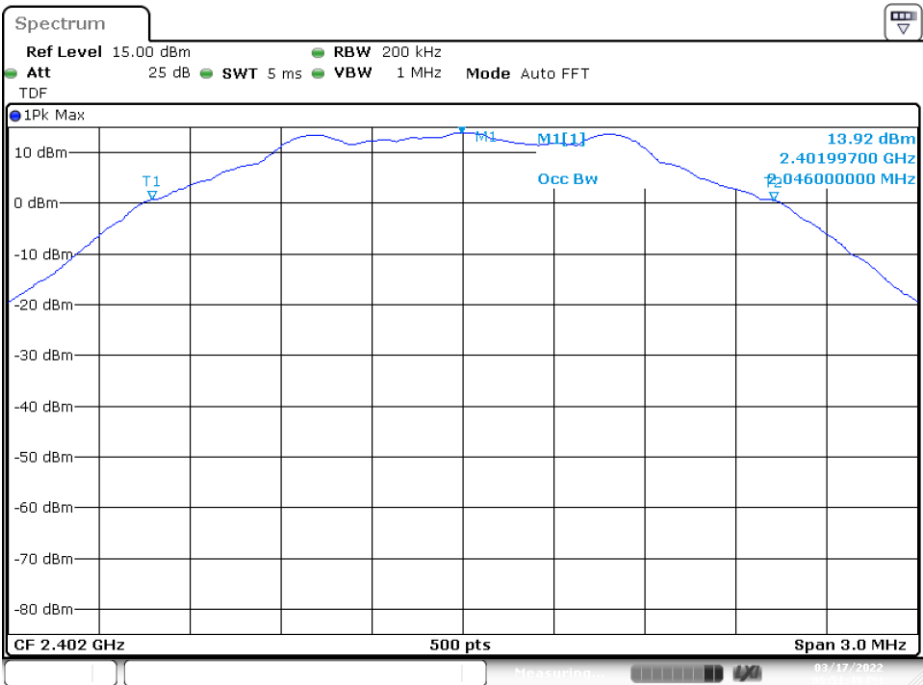

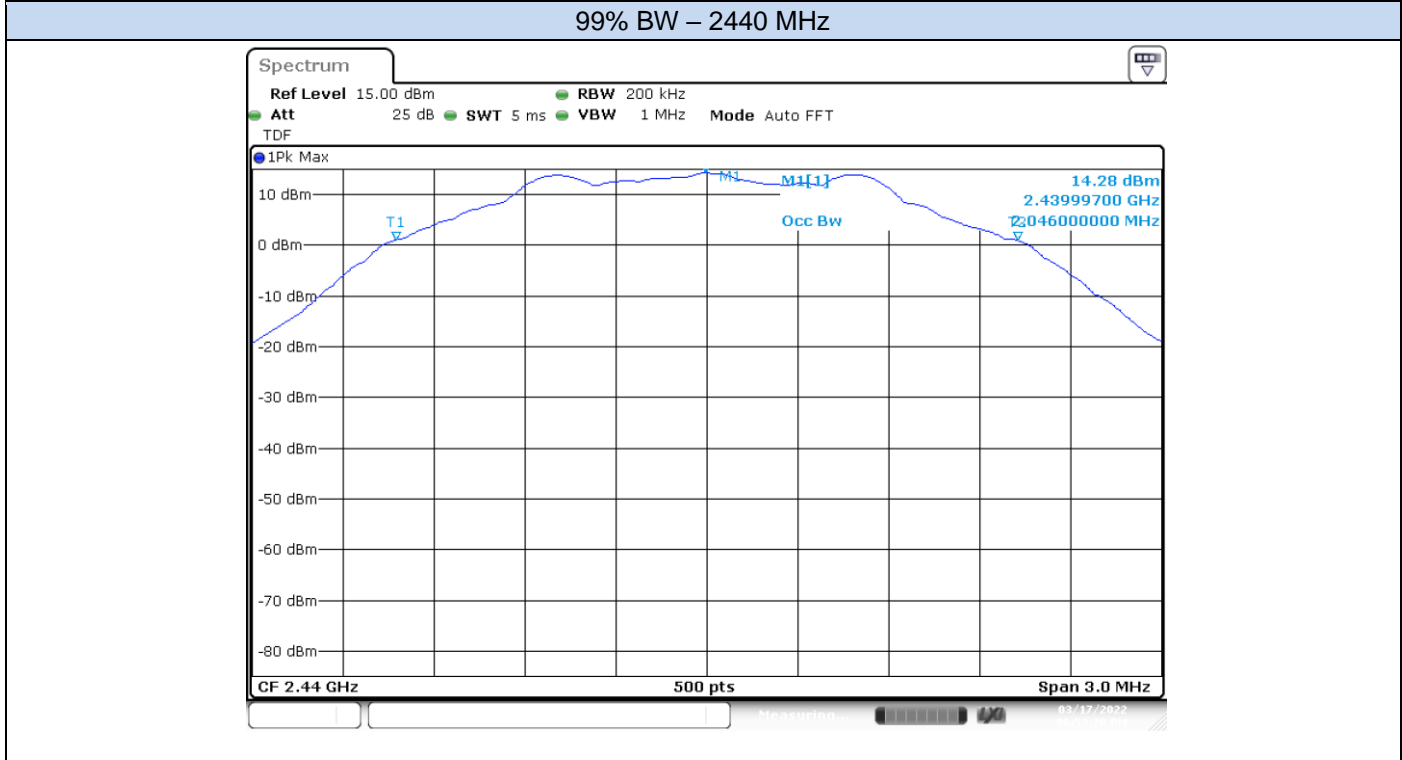
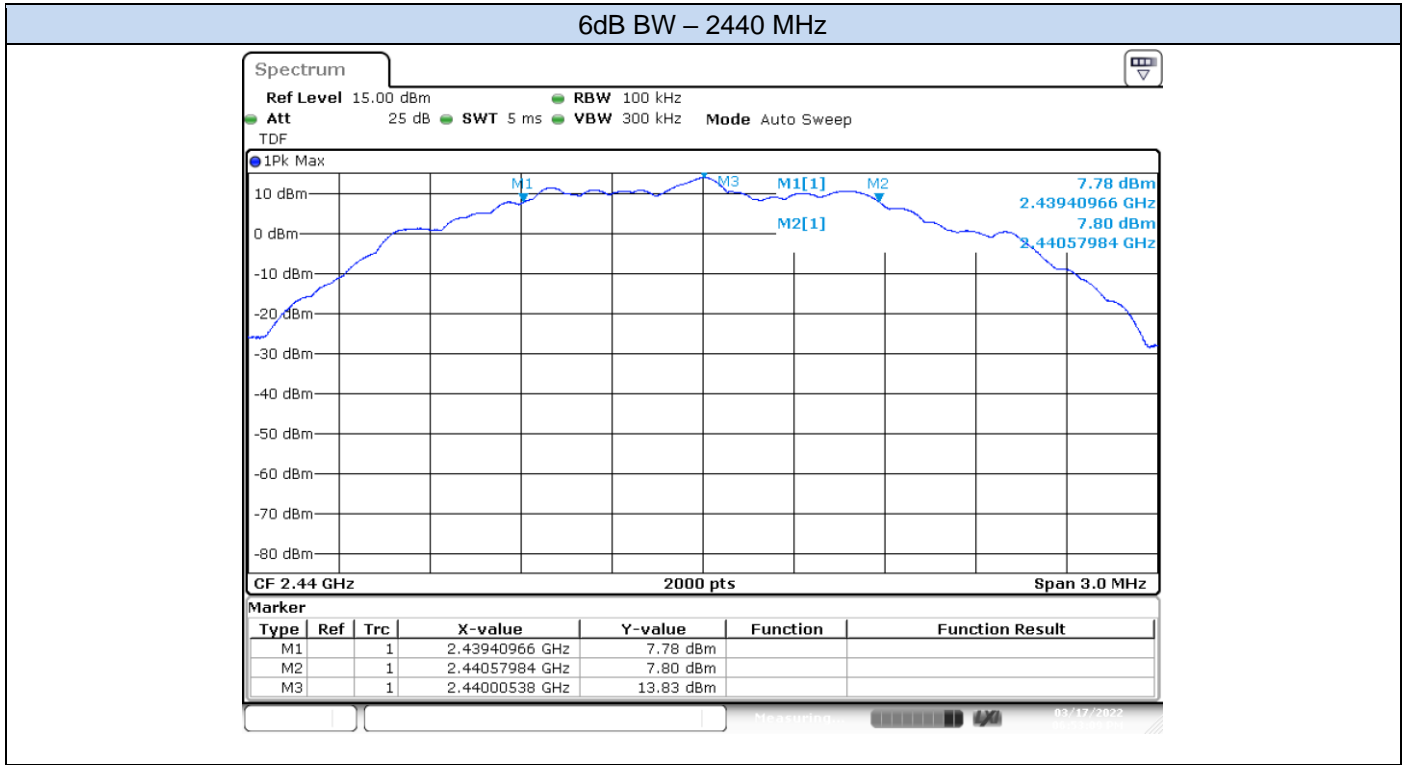

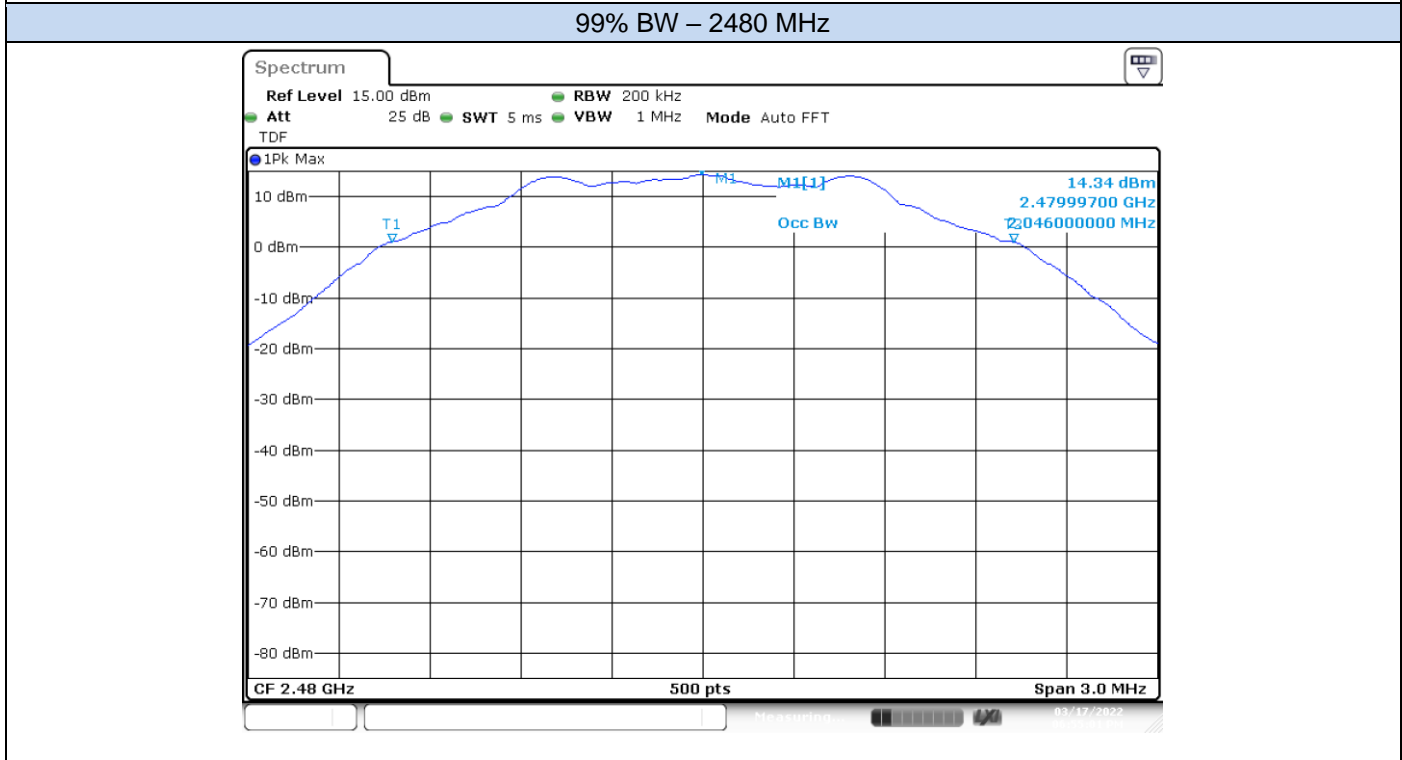
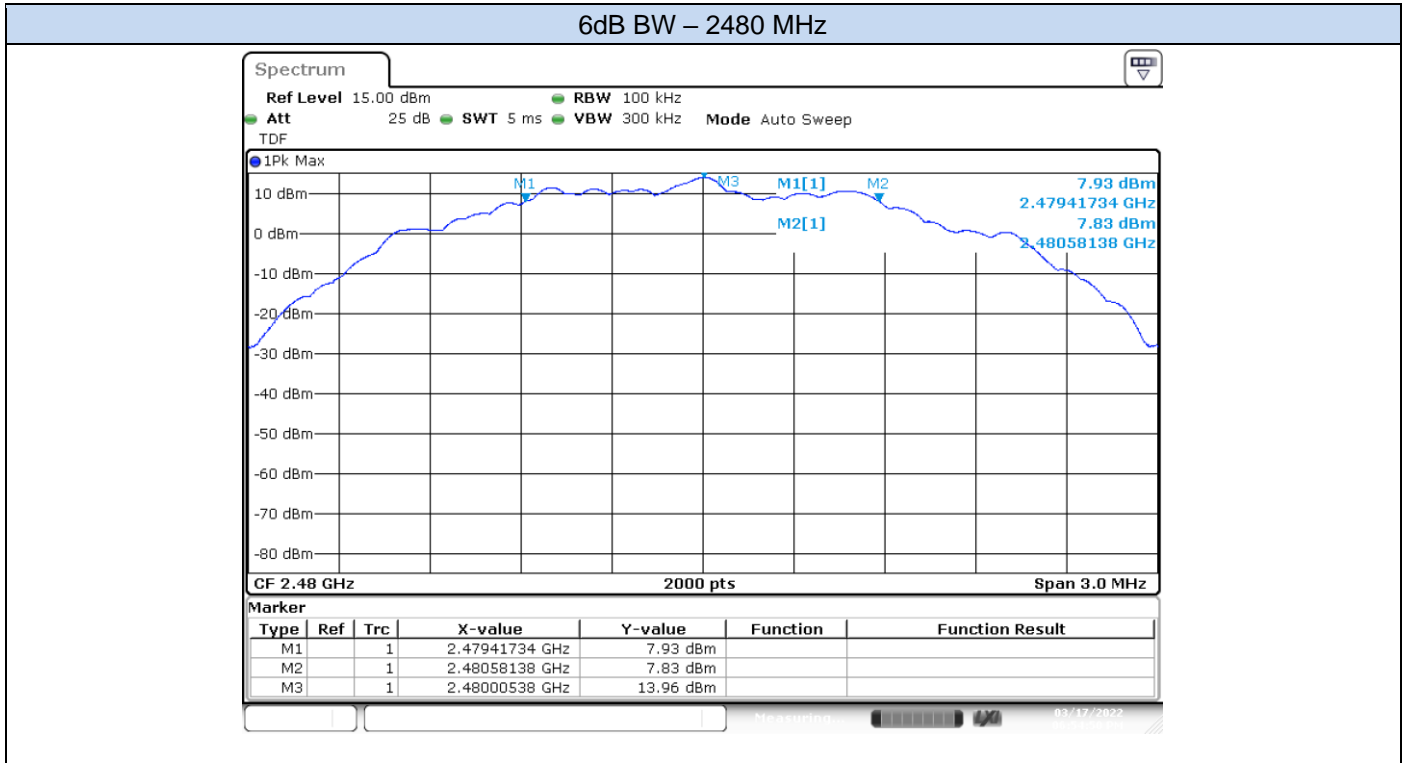

B.1.2 Maximum Output Power and antenna gain

Test limits

	Limits
FCC Part 15.247 (b) (3)	<p>(b) The maximum peak conducted output power of the intentional radiator shall not exceed the following:</p> <p>(3) For systems using digital modulation in the 902-928 MHz, 2400-2483.5 MHz, and 5725-5850 MHz bands: 1 Watt. As an alternative to a peak power measurement, compliance with the one Watt limit can be based on a measurement of the maximum conducted output power. Maximum Conducted Output Power is defined as the total transmit power delivered to all antennas and antenna elements averaged across all symbols in the signaling alphabet when the transmitter is operating at its maximum power control level. Power must be summed across all antennas and antenna elements. The average must not include any time intervals during which the transmitter is off or is transmitting at a reduced power level.</p> <p>(4) The conducted output power limit specified in paragraph (b) of this section is based on the use of antennas with directional gains that do not exceed 6 dBi.</p>
RSS-247 Clause 5.4 (d)	<p>For DTSs employing digital modulation techniques operating in the bands 902-928 MHz and 2400-2483.5 MHz, the maximum peak conducted output power shall not exceed 1W. The e.i.r.p. shall not exceed 4 W, except as provided in section 5.4(e).</p> <p>As an alternative to a peak power measurement, compliance can be based on a measurement of the maximum conducted output power. The maximum conducted output power is the total transmit power delivered to all antennas and antenna elements, averaged across all symbols in the signalling alphabet when the transmitter is operating at its maximum power control level. Power must be summed across all antennas and antenna elements. The average must not include any time intervals during which the transmitter is off or transmitting at a reduced power level. If multiple modes of operation are implemented, the maximum conducted output power is the highest total transmit power occurring in any mode</p>

Test procedure:

The Maximum peak conducted output power was measured using the $RBW \geq DTS \text{ bandwidth}$ method defined in paragraph 11.9.1.1 of ANSI C63.10-2013.

The Maximum conducted average output power was measured using the channel integration method according to Method AVGSA-2, defined in paragraph 11.9.2.2.4 of ANSI C63.10-2013.

The EIRP power (dBm) is calculated by adding the declared maximum antenna gain to the measured conducted power.

The conducted setup shown in section *Test & System Description* was used to measure the maximum conducted output power. The antenna terminal of the EUT is connected to the spectrum through an attenuator, and the spectrum analyzer reading is compensated to include the RF path loss.

Results tables

Mode	Meas. Duty Cycle [%]	Frequency [MHz]	Peak Power [dBm]		
			Measured Conducted Output Power	EIRP	Peak Output Power [mW]
BLE	30.55	2402	14.31	17.55	26.98
		2440	14.68	17.92	29.38
		2480	14.77	18.01	29.99

Max Value

Mode	Meas. Duty Cycle [%]	Frequency [MHz]	Average Output Power* [dBm]			
			Maximum Conducted Output Power	Maximum Conducted Output Power Duty cycle Compensated	EIRP	Average Output Power [mW]
BLE	30.55	2402	9.23	14.38	17.62	27.42
		2440	9.60	14.75	17.99	29.86
		2480	9.71	14.86	18.10	30.62

* Output Power RMS values are shown for indicative purpose only

Results screenshot

BLE

Max Power Peak – 2402 MHz

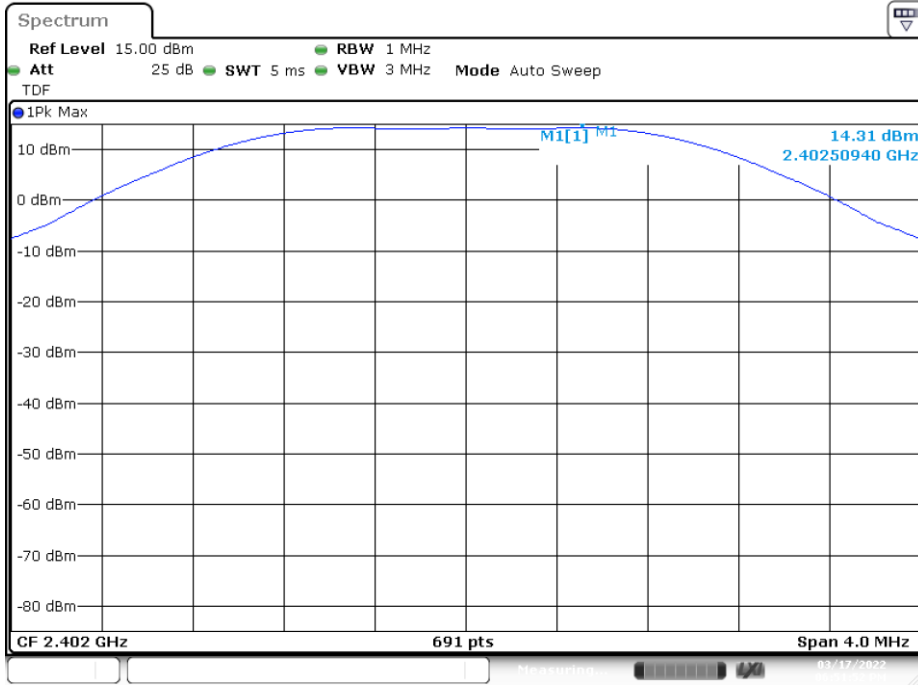

Max Power RMS – 2402 MHz

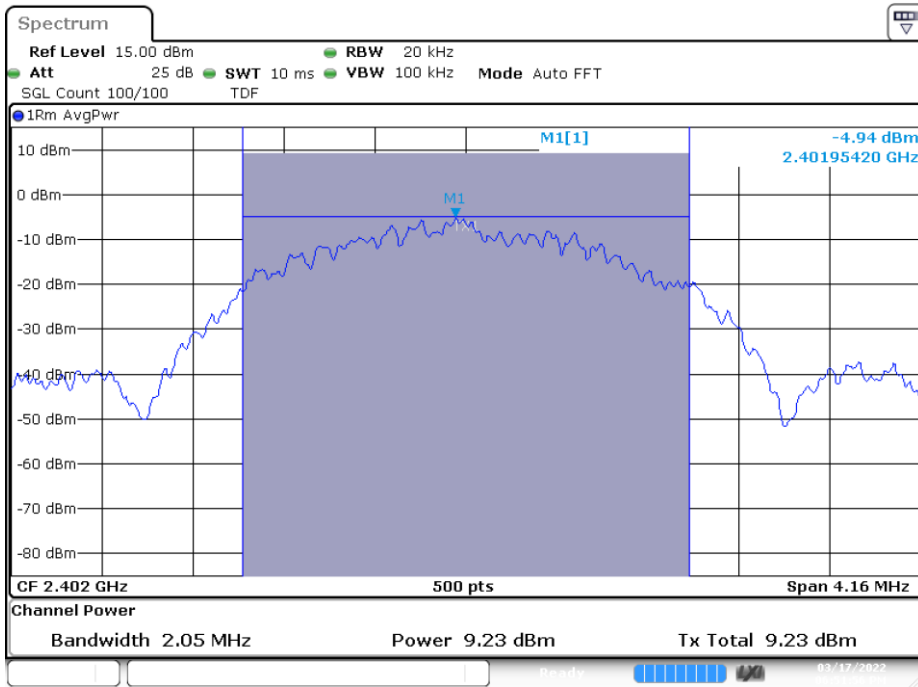

BLE

Max Power Peak – 2440 MHz

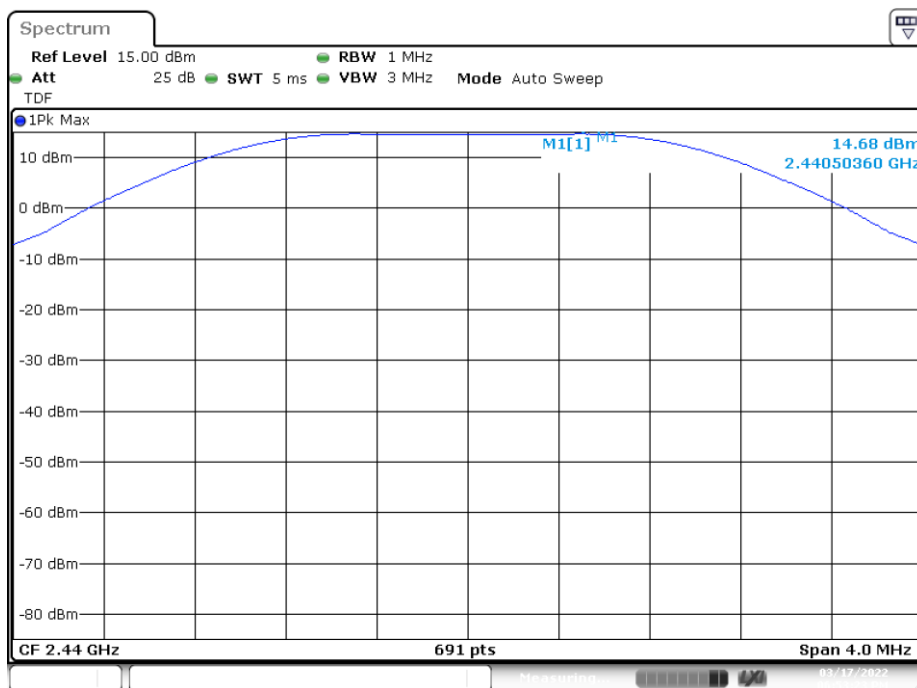

Max Power RMS – 2440 MHz

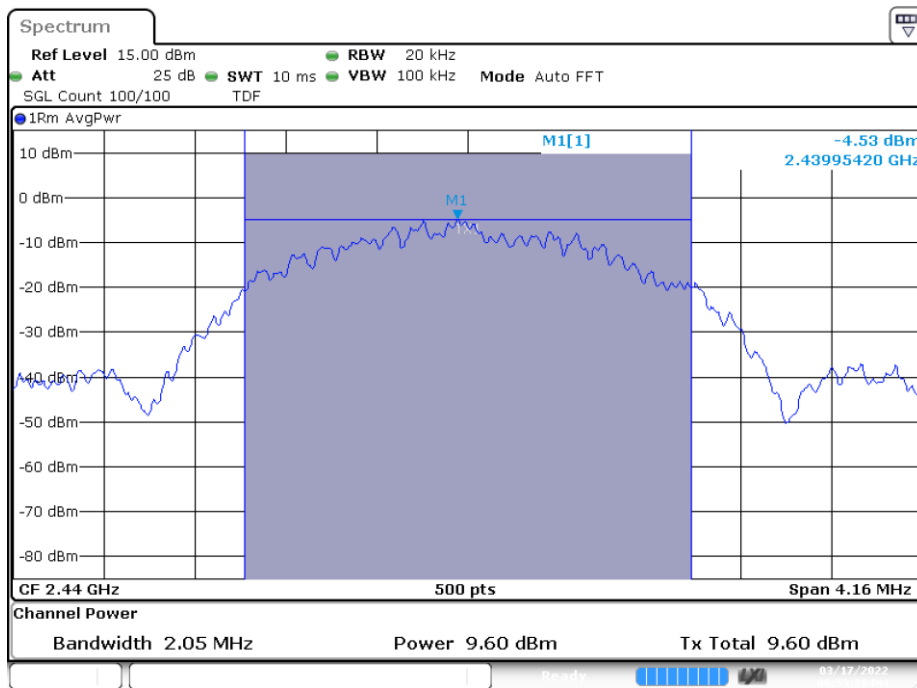

BLE

Max Power Peak – 2480 MHz

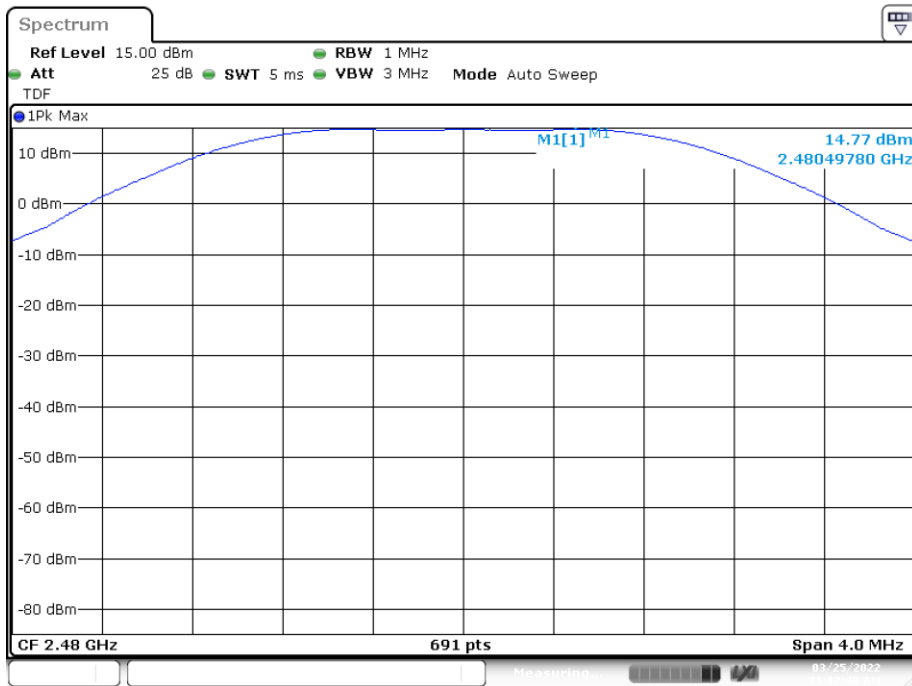

Max Power RMS – 2480 MHz

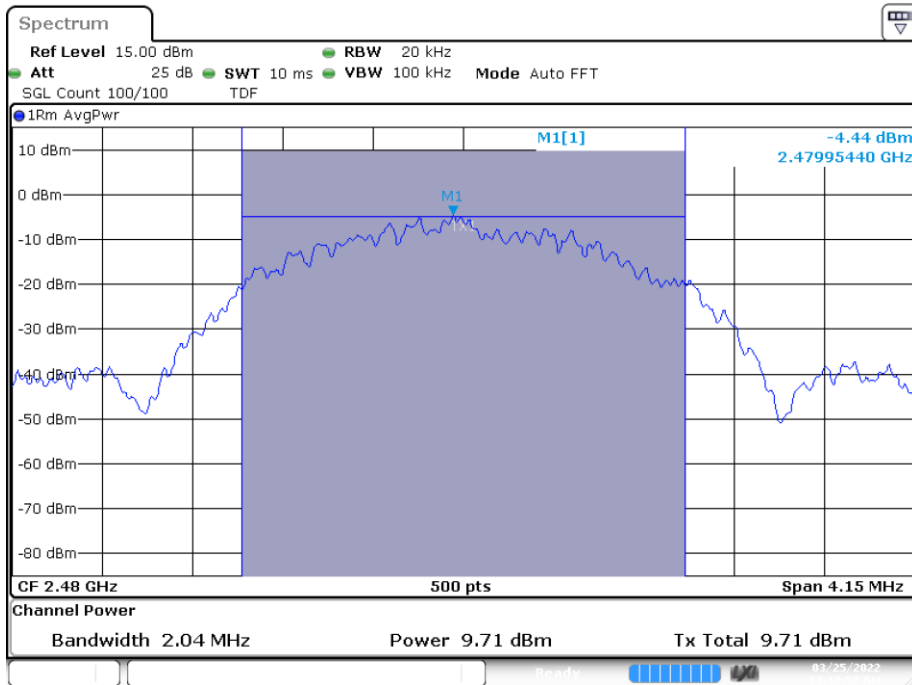

B.1.3 Power Spectral Density

Test limits

FCC part	RSS part	Limits
15.247 (e)	RSS-247 Clause 5.2 (b)	For digitally modulated systems, the power spectral density conducted from the intentional radiator to the antenna shall not be greater than 8 dBm in any 3 kHz band during any time interval of continuous transmission. This power spectral density shall be determined in accordance with the provisions of paragraph (b) of this section. The same method of determining the conducted output power shall be used to determine the power spectral density.

Test procedure

The maximum peak power spectral density level of the fundamental emission was measured using the method PKPSD, defined in paragraph 11.10.2 of ANSI C63.10-2013.

The conducted setup shown in section *Test & System Description* was used to measure the power spectral density. The antenna terminal of the EUT is connected to the spectrum through an attenuator, and the spectrum analyzer reading is compensated to include the RF path loss.

Results tables

Mode	CH	Frequency [MHz]	PSD Peak [dBm/3kHz]
BLE	0	2402	-3.34
	19	2440	-2.92
	39	2480	-2.82

B.1.4 Out-of-band emission (Conducted)

Test Limits

FCC part	RSS part	Limits																				
15.247 (d)	RSS-247 Clause 5.5	In any 100 kHz bandwidth outside the frequency band in which the spread spectrum or digitally modulated intentional radiator is operating, the radio frequency power that is produced by the intentional radiator shall be at least 20 dB below that in the 100 kHz bandwidth within the band that contains the highest level of the desired power, based on either an RF conducted or a radiated measurement, provided the transmitter demonstrates compliance with the peak conducted power limits.																				
15.209	RSS-Gen A1 Clause 8.9	<p>Radiated emissions which fall in the restricted bands, as defined in §15.205(a), must also comply with the radiated emission limits specified in §15.209(a):</p> <table border="1"> <thead> <tr> <th>Freq Range (MHz)</th> <th>Field Strength ($\mu\text{V}/\text{m}$)</th> <th>Field Strength ($\text{dB}\mu\text{V}/\text{m}$)</th> <th>Meas. Distance (m)</th> </tr> </thead> <tbody> <tr> <td>30-88</td> <td>100</td> <td>40</td> <td>3</td> </tr> <tr> <td>88-216</td> <td>150</td> <td>43.5</td> <td>3</td> </tr> <tr> <td>216-960</td> <td>200</td> <td>46</td> <td>3</td> </tr> <tr> <td>Above 960</td> <td>500</td> <td>54</td> <td>3</td> </tr> </tbody> </table> <p>The emission limits shown in the above table are based on measurements employing CISPR quasi-peak detector except for the frequency bands 9-90 kHz, 110-490 kHz and above 1000 MHz. Radiated emission limits in these three bands are based on measurements employing an average detector. For average radiated emission measurements above 1000 MHz, there is also a limit specified when measuring with peak detector function, corresponding to 20 dB above the indicated values in the table.</p>	Freq Range (MHz)	Field Strength ($\mu\text{V}/\text{m}$)	Field Strength ($\text{dB}\mu\text{V}/\text{m}$)	Meas. Distance (m)	30-88	100	40	3	88-216	150	43.5	3	216-960	200	46	3	Above 960	500	54	3
Freq Range (MHz)	Field Strength ($\mu\text{V}/\text{m}$)	Field Strength ($\text{dB}\mu\text{V}/\text{m}$)	Meas. Distance (m)																			
30-88	100	40	3																			
88-216	150	43.5	3																			
216-960	200	46	3																			
Above 960	500	54	3																			

Test procedure

In case of band edge measurements falling in restricted bands, the declared Antenna Gain is also compensated in the graph.

For band edge measurements falling in restricted bands, the following limits in dBm were applied for the average detector after the conversion from the limits detailed above in $\text{dB}\mu\text{V}/\text{m}$, according to FCC 47 CFR part 15 - Subpart C – §15.209(a). The limits in dBm for peak detector are 20dB above the indicated values in the table.

§15.209(a)			Converted values	
Freq Range (MHz)	Distance (m)	Field strength (microvolts/meter)	Field strength (dB microvolts/meter)	Power (dBm)
Above 960	3	500	54.0	-41.2

The conducted setup shown in section *Test & System Description* was used to measure the out-of-band emissions. The antenna terminal of the EUT is connected to the spectrum through an attenuator, and the spectrum analyzer reading is compensated to include the RF path loss.

BLE

BE Low (Restricted) – 2402 MHz

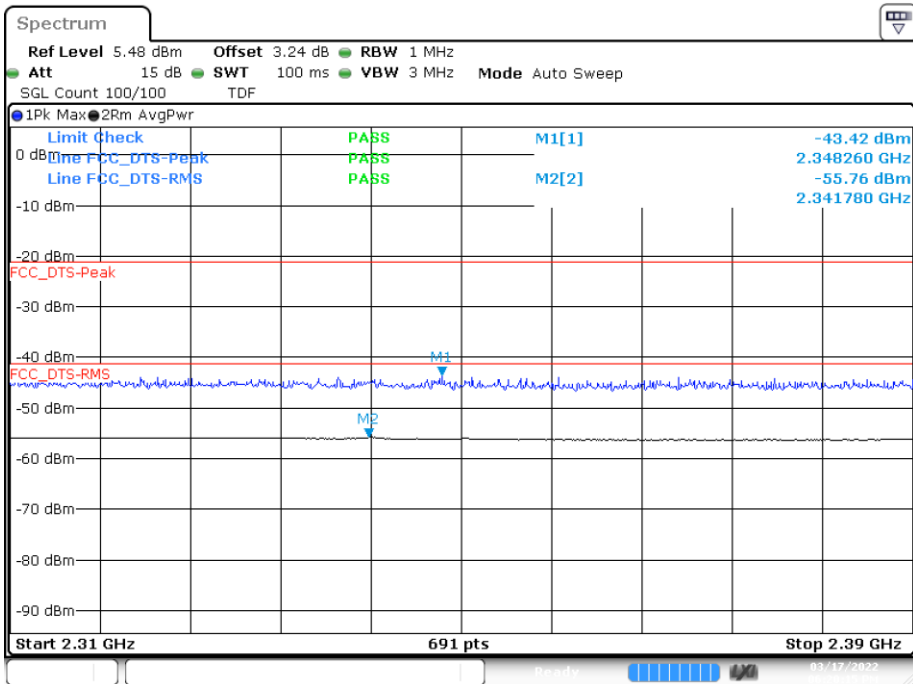

BE Low (Non Restricted) – 2402 MHz

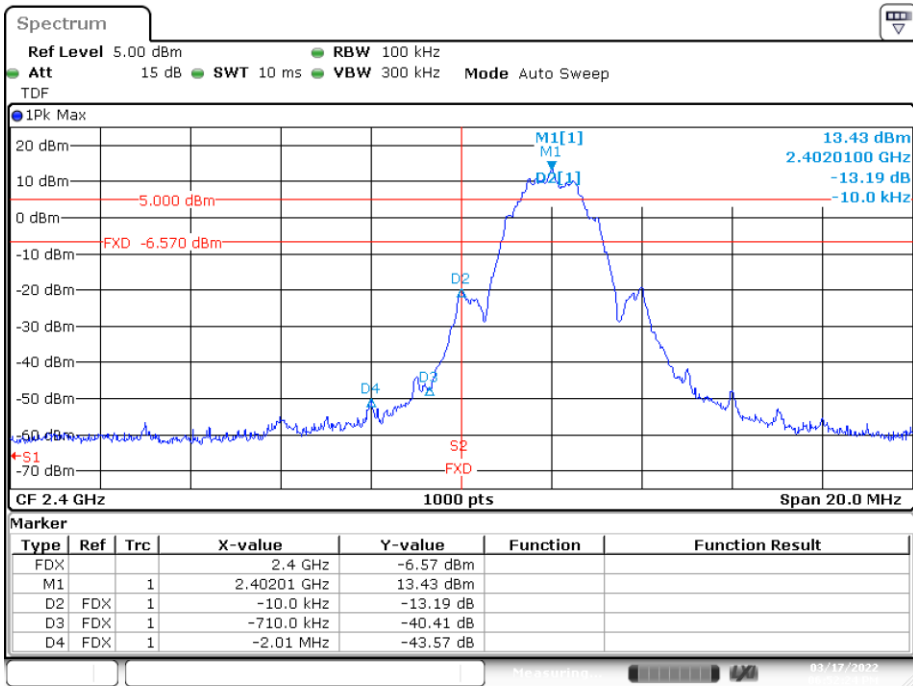

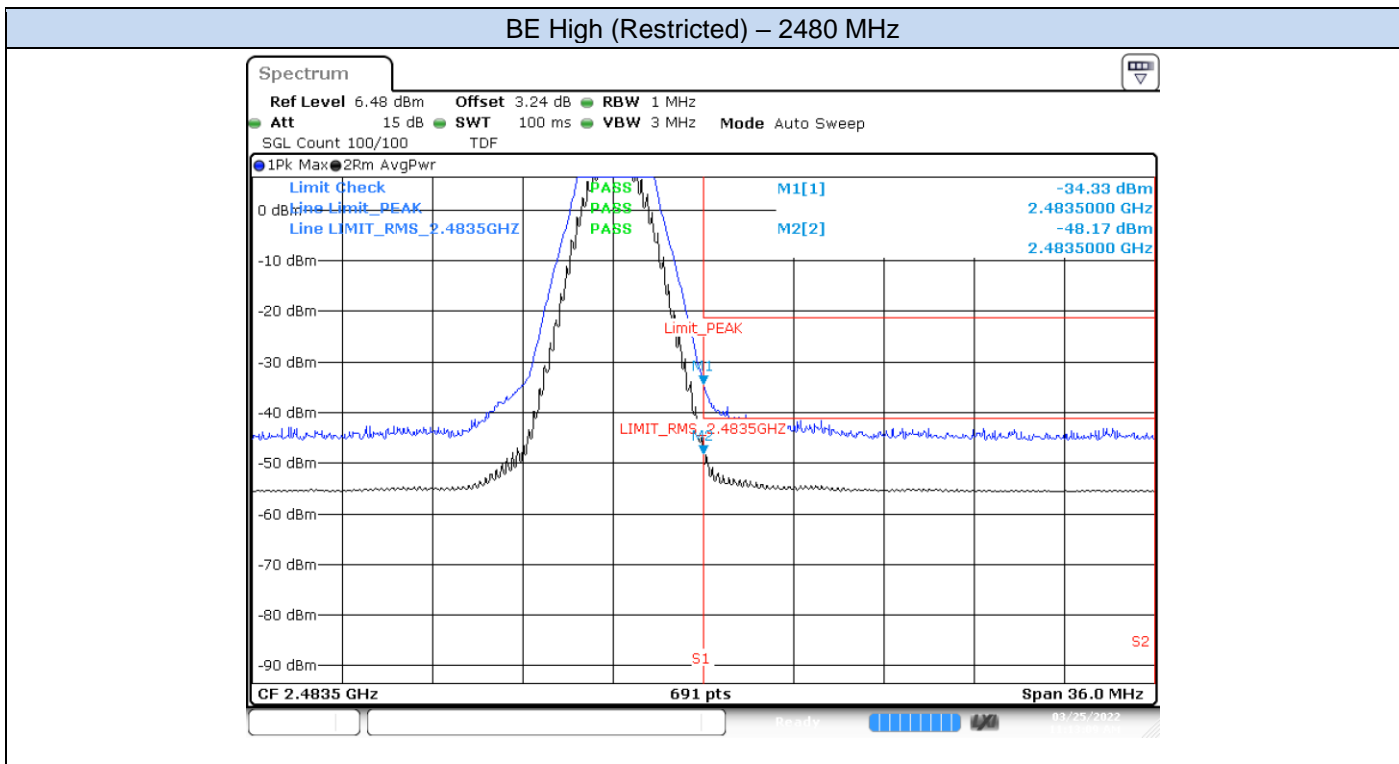

B.1.5 Radiated spurious emission

Standards references

FCC part	RSS part	Limits																					
<p>15.247 (d) 15.209</p>	<p>RSS-247 Clause 5.5 RSS-Gen A1 Clause 8.9</p>	<p>Radiated emissions which fall in the restricted bands, as defined in §15.205(a), must also comply with the radiated emission limits specified in §15.209(a):</p>																					
		<table border="1"> <thead> <tr> <th data-bbox="630 472 783 535">Freq Range (MHz)</th> <th data-bbox="788 472 833 680">Field Strength (μV/m)</th> <th data-bbox="837 472 1023 680">Field Strength (dBμV/m)</th> <th data-bbox="1027 472 1212 680">Meas. Distance (m)</th> </tr> </thead> <tbody> <tr> <td data-bbox="630 535 783 568">30-88</td> <td data-bbox="788 535 833 568">100</td> <td data-bbox="837 535 1023 568">40</td> <td data-bbox="1027 535 1212 568">3</td> </tr> <tr> <td data-bbox="630 568 783 602">88-216</td> <td data-bbox="788 568 833 602">150</td> <td data-bbox="837 568 1023 602">43.5</td> <td data-bbox="1027 568 1212 602">3</td> </tr> <tr> <td data-bbox="630 602 783 636">216-960</td> <td data-bbox="788 602 833 636">200</td> <td data-bbox="837 602 1023 636">46</td> <td data-bbox="1027 602 1212 636">3</td> </tr> <tr> <td data-bbox="630 636 783 680">Above 960</td> <td data-bbox="788 636 833 680">500</td> <td data-bbox="837 636 1023 680">54</td> <td data-bbox="1027 636 1212 680">3</td> </tr> </tbody> </table>	Freq Range (MHz)	Field Strength (μV/m)	Field Strength (dBμV/m)	Meas. Distance (m)	30-88	100	40	3	88-216	150	43.5	3	216-960	200	46	3	Above 960	500	54	3	
Freq Range (MHz)	Field Strength (μV/m)	Field Strength (dBμV/m)	Meas. Distance (m)																				
30-88	100	40	3																				
88-216	150	43.5	3																				
216-960	200	46	3																				
Above 960	500	54	3																				
<p>The emission limits shown in the above table are based on measurements employing CISPR quasi-peak detector except for the frequency bands 9-90 kHz, 110-490 kHz and above 1000 MHz. Radiated emission limits in these three bands are based on measurements employing an average detector. For average radiated emission measurements above 1000 MHz, there is also a limit specified when measuring with peak detector function, corresponding to 20 dB above the indicated values in the table.</p>																							

Test procedure

The radiated setups shown in section *Test & System Description* were used to measure the radiated spurious emissions. were used to measure the radiated spurious emissions.
 Depending of the frequency range and bands being tested, different antennas and filters were used.
 The final measurement is done by varying the antenna height from 1 to 4 meters, the EUT azimuth over 360° and for both Vertical and Horizontal polarizations.
 The radiated spurious emissions were measured on the lowest, middle and highest channels.

Test Results

Radiated Spurious - 30 MHz – 1 GHz**All modes**

Frequency	Level	Detector	Limit	Margin	Polar
MHz	dB μ V/m	---	dB μ V/m	dB	---
80.0	34.3	Quasi-Peak	40.0	5.7	H

Note 1: The spurious signals detected do not depend on either the operating channel or the modulation mode.

Radiated Spurious - 1 GHz – 26 GHz**BLE – 2402 MHz**

Frequency	Level	Detector	Limit	Margin	Polar
MHz	dB μ V/m	---	dB μ V/m	dB	---
2837.5	38.3	Average	54.0	15.7	H
2847.5	51.0	Peak	74.0	23.0	H
3057.5	51.7	Peak	74.0	22.3	H
3061.5	39.1	Average	54.0	14.9	H
9606.5	47.8	Peak	74.0	26.2	H
9607.0	35.8	Average	54.0	18.2	V
20998.5	46.9	Peak	74.0	27.1	V
21000.0	35.4	Average	54.0	18.6	V

BLE – 2440 MHz

Frequency	Level	Detector	Limit	Margin	Polar
MHz	dB μ V/m	---	dB μ V/m	dB	---
2717.0	37.9	Average	54.0	16.1	H
2718.0	50.3	Peak	74.0	23.7	V
3056.0	39.3	Average	54.0	14.7	H
3058.0	52.1	Peak	74.0	21.9	V
9760.5	47.6	Peak	74.0	26.4	V
9761.0	35.5	Average	54.0	18.5	V
20996.0	46.5	Peak	74.0	27.5	H
21000.0	34.8	Average	54.0	19.2	V

BLE – 2480 MHz

Frequency	Level	Detector	Limit	Margin	Polar
MHz	dBµV/m	---	dBµV/m	dB	---
3103.5	51.6	Peak	74.0	22.4	H
3106.0	39.6	Average	54.0	14.4	H
9920.5	35.0	Average	54.0	19.0	V
9926.5	47.8	Peak	74.0	26.2	H
21000.0	35.3	Average	54.0	18.7	V
21002.5	45.7	Peak	74.0	28.3	V