



TEST REPORT

EUT Description	Wireless Module installed in Convertible PC
Brand Name	Intel® Wi-Fi 6 AX203
Model Name	AX203NGW
FCC/IC ID	PD9AX203NG / 1000M-AX203NG
Date of Test Start/End	2023-01-13 / 2023-01-23
Features	802.11ax, Dual Band, 2x2 Wi-Fi + Bluetooth® 5.1 (see section 5)
Description	Platform: Yoga 7 16IRL8 + Luxshare and AWAN antennas

Applicant	Intel Mobile Communications
Address	100 Center Point Circle, Suite 200 / Columbia, SC 29210 / United States
Contact Person	Steven Hackett
Telephone/Fax/ Email	steven.c.hackett@intel.com

Reference Standards	FCC 47 CFR Part §2.1093 RSS-102, issue 5 (see section 1)	
RF Exposure Environment	Portable devices - General population/uncontrolled exposure	
Exposure Conditions	Body worn	
	SAR Result	SAR Limit
Maximum SAR Result & Limit	0.91 W/kg (1g)	1.6 W/kg (1g)
Min. test separation distance	0mm to phantom, 4.97mm to antenna edge	

Test Report identification	221226-01.TR02
Revision Control	Rev. 00 This test report revision replaces any previous test report revision (see section 8)

The test results relate only to the samples tested.
Reference to accreditation shall be used only by full reproduction of test report.

Issued by _____ Reviewed by _____

Adel LOUNES
(SAR Test Engineer Lead)

Zayd OUACHICHA
(Technical Manager)

Intel Corporation S.A.S – WRF Lab
425 rue de Goa – Le Cargo B6 - 06600 Antibes, France
Tel. +33493001400 / Fax +33493001401

Table of Contents

1. Standards, reference documents and applicable test methods	4
2. General conditions, competences and guarantees	4
3. Environmental Conditions	5
4. Test samples	5
5. EUT Features	6
6. Remarks and comments	10
7. Test Verdicts summary	10
8. Document Revision History	10
Annex A. Test & System Description	11
A.1 SAR DEFINITION.....	11
A.2 SPEAG SAR MEASUREMENT SYSTEM	12
A.2.1 SAR Measurement Setup.....	12
A.2.2 E-Field Measurement Probe.....	13
A.2.3 Flat Phantom	13
A.2.4 Device Positioner.....	14
A.3 DATA EVALUATION	15
A.4 SYSTEM AND LIQUID CHECK	17
A.4.1 System Check	17
A.4.2 Liquid Check.....	18
A.5 TEST EQUIPMENT LIST	19
A.5.1 Tissue Simulant Liquid	19
A.6 MEASUREMENT UNCERTAINTY EVALUATION	20
A.7 RF EXPOSURE LIMITS	21
Annex B. Test Results	22
B.1 TEST CONDITIONS.....	22
B.1.1 Test SAR Test positions relative to the phantom.....	22
B.1.2 Test signal, Output power and Test Frequencies	23
B.1.3 Evaluation Exclusion and Test Reductions.....	23
B.2 CONDUCTED POWER MEASUREMENTS.....	27
B.2.1 WLAN 2.4GHz.....	27
B.2.2 WLAN 5GHz (U-NII)	29
B.2.3 Bluetooth	40
B.3 TISSUE PARAMETERS MEASUREMENT	41
B.4 SYSTEM CHECK MEASUREMENTS	42
B.5 SAR TEST RESULTS	43
B.5.1 802.11b/g/n/ax – 2.4GHz - DTS	43
B.5.2 802.11a/n/ac/ax – 5.3 GHz – U-NII-2A.....	43
B.5.3 802.11a/n/ac/ax – 5.6 GHz – U-NII-2C.....	43
B.5.4 802.11a/n/ac/ax – 5.8 GHz – U-NII-3	44
B.5.5 SAR Measurement Variability.....	45
B.5.6 Simultaneous Transmission SAR Evaluation.....	46
Annex C. Test System Plots.....	47
Annex D. TSL Dielectric Parameters.....	56
D.1 BODY DTS 2450MHZ	56
D.2 BODY 5200MHZ-5800MHZ	57
Annex E. Calibration Certificates	58

Annex F. Photographs 59

F.1 TEST SAMPLE 59

F.2 TEST POSITIONS..... 61

F.3 ANTENNA HOST PLATFORM LOCATION AND ADJACENT EDGE POSITIONS RELATIVE TO THE BODY 62

F.4 PHANTOM LIQUID LEVEL DURING MEASUREMENTS 63

1. Standards, reference documents and applicable test methods

FCC	<ol style="list-style-type: none"> 1. FCC Title 47 CFR Part §2.1093 – Radiofrequency radiation exposure evaluation: portable devices. 2020-10-01 Edition 2. FCC OET KDB 447498 D04 Interim v01 General RF Exposure Guidance v01– RF Exposure Procedures and Equipment Authorization Policies for Mobile and Portable Devices. 3. FCC OET KDB 616217 D04 v01r02 – SAR Evaluation Considerations for Laptop, Notebook, Netbook and Tablet Computers. 4. FCC OET KDB 865664 D01 v01r04 – SAR Measurement Requirements for 100 MHz to 6 GHz. 5. FCC OET KDB 865664 D02 v01r02 – RF Exposure Compliance Reporting and Documentation Considerations. 6. IEEE Std 1528-2013 – IEEE Recommended Practice Determining the Peak Spatial-Average Specific Absorption Rate (SAR) in the Human Head from Wireless Communication Devices: Measurement Techniques...
ISED	<ol style="list-style-type: none"> 1. ISED RSS 102, Issue 5 – Radio Frequency (RF) Exposure Compliance of Radio communication Apparatus (All Frequency Bands) 2. ISED RSS-102 Supplementary Procedures SPR-001 SAR testing requirements with regard to bystanders for laptop type computers with antennas built-in on display screen (Laptop Mode / Tablet Mode) 3. ISED Notice 2020-DRS0020 Applicability of IEC/IEEE 62209-1528 and IEC 62209-3 Standard 4. ISED Notice 2016-DRS001 – Applicability of latest FCC RF Exposure KDB Procedures and Other Procedures. 5. ISED Notice 2012-DRS0529 – SAR correction for measured conductivity and relative permittivity based on IEC 62209-2 standard. 6. FCC OET KDB KDB447498 D01 V06 General RF Exposure Guidance – RF Exposure Procedures and Equipment Authorization Policies for Mobile and Portable Devices. 7. FCC OET KDB 616217 D04 v01r02 – SAR Evaluation Considerations for Laptop, Notebook, Netbook and Tablet Computers. 8. FCC OET KDB 865664 D01 v01r04 – SAR Measurement Requirements for 100 MHz to 6 GHz. 9. FCC OET KDB 865664 D02 v01r02 – RF Exposure Compliance Reporting and Documentation Considerations. 10. IEC/IEEE 62209-1528:2020 Measurement procedure for the assessment of specific absorption rate of human exposure to radio frequency fields from hand-held and body-mounted wireless communication devices – Part 1528: Human models, instrumentation, and procedures (Frequency range of 4 MHz to 10 GHz)

2. General conditions, competences and guarantees

- ✓ Tests performed under FCC standards identified in section 1 are covered by A2LA accreditation.
- ✓ Tests performed under ISED standards identified in section 1 are covered by Cofrac accreditation.
- ✓ Intel Corporation SAS Wireless RF Lab (Intel WRF Lab) is an ISO/IEC 17025:2017 laboratory accredited by the American Association for Laboratory Accreditation (A2LA) with the certificate number 3478.01.
- ✓ Intel Corporation SAS Wireless RF Lab (Intel WRF Lab) is an Accredited Test Firm recognized by the FCC, with Designation Number FR0011.
- ✓ Intel Corporation SAS Wireless RF Lab (Intel WRF Lab) is an ISO/IEC 17025:2017 testing laboratory accredited by the French Committee for Accreditation (Cofrac) with the certificate number 1-6736.
- ✓ Intel Corporation SAS Wireless RF Lab (Intel WRF Lab) is a Registered Test Site listed by ISED, with ISED #1000Y.
- ✓ Intel WRF Lab only provides testing services and is committed to providing reliable, unbiased test results and interpretations.
- ✓ Intel WRF Lab is liable to the client for the maintenance of the confidentiality of all information related to the item under test and the results of the test.
- ✓ Intel WRF Lab has developed calibration and proficiency programs for its measurement equipment to ensure correlated and reliable results to its customers.
- ✓ This report is only referred to the item that has undergone the test.
- ✓ This report does not imply an approval of the product by the Certification Bodies or competent Authorities.

3. Environmental Conditions

✓ At the site where the measurements were performed the following limits were not exceeded during the tests:

Temperature	22.0°C ± 1.4°C
Humidity	37.7% ± 10.0%
Liquid Temperature	21.5°C ± 1.2°C

4. Test samples

Sample	Control #	Description	Model	Serial #	Date of receipt	Note
#01	221226-01.S01	Wireless Module installed in Convertible PC	AX203NGW+Yoga 7 16IRL8	YX050ED0	2023-01-06	Luxshare antenna
#02	221226-01.S02	Wireless Module installed in Convertible PC	AX203NGW+Yoga 7 16IRL8	YX050ED9	2022-12-26	AWAN antenna

5. EUT Features

The herein information is provided by the customer.

Intel WRF Lab declines any responsibility for the accuracy of the stated customer provided information, especially if it has any impact on the correctness of test results presented in this report.

Brand Name	Intel® Wi-Fi 6 AX203		
Model Name	AX203NGW		
Software Version	02297.22.160.0		
Driver Version	22.160.0.3		
Prototype / Production	Production		
Host Identification	Yoga 7 16IRL8		
Supported Radios	802.11b/g/n/ax	2.4GHz (2400.0 – 2483.5 MHz)	
	802.11a/n/ac/ax	5.2GHz (5150.0 – 5350.0 MHz) 5.6GHz (5470.0 – 5725.0 MHz) 5.8GHz (5725.0 – 5850.0 MHz)	
Antenna Information	Bluetooth 5.1	2.4GHz (2400.0 – 2483.5 MHz)	
	Transmitter	Main	Aux
	Manufacturer	Luxshare	Luxshare
	Antenna type	PIFA	PIFA
	Part number	L01RF357-NB-H	L01RF356-NB-H
	Transmitter	Main	Aux
	Manufacturer	AWAN	AWAN
	Antenna type	PIFA	PIFA
	Part number	AYL6Y-100023	AYL6Y-100022
	See Annex F for more details on antennas location.		
Simultaneous Transmission Configurations	WLAN 2.4GHz Main + BT Aux WLAN 2.4GHz Main + WLAN 2.4GHz Aux WLAN 5GHz Main + BT Aux WLAN 5GHz Main + WLAN 5GHz Aux WLAN 5GHz Main + WLAN 5GHz Aux + BT Aux		
Additional Information	No WWAN transmitter is considered in this report		
	5.60-5.65 GHz band (TDWR) is supported by the device		
	Band gap is supported by the device		

Supported Radios

Mode	Duty Cycle	Modulation	Band	UL Freq Range (MHz)	Measured Max. Conducted Power (dBm)
802.11b/g/n/ax	100%	BPSK QPSK 16QAM 64QAM	2.4GHz	2400-2483.5	16.48
802.11a/n/ac/ax	100%	BPSK QPSK 16QAM 64QAM 256QAM	5.2GHz	5150-5250	NM
			5.3GHz	5250-5350	12.93
			5.6GHz	5475-5725	12.94
			5.8GHz	5725-5850	12.75
BDR/EDR v5.1	78%	GFSK π/4 DQPSK 8DPSK	2.4GHz	2400-2483.5	10.44
Bluetooth LE v5.1	64%	GFSK	2.4GHz	2400-2483.5	NM

NM: Not Measured

Maximum Output power specification + Tune up tolerance limit, as specified by the client			Notebook mode SISO mode	
Equipment Class	Mode	BW (MHz)	Main (dBm)	Aux (dBm)
DTS	802.11b	20	16.50	16.50
	802.11g	20	16.50	16.50
	802.11n20	20	16.50	16.50
	802.11ax20	20	16.50	16.50
	802.11n40	40	16.50	16.50
	802.11ax40	40	16.50	16.50
U-NII-1	802.11a	20	13.00	12.50
	802.11n20	20	13.00	12.50
	802.11ax20	20	13.00	12.50
	802.11n40	40	13.00	12.50
	802.11ax40	40	13.00	12.50
	802.11ac80	80	13.00	12.50
	802.11ax80	80	13.00	12.50
U-NII-2A	802.11a	20	13.00	12.50
	802.11n20	20	13.00	12.50
	802.11ax20	20	13.00	12.50
	802.11n40	40	13.00	12.50
	802.11ax40	40	13.00	12.50
	802.11ac80	80	13.00	12.50
	802.11ax80	80	13.00	12.50
U-NII-2C	802.11a	20	13.00	11.00
	802.11n20	20	13.00	11.00
	802.11ax20	20	13.00	11.00
	802.11n40	40	13.00	11.00
	802.11ax40	40	13.00	11.00
	802.11ac80	80	13.00	11.00
	802.11ax80	80	13.00	11.00
U-NII-3	802.11a	20	13.00	11.00
	802.11n20	20	13.00	11.00
	802.11ax20	20	13.00	11.00
	802.11n40	40	13.00	11.00
	802.11ax40	40	13.00	11.00
	802.11ac80	80	13.00	11.00
	802.11ax80	80	13.00	11.00

Maximum Output power specification + Tune up tolerance limit, as specified by the client			Notebook mode SISO mode	
Equipment Class	Mode	BW (MHz)	Main (dBm)	Aux (dBm)
BT	Bluetooth v5.1 BDR	1		10.50
	Bluetooth v5.1 EDR2	1		8.00
	Bluetooth v5.1 EDR3	1		7.00
	BLE	2		7.00

Maximum Output power specification + Tune up tolerance limit, as specified by the client			Tablet mode SISO mode	
Equipment Class	Mode	BW (MHz)	Main (dBm)	Aux (dBm)
DTS	802.11b	20	16.00	16.00
	802.11g	20	16.00	16.00
	802.11n20	20	16.00	16.00
	802.11ax20	20	16.00	16.00
	802.11n40	40	16.00	16.00
	802.11ax40	40	16.00	16.00
U-NII-1	802.11a	20	11.00	11.00
	802.11n20	20	11.00	11.00
	802.11ax20	20	11.00	11.00
	802.11n40	40	11.00	11.00
	802.11ax40	40	11.00	11.00
	802.11ac80	80	11.00	11.00
	802.11ax80	80	11.00	11.00
U-NII-2A	802.11a	20	11.00	11.00
	802.11n20	20	11.00	11.00
	802.11ax20	20	11.00	11.00
	802.11n40	40	11.00	11.00
	802.11ax40	40	11.00	11.00
	802.11ac80	80	11.00	11.00
	802.11ax80	80	11.00	11.00
U-NII-2C	802.11a	20	10.00	10.00
	802.11n20	20	10.00	10.00
	802.11ax20	20	10.00	10.00
	802.11n40	40	10.00	10.00
	802.11ax40	40	10.00	10.00
	802.11ac80	80	10.00	10.00
	802.11ax80	80	10.00	10.00
U-NII-3	802.11a	20	10.00	10.00
	802.11n20	20	10.00	10.00
	802.11ax20	20	10.00	10.00
	802.11n40	40	10.00	10.00
	802.11ax40	40	10.00	10.00
	802.11ac80	80	10.00	10.00
	802.11ax80	80	10.00	10.00

Maximum Output power specification + Tune up tolerance limit, as specified by the client			Tablet mode SISO mode	
Equipment Class	Mode	BW (MHz)	Main (dBm)	Aux (dBm)
BT	Bluetooth v5.1 BDR	1		10.50
	Bluetooth v5.1 EDR2	1		8.00
	Bluetooth v5.1 EDR3	1		7.00
	BLE	2		7.00

6. Remarks and comments

1. The conducted values are obtained by applying the BIOS SAR power values to the AX203NGW Intel module installed in the Yoga 7 16IRL8 identified in this report, as requested by the customer
2. For both platforms with different antenna manufacturers, the same module is swapped between platforms.
3. Variability and simultaneous transmission results shown in this report are based on the highest SAR value obtained among all antenna manufacturers.
4. Only the plots for the test positions with the highest measured SAR per band/mode are included in Annex C as required per FCC OET KDB 865664 D02, paragraph 2.3.8.

7. Test Verdicts summary

The statement of conformity to applicable standards in the table below are based on the measured values, without taking into account the measurement uncertainties.

Standard	Band	Highest Reported SAR (1g) (W/kg)	Verdict
802.11b/g/n/ax	2.4GHz	0.63	P
802.11a/n/ac/ax	5.2GHz	NM	NA
	5.3GHz	0.81	P
	5.6GHz	0.86	P
	5.8GHz	0.91	P
Bluetooth	2.4GHz	0.16	P

P: Pass
 F: Fail
 NM: Not Measured
 NA: Not Applicable

According to the FCC OET KDB 690783 D01, this is the summary of the values for the Grant Listing:

Exposure Condition	Highest Reported SAR (1g) (W/kg)		
	Equipment Class		
	DTS	DSS	U-NII
Body Worn	0.63	0.16	0.91
Simultaneous Tx	Sum-SAR: 1.13 SPLSR: NA	Sum-SAR: 1.59 SPLSR: NA	Sum-SAR: 1.59 SPLSR: NA

Considering the results of the performed test according to FCC 47CFR Part 2.1093 and ISED RSS 102, Issue 5 the item under test is IN COMPLIANCE with the requested specifications specified in Section1. Standards, reference documents and applicable test methods

8. Document Revision History

Revision #	Modified by	Revision Details
Rev. 00	A.Lounes	First Issue

Annex A. Test & System Description

A.1 SAR Definition

Specific Absorption rate is defined as the time derivative of the incremental energy (dW) absorbed by (dissipated in) and incremental mass (dm) contained in a volume element (dV) of a given density (ρ).

$$SAR = \frac{d}{dt} \cdot \left(\frac{dW}{dm} \right) = \frac{d}{dt} \cdot \left(\frac{dW}{\rho \cdot dV} \right)$$

SAR is expressed in units of watts per kilogram (W/kg). SAR can be related to the electric field at a point by

$$SAR = \frac{\sigma |E|^2}{\rho}$$

Where:

σ = Conductivity of the tissue (S/m)

ρ = Mass density of the tissue (kg/m³)

E = RMS electric field strength (V/m)

A.2 SAR Measurement System

A.2.1 SAR Measurement Setup

The DASY6 system for performing compliance tests consists of the following items:

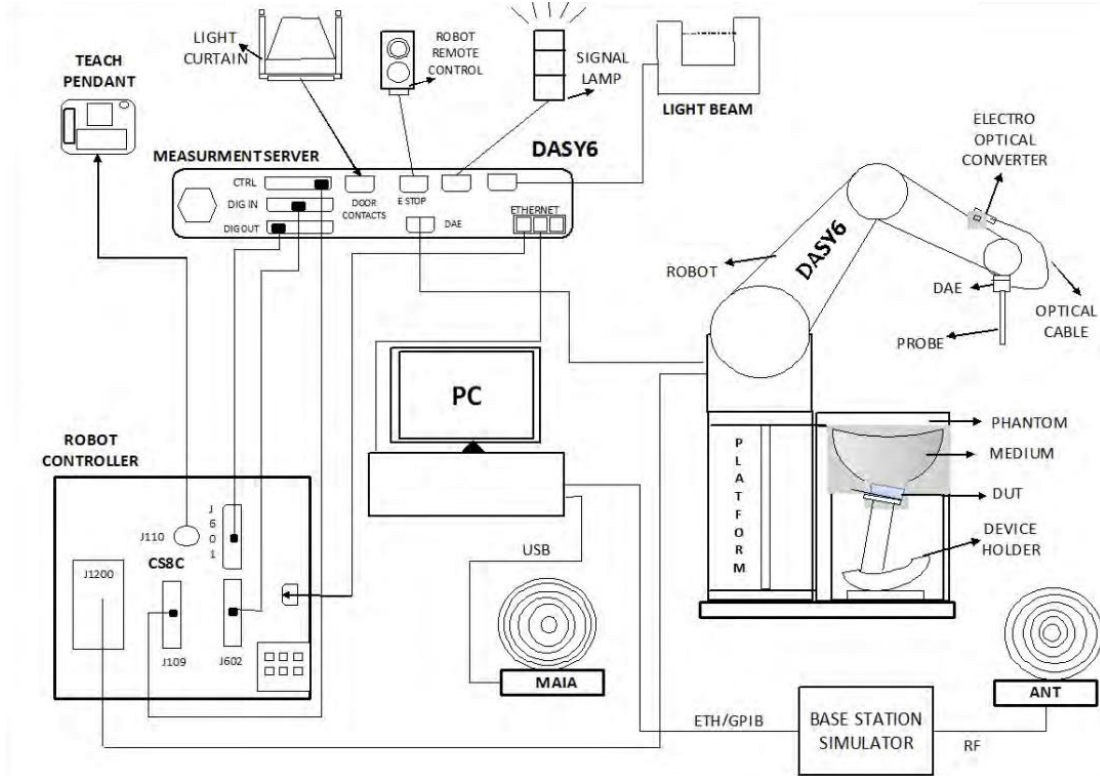

- ✓ A standard high precision 6-axis robot (Stäubli TX/RX family) with controller, teach pendant and software. It includes an arm extension for accommodating the data acquisition electronics (DAE)
- ✓ An isotropic field probe optimized and calibrated for the targeted measurements.
- ✓ A data acquisition electronics (DAE) which performs the signal amplification, signal multiplexing, AD-conversion, offset measurements, mechanical surface detection, collision detection, etc. The unit is battery powered with standard or rechargeable batteries. The signal is optically transmitted to the EOC.
- ✓ The Electro-optical Converter (EOC) performs the conversion from optical to electrical signals for the digital communication to the DAE. The EOC signal is transmitted to the measurement server.
- ✓ The function of the measurement server is to perform the time critical tasks such as signal filtering, control of the robot operation and fast movements interrupts.
- ✓ The Light Beam used is for probe alignment. This improves the (absolute) accuracy of the probe positioning.
- ✓ A computer running Win7 professional operating system and the DASY6 software.
- ✓ Remote control and teach pendant as well as additional circuitry for robot safety such as warning lamps, etc.
- ✓ The phantom, the device holder and other accessories according to the targeted measurement.
- ✓ MAIA is a hardware interface (Antenna) used to evaluate the modulation and audio interference characteristics of RF signals.
- ✓ ANT is an ultra-wideband antenna for use with the base station simulators over 698 MHz to 6GHz.
- ✓ The base station simulator is an equipment used for SAR cellular tests in order to emulate the cellular signals characteristics and behavior between a regular base station and the equipment under test.
- ✓ Tissue simulating liquid.
- ✓ System Validation dipoles.
- ✓ Network emulator or RF test tool.

A.2.2 E-Field Measurement Probe

The probe is constructed using three orthogonal dipole sensors arranged on an interlocking, triangular prism core. The probe has built-in shielding against static charges and is contained within a PEEK cylindrical enclosure material at the tip.

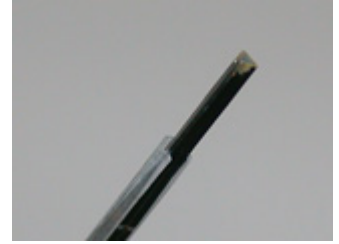

The probe's characteristics are:

Frequency Range	30MHz – 6GHz
Length	337 mm
Probe tip external diameter	2.5 mm
Typical distance between dipoles and the probe tip	1 mm
Axial Isotropy (in human-equivalent liquids)	±0.3 dB
Hemispherical Isotropy (in human-equivalent liquids)	±0.5 dB
Linearity	±0.2 dB
Maximum operating SAR	100 W/kg
Lower SAR detection threshold	0.001 W/kg

A.2.3 Flat Phantom

Phantom for compliance testing of handheld and body-mounted wireless devices in the frequency range of 30 MHz to 6 GHz. ELI is fully compatible with the IEC 62209-2 standard and all known tissue simulating liquids. ELI has been optimized regarding its performance and can be integrated into our standard phantom tables. A cover prevents evaporation of the liquid. Reference markings on the phantom allow installation of the complete setup, including all predefined phantom positions and measurement grids, by teaching three points. The phantom is compatible with all SPEAG dosimetric probes and dipoles.

The phantom's characteristics are:

Material	Vinylester, glass fiber reinforced (VE-GF)
Shell thickness	2 mm ± 0.2 mm
Filling volume	30 Liters approx.
Dimensions	Major axis: 600mm / Minor axis: 400mm

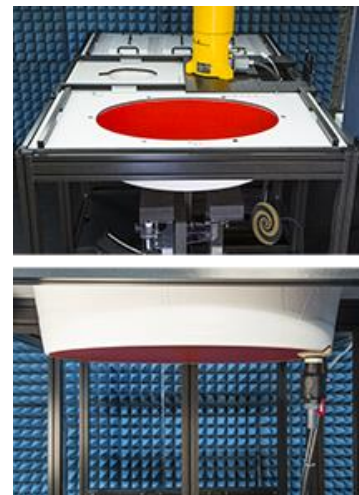

A.2.4 Device Positioner

The SAR in the phantom is approximately inversely proportional to the square of the distance between the source and the liquid surface. For a source at 5 mm distance, a positioning uncertainty of 0.5 mm would produce a SAR uncertainty of 20%. Accurate device positioning is therefore crucial for accurate and repeatable measurements. The positions in which the devices must be measured are defined by the standards.



The DASY device holder is designed to cope with the different positions given in the standard. It has two scales for device rotation (with respect to the body axis) and device inclination (with respect to the line between the ear reference points). The rotation center for both scales is the ear reference point (ERP). Thus the device needs no repositioning when changing the angles.

The DASY device holder is constructed of low-loss POM material having the following dielectric parameters: relative permittivity $\epsilon=3$ and loss tangent $\delta=0.02$. The amount of dielectric material has been reduced in the closest vicinity of the device, since measurements have suggested that the influence of the clamp on the test results could thus be lowered.

A simple but effective and easy-to-use extension for the Mounting Device; facilitates testing of larger devices according to IEC 62209-2 (e.g., laptops, cameras, etc.); lightweight and fits easily on the upper part of the Mounting Device in place of the phone positioner. The extension is fully compatible with the Twin SAM, ELI and other Flat Phantoms.



A.3 Data Evaluation

- **Power Reference measurement**

The robot measures the E field in a specified reference position that can be either the selected section's grid reference point or a user point in this section at 4mm of the inner surface of the phantom, 2mm for frequencies above 3GHz.

- **Area Scan**

Measurement procedures for evaluating SAR from wireless handsets typically start with a coarse measurement grid to determine the approximate location of the local peak SAR values. This is known as the area-scan procedure. The SAR distribution is scanned along the inside surface of one side of the phantom head, at least for an area larger than the projection of the handset and antenna. The distance between the measured points and phantom surface should be less than 8 mm, and should remain constant (with variation less than ± 1 mm) during the entire scan in order to determine the locations of the local peak SAR with sufficient accuracy. The angle between the probe axis and the surface normal line is recommended but not required to be less than 30° . If this angle is larger than 30° and the closest point on the probe-tip housing to the phantom surface is closer than a probe diameter, the boundary effect may become larger and polarization dependent. This additional uncertainty needs to be analyzed and accounted for. To achieve this, modified test procedures and additional uncertainty analyses not described in this recommended practice may be required. The measurement and interpolation point spacing should be chosen such as to allow identification of the local peak locations to within one-half of the linear dimension of a side of the zoom-scan volume. Because a local peak having specific amplitude and steep gradients may produce a lower peak spatial-average SAR compared to peaks with slightly lower amplitude and less steep gradients, it is necessary to evaluate these other peaks as well. However, since the spatial gradients of local SAR peaks are a function of the wavelength inside the tissue-equivalent liquid and the incident magnetic field strength, it is not necessary to evaluate local peaks that are less than 2 dB or more below the global maximum peak. Two-dimensional spline algorithms (Brishoual et al. 2001; Press et al., 1996) are typically used to determine the peaks and gradients within the scanned area. If a peak is found at a distance from the scan border of less than one-half the edge dimension of the desired 1 g or 10 g cube, the measurement area should be enlarged if possible.

- **Zoom Scan**

To evaluate the peak spatial-average SAR values for 1 g or 10 g cubes, fine resolution volume scans, called zoom scans, are performed at the peak SAR locations identified during the area scan. The minimum zoom scan volume size should extend at least 1.5 times the edge dimension of a 1 g cube in all directions from the center of the scan volume, for both 1 g and 10 g peak spatial-average SAR evaluations. Along the phantom curved surfaces, the front face of the volume facing the tissue/liquid interface conforms to the curved boundary, to ensure that all SAR peaks are captured. The back face should be equally distorted to maintain the correct averaging mass. The flatness and orientation of the four side faces are unchanged from that of a cube whose orientation is within $\pm 30^\circ$ of the line normal to the phantom at the center of the cube face next to the phantom surface. The peak local SAR locations that were determined in the area scan (interpolated values) should be used for the centers of the zoom scans. If a scan volume cannot be centered due to proximity of a phantom shape feature, the probe should be tilted to allow scan volume enlargement. If probe tilt is not feasible, the zoom-scan origin may be shifted, but not by more than half of the 1 g or 10 g cube edge dimension.

After the zoom-scan measurement, extrapolations from the closest measured points to the surface, for example along lines parallel to the zoom-scan centerline, and interpolations to a finer resolution between all measured and extrapolated points are performed. Extrapolation algorithm considerations are described in 6.5.3, and 3-D spline methods (Brishoual et al., 2001; Kreyszig, 1983; Press et al., 1996) can be used for interpolation. The peak spatial-average SAR is finally determined by a numerical averaging of the local SAR values in the interpolation grid, using for example a trapezoidal algorithm for the integration (averaging).

In some areas of the phantom, such as the jaw and upper head regions, the angle of the probe with respect to the line normal to the surface may be relatively large, e.g., greater than $\pm 30^\circ$, which could increase the boundary effect error to a larger level. In these cases, during the zoom scan a change in the orientation of the probe, the phantom, or both is recommended but not required for the duration of the zoom scan, so that the angle between the probe axis and the line normal to the surface is within 30° for all measurement points.

- **Power Drift measurement**

The robot re-measures the E-Field in the same reference location measured at the Power Reference. The drift measurement gives the field difference in dB from the first to the last reference reading. This allows a user to monitor the power drift of the device under test that must remain within a maximum variation of $\pm 5\%$.

- **Post-processing**

The procedure for spatial peak SAR evaluation has been implemented according to the IEEE1528 and IEC 62209-1/2 and IEC/IEEE 62209-1528:2020 standards. It can be conducted for 1g and 10g.

The software allows evaluations that combine measured data and robot positions, such as:

- ✓ Maximum search
- ✓ Extrapolation
- ✓ Boundary correction
- ✓ Peak search for averaged SAR

Interpolation between the measured points is performed when the resolution of the grid is not fine enough to compute the average SAR over a given mass.

Extrapolation routines are used to obtain SAR values between the lowest measurement points and the inner phantom surface. The extrapolation is determined by the surface detection distance and the probe sensor offset. Several measurements at different distances are necessary for the extrapolation.

A.4 System and Liquid Check

A.4.1 System Check

The system performance check verifies that the system operates within its specifications. System and operator errors can be detected and corrected. It is recommended that the system performance check be performed prior to any usage of the system in order to guarantee reproducible results.

The system performance check uses normal SAR measurements in a simplified setup with a well characterized source. This setup was selected to give a high sensitivity to all parameters that might fail or vary over time. The system check does not intend to replace the calibration of the components, but indicates situations where the system uncertainty is exceeded due to drift or failure.

In the simplified setup for system check, the EUT is replaced by a calibrated dipole and the power source is replaced by a controlled continuous wave generated by a signal generator. The calibrated dipole must be placed beneath the flat phantom section of the phantom at the correct distance.

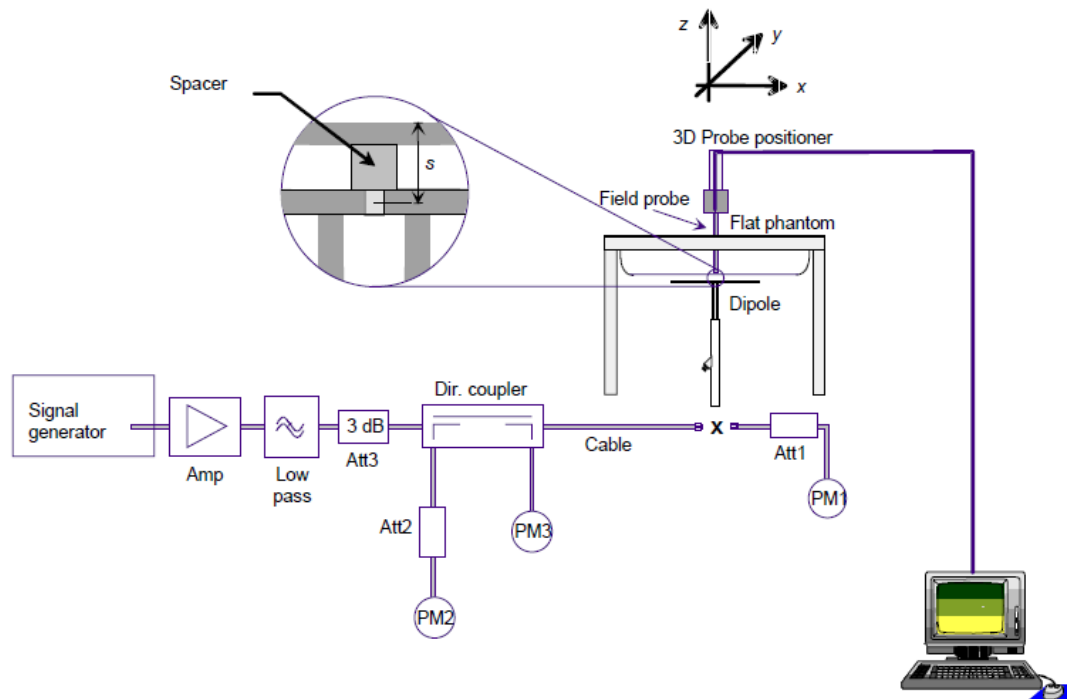

The equipment setup is shown below:

- ✓ Signal Generator
- ✓ Amplifier
- ✓ Directional coupler
- ✓ Power meter
- ✓ Calibrated dipole

First, the power meter PM1 (including attenuator Att1) is connected to the cable to measure the forward power at the location of the connector (x) to the system check source. The signal generator is adjusted for the desired forward power at the connector as read by power meter PM1 after attenuation Att1 and also as coupled through Att2 to PM2. After connecting the cable to the source, the signal generator is readjusted for the same reading at power meter PM2.

SAR results are normalized to a forward power of 1W to compare the values with the calibration reports results as described at IEEE 1528, IEC 62209 and IEC/IEEE 62209-1528:2020 standards

A.4.2 Liquid Check

The dielectric parameters check is done prior to the use of the tissue simulating liquid. The verification is made by comparing the relative permittivity and conductivity to the values recommended by the applicable standards.

The liquid verification was performed using the following test setup:

- ✓ VNA (Vector Network Analyzer)
- ✓ Open-Short-Load calibration kit
- ✓ RF Cable
- ✓ Open-Ended Coaxial probe
- ✓ DAK software tool
- ✓ SAR Liquid
- ✓ De-ionized water
- ✓ Thermometer

These are the target dielectric properties of the tissue-equivalent liquid material as defined in FCC OET KDB 865664 D01.

Frequency (MHz)	Body SAR	
	ϵ_r (F/m)	σ (S/m)
150	61.9	0.80
300	58.2	0.92
450	56.7	0.94
835	55.2	0.97
900	55.0	1.05
1450	54.0	1.30
1800-2000	53.3	1.52
2450	52.7	1.95
3000	52.0	2.73
5800	48.2	6.00

(ϵ_r = relative permittivity, σ = conductivity and ρ = 1000 kg/m³)

The measurement system implement a SAR error compensation algorithm as documented in IEEE Std 1528-2013 and IEC/IEEE 62209-1528:2020 (equivalent to draft standard IEEE P1528-2011) to automatically compensate the measured SAR results for deviations between the measured and required tissue dielectric parameters (applied to only scale up the measured SAR, and not downward) so, according to FCC OET KDB 865664 D01, the tolerance for ϵ_r and σ may be relaxed to $\pm 10\%$.

A.5 Test Equipment List

SAR system #3

ID #	Device	Type/Model	Serial Number	Manufacturer	Cal. Date	Cal. Due Date
003-000	6-Axis Robot	TX60 Lspeag	F17/59RCB1/A/01	STAÜBLI	NA	NA
003-001	Robot Controller	CS8C	F17/59RCB1/C/01	STAÜBLI	NA	NA
003-002	Oval Flat Phantom	ELI V5.0	1260	SPEAG	NA	NA
003-003	Light Beam Unit	SE UKS 030 AA	1170	Di-soric	NA	NA
003-004	Measurement Server	DASY6	1547	SPEAG	NA	NA
003-005	Electro Optical Converter	EOC60	1104	SPEAG	NA	NA
004-005	Measurement Software	DASY6 v16.0	9-658E90FA	SPEAG	NA	NA
086-000	Dosimetric E-Field probe	EX3DV4	7455	SPEAG	2022-03-21	2023-03-21
002-013	Data Acquisition Electronics	DAE4ip	1658	SPEAG	2022-08-19	2023-08-19
003-009	Laptop Holder	N/A	N/A	SPEAG	NA	NA

Shared equipment

ID #	Device	Type/Model	Serial Number	Manufacturer	Cal. Date	Cal. Due Date
123-000	USB Power Sensor	NRP-Z81	102278	R&S	2021-04-13	2023-04-13
124-000	USB Power Sensor	NRP-Z81	102279	R&S	2021-04-13	2023-04-13
458-000	Measurement Software	SARA V2.3	NA	Intel	NA	NA
099-000	Liquid measurement SW	DAK-3.5 V2.6.0.5	9-2687B491	SPEAG	NA	NA
369-000	Dielectric Probe Kit	DAK-3.5	1309	SPEAG	2021-03-10	2023-03-10
077-000	Coupler	CD0.5-8-20-30	1251-002	Amd-group	2022-08-26	2023-02-26
079-001	RF Cable	CBL-0.5M-SMSM+	226527	Mini-Circuits	2022-12-13	2023-06-13
167-001	RF Cable	CBL-2M-SMSM+	233846	Mini-Circuits	2022-12-13	2023-06-13
126-000	Vector Signal Generator	ESG E4438C	MY45092885	Agilent	2021-05-27	2023-05-27
327-000	Temp & Humidity Logger	RA32E-TH1-RAS	RA32-F0DED9	AVTECH	2021-03-09	2023-03-09
089-000	Vector Reflectometer R140	PLANAR R140	0190616	R&S	2021-09-02	2023-09-02
084-000	5GHz System Validation Dipole	D5GHzv2	1259	SPEAG	2022-03-17	2023-03-17
070-000	2.4GHz System Validation Dipole	D2450GHZV2	937	SPEAG	2022-05-19	2023-05-19

A.5.1 Tissue Simulant Liquid

TSL	Manufacturer / Model	Freq Range (MHz)	Main Ingredients
Body WideBand	SPEAG MBBL600-6000V6 Batch 220309-01	600-6000	Ethenediol, Sodium petroleum sulfonate, Hexylene Glycol / 2-Methyl-pentane-2.4-diol, Alkoxylated alcohol

A.6 Measurement Uncertainty Evaluation

The system uncertainty evaluation is shown in the table below with a coverage factor of $k = 2$ to indicate a 95% level of confidence:

SPEAG DASY6 Uncertainty Budget According to IEC/IEEE 62209-1528 (4 MHz - 6 GHz) including IEEE 1528-2013 and IEC 62209-1/2016, IEC 62209-2/2010								
Symbol	Error Description	Uncert. Value	Prob. Dist.	Div.	(ci) 1g	(ci) 10g	Std Unc. (1g)	Std Unc. (10g)
Measurement System Errors								
CF	<i>Probe Calibration</i>	±14.0 %	N	2	1	1	±7.0 %	±7.0 %
CF _{drift}	Probe Calibration Drift	±1.0 %	N	1	1	1	±1.0 %	±1.0 %
LIN	Probe Linearity	±4.7 %	R	√3	1	1	±2.7 %	±2.7 %
BBS	Broadband Signal	±3.0 %	N	2	1	1	±1.5 %	±1.5 %
ISO	<i>Axial Isotropy</i>	±4.7 %	R	√3	0.5	0.5	±1.4 %	±1.4 %
ISO	Hemispherical Isotropy	±9.6 %	R	√3	0.5	0.5	±2.8 %	±2.8 %
DAE	Data Acquisition	±0.3 %	N	1	1	1	±0.3 %	±0.3 %
AMB	RF Ambient	±1.8 %	N	1	1	1	±1.8 %	±1.8 %
Δ _{sys}	Probe Positioning	±0.2 %	N	1	0.33	0.33	±0.1 %	±0.1 %
DAT	Data Processing	±2.3 %	N	1	1	1	±2.3 %	±2.3 %
Phantom and Device Errors								
LIQ(σ)	Conductivity (meas.) _{DAK}	±2.5 %	N	1	0.78	0.71	±2.0 %	±1.8 %
LIQ(T _σ)	Conductivity (temp.) _{BB}	±3.4 %	R	√3	0.78	0.71	±1.5 %	±1.4 %
EPS	Phantom Permittivity	±14.0 %	R	√3	0.25	0.25	±2.0 %	±2.0 %
DAS	Distance DUT - TSL	±2.0 %	N	1	2	2	±4.0 %	±4.0 %
H	Device Holder	±3.6 %	N	1	1	1	±3.6 %	±3.6 %
MOD	DUT Modulation _m	±2.4 %	R	√3	1	1	±1.4 %	±1.4 %
TAS	Time-average SAR	±2.6 %	R	√3	1	1	±1.5 %	±1.5 %
RF _{drift}	DUT drift	±5.0 %	N	1	1	1	±2.9 %	±2.9 %
Correction to the SAR results								
C(ε, σ)	Deviation to Target	±1.9 %	N	1	1	0.84	±1.9 %	±1.6 %
Combined Std. Uncertainty							±11.5 %	±11.4 %
Expanded STD Uncertainty							±23.1 %	±22.9 %

A.7 RF Exposure Limits

SAR assessments have been made in line with the requirements of FCC 47CFR Part 2.1093 and ISED RSS 102 issue 5 on the limitation of exposure of the general population / uncontrolled exposure for portable devices.

Exposure Type	General Population / Uncontrolled Environment
Peak spatial-average SAR (averaged over any 1 gram of tissue)	1.6 W/kg
Whole body average SAR	0.08 W/kg
Peak spatial-average SAR (extremities) (averaged over any 10 grams of tissue)	4.0 W/kg

Annex B. Test Results

The herein test results were performed by:

Test case measurement	Test Personnel
Conducted measurement	F. Heurtematte
SAR measurement	A.Lounes

B.1 Test Conditions

B.1.1 Test SAR Test positions relative to the phantom

The device under test was an Intel® Wi-Fi 6 AX203 card inside a Convertible PC host platform (Yoga 7 16IRL8) using a set of PIFA antennas. The card was operated utilizing proprietary software (DRTU version 02297.22.160.0) and each channel was measured using a broadband power meter to determine the maximum average power.

According to FCC OET KDB 616217 D04, the back surface and edges of the tablet should be tested for SAR compliance with the tablet touching the phantom. The SAR Test Exclusion Threshold in FCC OET KDB 447498 can be applied to determine SAR test exclusion for adjacent edge configurations.

Antenna	Main	Aux
Position	<ul style="list-style-type: none"> • Laptop • Bottom Edge • Back Face 	<ul style="list-style-type: none"> • Laptop • Bottom Edge • Back Face

See B.1.3.1 for a more detailed list of the applied reductions.

See F.2 Test positions section for more information on the tested positions.

B.1.2 Test signal, Output power and Test Frequencies

For 802.11 transmission modes the device was put into operation by using an own control software to program the test mode required to select the continuous transmission with 100% duty cycle.

The output power of the device was set to transmit at maximum power for all tests.

B.1.3 Evaluation Exclusion and Test Reductions

B.1.3.1 SAR evaluation exclusion

For FCC:

The SAR Test Exclusion Threshold in FCC OET KDB 447498 can be applied to determine SAR test exclusion for adjacent edge configurations. For 100MHz to 6GHz and test separation distances ≤ 50 mm, the 1-g and 10-g SAR test exclusion thresholds are determined by the following formula:

$$\left[\frac{\text{(max. power of channel, including tune – up tolerance, mW)}}{\text{(min. test separation distance, mm)}} \right] \cdot \left[\sqrt{f_{\text{(GHz)}}} \right] \leq 3.0 \text{ for } 1g \text{ SAR, and } \leq 7.5 \text{ for } 10g \text{ extremity SAR} \quad (1)$$

Where:

- $f_{\text{(GHz)}}$ is the RF channel transmit frequency in GHz
- Power and distance are rounded to the nearest mW and mm before calculation
- The result is rounded to one decimal place for comparison
- The values 3.0 and 7.5 are referred to as numeric thresholds

The test exclusions are applicable only when the minimum test separation distance is ≤ 50 mm, and for transmission frequencies between 100 MHz and 6 GHz. When the minimum test separation distance is < 5 mm, a distance of 5 mm is applied to determine SAR test exclusion.

For test separation distances > 50 mm, the 1-g and 10-g SAR test exclusion thresholds are determined using the following formulas:

$$\left(\text{(Power allowed at numeric threshold for 50 mm in (1))} + (\text{test separation distance} - 50 \text{ mm}) \cdot (f_{\text{MHz}}/150) \right) \text{mW,} \quad (2)$$

for 100MHz to 1500MHz

$$\left(\text{(Power allowed at numeric threshold for 50 mm in (1))} + (\text{test separation distance} - 50 \text{ mm}) \cdot 10 \right) \text{mW,} \quad (3)$$

for 1500MHz and ≤ 6 GHz

For ISED:

According to RSS-102 section 2.5.1, SAR evaluation is required if the separation distance between the user and/or bystander and the antenna and/or radiating element of the device is less than or equal to 20 cm, except when the device operates at or below the applicable output power level (adjusted for tune-up tolerance) for the specified separation distance defined in Table below:

SAR evaluation — Exemption limits for routine evaluation based on frequency and separation distance					
Frequency	Exemption Limits (mW)				
(MHz)	At separation distance of ≤5 mm	At separation distance of 10 mm	At separation distance of 15 mm	At separation distance of 20 mm	At separation distance of 25 mm
≤300	71 mW	101 mW	132 mW	162 mW	193 mW
450	52 mW	70 mW	88 mW	106 mW	123 mW
835	17 mW	30 mW	42 mW	55 mW	67 mW
1900	7 mW	10 mW	18 mW	34 mW	60 mW
2450	4 mW	7 mW	15 mW	30 mW	52 mW
3500	2 mW	6 mW	16 mW	32 mW	55 mW
5800	1 mW	6 mW	15 mW	27 mW	41 mW

Frequency	Exemption Limits (mW)				
(MHz)	At separation distance of 30 mm	At separation distance of 35 mm	At separation distance of 40 mm	At separation distance of 45 mm	At separation distance of ≥50 mm
≤300	223 mW	254 mW	284 mW	315 mW	345 mW
450	141 mW	159 mW	177 mW	195 mW	213 mW
835	80 mW	92 mW	105 mW	117 mW	130 mW
1900	99 mW	153 mW	225 mW	316 mW	431 mW
2450	83 mW	123 mW	173 mW	235 mW	309 mW
3500	86 mW	124 mW	170 mW	225 mW	290 mW
5800	56 mW	71 mW	85 mW	97 mW	106 mW

LAN Antenna	Band Name	Output power Tablet mode		Back Face	Top Edge	Right Edge	Left Edge	Bottom Edge	Back Face	Top Edge	Right Edge	Left Edge	Bottom Edge
		dBm	mW										
WLAN Main	DTS	16.0	39.8	<50	>50	>50	<50	<50	T	R	R	R	T
	U-NII-1	11.0	12.6	<50	>50	>50	<50	<50	R	R	R	R	T
	U-NII-2A	11.0	12.6	<50	>50	>50	<50	<50	T	R	R	R	T
	U-NII-2C	10.0	10.0	<50	>50	>50	<50	<50	T	R	R	R	T
	U-NII-3	10.0	10.0	<50	>50	>50	<50	<50	T	R	R	R	T
WLAN Aux	DTS	16.0	39.8	<50	>50	<50	>50	<50	T	R	R	R	T
	U-NII-1	11.0	12.6	<50	>50	<50	>50	<50	R	R	R	R	T
	U-NII-2A	11.0	12.6	<50	>50	<50	>50	<50	T	R	R	R	T
	U-NII-2C	10.0	10.0	<50	>50	<50	>50	<50	T	R	R	R	T
	U-NII-3	10.0	10.0	<50	>50	<50	>50	<50	T	R	R	R	T
	BT	10.5	11.2	<50	>50	<50	>50	<50	T	R	R	R	T

LAN Antenna	Band Name	Output power Notebook mode		Laptop	Laptop
		dBm	mW		
WLAN Main	DTS	16.5	44.7	<50	T
	U-NII-1	13.0	20.0	<50	R
	U-NII-2A	13.0	20.0	<50	T
	U-NII-2C	13.0	20.0	<50	T
	U-NII-3	13.0	20.0	<50	T
WLAN Aux	DTS	16.5	44.7	<50	T
	U-NII-1	12.5	17.8	<50	R
	U-NII-2A	12.5	17.8	<50	T
	U-NII-2C	11.0	12.6	<50	T
	U-NII-3	11.0	12.6	<50	T
	BT	10.5	11.2	<50	T

T: Tested position
R: Reduced

See Annex F for a more detailed explanation of the separation distance related to the platform.

B.1.3.2 General SAR test reduction

According to FCC OET KDB 447498, testing of other required channels within the operating mode of a frequency band is not required when the reported 1-g or 10-g SAR for the mid-band or highest output power channel is:

- ≤ 0.8 W/kg or 2.0 W/kg, for 1-g or 10-g respectively, when the transmission band is ≤ 100 MHz
- ≤ 0.6 W/kg or 1.5 W/kg, for 1-g or 10-g respectively, when the transmission band is between 100 MHz and 200 MHz
- ≤ 0.4 W/kg or 1.0 W/kg, for 1-g or 10-g respectively, when the transmission band is ≥ 200 MHz

WLAN SAR Test reduction

Transmission Mode	SAR test exclusion/reduction
DSSS	<p>According to FCC OET KDB 248227 D01, SAR is measured for 2.4 GHz 802.11b, SAR test reduction is determined according to the following:</p> <ul style="list-style-type: none"> ▪ When the reported SAR of the highest measured maximum output power channel for the exposure configuration is ≤ 0.8 W/kg, no further SAR testing is required for 802.11b DSSS in that exposure configuration. ▪ When the reported SAR is > 0.8 W/kg, SAR is required for that exposure configuration using the next highest measured output power channel. When any reported SAR is > 1.2 W/kg, SAR is required for the third channel. <p>According to FCC OET KDB 248227 D01, SAR is not required for 2.4 GHz OFDM conditions when the highest reported SAR for DSSS is adjusted by the ratio of OFDM to DSSS specified maximum output power and the adjusted SAR is ≤ 1.2 W/kg.</p>
OFDM	<p>According to FCC OET KDB 248227 D01, 802.11a/g/n/ac modes have the same specified maximum output power, largest channel bandwidth, lowest order modulation and lowest data rate, the lowest order 802.11 mode is selected; i.e., 802.11a is chosen over 802.11n then 802.11ac or 802.11g is chosen over 802.11n.</p> <p>According to FCC OET KDB 248227 D01, an <i>initial test configuration</i> is determined for OFDM and DSSS transmission modes according to the channel bandwidth, modulation and data rate combination(s) with the highest maximum output power specified for production units in each standalone and aggregated frequency band. SAR is measured using the highest measured maximum output power channel. SAR test reduction for subsequent highest output test channels is determined according to reported SAR of the initial test configuration.</p> <p>The <i>initial test configuration</i> for 5 GHz OFDM transmission modes is determined by the 802.11 configuration with the highest maximum output power specified for production units, including tune-up tolerance, in each standalone and aggregated frequency band. SAR for the initial test configuration is measured using the highest maximum output power channel determined by the default power measurement procedures.</p> <p>According to FCC OET KDB 248227 D01, when the reported SAR of the initial test configuration is > 0.8 W/kg, SAR measurement is required for subsequent next highest measured output power channel(s) in the initial test configuration until reported SAR is ≤ 1.2 W/kg or all required channels are tested.</p>

B.2 Conducted Power Measurements

B.2.1 WLAN 2.4GHz

Tablet mode					Average Power (dBm) - Main			Average Power (dBm) - Aux			
Band	Mode	Data Rate	Ch#	Freq (MHz)	Luxshare	AWAN	Tune-up Pwr (dBm)	Luxshare	AWAN	Tune-up Pwr (dBm)	
DTS	802.11b	1	1	2412	15.88	15.99	16.00	15.86	15.67	16.00	
			6	2437	15.85	15.15	16.00	15.90	15.56	16.00	
			11	2462	15.89	15.16	16.00	15.96	15.83	16.00	
	802.11g	6	1	2412	NR	NR	16.00	NR	NR	NR	16.00
			6	2437							16.00
			11	2462							16.00
	802.11n20	HT0	1	2412							16.00
			6	2437							16.00
			11	2462							16.00
	802.11ax20	MCS0	1	2412							16.00
			6	2437							16.00
			11	2462							16.00
	802.11n40	HT0	3	2422							16.00
			6	2437							16.00
			9	2452							16.00
	802.11ax40	MCS0	3	2422							16.00
			6	2437							16.00
			9	2452							16.00

Initial test configuration

1. NR: Not Required
2. As per FCC OET KDB 248227 D01, conducted output power and SAR testing are not required for 802.11g/n/ax channels when the highest reported SAR for DSSS is adjusted by the ratio of OFDM to DSSS specified maximum output power and the adjusted SAR is $\leq 1.2W/kg$.
3. When the reported SAR of the initial test configuration is $> 0.8 W/kg$, SAR measurement is required for subsequent next highest measured output power channel(s) in the initial test configuration until reported SAR is $\leq 1.2 W/kg$ or all required channels are tested.

Notebook mode					Average Power (dBm) - Main			Average Power (dBm) - Aux		
Band	Mode	Data Rate	Ch#	Freq (MHz)	Luxshare	AWAN	Tune-up Pwr (dBm)	Luxshare	AWAN	Tune-up Pwr (dBm)
DTS	802.11b	1	1	2412	16.44	16.36	16.50	16.33	16.26	16.50
			6	2437	16.43	16.48	16.50	16.45	16.43	16.50
			11	2462	16.48	16.45	16.50	16.36	16.46	16.50
	802.11g	6	1	2412	NR	NR	16.50	NR	NR	16.50
			6	2437			16.50			
			11	2462			16.50			
	802.11n20	HT0	1	2412	NR	NR	16.50	NR	NR	16.50
			6	2437			16.50			
			11	2462			16.50			
	802.11ax20	MCS0	1	2412	NR	NR	16.50	NR	NR	16.50
			6	2437			16.50			
			11	2462			16.50			
	802.11n40	HT0	3	2422	NR	NR	16.50	NR	NR	16.50
			6	2437			16.50			
			9	2452			16.50			
	802.11ax40	MCS0	3	2422	NR	NR	16.50	NR	NR	16.50
			6	2437			16.50			
			9	2452			16.50			

B.2.2 WLAN 5GHz (U-NII)

B.2.2.1 5.2GHz and 5.3GHz (U-NII-1 and U-NII-2A)

Tablet mode					Average Power (dBm) - Main			Average Power (dBm) - Aux		
Band	Mode	Data Rate	Ch#	Freq (MHz)	Luxshare	AWAN	Tune-up Pwr (dBm)	Luxshare	AWAN	Tune-up Pwr (dBm)
UNII-1	802.11a20	6	36	5180	NR	NR	11.00	NR	NR	11.00
			40	5200			11.00			11.00
			44	5220			11.00			11.00
			48	5240			11.00			11.00
	802.11n20	HT0	36	5180			11.00			11.00
			40	5200			11.00			11.00
			44	5220			11.00			11.00
			48	5240			11.00			11.00
	802.11ax20	MCS0	36	5180			11.00			11.00
			40	5200			11.00			11.00
			44	5220			11.00			11.00
			48	5240			11.00			11.00
	802.11n40	HT0	38	5190			11.00			11.00
			46	5230			11.00			11.00
	802.11ax40	MCS0	38	5190			11.00			11.00
			46	5230			11.00			11.00
802.11ac80	VHT0	42	5210	11.00	11.00					
802.11ax80	MCS0	42	5210	11.00	11.00					

Initial test configuration

1. NR: Not Required
2. When the same maximum output power is specified for both bands, begin SAR measurement in U-NII-2A band by applying the OFDM SAR requirements. If the highest reported SAR for a test configuration is ≤ 1.2 W/kg, SAR is not required for U-NII-1 band (see §B.5.2 in this document).
3. Additional conducted power measurement is required when reported SAR is > 1.2 W/kg. In case the subsequent test configuration and the channel bandwidth is smaller than the initial test configuration, all channels that overlap with the larger channel bandwidth in the initial configuration should be tested.
4. The initial test configuration for 2.4 GHz and 5 GHz OFDM transmission modes is determined by the 802.11 configuration with the highest maximum output power specified for production units, including tune-up tolerance, in each standalone and aggregated frequency band. SAR for the initial test configuration is measured using the highest maximum output power channel determined by the default power measurement procedures. When multiple transmission modes (802.11a/g/n/ac) have the same specified maximum output power, largest channel bandwidth, lowest order modulation and lowest data rate, lowest order 802.11 mode is selected (i.e. a, g, n, ac then ax)
5. When the reported SAR of the initial test configuration is > 0.8 W/kg, SAR measurement is required for the subsequent next highest measured output power channel(s) in the initial test configuration until reported SAR is ≤ 1.2 W/kg or all required channels are tested.
6. When the highest reported SAR for the initial test configuration (when applicable, include subsequent highest output channels), according to the initial test position or fixed exposure requirements, is adjusted by the ratio of the subsequent test configuration to the initial test configuration specified maximum output power and the adjusted SAR is ≤ 1.2 W/kg, SAR is not required for that subsequent test configuration
7. SAR for subsequent highest measured maximum output power channels in the subsequent test configuration is required only when the reported SAR of the preceding higher maximum output power channel(s) in the subsequent test configuration is > 1.2 W/kg or until all required channels are tested.

Tablet mode					Average Power (dBm) - Main			Average Power (dBm) - Aux		
Band	Mode	Data Rate	Ch#	Freq (MHz)	Luxshare	AWAN	Tune-up Pwr (dBm)	Luxshare	AWAN	Tune-up Pwr (dBm)
UNII-2A	802.11a20	6	52	5260	NR	NR	11.00	NR	NR	11.00
			56	5280			11.00			11.00
			60	5300			11.00			11.00
			64	5320			11.00			11.00
	802.11n20	HT0	52	5260			11.00			11.00
			56	5280			11.00			11.00
			60	5300			11.00			11.00
			64	5320			11.00			11.00
	802.11ax20	MCS0	52	5260			11.00			11.00
			56	5280			11.00			11.00
			60	5300			11.00			11.00
			64	5320			11.00			11.00
	802.11n40	HT0	54	5270			11.00			11.00
			62	5310			11.00			11.00
	802.11ax40	MCS0	54	5270			11.00			11.00
			62	5310			11.00			11.00
802.11ac80	VHT0	58	5290	10.19	10.56	11.00	10.42	10.75	11.00	
802.11ax80	MCS0	58	5290	10.12	10.46	11.00	10.22	10.49	11.00	

Initial test configuration

1. NR: Not Required
2. The initial test configuration for 2.4 GHz and 5 GHz OFDM transmission modes is determined by the 802.11 configuration with the highest maximum output power specified for production units, including tune-up tolerance, in each standalone and aggregated frequency band. SAR for the initial test configuration is measured using the highest maximum output power channel determined by the default power measurement procedures. When multiple transmission modes (802.11a/g/n/ac) have the same specified maximum output power, largest channel bandwidth, lowest order modulation and lowest data rate, lowest order 802.11 mode is selected (i.e. a, g, n, ac then ax)
3. Additional conducted power measurement is required when reported SAR is > 1.2W/kg. In case the subsequent test configuration and the channel bandwidth is smaller than the initial test configuration, all channels that overlap with the larger channel bandwidth in the initial configuration should be tested.
4. When the reported SAR of the initial test configuration is > 0.8W/kg, SAR measurement is required for the subsequent next highest measured output power channel(s) in the initial test configuration until reported SAR is ≤1.2W/kg or all required channels are tested.
5. When the highest reported SAR for the initial test configuration (when applicable, include subsequent highest output channels), according to the initial test position or fixed exposure requirements, is adjusted by the ratio of the subsequent test configuration to the initial test configuration specified maximum output power and the adjusted SAR is ≤1.2 W/kg, SAR is not required for that subsequent test configuration.
6. SAR for subsequent highest measured maximum output power channels in the subsequent test configuration is required only when the reported SAR of the preceding higher maximum output power channel(s) in the subsequent test configuration is >1.2 W/kg or until all required channels are tested.

Notebook mode					Average Power (dBm) - Main			Average Power (dBm) - Aux		
Band	Mode	Data Rate	Ch#	Freq (MHz)	Luxshare	AWAN	Tune-up Pwr (dBm)	Luxshare	AWAN	Tune-up Pwr (dBm)
UNII-1	802.11a20	6	36	5180	NR	NR	13.00	NR	NR	12.50
			40	5200			13.00			12.50
			44	5220			13.00			12.50
			48	5240			13.00			12.50
	802.11n20	HT0	36	5180			13.00			12.50
			40	5200			13.00			12.50
			44	5220			13.00			12.50
			48	5240			13.00			12.50
	802.11ax20	MCS0	36	5180			13.00			12.50
			40	5200			13.00			12.50
			44	5220			13.00			12.50
			48	5240			13.00			12.50
	802.11n40	HT0	38	5190			13.00			12.50
			46	5230			13.00			12.50
	802.11ax40	MCS0	38	5190			13.00			12.50
			46	5230			13.00			12.50
802.11ac80	VHT0	42	5210	13.00	12.50					
802.11ax80	MCS0	42	5210	13.00	12.50					

Initial test configuration

1. NR: Not Required
2. The initial test configuration for 2.4 GHz and 5 GHz OFDM transmission modes is determined by the 802.11 configuration with the highest maximum output power specified for production units, including tune-up tolerance, in each standalone and aggregated frequency band. SAR for the initial test configuration is measured using the highest maximum output power channel determined by the default power measurement procedures. When multiple transmission modes (802.11a/g/n/ac) have the same specified maximum output power, largest channel bandwidth, lowest order modulation and lowest data rate, lowest order 802.11 mode is selected (i.e. a, g, n, ac then ax)
3. Additional conducted power measurement is required when reported SAR is > 1.2W/kg. In case the subsequent test configuration and the channel bandwidth is smaller than the initial test configuration, all channels that overlap with the larger channel bandwidth in the initial configuration should be tested.
4. When the reported SAR of the initial test configuration is > 0.8W/kg, SAR measurement is required for the subsequent next highest measured output power channel(s) in the initial test configuration until reported SAR is ≤1.2W/kg or all required channels are tested.
5. When the highest reported SAR for the initial test configuration (when applicable, include subsequent highest output channels), according to the initial test position or fixed exposure requirements, is adjusted by the ratio of the subsequent test configuration to the initial test configuration specified maximum output power and the adjusted SAR is ≤1.2 W/kg, SAR is not required for that subsequent test configuration.
6. SAR for subsequent highest measured maximum output power channels in the subsequent test configuration is required only when the reported SAR of the preceding higher maximum output power channel(s) in the subsequent test configuration is >1.2 W/kg or until all required channels are tested.

Notebook mode					Average Power (dBm) - Main			Average Power (dBm) - Aux		
Band	Mode	Data Rate	Ch#	Freq (MHz)	Luxshare	AWAN	Tune-up Pwr (dBm)	Luxshare	AWAN	Tune-up Pwr (dBm)
UNII-2A	802.11a20	6	52	5260	NR	NR	13.00	NR	NR	12.50
			56	5280			13.00			12.50
			60	5300			13.00			12.50
			64	5320			13.00			12.50
	802.11n20	HT0	52	5260			13.00			12.50
			56	5280			13.00			12.50
			60	5300			13.00			12.50
			64	5320			13.00			12.50
	802.11ax20	MCS0	52	5260			13.00			12.50
			56	5280			13.00			12.50
			60	5300			13.00			12.50
			64	5320			13.00			12.50
	802.11n40	HT0	54	5270			13.00			12.50
			62	5310			13.00			12.50
	802.11ax40	MCS0	54	5270			13.00			12.50
			62	5310			13.00			12.50
802.11ac80	VHT0	58	5290	12.69	12.93	13.00	12.47	12.38	12.50	
802.11ax80	MCS0	58	5290	12.60	12.66	13.00	12.19	12.23	12.50	
802.11ac160	VHT0	50	5250	NR	NR	13.00	NR	NR	12.50	
802.11ax160	MCS0	50	5250			13.00			12.50	

Initial test configuration

1. NR: Not Required
2. The initial test configuration for 2.4 GHz and 5 GHz OFDM transmission modes is determined by the 802.11 configuration with the highest maximum output power specified for production units, including tune-up tolerance, in each standalone and aggregated frequency band. SAR for the initial test configuration is measured using the highest maximum output power channel determined by the default power measurement procedures. When multiple transmission modes (802.11a/g/n/ac) have the same specified maximum output power, largest channel bandwidth, lowest order modulation and lowest data rate, lowest order 802.11 mode is selected (i.e. a, g, n, ac then ax)
3. Additional conducted power measurement is required when reported SAR is > 1.2W/kg. In case the subsequent test configuration and the channel bandwidth is smaller than the initial test configuration, all channels that overlap with the larger channel bandwidth in the initial configuration should be tested.
4. When the reported SAR of the initial test configuration is > 0.8W/kg, SAR measurement is required for the subsequent next highest measured output power channel(s) in the initial test configuration until reported SAR is ≤1.2W/kg or all required channels are tested.
5. When the highest reported SAR for the initial test configuration (when applicable, include subsequent highest output channels), according to the initial test position or fixed exposure requirements, is adjusted by the ratio of the subsequent test configuration to the initial test configuration specified maximum output power and the adjusted SAR is ≤1.2 W/kg, SAR is not required for that subsequent test configuration.
6. SAR for subsequent highest measured maximum output power channels in the subsequent test configuration is required only when the reported SAR of the preceding higher maximum output power channel(s) in the subsequent test configuration is >1.2 W/kg or until all required channels are tested.

B.2.2.2 5.6 (U-NII-2C)

Tablet mode					Average Power (dBm) - Main			Average Power (dBm) - Aux						
Band	Mode	Data Rate	Ch#	Freq (MHz)	Luxshare	AWAN	Tune-up Pwr (dBm)	Luxshare	AWAN	Tune-up Pwr (dBm)				
UNII-2C	802.11a20	6	100	5500	NR	NR	10.00	NR	NR	10.00				
			104	5520			10.00			10.00				
			108	5540			10.00			10.00				
			112	5560			10.00			10.00				
			116	5580			10.00			10.00				
			120	5600			10.00			10.00				
			124	5620			10.00			10.00				
			128	5640			10.00			10.00				
	802.11n20	HT0	100	5500			10.00			10.00				
			104	5520			10.00			10.00				
			108	5540			10.00			10.00				
			112	5560			10.00			10.00				
			116	5580			10.00			10.00				
			120	5600			10.00			10.00				
			124	5620			10.00			10.00				
			128	5640			10.00			10.00				
	802.11ax20	MCS0	100	5500			10.00			10.00				
			104	5520			10.00			10.00				
			108	5540			10.00			10.00				
			112	5560			10.00			10.00				
			116	5580			10.00			10.00				
			120	5600			10.00			10.00				
			124	5620			10.00			10.00				
			128	5640			10.00			10.00				
	802.11n40	HT0	102	5510			10.00			10.00				
			110	5550			10.00			10.00				
			118	5590			10.00			10.00				
			126	5630			10.00			10.00				
	802.11ax40	MCS0	102	5510			10.00			10.00				
			110	5550			10.00			10.00				
			118	5590			10.00			10.00				
			126	5630			10.00			10.00				
	802.11ac80	VHT0	106	5530			9.83			9.81	10.00	9.78	9.76	10.00
			122	5610			9.38			9.72	10.00	9.96	9.96	10.00
	802.11ax80	MCS0	106	5530			NR			NR	10.00	NR	NR	10.00
			122	5610							10.00			10.00

Initial test configuration

1. NR: Not Required
2. When band gap channels between U-NII-2C and U-NII-3 band are supported channels in U-NII-2C band below 5.65 GHz are considered as one band and channels above 5.65 GHz, together with channels in 5.8 GHz U-NII-3 or §15.247 band, are considered as a separate band
3. Additional conducted power measurement is required when reported SAR is $> 1.2\text{W/kg}$. In case the subsequent test configuration and the channel bandwidth is smaller than the initial test configuration, all channels that overlap with the larger channel bandwidth in the initial configuration should be tested
4. The initial test configuration for 2.4 GHz and 5 GHz OFDM transmission modes is determined by the 802.11 configuration with the highest maximum output power specified for production units, including tune-up tolerance, in each standalone and aggregated frequency band. SAR for the initial test configuration is measured using the highest maximum output power channel determined by the default power measurement procedures. When multiple transmission modes (802.11a/g/n/ac) have the same specified maximum output power, largest channel bandwidth, lowest order modulation and lowest data rate, lowest order 802.11 mode is selected (i.e. a, g, n, ac then ax)
5. When the reported SAR of the initial test configuration is $> 0.8\text{W/kg}$, SAR measurement is required for the subsequent next highest measured output power channel(s) in the initial test configuration until reported SAR is $\leq 1.2\text{W/kg}$ or all required channels are tested.
6. When the highest reported SAR for the initial test configuration (when applicable, include subsequent highest output channels), according to the initial test position or fixed exposure requirements, is adjusted by the ratio of the subsequent test configuration to the initial test configuration specified maximum output power and the adjusted SAR is $\leq 1.2\text{ W/kg}$, SAR is not required for that subsequent test configuration.
7. SAR for subsequent highest measured maximum output power channels in the subsequent test configuration is required only when the reported SAR of the preceding higher maximum output power channel(s) in the subsequent test configuration is $> 1.2\text{ W/kg}$ or until all required channels are tested.

Notebook mode					Average Power (dBm) - Main			Average Power (dBm) - Aux						
Band	Mode	Data Rate	Ch#	Freq (MHz)	Luxshare	AWAN	Tune-up Pwr (dBm)	Luxshare	AWAN	Tune-up Pwr (dBm)				
UNII-2C	802.11a20	6	100	5500	NR	NR	13.00	NR	NR	11.00				
			104	5520			13.00			11.00				
			108	5540			13.00			11.00				
			112	5560			13.00			11.00				
			116	5580			13.00			11.00				
			120	5600			13.00			11.00				
			124	5620			13.00			11.00				
			128	5640			13.00			11.00				
	802.11n20	HT0	100	5500			13.00			11.00				
			104	5520			13.00			11.00				
			108	5540			13.00			11.00				
			112	5560			13.00			11.00				
			116	5580			13.00			11.00				
			120	5600			13.00			11.00				
			124	5620			13.00			11.00				
			128	5640			13.00			11.00				
	802.11ax20	MCS0	100	5500			13.00			11.00				
			104	5520			13.00			11.00				
			108	5540			13.00			11.00				
			112	5560			13.00			11.00				
			116	5580			13.00			11.00				
			120	5600			13.00			11.00				
			124	5620			13.00			11.00				
			128	5640			13.00			11.00				
	802.11n40	HT0	102	5510			13.00			11.00				
			110	5550			13.00			11.00				
			118	5590			13.00			11.00				
			126	5630			13.00			11.00				
	802.11ax40	MCS0	102	5510			13.00			11.00				
			110	5550			13.00			11.00				
			118	5590			13.00			11.00				
			126	5630			13.00			11.00				
	802.11ac80	VHT0	106	5530			12.77			12.94	13.00	10.98	10.95	11.00
			122	5610			12.61			12.91	13.00	11.00	10.73	11.00
	802.11ax80	MCS0	106	5530			NR			NR	13.00	NR	NR	11.00
			122	5610			NR			NR	13.00	NR	NR	11.00

B.2.2.3 5.8GHz (U-NII-3)

Tablet mode					Average Power (dBm) - Main			Average Power (dBm) - Aux						
Band	Mode	Data Rate	Ch#	Freq (MHz)	Luxshare	AWAN	Tune-up Pwr (dBm)	Luxshare	AWAN	Tune-up Pwr (dBm)				
UNII-3	802.11a20	6	132	5660	NR	NR	10.00	NR	NR	10.00				
			136	5680			10.00			10.00				
			140	5700			10.00			10.00				
			144	5720			10.00			10.00				
			149	5745			10.00			10.00				
			153	5765			10.00			10.00				
			157	5785			10.00			10.00				
			161	5805			10.00			10.00				
	165	5825	10.00	10.00										
	802.11n20	HT0	132	5660			10.00			10.00				
			136	5680			10.00			10.00				
			140	5700			10.00			10.00				
			144	5720			10.00			10.00				
			149	5745			10.00			10.00				
			153	5765			10.00			10.00				
			157	5785			10.00			10.00				
			161	5805			10.00			10.00				
	165	5825	10.00	10.00										
	802.11ax20	MCS0	132	5660			10.00			10.00				
			136	5680			10.00			10.00				
			140	5700			10.00			10.00				
			144	5720			10.00			10.00				
			149	5745			10.00			10.00				
			153	5765			10.00			10.00				
			157	5785			10.00			10.00				
			161	5805			10.00			10.00				
	165	5825	10.00	10.00										
	802.11n40	HT0	134	5670			10.00			10.00				
			142	5710			10.00			10.00				
			151	5755			10.00			10.00				
			159	5795			10.00			10.00				
	802.11ax40	MCS0	134	5670			10.00			10.00				
			142	5710			10.00			10.00				
			151	5755			10.00			10.00				
			159	5795			10.00			10.00				
	802.11ac80	VHT0	138	5690			9.69			9.46	10.00	9.72	9.78	10.00
			155	5775			9.61			9.61	10.00	9.94	9.57	10.00
	802.11ax80	MCS0	138	5690			NR			NR	10.00	NR	NR	10.00
			155	5775			NR			NR	10.00	NR	NR	10.00

1. NR: Not Required
2. When band gap channels between U-NII-2C and U-NII-3 band are supported channels in U-NII-2C band below 5.65 GHz are considered as one band and channels above 5.65 GHz, together with channels in 5.8 GHz U-NII-3 or §15.247 band, are considered as a separate band
3. Additional conducted power measurement is required when reported SAR is $> 1.2\text{W/kg}$. In case the subsequent test configuration and the channel bandwidth is smaller than the initial test configuration, all channels that overlap with the larger channel bandwidth in the initial configuration should be tested
4. The initial test configuration for 2.4 GHz and 5 GHz OFDM transmission modes is determined by the 802.11 configuration with the highest maximum output power specified for production units, including tune-up tolerance, in each standalone and aggregated frequency band. SAR for the initial test configuration is measured using the highest maximum output power channel determined by the default power measurement procedures. When multiple transmission modes (802.11a/g/n/ac) have the same specified maximum output power, largest channel bandwidth, lowest order modulation and lowest data rate, lowest order 802.11 mode is selected (i.e. a, g, n, ac then ax)
5. When the reported SAR of the initial test configuration is $> 0.8\text{W/kg}$, SAR measurement is required for the subsequent next highest measured output power channel(s) in the initial test configuration until reported SAR is $\leq 1.2\text{W/kg}$ or all required channels are tested.
6. When the highest reported SAR for the initial test configuration (when applicable, include subsequent highest output channels), according to the initial test position or fixed exposure requirements, is adjusted by the ratio of the subsequent test configuration to the initial test configuration specified maximum output power and the adjusted SAR is $\leq 1.2\text{ W/kg}$, SAR is not required for that subsequent test configuration.
7. SAR for subsequent highest measured maximum output power channels in the subsequent test configuration is required only when the reported SAR of the preceding higher maximum output power channel(s) in the subsequent test configuration is $> 1.2\text{ W/kg}$ or until all required channels are tested.

Notebook mode					Average Power (dBm) - Main			Average Power (dBm) - Aux						
Band	Mode	Data Rate	Ch#	Freq (MHz)	Luxshare	AWAN	Tune-up Pwr (dBm)	Luxshare	AWAN	Tune-up Pwr (dBm)				
UNII-3	802.11a20	6	132	5660	NR	NR	13.00	NR	NR	11.00				
			136	5680			13.00			11.00				
			140	5700			13.00			11.00				
			144	5720			13.00			11.00				
			149	5745			13.00			11.00				
			153	5765			13.00			11.00				
			157	5785			13.00			11.00				
			161	5805			13.00			11.00				
	165	5825	13.00	11.00										
	802.11n20	HT0	132	5660			13.00			11.00				
			136	5680			13.00			11.00				
			140	5700			13.00			11.00				
			144	5720			13.00			11.00				
			149	5745			13.00			11.00				
			153	5765			13.00			11.00				
			157	5785			13.00			11.00				
			161	5805			13.00			11.00				
	165	5825	13.00	11.00										
	802.11ax20	MCS0	132	5660			13.00			11.00				
			136	5680			13.00			11.00				
			140	5700			13.00			11.00				
			144	5720			13.00			11.00				
			149	5745			13.00			11.00				
			153	5765			13.00			11.00				
			157	5785			13.00			11.00				
			161	5805			13.00			11.00				
	165	5825	13.00	11.00										
	802.11n40	HT0	134	5670			13.00			11.00				
			142	5710			13.00			11.00				
			151	5755			13.00			11.00				
			159	5795			13.00			11.00				
	802.11ax40	MCS0	134	5670			13.00			11.00				
			142	5710			13.00			11.00				
			151	5755			13.00			11.00				
			159	5795			13.00			11.00				
	802.11ac80	VHT0	138	5690			12.68			12.75	13.00	10.86	10.91	11.00
			155	5775			12.58			12.71	13.00	10.88	10.57	11.00
	802.11ax80	MCS0	138	5690			NR			NR	13.00	NR	NR	11.00
			155	5775			NR			NR	13.00	NR	NR	11.00

Initial test configuration

1. NR: Not Required
2. When band gap channels between U-NII-2C and U-NII-3 band are supported channels in U-NII-2C band below 5.65 GHz are considered as one band and channels above 5.65 GHz, together with channels in 5.8 GHz U-NII-3 or §15.247 band, are considered as a separate band
3. Additional conducted power measurement is required when reported SAR is $> 1.2\text{W/kg}$. In case the subsequent test configuration and the channel bandwidth is smaller than the initial test configuration, all channels that overlap with the larger channel bandwidth in the initial configuration should be tested
4. The initial test configuration for 2.4 GHz and 5 GHz OFDM transmission modes is determined by the 802.11 configuration with the highest maximum output power specified for production units, including tune-up tolerance, in each standalone and aggregated frequency band. SAR for the initial test configuration is measured using the highest maximum output power channel determined by the default power measurement procedures. When multiple transmission modes (802.11a/g/n/ac) have the same specified maximum output power, largest channel bandwidth, lowest order modulation and lowest data rate, lowest order 802.11 mode is selected (i.e. a, g, n, ac then ax)
5. When the reported SAR of the initial test configuration is $> 0.8\text{W/kg}$, SAR measurement is required for the subsequent next highest measured output power channel(s) in the initial test configuration until reported SAR is $\leq 1.2\text{W/kg}$ or all required channels are tested.
6. When the highest reported SAR for the initial test configuration (when applicable, include subsequent highest output channels), according to the initial test position or fixed exposure requirements, is adjusted by the ratio of the subsequent test configuration to the initial test configuration specified maximum output power and the adjusted SAR is $\leq 1.2\text{ W/kg}$, SAR is not required for that subsequent test configuration.
7. SAR for subsequent highest measured maximum output power channels in the subsequent test configuration is required only when the reported SAR of the preceding higher maximum output power channel(s) in the subsequent test configuration is $> 1.2\text{ W/kg}$ or until all required channels are tested.

B.2.3 Bluetooth

Notebook and Tablet mode						Average Power (dBm)		
Band	Mode	Data Rate	Channel	Frequency (MHz)	Antenna	Luxshare	AWAN	Tune-up Pwr (dBm)
Bluetooth	Bluetooth	Basic rate GFSK	0	2402	Aux	10.17	9.76	10.50
			39	2441	Aux	10.43	10.31	10.50
			78	2480	Aux	10.44	10.40	10.50
		Basic rate $\pi/4$ DQPSK	0	2402	Aux	NR	NR	8.00
			39	2441	Aux			8.00
			78	2480	Aux			8.00
		Basic rate 8-DPSK	0	2402	Aux			7.00
			39	2441	Aux			7.00
			78	2480	Aux			7.00
	BLE	Low energy GFSK	0	2402	Aux			7.00
			39	2441	Aux			7.00
			78	2480	Aux			7.00

Initial test configuration

1. NR: Not Required

B.3 Tissue Parameters Measurement**System #3**

Freq.(MHz)	Target Parameters		Measured TSL Parameters		Deviation (%)		Date
	ϵ' (F/m)	σ (S/m)	ϵ' (F/m)	σ (S/m)	Deviation ϵ'	Deviation σ	
2450	52.70	1.95	49.57	2.06	-5.94	5.64	2023-01-13
5200	49.01	5.30	44.99	5.34	-8.20	0.75	
5300	48.88	5.42	44.83	5.51	-8.29	1.66	
5500	48.61	5.65	44.58	5.78	-8.29	2.30	
5600	48.47	5.77	44.49	5.90	-8.21	2.25	
5800	48.20	6.00	43.99	6.20	-8.73	3.33	

See *Annex D* for more details.

B.4 System Check Measurements

Body Measurements

Frequency (MHz)	Average	Target SAR (W/kg)	Measured SAR (W/kg)	Forwarded Power (mW)	Deviation to target (%)	Limit (%)	Date
2450	1g	50.80	48.60	50.00	-4.33	± 10	2023-01-14
	10g	24.20	22.40		-7.44		2023-01-14
	1g	48.90	49.20		0.61		2023-01-15
	10g	23.20	22.60		-2.59		2023-01-15
5300	1g	71.70	71.60		-0.14		2023-01-14
	10g	20.00	21.00		5.00		2023-01-14
	1g	75.00	74.00		-1.33		2023-01-15
	10g	20.50	20.80		1.46		2023-01-15
5500	1g	76.90	72.60		-5.59		2023-01-14
	10g	21.20	21.00		-0.94		2023-01-14
	1g	80.80	79.20		-1.98		2023-01-15
	10g	21.90	22.20		1.37		2023-01-15
5600	1g	76.50	77.80		1.70		2023-01-14
	10g	21.20	22.40		5.66		2023-01-14
	1g	78.60	80.00		1.78		2023-01-15
	10g	21.50	22.00		2.33		2023-01-15
5800	1g	73.40	66.80	-8.99	2023-01-14		
	10g	20.00	19.32	-3.40	2023-01-14		
	1g	74.80	74.40	-0.53	2023-01-15		
	10g	20.20	20.80	2.97	2023-01-15		

See Annex C for more details.

B.5 SAR Test Results

B.5.1 802.11b/g/n/ax – 2.4GHz - DTS

Antenna Manufacturer	Mode	Data rate	BW (MHz)	Channel Number	Freq (MHz)	Test position mode	Antenna	Scaling Factor (dB)	Measured SAR 1g (W/kg)	Reported SAR 1g (W/kg)	Plot #
AWAN	802.15	DH5	1	78	2480	Back Face	Aux	0.10	0.06	0.06	
						Bottom Edge	Aux	0.10	0.12	0.12	
						Laptop	Aux	0.10	0.06	0.06	
	802.11b	1Mbps	20	1	2412	Back Face	Main	0.01	0.25	0.25	
						Bottom Edge	Main	0.01	0.46	0.46	
						Laptop	Main	0.02	0.38	0.38	
				11	2462	Back Face	Aux	0.17	0.24	0.25	
						Bottom Edge	Aux	0.17	0.49	0.51	
						Laptop	Aux	0.04	0.29	0.29	
						Back Face	Aux	0.04	0.36	0.37	
Luxshare	802.15	DH5	1	78	2480	Bottom Edge	Main	0.11	0.49	0.50	
						Bottom Edge	Aux	0.04	0.62	0.63	1
						Back Face	Main	0.11	0.36	0.37	
	802.11b	1Mbps	20	6	2437	Bottom Edge	Aux	0.06	0.09	0.09	
						Bottom Edge	Aux	0.06	0.16	0.16	
				11	2462	Laptop	Aux	0.06	0.12	0.12	
Laptop	Main	0.02	0.45			0.45					

B.5.2 802.11a/n/ac/ax – 5.3 GHz – U-NII-2A

Antenna Manufacturer	Mode	Data rate	BW (MHz)	Channel Number	Freq (MHz)	Test position mode	Antenna	Scaling Factor (dB)	Measured SAR 1g (W/kg)	Reported SAR 1g (W/kg)	Plot #
AWAN	802.11ac	VHT0	80	58	5290	Back Face	Aux	0.25	0.06	0.06	
						Bottom Edge	Aux	0.44	0.58	0.64	
						Laptop	Aux	0.12	0.54	0.56	
						Back Face	Main	0.44	0.01	0.01	
						Bottom Edge	Main	0.44	0.32	0.36	
						Laptop	Main	0.07	0.79	0.81	2
Luxshare	802.11ac	VHT0	80	58	5290	Back Face	Aux	0.58	0.14	0.16	
						Bottom Edge	Aux	0.58	0.61	0.70	
						Laptop	Aux	0.03	0.55	0.55	
						Back Face	Main	0.81	0.15	0.19	
						Bottom Edge	Main	0.81	0.57	0.69	
						Laptop	Main	0.31	0.63	0.68	

B.5.3 802.11a/n/ac/ax – 5.6 GHz – U-NII-2C

Antenna Manufacturer	Mode	Data rate	BW (MHz)	Channel Number	Freq (MHz)	Test position mode	Antenna	Scaling Factor (dB)	Measured SAR 1g (W/kg)	Reported SAR 1g (W/kg)	Plot #
AWAN	802.11ac	VHT0	80	106	5530	Laptop	Aux	0.05	0.47	0.48	
						Back Face	Main	0.19	0.08	0.08	
						Bottom Edge	Main	0.19	0.33	0.35	
				122	5610	Laptop	Main	0.06	0.85	0.86	3
						Back Face	Aux	0.04	0.02	0.02	
						Bottom Edge	Aux	0.04	0.41	0.42	
Luxshare	802.11ac	VHT0	80	106	5530	Laptop	Main	0.09	0.83	0.84	
						Back Face	Main	0.17	0.16	0.17	
						Bottom Edge	Main	0.17	0.52	0.54	
				122	5610	Laptop	Main	0.23	0.71	0.75	
						Back Face	Aux	0.04	0.14	0.14	
						Bottom Edge	Aux	0.04	0.50	0.50	
Laptop	Aux	0.00	0.28	0.28							

B.5.4 802.11a/n/ac/ax – 5.8 GHz – U-NII-3

Antenna Manufacturer	Mode	Data rate	BW (MHz)	Channel Number	Freq (MHz)	Test position mode	Antenna	Scaling Factor (dB)	Measured SAR 1g (W/kg)	Reported SAR 1g (W/kg)	Plot #
AWAN	802.11ac	VHT0	80	138	5690	Back Face	Aux	0.22	0.02	0.02	
						Bottom Edge	Aux	0.22	0.37	0.39	
						Laptop	Aux	0.09	0.49	0.50	
				Main	0.25		0.83	0.88			
				155	5775	Back Face	Main	0.39	0.03	0.03	
						Bottom Edge	Main	0.39	0.34	0.38	
Laptop	Main	0.29	0.85			0.91	4				
Luxshare	802.11ac	VHT0	80	138	5690	Back Face	Main	0.31	0.16	0.17	
						Bottom Edge	Main	0.31	0.43	0.46	
						Laptop	Main	0.32	0.68	0.74	
				155	5775	Back Face	Aux	0.06	0.16	0.17	
						Bottom Edge	Aux	0.06	0.47	0.48	
						Laptop	Aux	0.43	0.39	0.43	

B.5.5 SAR Measurement Variability

According to FCC OET KDB 865664, SAR Measurement variability is assessed when the maximum initial measured SAR is ≥ 0.8 W/kg for a certain band/mode. If the measured SAR value of the initial repeated measurement is < 1.45 W/kg with $< 20\%$ variation, only one repeated measurement is required to confirm that the results are not expected to have substantial variations.

A second repeated measurement is required only if the measured results for the initial repeated measurement are within 10% of the SAR limit or vary by more than 20%.

A third repeated measurement is required only if the original, first or second repeated measurement ≥ 1.5 W/Kg and the ratio of largest to smallest SAR for the original, first and second repeated measurement is > 1.2 .

Band / Mode	Position	Ch #	Freq. (MHz)	Measured SAR 1g (W/kg)	1st Repeated SAR 1g (W/kg)	Highest Ratio
5.5 GHz / 802.11ac - 80 MHz	Laptop	106	5530	0.85	0.84	1.02
5.6 GHz / 802.11ac - 80 MHz	Laptop	138	5690	0.83	0.82	1.02
5.8 GHz / 802.11ac - 80 MHz	Laptop	155	5775	0.85	0.85	1.00

B.5.6 Simultaneous Transmission SAR Evaluation

According to FCC OET KDB 447498, when the sum of 1g SAR for all simultaneously transmitting antennas in an operating mode and exposure condition combination is within the SAR limit, SAR test exclusion applies to that simultaneous transmission configuration.

All the values stated in the table below are the worst case found for standalone measurement with disregard of the transmission mode or channel where the worst case was found

Antenna	Position	Highest Reported SAR (1g) (W/kg)		
		WLAN 2.4GHz	WLAN 5GHz	Bluetooth
Main	Laptop	0.45	0.91	
Aux		0.58	0.56	0.12
Main	Bottom Edge	0.50	0.69	
Aux		0.63	0.70	0.16
Main	Back Face	0.37	0.19	
Aux		0.37	0.17	0.09

Position	Simultaneous Tx Antenna Combination		Σ SAR 1g (W/kg)	Limit (W/kg)
	Main Antenna	Aux Antenna		
Laptop	WLAN 5GHz	WLAN 5GHz	1.47	1.6
	WLAN 5GHz	WLAN 5GHz + BT	1.59	
	WLAN 5GHz	BT	1.03	
	WLAN 2.4GHz	WLAN 2.4GHz	1.03	
	WLAN 2.4GHz	BT	0.57	
Bottom Edge	WLAN 5GHz	WLAN 5GHz	1.39	
	WLAN 5GHz	WLAN 5GHz + BT	1.55	
	WLAN 5GHz	BT	0.85	
	WLAN 2.4GHz	WLAN 2.4GHz	1.13	
	WLAN 2.4GHz	BT	0.66	
Back Face	WLAN 5GHz	WLAN 5GHz	0.36	
	WLAN 5GHz	WLAN 5GHz + BT	0.45	
	WLAN 5GHz	BT	0.28	
	WLAN 2.4GHz	WLAN 2.4GHz	0.74	
	WLAN 2.4GHz	BT	0.46	

Considering the results described above and according to the simultaneous transmission evaluation exclusions described in FCC OET KDB 447498, no enlarged zoom scan measurements are required

Annex C. Test System Plots

1. DTS - 802.11b, CH11, Aux Antenna – Luxshare – Bottom Edge	48
2. U-NII-2A - 802.11ac80, CH58, Main Antenna – AWAN – Laptop	49
3. U-NII-2C - 802.11ac80, CH106, Main Antenna – AWAN – Laptop	50
4. U-NII-3 - 802.11ac80, CH155, Main Antenna – AWAN – Laptop.....	51
5. System Check Body Liquid 2450MHz	52
6. System Check Body Liquid 5300MHz	53
7. System Check Body Liquid 5500MHz	54
8. System Check Body Liquid 5800MHz	55

1. DTS - 802.11b, CH11, Aux Antenna – Luxshare – Bottom Edge

Device under Test Properties

Model, Manufacturer	Dimensions [mm]	SN	DUT Type
Lenovo Yoga 7 16IRL8,	220.0 x 320.0 x 15.0	YX050ED0	Convertible PC

Exposure Conditions

Phantom Section, TSL	Position, Test Distance [mm]	Band	Group, UID	Frequency [MHz], Channel Number	Conversion Factor	TSL Conductivity [S/m]	TSL Permittivity
Flat, MSL	EDGE BOTTOM, 0.00	WLAN 2.4GHz	WLAN, 10415-AAA	2462.0, 11	7.5	2.07	49.6

Hardware Setup

Phantom	TSL, Measured Date	Probe, Calibration Date	DAE, Calibration Date
ELI V8.0 (20deg probe tilt)	MABL-600-6000, 2023-Jan-13	EX3DV4 - SN7455, 2022-03-21	DAE4ip Sn1658, 2022-08-19

Scan Setup

	Area Scan	Zoom Scan
Grid Extents [mm]	60.0 x 140.0	30.0 x 30.0 x 30.0
Grid Steps [mm]	10.0 x 10.0	5.0 x 5.0 x 1.5
Sensor Surface [mm]	3.0	1.4
Graded Grid	Yes	Yes
Grading Ratio	1.5	1.5
MAIA	Confirmed by MAIA	Confirmed by MAIA
Surface Detection	Yes	Yes
Scan Method	Measured	Measured

Measurement Results

	Area Scan	Zoom Scan
Date	2023-01-14, 13:42	2023-01-14, 13:51
psSAR1g [W/Kg]	0.602	0.623
psSAR10g [W/Kg]	0.281	0.273
Power Drift [dB]	-0.14	-0.00
Power Scaling	Disabled	Disabled
Scaling Factor [dB]		
TSL Correction	Positive Only	Positive Only
M2/M1 [%]		79.8
Dist 3dB Peak [mm]		8.0

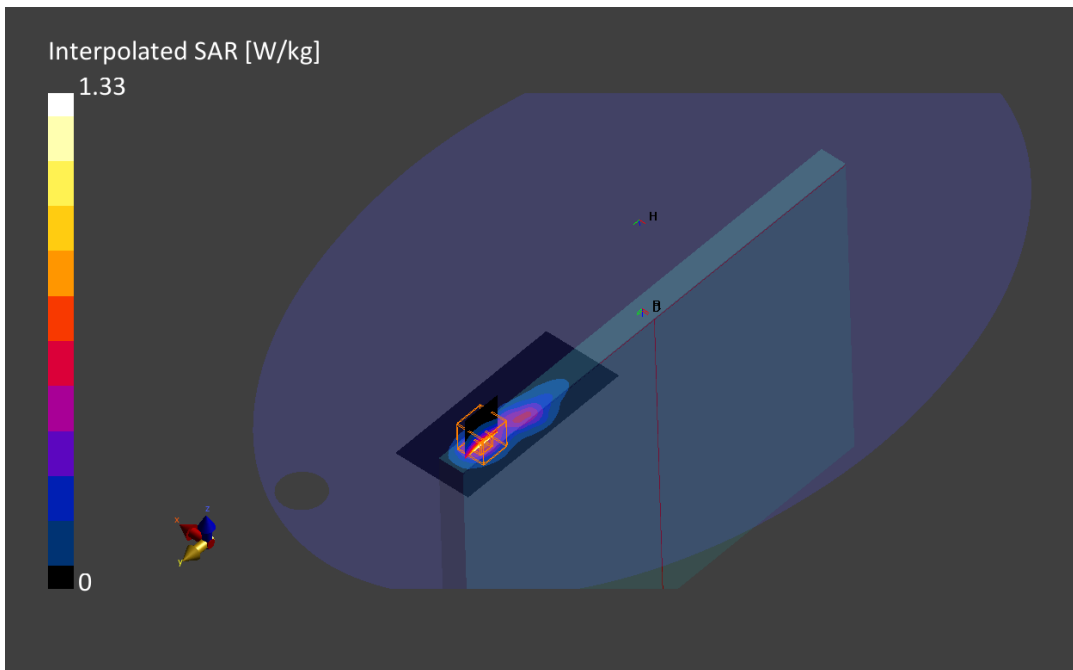

2. U-NII-2A - 802.11ac80, CH58, Main Antenna – AWAN – Laptop

Device under Test Properties

Model, Manufacturer	Dimensions [mm]	SN	DUT Type
Lenovo Yoga 7 16IRL8,	220.0 x 320.0 x 15.0	YX050ED9	Convertible PC

Exposure Conditions

Phantom Section, TSL	Position, Test Distance [mm]	Band	Group, UID	Frequency [MHz], Channel Number	Conversion Factor	TSL Conductivity [S/m]	TSL Permittivity
Flat, MSL	FRONT, 0.00	WLAN 5GHz	WLAN, 10402-AAE	5290.0, 58	4.6	5.49	44.8

Hardware Setup

Phantom	TSL, Measured Date	Probe, Calibration Date	DAE, Calibration Date
ELI V8.0 (20deg probe tilt)	MABL-600-6000, 2023-Jan-13	EX3DV4 - SN7455, 2022-03-21	DAE4ip Sn1658, 2022-08-19

Scan Setup

	Area Scan	Zoom Scan
Grid Extents [mm]	100.0 x 100.0	22.0 x 22.0 x 22.0
Grid Steps [mm]	10.0 x 10.0	4.0 x 4.0 x 1.4
Sensor Surface [mm]	3.0	1.4
Graded Grid	Yes	Yes
Grading Ratio	1.5	1.4
MAIA	Confirmed by MAIA	Confirmed by MAIA
Surface Detection	Yes	Yes
Scan Method	Measured	Measured

Measurement Results

	Area Scan	Zoom Scan
Date	2023-01-15, 17:21	2023-01-15, 17:32
psSAR1g [W/Kg]	0.625	0.794
psSAR10g [W/Kg]	0.223	0.226
Power Drift [dB]	0.20	0.15
Power Scaling	Disabled	Disabled
Scaling Factor [dB]		
TSL Correction	Positive Only	Positive Only
M2/M1 [%]		65.9
Dist 3dB Peak [mm]		6.2

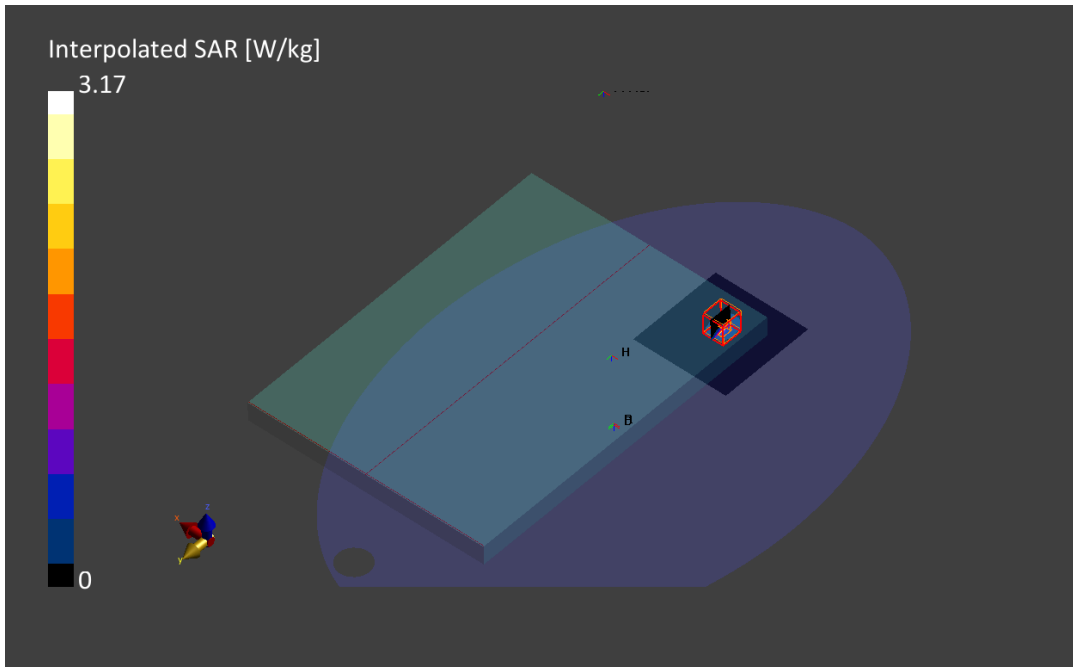

3. U-NII-2C - 802.11ac80, CH106, Main Antenna – AWAN – Laptop

Device under Test Properties

Model, Manufacturer	Dimensions [mm]	SN	DUT Type
Lenovo Yoga 7 16IRL8,	220.0 x 320.0 x 15.0	YX050ED9	Convertible PC

Exposure Conditions

Phantom Section, TSL	Position, Test Distance [mm]	Band	Group, UID	Frequency [MHz], Channel Number	Conversion Factor	TSL Conductivity [S/m]	TSL Permittivity
Flat, MSL	FRONT, 0.00	WLAN 5GHz	WLAN, 10402-AAE	5530.0, 106	4.2	5.81	44.6

Hardware Setup

Phantom	TSL, Measured Date	Probe, Calibration Date	DAE, Calibration Date
ELI V8.0 (20deg probe tilt)	MBBL-600-6000, 2023-Jan-13	EX3DV4 - SN7455, 2022-03-21	DAE4ip Sn1658, 2022-08-19

Scan Setup

	Area Scan	Zoom Scan
Grid Extents [mm]	100.0 x 100.0	22.0 x 22.0 x 22.0
Grid Steps [mm]	10.0 x 10.0	4.0 x 4.0 x 1.4
Sensor Surface [mm]	3.0	1.4
Graded Grid	Yes	Yes
Grading Ratio	1.5	1.4
MAIA	Confirmed by MAIA	Confirmed by MAIA
Surface Detection	Yes	Yes
Scan Method	Measured	Measured

Measurement Results

	Area Scan	Zoom Scan
Date	2023-01-15, 19:48	2023-01-15, 19:57
psSAR1g [W/Kg]	0.675	0.851
psSAR10g [W/Kg]	0.228	0.241
Power Drift [dB]	-0.19	0.11
Power Scaling	Disabled	Disabled
Scaling Factor [dB]		
TSL Correction	Positive Only	Positive Only
M2/M1 [%]		63.4
Dist 3dB Peak [mm]		6.8

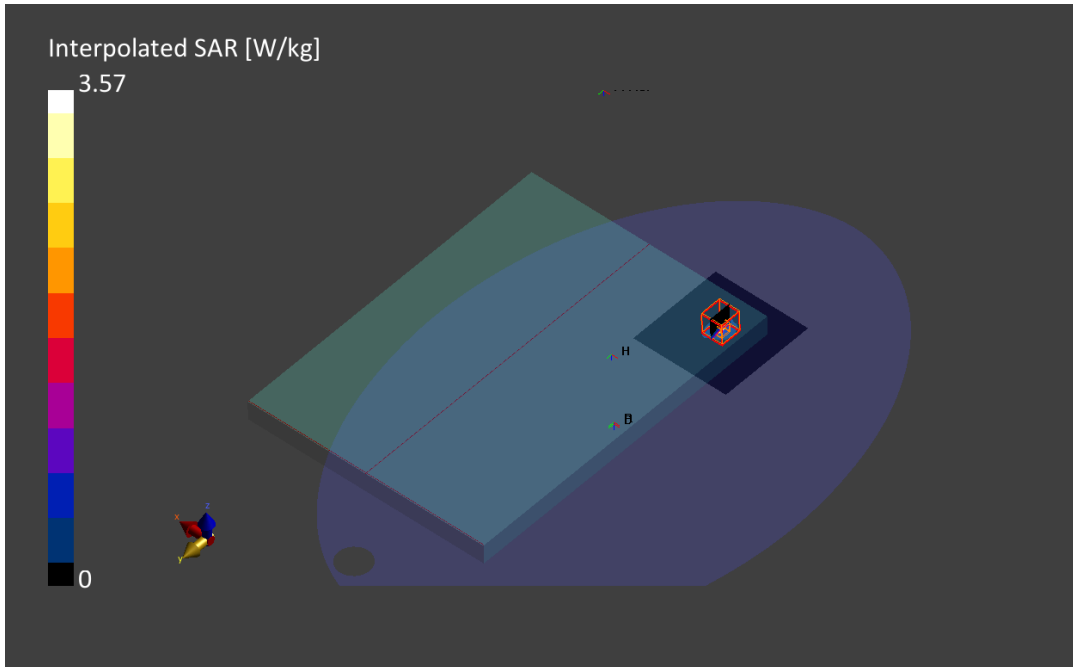

4. U-NII-3 - 802.11ac80, CH155, Main Antenna – AWAN – Laptop

Device under Test Properties

Model, Manufacturer	Dimensions [mm]	SN	DUT Type
Lenovo Yoga 7 16IRL8,	220.0 x 320.0 x 15.0	YX050ED9	Convertible PC

Exposure Conditions

Phantom Section, TSL	Position, Test Distance [mm]	Band	Group, UID	Frequency [MHz], Channel Number	Conversion Factor	TSL Conductivity [S/m]	TSL Permittivity
Flat, MSL	FRONT, 0.00	WLAN 5GHz	WLAN, 10402-AAE	5775.0, 155	4.25	6.16	44.1

Hardware Setup

Phantom	TSL, Measured Date	Probe, Calibration Date	DAE, Calibration Date
ELI V8.0 (20deg probe tilt)	MBBL-600-6000, 2023-Jan-13	EX3DV4 - SN7455, 2022-03-21	DAE4ip Sn1658, 2022-08-19

Scan Setup

	Area Scan	Zoom Scan
Grid Extents [mm]	100.0 x 100.0	22.0 x 22.0 x 22.0
Grid Steps [mm]	10.0 x 10.0	4.0 x 4.0 x 1.4
Sensor Surface [mm]	3.0	1.4
Graded Grid	Yes	Yes
Grading Ratio	1.5	1.4
MAIA	Confirmed by MAIA	Confirmed by MAIA
Surface Detection	Yes	Yes
Scan Method	Measured	Measured

Measurement Results

	Area Scan	Zoom Scan
Date	2023-01-15, 19:33	2023-01-15, 19:41
psSAR1g [W/Kg]	0.699	0.849
psSAR10g [W/Kg]	0.230	0.232
Power Drift [dB]	0.19	0.18
Power Scaling	Disabled	Disabled
Scaling Factor [dB]		
TSL Correction	Positive Only	Positive Only
M2/M1 [%]		58.2
Dist 3dB Peak [mm]		6.2

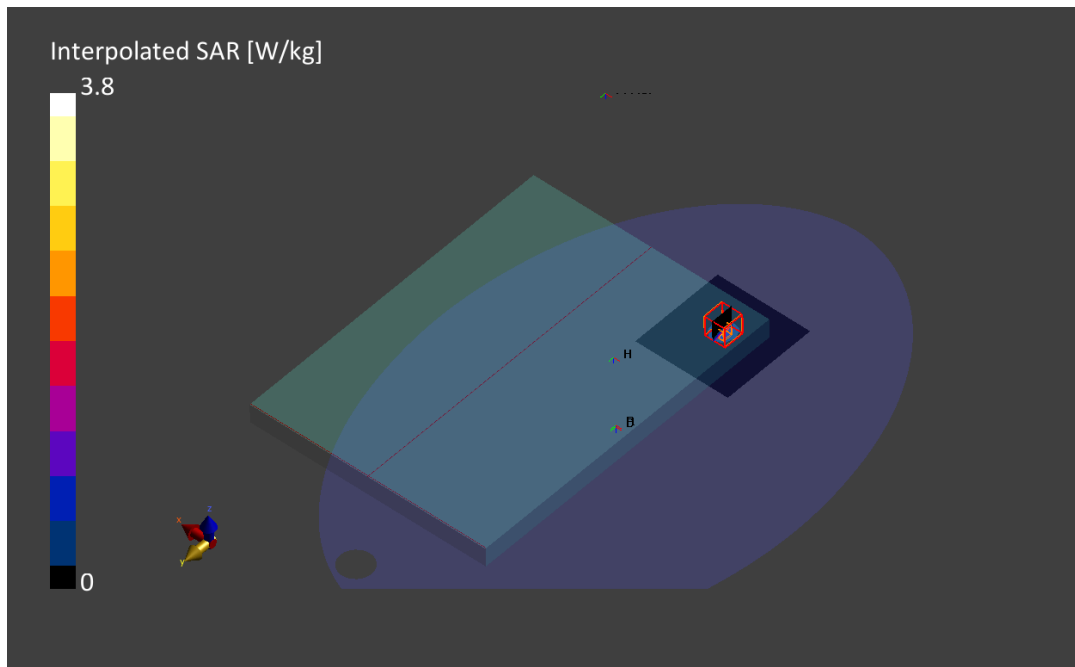

5. System Check Body Liquid 2450MHz

Device under Test Properties

Model, Manufacturer	Dimensions [mm]	Serial Number	DUT Type
D2450V2, SPEAG	50.0 x 10.0 x 15.0	937	Validation Dipole

Exposure Conditions

Phantom Section, TSL	Position, Test Distance [mm]	Band	Group, UID	Frequency [MHz], Channel Number	Conversion Factor	TSL Conductivity [S/m]	TSL Permittivity
Flat MSL			,	2450.0	7.5	2.06	49.6

Hardware Setup

Phantom	TSL, Measured Date	Probe, Calibration Date	DAE, Calibration Date
ELI V8.0 (20deg probe tilt) - xxxx	MBBL-600-6000 , 2023-Jan-13	EX3DV4 - SN7455, 2022-03-21	DAE4ip Sn1658, 2022-08-19

Scan Setup

	Area Scan	Zoom Scan
Grid Extents [mm]	40.0 x 80.0	30.0 x 30.0 x 30.0
Grid Steps [mm]	10.0 x 10.0	5.0 x 5.0 x 1.5
Sensor Surface [mm]	3.0	1.4
Graded Grid	Yes	Yes
Grading Ratio	1.5	1.5
MAIA	Confirmed by MAIA	Confirmed by MAIA
Surface Detection	Yes	Yes
Scan Method	Measured	Measured

Measurement Results

	Area Scan	Zoom Scan
Date	2023-01-14, 10:48	2023-01-14, 10:55
psSAR1g [W/Kg]	2.61	2.43
psSAR10g [W/Kg]	1.20	1.12
Power Drift [dB]	-0.09	-0.16
Power Scaling	Disabled	Disabled
Scaling Factor		
TSL Correction [dB]	Positive Only	Positive Only
M2/M1 [%]		80.9
Dist 3dB Peak [mm]		8.5

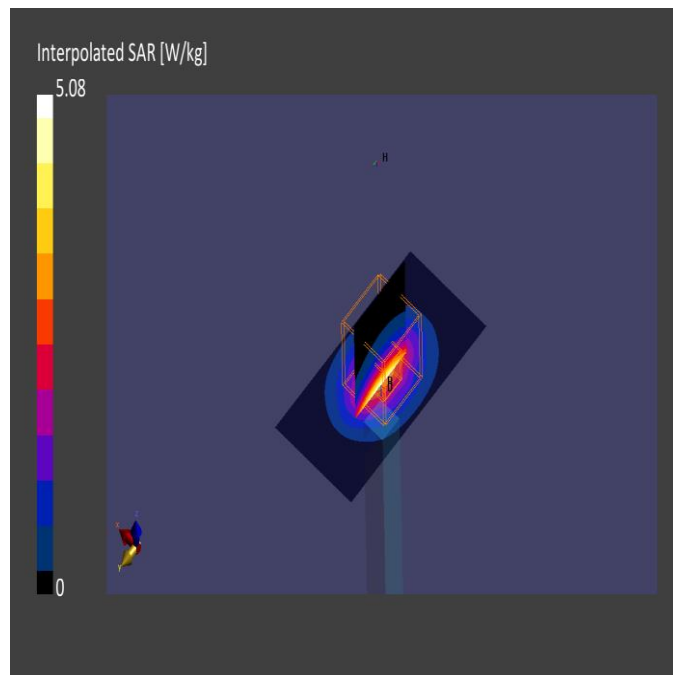

6. System Check Body Liquid 5300MHz

Device under Test Properties

Name, Manufacturer	Dimensions [mm]	Serial Number	DUT Type
D5.0GHzV2, SPEAG	50.0 x 10.0 x 18.0	1259	Validation Dipole

Exposure Conditions

Phantom Section, TSL	Position, Test Distance [mm]	Band	Group, UID	Frequency [MHz], Channel Number	Conversion Factor	TSL Conductivity [S/m]	TSL Permittivity
Flat MSL			,	5300.0	4.6	5.51	44.8

Hardware Setup

Phantom	TSL, Measured Date	Probe, Calibration Date	DAE, Calibration Date
ELI V8.0 (20deg probe tilt) - xxxx	MBBL-600-6000 , 2023-Jan-13	EX3DV4 - SN7455, 2022-03-21	DAE4ip Sn1658, 2022-08-19

Scan Setup

	Area Scan	Zoom Scan
Grid Extents [mm]	40.0 x 80.0	22.0 x 22.0 x 22.0
Grid Steps [mm]	10.0 x 10.0	4.0 x 4.0 x 1.4
Sensor Surface [mm]	3.0	1.4
Graded Grid	Yes	Yes
Grading Ratio	1.5	1.4
MAIA	Confirmed by MAIA	Confirmed by MAIA
Surface Detection	Yes	Yes
Scan Method	Measured	Measured

Measurement Results

	Area Scan	Zoom Scan
Date	2023-01-15, 15:48	2023-01-15, 15:55
psSAR1g [W/Kg]	3.28	3.70
psSAR10g [W/Kg]	1.01	1.04
Power Drift [dB]	0.05	-0.06
Power Scaling	Disabled	Disabled
Scaling Factor		
TSL Correction	Positive Only	Positive Only
M2/M1 [%]		64.4
Dist 3dB Peak [mm]		7.4

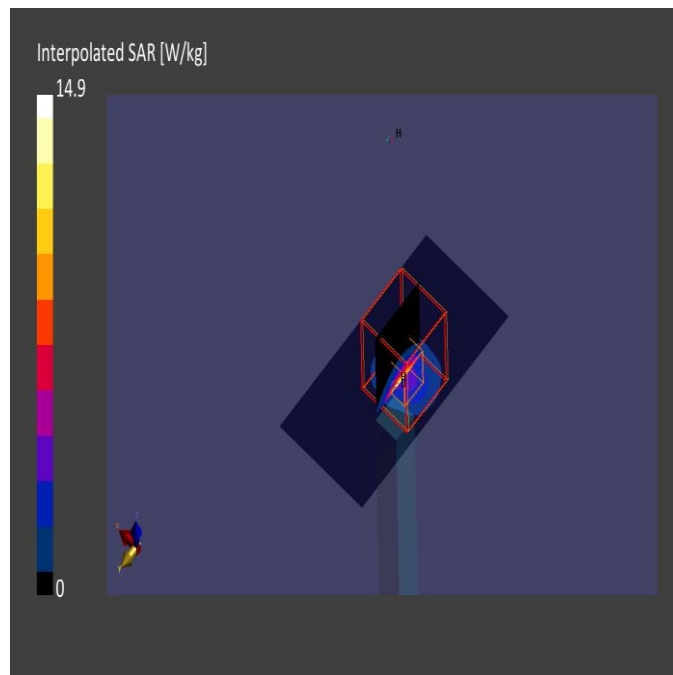

7. System Check Body Liquid 5500MHz

Device under Test Properties

Name, Manufacturer	Dimensions [mm]	Serial Number	DUT Type
D5.0GHzV2, SPEAG	50.0 x 10.0 x 18.0	1259	Validation Dipole

Exposure Conditions

Phantom Section, TSL	Position, Test Distance [mm]	Band	Group, UID	Frequency [MHz], Channel Number	Conversion Factor	TSL Conductivity [S/m]	TSL Permittivity
Flat MSL			,	5500.0	4.2	5.78	44.6

Hardware Setup

Phantom	TSL, Measured Date	Probe, Calibration Date	DAE, Calibration Date
ELI V8.0 (20deg probe tilt) - xxxx	MBBL-600-6000 , 2023-Jan-13	EX3DV4 - SN7455, 2022-03-21	DAE4ip Sn1658, 2022-08-19

Scan Setup

	Area Scan	Zoom Scan
Grid Extents [mm]	40.0 x 80.0	22.0 x 22.0 x 22.0
Grid Steps [mm]	10.0 x 10.0	4.0 x 4.0 x 1.4
Sensor Surface [mm]	3.0	1.4
Graded Grid	Yes	Yes
Grading Ratio	1.5	1.4
MAIA	Confirmed by MAIA	Confirmed by MAIA
Surface Detection	Yes	Yes
Scan Method	Measured	Measured

Measurement Results

	Area Scan	Zoom Scan
Date	2023-01-15, 15:59	2023-01-15, 16:06
psSAR1g [W/Kg]	3.47	3.96
psSAR10g [W/Kg]	1.07	1.11
Power Drift [dB]	0.10	0.04
Power Scaling	Disabled	Disabled
Scaling Factor		
TSL Correction	Positive Only	Positive Only
M2/M1 [%]		62.3
Dist 3dB Peak [mm]		7.4

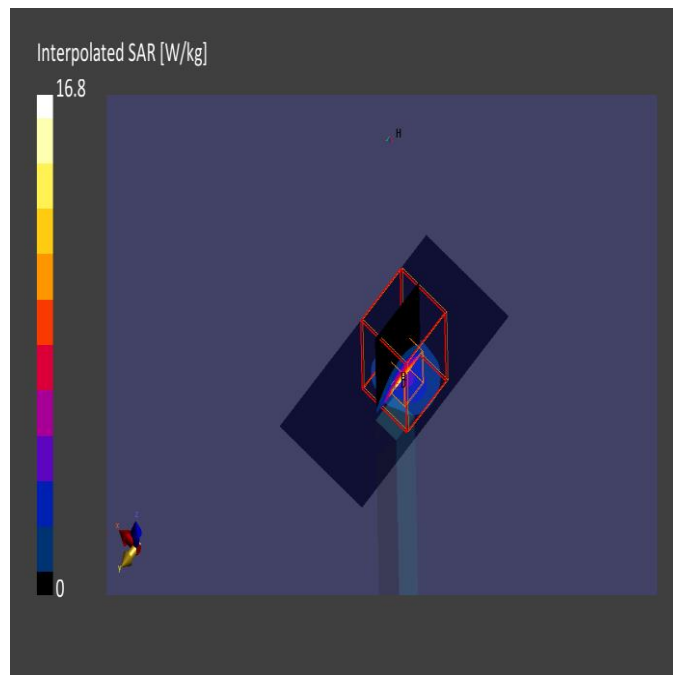

8. System Check Body Liquid 5800MHz

Device under Test Properties

Name, Manufacturer	Dimensions [mm]	Serial Number	DUT Type
D5.0GHzV2, SPEAG	50.0 x 10.0 x 18.0	1259	Validation Dipole

Exposure Conditions

Phantom Section, TSL	Position, Test Distance [mm]	Band	Group, UID	Frequency [MHz], Channel Number	Conversion Factor	TSL Conductivity [S/m]	TSL Permittivity
Flat MSL			,	5800.0	4.25	6.20	44.0

Hardware Setup

Phantom	TSL, Measured Date	Probe, Calibration Date	DAE, Calibration Date
ELI V8.0 (20deg probe tilt) - xxxx	MBBL-600-6000 , 2023-Jan-13	EX3DV4 - SN7455, 2022-03-21	DAE4ip Sn1658, 2022-08-19

Scan Setup

	Area Scan	Zoom Scan
Grid Extents [mm]	40.0 x 80.0	22.0 x 22.0 x 22.0
Grid Steps [mm]	10.0 x 10.0	4.0 x 4.0 x 1.4
Sensor Surface [mm]	3.0	1.4
Graded Grid	Yes	Yes
Grading Ratio	1.5	1.4
MAIA	Confirmed by MAIA	Confirmed by MAIA
Surface Detection	Yes	Yes
Scan Method	Measured	Measured

Measurement Results

	Area Scan	Zoom Scan
Date	2023-01-15, 16:19	2023-01-15, 16:26
psSAR1g [W/Kg]	3.28	3.72
psSAR10g [W/Kg]	1.00	1.04
Power Drift [dB]	0.14	0.01
Power Scaling	Disabled	Disabled
Scaling Factor [dB]		
TSL Correction	Positive Only	Positive Only
M2/M1 [%]		59.5
Dist 3dB Peak [mm]		7.5

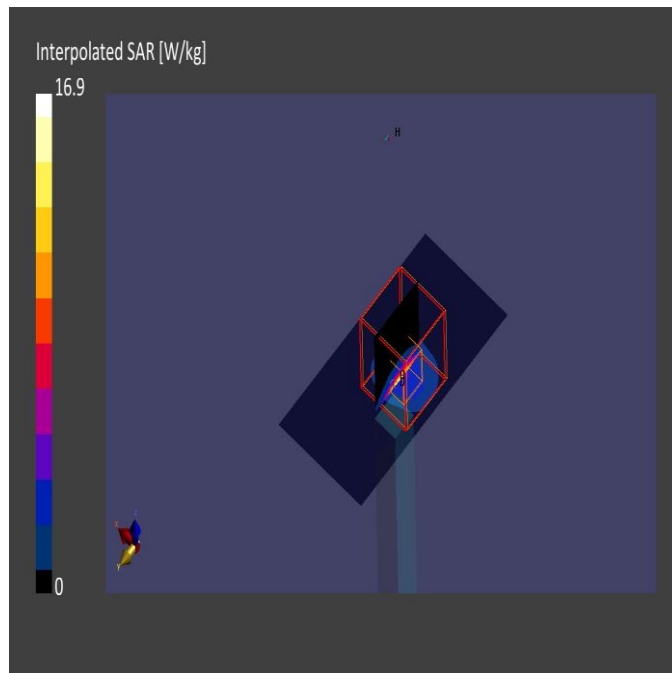

Annex D. TSL Dielectric Parameters

D.1 Body DTS 2450MHz

Freq.(MHz)	Target		Measured 2023-01-13	
	ϵ' (F/m)	σ (S/m)	$\epsilon'1$ (F/m)	$\sigma1$ (S/m)
2400	52.77	1.90	49.62	2.01
2450	52.70	1.95	49.57	2.06
2500	52.64	2.02	49.53	2.11

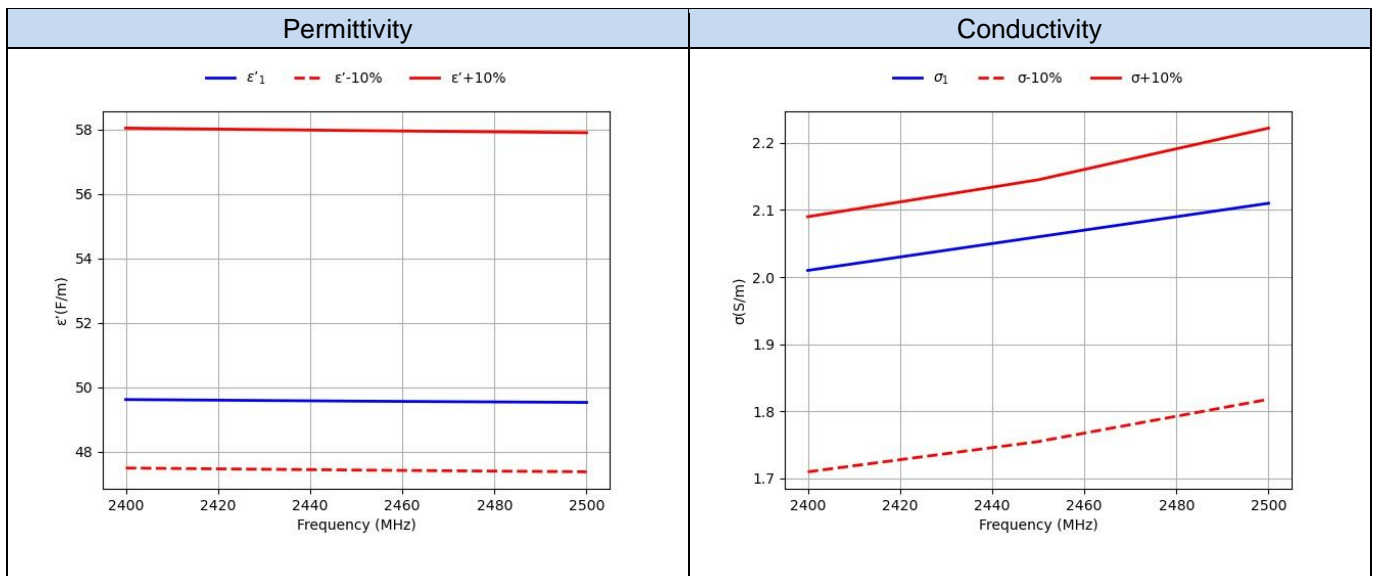

D.2 Body 5200MHz-5800MHz

Freq.(MHz)	Target		Measured 2023-01-13	
	ϵ' (F/m)	σ (S/m)	ϵ' 1(F/m)	σ 1(S/m)
5200	49.01	5.30	44.99	5.34
5250	48.95	5.36	44.91	5.43
5300	48.88	5.42	44.83	5.51
5350	48.81	5.47	44.76	5.59
5400	48.74	5.53	44.70	5.66
5450	48.67	5.59	44.65	5.72
5500	48.61	5.65	44.58	5.78
5550	48.54	5.71	44.54	5.84
5600	48.47	5.77	44.49	5.90
5650	48.40	5.82	44.39	5.98
5700	48.34	5.88	44.27	6.05
5750	48.27	5.94	44.14	6.13
5800	48.20	6.00	43.99	6.20
5850	48.13	6.06	43.85	6.27
5900	48.06	6.12	43.69	6.33

