

Regulatory WLAN Antenna Information (Plastic)

Platform information											
Brand	ODM	****End product model name	Intel platform (ex: Yes, No or NA)	Platform type (ex: regular NB, convertible PC, AIO...etc)	*SAR minimum separation (mm)						
Lenovo	Compal Electronics Inc.	IdeaPad Slim 5 16IRL8	Yes	regular NB	w/ bumper:12.5 w/o bumper:11						
		IdeaPad Slim 5 16IAH8	No								
****Please fill in exact product model name and make sure the model name is visible on product cover or any parts for end users recognize for authority inspection.											
Antenna information											
Vendor		Type	Antenna Part number (Main)				Antenna Part number (Aux)				
SOUTHSTAR TECHNOLOGY CO.,LTD		PIFA	DC33002SV00 (3.N201.0222)				DC33002SV00 (3.N201.0222)				
Peak gain w/ cable loss (dBi)*											
	2.4GHz 2400-2483.5 MHz	5.2GHz 5150-5250MHz	5.3GHz 5250-5350MHz	5.6GHz 5470-5725MHz	5.8GHz 5725-5850MHz	5.9GHz 5850-5895MHz	6.2GHz 5925-6425MHz	6.5GHz 6425-6525MHz	6.7GHz 6525-6875MHz	7.0 GHz 6875-7125MHz	
Main	0.24	2.87	2.90	2.95	2.87	2.50	2.40	2.65	0.98	0.98	
Aux	-0.90	-1.91	2.21	2.45	2.50	2.98	2.81	0.59	2.43	1.40	
Intel Reference Gain/Type/ Separation distance											
Antenna Type	Antenna Peak gain (In dBi)*										Distance to the end user (mm)
	2.4GHz 2400-2483.5 MHz	5.2GHz 5150-5250MHz	5.3GHz 5250-5350MHz	5.6GHz 5470-5725MHz	5.8GHz 5725-5850MHz	5.9GHz 5850-5895MHz	6.2GHz 5925-6425MHz	6.5GHz 6425-6525MHz	6.7GHz 6525-6875MHz	7.0GHz 6875-7125MHz	
Design	3.00	5.00	5.00	5.00	5.00	5.00	5.00	5.00	5.00	5.00	Generic: refer to modular FCC SAR report Mid-power: ≥ 8 mm Low power: ≥ 5 mm
PIFA	3.24	3.64	3.73	4.77	4.97	4.72	4.83	4.30	5.37	5.59	
Dipole	2.89	2.92	3.19	4.41	4.22	4.22	4.83	4.30	4.49	5.34	
Notes (marked with *)											
* SAR minimum separation (mm)											
- Regular NB: Minimum antenna-to-body (from antenna bottom to the bottom of the device)											
- Tablet / Convertible PC: Minimum antenna-to-edge (5 sides of the device)											
- Mini-tablet: Minimum antenna-to-edge (6 sides of the device)											
* 3D Peak Antenna gain should be equal or greater than -2 dBi											
- If a host integrator plans to use a lower gain antenna of the same type, additional CBP(FCC)/EDT(EU) testing need to be performed while the module is installed in the host.											

Table of contents

1. Applicable test method
2. Test & System Description
 - a. Test setup
 - b. Equipment list

3. Setup photo

[Section 1. Antenna Assembly Specifications](#)

[Section 2. Dimensioned Photos or Drawings of Antennas](#)

[Section 3. Radiation characteristics of antenna loaded in Host Platform](#)

[Section 4. Antenna Host Platform Location Information](#)

[Section 5. Antenna dimensional information for SAR evaluation](#)

[Section 6. Diagram Example of Co-Location Antenna Separation](#)

1. Applicable test methods

<insert test description here for test method>

[example] This test report is prepared for host antenna testing under a Full Anechoic Chamber.

The radiation pattern of antenna is measured in both horizontal polarization and vertical polarization. The radiation pattern measurements are performed in the three-dimensional anechoic chamber. The chamber provides less than -30dB reflectivity from 800MHz through 8GHz . The chamber is calibrated using both standard dipole antenna and horn antenna. The Gain here is expressed as dBi that standardizes the isotropic antenna. The Gain measurements and antenna radiation pattern are also performed in the same chamber described previously.

2. Test & System Description

a. Test setup

<insert test diagram here for test site utilized>

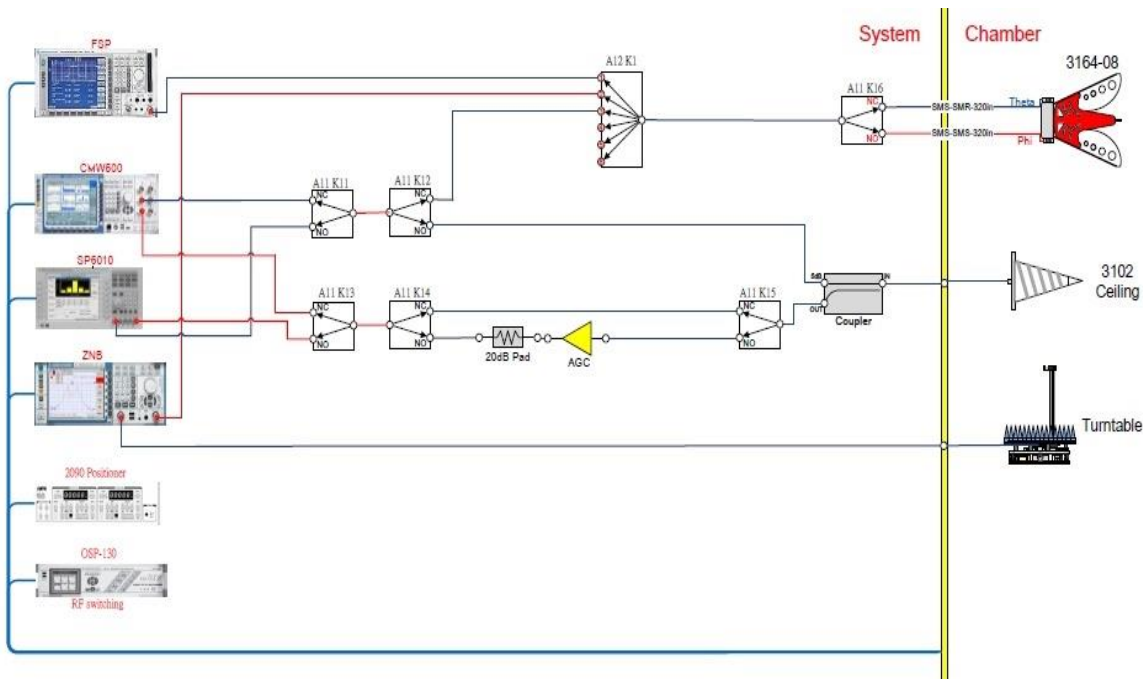

Radiated Setup 1 GHz – 6.4 GHz

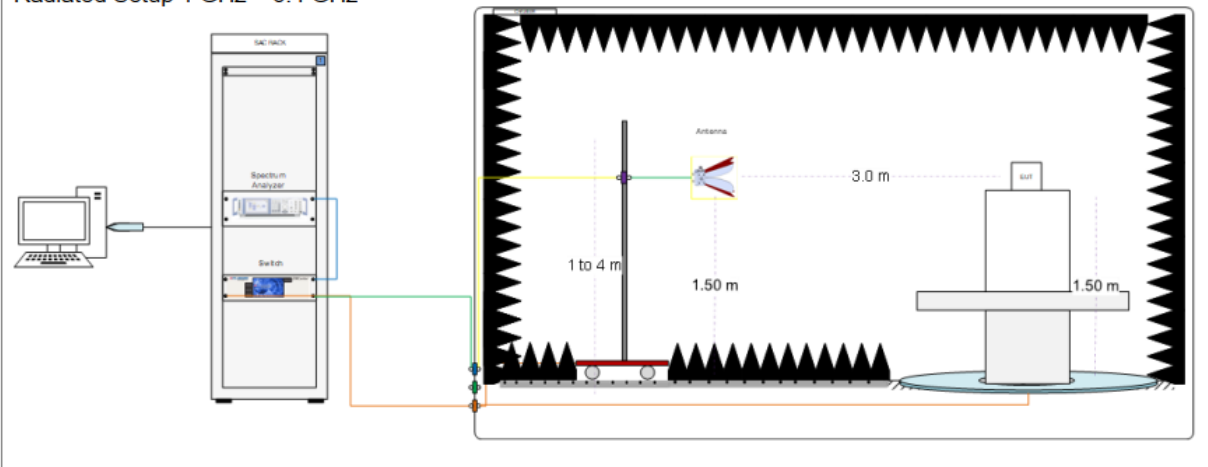

b. Equipment list

<insert test diagram here for test site utilized>

Device	Type/Model	Manufacturer	Cal.Date	Cal.Date
Customized Switch Module	-	BWant	N/A	N/A
Programmable Attenuator	PATT-121-4	BWant	N/A	N/A
Horn Antenna	700MHz-10GHz	BWant	2021.11.19	2023.11.19
Network Analyzer	ZNB 20	ROHDE&SCHWARZ	2022.1.10	2024.1.10
Cable	LL142	Fairview Microwave	2022.3.17	2023.9.17
Turn table	-	BWant	N/A	N/A
Anechoic Chamber	-	BWant	2022.5.10	2023.5.10

3. Setup photo

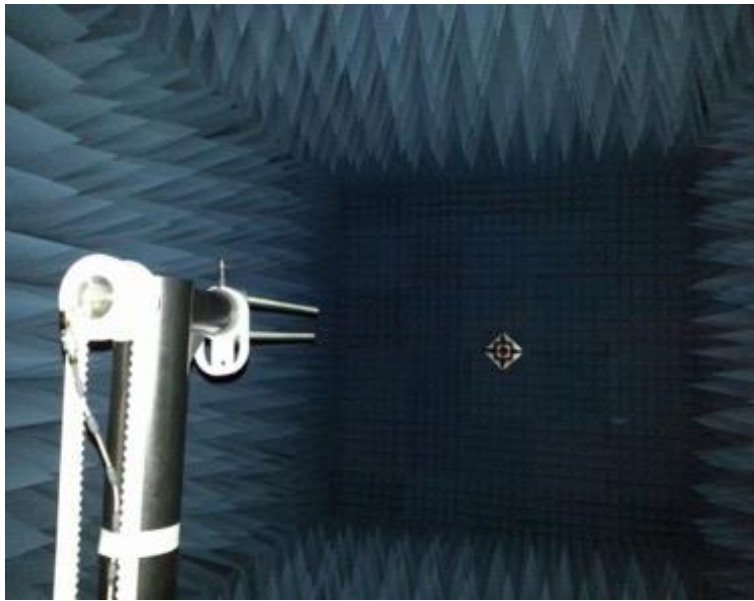
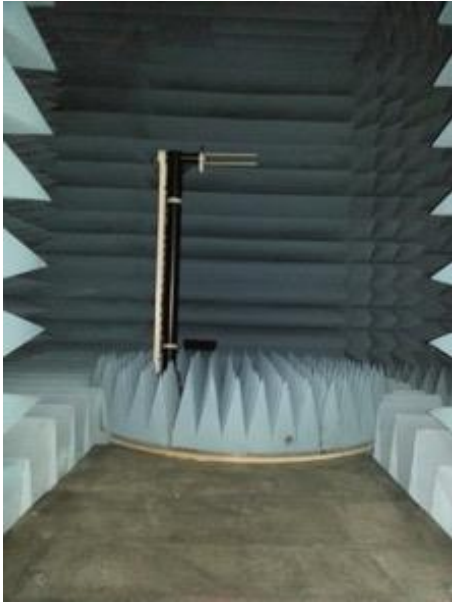

Antenna Information

Section 1. Antenna Assembly Specifications

1A Antenna Part Number	1B Manufacturer	1C Antenna Type	1D Cable Assembly Part Number and Information	Freq Range MHz	1E * Peak Gain W/ Cable loss (dBi)	1F Peak Gain w/o Cable Loss (dBi)	1G Max VSWR	1H Cable Loss (dB)
DC33002SV00 (3.N201.0222)	SOUTHSTAR TECHNOLOGY CO.,LTD	PIFA	(P/N: MHF-B13-N-01) 50 ohm Coaxial length: 35.3cm diameter: 1.1mm	2400-2483.5	0.24	1.13	3	0.89
				5150-5250	2.87	4.13	3	1.26
				5250-5350	2.90	4.19	3	1.29
				5470-5725	2.95	4.26	3	1.31
				5725-5850	2.87	4.24	3	1.37
				5850-5895	2.50	3.91	3	1.41
				5925-6425	2.40	3.83	3	1.43
				6425-6525	2.65	4.11	3	1.46
				6525-6875	0.98	2.40	3	1.42
				6875-7125	0.98	2.44	3	1.46
DC33002SV00 (3.N201.0222)	SOUTHSTAR TECHNOLOGY CO.,LTD	PIFA	(P/N: MHF-B13-N-01) 50 ohm Coaxial length: 43.3cm diameter: 1.1mm	2400-2483.5	-0.90	0.36	3	1.26
				5150-5250	-1.91	-0.16	3	1.75
				5250-5350	2.21	4.01	3	1.80
				5470-5725	2.45	4.27	3	1.82
				5725-5850	2.50	4.40	3	1.90
				5850-5895	2.98	4.91	3	1.93
				5925-6425	2.81	4.75	3	1.94
				6425-6525	0.59	2.54	3	1.95
				6525-6875	2.43	4.40	3	1.97
				6875-7125	1.40	3.42	3	2.02

- 3D Antenna Peak Gain required being test in system basis.

Section 2. Dimensioned Photos and Drawings of Antennas

Include the dimensioned photo and drawing of Main antenna here.

Main Antenna Drawing:

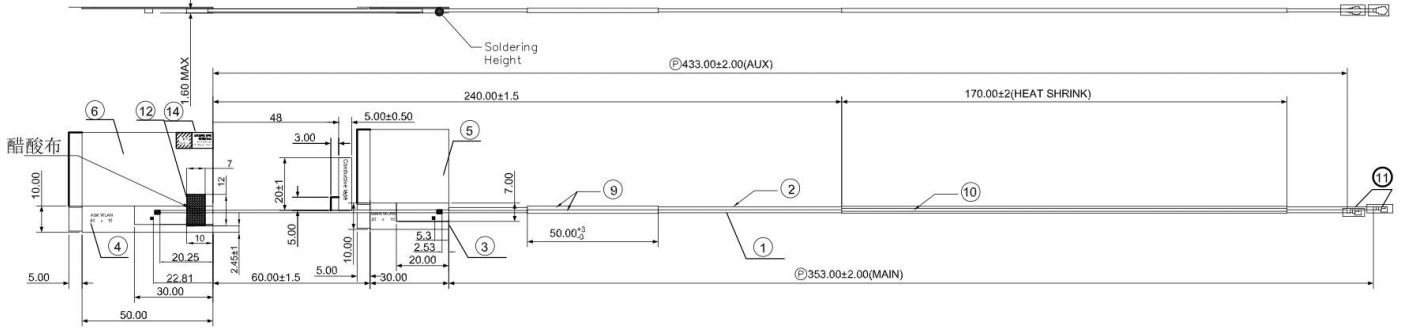

Main Antenna Photo (Front/Back):

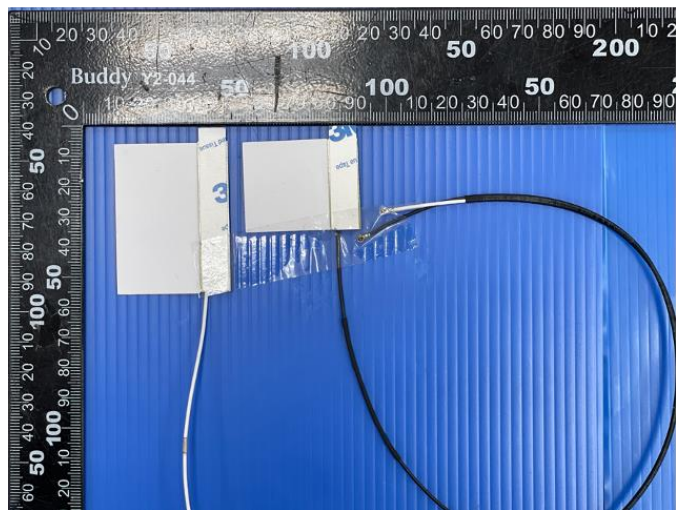
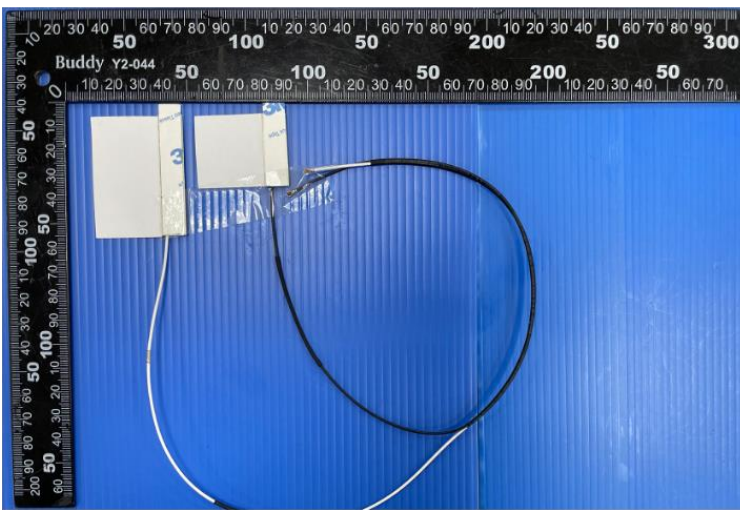
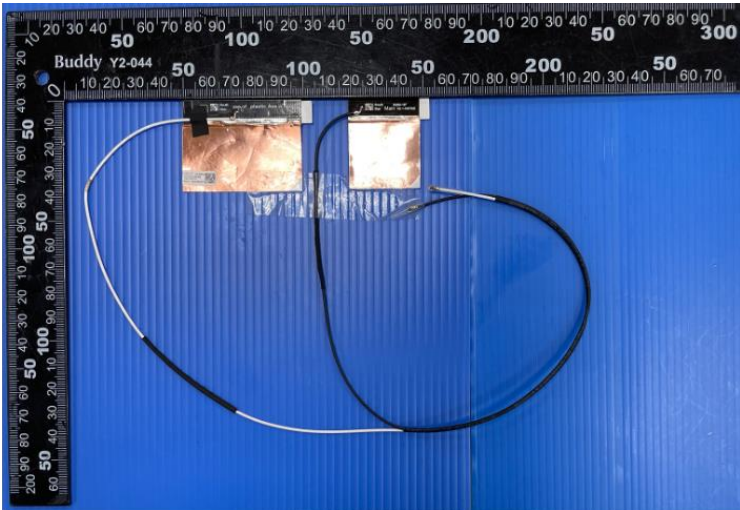

Note: antenna photo should include L type ruler

Include the dimensioned photo and drawing of Aux antenna here.

Aux Antenna Drawing:

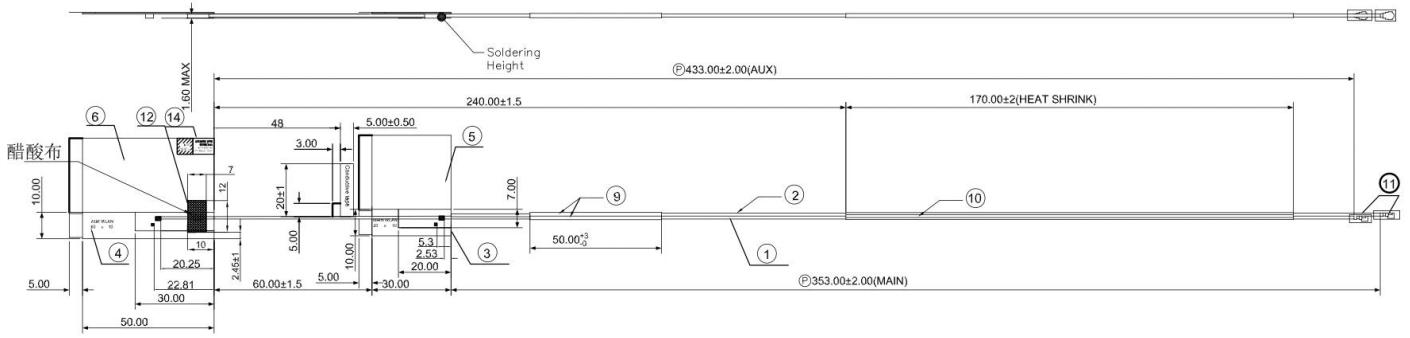

Aux Antenna Photo (Front/Back):

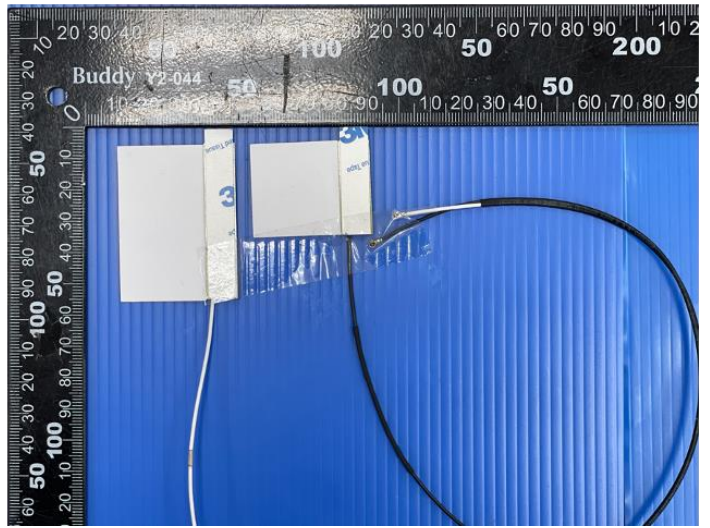
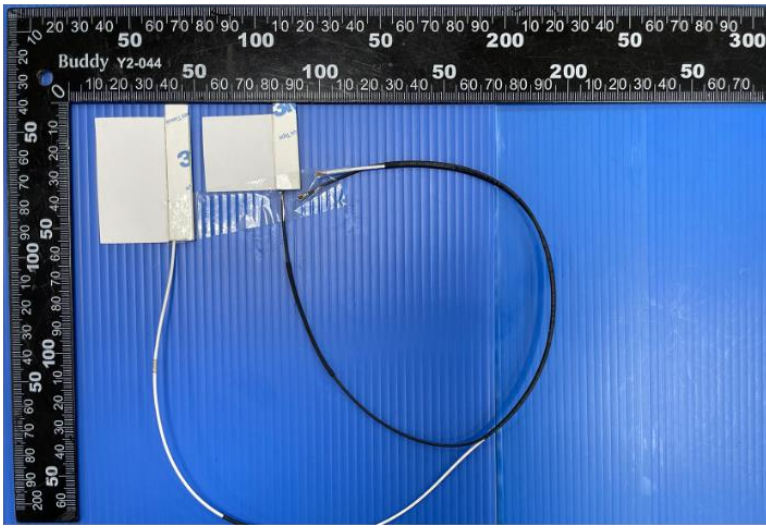
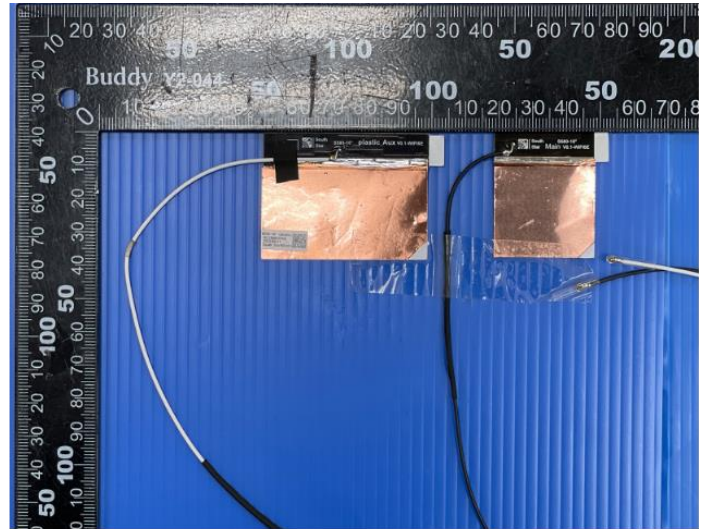
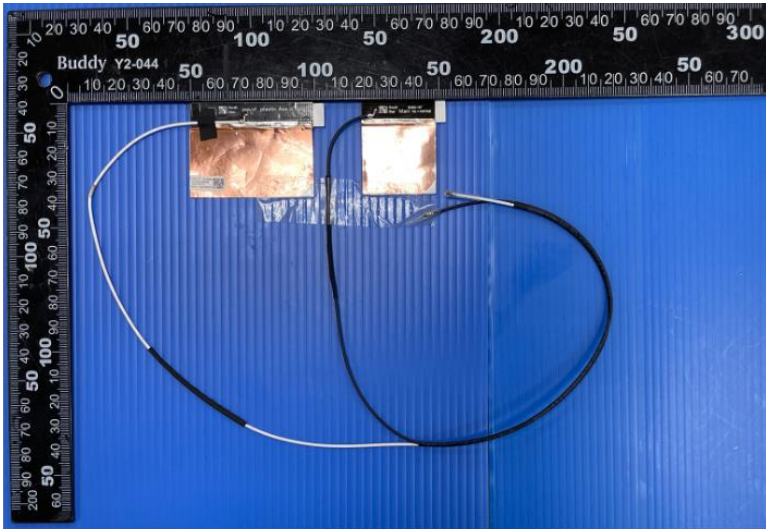

Note: antenna photo should include L type ruler

Section 3. Radiation characteristics of antenna loaded in Host Platform

Main Antenna

Max Antenna 3D Radiation Pattern 2400 – 2483.5 MHz

Frequency (MHz)	Peak Gain w/ Cable Loss (dBi)
2400-2483.5	0.24

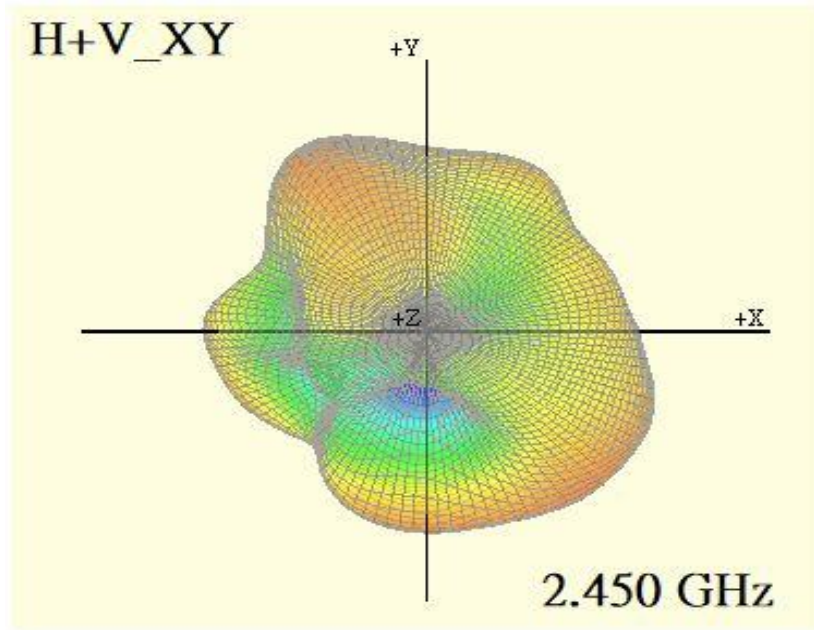

Max Antenna 3D Radiation Pattern 5150-5250 MHz

Frequency (MHz)	Peak Gain w/ Cable Loss (dBi)
5150-5250	2.87

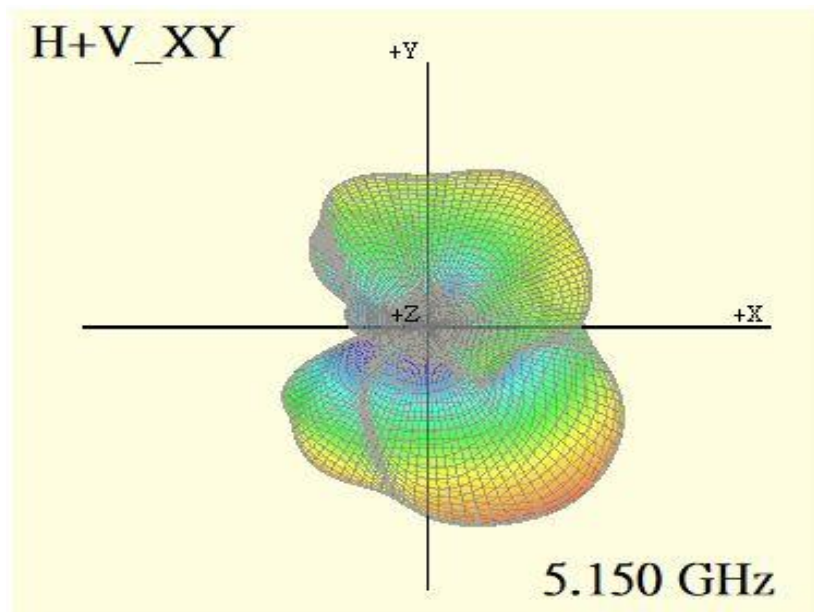

Max Antenna 3D Radiation Pattern 5250-5350 MHz

Frequency (MHz)	Peak Gain w/ Cable Loss (dBi)
5250-5350	2.90

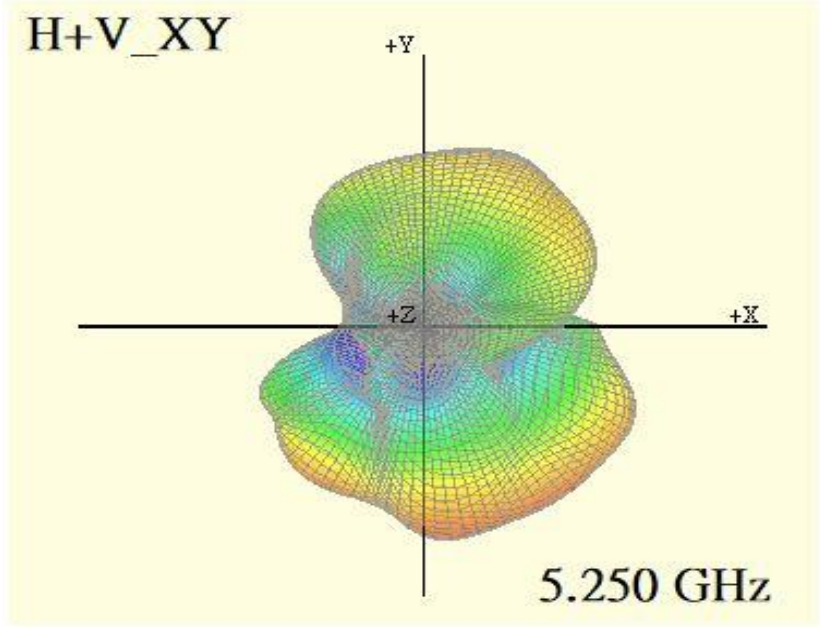

Max Antenna 3D Radiation Pattern 5470-5725 MHz

Frequency (MHz)	Peak Gain w/ Cable Loss (dBi)
5470-5725	2.95

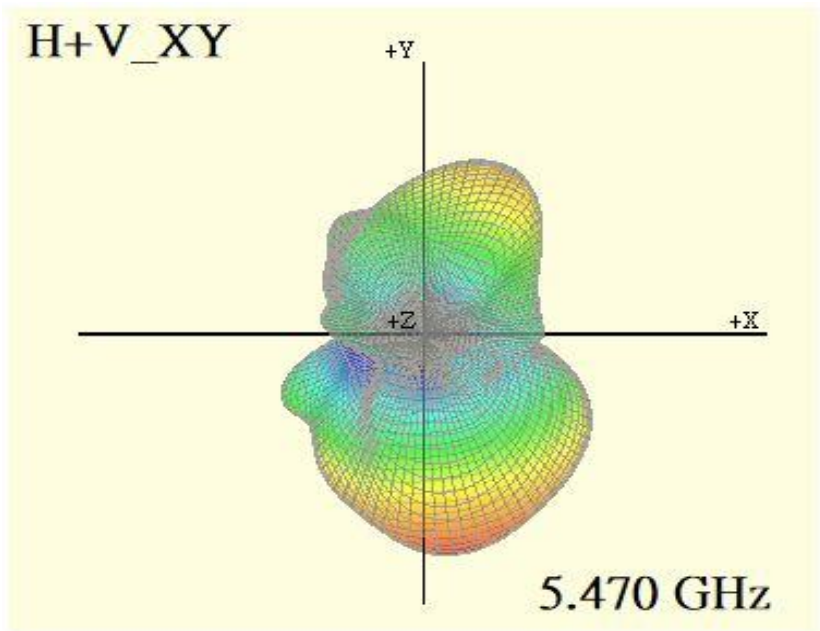

Max Antenna 3D Radiation Pattern 5725-5850 MHz

Frequency (MHz)	Peak Gain w/ Cable Loss (dBi)
5725-5850	2.87

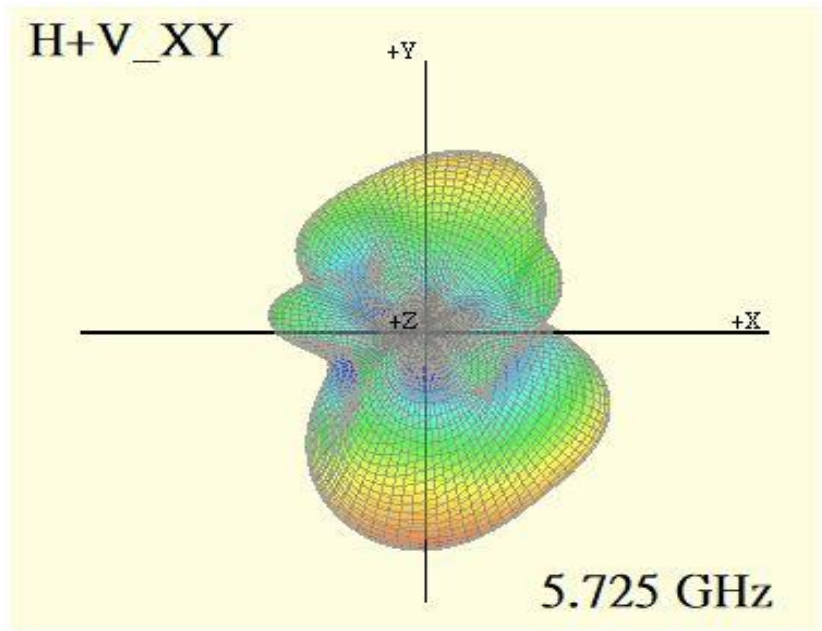

Max Antenna 3D Radiation Pattern 5850-5895 MHz

Frequency (MHz)	Peak Gain w/ Cable Loss (dBi)
5850-5895	2.50

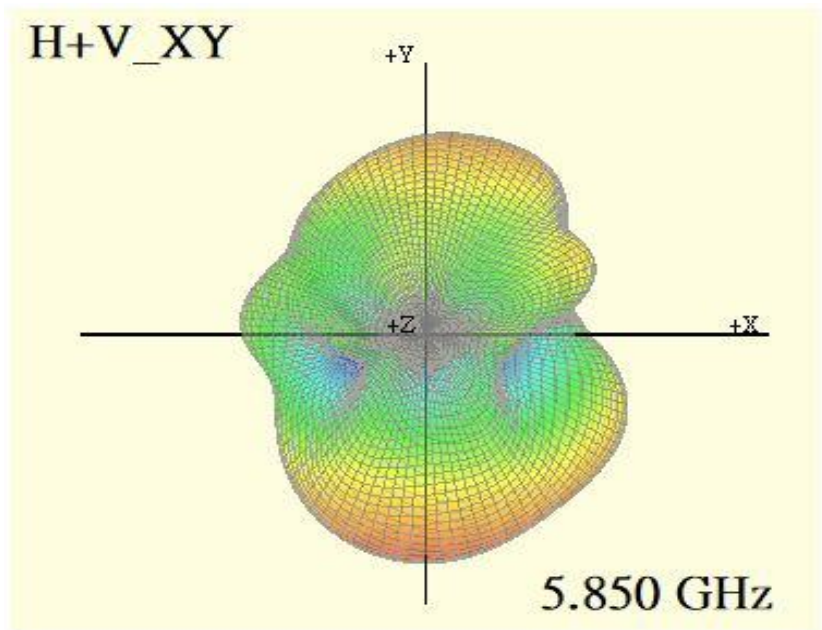

Max Antenna 3D Radiation Pattern 5925-6425 MHz

Frequency (MHz)	Peak Gain w/ Cable Loss (dBi)
5925-6425	2.40

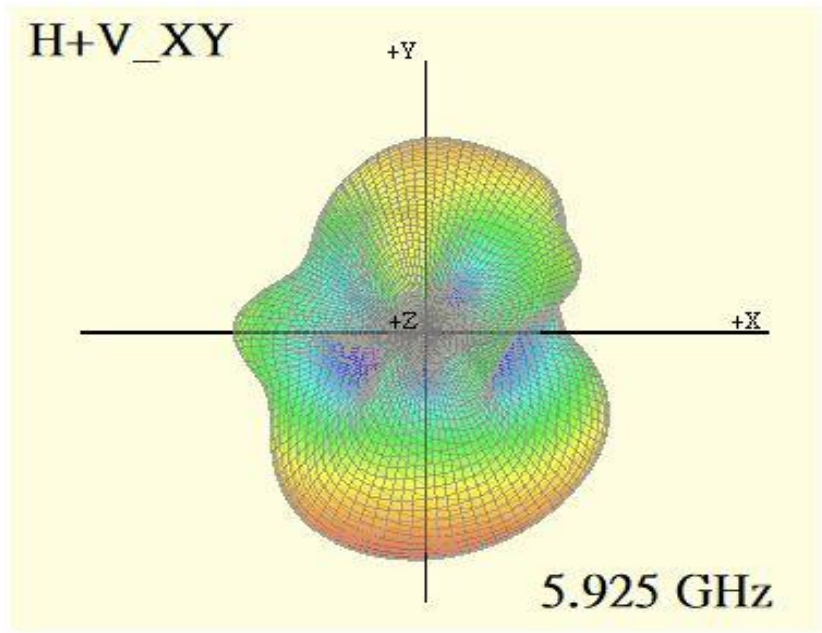

Max Antenna 3D Radiation Pattern 6405-6525 MHz

Frequency (MHz)	Peak Gain w/ Cable Loss (dBi)
6425-6525	2.65

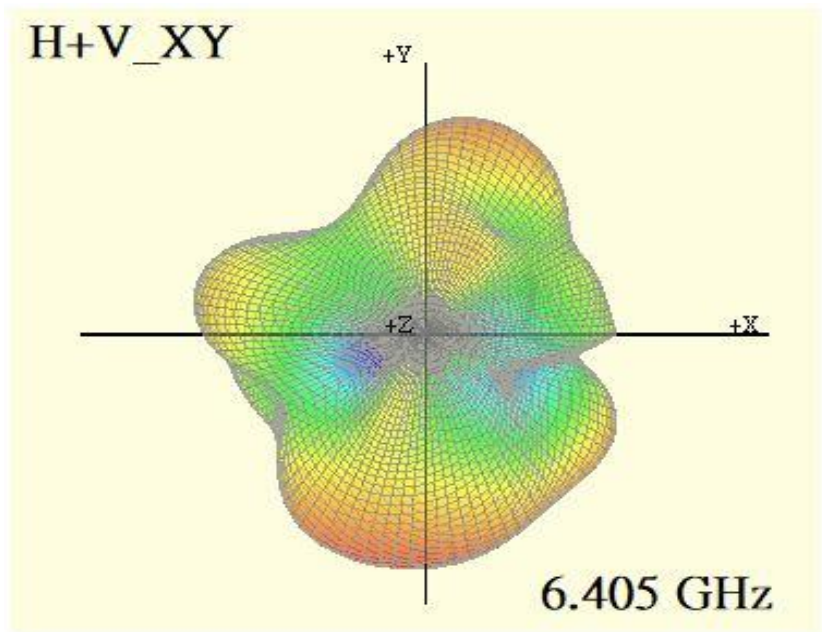

Max Antenna 3D Radiation Pattern 6525-6875 MHz

Frequency (MHz)	Peak Gain w/ Cable Loss (dBi)
6525-6875	0.98

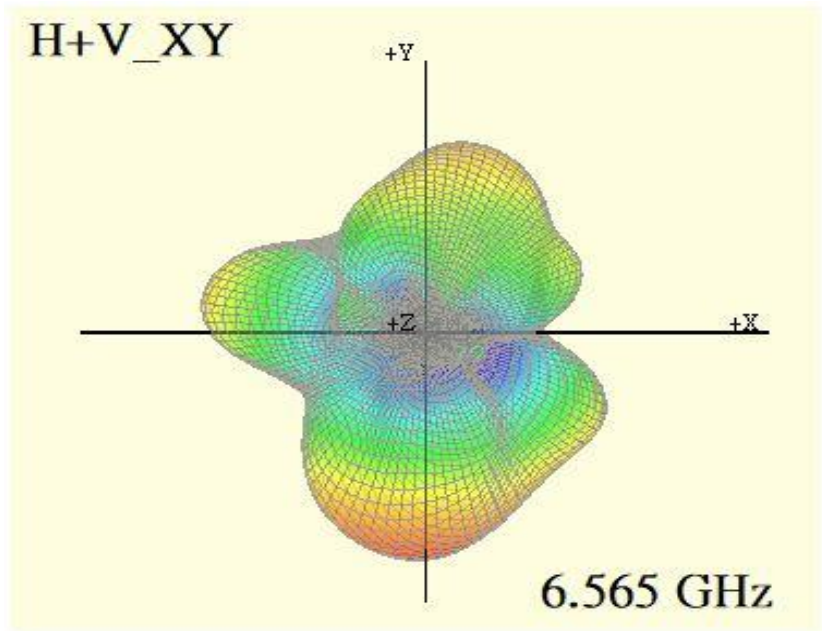

Max Antenna 3D Radiation Pattern 6875-7125 MHz

Frequency (MHz)	Peak Gain w/ Cable Loss (dBi)
6875-7125	0.98

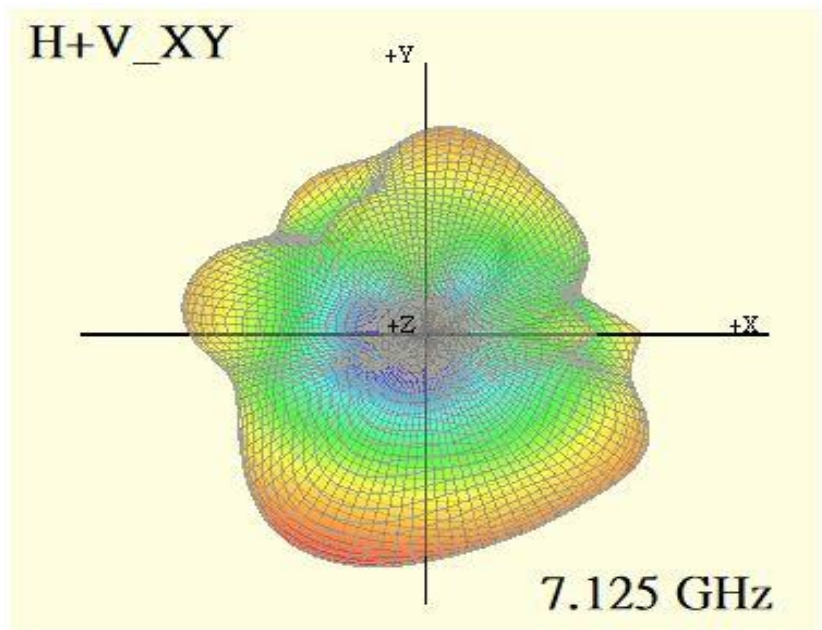

Auxiliary Antenna

Max Antenna 3D Radiation Pattern 2400 – 2483.5 MHz

Frequency (MHz)	Peak Gain w/ Cable Loss (dBi)
2400-2483.5	-0.90

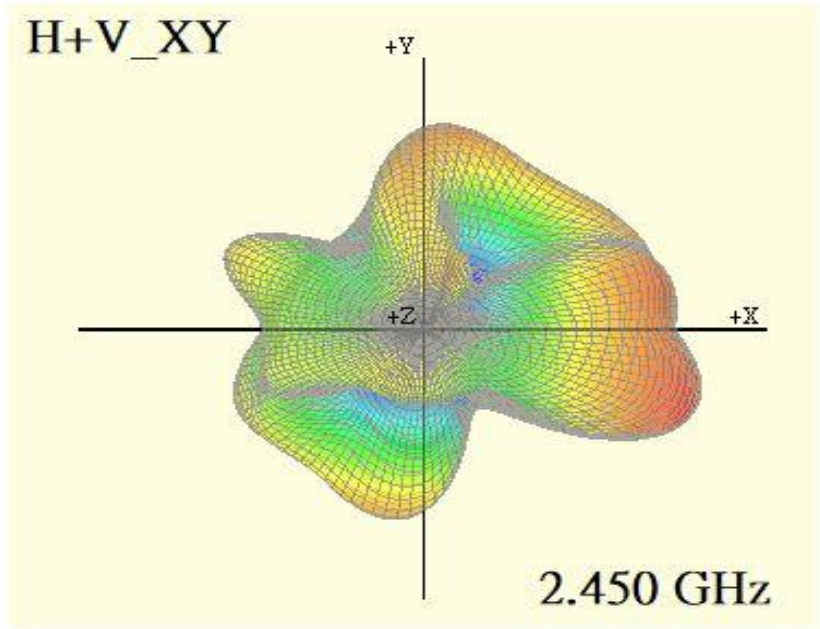

Max Antenna 3D Radiation Pattern 5150-5250 MHz

Frequency (MHz)	Peak Gain w/ Cable Loss (dBi)
5150-5250	-1.91

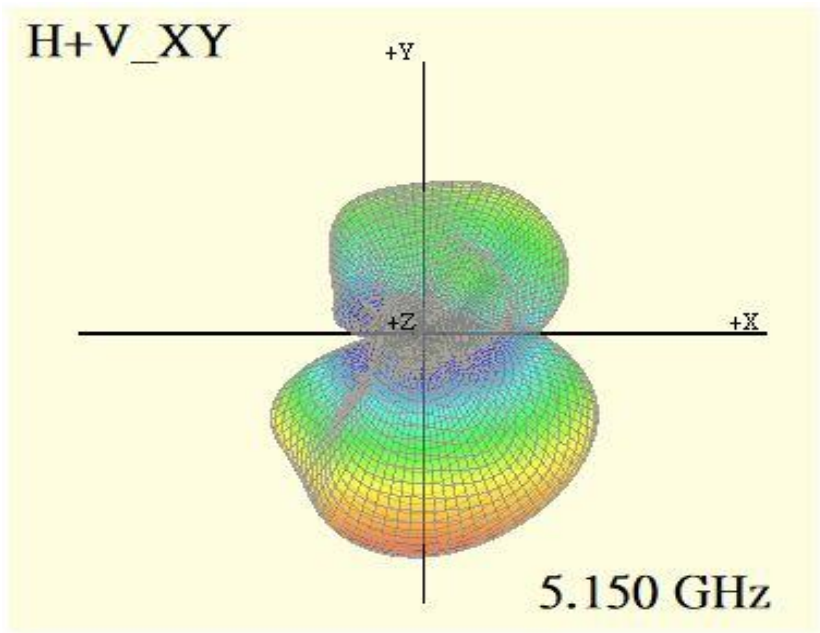

Max Antenna 3D Radiation Pattern 5250-5350 MHz

Frequency (MHz)	Peak Gain w/ Cable Loss (dBi)
5250-5350	2.21

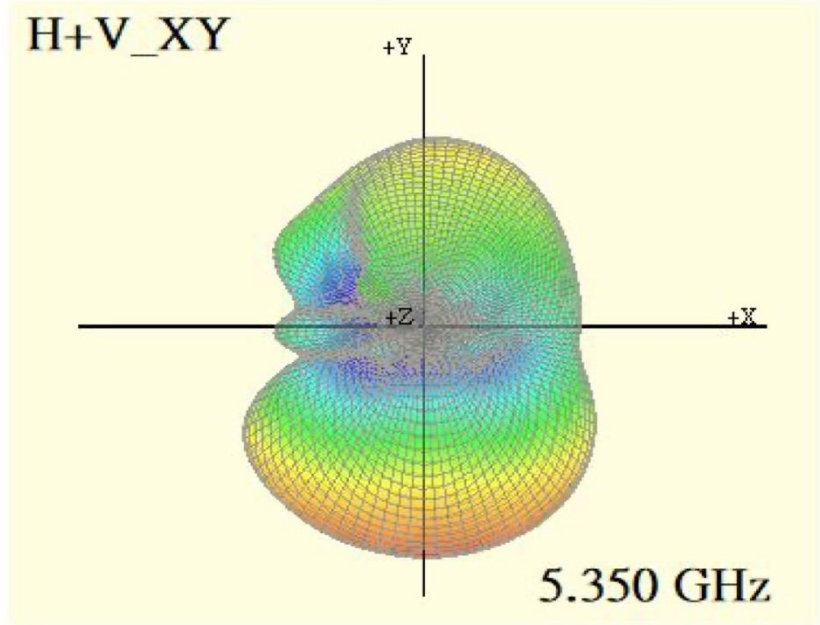

Max Antenna 3D Radiation Pattern 5470-5725 MHz

Frequency (MHz)	Peak Gain w/ Cable Loss (dBi)
5470-5725	2.45

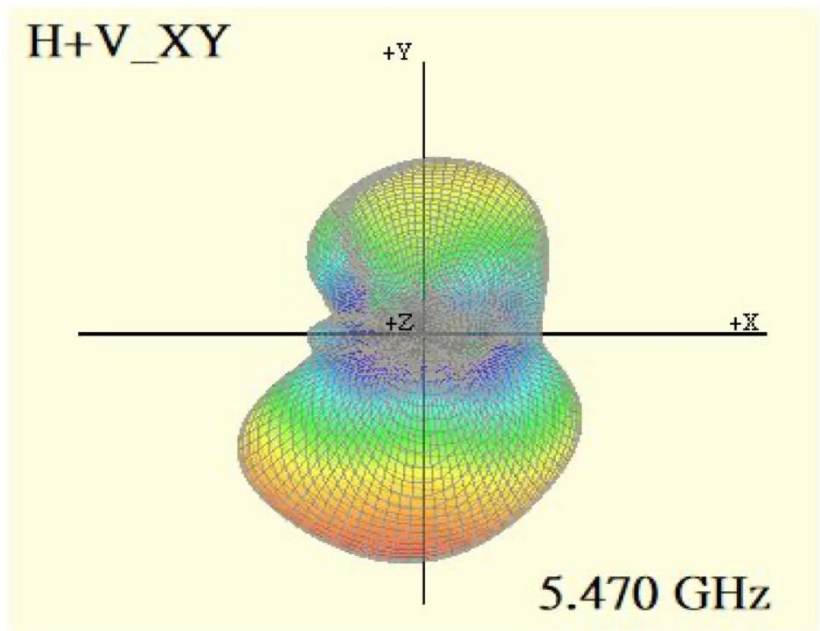

Max Antenna 3D Radiation Pattern 5725-5850 MHz

Frequency (MHz)	Peak Gain w/ Cable Loss (dBi)
5725-5850	2.50

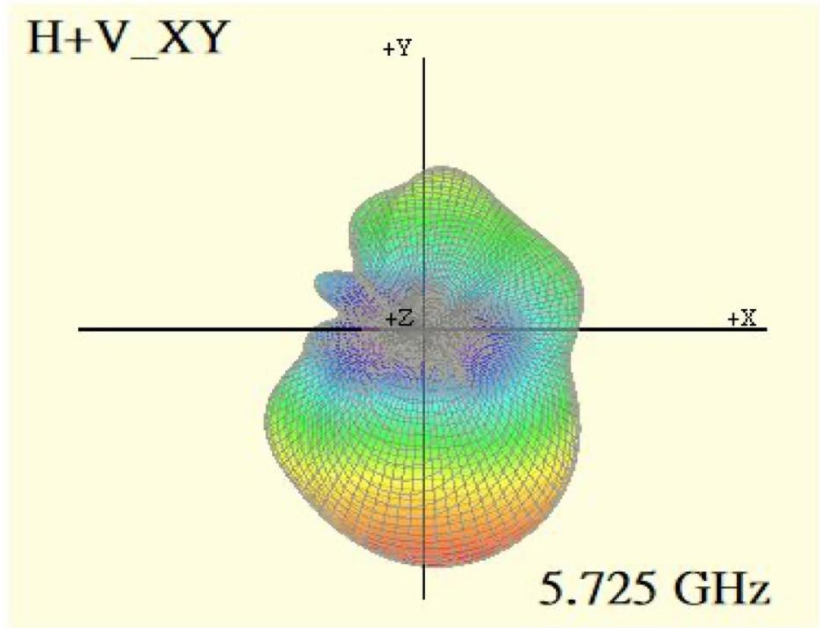

Max Antenna 3D Radiation Pattern 5850-5895 MHz

Frequency (MHz)	Peak Gain w/ Cable Loss (dBi)
5850-5895	2.98

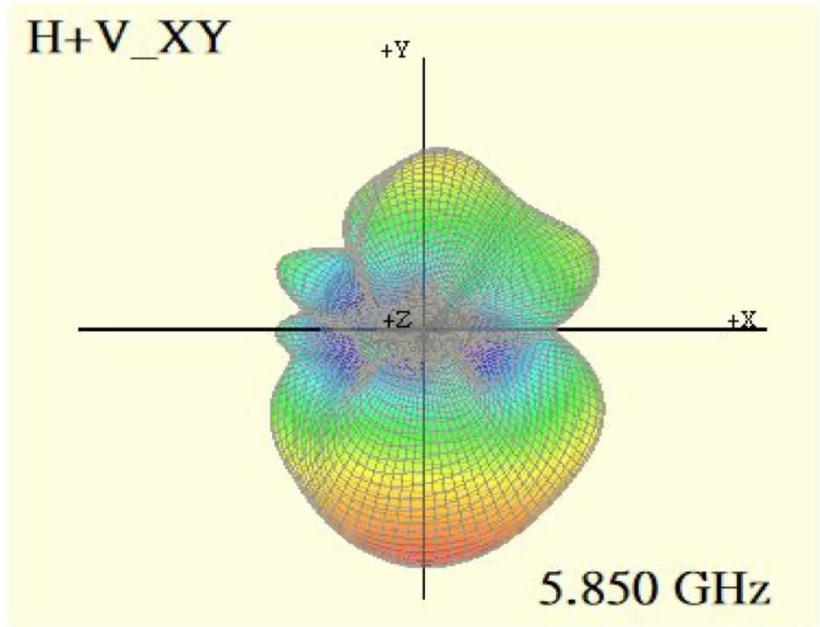

Max Antenna 3D Radiation Pattern 5925-6425 MHz

Frequency (MHz)	Peak Gain w/ Cable Loss (dBi)
5925-6425	2.81

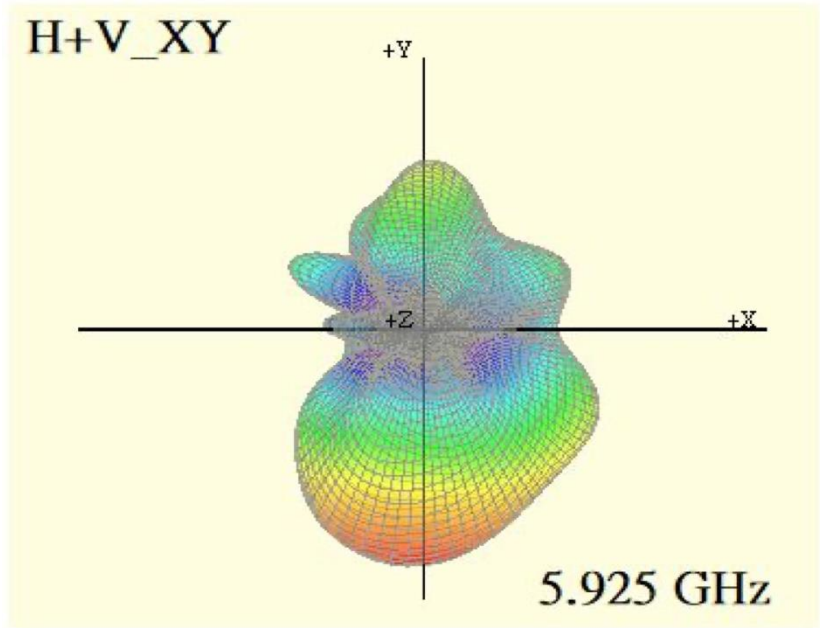

Max Antenna 3D Radiation Pattern 6405-6525 MHz

Frequency (MHz)	Peak Gain w/ Cable Loss (dBi)
6425-6525	0.59

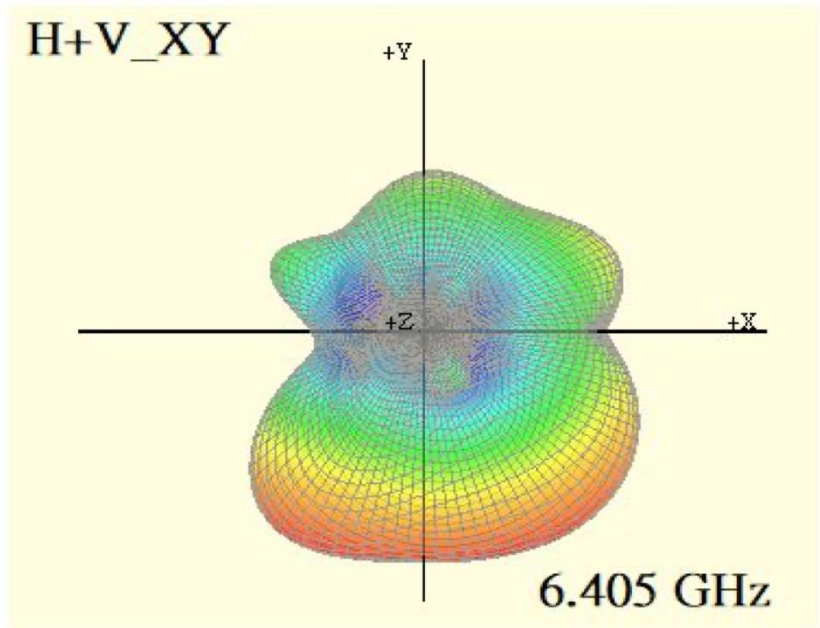

Max Antenna 3D Radiation Pattern 6525-6875 MHz

Frequency (MHz)	Peak Gain w/ Cable Loss (dBi)
6525-6875	2.43

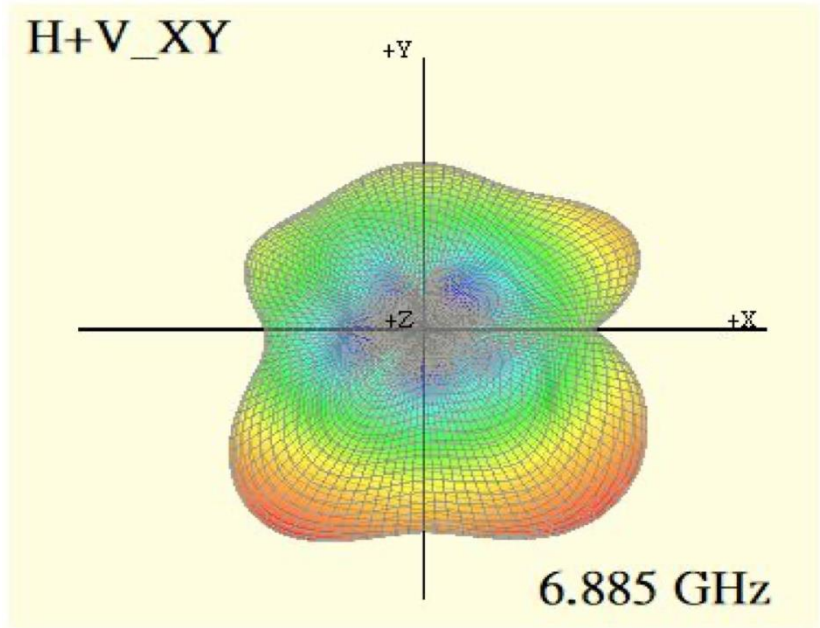

Max Antenna 3D Radiation Pattern 6875-7125 MHz

Frequency (MHz)	Peak Gain w/ Cable Loss (dBi)
6875-7125	1.40

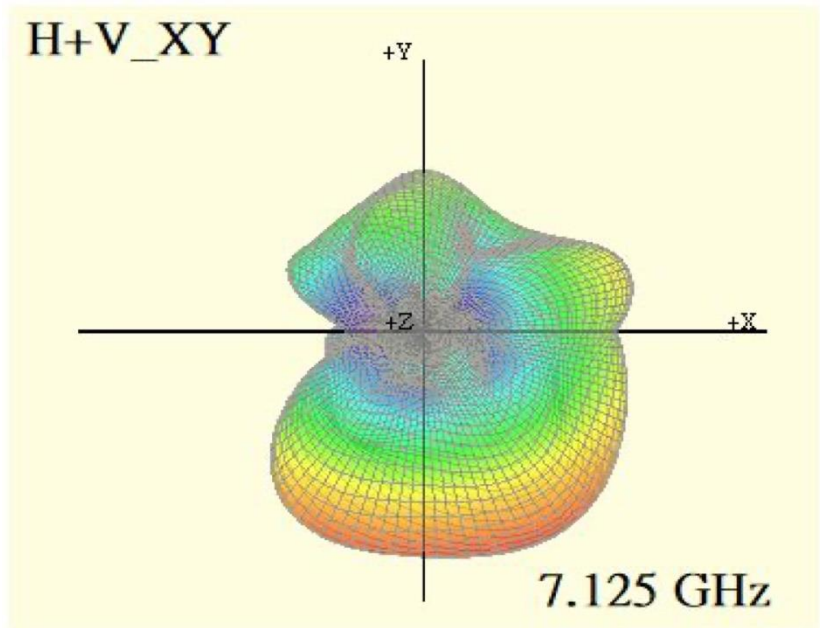

Section 4. Antenna Host Platform Location Information

Include a **dimensioned photo(s) or dimensioned drawing(s)** of Main and Aux antenna placements (measurements are not required for receive-only antenna).

Any antenna that transmits must show dimensions to bottom of laptop. Provide a description of the materials that are used for supporting or surrounding transmit antennas; for example, non-conductive plastics vs. conductive coated plastic or metallic materials.

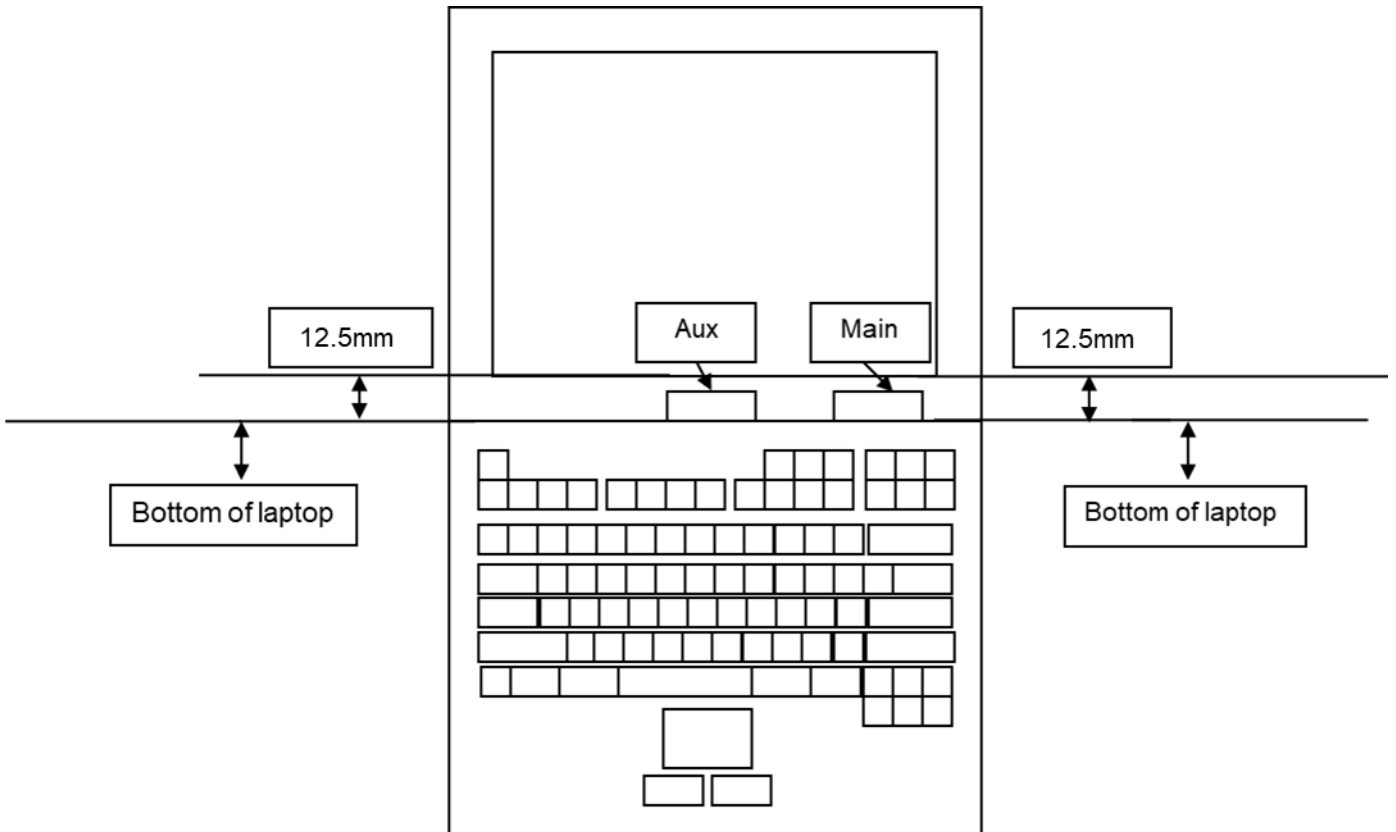

Section 5. Antenna dimensional information for SAR evaluation

Include a **dimensioned photo(s) or dimensioned drawing(s)** showing the distance (mm) between the transmit antennas and the user. For notebook/laptop hosts show lapheld position (example below). For tablet hosts show all orientations including lapheld, primary & secondary portrait, primary & secondary landscape positions. Include a description of any proximity sensors or power throttling implementations that limit or exclude use of any host orientation.

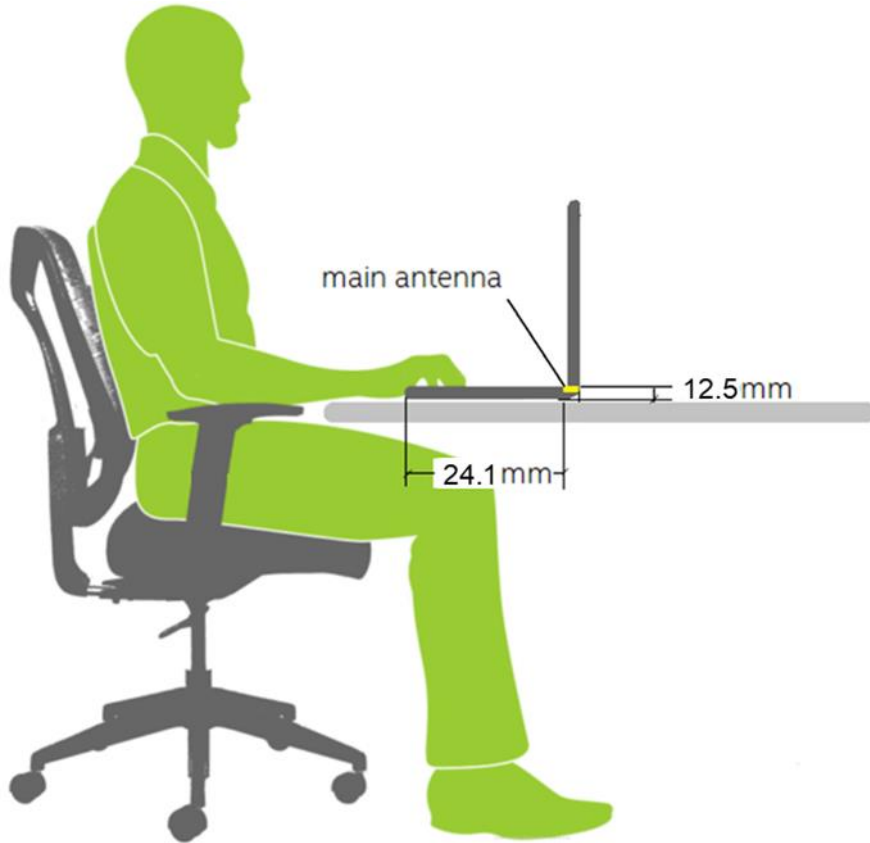

Section 6. Diagram Example of Co-Location Antenna Separation

Include a **dimensioned photo or dimensioned drawing** showing the distance (mm) between **all WLAN transmit antennas** and other co-located radiator transmit antenna such as Bluetooth, WWAN,..

(Note: Due to the evolving rules regarding co-location, each platform will need to be reviewed on a case by case basis)

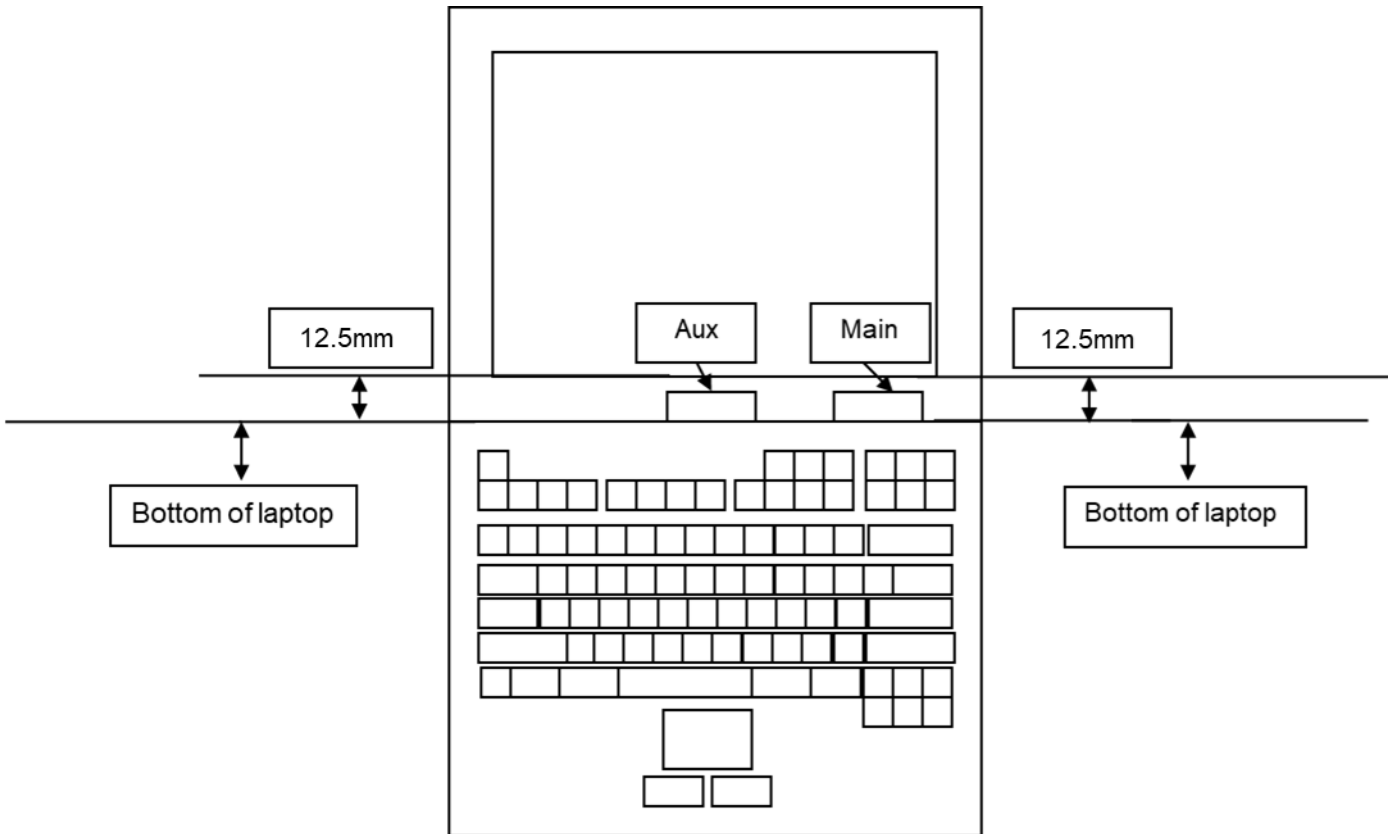

Revision History

Revision	Description	Date
10.3	<u>Page2-5</u> Add Applicable test method, Test & System Description and Setup photo	July 24, 2022
10.4	<u>Cover page</u> Add Intel 5.9GHz reference antenna gain <u>Cover page/Section1/Section3</u> Add 5.9GHz antenna gain information	September 15, 2022