

Prüfbericht-Nr.: <i>Test Report No.:</i>	20110201.f01	Auftrags-Nr.: <i>Order No.:</i>	89217850	Seite 1 von 27 <i>Page 1 of 27</i>
Kunden-Referenz-Nr.: <i>Client Reference No.:</i>	PO # 3001975319	Auftragsdatum: <i>Order date:</i>	November 4, 2020	
Auftraggeber: <i>Client:</i>	Intel Corporation SAS, Le Cargo B6 / 424 Rue de Goa, 06600 Antibes, France			
Prüfgegenstand: <i>Test item:</i>	Wireless Network Card			
Bezeichnung / Typ-Nr.: <i>Identification / Type No.:</i>	AX203D2W			
Auftrags-Inhalt: <i>Order content:</i>	Testing compliance with EMC Standards			
Prüfgrundlage: <i>Test specification:</i>	47 CFR PART 15 (10-1-19 EDITION), Subpart 15B ICES-003 (Issue 6, January 2016)			

Wareneingangsdatum: <i>Date of receipt:</i>	November 2, 2020
Prüfmuster-Nr.: <i>Test sample No.:</i>	1228
Prüfzeitraum: <i>Testing period:</i>	Nov.3, 2020 – Nov.9, 2020
Ort der Prüfung: <i>Place of testing:</i>	Leek
Prüflaboratorium: <i>Testing laboratory:</i>	TÜV Rheinland Nederland B.V. Leek Laboratory
Prüfergebnis*: <i>Test result*:</i>	Pass



Getested von / Tested by: W. Nelissen i.o./W. Brouwer		Genehmigt von / Authorized by: T.E.T. Koning	
Ausstelldatum: <i>Issue date:</i>	November 10, 2020	Ausstelldatum: <i>Issue date:</i>	November 12, 2020
Stellung / Position: EMC Expert		Stellung / Position: Senior EMC Expert	
Sonstiges / Other: None			
Zustand des Prüfgegenstandes bei Anlieferung: 1 <i>Condition of the test item at delivery: 1</i>		Prüfmuster vollständig und unbeschädigt <i>Test item complete and undamaged</i>	
* Legende: 1 = sehr gut P(ass) = entspricht o.g. Prüfgrundlage(n)		3 = befriedigend F(ail) = entspricht nicht o.g. Prüfgrundlage(n)	
Legend: 1 = very good P(ass) = passed a.m. Test specification(s)		4 = ausreichend N/A = not applicable	
		5 = mangelhaft N/T = nicht getestet	
		5 = poor N/T = not tested	
<p align="center"> Dieser Prüfbericht bezieht sich nur auf das o.g. Prüfmuster und darf ohne Genehmigung der Prüfstelle nicht auszugsweise vervielfältigt werden. Dieser Bericht berechtigt nicht zur Verwendung eines Prüfzeichens. <i>This test report only relates to the a.m. testsample. Without permission of the test center this test report is not permitted to be duplicated in extracts. This report does not entitle to carry any test mark</i> </p>			

Prüfbericht-Nr: 20110201.f01
Test report No: 20110201.f01

Seite 2 von 27
Page 2 of 27

Liste der verwendeten Prüfmittel
List of used test equipment

Prüfmittel Nr. / ID-Nr. Equipment No. / ID-No.	Prüfmittel Test equipment			Nächste Kalibrierung Next calibration
Conducted emission				
2790497	Rohde & Schwarz	ESCS30	Measurement Receiver	3-8-2021
2790495	Rohde & Schwarz	ESH3-Z2	Impulse Limiter	18-5-2021
2788823	Rohde & Schwarz	ESH3-Z2	Impulse Limiter	24-9-2021
2788795	Emco	3625/2	LISN 5 uH / 50 ohm	24-9-2021
2789124	Rohde & Schwarz	ESH2-Z5	LISN- artificial Network	12-8-2021
2788791	Rohde & Schwarz	ESH2-Z5	LISN- artificial Network	17-7-2021
2788866	COMTEST	1415	Conducted Reference Source 9kHz-50MHz	18-5-2021
2790528	Rohde & Schwarz	ESH 3-Z5	LISN	23-9-2021
2789211	Extech	SD 500	Humidity / Temperature Data logger	3-7-2021
Radiated emission				
2789083	Rohde & Schwarz	ESCI	Measurement Receiver (9kHz-3GHz)	12-3-2021
2789106	R&S	FSV30	Signal Analyzer/Spectrum Analyzer	28-8-2021
2790260	R&S	FSV40	Signal Analyzer/Spectrum Analyzer	20-8-2021
2788849	Chase	CBL6111B	Biconilog	29-10-2021
2788801	Emco	4610	Gen. field source	30-1-2021
2789009	Siepel	FCC	FCC Test Site Registration nr 786213	8-3-2022
2789082	Comtest		Site registration filing Industry Canada	8-5-2023
2789206	Siepel		S-AR	4-5-2023
2789217	Gigalink	APG0500	RF Cable S-AR	10-3-2021
2789237	Teseq	CBL 6111D	Antenne S-AR, BiLog 30MHz-1GHz	7-8-2021
2790499	Rohde & Schwarz	ESR7	EMI Test Receiver 7GHz	18-9-2021
2788776	Emco	3115	Guide ant. 1-18GHz	19-12-2020
2788777	Emco	3115	Guide ant. 1-18GHz	26-2-2022
2788779	Emco	3116	Guide ant. 18-40GHz	12-2-2022
2788780	Emco	3160-09	Gain horn 18-26.5GHz	12-2-2022
2788982	Emco	3160-09	Gain horn 18-26.5GHz	12-2-2022
2788983	Emco	3160-10	Gain horn 26.5-40GHz	12-2-2022
2789108	H&S	Sucotest 18/Sucoflex 102	Cable RF S-AR >1G setup	30-6-2021
2789109	H&S	Sucotest 18/Sucoflex 102	Cable RF	30-6-2021
2789110	H&S	Sucotest 18/Sucoflex 102	Cable RF	30-6-2021
9001993	Teseq	CMAD 20B	Common Mode Absorption Device	2-1-2022
9001994	Teseq	CMAD 20B	Common Mode Absorption Device	2-1-2022
9001995	Teseq	CMAD 20B	Common Mode Absorption Device	2-1-2022
2789214	Extech	SD 500	Humidity / Temperature Data logger	3-7-2021

Prüfbericht-Nr: 20110201.f01
Test report No: 20110201.f01

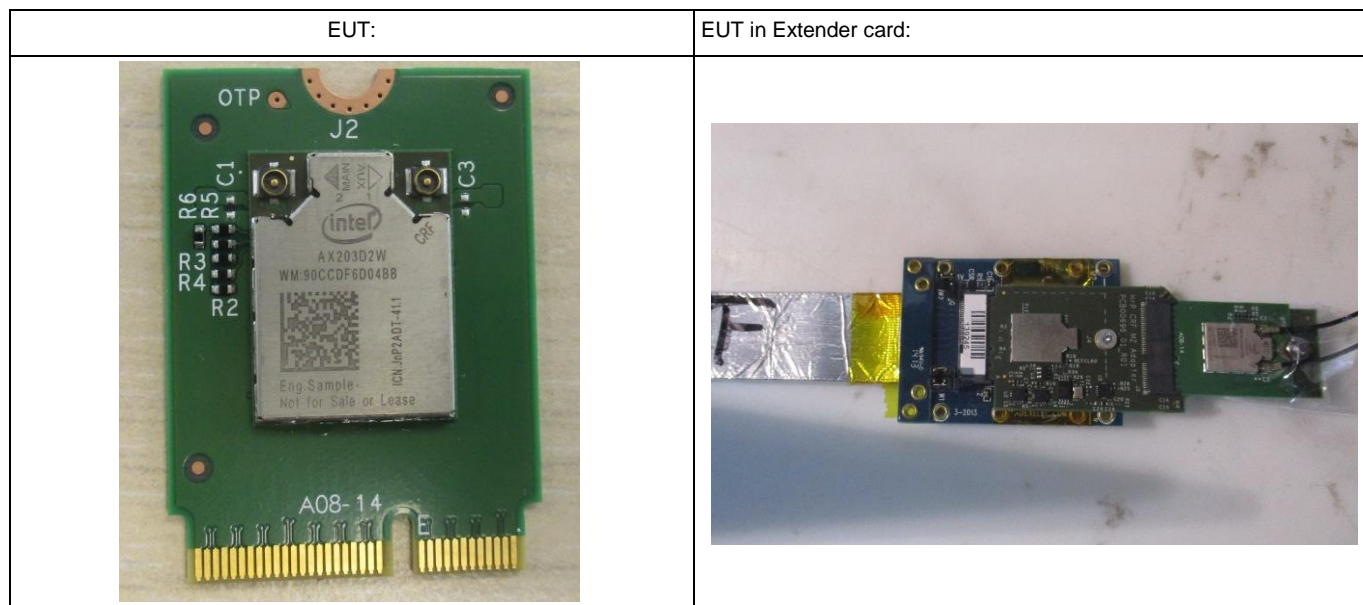
Seite 3 von 27
Page 3 of 27

1	Produktdetails <i>Product details</i>	Wireless Network Card AX203D2W
2	Maße / Gewicht <i>Dimensions / Weight</i>	<< 50 gr
3	Bedienelemente <i>Operating elements</i>	Built inside Extender, processed by laptop
4	Ausstattung / Zubehör <i>Equipment / Accessories</i>	Extender card
5	Verwendete Materialien <i>Used materials</i>	None
6	Sonstiges <i>Other</i>	None
7	Dieser raport betrifft: <i>This report concerns:</i>	EMC Verification

Prufbericht-Nr: 20110201.f01
Test report No: 20110201.f01

Seite 4 von 27
Page 4 of 27

Absatz Clause	Anforderungen – Prüfungen / Requirements - Tests		
1	47 CFR Part 15 (10-1-19 Edition) - 15.107(a) ICES-003 (Issue 6, January 2016) – Section 6.1 Table 2	AC Power Line Conducted Emissions	P <input checked="" type="checkbox"/> F <input type="checkbox"/> N/A <input type="checkbox"/> N/T <input type="checkbox"/>
2	47 CFR Part 15 (10-1-19 Edition) - 15.109 ICES-003 (Issue 6, January 2016) – Section 6.2.1 Table 5	Radiated unwanted emissions	P <input checked="" type="checkbox"/> F <input type="checkbox"/> N/A <input type="checkbox"/> N/T <input type="checkbox"/>



Prüfbericht-Nr: 20110201.f01
Test report No: 20110201.f01

Seite 5 von 27
 Page 5 of 27

Zusammenfassung der Prüfergebnisse Summary of test results					
Prüfung <i>Test</i>	Anwendbar <i>Applicable</i>	Prüfergebnis <i>Test result</i>	Paragraph <i>Paragraph</i>	Messungen un- ter Akkreditie- rung ausge- führt <i>under accredita- tion</i>	Kommentar <i>Remark</i>
Radiated emission < 1000 MHz	Yes	Pass	3.1	Yes	
Radiated emission > 1000 GHz	Yes	Pass	3.2	Yes	
Conducted emis- sion AC/DC port	Yes	Pass	3.3	Yes	

Table of contents

1	General test configuration.....	8
1.1	Tested system auxiliary details.....	9
	Description of test configuration.	9
1.2	Test methodology.	10
1.3	Test facility.	10
1.4	Test conditions.....	10
2	System test configuration.	10
2.1	Justification.	10
2.2	EUT mode of operation.....	10
2.3	Special accessories.	11
2.4	Equipment modifications.....	11
3	Test results Emission according to FCC CRF47 Part 15B.....	12
3.1	Enclosure Radiated Emission 30-1000 MHz.....	12
3.2	Enclosure Radiated emission 1000 MHz – 26500 MHz.....	16
3.3	AC Mains Conducted Emission 0.15-30 MHz.....	22

Prufbericht-Nr: 20110201.f01
Test report No: 20110201.f01

Seite 7 von 27
Page 7 of 27

Revisions <i>Revisions</i>			
Revision Revision	Datum Date	Anmerkung Remark	Verfasser Author
00	November 10, 2020	First Release	W. Brouwer

Note: Latest revision report will replace all previous reports

Prufbericht-Nr: 20110201.f01
Test report No: 20110201.f01

Seite 8 von 27
Page 8 of 27

CONDITIONS FOR TESTING

1 General test configuration.

Communication with access point is established and data is transferred and monitored with Iperf. Two modes were tested. 1 : 5GHz WIFI communication including Bluetooth (receiving dummy file from smartphone).
2 : 2.4GHz WIFI communication with auto channel. EUT tested in external extension board.

Remarks	All EMC Emission and Immunity testing has taken place: 1) within an environmental temperature range between 15 and 35 degrees Celsius 2) within an environmental relative humidity range between 20 and 85% 3) within an environmental air pressure range between 860 and 1060 mbar
---------	--

List of tested cables

Number	Function	From	To	Length	Remarks
1	AC	Mains	Laptop	< 3	

1.1 Tested system auxiliary details.

Details and an overview of the system and all of its components, as it has been tested, may be found below.

Description of test configuration.

Test item (EUT1)	: Wireless Communication Card
Manufacturer	: Intel Corporation SAS
Brand mark	: Intel
Model	: AX203D2W
Serial number	: Engineering Sample
Remark	: Tested in extender card on adapter
Test item (AUX1)	: Extender board
Manufacturer	: Intel Corporation SAS
Brand mark	: Intel
Remark	: Used to have a functional EUT outside a laptop
Test item (AUX2)	: Laptop including PSU
Manufacturer	: Dell
Brand mark	: Dell
Model	: E5401
Remark	: Used as Host for EUT1
Test item (AUX3)	: Mobile Phone
Manufacturer	: Samsung
Brand mark	: Samsung
Model	: Galaxy J7 (2016)
Remark	: Used for BT communication

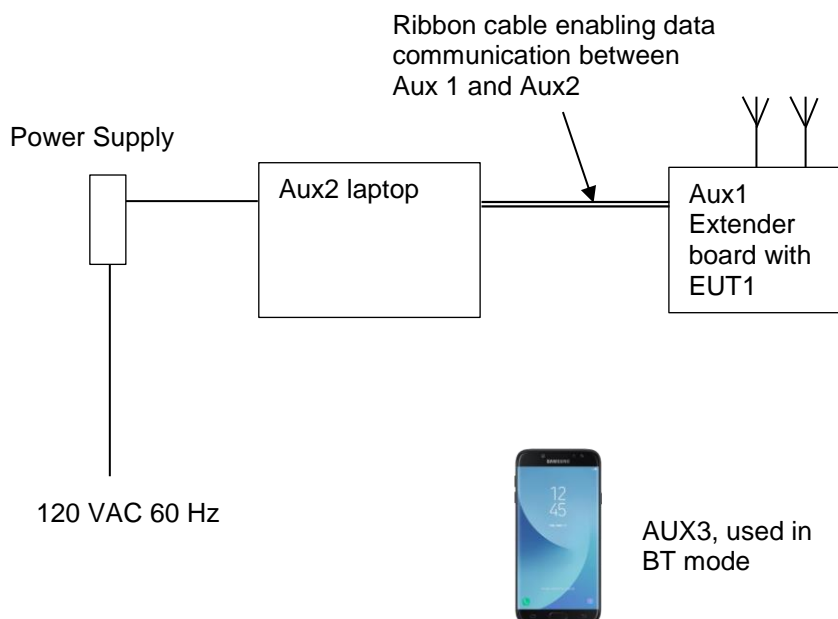


Figure 1. Total set-up used during testing

1.2 Test methodology.

The test methodology used is based on the requirements of 47 CFR Part 15 (10-1-19 Edition), sections 15.31, 15.107 and 15.109 and ICES-003 Issue 6 (January 2016) Sections 6.1 and 6.2. The EUT was tested in horizontal position only and is regarded as floor standing equipment.

The test methods, which have been used, are based on ANSI C63.4-2014.

Radiated emission tests were performed at a measurement distance of 3 meters.

The receivers are switching automatically to the right bandwidth in accordance with CISPR 16. This is implemented in the receiver. The antenna factors are programmed in the test receiver. The receiver automatically calculates the appropriate correction factor for the utilized antenna and also the appropriate antenna factor for the cable loss. The total correction is automatically added to the measured value.

1.3 Test facility.

The Federal Communications Commission and Industry Canada has reviewed the technical characteristics of the test facilities at TÜV Rheinland Nederland B.V., located at Eiberkamp 10, 9351 VT Leek, The Netherlands, and has found these test facilities to be in compliance with the requirements of 47 CFR Part 15, section 2.948.

The description of the test facilities has been filed at the Office of the Federal Communications Commission under registration number 786213. The facility has been added to the list of laboratories performing these test services for the public on a fee basis.

The description of the test facilities has been filed to Industry Canada under registration number 2932G-2. The facility has been added to the list of laboratories performing these test services for the public on a fee basis.

1.4 Test conditions.

Normal test conditions:

Temperature (*)	: +15°C to +35°C
Relative humidity(*)	: 20 % to 75 %
Supply voltage	: 120 Vac / 60 Hz

**When it was impracticable to carry out the tests under these conditions, a note to this effect stating the ambient temperature and relative humidity during the tests are stated separately.*

2 System test configuration.

2.1 Justification.

The system was configured for testing in a typical situation as a customer would normally use it. The test sample was configured by the applicant to enable continuous transmit.

The justification and manipulation of cables and equipment in order to simulate a worst-case behavior of the test setup has been carried out as prescribed in ANSI C63.4-2014.

2.2 EUT mode of operation.

The unintentional radiator tests have been performed with a complete functioning EUT.

Prufbericht-Nr: 20110201.f01
Test report No: 20110201.f01

Seite 11 von 27
Page 11 of 27

2.3 Special accessories.

No special accessories are used and/or needed to achieve compliance.

2.4 Equipment modifications.

No modifications have been made to the equipment.

3 Test results Emission according to FCC CRF47 Part 15B

3.1 Enclosure Radiated Emission 30-1000 MHz

3.1.1 Definition

Result of the measurements concerning radiated electromagnetic fields (electric component) emitted by the total set-up of the EUT.

3.1.2 Basic standard

The test is performed according to FCC CRF 47 Part 15B § 15.109

3.1.3 Limit

FCC 15.109(a) and IC ICES-003 section 6.2

Except for Class A digital devices, the field strength of radiated emissions from an unintentional radiator shall not exceed the field strength levels specified in the following table:

Frequency (MHz)	Field strength ($\mu\text{V}/\text{meter}$)	Field strength ($\text{dB}\mu\text{V}/\text{m}$)	Measurement distance (meters)
30-88	100	40.0	3
88-216	150	43.5	3
216-960	200	46.0	3
Above 960	500	54.0	3

Table of applicable limits

3.1.4 Test procedures

ANSI C63.4-2014.

Before final measurements of radiated emissions were performed, the EUT was scanned to determine its emission spectrum profile. The physical arrangement of the test system, the associated cabling and the EUT orientation (X, Y, Z) were varied in order to ensure that maximum emission amplitudes were attained.

The spectrum was examined from 30MHz to 26500 MHz, the fifth harmonic of the highest intentional generated frequency. Final radiated emission measurements were made at 3m distance.

At each frequency where a spurious emission was found, the EUT was rotated 360° and the antenna was raised and lowered from 1 to 4m in order to determine the emission's maximum level. Measurements were taken using both horizontal and vertical antenna polarizations.

The highest emission amplitudes relative to the appropriate limit were recorded in this report. Field strength values of radiated emissions at frequencies not listed in the tables are more than 20 dB below the applicable limit.

3.1.5 Test deviation

There is no deviation with the original standard.

3.1.6 Test results

Test conditions			
		Test location	Leek
Applied Standard(s)	FCC CRF 47 Part 15B § 15.109		
Test engineer	W. Nelissen i.o. / W. Brouwer	Test result	Pass
Test date	November 9, 2020		

Results and limits, 5GHz + Bluetooth mode						
Frequency (MHz)	Result (dB μ V/m)	Antenna polarization	Limit (dB μ V/m)	Margin	Height (cm)	Angle (deg)
87.17	35.7	Horizontal	40.0	4.3	278.4	309.5
219.85	35.8	Horizontal	43.5	7.7	99.8	279.9
361.13	34.4	Horizontal	46.0	11.6	101.0	325.9
426.89	31.0	Vertical	46.0	15.0	274.7	269.6
966.51	27.9	Vertical	54.0	27.1	216.3	188.7

Table 1 Results Enclosure Radiated Emission 30.0 – 1000 MHz, 5GHz + BT mode

Results and limits, 2.4 GHz mode						
Frequency (MHz)	Result (dB μ V/m)	Antenna polarization	Limit (dB μ V/m)	Margin	Height (cm)	Angle (deg)
31.77	21.1	Vertical	40.0	18.9	99.7	0.2
92.32	21.1	Horizontal	43.5	22.4	142.6	0.2
215.66	25.4	Vertical	43.5	18.1	99.9	305.2
423.92	28.6	Vertical	46.0	17.4	274.3	266.1
971.97	28.1	Vertical	54.0	25.9	204.4	359.7

Table 2 Results Enclosure Radiated Emission 30.0 – 1000 MHz, 2.4GHz mode

Used Equipment

2790499	2789109	2789237	2789217	2789110	2789029	2789206	2789214
---------	---------	---------	---------	---------	---------	---------	---------

Notes:

- Field strength values of radiated emissions at frequencies not listed in the table above are more than 20 dB below the applicable limit.
- Measurement uncertainty is +/- 5.22 dB.
- The EUT was tested in horizontal orientation only-it's normal operation orientation, the measuring antenna was varied in horizontal and vertical orientations and also around its axis and height. The reported value is the worst case found at the reported frequency.
- A selection of Photos and Graphical Displays is provided on the next pages.

3.1.7 Photograph test setup

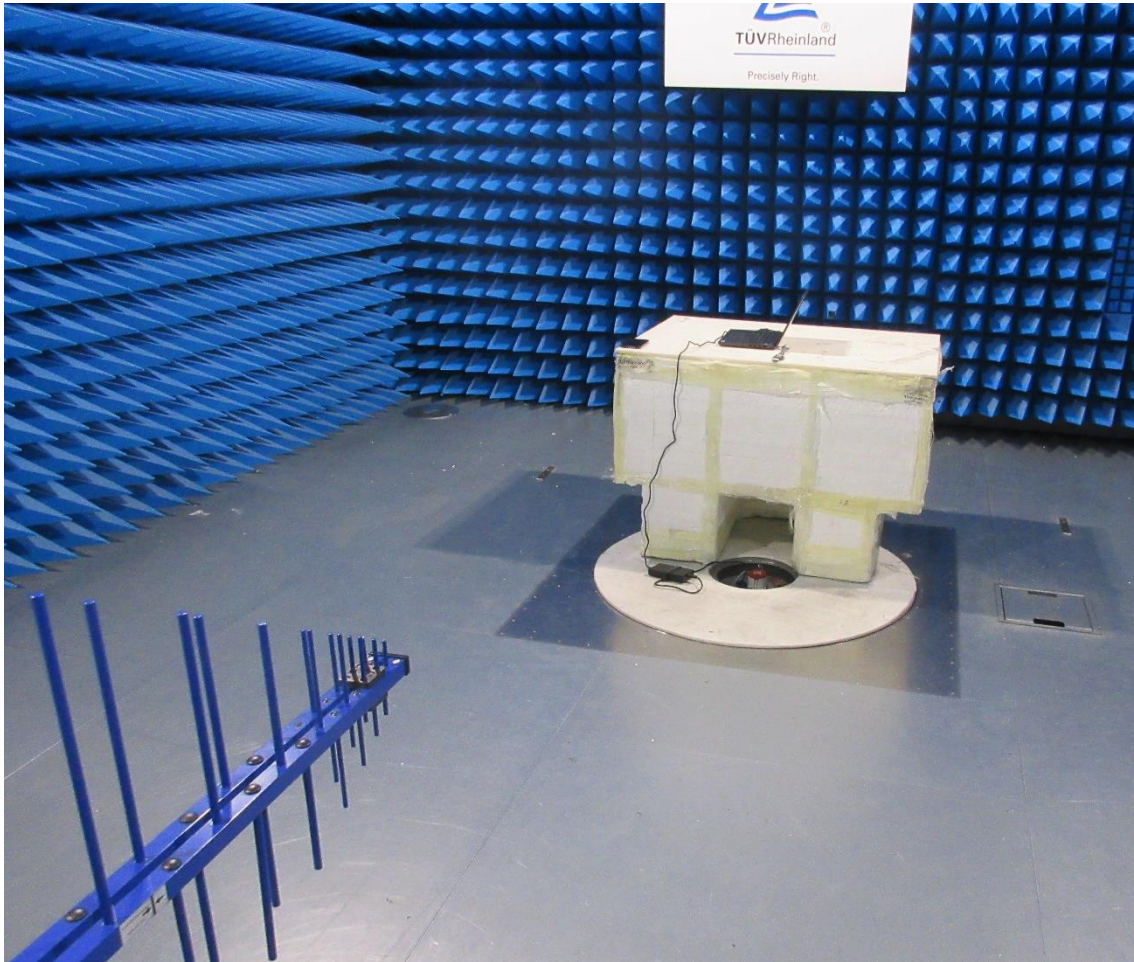
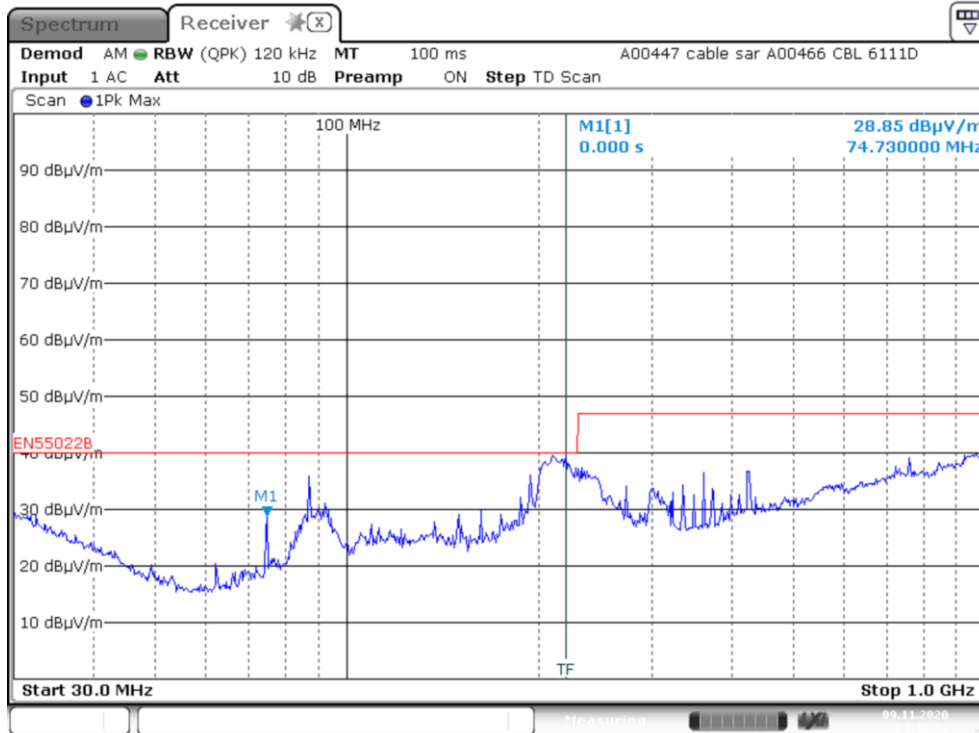


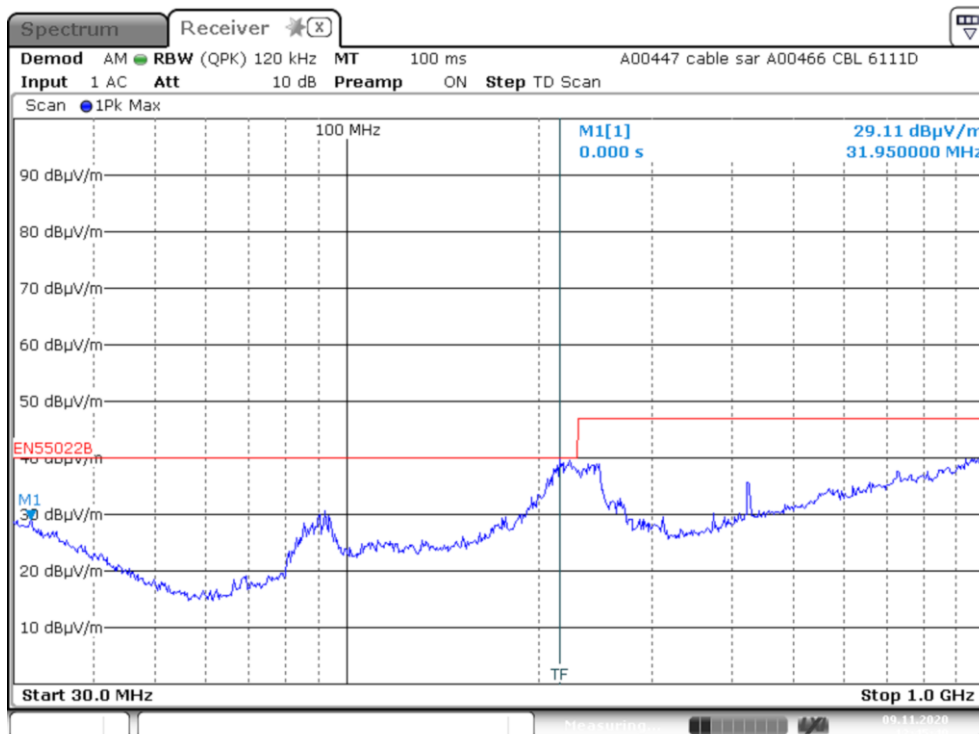
Photo 1 Photograph test setup radiated emissions 30-1000 MHz

3.1.8 Spectrum plot



Date: 9.NOV.2020 14:46:53

Plot 1: Pre-scan plot with peak detector. Radiated emissions from 30 MHz to 1000 MHz 5GHz + BT mode



Date: 9.NOV.2020 12:45:49

Plot 2: Pre-scan plot with peak detector. Radiated emissions from 30 MHz to 1000 MHz 2.4GHz mode

3.2 Enclosure Radiated emission 1000 MHz – 26500 MHz

Results and limits 5GHz + Bluetooth mode						
Frequency (GHz)	Peak Results			Average Results		
	Horizontal (dB μ V/m)	Vertical (dB μ V/m)	Limit (dB μ V/m)	Horizontal (dB μ V/m)	Vertical (dB μ V/m)	Limit (dB μ V/m)
1.20	41.2	41.8	74.0	24.3	24.2	54.0
1.71	40.6	47.5	74.0	27.4	27.5	54.0
2.92	47.6	47.3	74.0	33.7	34.0	54.0
3.49	49.7	49.6	74.0	36.2	36.2	54.0
5.82	61.4	62.0	74.0	48.2	48.2	54.0
11.48	62.9	63.2	74.0	51.0	50.9	54.0
17.64	70.7	70.9	74.0	51.9	52.0	54.0
18.33	53.2	52.5	74.0	39.9	39.8	54.0
21.66	52.3	51.8	74.0	39.4	39.4	54.0
23.91	51.0	51.8	74.0	39.1	39.1	54.0

Table 3 Results Enclosure Radiated Emission 1000.0 – 26500 MHz 5GHz + BT mode

Results and limits 2.4GHz mode						
Frequency (GHz)	Peak Results			Average Results		
	Horizontal (dB μ V/m)	Vertical (dB μ V/m)	Limit (dB μ V/m)	Horizontal (dB μ V/m)	Vertical (dB μ V/m)	Limit (dB μ V/m)
1.20	41.4	39.9	74.0	24.2	24.2	54.0
1.71	41.0	49.2	74.0	27.4	27.5	54.0
2.92	47.9	47.6	74.0	34.6	34.0	54.0
3.49	49.4	49.6	74.0	36.1	36.2	54.0
5.82	62.5	61.4	74.0	48.2	48.2	54.0
11.48	64.1	62.4	74.0	52.8	52.8	54.0
17.69	71.6	70.4	74.0	51.7	51.7	54.0
18.39	53.1	52.9	74.0	40.7	40.7	54.0
21.93	53.1	53.8	74.0	41.0	41.0	54.0

Table 4 Results Enclosure Radiated Emission 1000.0 – 26500 MHz 2.4GHz mode

Notes:

Field strength values of radiated emissions at frequencies not listed in the table above are more than 20 dB below the applicable limit.

1. Measurement uncertainty is +/- 5.1 dB
2. The reported field strength values are the worst case values at the indicated frequency. The receiving antenna was varied in horizontal and vertical orientations and also in height (between 1m and 4m).
3. A Peak and Average detector was used with a resolution bandwidth of 1MHz.

Used Equipment

2790499	2789109	2788776	2789217	2789110	2789029	2789206	2789108	2789214
---------	---------	---------	---------	---------	---------	---------	---------	---------

3.2.1 Photograph test setup

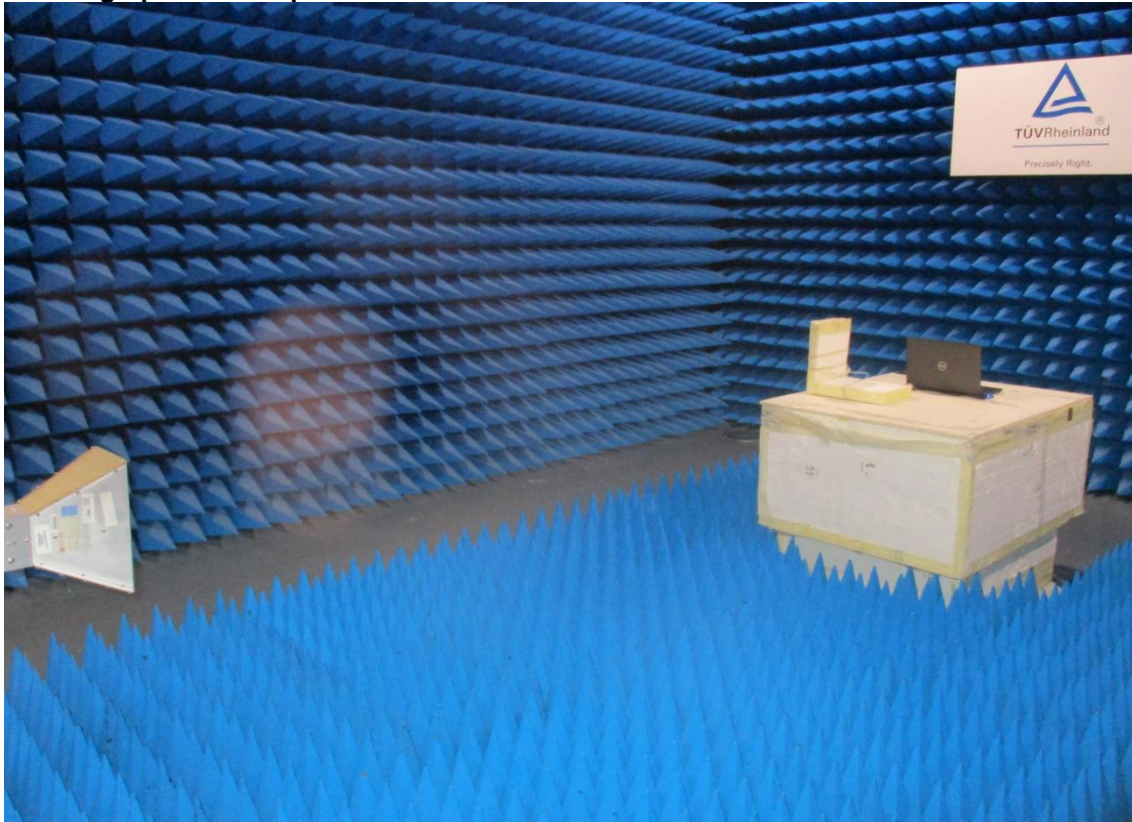


Photo 2: Photograph radiated emissions 1 – 18 GHz

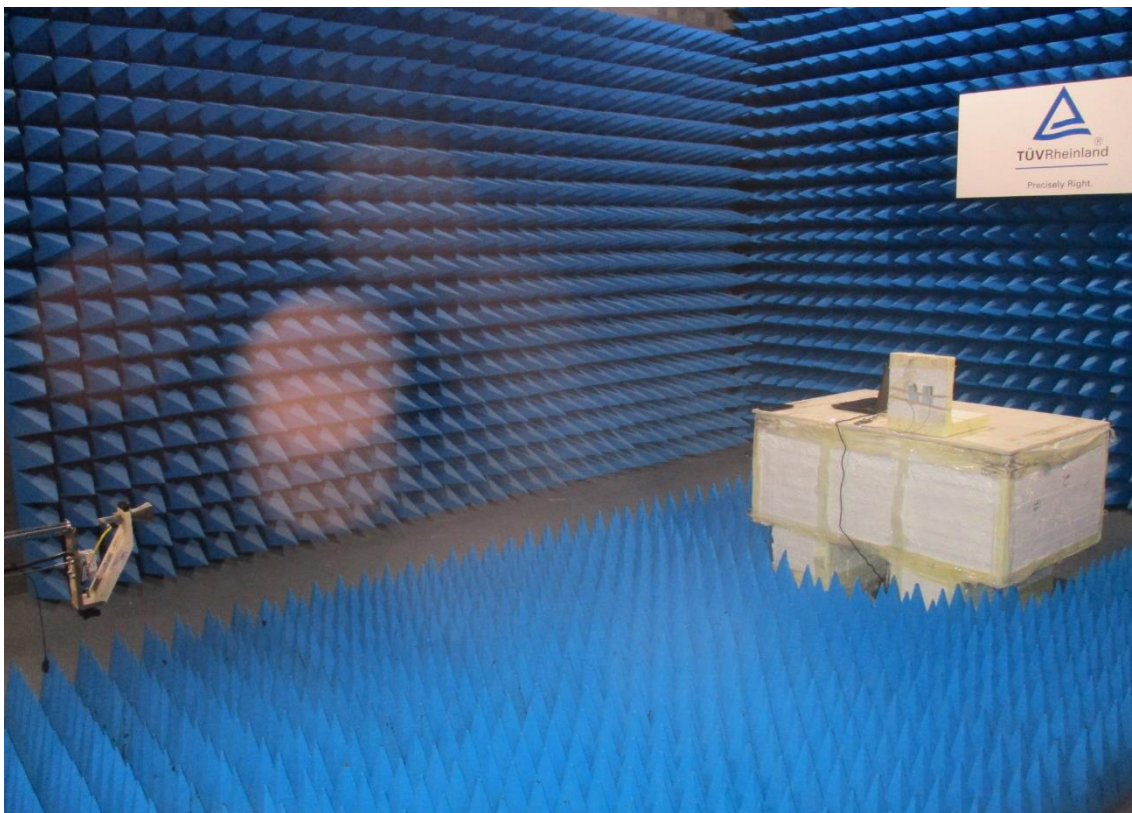
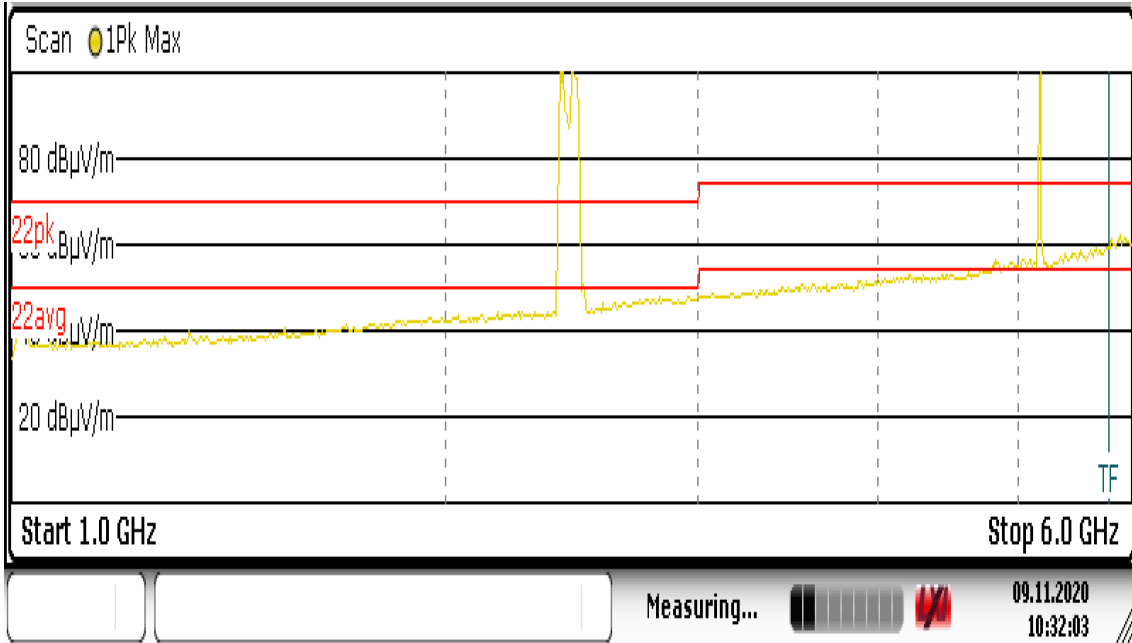


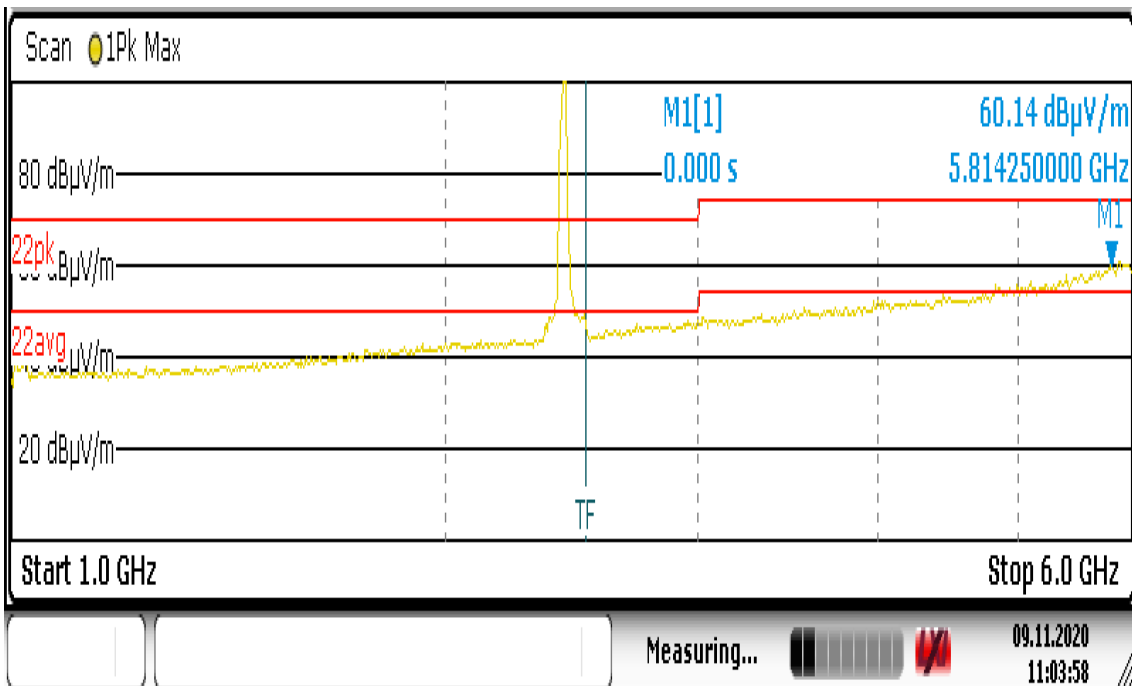
Photo 3: Photograph radiated emissions 18 – 26.5 GHz

3.2.2 Spectrum plot



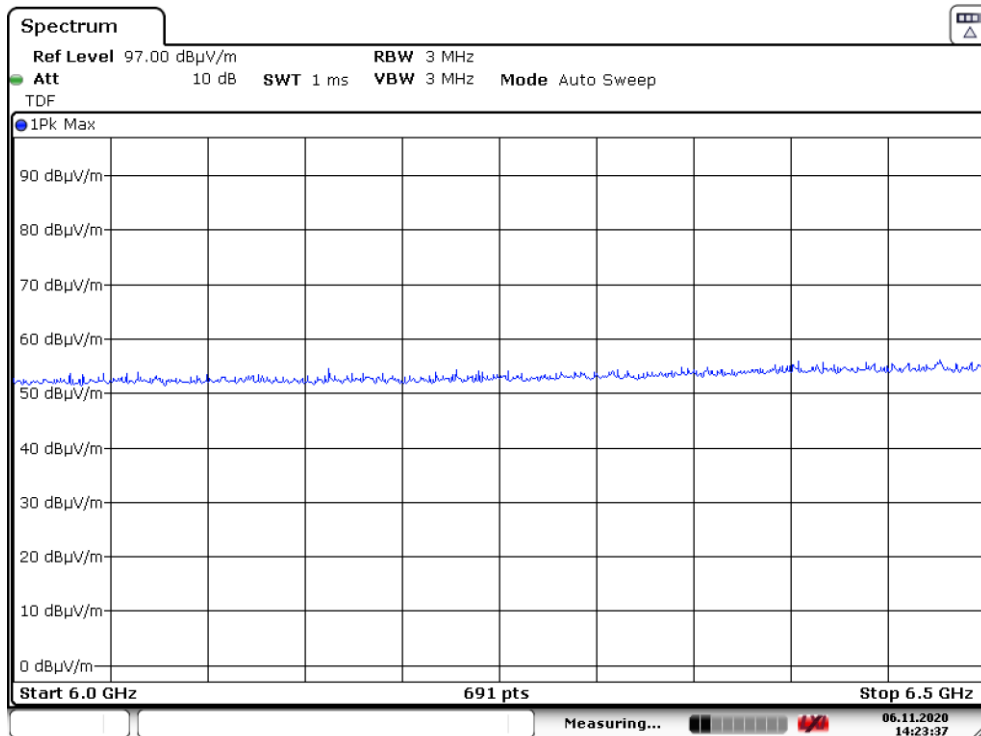
Date: 9.NOV.2020 10:32:03

Plot 3: Pre-scan plot with peak detector. Radiated emissions from 1 GHz – 6 GHz, 5GHz + BT mode



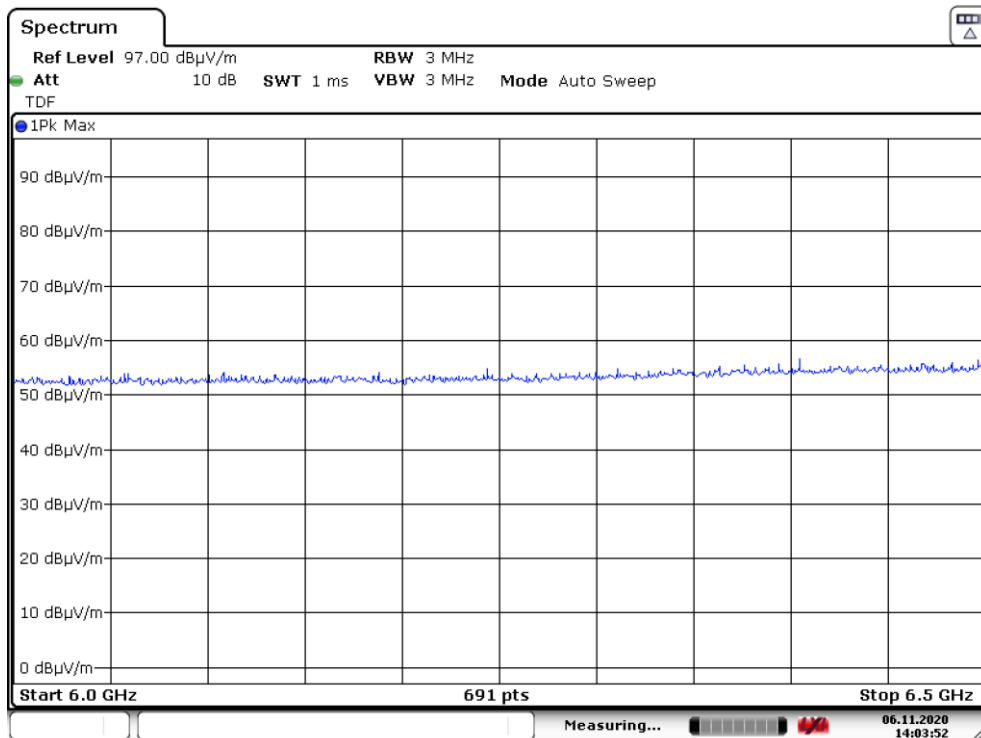
Date: 9.NOV.2020 11:03:58

Plot 4: Pre-scan plot with peak detector. Radiated emissions from 1 GHz – 6 GHz, 2.4GHz mode



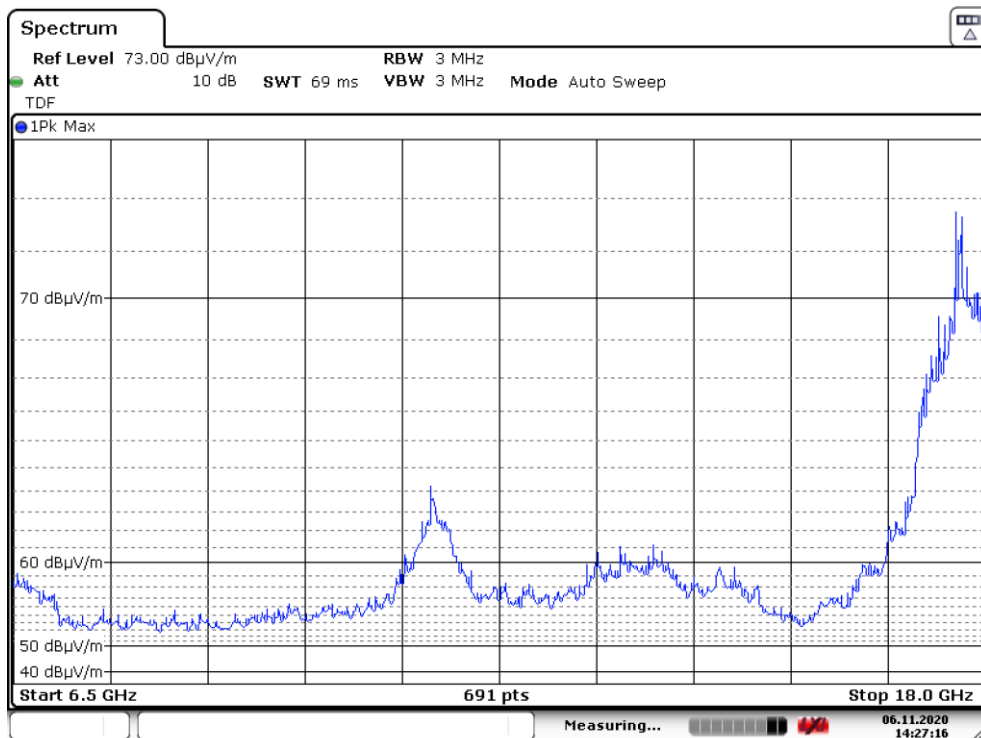
Date: 6.NOV.2020 14:23:37

Plot 5: Pre-scan plot with peak detector. Radiated emissions from 6 GHz – 6.5 GHz, 5GHz + BT mode



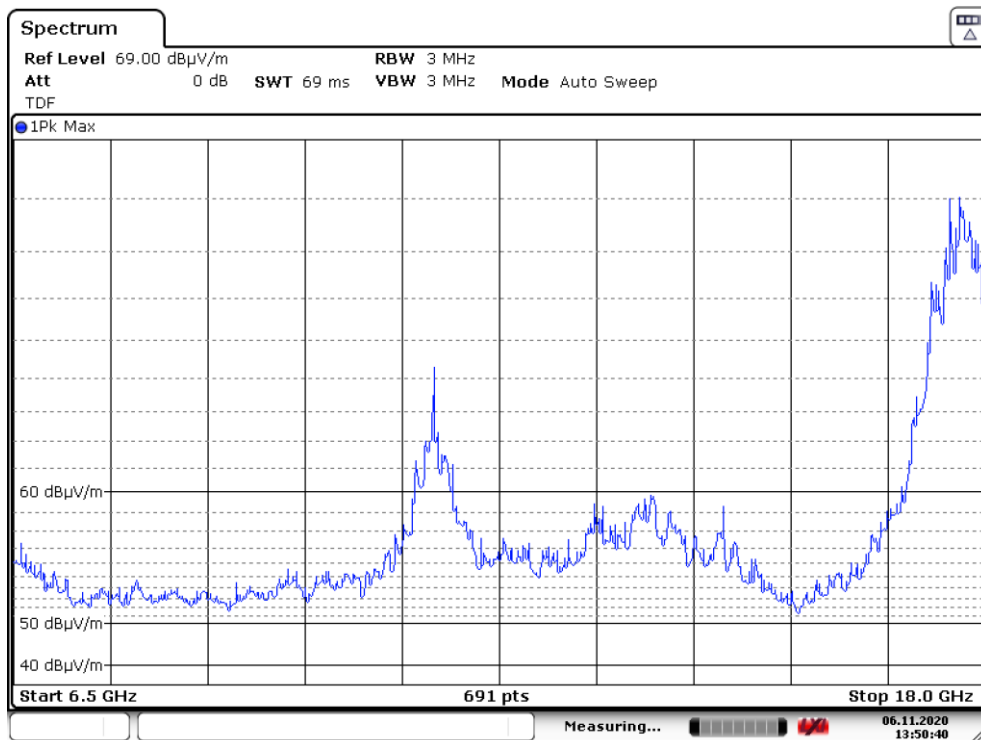
Date: 6.NOV.2020 14:03:52

Plot 6: Pre-scan plot with peak detector. Radiated emissions from 6 GHz – 6.5 GHz, 2.4GHz mode



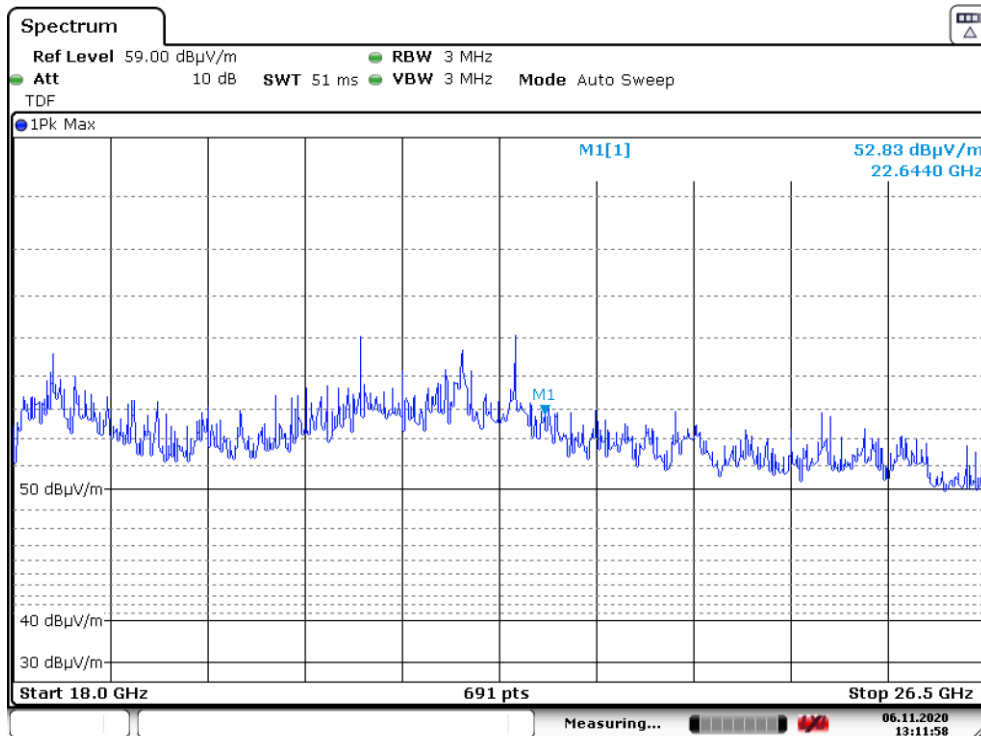
Date: 6.NOV.2020 14:27:16

Plot 7: Pre-scan plot with peak detector. Radiated emissions from 6.5 GHz – 18 GHz, 5GHz + BT mode



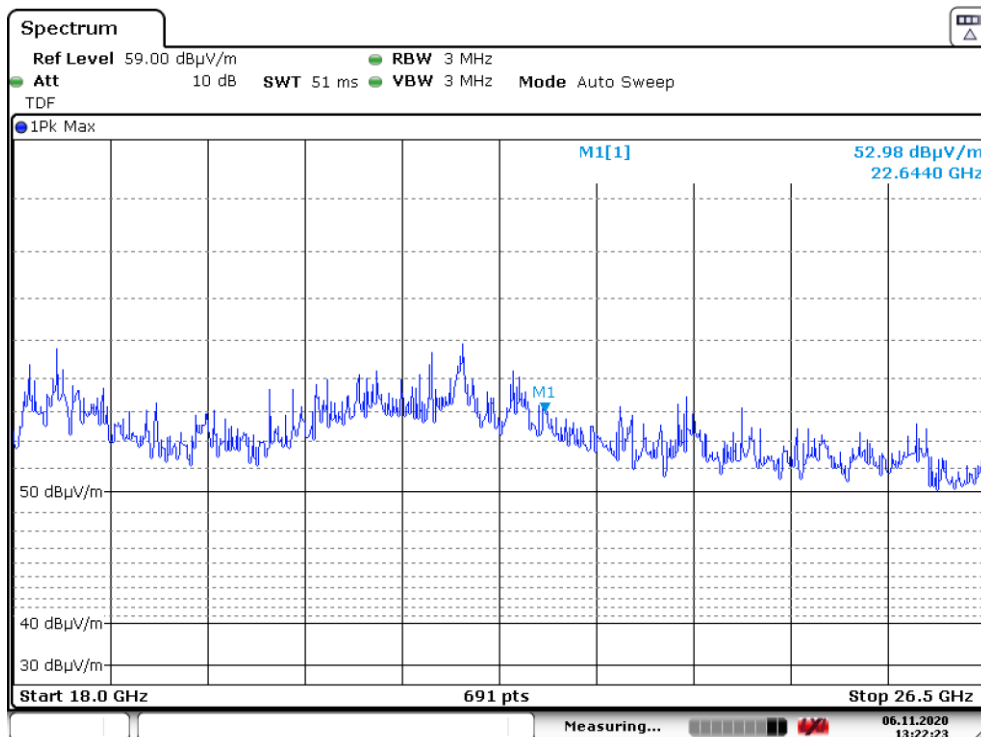
Date: 6.NOV.2020 13:50:41

Plot 8: Pre-scan plot with peak detector. Radiated emissions from 6.5 GHz – 18 GHz, 2.4GHz mode



Date: 6.NOV.2020 13:11:58

Plot 9: Pre-scan plot with peak detector. Radiated emissions from 18 GHz – 26.5 GHz, 5GHz + BT mode



Date: 6.NOV.2020 13:22:23

Plot 10: Pre-scan plot with peak detector. Radiated emissions from 18 GHz – 26.5 GHz, 2.4GHz mode

3.3 AC Mains Conducted Emission 0.15-30 MHz

3.3.1 Definition

Result of the measurements concerning the disturbance voltage level at the power input port emitted by the total set-up of the EUT.

3.3.2 Basic standard

The test is performed according to FCC CRF 47 Part 15B § 15.107

3.3.3 Limit

Frequency (MHz)	Limit Quasi-peak(dB μ V)	Limit Average(dB μ V)
0.15 - 0.50	66.0 – 56.0	56.0 – 46.0
0.50 - 5.0	56.0	46.0
5.0 – 30.0	60.0	50.0

3.3.4 Test procedures

Requirements: 15.107 (a) Except for Class A digital devices, for equipment that is designed to be connected to the public utility (AC) power line, the radio frequency voltage that is conducted back onto the AC power line on any frequency or frequencies within the band 150 kHz to 30 MHz shall not exceed the limits in the table above, as measured using a 50 μ H/50 ohms line impedance stabilization network (LISN). Compliance with the provisions of this paragraph shall be based on the measurement of the radio frequency voltage between each power line and ground at the power terminal. The lower limit applies at the band edges.

Test procedure according to ANSI C63.4-2014: Each phase and neutral of the AC power line were measured with respect to ground. Measurements were performed using a 50 μ H / 50 Ω LISN. The frequency range from 150kHz to 30MHz was examined. The six highest EUT emissions relative to the limit were noted. The EUT was positioned at least 40cm from a vertical ground reference plane and at least 80cm from the LISN.

3.3.5 Test deviation

There is no deviation with the original standard

3.3.6 Test results

Test conditions			
Applied Standard(s)	to FCC CRF 47 Part 15B § 15.107	Test location	Leek
Test engineer	W. Nelissen i.o. / W. Brouwer	Test result	Pass
Test date	November 5, 2020		

Results and limits Neutral, 5GHz + Bluetooth mode						
Frequency (MHz)	Quasi peak detector			Average detector		
	Result	Limit	Margin	Result	Limit	Margin
0.60	40.1	56.0	15.9	30.2	46.0	15.9
0.85	38.4	56.0	17.6	27.9	46.0	18.1
1.74	35.0	56.0	21.0	20.7	46.0	25.3
1.86	35.3	56.0	20.7	22.1	46.0	23.9
10.29	20.8	60.0	39.2	11.6	50.0	38.4
17.43	37.4	60.0	22.6	27.7	50.0	22.3

Results and limits L1, 5GHz + Bluetooth mode						
Frequency (MHz)	Quasi peak detector			Average detector		
	Result	Limit	Margin	Result	Limit	Margin
0.60	40.8	56.0	15.2	29.6	46.0	16.4
0.85	37.8	56.0	18.2	27.1	46.0	18.9
1.74	35.9	56.0	20.2	20.2	46.0	25.8
1.86	35.5	56.0	20.5	22.2	46.0	23.8
10.29	20.2	60.0	39.8	11.9	50.0	38.1
17.43	33.4	60.0	26.6	23.8	50.0	26.3

Table 5 Results Conducted Emission 0.15 - 30 MHz, 5GHz + BT mode

Results and limits Neutral, 2.4GHz mode						
Frequency (MHz)	Quasi peak detector			Average detector		
	Result	Limit	Margin	Result	Limit	Margin
0.20	39.4	63.6	24.2	15.2	53.6	38.4
0.46	39.6	56.7	17.1	24.7	46.7	22.0
0.86	38.5	56.0	17.5	29.3	46.0	16.7
1.61	36.5	56.0	19.5	24.0	46.0	22.0
4.88	27.4	56.0	28.6	15.3	46.0	30.7
12.92	24.6	60.0	35.4	16.0	50.0	34.0

Results and limits L1, 2.4GHz mode						
Frequency (MHz)	Quasi peak detector			Average detector		
	Result	Limit	Margin	Result	Limit	Margin
0.20	39.8	63.6	23.8	14.1	53.6	39.5
0.46	37.2	56.7	19.5	17.9	46.7	28.8
0.86	38.2	56.0	17.8	29.1	46.0	16.9
1.61	36.5	56.0	19.5	23.9	46.0	22.1
4.88	25.8	56.0	30.2	14.2	46.0	31.8
12.92	22.8	60.0	37.2	14.0	50.0	36.1

Table 6 Results Conducted Emission 0.15 - 30 MHz, 2.4GHz mode

The results of the AC power line conducted emission tests, carried out in accordance with 47 CFR Part 15 section 15.107 and ICES-003 Section 6.1, at the 120 Volts AC mains connection terminals of the system, are depicted in Table 4. Maximum values were recorded. The system is tested as in whole, so with all equipment as shown in Figure 1 in place and functioning. Being the worst case situation.

Prufbericht-Nr: 20110201.f01
Test report No: 20110201.f01

Seite 24 von 27
Page 24 of 27

Notes:

1. Measurement uncertainty is ± 3.5 dB
2. The resolution bandwidth used was 9 kHz.
3. The six highest values relative to the applicable limits were noted.
4. Photo and Graphical Display is provided on the next page.

Used Equipment

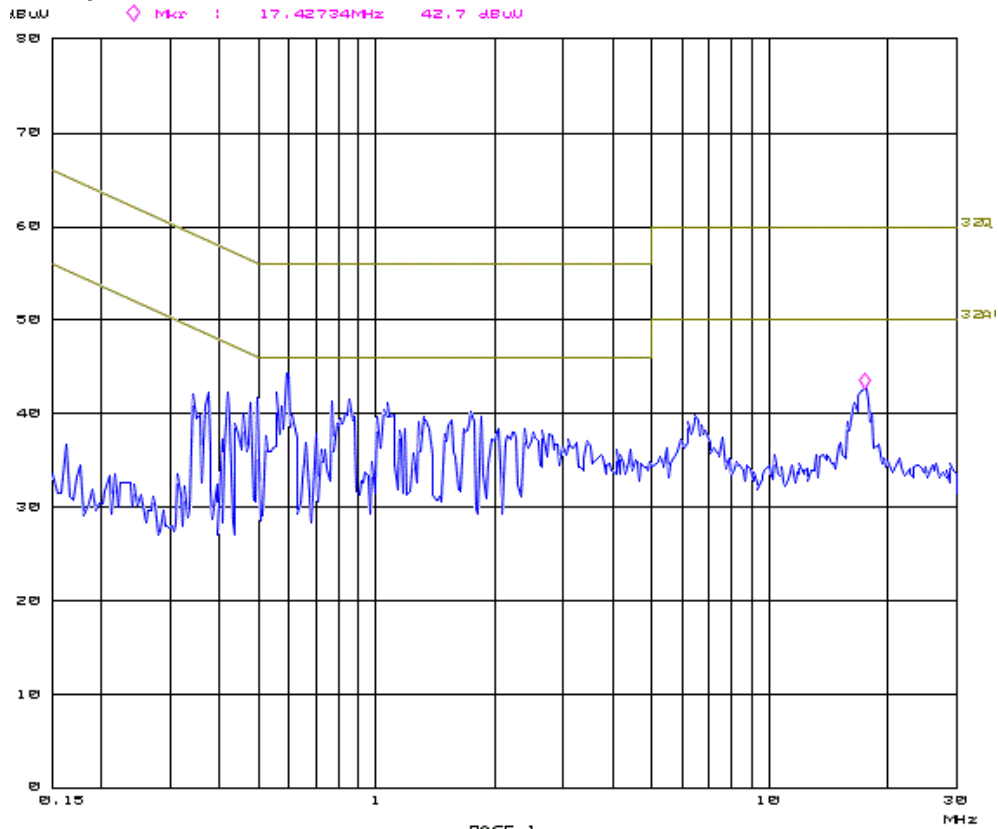
2789421	2790495	2788791	2789124	2788866	2790513	2789211
---------	---------	---------	---------	---------	---------	---------

3.3.7 Photograph test setup

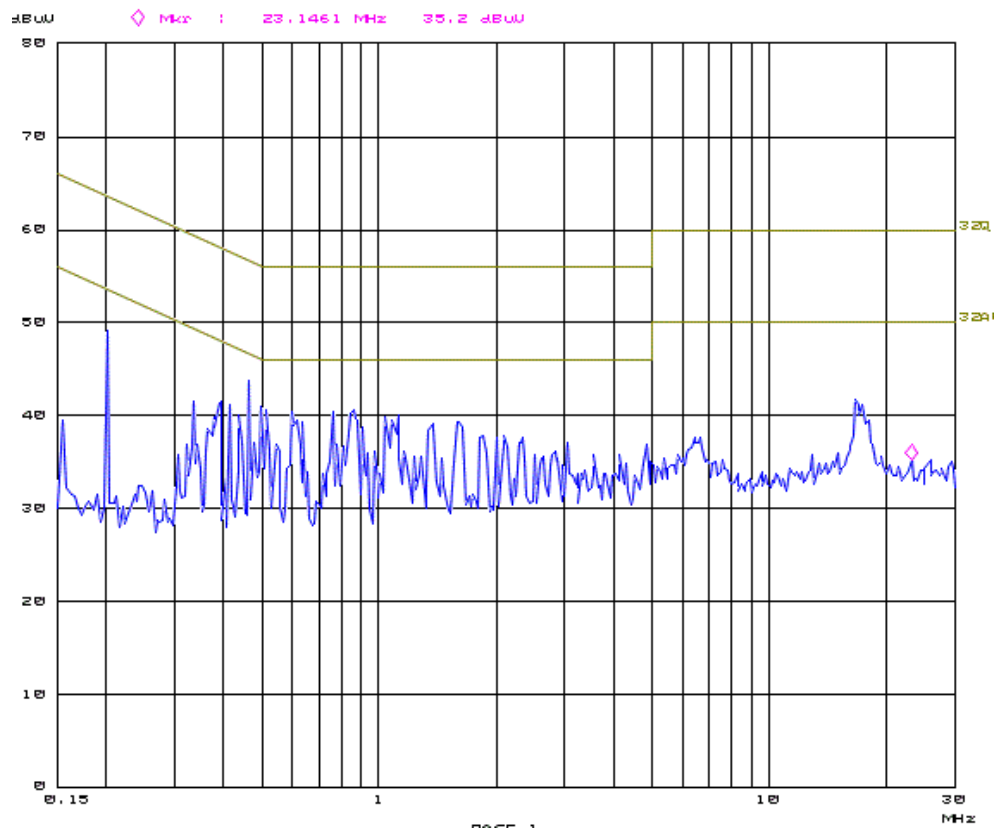


Photo 4: Photograph conducted emissions 0.15-30 MHz

3.3.8 Spectrum plot



Plot 11: Pre-scan plot with peak detector. Conducted emissions from 0.15 - 30 MHz, 5GHz + BT mode



Plot 12: Pre-scan plot with peak detector. Conducted emissions from 0.15 - 30 MHz, 2.4GHz mode

Prufbericht-Nr: 20110201.f01
Test report No: 20110201.f01

Seite 27 von 27
Page 27 of 27

END OF THIS EMC TESTREPORT