

Regulatory WLAN Antenna Information (Template)

English Language Required for Intel Regulatory Review / Approval

(OEM/ODM or antenna vendor is required to complete this document with platform antenna information.

Remove Intel references and make this your own document)

Platform information											
Brand	ODM	****End product model name	Intel platform (ex: Yes, No or NA)	Platform type (ex: regular NB, convertible PC, AIO...etc)	*SAR minimum separation (mm)						
DELL	Compal	P33T	Yes	Convertible PC	197.18						
*****Please fill in exact product model name and make sure the model name is visible on product cover or any parts for end users recognize for authority inspection.											
Antenna information											
Vendor	Type	Antenna Part number (Main)			Antenna Part number (Aux)						
Hong-BO Wireless Communication Technology Co., LTD.	PIFA	260-24347 (DC33002HK0L)			260-24347 (DC33002HK0L)						
Peak gain w/ cable loss (dBi)*											
	2.4GHz 2400-2483.5 MHz	5.2GHz 5150-5250MHz	5.3GHz 5250-5350MHz	5.6GHz 5470-5725MHz	5.8GHz 5725-5850MHz	5.9GHz 5850-5895MHz	6.2GHz 5925-6425MHz	6.5GHz 6425-6525MHz	6.7GHz 6525-6875MHz	7.0 GHz 6875-7125MHz	
Main	1.53	2.19	2.73	3.07	2.52	1.53	N/A	N/A	N/A	N/A	
Aux	2.90	2.50	2.84	3.38	3.38	2.30	N/A	N/A	N/A	N/A	
Intel Reference Gain/Type/ Separation distance											
Antenna Type	Antenna Peak gain (In dBi)*										Distance to the end user (mm)
	2.4GHz 2400-2483.5 MHz	5.2GHz 5150-5250MHz	5.3GHz 5250-5350MHz	5.6GHz 5470-5725MHz	5.8GHz 5725-5850MHz	5.9GHz 5850-5895MHz	6.2GHz 5925-6425MHz	6.5GHz 6425-6525MHz	6.7GHz 6525-6875MHz	7.0GHz 6875-7125MHz	Generic: refer to modular FCC SAR report
Design	3.00	5.00	5.00	5.00	5.00	5.00	5.00	5.00	5.00	5.00	Mid-power: ≥ 8 mm
PIFA	3.24	3.64	3.73	4.77	4.97	4.72	4.83	4.30	5.37	5.59	Low power: ≥ 5 mm
Dipole	2.89	2.92	3.19	4.41	4.22	4.22	4.83	4.30	4.49	5.34	
Notes (marked with *)											
* SAR minimum separation (mm)											
- Regular NB: Minimum antenna-to-body (from antenna bottom to the bottom of the device)											
- Tablet / Convertible PC: Minimum antenna-to-edge (5 sides of the device)											
- Mini-tablet: Minimum antenna-to-edge (6 sides of the device)											
* 3D Peak Antenna gain should be equal or greater than -2 dBi											
- If a host integrator plans to use a lower gain antenna of the same type, additional CBP(FCC)/EDT(EU) testing need to be performed while the module is installed in the host.											

Table of contents

1. Applicable test method
2. Test & System Description
 - a. Test setup
 - b. Equipment list

3. Setup photo

[Section 1. Antenna Assembly Specifications](#)

[Section 2. Dimensioned Photos or Drawings of Antennas](#)

[Section 3. Radiation characteristics of antenna loaded in Host Platform](#)

[Section 4. Antenna Host Platform Location Information](#)

[Section 5. Antenna dimensional information for SAR evaluation](#)

[Section 6. Diagram Example of Co-Location Antenna Separation](#)

1. **Applicable test methods**

This test report is prepared for host antenna testing under a Full Anechoic Chamber.

2. **Test & System Description**

a. Test setup

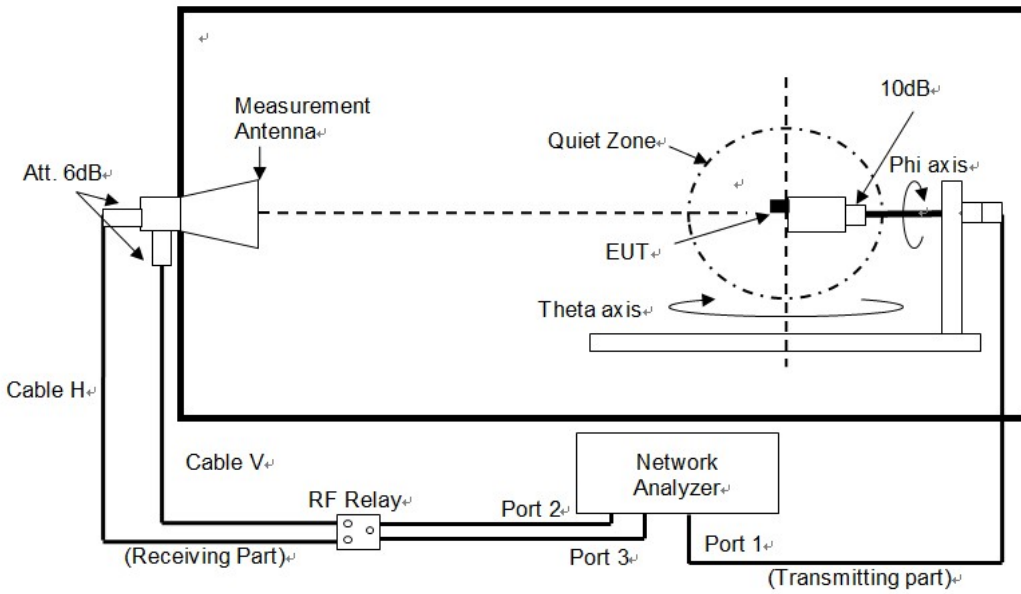

b. Equipment list

OTA03-HY					
Name	Manufacturer	Type/Model	Serial Number	Calibration	
				Last Cal.	Due Date
Anechoic chamber	ETS-Lindgren	AMS-8500	N/A	2022/1/6	2023/1/5
ENA Series Network Analyzer	Keysight	E5080B	MY59101211	2022/5/23	2023/5/22
RF Switch	Keysight	3499A	N/A	N/A	N/A
Multi-Axis Positioner Controller	ETS-Lindgren	2090	N/A	N/A	N/A
Medium-Duty Positioner	ETS-Lindgren	2015	N/A	N/A	N/A
Measurement Horn Antenna	EMCO	Aug-64	86722	2022/1/6	2023/1/6
12GHz SMA(M)-SMA(M)+20core for 60cm RG316DS Cable Assembly	Woken Technology Inc.	RG316DS	N/A	2022/1/6	2023/1/6
12GHz SMA(M)-SMA(M)+30core for 300cm RG316DS Cable Assembly	Woken Technology Inc.	RG316DS	N/A	2022/1/6	2023/1/6

Antenna Information

Section 1. Antenna Assembly Specifications

1A Antenna Part Number	1B Manufacturer	1C Antenna Type	1D Cable Assembly Part Number and Information	Freq Range MHz	1E * Peak Gain W/ Cable loss (dBi)	1F Peak Gain w/o Cable Loss (dBi)	1G Max VSWR	1H Cable Loss (dB)
Main Antenna Compal P/N DC33002HK0L Hong-Bo P/N 260-24347	Hong-Bo Corporation	PIFA	Connector P/N: MHF-B13-N-01 50 ohm Coaxial length: 305 mm Diameter: 1.13mm	2400-2483.5	1.53	2.30	2.5	0.77
				5150-5250	2.19	3.35	2.5	1.16
				5250-5350	2.73	3.91	2.5	1.18
				5470-5725	3.07	4.28	2.5	1.21
				5725-5850	2.52	3.75	2.5	1.23
				5850-5895	1.53	2.76	2.5	1.23
				5925-6425	N/A	N/A	N/A	N/A
				6425-6525	N/A	N/A	N/A	N/A
				6525-6875	N/A	N/A	N/A	N/A
Aux Antenna Compal P/N DC33002HK0L Hong-Bo P/N 260-24347	Hong-Bo Corporation	PIFA	Connector P/N: MHF-B13-N-01 50 ohm Coaxial length: 539 mm Diameter: 1.13mm	2400-2483.5	2.90	4.25	2.5	1.35
				5150-5250	2.50	4.55	2.5	2.05
				5250-5350	2.84	4.92	2.5	2.08
				5470-5725	3.38	5.53	2.5	2.15
				5725-5850	3.38	5.56	2.5	2.18
				5850-5895	2.30	4.48	2.5	2.18
				5925-6425	N/A	N/A	N/A	N/A
				6425-6525	N/A	N/A	N/A	N/A
				6525-6875	N/A	N/A	N/A	N/A
6875-7125	N/A	N/A	N/A	N/A				

- 3D Antenna Peak Gain required being test in system basis.

Section 3. Radiation characteristics of antenna loaded in Host Platform

Main Antenna

Max Antenna 3D Radiation Pattern 2400 – 2483.5 MHz

Frequency (MHz)	Peak Gain w/ Cable Loss (dBi)
2400-2483.5	1.53

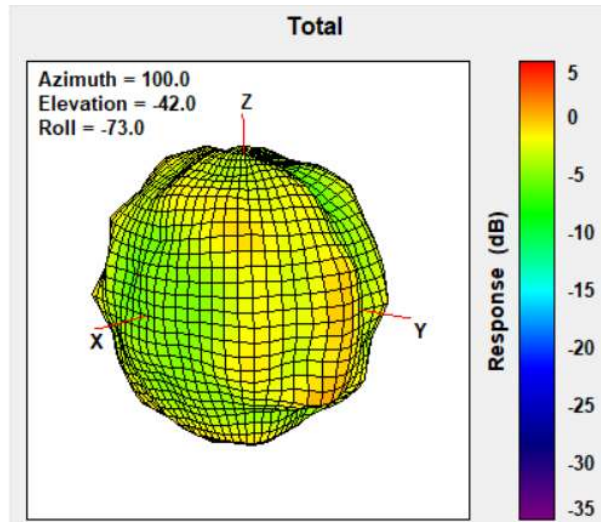

Max Antenna 3D Radiation Pattern 5150-5250 MHz

Frequency (MHz)	Peak Gain w/ Cable Loss (dBi)
5150-5250	2.19

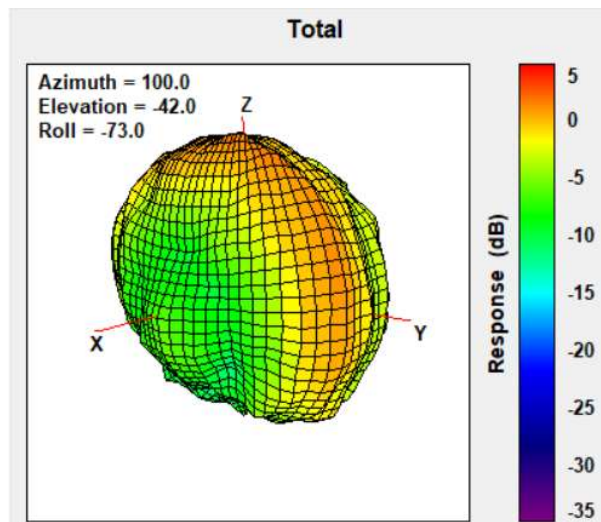

Max Antenna 3D Radiation Pattern 5250-5350 MHz

Frequency (MHz)	Peak Gain w/ Cable Loss (dBi)
5250-5350	2.73

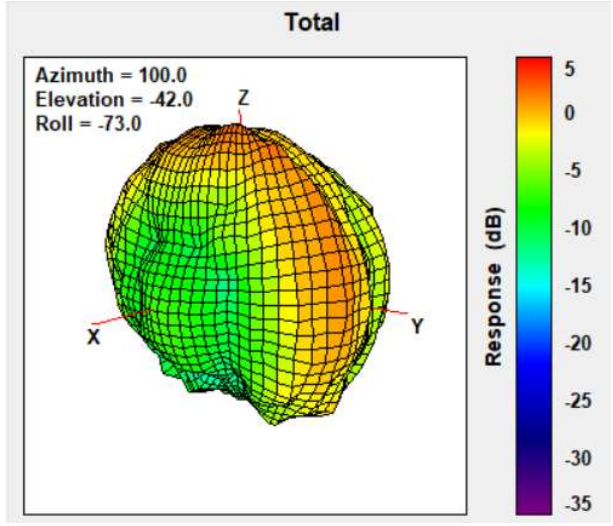

Max Antenna 3D Radiation Pattern 5470-5725 MHz

Frequency (MHz)	Peak Gain w/ Cable Loss (dBi)
5470-5725	3.07

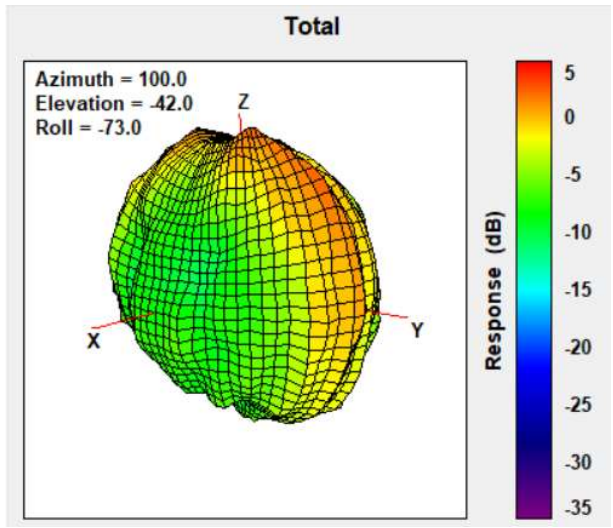

Max Antenna 3D Radiation Pattern 5725-5850 MHz

Frequency (MHz)	Peak Gain w/ Cable Loss (dBi)
5725-5850	2.52

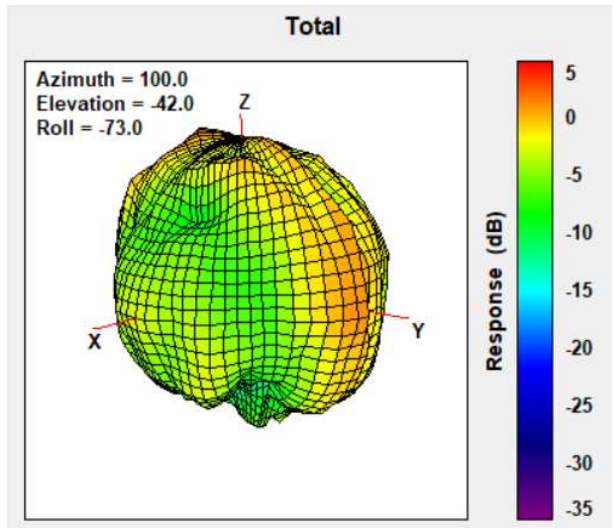

Max Antenna 3D Radiation Pattern 5850-5895 MHz

Frequency (MHz)	Peak Gain w/ Cable Loss (dBi)
5850-5895	1.53

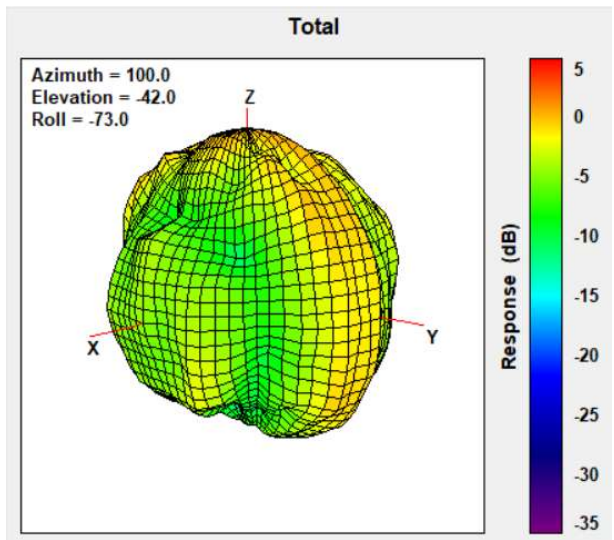

Auxiliary Antenna

Max Antenna 3D Radiation Pattern 2400 – 2483.5 MHz

Frequency (MHz)	Peak Gain w/ Cable Loss (dBi)
2400-2483.5	2.90

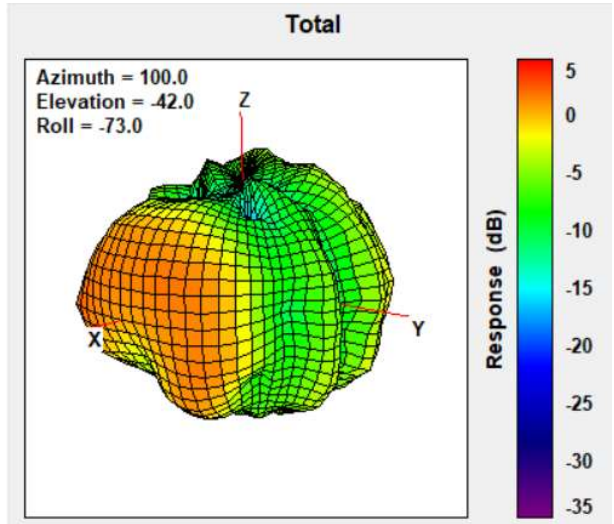

Max Antenna 3D Radiation Pattern 5150-5250 MHz

Frequency (MHz)	Peak Gain w/ Cable Loss (dBi)
5150-5250	2.50

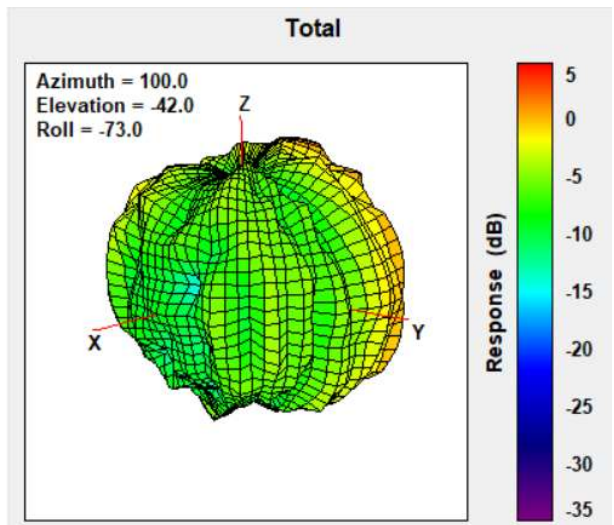

Max Antenna 3D Radiation Pattern 5250-5350 MHz

Frequency (MHz)	Peak Gain w/ Cable Loss (dBi)
5250-5350	2.84

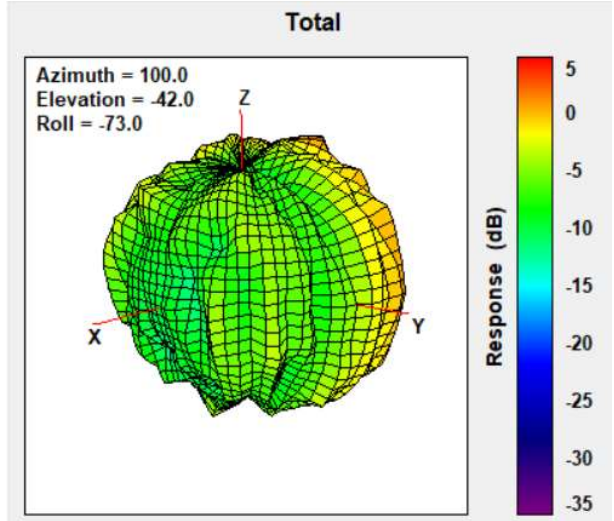

Max Antenna 3D Radiation Pattern 5470-5725 MHz

Frequency (MHz)	Peak Gain w/ Cable Loss (dBi)
5470-5725	3.38

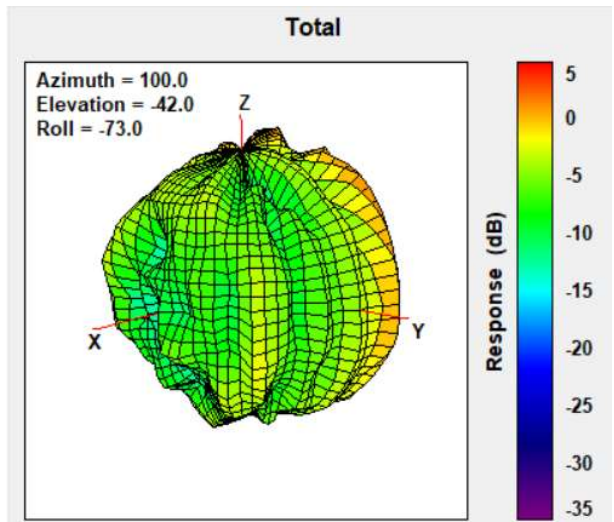

Max Antenna 3D Radiation Pattern 5725-5850 MHz

Frequency (MHz)	Peak Gain w/ Cable Loss (dBi)
5725-5850	3.38

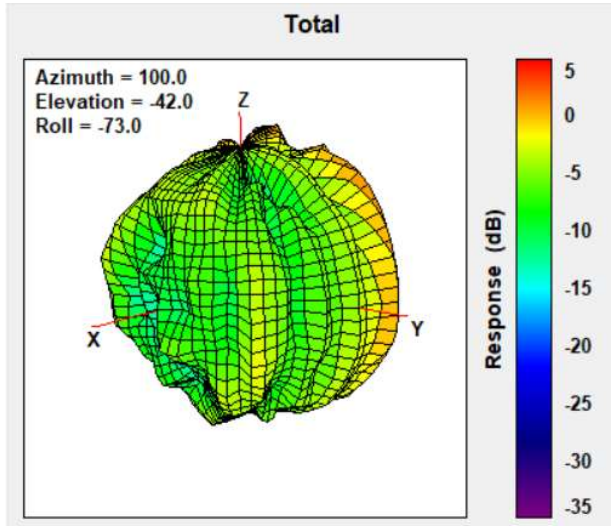

Max Antenna 3D Radiation Pattern 5850-5895 MHz

Frequency (MHz)	Peak Gain w/ Cable Loss (dBi)
5850-5895	2.30

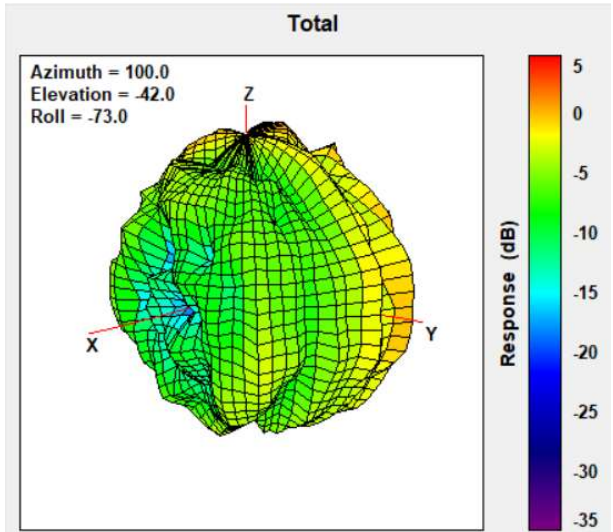

Revision History

Revision	Description	Date
10.3	<u>Page2-5</u> Add Applicable test method, Test & System Description and Setup photo	July 24, 2022
10.4	<u>Cover page</u> Add Intel 5.9GHz reference antenna gain <u>Cover page/Section1/Section3</u> Add 5.9GHz antenna gain information	September 15, 2022