

# TEST REPORT

EUT Description	<b>WLAN and BT, 1x1 PCIe M.2 1216 SD adapter card</b>
Brand Name	<b>Intel® Wireless-AC 9461</b>
Model Name	<b>9461D2W</b>
FCC ID	<b>PD99461D2</b>
ISED ID	<b>1000M-9461D2</b>
Date of Test Start/End	<b>2017-07-28 / 2017-09-20</b>
Features	<b>802.11 a/b/g/n/ac Wireless LAN + Bluetooth 5</b> (see section 5)

Applicant	<b>Intel Mobile Communications</b>
Address	<b>100 Center Point Circle, Suite 200 Columbia, South Carolina 29210 USA</b>
Contact Person	<b>Steven Hackett</b>
Telephone/Fax/ Email	<b>steven.c.hackett@intel.com</b>

Reference Standards	<b>FCC CFR Title 47 Part 15 E RSS-247 issue 2, RSS-Gen issue 4</b> (see section 1)
---------------------	---

Test Report identification	<b>170727-02.TR02</b>
Revision Control	<b>Rev. 01 This test report revision replaces any previous test report revision</b> (see section 8)

The test results relate only to the samples tested.  
The test report shall not be reproduced in full, without written approval of the laboratory.

Issued by \_\_\_\_\_

Reviewed by \_\_\_\_\_

Gregory ROUSTAN  
(Test Engineer Lead)

Olivier FARGANT  
(Technical Manager)

**Intel Mobile Communications France S.A.S – WRF Lab  
425 rue de Goa – Le Cargo B6 - 06600, Antibes, France  
Tel. +33493001400 / Fax +33493001401**

# Table of Contents

---

<b>1. Standards, reference documents and applicable test methods</b>	<b>3</b>
<b>2. General conditions, competences and guarantees</b>	<b>3</b>
<b>3. Environmental Conditions</b>	<b>3</b>
<b>4. Test samples</b>	<b>4</b>
<b>5. EUT Features</b>	<b>4</b>
<b>6. Remarks and comments</b>	<b>4</b>
<b>7. Test Verdicts summary</b>	<b>5</b>
7.1. 802.11 A/N/AC – U-NII-2C	5
<b>8. Document Revision History</b>	<b>5</b>
<b>Annex A. Test &amp; System Description</b>	<b>6</b>
A.1 MEASUREMENT SYSTEM	6
A.2 TEST EQUIPMENT LIST	9
A.3 MEASUREMENT UNCERTAINTY EVALUATION	11
<b>Annex B. Test Results U-NII-2C</b>	<b>12</b>
B.1 TEST CONDITIONS	12
B.2 TEST RESULTS TABLES	13
B.2.1 26dB & 99% Bandwidth	13
B.2.2 Power Limits. Maximum Output power & Maximum power spectral Density	16
B.2.3 Undesirable emission limits : Band Edge (Conducted)	21
B.2.4 Radiated spurious emission	23
B.2.5 AC power-line conducted emission	33
B.3 TEST RESULTS SCREENSHOTS	37
B.3.1 26dB Bandwidth	37
B.3.2 99% Bandwidth	39
B.3.3 Maximum Output Power & Maximum power spectral Density	41
B.3.4 Undesirable emission limits : Band Edge (Conducted)	45
<b>Annex C. Photographs</b>	<b>53</b>
C.1 TEST SETUP	53
C.1.1 Test Sample	56

## 1. Standards, reference documents and applicable test methods

1. FCC 47 CFR part 15 – Subpart E – Unlicensed National Information Infrastructure Devices.
2. FCC 47 CFR part 15 - Subpart C – §15.207 Conducted emission limits.
3. FCC 47 CFR part 15 - Subpart C – §15.209 Radiated emission limits; general requirements.
4. FCC OET KDB 789033 D02 General U-NII Test Procedures New Rules v01r04 – Guidelines for compliance testing of Unlicensed National Information Infrastructure (U-NII) Devices (Part 15, Subpart E)
5. FCC OET KDB 644545 D03 Guidance for IEEE 802.11ac v01 - GUIDANCE FOR IEEE Std 802.11ac™ DEVICES EMISSION TESTING.
6. ANSI C63.10-2013 American National Standard of Procedures for Compliance Testing of Unlicensed Wireless Devices.
7. RSS-247 Issue 2 - Digital Transmission Systems (DTSS), Frequency Hopping Systems (FHSs) and Licence-Exempt Local Area Network (LE-LAN) Devices.
8. RSS-Gen Issue 4 - General Requirements for Compliance of Radio Apparatus.

## 2. General conditions, competences and guarantees

- ✓ Intel Mobile Communications France SAS Wireless RF Lab (Intel WRF Lab) is an ISO/IEC 17025:2005 testing laboratory accredited by the American Association for Laboratory Accreditation (A2LA) with the certificate number 3478.01.
- ✓ Intel Mobile Communications France SAS Wireless RF Lab (Intel WRF Lab) is an Accredited Test Firm recognized by the FCC, with Designation Number FR0011.
- ✓ Intel Mobile Communications France SAS Wireless RF Lab (Intel WRF Lab) is a Registered Test Site listed by ISED, with ISED Assigned Code 1000Y.
- ✓ Intel WRF Lab only provides testing services and is committed to providing reliable, unbiased test results and interpretations.
- ✓ Intel WRF Lab is liable to the client for the maintenance of the confidentiality of all information related to the item under test and the results of the test.
- ✓ Intel WRF Lab has developed calibration and proficiency programs for its measurement equipment to ensure correlated and reliable results to its customers.
- ✓ This report is only referred to the item that has undergone the test.
- ✓ This report does not imply an approval of the product by the Certification Bodies or competent Authorities.

## 3. Environmental Conditions

- ✓ At the site where the measurements were performed the following limits were not exceeded during the tests:

Temperature	22°C ± 1°C
Humidity	55% ± 14%

#### 4. Test samples

Sample	Control #	Description	Model	Serial #	Date of receipt	Note
#01	170727-02.S01	Module	9461D2W	WFM 3413E86B17D7	2017-07-28	Used for conducted tests
	170524-02.S15	Extender Board	PCB00609_01	6092416-442	2017-05-30	
	170220-04.S04	Adapter 1216SD to M.2	JfP Adapter M2	N/A	2017-04-10	
	170000-01.S04	Laptop	Latitude E5470	DMRKMC2	2017-05-10	
#02	170727-02.S05	Module	9461D2W	WFM 3413E86B1809	2017-07-21	Used for radiated tests
	170727-02.S11	Adapter 1216SD to M.2	JfP Adapter M2	N/A	2017-08-09	
	170220-02.S03	Extender Board	PCB00609_01	6092416-446	2017-02-20	
	170000-01.S13	Laptop	Latitude E5470	FT6LMC2	2017-04-25	
#03	170727-02.S02	Module	9461D2W	WFM 3413E86B181D	2017-07-28	Used for AC power-line conducted emission measurements
	170524-02.S13	Extender Board	PCB00609_01	6092416-418	2017-02-20	
	170000-01.S02	Laptop	Latitude E5470	21HTPF2	2017-04-25	
	170727-02.S12	Adapter 1216SD to M.2	JfP Adapter M2	N/A	2017-08-09	

#### 5. EUT Features

Brand Name	Intel® Wireless-AC 9461	
Model Name	9461D2W	
FCC/IC ID	PD99461D2	
ISED ID	1000M-9461D2	
Software Version	10.1731.0-05646	
Driver Version	99.0.28.6	
Prototype / Production	Production	
Supported Radios	802.11b/g/n	2.4GHz (2400.0 – 2483.5 MHz)
	802.11a/n/ac	5.2GHz (5150.0 – 5350.0 MHz) 5.6GHz (5470.0 – 5725.0 MHz) 5.8GHz (5725.0 – 5850.0 MHz)
	Bluetooth 5	2.4GHz (2400.0 – 2483.5 MHz)
Antenna Information	<b>WLAN/BT:</b> Slot antenna. WiFi 2.4GHz & 5GHz and BT (DRTU CHAIN A)	

#### 6. Remarks and comments

N/A

## 7. Test Verdicts summary

### 7.1. 802.11 a/n/ac – U-NII-2C

FCC part	RSS part	Test name	Verdict
15.407 (a) (2)	RSS-247 Clause 6.2.3.1	Power Limits. Maximum output power	P
15.407 (a) (2)	RSS-247 Clause 6.2.3.1	Peak power spectral density	P
15.407 (b) (3) 15.209 (a)	RSS-247 Clause 6.2.3.2 RSS-GEN Clause 8.9	Undesirable emissions limits: Band Edge (conducted)	P
15.407 (b) (3) 15.209 (a)	RSS-247 Clause 6.2.3.2 RSS-GEN Clause 8.9	Undesirable emissions limits (radiated)	P
15.407 (6) 15.207	RSS-GEN Clause 8.8	AC power-line conducted emission measurements	P

## 8. Document Revision History

Revision #	Date	Modified by	Revision Details
Rev. 00	2017-09-11	ASayoud	First Issue
Rev. 01	2017-09-19	ZOuachicha	Data update for 802.11a & 802.11n20 on Ch120

# Annex A. Test & System Description

## A.1 Measurement System

Measurements were performed using the following setups, made in accordance to the general provisions of FCC KDB 789033 D02 General UNII Test Procedures.

The DUT was installed in a test fixture and this test fixture is connected to a laptop computer and AC/DC power adapter. The laptop computer was used to configure the EUT to continuously transmit at a specified output power using all different modes and modulation schemes, using the Intel proprietary tool DRTU.

### Conducted Setup

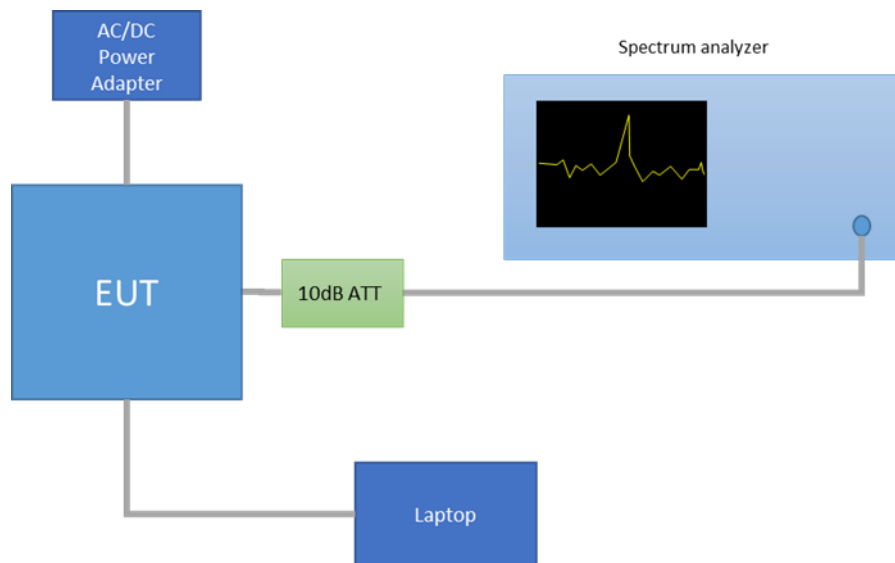

### Radiated Setup < 1GHz

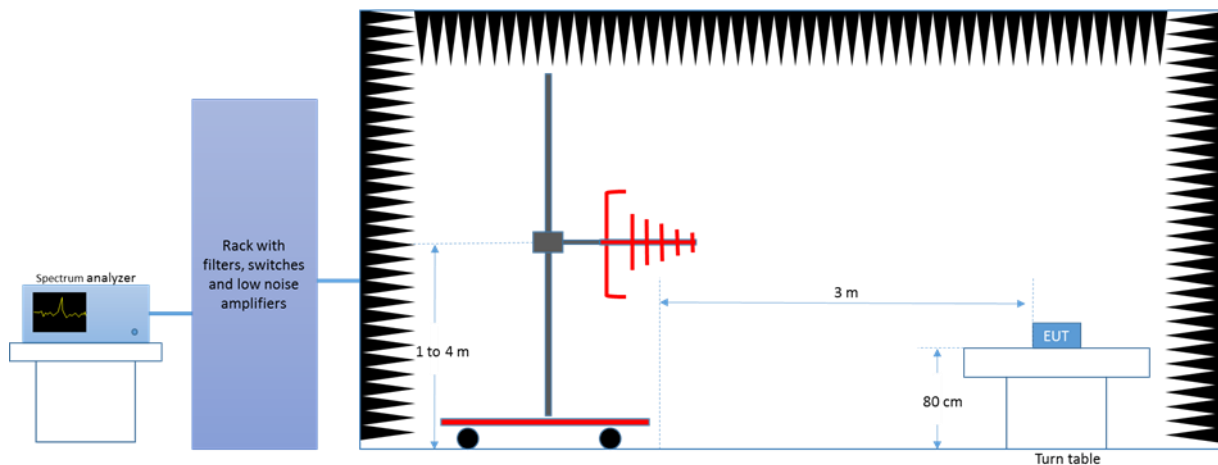

*Radiated Setup 1 GHz – 18 GHz*

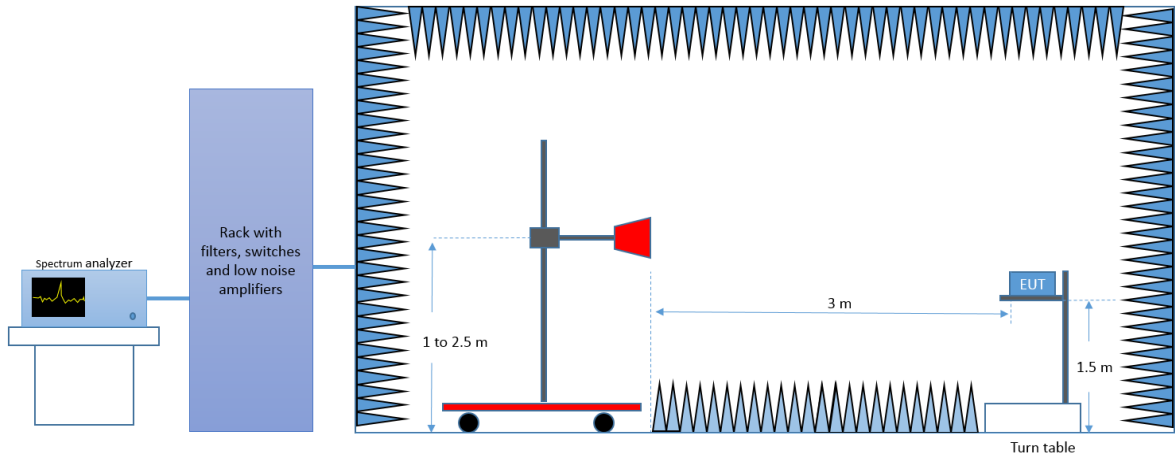

*Radiated Setup 18 GHz – 40 GHz*

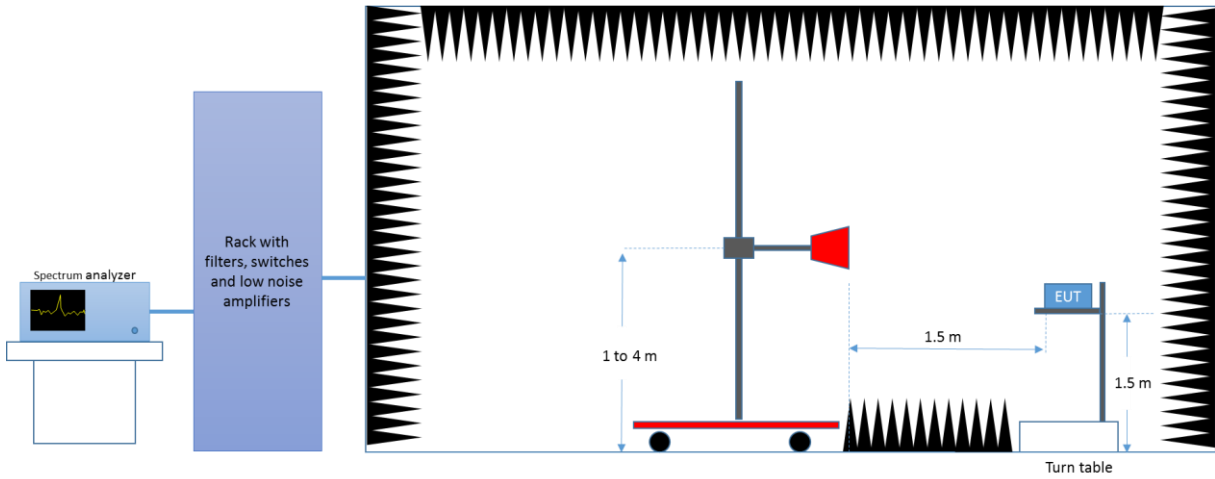

*AC power-line conducted emission Setup 150 kHz – 30 MHz*

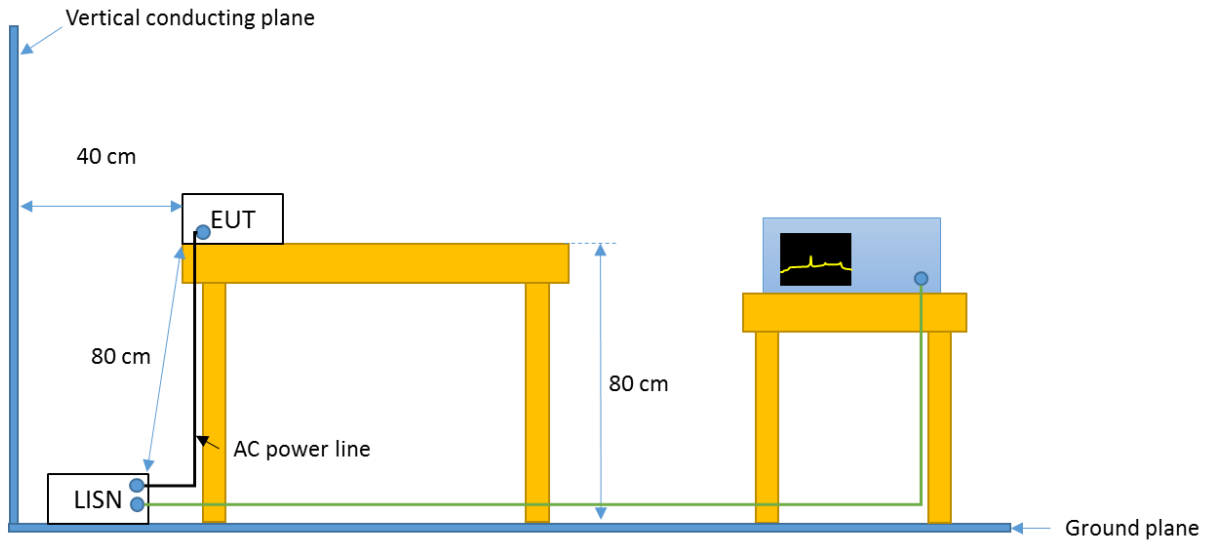



## A.2 Test Equipment List

### Conducted Setup

ID#	Device	Type/Model	Serial #	Manufacturer	Cal. Date	Cal. Due Date
0316	Spectrum analyzer	FSV30	103309	Rohde & Schwarz	2017-01-30	2019-01-30
0318	Spectrum analyzer	FSV30	103310	Rohde & Schwarz	2016-09-19	2018-09-19

### Radiated Setup-1

ID#	Device	Type/Model	Serial #	Manufacturer	Cal. Date	Cal. Due Date
0133	Spectrum analyzer	FSV40	101358	Rohde & Schwarz	2016-04-15	2018-04-15
0137	Log antenna 30 MHz – 1 GHz	3142E	00156946	ETS Lindgren	2015-12-11	2017-12-11
0139	Horn Antenna 18 GHz - 26.5 GHz	114514	00167100	ETS Lindgren	2016-03-16	2018-03-16
0140	Horn Antenna 26.5 GHz - 40 GHz	120722	00169638	ETS Lindgren	2016-07-26	2018-07-26
0135	Semi Anechoic chamber	FACT 3	5720	ETS Lindgren	2016-04-28	2018-04-28
0530	Measurement Software	EMC32	100623	Rohde & Schwarz	N/A	N/A
0296	Power Supply	6673A	MY41000318	Agilent	N/A	N/A
0346	Multimeter	34401A	US36054685	HP	2016-02-04	2018-02-04

### Radiated Setup-2

ID#	Device	Type/Model	Serial #	Manufacturer	Cal. Date	Cal. Due Date
0420	Spectrum analyzer	FSV40	101556	Rohde & Schwarz	2016-04-15	2018-04-15
0138	Horn antenna 1 GHz – 6.4 GHz	3117	00152266	ETS Lindgren	2016-03-14	2018-03-14
0141	Double Ridge Horn Antenna 1 GHz – 18 GHz	3117	00157736	ETS Lindgren	2016-04-13	2018-04-13
0409	PreAmplifier	3117-PA	00157993	ETS Lindgren	N/A	N/A
0337	Full Anechoic chamber	RFD_FA_100	5996	ETS Lindgren	2016-04-28	2018-04-28
0329	Measurement Software	EMC32	100401	Rohde & Schwarz	N/A	N/A

N/A: Not Applicable

### Radiated Setup - shared equipments

ID#	Device	Type/Model	Serial #	Manufacturer	Cal. Date	Cal. Due Date
0014	Power Sensor	NRP-Z57	101280	Rohde & Schwarz	2017-04-25	2019-04-25

N/A: Not Applicable

## AC power-line conducted emission Setup

ID#	Device	Type/Model	Serial Number	Manufacturer	Cal. Date	Cal. Due Date
0027	Measurement software	EMC32	1300.7010.02	Rohde & Schwarz	NA	NA
0317	Spectrum Analyzer	FSV30	103308	Rohde & Schwarz	2017-08-05	2019-08-05
0532	LISN	ENV216	101321	Rohde & Schwarz	2016-09-13	2018-09-13
0607	LISN	ENV216	101342	Rohde & Schwarz	2017-09-06	2018-09-06
0538	Transformer	Monophase	TIMM3.15	Montelem	NA	NA
0095	Millivoltmeter	2000	4009301	KEITHLEY	2015-10-26	2017-10-26
0624	AC power source	61604	SM135546	CHROMA	NA	NA
0346	Multimeter	34401A	US36054685	HP	2016-02-04	2018-02-04

N/A: Not Applicable

### A.3 Measurement Uncertainty Evaluation

The system uncertainty evaluation is shown in the below table:

Measurement type	Uncertainty [ $\pm$ dB]
Conducted Power	$\pm 1.0$
Conducted Spurious Emission	$\pm 2.9$
Radiated tests <1GHz	$\pm 3.8$
Radiated tests 1GHz - 40 GHz	$\pm 4.7$
AC power-line conducted emission	$\pm 1.45$

# Annex B. Test Results U-NII-2C

## B.1 Test Conditions

The conducted RF output power at chain A was adjusted according to the client's supplied Target values (see following table) using the Intel DRTU tool and measuring the power by using a spectrum analyser with the channel integration method according to point II) E) 2) e) (Method SA-2 Alternative) of Guidance 789033 D02. Measured values for adjustment were within +/- 0.25 dB from the declared Target values.

U-NII-2C					Conducted Power Target Value (dBm)
Mode	BW (MHz)	Data Rate	CH #	Freq. (MHz)	SISO Chain A
802.11a	20	6Mbps	100	5500	19.00
			120	5600	21.00
			140	5700	19.50
802.11n	20	HT0	100	5500	19.50
			120	5600	21.00
			140	5700	19.00
	40	HT0	102F	5510	17.50
			118F	5590	20.50
			134F	5670	19.00
802.11ac	80	VHT0	106ac80	5530	18.00
			122ac80	5610	20.00

Overlapped channels between UNII-2C and UNII-3					Conducted Power Target Value (dBm)
Mode	BW (MHz)	Data Rate	CH #	Freq. (MHz)	SISO Chain A
802.11n	20	HT0	144	5720	21.00
	40	HT0	142F	5710	21.00
802.11ac	80	VHT0	138ac80	5690	20.50

The following data rates were selected based on preliminary testing that identified those rates as the worst cases for output power and spurious levels at the band edges:

- 802.11a → 6Mbps
- 802.11n20 and 802.11n40 (SISO) → HT0
- 802.11ac80 (SISO) → VHT0

Alternative channels to the lowest and highest channels per band have been also tested for Band Edge compliance.

## B.2 Test Results Tables

### B.2.1 26dB & 99% Bandwidth

#### Test procedure

The setup below was used to measure the 26dB & 99% Bandwidth. The antenna terminal of the EUT is connected to the spectrum analyzer through an attenuator, and the spectrum analyzer reading is compensated to include the RF path loss.

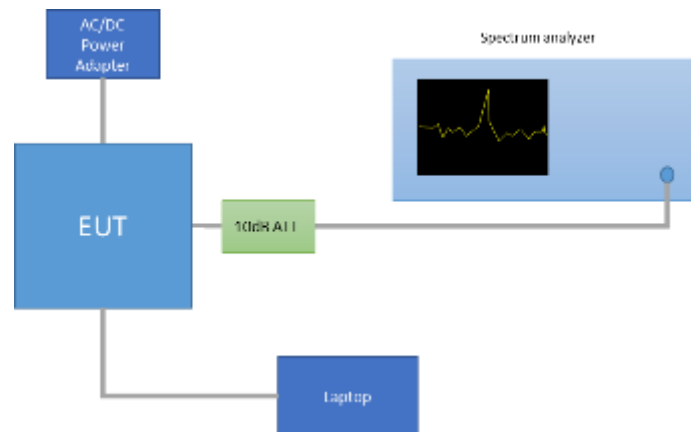

For the overlapped channels between U-NII-2C and U-NII-3 bands, and according to FCC KDB 644545 D03, the boundary frequency between the bands is used as one edge for defining the portion of the 26dB bandwidth that falls within a particular U-NII band. This rule is only applicable for the 26dB bandwidth and for those channels marked as overlapped.

**Results tables**
**U-NII-2C channels**

Mode	Rate	Antenna	Channel	Frequency [MHz]	26dB BW [MHz]	99% BW [MHz]
802.11a	6Mbps	SISO CHAIN A	100	5500	24.82	16.84
			120	5600	27.38	18.96
			140	5700	24.72	16.84
802.11n20	HT0		100	5500	25.43	17.92
			120	5600	29.68	18.24
			140	5700	25.28	17.96
802.11n40	HT0		102F	5510	45.05	36.56
			118F	5590	46.66	36.72
			134F	5670	46.22	36.72
802.11ac80	VHT0		106ac80	5530	84.83	75.00
			122ac80	5610	86.54	75.12

**Max Value**

**Overlapped channels between U-NII-2C and U-NII-3**

Mode	Rate	Antenna	Channel	Freq. [MHz]	26dB BW UNII-2C [MHz]
802.11n20	HT0	SISO CHAIN A	144	5720	17.47
802.11n40	HT0	SISO CHAIN A	142F	5710	38.53
802.11ac80	VHT0	SISO CHAIN A	138ac80	5690	78.60

**Max Value**

**See Section B.3.1 and Section B.3.2 for the screenshot results.**

## B.2.2 Power Limits. Maximum Output power & Maximum power spectral Density

### Test limits

Part	Limits
FCC 15.407 (a) (2)	For the 5.25–5.35 GHz and 5.47–5.725 GHz bands, the maximum conducted output power over the frequency bands of operation shall not exceed the lesser of 250 mW or 11 dBm + 10 log B, where B is the 26 dB emission bandwidth in megahertz. In addition, the peak power spectral density shall not exceed 11 dBm in any 1 megahertz band.
RSS-247 Clause 6.2.3 (1)	The maximum conducted output power shall not exceed 250 mW or 11 + 10 log <sub>10</sub> B, dBm, whichever is less. The power spectral density shall not exceed 11 dBm in any 1.0 MHz band.  The maximum e.i.r.p. shall not exceed 1.0 W or 17 + 10 log <sub>10</sub> B, dBm, whichever is less. B is the 99% emission bandwidth in megahertz. Note that devices with a maximum e.i.r.p. greater than 500 mW shall implement TPC in order to have the capability to operate at least 6 dB below the maximum permitted e.i.r.p. of 1 W.

### Test procedure

The Maximum Conducted Output Power was measured using the channel integration method according to point E) 2) e) (Method SA-2 Alternative) of KDB 789033 D02.

The maximum power spectral density (PSD) was measured using the method according to point F) (Method SA-2 Alternative) of KDB 789033 D02.

The EIRP power (dBm) is calculated by adding the declared maximum antenna gain to the measured conducted power.

The setup below was used to measure the maximum conducted output power and power spectral density. The antenna terminal of the EUT is connected to the spectrum analyzer through an attenuator, and the spectrum analyzer reading is compensated to include the RF path loss.

The declared maximum antenna gain is 5dBi.

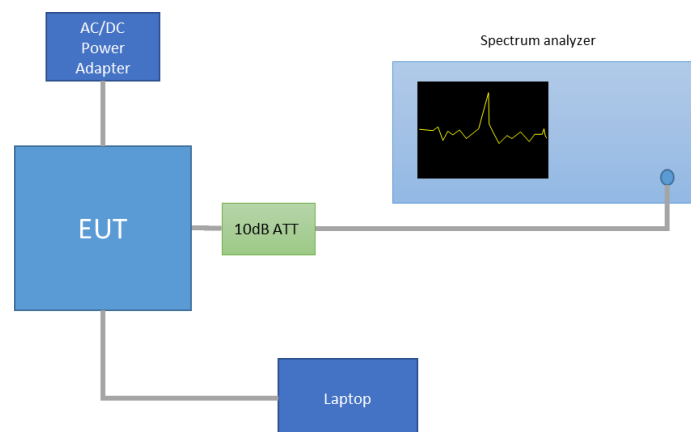

For the overlapped channels between U-NII-2C and U-NII-3, and according to FCC KDB 644545 D03, the power is computed based on the portion of the emission bandwidth contained within that band. This rule is only applicable for those channels marked as overlapped



Results tables
Duty cycle

Mode	Rate	Antenna	Transmission Duration [ms]	Transmission Period [ms]	Duty Cycle [%]
802.11a	6Mbps	SISO-A	2.036	2.071	98.31%
802.11n20	HT0	SISO-A	1.894	1.929	98.19%
802.11n40	HT0	SISO-A	0.937	0.969	96.70%
802.11ac80	VHT0	SISO-A	0.458	0.493	92.90%

Maximum output power – U-NII-2C Channels

Mode	Rate	Channel	Freq. [MHz]	Antenna	Average Conducted Output Power [dBm]	Maximum* Conducted Output Power [dBm]	Maximum* Conducted Output Power [mW]	Max of EIRP [dBm]
802.11a	6Mbps	100	5500	SISO CHAIN A	19.12	19.12	<b>81.66</b>	24.12
		120	5600	SISO CHAIN A	21.12	21.12	<b>129.42</b>	26.12
		140	5700	SISO CHAIN A	19.25	19.25	84.14	24.25
802.11n20	HT0	100	5500	SISO CHAIN A	19.62	19.62	91.62	24.62
		120	5600	SISO CHAIN A	20.99	20.99	<b>125.60</b>	25.99
		140	5700	SISO CHAIN A	18.91	18.91	<b>77.80</b>	23.91
802.11n40	HT0	102F	5510	SISO CHAIN A	17.16	17.35	<b>54.33</b>	22.35
		118F	5590	SISO CHAIN A	20.47	20.66	<b>116.42</b>	25.66
		134F	5670	SISO CHAIN A	18.92	19.11	81.48	24.11
802.11ac80	VHT0	106ac80	5610	SISO CHAIN A	17.82	18.14	<b>65.11</b>	23.14
		122ac80	5570	SISO CHAIN A	19.48	19.80	<b>95.42</b>	24.80

\* Maximum values are the duty cycle compensated values calculated from the average (measured) values

**Max Value**

**Min Value**

## Maximum output power – Overlapped channels between U-NII-2C and U-NII-3

Mode	Rate	Channel	Freq. [MHz]	Antenna	Average Cond. Output Power - UNII-2C [dBm]	Max.* Cond. Output Power - UNII-2C [dBm]	Max.* Cond. Output Power - UNII-2C [mW]	Max.* EIRP UNII2C [dBm]
802.11n20	HT0	144	5720	SISO CHAIN A	19.15	19.23	<b>83.78</b>	24.23
802.11n40	HT0	142F	5710	SISO CHAIN A	20.26	20.45	<b>110.92</b>	25.45
802.11ac80	VHT0	138ac80	5690	SISO CHAIN A	20.01	20.33	<b>107.81</b>	25.33

\* Maximum values are the duty cycle compensated values calculated from the measured average values

**Max Value**

**Min Value**

Maximum Power Spectral Density (PSD) – U-NII-2C channels

Mode	Rate	Channel	Freq. [MHz]	Antenna	Average conducted PSD [dBm/MHz]	Maximum* conducted PSD [dBm/MHz]
802.11a	6Mbps	100	5500	SISO CHAIN A	7.52	7.52
		120	5600	SISO CHAIN A	9.30	9.30
		140	5700	SISO CHAIN A	7.52	7.52
802.11n20	HT0	100	5500	SISO CHAIN A	7.71	7.71
		120	5600	SISO CHAIN A	8.98	8.98
		140	5700	SISO CHAIN A	6.96	6.96
802.11n40	HT0	102F	5510	SISO CHAIN A	2.20	2.39
		118F	5590	SISO CHAIN A	5.42	5.61
		134F	5670	SISO CHAIN A	3.84	4.03
802.11ac80	VHT0	106ac80	5610	SISO CHAIN A	0.45	0.77
		122ac80	5570	SISO CHAIN A	1.56	1.88

\* Maximum values are the duty cycle compensated values calculated from the average (measured) values

**Maximum Power Spectral Density (PSD) – Overlapped channels between U-NII-2C and U-NII-3**

Mode	Rate	Channel	Freq. [MHz]	Antenna	Average Cond. Output Power - UNII-2C [dBm]	Max.* Cond. Output Power - UNII-2C [dBm]
802.11n20	HT0	144	5720	SISO CHAIN A	8.18	8.26
802.11n40	HT0	142F	5710	SISO CHAIN A	5.57	5.76
802.11ac80	VHT0	138ac80	5690	SISO CHAIN A	2.73	3.05

\* Maximum values are the duty cycle compensated values calculated from the average (measured) values

**See Section B.3.3 for the screenshot results.**

### B.2.3 Undesirable emission limits : Band Edge (Conducted)

#### Test limits

FCC part	RSS part	Limits																				
15.407 (b) (3)	RSS-247 Clause 6.2.3 (2)	For transmitters operating in the 5.47–5.725 GHz band: all emissions outside of the 5.47–5.725 GHz band shall not exceed an EIRP of -27 dBm/MHz.																				
15.209	RSS-GEN, Clause 8.9	<p>Radiated emissions which fall in the restricted bands, as defined in §15.205(a), must also comply with the radiated emission limits specified in §15.209(a):</p> <table border="1"> <thead> <tr> <th>Freq Range (MHz)</th> <th>Field Strength (<math>\mu\text{V}/\text{m}</math>)</th> <th>Field Strength (<math>\text{dB}\mu\text{V}/\text{m}</math>)</th> <th>Meas. Distance (m)</th> </tr> </thead> <tbody> <tr> <td>30-88</td> <td>100</td> <td>40</td> <td>3</td> </tr> <tr> <td>88-216</td> <td>150</td> <td>43.5</td> <td>3</td> </tr> <tr> <td>216-960</td> <td>200</td> <td>46</td> <td>3</td> </tr> <tr> <td>960-25000</td> <td>500</td> <td>54</td> <td>3</td> </tr> </tbody> </table> <p>The emission limits shown in the table above are based on measurements employing CISPR quasi-peak detector except for the frequency bands 9-90 kHz, 110-490 kHz and above 1000 MHz. Radiated emission limits in these three bands are based on measurements employing an average detector.</p> <p>For average radiated emission measurements above 1000 MHz, there is also a limit specified when measuring with peak detector function, corresponding to 20 dB above the indicated values in the table.</p>	Freq Range (MHz)	Field Strength ( $\mu\text{V}/\text{m}$ )	Field Strength ( $\text{dB}\mu\text{V}/\text{m}$ )	Meas. Distance (m)	30-88	100	40	3	88-216	150	43.5	3	216-960	200	46	3	960-25000	500	54	3
Freq Range (MHz)	Field Strength ( $\mu\text{V}/\text{m}$ )	Field Strength ( $\text{dB}\mu\text{V}/\text{m}$ )	Meas. Distance (m)																			
30-88	100	40	3																			
88-216	150	43.5	3																			
216-960	200	46	3																			
960-25000	500	54	3																			

#### Test procedure

The setup below was used to measure undesirable emissions on the Band Edge domain. The antenna terminal of the EUT is connected to the spectrum analyzer through an attenuator, and the spectrum analyzer reading is compensated to include the RF path loss and the declared Antenna Gain.

For Band Edge measurements in average mode on the low frequency section, the Video Bandwidth Method was used according to section G) 6) (KDB 789033 D02), with the following parameters:

- When the duty cycle is  $> 98\%$ ,  $\text{VBW} = 10\text{Hz}$
- When the duty cycle is  $< 98\%$ ,  $\text{VBW} > 1/T$ , where T is defined in section II.B.1.a

For the BE High, we use the integration method as defined in the band edge measurements section (paragraph II.G.3.d) of KDB 789033 D02.

In case of Band Edge measurements falling in restricted bands, the declared Antenna Gain is also compensated in the graph.

The declared maximum antenna gain is 5dBi.

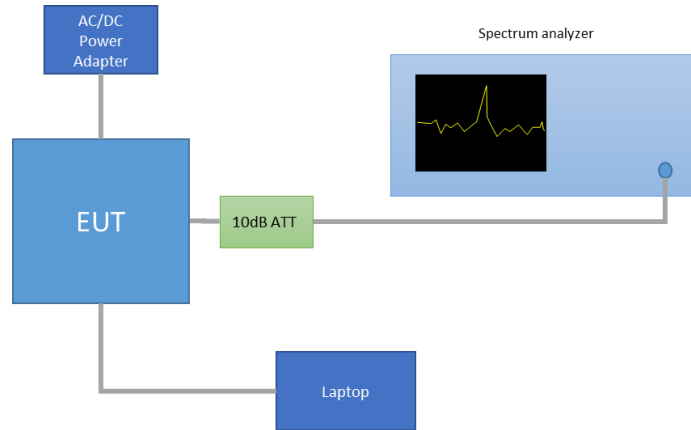

The following limits in dBm were applied for the average detector after the conversion from the limits detailed above in dBμV/m, according to FCC 47 CFR part 15 - Subpart C – §15.209(a). The limits in dBm for peak detector are 20dB above the indicated values in the table.

§15.209(a)			Converted values	
Freq Range (MHz)	Distance (m)	Field strength (microvolts/meter)	Field strength (dB microvolts/meter)	Power (dBm)
960-25000	3	500	53.98	-41.25

See Section B.3.4 for the screenshot results.

## B.2.4 Radiated spurious emission

### Standard references

FCC part	RSS part	Limits																									
15.407 (b) (3)	RSS-247 Clause 6.2.3 (2)	For transmitters operating in the 5.47–5.725 GHz band: all emissions outside of the 5.47–5.725 GHz band shall not exceed an EIRP of -27 dBm/MHz.																									
15.209	RSS-GEN, Clause 8.9	<p>Radiated emissions which fall in the restricted bands, as defined in §15.205(a), must also comply with the radiated emission limits specified in §15.209(a):</p> <table border="1"> <thead> <tr> <th>Freq (MHz)</th> <th>Range</th> <th>Field Strength (<math>\mu\text{V}/\text{m}</math>)</th> <th>Field Strength (<math>\text{dB}\mu\text{V}/\text{m}</math>)</th> <th>Meas. Distance (m)</th> </tr> </thead> <tbody> <tr> <td>30-88</td> <td></td> <td>100</td> <td>40</td> <td>3</td> </tr> <tr> <td>88-216</td> <td></td> <td>150</td> <td>43.5</td> <td>3</td> </tr> <tr> <td>216-960</td> <td></td> <td>200</td> <td>46</td> <td>3</td> </tr> <tr> <td>Above 960</td> <td></td> <td>500</td> <td>54</td> <td>3</td> </tr> </tbody> </table> <p>The emission limits shown in the above table are based on measurements employing CISPR quasi-peak detector except for the frequency bands 9-90 kHz, 110-490 kHz and above 1000 MHz. Radiated emission limits in these three bands are based on measurements employing an average detector.</p> <p>For average radiated emission measurements above 1000 MHz, there is also a limit specified when measuring with peak detector function, corresponding to 20 dB above the indicated values in the table.</p>	Freq (MHz)	Range	Field Strength ( $\mu\text{V}/\text{m}$ )	Field Strength ( $\text{dB}\mu\text{V}/\text{m}$ )	Meas. Distance (m)	30-88		100	40	3	88-216		150	43.5	3	216-960		200	46	3	Above 960		500	54	3
Freq (MHz)	Range	Field Strength ( $\mu\text{V}/\text{m}$ )	Field Strength ( $\text{dB}\mu\text{V}/\text{m}$ )	Meas. Distance (m)																							
30-88		100	40	3																							
88-216		150	43.5	3																							
216-960		200	46	3																							
Above 960		500	54	3																							

### Test procedure

The setup below was used to measure the radiated spurious emissions.

Depending of the frequency range and bands being tested, different antennas and filters were used.

The final measurement is done by varying the antenna height, the EUT azimuth over 360° and for both Vertical and Horizontal polarizations.

The radiated spurious emission was measured on the worst case configuration selected from the chapter B.2.2 and using the low, middle and high channel.

*Radiated Setup < 1GHz*

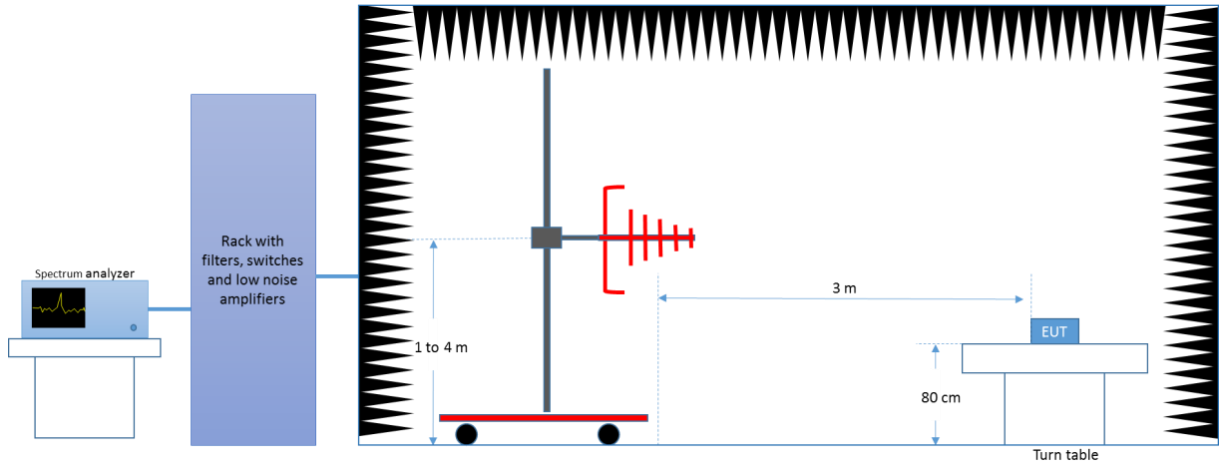

*Radiated Setup 1 GHz - 18 GHz*

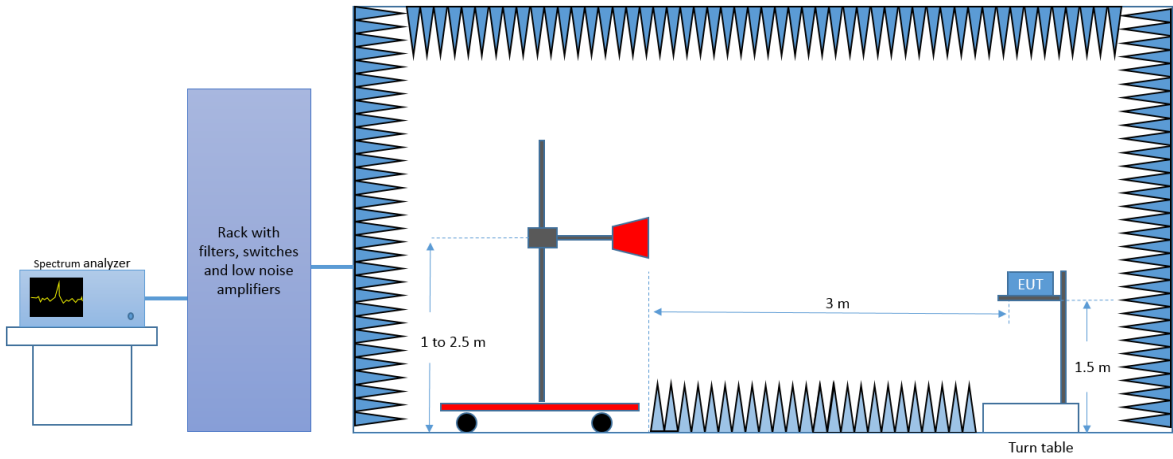

*Radiated Setup 18 GHz - 40 GHz*

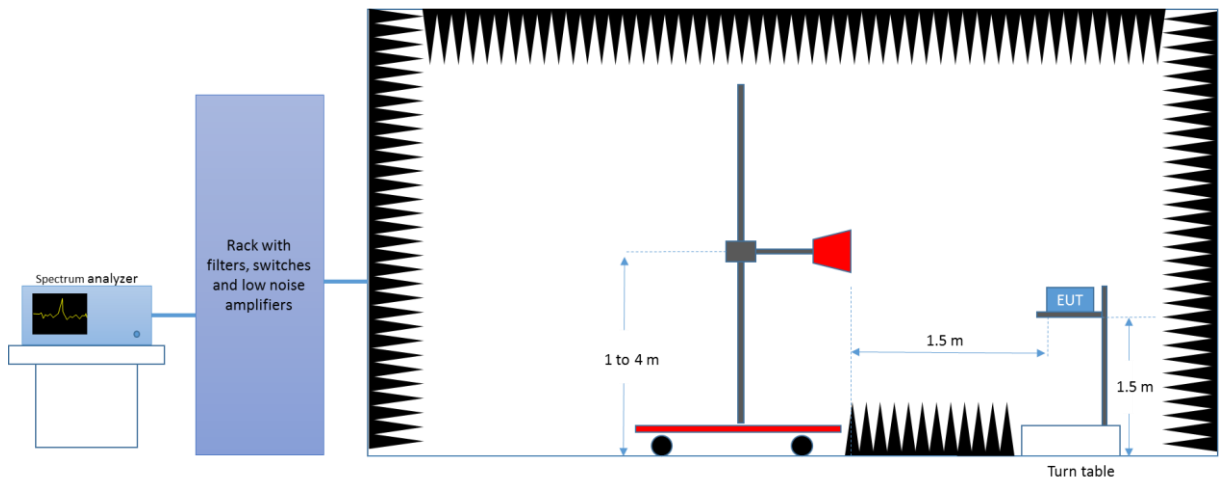



## Test Results

**30 MHz – 40 GHz, 802.11a, 6Mbps, Chain A**
**Radiated Spurious – CH100**

Frequency	MaxPeak	Avg	Limit	Margin
MHz	dB $\mu$ V/m	dB $\mu$ V/m	dB $\mu$ V/m	dB
62.5	31.4	---	40.0	8.6
6026.4	---	48.6	54.0	5.4
6065.0	60.1	---	74.0	13.9
16488.9	56.2	---	74.0	17.8
16502.7	---	44.7	54.0	9.3
21999.7	---	40.3	54.0	13.7
22000.2	45.4	---	74.0	28.6
35082.1	---	34.2	54.0	19.9
35082.1	45.8	---	74.0	28.2

**Radiated Spurious – CH120**

Frequency	MaxPeak	Avg	Limit	Margin
MHz	dB $\mu$ V/m	dB $\mu$ V/m	dB $\mu$ V/m	dB
62.5	31.1	---	40.0	8.9
6053.9	---	<b>48.7</b>	54.0	5.3
6091.0	61.1	---	74.0	12.9
17522.2	---	45.5	54.0	8.5
17531.1	57.2	---	74.0	16.8
22400.2	---	44.2	54.0	9.8
22400.2	49.6	---	74.0	24.4
33607.8	---	37.0	54.0	17.0
33611.6	46.6	---	74.0	27.4

**Radiated Spurious – CH140**

Frequency	MaxPeak	Avg	Limit	Margin
MHz	dB $\mu$ V/m	dB $\mu$ V/m	dB $\mu$ V/m	dB
62.4	32.0	---	40.0	8.0
6054.2	---	48.5	54.0	5.6
6134.4	60.5	---	74.0	13.6
17097.0	58.2	---	74.0	15.8
17101.9	---	46.8	54.0	7.2
22800.1	48.6	---	74.0	25.4
22800.1	---	45.9	54.0	8.1
34196.9	---	36.5	54.0	17.5
34209.5	46.3	---	74.0	27.8

**30 MHz – 40 GHz, 802.11n20, HT0, Chain A**

**Radiated Spurious – CH100**

Frequency	MaxPeak	Avg	Limit	Margin
MHz	dBµV/m	dBµV/m	dBµV/m	dB
47.4	33.3	---	40.0	6.7
6059.3	60.9	---	74.0	13.1
6064.5	---	49.3	54.0	4.8
16504.9	---	45.2	54.0	8.8
16508.5	55.5	---	74.0	18.5
21999.7	---	39.7	54.0	14.3
21999.7	45.9	---	74.0	28.1
38059.9	45.3	---	74.0	28.7
38102.3	---	34.7	54.0	19.3

**Radiated Spurious – CH120**

Frequency	MaxPeak	Avg	Limit	Margin
MHz	dBµV/m	dBµV/m	dBµV/m	dB
53.0	31.7	---	40.0	8.4
6046.8	61.1	---	74.0	12.9
6059.8	---	<b>49.4</b>	54.0	4.6
17636.8	57.6	---	74.0	16.4
17644.4	---	46.0	54.0	8.0
22399.2	51.7	---	74.0	22.4
22400.2	---	43.6	54.0	10.4
33598.1	---	36.5	54.0	17.5
33603.9	47.7	---	74.0	26.3

**Radiated Spurious – CH140**

Frequency	MaxPeak	Avg	Limit	Margin
MHz	dB $\mu$ V/m	dB $\mu$ V/m	dB $\mu$ V/m	dB
38.1	33.8	---	40.0	6.3
6064.7	---	49.3	54.0	4.7
6071.8	60.7	---	74.0	13.3
17096.1	---	46.7	54.0	7.3
17097.4	58.7	---	74.0	15.4
22800.1	49.3	---	74.0	24.7
22800.1	---	46.3	54.0	7.7
35009.3	---	35.4	54.0	18.6
35028.1	45.7	---	74.0	28.3

**30 MHz – 40 GHz, 802.11n40, HT0, Chain A**

**Radiated Spurious – CH102F**

Frequency	MaxPeak	Avg	Limit	Margin
MHz	dBµV/m	dBµV/m	dBµV/m	dB
62.5	32.0	---	40.0	8.0
6070.4	---	49.3	54.0	4.7
6070.8	61.7	---	74.0	12.3
17648.0	58.4	---	74.0	15.6
17650.7	---	45.9	54.0	8.1
22039.9	---	41.6	54.0	12.4
22039.9	45.4	---	74.0	28.6
35011.8	---	35.3	54.0	18.7
35056.6	45.6	---	74.0	28.4

**Radiated Spurious – CH118F**

Frequency	MaxPeak	Avg	Limit	Margin
MHz	dBµV/m	dBµV/m	dBµV/m	dB
55.0	33.0	---	40.0	7.0
6023.5	61.2	---	74.0	12.9
6025.7	---	48.3	54.0	5.7
17031.8	56.4	---	74.0	17.6
17032.3	---	44.4	54.0	9.6
22360.0	---	42.3	54.0	11.7
22360.0	47.2	---	74.0	26.8
35001.1	---	35.0	54.0	19.0
35015.6	45.7	---	74.0	28.4

**Radiated Spurious – CH134F**

Frequency	MaxPeak	Avg	Limit	Margin
MHz	dB $\mu$ V/m	dB $\mu$ V/m	dB $\mu$ V/m	dB
47.2	31.9	---	40.0	8.1
6065.2	60.6	---	74.0	13.4
6065.7	---	48.9	54.0	5.1
17012.7	56.9	---	74.0	17.1
17013.1	---	46.3	54.0	7.7
22680.2	---	45.2	54.0	8.8
22680.2	48.1	---	74.0	25.9
37799.0	---	34.7	54.0	19.4
37823.6	45.3	---	74.0	28.7

**30 MHz – 40 GHz, 802.11ac80, HT0, Chain A**

**Radiated Spurious – CH106ac80**

Frequency	MaxPeak	Avg	Limit	Margin
MHz	dBµV/m	dBµV/m	dBµV/m	dB
46.4	34.0	---	40.0	6.0
6085.8	---	49.5	54.0	4.5
6087.3	61.3	---	74.0	12.7
17039.4	---	44.4	54.0	9.7
17045.7	56.0	---	74.0	18.0
22119.7	45.3	---	74.0	28.7
22120.1	---	40.2	54.0	13.9
35011.8	45.6	---	74.0	28.4
35023.8	---	35.0	54.0	19.0

**Radiated Spurious – CH122ac80**

Frequency	MaxPeak	Avg	Limit	Margin
MHz	dBµV/m	dBµV/m	dBµV/m	dB
62.5	30.4	---	40.0	9.6
6209.3	60.8	---	74.0	13.2
6211.0	---	48.9	54.0	5.1
17043.4	56.5	---	74.0	17.5
17048.4	---	44.7	54.0	9.3
22439.8	---	43.1	54.0	10.9
22440.3	46.9	---	74.0	27.1
35013.2	45.8	---	74.0	28.2
35014.6	---	35.3	54.0	18.7

**Radiated Spurious – CH138ac80**

Frequency	MaxPeak	Avg	Limit	Margin
MHz	dB $\mu$ V/m	dB $\mu$ V/m	dB $\mu$ V/m	dB
62.5	31.3	---	40.0	8.8
6110.4	61.0	---	74.0	13.0
6110.9	---	48.8	54.0	5.2
17049.7	56.2	---	74.0	17.8
17070.7	---	46.1	54.0	7.9
22760.0	---	46.0	54.0	8.0
22760.0	48.8	---	74.0	25.2
37799.0	---	34.7	54.0	19.4
37823.6	45.3	---	74.0	28.7



## B.2.5 AC power-line conducted emission

### Standard references:

FCC part	RSS part	Limits														
15.207 15.407 (6)	RSS-GEN, Clause 8.8	<p>Except as shown in paragraphs (b) and (c) of this section, for an intentional radiator that is designed to be connected to the public utility (AC) power line, the radio frequency voltage that is conducted back onto the AC power line on any frequency or frequencies, within the band 150 kHz to 30 MHz, shall not exceed the limits in the following table, as measured using a 50 <math>\mu</math>H/50 ohms line impedance stabilization network (LISN). Compliance with the provisions of this paragraph shall be based on the measurement of the radio frequency voltage between each power line and ground at the power terminal. The lower limit applies at the boundary between the frequency ranges.</p> <table border="1"> <thead> <tr> <th rowspan="2">Frequency of emission (MHz)</th> <th colspan="2">Conducted limit (dB<math>\mu</math>V)</th> </tr> <tr> <th>Quasi-peak</th> <th>Average</th> </tr> </thead> <tbody> <tr> <td>0.15-0.5</td> <td>66 to 56*</td> <td>56 to 46*</td> </tr> <tr> <td>0.5-5</td> <td>56</td> <td>46</td> </tr> <tr> <td>5-30</td> <td>60</td> <td>50</td> </tr> </tbody> </table> <p>*Decreases with the logarithm of the frequency.</p>	Frequency of emission (MHz)	Conducted limit (dB $\mu$ V)		Quasi-peak	Average	0.15-0.5	66 to 56*	56 to 46*	0.5-5	56	46	5-30	60	50
Frequency of emission (MHz)	Conducted limit (dB $\mu$ V)															
	Quasi-peak	Average														
0.15-0.5	66 to 56*	56 to 46*														
0.5-5	56	46														
5-30	60	50														

### Test procedure:

The EUT and peripherals are placed on a wooden table with a nominal size of 1.0 m by 1.5 m, raised 80 cm above the reference ground plane. The EUT is connected to AC-Power line through a Line Impedance Stabilization Network (LISN) to accommodate a 50  $\Omega$ /50  $\mu$ H coupling impedance for the measurement system. The EUT control PC is considered as a peripheral and therefore is connected to a second LISN which has the measurement port connected to a 50 ohms impedance.

Each measurement is done for each current-carrying conductor (Line and Neutral) at the end plug of the EUT power cord. The EUT is tested for several transmission modes (frequency channel, modulation, etc.) and the result providing the maximum measured emission is reported.

The exploratory measurement is done over the frequency range from 150 kHz to 30 MHz, while the measurement receiver is recording the Peak and Average signal at 10 kHz steps in Max Hold mode. The cables manipulation is performed within the range of likely configurations to determine the maximum emission. Once the EUT cable configuration, arrangement and mode of operation that produced the emission with the highest amplitude relative to the limit is found the six highest AC power-line conducted emissions relative to 20 dB of the limit are reported as the final measurement. If fewer than six emission frequencies are within 20 dB of the limit, the noise level is reported. For the final measurement, the measurement receiver records the Quasi Peak values with 9 kHz resolution bandwidth and the average values with 10 kHz resolution bandwidth.

*EUT arrangement for AC power-line conducted emission tests*

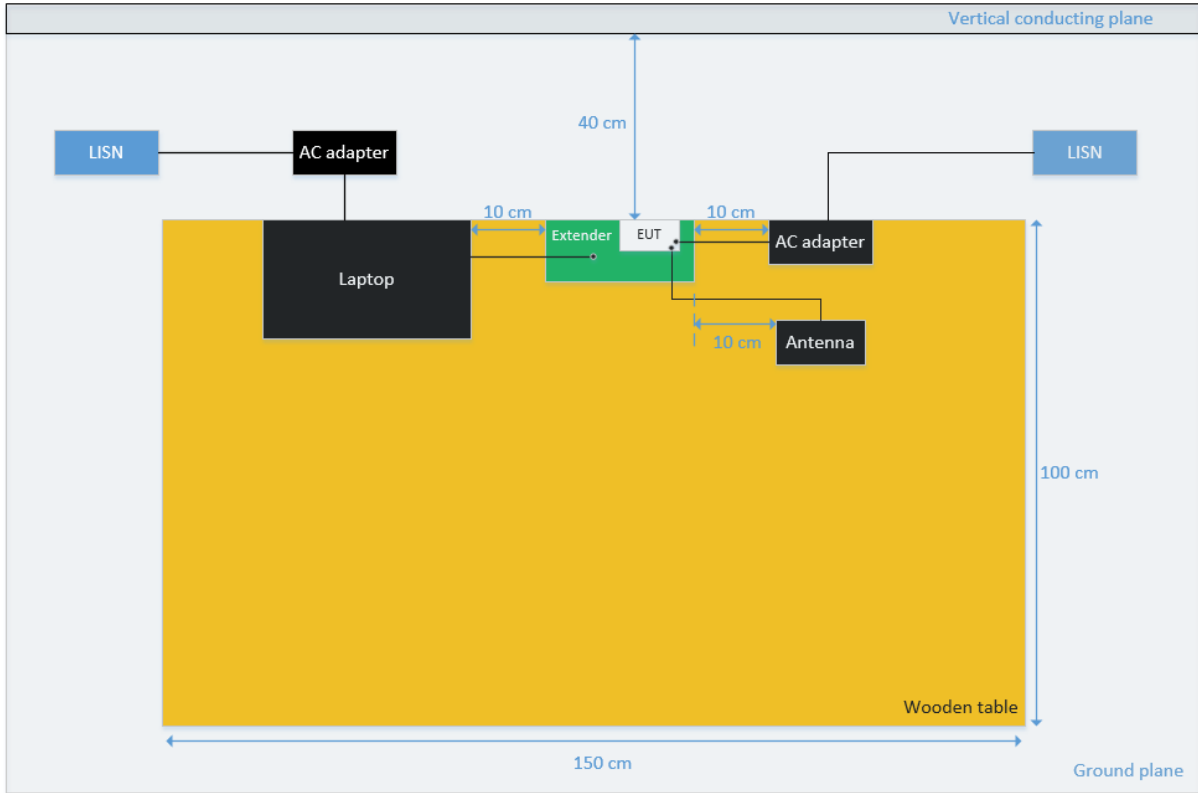

Sample Calculation:

The measured level at the spectrum analyzer in dBuV is corrected by a transducer factor taking into account the losses of the RF cable and the LISN as follows:

$$\text{Conducted Emission level (dBuV)} = \text{SA}_{\text{Level}} + \text{RFCable}_{\text{Losses}} + \text{LISN}_{\text{Losses}}$$

Where:

$\text{SA}_{\text{Level}}$  is the voltage level displayed on the measurement receiver, in dBuV.

$\text{RFCable}_{\text{Losses}}$  is the value of the cable losses between the LISN and the measurement receiver, in dB.

$\text{LISN}_{\text{Losses}}$  is the value of the insertion losses of the LISN, in dB.

**Test Results:**

**150kHz – 30MHz, all mode**

**AC power-line conducted emissions – Phase L1**

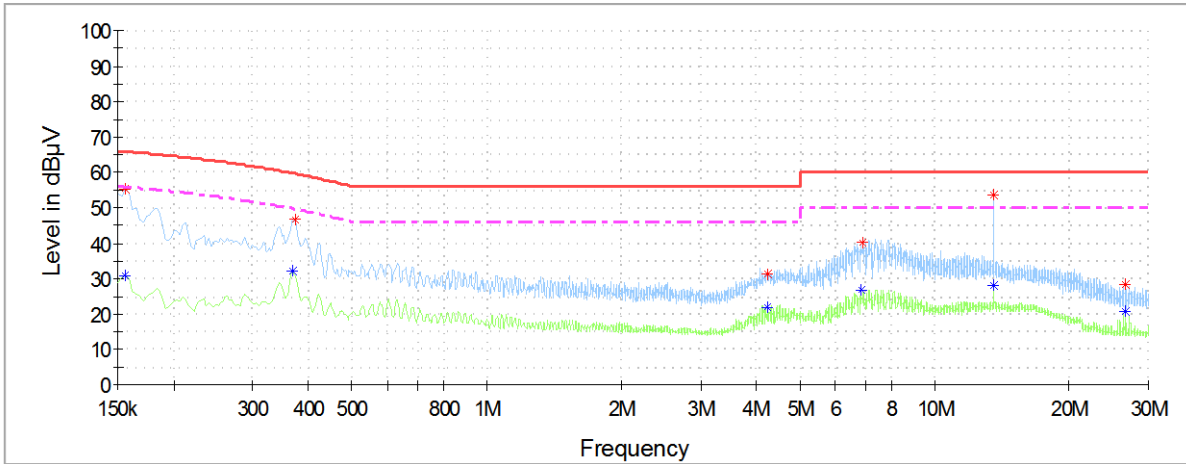

— Peak measurements     
 — Avg measurements     
 — Limit FCC Quasi-Peak     
 - - - Limit FCC Avg

Frequency	Max Peak	Avg	Limit	Margin
MHz	dBµV	dBµV	dBµV	dB
0.1560	55.5	---	65.83	10.4
0.1560	---	30.8	55.83	25.0
0.3739	46.8	---	59.60	12.8
0.3679	---	32.1	49.77	17.6
4.2245	31.5	---	56.00	24.5
4.2395	---	22.1	46.00	23.9
6.8812	40.1	---	60.00	19.9
6.8603	---	26.7	50.00	23.3
13.5556	53.8	---	60.00	6.2
13.5527	---	28.0	50.00	22.0
26.6061	28.3	---	60.00	31.7
26.6120	---	20.6	50.00	29.4

Note: The emissions found do not change with the modulation and/or frequency.

**AC power-line conducted emissions – Neutral N**

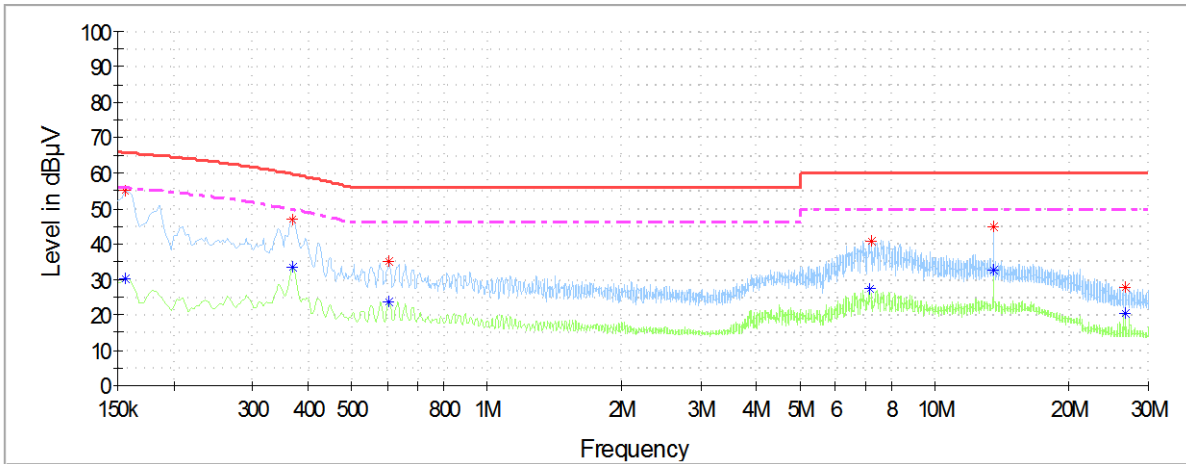

— Peak measurements      — Avg measurements      — Limit FCC Quasi-Peak      - - - Limit FCC Avg

Frequency	Max Peak	Avg	Limit	Margin
MHz	dBµV	dBµV	dBµV	dB
0.1560	55.2	---	65.83	10.6
0.1560	---	30.2	55.83	25.6
0.3679	47.0	---	59.77	12.7
0.3679	---	33.4	49.77	16.3
0.6067	35.0	---	56.00	21.0
0.6037	---	23.6	46.00	22.4
7.2036	40.6	---	60.00	19.4
7.1468	---	27.6	50.00	22.5
13.5795	45.1	---	60.00	14.9
13.5616	---	32.6	50.00	17.4
26.6090	27.9	---	60.00	32.1
26.6120	---	20.5	50.00	29.5

Note: The emissions found do not change with the modulation and/or frequency.

### B.3 Test Results Screenshots

#### B.3.1 26dB Bandwidth

## SISO-A, 802.11a, 6Mbps

Channel 120

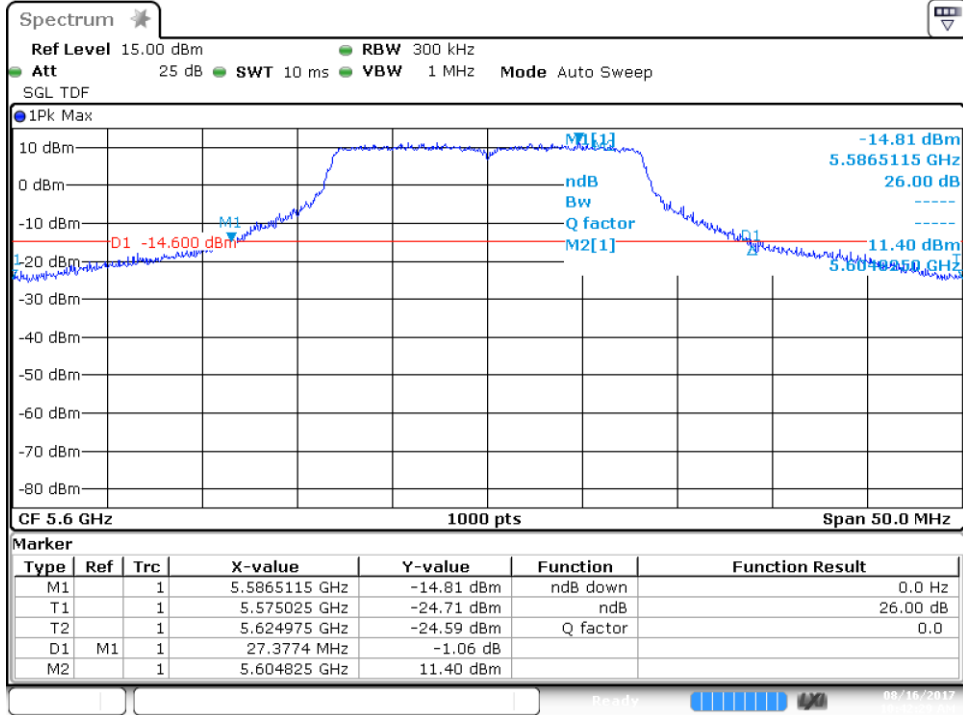

## SISO-A, 802.11n20, HT0

Channel 120

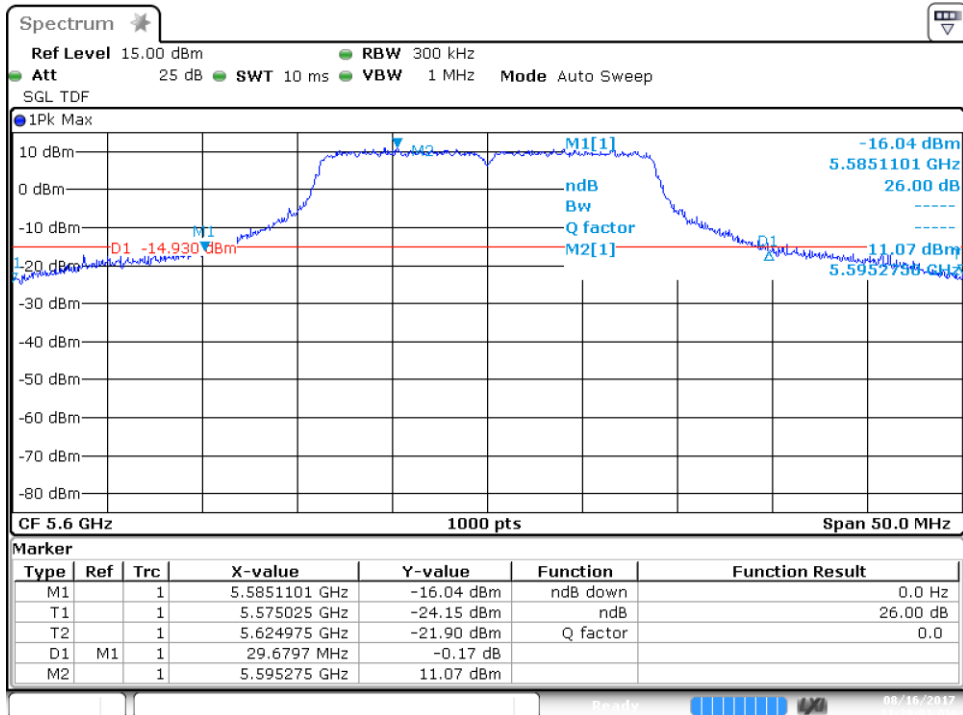

# SISO-A, 802.11n40, HT0

Channel 118F

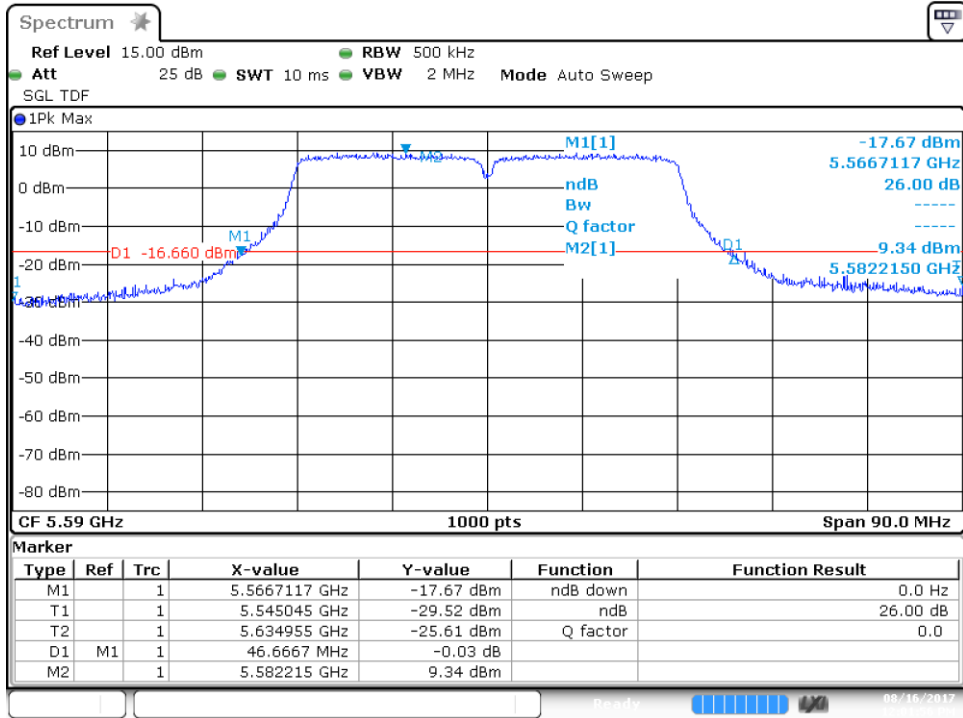

# SISO-A, 802.11ac80, VHT0

Channel 122ac80

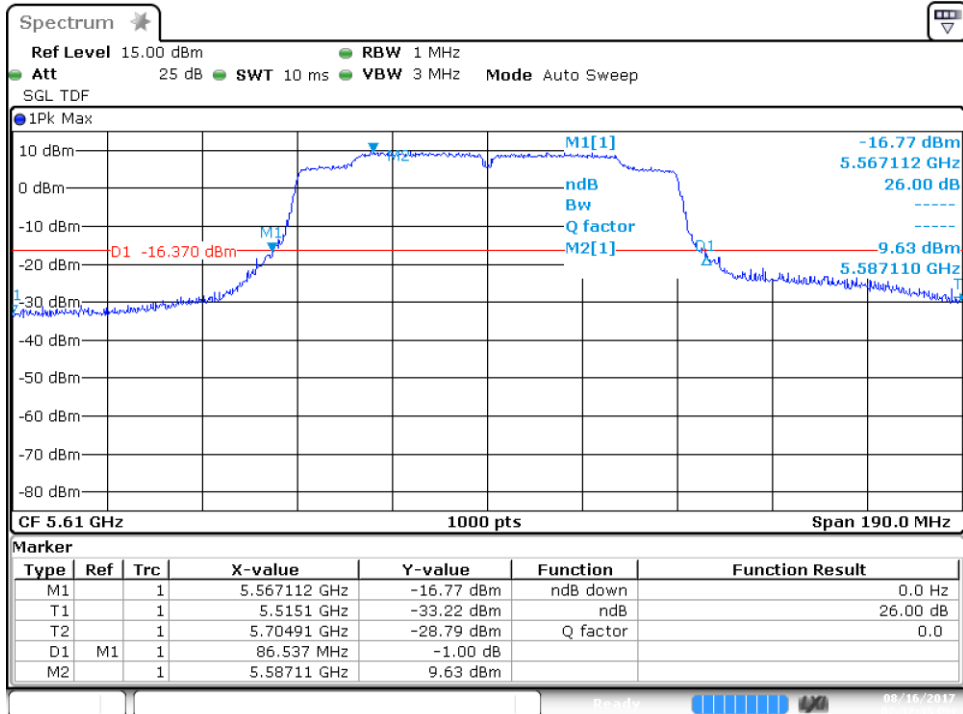

### B.3.2 99% Bandwidth

## SISO-A, 802.11a, 6Mbps

Channel 120

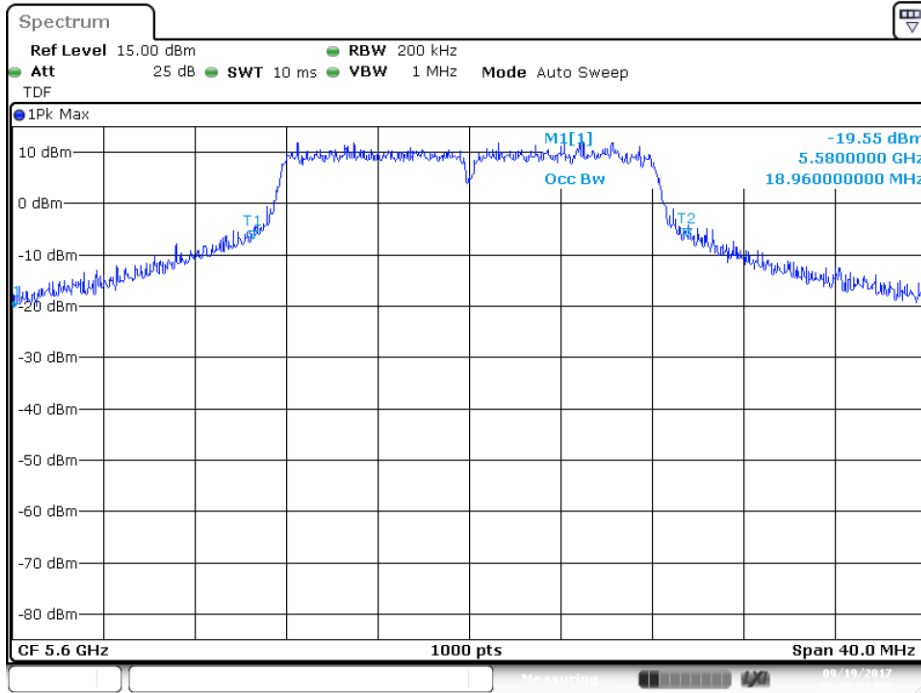

## SISO-A, 802.11n20, HT0

Channel 120

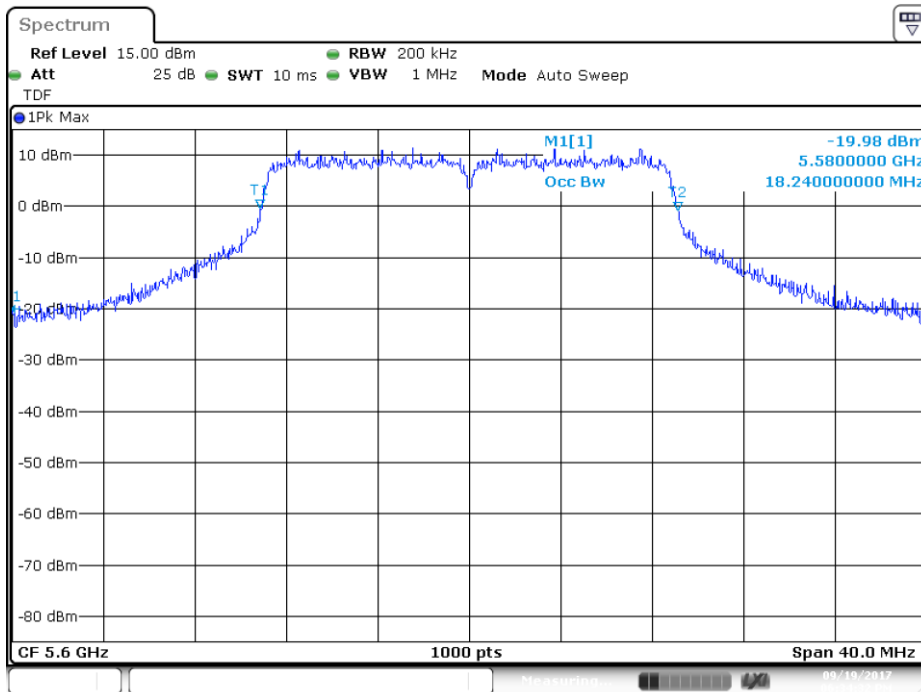

# SISO-A, 802.11n40, HT0

Channel 118F

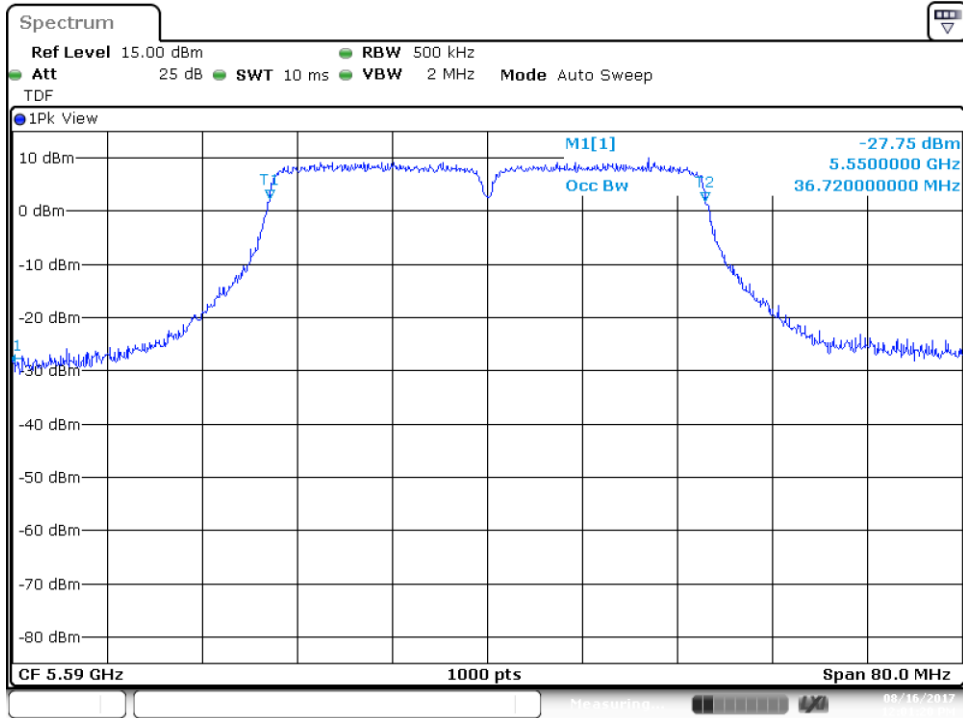

# SISO-A, 802.11ac80, VHT0

Channel 122ac80

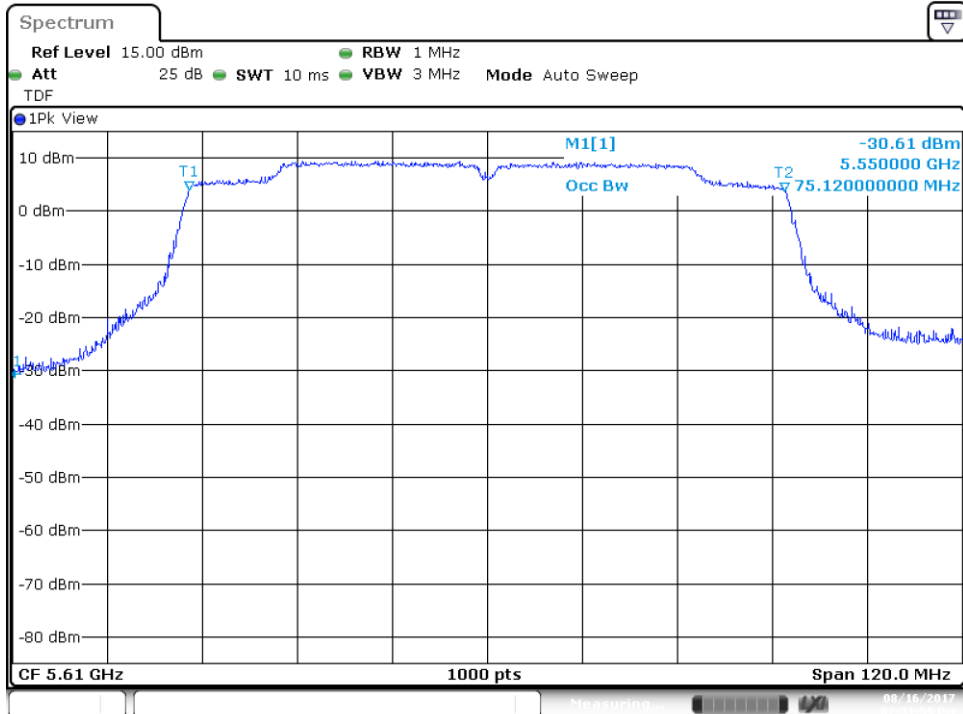



### B.3.3 Maximum Output Power & Maximum power spectral Density

## SISO-A, 802.11a, 6Mbps

Channel 100

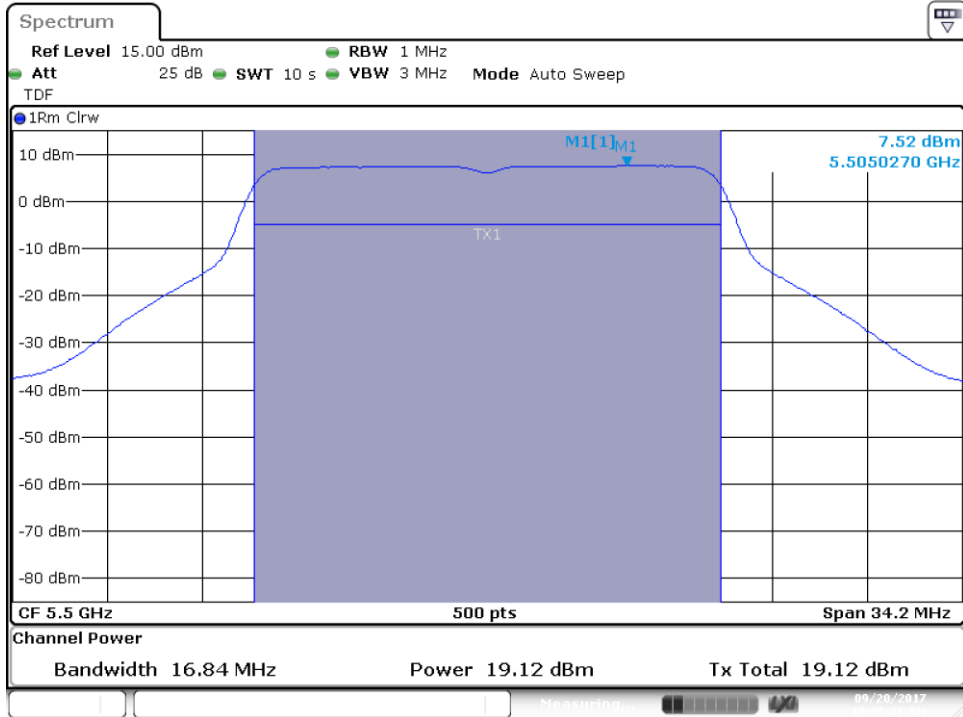

Channel 120

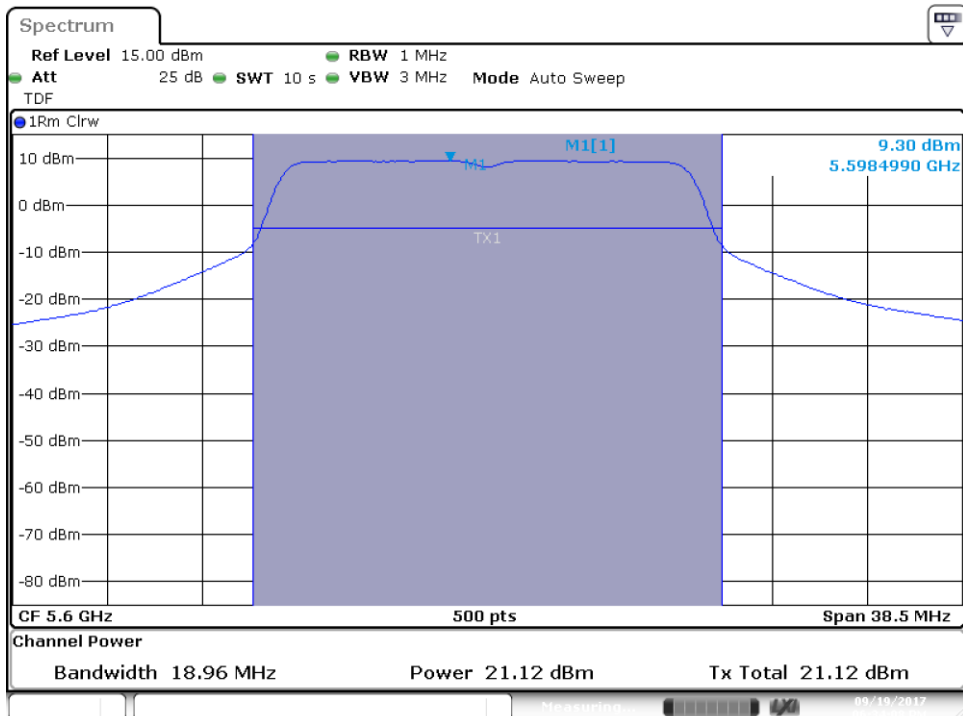

# SISO-A, 802.11n20, HT0

Channel 120

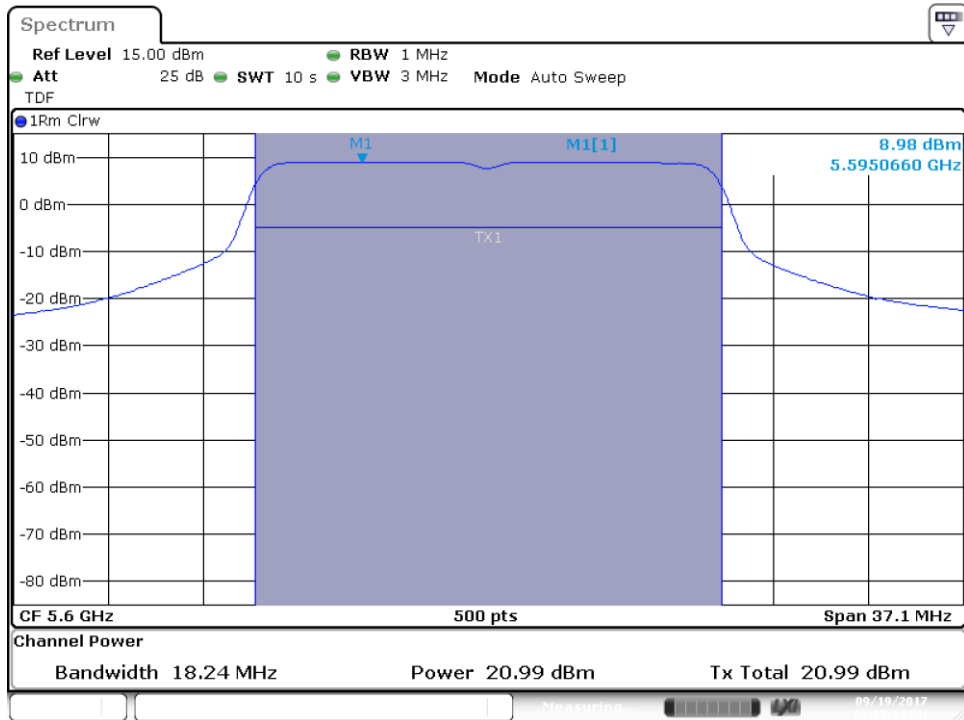

Channel 140

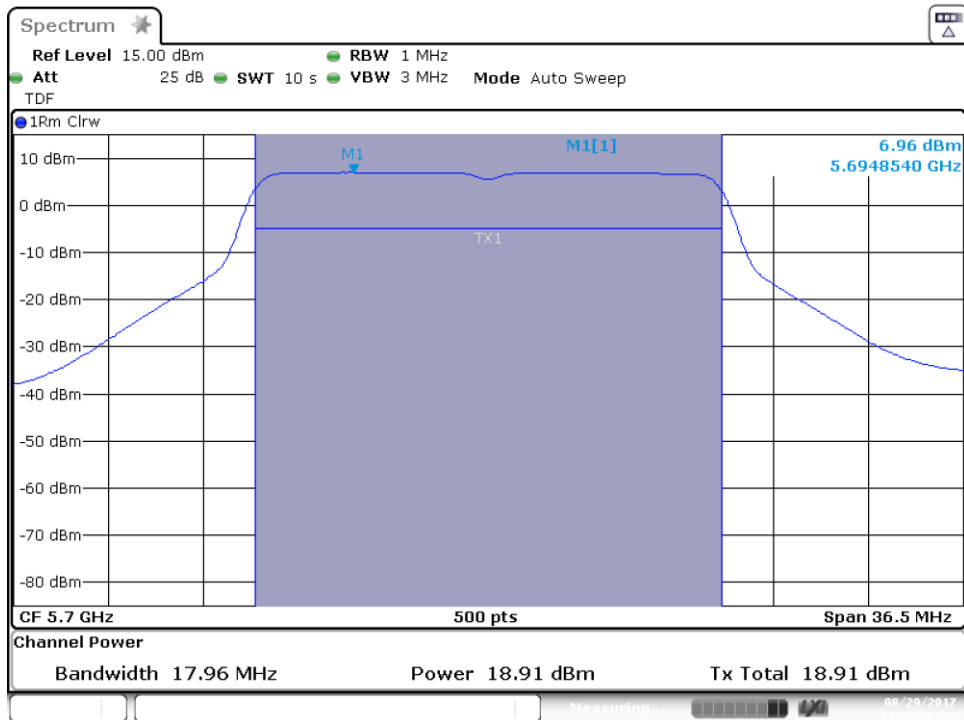

# SISO-A, 802.11n40, HT0

Channel 102F

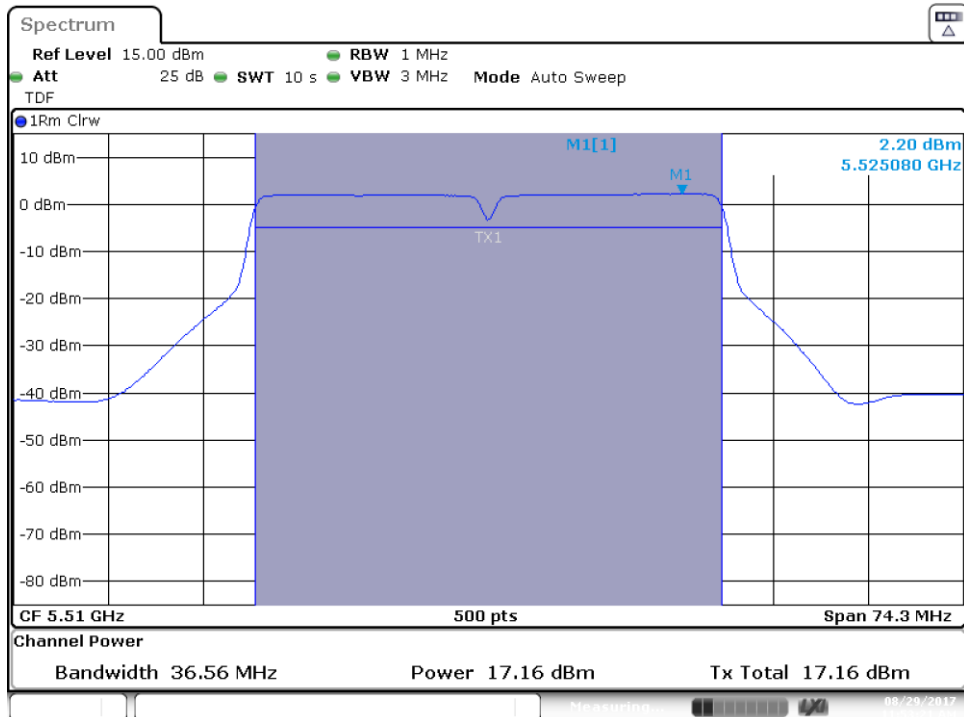

Channel 118F

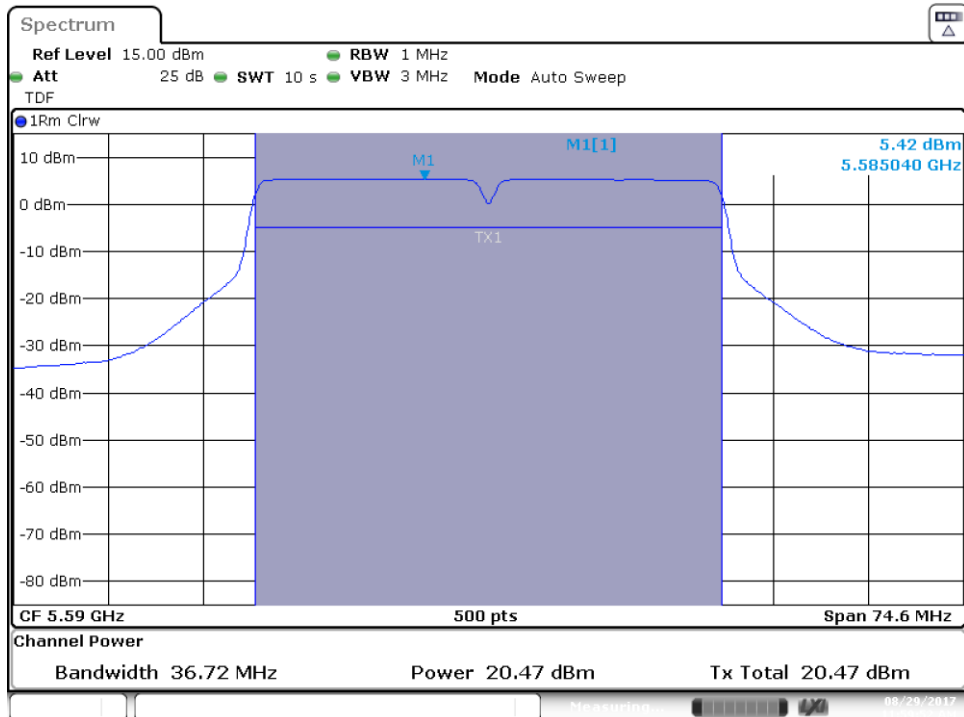

# SISO-A, 802.11ac80, VHT0

Channel 106ac80

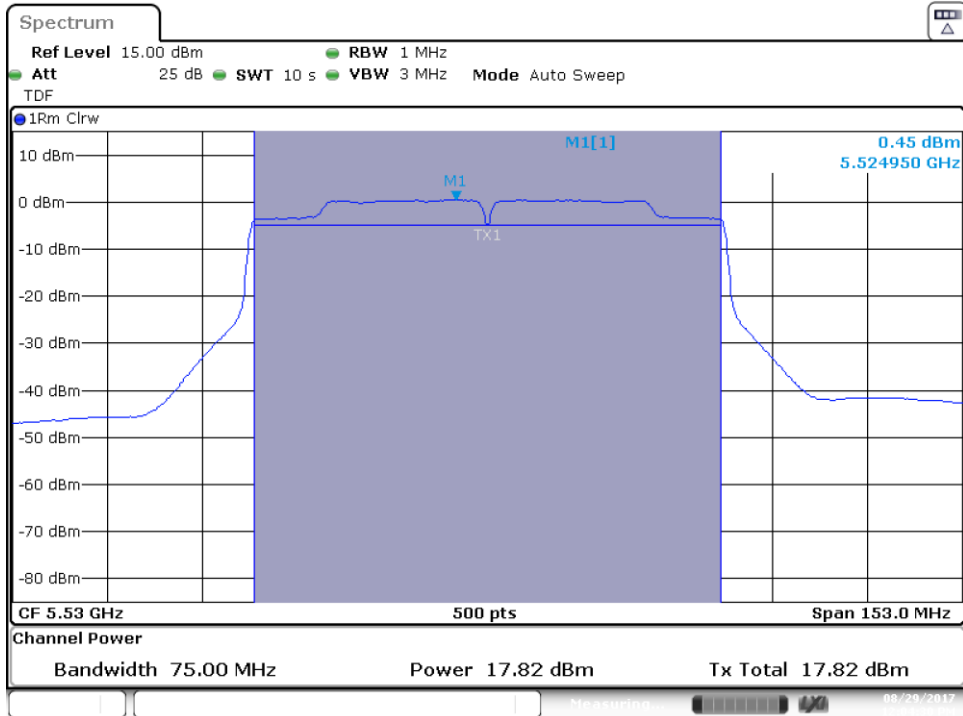

Channel 122ac80

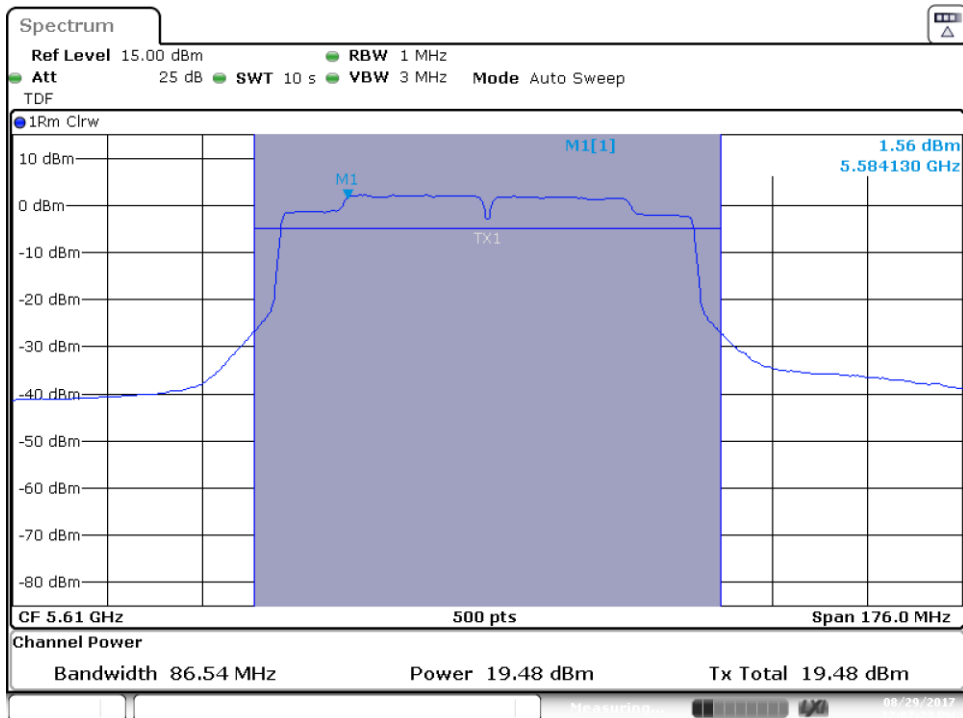

### B.3.4 Undesirable emission limits : Band Edge (Conducted)

## 802.11a, 6Mbps – Chain A

### BE Low Freq Section, Peak – CH100

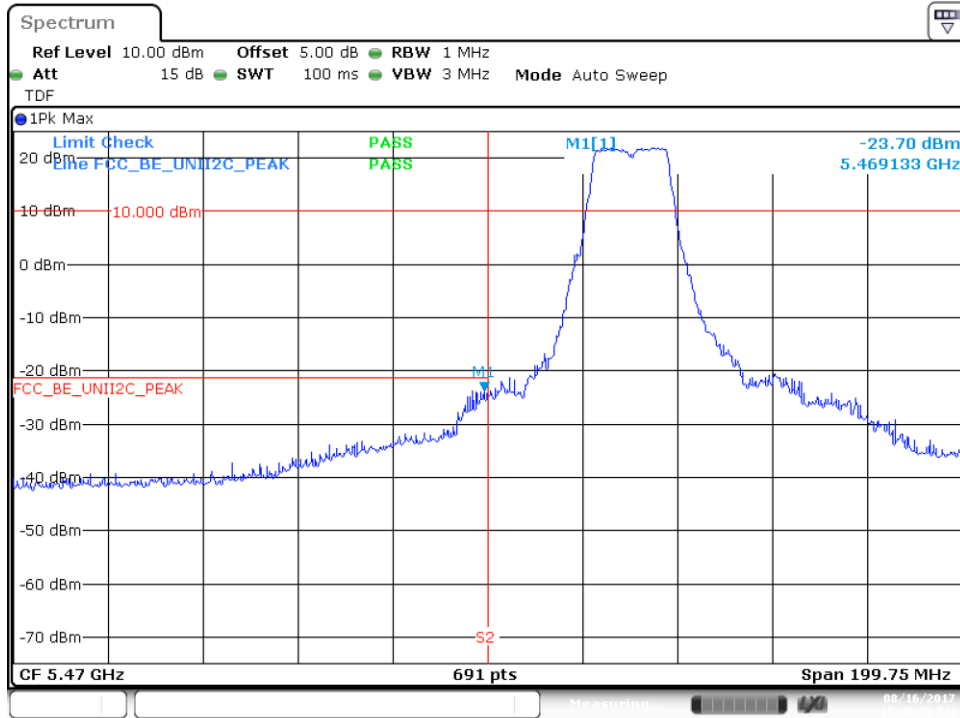

### BE Low Freq Section, RMS – CH100

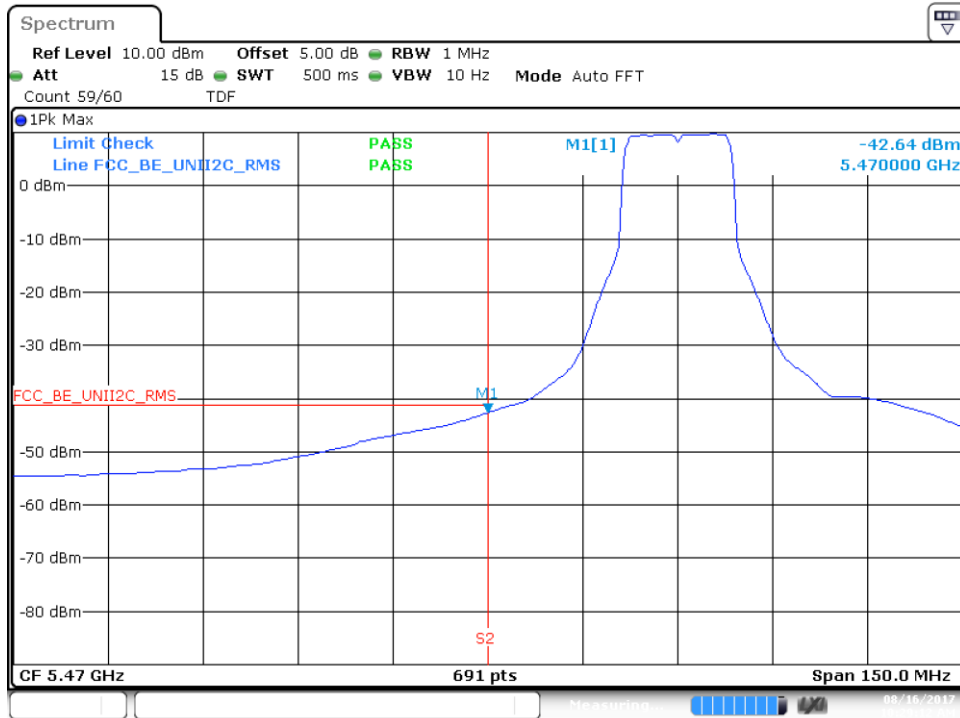

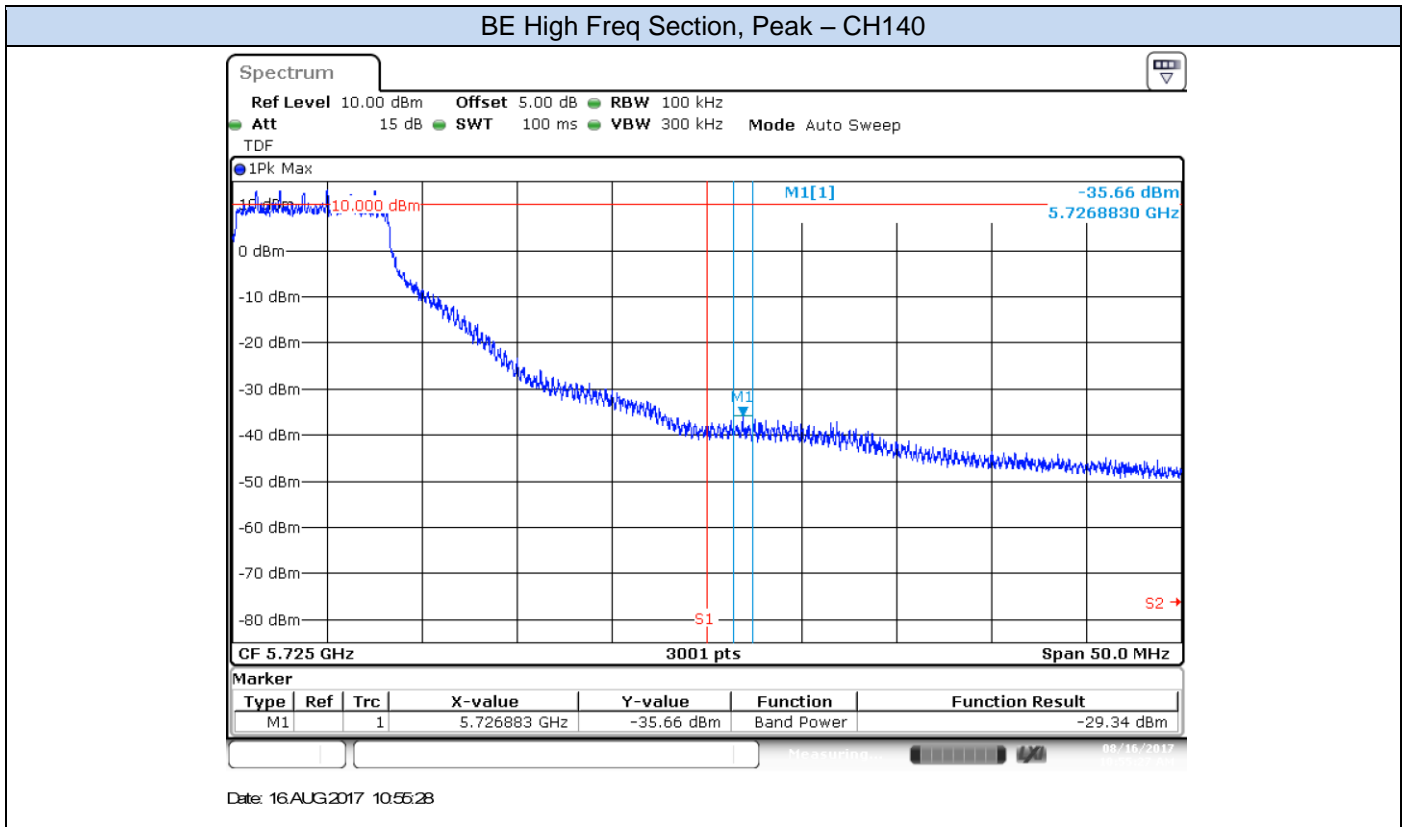

### 802.11n20, HT0 (SISO) – Chain A

#### BE Low Freq Section, Peak – CH100

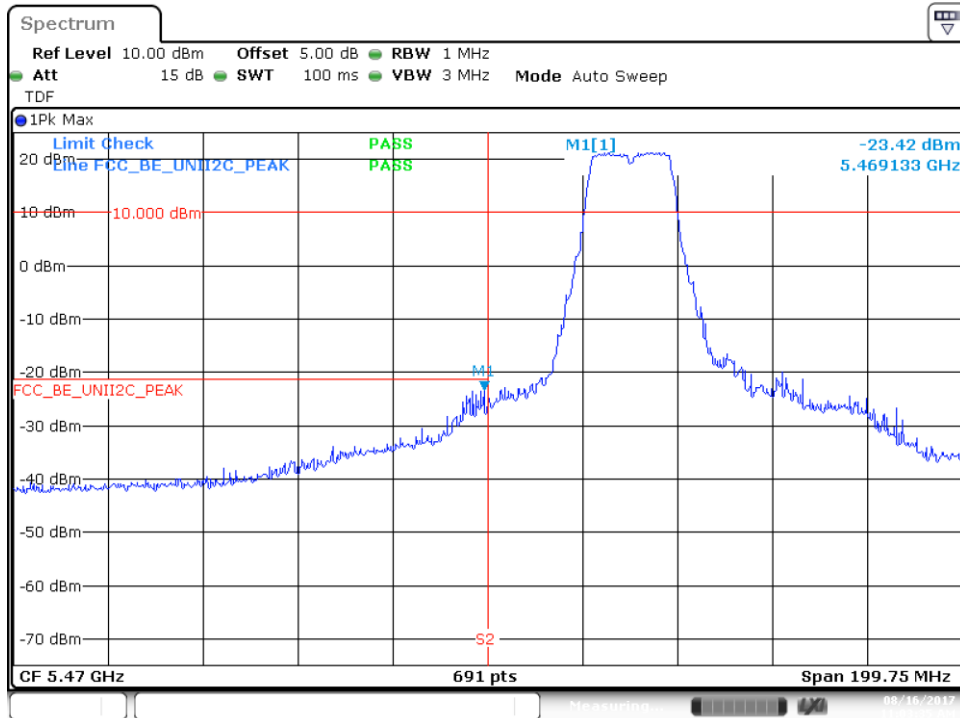

#### BE Low Freq Section, RMS – CH100

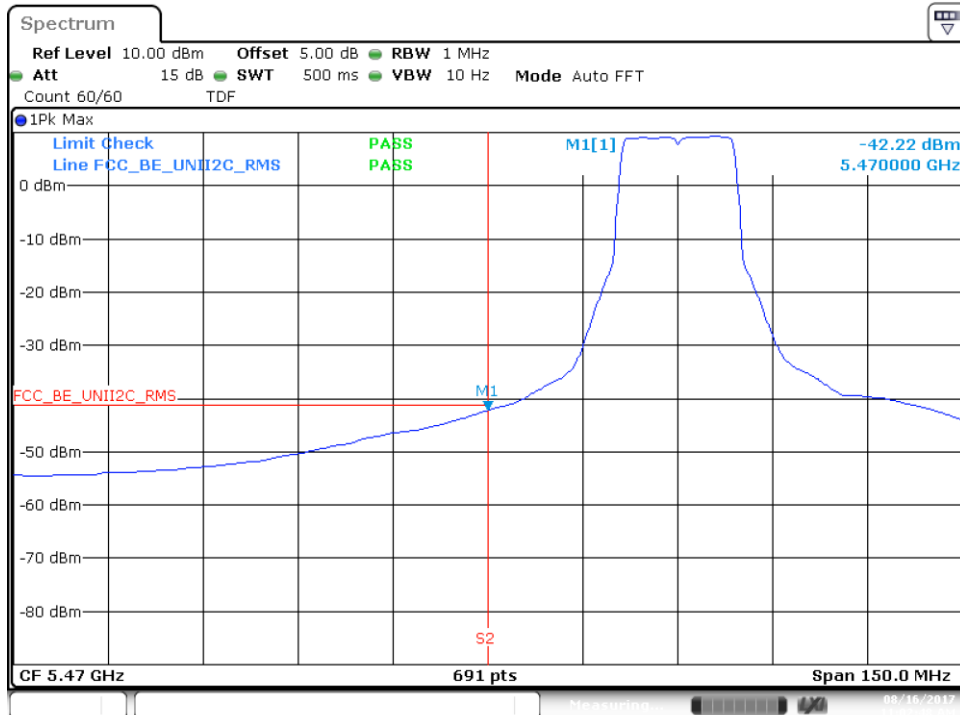

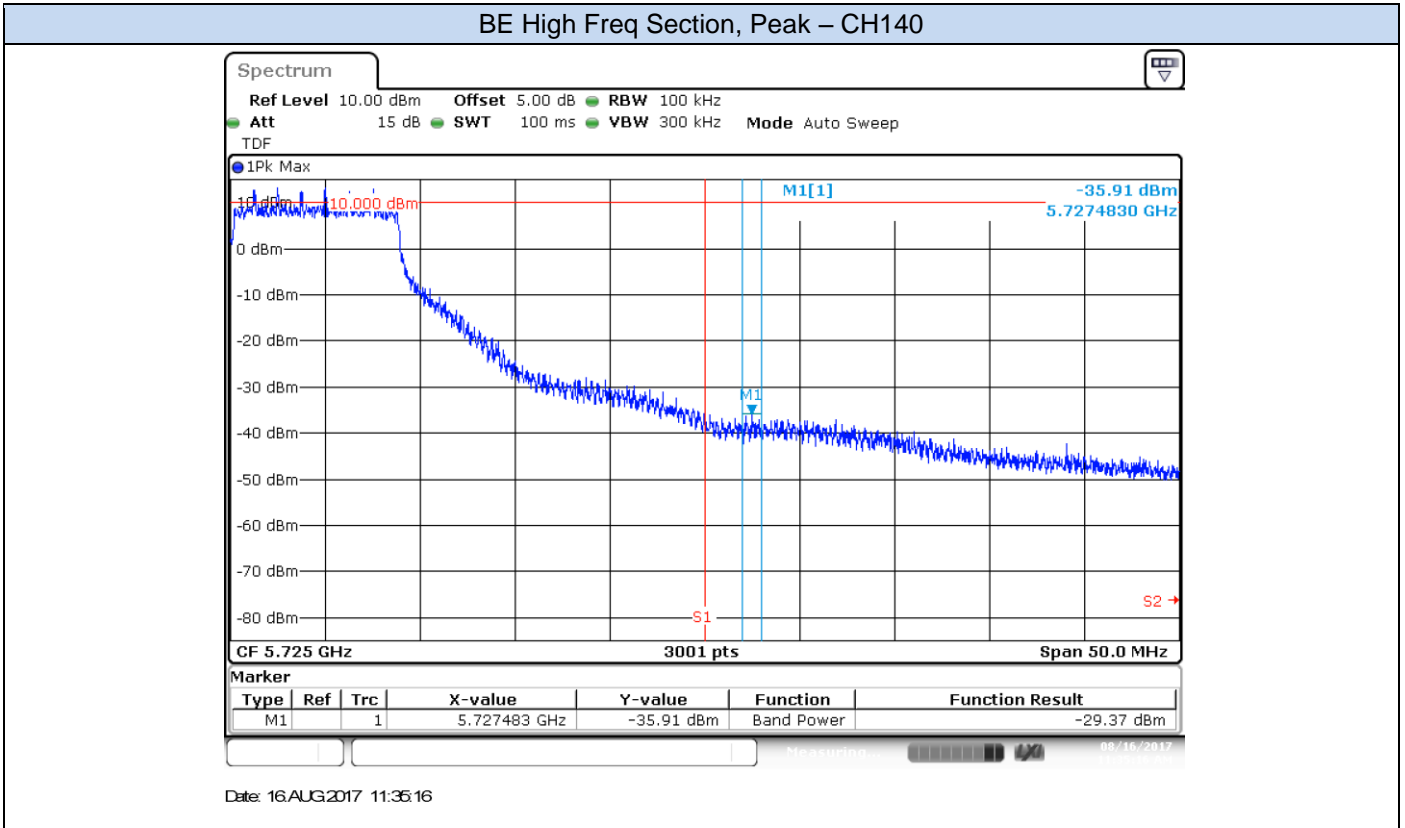



### 802.11n40, HT0 (SISO) – Chain A

#### BE Low Freq Section, Peak – CH102F

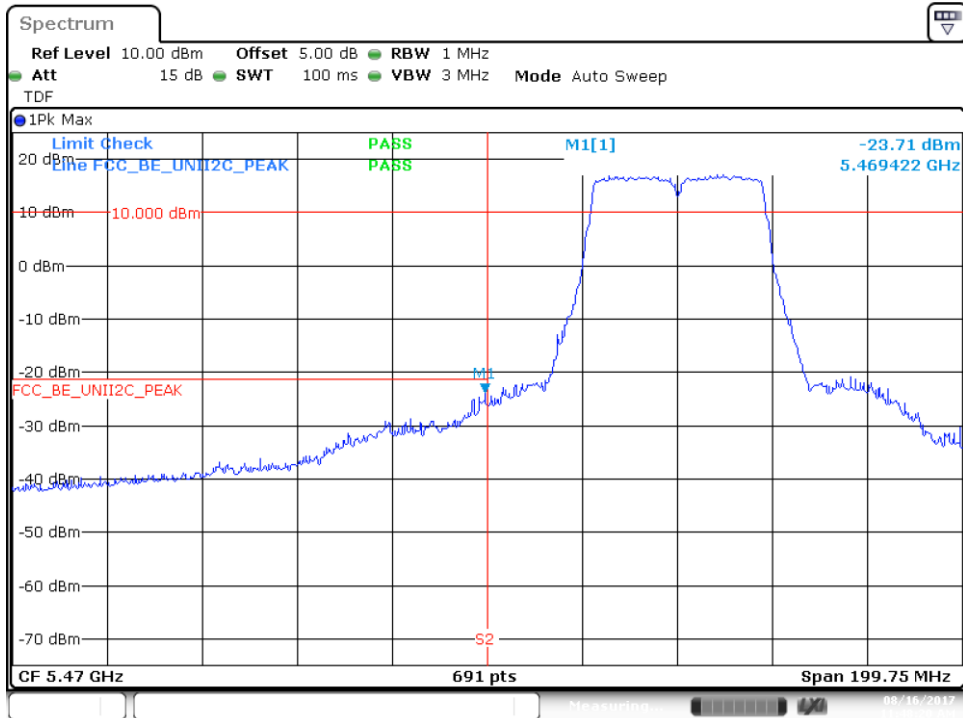

#### BE Low Freq Section, RMS – CH102F

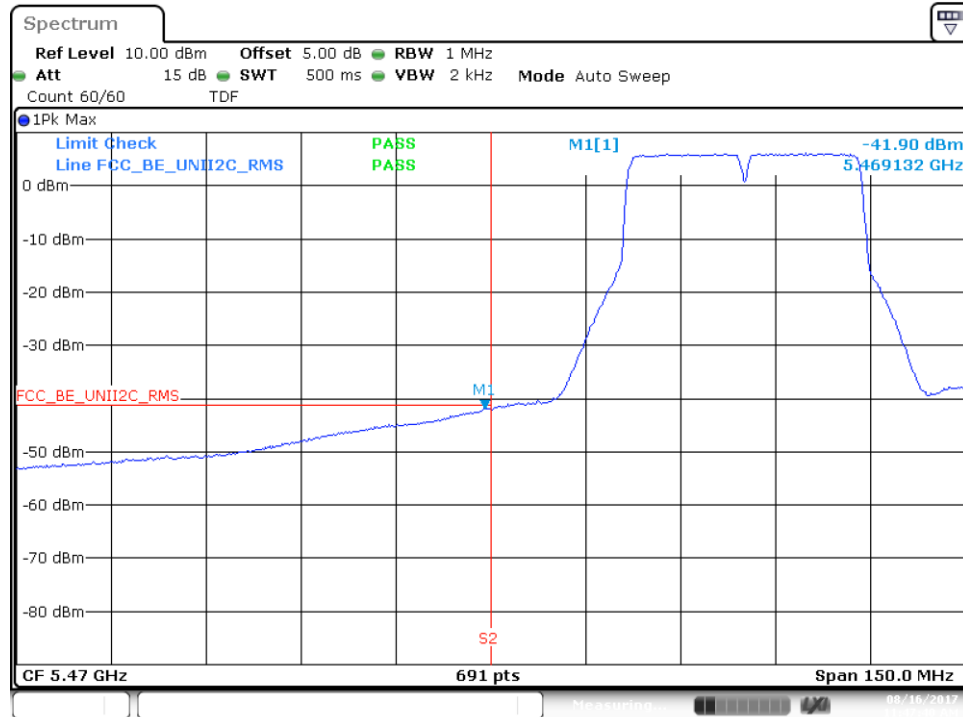

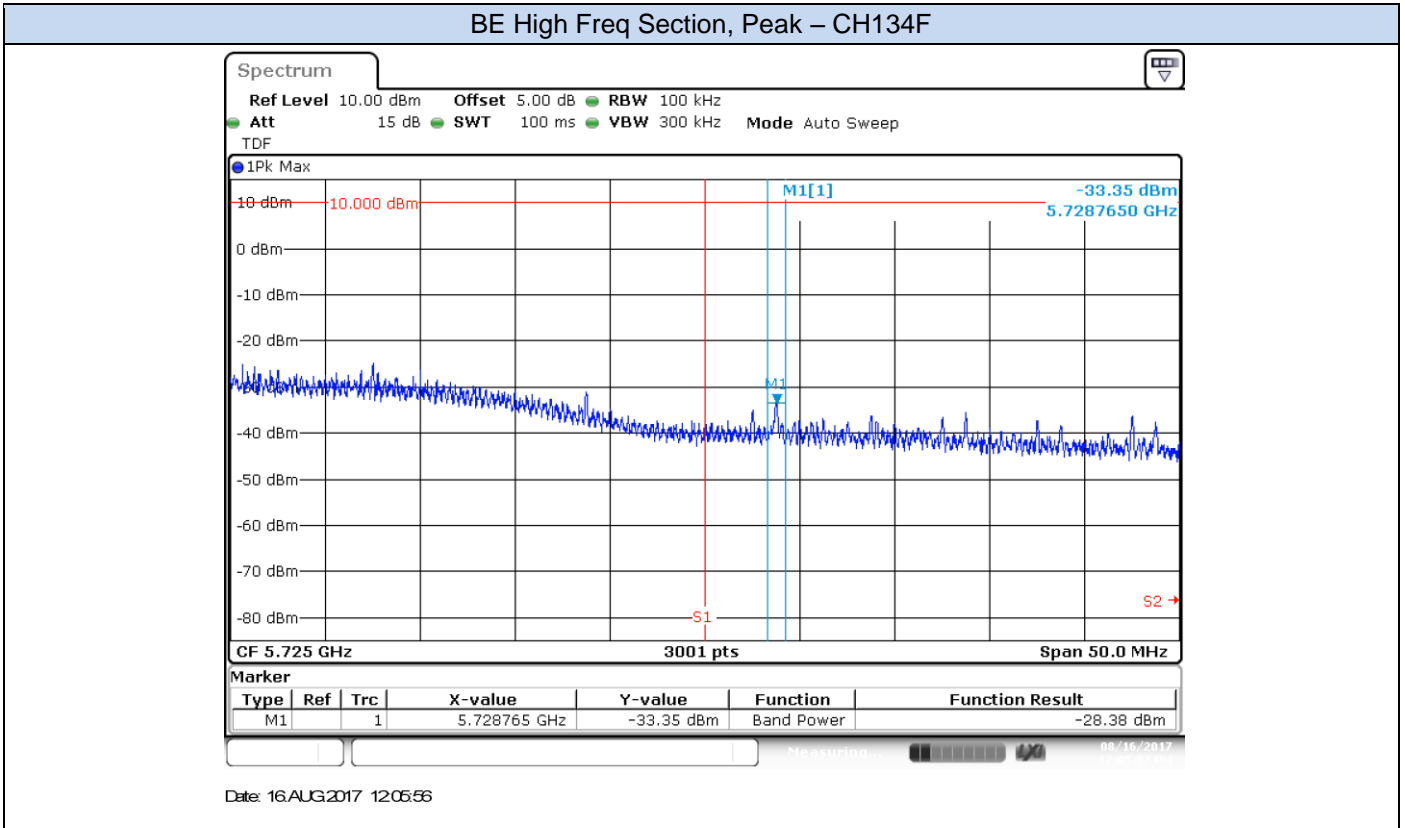

## 802.11ac80, VHT0 (SISO) – Chain A

### BE Low Freq Section, Peak – CH106ac80

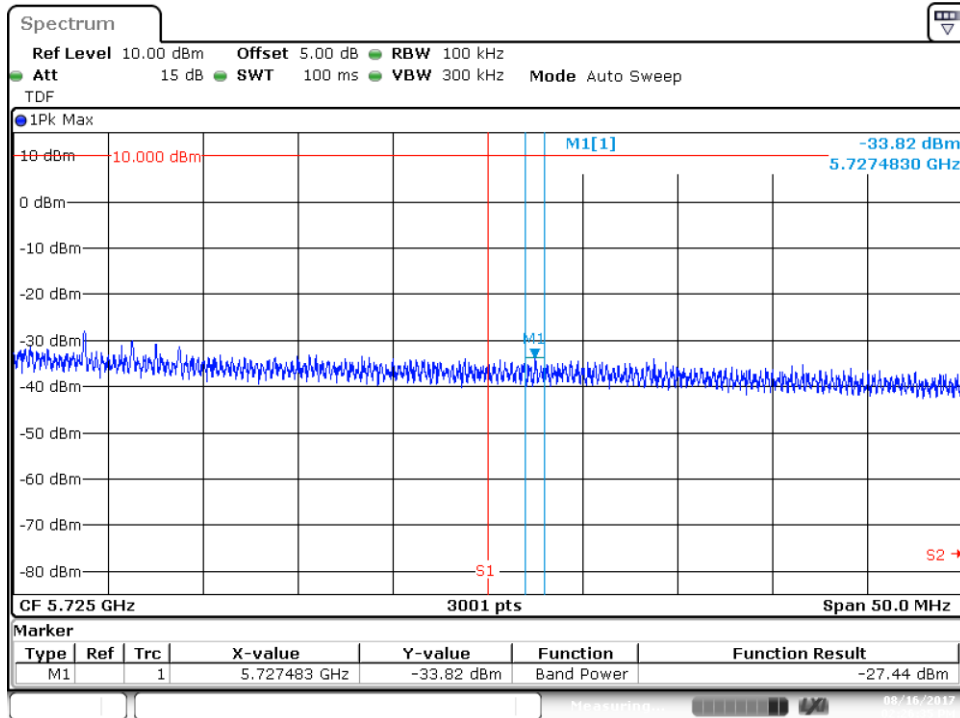

### BE Low Freq Section, RMS – CH106ac80

