



TESTING CERT #3478.01



TEST REPORT

EUT Description	WLAN and BT, 2x2 PCIe M.2 adapter card
Brand Name	Intel
Model Name	Intel® Dual-Band Wireless-AC 8260
Serial Number	TA#: H74231-001 / H74231-001 WF MAC: 34:13:E8:36:93:E5 / 34:13:E8:36:93:22 BT MAC: 34:13:E8:36:93:E9 / 34:13:E8:36:93:26 (see section 4)
FCC/IC ID	FCC ID: PD98260NGH / PD98260NGHU IC ID: 1000M-8260NGH
Antenna type	SkyCross WIMAX/WLAN Reference Antenna
Hardware/Software Version	HW: TF5 Test SW: DRTU version 1.8.1-01336 Op SW: 18.10.0.19
Date of Sample Receipt	2015-05-11
Date of Test	2015-05-26
Features	802.11 a/n/ac Wireless LAN + BT 1.2 (see section 5)

Applicant	Intel Mobile Communications
Address	100 Center Point Circle, Suite 200 Columbia, South Carolina 29210 USA
Contact Person	Steven Hackett
Telephone/Fax/ Email	steven.c.hackett@intel.com

Reference Standards	FCC CFR Title 47 Part 15E (see section 1)
---------------------	--

Test Report number	15051101.TR02
Revision Control	Rev. 00

The test results relate only to the samples tested.
The test report shall not be reproduced in full, without written approval of the laboratory.

_____ Issued by _____ Reviewed by _____ Approved by _____

Jose M. FORTES
(Technical Manager)

Jose M. FORTES
(Technical Manager)

Nawfal ASRIH
(Laboratory Manager)

Intel Mobile Communications France S.A.S – WRF Lab
425 rue de Goa – Le Cargo B6 – Zone des 3 Moulins – 06600, Antibes, France
Tel. +33493001400 / Fax +33493001401

Table of Contents

1. Standards, reference documents and applicable test methods	3
2. General conditions, competences and guarantees.....	3
3. Environmental Conditions.....	3
4. Test samples	4
5. EUT features.....	4
6. Remarks and comments.....	4
7. Test Verdicts summary	5
7.1. 802.11 A/N/AC	5
8. Document Revision History.....	5
Annex A. Test & System Description	6
A.1 TEST CONDITIONS	6
A.2 MEASUREMENT SYSTEM.....	7
A.3 TEST EQUIPMENT LIST	8
A.4 MEASUREMENT UNCERTAINTY EVALUATION	9
Annex B. Test Results	10
B.1 26dB & 99% BANDWIDTH	10
B.2 POWER LIMITS, MAXIMUM OUTPUT POWER & PEAK POWER SPECTRAL DENSITY	24
B.3 UNDESIRABLE EMISSIONS LIMITS: BAND EDGE (CONDUCTED).....	33
B.4 RADIATED SPURIOUS EMISSION	46
Annex C. Photographs.....	61

1. Standards, reference documents and applicable test methods

1. FCC 47 CFR part 15 - Subpart E – Unlicensed National Information Infrastructure Devices.
2. FCC 47 CFR part 15 - Subpart C – §15.209 Radiated emission limits; general requirements.
3. FCC OET KDB 789033 D02 – Guidelines for compliance testing of Unlicensed National Information Infrastructure (U-NII) Devices.
4. FCC OET KDB 662911 D01 – Emissions Testing of Transmitters with Multiple Outputs in the Same Band.
5. ANSI C63.10-2009 American National Standard of Procedures for Compliance Testing of Unlicensed Wireless Devices.

2. General conditions, competences and guarantees

- ✓ Intel Mobile Communications Wireless RF Lab (Intel WRF Lab) is a testing laboratory accredited by the American Association for Laboratory Accreditation (A2LA).
- ✓ Intel Mobile Communications Wireless RF Lab (Intel WRF Lab) is an Accredited Test Firm listed by the FCC, with Designation Number FR0011.
- ✓ Intel Mobile Communications Wireless RF Lab (Intel WRF Lab) is a Registered Test Site listed by IC, with IC Assigned Code 1000Y.
- ✓ Intel WRF Lab only provides testing services and is committed to providing reliable, unbiased test results and interpretations.
- ✓ Intel WRF Lab is liable to the client for the maintenance of the confidentiality of all information related to the item under test and the results of the test.
- ✓ Intel WRF Lab has developed calibration and proficiency programs for its measurement equipment to ensure correlated and reliable results to its customers.
- ✓ This report is only referred to the item that has undergone the test.
- ✓ This report does not imply an approval of the product by the Certification Bodies or competent Authorities.
- ✓ Complete or partial reproduction of the report cannot be made without written permission of Intel WRF Lab.

3. Environmental Conditions

- ✓ At the site where the measurements were performed the following limits were not exceeded during the tests:

Temperature	22°C ± 2°C
Humidity	45% ± 2%

4. Test samples

Sample	Control #	Description	Model	Serial #	Date of reception	Note
#01	15051101.S01	WiFi/BT High End Module	8260NGW H	WF MAC: 34:13:E8:36:93:E5	2015-05-11	Used for conducted tests
	15051101.S12	Extender board	PCB00495	ASS0495-001, 4950414-064	2015-05-12	
	15051101.S11	Switching power supply SINPRO 5V 6A	SPU60-102	07990499 1249	2015-05-12	
	15051101.S15	Laptop	DELL E5440	BJSYN32	2015-05-20	
#02	15051101.S04	WiFi/BT High End Module	8260NGW H	WF MAC: 3413E8369322	2015-05-11	Used for radiated tests
	15051101.S05	Switching power supply SINPRO 5V 6A	SPU60-102	07990495-1249	2015-05-12	
	15051101.S06	Extender board	PCB00495	ASS0495-001, 4950414-019	2015-05-12	
	15051101.S07	USB Cable	E154336	NA	2015-05-12	
	15051101.S08	PCI Cable	Blue cable 1 meter	NA	2015-05-12	
	15051101.S09	Laptop	Dell E5440	9FSYN32	2015-05-12	
	15051101.S10	AC/DC Adapter	90W 19.5V 4.62A	CN-OJCF3V- 48661-51S-OPIC- A02	2015-05-12	

NA: Not Applicable

5. EUT features

These are the detailed bands and modes supported by the Equipment Under Test:

802.11a/n/ac	5.2GHz (5150.0 – 5250.0 MHz) 5.8GHz (5725.0 – 5850.0 MHz)
BDR v1.2	2.4GHz (2400.0 – 2483.5 MHz)

6. Remarks and comments

N/A

7. Test Verdicts summary

7.1. 802.11 a/n/ac

FCC part	Test name	Verdict
15.407 (a) (1)	Power Limits. Maximum output power	P
15.407 (a) (1)	Peak power spectral density	P
15.407 (b) (1) 15.209	Undesirable emissions limits: Band Edge (conducted)	P
15.407 (b) (1) 15.209	Undesirable emissions limits (radiated)	P

P: Pass

F: Fail

NM: Not Measured

NA: Not Applicable

8. Document Revision History

Revision #	Date	Modified by	Details
Rev. 00	2015-05-27	J.M. Fortes	First Issue

Annex A. Test & System Description

A.1 Test Conditions

For 802.11a mode the EUT can transmit at both CHAIN A and CHAIN B RF outputs individually, but not simultaneously.

For 802.11n20 (20 MHz channel bandwidth), 802.11n40 (40MHz channel bandwidth) and 802.11ac80 (80MHz channel bandwidth) modes the EUT can transmit at both CHAIN A and CHAIN B RF outputs individually, and also simultaneously.

The conducted RF output power at each chain was adjusted according to the client's supplied Target values (see following table) using the Intel DRTU tool and measuring the power by using a calibrated average power meter. Measured values for adjustment were within -0.2 dB/+0.3 dB from the declared Target values.

Mode	BW (MHz)	Data Rate	CH #	Freq. (MHz)	Conducted Power Target Value (dBm)		
					SISO Chain A	SISO Chain B	MIMO at both ports A and B
802.11a	20	6Mbps	36	5180	18.5	18.5	-
			40	5200	18.5	18.5	-
			48	5240	21.0	21.0	-
802.11n	20	HT0 HT8*	36	5180	18.0	19.0	17.0
			40	5200	18.0	18.0	17.0
			48	5240	21.0	21.0	18.0
	40	HT0 HT8*	38F	5190	18.0	17.5	16.5
46F			5230	20.0	20.0	17.0	
802.11ac	80	VHT0/8	42ac80	5210	16.5	16.5	12.0

* Note: HT8 for MIMO modes only.

The following data rates were selected based on preliminary testing that identified those rates as the worst cases for output power and spurious levels at the band edges:

802.11a → 6Mbps
 802.11n20 and 802.11n40 (SISO) → HT0
 802.11n20 and 802.11n40 (MIMO) → HT8
 802.11ac80 (SISO) → VHT0
 802.11ac80 (MIMO) → VHT8

A.2 Measurement system

Measurements were performed using the following setups, made in accordance to the general provisions of FCC KDB 789033 D02 General UNII Test Procedures.

The DUT was installed in a test fixture and this test fixture is connected to a laptop computer and AC/DC power adapter. The laptop computer was used to configure the EUT to continuously transmit at a specified output power using all different modes and modulation schemes, using the Intel proprietary tool DRTU.

Conducted Setup

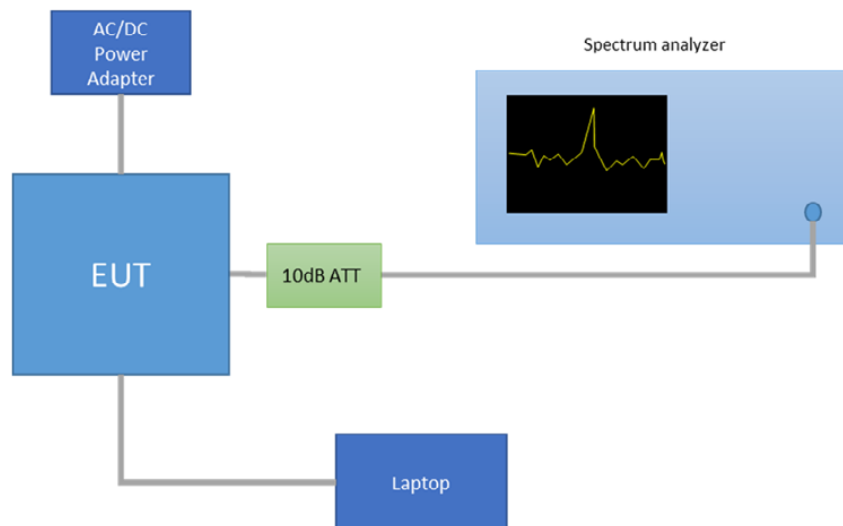

Radiated Setup < 1GHz

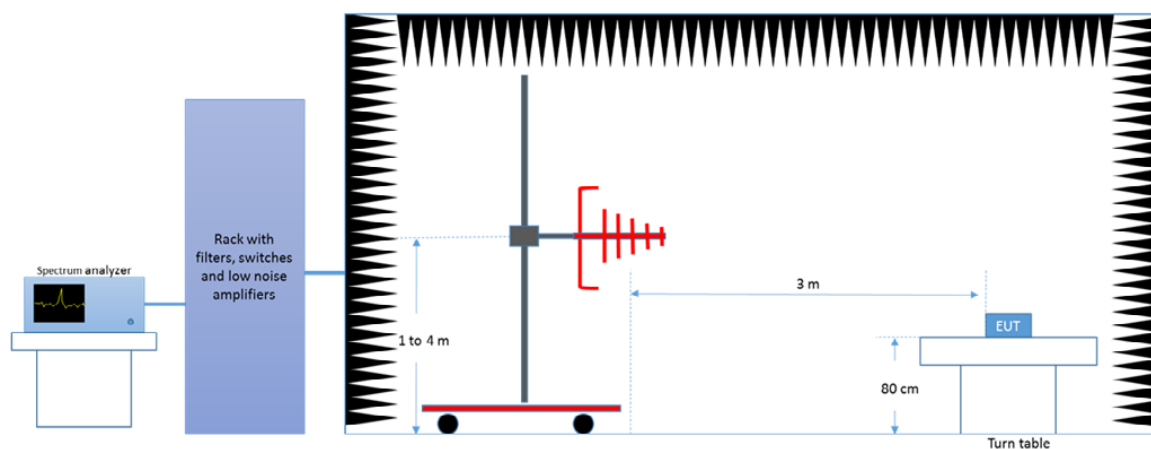

Radiated Setup > 1GHz

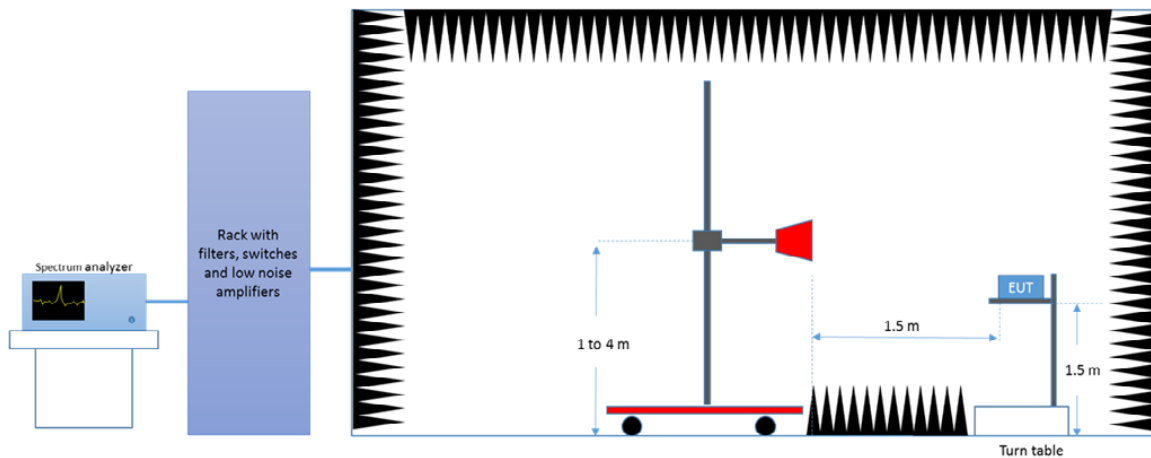

A.3 Test Equipment List

Conducted Setup

ID#	Device	Type/Model	Serial Number	Manufacturer	Cal. Date	Cal. Due Date
0310	Spectrum analyzer	FSV40	101425	Rohde & Schwarz	2015-03-25	2017-03-25

Radiated Setup

ID#	Device	Type/Model	Serial Number	Manufacturer	Cal. Date	Cal. Due Date
0133	Spectrum analyzer	FSV40	101358	Rohde & Schwarz	2014-05-03	2016-05-03
0137	Log antenna 30 MHz – 1 GHz	3142E	00156946	ETS Lindgren	2014-05-03	2016-05-03
0138	Horn antenna 1 GHz – 6.4 GHz	3117	00152266	ETS Lindgren	2014-03-04	2016-03-04
0141	Horn Antenna 6.4 GHz – 18 GHz	3117-PA	00157736	ETS Lindgren	2014-06-03	2016-06-03
0248	Horn Antenna 1 GHz – 18 GHz	3117	00167062	ETS Lindgren	2014-06-23	2014-06-23
0139	Horn Antenna 18GHz – 26GHz	114514	00167100	ETS Lindgren	2014-04-25	2016-04-25
0140	Horn Antenna 26GHz – 40GHz	120722	00169638	ETS Lindgren	2014-06-16	2016-06-16
0135	Anechoic chamber	FACT 3	RFD_FA_100	ETS Lindgren	2014-06-05	2016-06-05

A.4 Measurement Uncertainty Evaluation

The system uncertainty evaluation is shown in the below table:

Measurement type	Uncertainty [±dB]
Conducted Power	±1.0
Conducted spurious emission	±2.9
Radiated test < 1GHz	± 3.8
Radiated test 1GHz - 40 GHz	± 4.7

Annex B. Test Results

B.1 26dB & 99% Bandwidth

Test procedure

The setup below was used to measure the 26dB & 99% Bandwidth. The antenna terminal of the EUT is connected to the spectrum through an attenuator, and the spectrum analyzer reading is compensated to include the RF path loss.

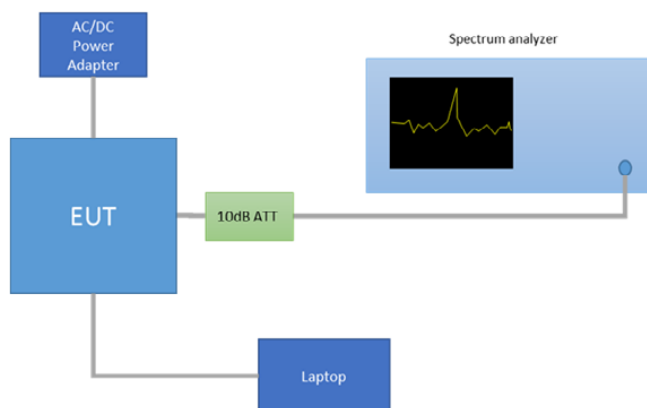

Results tables

Mode	Rate	Antenna	Channel	Frequency [MHz]	26dB BW [MHz]	99% BW [MHz]
802.11a	6Mbps	SISO CHAIN A	36	5180	23.25	16.61
			40	5200	22.65	16.54
			48	5240	30.53	19.70
		SISO CHAIN B	36	5180	23.81	16.69
			40	5200	23.54	16.59
			48	5240	31.63	20.78
802.11n20	HT0	SISO CHAIN A	36	5180	23.48	17.74
			40	5200	24.52	17.81
			48	5240	32.79	19.96
		SISO CHAIN B	36	5180	24.39	17.83
			40	5200	24.21	17.81
			48	5240	32.44	21.16
802.11n20	HT8	MIMO CHAIN A	36	5180	23.54	17.71
			40	5200	23.56	17.82
			48	5240	26.52	17.98
		MIMO CHAIN B	36	5180	23.92	17.80
			40	5200	23.60	17.75
			48	5240	26.60	18.03

Mode	Rate	Antenna	Channel	Frequency [MHz]	26dB BW [MHz]	99% BW [MHz]
802.11n40	HT0	SISO CHAIN A	38F	5190	45.08	36.16
			46F	5230	46.59	36.33
		SISO CHAIN B	38F	5190	45.81	36.23
			46F	5230	48.35	36.44
	HT8	MIMO CHAIN A	38F	5190	44.96	36.25
			46F	5230	44.93	36.26
		MIMO CHAIN B	38F	5190	42.29	36.08
			46F	5230	43.21	36.08
802.11ac80	VHT0	SISO CHAIN A	42ac80	5210	81.19	74.86
		SISO CHAIN B	42ac80	5210	81.09	74.90
	VHT8	MIMO CHAIN A	42ac80	5210	80.16	74.87
		MIMO CHAIN B	42ac80	5210	79.13	74.82

Results screenshot

802.11a, 6Mbps – Chain A

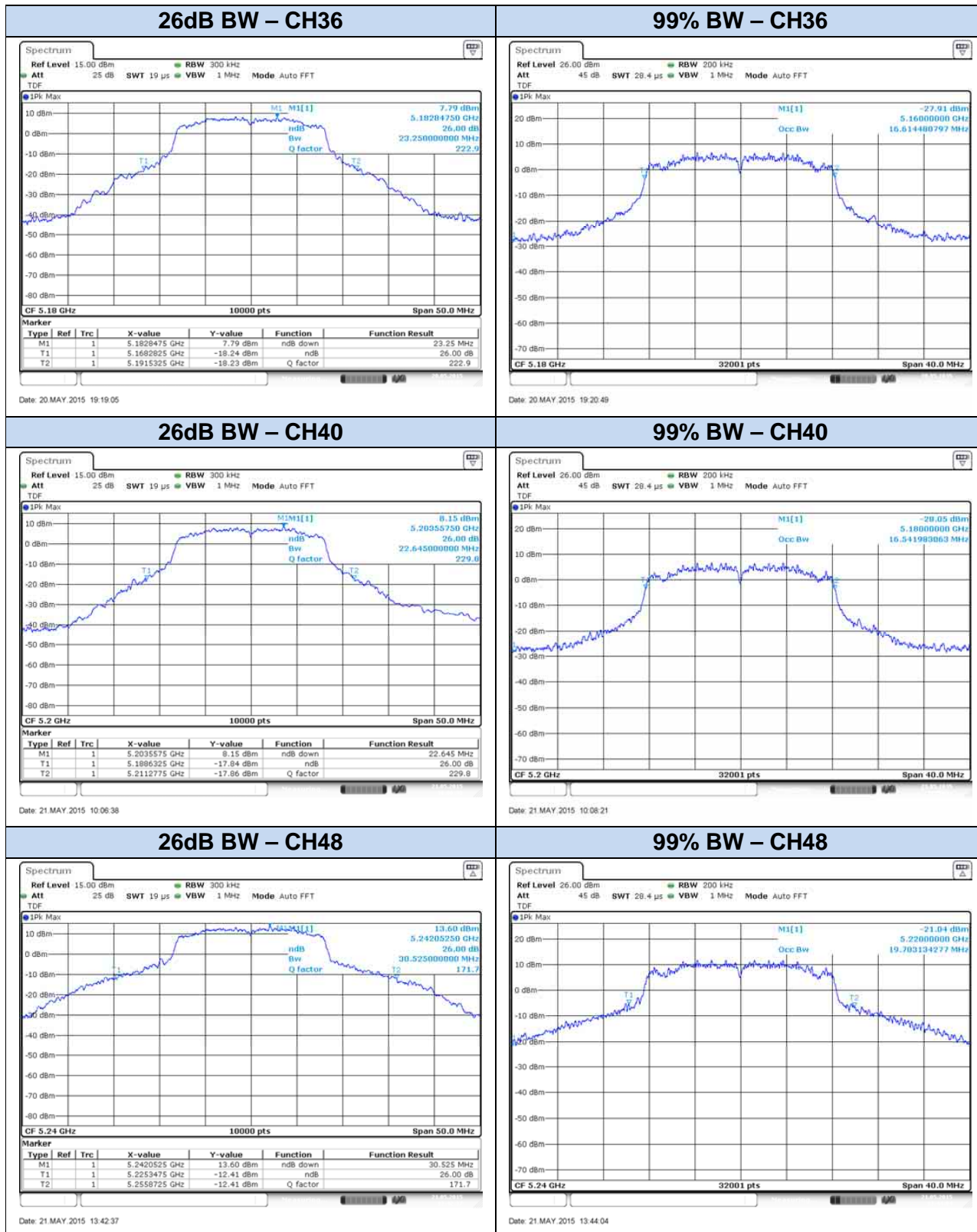

802.11a, 6Mbps – Chain B

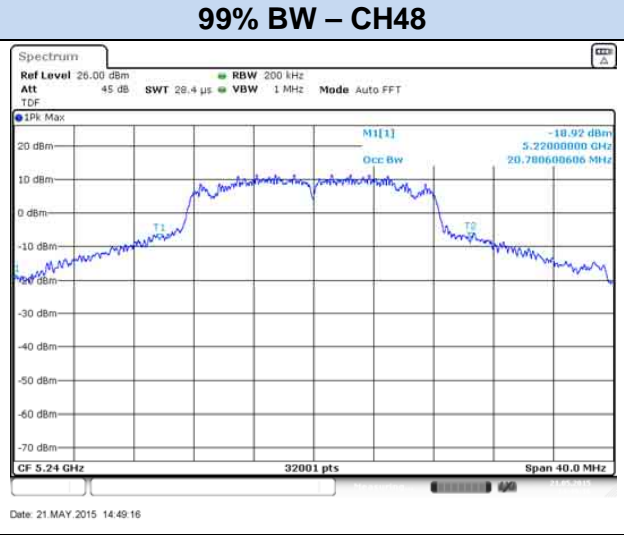
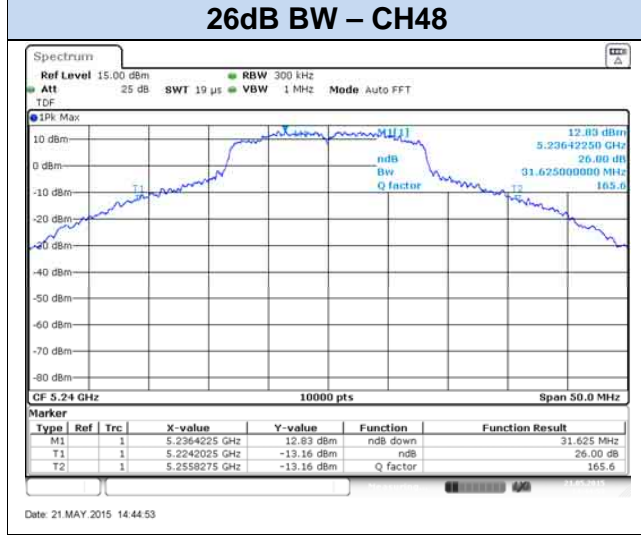
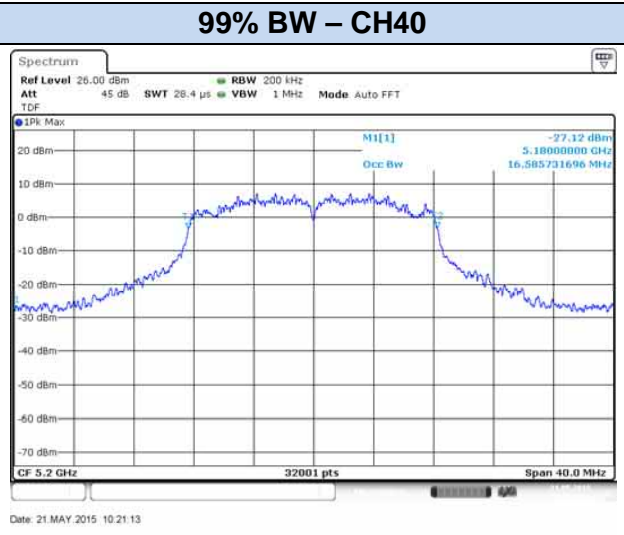
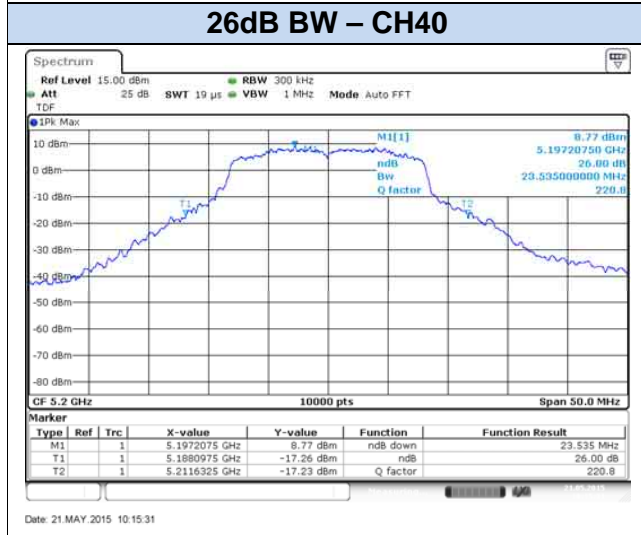
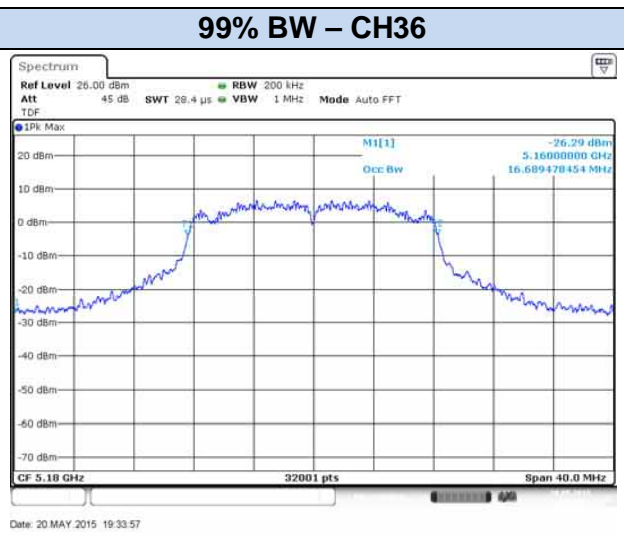
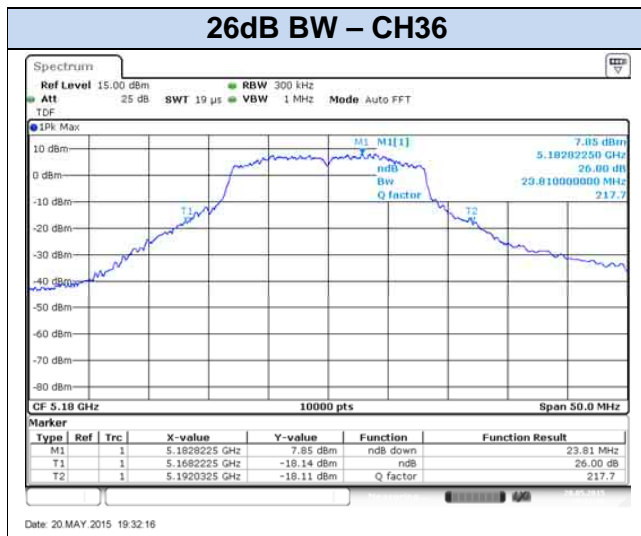

802.11n20, HT0 (SISO) – Chain A

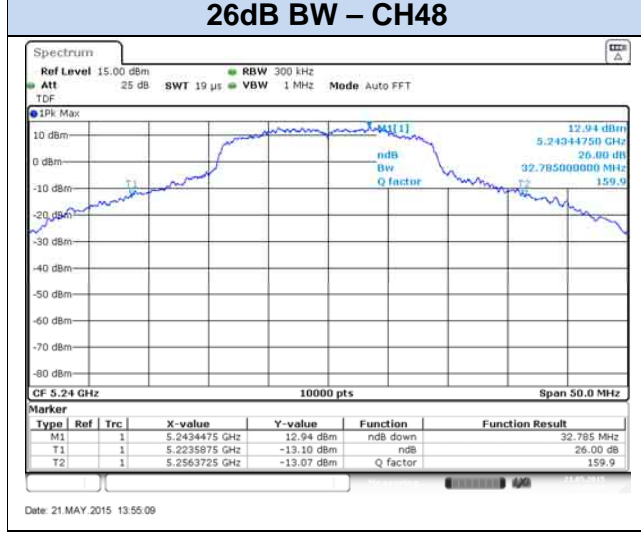
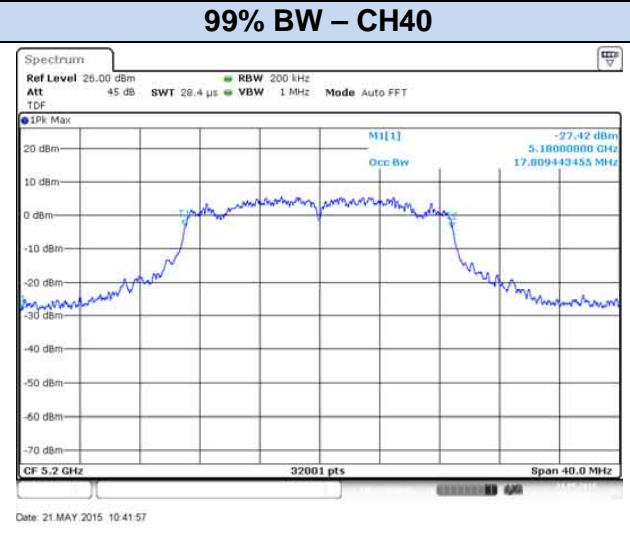
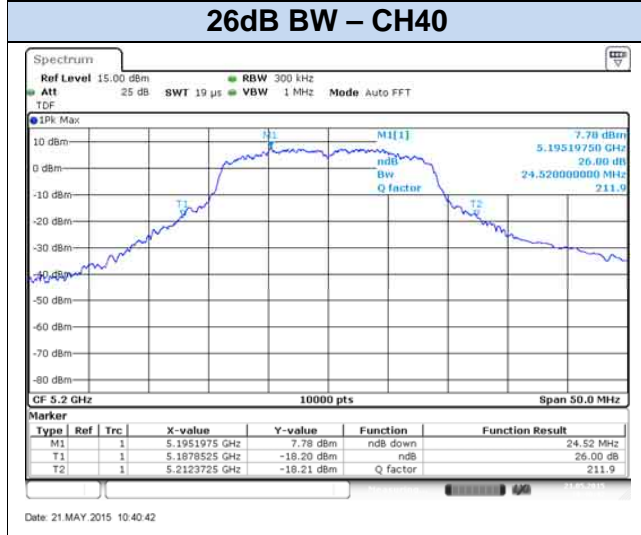
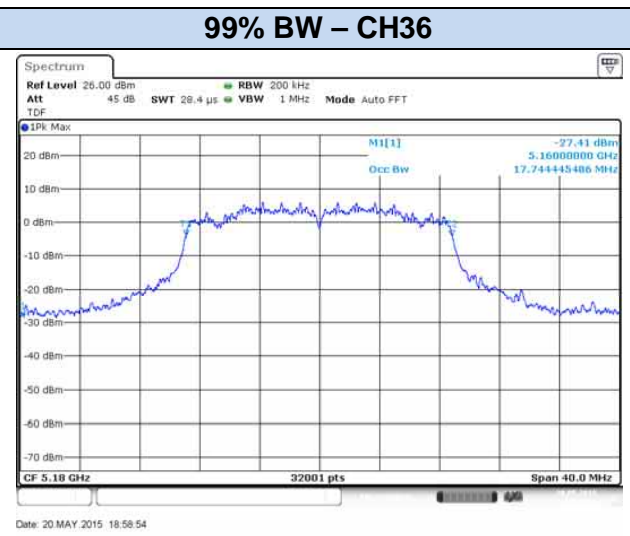
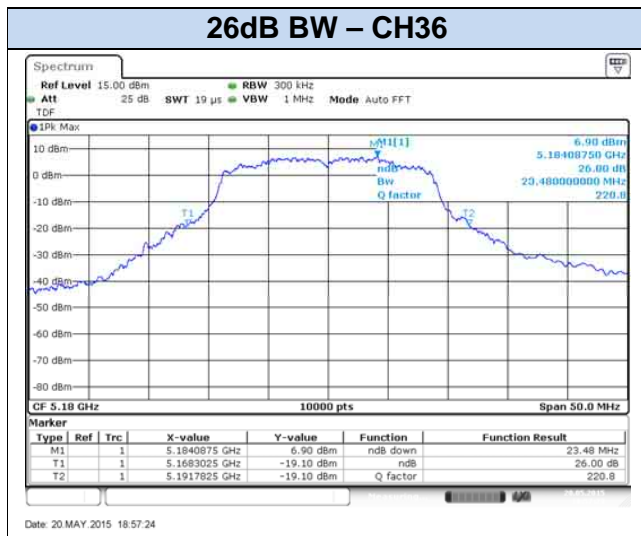

802.11n20, HT0 (SISO) – Chain B

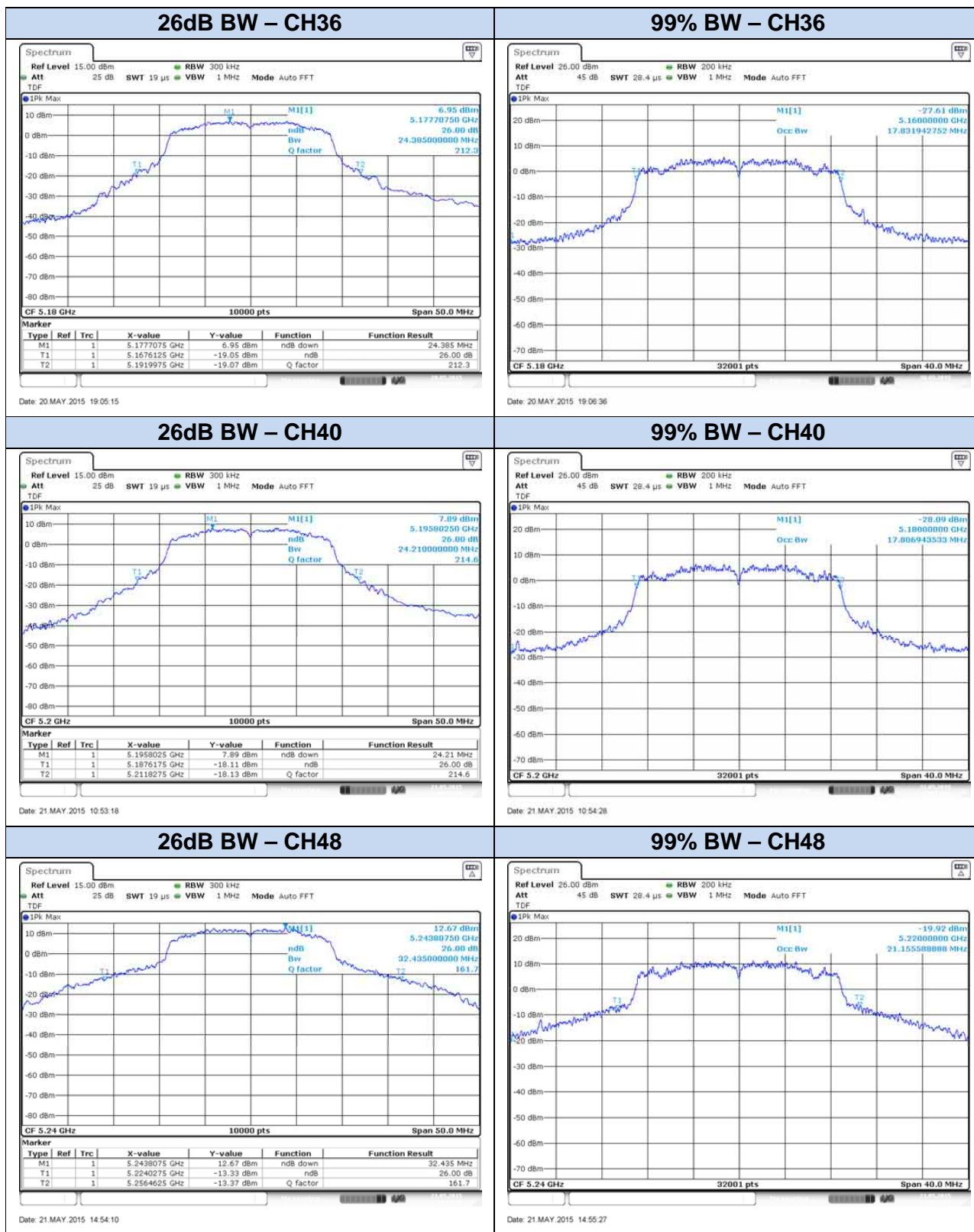

802.11n20, HT8 (MIMO) – Chain A

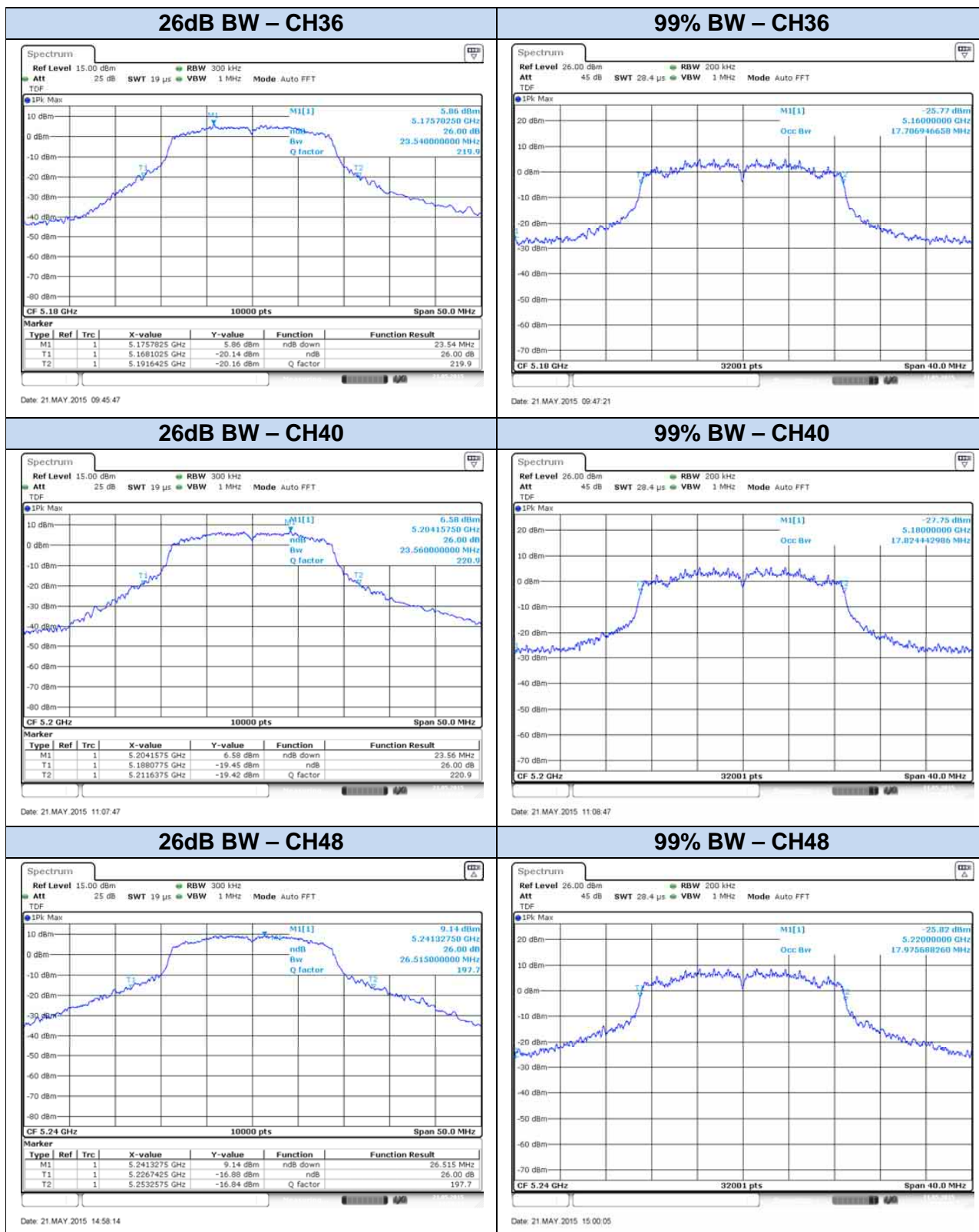

802.11n20, HT8 (MIMO) – Chain B

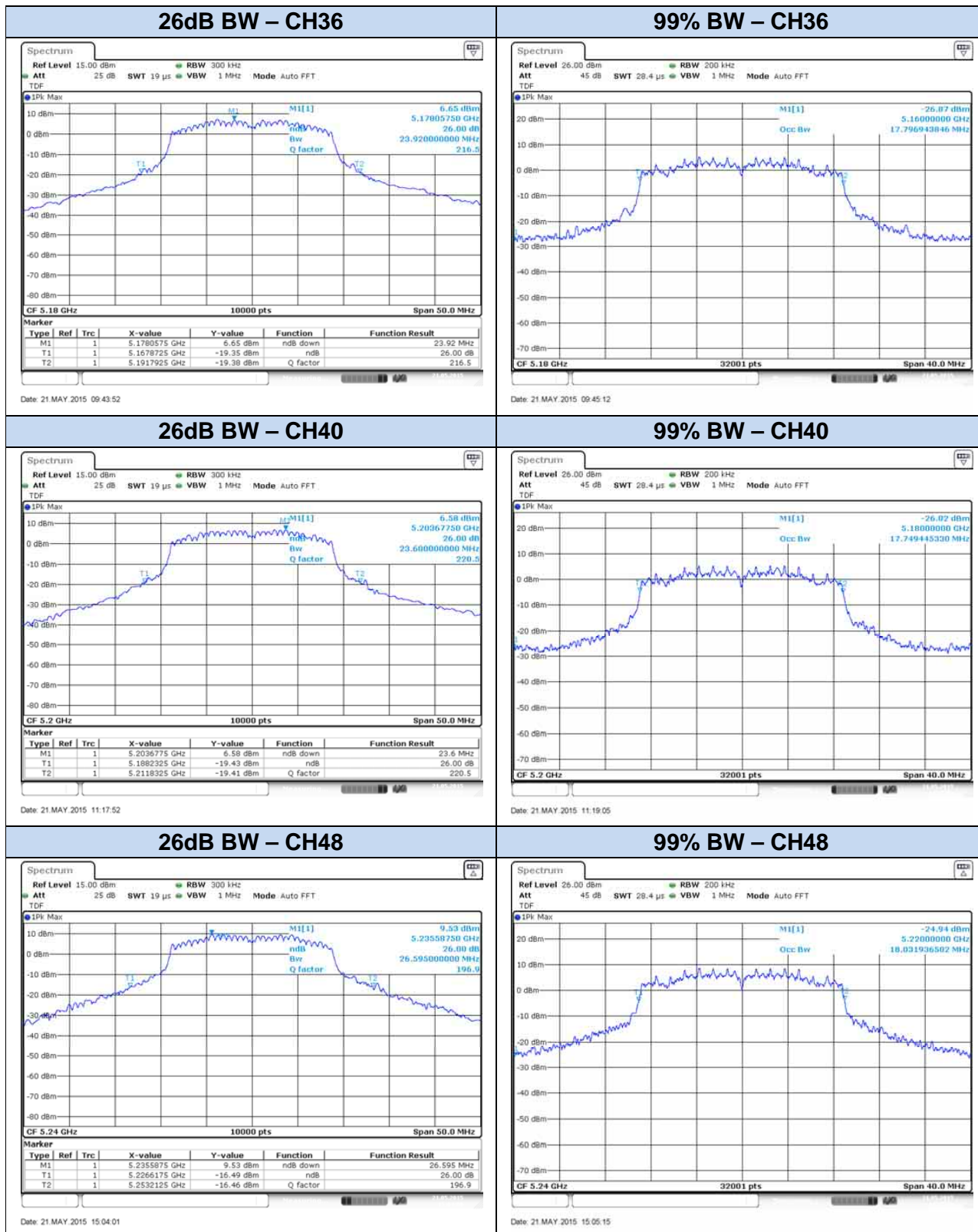

802.11n40, HT0 (SISO) – Chain A

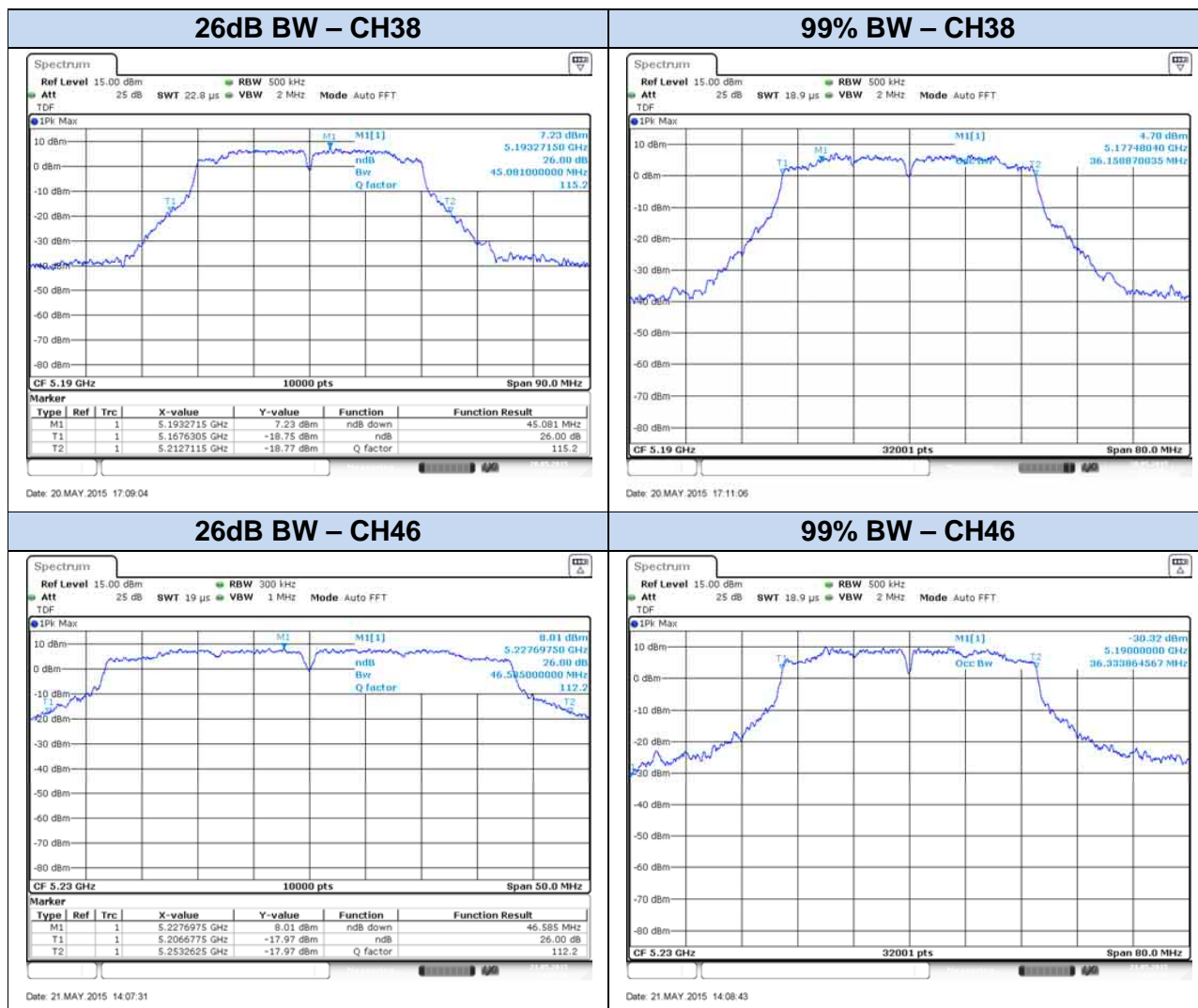

802.11n40, HT0 (SISO) – Chain B

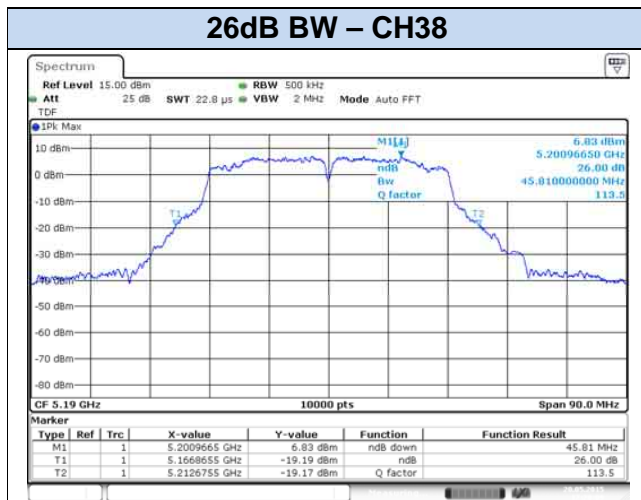

Date: 20 MAY 2015 17:28:09

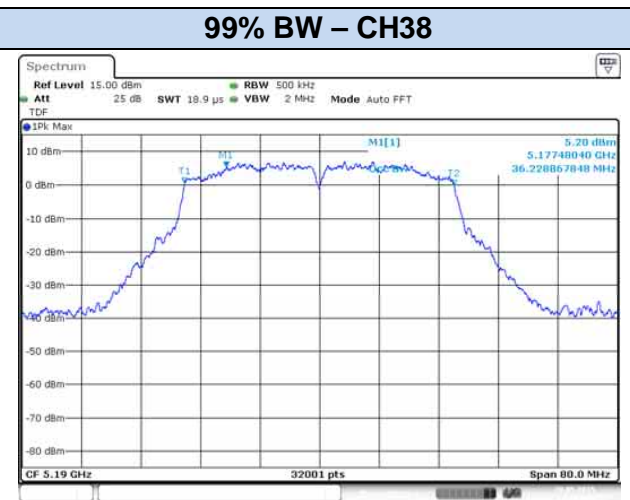

Date: 20 MAY 2015 17:34:35

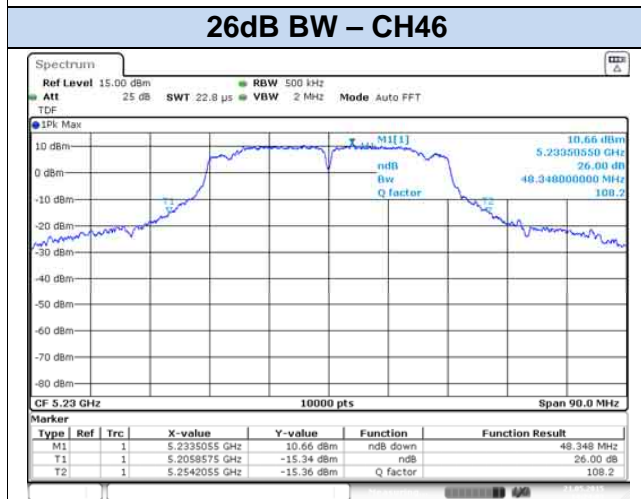

Date: 21 MAY 2015 14:24:03

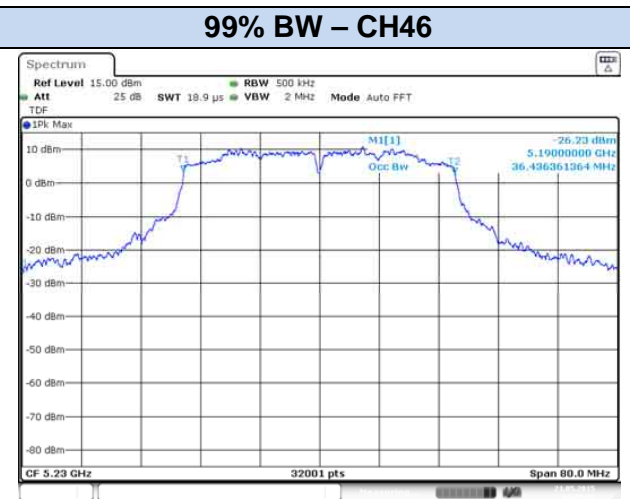

Date: 21 MAY 2015 14:25:27

802.11n40, HT8 (MIMO) – Chain A

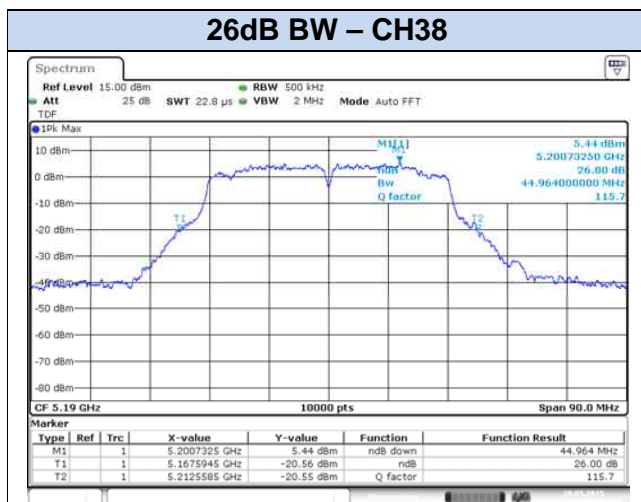

Date: 20 MAY 2015 17:48:59

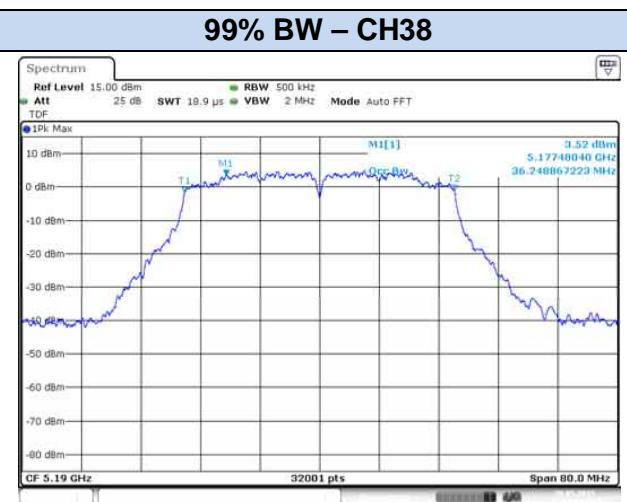

Date: 20 MAY 2015 17:48:24

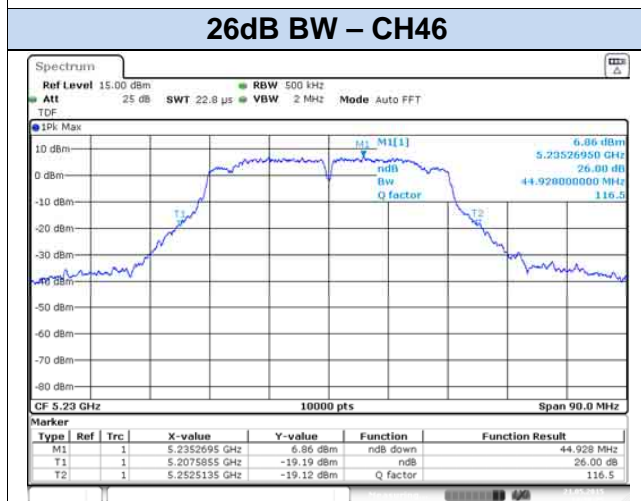

Date: 21 MAY 2015 14:38:25

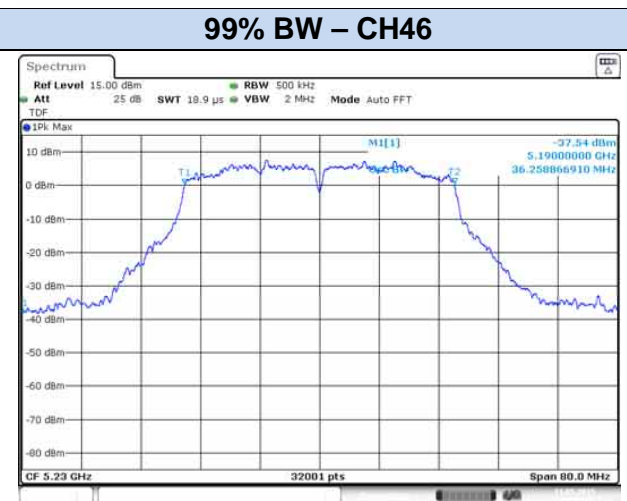

Date: 21 MAY 2015 14:39:45

802.11n40, HT8 (MIMO) – Chain B

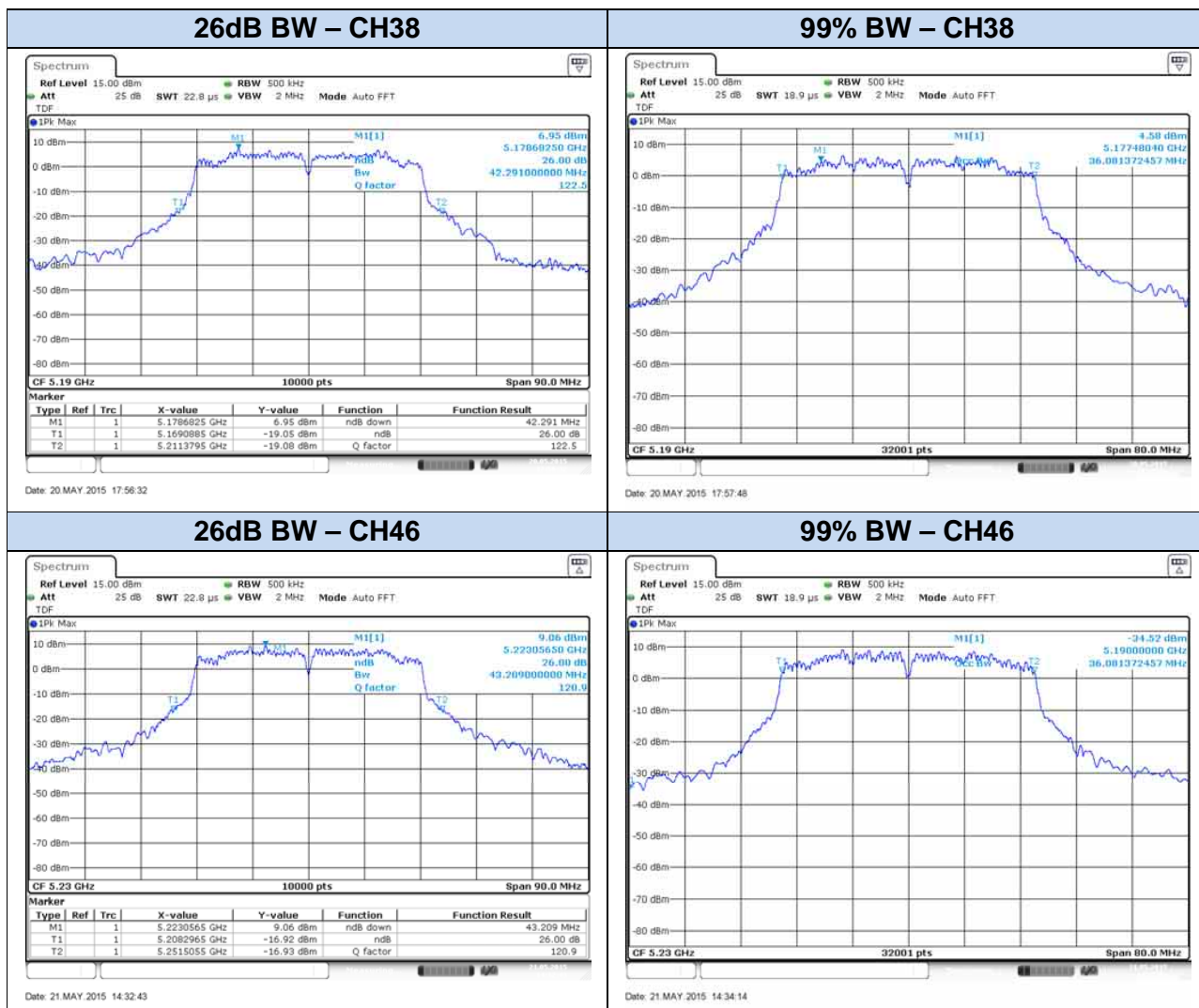

802.11ac80, VHT0 (SISO)

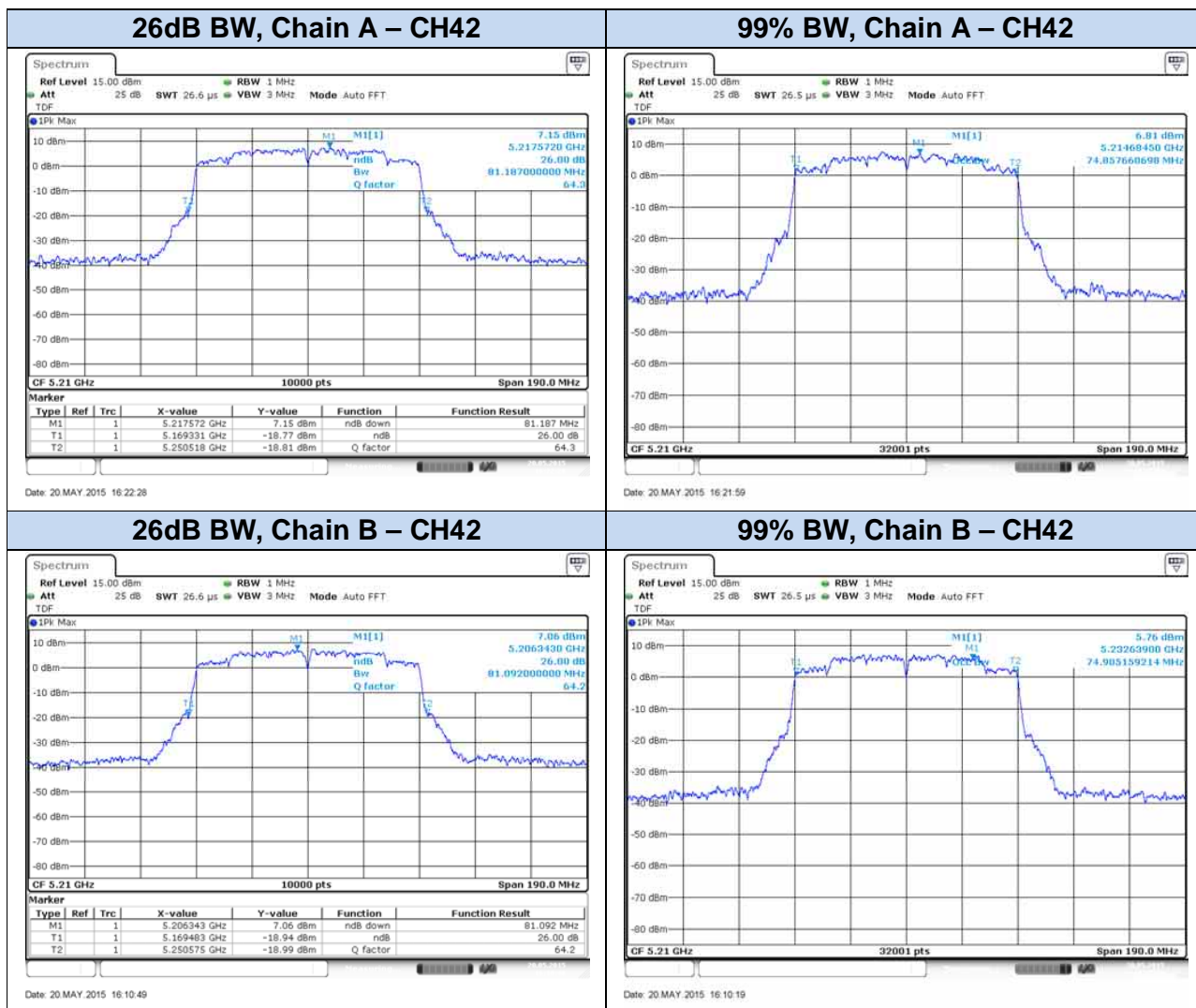

802.11ac80, VHT0 (MIMO)

26dB BW, Chain A – CH42

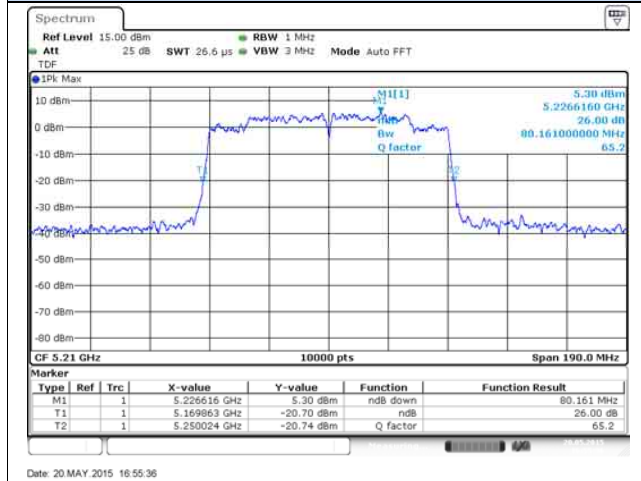

Date: 20 MAY 2015 16:55:36

99% BW, Chain A – CH42



Date: 20 MAY 2015 16:57:06

26dB BW, Chain B – CH42

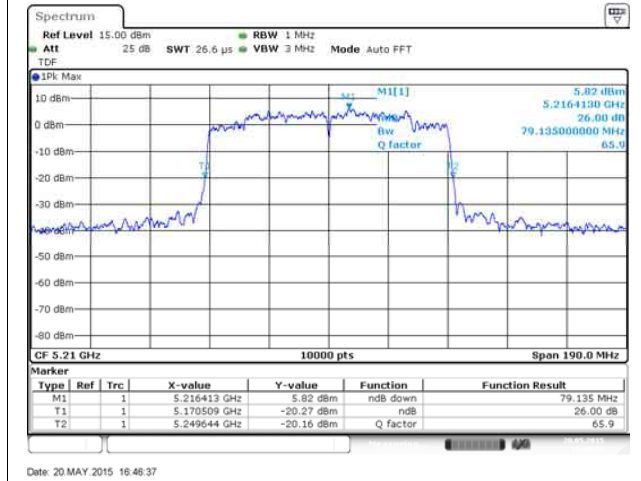

Date: 20 MAY 2015 16:48:37

99% BW, Chain B – CH42

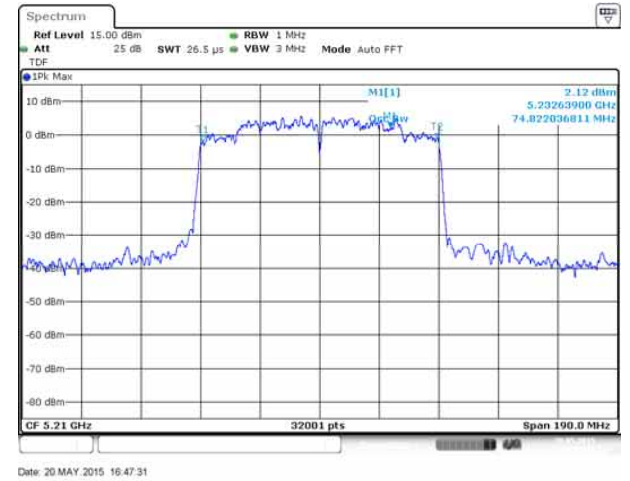

Date: 20 MAY 2015 16:47:31

B.2 Power Limits. Maximum Output power & Peak power spectral density

Test limits

FCC part	Limits
15.407 (a) (1) (iv)	For mobile and portable client devices in the 5.15-5.25 GHz band, the maximum conducted output power over the frequency band of operation shall not exceed 250 mW provided the maximum antenna gain does not exceed 6 dBi. In addition, the maximum power spectral density shall not exceed 11 dBm in any 1 megahertz band.

Test procedure

The Maximum Conducted Output Power was measured using the channel integration method according to point E) 2) e) (Method SA-2 Alternative) of Guidance 789033 D01.

The maximum power spectral density (PSD) was measured using the method according to point F) (Method SA-2 Alternative) of Guidance 789033 D01.

In the measure-and-sum approach for MIMO mode, the conducted emission level (e.g., transmit power or power in specified bandwidth) is measured at each antenna port. The measured results at the various antenna ports are then summed mathematically in linear power units to determine the total emission level from the device.

The EIRP power (dBm) is calculated by adding the declared maximum antenna gain to the measured conducted power.

The setup below was used to measure the maximum conducted output power and power spectral density. The antenna terminal of the EUT is connected to the spectrum through an attenuator, and the spectrum analyzer reading is compensated to include the RF path loss.

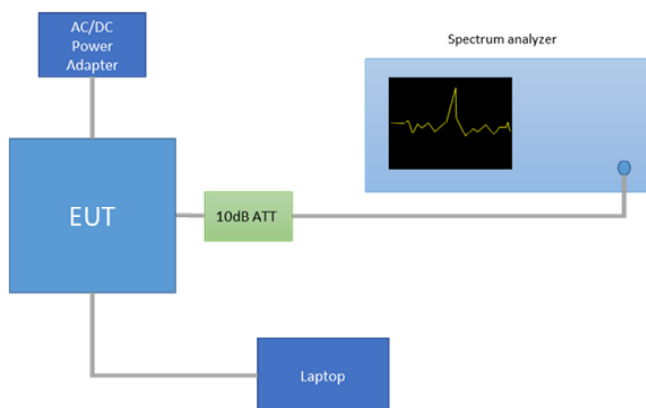

The declared maximum antenna gain is 5dBi.

Results tables

Mode	Rate	Meas. Duty Cycle [%]	CH	Freq. [MHz]	Antenna	Power [dBm]				
						Meas. Cond RMS	Duty cycle Compensated	EIRP	PSD	
802.11a	6Mbps	0.98	36	5180	SISO CHAIN A	18.45	18.52	23.52	7.50	
					SISO CHAIN B	18.34	18.41	23.41	6.87	
			40	5200	SISO CHAIN A	18.31	18.38	23.38	7.36	
					SISO CHAIN B	18.34	18.41	23.41	7.37	
			48	5240	SISO CHAIN A	20.93	21.00	26.00	9.97	
					SISO CHAIN B	20.69	20.76	25.76	9.71	
802.11n20	HT0	0.96	36	5180	SISO CHAIN A	17.80	17.96	22.96	6.67	
					SISO CHAIN B	18.63	18.79	23.79	7.88	
			40	5200	SISO CHAIN A	17.81	17.97	22.97	6.68	
					SISO CHAIN B	17.80	17.96	22.96	7.12	
			48	5240	SISO CHAIN A	20.93	21.09	26.09	9.78	
					SISO CHAIN B	20.73	20.89	25.89	9.56	
	HT8	0.96	36	5180	MIMO CHAIN A	16.92	17.08	22.08	6.16	
					MIMO CHAIN B	15.64	15.80	20.80	5.59	
			40	5200	MIMO CHAIN A	17.33	17.49	22.49	6.24	
					MIMO CHAIN B	16.64	16.80	21.80	5.47	
			48	5240	MIMO CHAIN A	18.09	18.25	23.25	6.93	
					MIMO CHAIN B	17.55	17.71	22.71	6.41	
802.11n40	HT0	0.93	38F	5190	SISO CHAIN A	17.58	17.89	22.89	3.10	
					SISO CHAIN B	17.10	17.41	22.41	2.62	
			46F	5230	SISO CHAIN A	19.91	20.22	25.22	5.43	
					SISO CHAIN B	20.13	20.44	25.44	5.67	
	HT8	0.93	38F	5190	MIMO CHAIN A	16.60	16.91	21.91	2.16	
					MIMO CHAIN B	16.38	16.69	21.69	2.01	
			46F	5230	MIMO CHAIN A	16.83	17.14	22.14	2.43	
					MIMO CHAIN B	16.79	17.10	22.10	2.38	
802.11ac80	VHT0	0.94	42ac80	5210	SISO CHAIN A	16.63	16.92	21.92	-0.56	
					SISO CHAIN B	16.36	16.65	21.65	-0.83	
	VHT8		0.63	42ac80	5210	MIMO CHAIN A	11.96	13.96	18.96	-4.73
						MIMO CHAIN B	11.48	13.41	18.41	-5.08

MIMO modes – Combined results					Power [dBm]		
Mode	Rate	Channel	Frequency (MHz)	Antenna	Combined, Duty Cycle compensated	EIRP	Combined PSD
802.11n20	HT8	36	5180	MIMO CHAIN A + CHAIN B	19.5	24.50	8.89
		40	5200		20.2	25.18	8.90
		48	5240		21.0	26.00	9.69
802.11n40	HT8	38F	5190		19.8	24.81	5.10
		46F	5230		20.1	25.13	5.42
802.11ac80	VHT8	42ac80	5210		16.7	21.71	-1.90

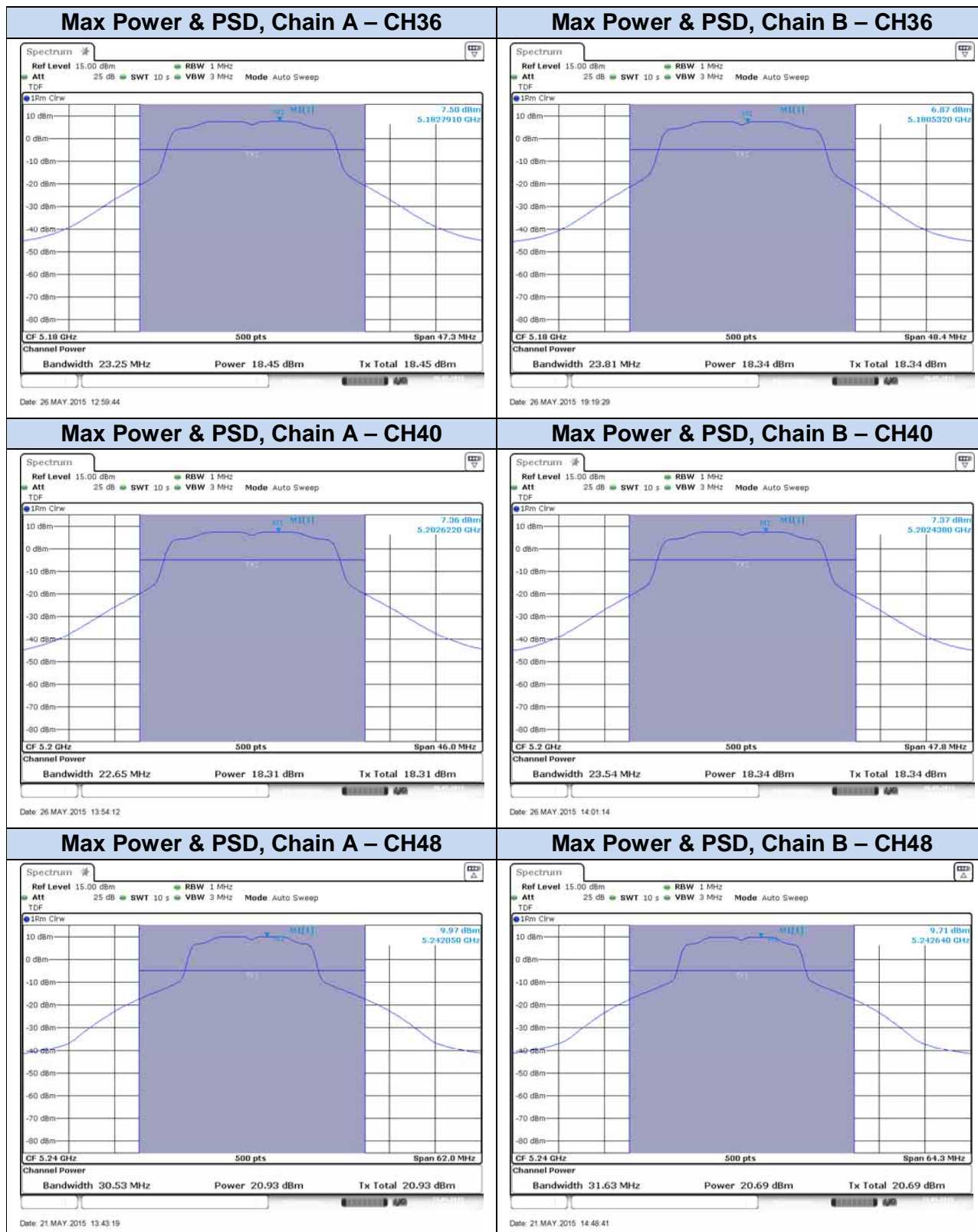
Results screenshot**802.11a, 6Mbps**

802.11n20, HT0 (SISO)

Max Power & PSD, Chain A – CH36



Max Power & PSD, Chain B – CH36

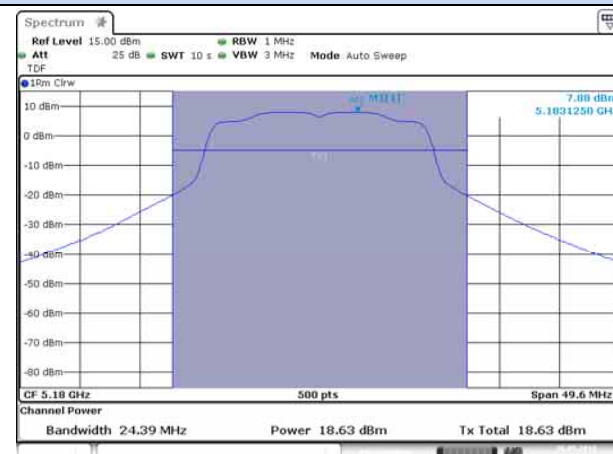

Max Power & PSD, Chain A – CH40

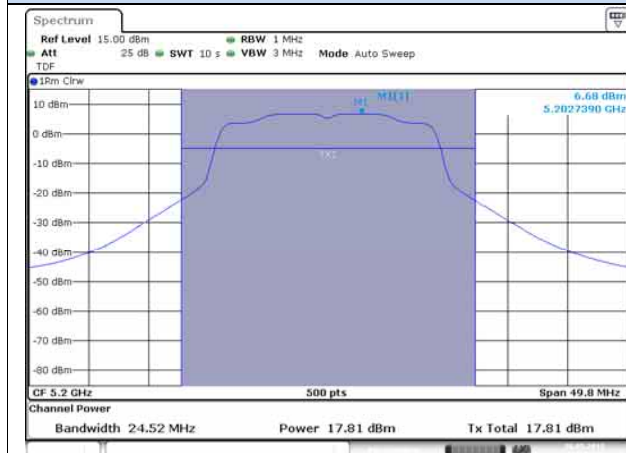

Max Power & PSD, Chain B – CH40

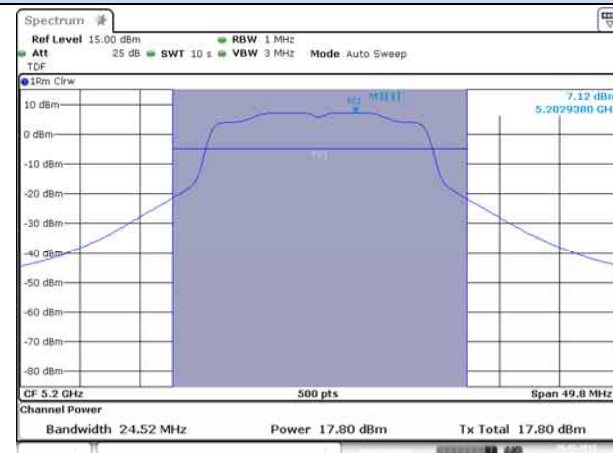

Max Power & PSD, Chain A – CH48

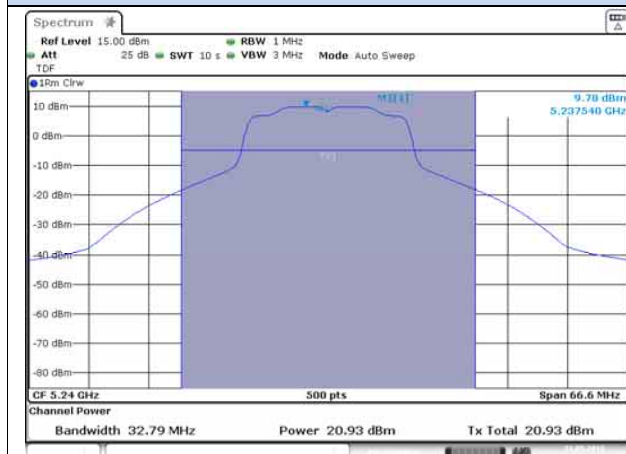

Max Power & PSD, Chain B – CH48



802.11n20, HT8 (MIMO)

Max Power & PSD, Chain A – CH36

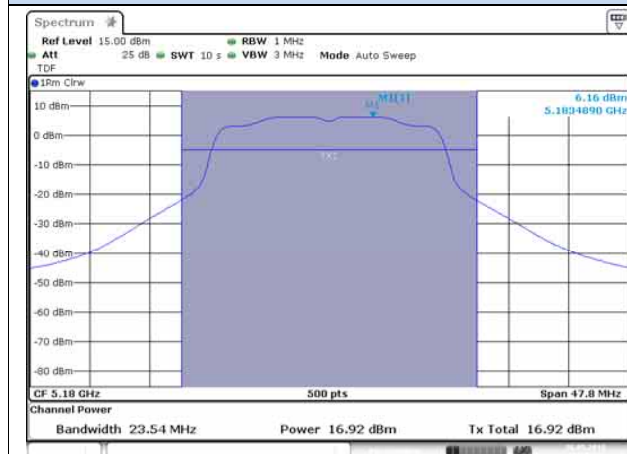

Max Power & PSD, Chain B – CH36



Max Power & PSD, Chain A – CH40



Max Power & PSD, Chain B – CH40

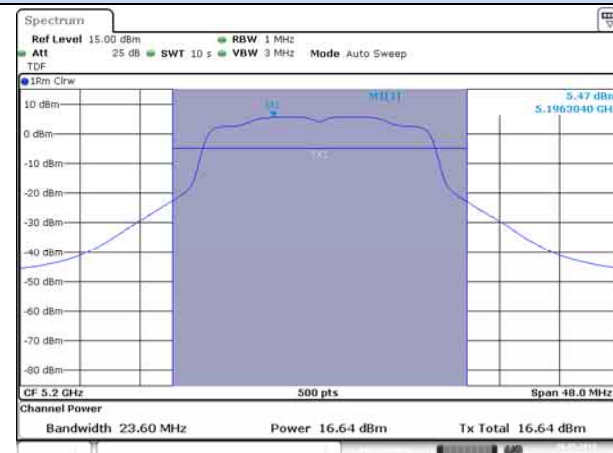

Max Power & PSD, Chain A – CH48

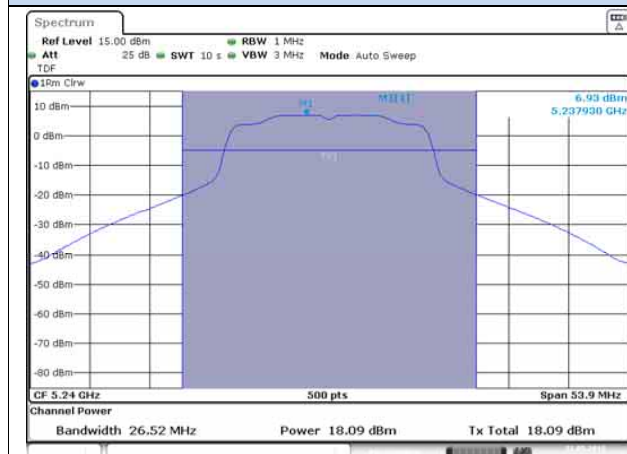

Max Power & PSD, Chain B – CH48

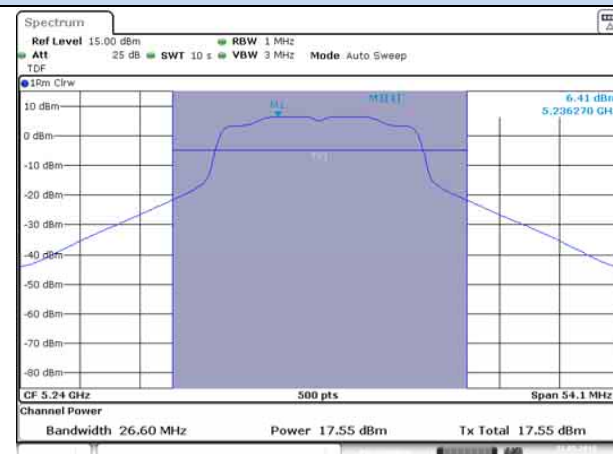

802.11n40, HT0 (SISO)

Max Power & PSD, Chain A – CH38



Max Power & PSD, Chain B – CH38

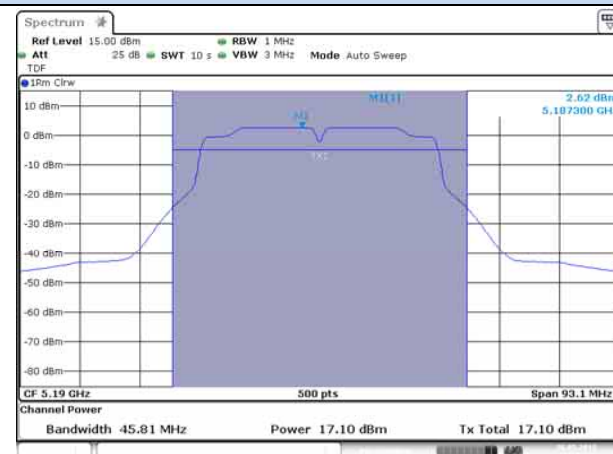

Max Power & PSD, Chain A – CH46



Max Power & PSD, Chain B – CH46

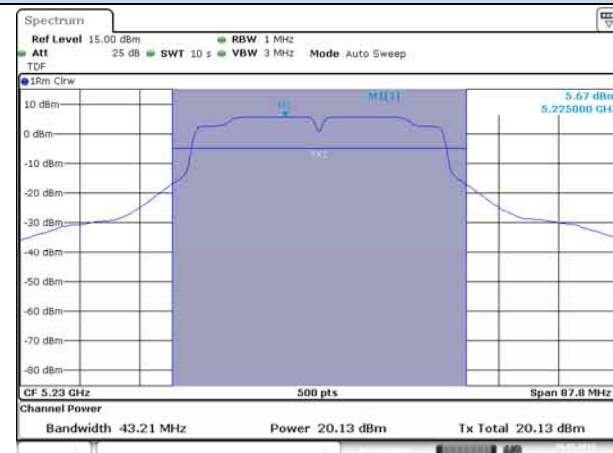

802.11n40, HT8 (MIMO)

Max Power & PSD, Chain A – CH38

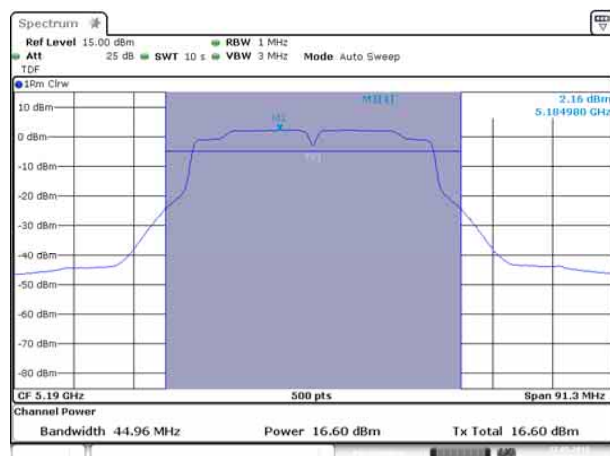

Date: 27 MAY 2015 12:07:34

Max Power & PSD, Chain B – CH38

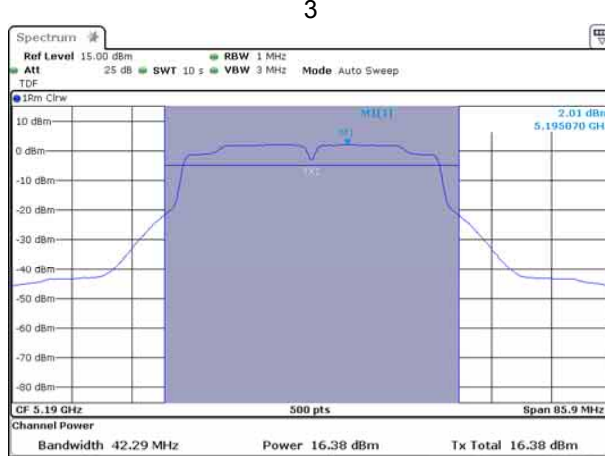

Date: 28 MAY 2015 17:25:38

Max Power & PSD, Chain A – CH46

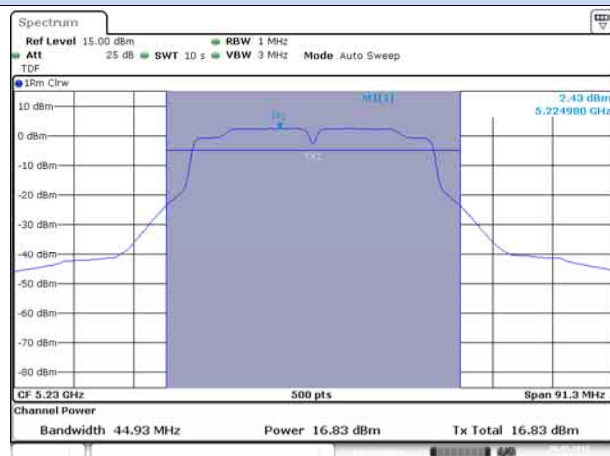

Date: 26 MAY 2015 20:23:50

Max Power & PSD, Chain B – CH46

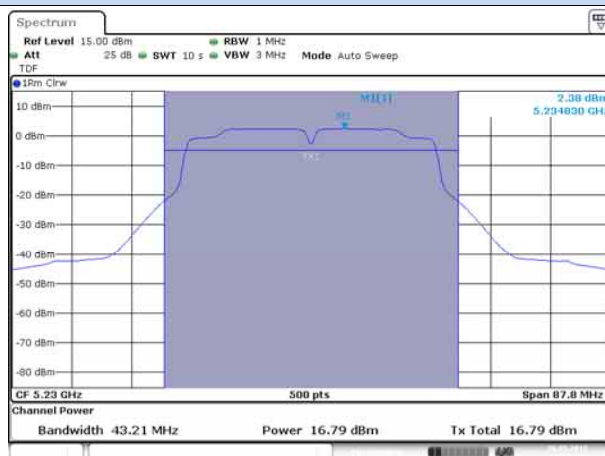

Date: 26 MAY 2015 20:01:35

802.11ac80, VHT0 (SISO)

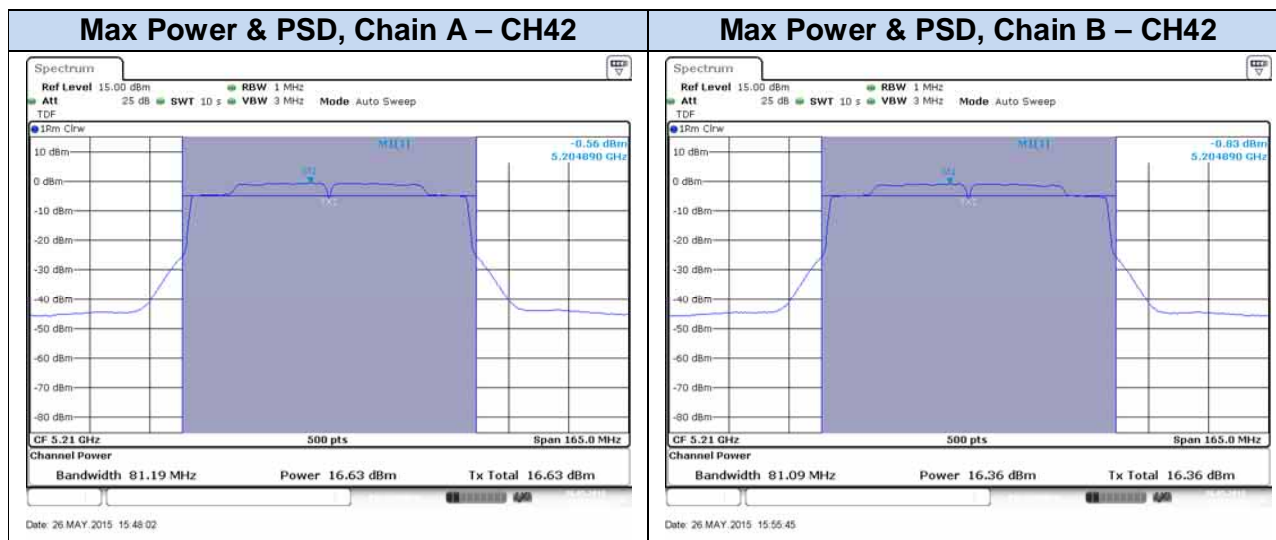

802.11ac80, VHT0 (MIMO)

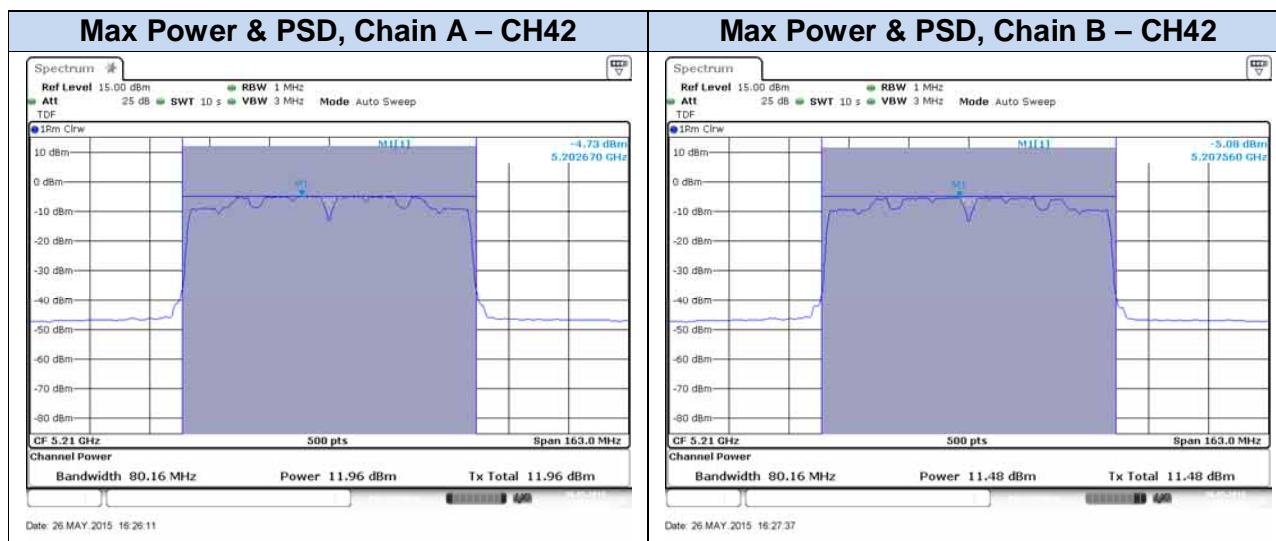

B.3 Undesirable emissions limits: Band Edge (conducted)

Test limits

FCC part	Limits																																
15.407 (b) (1)	For transmitters operating in the 5.15-5.25 GHz band: All emissions outside of the 5.15-5.35 GHz band shall not exceed an e.i.r.p. of -27 dBm/MHz.																																
15.209	<p>Radiated emissions which fall in the restricted bands, as defined in §15.205(a), must also comply with the radiated emission limits specified in §15.209(a):</p> <table border="1"> <thead> <tr> <th>Freq Range (MHz)</th> <th>Field Strength ($\mu\text{V}/\text{m}$)</th> <th>Field Strength ($\text{dB}\mu\text{V}/\text{m}$)</th> <th>Meas. Distance (m)</th> </tr> </thead> <tbody> <tr> <td>0.009-0.490</td> <td>2400/f(kHz)</td> <td>-</td> <td>300</td> </tr> <tr> <td>0.490-1.705</td> <td>24000/f(kHz)</td> <td>-</td> <td>300</td> </tr> <tr> <td>1.705-30.0</td> <td>30</td> <td>-</td> <td>30</td> </tr> <tr> <td>30-88</td> <td>100</td> <td>40</td> <td>3</td> </tr> <tr> <td>88-216</td> <td>150</td> <td>43.5</td> <td>3</td> </tr> <tr> <td>216-960</td> <td>200</td> <td>46</td> <td>3</td> </tr> <tr> <td>960-25000</td> <td>500</td> <td>54</td> <td>3</td> </tr> </tbody> </table> <p>The emission limits shown in the above table are based on measurements employing CISPR quasi-peak detector except for the frequency bands 9-90 kHz, 110-490 kHz and above 1000 MHz. Radiated emission limits in these three bands are based on measurements employing an average detector.</p> <p>For average radiated emission measurements above 1000 MHz, there is also a limit specified when measuring with peak detector function, corresponding to 20 dB above the indicated values in the table.</p>	Freq Range (MHz)	Field Strength ($\mu\text{V}/\text{m}$)	Field Strength ($\text{dB}\mu\text{V}/\text{m}$)	Meas. Distance (m)	0.009-0.490	2400/f(kHz)	-	300	0.490-1.705	24000/f(kHz)	-	300	1.705-30.0	30	-	30	30-88	100	40	3	88-216	150	43.5	3	216-960	200	46	3	960-25000	500	54	3
Freq Range (MHz)	Field Strength ($\mu\text{V}/\text{m}$)	Field Strength ($\text{dB}\mu\text{V}/\text{m}$)	Meas. Distance (m)																														
0.009-0.490	2400/f(kHz)	-	300																														
0.490-1.705	24000/f(kHz)	-	300																														
1.705-30.0	30	-	30																														
30-88	100	40	3																														
88-216	150	43.5	3																														
216-960	200	46	3																														
960-25000	500	54	3																														

Test procedure

The setup below was used to measure the maximum peak output power. The antenna terminal of the EUT is connected to the spectrum through an attenuator, and the spectrum analyzer reading is compensated to include the RF path loss and the declared Antenna Gain.

In case of Band Edge measurements falling in restricted bands, the declared Antenna Gain is also compensated in the graph.

The declared maximum antenna gain is 5dBi.

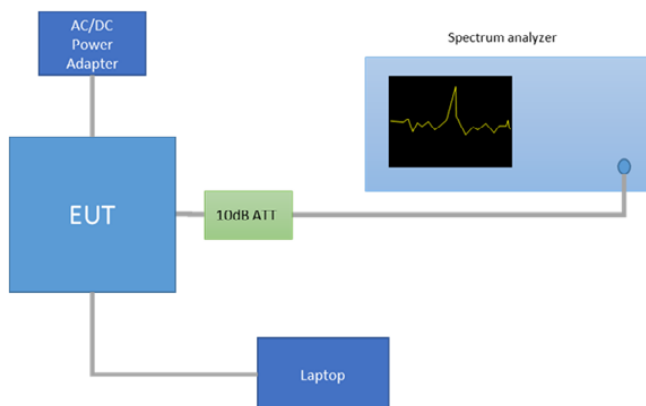

Results Screenshot**802.11a, 6Mbps – Chain A****BE Low Freq Section, Peak – CH36****BE Low Freq Section, RMS – CH36****BE Low Freq Section, Peak – CH40****BE Low Freq Section, RMS – CH40**

802.11a, 6Mbps – Chain B

BE Low Freq Section, Peak – CH36

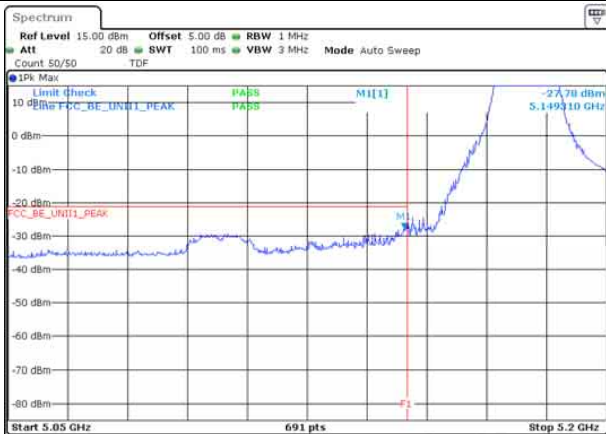

Date: 26 MAY 2015 13:39:33

BE Low Freq Section, RMS – CH36



Date: 27 MAY 2015 16:16:08

BE Low Freq Section, Peak – CH40

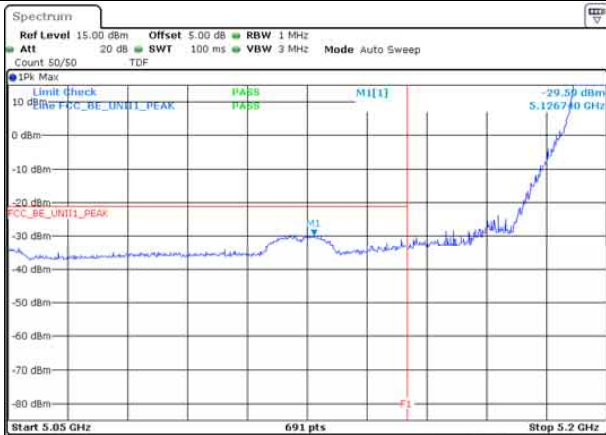

Date: 26 MAY 2015 13:59:39

BE Low Freq Section, RMS – CH40

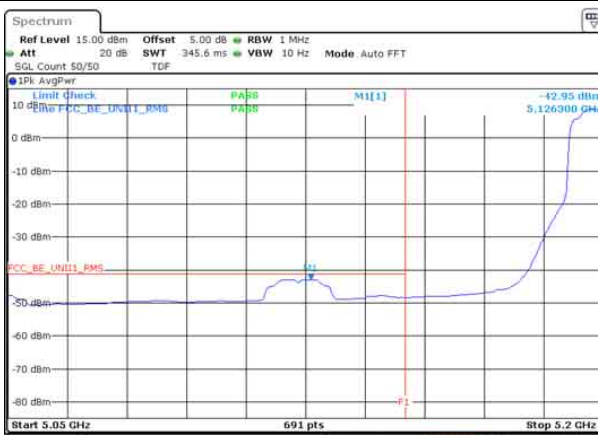

Date: 27 MAY 2015 16:18:21

802.11n20, HT0 (SISO) – Chain A

BE Low Freq Section, Peak – CH36

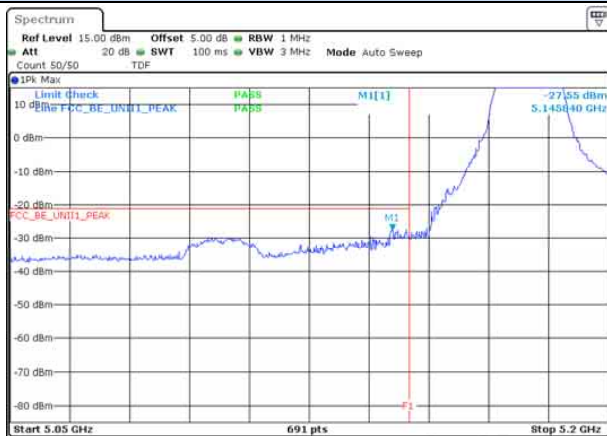

Date: 26 MAY 2015 14:21:26

BE Low Freq Section, RMS – CH36



Date: 27 MAY 2015 15:58:10

BE Low Freq Section, Peak – CH40

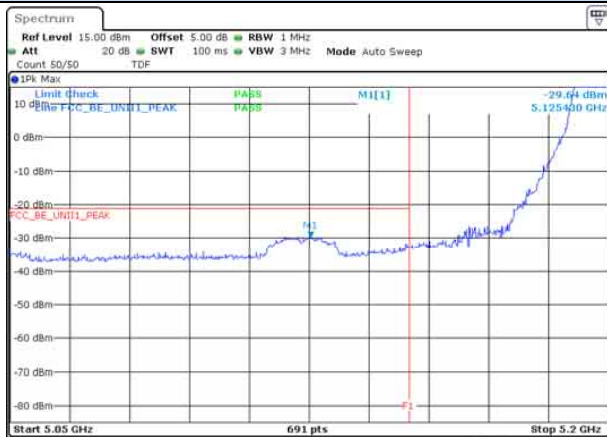

Date: 26 MAY 2015 15:02:24

BE Low Freq Section, RMS – CH40



Date: 27 MAY 2015 16:01:35

802.11n20, HT0 (SISO) – Chain B

BE Low Freq Section, Peak – CH36



BE Low Freq Section, RMS – CH36

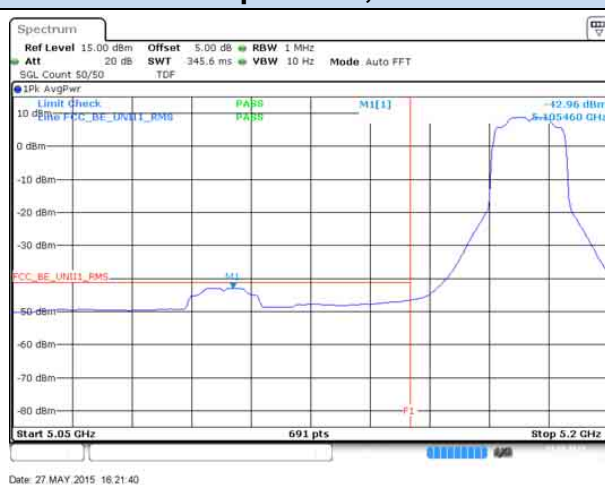

BE Low Freq Section, Peak – CH40



BE Low Freq Section, RMS – CH40



802.11n20, HT8 (MIMO) – Chain A

BE Low Freq Section, Peak – CH36

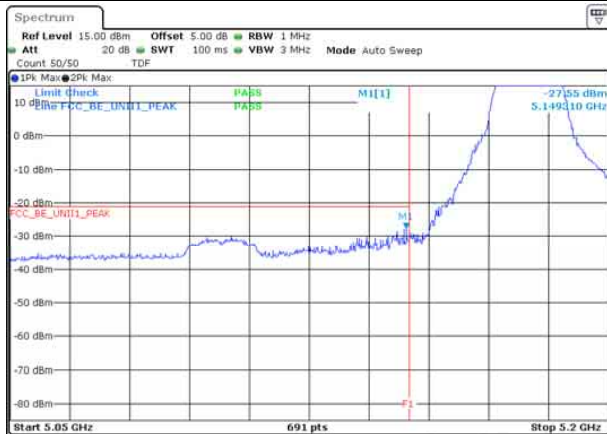

Date: 26 MAY 2015 14:37:04

BE Low Freq Section, RMS – CH36

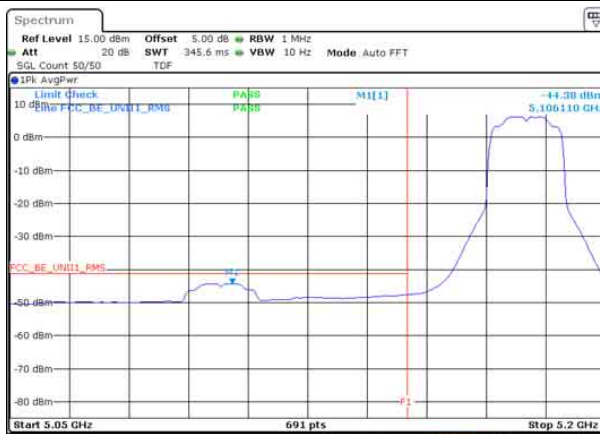

Date: 27 MAY 2015 16:29:42

BE Low Freq Section, Peak – CH40

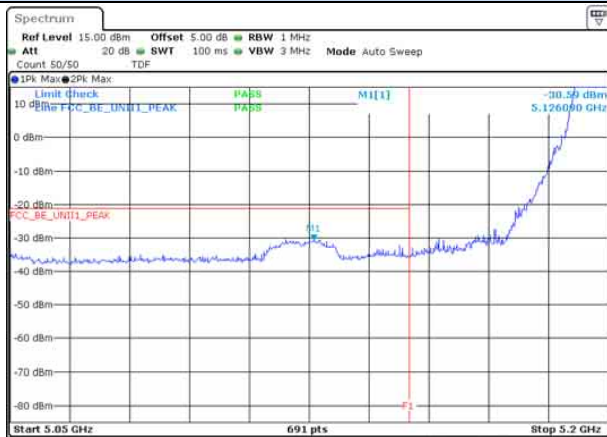

Date: 26 MAY 2015 16:41:50

BE Low Freq Section, RMS – CH40

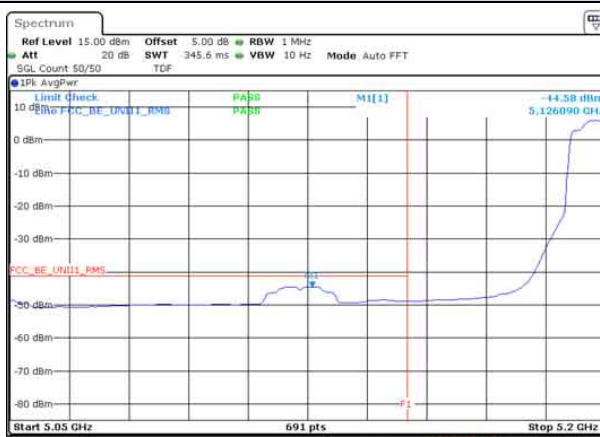

Date: 27 MAY 2015 16:55:34

802.11n20, HT8 (MIMO) – Chain B

BE Low Freq Section, Peak – CH36



Date: 26 MAY 2015 14:43:01

BE Low Freq Section, RMS – CH36



Date: 27 MAY 2015 16:26:24

BE Low Freq Section, Peak – CH40



Date: 26 MAY 2015 16:52:35

BE Low Freq Section, RMS – CH40

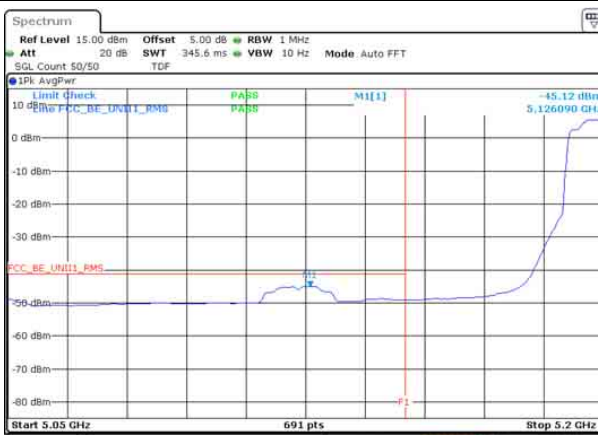

Date: 27 MAY 2015 16:58:56

802.11n40, HT0 (SISO) – Chain A

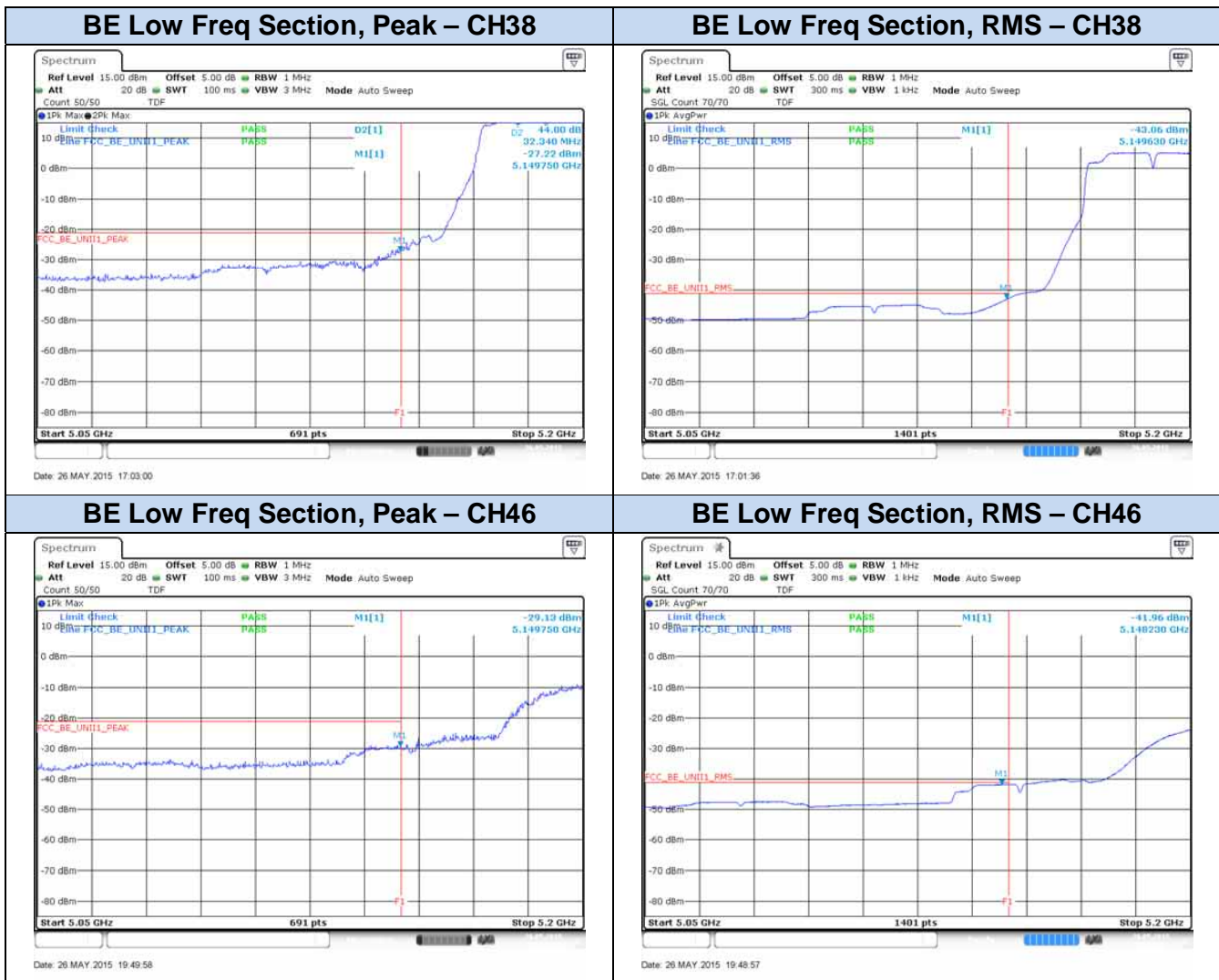

802.11n40, HT0 (SISO) – Chain B

BE Low Freq Section, Peak – CH38



Date: 26 MAY 2015 17:09:18

BE Low Freq Section, RMS – CH38



Date: 26 MAY 2015 17:07:56

BE Low Freq Section, Peak – CH46



Date: 26 MAY 2015 19:53:36

BE Low Freq Section, RMS – CH46



Date: 26 MAY 2015 19:52:43

802.11n40, HT8 (MIMO) – Chain A

BE Low Freq Section, Peak – CH38

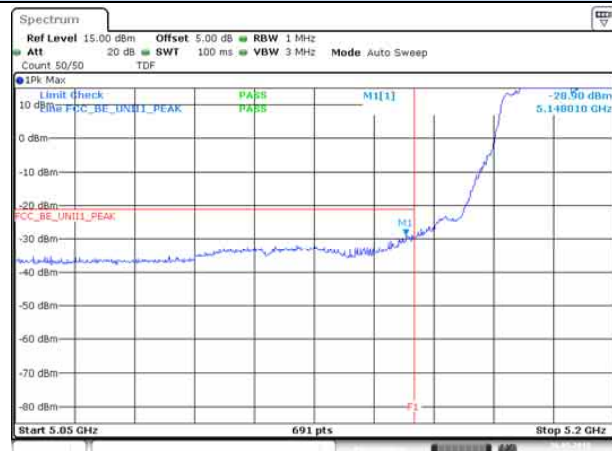

BE Low Freq Section, RMS – CH38



BE Low Freq Section, Peak – CH46

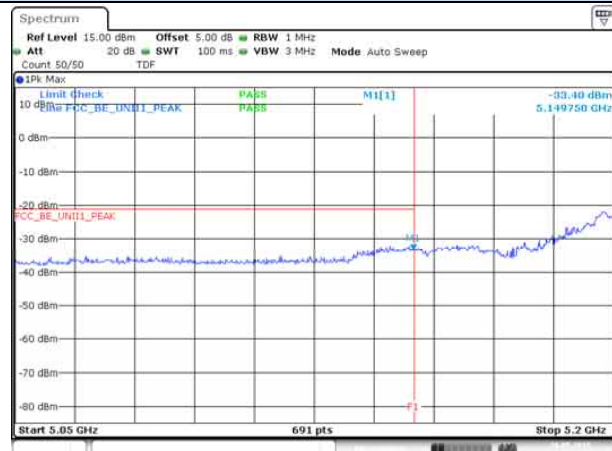

BE Low Freq Section, RMS – CH46



802.11n40, HT8 (MIMO) – Chain B

BE Low Freq Section, Peak – CH38



BE Low Freq Section, RMS – CH38



BE Low Freq Section, Peak – CH46

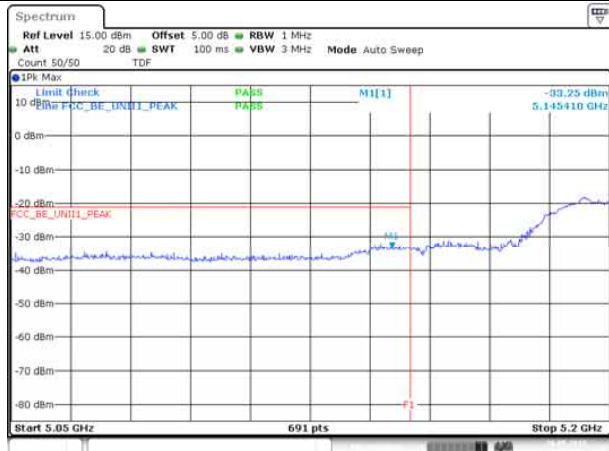

BE Low Freq Section, RMS – CH46



802.11ac80, VHT0 (SISO)- Chain A

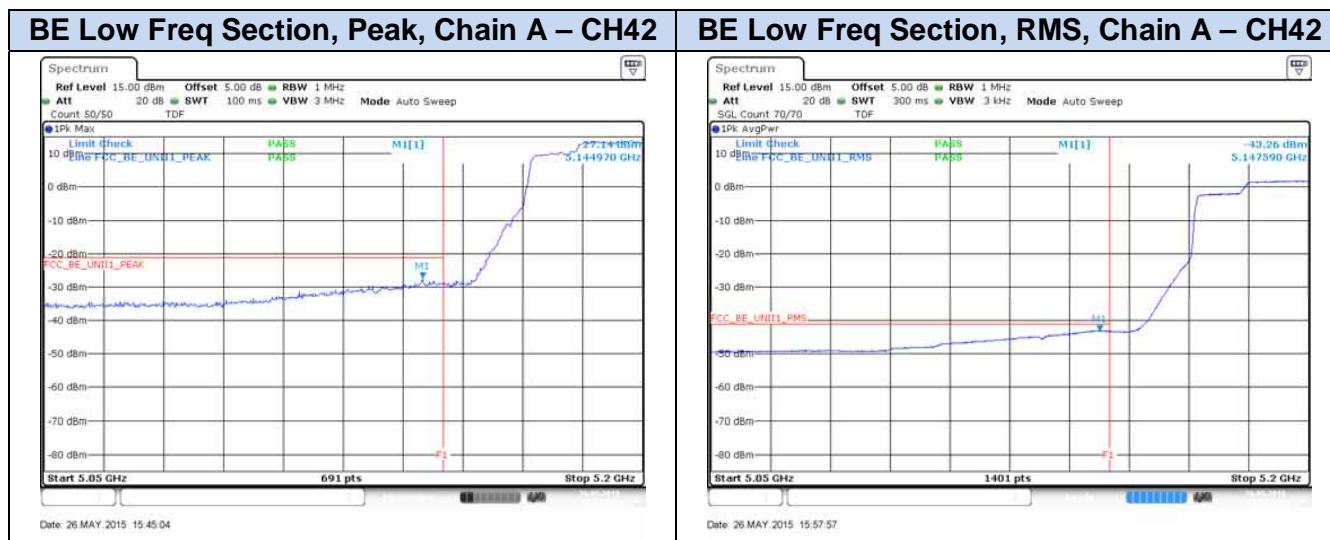

802.11ac80, VHT0 (SISO)- Chain B

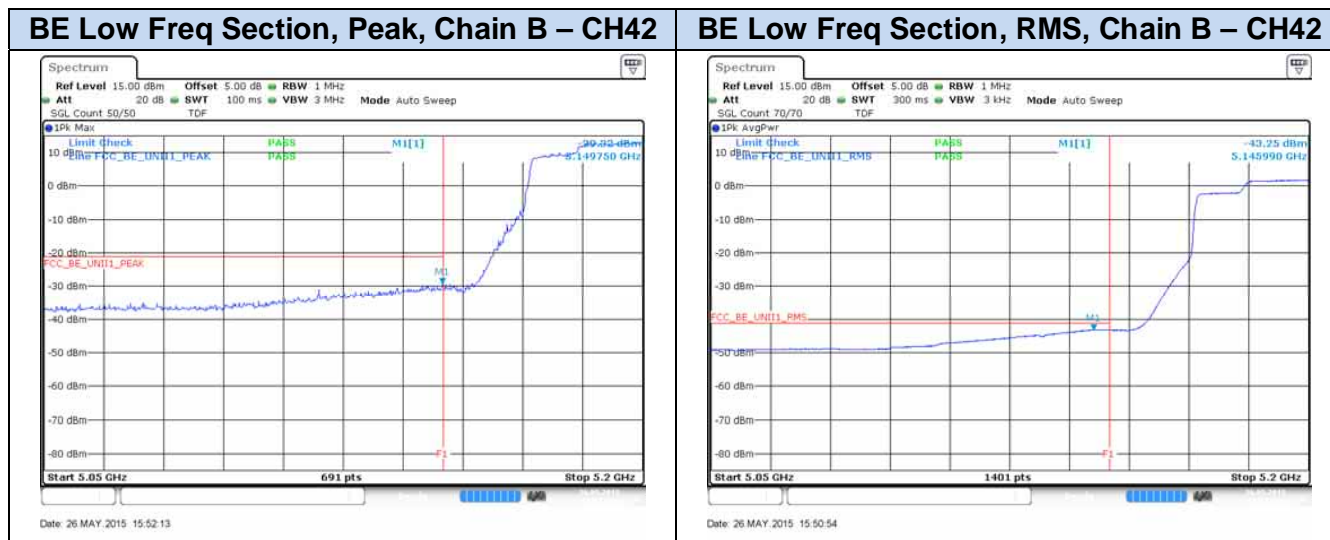

802.11ac80, VHT8 (MIMO)- Chain A

BE Low Freq Section, Peak, Chain A – CH42

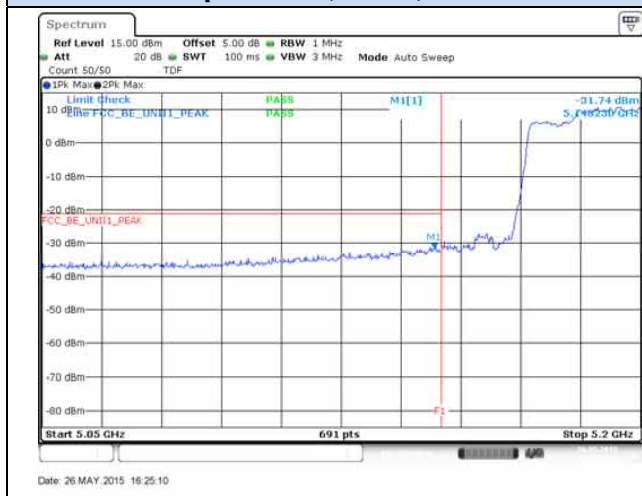

BE Low Freq Section, RMS, Chain A – CH42

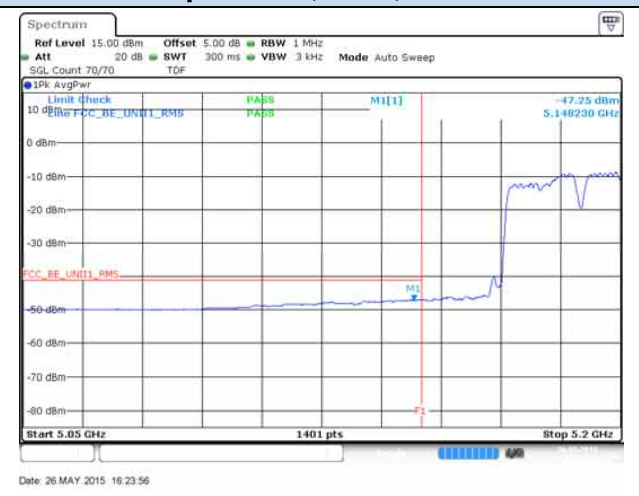

802.11ac80, VHT8 (MIMO)- Chain B

BE Low Freq Section, Peak, Chain A – CH42

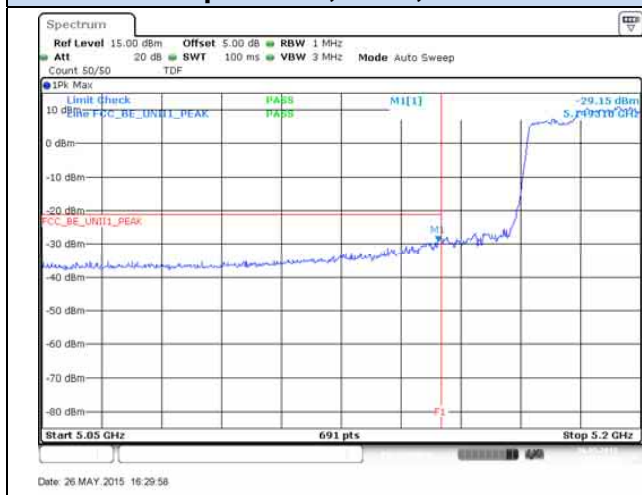

BE Low Freq Section, RMS, Chain B – CH42

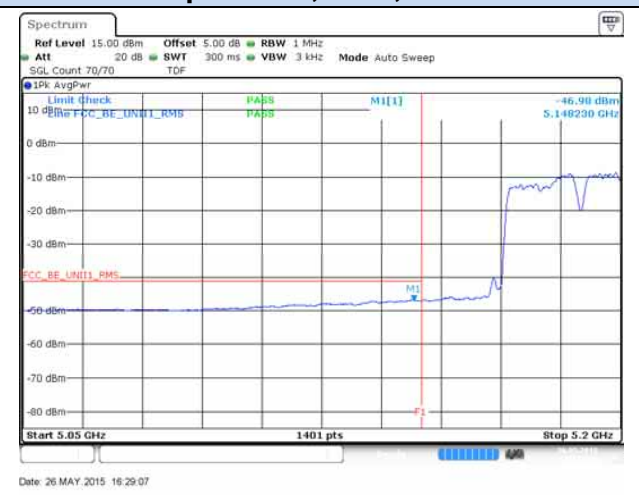

B.4 Radiated spurious emission

Standard references

FCC part	RSS part	Limits			
15.247 (d)	RSS-210 Clause A8.5	Radiated emissions which fall in the restricted bands, as defined in §15.205(a), must also comply with the radiated emission limits specified in §15.209(a):			
		Freq Range (MHz)	Field Strength ($\mu\text{V}/\text{m}$)	Field Strength ($\text{dB}\mu\text{V}/\text{m}$)	Meas. Distance (m)
		0.009-0.490	2400/f(kHz)	-	300
		0.490-1.705	24000/f(kHz)	-	300
		1.705-30.0	30	-	30
		30-88	100	40	3
		88-216	150	43.5	3
		216-960	200	46	3
		960-25000	500	54	3
		The emission limits shown in the above table are based on measurements employing CISPR quasi-peak detector except for the frequency bands 9-90 kHz, 110-490 kHz and above 1000 MHz. Radiated emission limits in these three bands are based on measurements employing an average detector. For average radiated emission measurements above 1000 MHz, there is also a limit specified when measuring with peak detector function, corresponding to 20 dB above the indicated values in the table.			

Test procedure

The setup below was used to measure the radiated spurious emissions. Depending of the frequency range and bands being tested, different antennas and filters were used. The final measurement is done by varying the antenna height from 1 to 4 meters, the EUT azimuth over 360° and for both Vertical and Horizontal polarizations. The radiated spurious emission was measured on the worst case configuration selected from the chapter **Error! Reference source not found.** and on the low, middle and high channel.

Radiated Setup < 1GHz

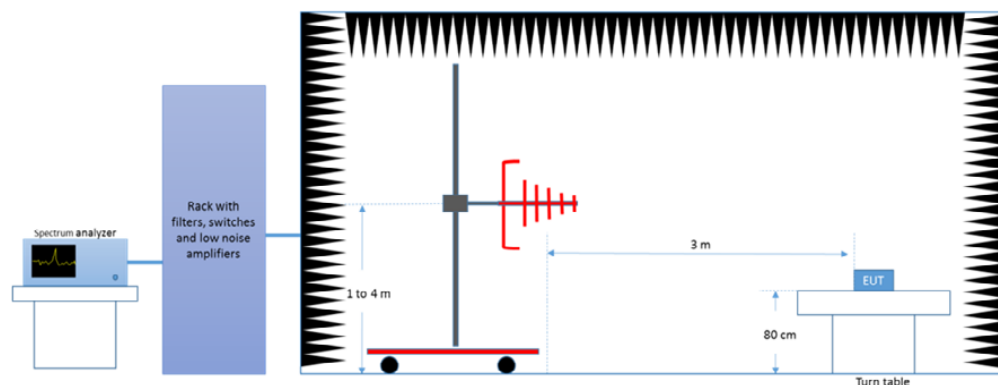

Radiated Setup > 1GHz

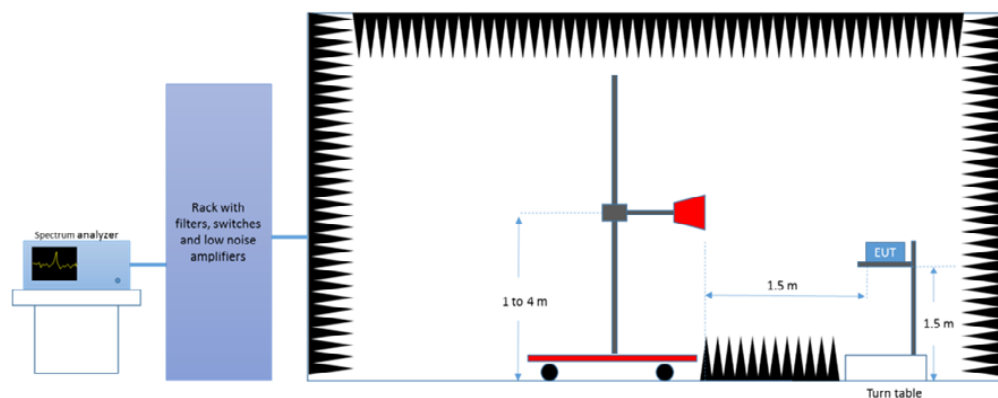

Test Results

30 MHz – 1 GHz

Radiated Spurious – All modes

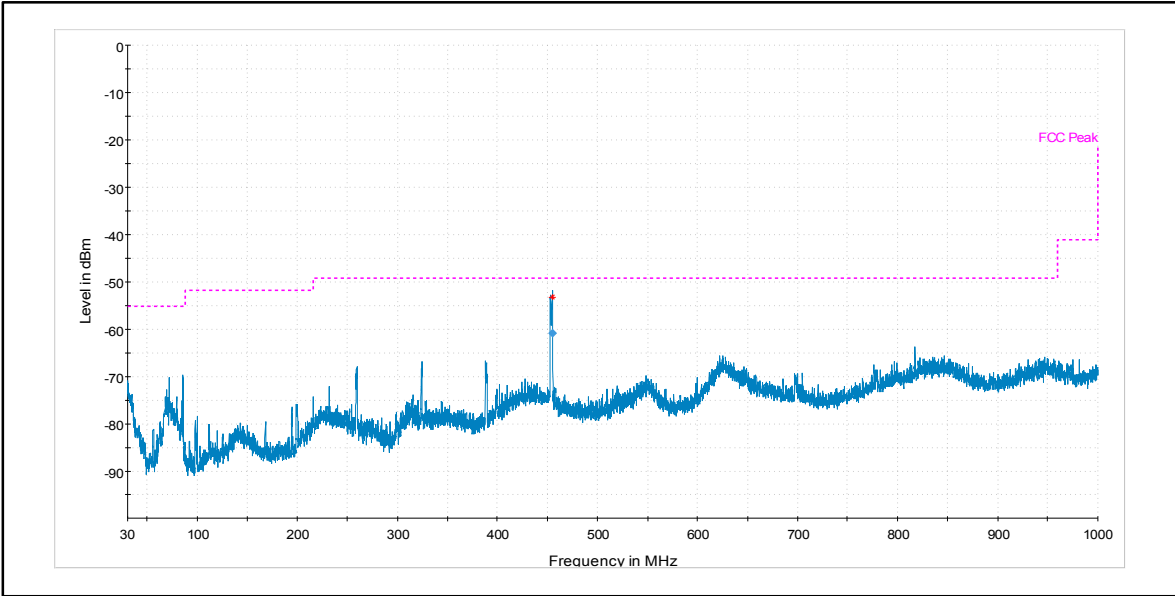

Frequency	MaxPeak	RMS	Height	Pol	Azimuth	Corr.
MHz	dBm	dBm	cm		deg	dB
454.593265		-57.14	208.1	H	112.0	103.1
454.593265	-50.64	---	208.2	H	110.0	-103.2

Note 1: The spurious signals detected do not depend on either the operating channel or the modulation mode.
 Note 2: This plot is valid for both SISO and MIMO modes.

1 GHz – 18GHz

Radiated Spurious – 802.11a, Chain A, CH40

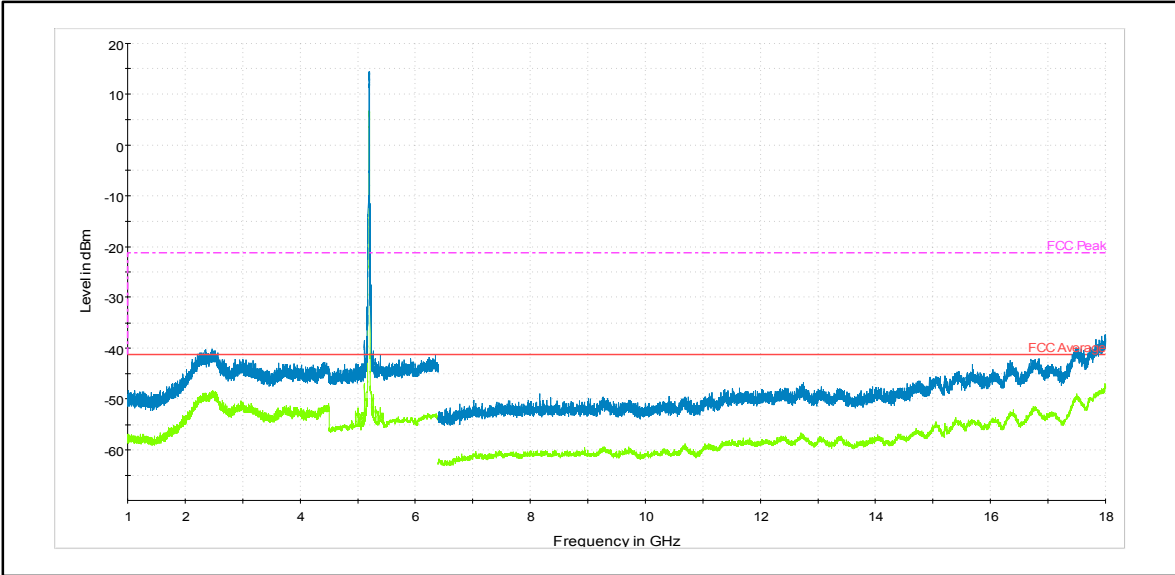

Frequency MHz	MaxPeak dBm	RMS dBm	Height cm	Pol	Azimuth deg	Corr. dB
2512.000000	---	-48.84	150.0	H	170.0	-90.0
2518.000000	-40.54	---	150.0	H	161.0	-90.1
17922.666667	---	-47.88	150.0	H	0.0	-84.8
17926.533333	-37.64	---	150.0	H	318.0	-84.7

Note 1: The spurious signals detected do not depend on the operating channel.

1 GHz – 18GHz

Radiated Spurious – 802.11a, Chain B, CH40

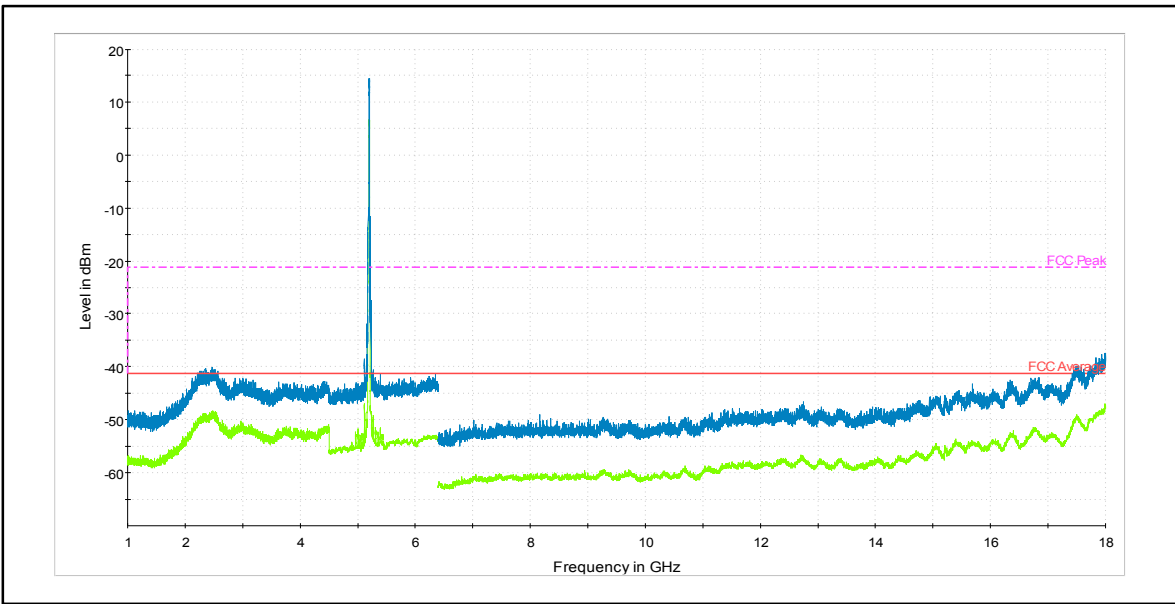

Frequency	MaxPeak	RMS	Height	Pol	Azimuth	Corr.
MHz	dBm	dBm	cm		deg	dB
2495.000000	-40.64	---	150.0	H	113.0	-89.8
2495.000000	---	-48.37	150.0	H	113.0	-89.8
17969.066667	-39.28	---	150.0	H	0.0	-83.8
17969.066667	---	-47.42	150.0	H	0.0	-83.8

Note 1: The spurious signals detected do not depend on the operating channel.

1 GHz – 18GHz

Radiated Spurious – 802.11n20, Chain A, CH40

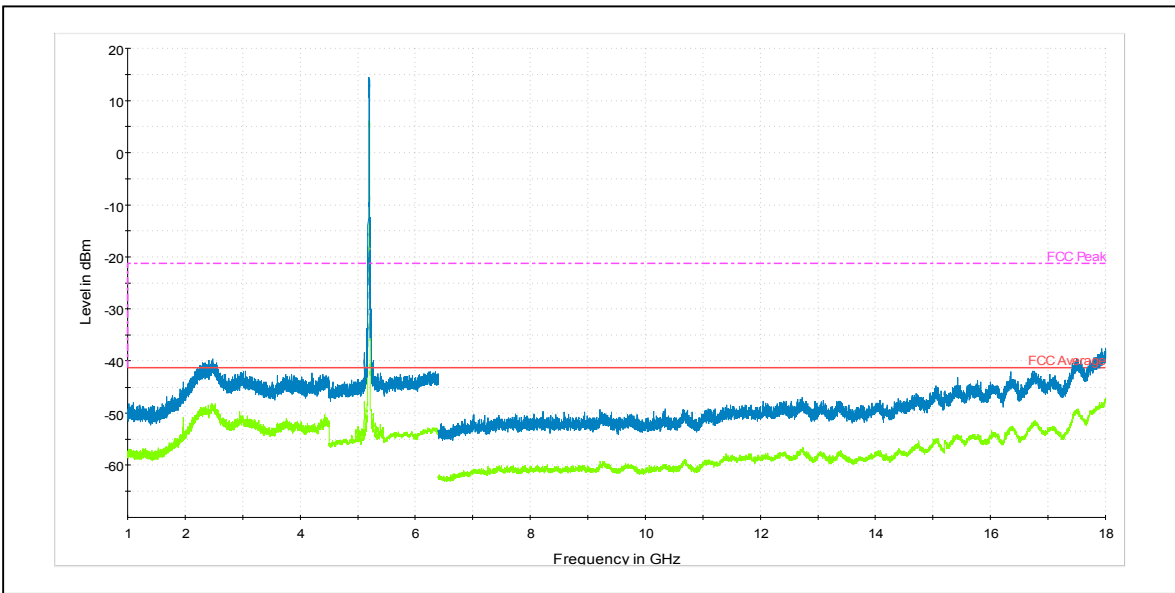

Frequency	MaxPeak	RMS	Height	Pol	Azimuth	Corr.
MHz	dBm	dBm	cm		deg	dB
2459.000000	-41.20	---	150.0	H	149.0	-90.0
2459.000000	---	-48.25	150.0	H	149.0	-90.0
17966.166667	---	-47.97	150.0	H	257.0	-83.8
17967.133333	-39.16	---	150.0	H	196.0	-83.8

Note 1: The spurious signals detected do not depend on the operating channel.

1 GHz – 18GHz

Radiated Spurious – 802.11n20, Chain B, CH40

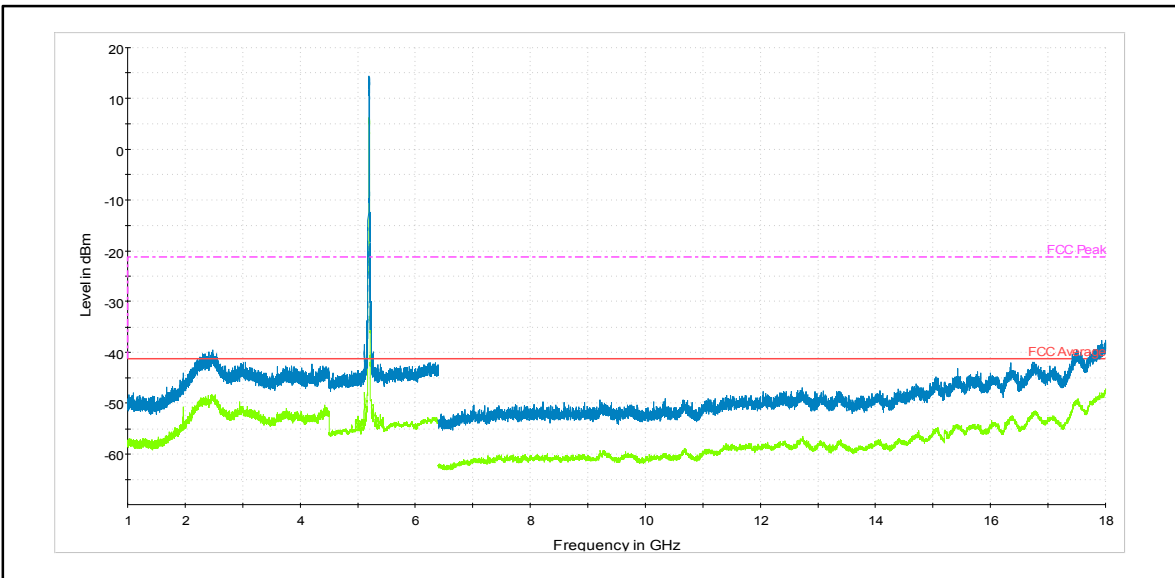

Frequency	MaxPeak	RMS	Height	Pol	Azimuth	Corr.
MHz	dBm	dBm	cm		deg	dB
2488.000000	-40.53	---	150.0	H	202.0	-89.8
2488.000000	---	-48.17	150.0	H	202.0	-89.8
17955.533333	-39.87	---	150.0	H	273.0	-84.1
17955.533333	---	-48.19	150.0	H	273.0	-84.1

Note 1: The spurious signals detected do not depend on the operating channel.

1 GHz – 18GHz

Radiated Spurious – 802.11n20, MIMO Chain A+B, CH40

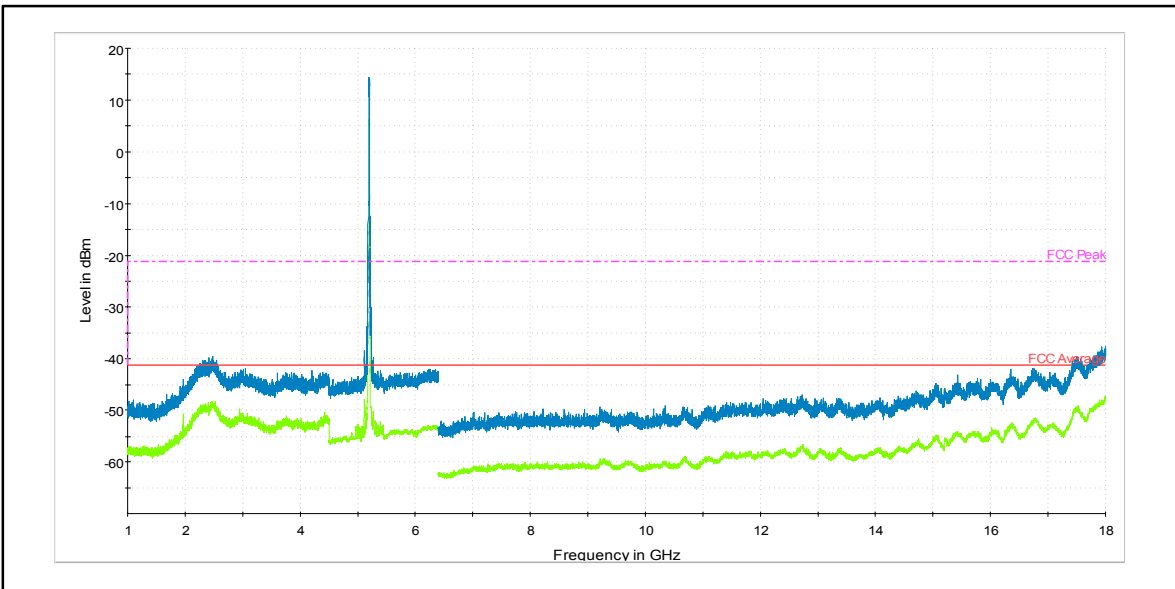

Frequency	MaxPeak	RMS	Height	Pol	Azimuth	Corr.
MHz	dBm	dBm	cm		deg	dB
2508.000000	-40.12	---	150.0	H	273.0	-89.9
2516.500000	---	-47.65	150.0	H	273.0	-90.0
17909.133333	-39.65	---	150.0	H	142.0	-85.0
17909.133333	---	-48.20	150.0	H	142.0	-85.0

Note 1: The spurious signals detected do not depend on the operating channel.

1 GHz – 18GHz

Radiated Spurious – 802.11n40, SISO Chain A, CH46

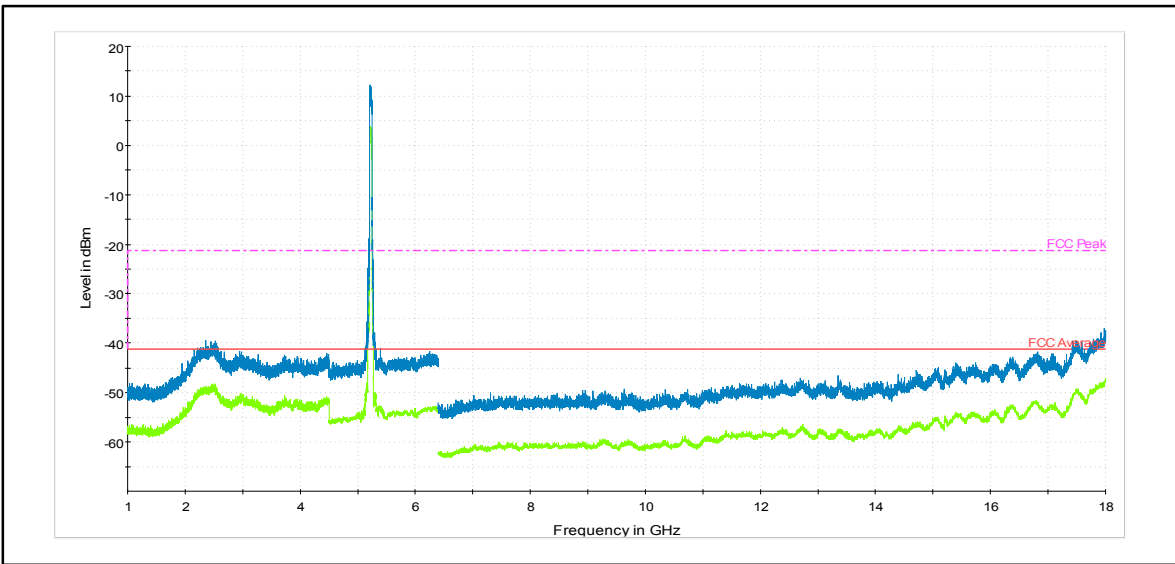

Frequency	MaxPeak	RMS	Height	Pol	Azimuth	Corr.
MHz	dBm	dBm	cm		deg	dB
2491.000000	-41.14	---	150.0	H	158.0	-89.8
2491.000000	---	-48.38	150.0	H	158.0	-89.8
17920.733333	-37.79	---	150.0	H	0.0	-84.8
17929.433333	---	-48.05	150.0	H	313.0	-84.6

Note 1: The spurious signals detected do not depend on the operating channel.

1 GHz – 18GHz

Radiated Spurious – 802.11n40, SISO Chain B, CH46

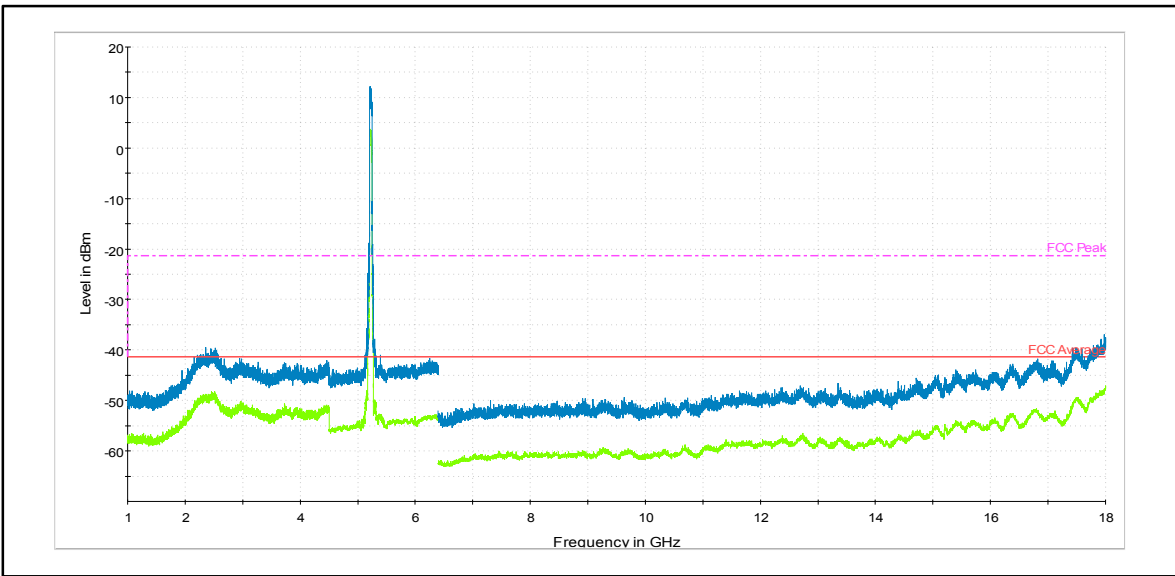

Frequency	MaxPeak	RMS	Height	Pol	Azimuth	Corr.
MHz	dBm	dBm	cm		deg	dB
2470.500000	-40.41	---	150.0	H	99.0	-89.9
2470.500000	---	-47.91	150.0	H	99.0	-89.9
17933.300000	---	-48.37	150.0	H	80.0	-84.5
17934.266667	-39.71	---	150.0	V	142.0	-85.4

Note 1: The spurious signals detected do not depend on the operating channel.

1 GHz – 18GHz

Radiated Spurious – 802.11n40, MIMO Chain A+B, CH46

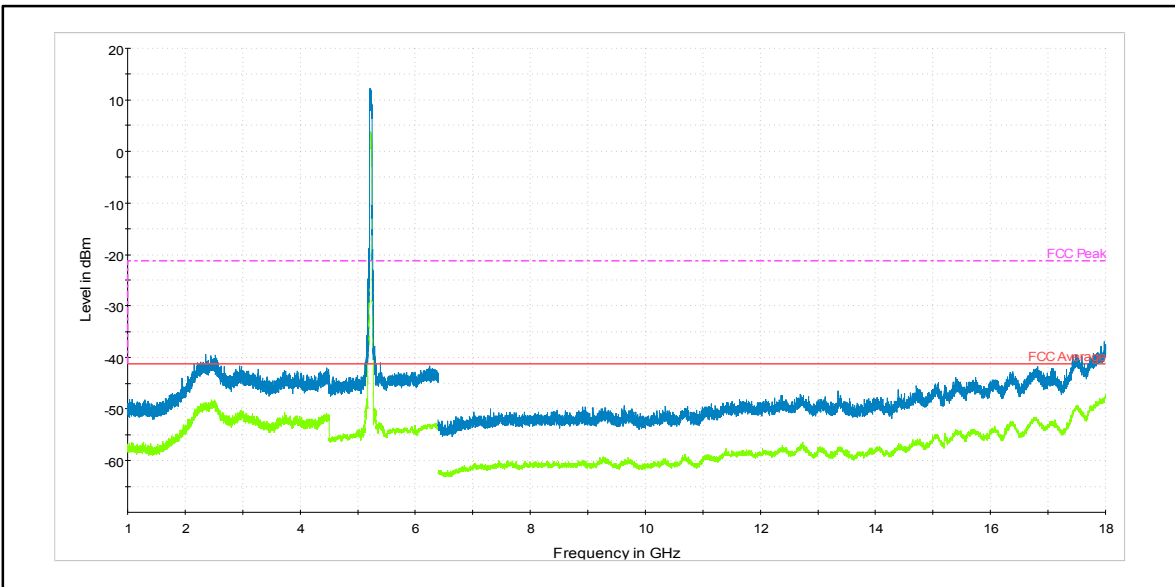

Frequency	MaxPeak	RMS	Height	Pol	Azimuth	Corr.
MHz	dBm	dBm	cm		deg	dB
2480.500000	-40.62	---	150.0	H	305.0	-89.9
2480.500000	---	-48.12	150.0	H	305.0	-89.9
17972.933333	-39.67	---	150.0	H	181.0	-83.7
17972.933333	---	-47.79	150.0	H	181.0	-83.7

Note 1: The spurious signals detected do not depend on the operating channel.

1 GHz – 18GHz

Radiated Spurious – 802.11ac80, SISO Chain A, CH42

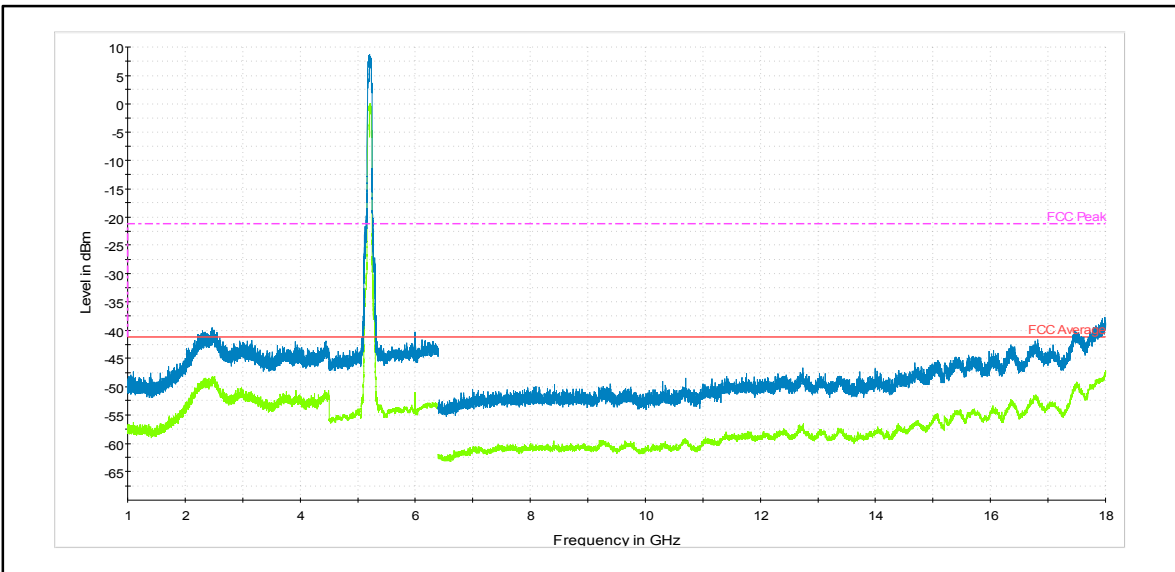

Frequency	MaxPeak	RMS	Height	Pol	Azimuth	Corr.
MHz	dBm	dBm	cm		deg	dB
2494.000000	-40.66	---	150.0	H	33.0	-89.8
2494.000000	---	-48.13	150.0	H	33.0	-89.8
17906.233333	-40.05	---	150.0	V	174.0	-86.0
17906.233333	---	-48.54	150.0	H	322.0	-85.1

Note 1: The spurious signals detected do not depend on the operating channel.

1 GHz – 18GHz

Radiated Spurious – 802.11ac80, SISO Chain B, CH42

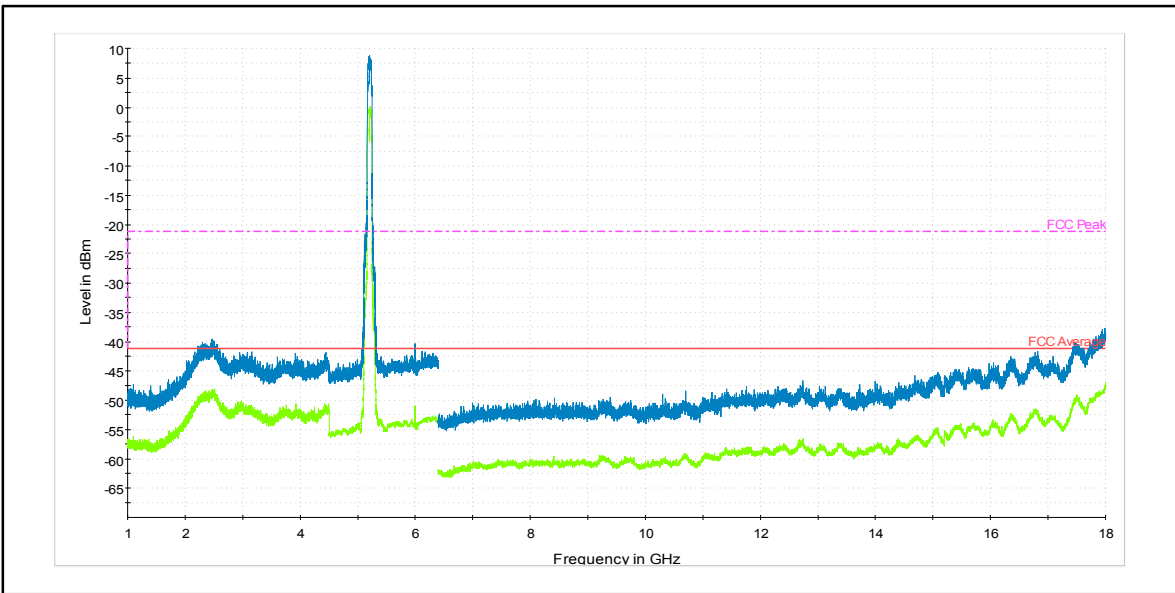

Frequency	MaxPeak	RMS	Height	Pol	Azimuth	Corr.
MHz	dBm	dBm	cm		deg	dB
2490.500000	-40.50	---	150.0	H	261.0	-89.8
2490.500000	---	-47.85	150.0	H	261.0	-89.8
17913.000000	-38.83	---	150.0	H	32.0	-85.0
17914.933333	---	-47.95	150.0	H	0.0	-84.9

Note 1: The spurious signals detected do not depend on the operating channel.

1 GHz – 18GHz

Radiated Spurious – 802.11ac80, Channel 42, Chain A+B

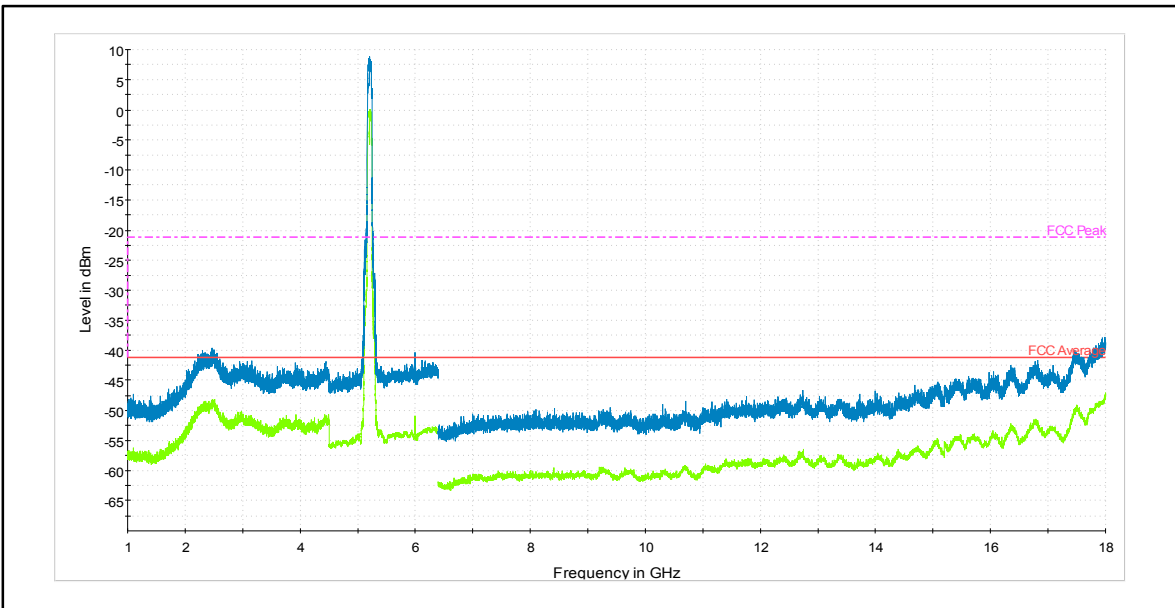

Frequency	MaxPeak	RMS	Height	Pol	Azimuth	Corr.
MHz	dBm	dBm	cm		deg	dB
2483.000000	-40.22	---	150.0	H	0.0	-89.9
2485.000000	---	-48.38	150.0	H	350.0	-89.9
17922.666667	-39.87	---	150.0	H	332.0	-84.8
17922.666667	---	-48.03	150.0	H	332.0	-84.8

Note 1: The spurious signals detected do not depend on the operating channel.

18 GHz – 40GHz

Radiated Spurious – All modes

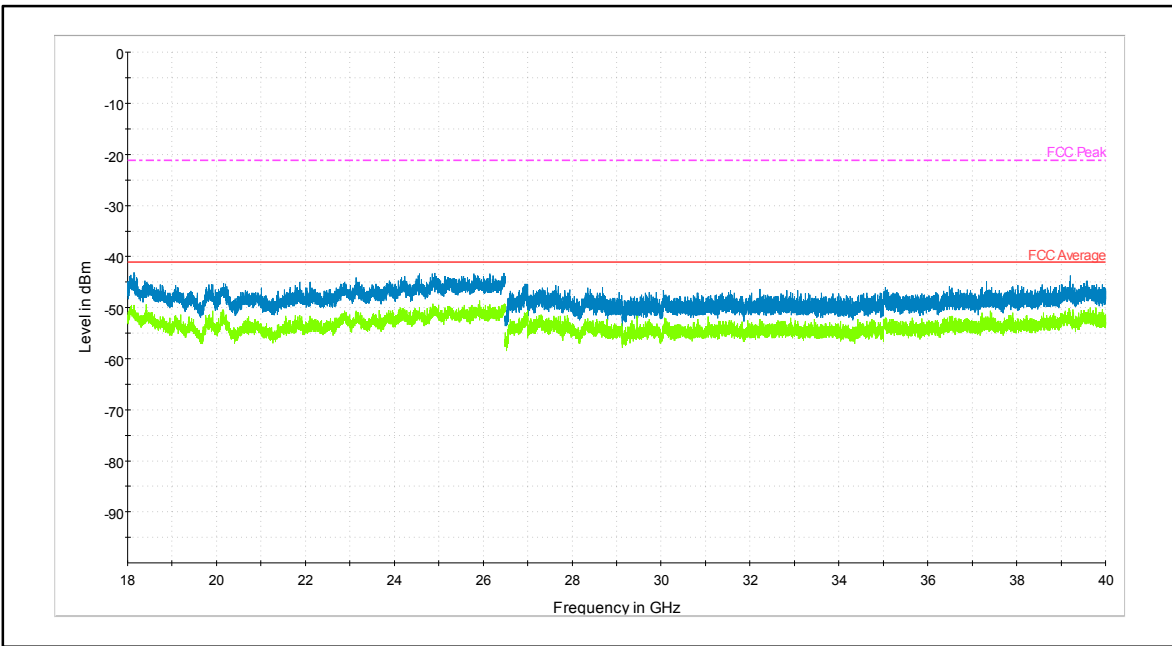

Frequency	MaxPeak	RMS	Height	Pol	Azimuth	Corr.
MHz	dBm	dBm	cm		deg	dB
18143.313953	---	-49.56	150.0	V	143.0	-91.1
18143.313953	-42.99	---	150.0	V	143.0	-91.1
39209.406250	---	-50.98	150.0	V	92.0	-79.6
39209.406250	-43.73	---	150.0	V	92.0	-79.6

Note 1: The spurious signals detected do not depend on either the operating channel or the modulation mode.

Note 2: This plot is valid for both SISO and MIMO modes.