

# RF Exposure Lab

802 N. Twin Oaks Valley Road, Suite 105 • San Marcos, CA 92069 • U.S.A.

TEL (760) 471-2100 • FAX (760) 471-2121

<http://www.rfexposurelab.com>

## CERTIFICATE OF COMPLIANCE SAR EVALUATION

Intel Mobile Communication  
100 Center Point Circle, Suite 200  
Columbia, SC 29210

Dates of Test:  
Test Report Number:

May 5-9, 2014  
SAR.20140502

FCC ID:	PD97260NG (Contains Model 7260NGW, 7260NGW AN, 7260NGW BN, 7260NGW NB)
IC Certificate:	1000M-7260NG (Contains Model 7260NGW, 7260NGW AN, 7260NGW BN, 7260NGW NB)
Model(s):	HSTNN-I19C
Contains WLAN Model(s):	Intel® Dual Band Wireless-AC 7260 (Model 7260NGW, 7260NGW AN, 7260NGW BN, 7260NGW NB)
Test Sample:	Engineering Unit Same as Production
MAC Address:	7C7A913CDAA7
Equipment Type:	Wireless Module Installed in Notebook/Tablet
Classification:	Portable Transmitter Next to Body
TX Frequency Range:	2412 – 2462 MHz; 5180 – 5320 MHz; 5500 – 5700 MHz; 5745 – 5825 MHz
Frequency Tolerance:	± 2.5 ppm
Maximum RF Output:	2450 MHz (b) – 15.50 dB, 2450 MHz (g) – 16.50 dB, 2450 MHz (n20) – 16.50 dB, 2450 MHz (n40) – 16.50 dB, 5250 MHz (a) – 16.00 dB, 5250 MHz (n20) – 16.00 dB, 5250 MHz (n40) – 15.50 dB, 5250 MHz (ac) – 11.00 dB, 5600 MHz (a) – 16.50 dB, 5600 MHz (n20) – 16.50 dB, 5600 MHz (n40) – 16.50 dB, 5600 MHz (ac) – 16.50 dB, 5800 MHz (a) – 16.50 dB, 5800 MHz (n20) – 16.50 dB, 5800 MHz (n40) – 16.50 dB, 5800 MHz (ac) – 14.00 dB Conducted
Signal Modulation:	DSSS, OFDM
Antenna Type:	Wistron Neweb Corp., P/N 6036B0126301 (81EAAK15.GCP) (Tx1), 6036B0126401 (81EAAK15.GCR) (Tx2); PIFA Antenna
Application Type:	Certification
FCC Rule Parts:	Part 2, 15C, 15E
KDB Test Methodology:	KDB 447498 D01 v05r02, KDB 248227 v01r02, KDB 616217 D04 v01
Industry Canada:	RSS-102, Safety Code 6
Maximum SAR Value:	0.68 W/kg Reported
Max. Simultaneous SAR:	0.73 W/kg Reported
Separation Distance:	6.27 mm

This wireless mobile and/or portable device has been shown to be compliant for localized specific absorption rate (SAR) for uncontrolled environment/general exposure limits specified in ANSI/IEEE Std. C95.1-1992 and had been tested in accordance with the measurement procedures specified in IEEE 1528-2013 and IEC 62209-2 (See test report).

I attest to the accuracy of the data. All measurements were performed by myself or were made under my supervision and are correct to the best of my knowledge and belief. I assume full responsibility for the completeness of these measurements and vouch for the qualifications of all persons taking them.

RF Exposure Lab, LLC certifies that no party to this application is subject to a denial of Federal benefits that includes FCC benefits pursuant to Section 5301 of the Anti-Drug Abuse Act of 1988, 21 U.S.C. 853(a).

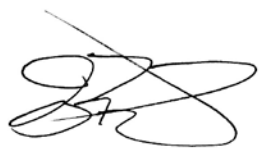

Jay M. Moulton  
Vice President



Certificate # 2387.01

## Table of Contents

1.	Introduction .....	3
	SAR Definition [5].....	4
2.	SAR Measurement Setup.....	5
	Robotic System.....	5
	System Hardware.....	5
	System Electronics.....	6
	Probe Measurement System.....	6
3.	Probe and Dipole Calibration.....	11
4.	Phantom & Simulating Tissue Specifications.....	12
	Head & Body Simulating Mixture Characterization .....	12
5.	ANSI/IEEE C95.1 – 1992 RF Exposure Limits [2].....	13
	Uncontrolled Environment .....	13
	Controlled Environment.....	13
6.	Measurement Uncertainty .....	14
7.	System Validation.....	15
	Tissue Verification.....	15
	Test System Verification.....	15
8.	SAR Test Data Summary .....	16
	Procedures Used To Establish Test Signal .....	16
	Device Test Condition .....	16
	SAR Data Summary – 2450 MHz Body 802.11b & BT .....	35
	SAR Data Summary – 5250 MHz Body 802.11a .....	36
	SAR Data Summary – 5600 MHz Body 802.11a .....	37
	SAR Data Summary – 5800 MHz Body 802.11a .....	38
	SAR Data Summary – 5 GHz Body 802.11ac 80 MHz Bandwidth .....	39
	SAR Data Summary – Simultaneous Evaluation .....	40
9.	Test Equipment List.....	41
10.	Conclusion .....	42
11.	References.....	43
	Appendix A – System Validation Plots and Data .....	44
	Appendix B – SAR Test Data Plots .....	54
	Appendix C – SAR Test Setup Photos .....	59
	Appendix D – Probe Calibration Data Sheets.....	66
	Appendix E – Dipole Calibration Data Sheets .....	78
	Appendix F – Phantom Calibration Data Sheets .....	101
	Appendix G – MPE Calculations .....	103

## 1. Introduction

This measurement report shows compliance of the Intel Mobile Communications Model 7260NGW including family sub-models 7260NGW AN, 7260NGW NB & 7260NGW BN installed in HP Model HSTNN-I19C FCC ID: PD97260NG with FCC Part 2, 1093, ET Docket 93-62 Rules for mobile and portable devices and IC Certificate: 1000M-7260NG with RSS102 & Safety Code 6. The FCC have adopted the guidelines for evaluating the environmental effects of radio frequency radiation in ET Docket 93-62 on August 6, 1996 to protect the public and workers from the potential hazards of RF emissions due to FCC regulated portable devices. [1], [6]

The test results recorded herein are based on a single type test of Intel Mobile Communications Model 7260NGW including family sub-models 7260NGW AN, 7260NGW NB & 7260NGW BN installed in HP Model HSTNN-I19C and therefore apply only to the tested sample.

The test procedures, as described in ANSI C95.1 – 1999 Standard for Safety Levels with Respect to Human Exposure to Radio Frequency Electromagnetic Fields, 3 kHz to 300 GHz [2], ANSI C95.3 – 2002 Recommended Practice for the Measurement of Potentially Hazardous Electromagnetic Fields [3], FCC OET Bulletin 65 Supp. C – 2001 [4], IEEE Std.1528 – 2003 Recommended Practice [5], and Industry Canada Safety Code 6 Limits of Human Exposure to Radiofrequency Electromagnetic Fields in the Frequency Range from 3kHz to 300 GHz were employed.

The following table indicates all the wireless technologies operating in the 7260NGW including family sub-models 7260NGW AN, 7260NGW NB & 7260NGW BN installed in HP Model HSTNN-I19C wireless modem. The table also shows the tolerance for the power level for each mode.

Band	Technology	Class	3GPP Nominal Power dBm	Setpoint Nominal Power dBm	Tolerance dBm	Lower Tolerance dBm	Upper Tolerance dBm
WLAN – 2.4 GHz	802.11b	N/A	N/A	15	±1.5	13.5	16.5
WLAN – 2.4 GHz	802.11g/n(Ch. 1 and 11)	N/A	N/A	13	±1.5	11.5	14.5
WLAN – 2.4 GHz	802.11 g/n(Ch. 2-10)	N/A	N/A	15	±1.5	13.5	16.5
WLAN – 5 GHz	802.11a	N/A	N/A	15	±1.5	13.5	16.5
WLAN – 5 GHz	802.11n	N/A	N/A	15	±1.5	13.5	16.5

**SAR Definition [5]**

Specific Absorption Rate is defined as the time derivative (rate) of the incremental energy ( $dW$ ) absorbed by (dissipated in) an incremental mass ( $dm$ ) contained in a volume element ( $dV$ ) of a given density ( $\rho$ ).

$$SAR = \frac{d}{dt} \left( \frac{dW}{dm} \right) = \frac{d}{dt} \left( \frac{dW}{\rho dV} \right)$$

SAR is expressed in units of watts per kilogram (W/kg). SAR can be related to the electric field at a point by

$$SAR = \frac{\sigma |E|^2}{\rho}$$

where:

$\sigma$  = conductivity of the tissue (S/m)

$\rho$  = mass density of the tissue (kg/m<sup>3</sup>)

$E$  = rms electric field strength (V/m)

## 2. SAR Measurement Setup

### Robotic System

These measurements are performed using the DASY52 automated dosimetric assessment system. The DASY52 is made by Schmid & Partner Engineering AG (SPEAG) in Zurich, Switzerland and consists of high precision robotics system (Staubli), robot controller, Intel Core2 computer, near-field probe, probe alignment sensor, and the generic twin phantom containing the brain equivalent material. The robot is a six-axis industrial robot performing precise movements to position the probe to the location (points) of maximum electromagnetic field (EMF) (see Fig. 2.1).

### System Hardware

A cell controller system contains the power supply, robot controller teach pendant (Joystick), and a remote control used to drive the robot motors. The PC consists of the HP Intel Core2 computer with Windows XP system and SAR Measurement Software DASY52, A/D interface card, monitor, mouse, and keyboard. The Staubli Robot is connected to the cell controller to allow software manipulation of the robot. A data acquisition electronic (DAE) circuit that performs the signal amplification, signal multiplexing, AD-conversion, offset measurements, mechanical surface detection, collision detection, etc. is connected to the Electro-optical coupler (EOC). The EOC performs the conversion from the optical into digital electric signal of the DAE and transfers data to the PC plug-in card.

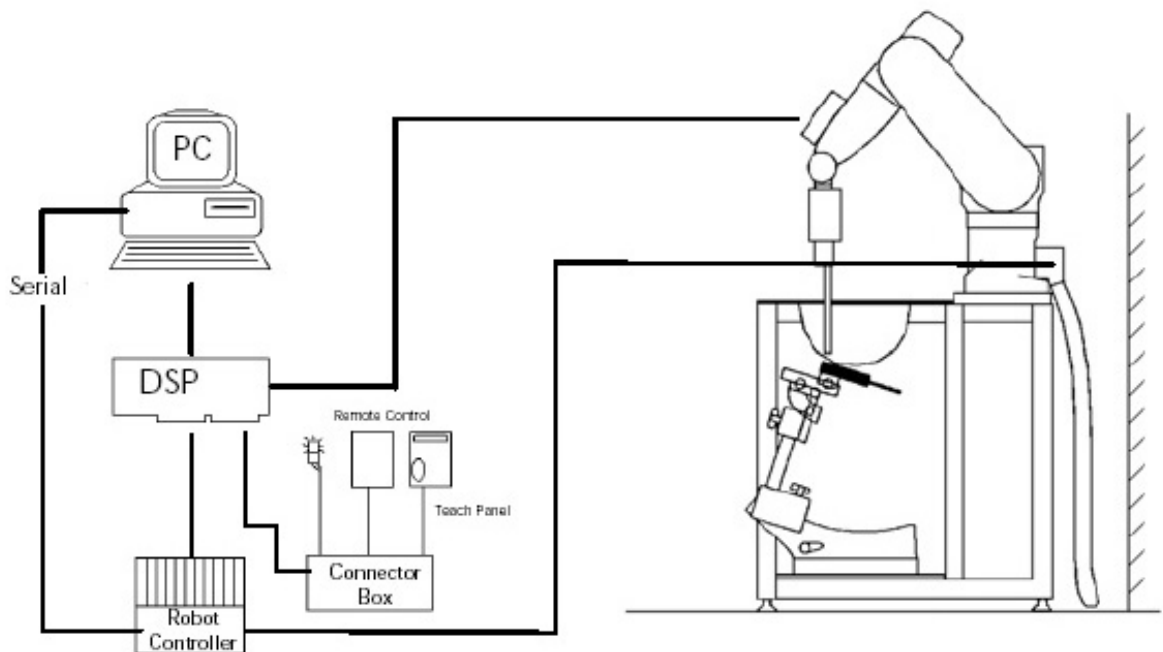

**Figure 2.1 SAR Measurement System Setup**

## System Electronics

The DAE4 consists of a highly sensitive electrometer-grade preamplifier with auto-zeroing, a channel and gain-switching multiplexer, a fast 16 bit AD-converter and a command decoder and control logic unit. Transmission to the PC-card is accomplished through an optical downlink for data and status information and an optical uplink for commands and clock lines. The mechanical probe mounting device includes two different sensor systems for frontal and sidewise probe contacts. They are also used for mechanical surface detection and probe collision detection. The robot uses its own controller with a built in VME-bus computer. The system is described in detail in.

## Probe Measurement System

The SAR measurements were conducted with the dosimetric probe EX3DV4, designed in the classical triangular configuration (see Fig. 2.2) and optimized for dosimetric evaluation. The probe is constructed using the thick film technique; with printed resistive lines on ceramic substrates. The probe is equipped with an optical multi fiber line ending at the front of the probe tip. (see Fig. 2.3) It is connected to the EOC box on the robot arm and provides an automatic detection of the phantom surface. Half of the fibers are connected to a pulsed infrared transmitter, the other half to a synchronized receiver. As the probe approaches the surface, the reflection from the surface produces a coupling from the transmitting to the receiving fibers. This reflection increases first during the approach, reaches maximum and then decreases. If the probe is flatly touching the surface, the coupling is zero. The distance of the coupling maximum to the surface is independent of the surface reflectivity and largely independent of the surface to probe angle. The DASY52 software reads the reflection during a software approach and looks for the maximum using a 2nd order fitting. The approach is stopped at reaching the maximum.



**DAE System**

**Probe Specifications**

**Calibration:** In air from 10 MHz to 6.0 GHz  
In brain and muscle simulating tissue at Frequencies of 450 MHz, 835 MHz, 1750 MHz, 1900 MHz, 2450 MHz, 2600 MHz, 3500 MHz, 5200 MHz, 5300 MHz, 5600 MHz, 5800 MHz

**Frequency:** 10 MHz to 6 GHz

**Linearity:**  $\pm 0.2$ dB (30 MHz to 6 GHz)

**Dynamic:** 10 mW/kg to 100 W/kg

**Range:** Linearity:  $\pm 0.2$ dB

**Dimensions:** Overall length: 330 mm

**Tip length:** 20 mm

**Body diameter:** 12 mm

**Tip diameter:** 2.5 mm

**Distance from probe tip to sensor center:** 1 mm

**Application:** SAR Dosimetry Testing  
Compliance tests of wireless device

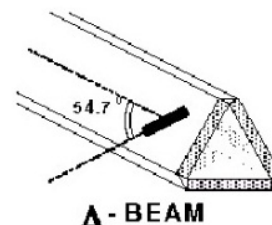

Figure 2.2 Triangular Probe Configurations



Figure 2.3 Probe Thick-Film Technique



## Probe Calibration Process

### Dosimetric Assessment Procedure

Each probe is calibrated according to a dosimetric assessment procedure described in with accuracy better than +/- 10%. The spherical isotropy was evaluated with the procedure described in and found to be better than +/-0.25dB. The sensitivity parameters (Norm X, Norm Y, Norm Z), the diode compression parameter (DCP) and the conversion factor (Conv F) of the probe is tested.

### Free Space Assessment

The free space E-field from amplified probe outputs is determined in a test chamber. This is performed in a TEM cell for frequencies below 1 GHz, and in a waveguide above 1GHz for free space. For the free space calibration, the probe is placed in the volumetric center of the cavity at the proper orientation with the field. The probe is then rotated 360 degrees until the three channels show the maximum reading. The power density readings equates to 1 mW/cm<sup>2</sup>.

### Temperature Assessment \*

E-field temperature correlation calibration is performed in a flat phantom filled with the appropriate simulated brain tissue. The measured free space E-field in the medium, correlates to temperature rise in a dielectric medium. For temperature correlation calibration a RF transparent thermistor based temperature probe is used in conjunction with the E-field probe

$$SAR = C \frac{\Delta T}{\Delta t}$$

$$SAR = \frac{|E|^2 \cdot \sigma}{\rho}$$

where:

where:

$\Delta t$  = exposure time (30 seconds),

$\sigma$  = simulated tissue conductivity,

C = heat capacity of tissue (brain or muscle),

$\rho$  = Tissue density (1.25 g/cm<sup>3</sup> for brain tissue)

$\Delta T$  = temperature increase due to RF exposure.

SAR is proportional to  $\Delta T / \Delta t$ , the initial rate of tissue heating, before thermal diffusion takes place.

Now it's possible to quantify the electric field in the simulated tissue by equating the thermally derived SAR to the E- field;



**Figure 2.4 E-Field and Temperature Measurements at 900MHz**



**Figure 2.5 E-Field and Temperature Measurements at 1800MHz**



## Data Extrapolation

The DASY52 software automatically executes the following procedures to calculate the field units from the microvolt readings at the probe connector. The first step of the evaluation is a linearization of the filtered input signal to account for the compression characteristics of the detector diode. The compensation depends on the input signal, the diode type and the DC-transmission factor from the diode to the evaluation electronics. If the exciting field is pulsed, the crest factor of the signal must be known to correctly compensate for peak power. The formula for each channel can be given like below;

$$V_i = U_i + U_i^2 \cdot \frac{cf}{dcp_i}$$

with  $V_i$  = compensated signal of channel i (i=x,y,z)  
 $U_i$  = input signal of channel i (i=x,y,z)  
 $cf$  = crest factor of exciting field (DASY parameter)  
 $dcp_i$  = diode compression point (DASY parameter)

From the compensated input signals the primary field data for each channel can be evaluated:

E-field probes:

$$E_i = \sqrt{\frac{V_i}{Norm_i \cdot ConvF}}$$

with  $V_i$  = compensated signal of channel i (i = x,y,z)  
 $Norm_i$  = sensor sensitivity of channel i (i = x,y,z)  
 $\mu V/(V/m)^2$  for E-field probes  
 $ConvF$  = sensitivity of enhancement in solution  
 $E_i$  = electric field strength of channel i in V/m

The RSS value of the field components gives the total field strength (Hermetian magnitude):

$$E_{tot} = \sqrt{E_x^2 + E_y^2 + E_z^2}$$

The primary field data are used to calculate the derived field units.

$$SAR = E_{tot}^2 \cdot \frac{\sigma}{\rho \cdot 1000}$$

with SAR = local specific absorption rate in W/g  
 $E_{tot}$  = total field strength in V/m  
 $\sigma$  = conductivity in [mho/m] or [Siemens/m]  
 $\rho$  = equivalent tissue density in g/cm<sup>3</sup>

The power flow density is calculated assuming the excitation field to be a free space field.

$$P_{free} = \frac{E_{tot}^2}{3770}$$

with  $P_{pwe}$  = equivalent power density of a plane wave in W/cm<sup>2</sup>  
 $E_{tot}$  = total electric field strength in V/m

**SAM PHANTOM**

The SAM Twin Phantom V4.0 is constructed of a fiberglass shell integrated in a wooden table. The shape of the shell is based on data from an anatomical study designed to determine the maximum exposure in at least 90% of all users. It enables the dosimetric evaluation of left and right hand phone usage as well as body mounted usage at the flat phantom region. A cover prevents the evaporation of the liquid. Reference markings on the Phantom allow the complete setup of all predefined phantom positions and measurement grids by manually teaching three points in the robot. (see Fig. 2.6)

**Phantom Specification**

**Phantom:** SAM Twin Phantom (V4.0)  
**Shell Material:** Vivac Composite  
**Thickness:**  $2.0 \pm 0.2$  mm

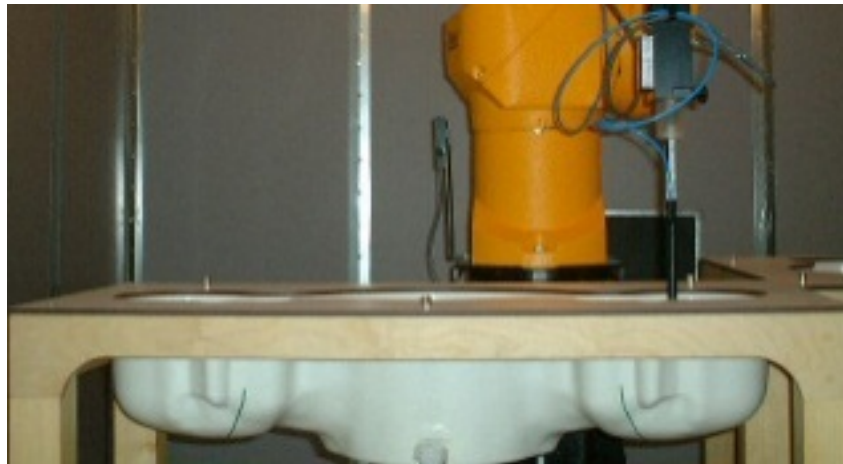

**Figure 2.6 SAM Twin Phantom**

**Device Holder for Transmitters**

In combination with the SAM Twin Phantom V4.0 the Mounting Device (see Fig. 2.7), enables the rotation of the mounted transmitter in spherical coordinates whereby the rotation point is the ear opening. The devices can be easily, accurately, and repeatedly positioned according to the FCC, CENELEC, IEC and IEEE specifications. The device holder can be locked at different phantom locations (left head, right head, flat phantom).



**Figure 2.7 Mounting Device**

Note: A simulating human hand is not used due to the complex anatomical and geometrical structure of the hand that may produce infinite number of configurations. To produce the worst-case condition (the hand absorbs antenna output power), the hand is omitted during the tests.

### **3. Probe and Dipole Calibration**

**See Appendix D and E.**

## 4. Phantom & Simulating Tissue Specifications

### Head & Body Simulating Mixture Characterization

The head and body mixtures consist of the material based on the table listed below. The mixture is calibrated to obtain proper dielectric constant (permittivity) and conductivity of the desired tissue. Body tissue parameters that have not been specified in P1528 are derived from the tissue dielectric parameters computed from the 4-Cole-Cole equations.

**Table 4.1 Typical Composition of Ingredients for Tissue**

Ingredients	Simulating Tissue				
	2450 MHz Body	5250 MHz Body	5600 MHz Body	5785 MHz Body	
Mixing Percentage					
Water	73.20	Proprietary Mixture			
Sugar	0.00				
Salt	0.04				
HEC	0.00				
Bactericide	0.00				
DGBE	26.70				
Dielectric Constant	Target	52.70	48.96	48.47	48.25
Conductivity (S/m)	Target	1.95	5.35	5.77	5.96

## 5. ANSI/IEEE C95.1 – 1992 RF Exposure Limits [2]

### Uncontrolled Environment

Uncontrolled Environments are defined as locations where there is the exposure of individuals who have no knowledge or control of their exposure. The general population/uncontrolled exposure limits are applicable to situations in which the general public may be exposed or in which persons who are exposed as a consequence of their employment may not be made fully aware of the potential for exposure or cannot exercise control over their exposure. Members of the general public would come under this category when exposure is not employment-related; for example, in the case of a wireless transmitter that exposes persons in its vicinity.

### Controlled Environment

Controlled Environments are defined as locations where there is exposure that may be incurred by persons who are aware of the potential for exposure, (i.e. as a result of employment or occupation). In general, occupational/controlled exposure limits are applicable to situations in which persons are exposed as a consequence of their employment, who have been made fully aware of the potential for exposure and can exercise control over their exposure. This exposure category is also applicable when the exposure is of a transient nature due to incidental passage through a location where the exposure levels may be higher than the general population/uncontrolled limits, but the exposed person is fully aware of the potential for exposure and can exercise control over his or her exposure by leaving the area or by some other appropriate means.

**Table 5.1 Human Exposure Limits**

	UNCONTROLLED ENVIRONMENT General Population (W/kg) or (mW/g)	CONTROLLED ENVIROMENT Professional Population (W/kg) or (mW/g)
SPATIAL PEAK SAR <sup>1</sup> Head	1.60	8.00
SPATIAL AVERAGE SAR <sup>2</sup> Whole Body	0.08	0.40
SPATIAL PEAK SAR <sup>3</sup> Hands, Feet, Ankles, Wrists	4.00	20.00

<sup>1</sup> The Spatial Peak value of the SAR averaged over any 1 gram of tissue (defined as a tissue volume in the shape of a cube) and over the appropriate averaging time.

<sup>2</sup> The Spatial Average value of the SAR averaged over the whole body.

<sup>3</sup> The Spatial Peak value of the SAR averaged over any 10 grams of tissue (defined as a tissue volume in the shape of a cube) and over the appropriate averaging time.

## 6. Measurement Uncertainty

Measurement uncertainty table is not required per KDB 865664 D01 v01 section 2.8.2 page 12. SAR measurement uncertainty analysis is required in the SAR report only when the highest measured SAR in a frequency band is  $\geq 1.5$  W/kg for 1-g SAR. The equivalent ratio (1.5/1.6) should be applied to extremity and occupational exposure conditions. The highest reported value is less than 1.5 W/kg. Therefore, the measurement uncertainty table is not required.

## 7. System Validation

### Tissue Verification

**Table 7.1 Measured Tissue Parameters**

		2450 MHz Body		5200 MHz Body	
Date(s)		May 8, 2014		May 5, 2014	
Liquid Temperature (°C)	20.0	Target	Measured	Target	Measured
Dielectric Constant: $\epsilon$		52.70	52.77	49.01	49.07
Conductivity: $\sigma$		1.95	1.92	5.30	5.21
		5600 MHz Body		5800 MHz Body	
Date(s)		May 5, 2014		May 5, 2014	
Liquid Temperature (°C)	20.0	Target	Measured	Target	Measured
Dielectric Constant: $\epsilon$		48.47	48.47	48.20	48.17
Conductivity: $\sigma$		5.77	5.73	6.00	5.99

See Appendix A for data printout.

### Test System Verification

Prior to assessment, the system is verified to the  $\pm 10\%$  of the specifications at the test frequency by using the system kit. Power is normalized to 1 watt. (Graphic Plots Attached)

**Table 7.2 System Dipole Validation Target & Measured**

	Test Frequency	Targeted SAR <sub>1g</sub> (W/kg)	Measure SAR <sub>1g</sub> (W/kg)	Tissue Used for Verification	Deviation Target and Fast SAR to SAR (%)	Plot Number
08-May-2014	2450 MHz	51.50	51.20	Body	- 0.58	1
05-May-2014	5200 MHz	73.40	76.30	Body	+ 3.95	2
06-May-2014	5600 MHz	79.10	78.30	Body	- 1.01	3
07-May-2014	5800 MHz	72.90	74.90	Body	+ 2.74	4

See Appendix A for data plots.5

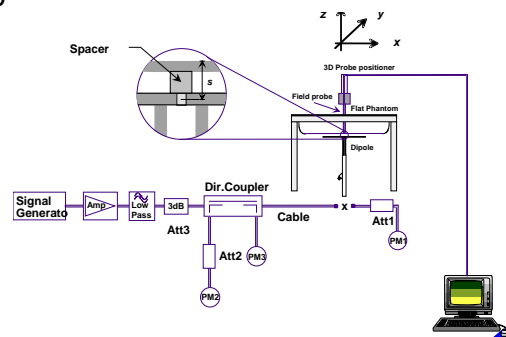

**Figure 7.1 Dipole Validation Test Setup**



## 8. SAR Test Data Summary

### See Measurement Result Data Pages

See Appendix B for SAR Test Data Plots.  
See Appendix C for SAR Test Setup Photos.

### Procedures Used To Establish Test Signal

The device was either placed into simulated transmit mode using the manufacturer's test codes or the actual transmission is activated through a base station simulator or similar equipment. See data pages for actual procedure used in measurement.

### Device Test Condition

In order to verify that the device was tested at full power, conducted output power measurements were performed before and after each SAR measurement to confirm the output power unless otherwise noted. If a conducted power deviation of more than 5% occurred, the test was repeated. The power drift of each test is measured at the start of the test and again at the end of the test. The drift percentage is calculated by the formula  $((\text{end}/\text{start})-1)*100$  and rounded to three decimal places. The drift percentage is calculated into the resultant SAR value on the data sheet for each test.

The EUT was tested in on all sides of the device where the antenna was within 25 mm of that side. All measurements for the tablet condition were conducted with the side of the device in direct contact with the phantom. For the laptop condition, the antennas are at least 20 cm from the user during normal usage. Therefore, the laptop condition is evaluated for MPE requirements as shown in Appendix G. For sides of the antenna which were not measured in this report, the SAR was conduct on the module in the modular approval with the maximum distance of 8 mm on all six sides of the antenna. Therefore, the requirements mentioned in RSS-102 Supplementary Procedures (SPR)-001 – SAR Testing Requirements with Regards to Bystanders for Laptop Type Computers with Antennas Built-In on Display Screen (Laptop/Tablet Mode) are covered.

The Bluetooth transmitter does simultaneously transmit with the WiFi transmitter. When the BT is turned on, it transmits on Main and the WiFi transmits on Aux. Simultaneous transmission is evaluated on page 40.

The main antenna was evaluated for stand-alone SAR per the Draft RSS-102 Issue 5. The Tablet Back, Top Edge, Curved Edge and Left Side was tested. The Bottom and Right sides were excluded due to distance from the antenna (191 mm and 220 mm respectively). Please see data sheet summary on page 35.

The data rates used when evaluating the WiFi transmitter were the lowest data rates for each mode. The device was operating at its maximum output power at the lowest data rate for all measurements.

The tablet was using the Intel test utility DRTU Version 1.7.1-850 and the device driver was version 16.6.0.1.

The antenna was on a minimum of 10 cm of Styrofoam during each test. The following is a pictorial drawing of the locations and separation distances.

**Location and Separation Distances Diagrams Tablet Mode**

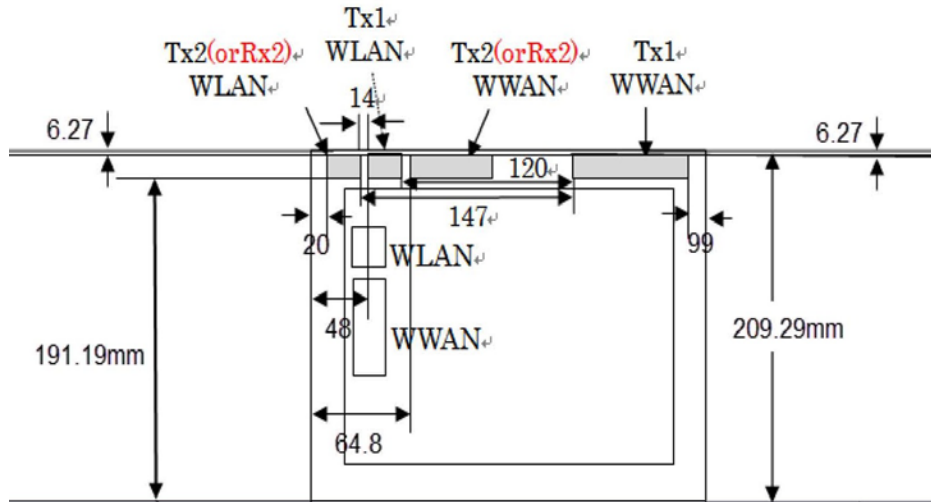

**Location and Separation Distances Diagrams Laptop Mode**

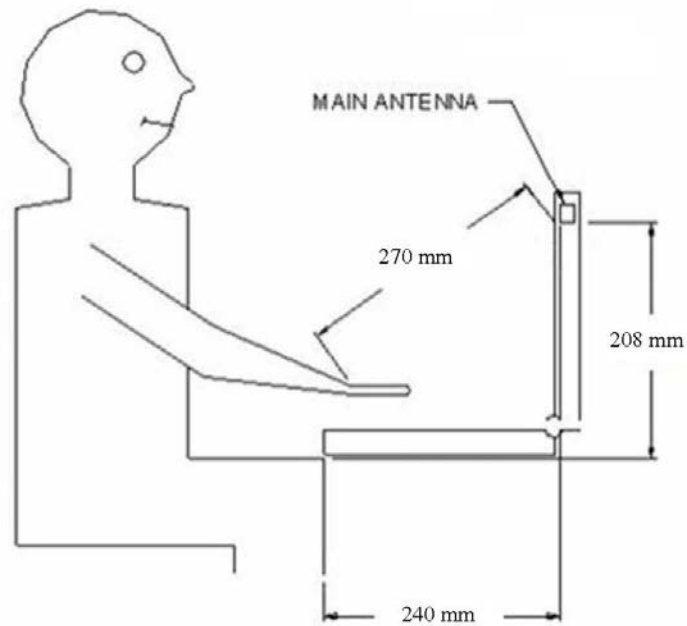

Band	Mode	Bandwidth (MHz)	Channel	Frequency (MHz)	Data Rate	Antenna	Power (dBm)
2450 MHz	802.11b	20	1	2412	1 Mbps	Main	15.47
			6	2437			16.50
			11	2462			15.48
			1	2412		Aux	13.98
			6	2437			14.00
			11	2462			13.99
	802.11g	20	2	2417	6 Mbps	Main	16.48
			6	2437			16.50
			10	2457			16.47
			1	2412		Aux	11.99
			6	2437			15.49
			11	2462			13.46
	802.11n	20	1	2412	HT4	Main	13.48
			6	2437			16.50
			11	2462			13.46
			1	2412		Aux	11.97
			6	2437			15.50
			11	2462			13.42
	802.11n	40	3	2422	HT4	Main	11.96
			6	2437			16.47
9			2452	12.90			
3			2422	Aux		9.92	
6			2437			13.42	
9			2452			12.89	
5.15-5.25 GHz	802.11a	20	36	5180	6 Mbps	Main	13.46
			40	5200			15.86
			44	5220			16.00
			48	5240			14.98
			36	5180		Aux	12.89
			40	5200			15.92
			44	5220			16.00
			48	5240			14.96
	802.11n	20	36	5180	HT4	Main	13.42
			40	5200			15.87
			44	5220			16.00
			48	5240			15.48
			36	5180		Aux	12.86
			40	5200			15.91
			44	5220			16.00
			48	5240			15.46
	802.11n	40	38	5190	HT4	Main	9.46
			46	5230			15.42
			38	5190	HT4	Aux	9.94
			46	5230			15.37
802.11ac	80	42	5210	VHT6	Main	8.46	
					Aux	8.39	
5.25-5.35 GHz	802.11a	20	52	5260	6 Mbps	Main	13.45
			56	5280			15.87
			60	5300			16.00
			64	5320			13.46
			52	5260		Aux	12.90
			56	5280			15.93
			60	5300			16.00
			64	5320			12.94
	802.11n	20	52	5260	HT4	Main	13.42
			56	5280			15.81
			60	5300			15.94
			64	5320			13.48
			52	5260		Aux	12.85
			56	5280			15.93
			60	5300			15.85
			64	5320			13.00
	802.11n	40	54	5270	HT4	Main	9.48
			62	5310			11.00
			54	5270	HT4	Aux	9.99
			62	5310			10.97
802.11ac	80	58	5290	VHT6	Main	10.47	
					Aux	10.92	

Band	Mode	Bandwidth (MHz)	Channel	Frequency (MHz)	Data Rate	Antenna	Power (dBm)					
5600 MHz	802.11a	20	100	5500	6 Mbps	Main	13.46					
			104	5520			16.42					
			108	5540			16.39					
			112	5560			16.48					
			116	5580			16.50					
			120	5600			16.42					
			124	5620			16.46					
			128	5640			16.37					
			132	5660			16.50					
			136	5680			16.47					
			140	5700			12.93					
			100	5500			12.95					
			104	5520			16.42					
			108	5540			16.50					
			112	5560		16.38						
			116	5580		16.43						
			120	5600		16.48						
			124	5620		16.42						
			128	5640		16.40						
			132	5660		16.38						
			136	5680		16.50						
			140	5700		12.42						
			802.11n	20		20	100	5500	HT4	Main	13.50	
							104	5520			16.42	
							108	5540			16.48	
							112	5560			16.45	
							116	5580			16.37	
							120	5600			16.48	
	124	5620			16.50							
	128	5640			16.41							
	132	5660			16.45							
	136	5680			16.39							
	140	5700			12.98							
	100	5500			12.99							
	104	5520			16.34							
	108	5540			16.39							
	112	5560			16.41							
	116	5580			16.50							
	120	5600			16.42							
	124	5620			16.48							
	128	5640			16.43							
	132	5660			16.47							
	136	5680			16.48							
	140	5700			12.49							
	802.11n	40			20		102	5510		HT4	Main	10.42
							110	5550				16.48
							118	5580				16.42
							126	5610				16.47
							134	5670				15.49
					102		5510	HT4		Aux	10.48	
			110	5550	16.48							
			118	5580	16.43							
			126	5610	16.38							
			134	5670	15.46							
802.11ac	20	144	5720	VHT0	Main	16.48						
					Aux	16.42						
					Main	16.43						
					Aux	16.47						
	80	142	5710	VHT6	Main	8.97						
						122	5610	13.95				
						138	5690	13.92				
					Aux	106	5530	8.91				
						122	5610	13.97				
						138	5690	13.99				

Band	Mode	Bandwidth (MHz)	Channel	Frequency (MHz)	Data Rate	Antenna	Power (dBm)	
5800 MHz	802.11a	20	149	5745	6 Mbps	Main	16.48	
			153	5765			16.47	
			157	5785			16.50	
			161	5805			16.43	
			165	5825			16.48	
			149	5745		Aux	16.42	
			153	5765			16.45	
			157	5785			16.50	
			161	5805			16.47	
			165	5825			16.49	
	802.11n	20	20	149	5745	HT8	Main	16.42
				153	5765			16.45
				157	5785			16.48
				161	5805			16.43
				165	5825			16.41
				149	5745		Aux	16.40
				153	5765			16.48
				157	5785			16.39
				161	5805			16.47
				165	5825			16.45
	802.11n	40	40	151	5755	HT8	Main	16.43
				159	5795			16.37
				151	5755		Aux	16.36
				159	5795			16.42
	802.11ac	80	80	155	5775	VHT6	Main	13.98
							Aux	14.00

**Figure 8.1 Test Reduction Table – 2.4 GHz Main**

Mode	Side	Required Channel	Tested/Reduced
802.11b	Back	1 – 2412 MHz	Reduced <sup>1</sup>
		6 – 2437 MHz	Tested
		11 – 2462 MHz	Reduced <sup>1</sup>
	Top	1 – 2412 MHz	Reduced <sup>1</sup>
		6 – 2437 MHz	Tested
		11 – 2462 MHz	Reduced <sup>1</sup>
	Left	1 – 2412 MHz	Reduced <sup>1</sup>
		6 – 2437 MHz	Tested
		11 – 2462 MHz	Reduced <sup>1</sup>
	Bottom & Right	1 – 2412 MHz	Reduced <sup>3</sup>
		6 – 2437 MHz	Reduced <sup>3</sup>
		11 – 2462 MHz	Reduced <sup>3</sup>
Curved Edge	1 – 2412 MHz	Reduced <sup>1</sup>	
	6 – 2437 MHz	Tested	
	11 – 2462 MHz	Reduced <sup>1</sup>	
802.11g	Back	1 – 2412 MHz	Reduced <sup>2</sup>
		6 – 2437 MHz	Reduced <sup>2</sup>
		11 – 2462 MHz	Reduced <sup>2</sup>
	Top	1 – 2412 MHz	Reduced <sup>2</sup>
		6 – 2437 MHz	Reduced <sup>2</sup>
		11 – 2462 MHz	Reduced <sup>2</sup>
	Left	1 – 2412 MHz	Reduced <sup>2</sup>
		6 – 2437 MHz	Reduced <sup>2</sup>
		11 – 2462 MHz	Reduced <sup>2</sup>
	Bottom & Right	1 – 2412 MHz	Reduced <sup>2</sup>
		6 – 2437 MHz	Reduced <sup>2</sup>
		11 – 2462 MHz	Reduced <sup>2</sup>
Curved Edge	1 – 2412 MHz	Reduced <sup>2</sup>	
	6 – 2437 MHz	Reduced <sup>2</sup>	
	11 – 2462 MHz	Reduced <sup>2</sup>	
802.11n	Back	1 – 2412 MHz	Reduced <sup>2</sup>
		6 – 2437 MHz	Reduced <sup>2</sup>
		11 – 2462 MHz	Reduced <sup>2</sup>
	Top	1 – 2412 MHz	Reduced <sup>2</sup>
		6 – 2437 MHz	Reduced <sup>2</sup>
		11 – 2462 MHz	Reduced <sup>2</sup>
	Left	1 – 2412 MHz	Reduced <sup>2</sup>
		6 – 2437 MHz	Reduced <sup>2</sup>
		11 – 2462 MHz	Reduced <sup>2</sup>
	Bottom & Right	1 – 2412 MHz	Reduced <sup>2</sup>
		6 – 2437 MHz	Reduced <sup>2</sup>
		11 – 2462 MHz	Reduced <sup>2</sup>
Curved Edge	1 – 2412 MHz	Reduced <sup>2</sup>	
	6 – 2437 MHz	Reduced <sup>2</sup>	
	11 – 2462 MHz	Reduced <sup>2</sup>	

Reduced<sup>1</sup> – When the mid channel is 3 dB below the limit, the remaining channels are not required per KDB 447498 D01 v05r02 section 4.3.3 page 14.

Reduced<sup>2</sup> – When the conducted power in this mode is less than 0.25 dB higher than the b mode, testing is not required per KDB 248227 page 5.

Reduced<sup>3</sup> – When the antenna is more than 25 mm from a side, the test can be reduced per KDB447498 D01 v05r02 section 4.3.1 1) page 11. See below for calculations.

**Calculations for test exclusion for right and left side.**

Maximum power: 44.7 mW  
 Bottom Side distance: 191 mm  
 Right Side distance: 220 mm

The closest distance is from the bottom side. Therefore, if the bottom side is excluded the right side would also be excluded.

$[(44.7 \text{ mW}) / (191 \text{ mm})] * \sqrt{2.462} = 0.37$  which is equal to or less than 3.0.

**Figure 8.2 Test Reduction Table – 2.4 GHz Aux**

Mode	Side	Required Channel	Tested/Reduced
802.11b	Back	1 – 2412 MHz	Reduced <sup>1</sup>
		6 – 2437 MHz	Tested
		11 – 2462 MHz	Reduced <sup>1</sup>
	Top	1 – 2412 MHz	Reduced <sup>1</sup>
		6 – 2437 MHz	Tested
		11 – 2462 MHz	Reduced <sup>1</sup>
	Left	1 – 2412 MHz	Reduced <sup>1</sup>
		6 – 2437 MHz	Tested
		11 – 2462 MHz	Reduced <sup>1</sup>
	Bottom & Right	1 – 2412 MHz	Reduced <sup>3</sup>
		6 – 2437 MHz	Reduced <sup>3</sup>
		11 – 2462 MHz	Reduced <sup>3</sup>
Curved Edge	1 – 2412 MHz	Reduced <sup>1</sup>	
	6 – 2437 MHz	Tested	
	11 – 2462 MHz	Reduced <sup>1</sup>	
802.11g	Back	1 – 2412 MHz	Reduced <sup>2</sup>
		6 – 2437 MHz	Reduced <sup>2</sup>
		11 – 2462 MHz	Reduced <sup>2</sup>
	Top	1 – 2412 MHz	Reduced <sup>2</sup>
		6 – 2437 MHz	Reduced <sup>2</sup>
		11 – 2462 MHz	Reduced <sup>2</sup>
	Left	1 – 2412 MHz	Reduced <sup>2</sup>
		6 – 2437 MHz	Reduced <sup>2</sup>
		11 – 2462 MHz	Reduced <sup>2</sup>
	Bottom & Right	1 – 2412 MHz	Reduced <sup>2</sup>
		6 – 2437 MHz	Reduced <sup>2</sup>
		11 – 2462 MHz	Reduced <sup>2</sup>
Curved Edge	1 – 2412 MHz	Reduced <sup>2</sup>	
	6 – 2437 MHz	Reduced <sup>2</sup>	
	11 – 2462 MHz	Reduced <sup>2</sup>	
802.11n	Back	1 – 2412 MHz	Reduced <sup>2</sup>
		6 – 2437 MHz	Reduced <sup>2</sup>
		11 – 2462 MHz	Reduced <sup>2</sup>
	Top	1 – 2412 MHz	Reduced <sup>2</sup>
		6 – 2437 MHz	Reduced <sup>2</sup>
		11 – 2462 MHz	Reduced <sup>2</sup>
	Left	1 – 2412 MHz	Reduced <sup>2</sup>
		6 – 2437 MHz	Reduced <sup>2</sup>
		11 – 2462 MHz	Reduced <sup>2</sup>
	Bottom & Right	1 – 2412 MHz	Reduced <sup>2</sup>
		6 – 2437 MHz	Reduced <sup>2</sup>
		11 – 2462 MHz	Reduced <sup>2</sup>
Curved Edge	1 – 2412 MHz	Reduced <sup>2</sup>	
	6 – 2437 MHz	Reduced <sup>2</sup>	
	11 – 2462 MHz	Reduced <sup>2</sup>	

Reduced<sup>1</sup> – When the mid channel is 3 dB below the limit, the remaining channels are not required per KDB 447498 D01 v05r02 section 4.3.3 page 14.

Reduced<sup>2</sup> – When the conducted power in this mode is less than 0.25 dB higher than the b mode, testing is not required per KDB 248227 page 5.

Reduced<sup>3</sup> – When the antenna is more than 25 mm from a side, the test can be reduced per KDB447498 D01 v05r02 section 4.3.1 1) page 11. See below for calculations.

**Calculations for test exclusion for right and left side.**

Maximum power: 44.7 mW  
 Bottom Side distance: 191 mm  
 Right Side distance: 220 mm

The closest distance is from the bottom side. Therefore, if the bottom side is excluded the right side would also be excluded.

$[(44.7 \text{ mW}) / (191 \text{ mm})] * \sqrt{2.462} = 0.37$  which is equal to or less than 3.0.



**Figure 8.3 Test Reduction Table – 5.1 GHz Main**

Mode	Side	Required Channel	Tested/Reduced
802.11a 5150 MHz	Back	36 – 5180 MHz	Reduced <sup>1</sup>
		40 – 5200 MHz	Reduced <sup>1</sup>
		44 – 5220 MHz	Tested
		48 – 5240 MHz	Reduced <sup>1</sup>
	Top	36 – 5180 MHz	Reduced <sup>1</sup>
		40 – 5200 MHz	Reduced <sup>1</sup>
		44 – 5220 MHz	Tested
		48 – 5240 MHz	Reduced <sup>1</sup>
	Left	36 – 5180 MHz	Reduced <sup>1</sup>
		40 – 5200 MHz	Reduced <sup>1</sup>
		44 – 5220 MHz	Tested
		48 – 5240 MHz	Reduced <sup>1</sup>
	Bottom & Right	36 – 5180 MHz	Reduced <sup>3</sup>
		40 – 5200 MHz	Reduced <sup>3</sup>
		44 – 5220 MHz	Reduced <sup>3</sup>
		48 – 5240 MHz	Reduced <sup>3</sup>
Curved Edge	36 – 5180 MHz	Reduced <sup>1</sup>	
	40 – 5200 MHz	Reduced <sup>1</sup>	
	44 – 5220 MHz	Tested	
	48 – 5240 MHz	Reduced <sup>1</sup>	
802.11n 5150 MHz	Back	36 – 5180 MHz	Reduced <sup>2</sup>
		40 – 5200 MHz	Reduced <sup>2</sup>
		44 – 5220 MHz	Reduced <sup>2</sup>
		48 – 5240 MHz	Reduced <sup>2</sup>
	Top	36 – 5180 MHz	Reduced <sup>2</sup>
		40 – 5200 MHz	Reduced <sup>2</sup>
		44 – 5220 MHz	Reduced <sup>2</sup>
		48 – 5240 MHz	Reduced <sup>2</sup>
	Left	36 – 5180 MHz	Reduced <sup>2</sup>
		40 – 5200 MHz	Reduced <sup>2</sup>
		44 – 5220 MHz	Reduced <sup>2</sup>
		48 – 5240 MHz	Reduced <sup>2</sup>
	Bottom & Right	36 – 5180 MHz	Reduced <sup>2</sup>
		40 – 5200 MHz	Reduced <sup>2</sup>
		44 – 5220 MHz	Reduced <sup>2</sup>
		48 – 5240 MHz	Reduced <sup>2</sup>
Curved Edge	36 – 5180 MHz	Reduced <sup>2</sup>	
	40 – 5200 MHz	Reduced <sup>2</sup>	
	44 – 5220 MHz	Reduced <sup>2</sup>	
	48 – 5240 MHz	Reduced <sup>2</sup>	
802.11ac 5210 MHz	Back	42 – 5210 MHz	Reduced <sup>2</sup>
	Top	42 – 5210 MHz	Reduced <sup>2</sup>
	Left	42 – 5210 MHz	Reduced <sup>2</sup>
	Bottom & Right	42 – 5210 MHz	Reduced <sup>2</sup>
	Curved Edge	42 – 5210 MHz	Tested

Reduced<sup>1</sup> – When the mid channel is 3 dB below the limit, the remaining channels are not required per KDB 447498 D01 v05r02 section 4.3.3 page 14.

Reduced<sup>2</sup> – When the conducted power in this mode is less than 0.25 dB higher than the a mode, testing is not required per KDB 248227 page 5.

Reduced<sup>3</sup> – When the antenna is more than 25 mm from a side, the test can be reduced per KDB447498 D01 v05r02 section 4.3.1 1) page 11. See below for calculations.

**Calculations for test exclusion for right and left side.**

Maximum power: 44.7 mW  
 Bottom Side distance: 191 mm  
 Right Side distance: 220 mm

The closest distance is from the bottom side. Therefore, if the bottom side is excluded the right side would also be excluded.

$[(44.7 \text{ mW}) / (191 \text{ mm})] * \sqrt{5.24} = 0.54$  which is equal to or less than 3.0.

**Figure 8.4 Test Reduction Table – 5.1 GHz Aux**

Mode	Side	Required Channel	Tested/Reduced
802.11a 5150 MHz	Back	36 – 5180 MHz	Reduced <sup>1</sup>
		40 – 5200 MHz	Reduced <sup>1</sup>
		44 – 5220 MHz	Tested
		48 – 5240 MHz	Reduced <sup>1</sup>
	Top	36 – 5180 MHz	Reduced <sup>1</sup>
		40 – 5200 MHz	Reduced <sup>1</sup>
		44 – 5220 MHz	Tested
		48 – 5240 MHz	Reduced <sup>1</sup>
	Left	36 – 5180 MHz	Reduced <sup>1</sup>
		40 – 5200 MHz	Reduced <sup>1</sup>
		44 – 5220 MHz	Tested
		48 – 5240 MHz	Reduced <sup>1</sup>
	Bottom & Right	36 – 5180 MHz	Reduced <sup>3</sup>
		40 – 5200 MHz	Reduced <sup>3</sup>
		44 – 5220 MHz	Reduced <sup>3</sup>
		48 – 5240 MHz	Reduced <sup>3</sup>
Curved Edge	36 – 5180 MHz	Reduced <sup>1</sup>	
	40 – 5200 MHz	Reduced <sup>1</sup>	
	44 – 5220 MHz	Tested	
	48 – 5240 MHz	Reduced <sup>1</sup>	
802.11n 5150 MHz	Back	36 – 5180 MHz	Reduced <sup>2</sup>
		40 – 5200 MHz	Reduced <sup>2</sup>
		44 – 5220 MHz	Reduced <sup>2</sup>
		48 – 5240 MHz	Reduced <sup>2</sup>
	Top	36 – 5180 MHz	Reduced <sup>2</sup>
		40 – 5200 MHz	Reduced <sup>2</sup>
		44 – 5220 MHz	Reduced <sup>2</sup>
		48 – 5240 MHz	Reduced <sup>2</sup>
	Left	36 – 5180 MHz	Reduced <sup>2</sup>
		40 – 5200 MHz	Reduced <sup>2</sup>
		44 – 5220 MHz	Reduced <sup>2</sup>
		48 – 5240 MHz	Reduced <sup>2</sup>
	Bottom & Right	36 – 5180 MHz	Reduced <sup>2</sup>
		40 – 5200 MHz	Reduced <sup>2</sup>
		44 – 5220 MHz	Reduced <sup>2</sup>
		48 – 5240 MHz	Reduced <sup>2</sup>
Curved Edge	36 – 5180 MHz	Reduced <sup>2</sup>	
	40 – 5200 MHz	Reduced <sup>2</sup>	
	44 – 5220 MHz	Reduced <sup>2</sup>	
	48 – 5240 MHz	Reduced <sup>2</sup>	
802.11ac 5210 MHz	Back	42 – 5210 MHz	Reduced <sup>2</sup>
	Top	42 – 5210 MHz	Reduced <sup>2</sup>
	Left	42 – 5210 MHz	Reduced <sup>2</sup>
	Bottom & Right	42 – 5210 MHz	Reduced <sup>2</sup>
	Curved Edge	42 – 5210 MHz	Tested

Reduced<sup>1</sup> – When the mid channel is 3 dB below the limit, the remaining channels are not required per KDB 447498 D01 v05r02 section 4.3.3 page 14.

Reduced<sup>2</sup> – When the conducted power in this mode is less than 0.25 dB higher than the a mode, testing is not required per KDB 248227 page 5.

Reduced<sup>3</sup> – When the antenna is more than 25 mm from a side, the test can be reduced per KDB447498 D01 v05r02 section 4.3.1 1) page 11. See below for calculations.

**Calculations for test exclusion for right and left side.**

Maximum power: 44.7 mW  
 Bottom Side distance: 191 mm  
 Right Side distance: 220 mm

The closest distance is from the bottom side. Therefore, if the bottom side is excluded the right side would also be excluded.

$[(44.7 \text{ mW}) / (191 \text{ mm})] * \sqrt{5.24} = 0.54$  which is equal to or less than 3.0.

**Figure 8.5 Test Reduction Table – 5.2 GHz Main**

Mode	Side	Required Channel	Tested/Reduced
802.11a 5250 MHz	Back	52 – 5260 MHz	Reduced <sup>1</sup>
		56 – 5280 MHz	Reduced <sup>1</sup>
		60 – 5300 MHz	Tested
		64 – 5320 MHz	Reduced <sup>1</sup>
	Top	52 – 5260 MHz	Reduced <sup>1</sup>
		56 – 5280 MHz	Reduced <sup>1</sup>
		60 – 5300 MHz	Tested
		64 – 5320 MHz	Reduced <sup>1</sup>
	Left	52 – 5260 MHz	Reduced <sup>1</sup>
		56 – 5280 MHz	Reduced <sup>1</sup>
		60 – 5300 MHz	Tested
		64 – 5320 MHz	Reduced <sup>1</sup>
	Bottom & Right	52 – 5260 MHz	Reduced <sup>3</sup>
		56 – 5280 MHz	Reduced <sup>3</sup>
		60 – 5300 MHz	Reduced <sup>3</sup>
		64 – 5320 MHz	Reduced <sup>3</sup>
Curved Edge	52 – 5260 MHz	Reduced <sup>1</sup>	
	56 – 5280 MHz	Reduced <sup>1</sup>	
	60 – 5300 MHz	Tested	
	64 – 5320 MHz	Reduced <sup>1</sup>	
802.11n 5250 MHz	Back	52 – 5260 MHz	Reduced <sup>2</sup>
		56 – 5280 MHz	Reduced <sup>2</sup>
		60 – 5300 MHz	Reduced <sup>2</sup>
		64 – 5320 MHz	Reduced <sup>2</sup>
	Top	52 – 5260 MHz	Reduced <sup>2</sup>
		56 – 5280 MHz	Reduced <sup>2</sup>
		60 – 5300 MHz	Reduced <sup>2</sup>
		64 – 5320 MHz	Reduced <sup>2</sup>
	Left	52 – 5260 MHz	Reduced <sup>2</sup>
		56 – 5280 MHz	Reduced <sup>2</sup>
		60 – 5300 MHz	Reduced <sup>2</sup>
		64 – 5320 MHz	Reduced <sup>2</sup>
	Bottom & Right	52 – 5260 MHz	Reduced <sup>2</sup>
		56 – 5280 MHz	Reduced <sup>2</sup>
		60 – 5300 MHz	Reduced <sup>2</sup>
		64 – 5320 MHz	Reduced <sup>2</sup>
Curved Edge	52 – 5260 MHz	Reduced <sup>2</sup>	
	56 – 5280 MHz	Reduced <sup>2</sup>	
	60 – 5300 MHz	Reduced <sup>2</sup>	
	64 – 5320 MHz	Reduced <sup>2</sup>	
802.11ac 5210 MHz	Back	58 – 5290 MHz	Reduced <sup>2</sup>
	Top	58 – 5290 MHz	Reduced <sup>2</sup>
	Left	58 – 5290 MHz	Reduced <sup>2</sup>
	Bottom & Right	58 – 5290 MHz	Reduced <sup>2</sup>
	Curved Edge	58 – 5290 MHz	Tested

Reduced<sup>1</sup> – When the mid channel is 3 dB below the limit, the remaining channels are not required per KDB 447498 D01 v05r02 section 4.3.3 page 14.

Reduced<sup>2</sup> – When the conducted power in this mode is less than 0.25 dB higher than the a mode, testing is not required per KDB 248227 page 5.

Reduced<sup>3</sup> – When the antenna is more than 25 mm from a side, the test can be reduced per KDB447498 D01 v05r02 section 4.3.1 1) page 11. See below for calculations.

### Calculations for test exclusion for right and left side.

Maximum power: 44.7 mW  
 Bottom Side distance: 191 mm  
 Right Side distance: 220 mm

The closest distance is from the bottom side. Therefore, if the bottom side is excluded the right side would also be excluded.

$[(44.7 \text{ mW}) / (191 \text{ mm})] * \sqrt{5.32} = 0.54$  which is equal to or less than 3.0.

**Figure 8.6 Test Reduction Table – 5.2 GHz Aux**

Mode	Side	Required Channel	Tested/Reduced
802.11a 5250 MHz	Back	52 – 5260 MHz	Reduced <sup>1</sup>
		56 – 5280 MHz	Reduced <sup>1</sup>
		60 – 5300 MHz	Tested
		64 – 5320 MHz	Reduced <sup>1</sup>
	Top	52 – 5260 MHz	Reduced <sup>1</sup>
		56 – 5280 MHz	Reduced <sup>1</sup>
		60 – 5300 MHz	Tested
		64 – 5320 MHz	Reduced <sup>1</sup>
	Left	52 – 5260 MHz	Reduced <sup>1</sup>
		56 – 5280 MHz	Reduced <sup>1</sup>
		60 – 5300 MHz	Tested
		64 – 5320 MHz	Reduced <sup>1</sup>
	Bottom & Right	52 – 5260 MHz	Reduced <sup>3</sup>
		56 – 5280 MHz	Reduced <sup>3</sup>
		60 – 5300 MHz	Reduced <sup>3</sup>
		64 – 5320 MHz	Reduced <sup>3</sup>
Curved Edge	52 – 5260 MHz	Reduced <sup>1</sup>	
	56 – 5280 MHz	Reduced <sup>1</sup>	
	60 – 5300 MHz	Tested	
	64 – 5320 MHz	Reduced <sup>1</sup>	
802.11n 5250 MHz	Back	52 – 5260 MHz	Reduced <sup>2</sup>
		56 – 5280 MHz	Reduced <sup>2</sup>
		60 – 5300 MHz	Reduced <sup>2</sup>
		64 – 5320 MHz	Reduced <sup>2</sup>
	Top	52 – 5260 MHz	Reduced <sup>2</sup>
		56 – 5280 MHz	Reduced <sup>2</sup>
		60 – 5300 MHz	Reduced <sup>2</sup>
		64 – 5320 MHz	Reduced <sup>2</sup>
	Left	52 – 5260 MHz	Reduced <sup>2</sup>
		56 – 5280 MHz	Reduced <sup>2</sup>
		60 – 5300 MHz	Reduced <sup>2</sup>
		64 – 5320 MHz	Reduced <sup>2</sup>
	Bottom & Right	52 – 5260 MHz	Reduced <sup>2</sup>
		56 – 5280 MHz	Reduced <sup>2</sup>
		60 – 5300 MHz	Reduced <sup>2</sup>
		64 – 5320 MHz	Reduced <sup>2</sup>
Curved Edge	52 – 5260 MHz	Reduced <sup>2</sup>	
	56 – 5280 MHz	Reduced <sup>2</sup>	
	60 – 5300 MHz	Reduced <sup>2</sup>	
	64 – 5320 MHz	Reduced <sup>2</sup>	
802.11ac 5210 MHz	Back	58 – 5290 MHz	Reduced <sup>2</sup>
	Top	58 – 5290 MHz	Reduced <sup>2</sup>
	Left	58 – 5290 MHz	Reduced <sup>2</sup>
	Bottom & Right	58 – 5290 MHz	Reduced <sup>2</sup>
	Curved Edge	58 – 5290 MHz	Tested

Reduced<sup>1</sup> – When the mid channel is 3 dB below the limit, the remaining channels are not required per KDB 447498 D01 v05r02 section 4.3.3 page 14.

Reduced<sup>2</sup> – When the conducted power in this mode is less than 0.25 dB higher than the a mode, testing is not required per KDB 248227 page 5.

Reduced<sup>3</sup> – When the antenna is more than 25 mm from a side, the test can be reduced per KDB447498 D01 v05r02 section 4.3.1 1) page 11. See below for calculations.

**Calculations for test exclusion for right and left side.**

Maximum power: 44.7 mW  
 Bottom Side distance: 191 mm  
 Right Side distance: 220 mm

The closest distance is from the bottom side. Therefore, if the bottom side is excluded the right side would also be excluded.

$[(44.7 \text{ mW}) / (191 \text{ mm})]^2 \cdot \sqrt{5.32} = 0.54$  which is equal to or less than 3.0.

**Figure 8.7 Test Reduction Table – 5.6 GHz Main**

Mode	Side	Required Channel	Tested/Reduced
802.11a 5600 MHz	Back	100 – 5500 MHz	Reduced <sup>1</sup>
		104 – 5520 MHz	Reduced <sup>1</sup>
		108 – 5540 MHz	Reduced <sup>1</sup>
		112 – 5560 MHz	Reduced <sup>1</sup>
		116 – 5580 MHz	Tested
		120 – 5600 MHz	Reduced <sup>1</sup>
		124 – 5620 MHz	Reduced <sup>1</sup>
		128 – 5640 MHz	Reduced <sup>1</sup>
		132 – 5660 MHz	Reduced <sup>1</sup>
		136 – 5680 MHz	Tested
	140 – 5700 MHz	Reduced <sup>1</sup>	
	Top	100 – 5500 MHz	Reduced <sup>1</sup>
		104 – 5520 MHz	Reduced <sup>1</sup>
		108 – 5540 MHz	Reduced <sup>1</sup>
		112 – 5560 MHz	Reduced <sup>1</sup>
		116 – 5580 MHz	Tested
		120 – 5600 MHz	Reduced <sup>1</sup>
		124 – 5620 MHz	Reduced <sup>1</sup>
		128 – 5640 MHz	Reduced <sup>1</sup>
		132 – 5660 MHz	Reduced <sup>1</sup>
		136 – 5680 MHz	Tested
	140 – 5700 MHz	Reduced <sup>1</sup>	
	Left	100 – 5500 MHz	Reduced <sup>1</sup>
		104 – 5520 MHz	Reduced <sup>1</sup>
		108 – 5540 MHz	Reduced <sup>1</sup>
		112 – 5560 MHz	Reduced <sup>1</sup>
		116 – 5580 MHz	Tested
		120 – 5600 MHz	Reduced <sup>1</sup>
		124 – 5620 MHz	Reduced <sup>1</sup>
		128 – 5640 MHz	Reduced <sup>1</sup>
		132 – 5660 MHz	Reduced <sup>1</sup>
		136 – 5680 MHz	Tested
	140 – 5700 MHz	Reduced <sup>1</sup>	
	Bottom & Right	100 – 5500 MHz	Reduced <sup>2</sup>
		104 – 5520 MHz	Reduced <sup>2</sup>
		108 – 5540 MHz	Reduced <sup>2</sup>
		112 – 5560 MHz	Reduced <sup>2</sup>
		116 – 5580 MHz	Reduced <sup>2</sup>
		120 – 5600 MHz	Reduced <sup>2</sup>
		124 – 5620 MHz	Reduced <sup>2</sup>
		128 – 5640 MHz	Reduced <sup>2</sup>
		132 – 5660 MHz	Reduced <sup>2</sup>
		136 – 5680 MHz	Reduced <sup>2</sup>
	140 – 5700 MHz	Reduced <sup>2</sup>	
	Curved Edge	100 – 5500 MHz	Reduced <sup>1</sup>
		104 – 5520 MHz	Reduced <sup>1</sup>
		108 – 5540 MHz	Reduced <sup>1</sup>
		112 – 5560 MHz	Reduced <sup>1</sup>
116 – 5580 MHz		Tested	
120 – 5600 MHz		Reduced <sup>1</sup>	
124 – 5620 MHz		Reduced <sup>1</sup>	
128 – 5640 MHz		Reduced <sup>1</sup>	
132 – 5660 MHz		Reduced <sup>1</sup>	
136 – 5680 MHz		Tested	
140 – 5700 MHz	Reduced <sup>1</sup>		

Reduced<sup>1</sup> – When the tested channel is 3 dB below the limit, the remaining channels are not required per KDB 447498 D01 v05r02 section 4.3.3 page 14.

Reduced<sup>2</sup> – When the conducted power in this mode is less than 0.25 dB higher than the a mode, testing is not required per KDB 248227 page 5.

Reduced<sup>3</sup> – When the antenna is more than 25 mm from a side, the test can be reduced per KDB447498 D01 v05r02 section 4.3.1 1) page 11. See below for calculations.

**Calculations for test exclusion for right and left side.**

Maximum power: 44.7 mW  
 Bottom Side distance: 191 mm  
 Right Side distance: 220 mm

The closest distance is from the bottom side. Therefore, if the bottom side is excluded the right side would also be excluded.

$[(44.7 \text{ mW}) / (191 \text{ mm})] * \sqrt{5.70} = 0.56$  which is equal to or less than 3.0.

**Figure 8.8 Test Reduction Table – 5.6 GHz Main**

Mode	Side	Required Channel	Tested/Reduced
802.11n 5600 MHz	Back	100 – 5500 MHz	Reduced <sup>2</sup>
		104 – 5520 MHz	Reduced <sup>2</sup>
		108 – 5540 MHz	Reduced <sup>2</sup>
		112 – 5560 MHz	Reduced <sup>2</sup>
		116 – 5580 MHz	Reduced <sup>2</sup>
		120 – 5600 MHz	Reduced <sup>2</sup>
		124 – 5620 MHz	Reduced <sup>2</sup>
		128 – 5640 MHz	Reduced <sup>2</sup>
		132 – 5660 MHz	Reduced <sup>2</sup>
	136 – 5680 MHz	Reduced <sup>2</sup>	
	140 – 5700 MHz	Reduced <sup>2</sup>	
	Top	100 – 5500 MHz	Reduced <sup>2</sup>
		104 – 5520 MHz	Reduced <sup>2</sup>
		108 – 5540 MHz	Reduced <sup>2</sup>
		112 – 5560 MHz	Reduced <sup>2</sup>
		116 – 5580 MHz	Reduced <sup>2</sup>
		120 – 5600 MHz	Reduced <sup>2</sup>
		124 – 5620 MHz	Reduced <sup>2</sup>
		128 – 5640 MHz	Reduced <sup>2</sup>
		132 – 5660 MHz	Reduced <sup>2</sup>
	136 – 5680 MHz	Reduced <sup>2</sup>	
	140 – 5700 MHz	Reduced <sup>2</sup>	
	Left	100 – 5500 MHz	Reduced <sup>2</sup>
		104 – 5520 MHz	Reduced <sup>2</sup>
		108 – 5540 MHz	Reduced <sup>2</sup>
		112 – 5560 MHz	Reduced <sup>2</sup>
		116 – 5580 MHz	Reduced <sup>2</sup>
		120 – 5600 MHz	Reduced <sup>2</sup>
		124 – 5620 MHz	Reduced <sup>2</sup>
		128 – 5640 MHz	Reduced <sup>2</sup>
		132 – 5660 MHz	Reduced <sup>2</sup>
	136 – 5680 MHz	Reduced <sup>2</sup>	
	140 – 5700 MHz	Reduced <sup>2</sup>	
	Bottom & Right	100 – 5500 MHz	Reduced <sup>2</sup>
		104 – 5520 MHz	Reduced <sup>2</sup>
		108 – 5540 MHz	Reduced <sup>2</sup>
		112 – 5560 MHz	Reduced <sup>2</sup>
		116 – 5580 MHz	Reduced <sup>2</sup>
		120 – 5600 MHz	Reduced <sup>2</sup>
		124 – 5620 MHz	Reduced <sup>2</sup>
		128 – 5640 MHz	Reduced <sup>2</sup>
		132 – 5660 MHz	Reduced <sup>2</sup>
	136 – 5680 MHz	Reduced <sup>2</sup>	
	140 – 5700 MHz	Reduced <sup>2</sup>	
	Curved Edge	100 – 5500 MHz	Reduced <sup>2</sup>
		104 – 5520 MHz	Reduced <sup>2</sup>
		108 – 5540 MHz	Reduced <sup>2</sup>
		112 – 5560 MHz	Reduced <sup>2</sup>
116 – 5580 MHz		Reduced <sup>2</sup>	
120 – 5600 MHz		Reduced <sup>2</sup>	
124 – 5620 MHz		Reduced <sup>2</sup>	
128 – 5640 MHz		Reduced <sup>2</sup>	
132 – 5660 MHz		Reduced <sup>2</sup>	
136 – 5680 MHz	Reduced <sup>2</sup>		
140 – 5700 MHz	Reduced <sup>2</sup>		

Reduced<sup>2</sup> – When the conducted power in this mode is less than 0.25 dB higher than the a mode, testing is not required per KDB 248227 page 5.

**Figure 8.9 Test Reduction Table – 5.6 GHz Main**

Mode	Side	Required Channel	Tested/Reduced
802.11ac 5600 MHz	Back	106 – 5530 MHz	Reduced <sup>2</sup>
		122 – 5610 MHz	Reduced <sup>2</sup>
		138 – 5690 MHz	Reduced <sup>2</sup>
	Top	106 – 5530 MHz	Reduced <sup>2</sup>
		122 – 5610 MHz	Reduced <sup>2</sup>
		138 – 5690 MHz	Reduced <sup>2</sup>
	Left	106 – 5530 MHz	Reduced <sup>2</sup>
		122 – 5610 MHz	Reduced <sup>2</sup>
		138 – 5690 MHz	Reduced <sup>2</sup>
	Bottom & Right	106 – 5530 MHz	Reduced <sup>2</sup>
		122 – 5610 MHz	Reduced <sup>2</sup>
		138 – 5690 MHz	Reduced <sup>2</sup>
	Curved Edge	106 – 5530 MHz	Reduced <sup>2</sup>
		122 – 5610 MHz	Tested
		138 – 5690 MHz	Reduced <sup>2</sup>

Reduced<sup>2</sup> – When the conducted power in this mode is less than 0.25 dB higher than the a mode, testing is not required per KDB 248227 page 5.



**Figure 8.10 Test Reduction Table – 5.6 GHz Aux**

Mode	Side	Required Channel	Tested/Reduced
802.11a 5600 MHz	Back	100 – 5500 MHz	Reduced <sup>1</sup>
		104 – 5520 MHz	Reduced <sup>1</sup>
		108 – 5540 MHz	Reduced <sup>1</sup>
		112 – 5560 MHz	Reduced <sup>1</sup>
		116 – 5580 MHz	Tested
		120 – 5600 MHz	Reduced <sup>1</sup>
		124 – 5620 MHz	Reduced <sup>1</sup>
		128 – 5640 MHz	Reduced <sup>1</sup>
		132 – 5660 MHz	Reduced <sup>1</sup>
		136 – 5680 MHz	Tested
	140 – 5700 MHz	Reduced <sup>1</sup>	
	Top	100 – 5500 MHz	Reduced <sup>1</sup>
		104 – 5520 MHz	Reduced <sup>1</sup>
		108 – 5540 MHz	Reduced <sup>1</sup>
		112 – 5560 MHz	Reduced <sup>1</sup>
		116 – 5580 MHz	Tested
		120 – 5600 MHz	Reduced <sup>1</sup>
		124 – 5620 MHz	Reduced <sup>1</sup>
		128 – 5640 MHz	Reduced <sup>1</sup>
		132 – 5660 MHz	Reduced <sup>1</sup>
		136 – 5680 MHz	Tested
	140 – 5700 MHz	Reduced <sup>1</sup>	
	Left	100 – 5500 MHz	Reduced <sup>1</sup>
		104 – 5520 MHz	Reduced <sup>1</sup>
		108 – 5540 MHz	Reduced <sup>1</sup>
		112 – 5560 MHz	Reduced <sup>1</sup>
		116 – 5580 MHz	Tested
		120 – 5600 MHz	Reduced <sup>1</sup>
		124 – 5620 MHz	Reduced <sup>1</sup>
		128 – 5640 MHz	Reduced <sup>1</sup>
		132 – 5660 MHz	Reduced <sup>1</sup>
		136 – 5680 MHz	Tested
	140 – 5700 MHz	Reduced <sup>1</sup>	
	Bottom & Right	100 – 5500 MHz	Reduced <sup>2</sup>
		104 – 5520 MHz	Reduced <sup>2</sup>
		108 – 5540 MHz	Reduced <sup>2</sup>
		112 – 5560 MHz	Reduced <sup>2</sup>
		116 – 5580 MHz	Reduced <sup>2</sup>
		120 – 5600 MHz	Reduced <sup>2</sup>
		124 – 5620 MHz	Reduced <sup>2</sup>
		128 – 5640 MHz	Reduced <sup>2</sup>
		132 – 5660 MHz	Reduced <sup>2</sup>
		136 – 5680 MHz	Reduced <sup>2</sup>
	140 – 5700 MHz	Reduced <sup>2</sup>	
	Curved Edge	100 – 5500 MHz	Reduced <sup>1</sup>
		104 – 5520 MHz	Reduced <sup>1</sup>
		108 – 5540 MHz	Reduced <sup>1</sup>
		112 – 5560 MHz	Reduced <sup>1</sup>
116 – 5580 MHz		Tested	
120 – 5600 MHz		Reduced <sup>1</sup>	
124 – 5620 MHz		Reduced <sup>1</sup>	
128 – 5640 MHz		Reduced <sup>1</sup>	
132 – 5660 MHz		Reduced <sup>1</sup>	
136 – 5680 MHz		Tested	
140 – 5700 MHz	Reduced <sup>1</sup>		

Reduced<sup>1</sup> – When the tested channel is 3 dB below the limit, the remaining channels are not required per KDB 447498 D01 v05r02 section 4.3.3 page 14.

Reduced<sup>2</sup> – When the conducted power in this mode is less than 0.25 dB higher than the a mode, testing is not required per KDB 248227 page 5.

Reduced<sup>3</sup> – When the antenna is more than 25 mm from a side, the test can be reduced per KDB447498 D01 v05r02 section 4.3.1 1) page 11. See below for calculations.

**Calculations for test exclusion for right and left side.**

Maximum power: 44.7 mW  
 Bottom Side distance: 191 mm  
 Right Side distance: 220 mm

The closest distance is from the bottom side. Therefore, if the bottom side is excluded the right side would also be excluded.

$[(44.7 \text{ mW}) / (191 \text{ mm})] * \sqrt{5.70} = 0.56$  which is equal to or less than 3.0.

**Figure 8.11 Test Reduction Table – 5.6 GHz Aux**

Mode	Side	Required Channel	Tested/Reduced
802.11n 5600 MHz	Back	100 – 5500 MHz	Reduced <sup>2</sup>
		104 – 5520 MHz	Reduced <sup>2</sup>
		108 – 5540 MHz	Reduced <sup>2</sup>
		112 – 5560 MHz	Reduced <sup>2</sup>
		116 – 5580 MHz	Reduced <sup>2</sup>
		120 – 5600 MHz	Reduced <sup>2</sup>
		124 – 5620 MHz	Reduced <sup>2</sup>
		128 – 5640 MHz	Reduced <sup>2</sup>
		132 – 5660 MHz	Reduced <sup>2</sup>
	136 – 5680 MHz	Reduced <sup>2</sup>	
	140 – 5700 MHz	Reduced <sup>2</sup>	
	Top	100 – 5500 MHz	Reduced <sup>2</sup>
		104 – 5520 MHz	Reduced <sup>2</sup>
		108 – 5540 MHz	Reduced <sup>2</sup>
		112 – 5560 MHz	Reduced <sup>2</sup>
		116 – 5580 MHz	Reduced <sup>2</sup>
		120 – 5600 MHz	Reduced <sup>2</sup>
		124 – 5620 MHz	Reduced <sup>2</sup>
		128 – 5640 MHz	Reduced <sup>2</sup>
		132 – 5660 MHz	Reduced <sup>2</sup>
	136 – 5680 MHz	Reduced <sup>2</sup>	
	140 – 5700 MHz	Reduced <sup>2</sup>	
	Left	100 – 5500 MHz	Reduced <sup>2</sup>
		104 – 5520 MHz	Reduced <sup>2</sup>
		108 – 5540 MHz	Reduced <sup>2</sup>
		112 – 5560 MHz	Reduced <sup>2</sup>
		116 – 5580 MHz	Reduced <sup>2</sup>
		120 – 5600 MHz	Reduced <sup>2</sup>
		124 – 5620 MHz	Reduced <sup>2</sup>
		128 – 5640 MHz	Reduced <sup>2</sup>
		132 – 5660 MHz	Reduced <sup>2</sup>
	136 – 5680 MHz	Reduced <sup>2</sup>	
	140 – 5700 MHz	Reduced <sup>2</sup>	
	Bottom & Right	100 – 5500 MHz	Reduced <sup>2</sup>
		104 – 5520 MHz	Reduced <sup>2</sup>
		108 – 5540 MHz	Reduced <sup>2</sup>
		112 – 5560 MHz	Reduced <sup>2</sup>
		116 – 5580 MHz	Reduced <sup>2</sup>
		120 – 5600 MHz	Reduced <sup>2</sup>
		124 – 5620 MHz	Reduced <sup>2</sup>
		128 – 5640 MHz	Reduced <sup>2</sup>
		132 – 5660 MHz	Reduced <sup>2</sup>
	136 – 5680 MHz	Reduced <sup>2</sup>	
	140 – 5700 MHz	Reduced <sup>2</sup>	
	Curved Edge	100 – 5500 MHz	Reduced <sup>2</sup>
		104 – 5520 MHz	Reduced <sup>2</sup>
		108 – 5540 MHz	Reduced <sup>2</sup>
		112 – 5560 MHz	Reduced <sup>2</sup>
116 – 5580 MHz		Reduced <sup>2</sup>	
120 – 5600 MHz		Reduced <sup>2</sup>	
124 – 5620 MHz		Reduced <sup>2</sup>	
128 – 5640 MHz		Reduced <sup>2</sup>	
132 – 5660 MHz		Reduced <sup>2</sup>	
136 – 5680 MHz	Reduced <sup>2</sup>		
140 – 5700 MHz	Reduced <sup>2</sup>		

Reduced<sup>2</sup> – When the conducted power in this mode is less than 0.25 dB higher than the a mode, testing is not required per KDB 248227 page 5.

**Figure 8.12 Test Reduction Table – 5.6 GHz Aux**

Mode	Side	Required Channel	Tested/Reduced
802.11ac 5600 MHz	Back	106 – 5530 MHz	Reduced <sup>2</sup>
		122 – 5610 MHz	Reduced <sup>2</sup>
		138 – 5690 MHz	Reduced <sup>2</sup>
	Top	106 – 5530 MHz	Reduced <sup>2</sup>
		122 – 5610 MHz	Reduced <sup>2</sup>
		138 – 5690 MHz	Reduced <sup>2</sup>
	Left	106 – 5530 MHz	Reduced <sup>2</sup>
		122 – 5610 MHz	Reduced <sup>2</sup>
		138 – 5690 MHz	Reduced <sup>2</sup>
	Bottom & Right	106 – 5530 MHz	Reduced <sup>2</sup>
		122 – 5610 MHz	Reduced <sup>2</sup>
		138 – 5690 MHz	Reduced <sup>2</sup>
	Curved Edge	106 – 5530 MHz	Reduced <sup>2</sup>
		122 – 5610 MHz	Tested
		138 – 5690 MHz	Reduced <sup>2</sup>

Reduced<sup>2</sup> – When the conducted power in this mode is less than 0.25 dB higher than the a mode, testing is not required per KDB 248227 page 5.

**Figure 8.13 Test Reduction Table – 5.8 GHz Main**

Mode	Side	Required Channel	Tested/Reduced
802.11a 5800 MHz	Back	149 – 5745 MHz	Reduced <sup>1</sup>
		153 – 5765 MHz	Reduced <sup>1</sup>
		157 – 5785 MHz	Tested
		161 – 5805 MHz	Reduced <sup>1</sup>
	Top	165 – 5825 MHz	Reduced <sup>1</sup>
		149 – 5745 MHz	Reduced <sup>1</sup>
		153 – 5765 MHz	Reduced <sup>1</sup>
		157 – 5785 MHz	Tested
	Left	161 – 5805 MHz	Reduced <sup>1</sup>
		165 – 5825 MHz	Reduced <sup>1</sup>
		149 – 5745 MHz	Reduced <sup>1</sup>
		153 – 5765 MHz	Reduced <sup>1</sup>
	Bottom & Right	157 – 5785 MHz	Tested
		161 – 5805 MHz	Reduced <sup>1</sup>
		165 – 5825 MHz	Reduced <sup>1</sup>
		149 – 5745 MHz	Reduced <sup>3</sup>
Curved Edge	153 – 5765 MHz	Reduced <sup>3</sup>	
	157 – 5785 MHz	Reduced <sup>3</sup>	
	161 – 5805 MHz	Reduced <sup>3</sup>	
	165 – 5825 MHz	Reduced <sup>3</sup>	
802.11n 5800 MHz	Back	149 – 5745 MHz	Reduced <sup>1</sup>
		153 – 5765 MHz	Reduced <sup>1</sup>
		157 – 5785 MHz	Tested
		161 – 5805 MHz	Reduced <sup>1</sup>
	Top	165 – 5825 MHz	Reduced <sup>1</sup>
		149 – 5745 MHz	Reduced <sup>2</sup>
		153 – 5765 MHz	Reduced <sup>2</sup>
		157 – 5785 MHz	Reduced <sup>2</sup>
	Left	161 – 5805 MHz	Reduced <sup>2</sup>
		165 – 5825 MHz	Reduced <sup>2</sup>
		149 – 5745 MHz	Reduced <sup>2</sup>
		153 – 5765 MHz	Reduced <sup>2</sup>
	Bottom & Right	157 – 5785 MHz	Reduced <sup>2</sup>
		161 – 5805 MHz	Reduced <sup>2</sup>
		165 – 5825 MHz	Reduced <sup>2</sup>
		149 – 5745 MHz	Reduced <sup>2</sup>
Curved Edge	153 – 5765 MHz	Reduced <sup>2</sup>	
	157 – 5785 MHz	Reduced <sup>2</sup>	
	161 – 5805 MHz	Reduced <sup>2</sup>	
	165 – 5825 MHz	Reduced <sup>2</sup>	
802.11ac 5775 MHz	Back	155 – 5775 MHz	Reduced <sup>2</sup>
	Top	155 – 5775 MHz	Reduced <sup>2</sup>
	Left	155 – 5775 MHz	Reduced <sup>2</sup>
	Bottom & Right	155 – 5775 MHz	Reduced <sup>2</sup>
	Curved Edge	155 – 5775 MHz	Tested

Reduced<sup>1</sup> – When the mid channel is 3 dB below the limit, the remaining channels are not required per KDB 447498 D01 v05r02 section 4.3.3 page 14.

Reduced<sup>2</sup> – When the conducted power in this mode is less than 0.25 dB higher than the a mode, testing is not required per KDB 248227 page 5.

Reduced<sup>3</sup> – When the antenna is more than 25 mm from a side, the test can be reduced per KDB447498 D01 v05r02 section 4.3.1) page 11. See below for calculations.

Calculations for test exclusion for right and left side.

Maximum power: 44.7 mW  
 Bottom Side distance: 191 mm  
 Right Side distance: 220 mm

The closest distance is from the bottom side. Therefore, if the bottom side is excluded the right side would also be excluded.

$[(44.7 \text{ mW}) / (191 \text{ mm})] * \sqrt{5.825} = 0.57$  which is equal to or less than 3.0.

**Figure 8.14 Test Reduction Table – 5.8 GHz Aux**

Mode	Side	Required Channel	Tested/Reduced
802.11a 5800 MHz	Back	149 – 5745 MHz	Reduced <sup>1</sup>
		153 – 5765 MHz	Reduced <sup>1</sup>
		157 – 5785 MHz	Tested
		161 – 5805 MHz	Reduced <sup>1</sup>
		165 – 5825 MHz	Reduced <sup>1</sup>
	Top	149 – 5745 MHz	Reduced <sup>1</sup>
		153 – 5765 MHz	Reduced <sup>1</sup>
		157 – 5785 MHz	Tested
		161 – 5805 MHz	Reduced <sup>1</sup>
		165 – 5825 MHz	Reduced <sup>1</sup>
	Left	149 – 5745 MHz	Reduced <sup>1</sup>
		153 – 5765 MHz	Reduced <sup>1</sup>
		157 – 5785 MHz	Tested
		161 – 5805 MHz	Reduced <sup>1</sup>
		165 – 5825 MHz	Reduced <sup>1</sup>
	Bottom & Right	149 – 5745 MHz	Reduced <sup>3</sup>
		153 – 5765 MHz	Reduced <sup>3</sup>
		157 – 5785 MHz	Reduced <sup>3</sup>
		161 – 5805 MHz	Reduced <sup>3</sup>
		165 – 5825 MHz	Reduced <sup>3</sup>
Curved Edge	149 – 5745 MHz	Reduced <sup>1</sup>	
	153 – 5765 MHz	Reduced <sup>1</sup>	
	157 – 5785 MHz	Tested	
	161 – 5805 MHz	Reduced <sup>1</sup>	
	165 – 5825 MHz	Reduced <sup>1</sup>	
802.11n 5800 MHz	Back	149 – 5745 MHz	Reduced <sup>2</sup>
		153 – 5765 MHz	Reduced <sup>2</sup>
		157 – 5785 MHz	Reduced <sup>2</sup>
		161 – 5805 MHz	Reduced <sup>2</sup>
		165 – 5825 MHz	Reduced <sup>2</sup>
	Top	149 – 5745 MHz	Reduced <sup>2</sup>
		153 – 5765 MHz	Reduced <sup>2</sup>
		157 – 5785 MHz	Reduced <sup>2</sup>
		161 – 5805 MHz	Reduced <sup>2</sup>
		165 – 5825 MHz	Reduced <sup>2</sup>
	Left	149 – 5745 MHz	Reduced <sup>2</sup>
		153 – 5765 MHz	Reduced <sup>2</sup>
		157 – 5785 MHz	Reduced <sup>2</sup>
		161 – 5805 MHz	Reduced <sup>2</sup>
		165 – 5825 MHz	Reduced <sup>2</sup>
	Bottom & Right	149 – 5745 MHz	Reduced <sup>2</sup>
		153 – 5765 MHz	Reduced <sup>2</sup>
		157 – 5785 MHz	Reduced <sup>2</sup>
		161 – 5805 MHz	Reduced <sup>2</sup>
		165 – 5825 MHz	Reduced <sup>2</sup>
Curved Edge	149 – 5745 MHz	Reduced <sup>2</sup>	
	153 – 5765 MHz	Reduced <sup>2</sup>	
	157 – 5785 MHz	Reduced <sup>2</sup>	
	161 – 5805 MHz	Reduced <sup>2</sup>	
	165 – 5825 MHz	Reduced <sup>2</sup>	
802.11ac 5775 MHz	Back	155 – 5775 MHz	Reduced <sup>2</sup>
	Top	155 – 5775 MHz	Reduced <sup>2</sup>
	Left	155 – 5775 MHz	Reduced <sup>2</sup>
	Bottom & Right	155 – 5775 MHz	Reduced <sup>2</sup>
	Curved Edge	155 – 5775 MHz	Tested

Reduced<sup>1</sup> – When the mid channel is 3 dB below the limit, the remaining channels are not required per KDB 447498 D01 v05r02 section 4.3.3 page 14.

Reduced<sup>2</sup> – When the conducted power in this mode is less than 0.25 dB higher than the a mode, testing is not required per KDB 248227 page 5.

Reduced<sup>3</sup> – When the antenna is more than 25 mm from a side, the test can be reduced per KDB447498 D01 v05r02 section 4.3.1) page 11. See below for calculations.

Calculations for test exclusion for right and left side.

Maximum power: 44.7 mW  
 Bottom Side distance: 191 mm  
 Right Side distance: 220 mm

The closest distance is from the bottom side. Therefore, if the bottom side is excluded the right side would also be excluded.

$[(44.7 \text{ mW}) / (191 \text{ mm})] * \sqrt{5.825} = 0.57$  which is equal to or less than 3.0.

**SAR Data Summary – 2450 MHz Body 802.11b & BT**

MEASUREMENT RESULTS									
Plot	Gap	Position	Frequency		Modulation	Antenna	End Power	Measured SAR (W/kg)	Reported SAR (W/kg)
			MHz	Ch.			(dBm)		
----	0 mm	Back	2437	6	DSSS	Main	16.50	0.362	0.36
----		Top	2437	6	DSSS		16.50	0.124	0.12
----		Left	2437	6	DSSS		16.50	0.105	0.11
1		Curved Edge	2437	6	DSSS		16.50	0.614	0.61
----		Back	2437	6	DSSS	Aux	16.50	0.243	0.24
----		Top	2437	6	DSSS		16.50	0.109	0.11
----		Left	2437	6	DSSS		16.50	0.0567	0.06
----		Curved Edge	2437	6	DSSS		16.50	0.227	0.23
----		Back	2440	39	GFSK	Main	7.78	0.0364	0.04
----		Top	2440	39	GFSK		7.78	0.0115	0.01
----		Left	2440	39	GFSK		7.78	0.0102	0.01
----		Curved Edge	2440	39	GFSK		7.78	0.0449	0.05

**Body**  
**1.6 W/kg (mW/g)**  
averaged over 1 gram

1. Battery is fully charged for all tests.  
 Power Measured       Conducted       ERP       EIRP
2. SAR Measurement  
 Phantom Configuration       Left Head       Eli4       Right Head  
 SAR Configuration       Head       Body
3. Test Signal Call Mode       Test Code       Base Station Simulator
4. Test Configuration       With Belt Clip       Without Belt Clip       N/A
5. Tissue Depth is at least 15.0 cm

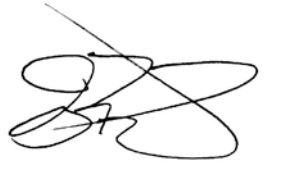

\_\_\_\_\_  
 Jay M. Moulton  
 Vice President

**SAR Data Summary – 5250 MHz Body 802.11a**

MEASUREMENT RESULTS										
Plot	Gap	Position	Frequency		Modulation	Antenna	End Power	Measured SAR (W/kg)	Reported SAR (W/kg)	
			MHz	Ch.			(dBm)			
----	0 mm	Back	5220	44	OFDM	Main	16.00	0.275	0.28	
----			5300	60	OFDM		16.00	0.298	0.30	
----		Top	5220	44	OFDM		16.00	0.332	0.33	
----			5300	60	OFDM		16.00	0.415	0.42	
----		Left	5220	44	OFDM		16.00	0.0123	0.01	
----			5300	60	OFDM		16.00	0.0174	0.02	
----		Curved Edge	5220	44	OFDM		16.00	0.365	0.37	
----			5300	60	OFDM		16.00	0.457	0.46	
----		Back	5220	44	OFDM		Aux	16.00	0.350	0.35
----			5300	60	OFDM			16.00	0.401	0.40
----		Top	5220	44	OFDM			16.00	0.193	0.19
----			5300	60	OFDM			16.00	0.221	0.22
----		Left	5220	44	OFDM			16.00	0.0097	0.01
----			5300	60	OFDM			16.00	0.0082	0.01
----		Curved Edge	5220	44	OFDM			16.00	0.380	0.38
2			5300	60	OFDM			16.00	0.543	0.54

**Body**  
**1.6 W/kg (mW/g)**  
averaged over 1 gram

1. Battery is fully charged for all tests.  
 Power Measured       Conducted       ERP       EIRP
2. SAR Measurement  
 Phantom Configuration       Left Head       Eli4       Right Head  
 SAR Configuration       Head       Body
3. Test Signal Call Mode       Test Code       Base Station Simulator
4. Test Configuration       With Belt Clip       Without Belt Clip       N/A
5. Tissue Depth is at least 15.0 cm

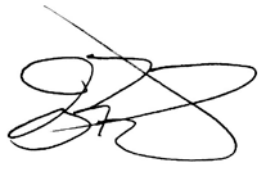

\_\_\_\_\_  
 Jay M. Moulton  
 Vice President

**SAR Data Summary – 5600 MHz Body 802.11a**

MEASUREMENT RESULTS										
Plot	Gap	Position	Frequency		Modulation	Antenna	End Power	Measured SAR (W/kg)	Reported SAR (W/kg)	
			MHz	Ch.			(dBm)			
----	0 mm	Back	5580	116	OFDM	Main	16.50	0.460	0.46	
----			5680	136	OFDM		16.47	0.331	0.33	
----		Top	5580	116	OFDM		16.50	0.347	0.35	
----			5680	136	OFDM		16.47	0.272	0.27	
----		Left	5580	116	OFDM		16.50	0.0126	0.01	
----			5680	136	OFDM		16.47	0.0149	0.02	
----		Curved Edge	5580	116	OFDM		16.50	0.363	0.36	
----			5680	136	OFDM		16.47	0.300	0.30	
----		Back	5580	116	OFDM		Aux	16.43	0.482	0.49
----			5680	136	OFDM			16.50	0.454	0.45
----		Top	5580	116	OFDM			16.43	0.368	0.37
----			5680	136	OFDM			16.50	0.376	0.38
----		Left	5580	116	OFDM			16.43	0.0137	0.01
----			5680	136	OFDM			16.50	0.0167	0.02
----		Curved Edge	5580	116	OFDM			16.43	0.542	0.55
3			5680	136	OFDM			16.50	0.683	0.68

**Body**  
**1.6 W/kg (mW/g)**  
averaged over 1 gram

1. Battery is fully charged for all tests.  
 Power Measured  Conducted  ERP  EIRP
2. SAR Measurement  
 Phantom Configuration  Left Head  Eli4  Right Head  
 SAR Configuration  Head  Body
3. Test Signal Call Mode  Test Code  Base Station Simulator
4. Test Configuration  With Belt Clip  Without Belt Clip  N/A
5. Tissue Depth is at least 15.0 cm



Jay M. Moulton  
 Vice President



**SAR Data Summary – 5800 MHz Body 802.11a**

MEASUREMENT RESULTS									
Plot	Gap	Position	Frequency		Modulation	Antenna	End Power (dBm)	Measured SAR (W/kg)	Reported SAR (W/kg)
			MHz	Ch.					
-----	0 mm	Back	5785	157	OFDM	Main	16.50	0.207	0.21
-----		Top	5785	157	OFDM		16.50	0.257	0.26
-----		Left	5785	157	OFDM		16.50	0.077	0.08
-----		Curved Edge	5785	157	OFDM		16.50	0.314	0.31
-----		Back	5785	157	OFDM	Aux	16.50	0.379	0.38
-----		Top	5785	157	OFDM		16.50	0.309	0.31
-----		Left	5785	157	OFDM		16.50	0.096	0.10
4		Curved Edge	5785	157	OFDM		16.50	0.540	0.54

**Body**  
**1.6 W/kg (mW/g)**  
averaged over 1 gram

1. Battery is fully charged for all tests.  
 Power Measured             Conducted             ERP             EIRP
2. SAR Measurement  
 Phantom Configuration     Left Head             Eli4             Right Head  
 SAR Configuration         Head             Body
3. Test Signal Call Mode     Test Code             Base Station Simulator
4. Test Configuration         With Belt Clip         Without Belt Clip     N/A
5. Tissue Depth is at least 15.0 cm

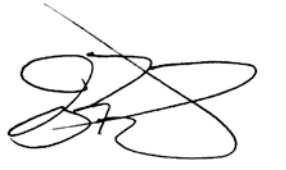

Jay M. Moulton  
 Vice President

**SAR Data Summary – 5 GHz Body 802.11ac 80 MHz Bandwidth**

**MEASUREMENT RESULTS**

Plot	Gap	Position	Frequency		Modulation	Antenna	End Power	Measured SAR (W/kg)	Reported SAR (W/kg)
			MHz	Ch.			(dBm)		
----	0 mm	Curved Edge	5210	42	OFDM	Aux	8.39	0.109	0.11
----			5290	58	OFDM		10.92	0.189	0.19
----			5610	122	OFDM		13.97	0.352	0.35
----			5775	155	OFDM		14.00	0.397	0.40

**Body**  
**1.6 W/kg (mW/g)**  
averaged over 1 gram

1. Battery is fully charged for all tests.  
 Power Measured       Conducted       ERP       EIRP
2. SAR Measurement  
 Phantom Configuration       Left Head       Eli4       Right Head  
 SAR Configuration       Head       Body
3. Test Signal Call Mode       Test Code       Base Station Simulator
4. Test Configuration       With Belt Clip       Without Belt Clip       N/A
5. Tissue Depth is at least 15.0 cm

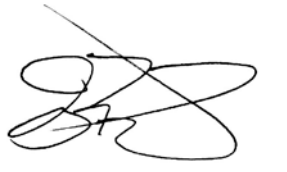

Jay M. Moulton  
 Vice President

## SAR Data Summary – Simultaneous Evaluation

MEASUREMENT RESULTS								
Frequency		Modulation	Frequency		Modulation	SAR <sub>1</sub>	SAR <sub>2</sub>	SAR Total
MHz	Ch.		MHz	Ch.				
2437	6	DSSS	2440	39	GFSK	0.61	0.05	0.66
5280	56	OFDM	2440	39	GFSK	0.54	0.05	0.59
5680	136	OFDM	2440	39	GFSK	0.68	0.05	0.73
5785	157	OFDM	2440	39	GFSK	0.54	0.05	0.59

**Body**  
**1.6 W/kg (mW/g)**  
 averaged over 1 gram

The sum of the two transmitters is less than the limit; therefore, the simultaneous transmission meets the requirements of KDB447498 D01 v05r02 section 4.3.2 page 11.

## 9. Test Equipment List

**Table 9.1 Equipment Specifications**

Type	Calibration Due Date	Calibration Done Date	Serial Number
Staubli Robot TX60L	N/A	N/A	F07/55M6A1/A/01
Measurement Controller CS8c	N/A	N/A	1012
ELI4 Flat Phantom	N/A	N/A	1065
Device Holder	N/A	N/A	N/A
Data Acquisition Electronics 4	08/15/2014	08/15/2013	759
SPEAG E-Field Probe EX3DV4	08/27/2014	08/27/2013	3693
Speag Validation Dipole D2450V2	12/04/2014	12/04/2012	829
Speag Validation Dipole D5GHzV2	12/11/2014	12/11/2012	1085
Agilent N1911A Power Meter	03/24/2015	03/24/2014	GB45100254
Agilent N1922A Power Sensor	06/25/2014	06/25/2013	MY45240464
Advantest R3261A Spectrum Analyzer	03/24/2015	03/24/2014	31720068
Agilent (HP) 8350B Signal Generator	03/24/2015	03/24/2014	2749A10226
Agilent (HP) 83525A RF Plug-In	03/24/2015	03/24/2014	2647A01172
Agilent (HP) 8753C Vector Network Analyzer	03/25/2015	03/25/2014	3135A01724
Agilent (HP) 85047A S-Parameter Test Set	03/25/2015	03/25/2014	2904A00595
Agilent (HP) 8960 Base Station Sim.	10/23/2014	10/23/2012	MY48360364
Anritsu MT8820C	08/03/2014	08/03/2012	6201176199
Aprel Dielectric Probe Assembly	N/A	N/A	0011
Body Equivalent Matter (2450 MHz)	N/A	N/A	N/A
Body Equivalent Matter (5 Ghz)	N/A	N/A	N/A

## 10. Conclusion

The SAR measurement indicates that the EUT complies with the RF radiation exposure limits of the FCC. These measurements are taken to simulate the RF effects exposure under worst-case conditions. Precise laboratory measures were taken to assure repeatability of the tests. The tested device complies with the requirements in respect to all parameters subject to the test. The test results and statements relate only to the item(s) tested.

Please note that the absorption and distribution of electromagnetic energy in the body is a very complex phenomena that depends on the mass, shape, and size of the body; the orientation of the body with respect to the field vectors; and, the electrical properties of both the body and the environment. Other variables that may play a substantial role in possible biological effects are those that characterize the environment (e.g. ambient temperature, air velocity, relative humidity, and body insulation) and those that characterize the individual (e.g. age, gender, activity level, debilitation, or disease). Because innumerable factors may interact to determine the specific biological outcome of an exposure to electromagnetic fields, any protection guide shall consider maximal amplification of biological effects as a result of field-body interactions, environmental conditions, and physiological variables.

## 11. References

- [1] Federal Communications Commission, ET Docket 93-62, Guidelines for Evaluating the Environmental Effects of Radio Frequency Radiation, August 1996
- [2] ANSI/IEEE C95.1 – 1992, American National Standard Safety Levels with respect to Human Exposure to Radio Frequency Electromagnetic Fields, 300kHz to 100GHz, New York: IEEE, 1992.
- [3] ANSI/IEEE C95.3 – 1992, IEEE Recommended Practice for the Measurement of Potentially Hazardous Electromagnetic Fields – RF and Microwave, New York: IEEE, 1992.
- [4] IEEE Standard 1528 – 2013, IEEE Recommended Practice for Determining the Peak-Spatial Average Specific Absorption Rate (SAR) in the Human Head from Wireless Communication Devices: Measurement Techniques, June 2013.
- [5] Industry Canada, RSS – 102e, Radio Frequency Exposure Compliance of Radiocommunication Apparatus (All Frequency Bands), March 2010.
- [6] Health Canada, Safety Code 6, Limits of Human Exposure to Radiofrequency Electromagnetic Fields in the Frequency Range from 3kHz to 300 GHz, 2009.

## Appendix A – System Validation Plots and Data

```
*****  
Test Result for UIM Dielectric Parameter  
Thu 08/May/2014  
Freq Frequency(GHz)  
FCC_eH FCC Bulletin 65 Supplement C ( June 2001) Limits for Head Epsilon  
FCC_sH FCC Bulletin 65 Supplement C (June 2001) Limits for Head Sigma  
FCC_eB FCC Limits for Body Epsilon  
FCC_sB FCC Limits for Body Sigma  
Test_e Epsilon of UIM  
Test_s Sigma of UIM  
*****
```

Freq	FCC_eB	FCC_sB	Test_e	Test_s
2.4100	52.75	1.91	52.85	1.88
2.4120	52.748	1.912	52.846	1.882*
2.4200	52.74	1.92	52.83	1.89
2.4300	52.73	1.93	52.81	1.90
2.4370	52.716	1.937	52.796	1.907*
2.4400	52.71	1.94	52.79	1.91
2.4500	52.70	1.95	52.77	1.92
2.4600	52.69	1.96	52.75	1.93
2.4620	52.686	1.964	52.746	1.932*
2.4700	52.67	1.98	52.73	1.94
2.4800	52.66	1.99	52.71	1.95

\* value interpolated

\*\*\*\*\*

Test Result for UIM Dielectric Parameter

Mon 05/May/2014

Freq Frequency(GHz)

FCC\_eH FCC Bulletin 65 Supplement C ( June 2001) Limits for Head Epsilon

FCC\_sH FCC Bulletin 65 Supplement C (June 2001) Limits for Head Sigma

FCC\_eB FCC Limits for Body Epsilon

FCC\_sB FCC Limits for Body Sigma

Test\_e Epsilon of UIM

Test\_s Sigma of UIM

\*\*\*\*\*

Freq	FCC_eB	FCC_sB	Test_e	Test_s
5.1000	49.15	5.18	49.22	5.10
5.1200	49.12	5.21	49.19	5.12
5.1400	49.10	5.23	49.16	5.14
5.1600	49.07	5.25	49.13	5.16
5.1800	49.04	5.28	49.10	5.19
5.2000	49.01	5.30	49.07	5.21
5.2100	49.00	5.31	49.055	5.22*
5.2200	48.99	5.32	49.04	5.23
5.2400	48.96	5.35	49.01	5.25
5.2600	48.93	5.37	48.98	5.28
5.2800	48.91	5.39	48.95	5.31
5.2900	48.895	5.405	48.935	5.32*
5.3000	48.88	5.42	48.92	5.33
5.3200	48.85	5.44	48.89	5.36
5.3400	48.82	5.46	48.86	5.38
5.3600	48.80	5.49	48.83	5.40
5.3800	48.77	5.51	48.80	5.43
5.4000	48.74	5.53	48.77	5.46
5.4200	48.72	5.56	48.74	5.49
5.4400	48.69	5.58	48.71	5.51
5.4600	48.66	5.60	48.68	5.53
5.4800	48.63	5.63	48.65	5.55
5.5000	48.61	5.65	48.62	5.58
5.5200	48.58	5.67	48.59	5.61
5.5400	48.55	5.70	48.56	5.64
5.5600	48.53	5.72	48.53	5.67
5.5800	48.50	5.74	48.50	5.70
5.6000	48.47	5.77	48.47	5.73
5.6100	48.455	5.78	48.455	5.74*
5.6200	48.44	5.79	48.44	5.75
5.6400	48.42	5.81	48.41	5.78
5.6600	48.39	5.84	48.38	5.81
5.6800	48.36	5.86	48.35	5.84
5.7000	48.34	5.88	48.32	5.86
5.7200	48.31	5.91	48.29	5.89
5.7400	48.28	5.93	48.26	5.91
5.7450	48.273	5.935	48.253	5.918*
5.7600	48.25	5.95	48.23	5.94
5.7750	48.235	5.973	48.208	5.963*
5.7800	48.23	5.98	48.20	5.97
5.7850	48.223	5.985	48.193	5.975*
5.8000	48.20	6.00	48.17	5.99
5.8200	48.17	6.02	48.14	6.02
5.8250	48.165	6.028	48.133	6.025*
5.8400	48.15	6.05	48.11	6.04

\* value interpolated



# RF Exposure Lab

## Plot 1

**DUT: Dipole 2450 MHz D2450V2; Type: D2450V2; Serial: D2450V2 - SN: 829**

Communication System: CW; Frequency: 2450 MHz; Duty Cycle: 1:1  
 Medium: MSL2450; Medium parameters used:  $f = 2450$  MHz;  $\sigma = 1.92$  S/m;  $\epsilon_r = 52.77$ ;  $\rho = 1000$  kg/m<sup>3</sup>  
 Phantom section: Flat Section

Test Date: Date: 5/8/2014; Ambient Temp: 23 °C; Tissue Temp: 21 °C  
 Probe: EX3DV4 - SN3693; ConvF(6.7, 6.7, 6.7); Calibrated: 8/27/2013;  
 Sensor-Surface: 2mm (Mechanical Surface Detection)  
 Electronics: DAE4 Sn759; Calibrated: 8/15/2013  
 Phantom: ELI v4.0; Type: QDOVA001BB; Serial: TP: 1065  
 Measurement SW: DASY52, Version 52.8 (7); SEMCAD X Version 14.6.10 (7164)

### Procedure Notes:

**Body Verification/2450 MHz/Area Scan (61x101x1):** Interpolated grid: dx=1.200 mm, dy=1.200 mm  
 Maximum value of SAR (interpolated) = 8.92 W/kg

**Body Verification/2450 MHz/Zoom Scan (7x7x7)/Cube 0:** Measurement grid: dx=5mm, dy=5mm, dz=5mm  
 Reference Value = 53.359 V/m; Power Drift = -0.02 dB  
 Peak SAR (extrapolated) = 11.04 W/kg  
**SAR(1 g) = 5.12 W/kg; SAR(10 g) = 2.37 W/kg**  
 Maximum value of SAR (measured) = 8.79 W/kg

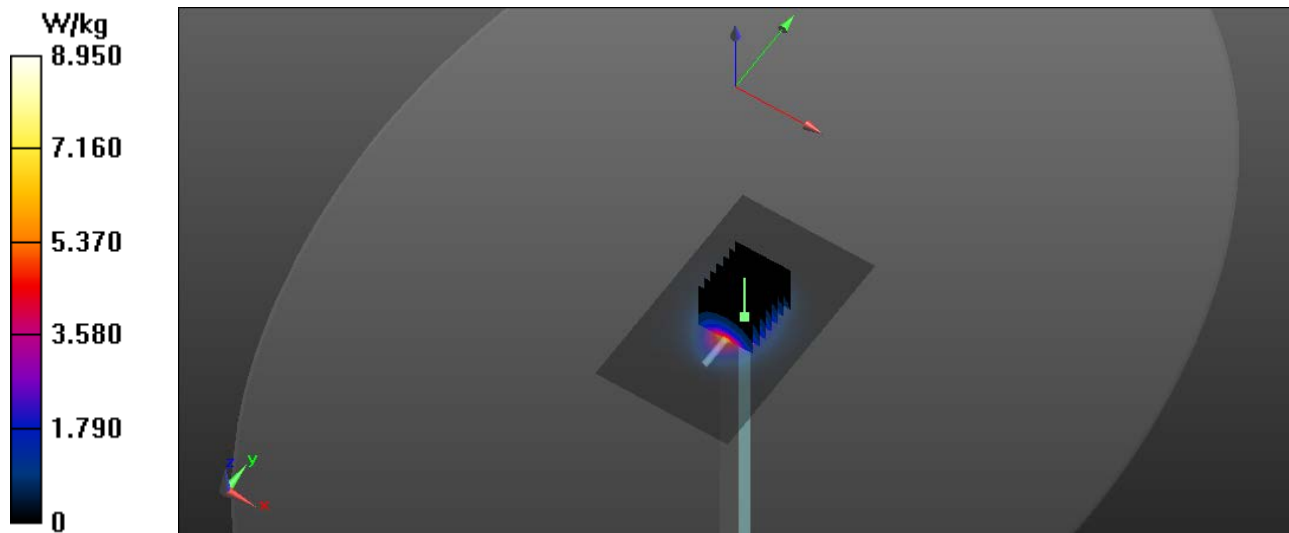

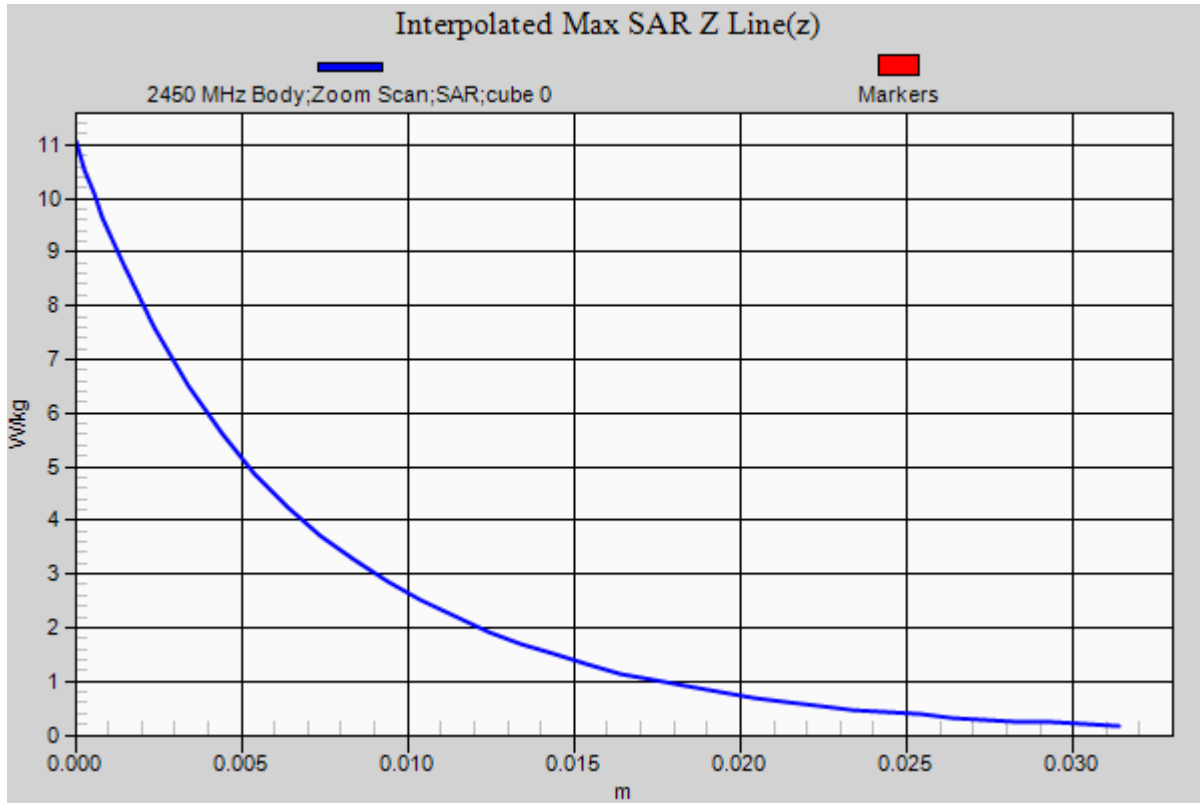

# RF Exposure Lab

## Plot 2

**DUT: Dipole D5GHzV2; Type: D5GHzV2; Serial: D5GHzV2 - SN:1085**

Communication System: CW; Frequency: 5200 MHz; Duty Cycle: 1:1  
 Medium: MSL 3-6 GHz; Medium parameters used:  $f = 5200$  MHz;  $\sigma = 5.21$  S/m;  $\epsilon_r = 49.07$ ;  $\rho = 1000$  kg/m<sup>3</sup>  
 Phantom section: Flat Section

Test Date: Date: 5/5/2014; Ambient Temp: 23 °C; Tissue Temp: 21 °C  
 Probe: EX3DV4 - SN3693; ConvF(4.39, 4.39, 4.39); Calibrated: 8/27/2013;  
 Sensor-Surface: 2mm (Mechanical Surface Detection)  
 Electronics: DAE4 Sn759; Calibrated: 8/15/2013  
 Phantom: ELI v4.0; Type: QDOVA001BB; Serial: TP:1065  
 Measurement SW: DASY52, Version 52.8 (7); SEMCAD X Version 14.6.10 (7164)

### Procedure Notes:

**5200 MHz Body/Verification/Area Scan (7x9x1):** Measurement grid: dx=10mm, dy=10mm  
 Maximum value of SAR (measured) = 1.58 W/kg

**5200 MHz Body/Verification/Zoom Scan (7x7x12)/Cube 0:** Measurement grid: dx=4mm, dy=4mm, dz=2mm  
 Reference Value = 11.705 V/m; Power Drift = 0.01 dB  
 Peak SAR (extrapolated) = 3.75 W/kg  
**SAR(1 g) = 0.763 W/kg; SAR(10 g) = 0.211 W/kg**  
 Maximum value of SAR (measured) = 1.65 W/kg

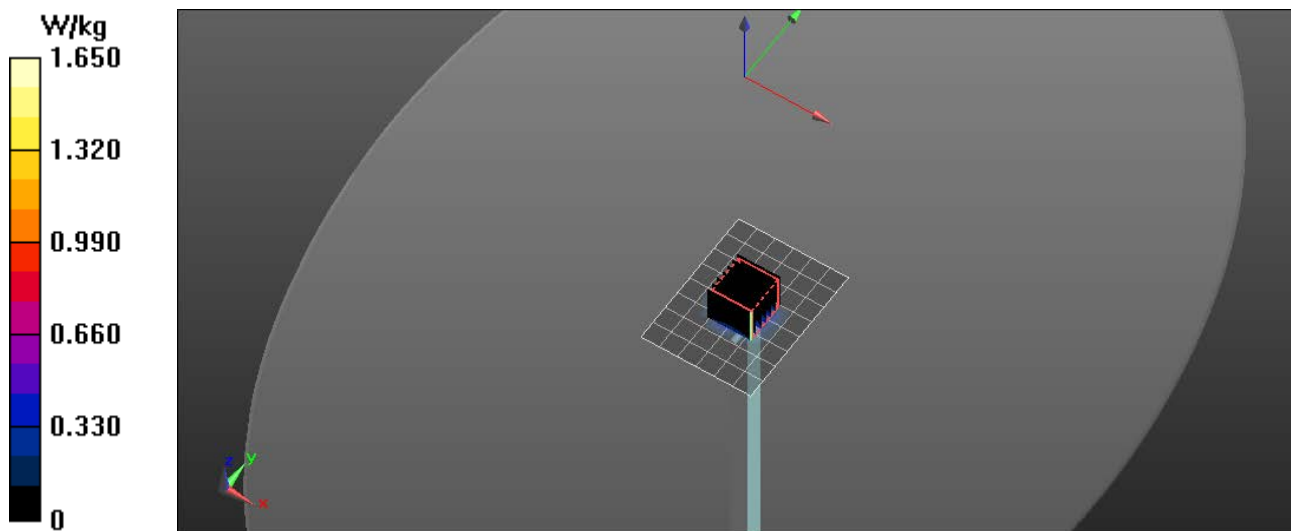

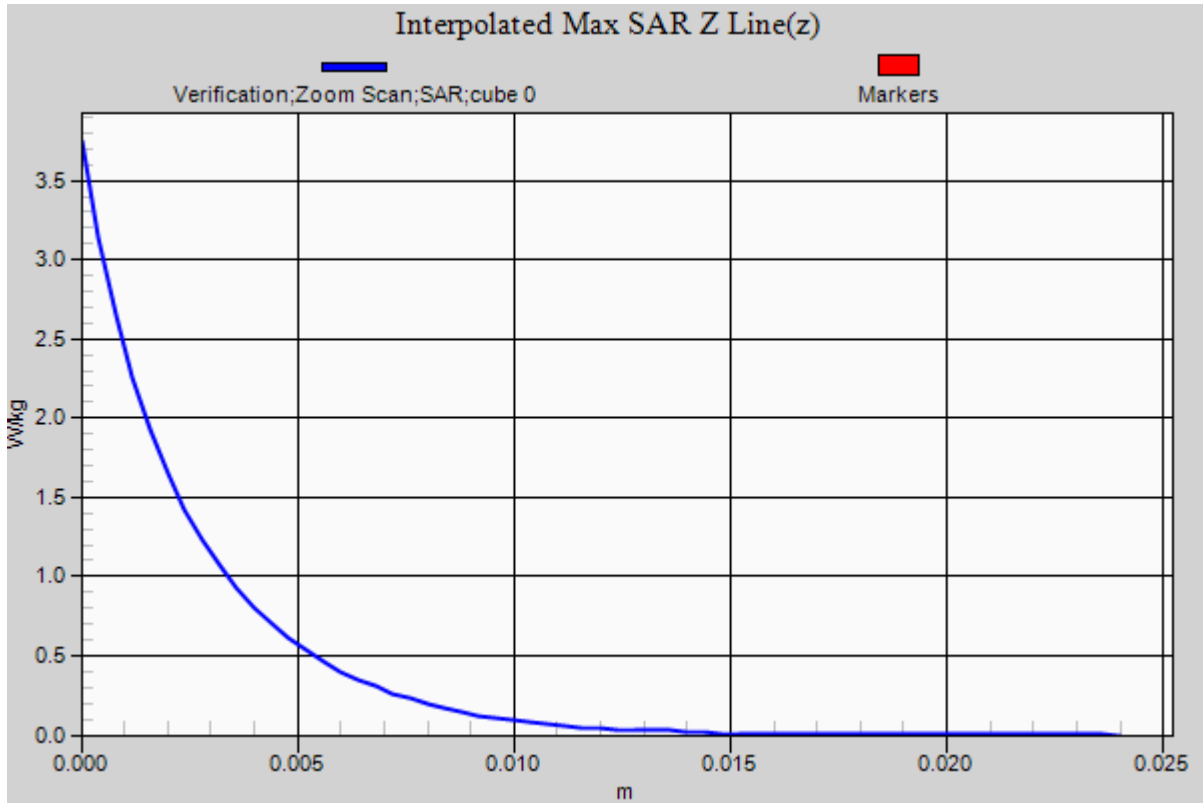

# RF Exposure Lab

## Plot 3

**DUT: Dipole D5GHzV2; Type: D5GHzV2; Serial: D5GHzV2 - SN:1085**

Communication System: CW; Frequency: 5600 MHz; Duty Cycle: 1:1  
 Medium: MSL 3-6 GHz; Medium parameters used:  $f = 5600$  MHz;  $\sigma = 5.73$  S/m;  $\epsilon_r = 48.47$ ;  $\rho = 1000$  kg/m<sup>3</sup>  
 Phantom section: Flat Section

Test Date: Date: 5/6/2014; Ambient Temp: 23 °C; Tissue Temp: 21 °C  
 Probe: EX3DV4 - SN3693; ConvF(3.63, 3.63, 3.63); Calibrated: 8/27/2013;  
 Sensor-Surface: 2mm (Mechanical Surface Detection)  
 Electronics: DAE4 Sn759; Calibrated: 8/15/2013  
 Phantom: ELI v4.0; Type: QDOVA001BB; Serial: TP:1065  
 Measurement SW: DASY52, Version 52.8 (7); SEMCAD X Version 14.6.10 (7164)

### Procedure Notes:

**5600 MHz Body/Verification/Area Scan (7x9x1):** Measurement grid: dx=10mm, dy=10mm  
 Maximum value of SAR (measured) = 1.64 W/kg

**5600 MHz Body/Verification/Zoom Scan (7x7x12)/Cube 0:** Measurement grid: dx=4mm, dy=4mm, dz=2mm  
 Reference Value = 11.892 V/m; Power Drift = 0.01 dB  
 Peak SAR (extrapolated) = 3.63 W/kg  
**SAR(1 g) = 0.783 W/kg; SAR(10 g) = 0.216 W/kg**  
 Maximum value of SAR (measured) = 1.70 W/kg

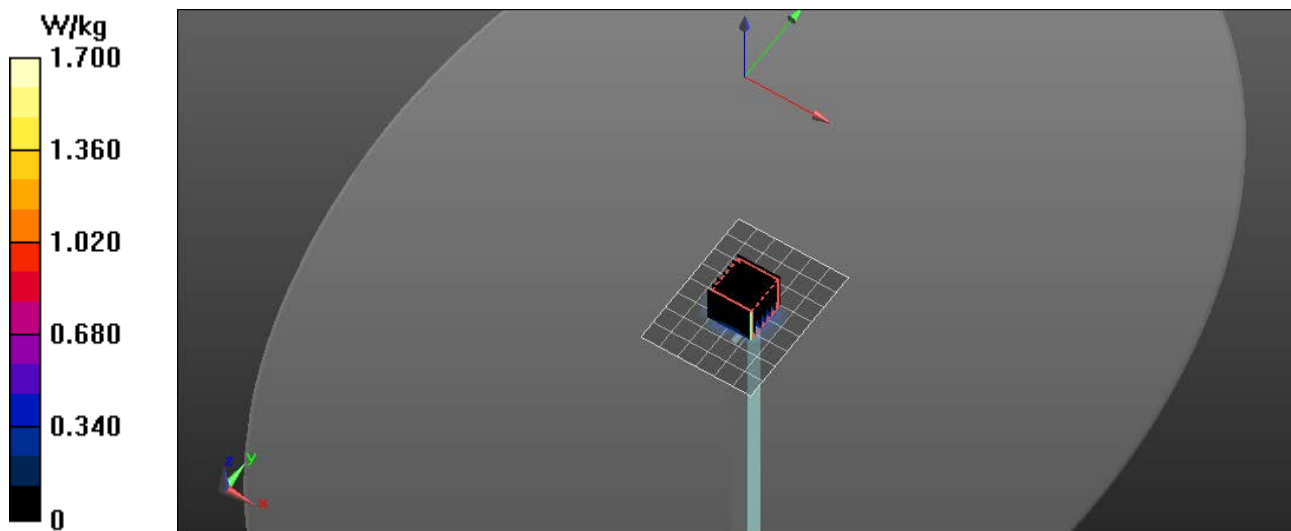

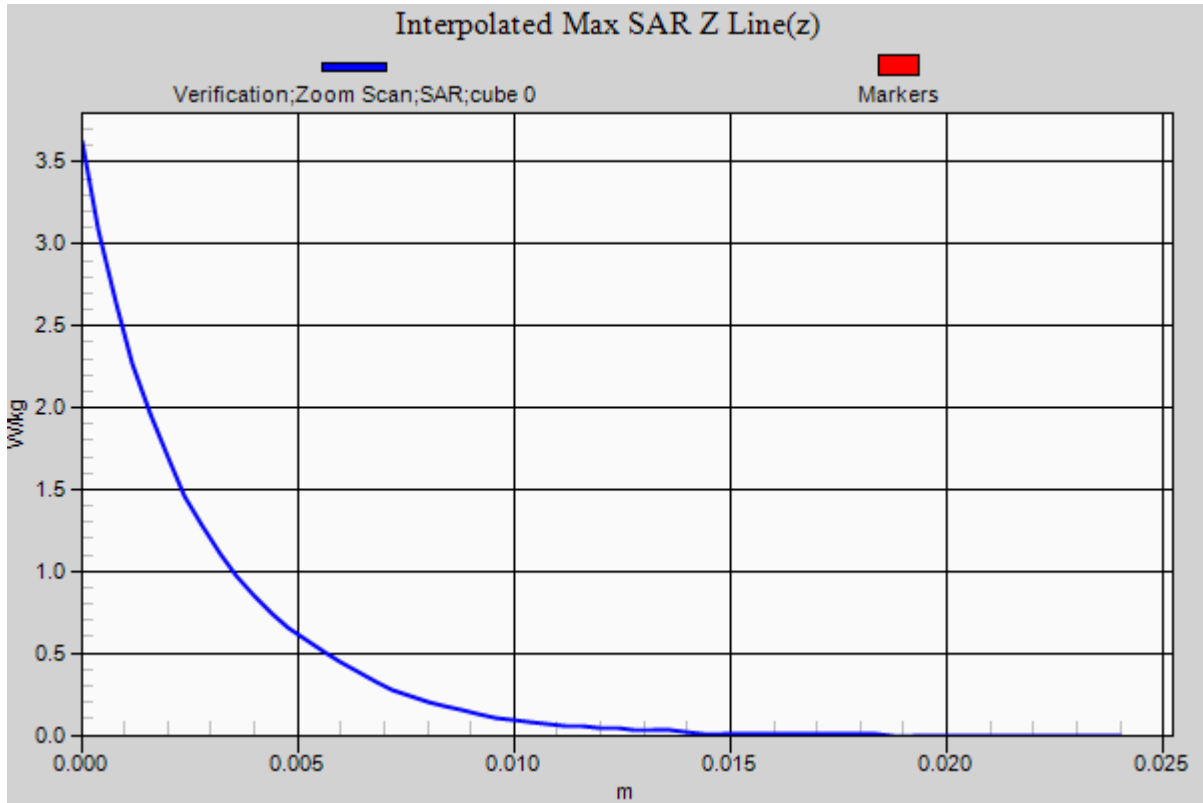

# RF Exposure Lab

## Plot 4

**DUT: Dipole D5GHzV2; Type: D5GHzV2; Serial: D5GHzV2 - SN:1085**

Communication System: CW; Frequency: 5800 MHz; Duty Cycle: 1:1  
 Medium: MSL 3-6 GHz; Medium parameters used:  $f = 5800$  MHz;  $\sigma = 5.99$  S/m;  $\epsilon_r = 48.17$ ;  $\rho = 1000$  kg/m<sup>3</sup>  
 Phantom section: Flat Section

Test Date: Date: 5/7/2014; Ambient Temp: 23 °C; Tissue Temp: 21 °C  
 Probe: EX3DV4 - SN3693; ConvF(4.04, 4.04, 4.04); Calibrated: 8/27/2013;  
 Sensor-Surface: 2mm (Mechanical Surface Detection)  
 Electronics: DAE4 Sn759; Calibrated: 8/15/2013  
 Phantom: ELI v4.0; Type: QDOVA001BB; Serial: TP:1065  
 Measurement SW: DASY52, Version 52.8 (7); SEMCAD X Version 14.6.10 (7164)

### Procedure Notes:

**5800 MHz Body/Verification/Area Scan (7x9x1):** Measurement grid: dx=10mm, dy=10mm  
 Maximum value of SAR (measured) = 1.56 W/kg

**5800 MHz Body/Verification/Zoom Scan (7x7x12)/Cube 0:** Measurement grid: dx=4mm, dy=4mm, dz=2mm  
 Reference Value = 11.621 V/m; Power Drift = -0.01 dB  
 Peak SAR (extrapolated) = 3.47 W/kg  
**SAR(1 g) = 0.749 W/kg; SAR(10 g) = 0.208 W/kg**  
 Maximum value of SAR (measured) = 1.63 W/kg

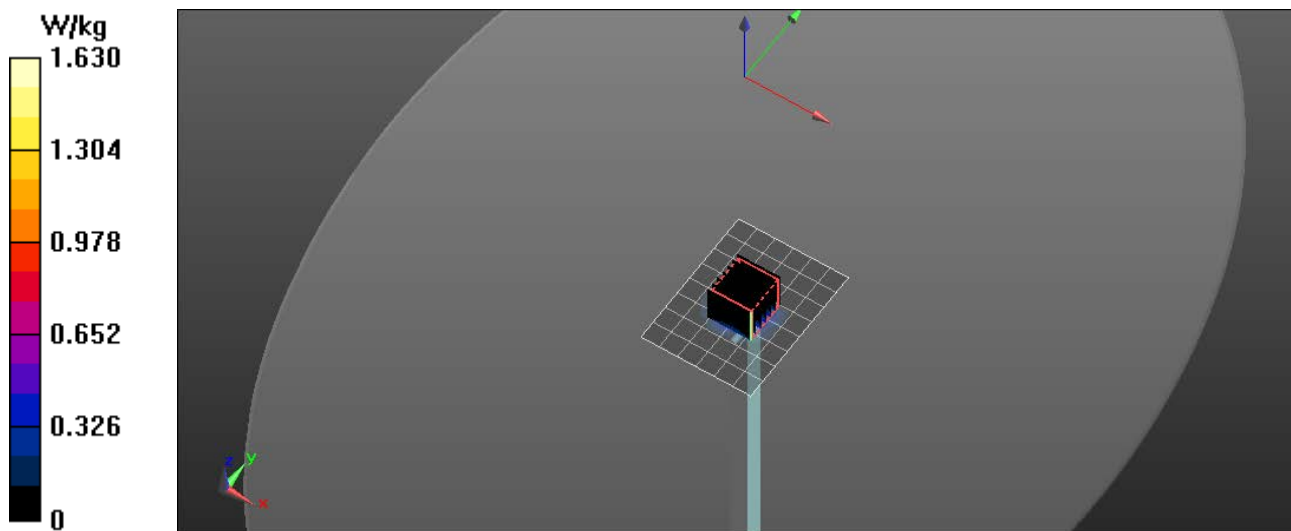

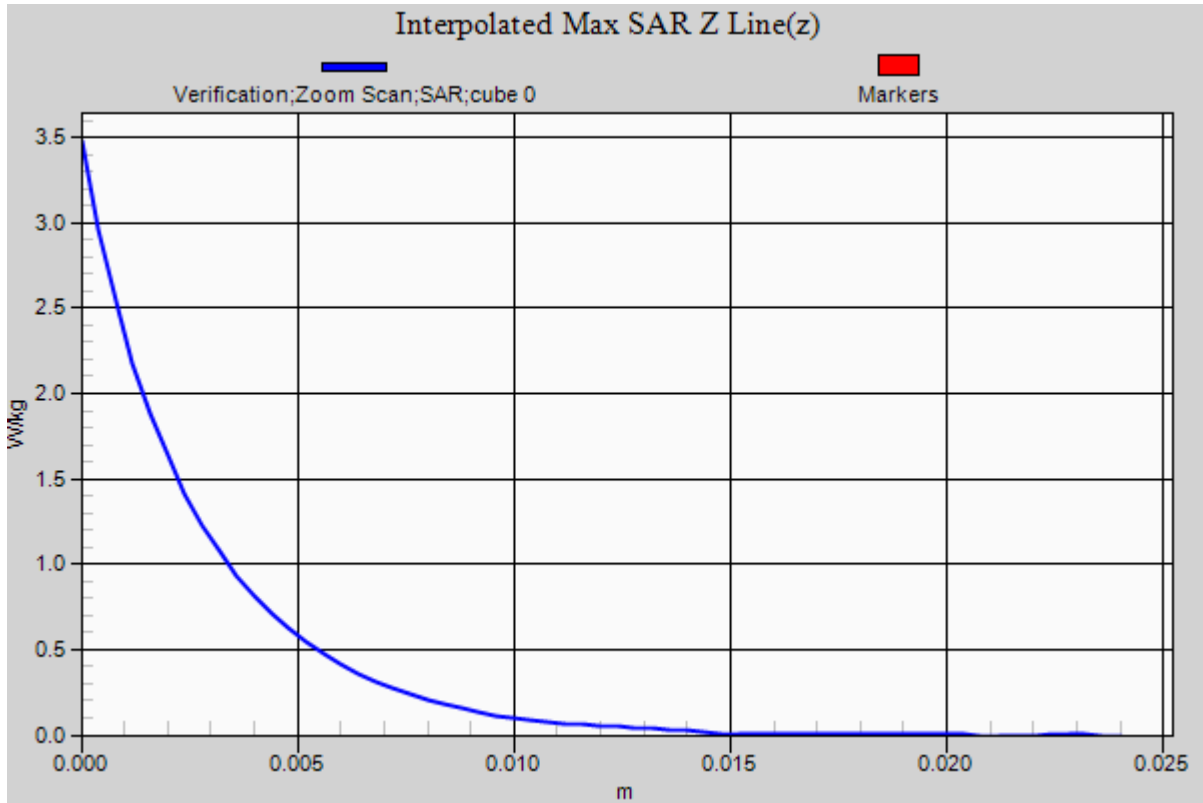



## **Appendix B – SAR Test Data Plots**

# RF Exposure Lab

## Plot 1

**DUT: HSTNN-I19C; Type: Convertible Laptop; Serial: 74211S20LC**

Communication System: WiFi 802.11b (DSSS, 1 Mbps); Frequency: 2437 MHz; Duty Cycle: 1:1  
Medium: MSL2450; Medium parameters used (interpolated):  $f = 2437$  MHz;  $\sigma = 1.907$  S/m;  $\epsilon_r = 52.796$ ;  $\rho = 1000$  kg/m<sup>3</sup>  
Phantom section: Flat Section

Test Date: Date: 5/8/2014; Ambient Temp: 23 °C; Tissue Temp: 21 °C

Probe: EX3DV4 - SN3693; ConvF(6.7, 6.7, 6.7); Calibrated: 8/27/2013;  
Sensor-Surface: 2mm (Mechanical Surface Detection)  
Electronics: DAE4 Sn759; Calibrated: 8/15/2013  
Phantom: ELI v4.0; Type: QDOVA001BB; Serial: TP:1065  
Measurement SW: DASY52, Version 52.8 (7); SEMCAD X Version 14.6.10 (7164)

### Procedure Notes:

**2450 MHz/Curved Tx1 Mid/Area Scan (7x9x1):** Measurement grid: dx=10mm, dy=10mm

[Info: Interpolated medium parameters used for SAR evaluation.](#)

Maximum value of SAR (measured) = 0.767 W/kg

**2450 MHz/Curved Tx1 Mid/Zoom Scan (7x7x7)/Cube 0:** Measurement grid: dx=5mm, dy=5mm, dz=5mm

Reference Value = 15.590 V/m; Power Drift = -0.02 dB

Peak SAR (extrapolated) = 1.39 W/kg

**SAR(1 g) = 0.614 W/kg**

[Info: Interpolated medium parameters used for SAR evaluation.](#)

Maximum value of SAR (measured) = 0.986 W/kg

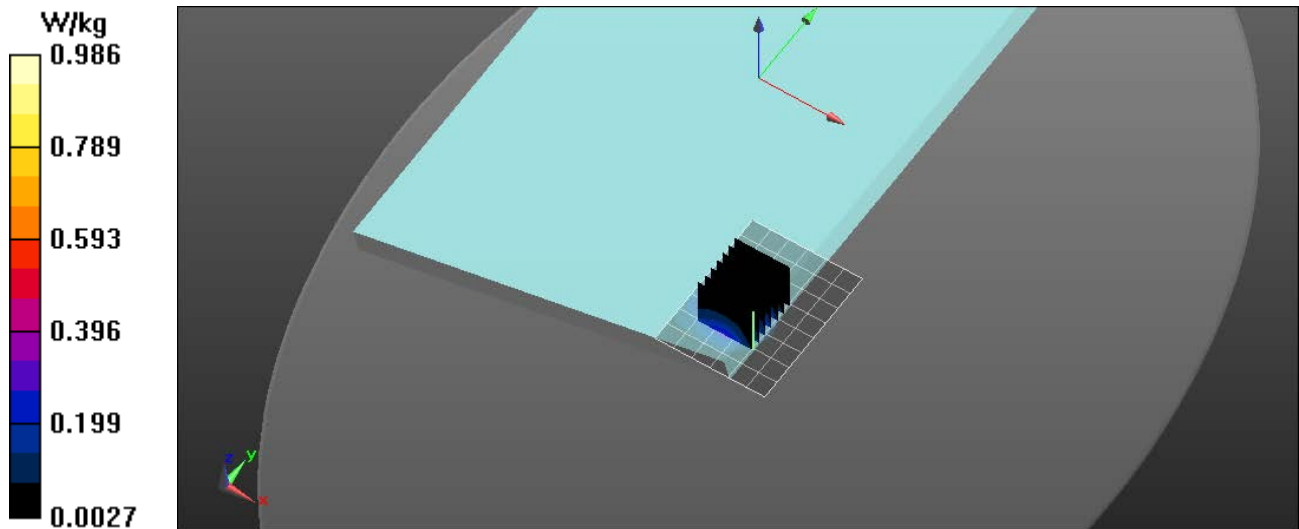

# RF Exposure Lab

## Plot 2

**DUT: HSTNN-I19C; Type: Convertible Laptop; Serial: 74211S20LC**

Communication System: WiFi 802.11a (OFDM, 6 Mbps); Frequency: 5300 MHz; Duty Cycle: 1:1  
Medium: MSL 3-6 GHz; Medium parameters used:  $f = 5300$  MHz;  $\sigma = 5.33$  S/m;  $\epsilon_r = 48.92$ ;  $\rho = 1000$  kg/m<sup>3</sup>  
Phantom section: Flat Section

Test Date: Date: 5/6/2014; Ambient Temp: 23 °C; Tissue Temp: 21 °C

Probe: EX3DV4 - SN3693; ConvF(4.1, 4.1, 4.1); Calibrated: 8/27/2013;  
Sensor-Surface: 2mm (Mechanical Surface Detection)  
Electronics: DAE4 Sn759; Calibrated: 8/15/2013  
Phantom: ELI v4.0; Type: QDOVA001BB; Serial: TP:1065  
Measurement SW: DASY52, Version 52.8 (7); SEMCAD X Version 14.6.10 (7164)

### Procedure Notes:

**5200 MHz/Curved Tx2 60/Area Scan (7x9x1):** Measurement grid: dx=10mm, dy=10mm  
Maximum value of SAR (measured) = 0.787 W/kg

**5200 MHz/Curved Tx2 60/Zoom Scan (7x7x12)/Cube 0:** Measurement grid: dx=4mm, dy=4mm, dz=2mm  
Reference Value = 9.182 V/m; Power Drift = 0.00 dB  
Peak SAR (extrapolated) = 2.47 W/kg  
**SAR(1 g) = 0.543 W/kg**  
Maximum value of SAR (measured) = 1.14 W/kg

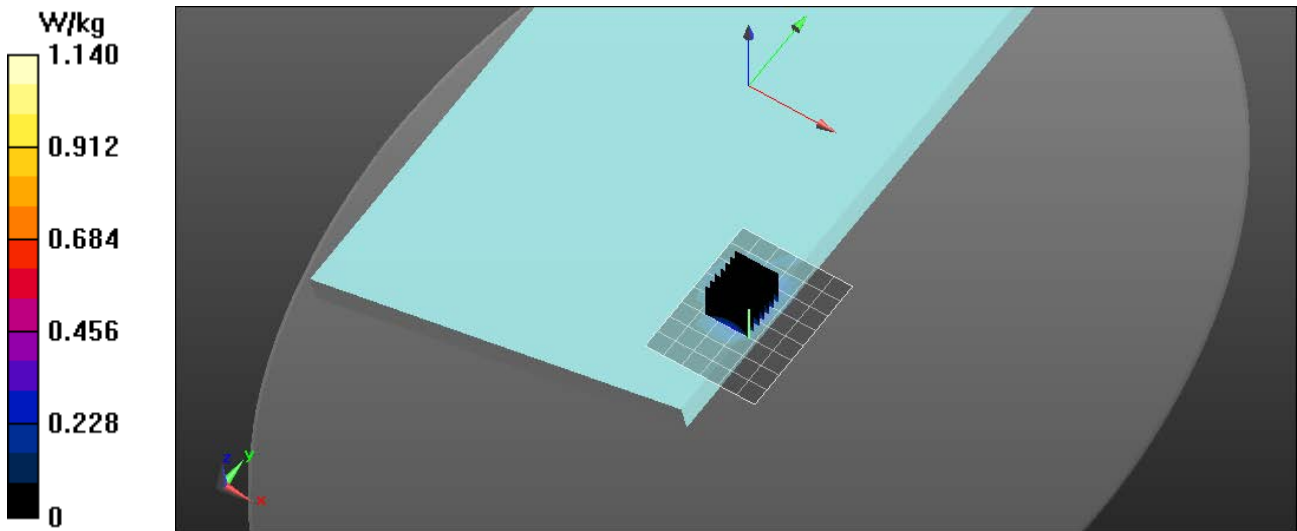

# RF Exposure Lab

## Plot 3

**DUT: HSTNN-I19C; Type: Convertible Laptop; Serial: 74211S20LC**

Communication System: WiFi 802.11a (OFDM, 6 Mbps); Frequency: 5680 MHz; Duty Cycle: 1:1  
Medium: MSL 3-6 GHz; Medium parameters used:  $f = 5680$  MHz;  $\sigma = 5.84$  S/m;  $\epsilon_r = 48.35$ ;  $\rho = 1000$  kg/m<sup>3</sup>  
Phantom section: Flat Section

Test Date: Date: 5/7/2014; Ambient Temp: 23 °C; Tissue Temp: 21 °C

Probe: EX3DV4 - SN3693; ConvF(3.63, 3.63, 3.63); Calibrated: 8/27/2013;  
Sensor-Surface: 2mm (Mechanical Surface Detection)  
Electronics: DAE4 Sn759; Calibrated: 8/15/2013  
Phantom: ELI v4.0; Type: QDOVA001BB; Serial: TP:1065  
Measurement SW: DASY52, Version 52.8 (7); SEMCAD X Version 14.6.10 (7164)

### Procedure Notes:

**5600 MHz/Curved Tx2 136/Area Scan (7x9x1):** Measurement grid: dx=10mm, dy=10mm  
Maximum value of SAR (measured) = 1.09 W/kg

**5600 MHz/Curved Tx2 136/Zoom Scan (7x7x12)/Cube 0:** Measurement grid: dx=4mm, dy=4mm, dz=2mm  
Reference Value = 10.290 V/m; Power Drift = -0.03 dB  
Peak SAR (extrapolated) = 3.19 W/kg  
**SAR(1 g) = 0.683 W/kg**  
Maximum value of SAR (measured) = 1.47 W/kg

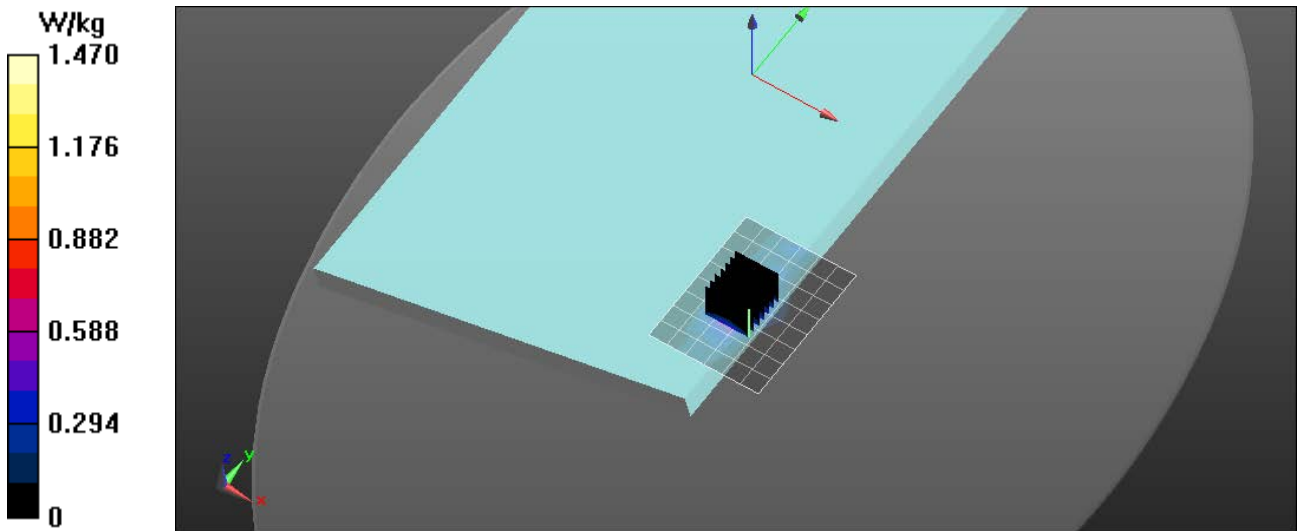

# RF Exposure Lab

## Plot 4

**DUT: HSTNN-I19C; Type: Convertible Laptop; Serial: 74211S20LC**

Communication System: WiFi 802.11a (OFDM, 6 Mbps); Frequency: 5785 MHz; Duty Cycle: 1:1  
Medium: MSL 3-6 GHz; Medium parameters used (interpolated):  $f = 5785$  MHz;  $\sigma = 5.975$  S/m;  $\epsilon_r = 48.193$ ;  $\rho = 1000$  kg/m<sup>3</sup>  
Phantom section: Flat Section

Test Date: Date: 5/8/2014; Ambient Temp: 23 °C; Tissue Temp: 21 °C

Probe: EX3DV4 - SN3693; ConvF(4.04, 4.04, 4.04); Calibrated: 8/27/2013;  
Sensor-Surface: 2mm (Mechanical Surface Detection)  
Electronics: DAE4 Sn759; Calibrated: 8/15/2013  
Phantom: ELI v4.0; Type: QDOVA001BB; Serial: TP:1065  
Measurement SW: DASY52, Version 52.8 (7); SEMCAD X Version 14.6.10 (7164)

### Procedure Notes:

**5800 MHz/Curved Tx2 157/Area Scan (7x9x1):** Measurement grid: dx=10mm, dy=10mm

[Info: Interpolated medium parameters used for SAR evaluation.](#)

Maximum value of SAR (measured) = 0.818 W/kg

**5800 MHz/Curved Tx2 157/Zoom Scan (7x7x12)/Cube 0:** Measurement grid: dx=4mm, dy=4mm, dz=2mm

Reference Value = 8.434 V/m; Power Drift = -0.01 dB

Peak SAR (extrapolated) = 2.69 W/kg

**SAR(1 g) = 0.540 W/kg**

[Info: Interpolated medium parameters used for SAR evaluation.](#)

Maximum value of SAR (measured) = 1.13 W/kg

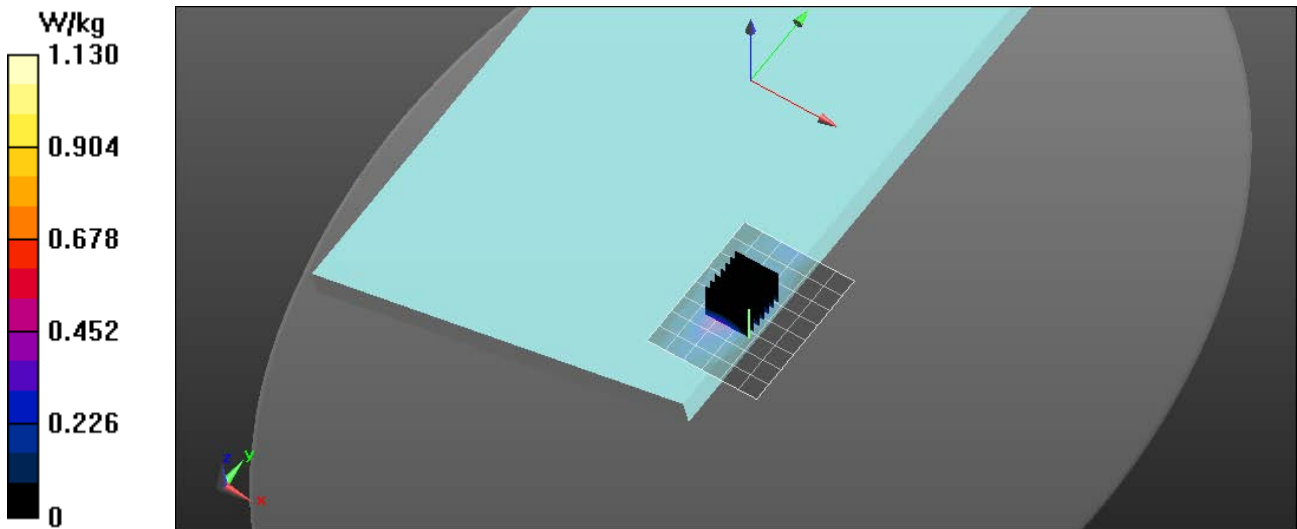

## Appendix D – Probe Calibration Data Sheets



Accredited by the Swiss Accreditation Service (SAS)  
The Swiss Accreditation Service is one of the signatories to the EA  
Multilateral Agreement for the recognition of calibration certificates

Accreditation No.: **SCS 108**

Client **RF Exposure lab**

Certificate No: **EX3-3693\_Aug13**

## CALIBRATION CERTIFICATE

Object: **EX3DV4 - SN:3693**

Calibration procedure(s): **QA CAL-01.v9, QA CAL-14.v4, QA CAL-23.v5, QA CAL-25.v6**  
Calibration procedure for dosimetric E-field probes

Calibration date: **August 27, 2013**

This calibration certificate documents the traceability to national standards, which realize the physical units of measurements (SI).  
The measurements and the uncertainties with confidence probability are given on the following pages and are part of the certificate.

All calibrations have been conducted in the closed laboratory facility: environment temperature  $(22 \pm 3)^\circ\text{C}$  and humidity  $< 70\%$ .

Calibration Equipment used (M&TE critical for calibration)

Primary Standards	ID	Cal Date (Certificate No.)	Scheduled Calibration
Power meter E4419B	GB41293874	04-Apr-13 (No. 217-01733)	Apr-14
Power sensor E4412A	MY41498087	04-Apr-13 (No. 217-01733)	Apr-14
Reference 3 dB Attenuator	SN: S5054 (3c)	04-Apr-13 (No. 217-01737)	Apr-14
Reference 20 dB Attenuator	SN: S5277 (20x)	04-Apr-13 (No. 217-01735)	Apr-14
Reference 30 dB Attenuator	SN: S5129 (30b)	04-Apr-13 (No. 217-01738)	Apr-14
Reference Probe ES3DV2	SN: 3013	28-Dec-12 (No. ES3-3013_Dec12)	Dec-13
DAE4	SN: 660	31-Jan-13 (No. DAE4-660_Jan13)	Jan-14
Secondary Standards	ID	Check Date (in house)	Scheduled Check
RF generator HP 8648C	US3642U01700	4-Aug-99 (in house check Apr-13)	In house check Apr-15
Network Analyzer HP 8753E	US37390585	18-Oct-01 (in house check Oct-12)	In house check Oct-13

	Name	Function	Signature
Calibrated by:	Jeton Kastrati	Laboratory Technician	
Approved by:	Katja Pokovic	Technical Manager	
			Issued: August 29, 2013
This calibration certificate shall not be reproduced except in full without written approval of the laboratory			



Accredited by the Swiss Accreditation Service (SAS)

Accreditation No.: **SCS 108**

The Swiss Accreditation Service is one of the signatories to the EA  
Multilateral Agreement for the recognition of calibration certificates

### Glossary:

TSL	tissue simulating liquid
NORM <sub>x,y,z</sub>	sensitivity in free space
ConvF	sensitivity in TSL / NORM <sub>x,y,z</sub>
DCP	diode compression point
CF	crest factor (1/duty_cycle) of the RF signal
A, B, C, D	modulation dependent linearization parameters
Polarization $\varphi$	$\varphi$ rotation around probe axis
Polarization $\vartheta$	$\vartheta$ rotation around an axis that is in the plane normal to probe axis (at measurement center), i.e., $\vartheta = 0$ is normal to probe axis

### Calibration is Performed According to the Following Standards:

- IEEE Std 1528-2003, "IEEE Recommended Practice for Determining the Peak Spatial-Averaged Specific Absorption Rate (SAR) in the Human Head from Wireless Communications Devices: Measurement Techniques", December 2003
- IEC 62209-1, "Procedure to measure the Specific Absorption Rate (SAR) for hand-held devices used in close proximity to the ear (frequency range of 300 MHz to 3 GHz)", February 2005

### Methods Applied and Interpretation of Parameters:

- NORM<sub>x,y,z</sub>**: Assessed for E-field polarization  $\vartheta = 0$  ( $f \leq 900$  MHz in TEM-cell;  $f > 1800$  MHz; R22 waveguide). NORM<sub>x,y,z</sub> are only intermediate values, i.e., the uncertainties of NORM<sub>x,y,z</sub> does not affect the E<sup>2</sup>-field uncertainty inside TSL (see below ConvF).
- NORM( $\bar{f}$ )<sub>x,y,z</sub> = NORM<sub>x,y,z</sub> \* frequency\_response** (see Frequency Response Chart). This linearization is implemented in DASY4 software versions later than 4.2. The uncertainty of the frequency response is included in the stated uncertainty of ConvF.
- DCP<sub>x,y,z</sub>**: DCP are numerical linearization parameters assessed based on the data of power sweep with CW signal (no uncertainty required). DCP does not depend on frequency nor media.
- PAR**: PAR is the Peak to Average Ratio that is not calibrated but determined based on the signal characteristics
- A<sub>x,y,z</sub>; B<sub>x,y,z</sub>; C<sub>x,y,z</sub>; D<sub>x,y,z</sub>; VR<sub>x,y,z</sub>; A, B, C, D** are numerical linearization parameters assessed based on the data of power sweep for specific modulation signal. The parameters do not depend on frequency nor media. VR is the maximum calibration range expressed in RMS voltage across the diode.
- ConvF and Boundary Effect Parameters**: Assessed in flat phantom using E-field (or Temperature Transfer Standard for  $f \leq 800$  MHz) and inside waveguide using analytical field distributions based on power measurements for  $f > 800$  MHz. The same setups are used for assessment of the parameters applied for boundary compensation (alpha, depth) of which typical uncertainty values are given. These parameters are used in DASY4 software to improve probe accuracy close to the boundary. The sensitivity in TSL corresponds to NORM<sub>x,y,z</sub> \* ConvF whereby the uncertainty corresponds to that given for ConvF. A frequency dependent ConvF is used in DASY version 4.4 and higher which allows extending the validity from  $\pm 50$  MHz to  $\pm 100$  MHz.
- Spherical isotropy (3D deviation from isotropy)**: in a field of low gradients realized using a flat phantom exposed by a patch antenna.
- Sensor Offset**: The sensor offset corresponds to the offset of virtual measurement center from the probe tip (on probe axis). No tolerance required.



# Probe EX3DV4

## SN:3693

Manufactured: April 22, 2009  
Calibrated: August 27, 2013

Calibrated for DASY/EASY Systems  
(Note: non-compatible with DASY2 system!)

## DASY/EASY - Parameters of Probe: EX3DV4 - SN:3693

### Basic Calibration Parameters

	Sensor X	Sensor Y	Sensor Z	Unc (k=2)
Norm ( $\mu\text{V}/(\text{V}/\text{m})^2$ ) <sup>A</sup>	0.49	0.48	0.46	$\pm 10.1\%$
DCP (mV) <sup>B</sup>	97.4	101.0	102.0	

### Modulation Calibration Parameters

UID	Communication System Name		A dB	B dB $\sqrt{\mu\text{V}}$	C	D dB	VR mV	Unc <sup>E</sup> (k=2)
0	CW	X	0.0	0.0	1.0	0.00	166.1	$\pm 3.0\%$
		Y	0.0	0.0	1.0		162.2	
		Z	0.0	0.0	1.0		163.1	

The reported uncertainty of measurement is stated as the standard uncertainty of measurement multiplied by the coverage factor k=2, which for a normal distribution corresponds to a coverage probability of approximately 95%.

<sup>A</sup> The uncertainties of Norm X,Y,Z do not affect the E<sup>2</sup>-field uncertainty inside TSL (see Pages 5 and 6).

<sup>B</sup> Numerical linearization parameter; uncertainty not required

<sup>E</sup> Uncertainty is determined using the max. deviation from linear response applying rectangular distribution and is expressed for the square of the field value

## DASY/EASY - Parameters of Probe: EX3DV4 - SN:3693

### Calibration Parameter Determined in Head Tissue Simulating Media

f (MHz) <sup>C</sup>	Relative Permittivity <sup>F</sup>	Conductivity (S/m) <sup>F</sup>	ConvF X	ConvF Y	ConvF Z	Alpha	Depth (mm)	Unct. (k=2)
750	41.9	0.89	9.00	9.00	9.00	0.21	1.28	± 12.0 %
835	41.5	0.90	8.84	8.84	8.84	0.80	0.60	± 12.0 %
900	41.5	0.97	8.61	8.61	8.61	0.39	0.89	± 12.0 %
1750	40.1	1.37	7.69	7.69	7.69	0.41	0.75	± 12.0 %
1900	40.0	1.40	7.49	7.49	7.49	0.53	0.68	± 12.0 %
2450	39.2	1.80	6.79	6.79	6.79	0.30	0.92	± 12.0 %
2550	39.1	1.91	6.64	6.64	6.64	0.30	0.96	± 12.0 %
2600	39.0	1.96	6.66	6.66	6.66	0.26	1.07	± 12.0 %
5200	36.0	4.66	4.93	4.93	4.93	0.40	1.80	± 13.1 %
5300	35.9	4.76	4.59	4.59	4.59	0.40	1.80	± 13.1 %
5600	35.5	5.07	4.34	4.34	4.34	0.40	1.80	± 13.1 %
5800	35.3	5.27	4.25	4.25	4.25	0.45	1.80	± 13.1 %

<sup>C</sup> Frequency validity of ± 100 MHz only applies for DASY v4.4 and higher (see Page 2), else it is restricted to ± 50 MHz. The uncertainty is the RSS of the ConvF uncertainty at calibration frequency and the uncertainty for the indicated frequency band.

<sup>F</sup> At frequencies below 3 GHz, the validity of tissue parameters ( $\epsilon$  and  $\sigma$ ) can be relaxed to ± 10% if liquid compensation formula is applied to measured SAR values. At frequencies above 3 GHz, the validity of tissue parameters ( $\epsilon$  and  $\sigma$ ) is restricted to ± 5%. The uncertainty is the RSS of the ConvF uncertainty for indicated target tissue parameters.

## DASY/EASY - Parameters of Probe: EX3DV4 - SN:3693

### Calibration Parameter Determined in Body Tissue Simulating Media

f (MHz) <sup>C</sup>	Relative Permittivity <sup>F</sup>	Conductivity (S/m) <sup>F</sup>	ConvF X	ConvF Y	ConvF Z	Alpha	Depth (mm)	Unct. (k=2)
750	55.5	0.96	8.67	8.67	8.67	0.55	0.76	± 12.0 %
835	55.2	0.97	8.66	8.66	8.66	0.31	1.03	± 12.0 %
900	55.0	1.05	8.46	8.46	8.46	0.24	1.34	± 12.0 %
1750	53.4	1.49	7.35	7.35	7.35	0.33	0.97	± 12.0 %
1900	53.3	1.52	7.10	7.10	7.10	0.27	1.01	± 12.0 %
2450	52.7	1.95	6.70	6.70	6.70	0.72	0.60	± 12.0 %
2550	52.6	2.09	6.79	6.79	6.79	0.74	0.62	± 12.0 %
2600	52.5	2.16	6.61	6.61	6.61	0.77	0.55	± 12.0 %
5200	49.0	5.30	4.39	4.39	4.39	0.40	1.90	± 13.1 %
5300	48.9	5.42	4.10	4.10	4.10	0.45	1.90	± 13.1 %
5600	48.5	5.77	3.63	3.63	3.63	0.50	1.90	± 13.1 %
5800	48.2	6.00	4.04	4.04	4.04	0.50	1.90	± 13.1 %

<sup>C</sup> Frequency validity of ± 100 MHz only applies for DASY v4.4 and higher (see Page 2), else it is restricted to ± 50 MHz. The uncertainty is the RSS of the ConvF uncertainty at calibration frequency and the uncertainty for the indicated frequency band.

<sup>F</sup> At frequencies below 3 GHz, the validity of tissue parameters ( $\epsilon$  and  $\sigma$ ) can be relaxed to ± 10% if liquid compensation formula is applied to measured SAR values. At frequencies above 3 GHz, the validity of tissue parameters ( $\epsilon$  and  $\sigma$ ) is restricted to ± 5%. The uncertainty is the RSS of the ConvF uncertainty for indicated target tissue parameters.

# Frequency Response of E-Field (TEM-Cell:ifr110 EXX, Waveguide: R22)

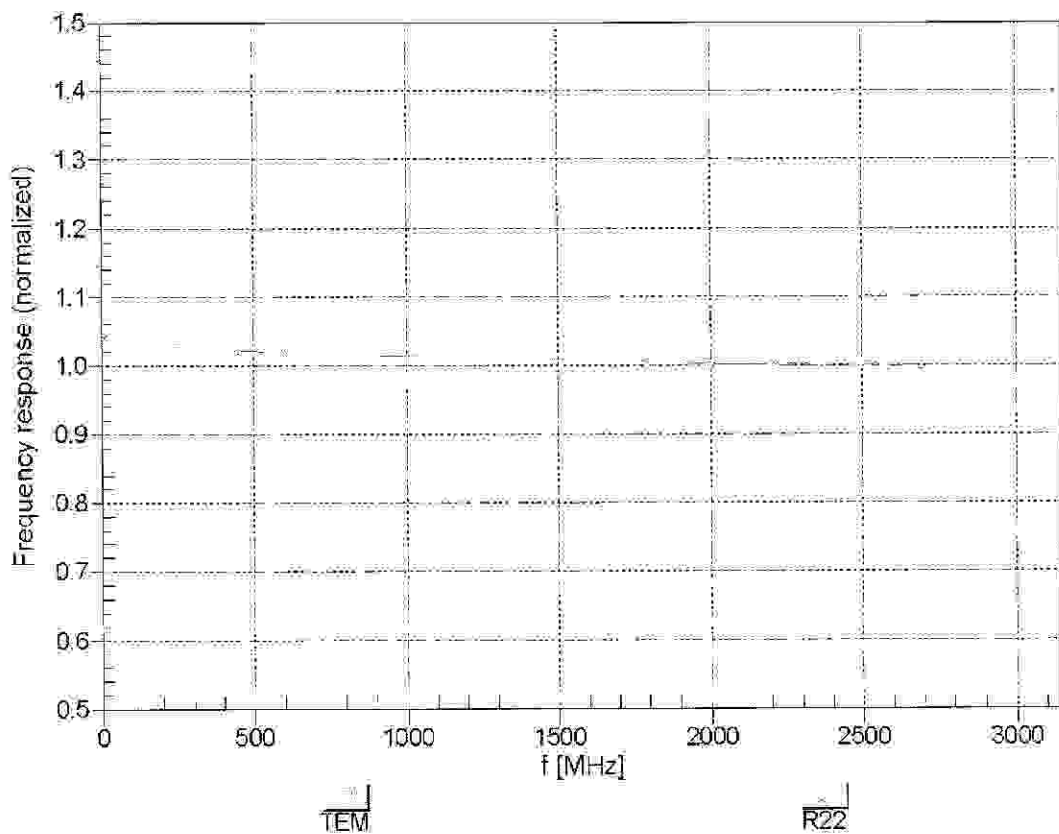

Uncertainty of Frequency Response of E-field:  $\pm 6.3\%$  ( $k=2$ )

### Receiving Pattern ( $\phi$ ), $\theta = 0^\circ$

f=600 MHz, TEM

f=1800 MHz, R22

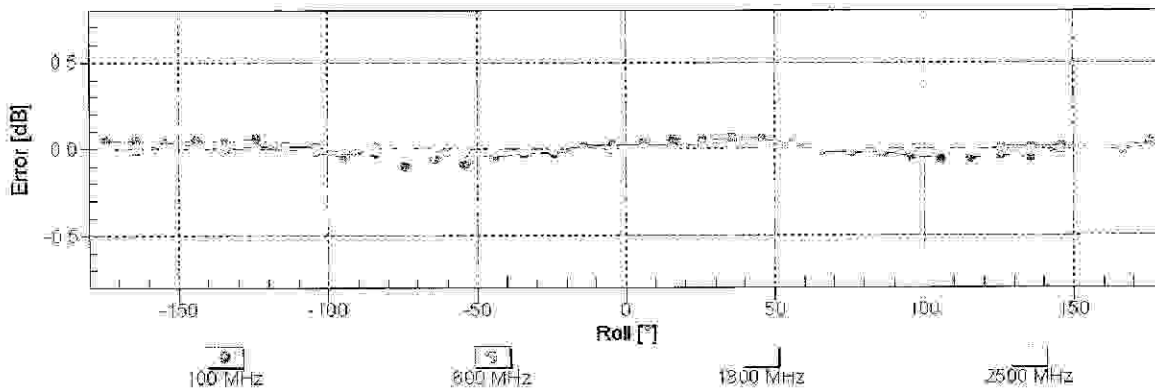
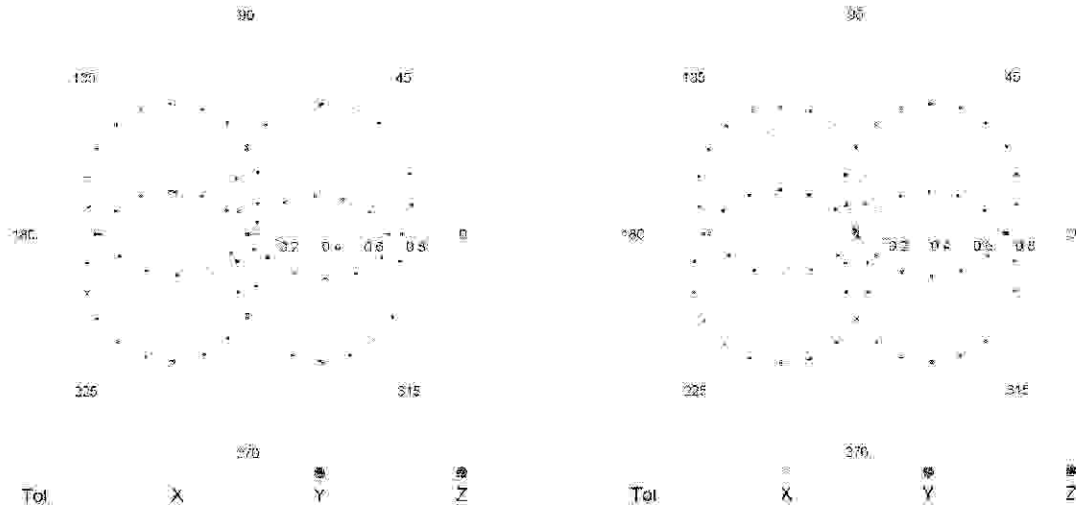

Uncertainty of Axial Isotropy Assessment:  $\pm 0.5\%$  (k=2)

## Dynamic Range $f(SAR_{head})$ (TEM cell , $f = 900$ MHz)

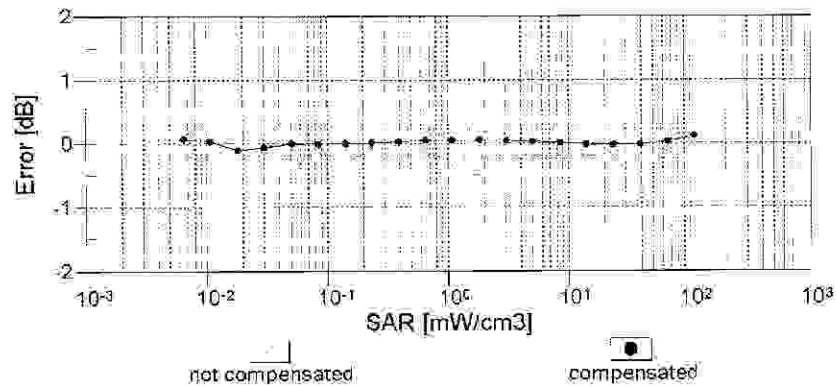
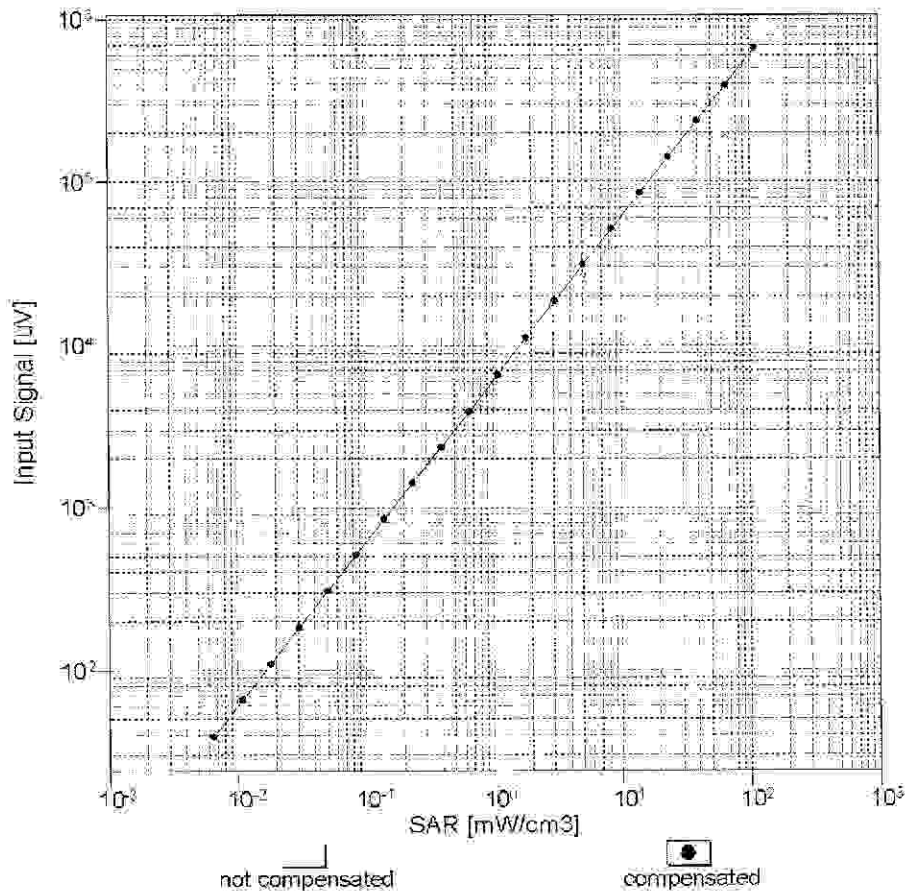

**Uncertainty of Linearity Assessment: ± 0.6% (k=2)**

# Conversion Factor Assessment

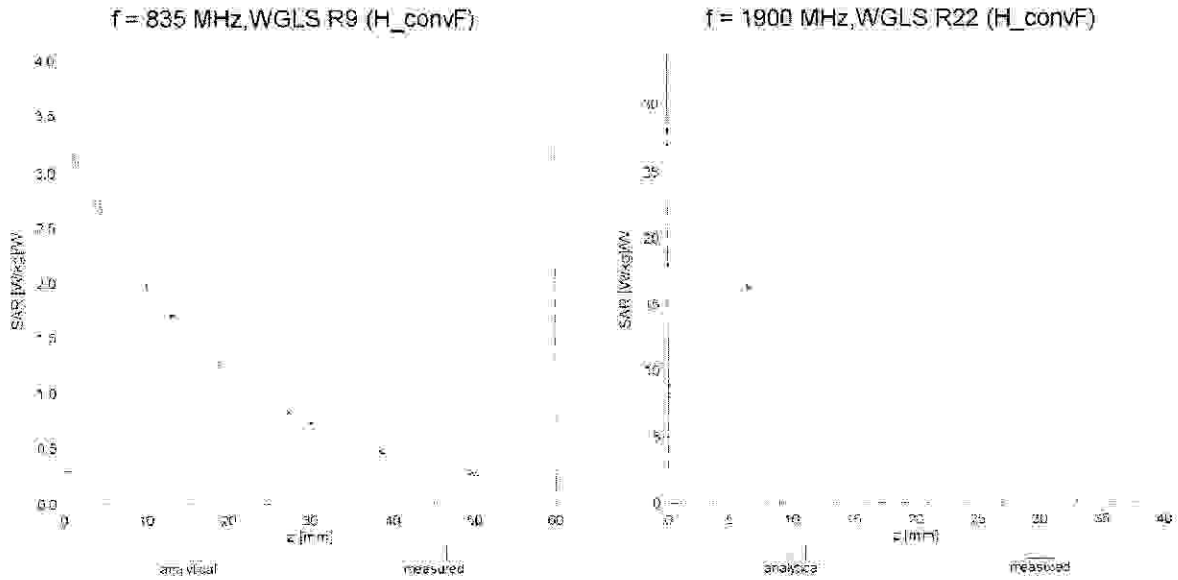

## Deviation from Isotropy in Liquid Error ( $\phi, \theta$ ), f = 900 MHz

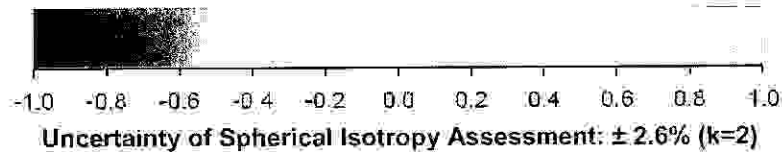
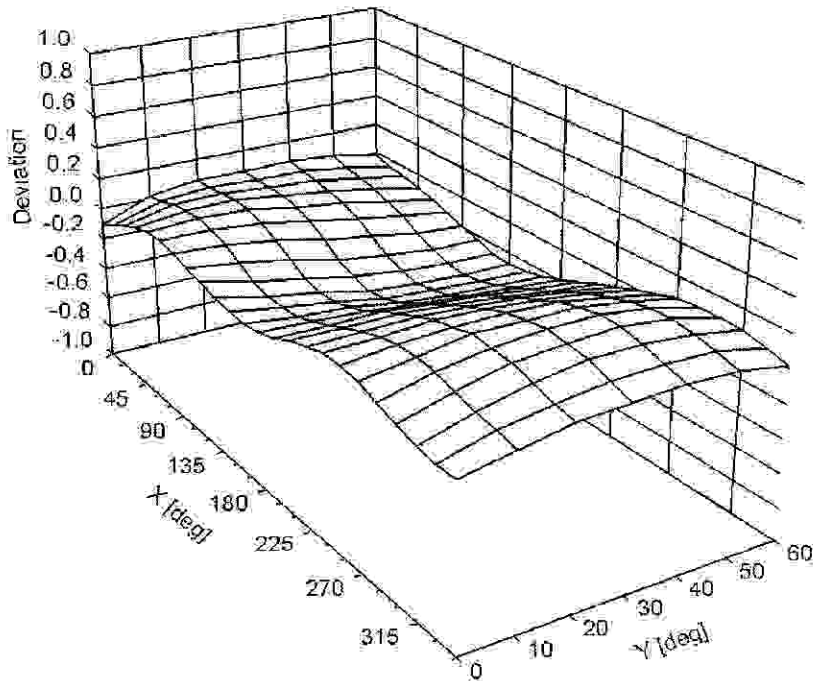



## DASY/EASY - Parameters of Probe: EX3DV4 - SN:3693

### Other Probe Parameters

Sensor Arrangement	Triangular
Connector Angle (°)	-24.1
Mechanical Surface Detection Mode	enabled
Optical Surface Detection Mode	disabled
Probe Overall Length	337 mm
Probe Body Diameter	10 mm
Tip Length	9 mm
Tip Diameter	2.5 mm
Probe Tip to Sensor X Calibration Point	1 mm
Probe Tip to Sensor Y Calibration Point	1 mm
Probe Tip to Sensor Z Calibration Point	1 mm
Recommended Measurement Distance from Surface	2 mm

## Appendix E – Dipole Calibration Data Sheets



Accredited by the Swiss Accreditation Service (SAS)  
The Swiss Accreditation Service is one of the signatories to the EA  
Multilateral Agreement for the recognition of calibration certificates

Accreditation No.: **SCS 108**

Client **RF Exposure Lab**

Certificate No: **D2450V2-829\_Dec12**

## CALIBRATION CERTIFICATE

Object **D2450V2 - SN: 829**

Calibration procedure(s) **QA CAL-05.v8**  
**Calibration procedure for dipole validation kits above 700 MHz**

Calibration date: **December 04, 2012**

This calibration certificate documents the traceability to national standards, which realize the physical units of measurements (SI).  
The measurements and the uncertainties with confidence probability are given on the following pages and are part of the certificate.

All calibrations have been conducted in the closed laboratory facility: environment temperature  $(22 \pm 3)^\circ\text{C}$  and humidity  $< 70\%$ .

Calibration Equipment used (M&TE critical for calibration)

Primary Standards	ID #	Cal Date (Certificate No.)	Scheduled Calibration
Power meter EPM-442A	GB37480704	01-Nov-12 (No. 217-01640)	Oct-13
Power sensor HP 8481A	US37292783	01-Nov-12 (No. 217-01640)	Oct-13
Reference 20 dB Attenuator	SN: 5058 (20k)	27-Mar-12 (No. 217-01530)	Apr-13
Type-N mismatch combination	SN: 5047.3 / 06327	27-Mar-12 (No. 217-01533)	Apr-13
Reference Probe ES3DV3	SN: 3205	30-Dec-11 (No. ES3-3205_Dec11)	Dec-12
DAE4	SN: 601	27-Jun-12 (No. DAE4-601_Jun12)	Jun-13
Secondary Standards	ID #	Check Date (in house)	Scheduled Check
Power sensor HP 8481A	MY41092317	18-Oct-02 (in house check Oct-11)	In house check: Oct-13
RF generator R&S SMT-06	100005	04-Aug-99 (in house check Oct-11)	In house check: Oct-13
Network Analyzer HP 8753E	US37390585 S4206	18-Oct-01 (in house check Oct-12)	In house check: Oct-13

Calibrated by: **Name** Leif Klysner **Function** Laboratory Technician

Signature

Approved by: **Name** Katja Pokovic **Function** Technical Manager

Issued: December 4, 2012

This calibration certificate shall not be reproduced except in full without written approval of the laboratory.



Accredited by the Swiss Accreditation Service (SAS)

Accreditation No.: **SCS 108**

The Swiss Accreditation Service is one of the signatories to the EA Multilateral Agreement for the recognition of calibration certificates

### Glossary:

TSL	tissue simulating liquid
ConvF	sensitivity in TSL / NORM x,y,z
N/A	not applicable or not measured

### Calibration is Performed According to the Following Standards:

- IEEE Std 1528-2003, "IEEE Recommended Practice for Determining the Peak Spatial-Averaged Specific Absorption Rate (SAR) in the Human Head from Wireless Communications Devices: Measurement Techniques", December 2003
- IEC 62209-1, "Procedure to measure the Specific Absorption Rate (SAR) for hand-held devices used in close proximity to the ear (frequency range of 300 MHz to 3 GHz)", February 2005
- Federal Communications Commission Office of Engineering & Technology (FCC OET), "Evaluating Compliance with FCC Guidelines for Human Exposure to Radiofrequency Electromagnetic Fields; Additional Information for Evaluating Compliance of Mobile and Portable Devices with FCC Limits for Human Exposure to Radiofrequency Emissions", Supplement C (Edition 01-01) to Bulletin 65

### Additional Documentation:

- DASY4/5 System Handbook

### Methods Applied and Interpretation of Parameters:

- Measurement Conditions:* Further details are available from the Validation Report at the end of the certificate. All figures stated in the certificate are valid at the frequency indicated.
- Antenna Parameters with TSL:* The dipole is mounted with the spacer to position its feed point exactly below the center marking of the flat phantom section, with the arms oriented parallel to the body axis.
- Feed Point Impedance and Return Loss:* These parameters are measured with the dipole positioned under the liquid filled phantom. The impedance stated is transformed from the measurement at the SMA connector to the feed point. The Return Loss ensures low reflected power. No uncertainty required.
- Electrical Delay:* One-way delay between the SMA connector and the antenna feed point. No uncertainty required.
- SAR measured:* SAR measured at the stated antenna input power.
- SAR normalized:* SAR as measured, normalized to an input power of 1 W at the antenna connector.
- SAR for nominal TSL parameters:* The measured TSL parameters are used to calculate the nominal SAR result.

The reported uncertainty of measurement is stated as the standard uncertainty of measurement multiplied by the coverage factor  $k=2$ , which for a normal distribution corresponds to a coverage probability of approximately 95%.

## Measurement Conditions

DASY system configuration, as far as not given on page 1.

<b>DASY Version</b>	DASY5	V52.8.3
<b>Extrapolation</b>	Advanced Extrapolation	
<b>Phantom</b>	Modular Flat Phantom	
<b>Distance Dipole Center - TSL</b>	10 mm	with Spacer
<b>Zoom Scan Resolution</b>	dx, dy, dz = 5 mm	
<b>Frequency</b>	2450 MHz $\pm$ 1 MHz	

## Head TSL parameters

The following parameters and calculations were applied.

	Temperature	Permittivity	Conductivity
<b>Nominal Head TSL parameters</b>	22.0 °C	39.2	1.80 mho/m
<b>Measured Head TSL parameters</b>	(22.0 $\pm$ 0.2) °C	38.2 $\pm$ 6 %	1.84 mho/m $\pm$ 6 %
<b>Head TSL temperature change during test</b>	< 0.5 °C	----	----

## SAR result with Head TSL

<b>SAR averaged over 1 cm<sup>3</sup> (1 g) of Head TSL</b>	Condition	
SAR measured	250 mW input power	13.7 W/kg
SAR for nominal Head TSL parameters	normalized to 1W	<b>53.9 W/kg <math>\pm</math> 17.0 % (k=2)</b>

<b>SAR averaged over 10 cm<sup>3</sup> (10 g) of Head TSL</b>	condition	
SAR measured	250 mW input power	6.33 W/kg
SAR for nominal Head TSL parameters	normalized to 1W	<b>25.1 W/kg <math>\pm</math> 16.5 % (k=2)</b>

## Body TSL parameters

The following parameters and calculations were applied.

	Temperature	Permittivity	Conductivity
<b>Nominal Body TSL parameters</b>	22.0 °C	52.7	1.95 mho/m
<b>Measured Body TSL parameters</b>	(22.0 $\pm$ 0.2) °C	50.7 $\pm$ 6 %	2.02 mho/m $\pm$ 6 %
<b>Body TSL temperature change during test</b>	< 0.5 °C	----	----

## SAR result with Body TSL

<b>SAR averaged over 1 cm<sup>3</sup> (1 g) of Body TSL</b>	Condition	
SAR measured	250 mW input power	13.2 W/kg
SAR for nominal Body TSL parameters	normalized to 1W	<b>51.5 W/kg <math>\pm</math> 17.0 % (k=2)</b>

<b>SAR averaged over 10 cm<sup>3</sup> (10 g) of Body TSL</b>	condition	
SAR measured	250 mW input power	6.08 W/kg
SAR for nominal Body TSL parameters	normalized to 1W	<b>24.0 W/kg <math>\pm</math> 16.5 % (k=2)</b>

## Appendix

### Antenna Parameters with Head TSL

Impedance, transformed to feed point	53.1 $\Omega$ + 4.2 j $\Omega$
Return Loss	- 25.9 dB

### Antenna Parameters with Body TSL

Impedance, transformed to feed point	49.7 $\Omega$ + 5.1 j $\Omega$
Return Loss	- 25.9 dB

### General Antenna Parameters and Design

Electrical Delay (one direction)	1.158 ns
----------------------------------	----------

After long term use with 100W radiated power, only a slight warming of the dipole near the feedpoint can be measured.

The dipole is made of standard semirigid coaxial cable. The center conductor of the feeding line is directly connected to the second arm of the dipole. The antenna is therefore short-circuited for DC-signals. On some of the dipoles, small end caps are added to the dipole arms in order to improve matching when loaded according to the position as explained in the "Measurement Conditions" paragraph. The SAR data are not affected by this change. The overall dipole length is still according to the Standard.

No excessive force must be applied to the dipole arms, because they might bend or the soldered connections near the feedpoint may be damaged.

### Additional EUT Data

Manufactured by	SPEAG
Manufactured on	December 11, 2008

D2450V2 SN: 829 - Body				
Date of Measurement	Return Loss (dB)	$\Delta\%$	Impedance ( $\Omega$ )	$\Delta\Omega$
12/4/2012	-25.9		49.7	
12/5/2013	-26.2	1.2	48.5	-1.2

D2450V2 SN: 829 - Head				
Date of Measurement	Return Loss (dB)	$\Delta\%$	Impedance ( $\Omega$ )	$\Delta\Omega$
12/4/2012	-25.9		53.1	
12/5/2013	-26.5	2.3	52.6	-0.5

Test Laboratory: SPEAG, Zurich, Switzerland

**DUT: Dipole 2450 MHz; Type: D2450V2; Serial: D2450V2 - SN: 829**

Communication System: CW; Frequency: 2450 MHz

Medium parameters used:  $f = 2450$  MHz;  $\sigma = 1.84$  mho/m;  $\epsilon_r = 38.2$ ;  $\rho = 1000$  kg/m<sup>3</sup>

Phantom section: Flat Section

Measurement Standard: DASY5 (IEEE/IEC/ANSI C63.19-2007)

DASY52 Configuration:

- Probe: ES3DV3 - SN3205; ConvF(4.45, 4.45, 4.45); Calibrated: 30.12.2011;
- Sensor-Surface: 3mm (Mechanical Surface Detection)
- Electronics: DAE4 Sn601; Calibrated: 27.06.2012
- Phantom: Flat Phantom 5.0 (front); Type: QD000P50AA; Serial: 1001
- DASY52 52.8.3(988); SEMCAD X 14.6.7(6848)

**Dipole Calibration for Head Tissue/Pin=250 mW, d=10mm/Zoom Scan (7x7x7)/Cube 0:**

Measurement grid: dx=5mm, dy=5mm, dz=5mm

Reference Value = 102.1 V/m; Power Drift = 0.05 dB

Peak SAR (extrapolated) = 28.3 W/kg

**SAR(1 g) = 13.7 W/kg; SAR(10 g) = 6.33 W/kg**

Maximum value of SAR (measured) = 17.8 W/kg

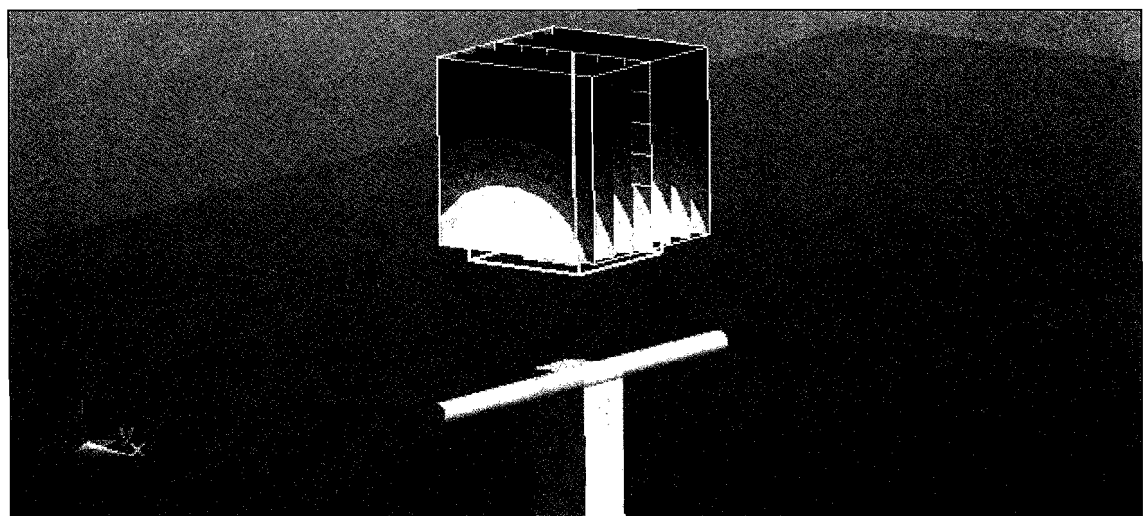
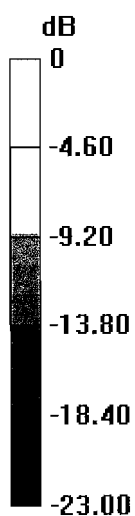

0 dB = 17.8 W/kg = 12.50 dBW/kg

# Impedance Measurement Plot for Head TSL

4 Dec 2012 10:08:57

CH1 S11 1 U FS 1: 53.113  $\angle$  4.1680  $\angle$  270.76  $\mu$ H 2 450.000 000 MHz

\*  
De1  
Ca

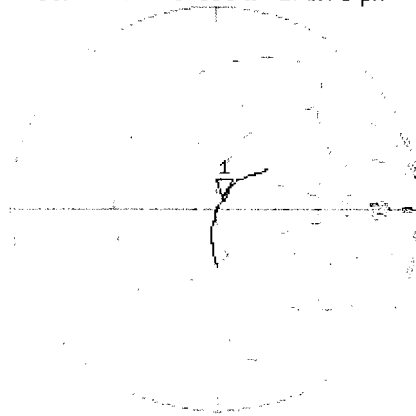

Avg  
16

H1d

CH2 S11 L06 5 dB/REF -20 dB 1: -25.942 dB 2 450.000 000 MHz

Ca

Avg  
16

H1d

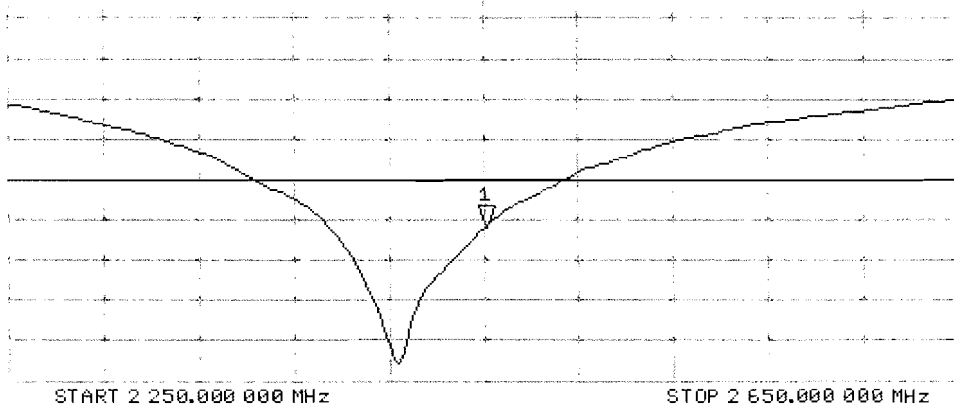



Test Laboratory: SPEAG, Zurich, Switzerland

**DUT: Dipole 2450 MHz; Type: D2450V2; Serial: D2450V2 - SN: 829**

Communication System: CW; Frequency: 2450 MHz

Medium parameters used:  $f = 2450$  MHz;  $\sigma = 2.02$  mho/m;  $\epsilon_r = 50.7$ ;  $\rho = 1000$  kg/m<sup>3</sup>

Phantom section: Flat Section

Measurement Standard: DASY5 (IEEE/IEC/ANSI C63.19-2007)

DASY52 Configuration:

- Probe: ES3DV3 - SN3205; ConvF(4.26, 4.26, 4.26); Calibrated: 30.12.2011;
- Sensor-Surface: 3mm (Mechanical Surface Detection)
- Electronics: DAE4 Sn601; Calibrated: 27.06.2012
- Phantom: Flat Phantom 5.0 (back); Type: QD000P50AA; Serial: 1002
- DASY52 52.8.3(988); SEMCAD X 14.6.7(6848)

**Dipole Calibration for Body Tissue/Pin=250 mW, d=10mm/Zoom Scan (7x7x7)/Cube 0:**

Measurement grid: dx=5mm, dy=5mm, dz=5mm

Reference Value = 102.1 V/m; Power Drift = 0.05 dB

Peak SAR (extrapolated) = 27.4 W/kg

**SAR(1 g) = 13.2 W/kg; SAR(10 g) = 6.08 W/kg**

Maximum value of SAR (measured) = 17.5 W/kg

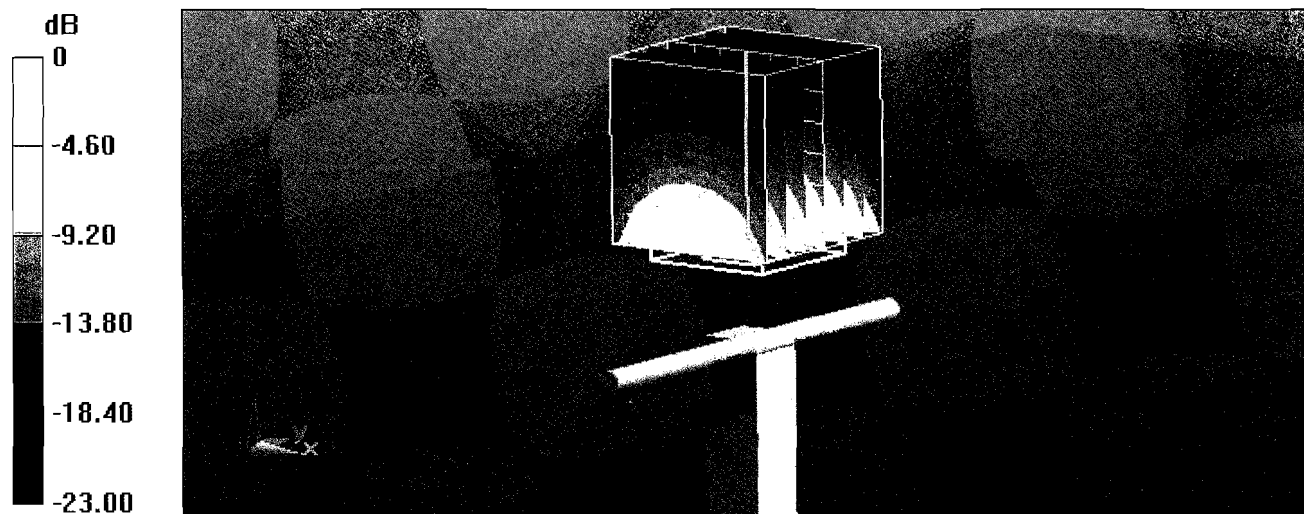

0 dB = 17.5 W/kg = 12.43 dBW/kg

# Impedance Measurement Plot for Body TSL

4 Dec 2012 10:08:01

CH1 S11 1 U FS 1: 49.723  $\Omega$  5.0505  $\Omega$  328.74 pF 2 450.000 000 MHz

\*

De1

Ca

Avg  
16

H1d

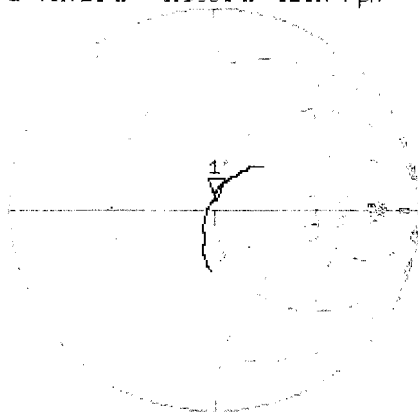

CH2 S11 LOG 5 dB/REF -20 dB 1: -25.889 dB 2 450.000 000 MHz

Ca

Avg  
16

H1d

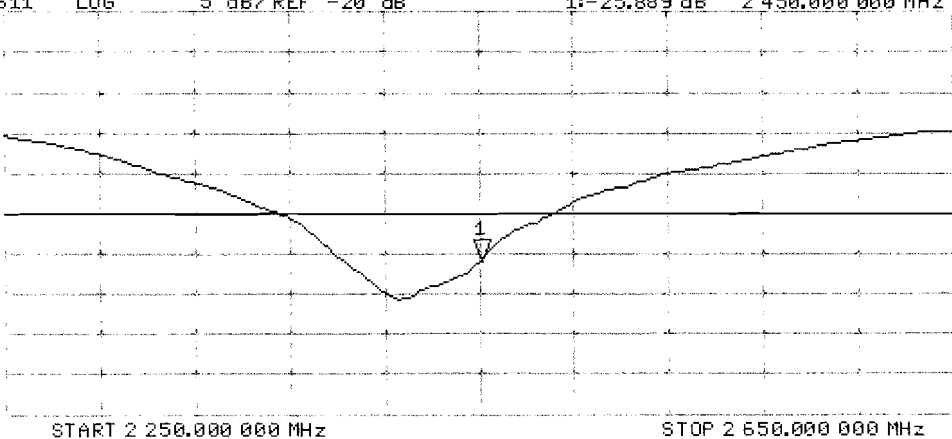



Accredited by the Swiss Accreditation Service (SAS)  
The Swiss Accreditation Service is one of the signatories to the EA  
Multilateral Agreement for the recognition of calibration certificates

Accreditation No.: **SCS 108**

Client **RF Exposure Lab**

Certificate No: **D5GHzV2-1085\_Dec12**

**CALIBRATION CERTIFICATE**

Object **D5GHzV2 - SN: 1085**

Calibration procedure(s) **QA CAL-22.v1**  
**Calibration procedure for dipole validation kits between 3-6 GHz**

Calibration date: **December 11, 2012**

This calibration certificate documents the traceability to national standards, which realize the physical units of measurements (SI).  
The measurements and the uncertainties with confidence probability are given on the following pages and are part of the certificate.

All calibrations have been conducted in the closed laboratory facility: environment temperature (22 ± 3)°C and humidity < 70%.

Calibration Equipment used (M&TE critical for calibration)

Primary Standards	ID #	Cal Date (Certificate No.)	Scheduled Calibration
Power meter EPM-442A	GB37480704	01-Nov-12 (No. 217-01640)	Oct-13
Power sensor HP 8481A	US37292783	01-Nov-12 (No. 217-01640)	Oct-13
Reference 20 dB Attenuator	SN: 5058 (20k)	27-Mar-12 (No. 217-01530)	Apr-13
Type-N mismatch combination	SN: 5047.3 / 06327	27-Mar-12 (No. 217-01533)	Apr-13
Reference Probe EX3DV4	SN: 3503	30-Dec-11 (No. EX3-3503_Dec11)	Dec-12
DAE4	SN: 601	27-Jun-12 (No. DAE4-601_Jun12)	Jun-13
Secondary Standards	ID #	Check Date (in house)	Scheduled Check
Power sensor HP 8481A	MY41092317	18-Oct-02 (in house check Oct-11)	In house check: Oct-13
RF generator R&S SMT-06	100005	04-Aug-99 (in house check Oct-11)	In house check: Oct-13
Network Analyzer HP 8753E	US37390585 S4206	18-Oct-01 (in house check Oct-12)	In house check: Oct-13

Calibrated by:	Name Israe El-Naouq	Function Laboratory Technician	Signature 
Approved by:	Katja Pokovic	Technical Manager	

Issued: December 11, 2012

This calibration certificate shall not be reproduced except in full without written approval of the laboratory.



Accredited by the Swiss Accreditation Service (SAS)

The Swiss Accreditation Service is one of the signatories to the EA  
Multilateral Agreement for the recognition of calibration certificates

Accreditation No.: **SCS 108**

### Glossary:

TSL	tissue simulating liquid
ConvF	sensitivity in TSL / NORM x,y,z
N/A	not applicable or not measured

### Calibration is Performed According to the Following Standards:

- IEC 62209-2, "Evaluation of Human Exposure to Radio Frequency Fields from Handheld and Body-Mounted Wireless Communication Devices in the Frequency Range of 30 MHz to 6 GHz: Human models, Instrumentation, and Procedures"; Part 2: "Procedure to determine the Specific Absorption Rate (SAR) for including accessories and multiple transmitters", March 2010
- Federal Communications Commission Office of Engineering & Technology (FCC OET), "Evaluating Compliance with FCC Guidelines for Human Exposure to Radiofrequency Electromagnetic Fields; Additional Information for Evaluating Compliance of Mobile and Portable Devices with FCC Limits for Human Exposure to Radiofrequency Emissions", Supplement C (Edition 01-01) to Bulletin 65

### Additional Documentation:

- DASY4/5 System Handbook

### Methods Applied and Interpretation of Parameters:

- Measurement Conditions:* Further details are available from the Validation Report at the end of the certificate. All figures stated in the certificate are valid at the frequency indicated.
- Antenna Parameters with TSL:* The dipole is mounted with the spacer to position its feed point exactly below the center marking of the flat phantom section, with the arms oriented parallel to the body axis.
- Feed Point Impedance and Return Loss:* These parameters are measured with the dipole positioned under the liquid filled phantom. The impedance stated is transformed from the measurement at the SMA connector to the feed point. The Return Loss ensures low reflected power. No uncertainty required.
- Electrical Delay:* One-way delay between the SMA connector and the antenna feed point. No uncertainty required.
- SAR measured:* SAR measured at the stated antenna input power.
- SAR normalized:* SAR as measured, normalized to an input power of 1 W at the antenna connector.
- SAR for nominal TSL parameters:* The measured TSL parameters are used to calculate the nominal SAR result.

The reported uncertainty of measurement is stated as the standard uncertainty of measurement multiplied by the coverage factor  $k=2$ , which for a normal distribution corresponds to a coverage probability of approximately 95%.

## Measurement Conditions

DASY system configuration, as far as not given on page 1.

<b>DASY Version</b>	DASY5	V52.8.3
<b>Extrapolation</b>	Advanced Extrapolation	
<b>Phantom</b>	Modular Flat Phantom V5.0	
<b>Distance Dipole Center - TSL</b>	10 mm	with Spacer
<b>Zoom Scan Resolution</b>	dx, dy = 4.0 mm, dz = 1.4 mm	Graded Ratio = 1.4 (Z direction)
<b>Frequency</b>	5200 MHz ± 1 MHz 5300 MHz ± 1 MHz 5600 MHz ± 1 MHz 5800 MHz ± 1 MHz	

## Head TSL parameters at 5200 MHz

The following parameters and calculations were applied.

	Temperature	Permittivity	Conductivity
<b>Nominal Head TSL parameters</b>	22.0 °C	36.0	4.66 mho/m
<b>Measured Head TSL parameters</b>	(22.0 ± 0.2) °C	34.8 ± 6 %	4.53 mho/m ± 6 %
<b>Head TSL temperature change during test</b>	< 0.5 °C	----	----

## SAR result with Head TSL at 5200 MHz

<b>SAR averaged over 1 cm<sup>3</sup> (1 g) of Head TSL</b>	Condition	
SAR measured	100 mW input power	8.20 W/kg
SAR for nominal Head TSL parameters	normalized to 1W	<b>81.4 W/kg ± 19.9 % (k=2)</b>

<b>SAR averaged over 10 cm<sup>3</sup> (10 g) of Head TSL</b>	condition	
SAR measured	100 mW input power	2.35 W/kg
SAR for nominal Head TSL parameters	normalized to 1W	<b>23.3 W/kg ± 19.5 % (k=2)</b>

## Head TSL parameters at 5300 MHz

The following parameters and calculations were applied.

	Temperature	Permittivity	Conductivity
<b>Nominal Head TSL parameters</b>	22.0 °C	35.9	4.76 mho/m
<b>Measured Head TSL parameters</b>	(22.0 ± 0.2) °C	34.7 ± 6 %	4.63 mho/m ± 6 %
<b>Head TSL temperature change during test</b>	< 0.5 °C	----	----

## SAR result with Head TSL at 5300 MHz

<b>SAR averaged over 1 cm<sup>3</sup> (1 g) of Head TSL</b>	Condition	
SAR measured	100 mW input power	8.35 W/kg
SAR for nominal Head TSL parameters	normalized to 1W	<b>82.9 W / kg ± 19.9 % (k=2)</b>

<b>SAR averaged over 10 cm<sup>3</sup> (10 g) of Head TSL</b>	condition	
SAR measured	100 mW input power	2.39 W/kg
SAR for nominal Head TSL parameters	normalized to 1W	<b>23.7 W/kg ± 19.5 % (k=2)</b>

## Head TSL parameters at 5600 MHz

The following parameters and calculations were applied.

	Temperature	Permittivity	Conductivity
Nominal Head TSL parameters	22.0 °C	35.5	5.07 mho/m
Measured Head TSL parameters	(22.0 ± 0.2) °C	34.2 ± 6 %	4.93 mho/m ± 6 %
Head TSL temperature change during test	< 0.5 °C	----	----

## SAR result with Head TSL at 5600 MHz

SAR averaged over 1 cm <sup>3</sup> (1 g) of Head TSL	Condition	
SAR measured	100 mW input power	8.69 W/kg
SAR for nominal Head TSL parameters	normalized to 1W	<b>86.1 W/kg ± 19.9 % (k=2)</b>

SAR averaged over 10 cm <sup>3</sup> (10 g) of Head TSL	condition	
SAR measured	100 mW input power	2.48 W/kg
SAR for nominal Head TSL parameters	normalized to 1W	<b>24.5 W/kg ± 19.5 % (k=2)</b>

## Head TSL parameters at 5800 MHz

The following parameters and calculations were applied.

	Temperature	Permittivity	Conductivity
Nominal Head TSL parameters	22.0 °C	35.3	5.27 mho/m
Measured Head TSL parameters	(22.0 ± 0.2) °C	34.0 ± 6 %	5.15 mho/m ± 6 %
Head TSL temperature change during test	< 0.5 °C	----	----

## SAR result with Head TSL at 5800 MHz

SAR averaged over 1 cm <sup>3</sup> (1 g) of Head TSL	Condition	
SAR measured	100 mW input power	8.16 W/kg
SAR for nominal Head TSL parameters	normalized to 1W	<b>80.9 W/kg ± 19.9 % (k=2)</b>

SAR averaged over 10 cm <sup>3</sup> (10 g) of Head TSL	condition	
SAR measured	100 mW input power	2.33 W/kg
SAR for nominal Head TSL parameters	normalized to 1W	<b>23.1 W/kg ± 19.5 % (k=2)</b>

## Body TSL parameters at 5200 MHz

The following parameters and calculations were applied.

	Temperature	Permittivity	Conductivity
Nominal Body TSL parameters	22.0 °C	49.0	5.30 mho/m
Measured Body TSL parameters	(22.0 ± 0.2) °C	46.8 ± 6 %	5.35 mho/m ± 6 %
Body TSL temperature change during test	< 0.5 °C	----	----

## SAR result with Body TSL at 5200 MHz

SAR averaged over 1 cm <sup>3</sup> (1 g) of Body TSL	Condition	
SAR measured	100 mW input power	7.41 W/kg
SAR for nominal Body TSL parameters	normalized to 1W	<b>73.4 W/kg ± 19.9 % (k=2)</b>

SAR averaged over 10 cm <sup>3</sup> (10 g) of Body TSL	condition	
SAR measured	100 mW input power	2.08 W/kg
SAR for nominal Body TSL parameters	normalized to 1W	<b>20.6 W/kg ± 19.5 % (k=2)</b>

## Body TSL parameters at 5300 MHz

The following parameters and calculations were applied.

	Temperature	Permittivity	Conductivity
Nominal Body TSL parameters	22.0 °C	48.9	5.42 mho/m
Measured Body TSL parameters	(22.0 ± 0.2) °C	46.7 ± 6 %	5.47 mho/m ± 6 %
Body TSL temperature change during test	< 0.5 °C	----	----

## SAR result with Body TSL at 5300 MHz

SAR averaged over 1 cm <sup>3</sup> (1 g) of Body TSL	Condition	
SAR measured	100 mW input power	7.43 W/kg
SAR for nominal Body TSL parameters	normalized to 1W	<b>73.6 W/kg ± 19.9 % (k=2)</b>

SAR averaged over 10 cm <sup>3</sup> (10 g) of Body TSL	condition	
SAR measured	100 mW input power	2.09 W/kg
SAR for nominal Body TSL parameters	normalized to 1W	<b>20.7 W/kg ± 19.5 % (k=2)</b>

### Body TSL parameters at 5600 MHz

The following parameters and calculations were applied.

	Temperature	Permittivity	Conductivity
Nominal Body TSL parameters	22.0 °C	48.5	5.77 mho/m
Measured Body TSL parameters	(22.0 ± 0.2) °C	46.2 ± 6 %	5.86 mho/m ± 6 %
Body TSL temperature change during test	< 0.5 °C	----	----

### SAR result with Body TSL at 5600 MHz

SAR averaged over 1 cm <sup>3</sup> (1 g) of Body TSL	Condition	
SAR measured	100 mW input power	7.98 W/kg
SAR for nominal Body TSL parameters	normalized to 1W	<b>79.1 W/kg ± 19.9 % (k=2)</b>

SAR averaged over 10 cm <sup>3</sup> (10 g) of Body TSL	condition	
SAR measured	100 mW input power	2.22 W/kg
SAR for nominal Body TSL parameters	normalized to 1W	<b>21.9 W/kg ± 19.5 % (k=2)</b>

### Body TSL parameters at 5800 MHz

The following parameters and calculations were applied.

	Temperature	Permittivity	Conductivity
Nominal Body TSL parameters	22.0 °C	48.2	6.00 mho/m
Measured Body TSL parameters	(22.0 ± 0.2) °C	45.9 ± 6 %	6.13 mho/m ± 6 %
Body TSL temperature change during test	< 0.5 °C	----	----

### SAR result with Body TSL at 5800 MHz

SAR averaged over 1 cm <sup>3</sup> (1 g) of Body TSL	Condition	
SAR measured	100 mW input power	7.36 W/kg
SAR for nominal Body TSL parameters	normalized to 1W	<b>72.9 W/kg ± 19.9 % (k=2)</b>

SAR averaged over 10 cm <sup>3</sup> (10 g) of Body TSL	condition	
SAR measured	100 mW input power	2.04 W/kg
SAR for nominal Body TSL parameters	normalized to 1W	<b>20.2 W/kg ± 19.5 % (k=2)</b>



## Appendix

### Antenna Parameters with Head TSL at 5200 MHz

Impedance, transformed to feed point	50.9 $\Omega$ - 9.9 j $\Omega$
Return Loss	- 20.2 dB

### Antenna Parameters with Head TSL at 5300 MHz

Impedance, transformed to feed point	48.7 $\Omega$ - 5.6 j $\Omega$
Return Loss	- 24.7 dB

### Antenna Parameters with Head TSL at 5600 MHz

Impedance, transformed to feed point	56.1 $\Omega$ - 4.4 j $\Omega$
Return Loss	- 23.0 dB

### Antenna Parameters with Head TSL at 5800 MHz

Impedance, transformed to feed point	51.9 $\Omega$ - 4.6 j $\Omega$
Return Loss	- 26.2 dB

### Antenna Parameters with Body TSL at 5200 MHz

Impedance, transformed to feed point	50.0 $\Omega$ - 9.5 j $\Omega$
Return Loss	- 20.5 dB

### Antenna Parameters with Body TSL at 5300 MHz

Impedance, transformed to feed point	49.7 $\Omega$ - 5.0 j $\Omega$
Return Loss	- 26.0 dB

### Antenna Parameters with Body TSL at 5600 MHz

Impedance, transformed to feed point	56.5 $\Omega$ - 3.4 j $\Omega$
Return Loss	- 23.2 dB

### Antenna Parameters with Body TSL at 5800 MHz

Impedance, transformed to feed point	53.5 $\Omega$ - 4.7 j $\Omega$
Return Loss	- 25.0 dB

## General Antenna Parameters and Design

Electrical Delay (one direction)	1.207 ns
----------------------------------	----------

After long term use with 100W radiated power, only a slight warming of the dipole near the feedpoint can be measured.

The dipole is made of standard semirigid coaxial cable. The center conductor of the feeding line is directly connected to the second arm of the dipole. The antenna is therefore short-circuited for DC-signals. On some of the dipoles, small end caps are added to the dipole arms in order to improve matching when loaded according to the position as explained in the "Measurement Conditions" paragraph. The SAR data are not affected by this change. The overall dipole length is still according to the Standard.

No excessive force must be applied to the dipole arms, because they might bend or the soldered connections near the feedpoint may be damaged.

## Additional EUT Data

Manufactured by	SPEAG
Manufactured on	December 21, 2009

D5GHzV2 SN: 1085 - Head					
Date of Measurement	Frequency	Return Loss (dB)	$\Delta\%$	Impedance ( $\Omega$ )	$\Delta\Omega$
12/11/2012	5200 MHz	-20.2		50.9	
12/11/2013		-21.3	5.4	51.2	0.3
12/11/2012	5300 MHz	-24.7		48.7	
12/11/2013		-24.3	-1.6	47.9	-0.8
12/11/2012	5600 MHz	-23.0		56.1	
12/11/2013		-23.9	3.9	55.0	-1.1
12/11/2012	5800 MHz	-26.2		51.9	
12/11/2013		-25.6	-2.3	53.1	1.2

D5GHzV2 SN: 1085 - Body					
Date of Measurement	Frequency	Return Loss (dB)	$\Delta\%$	Impedance ( $\Omega$ )	$\Delta\Omega$
12/11/2012	5200 MHz	-20.5		50.0	
12/11/2013		-21.3	3.9	51.2	1.2
12/11/2012	5300 MHz	-26.0		49.7	
12/11/2013		-25.3	-2.7	51.3	1.6
12/11/2012	5600 MHz	-23.2		56.5	
12/11/2013		-22.6	-2.6	55.9	-0.6
12/11/2012	5800 MHz	-25.0		53.5	
12/11/2013		-23.9	-4.4	52.6	-0.9

Test Laboratory: SPEAG, Zurich, Switzerland

**DUT: Dipole 5GHz; Type: D5GHzV2; Serial: D5GHzV2 - SN: 1085**

Communication System: CW; Frequency: 5200 MHz, Frequency: 5300 MHz, Frequency: 5600 MHz, Frequency: 5800 MHz

Medium parameters used:  $f = 5200$  MHz;  $\sigma = 4.53$  mho/m;  $\epsilon_r = 34.8$ ;  $\rho = 1000$  kg/m<sup>3</sup>, Medium parameters used:  $f = 5300$  MHz;  $\sigma = 4.63$  mho/m;  $\epsilon_r = 34.7$ ;  $\rho = 1000$  kg/m<sup>3</sup>, Medium parameters used:  $f = 5600$  MHz;  $\sigma = 4.93$  mho/m;  $\epsilon_r = 34.2$ ;  $\rho = 1000$  kg/m<sup>3</sup>, Medium parameters used:  $f = 5800$  MHz;  $\sigma = 5.15$  mho/m;  $\epsilon_r = 34$ ;  $\rho = 1000$  kg/m<sup>3</sup>

Phantom section: Flat Section

Measurement Standard: DASY5 (IEEE/IEC/ANSI C63.19-2007)

## DASY52 Configuration:

- Probe: EX3DV4 - SN3503; ConvF(5.41, 5.41, 5.41); Calibrated: 30.12.2011, ConvF(5.1, 5.1, 5.1); Calibrated: 30.12.2011, ConvF(4.76, 4.76, 4.76); Calibrated: 30.12.2011, ConvF(4.81, 4.81, 4.81); Calibrated: 30.12.2011;
- Sensor-Surface: 1.4mm (Mechanical Surface Detection)
- Electronics: DAE4 Sn601; Calibrated: 27.06.2012
- Phantom: Flat Phantom 5.0 (front); Type: QD000P50AA; Serial: 1001
- DASY52 52.8.3(988); SEMCAD X 14.6.7(6848)

**Dipole Calibration for Head Tissue/Pin=100mW, dist=10mm, f=5200 MHz/Zoom Scan, dist=1.4mm (8x8x7)/Cube 0:**

Measurement grid: dx=4mm, dy=4mm, dz=1.4mm

Reference Value = 64.782 V/m; Power Drift = 0.07 dB

Peak SAR (extrapolated) = 30.1 W/kg

**SAR(1 g) = 8.2 W/kg; SAR(10 g) = 2.35 W/kg**

Maximum value of SAR (measured) = 18.9 W/kg

**Dipole Calibration for Head Tissue/Pin=100mW, dist=10mm, f=5300 MHz/Zoom Scan, dist=1.4mm (8x8x7)/Cube 0:**

Measurement grid: dx=4mm, dy=4mm, dz=1.4mm

Reference Value = 64.947 V/m; Power Drift = 0.04 dB

Peak SAR (extrapolated) = 31.3 W/kg

**SAR(1 g) = 8.35 W/kg; SAR(10 g) = 2.39 W/kg**

Maximum value of SAR (measured) = 19.4 W/kg

**Dipole Calibration for Head Tissue/Pin=100mW, dist=10mm, f=5600 MHz/Zoom Scan, dist=1.4mm (8x8x7)/Cube 0:**

Measurement grid: dx=4mm, dy=4mm, dz=1.4mm

Reference Value = 64.857 V/m; Power Drift = 0.05 dB

Peak SAR (extrapolated) = 34.4 W/kg

**SAR(1 g) = 8.69 W/kg; SAR(10 g) = 2.48 W/kg**

Maximum value of SAR (measured) = 20.8 W/kg

**Dipole Calibration for Head Tissue/Pin=100mW, dist=10mm, f=5800 MHz/Zoom Scan,**

**dist=1.4mm (8x8x7)/Cube 0:** Measurement grid: dx=4mm, dy=4mm, dz=1.4mm

Reference Value = 61.816 V/m; Power Drift = 0.06 dB

Peak SAR (extrapolated) = 33.5 W/kg

**SAR(1 g) = 8.16 W/kg; SAR(10 g) = 2.33 W/kg**

Maximum value of SAR (measured) = 19.9 W/kg

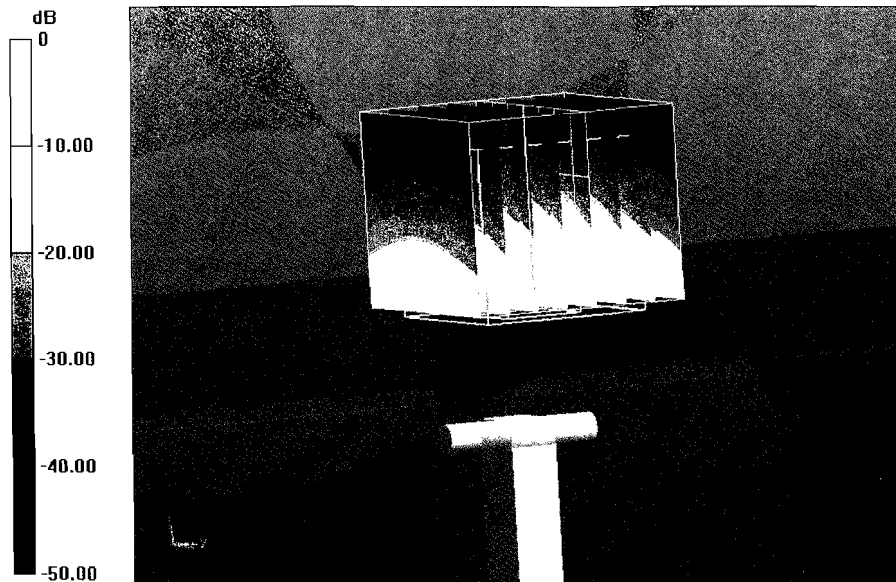

0 dB = 19.9 W/kg = 12.99 dBW/kg

# Impedance Measurement Plot for Head TSL

11 Dec 2012 16:17:51

CH1 S11 1 U FS 1: 50.916  $\Omega$  -9.8672  $\Omega$  3.1019 pF 5 200.000 000 MHz

\*

De1

Cor

Avg  
16

H1d

CH2 S11 L06 5 dB/REF -20 dB 1: -20.201 dB 5 200.000 000 MHz

Cor

Avg  
16

H1d

START 5 000.000 000 MHz

STOP 6 000.000 000 MHz

CH1 Markers

2: 48.664  $\Omega$   
-5.5938  $\Omega$   
5.30000 GHz  
4: 56.137  $\Omega$   
-4.3555  $\Omega$   
5.60000 GHz  
5: 51.922  $\Omega$   
-4.6328  $\Omega$   
5.80000 GHz

CH2 Markers

2: -24.698 dB  
5.30000 GHz  
4: -22.991 dB  
5.60000 GHz  
5: -26.163 dB  
5.80000 GHz

Test Laboratory: SPEAG, Zurich, Switzerland

**DUT: Dipole 5GHz; Type: D5GHzV2; Serial: D5GHzV2 - SN: 1085**

Communication System: CW; Frequency: 5200 MHz, Frequency: 5300 MHz, Frequency: 5600 MHz, Frequency: 5800 MHz

Medium parameters used:  $f = 5200$  MHz;  $\sigma = 5.35$  mho/m;  $\epsilon_r = 46.8$ ;  $\rho = 1000$  kg/m<sup>3</sup>, Medium parameters used:  $f = 5300$  MHz;  $\sigma = 5.47$  mho/m;  $\epsilon_r = 46.7$ ;  $\rho = 1000$  kg/m<sup>3</sup>, Medium parameters used:  $f = 5600$  MHz;  $\sigma = 5.86$  mho/m;  $\epsilon_r = 46.2$ ;  $\rho = 1000$  kg/m<sup>3</sup>, Medium parameters used:  $f = 5800$  MHz;  $\sigma = 6.13$  mho/m;  $\epsilon_r = 45.9$ ;  $\rho = 1000$  kg/m<sup>3</sup>

Phantom section: Flat Section

Measurement Standard: DASY5 (IEEE/IEC/ANSI C63.19-2007)

DASY52 Configuration:

- Probe: EX3DV4 - SN3503; ConvF(4.91, 4.91, 4.91); Calibrated: 30.12.2011, ConvF(4.67, 4.67, 4.67); Calibrated: 30.12.2011, ConvF(4.22, 4.22, 4.22); Calibrated: 30.12.2011, ConvF(4.38, 4.38, 4.38); Calibrated: 30.12.2011;
- Sensor-Surface: 1.4mm (Mechanical Surface Detection)
- Electronics: DAE4 Sn601; Calibrated: 27.06.2012
- Phantom: Flat Phantom 5.0 (back); Type: QD000P50AA; Serial: 1002
- DASY52 52.8.3(988); SEMCAD X 14.6.7(6848)

**Dipole Calibration for Body Tissue/Pin=100mW, dist=10mm, f=5200 MHz/Zoom Scan, dist=1.4mm (8x8x7)/Cube 0:**

Measurement grid: dx=4mm, dy=4mm, dz=1.4mm

Reference Value = 58.435 V/m; Power Drift = -0.01 dB

Peak SAR (extrapolated) = 29.5 W/kg

**SAR(1 g) = 7.41 W/kg; SAR(10 g) = 2.08 W/kg**

Maximum value of SAR (measured) = 17.3 W/kg

**Dipole Calibration for Body Tissue/Pin=100mW, dist=10mm, f=5300 MHz/Zoom Scan, dist=1.4mm (8x8x7)/Cube 0:**

Measurement grid: dx=4mm, dy=4mm, dz=1.4mm

Reference Value = 57.938 V/m; Power Drift = -0.01 dB

Peak SAR (extrapolated) = 30.1 W/kg

**SAR(1 g) = 7.43 W/kg; SAR(10 g) = 2.09 W/kg**

Maximum value of SAR (measured) = 17.4 W/kg

**Dipole Calibration for Body Tissue/Pin=100mW, dist=10mm, f=5600 MHz/Zoom Scan, dist=1.4mm (8x8x7)/Cube 0:**

Measurement grid: dx=4mm, dy=4mm, dz=1.4mm

Reference Value = 58.467 V/m; Power Drift = -0.01 dB

Peak SAR (extrapolated) = 35.4 W/kg

**SAR(1 g) = 7.98 W/kg; SAR(10 g) = 2.22 W/kg**

Maximum value of SAR (measured) = 19.5 W/kg

**Dipole Calibration for Body Tissue/Pin=100mW, dist=10mm, f=5800 MHz/Zoom Scan,**

**dist=1.4mm (8x8x7)/Cube 0:** Measurement grid: dx=4mm, dy=4mm, dz=1.4mm

Reference Value = 54.901 V/m; Power Drift = -0.01 dB

Peak SAR (extrapolated) = 34.6 W/kg

**SAR(1 g) = 7.36 W/kg; SAR(10 g) = 2.04 W/kg**

Maximum value of SAR (measured) = 18.3 W/kg

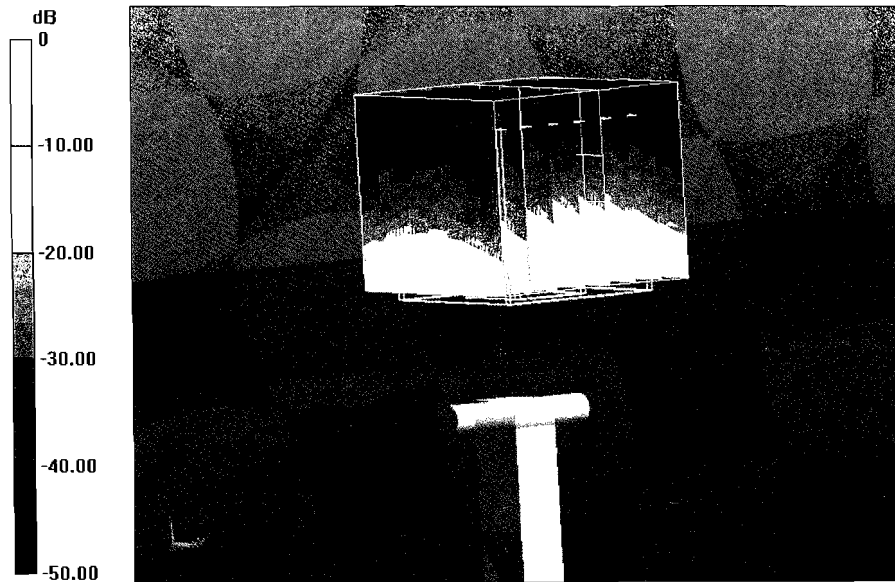

0 dB = 18.3 W/kg = 12.62 dBW/kg

# Impedance Measurement Plot for Body TSL

10 Dec 2012 14:55:30

[CH1] S11 1 U FS 1: 50.000  $\Omega$  -9.4551  $\Omega$  3.2371 pF 5 200.000 000 MHz

\*

Del

Cor

Avg  
16

H1d

CH2 S11 L00 5 dB/REF -20 dB 1: -20.524 dB 5 200.000 000 MHz

Cor

Avg  
16

H1d

START 5 000.000 000 MHz

STOP 5 000.000 000 MHz

CH1 Markers

2: 49.746  $\Omega$   
-4.9941  $\Omega$   
5.30000 GHz  
4: 56.488  $\Omega$   
-3.4395  $\Omega$   
5.60000 GHz  
5: 53.482  $\Omega$   
-4.6660  $\Omega$   
5.80000 GHz

CH2 Markers

2: -26.005 dB  
5.30000 GHz  
4: -23.234 dB  
5.60000 GHz  
5: -25.002 dB  
5.80000 GHz



## Appendix F – Phantom Calibration Data Sheets

Zeughausstrasse 43, 8004 Zurich, Switzerland  
 Phone +41 44 245 9700, Fax +41 44 245 9779  
 info@speag.com, http://www.speag.com

## Certificate of Conformity / First Article Inspection

Item	Oval Flat Phantom ELI 4.0
Type No	QD OVA 001 B
Series No	1003 and higher
Manufacturer	Untersee Composites Knebelstrasse 8 CH-8268 Mannenbach, Switzerland

### Tests

Complete tests were made on the prototype units QD OVA 001 AA 1001, QD OVA 001 AB 1002, pre-series units QD OVA 001 BA 1003-1005 as well as on the series units QD OVA 001 BB, 1006 ff.

Test	Requirement	Details	Units tested
Material thickness	Compliant with the standard requirements	Bottom plate: 2.0mm +/- 0.2mm	all
Material parameters	Dielectric parameters for required frequencies	< 6 GHz: Rel. permittivity = 4 +/-1, Loss tangent ≤ 0.05	Material sample
Material resistivity	The material has been tested to be compatible with the liquids defined in the standards if handled and cleaned according to the instructions.	DGBE based simulating liquids. Observe Technical Note for material compatibility.	Equivalent phantoms, Material sample
Shape	Thickness of bottom material, Internal dimensions, Sagging compatible with standards from minimum frequency	Bottom elliptical 600 x 400 mm Depth 190 mm, Shape is within tolerance for filling height up to 155 mm, Eventual sagging is reduced or eliminated by support via DUT	Prototypes, Sample testing

### Standards

- [1] CENELEC EN 50361-2001, « Basic standard for the measurement of the Specific Absorption Rate related to human exposure to electromagnetic fields from mobile phones (300 MHz – 3 GHz) », July 2001
- [2] IEEE 1528-2003, "Recommended Practice for Determining the Peak Spatial-Average Specific Absorption Rate (SAR) in the Human Head from Wireless Communications Devices: Measurement Techniques, December 2003
- [3] IEC 62209 – 1, "Specific Absorption Rate (SAR) in the frequency range of 300 MHz to 3 GHz – Measurement Procedure, Part 1: Hand-held mobile wireless communication devices", February 2005
- [4] IEC 62209 – 2, Draft, "Human Exposure to Radio Frequency Fields from Handheld and Body-Mounted Wireless Communication Devices – Human models, Instrumentation and Procedures – Part 2: Procedure to determine the Specific Absorption Rate (SAR) in the head and body for 30 MHz to 6 GHz Handheld and Body-Mounted Devices used in close proximity to the Body.", February 2005
- [5] OET Bulletin 65, Supplement C, "Evaluating Compliance with FCC Guidelines for Human Exposure to Radiofrequency Electromagnetic Fields", Edition January 2001

Based on the tests above, we certify that this item is in compliance with the standards [1] to [5] if operated according to the specific requirements and considering the thickness. The dimensions are fully compliant with [4] from 30 MHz to 6 GHz. For the other standards, the minimum lower frequency limit is limited due to the dimensional requirements ([1]: 450 MHz, [2]: 300 MHz, [3]: 800 MHz, [5]: 375 MHz) and possibly further by the dimensions of the DUT.

Date 28.4.2008

Signature / Stamp

**s p e a g**  
 Schmid & Partner Engineering AG  
 Zeughausstrasse 43, 8004 Zurich, Switzerland  
 Phone +41 44 245 9700, Fax +41 44 245 9779  
 info@speag.com; http://www.speag.com

## Appendix G – MPE Calculations

### Calculations for 13.5” Model

Calculation of EIRP from maximum conducted power.

Frequency Band	Mode	Frequency Range (MHz)	Maximum Conducted output power (dBm)	Maximum Conducted output power (mW)	Duty Cycle	Equivalent conducted output power (mW)	Maximum antenna gain (dBi)	Maximum antenna gain (numerical)	EIRP (mW)
802.11	b	2412-2482	16.5	44.7	100%	44.7	1.47	1.40	62.6
	g	2412-2482	16.5	44.7	100%	44.7	1.47	1.40	62.6
	n	2412-2482	16.5	44.7	100%	44.7	1.47	1.40	62.6
	a	5180-5320	16.5	44.7	100%	44.7	2.10	1.62	72.4
	n	5180-5320	16.5	44.7	100%	44.7	2.10	1.62	72.4
	a	5500-5700	16.5	44.7	100%	44.7	2.51	1.78	79.6
	n	5500-5700	16.5	44.7	100%	44.7	2.51	1.78	79.6
	a	5745-5825	16.5	44.7	100%	44.7	0.92	1.24	55.4
	n	5745-5825	16.5	44.7	100%	44.7	0.92	1.24	55.4

Calculation of spectral power density.

Frequency Band	Mode	Frequency Range (MHz)	EIRP (mW)	Evaluation distance (R) (cm)	Power Density ( $S_{eq}$ ) $S = \frac{P \cdot G}{4\pi R^2} = \frac{EIRP}{4\pi R^2}$ (mW/cm <sup>2</sup> )	MPE limit ( $S_{lim}$ ) (mW/cm <sup>2</sup> )	Compliance ( $S_{eq} < S_{lim}$ ) (mW/cm <sup>2</sup> )
802.11	b	2412-2482	62.6	20	0.013	1.0	COMPLIANT
	g	2412-2482	62.6	20	0.013	1.0	COMPLIANT
	n	2412-2482	62.6	20	0.013	1.0	COMPLIANT
	a	5180-5320	72.4	20	0.014	1.0	COMPLIANT
	n	5180-5320	72.4	20	0.014	1.0	COMPLIANT
	a	5500-5700	79.6	20	0.016	1.0	COMPLIANT
	n	5500-5700	79.6	20	0.016	1.0	COMPLIANT
	a	5745-5825	55.4	20	0.011	1.0	COMPLIANT
n	5745-5825	55.4	20	0.011	1.0	COMPLIANT	