

EMC Test Report

Application for Grant of Equipment Authorization

Industry Canada RSS-Gen Issue 3 / RSS 210 Issue 8 FCC Part 15 Subpart C

Models: 6235ANNGW and 6235ANNGU

IC CERTIFICATION #: 1000M-6235ANNG and 1000M-6235ANNGU
FCC ID: PD96235ANNG and PD96235ANNGU

APPLICANT: Intel Corporation
100 Center Point Circle, Suite 200
Columbia, SC 29210, USA

TEST SITE(S): NTS Silicon Valley
41039 Boyce Road.
Fremont, CA. 94538-2435

IC SITE REGISTRATION #: 2845B-3; 2845B-4, 2845B-5, 2845B-7

REPORT DATE: January 14, 2013

FINAL TEST DATES: December 21, 26, 27 and January 4, 2012

TOTAL NUMBER OF PAGES: 89

PROGRAM MGR /
TECHNICAL REVIEWER:



David W. Bare
Chief Engineer

QUALITY ASSURANCE DELEGATE /
FINAL REPORT PREPARER:

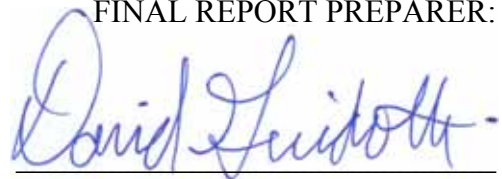

David Guidotti
Senior Technical Writer



NTS Silicon Valley is accredited by the A2LA, certificate number 0214.26, to perform the test(s) listed in this report, except where noted otherwise. This report and the information contained herein represent the results of testing test articles identified and selected by the client performed to specifications and/or procedures selected by the client. National Technical Systems (NTS) makes no representations, expressed or implied, that such testing is adequate (or inadequate) to demonstrate efficiency, performance, reliability, or any other characteristic of the articles being tested, or similar products. This report should not be relied upon as an endorsement or certification by NTS of the equipment tested, nor does it represent any statement whatsoever as to its merchantability or fitness of the test article, or similar products, for a particular purpose. This report shall not be reproduced except in full

REVISION HISTORY

Rev#	Date	Comments	Modified By
1	1-14-2013	First release	

TABLE OF CONTENTS

REVISION HISTORY2

TABLE OF CONTENTS3

SCOPE.....4

OBJECTIVE5

STATEMENT OF COMPLIANCE.....5

DEVIATIONS FROM THE STANDARDS.....5

TEST RESULTS SUMMARY6

 FREQUENCY HOPPING SPREAD SPECTRUM (2400 – 2483.5 MHZ, LESS THAN 75 CHANNELS)6

 GENERAL REQUIREMENTS APPLICABLE TO ALL BANDS.....7

 ADDITIONAL MEASUREMENTS.....7

 MEASUREMENT UNCERTAINTIES.....8

EQUIPMENT UNDER TEST (EUT) DETAILS.....9

 GENERAL.....9

 ANTENNA SYSTEM.....9

 ENCLOSURE.....9

 MODIFICATIONS.....9

 SUPPORT EQUIPMENT.....9

 EUT INTERFACE PORTS.....10

 EUT OPERATION.....10

TEST SITE.....11

 GENERAL INFORMATION.....11

 CONDUCTED EMISSIONS CONSIDERATIONS.....11

 RADIATED EMISSIONS CONSIDERATIONS.....11

MEASUREMENT INSTRUMENTATION12

 RECEIVER SYSTEM.....12

 INSTRUMENT CONTROL COMPUTER.....12

 LINE IMPEDANCE STABILIZATION NETWORK (LISN).....12

 FILTERS/ATTENUATORS.....13

 ANTENNAS.....13

 ANTENNA MAST AND EQUIPMENT TURNTABLE.....13

 INSTRUMENT CALIBRATION.....13

TEST PROCEDURES14

 EUT AND CABLE PLACEMENT.....14

 CONDUCTED EMISSIONS.....14

 RADIATED EMISSIONS.....15

 CONDUCTED EMISSIONS FROM ANTENNA PORT.....17

 BANDWIDTH MEASUREMENTS.....17

 SPECIFICATION LIMITS AND SAMPLE CALCULATIONS.....18

 CONDUCTED EMISSIONS SPECIFICATION LIMITS: FCC 15.207; FCC 15.107(A), RSS GEN.....18

 GENERAL TRANSMITTER RADIATED EMISSIONS SPECIFICATION LIMITS.....19

 RECEIVER RADIATED SPURIOUS EMISSIONS SPECIFICATION LIMITS.....19

 OUTPUT POWER LIMITS – FHSS SYSTEMS.....20

 TRANSMIT MODE SPURIOUS RADIATED EMISSIONS LIMITS – FHSS AND DTS SYSTEMS.....20

 SAMPLE CALCULATIONS - CONDUCTED EMISSIONS.....20

 SAMPLE CALCULATIONS - FIELD STRENGTH TO EIRP CONVERSION.....20

 SAMPLE CALCULATIONS - RADIATED EMISSIONS.....21

APPENDIX A TEST EQUIPMENT CALIBRATION DATA22

APPENDIX B TEST DATA24

END OF REPORT89

SCOPE

An electromagnetic emissions test has been performed on the Intel Corporation models 6235ANNGW and 6235ANNGU, pursuant to the following rules:

Industry Canada RSS-Gen Issue 3

RSS 210 Issue 8 “Low-power Licence-exempt Radiocommunication Devices (All Frequency Bands): Category I Equipment”

FCC Part 15 Subpart C

Conducted and radiated emissions data has been collected, reduced, and analyzed within this report in accordance with measurement guidelines set forth in the following reference standards and as outlined in NTS Silicon Valley test procedures:

ANSI C63.4:2003

FHSS test procedure DA 00-0705A1, March 2000

The intentional radiator above has been tested in a simulated typical installation to demonstrate compliance with the relevant Industry Canada performance and procedural standards.

Final system data was gathered in a mode that tended to maximize emissions by varying orientation of EUT, orientation of power and I/O cabling, antenna search height, and antenna polarization.

Every practical effort was made to perform an impartial test using appropriate test equipment of known calibration. All pertinent factors have been applied to reach the determination of compliance.

OBJECTIVE

The primary objective of the manufacturer is compliance with the regulations outlined in the previous section.

Prior to marketing in the USA, all unlicensed transmitters and transceivers require certification. Receive-only devices operating between 30 MHz and 960 MHz are subject to either certification or a manufacturer's declaration of conformity, with all other receive-only devices exempt from the technical requirements.

Prior to marketing in Canada, Class I transmitters, receivers and transceivers require certification. Class II devices are required to meet the appropriate technical requirements but are exempt from certification requirements.

Certification is a procedure where the manufacturer submits test data and technical information to a certification body and receives a certificate or grant of equipment authorization upon successful completion of the certification body's review of the submitted documents. Once the equipment authorization has been obtained, the label indicating compliance must be attached to all identical units, which are subsequently manufactured.

Maintenance of compliance is the responsibility of the manufacturer. Any modification of the product which may result in increased emissions should be checked to ensure compliance has been maintained (i.e., printed circuit board layout changes, different line filter, different power supply, harnessing or I/O cable changes, etc.).

STATEMENT OF COMPLIANCE

The tested sample(s) of Intel Corporation model 6235ANNGW and 6235ANNGU complied with the requirements of the following regulations:

- Industry Canada RSS-Gen Issue 3
- RSS 210 Issue 8 "Low-power Licence-exempt Radiocommunication Devices (All Frequency Bands): Category I Equipment"
- FCC Part 15 Subpart C

Maintenance of compliance is the responsibility of the manufacturer. Any modifications to the product should be assessed to determine their potential impact on the compliance status of the device with respect to the standards detailed in this test report.

The test results recorded herein are based on a single type test of Intel Corporation models 6235ANNGW and 6235ANNGU and therefore apply only to the tested sample(s). The sample(s) were selected and prepared by Stephen Hackett of Intel Corporation.

DEVIATIONS FROM THE STANDARDS

No deviations were made from the published requirements listed in the scope of this report.

TEST RESULTS SUMMARY

FREQUENCY HOPPING SPREAD SPECTRUM (2400 – 2483.5 MHz, less than 75 channels)

FCC Rule Part	RSS Rule Part	Description	Measured Value / Comments	Limit / Requirement	Result
15.247 (a) (1)	RSS 210 A8.1 (1)	20dB Bandwidth	Basic Rate: 1.042 MHz EDR: 1.383 MHz	Channel spacing > 2/3rds of 20dB bandwidth	Complies
		Channel Separation	1.0 MHz		Complies
15.247 (a) (1) (iii)	RSS 210 A8.1 (4)	Channel Dwell Time (average time of occupancy)	<0.4 second within a period of 0.4 x number of channels	<0.4 second within a period of 0.4 x number of channels	Complies
15.247 (a) (1) (iii)	RSS 210 A8.1 (4)	Number of Channels	Min: 20 Max: 79	15 or more	Complies
15.247 (a) (1)	RSS 210 A8.1 (1)	Channel Utilization	The system uses the BlueTooth algorithm and, therefore, meets all requirements for channel utilization.	All channels shall, on average, be used equally	Complies
15.247 (b) (3)	RSS 210 A8.4 (2)	Output Power (multipoint systems)	Basic rate: 6.1 dBm EDR: 4.7 dBm EIRP = 0.085 W ^{Note 1}	0.125Watt, EIRP limited to 0.5 Watts	Complies
15.247(c)	RSS 210 A8.5	Spurious Emissions – 30MHz – 25GHz	All spurious emissions < -20dBc	< -20dBc	Complies
15.247(c) / 15.209	RSS 210 A8.5 Table 2, 3	Radiated Spurious Emissions 30MHz – 25GHz	52.6 dBμV/m @ 2483.9 MHz (-1.4 dB)	15.209 in restricted bands, all others < -20dBc	Complies
15.247 (a) (1)	RSS 210 A8.1(2)	Receiver bandwidth	Refer to operational description, Page 2	Shall match the channel bandwidth	Complies
Note 1: EIRP calculated using antenna gain of 3.2 dBi					

GENERAL REQUIREMENTS APPLICABLE TO ALL BANDS

FCC Rule Part	RSS Rule part	Description	Measured Value / Comments	Limit / Requirement	Result (margin)
15.203	-	RF Connector	Not applicable as antennas are integral in host systems	Unique or integral antenna required	Complies
15.207	RSS GEN Table 2	AC Conducted Emissions	31.3 dB μ V @ 4.428 MHz (-24.7 dB)	Refer to page 18	Complies
15.247 (b) (5) 15.407 (f)	RSS 102	RF Exposure Requirements	Not applicable – the output power is less than the 60/f _{GHz} threshold		
-	RSP 100 RSS GEN 7.1.5	User Manual	Refer to User Manual for details	Statement required regarding non-interference	Complies
-	RSP 100 RSS GEN 7.1.5	User Manual	No detachable antenna	Statement for products with detachable antenna	Complies
-	RSP 100 RSS GEN 4.4.1	99% Bandwidth	Basic Rate: 894 kHz EDR: 1.203 MHz	Information only	N/A

ADDITIONAL MEASUREMENTS

As both Bluetooth and 802.11 transmissions can occur simultaneously, radiated spurious measurements were made with both Bluetooth and 802.11 devices transmitting simultaneously.

DTS (Wi-Fi in 2.4GHz and 5.8GHz bands) and Bluetooth					
FCC Rule Part	RSS Rule part	Description	Measured Value / Comments	Limit / Requirement	Result (margin)
15.209	RSS 210	Spurious emissions	53.3 dB μ V/m @ 4874.0 MHz (-0.7 dB)	15.209 in restricted bands, all others < -20dBc	Complies

LELAN/NII (Wi-Fi in 5150-5350/5470-5725MHz bands) and Bluetooth					
FCC Rule Part	RSS Rule part	Description	Measured Value / Comments	Limit / Requirement	Result (margin)
15.209	RSS 210	Spurious emissions	46.4 dB μ V/m @ 11159.7 MHz (-7.6 dB)	15.209 in restricted bands, all others < -20dBc	Complies

Note: Highest observed emissions above were actually second harmonic of 802.11 signal and not an inter-modulation product, but this was the highest level signal observed with both Bluetooth and Wi-Fi transmitters operational simultaneously.

MEASUREMENT UNCERTAINTIES

ISO/IEC 17025 requires that an estimate of the measurement uncertainties associated with the emissions test results be included in the report. The measurement uncertainties given below are based on a 95% confidence level and were calculated in accordance with UKAS document LAB 34.

Measurement Type	Measurement Unit	Frequency Range	Expanded Uncertainty
RF power, conducted (power meter)	dBm	25 to 7000 MHz	± 0.52 dB
RF power, conducted (Spectrum analyzer)	dBm	25 to 7000 MHz	± 0.7 dB
Conducted emission of transmitter	dBm	25 to 26500 MHz	± 0.7 dB
Conducted emission of receiver	dBm	25 to 26500 MHz	± 0.7 dB
Radiated emission (substitution method)	dBm	25 to 26500 MHz	± 2.5 dB
Radiated emission (field strength)	dB μ V/m	25 to 1000 MHz	± 3.6 dB
		1000 to 40000 MHz	± 6.0 dB
Conducted Emissions (AC Power)	dB μ V	0.15 to 30 MHz	± 2.4 dB

EQUIPMENT UNDER TEST (EUT) DETAILS

GENERAL

The Intel Corporation Intel® Centrino® Advanced-N 6235 models 6235ANNGW and 6235ANNGU are Bluetooth/IEEE 802.11a/b/g/n wireless network adapter modules. The modules support MIMO (2x2) for 802.11n modes and MISO (1x2) for 802.11a/b/g modes. Bluetooth only operation mode is a 1x1. When Bluetooth is operational then 802.11b/g/n modes operate as SISO (1x1). 802.11a/n modes still operate as MIMO (2x2) with Bluetooth operational.

The card is sold under two different FCC/IC ID numbers (see table below). The ID's ending in "U" are intended to allow user install conditions and host systems must be provided with a BIOS locking feature that prevents installation of unauthorized devices. For radio testing purposes the card was installed in a test fixture that exposed all sides of the card. For digital device testing for certification under equipment code JBP the card was installed in a test fixture external to the PC.

The samples were received on December 1, 2012 and tested on December 21, 26, 27 and January 4, 2012. The samples tested are as follows:

Company	Model	Description	Serial Number	FCC ID
Intel Corporation	6235ANNGW	Bluetooth / IEEE 802.11a/b/g/n wireless network adapter module	50405 (JBP) 50405 (DSS, DTS and NII)	PD96235ANNG
	6235ANNGU			PD96235ANNGU 1000M-6235ANNG 1000M-6235ANNGU

ANTENNA SYSTEM

The EUT antenna is a two-antenna PIFA antenna system – Shanghai Universe Communication Electron Co., Ltd,

The antenna connects to the EUT via a non-standard antenna connector, thereby meeting the requirements of FCC 15.203.

ENCLOSURE

The EUT has no enclosure. It is designed to be installed within the enclosure of a host computer.

MODIFICATIONS

No modifications were made to the EUT during the time the product was at NTS Silicon Valley.

SUPPORT EQUIPMENT

The following equipment was used as support equipment for testing:

Company	Model	Description	Serial Number	FCC ID
Intel Corporation	-	NGFF Test Fixture	3902412-151	N/A
Dell	Latitude D520	Laptop PC	HM9383J	N/A
Dell	Latitude E5400	Laptop PC	GFZW54J	N/A
Agilent	E3610A	DC Supply	MY4001740	N/A

EUT INTERFACE PORTS

The I/O cabling configuration during testing was as follows:

Port	Connected To	Description	Cable(s)	
			Shielded or Unshielded	Length(m)
Laptop USB	Fixture USB	USB cable	Shielded	1.5
Laptop Mini PCI	Fixture PCIe	Ribbon	unshielded	0.7
DC Power	Fixture DC power	2-wire	unshielded	0.7

EUT OPERATION

The EUT was installed into a test fixture that exposed all sides of the card. The test fixture interfaced to a laptop computer and dc power supply. The laptop computer was used to configure the EUT to continuously transmit at a specified output power on the channel specified in the test data. For transmit mode measurements the system was configured to operate in each of the available operating modes – 802.11b, 802.11g, 802.11n (20 MHz channel bandwidth) and 802.11n (40MHz channel bandwidth), Bluetooth 1Mb/s and Bluetooth 3Mb/s. In addition radiated spurious tests were repeated with the device operating in both Bluetooth and 802.11 modes to determine if any spurious emissions due to intermodulation products were created.

The data rates used for all tests were the lowest data rates for each 802.11 mode – 1Mb/s for 802.11b, 6Mb/s for 802.11a and 802.11g, 6.5MB/s for 802.11n (20MHz), and 13 Mb/s for 802.11n (40MHz) except that power for 802.11b mode was tested at 5.5Mb/s. The device operates at its maximum output power at the lowest data rate except for 802.11b mode (this was confirmed through separate measurements – refer to test data for actual measurements). Bluetooth operation was evaluated at both 1Mb/s and 3Mb/s data rates. 2Mb/s data rate was found, through preliminary testing, to produce emissions similar to those for 3Mb/s.

The PC was using the Intel test utility DRTU Version 1.5.6-0445 and the device driver was version 15.3.1.2.

TEST SITE

GENERAL INFORMATION

Final test measurements were taken at the test sites listed below. Pursuant to section 2.948 of the FCC’s Rules and section 3.3 of RSP-100, construction, calibration, and equipment data has been filed with the Commission and with industry Canada.

Site	Registration Numbers		Location
	FCC	Canada	
Chamber 3	769238	2845B-3	41039 Boyce Road Fremont, CA 94538-2435
Chamber 4	211948	2845B-4	
Chamber 5	211948	2845B-5	
Chamber 7	A2LA accreditation	2845B-7	

ANSI C63.4:2003 recommends that ambient noise at the test site be at least 6 dB below the allowable limits. Ambient levels are below this requirement. The test site(s) contain separate areas for radiated and conducted emissions testing. Considerable engineering effort has been expended to ensure that the facilities conform to all pertinent requirements of ANSI C63.4:2003.

CONDUCTED EMISSIONS CONSIDERATIONS

Conducted emissions testing is performed in conformance with ANSI C63.4:2003. Measurements are made with the EUT connected to the public power network through a nominal, standardized RF impedance, which is provided by a line impedance stabilization network, known as a LISN. A LISN is inserted in series with each current-carrying conductor in the EUT power cord.

RADIATED EMISSIONS CONSIDERATIONS

The FCC has determined that radiation measurements made in a shielded enclosure are not suitable for determining levels of radiated emissions. Radiated measurements are performed in an open field environment or in a semi-anechoic chamber. The test sites are maintained free of conductive objects within the CISPR defined elliptical area incorporated in ANSI C63.4:2003 guidelines and meet the Normalized Site Attenuation (NSA) requirements of ANSI C63.4:2003.

MEASUREMENT INSTRUMENTATION

RECEIVER SYSTEM

An EMI receiver as specified in CISPR 16-1-1 is used for emissions measurements. The receivers used can measure over the frequency range of 9 kHz up to 2000 MHz. These receivers allow both ease of measurement and high accuracy to be achieved. The receivers have Peak, Average, and CISPR (Quasi-peak) detectors built into their design so no external adapters are necessary. The receiver automatically sets the required bandwidth for the CISPR detector used during measurements. If the repetition frequency of the signal being measured is below 20Hz, peak measurements are made in lieu of Quasi-Peak measurements.

For measurements above the frequency range of the receivers, a spectrum analyzer is utilized because it provides visibility of the entire spectrum along with the precision and versatility required to support engineering analysis. Average measurements above 1000MHz are performed on the spectrum analyzer using the linear-average method with a resolution bandwidth of 1 MHz and a video bandwidth of 10 Hz, unless the signal is pulsed in which case the average (or video) bandwidth of the measuring instrument is reduced to onset of pulse desensitization and then increased.

INSTRUMENT CONTROL COMPUTER

The receivers utilize either a Rohde & Schwarz EZM Spectrum Monitor/Controller or contain an internal Spectrum Monitor/Controller to view and convert the receiver measurements to the field strength at an antenna or voltage developed at the LISN measurement port, which is then compared directly with the appropriate specification limit. This provides faster, more accurate readings by performing the conversions described under Sample Calculations within the Test Procedures section of this report. Results are printed in a graphic and/or tabular format, as appropriate. A personal computer is used to record all measurements made with the receivers.

The Spectrum Monitor provides a visual display of the signal being measured. In addition, the controller or a personal computer run automated data collection programs which control the receivers. This provides added accuracy since all site correction factors, such as cable loss and antenna factors are added automatically.

LINE IMPEDANCE STABILIZATION NETWORK (LISN)

Line conducted measurements utilize a fifty microhenry Line Impedance Stabilization Network as the monitoring point. The LISN used also contains a 250 uH CISPR adapter. This network provides for calibrated radio frequency noise measurements by the design of the internal low pass and high pass filters on the EUT and measurement ports, respectively.

FILTERS/ATTENUATORS

External filters and precision attenuators are often connected between the receiving antenna or LISN and the receiver. This eliminates saturation effects and non-linear operation due to high amplitude transient events.

ANTENNAS

A loop antenna is used below 30 MHz. For the measurement range 30 MHz to 1000 MHz either a combination of a biconical antenna and a log periodic or a bi-log antenna is used. Above 1000 MHz, horn antennas are used. The antenna calibration factors to convert the received voltage to an electric field strength are included with appropriate cable loss and amplifier gain factors to determine an overall site factor, which is then programmed into the test receivers or incorporated into the test software.

ANTENNA MAST AND EQUIPMENT TURNTABLE

The antennas used to measure the radiated electric field strength are mounted on a non-conductive antenna mast equipped with a motor-drive to vary the antenna height. Measurements below 30 MHz are made with the loop antenna at a fixed height of 1m above the ground plane.

ANSI C63.4:2003 specifies that the test height above ground for table mounted devices shall be 80 centimeters. Floor mounted equipment shall be placed on the ground plane if the device is normally used on a conductive floor or separated from the ground plane by insulating material from 3 to 12 mm if the device is normally used on a non-conductive floor. During radiated measurements, the EUT is positioned on a motorized turntable in conformance with this requirement.

INSTRUMENT CALIBRATION

All test equipment is regularly checked to ensure that performance is maintained in accordance with the manufacturer's specifications. All antennas are calibrated at regular intervals with respect to tuned half-wave dipoles. An exhibit of this report contains the list of test equipment used and calibration information.

TEST PROCEDURES

EUT AND CABLE PLACEMENT

The regulations require that interconnecting cables be connected to the available ports of the unit and that the placement of the unit and the attached cables simulate the worst case orientation that can be expected from a typical installation, so far as practicable. To this end, the position of the unit and associated cabling is varied within the guidelines of ANSI C63.4:2003, and the worst-case orientation is used for final measurements.

CONDUCTED EMISSIONS

Conducted emissions are measured at the plug end of the power cord supplied with the EUT. Excess power cord length is wrapped in a bundle between 30 and 40 centimeters in length near the center of the cord. Preliminary measurements are made to determine the highest amplitude emission relative to the specification limit for all the modes of operation. Placement of system components and varying of cable positions are performed in each mode. A final peak mode scan is then performed in the position and mode for which the highest emission was noted on all current carrying conductors of the power cord.

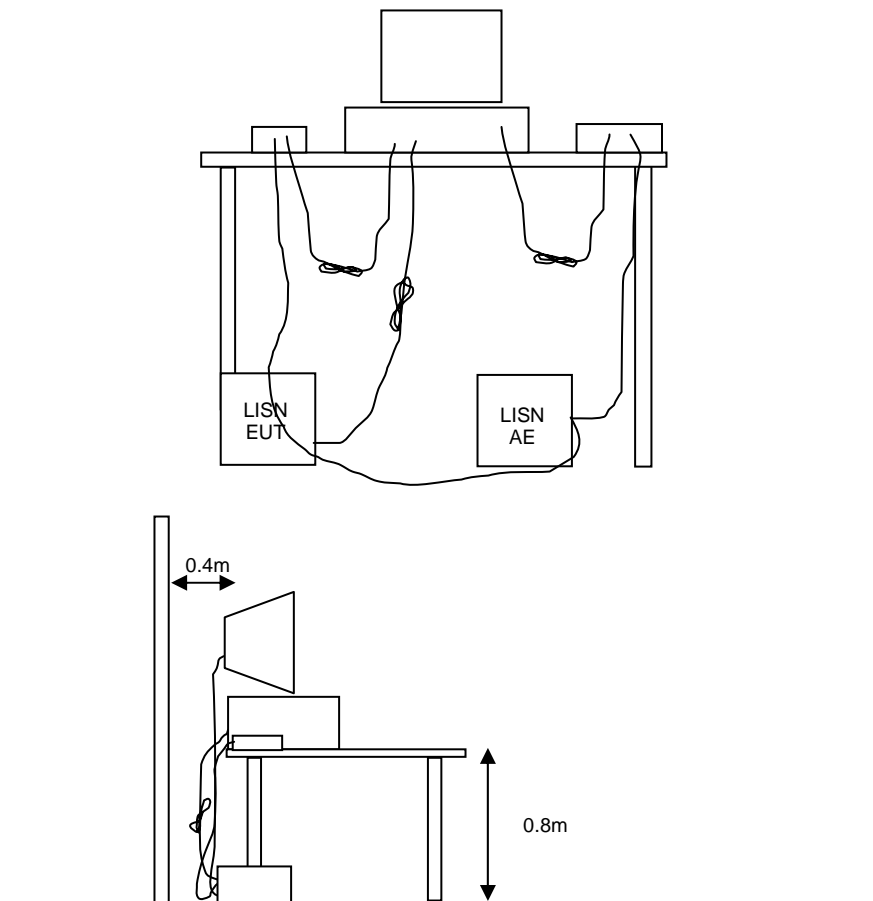

Figure 1 Typical Conducted Emissions Test Configuration

RADIATED EMISSIONS

A preliminary scan of the radiated emissions is performed in which all significant EUT frequencies are identified with the system in a nominal configuration. At least two scans are performed, one scan for each antenna polarization (horizontal and vertical; loop parallel and perpendicular to the EUT). During the preliminary scans, the EUT is rotated through 360°, the antenna height is varied (for measurements above 30 MHz) and cable positions are varied to determine the highest emission relative to the limit. Preliminary scans may be performed in a fully anechoic chamber for the purposes of identifying the frequencies of the highest emissions from the EUT.

A speaker is provided in the receiver to aid in discriminating between EUT and ambient emissions. Other methods used during the preliminary scan for EUT emissions involve scanning with near field magnetic loops, monitoring I/O cables with RF current clamps, and cycling power to the EUT.

Final maximization is a phase in which the highest amplitude emissions identified in the spectral search are viewed while the EUT azimuth angle is varied from 0 to 360 degrees relative to the receiving antenna. The azimuth, which results in the highest emission is then maintained while varying the antenna height from one to four meters (for measurements above 30 MHz, measurements below 30 MHz are made with the loop antenna at a fixed height of 1m). The result is the identification of the highest amplitude for each of the highest peaks. Each recorded level is corrected in the receiver using appropriate factors for cables, connectors, antennas, and preamplifier gain.

When testing above 18 GHz, the receive antenna is located at 1meter from the EUT and the antenna height is restricted to a maximum of 2.5 meters.

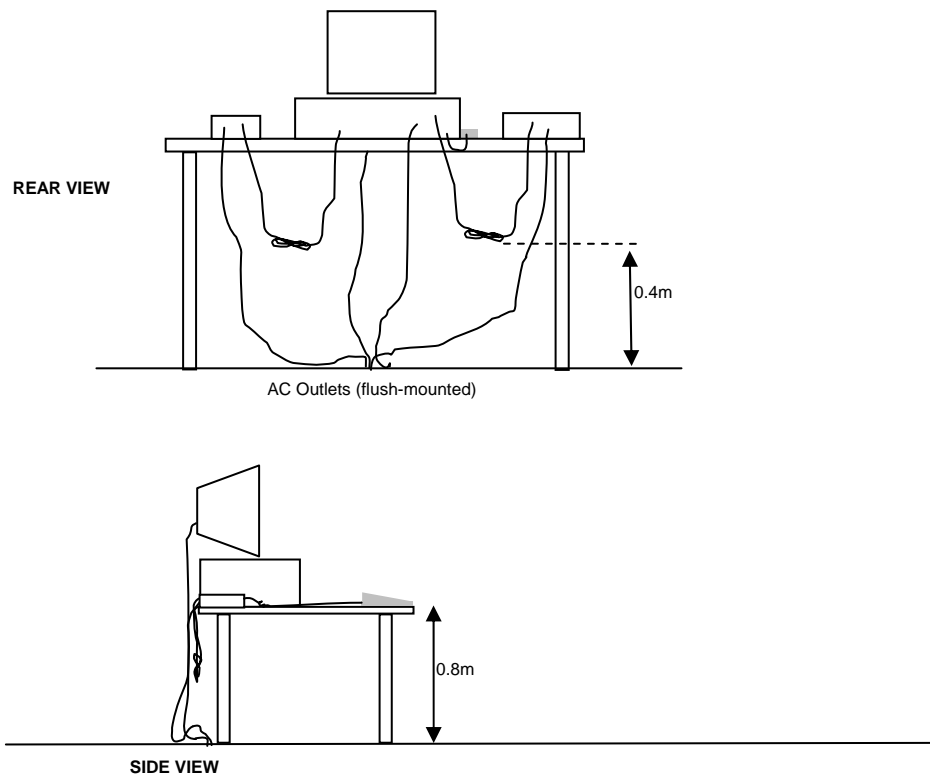

Typical Test Configuration for Radiated Field Strength Measurements

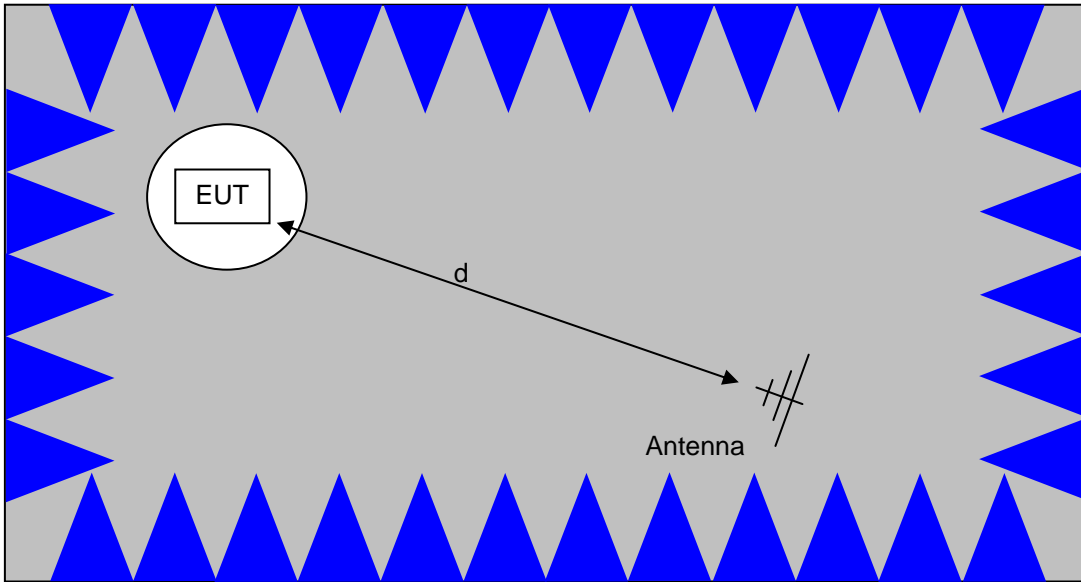

The anechoic materials on the walls and ceiling ensure compliance with the normalized site attenuation requirements of CISPR 16 / CISPR 22 / ANSI C63.4 for an alternate test site at the measurement distances used.

Floor-standing equipment is placed on the floor with insulating supports between the unit and the ground plane.

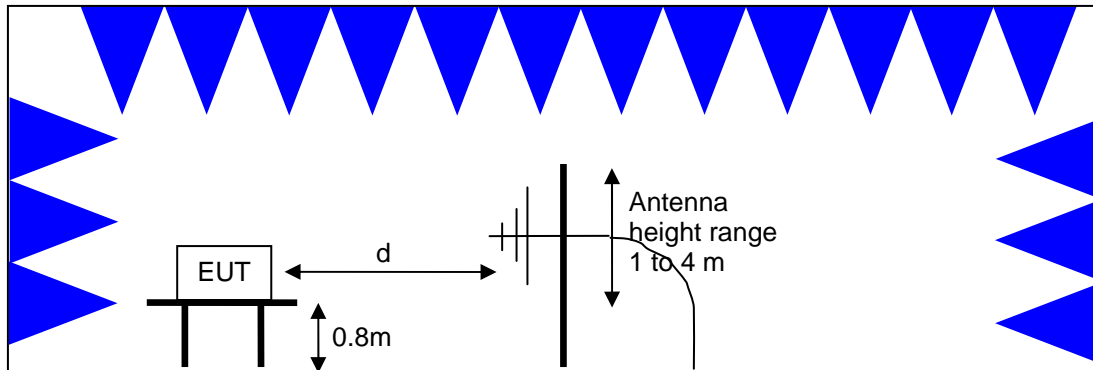

Test Configuration for Radiated Field Strength Measurements
Semi-Anechoic Chamber, Plan and Side Views

CONDUCTED EMISSIONS FROM ANTENNA PORT

Direct measurements of power, bandwidth and power spectral density are performed, where possible, with the antenna port of the EUT connected to either the power meter or spectrum analyzer via a suitable attenuator and/or filter. These are used to ensure that the front end of the measurement instrument is not overloaded by the fundamental transmission.

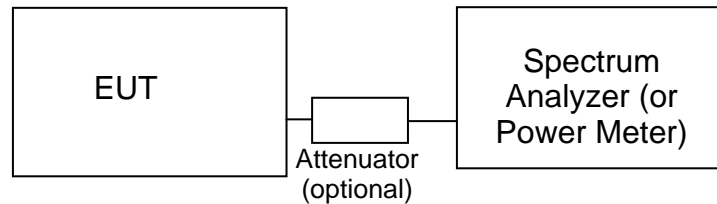
**Test Configuration for Antenna Port Measurements**

Measurement bandwidths (video and resolution) are set in accordance with the relevant standards and NTS Silicon Valley's test procedures for the type of radio being tested. When power measurements are made using a resolution bandwidth less than the signal bandwidth the power is calculated by summing the power across the signal bandwidth using either the analyzer channel power function or by capturing the trace data and calculating the power using software. In both cases the summed power is corrected to account for the equivalent noise bandwidth (ENBW) of the resolution bandwidth used.

If power averaging is used (typically for certain digital modulation techniques), the EUT is configured to transmit continuously. Power averaging is performed using either the built-in function of the analyzer or, if the analyzer does not feature power averaging, using external software. In both cases the average power is calculated over a number of sweeps (typically 100). When the EUT cannot be configured to continuously transmit then either the analyzer is configured to perform a gated sweep to ensure that the power is averaged over periods that the device is transmitting or power averaging is disabled and a max-hold feature is used.

If a power meter is used to make output power measurements the sensor head type (peak or average) is stated in the test data table.

BANDWIDTH MEASUREMENTS

The 6dB, 20dB and/or 26dB signal bandwidth is measured in using the bandwidths recommended by ANSI C63.4. When required, the 99% bandwidth is measured using the methods detailed in RSS GEN.

SPECIFICATION LIMITS AND SAMPLE CALCULATIONS

The limits for conducted emissions are given in units of microvolts, and the limits for radiated emissions are given in units of microvolts per meter at a specified test distance. Data is measured in the logarithmic form of decibels relative to one microvolt, or dB microvolts (dBuV). For radiated emissions, the measured data is converted to the field strength at the antenna in dB microvolts per meter (dBuV/m). The results are then converted to the linear forms of uV and uV/m for comparison to published specifications.

For reference, converting the specification limits from linear to decibel form is accomplished by taking the base ten logarithm, then multiplying by 20. These limits in both linear and logarithmic form are as follows:

CONDUCTED EMISSIONS SPECIFICATION LIMITS: FCC 15.207; FCC 15.107(a), RSS GEN

The table below shows the limits for the emissions on the AC power line from an intentional radiator and a receiver.

Frequency (MHz)	Average Limit (dBuV)	Quasi Peak Limit (dBuV)
0.150 to 0.500	Linear decrease on logarithmic frequency axis between 56.0 and 46.0	Linear decrease on logarithmic frequency axis between 66.0 and 56.0
0.500 to 5.000	46.0	56.0
5.000 to 30.000	50.0	60.0

GENERAL TRANSMITTER RADIATED EMISSIONS SPECIFICATION LIMITS

The table below shows the limits for the spurious emissions from transmitters that fall in restricted bands¹ (with the exception of transmitters operating under FCC Part 15 Subpart D and RSS 210 Annex 9), the limits for all emissions from a low power device operating under the general rules of RSS 310 (tables 3 and 4), RSS 210 (table 2) and FCC Part 15 Subpart C section 15.209.

Frequency Range (MHz)	Limit (uV/m)	Limit (dBuV/m @ 3m)
0.009-0.490	2400/F _{KHz} @ 300m	67.6-20*log ₁₀ (F _{KHz}) @ 300m
0.490-1.705	24000/F _{KHz} @ 30m	87.6-20*log ₁₀ (F _{KHz}) @ 30m
1.705 to 30	30 @ 30m	29.5 @ 30m
30 to 88	100 @ 3m	40 @ 3m
88 to 216	150 @ 3m	43.5 @ 3m
216 to 960	200 @ 3m	46.0 @ 3m
Above 960	500 @ 3m	54.0 @ 3m

RECEIVER RADIATED SPURIOUS EMISSIONS SPECIFICATION LIMITS

The table below shows the limits for the spurious emissions from receivers as detailed in FCC Part 15.109, RSS 210 Table 2, RSS GEN Table 1 and RSS 310 Table 3. Note that receivers operating outside of the frequency range 30 MHz – 960 MHz are exempt from the requirements of 15.109.

Frequency Range (MHz)	Limit (uV/m @ 3m)	Limit (dBuV/m @ 3m)
30 to 88	100	40
88 to 216	150	43.5
216 to 960	200	46.0
Above 960	500	54.0

¹ The restricted bands are detailed in FCC 15.203, RSS 210 Table 1 and RSS 310 Table 2

OUTPUT POWER LIMITS – FHSS SYSTEMS

The table below shows the limits for output power based on the number of channels available for the hopping system.

Operating Frequency (MHz)	Number of Channels	Output Power
902 – 928	≥ 50	1 Watt (30 dBm)
902 – 928	25 to 49	0.25 Watts (24 dBm)
2400 – 2483.5	≥ 75	1 Watt (30 dBm)
2400 – 2483.5	< 75	0.125 Watts (21 dBm)
5725 – 5850	75	1 Watt (30 dBm)

The maximum permitted output power is reduced by 1dB for every dB the antenna gain exceeds 6dBi. Fixed point-to-point applications using the 5725 – 5850 MHz band are not subject to this restriction.

TRANSMIT MODE SPURIOUS RADIATED EMISSIONS LIMITS – FHSS and DTS SYSTEMS

The limits for unwanted (spurious) emissions from the transmitter falling in the restricted bands are those specified in the general limits sections of FCC Part 15 and RSS 210. All other unwanted (spurious) emissions shall be at least 20dB below the level of the highest in-band signal level (30dB if the power is measured using the sample detector/power averaging method).

SAMPLE CALCULATIONS - CONDUCTED EMISSIONS

Receiver readings are compared directly to the conducted emissions specification limit (decibel form) as follows:

$$R_r - S = M$$

where:

R_r = Receiver Reading in dBuV

S = Specification Limit in dBuV

M = Margin to Specification in +/- dB

SAMPLE CALCULATIONS - FIELD STRENGTH TO EIRP CONVERSION

Where the radiated electric field strength is expressed in terms of the equivalent isotropic radiated power (eirp), or where a field strength measurement of output power is made in lieu of a direct measurement, the following formula is used to convert between eirp and field strength at a distance of d (meters) from the equipment under test:

$$E = \frac{1000000 \sqrt{30 P}}{d} \text{ microvolts per meter}$$

where P is the eirp (Watts)

For a measurement at 3m the conversion from a logarithmic value for field strength (dBuV/m) to an eirp power (dBm) is -95.3dB.

SAMPLE CALCULATIONS - RADIATED EMISSIONS

Receiver readings are compared directly to the specification limit (decibel form). The receiver internally corrects for cable loss, preamplifier gain, and antenna factor. The calculations are in the reverse direction of the actual signal flow, thus cable loss is added and the amplifier gain is subtracted. The Antenna Factor converts the voltage at the antenna coaxial connector to the field strength at the antenna elements.

A distance factor, when used for electric field measurements above 30MHz, is calculated by using the following formula:

$$F_d = 20 * \text{LOG}_{10} (D_m/D_s)$$

where:

$$F_d = \text{Distance Factor in dB}$$

$$D_m = \text{Measurement Distance in meters}$$

$$D_s = \text{Specification Distance in meters}$$

For electric field measurements below 30MHz the extrapolation factor is either determined by making measurements at multiple distances or a theoretical value is calculated using the formula:

$$F_d = 40 * \text{LOG}_{10} (D_m/D_s)$$

Measurement Distance is the distance at which the measurements were taken and Specification Distance is the distance at which the specification limits are based. The antenna factor converts the voltage at the antenna coaxial connector to the field strength at the antenna elements.

The margin of a given emission peak relative to the limit is calculated as follows:

$$R_c = R_r + F_d$$

and

$$M = R_c - L_s$$

where:

$$R_r = \text{Receiver Reading in dBuV/m}$$

$$F_d = \text{Distance Factor in dB}$$

$$R_c = \text{Corrected Reading in dBuV/m}$$

$$L_s = \text{Specification Limit in dBuV/m}$$

$$M = \text{Margin in dB Relative to Spec}$$

Appendix A Test Equipment Calibration Data

<u>Manufacturer</u>	<u>Description</u>	<u>Model #</u>	<u>Asset #</u>	<u>Cal Due</u>
Conducted Emissions, 18-Dec-12				
EMCO	LISN, 10 kHz-100 MHz	3825/2	1293	16-Feb-13
Rohde & Schwarz	Pulse Limiter	ESH3 Z2	1401	15-May-13
Rohde & Schwarz	EMI Test Receiver, 20 Hz-7 GHz	ESIB7	1538	12-Dec-13
Com-Power	9KHz-30MHz, 50uH, 15Aac, 10Adc, max	LI-215A	2672	25-May-13
Radiated Spurious Emissions, 1000 - 25,000 MHz, 21-Dec-12				
EMCO	Antenna, Horn, 1-18 GHz	3115	487	19-Jul-14
Hewlett Packard	Microwave Preamplifier, 1-26.5GHz	8449B	2199	23-Feb-13
Micro-Tronics	Band Reject Filter, 2400-2500 MHz	BRM50702-02	2249	11-Oct-13
Hewlett Packard	SpecAn 9 kHz - 40 GHz, (SA40) Purple	8564E (84125C)	2415	10-Aug-13
Rohde & Schwarz	EMI Test Receiver, 20 Hz-40 GHz	ESIB40 (1088.7490.40)	2493	09-Jan-13
Radiated Spurious Emissions, 1000 - 25,000 MHz, 26-Dec-12				
EMCO	Antenna, Horn, 1-18 GHz	3115	487	19-Jul-14
Hewlett Packard	Microwave Preamplifier, 1-26.5GHz	8449B	2199	23-Feb-13
Micro-Tronics	Band Reject Filter, 2400-2500 MHz	BRM50702-02	2249	11-Oct-13
Hewlett Packard	SpecAn 9 kHz - 40 GHz, (SA40) Purple	8564E (84125C)	2415	10-Aug-13
Hewlett Packard	Head (Inc W1-W4, 1946 , 1947) Purple	84125C	1772	01-May-13
A.H. Systems	Purple System Horn, 18-40GHz	SAS-574, p/n: 2581	2160	17-Apr-13
Radiated Emissions, 30 - 15,000 MHz, 28-Dec-12				
EMCO	Antenna, Horn, 1-18 GHz	3115	487	19-Jul-14
Hewlett Packard	Preamplifier, 100 kHz - 1.3 GHz	8447D OPT 010	1826	18-May-13
Sunol Sciences	Biconilog, 30-3000 MHz	JB3	2197	07-Feb-14
Hewlett Packard	Microwave Preamplifier, 1-26.5GHz	8449B	2199	23-Feb-13
Micro-Tronics	Band Reject Filter, 5150-5350 MHz	BRC50703-02	2239	04-Oct-13
Micro-Tronics	Band Reject Filter, 5470-5725 MHz	BRC50704-02	2240	04-Oct-13
Micro-Tronics	Band Reject Filter, 5725-5875 MHz	BRC50705-02	2241	04-Oct-13

<u>Manufacturer</u>	<u>Description</u>	<u>Model #</u>	<u>Asset #</u>	<u>Cal Due</u>
Micro-Tronics	Band Reject Filter, 2400-2500 MHz	BRM50702-02	2249	11-Oct-13
Hewlett Packard	SpecAn 9 kHz - 40 GHz, (SA40) Purple	8564E (84125C)	2415	10-Aug-13
Rohde & Schwarz	EMI Test Receiver, 20 Hz-40 GHz	ESIB40 (1088.7490.40)	2493	09-Jan-13
Radio Antenna Port (Power and Spurious Emissions), 04-Jan-13				
Agilent	PSA, Spectrum Analyzer	E4446A	2139	23-Feb-13

Appendix B Test Data

T89578 Pages 25 - 88



EMC Test Data

Client:	Intel	Job Number:	J88901
Product:	Intel® Centrino® Advanced-N 6235	T-Log Number:	T89578
		Account Manager:	Christine Krebill
Contact:	Steve Hackett		
Emissions Standard(s):	FCC 15.247, 15.407, 15.209, RSS 210	Class:	B
Immunity Standard(s):	-	Environment:	Radio

EMC Test Data

For The

Intel

Product

Intel® Centrino® Advanced-N 6235

Date of Last Test: 1/10/2013



EMC Test Data

Client:	Intel	Job Number:	J88901
Model:	Intel® Centrino® Advanced-N 6235	T-Log Number:	T89578
Contact:	Steve Hackett	Account Manager:	Christine Krebill
Standard:	FCC 15.247, 15.407, 15.209, RSS 210	Class:	N/A

FCC 15.247 FHSS - Power, Bandwidth and Spurious Emissions

Test Specific Details

Objective: The objective of this test session is to perform final qualification testing of the EUT with respect to the specification listed above.

Date of Test: 1/4/2013
 Test Engineer: John Caizzi, Joseph Cadigal
 Test Location: Power Fault Lab

Config. Used: 1
 Config Change: none
 Host Unit Voltage 120V / 60 Hz

General Test Configuration

When measuring the conducted emissions from the EUT's antenna port, the antenna port of the EUT was connected to the spectrum analyzer or power meter via a suitable attenuator to prevent overloading the measurement system. All measurements are corrected to allow for the external attenuators used.

Unless stated otherwise the EUT was operating such that it constantly hopped on either the low, center or high channels.

Ambient Conditions:

Temperature: 18 °C
 Rel. Humidity: 25 %

Summary of Results

MAC Address: 001500B50405 DRTU Tool Version 1.5.6-0445 Driver version 15.3.1.2

Run #	Test Performed	Limit	Pass / Fail	Result / Margin
1	30 - 25,000 MHz - Transmitter Conducted Spurious Emissions	FCC Part 15.247(c)	Pass	All emissions < -20dBc
2	Output Power	15.247(b)	Pass	Basic Rate: 6.1 dBm (4.1mW) EDR: 4.7 dBm (3.0mW)
3	20dB Bandwidth	15.247(a)	Pass	Basic Rate: 1.042 MHz EDR: 1.383 MHz
3	99% bandwidth	15.247(a)	NA	Basic Rate: 894 kHz EDR: 1.203 MHz
3	Channel Occupancy	15.247(a)	Pass	Complies with Bluetooth protocol
3	Number of Channels	15.247(a)	Pass	20 - 79 channels

Modifications Made During Testing:

No modifications were made to the EUT during testing

Deviations From The Standard

No deviations were made from the requirements of the standard.



EMC Test Data

Client:	Intel	Job Number:	J88901
Model:	Intel® Centrino® Advanced-N 6235	T-Log Number:	T89578
Contact:	Steve Hackett	Account Manager:	Christine Krebill
Standard:	FCC 15.247, 15.407, 15.209, RSS 210	Class:	N/A

Run #1: Antenna Conducted Spurious Emissions, 30 - 25,000 MHz.

Date of Test: 1/4/2013
Test Engineer: John Caizzi
Test Location: Power Fault Lab

Refer to plots below. Scans made using RBW=VB=100 KHz with the limit line set at 20dB below the highest in-band signal level with the hopping feature disabled.

Basic rate (1Mb/s)
Low channel

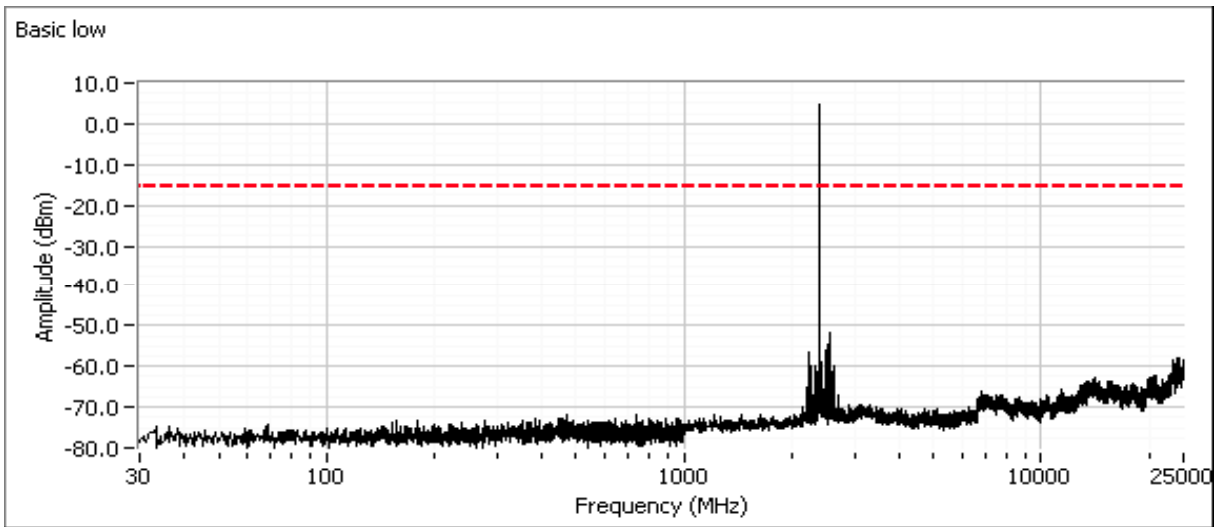

Client:	Intel	Job Number:	J88901
Model:	Intel® Centrino® Advanced-N 6235	T-Log Number:	T89578
Contact:	Steve Hackett	Account Manager:	Christine Krebill
Standard:	FCC 15.247, 15.407, 15.209, RSS 210	Class:	N/A

Plot showing -20dBc at the lower band edge

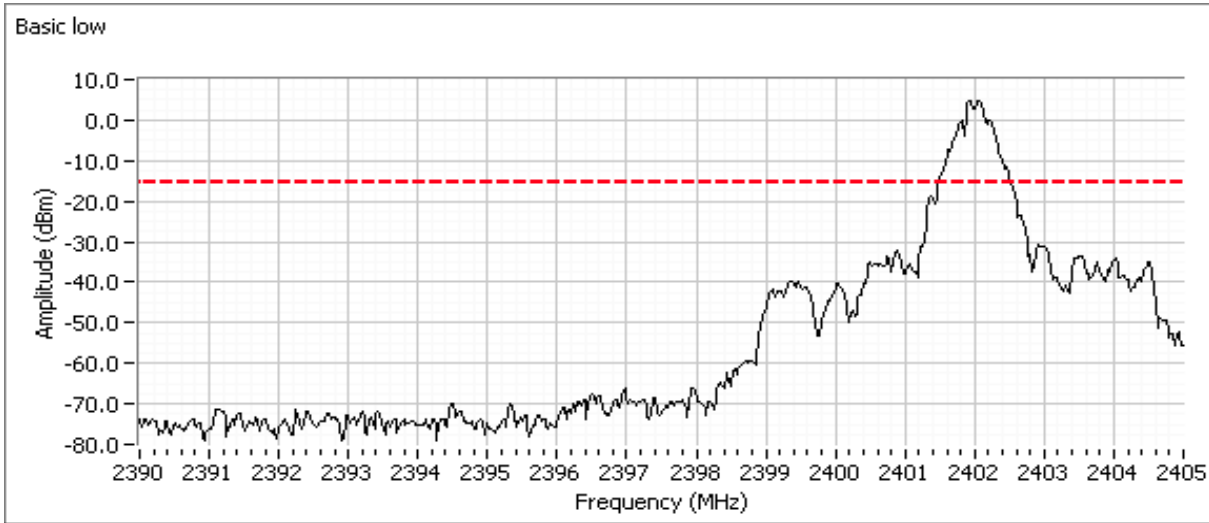

Center channel

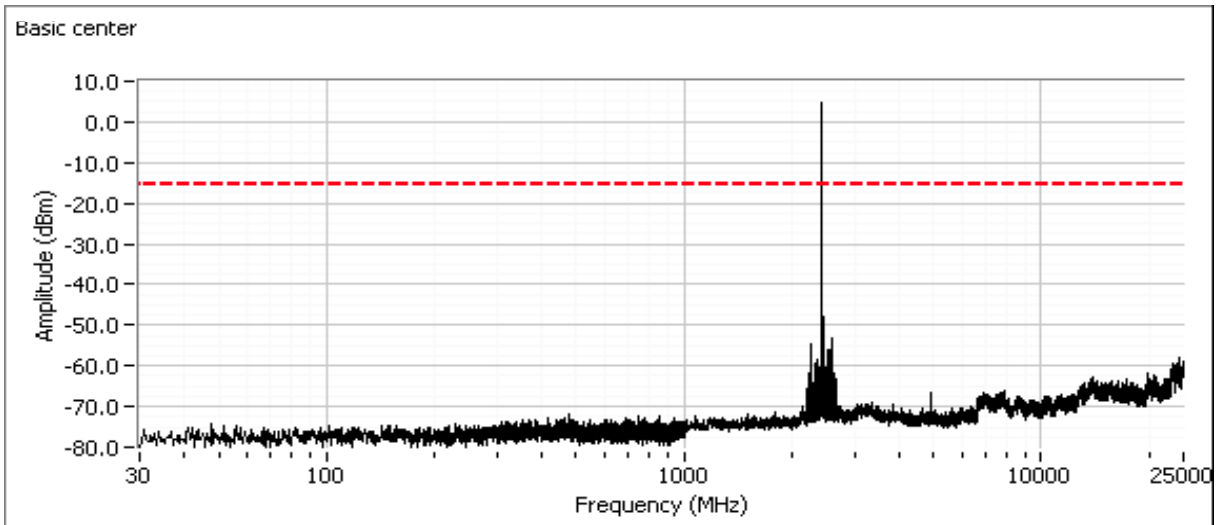

Client:	Intel	Job Number:	J88901
Model:	Intel® Centrino® Advanced-N 6235	T-Log Number:	T89578
Contact:	Steve Hackett	Account Manager:	Christine Krebill
Standard:	FCC 15.247, 15.407, 15.209, RSS 210	Class:	N/A

High channel

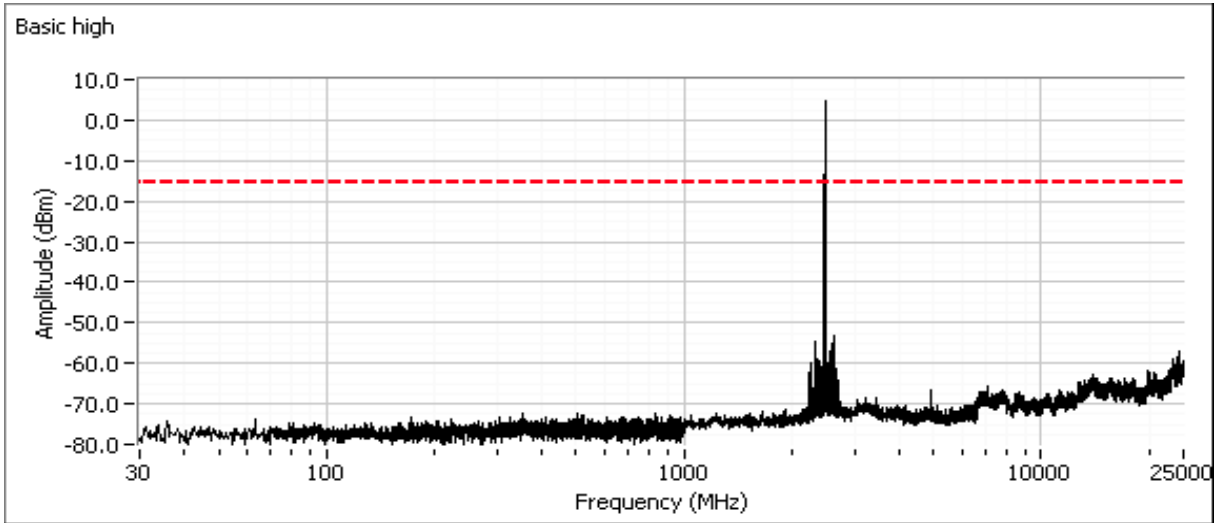

Plot showing -20dBc at the upper band edge

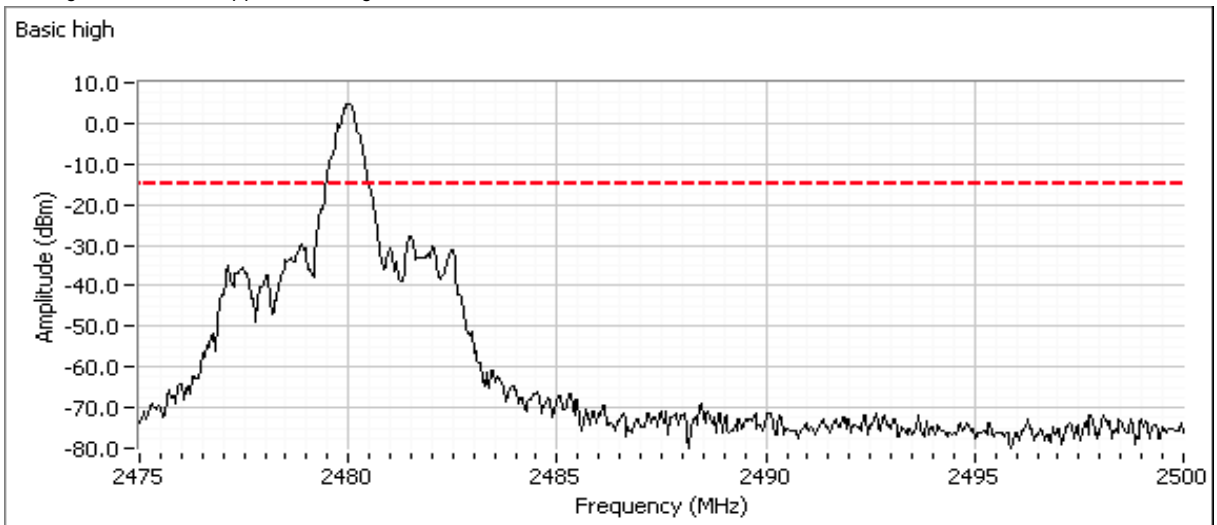

Client:	Intel	Job Number:	J88901
Model:	Intel® Centrino® Advanced-N 6235	T-Log Number:	T89578
Contact:	Steve Hackett	Account Manager:	Christine Krebill
Standard:	FCC 15.247, 15.407, 15.209, RSS 210	Class:	N/A

Refer to plots below. Scans made using RBW=VB=100 KHz with the limit line set at 20dB below the highest in-band signal level with the **hopping feature enabled** to show compliance with the -20dBc requirement at the allocated band edge. The spectrum analyzer is left in max hold mode until the trace stabilizes.

Low channel, hopping enabled

Plot showing -20dBc at the lower band edge

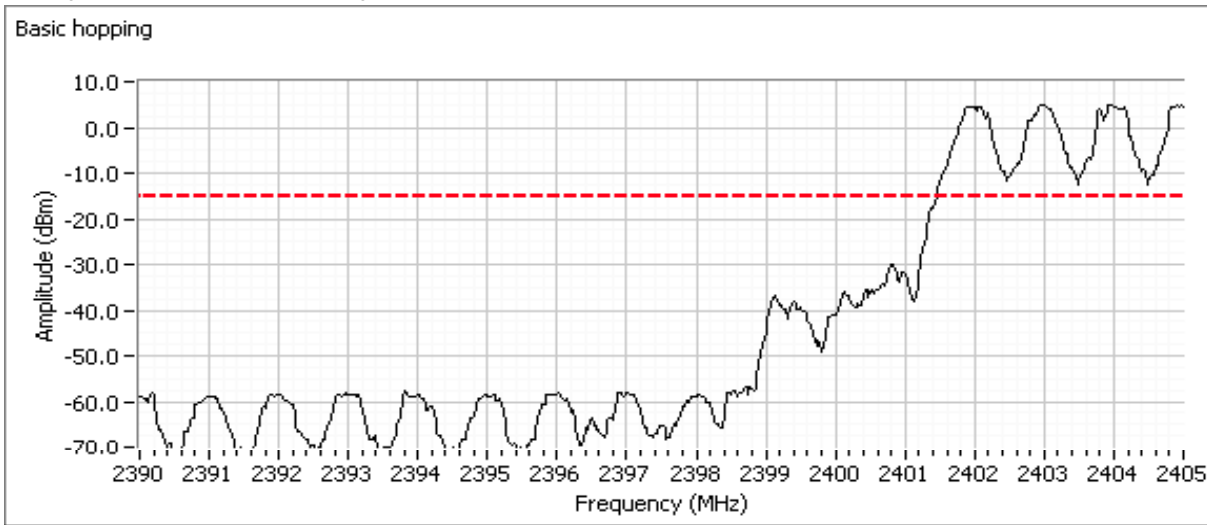

High channel, hopping enabled

Plot showing -20dBc at the upper band edge

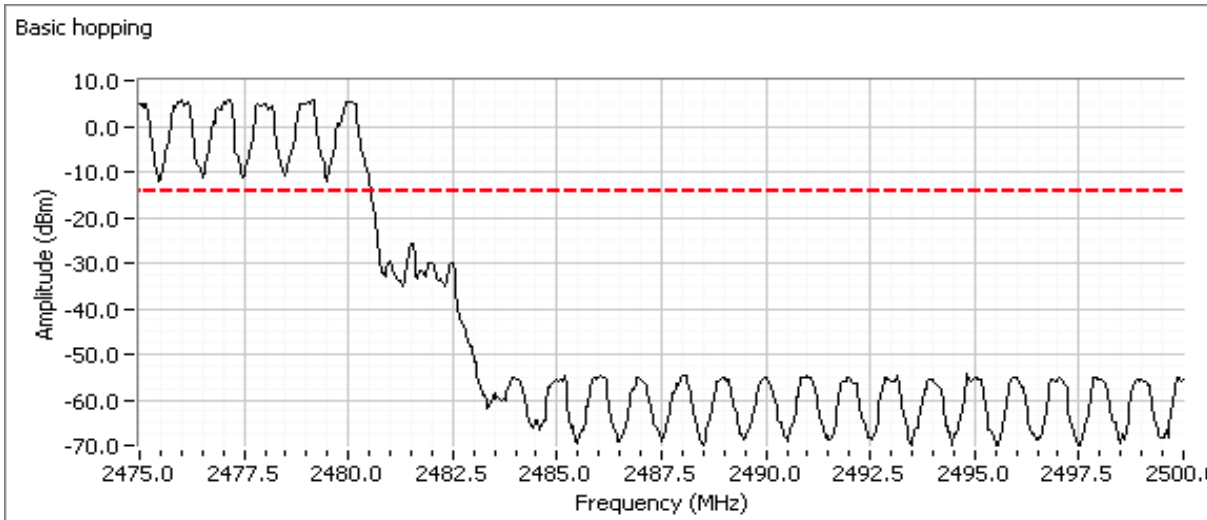

Client:	Intel	Job Number:	J88901
Model:	Intel® Centrino® Advanced-N 6235	T-Log Number:	T89578
Contact:	Steve Hackett	Account Manager:	Christine Krebill
Standard:	FCC 15.247, 15.407, 15.209, RSS 210	Class:	N/A

EDR (3Mb/s)

Low channel

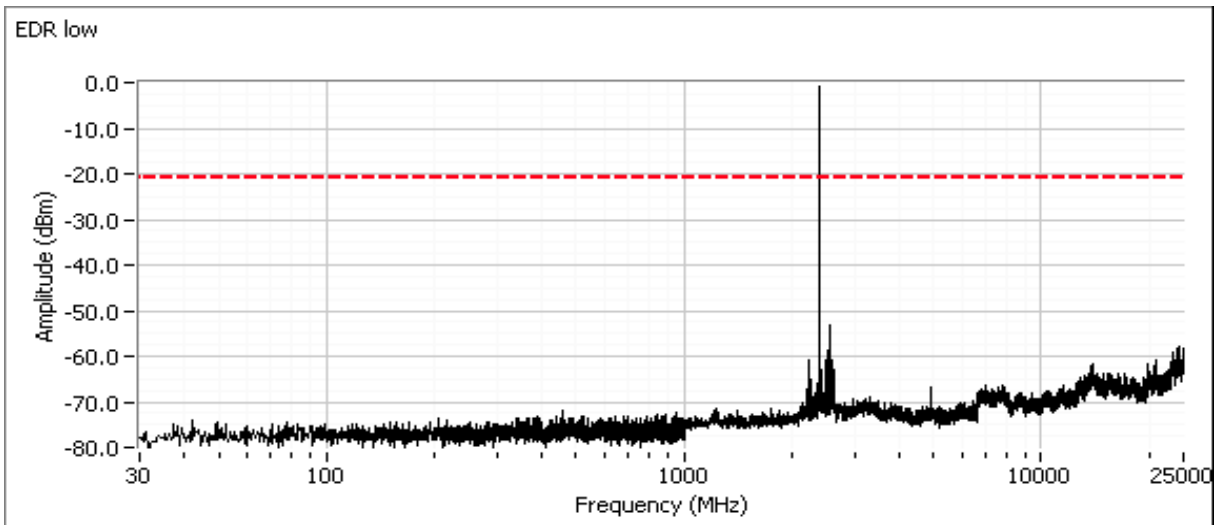

Plot showing -20dBc at the lower band edge

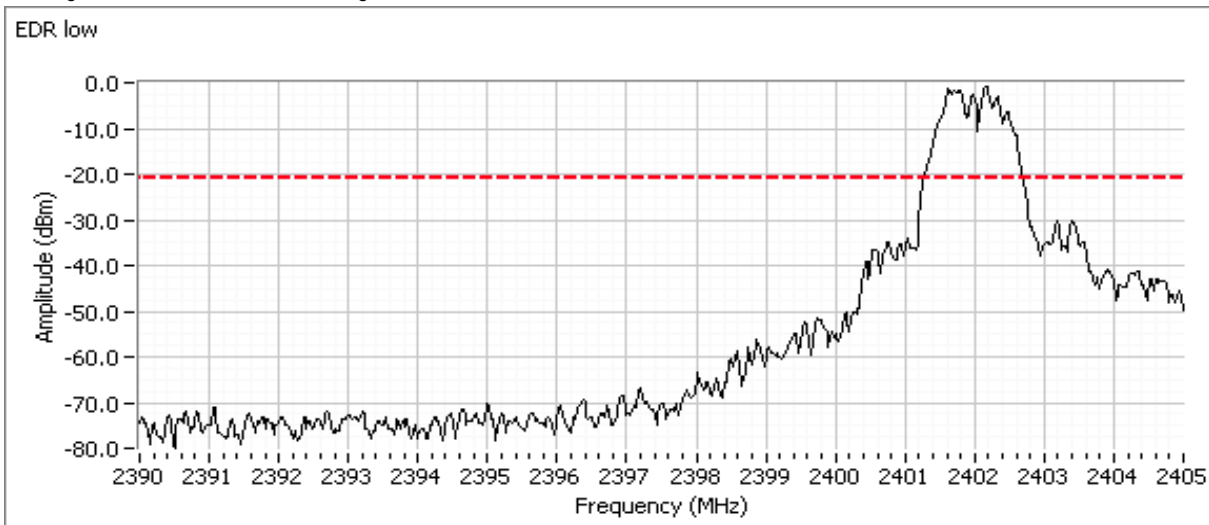

Client:	Intel	Job Number:	J88901
Model:	Intel® Centrino® Advanced-N 6235	T-Log Number:	T89578
Contact:	Steve Hackett	Account Manager:	Christine Krebill
Standard:	FCC 15.247, 15.407, 15.209, RSS 210	Class:	N/A

Center channel
Broadband plot

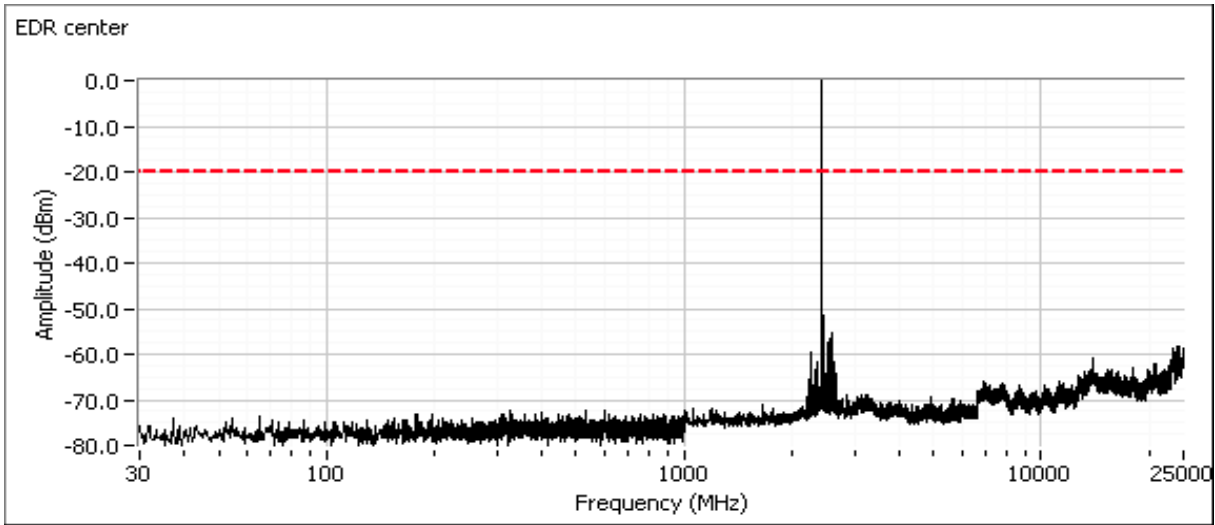

High channel

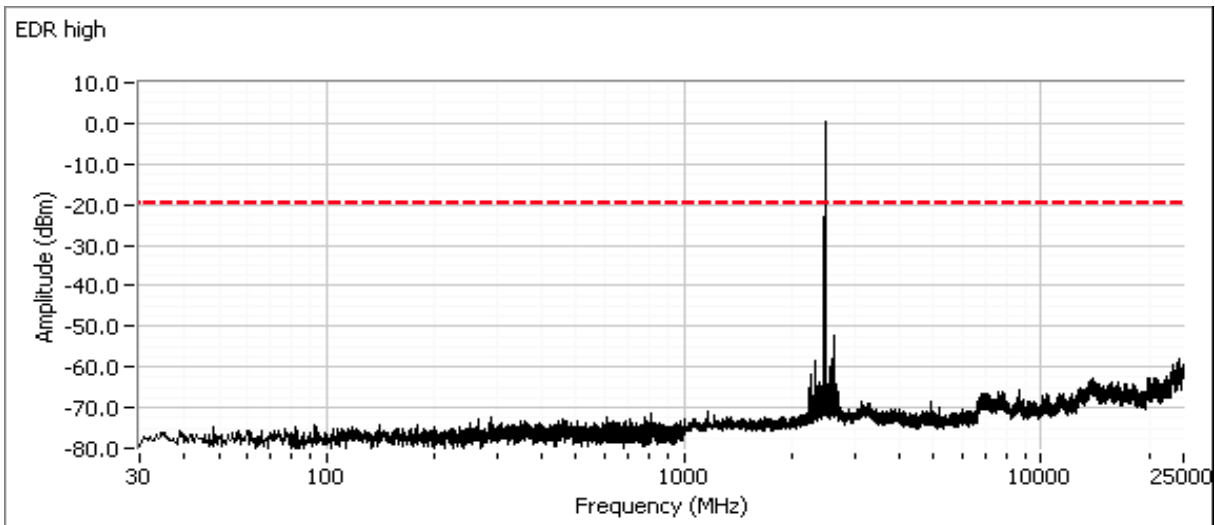

Client:	Intel	Job Number:	J88901
Model:	Intel® Centrino® Advanced-N 6235	T-Log Number:	T89578
Contact:	Steve Hackett	Account Manager:	Christine Krebill
Standard:	FCC 15.247, 15.407, 15.209, RSS 210	Class:	N/A

Plot showing -20dBc at the upper band edge

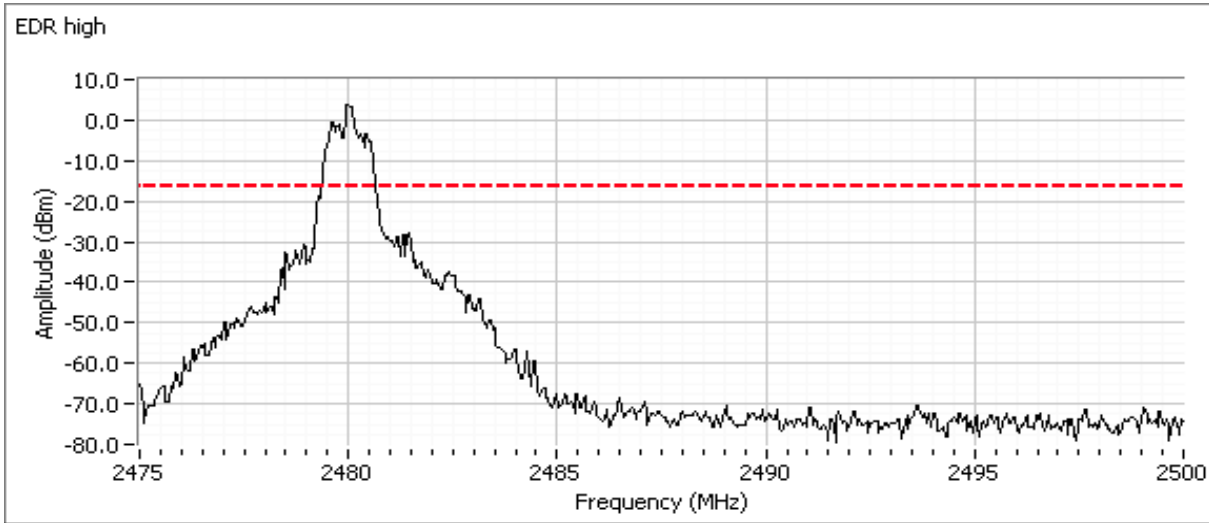

Client:	Intel	Job Number:	J88901
Model:	Intel® Centrino® Advanced-N 6235	T-Log Number:	T89578
Contact:	Steve Hackett	Account Manager:	Christine Krebill
Standard:	FCC 15.247, 15.407, 15.209, RSS 210	Class:	N/A

Refer to plots below. Scans made using RBW=VB=100 KHz with the limit line set at 20dB below the highest in-band signal level with the **hopping feature enabled** to show compliance with the -20dBc requirement at the allocated band edge. The spectrum analyzer is left in max hold mode until the trace stabilizes.

Low channel, hopping enabled

Plot showing -20dBc at the lower band edge

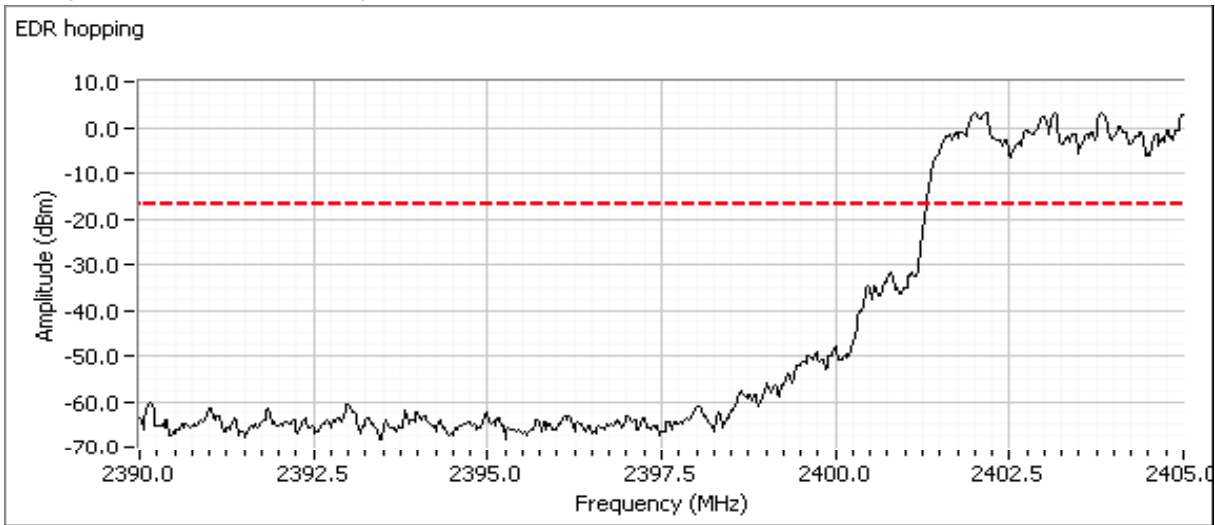

High channel, hopping enabled

Plot showing -20dBc at the upper band edge

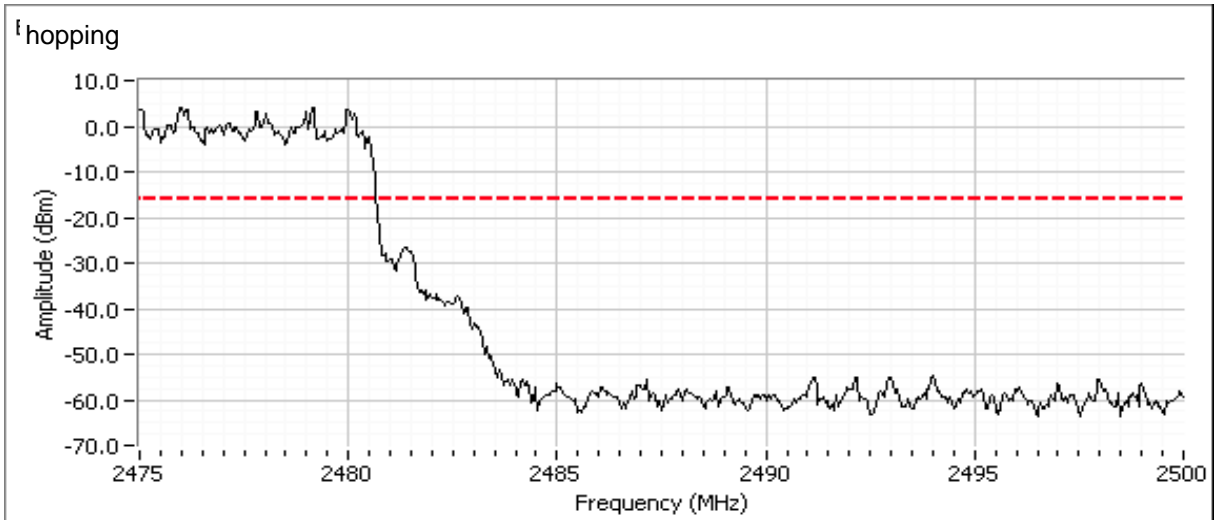



EMC Test Data

Client:	Intel	Job Number:	J88901
Model:	Intel® Centrino® Advanced-N 6235	T-Log Number:	T89578
Contact:	Steve Hackett	Account Manager:	Christine Krebill
Standard:	FCC 15.247, 15.407, 15.209, RSS 210	Class:	N/A

Run #2: Output Power

For frequency hopping systems operating in the 2400-2483.5 MHz band employing at least 75 non-overlapping hopping channels, and all frequency hopping systems in the 5725-5850 MHz band: 1 watt.
 For all other frequency hopping systems in the 2400-2483.5 MHz band: 0.125 watts.

Maximum antenna gain: 3.2 dBi

Mode	Channel	Frequency (MHz)	Res BW	Pavg	Output Power (dBm)	Output Power (W)	EIRP (W)
Basic	Low	2402	NA		5.7	0.0037	0.0078
	Mid	2440			5.9	0.0039	0.0081
	High	2480			6.1	0.0041	0.0085
EDR	Low	2402			4.6	0.0029	0.0060
	Mid	2440			4.7	0.0030	0.0062
	High	2480			4.6	0.0029	0.0060

Note 1: Output power is measured as a peak power using either a peak power meter or a spectrum analyzer with $VB > 3 \times RB$ and $RB > 20dB$ bandwidth. The actual method used was a peak power meter.

Note 2: The software setting for all modes & all channels was 8 dBm, the default maximum.

Run #3: Bandwidth, Channel Occupancy, Spacing and Number of Channels

Mode	Channel	Frequency (MHz)	Resolution Bandwidth	20dB Bandwidth (kHz)	Resolution Bandwidth	99% Bandwidth (kHz)
Basic	Low	2402	100 kHz	1042	30kHz	889
	Mid	2440		933	30kHz	894
	High	2480		892	30kHz	894
EDR	Low	2402		1383	30kHz	1178
	Mid	2440		1342	30kHz	1198
	High	2480		1350	30kHz	1203

Note 1: 20dB bandwidth measured using $RBW = 100$ kHz, $VBW = 300$ kHz.

Note 2: 99% bandwidth measured using $RB = 30$ kHz, $VB = 100$ kHz ($VB \geq 3RB$)



EMC Test Data

Client:	Intel	Job Number:	J88901
Model:	Intel® Centrino® Advanced-N 6235	T-Log Number:	T89578
Contact:	Steve Hackett	Account Manager:	Christine Krebill
Standard:	FCC 15.247, 15.407, 15.209, RSS 210	Class:	N/A

The channel spacing is 1MHz with a minimum of 20 channels and a maximum of 79 channels used. See plots below showing all 79 channels, with first channel at 2402 MHz and last channel at 2480 MHz

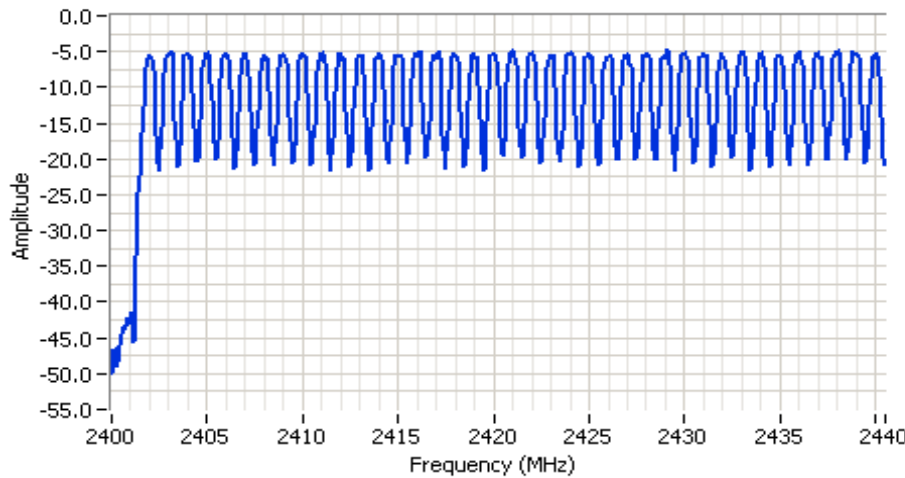

Analyzer Settings
 Agilent Technologies, E4446A
 CF: 2420.250 MHz
 SPAN: 40.500 MHz
 RB: 100 kHz
 VB: 100 kHz
 Detector: POS
 Attn: 10 DB
 RL Offset: 0.0 DB
 Sweep Time: 4.9ms
 Ref Lvl: 0.0 DBM

Comments
 BT basic
 # of channels

Cursor 1 2391.7734 0.78

0.0000 0.00

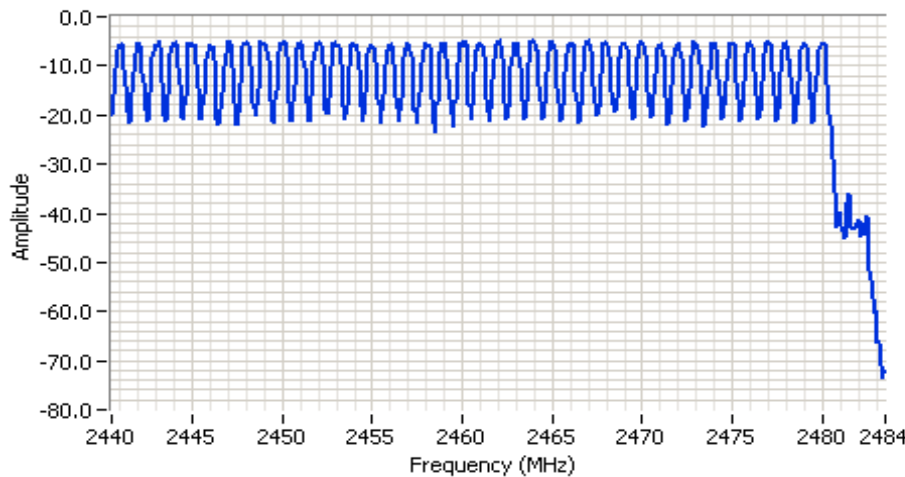

Analyzer Settings
 Agilent Technologies, E4446A
 CF: 2462.000 MHz
 SPAN: 43.000 MHz
 RB: 100 kHz
 VB: 100 kHz
 Detector: POS
 Attn: 10 DB
 RL Offset: 0.0 DB
 Sweep Time: 5.2ms
 Ref Lvl: 0.0 DBM

Comments
 BT basic
 # of channels

Cursor 1 2440.3880 4.17

0.0000 0.00





EMC Test Data

Client:	Intel	Job Number:	J88901
Model:	Intel® Centrino® Advanced-N 6235	T-Log Number:	T89578
		Account Manager:	Christine Krebill
Contact:	Steve Hackett		
Standard:	FCC 15.247, 15.407, 15.209, RSS 210	Class:	N/A

Requirement: Frequency hopping systems in the **2400-2483.5 MHz** band shall use at least 15 channels. The average time of occupancy on any channel shall not be greater than 0.4 seconds within a period of 0.4 seconds multiplied by the number of hopping channels employed. (Frequency hopping systems may avoid or suppress transmissions on a particular hopping frequency provided that a minimum of 15 channels are used.)

The device complies with the Bluetooth protocol and employs a minimum of 20 of the available 79 hopping channels when employing adaptive frequency hopping and all 79 channels when not. Channels are selected in a pseudo random manner to ensure, on average, all channels are used equally.

The hopping rate is 1600 hops per second although any one channel may be used for a single hop slot, 3 hop slots or 5 hop slots. The dwell time per channel is, therefore either 0.625ms (single slot), 1.875ms (three slot) or 3.125ms (five slot). The average time of occupancy will not exceed 0.4s in any time interval of 0.4s multiplied by the number of channels being used.



EMC Test Data

Client:	Intel	Job Number:	J88901
Model:	Intel® Centrino® Advanced-N 6235	T-Log Number:	T89578
Contact:	Steve Hackett	Account Manager:	Christine Krebill
Standard:	FCC 15.247, 15.407, 15.209, RSS 210	Class:	N/A

RSS 210 and FCC 15.247 (DSS) Radiated Spurious Emissions

Test Specific Details

Objective: The objective of this test session is to perform final qualification testing of the EUT with respect to the specification listed above.

General Test Configuration

The EUT and all local support equipment were located on the turntable for radiated spurious emissions testing. For radiated emissions testing the measurement antenna was located 3 meters from the EUT.

Ambient Conditions:

Temperature: 19 °C
Rel. Humidity: 40 %

Summary of Results - Device Operating in the 2400-2483.5 MHz Band

MAC Address: 001500B50405 DRTU Tool Version 1.5.6-0445 Driver version 15.3.1.2

Run #	Mode	Channel	Power Setting	Measured Power	Test Performed	Limit	Result / Margin
1a	Bluetooth basic rate (1Mb/s)	low	8	NA	Restricted Band Edge (2390 MHz)	FCC Part 15.209 / 15.247(c)	47.1 dBµV/m @ 2241.9 MHz (-6.9 dB)
1b		center			Radiated Emissions, 1 - 25 GHz		49.9 dBµV/m @ 4803.6 MHz (-4.1 dB)
1c		high			Radiated Emissions, 1 - 25 GHz		48.8 dBµV/m @ 4880.3 MHz (-5.2 dB)
2a	Bluetooth EDR (3 Mb/s)	low			Restricted Band Edge (2483.5 MHz)		52.2 dBµV/m @ 2483.5 MHz (-1.8 dB)
					Radiated Emissions, 1 - 25 GHz		46.3 dBµV/m @ 4960.1 MHz (-7.7 dB)
2b		center			Restricted Band Edge (2390 MHz)		46.2 dBµV/m @ 2241.9 MHz (-7.8 dB)
			Radiated Emissions, 1 - 25 GHz	50.3 dBµV/m @ 4804.0 MHz (-3.7 dB)			
2c		high	Radiated Emissions, 1 - 25 GHz	51.6 dBµV/m @ 4880.4 MHz (-2.4 dB)			
			Restricted Band Edge (2483.5 MHz)	52.6 dBµV/m @ 2483.9 MHz (-1.4 dB)			
					Radiated Emissions, 1 - 25 GHz		49.1 dBµV/m @ 4959.6 MHz (-4.9 dB)

Client: Intel	Job Number: J88901
Model: Intel® Centrino® Advanced-N 6235	T-Log Number: T89578
	Account Manager: Christine Krebill
Contact: Steve Hackett	
Standard: FCC 15.247, 15.407, 15.209, RSS 210	Class: N/A

Modifications Made During Testing

No modifications were made to the EUT during testing

Deviations From The Standard

No deviations were made from the requirements of the standard.

Antenna: antenna connected.

Basic data rate

Duty Cycle: 0.928

Correction Factor (dB) 0.7

Extended data rate

Duty Cycle: 0.935

Correction Factor (dB) 0.6

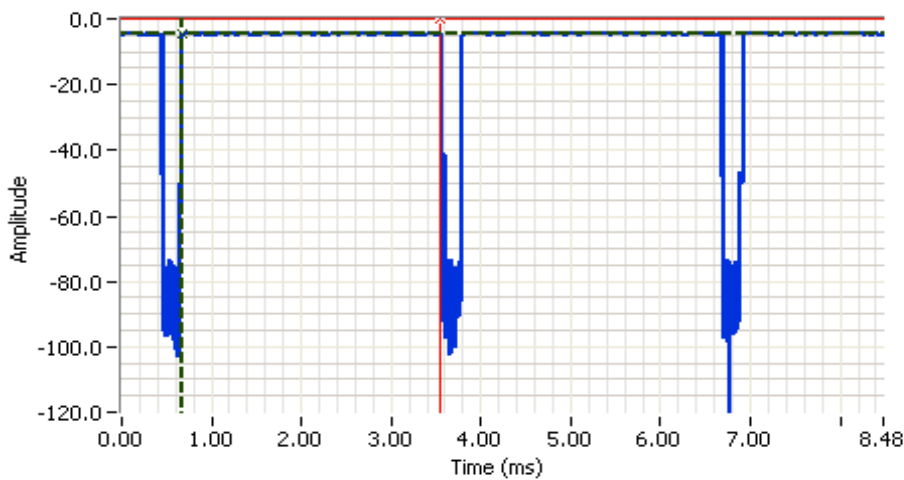

Analyzer Settings

Agilent Technologies, E4446A
 CF: 2440.000 MHz
 SPAN: 0.000 MHz
 RB: 1.000 MHz
 VB: 1.000 MHz
 Detector: Normal
 Attn: 10 DB
 RL Offset: 0.0 DB
 Sweep Time: 8.5ms
 Ref Lvl: 0.0 DBM

Comments

Cursor 1	0.6730	-4.41	⊕ ⊖ 🔒	Delta Time (ms)	2.87
Cursor 1	3.5446	0.00	⊕ ⊖ 🔒	Delta Amplitude	4.41
Start	0.4487				



Basic Rate



EMC Test Data

Client: Intel	Job Number: J88901
Model: Intel® Centrino® Advanced-N 6235	T-Log Number: T89578
Contact: Steve Hackett	Account Manager: Christine Krebill
Standard: FCC 15.247, 15.407, 15.209, RSS 210	Class: N/A

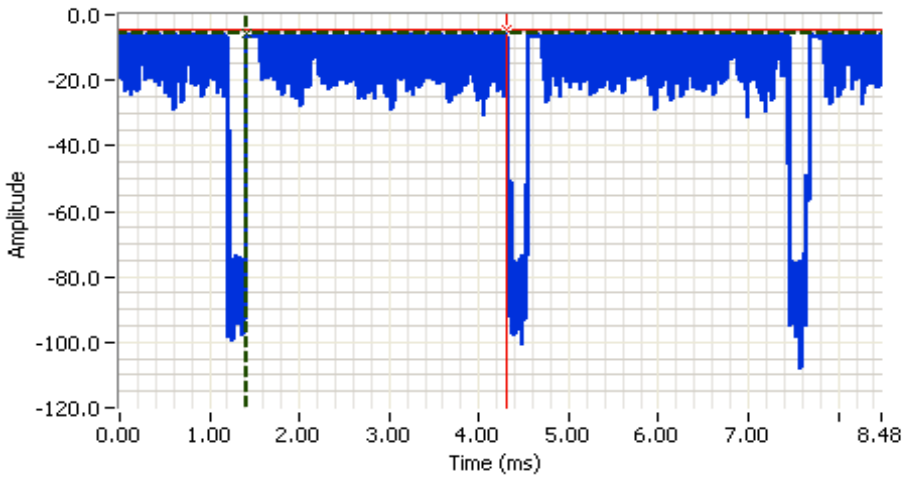

Analyzer Settings
Agilent Technologies, E4446A
CF: 2440.000 MHz
SPAN: 0.000 MHz
RB: 1.000 MHz
VB: 1.000 MHz
Detector: Normal
Attn: 10 DB
RL Offset: 0.0 DB
Sweep Time: 8.5ms
Ref Lvl: 0.0 DBM

Comments

Cursor 1	1.4133	-5.79		Delta Time (ms)	2.89
Cursor 1	4.3073	-4.55		Delta Amplitude	1.24
Start	1.2114				



EDR Rate



EMC Test Data

Client:	Intel	Job Number:	J88901
Model:	Intel® Centrino® Advanced-N 6235	T-Log Number:	T89578
Contact:	Steve Hackett	Account Manager:	Christine Krebill
Standard:	FCC 15.247, 15.407, 15.209, RSS 210	Class:	N/A

Run #1: Radiated Spurious Emissions, 1000-26000 MHz. Operating Mode: Basic data rate (1Mb/s)

Date of Test: 12/21/2012 & 12/26/12
 Test Engineer: John Caizzi

Test Location: Chamber 5
 Config Change: none

Run #1a, EUT on Channel #1 2402MHz

	Target (dBm)	Power Settings Measured (dBm)	Software Setting
Chain B	Max	NA	8.0

Band Edge Signal Field Strength - Direct measurement of field strength

Frequency	Level	Pol	15.209 / 15.247		Detector	Azimuth	Height	Comments
MHz	dB μ V/m	v/h	Limit	Margin	Pk/QP/Avg	degrees	meters	
2347.310	46.4	V	54.0	-7.6	PK	66	1.06	Pk reading vs avg limit.
2347.310	46.4	V	74.0	-27.6	PK	66	1.06	
2241.880	47.1	H	54.0	-6.9	PK	115	1.08	Pk reading vs avg limit.
2241.880	47.1	H	74.0	-26.9	PK	115	1.08	

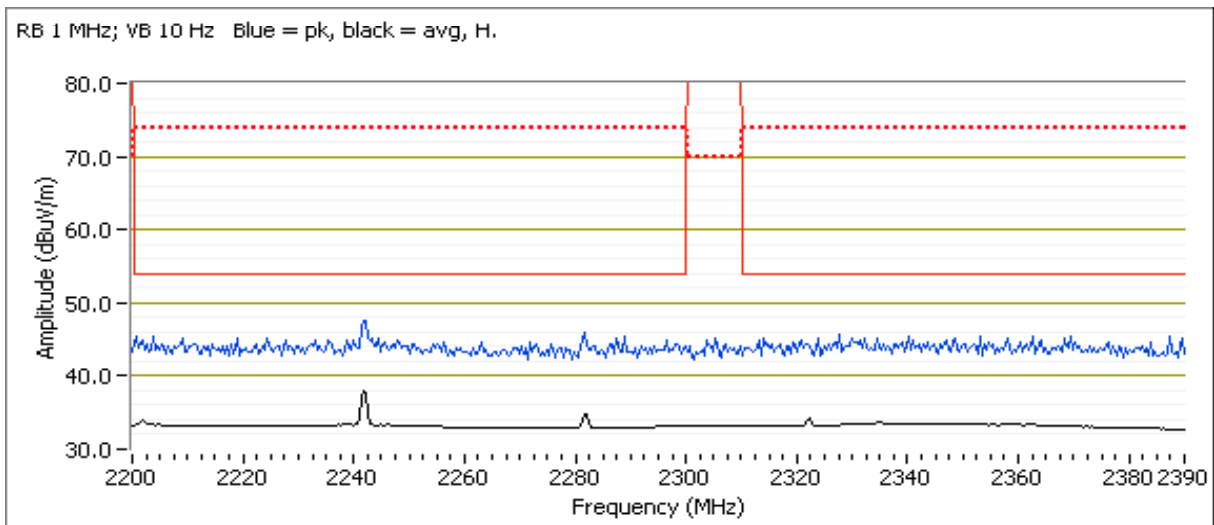



EMC Test Data

Client:	Intel	Job Number:	J88901
Model:	Intel® Centrino® Advanced-N 6235	T-Log Number:	T89578
Contact:	Steve Hackett	Account Manager:	Christine Krebill
Standard:	FCC 15.247, 15.407, 15.209, RSS 210	Class:	N/A

Spurious Radiated Emissions:

Frequency MHz	Level dB μ V/m	Pol v/h	15.209/15.247		Detector PK/QP/Avg	Azimuth degrees	Height meters	Comments
			Limit	Margin				
1191.670	42.4	V	54.0	-11.6	Peak	211	2.0	Not radio related.
1591.670	39.9	V	54.0	-14.1	Peak	144	1.0	Not radio related.
4803.630	49.9	V	54.0	-4.1	PK	270	1.58	Pk reading vs avg limit.
4803.630	49.9	V	74.0	-24.1	PK	270	1.58	
4923.940	44.8	V	54.0	-9.2	PK	269	2.50	Pk reading vs avg limit.
4923.940	44.8	V	74.0	-29.2	PK	269	2.50	

Note 1: For emissions in restricted bands, the limit of 15.209 was used.

Note 2: Since the center channel scan showed no emissions above 5 GHz, this scan was stopped at 11 GHz.

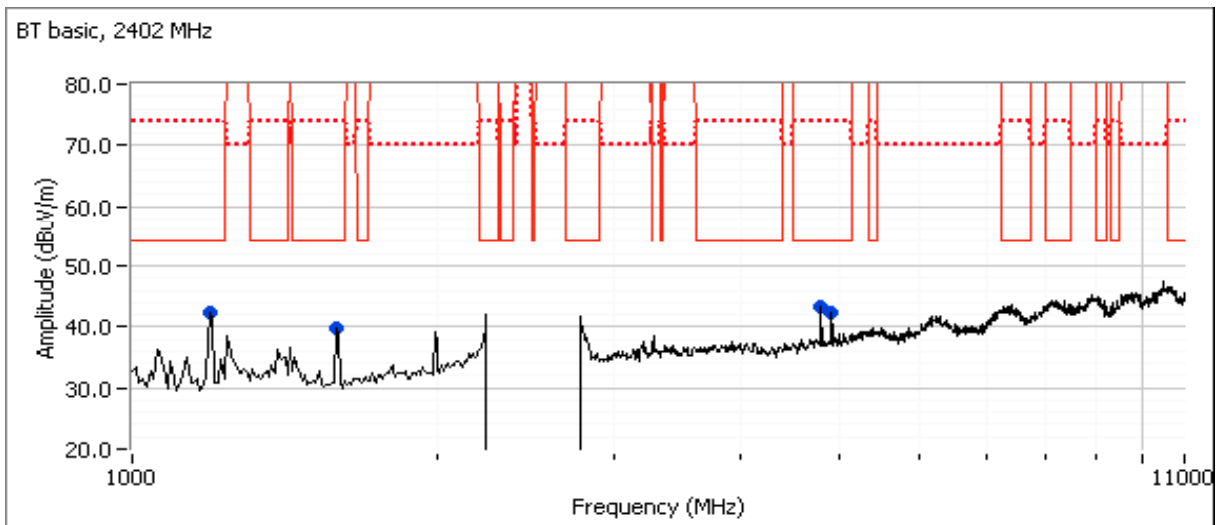

Client:	Intel	Job Number:	J88901
Model:	Intel® Centrino® Advanced-N 6235	T-Log Number:	T89578
Contact:	Steve Hackett	Account Manager:	Christine Krebill
Standard:	FCC 15.247, 15.407, 15.209, RSS 210	Class:	N/A

Run #1b: , EUT on Channel #39 2440MHz

	Target (dBm)	Power Settings Measured (dBm)	Software Setting
Chain B	Max	NA	8.0

Spurious Radiated Emissions:

Frequency	Level	Pol	15.209/15.247		Detector	Azimuth	Height	Comments
MHz	dBμV/m	v/h	Limit	Margin	Pk/QP/Avg	degrees	meters	
1191.670	42.0	H	54.0	-12.0	Peak	235	1.0	Not radio related.
1600.000	41.2	V	54.0	-12.8	Peak	39	1.0	Not radio related.
4880.310	48.8	V	54.0	-5.2	PK	275	1.38	Pk reading vs avg limit.
4880.310	48.8	V	74.0	-25.2	PK	275	1.38	
4924.000	41.1	V	54.0	-12.9	AVG	213	2.46	
4923.900	46.6	V	74.0	-27.4	PK	213	2.46	

Note 1: For emissions in restricted bands, the limit of 15.209 was used.

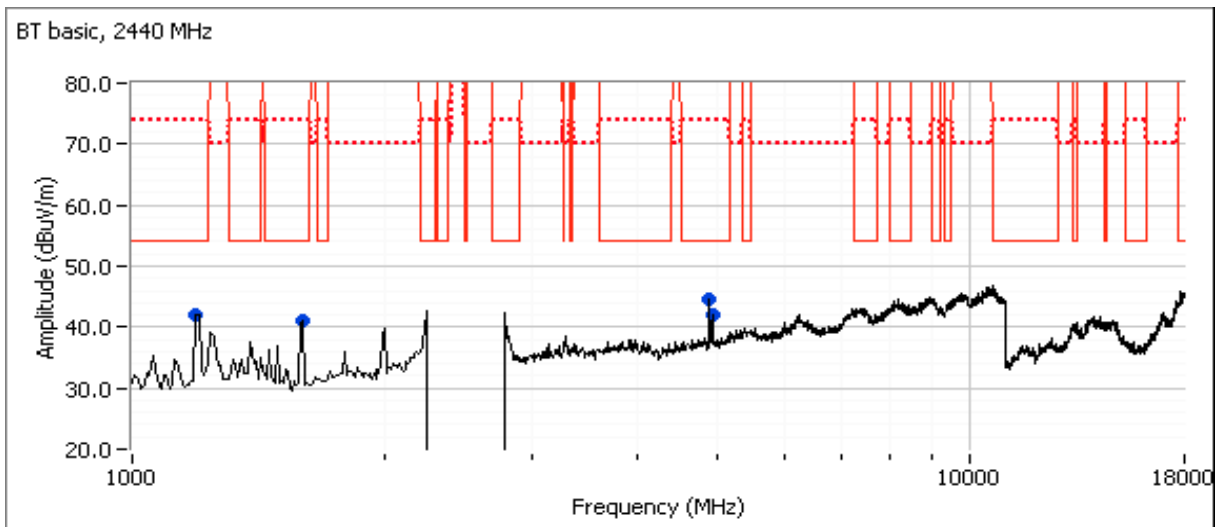

Client:	Intel	Job Number:	J88901
Model:	Intel® Centrino® Advanced-N 6235	T-Log Number:	T89578
Contact:	Steve Hackett	Account Manager:	Christine Krebill
Standard:	FCC 15.247, 15.407, 15.209, RSS 210	Class:	N/A

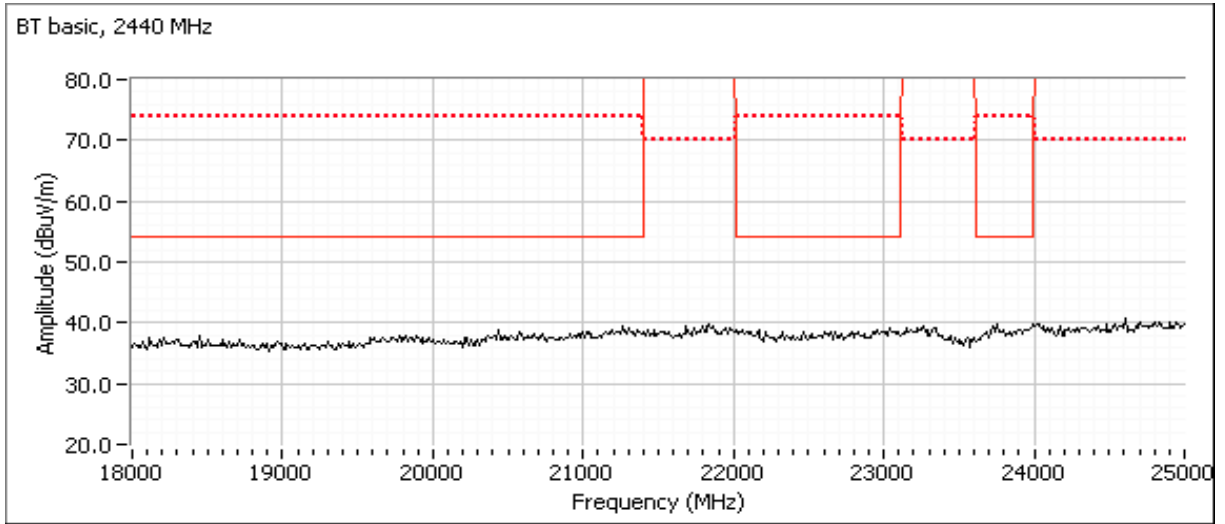



EMC Test Data

Client:	Intel	Job Number:	J88901
Model:	Intel® Centrino® Advanced-N 6235	T-Log Number:	T89578
Contact:	Steve Hackett	Account Manager:	Christine Krebill
Standard:	FCC 15.247, 15.407, 15.209, RSS 210	Class:	N/A

Run #1c: , EUT on Channel #79 2480MHz

	Target (dBm)	Power Settings Measured (dBm)	Software Setting
Chain B	Max	NA	8.0

Band Edge Signal Field Strength - Direct measurement of field strength

Frequency	Level	Pol	15.209 / 15.247		Detector	Azimuth	Height	Comments
MHz	dB μ V/m	v/h	Limit	Margin	PK/QP/Avg	degrees	meters	
2483.530	52.2	H	54.0	-1.8	PK	346	1.09	Pk reading vs avg limit.
2483.530	52.2	H	74.0	-21.8	PK	346	1.09	
2483.500	50.0	V	54.0	-4.0	PK	82	2.03	Pk reading vs avg limit.
2483.500	50.0	V	74.0	-24.0	PK	82	2.03	

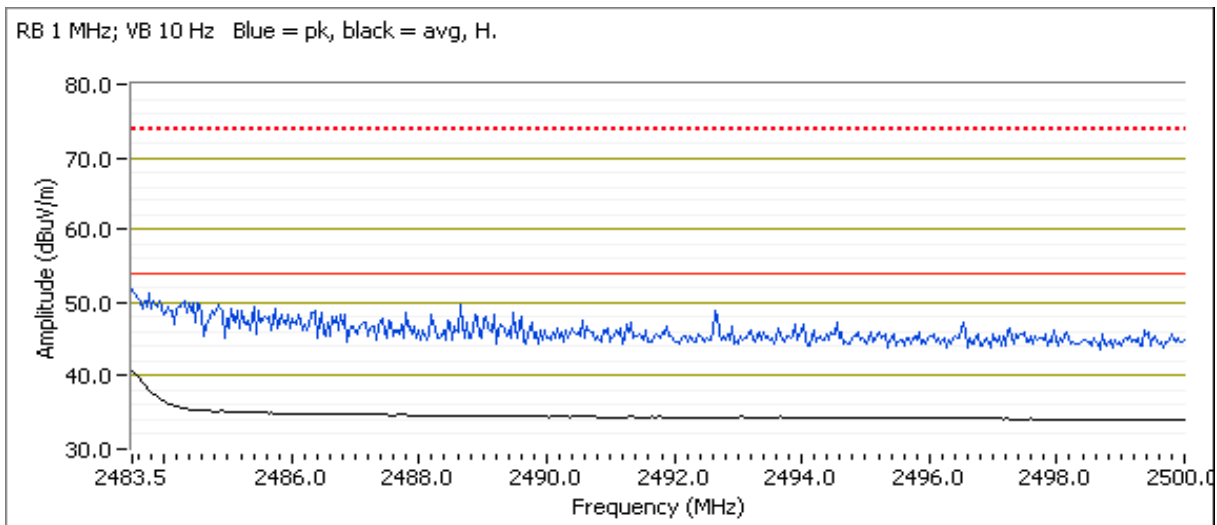

Spurious Radiated Emissions:

Frequency	Level	Pol	15.209/15.247		Detector	Azimuth	Height	Comments
MHz	dB μ V/m	v/h	Limit	Margin	PK/QP/Avg	degrees	meters	
1200.000	41.6	H	54.0	-12.2	Peak	125	1.0	Not radio related.
1591.670	39.5	V	54.0	-14.5	Peak	228	1.5	Not radio related.
4924.020	40.7	V	54.0	-13.3	AVG	214	2.25	
4923.940	46.4	V	74.0	-27.6	PK	214	2.25	
4960.120	46.3	V	54.0	-7.7	PK	276	1.69	Pk reading vs avg limit.
4960.120	46.3	V	74.0	-27.7	PK	276	1.69	

Client:	Intel	Job Number:	J88901
Model:	Intel® Centrino® Advanced-N 6235	T-Log Number:	T89578
Contact:	Steve Hackett	Account Manager:	Christine Krebill
Standard:	FCC 15.247, 15.407, 15.209, RSS 210	Class:	N/A

Note 1: For emissions in restricted bands, the limit of 15.209 was used. For all other emissions, the limit is -30dBc for peak measurements in a measurement bandwidth of 100kHz.

Note 2: Since the center channel scan showed no emissions above 5 GHz, this scan was stopped at 11 GHz.

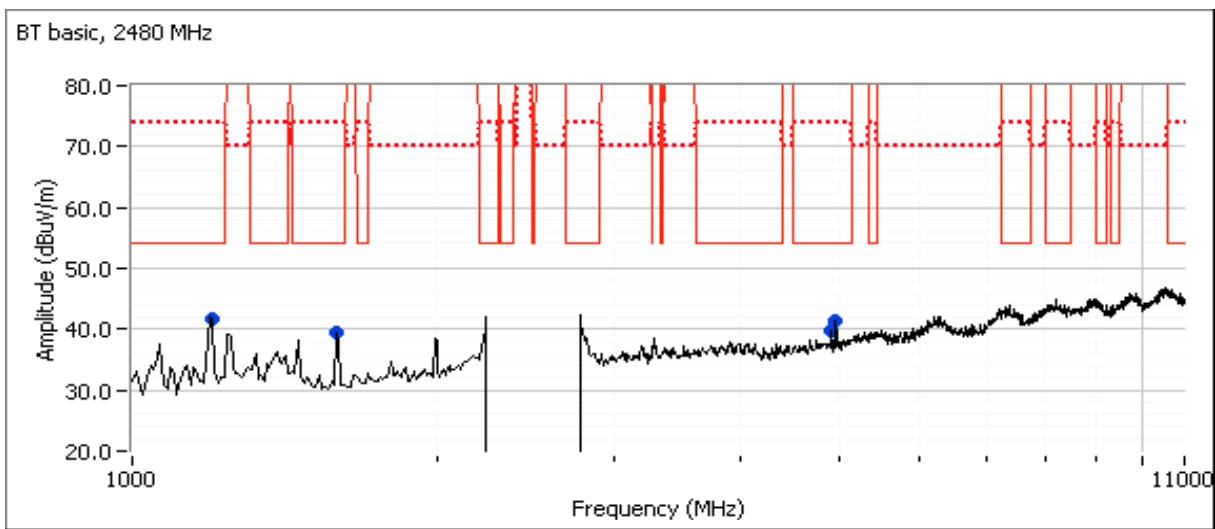



EMC Test Data

Client:	Intel	Job Number:	J88901
Model:	Intel® Centrino® Advanced-N 6235	T-Log Number:	T89578
Contact:	Steve Hackett	Account Manager:	Christine Krebill
Standard:	FCC 15.247, 15.407, 15.209, RSS 210	Class:	N/A

Run #2: Radiated Spurious Emissions, 1000-26000 MHz. Operating Mode: Extended data rate (3Mb/s)

Date of Test: 12/21/2012 & 12/26/12
 Test Engineer: John Caizzi

Test Location: Chamber 5
 Config Change: none

Run #2a, EUT on Channel #1 2402MHz

	Target (dBm)	Power Settings Measured (dBm)	Software Setting
Chain B	Max	NA	8.0

Band Edge Signal Field Strength - Direct measurement of field strength

Frequency	Level	Pol	15.209 / 15.247		Detector	Azimuth	Height	Comments
MHz	dB μ V/m	v/h	Limit	Margin	Pk/QP/Avg	degrees	meters	
2241.880	46.2	H	54.0	-7.8	PK	117	1.06	Pk reading vs avg limit.
2241.880	46.2	H	74.0	-27.8	PK	117	1.06	

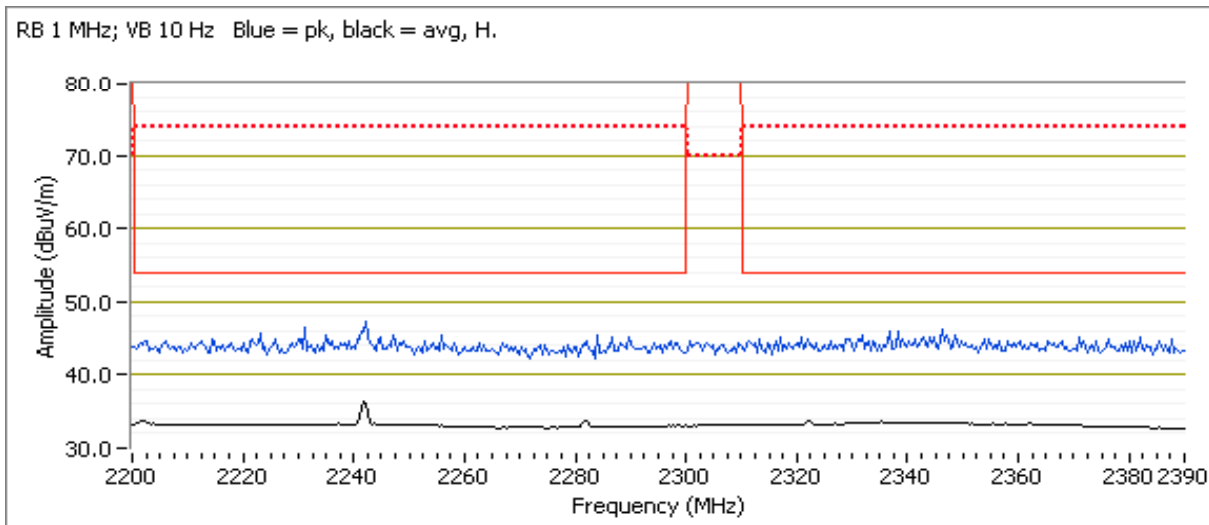



EMC Test Data

Client:	Intel	Job Number:	J88901
Model:	Intel® Centrino® Advanced-N 6235	T-Log Number:	T89578
Contact:	Steve Hackett	Account Manager:	Christine Krebill
Standard:	FCC 15.247, 15.407, 15.209, RSS 210	Class:	N/A

Spurious Radiated Emissions:

Frequency MHz	Level dBµV/m	Pol v/h	15.209/15.247		Detector PK/QP/Avg	Azimuth degrees	Height meters	Comments
			Limit	Margin				
1191.670	41.9	V	54.0	-12.1	Peak	250	1.5	Not radio related.
1591.670	41.2	V	54.0	-12.8	Peak	234	1.5	Not radio related.
4803.980	50.3	V	54.0	-3.7	PK	255	2.33	Pk reading vs avg limit.
4803.980	50.3	V	74.0	-23.7	PK	255	2.33	

- Note 1: For emissions in restricted bands, the limit of 15.209 was used.
- Note 2: Since the center channel scan showed no emissions above 5 GHz, this scan was stopped at 11 GHz.

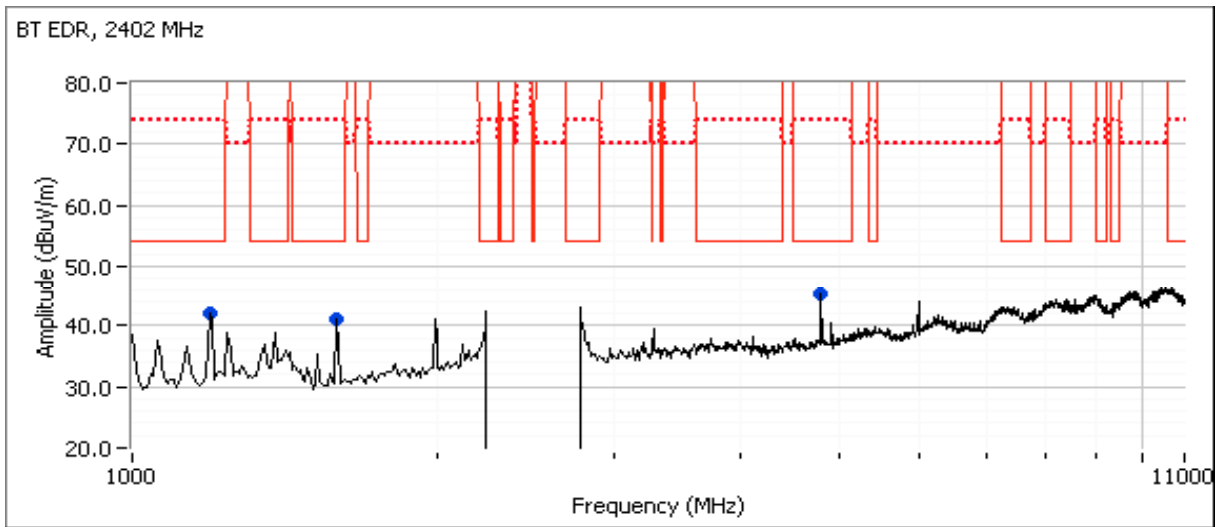

Client:	Intel	Job Number:	J88901
Model:	Intel® Centrino® Advanced-N 6235	T-Log Number:	T89578
Contact:	Steve Hackett	Account Manager:	Christine Krebill
Standard:	FCC 15.247, 15.407, 15.209, RSS 210	Class:	N/A

Run #2b: , EUT on Channel #39 2440MHz

	Target (dBm)	Power Settings Measured (dBm)	Software Setting
Chain B	Max	NA	8.0

Spurious Radiated Emissions:

Frequency	Level	Pol	15.209/15.247		Detector	Azimuth	Height	Comments
MHz	dB μ V/m	v/h	Limit	Margin	Pk/QP/Avg	degrees	meters	
1191.670	42.0	V	54.0	-12.0	Peak	198	1.0	Not radio related.
1600.000	38.7	V	54.0	-15.3	Peak	302	1.0	Not radio related.
4880.360	51.6	V	54.0	-2.4	PK	275	1.37	Pk reading vs avg limit.
4880.360	51.6	V	74.0	-22.4	PK	275	1.37	

Note 1: For emissions in restricted bands, the limit of 15.209 was used.

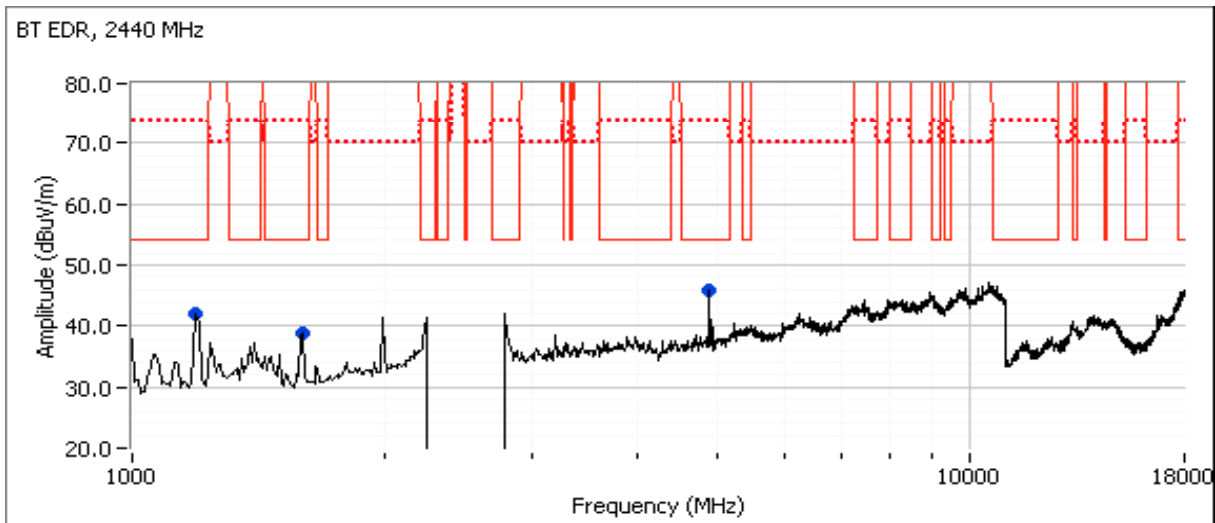

Client: Intel	Job Number: J88901
Model: Intel® Centrino® Advanced-N 6235	T-Log Number: T89578
	Account Manager: Christine Krebill
Contact: Steve Hackett	
Standard: FCC 15.247, 15.407, 15.209, RSS 210	Class: N/A

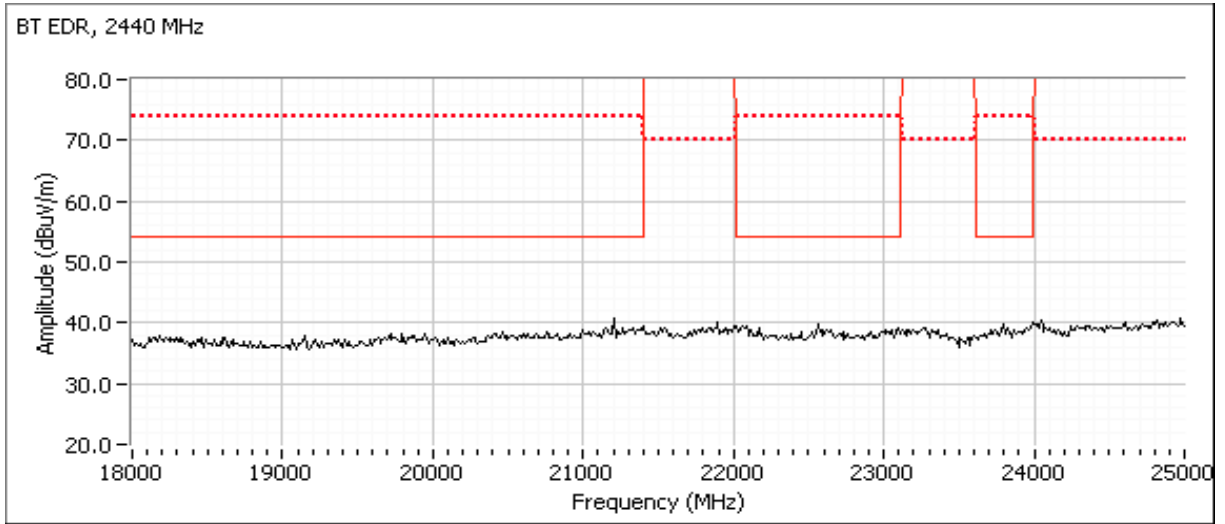



EMC Test Data

Client:	Intel	Job Number:	J88901
Model:	Intel® Centrino® Advanced-N 6235	T-Log Number:	T89578
Contact:	Steve Hackett	Account Manager:	Christine Krebill
Standard:	FCC 15.247, 15.407, 15.209, RSS 210	Class:	N/A

Run #2c: , EUT on Channel #79 2480MHz

	Target (dBm)	Power Settings Measured (dBm)	Software Setting
Chain B	Max	NA	8.0

Band Edge Signal Field Strength - Direct measurement of field strength

Frequency	Level	Pol	15.209 / 15.247		Detector	Azimuth	Height	Comments
MHz	dB μ V/m	v/h	Limit	Margin	Pk/QP/Avg	degrees	meters	
2483.860	56.0	H	54.0	2.0	PK	340	1.05	Note 2
2483.860	56.6	H	74.0	-17.4	PK	340	1.05	

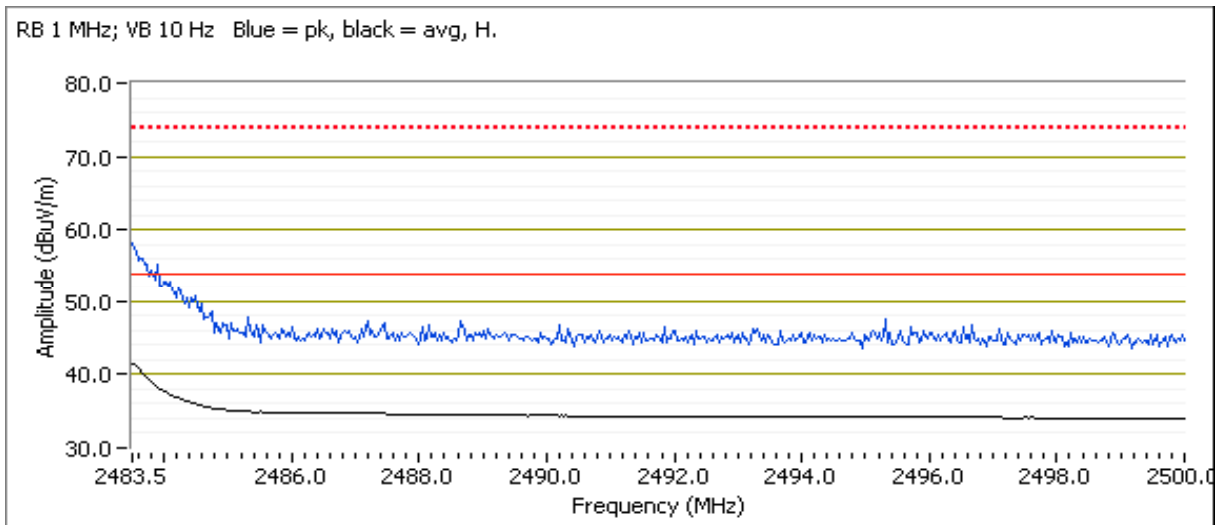

Spurious Radiated Emissions:

Frequency	Level	Pol	15.209/15.247		Detector	Azimuth	Height	Comments
MHz	dB μ V/m	v/h	Limit	Margin	Pk/QP/Avg	degrees	meters	
1191.670	43.5	V	54.0	-10.5	Peak	213	1.0	Not radio related.
1600.000	40.7	V	54.0	-13.3	Peak	125	1.5	Not radio related.
4959.600	49.1	V	54.0	-4.9	PK	282	2.24	Pk reading vs avg limit.
4959.600	49.1	V	74.0	-24.9	PK	282	2.24	

Note 1:	For emissions in restricted bands, the limit of 15.209 was used.
Note 2:	Calculated value based on the pk reading - the duty cycle correction factor.
Note 3:	Since the center channel scan showed no emissions above 5 GHz, this scan was stopped at 11 GHz.

Client: Intel	Job Number: J88901
Model: Intel® Centrino® Advanced-N 6235	T-Log Number: T89578
	Account Manager: Christine Krebill
Contact: Steve Hackett	
Standard: FCC 15.247, 15.407, 15.209, RSS 210	Class: N/A

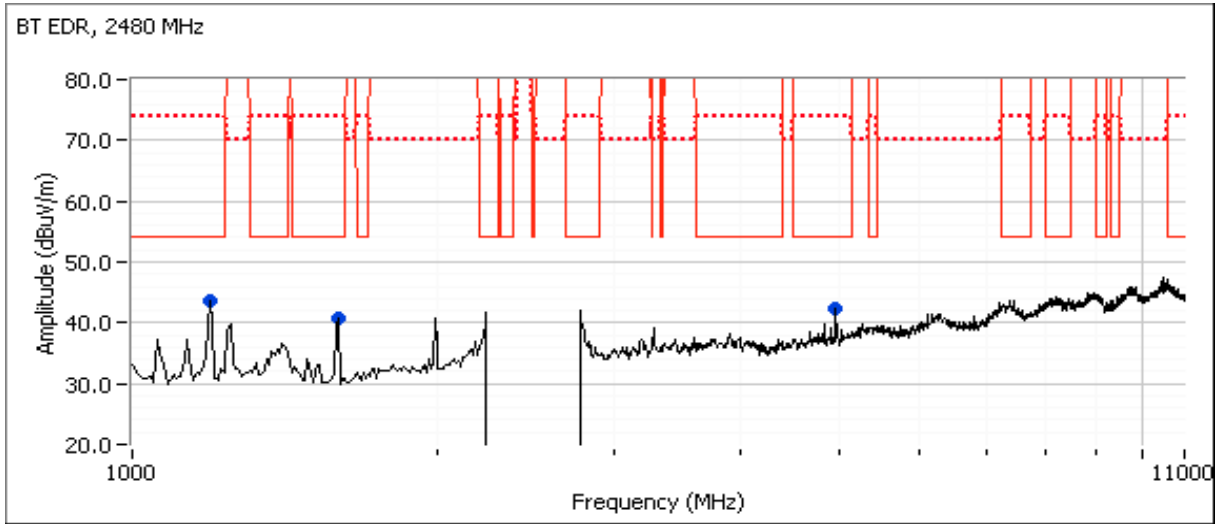



EMC Test Data

Client:	Intel	Job Number:	J88901
Model:	Intel® Centrino® Advanced-N 6235	T-Log Number:	T89578
		Account Manager:	Christine Krebill
Contact:	Steve Hackett		
Standard:	FCC 15.247, 15.407, 15.209, RSS 210	Class:	N/A

RSS 210 and FCC 15.247 (DTS) Radiated Spurious Emissions

Test Specific Details

Objective: The objective of this test session is to perform final qualification testing of the EUT with respect to the specification listed above.

General Test Configuration

The EUT and all local support equipment were located on the turntable for radiated spurious emissions testing. For radiated emissions testing the measurement antenna was located 3 meters from the EUT.

For Bluetooth: Tx is chain 2, Rx is chain 2. For WiFi, only Chain 1 is used for transmit in the 2.4GHz band, both chains used in 5GHz bands.

Ambient Conditions: Temperature: 13-15 °C
 Rel. Humidity: 35-45 %

Modifications Made During Testing

No modifications were made to the EUT during testing

Deviations From The Standard

No deviations were made from the requirements of the standard.

Notes:

Bluetooth uses a frequency hopping algorithm that means that the device, during normal operation, is only on a specific channel for a short period of time. The average correction factor is calculated as follows:

A maximum length packet has a duration of 5 time slots.

The hopping rate is 1600 hops/second so the maximum dwell time is 5/1600 seconds, or 3.125ms.

With a minimum of 20 hopping channels a channel will not be used more than 4 times in any 100ms period.

The maximum dwell time in a 100ms period is 4 x 3.125ms = 12.5ms.

The average correction factor is, therefore, $20\log(12.5/100) = -18\text{dB}$

As this is a hopping radio the correction factor can be applied to the average value of the signal provided the average value was measured with the device continuously transmitting. DA 00-0705 permits the use of the average correction on the measured average value for frequency hopping radios.

All measurements in this data sheet do not include the average correction factor.

Note - measured power in table below is average power using gated average power meter and is for reference only.



EMC Test Data

Client:	Intel	Job Number:	J88901
Model:	Intel® Centrino® Advanced-N 6235	T-Log Number:	T89578
Contact:	Steve Hackett	Account Manager:	Christine Krebill
Standard:	FCC 15.247, 15.407, 15.209, RSS 210	Class:	N/A

Summary of Results

MAC Address: 001500B50405 DRTU Tool Version 1.5.6-0445 Driver version 15.3.1.2

Run #	Mode	Channel	Power Setting	Measured Power	Test Performed	Limit	Result / Margin
1	BT 1Mb/s 802.11b	2402MHz 2412MHz	8.0 20.0	NA 12.4	Radiated Emissions 1- 10 GHz	FCC 15.247	52.8dBµV/m @ 4823.96MHz (-1.2 dB)
2	BT 1Mb/s 802.11b	2480MHz 2462MHz	8.0 23.5	NA 15.2		FCC 15.247	53.2dBµV/m @ 4923.98MHz (-0.8 dB)
3	BT 1Mb/s 802.11g	2402MHz 2412MHz	8.0 28.5	NA 14.5		FCC 15.247	46.6 dBµV/m @ 4824.0 MHz (-7.4 dB)
4	BT 1Mb/s 802.11g	2480MHz 2462MHz	8.0 28.0	NA 14.1		FCC 15.247	41.5 dBµV/m @ 4924.1 MHz (-12.5 dB)

WiFi mode for the following runs based on worst case mode from runs 1 through 4

5	BT 1Mb/s 802.11b	2402MHz 2437MHz	8.0 21.0	NA 13.3	Radiated Emissions 1- 10 GHz	FCC 15.247	53.3 dBµV/m @ 4874.0 MHz (-0.7 dB)
6	BT 1Mb/s 802.11b	2440MHz 2412MHz	8.0 20.5	NA 12.7		FCC 15.247	52.8 dBµV/m @ 4824.0 MHz (-1.2 dB)
7	BT 1Mb/s 802.11b	2440MHz 2462MHz	8.0 25.0	NA 16.6	Radiated Emissions 1- 10 GHz	FCC 15.247	51.2 dBµV/m @ 4924.0 MHz (-2.8 dB)
8	BT 1Mb/s 802.11b	2480MHz 2437MHz	8.0 23.0	NA 14.8		FCC 15.247	52.8 dBµV/m @ 4874.0 MHz (-1.2 dB)

WiFi mode and channel and Bluetooth channel based on the worst case mode from runs 1 through 8

9	BT 3Mb/s 802.11b	2402MHz 2412MHz	8.0 21.0	NA 13.1	Radiated Emissions 1- 10 GHz	FCC 15.247	52.7 dBµV/m @ 4824.0 MHz (-1.3 dB)
10	BTLE 802.11b	2402MHz 2412MHz	NA 22.0	NA 14.1		FCC 15.247	53.0 dBµV/m @ 4824.0 MHz (-1.0 dB)

WiFi mode - 802.11n 20MHz with both chains active at 16.5dBm per chain, center channel in each 5GHz band. Bluetooth on center channel, 1Mb/s mode

11	BT 1Mb/s 802.11n20	2440MHz 5200MHz	8.0 39.0 / 39.0	NA 14.3 / 13.5	Radiated Emissions 1- 15 GHz	FCC 15.247	58.5 dBµV/m @ 10399.7 MHz (-9.8 dB)
12	BT 1Mb/s 802.11n20	2440MHz 5300MHz		NA 14.2 / 13.2			45.8 dBµV/m @ 10600.7 MHz (-8.2 dB)
13	BT 1Mb/s 802.11n20	2440MHz 5580MHz		NA 12.8 / 13.9			46.4 dBµV/m @ 11159.7 MHz (-7.6 dB)
14	BT 1Mb/s 802.11n20	2440MHz 5785MHz		NA 11.2 / 11.1			47.9 dBµV/m @ 11569.8 MHz (-6.1 dB)



EMC Test Data

Client:	Intel	Job Number:	J88901
Model:	Intel® Centrino® Advanced-N 6235	T-Log Number:	T89578
Contact:	Steve Hackett	Account Manager:	Christine Krebill
Standard:	FCC 15.247, 15.407, 15.209, RSS 210	Class:	N/A

Run #1: 1-10GHz, 802.11b @ 2412 MHz Chain A, BT Basic Rate @ 2402 MHz Chain B
 Date of Test: 12/26/2012 & 12/27/2012 Test Location: FT chambers #5 & #4
 Test Engineer: M. Birgani & J. Caizzi Config Change: -

	Target (dBm)	Power Settings Measured (dBm)	Software Setting
Chain A	16.5	12.4	20.0
Chain B	NA	5.5	8.0

Note - measured power in table above is average power using gated average power meter and is for reference only.

Preliminary Measurements (Peak versus average limit)

Frequency	Level	Pol	15.209/15.247		Detector	Azimuth	Height	Comments
MHz	dB μ V/m	v/h	Limit	Margin	PK/QP/Avg	degrees	meters	
4825.000	55.4	V	54.0	1.4	Pk	279	1.7	

Spurious Emissions excluding allocated band (final measurements at 3m)

Frequency	Level	Pol	15.209 / 15.247		Detector	Azimuth	Height	Comments
MHz	dB μ V/m	v/h	Limit	Margin	PK/QP/Avg	degrees	meters	
4823.960	52.8	V	54.0	-1.2	AVG	279	1.7	Setting: 20.0, 1Mbps (12.4dBm)
4823.990	55.4	V	74.0	-18.6	PK	279	1.7	Setting: 20.0, 1Mbps (12.4dBm)

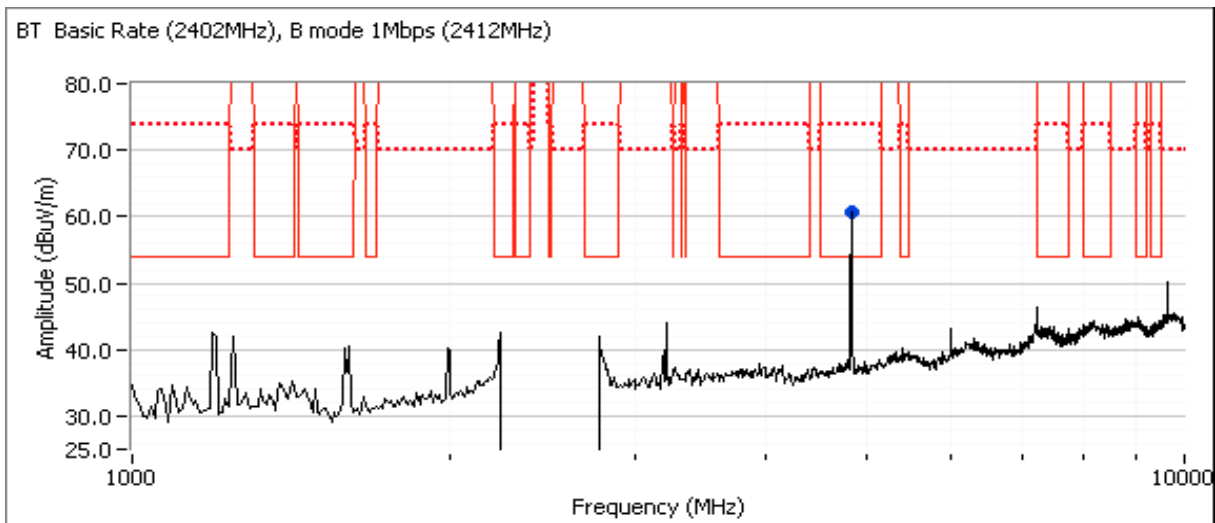



EMC Test Data

Client:	Intel	Job Number:	J88901
Model:	Intel® Centrino® Advanced-N 6235	T-Log Number:	T89578
Contact:	Steve Hackett	Account Manager:	Christine Krebill
Standard:	FCC 15.247, 15.407, 15.209, RSS 210	Class:	N/A

Preliminary Measurements (Peak versus average limit) at 20-30cm from EUT

Frequency	Level	Pol	15.209/15.247		Detector	Azimuth	Height	Comments
MHz	dB μ V/m	v/h	Limit	Margin	Pk/QP/Avg	degrees	meters	

Spurious Emissions near allocated band (final measurements at 3m)

Frequency	Level	Pol	15.209 / 15.247		Detector	Azimuth	Height	Comments
MHz	dB μ V/m	v/h	Limit	Margin	Pk/QP/Avg	degrees	meters	

Note 1: For emissions in restricted bands, the limit of 15.209 was used. For all other emissions, the limit was set 30dB below the level of the fundamental and measured in 100kHz.

Note 2: Signal is not in a restricted band but the more stringent restricted band limit was used.

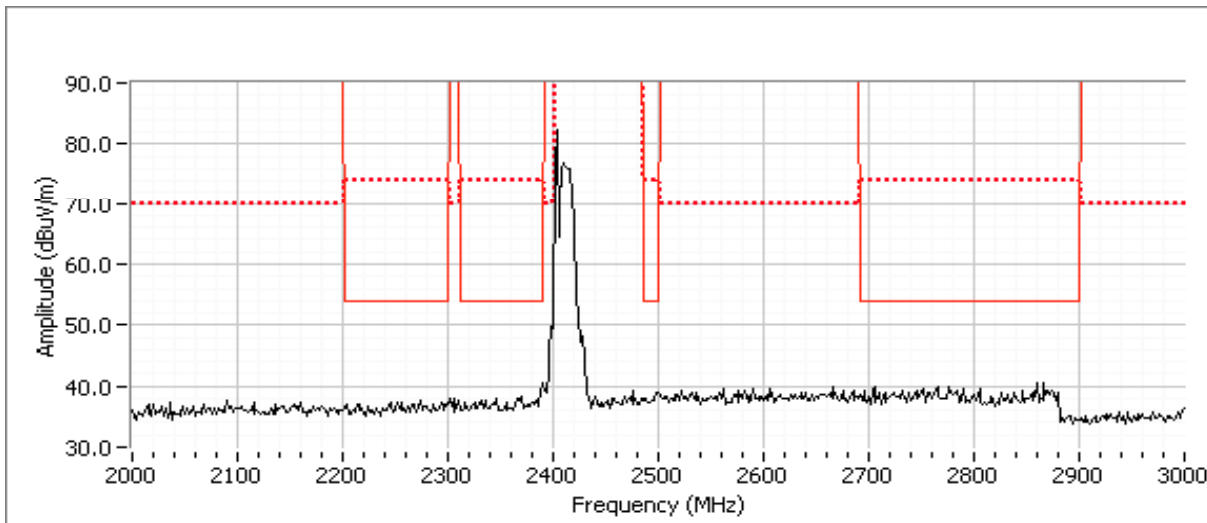



EMC Test Data

Client:	Intel	Job Number:	J88901
Model:	Intel® Centrino® Advanced-N 6235	T-Log Number:	T89578
Contact:	Steve Hackett	Account Manager:	Christine Krebill
Standard:	FCC 15.247, 15.407, 15.209, RSS 210	Class:	N/A

Run #2: 1-10GHz, 802.11b @ 2462 MHz Chain A, BT Basic Rate @ 2480 MHz Chain B
 Date of Test: 12/26/2012 & 12/27/2012 Test Location: FT chambers #5 & #4
 Test Engineer: M. Birgani & J. Caizzi Config Change: -

	Target (dBm)	Power Settings Measured (dBm)	Software Setting
Chain A	16.5	15.2	23.5
Chain B	NA		8.0

Note - measured power in table above is average power using gated average power meter and is for reference only.

Preliminary Measurements (Peak versus average limit)

Frequency	Level	Pol	15.209/15.247		Detector	Azimuth	Height	Comments
MHz	dB μ V/m	v/h	Limit	Margin	PK/QP/Avg	degrees	meters	
4925.000	55.7	V	54.0	1.7	Peak	63	1.0	

Spurious Emissions excluding allocated band (final measurements at 3m)

Frequency	Level	Pol	15.209 / 15.247		Detector	Azimuth	Height	Comments
MHz	dB μ V/m	v/h	Limit	Margin	PK/QP/Avg	degrees	meters	
4923.980	53.2	V	54.0	-0.8	AVG	63	1.0	Setting: 23.5 (15.2dBm)
4924.070	55.7	V	74.0	-18.3	PK	63	1.0	Setting: 23.5 (15.2dBm)

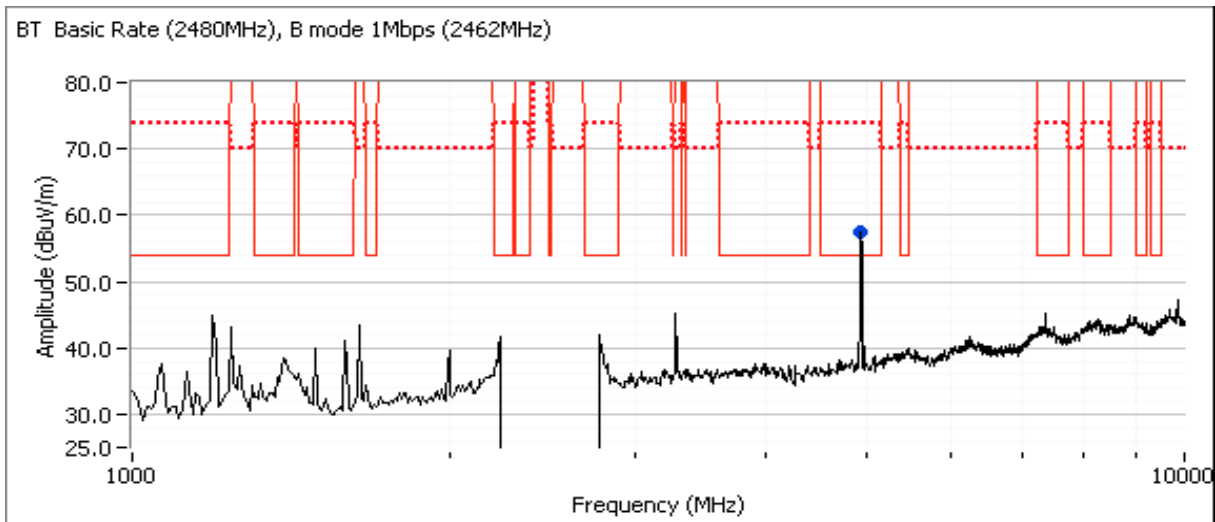



EMC Test Data

Client: Intel	Job Number: J88901
Model: Intel® Centrino® Advanced-N 6235	T-Log Number: T89578
	Account Manager: Christine Krebill
Contact: Steve Hackett	
Standard: FCC 15.247, 15.407, 15.209, RSS 210	Class: N/A

Preliminary Measurements (Peak versus average limit) at 20-30cm from EUT

Frequency	Level	Pol	15.209/15.247		Detector	Azimuth	Height	Comments
MHz	dB μ V/m	v/h	Limit	Margin	PK/QP/Avg	degrees	meters	

Spurious Emissions near allocated band (final measurements at 3m)

Frequency	Level	Pol	15.209 / 15.247		Detector	Azimuth	Height	Comments
MHz	dB μ V/m	v/h	Limit	Margin	PK/QP/Avg	degrees	meters	

Note 1: For emissions in restricted bands, the limit of 15.209 was used. For all other emissions, the limit was set 30dB below the level of the fundamental and measured in 100kHz.

Note 2: Signal is not in a restricted band but the more stringent restricted band limit was used.

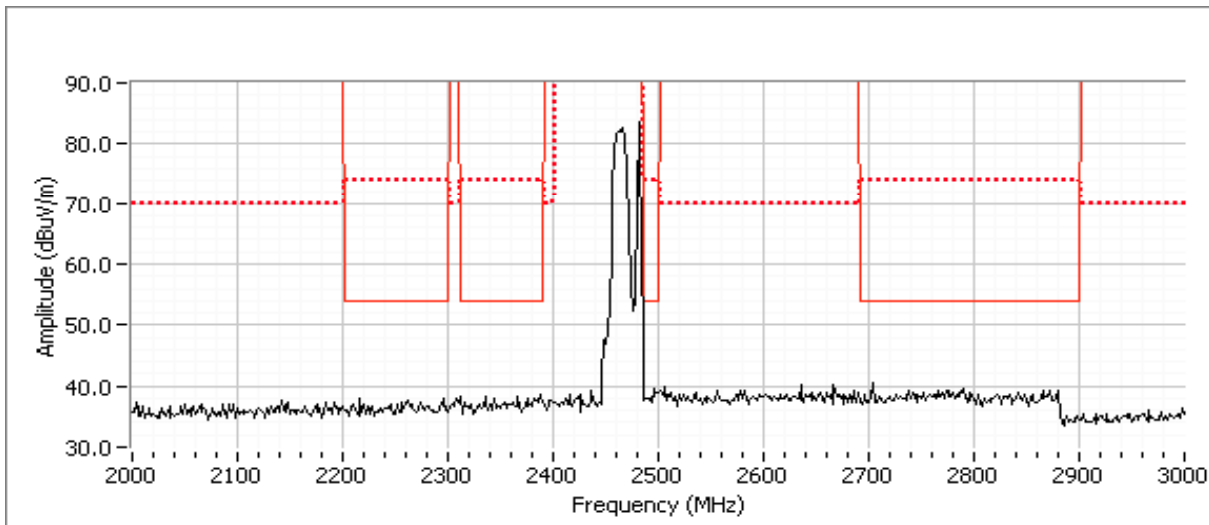



EMC Test Data

Client: Intel	Job Number: J88901
Model: Intel® Centrino® Advanced-N 6235	T-Log Number: T89578
Contact: Steve Hackett	Account Manager: Christine Krebill
Standard: FCC 15.247, 15.407, 15.209, RSS 210	Class: N/A

Run #3: 1-10GHz, 802.11g @ 2412 MHz Chain A, BT Basic Rate @ 2402 MHz Chain B
 Date of Test: 12/26/2012 Test Location: FT chamber #5
 Test Engineer: M. Birgani Config Change: -

	Target (dBm)	Power Settings Measured (dBm)	Software Setting
Chain A	14.5	14.5	28.5
Chain B	NA		8.0

Note - measured power in table above is average power using gated average power meter and is for reference only.

Preliminary Measurements (Peak versus average limit)

Frequency	Level	Pol	15.209/15.247		Detector	Azimuth	Height	Comments
MHz	dB μ V/m	v/h	Limit	Margin	PK/QP/Avg	degrees	meters	
4825.000	49.1	V	54.0	-4.9	Peak	235	1.5	

Spurious Emissions excluding allocated band (final measurements at 3m)

Frequency	Level	Pol	15.209 / 15.247		Detector	Azimuth	Height	Comments
MHz	dB μ V/m	v/h	Limit	Margin	PK/QP/Avg	degrees	meters	
4824.000	46.6	V	54.0	-7.4	AVG	270	1.6	RB 1 MHz;VB 10 Hz;Peak
4824.870	58.7	V	74.0	-15.3	PK	270	1.6	RB 1 MHz;VB 3 MHz;Peak

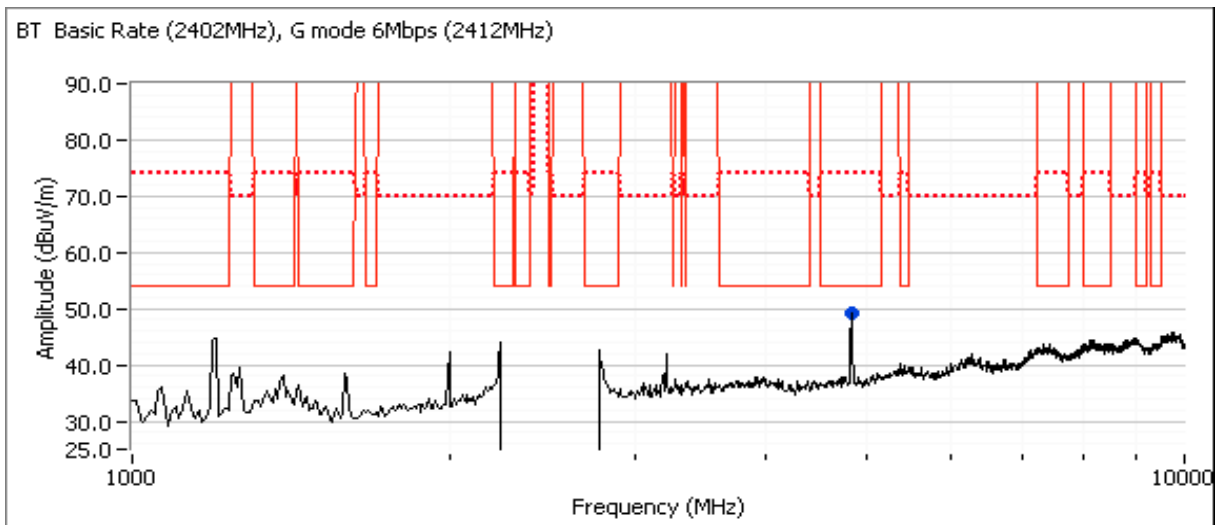



EMC Test Data

Client:	Intel	Job Number:	J88901
Model:	Intel® Centrino® Advanced-N 6235	T-Log Number:	T89578
Contact:	Steve Hackett	Account Manager:	Christine Krebill
Standard:	FCC 15.247, 15.407, 15.209, RSS 210	Class:	N/A

Preliminary Measurements (Peak versus average limit) at 20-30cm from EUT

Frequency	Level	Pol	15.209/15.247		Detector	Azimuth	Height	Comments
MHz	dB μ V/m	v/h	Limit	Margin	Pk/QP/Avg	degrees	meters	

Spurious Emissions near allocated band (final measurements at 3m)

Frequency	Level	Pol	15.209 / 15.247		Detector	Azimuth	Height	Comments
MHz	dB μ V/m	v/h	Limit	Margin	Pk/QP/Avg	degrees	meters	

Note 1: For emissions in restricted bands, the limit of 15.209 was used. For all other emissions, the limit was set 30dB below the level of the fundamental and measured in 100kHz.

Note 2: Signal is not in a restricted band but the more stringent restricted band limit was used.

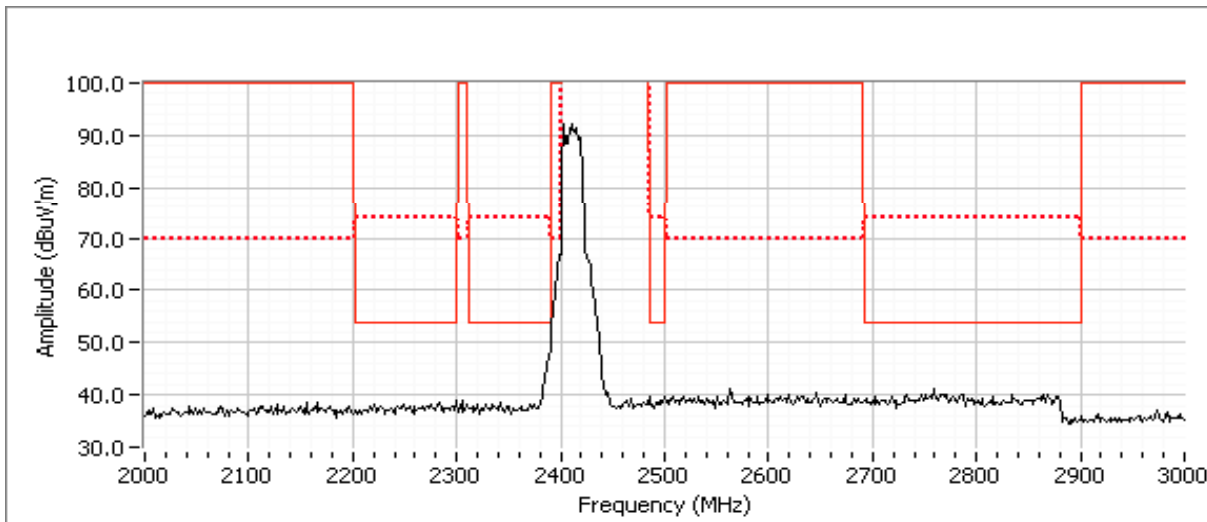



EMC Test Data

Client: Intel	Job Number: J88901
Model: Intel® Centrino® Advanced-N 6235	T-Log Number: T89578
Contact: Steve Hackett	Account Manager: Christine Krebill
Standard: FCC 15.247, 15.407, 15.209, RSS 210	Class: N/A

Run #4: 1-10GHz, 802.11g @ 2462 MHz Chain A, BT Basic Rate @ 2480 MHz Chain B
 Date of Test: 12/26/2012 Test Location: FT chamber #5
 Test Engineer: M. Birgani Config Change: -

	Target (dBm)	Power Settings Measured (dBm)	Software Setting
Chain A	14.0	14.1	28.0
Chain B	NA		8.0

Note - measured power in table above is average power using gated average power meter and is for reference only.

Preliminary Measurements (Peak versus average limit)

Frequency	Level	Pol	15.209/15.247		Detector	Azimuth	Height	Comments
MHz	dB μ V/m	v/h	Limit	Margin	PK/QP/Avg	degrees	meters	
4925.000	46.7	V	54.0	-7.3	Peak	284	2.5	

Spurious Emissions excluding allocated band (final measurements at 3m)

Frequency	Level	Pol	15.209 / 15.247		Detector	Azimuth	Height	Comments
MHz	dB μ V/m	v/h	Limit	Margin	PK/QP/Avg	degrees	meters	
4924.130	41.5	V	54.0	-12.5	AVG	67	1.0	RB 1 MHz;VB 10 Hz;Peak
4920.400	53.2	V	74.0	-20.8	PK	67	1.0	RB 1 MHz;VB 3 MHz;Peak

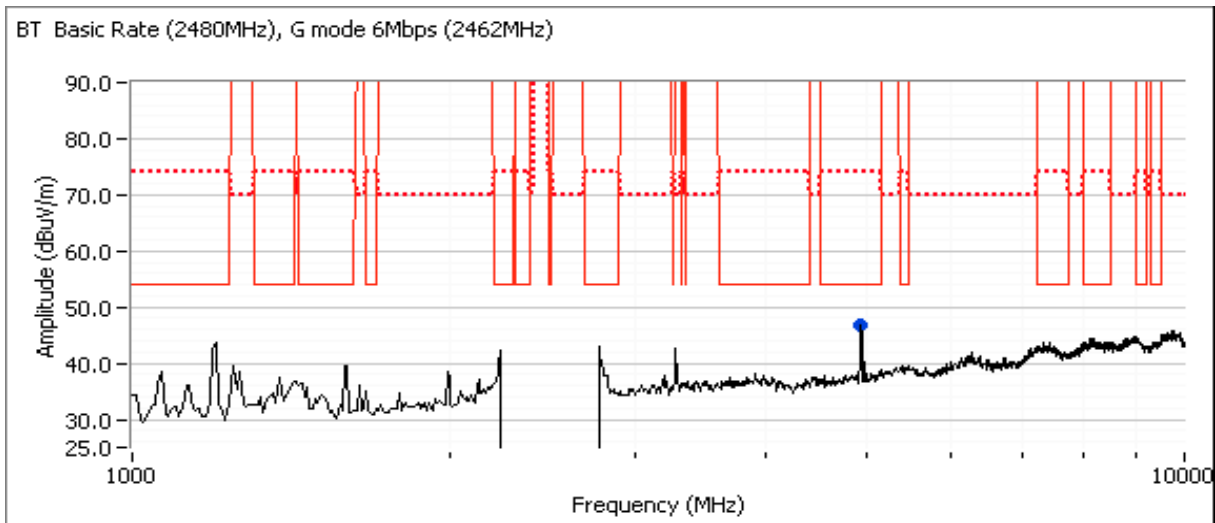



EMC Test Data

Client:	Intel	Job Number:	J88901
Model:	Intel® Centrino® Advanced-N 6235	T-Log Number:	T89578
Contact:	Steve Hackett	Account Manager:	Christine Krebill
Standard:	FCC 15.247, 15.407, 15.209, RSS 210	Class:	N/A

Preliminary Measurements (Peak versus average limit) at 20-30cm from EUT

Frequency	Level	Pol	15.209/15.247		Detector	Azimuth	Height	Comments
MHz	dB μ V/m	v/h	Limit	Margin	Pk/QP/Avg	degrees	meters	

Spurious Emissions near allocated band (final measurements at 3m)

Frequency	Level	Pol	15.209 / 15.247		Detector	Azimuth	Height	Comments
MHz	dB μ V/m	v/h	Limit	Margin	Pk/QP/Avg	degrees	meters	

Note 1: For emissions in restricted bands, the limit of 15.209 was used. For all other emissions, the limit was set 30dB below the level of the fundamental and measured in 100kHz.

Note 2: Signal is not in a restricted band but the more stringent restricted band limit was used.

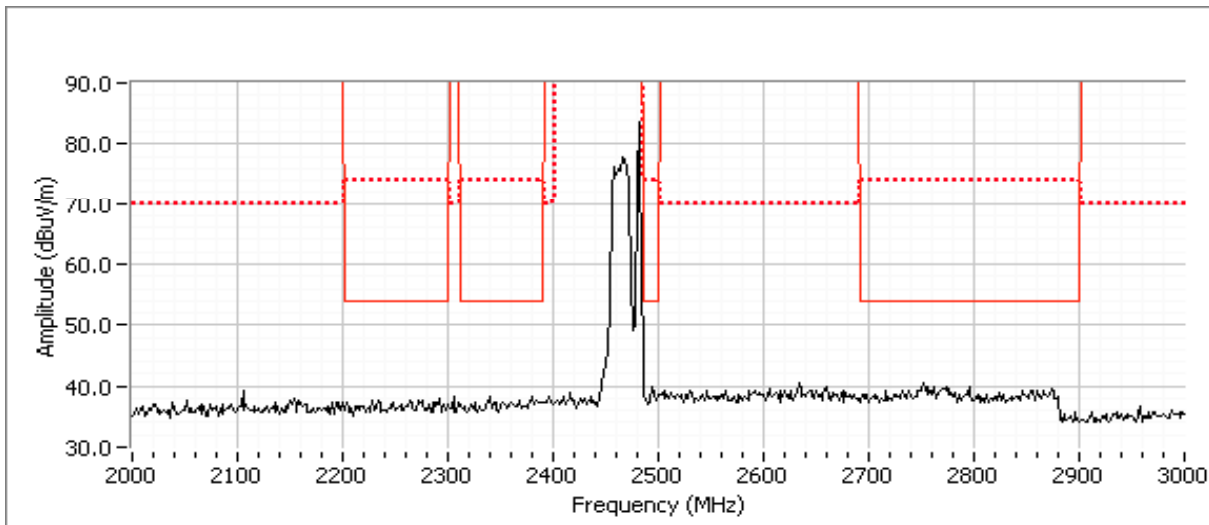

Client:	Intel	Job Number:	J88901
Model:	Intel® Centrino® Advanced-N 6235	T-Log Number:	T89578
Contact:	Steve Hackett	Account Manager:	Christine Krebill
Standard:	FCC 15.247, 15.407, 15.209, RSS 210	Class:	N/A

Run #5: 1-10GHz, 802.11b @ 2437 MHz Chain A, BT Basic Rate @ 2402 MHz Chain B
 Date of Test: 12/27/2012 Test Location: Chamber 4
 Test Engineer: M. Birgani Config Change: -

	Power Settings		
	Target (dBm)	Measured (dBm)	Software Setting
Chain A	16.0	13.3	21.0
Chain B	NA	NA	8.0

Note - measured power in table above is average power using gated average power meter and is for reference only.

Preliminary Measurements (Peak versus average limit)

Frequency	Level	Pol	15.209/15.247		Detector	Azimuth	Height	Comments
MHz	dB μ V/m	v/h	Limit	Margin	PK/QP/Avg	degrees	meters	
4874.080	56.0	V	54.0	2.0	Peak	275	1.0	
4804.000	46.8	V	54.0	-7.2	Peak	273	1.0	

Spurious Emissions excluding allocated band (final measurements at 3m)

Frequency	Level	Pol	15.209 / 15.247		Detector	Azimuth	Height	Comments
MHz	dB μ V/m	v/h	Limit	Margin	PK/QP/Avg	degrees	meters	
4874.030	53.3	V	54.0	-0.7	AVG	275	1.3	Setting: 21.0 (13.3dBm)
4873.990	56.0	V	74.0	-18.0	PK	275	1.3	Setting: 21.0 (13.3dBm)
4804.250	52.1	V	74.0	-21.9	PK	272	1.3	
4803.930	52.1	V	54.0	-1.9	AVG	272	1.3	Note 3

Note 3: Signal is only present when Bluetooth is enabled, average correction for hopping occupancy could be applied

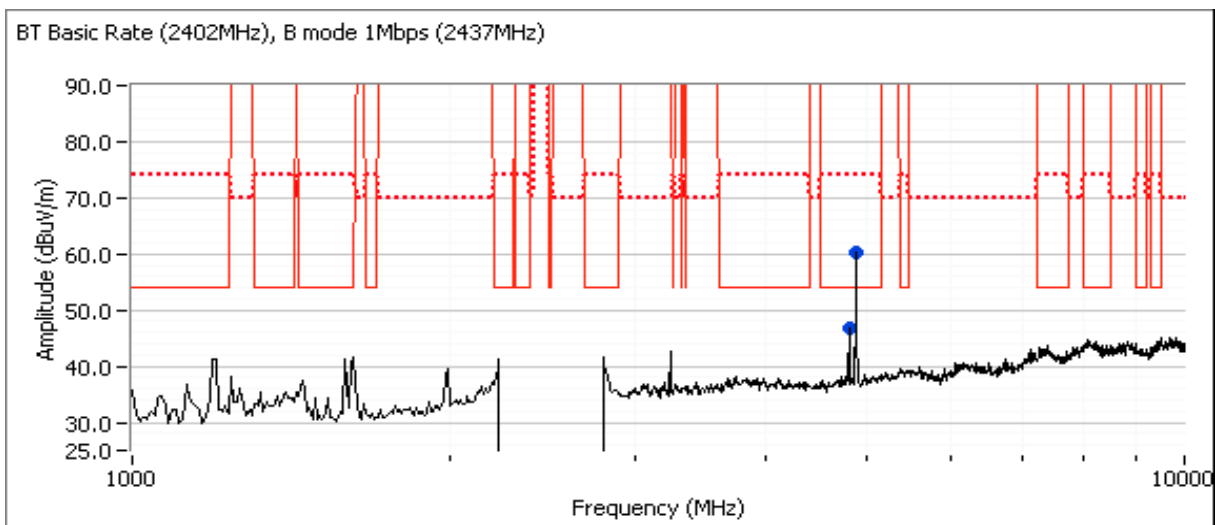



EMC Test Data

Client:	Intel	Job Number:	J88901
Model:	Intel® Centrino® Advanced-N 6235	T-Log Number:	T89578
Contact:	Steve Hackett	Account Manager:	Christine Krebill
Standard:	FCC 15.247, 15.407, 15.209, RSS 210	Class:	N/A

Preliminary Measurements (Peak versus average limit) at 20-30cm from EUT

Frequency	Level	Pol	15.209/15.247		Detector	Azimuth	Height	Comments
MHz	dB μ V/m	v/h	Limit	Margin	PK/QP/Avg	degrees	meters	

Spurious Emissions near allocated band (final measurements at 3m)

Frequency	Level	Pol	15.209 / 15.247		Detector	Azimuth	Height	Comments
MHz	dB μ V/m	v/h	Limit	Margin	PK/QP/Avg	degrees	meters	

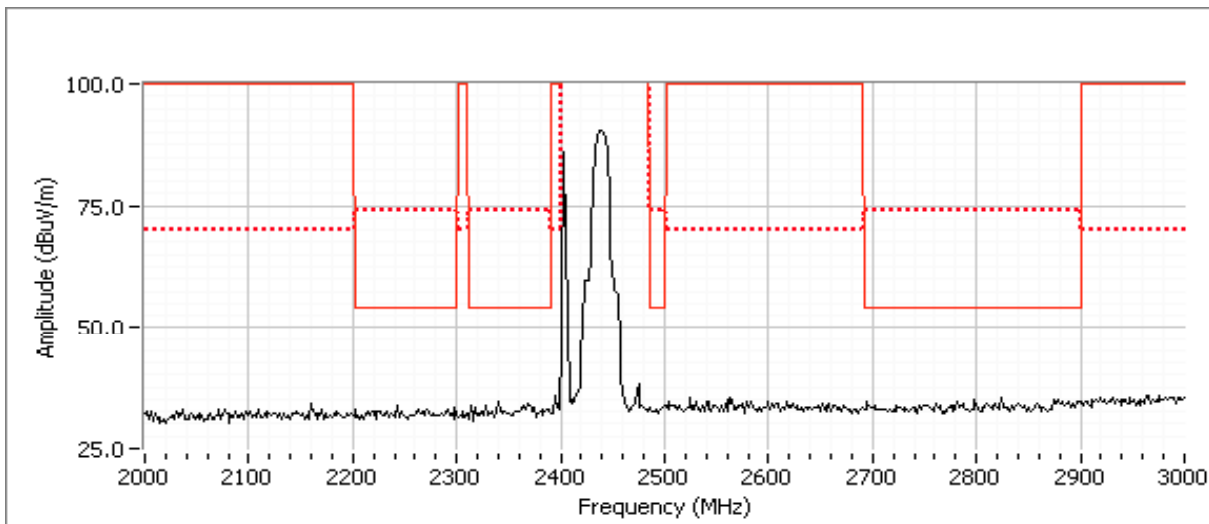



EMC Test Data

Client:	Intel	Job Number:	J88901
Model:	Intel® Centrino® Advanced-N 6235	T-Log Number:	T89578
Contact:	Steve Hackett	Account Manager:	Christine Krebill
Standard:	FCC 15.247, 15.407, 15.209, RSS 210	Class:	N/A

Run #6: 1-10GHz, 802.11b @ 2412 MHz Chain A, BT Basic Rate @ 2440 MHz Chain B
 Date of Test: 12/27/2012 Test Location: Chamber 4
 Test Engineer: M. Birgani Config Change: -

	Power Settings		
	Target (dBm)	Measured (dBm)	Software Setting
Chain A	16.5	12.7	20.5
Chain B	NA	5.8	8.0

Note - measured power in table above is average power using gated average power meter and is for reference only.

Preliminary Measurements (Peak versus average limit)

Frequency	Level	Pol	15.209/15.247		Detector	Azimuth	Height	Comments
MHz	dB μ V/m	v/h	Limit	Margin	PK/QP/Avg	degrees	meters	
4824.060	59.8	V	54.0	5.8	Peak	240	2.5	
4879.990	42.9	V	54.0	-11.1	Peak	90	2.5	

Spurious Emissions excluding allocated band (final measurements at 3m)

Frequency	Level	Pol	15.209 / 15.247		Detector	Azimuth	Height	Comments
MHz	dB μ V/m	v/h	Limit	Margin	PK/QP/Avg	degrees	meters	
4824.020	52.8	V	54.0	-1.2	AVG	272	2.3	Setting: 20.5 (12.7dBm)
4824.160	55.7	V	74.0	-18.3	PK	272	2.3	Setting: 20.5 (12.7dBm)
4879.990	47.2	V	54.0	-6.8	AVG	35	1.0	Note 3
4880.510	47.2	V	74.0	-26.8	PK	35	1.0	

Note 3: Signal is only present when Bluetooth is enabled, average correction for hopping occupancy could be applied

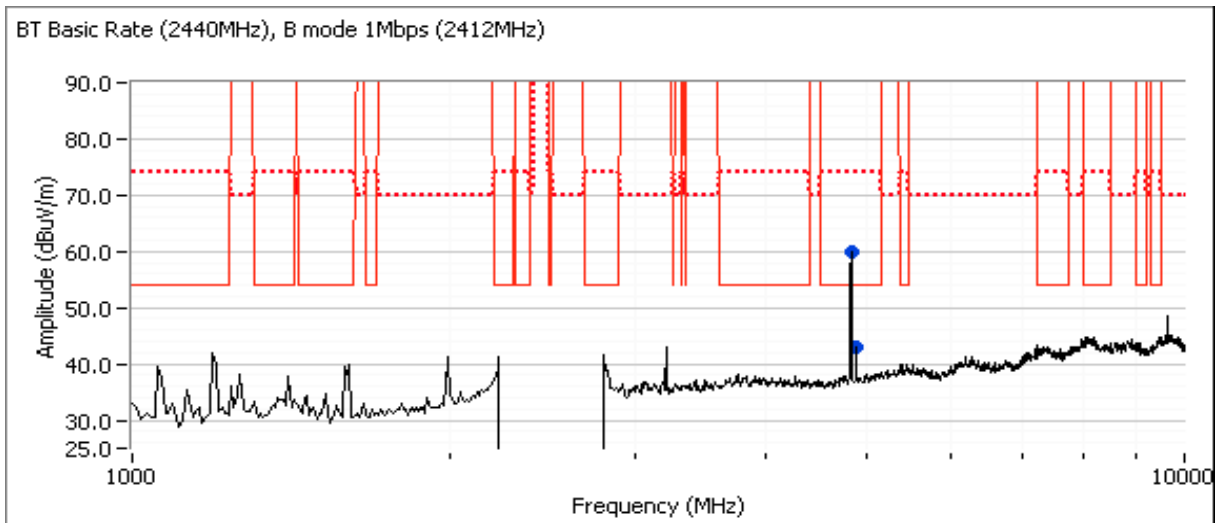



EMC Test Data

Client:	Intel	Job Number:	J88901
Model:	Intel® Centrino® Advanced-N 6235	T-Log Number:	T89578
Contact:	Steve Hackett	Account Manager:	Christine Krebill
Standard:	FCC 15.247, 15.407, 15.209, RSS 210	Class:	N/A

Preliminary Measurements (Peak versus average limit) at 20-30cm from EUT

Frequency	Level	Pol	15.209/15.247		Detector	Azimuth	Height	Comments
MHz	dB μ V/m	v/h	Limit	Margin	PK/QP/Avg	degrees	meters	

Spurious Emissions near allocated band (final measurements at 3m)

Frequency	Level	Pol	15.209 / 15.247		Detector	Azimuth	Height	Comments
MHz	dB μ V/m	v/h	Limit	Margin	PK/QP/Avg	degrees	meters	

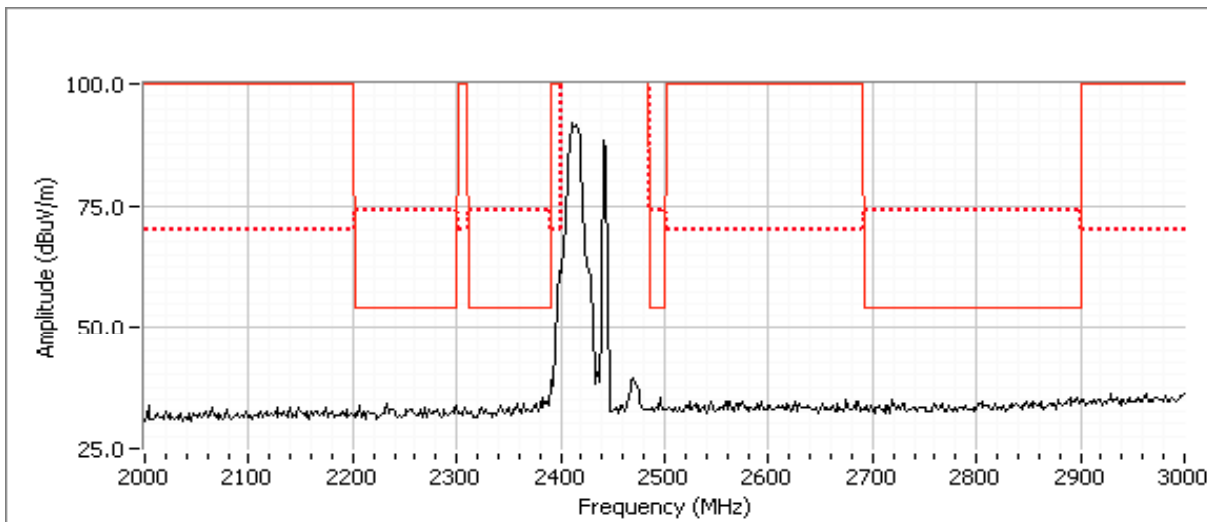



EMC Test Data

Client: Intel	Job Number: J88901
Model: Intel® Centrino® Advanced-N 6235	T-Log Number: T89578
	Account Manager: Christine Krebill
Contact: Steve Hackett	
Standard: FCC 15.247, 15.407, 15.209, RSS 210	Class: N/A

Run #7: 1-10GHz, 802.11b @ 2462 MHz Chain A, BT Basic Rate @ 2440 MHz Chain B
 Date of Test: 12/27/2012 Test Location: Chamber 4
 Test Engineer: Rafael Varelas Config Change: None

	Power Settings		
	Target (dBm)	Measured (dBm)	Software Setting
Chain A	16.5	16.6	25.0
Chain B	NA		8.0

Note - measured power in table above is average power, for reference only.

Preliminary Measurements (Peak versus average limit)

Frequency MHz	Level dB μ V/m	Pol v/h	15.209/15.247		Detector PK/QP/Avg	Azimuth degrees	Height meters	Comments
			Limit	Margin				
4879.650	43.1	V	54.0	-10.9	Peak	277	1.9	
4923.960	56.1	V	54.0	2.1	Peak	79	1.9	

Spurious Emissions excluding allocated band (final measurements at 3m)

Frequency MHz	Level dB μ V/m	Pol v/h	15.209 / 15.247		Detector PK/QP/Avg	Azimuth degrees	Height meters	Comments
			Limit	Margin				
4924.020	51.2	V	54.0	-2.8	AVG	298	1.0	RB 1 MHz;VB 10 Hz;Peak
4924.020	54.0	V	74.0	-20.0	PK	298	1.0	RB 1 MHz;VB 3 MHz;Peak
4880.010	39.1	V	54.0	-14.9	AVG	305	1.0	RB 1 MHz;VB 10 Hz;Peak
4879.420	47.8	V	74.0	-26.2	PK	305	1.0	RB 1 MHz;VB 3 MHz;Peak

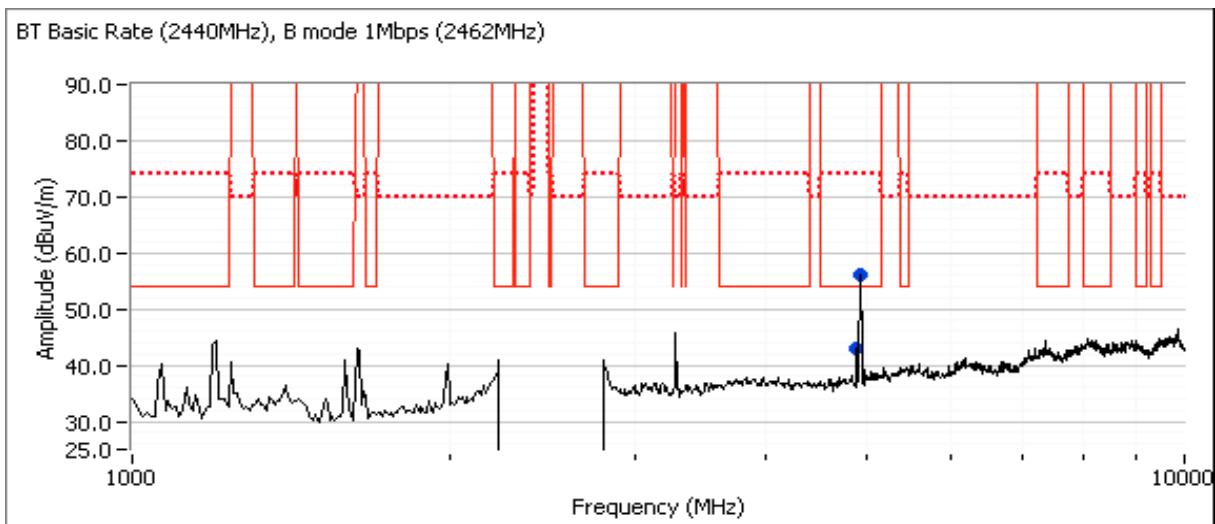



EMC Test Data

Client:	Intel	Job Number:	J88901
Model:	Intel® Centrino® Advanced-N 6235	T-Log Number:	T89578
Contact:	Steve Hackett	Account Manager:	Christine Krebill
Standard:	FCC 15.247, 15.407, 15.209, RSS 210	Class:	N/A

Preliminary Measurements (Peak versus average limit) at 20-30cm from EUT

Frequency	Level	Pol	15.209/15.247		Detector	Azimuth	Height	Comments
MHz	dB μ V/m	v/h	Limit	Margin	Pk/QP/Avg	degrees	meters	

Spurious Emissions near allocated band (final measurements at 3m)

Frequency	Level	Pol	15.209 / 15.247		Detector	Azimuth	Height	Comments
MHz	dB μ V/m	v/h	Limit	Margin	Pk/QP/Avg	degrees	meters	

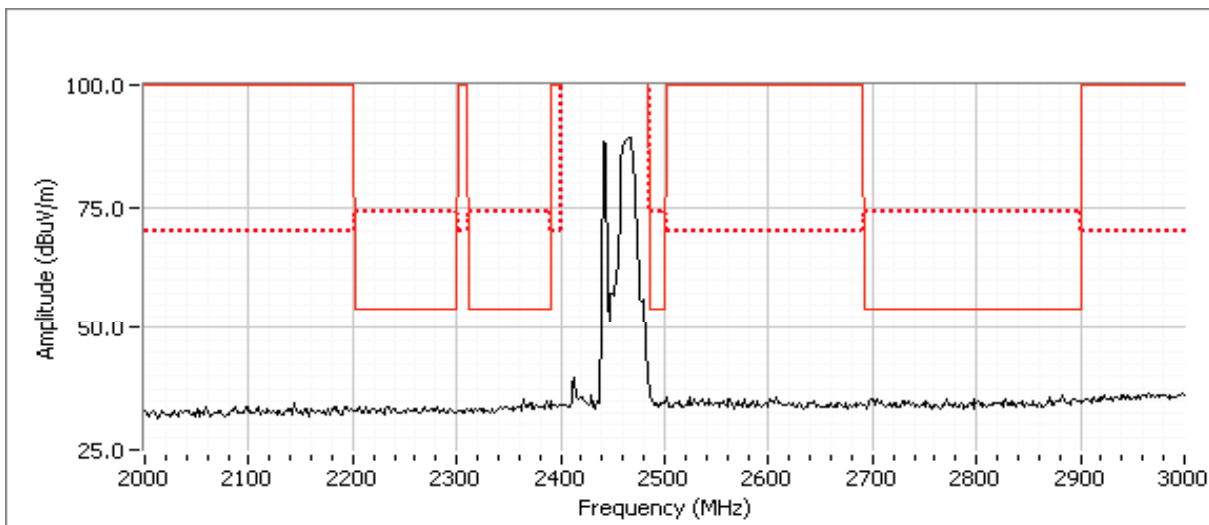



EMC Test Data

Client:	Intel	Job Number:	J88901
Model:	Intel® Centrino® Advanced-N 6235	T-Log Number:	T89578
Contact:	Steve Hackett	Account Manager:	Christine Krebill
Standard:	FCC 15.247, 15.407, 15.209, RSS 210	Class:	N/A

Run #8: 1-10GHz, 802.11b @ 2437 MHz Chain A, BT Basic Rate @ 2480 MHz Chain B
 Date of Test: 12/27/2012 Test Location: Chamber 4
 Test Engineer: Rafael Varelas Config Change: None

	Target (dBm)	Power Settings Measured (dBm)	Software Setting
Chain A	16.0	14.8	23.0
Chain B	NA		8.0

Note - measured power in table above is average power, for reference only.

Preliminary Measurements (Peak versus average limit)

Frequency	Level	Pol	15.209/15.247		Detector	Azimuth	Height	Comments
MHz	dB μ V/m	v/h	Limit	Margin	PK/QP/Avg	degrees	meters	
4874.030	55.0	V	54.0	1.0	Peak	273	2.5	

Spurious Emissions excluding allocated band (final measurements at 3m)

Frequency	Level	Pol	15.209 / 15.247		Detector	Azimuth	Height	Comments
MHz	dB μ V/m	v/h	Limit	Margin	PK/QP/Avg	degrees	meters	
4874.020	52.8	V	54.0	-1.2	AVG	272	1.2	Setting: 23, 1Mbps
4874.050	55.5	V	74.0	-18.5	PK	272	1.2	Setting: 23, 1Mbps

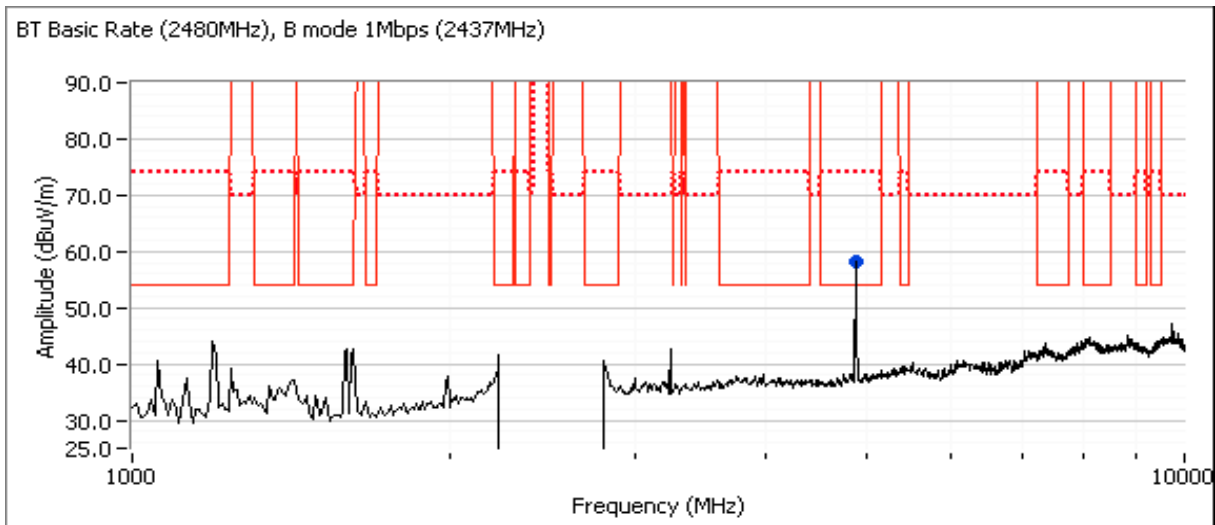

Client: Intel	Job Number: J88901
Model: Intel® Centrino® Advanced-N 6235	T-Log Number: T89578
	Account Manager: Christine Krebill
Contact: Steve Hackett	
Standard: FCC 15.247, 15.407, 15.209, RSS 210	Class: N/A

Preliminary Measurements (Peak versus average limit) at 20-30cm from EUT

Frequency	Level	Pol	15.209/15.247		Detector	Azimuth	Height	Comments
MHz	dB μ V/m	v/h	Limit	Margin	Pk/QP/Avg	degrees	meters	

Spurious Emissions near allocated band (final measurements at 3m)

Frequency	Level	Pol	15.209 / 15.247		Detector	Azimuth	Height	Comments
MHz	dB μ V/m	v/h	Limit	Margin	Pk/QP/Avg	degrees	meters	

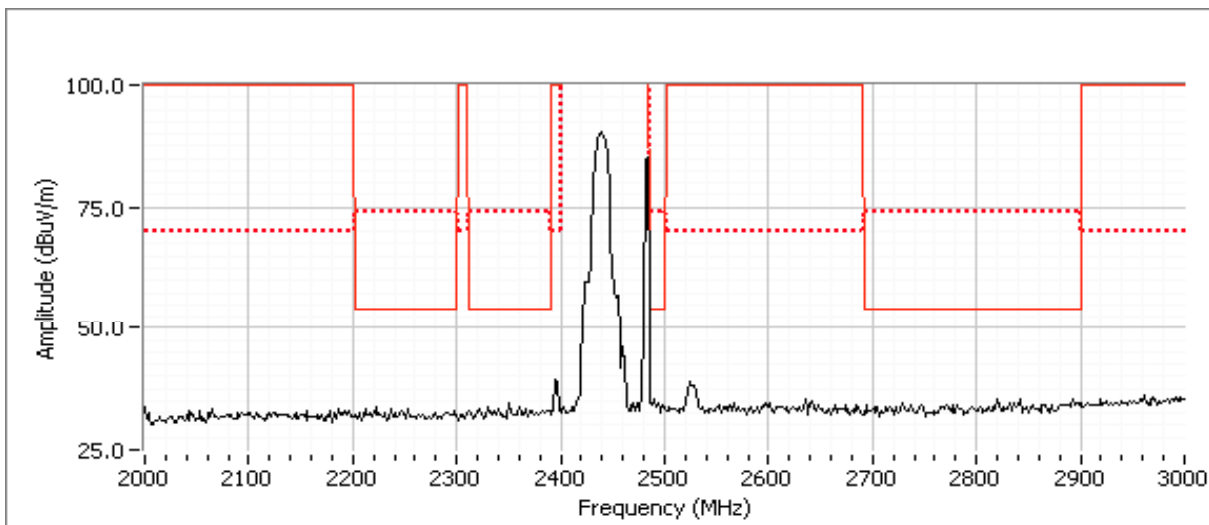



EMC Test Data

Client:	Intel	Job Number:	J88901
Model:	Intel® Centrino® Advanced-N 6235	T-Log Number:	T89578
Contact:	Steve Hackett	Account Manager:	Christine Krebill
Standard:	FCC 15.247, 15.407, 15.209, RSS 210	Class:	N/A

Run #9: 1-10GHz, 802.11b @ 2412 MHz Chain A, BT EDR Rate @ 2402 MHz Chain B
 Date of Test: 12/27/2012 Test Location: Chamber 4
 Test Engineer: Rafael Varelas Config Change: None

	Target (dBm)	Power Settings Measured (dBm)	Software Setting
Chain A	16.5	13.1	21.0
Chain B	NA		8.0

Note - measured power in table above is average power, for reference only.

Preliminary Measurements (Peak versus average limit)

Frequency	Level	Pol	15.209/15.247		Detector	Azimuth	Height	Comments
MHz	dB μ V/m	v/h	Limit	Margin	PK/QP/Avg	degrees	meters	
4824.030	55.2	V	54.0	1.2	Peak	271	2.5	

Spurious Emissions excluding allocated band (final measurements at 3m)

Frequency	Level	Pol	15.209 / 15.247		Detector	Azimuth	Height	Comments
MHz	dB μ V/m	v/h	Limit	Margin	PK/QP/Avg	degrees	meters	
4824.040	52.7	V	54.0	-1.3	AVG	277	2.3	Setting: 21.0, 1Mbps
4823.860	55.5	V	74.0	-18.5	PK	277	2.3	Setting: 21.0, 1Mbps

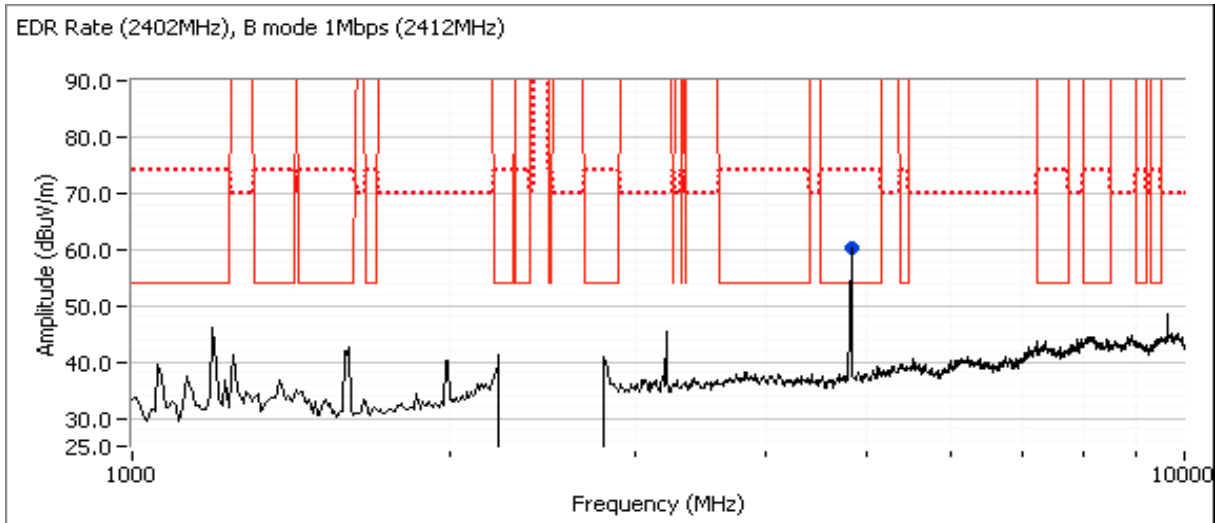



EMC Test Data

Client:	Intel	Job Number:	J88901
Model:	Intel® Centrino® Advanced-N 6235	T-Log Number:	T89578
Contact:	Steve Hackett	Account Manager:	Christine Krebill
Standard:	FCC 15.247, 15.407, 15.209, RSS 210	Class:	N/A

Preliminary Measurements (Peak versus average limit) at 20-30cm from EUT

Frequency	Level	Pol	15.209/15.247		Detector	Azimuth	Height	Comments
MHz	dB μ V/m	v/h	Limit	Margin	Pk/QP/Avg	degrees	meters	

Spurious Emissions near allocated band (final measurements at 3m)

Frequency	Level	Pol	15.209 / 15.247		Detector	Azimuth	Height	Comments
MHz	dB μ V/m	v/h	Limit	Margin	Pk/QP/Avg	degrees	meters	

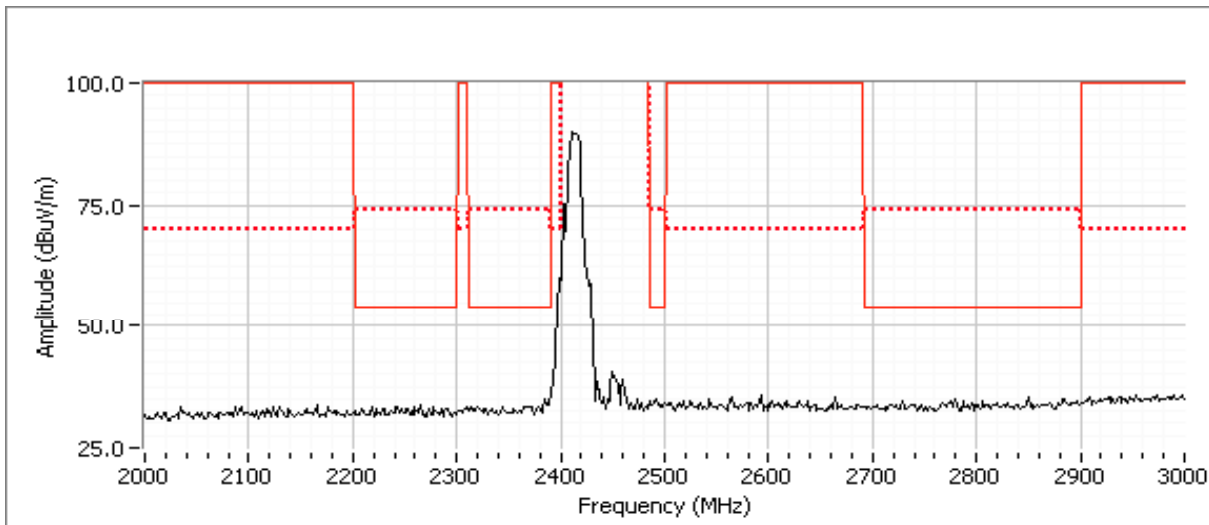



EMC Test Data

Client: Intel	Job Number: J88901
Model: Intel® Centrino® Advanced-N 6235	T-Log Number: T89578
	Account Manager: Christine Krebill
Contact: Steve Hackett	
Standard: FCC 15.247, 15.407, 15.209, RSS 210	Class: N/A

Run #10: 1-10GHz, 802.11b @ 2412 MHz Chain A, BTLE @ 2402 MHz Chain B
 Date of Test: 12/27/2012 Test Location: Chamber 4
 Test Engineer: Rafael Varelas Config Change: None

	Target (dBm)	Power Settings Measured (dBm)	Software Setting
Chain A	16.5	14.1	22.0
Chain B	NA		37bytes

Note - measured power in table above is average power, for reference only.

Preliminary Measurements (Peak versus average limit)

Frequency	Level	Pol	15.209/15.247		Detector	Azimuth	Height	Comments
MHz	dB μ V/m	v/h	Limit	Margin	PK/QP/Avg	degrees	meters	
4824.030	55.6	V	54.0	1.6	Peak	74	1.3	

Spurious Emissions excluding allocated band (final measurements at 3m)

Frequency	Level	Pol	15.209 / 15.247		Detector	Azimuth	Height	Comments
MHz	dB μ V/m	v/h	Limit	Margin	PK/QP/Avg	degrees	meters	
4824.040	53.0	V	54.0	-1.0	AVG	66	1.2	Setting: 22.0, 1Mbps
4824.190	55.9	V	74.0	-18.1	PK	66	1.2	Setting: 22.0, 1Mbps

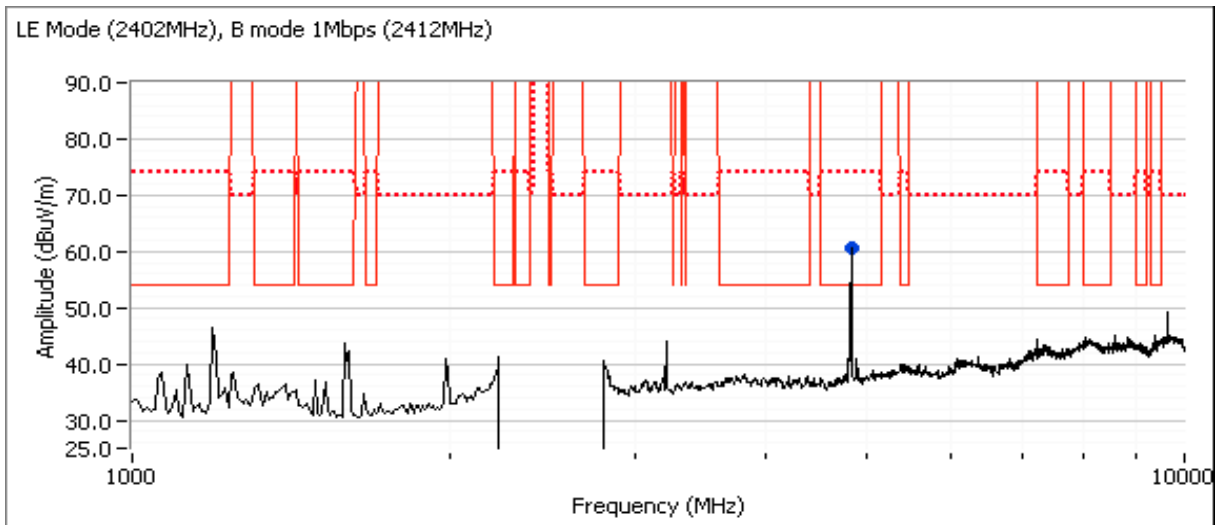



EMC Test Data

Client:	Intel	Job Number:	J88901
Model:	Intel® Centrino® Advanced-N 6235	T-Log Number:	T89578
Contact:	Steve Hackett	Account Manager:	Christine Krebill
Standard:	FCC 15.247, 15.407, 15.209, RSS 210	Class:	N/A

Preliminary Measurements (Peak versus average limit) at 20-30cm from EUT

Frequency	Level	Pol	15.209/15.247		Detector	Azimuth	Height	Comments
MHz	dB μ V/m	v/h	Limit	Margin	Pk/QP/Avg	degrees	meters	

Spurious Emissions near allocated band (final measurements at 3m)

Frequency	Level	Pol	15.209 / 15.247		Detector	Azimuth	Height	Comments
MHz	dB μ V/m	v/h	Limit	Margin	Pk/QP/Avg	degrees	meters	

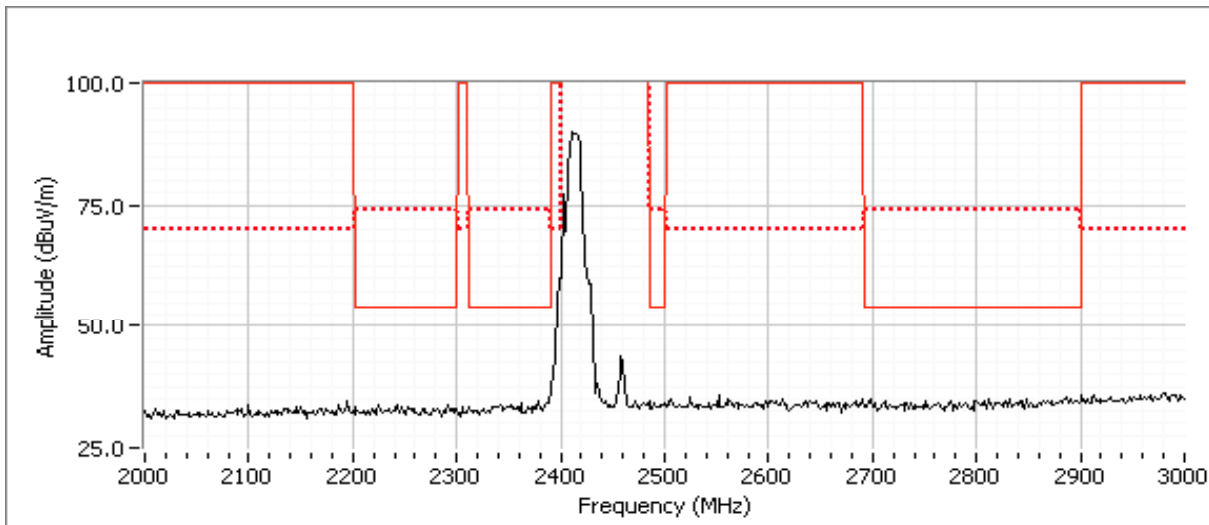



EMC Test Data

Client:	Intel	Job Number:	J88901
Model:	Intel® Centrino® Advanced-N 6235	T-Log Number:	T89578
Contact:	Steve Hackett	Account Manager:	Christine Krebill
Standard:	FCC 15.247, 15.407, 15.209, RSS 210	Class:	N/A

Run #11: 1-15GHz, 802.11n20 @ 5200 MHz Chain A+B, BT Basic Rate @ 2440 MHz Chain B

Date of Test: 12/28/2012
 Test Engineer: John Caizzi

Test Location: Chamber 5
 Config Change: none

	Power Settings		
	Target (dBm)	Measured (dBm)	Software Setting
Chain A	16.0	14.3	39.0
Chain B	16.0	13.5	39.0
Bluetooth	Max	NA	8 dBm

Note - measured power in table above is average power, for reference only.

Preliminary Measurements (Peak versus average limit)

Frequency	Level	Pol	15.209/15.247		Detector	Azimuth	Height	Comments
MHz	dB μ V/m	v/h	Limit	Margin	PK/QP/Avg	degrees	meters	
10408.330	53.4	V	68.3	-14.9	Peak	69	1.0	

Spurious Emissions (final measurements at 3m)

Frequency	Level	Pol	15.209 / 15.247		Detector	Azimuth	Height	Comments
MHz	dB μ V/m	v/h	Limit	Margin	PK/QP/Avg	degrees	meters	
10399.660	58.5	V	68.3	-9.8	PK	70	1.47	

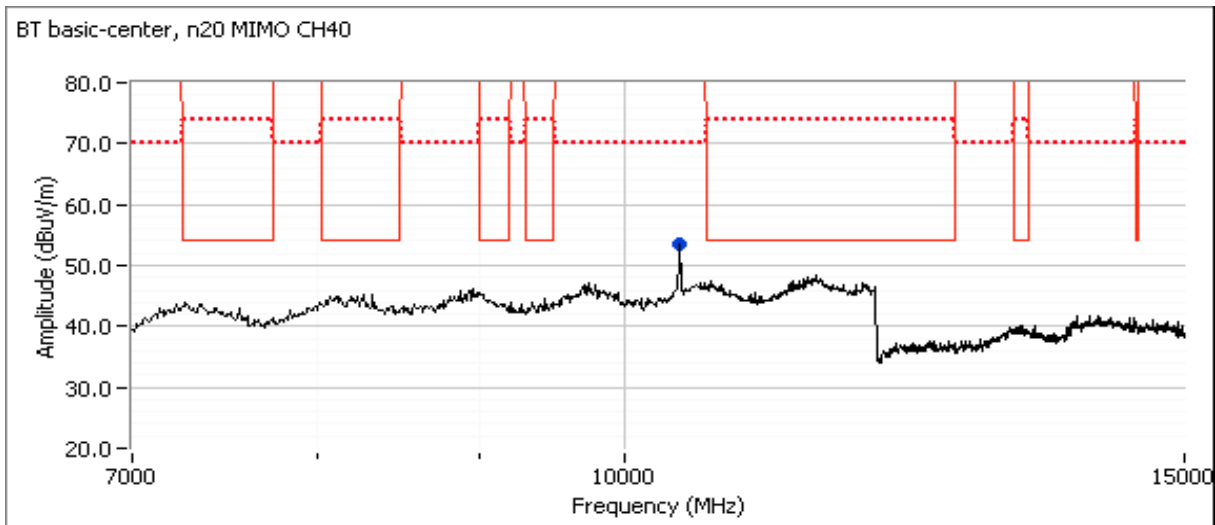



EMC Test Data

Client:	Intel	Job Number:	J88901
Model:	Intel® Centrino® Advanced-N 6235	T-Log Number:	T89578
Contact:	Steve Hackett	Account Manager:	Christine Krebill
Standard:	FCC 15.247, 15.407, 15.209, RSS 210	Class:	N/A

Preliminary Measurements (Peak versus average limit) at 20-30cm from EUT

Frequency	Level	Pol	15.209/15.247		Detector	Azimuth	Height	Comments
MHz	dBμV/m	v/h	Limit	Margin	PK/QP/Avg	degrees	meters	
1841.680	45.6	V	54.0	-8.4	Peak	0	1.0	
1925.850	42.5	V	74.0	-31.5	Peak	0	1.0	

Spurious Emissions (final measurements at 3m)

Frequency	Level	Pol	15.209 / 15.247		Detector	Azimuth	Height	Comments
MHz	dBμV/m	v/h	Limit	Margin	PK/QP/Avg	degrees	meters	
1840.190	32.8	V	54.0	-21.2	AVG	0	1.0	Note 1
1841.120	44.4	V	74.0	-29.6	PK	0	1.0	Note 1
1924.700	33.1	V	54.0	-20.9	AVG	0	1.0	Note 1
1924.360	45.9	V	74.0	-28.1	PK	0	1.0	Note 1

Note 1: Noise floor measurement. Could not find signals when maximizing.

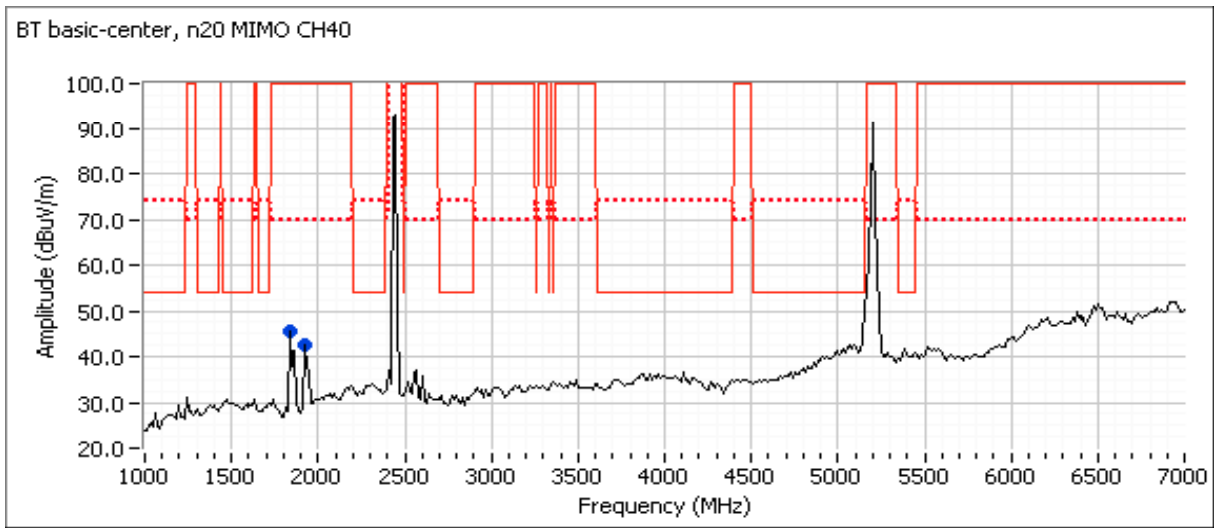



EMC Test Data

Client: Intel	Job Number: J88901
Model: Intel® Centrino® Advanced-N 6235	T-Log Number: T89578
	Account Manager: Christine Krebill
Contact: Steve Hackett	
Standard: FCC 15.247, 15.407, 15.209, RSS 210	Class: N/A

Run #12: 1-15GHz, 802.11n20 @ 5300 MHz Chain A+B, BT Basic Rate @ 2440 MHz Chain B

Date of Test: 12/28/2012
 Test Engineer: John Caizzi

Test Location: Chamber 5
 Config Change: none

	Power Settings		
	Target (dBm)	Measured (dBm)	Software Setting
Chain A	16.0	14.2	39.0
Chain B	16.0	13.2	39.0
Bluetooth	Max	NA	8 dBm

Note - measured power in table above is average power, for reference only.

Preliminary Measurements (Peak versus average limit)

Frequency	Level	Pol	15.209/15.247		Detector	Azimuth	Height	Comments
MHz	dB μ V/m	v/h	Limit	Margin	PK/QP/Avg	degrees	meters	
10608.330	52.7	V	54.0	-1.3	Peak	127	1.0	

Spurious Emissions (final measurements at 3m)

Frequency	Level	Pol	15.209 / 15.247		Detector	Azimuth	Height	Comments
MHz	dB μ V/m	v/h	Limit	Margin	PK/QP/Avg	degrees	meters	
10600.710	45.8	V	54.0	-8.2	AVG	116	1.00	
10603.870	57.6	V	74.0	-16.4	PK	116	1.00	

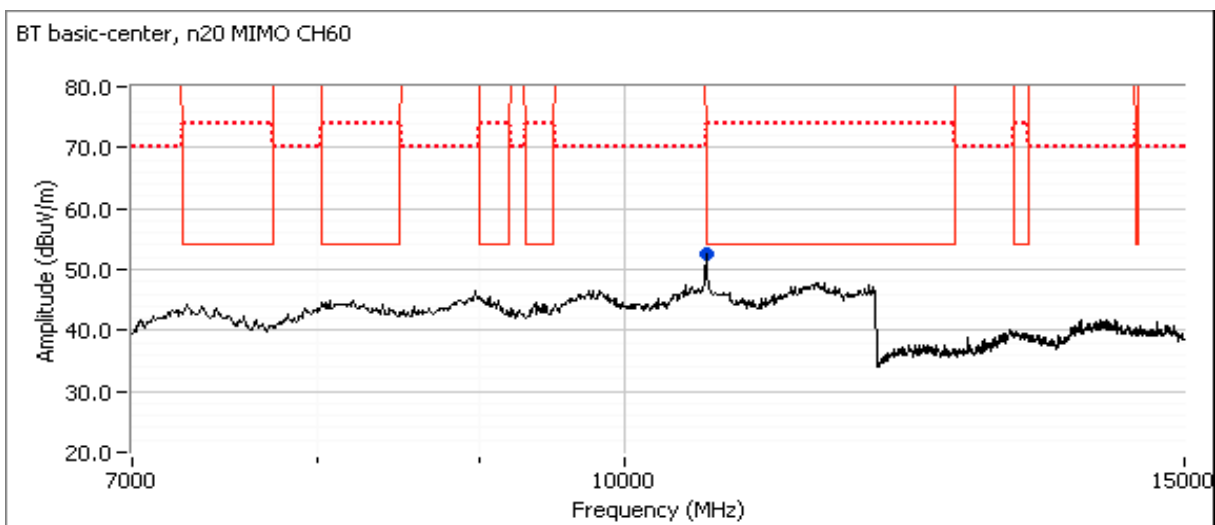



EMC Test Data

Client: Intel	Job Number: J88901
Model: Intel® Centrino® Advanced-N 6235	T-Log Number: T89578
	Account Manager: Christine Krebill
Contact: Steve Hackett	
Standard: FCC 15.247, 15.407, 15.209, RSS 210	Class: N/A

Preliminary Measurements (Peak versus average limit) at 20-30cm from EUT

Frequency	Level	Pol	15.209/15.247		Detector	Azimuth	Height	Comments
MHz	dB μ V/m	v/h	Limit	Margin	PK/QP/Avg	degrees	meters	

Spurious Emissions (final measurements at 3m)

Frequency	Level	Pol	15.209 / 15.247		Detector	Azimuth	Height	Comments
MHz	dB μ V/m	v/h	Limit	Margin	PK/QP/Avg	degrees	meters	

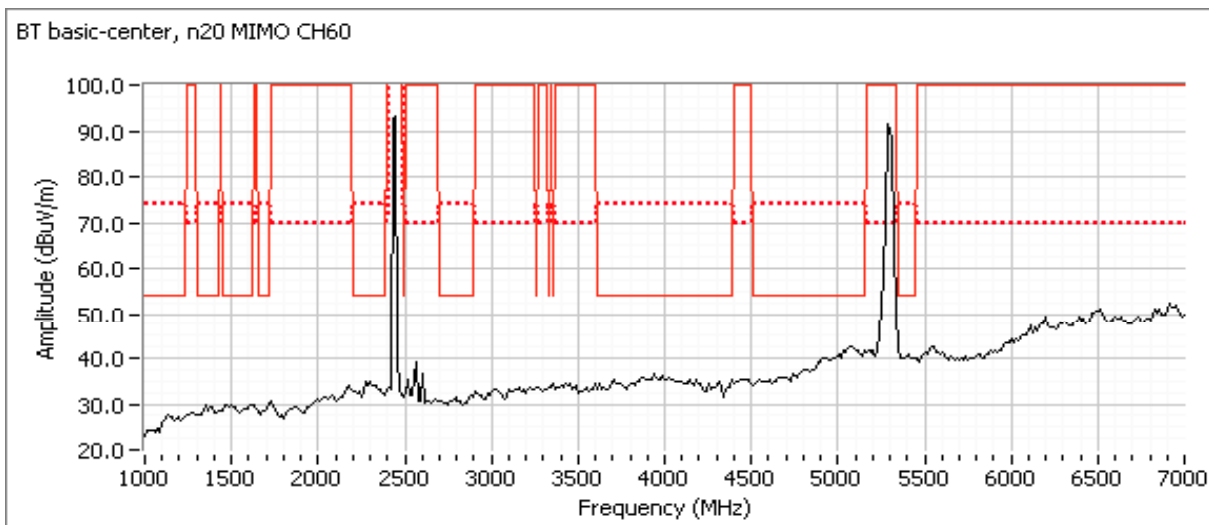



EMC Test Data

Client: Intel	Job Number: J88901
Model: Intel® Centrino® Advanced-N 6235	T-Log Number: T89578
	Account Manager: Christine Krebill
Contact: Steve Hackett	
Standard: FCC 15.247, 15.407, 15.209, RSS 210	Class: N/A

Run #13: 1-15GHz, 802.11n20 @ 5580 MHz Chain A+B, BT Basic Rate @ 2440 MHz Chain B

Date of Test: 12/28/2012
 Test Engineer: John Caizzi

Test Location: Chamber 5
 Config Change: none

	Target (dBm)	Power Settings Measured (dBm)	Software Setting
Chain A	16.0	12.8	39.0
Chain B	16.0	13.9	39.0
Bluetooth	Max	NA	8 dBm

Note - measured power in table above is average power, for reference only.

Preliminary Measurements (Peak versus average limit)

Frequency	Level	Pol	15.209/15.247		Detector	Azimuth	Height	Comments
MHz	dB μ V/m	v/h	Limit	Margin	PK/QP/Avg	degrees	meters	
11166.670	55.9	V	54.0	1.9	Peak	249	1.0	

Spurious Emissions (final measurements at 3m)

Frequency	Level	Pol	15.209 / 15.247		Detector	Azimuth	Height	Comments
MHz	dB μ V/m	v/h	Limit	Margin	PK/QP/Avg	degrees	meters	
11159.670	46.4	V	54.0	-7.6	AVG	250	1.00	
11160.340	61.6	V	74.0	-12.4	PK	250	1.00	

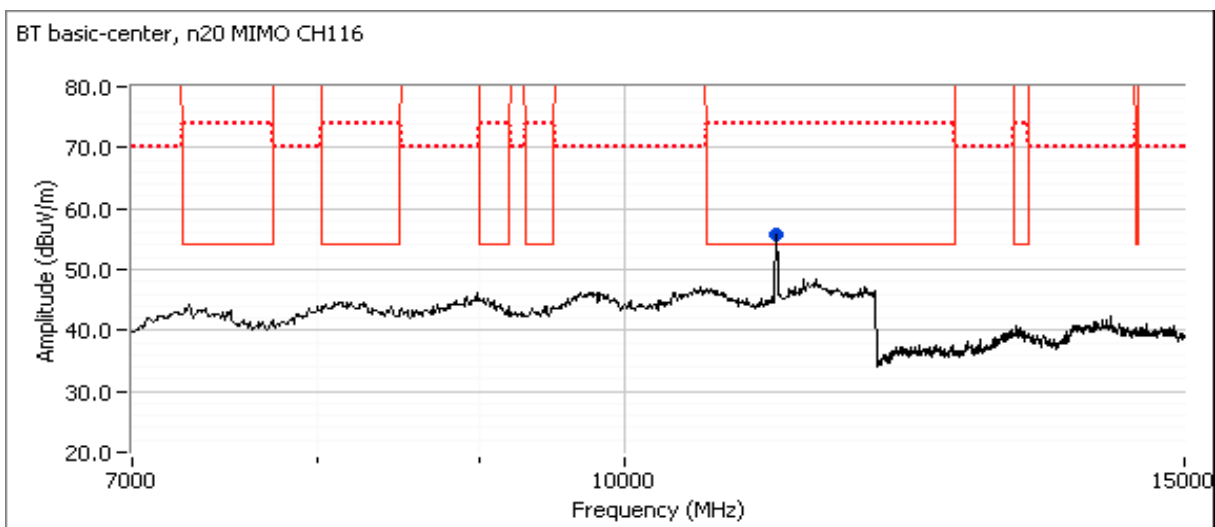



EMC Test Data

Client:	Intel	Job Number:	J88901
Model:	Intel® Centrino® Advanced-N 6235	T-Log Number:	T89578
Contact:	Steve Hackett	Account Manager:	Christine Krebill
Standard:	FCC 15.247, 15.407, 15.209, RSS 210	Class:	N/A

Preliminary Measurements (Peak versus average limit) at 20-30cm from EUT

Frequency	Level	Pol	15.209/15.247		Detector	Azimuth	Height	Comments
MHz	dB μ V/m	v/h	Limit	Margin	PK/QP/Avg	degrees	meters	

Spurious Emissions (final measurements at 3m)

Frequency	Level	Pol	15.209 / 15.247		Detector	Azimuth	Height	Comments
MHz	dB μ V/m	v/h	Limit	Margin	PK/QP/Avg	degrees	meters	

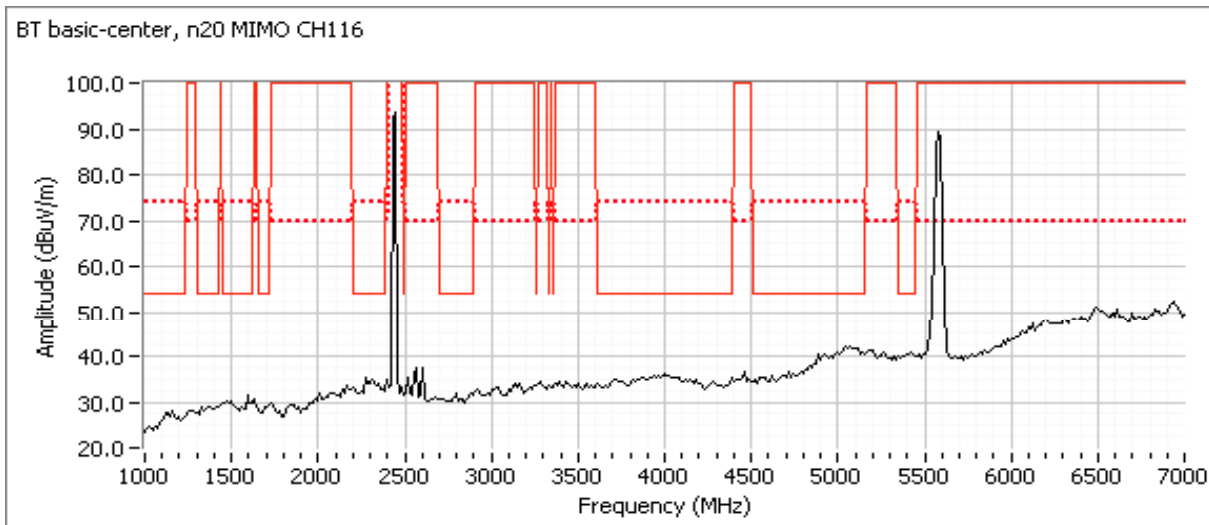



EMC Test Data

Client: Intel	Job Number: J88901
Model: Intel® Centrino® Advanced-N 6235	T-Log Number: T89578
	Account Manager: Christine Krebill
Contact: Steve Hackett	
Standard: FCC 15.247, 15.407, 15.209, RSS 210	Class: N/A

Run #14: 1-15GHz, 802.11n20 @ 5785 MHz Chain A+B, BT Basic Rate @ 2440 MHz Chain B

Date of Test: 12/28/2012
 Test Engineer: John Caizzi

Test Location: Chamber 5
 Config Change: none

	Power Settings		
	Target (dBm)	Measured (dBm)	Software Setting
Chain A	16.0	11.2	39.0
Chain B	16.0	11.1	39.0
Bluetooth	Max	NA	8 dBm

Note - measured power in table above is average power, for reference only.

Preliminary Measurements (Peak versus average limit)

Frequency	Level	Pol	15.209/15.247		Detector	Azimuth	Height	Comments
MHz	dB μ V/m	v/h	Limit	Margin	PK/QP/Avg	degrees	meters	
11575.000	52.0	V	54.0	-2.0	Peak	72	1.0	

Spurious Emissions (final measurements at 3m)

Frequency	Level	Pol	15.209 / 15.247		Detector	Azimuth	Height	Comments
MHz	dB μ V/m	v/h	Limit	Margin	PK/QP/Avg	degrees	meters	
11569.800	47.9	V	54.0	-6.1	AVG	131	1.33	
11570.470	60.9	V	74.0	-13.1	PK	131	1.33	

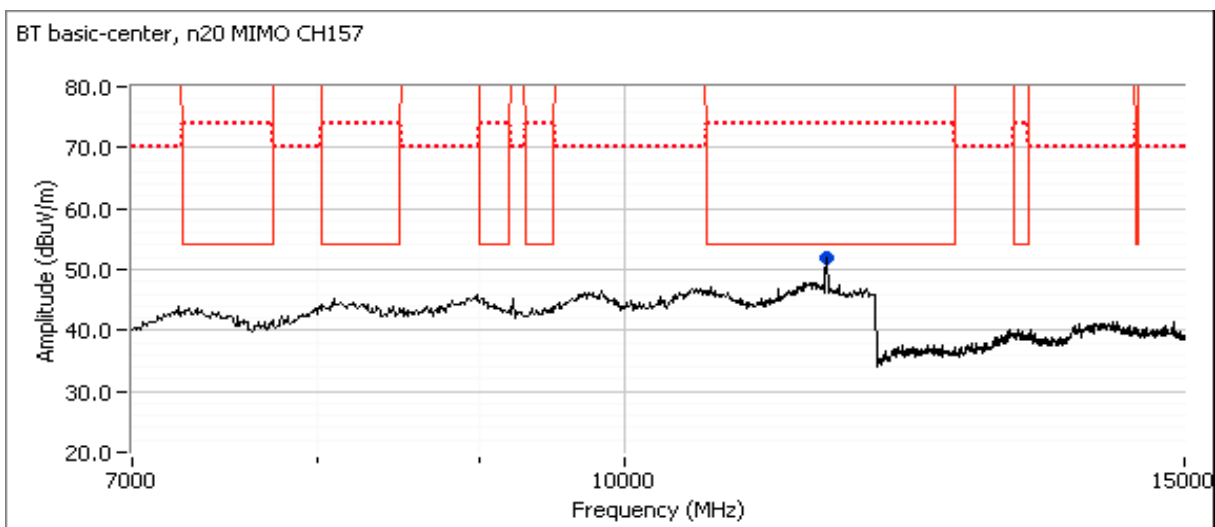



EMC Test Data

Client:	Intel	Job Number:	J88901
Model:	Intel® Centrino® Advanced-N 6235	T-Log Number:	T89578
Contact:	Steve Hackett	Account Manager:	Christine Krebill
Standard:	FCC 15.247, 15.407, 15.209, RSS 210	Class:	N/A

Preliminary Measurements (Peak versus average limit) at 20-30cm from EUT

Frequency	Level	Pol	15.209/15.247		Detector	Azimuth	Height	Comments
MHz	dB μ V/m	v/h	Limit	Margin	PK/QP/Avg	degrees	meters	

Spurious Emissions (final measurements at 3m)

Frequency	Level	Pol	15.209 / 15.247		Detector	Azimuth	Height	Comments
MHz	dB μ V/m	v/h	Limit	Margin	PK/QP/Avg	degrees	meters	

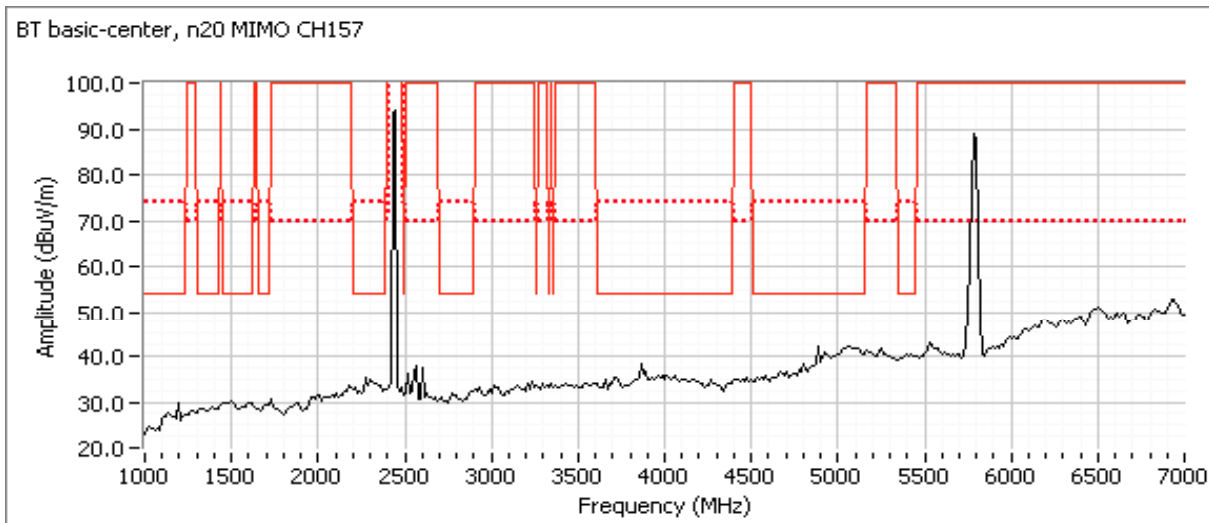



EMC Test Data

Client:	Intel	Job Number:	J88901
Model:	Intel® Centrino® Advanced-N 6235	T-Log Number:	T89578
Contact:	Steve Hackett	Account Manager:	Christine Krebill
Standard:	FCC 15.247, 15.407, 15.209, RSS 210	Class:	B

Radiated Emissions

(Elliott Laboratories Fremont Facility, Semi-Anechoic Chamber)

Test Specific Details

Objective: The objective of this test session is to perform final qualification testing of the EUT with respect to the specification listed above.

Date of Test: 12/28/2012
 Test Engineer: John Caizzi
 Test Location: Chamber 5

Config. Used: 1
 Config Change: none
 Host Unit Voltage 120V/60Hz

General Test Configuration

The EUT and any local support equipment were located on the turntable for radiated emissions testing. The test distance and extrapolation factor (if applicable) are detailed under each run description.

Ambient Conditions:

Temperature: 18 °C
 Rel. Humidity: 39 %

Summary of Results

MAC Address: 001500B50405 DRTU Tool Version 1.5.6-0445 Driver version 15.3.1.2

Run #	Test Performed	Limit	Result	Margin
1	Radiated Emissions 30 - 1000 MHz, Maximized	FCC 15.209 / RSS 210	Pass	29.0 dBµV/m @ 48.02 MHz (-11.0 dB)

Note - preliminary measurements indicated that the radiated emissions from the combination of test fixture and EUT were not affected by the modules operating frequency or mode (transmit versus receive mode). The system was therefore evaluated against the most stringent set of limits from FCC 15.247, FCC 15E and RSS 210 with the device operating at max power (16.5dBm) on Chain A at 2437MHz, 802.11b mode and max power (7dBm) on the top channel in Bluetooth mode (1Mb/s data rate).

Modifications Made During Testing

No modifications were made to the EUT during testing

Deviations From The Standard

No deviations were made from the requirements of the standard.



EMC Test Data

Client:	Intel	Job Number:	J88901
Model:	Intel® Centrino® Advanced-N 6235	T-Log Number:	T89578
Contact:	Steve Hackett	Account Manager:	Christine Krebill
Standard:	FCC 15.247, 15.407, 15.209, RSS 210	Class:	B

Run #1: Preliminary Radiated Emissions, 30 - 1000 MHz
 Configured to TX , 802.11b, 16.5dBm on Chain A (setting 26.0) on channel 6, Bluetooth 7dBm, 1Mb/s (setting 8.0)

Test Parameters for Preliminary Scan(s)			
Frequency Range	Prescan Distance	Limit Distance	Extrapolation Factor
30 - 1000 MHz	3	3	0.0

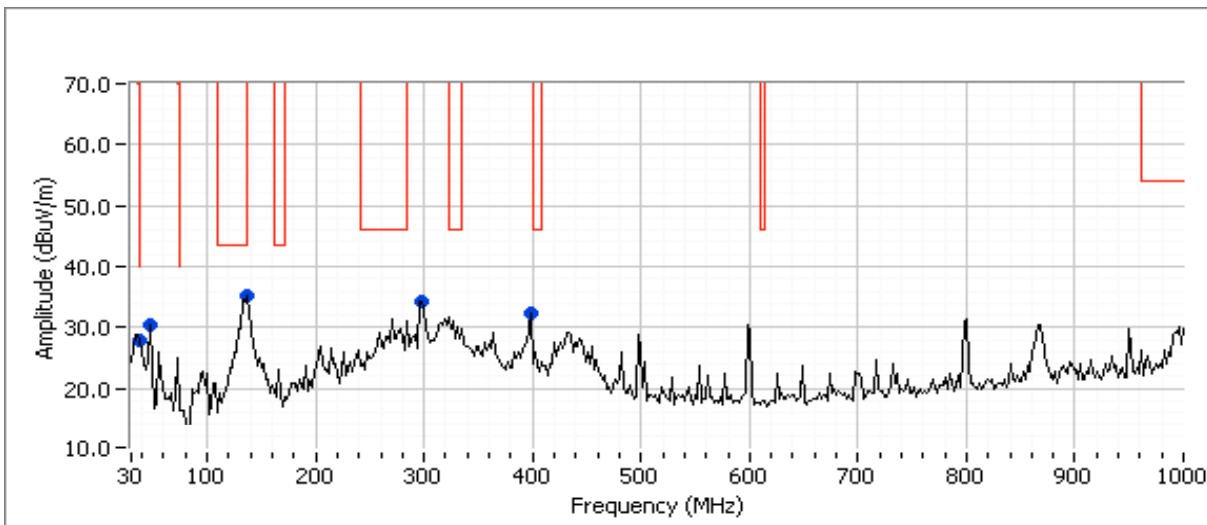

Preliminary peak readings captured during pre-scan

Frequency	Level	Pol	FCC 15.209 / RSS 210		Detector	Azimuth	Height	Comments
MHz	dB μ V/m	v/h	Limit	Margin	Pk/QP/Avg	degrees	meters	
136.412	35.1	V	43.5	-8.4	Peak	129	1.0	
37.881	28.0	V	40.0	-12.0	Peak	335	1.0	
399.938	32.5	H	46.0	-13.5	Peak	322	1.0	
48.020	30.4	V	40.0	-9.6	Peak	263	1.0	Note 1
299.808	34.4	H	46.0	-11.6	Peak	33	1.0	Note 1

Preliminary quasi-peak readings (no manipulation of EUT interface cables)

Frequency	Level	Pol	FCC 15.209 / RSS 210		Detector	Azimuth	Height	Comments
MHz	dB μ V/m	v/h	Limit	Margin	Pk/QP/Avg	degrees	meters	
48.020	29.0	V	40.0	-11.0	QP	304	1.00	Note 1
37.881	23.8	V	40.0	-16.2	QP	346	1.00	
399.938	25.2	H	46.0	-20.8	QP	327	1.00	
48.020	29.0	V	40.0	-11.0	QP	304	1.00	Note 1
136.412	32.1	V	43.5	-11.4	QP	140	1.00	
299.808	29.8	H	46.0	-16.2	QP	31	1.00	Note 1



EMC Test Data

Client:	Intel	Job Number:	J88901
Model:	Intel® Centrino® Advanced-N 6235	T-Log Number:	T89578
Contact:	Steve Hackett	Account Manager:	Christine Krebill
Standard:	FCC 15.247, 15.407, 15.209, RSS 210	Class:	B

Note 1: Emission is not in restricted band, but the more stringent restricted band limit was used.



EMC Test Data

Client:	Intel	Job Number:	J88901
Model:	Intel® Centrino® Advanced-N 6235	T-Log Number:	T89578
		Account Manager:	Christine Krebill
Contact:	Steve Hackett		
Standard:	FCC 15.247, 15.407, 15.209, RSS 210	Class:	B

Conducted Emissions

(Elliott Laboratories Fremont Facility, Semi-Anechoic Chamber)

Test Specific Details

Objective: The objective of this test session is to perform final qualification testing of the EUT with respect to the specification listed above.

Date of Test: 12/18/2012	Config. Used: 1
Test Engineer: Mark Hill	Config Change: -
Test Location: Fremont Chamber #4	EUT Voltage: 120V/60Hz

General Test Configuration

For tabletop equipment, the EUT was located on a wooden table inside the semi-anechoic chamber, 40 cm from a vertical coupling plane and 80cm from the LISN. A second LISN was used for all local support equipment. Remote support equipment was located outside of the semi-anechoic chamber. Any cables running to remote support equipment were routed through metal conduit and when possible passed through a ferrite clamp upon exiting the chamber.

Ambient Conditions:	Temperature:	19 °C
	Rel. Humidity:	41 %

Summary of Results

Run #	Test Performed	Limit	Result	Margin
1	CE, AC Power, 120V/60Hz	Class B	Pass	31.3 dBµV @ 4.428 MHz (-24.7 dB)

Modifications Made During Testing

No modifications were made to the EUT during testing

Deviations From The Standard

No deviations were made from the requirements of the standard.



EMC Test Data

Client:	Intel	Job Number:	J88901
Model:	Intel® Centrino® Advanced-N 6235	T-Log Number:	T89578
Contact:	Steve Hackett	Account Manager:	Christine Krebill
Standard:	FCC 15.247, 15.407, 15.209, RSS 210	Class:	B

Run #1: AC Power Port Conducted Emissions, 0.15 - 30MHz, 120V/60Hz

Preliminary peak readings captured during pre-scan (peak readings vs. average limit)

Frequency MHz	Level dB μ V	AC Line	Class B		Detector QP/Ave	Comments
			Limit	Margin		
0.455	33.7	Neutral	46.8	-13.1	Peak	
0.471	33.1	Neutral	46.5	-13.4	Peak	
4.428	36.6	Neutral	46.0	-9.4	Peak	
5.983	37.4	Neutral	50.0	-12.6	Peak	
0.443	33.0	Line 1	47.0	-14.0	Peak	
0.473	32.5	Line 1	46.5	-14.0	Peak	
4.621	34.6	Line 1	46.0	-11.4	Peak	
13.329	38.9	Line 1	50.0	-11.1	Peak	

Final quasi-peak and average readings

Frequency MHz	Level dB μ V	AC Line	Class B		Detector QP/Ave	Comments
			Limit	Margin		
4.428	31.3	Neutral	56.0	-24.7	QP	QP (1.00s)
4.428	20.4	Neutral	46.0	-25.6	AVG	AVG (0.10s)
4.621	28.5	Line 1	56.0	-27.5	QP	QP (1.00s)
5.983	30.9	Neutral	60.0	-29.1	QP	QP (1.00s)
4.621	16.8	Line 1	46.0	-29.2	AVG	AVG (0.10s)
13.329	20.5	Line 1	50.0	-29.5	AVG	AVG (0.10s)
0.443	26.8	Line 1	57.0	-30.2	QP	QP (1.00s)
0.473	26.3	Line 1	56.5	-30.2	QP	QP (1.00s)
0.471	26.2	Neutral	56.5	-30.3	QP	QP (1.00s)
0.455	26.4	Neutral	56.8	-30.4	QP	QP (1.00s)
5.983	19.5	Neutral	50.0	-30.5	AVG	AVG (0.10s)
13.329	28.3	Line 1	60.0	-31.7	QP	QP (1.00s)
0.443	8.3	Line 1	47.0	-38.7	AVG	AVG (0.10s)
0.473	6.9	Line 1	46.5	-39.6	AVG	AVG (0.10s)
0.455	6.6	Neutral	46.8	-40.2	AVG	AVG (0.10s)
0.471	6.1	Neutral	46.5	-40.4	AVG	AVG (0.10s)

Client: Intel	Job Number: J88901
Model: Intel® Centrino® Advanced-N 6235	T-Log Number: T89578
	Account Manager: Christine Krebill
Contact: Steve Hackett	
Standard: FCC 15.247, 15.407, 15.209, RSS 210	Class: B

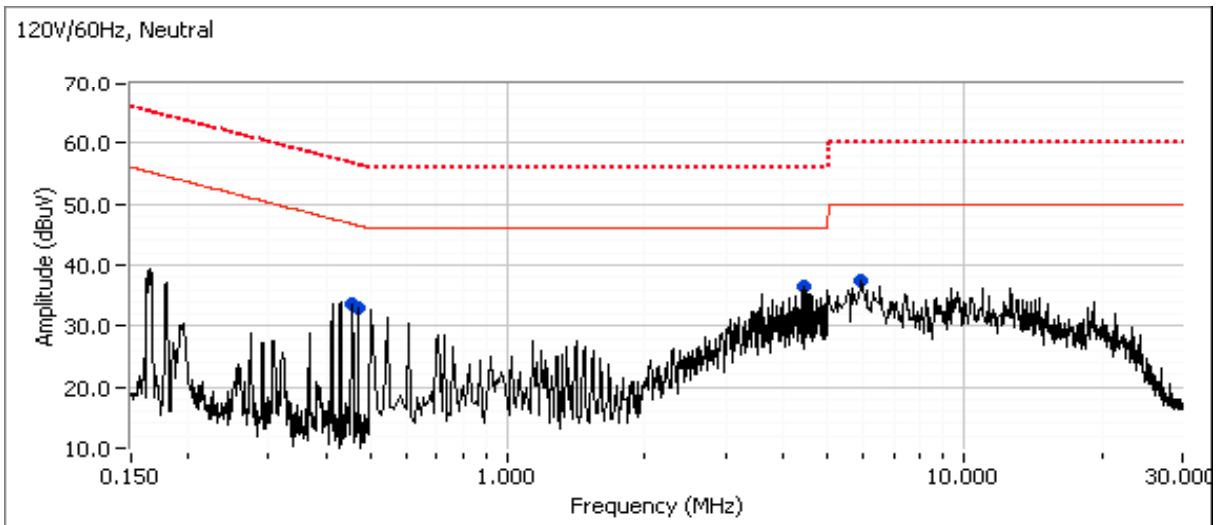
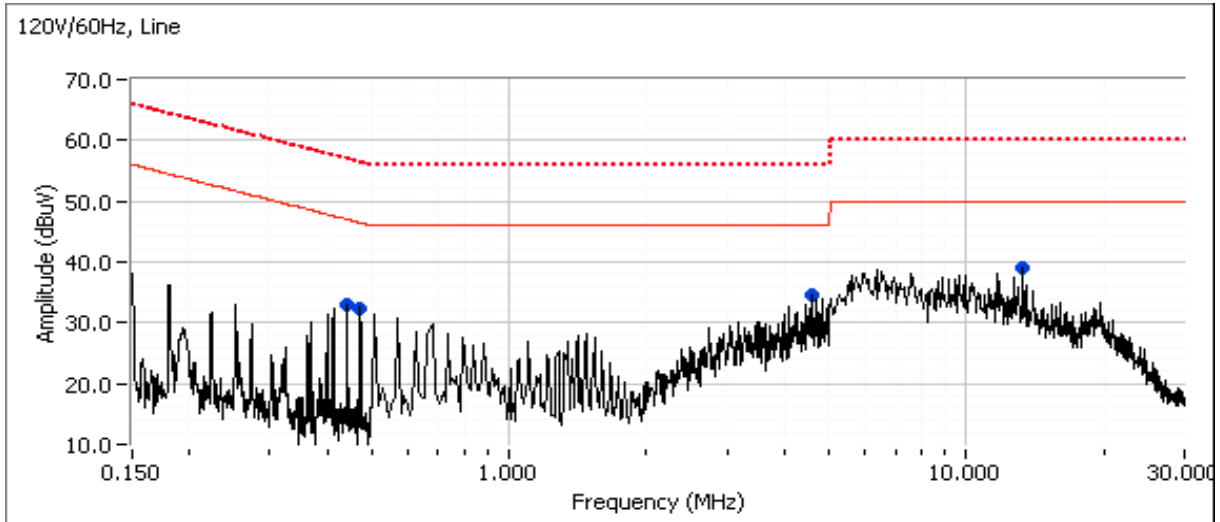

End of Report

This page is intentionally blank and marks the last page of this test report.