

EMC Test Report

Application for Grant of Equipment Authorization

*Industry Canada RSS-Gen Issue 3 / RSS 210 Issue 8
FCC Part 15, Subpart E*

Models: 6235ANNGW and 6235ANNGU

IC CERTIFICATION #: 1000M-6235ANNG and 1000M-6235ANNGU
FCC ID: PD96235ANNG and PD96235ANNGU

APPLICANT: Intel Corporation
100 Center Point Circle, Suite 200
Columbia, SC 29210, USA

TEST SITE(S): NTS Silicon Valley
41039 Boyce Road.
Fremont, CA. 94538-2435

IC SITE REGISTRATION #: 2845B-3; 2845B-4, 2845B-5, 2845B-7

REPORT DATE: January 14, 2013

FINAL TEST DATES: December 7, 9, 10, 11, 17, 18, 19, 20, 28 and
January 3, 4, 6, 2013

TOTAL NUMBER OF PAGES: 182

PROGRAM MGR /
TECHNICAL REVIEWER:



David W. Bare
Chief Engineer

QUALITY ASSURANCE DELEGATE /
FINAL REPORT PREPARER:



David Guidotti
Senior Technical Writer



NTS Silicon Valley is accredited by the A2LA, certificate number 0214.26, to perform the test(s) listed in this report, except where noted otherwise. This report and the information contained herein represent the results of testing test articles identified and selected by the client performed to specifications and/or procedures selected by the client. National Technical Systems (NTS) makes no representations, expressed or implied, that such testing is adequate (or inadequate) to demonstrate efficiency, performance, reliability, or any other characteristic of the articles being tested, or similar products. This report should not be relied upon as an endorsement or certification by NTS of the equipment tested, nor does it represent any statement whatsoever as to its merchantability or fitness of the test article, or similar products, for a particular purpose. This report shall not be reproduced except in full

REVISION HISTORY

Rev#	Date	Comments	Modified By
1	1-14-2013	First release	

TABLE OF CONTENTS

REVISION HISTORY2

TABLE OF CONTENTS3

SCOPE.....4

OBJECTIVE5

STATEMENT OF COMPLIANCE.....5

DEVIATIONS FROM THE STANDARDS.....5

TEST RESULTS SUMMARY6

 UNII / LELAN DEVICES6

 GENERAL REQUIREMENTS APPLICABLE TO ALL BANDS8

 ADDITIONAL MEASUREMENTS8

 MEASUREMENT UNCERTAINTIES9

EQUIPMENT UNDER TEST (EUT) DETAILS.....10

 ANTENNA SYSTEM10

 ENCLOSURE10

 MODIFICATIONS10

 SUPPORT EQUIPMENT10

 EUT INTERFACE PORTS11

 EUT OPERATION11

TEST SITE.....12

 GENERAL INFORMATION12

 CONDUCTED EMISSIONS CONSIDERATIONS12

 RADIATED EMISSIONS CONSIDERATIONS12

MEASUREMENT INSTRUMENTATION13

 RECEIVER SYSTEM13

 INSTRUMENT CONTROL COMPUTER13

 LINE IMPEDANCE STABILIZATION NETWORK (LISN)13

 FILTERS/ATTENUATORS14

 ANTENNAS14

 ANTENNA MAST AND EQUIPMENT TURNTABLE14

 INSTRUMENT CALIBRATION14

TEST PROCEDURES15

 EUT AND CABLE PLACEMENT15

 CONDUCTED EMISSIONS15

 RADIATED EMISSIONS16

 CONDUCTED EMISSIONS FROM ANTENNA PORT18

 BANDWIDTH MEASUREMENTS18

 SPECIFICATION LIMITS AND SAMPLE CALCULATIONS19

 CONDUCTED EMISSIONS SPECIFICATION LIMITS: FCC 15.207; FCC 15.107(A), RSS GEN19

 GENERAL TRANSMITTER RADIATED EMISSIONS SPECIFICATION LIMITS20

 RECEIVER RADIATED SPURIOUS EMISSIONS SPECIFICATION LIMITS20

 FCC 15.407 (A) OUTPUT POWER LIMITS21

 OUTPUT POWER LIMITS –LELAN DEVICES21

 SPURIOUS EMISSIONS LIMITS –UNII AND LELAN DEVICES22

 SAMPLE CALCULATIONS - CONDUCTED EMISSIONS22

 SAMPLE CALCULATIONS - RADIATED EMISSIONS22

 SAMPLE CALCULATIONS - FIELD STRENGTH TO EIRP CONVERSION23

APPENDIX A TEST EQUIPMENT CALIBRATION DATA24

APPENDIX B TEST DATA28

END OF REPORT182

SCOPE

An electromagnetic emissions test has been performed on the Intel Corporation models 6235ANNGW and 6235ANNGU, pursuant to the following rules:

Industry Canada RSS-Gen Issue 3
RSS 210 Issue 8 “Low-power Licence-exempt Radiocommunication Devices (All Frequency Bands): Category I Equipment”
FCC Part 15, Subpart E requirements for UNII Devices

Conducted and radiated emissions data has been collected, reduced, and analyzed within this report in accordance with measurement guidelines set forth in the following reference standards and as outlined in NTS Silicon Valley test procedures:

ANSI C63.4:2003
FCC UNII test procedure KDB 789033

The intentional radiator above has been tested in a simulated typical installation to demonstrate compliance with the relevant Industry Canada performance and procedural standards.

Final system data was gathered in a mode that tended to maximize emissions by varying orientation of EUT, orientation of power and I/O cabling, antenna search height, and antenna polarization.

Every practical effort was made to perform an impartial test using appropriate test equipment of known calibration. All pertinent factors have been applied to reach the determination of compliance.

OBJECTIVE

The primary objective of the manufacturer is compliance with the regulations outlined in the previous section.

Prior to marketing in the USA, all unlicensed transmitters and transceivers require certification. Receive-only devices operating between 30 MHz and 960 MHz are subject to either certification or a manufacturer's declaration of conformity, with all other receive-only devices exempt from the technical requirements.

Prior to marketing in Canada, Class I transmitters, receivers and transceivers require certification. Class II devices are required to meet the appropriate technical requirements but are exempt from certification requirements.

Certification is a procedure where the manufacturer submits test data and technical information to a certification body and receives a certificate or grant of equipment authorization upon successful completion of the certification body's review of the submitted documents. Once the equipment authorization has been obtained, the label indicating compliance must be attached to all identical units, which are subsequently manufactured.

Maintenance of compliance is the responsibility of the manufacturer. Any modification of the product which may result in increased emissions should be checked to ensure compliance has been maintained (i.e., printed circuit board layout changes, different line filter, different power supply, harnessing or I/O cable changes, etc.).

STATEMENT OF COMPLIANCE

The tested sample(s) of Intel Corporation models 6235ANNGW and 6235ANNGU complied with the requirements of the following regulations:

RSS 210 Issue 8 "Low-power Licence-exempt Radiocommunication Devices (All Frequency Bands): Category I Equipment"
FCC Part 15, Subpart E requirements for UNII Devices

Maintenance of compliance is the responsibility of the manufacturer. Any modifications to the product should be assessed to determine their potential impact on the compliance status of the device with respect to the standards detailed in this test report.

The test results recorded herein are based on a single type test of Intel Corporation models 6235ANNGW and 6235ANNGU and therefore apply only to the tested sample(s). The sample(s) were selected and prepared by Stephen Hackett of Intel Corporation.

DEVIATIONS FROM THE STANDARDS

No deviations were made from the published requirements listed in the scope of this report.

TEST RESULTS SUMMARY

UNII / LELAN DEVICES

Operation in the 5.15 – 5.25 GHz Band

FCC Rule Part	RSS Rule Part	Description	Measured Value / Comments	Limit / Requirement	Result
15.407(e)		Indoor operation only	Refer to user's manual	N/A	Complies
15.407(a)(2)		26dB Bandwidth	>20 MHz in all modes	N/A – limits output power if < 20MHz	N/A
15.407 (a)(1)		Output Power	a: 0.041 W n20: 0.039 W n40: 0.038 W (Max eirp: 0.093 W) ¹	17dBm (50 mW) (eirp < 23dBm)	Complies
	A9.2(1)	Output Power	a: 0.041 W n20: 0.039 W n40: 0.038 W (Max eirp: 0.093 W) ¹	16.5dBm ² (45 mW) (eirp < 23dBm)	Complies
15.407 (a)(1)	-	Power Spectral Density	a: 3.3 dBm/MHz n20: 2.7 dBm/MHz n40: 0.4 dBm/MHz	4 dBm/MHz	Complies
-	A9.5 (2)			6.4 dBm/MHz	Complies
Note 1: EIRP calculated using antenna gain of 3.6 dBi for the highest EIRP system.					
Note 2: Power for RSS 210 is limited by minimum 99% bandwidth and this is the lowest limit based on the results.					

Operation in the 5.25 – 5.35 GHz Band

Note: The device is restricted to indoor use only, therefore the spectral density of spurious emissions in the 5.15 – 5.25 GHz band were limited to the power spectral limits for intentional signals detailed in FCC 15.407(a)(1) and RSS 210 6.2.2 q1 (i)

FCC Rule Part	RSS Rule Part	Description	Measured Value / Comments	Limit / Requirement	Result (margin)
15.407(a)(2)		26dB Bandwidth	>20 MHz in all modes	N/A – limits output power if < 20MHz	N/A
15.407(a)(2)	A9.2(2)	Output Power	a: 0.040 W n20: 0.039 W n40: 0.034 W (Max eirp: 0.094 W) ¹	24dBm (250mW) (eirp < 30dBm)	Complies
15.407(a)(2)	-	Power Spectral Density	a: 3.2 dBm/MHz n20: 2.9 dBm/MHz n40: -0.2 dBm/MHz	11 dBm/MHz	Complies
-	A9.2(2) / A9.5 (2)	Power Spectral Density		11 dBm / MHz	Complies
Note 1: EIRP calculated using antenna gain of 3.7 dBi for the highest EIRP system.					

Operation in the 5.47 – 5.725 GHz Band

FCC Rule Part	RSS Rule Part	Description	Measured Value / Comments	Limit / Requirement	Result (margin)
15.407(a)(2)		26dB Bandwidth	>20 MHz in all modes	N/A – limits output power if < 20MHz	N/A
15.407(a)(2)	A9.2(2)	Output Power	a: 0.033 W n20: 0.041 W n40: 0.038 W (Max eirp: 0.101 W)	24 dBm 250mW (eirp < 30dBm)	Complies
15.407(a)(2))		Power Spectral Density	a: 2.4 dBm/MHz n20: 2.9 dBm/MHz n40: 0.3 dBm/MHz	11 dBm/MHz	Complies
	A9.2(2) / A9.5 (2)	Power Spectral Density		11 dBm / MHz	Complies
KDB 443999	A9	Non-operation in 5600 – 5650 MHz sub band	Device cannot operate in the 5600 – 5650 MHz band –refer to Operational Description		Complies

Requirements for all U-NII/LELAN bands

FCC Rule Part	RSS Rule Part	Description	Measured Value / Comments	Limit / Requirement	Result
15.407	A9.5a	Modulation	Digital Modulation is used	Digital modulation is required	Complies
15.407(b)(5) / 15.209	A9.3	Spurious Emissions	68.2 dBμV/m @ 5469.2 MHz (-0.1 dB)	Refer to page 22	Complies
15.407(a)(6)	-	Peak Excursion Ratio	Maximum 8.7 dB	< 13dB	Complies
	A9.5 (3)	Channel Selection	Spurious emissions tested at outermost channels in each band	Device was tested on the top, bottom and center channels in each band	Complies
15			Measurements on three channels in each band		Complies
15.407 (c)	A9.5(4)	Operation in the absence of information to transmit	Operation is discontinued in the absence of information (Operational Description page 9)	Device shall automatically discontinue operation in the absence of information to transmit	Complies
15.407 (g)	A9.5 (5)	Frequency Stability	Frequency stability is better than 20ppm (Operational Description page 9)	Signal shall remain within the allocated band	Complies
15.407 (h1)	A9.4	Transmit Power Control	TPC is not required as the device operates at below 500mW eirp	The U-NII device shall have the capability to operate with a mean EIRP value lower than 24dBm (250mW)	Complies
15.407 (h2)	A9.4	Dynamic frequency Selection (device without radar detection)	Refer to separate test report, reference R90475	Channel move time < 10s Channel closing transmission time < 260ms	Complies
	A9.9g	User Manual information	Refer to Pages 20 of the user manual for details	Warning regarding interference from Satellite Systems	Complies

GENERAL REQUIREMENTS APPLICABLE TO ALL BANDS

FCC Rule Part	RSS Rule part	Description	Measured Value / Comments	Limit / Requirement	Result (margin)
15.203	-	RF Connector	Not applicable as antennas are integral in host systems	Unique or integral antenna required	Complies
15.207	RSS GEN Table 2	AC Conducted Emissions	31.3 dB μ V @ 4.428 MHz (-24.7 dB)	Refer to page 19	Complies (- ?? dB)
15.247 (b) (5) 15.407 (f)	RSS 102	RF Exposure Requirements	Refer to SAR report and RSS 102 declaration	Refer to OET 65, FCC Part 1 and RSS 102	Complies
-	RSP 100 RSS GEN 7.1.5	User Manual	Refer to User Manual for details	Statement required regarding non-interference	Complies
-	RSP 100 RSS GEN 7.1.5	User Manual	No detachable antenna	Statement for products with detachable antenna	Complies
-	RSP 100 RSS GEN 4.4.1	99% Bandwidth	a: 32.7 MHz n20: 33.9 MHz n40: 58.8 MHz	Information only	N/A

ADDITIONAL MEASUREMENTS

As both Bluetooth and 802.11 transmissions can occur simultaneously, radiated spurious measurements were made with both Bluetooth and 802.11 transmitting simultaneously.

FCC Rule Part	RSS Rule Part	Description	Measured Value / Comments	Limit / Requirement	Result
15.209	RSS 210 A8.5	Radiated Spurious Emissions	46.4 dB μ V/m @ 11159.7 MHz (-7.6 dB)	15.209 in restricted bands, all others < -20dBc or < -30dBc ^{Note 2}	Complies
Emission was second harmonic of the 802.11 signal and not an intermodulation product, but was the highest amplitude emissions observed with both Bluetooth and Wi-Fi operating simultaneously.					

MEASUREMENT UNCERTAINTIES

ISO/IEC 17025 requires that an estimate of the measurement uncertainties associated with the emissions test results be included in the report. The measurement uncertainties given below are based on a 95% confidence level and were calculated in accordance with UKAS document LAB 34.

Measurement Type	Measurement Unit	Frequency Range	Expanded Uncertainty
RF power, conducted (power meter)	dBm	25 to 7000 MHz	± 0.52 dB
RF power, conducted (Spectrum analyzer)	dBm	25 to 7000 MHz	± 0.7 dB
Conducted emission of transmitter	dBm	25 to 26500 MHz	± 0.7 dB
Conducted emission of receiver	dBm	25 to 26500 MHz	± 0.7 dB
Radiated emission (substitution method)	dBm	25 to 26500 MHz	± 2.5 dB
Radiated emission (field strength)	dB μ V/m	25 to 1000 MHz	± 3.6 dB
		1000 to 40000 MHz	± 6.0 dB
Conducted Emissions (AC Power)	dB μ V	0.15 to 30 MHz	± 2.4 dB

EQUIPMENT UNDER TEST (EUT) DETAILS

The Intel Corporation Intel® Centrino® Advanced-N 6235 models 6235ANNGW and 6235ANNGU are Bluetooth/IEEE 802.11a/b/g/n wireless network adapter modules. The modules support MIMO (2x2) for 802.11n modes and MISO (1x2) for 802.11a/b/g modes. Bluetooth only operation mode is a 1x1. When Bluetooth is operational then 802.11b/g/n modes operate as SISO (1x1). 802.11a/n modes still operate as MIMO (2x2) with Bluetooth operational.

The card is sold under two different FCC/IC ID numbers (see table below). The ID's ending in "U" are intended to allow user install conditions and host systems must be provided with a BIOS locking feature that prevents installation of unauthorized devices. For radio testing purposes the card was installed in a test fixture that exposed all sides of the card. For digital device testing for certification under equipment code JBP the card was installed in a test fixture external to the PC.

The samples were received on December 1, 2012 and tested on December 7, 9, 10, 11, 17, 18, 19, 20, 28 and January 3, 4, 6, 2013. The samples tested are as follows:

Company	Model	Description	Serial Number	FCC ID
Intel Corporation	6235ANNGW	Bluetooth / IEEE 802.11a/b/g/n wireless network adapter module	50405 (JBP)	PD96235ANNG
	6235ANNGU		50405 (DSS, DTS and NII)	PD96235ANNGU 1000M-6235ANNG 1000M-6235ANNGU

ANTENNA SYSTEM

The EUT antenna is a two-antenna PIFA antenna system – Shanghai Universe Communication Electron Co., Ltd,
 The antenna connects to the EUT via a non-standard antenna connector, thereby meeting the requirements of FCC 15.203.

ENCLOSURE

The EUT has no enclosure. It is designed to be installed within the enclosure of a host computer.

MODIFICATIONS

No modifications were made to the EUT during the time the product was at NTS Silicon Valley.

SUPPORT EQUIPMENT

The following equipment was used as support equipment for testing:

Company	Model	Description	Serial Number	FCC ID
Intel Corporation	-	NGFF Test Fixture	3902412-151	N/A
Dell	Latitude D520	Laptop PC	HM9383J	N/A
Dell	Latitude E5400	Laptop PC	GFZW54J	N/A
Agilent	E3610A	DC Supply	MY4001740	N/A

EUT INTERFACE PORTS

The I/O cabling configuration during testing was as follows:

Port	Connected To	Description	Cable(s)	
			Shielded or Unshielded	Length(m)
Laptop USB	Fixture USB	USB cable	Shielded	1.5
Laptop Mini PCI	Fixture PCIe	Ribbon	unshielded	0.7
DC Power	Fixture DC power	2-wire	unshielded	0.7

EUT OPERATION

The EUT was installed into a test fixture that exposed all sides of the card. The test fixture interfaced to a laptop computer and dc power supply. The laptop computer was used to configure the EUT to continuously transmit at a specified output power on the channel specified in the test data. For transmit mode measurements the system was configured to operate in each of the available operating modes – 802.11b, 802.11g, 802.11n (20 MHz channel bandwidth) and 802.11n (40MHz channel bandwidth), Bluetooth 1Mb/s and Bluetooth 3Mb/s. In addition radiated spurious tests were repeated with the device operating in both Bluetooth and 802.11 modes to determine if any spurious emissions due to intermodulation products were created.

The data rates used for all tests were the lowest data rates for each 802.11 mode – 1Mb/s for 802.11b, 6Mb/s for 802.11a and 802.11g, 6.5MB/s for 802.11n (20MHz), and 13 Mb/s for 802.11n (40MHz) except that power for 802.11b mode was tested at 5.5Mb/s. The device operates at its maximum output power at the lowest data rate except for 802.11b mode (this was confirmed through separate measurements – refer to test data for actual measurements). Bluetooth operation was evaluated at both 1Mb/s and 3Mb/s data rates. 2Mb/s data rate was found, through preliminary testing, to produce emissions similar to those for 3Mb/s.

The PC was using the Intel test utility DRTU Version 1.5.6-0445 and the device driver was version 15.3.1.2.

TEST SITE

GENERAL INFORMATION

Final test measurements were taken at the test sites listed below. Pursuant to section 2.948 of the FCC’s Rules and section 3.3 of RSP-100, construction, calibration, and equipment data has been filed with the Commission and with industry Canada.

Site	Registration Numbers		Location
	FCC	Canada	
Chamber 3	769238	2845B-3	41039 Boyce Road Fremont, CA 94538-2435
Chamber 4	211948	2845B-4	
Chamber 5	211948	2845B-5	
Chamber 7	A2LA accreditation	2845B-7	

ANSI C63.4:2003 recommends that ambient noise at the test site be at least 6 dB below the allowable limits. Ambient levels are below this requirement. The test site(s) contain separate areas for radiated and conducted emissions testing. Considerable engineering effort has been expended to ensure that the facilities conform to all pertinent requirements of ANSI C63.4:2003.

CONDUCTED EMISSIONS CONSIDERATIONS

Conducted emissions testing is performed in conformance with ANSI C63.4:2003. Measurements are made with the EUT connected to the public power network through a nominal, standardized RF impedance, which is provided by a line impedance stabilization network, known as a LISN. A LISN is inserted in series with each current-carrying conductor in the EUT power cord.

RADIATED EMISSIONS CONSIDERATIONS

The FCC has determined that radiation measurements made in a shielded enclosure are not suitable for determining levels of radiated emissions. Radiated measurements are performed in an open field environment or in a semi-anechoic chamber. The test sites are maintained free of conductive objects within the CISPR defined elliptical area incorporated in ANSI C63.4:2003 guidelines and meet the Normalized Site Attenuation (NSA) requirements of ANSI C63.4:2003.

MEASUREMENT INSTRUMENTATION

RECEIVER SYSTEM

An EMI receiver as specified in CISPR 16-1-1 is used for emissions measurements. The receivers used can measure over the frequency range of 9 kHz up to 2000 MHz. These receivers allow both ease of measurement and high accuracy to be achieved. The receivers have Peak, Average, and CISPR (Quasi-peak) detectors built into their design so no external adapters are necessary. The receiver automatically sets the required bandwidth for the CISPR detector used during measurements. If the repetition frequency of the signal being measured is below 20Hz, peak measurements are made in lieu of Quasi-Peak measurements.

For measurements above the frequency range of the receivers, a spectrum analyzer is utilized because it provides visibility of the entire spectrum along with the precision and versatility required to support engineering analysis. Average measurements above 1000MHz are performed on the spectrum analyzer using the linear-average method with a resolution bandwidth of 1 MHz and a video bandwidth of 10 Hz, unless the signal is pulsed in which case the average (or video) bandwidth of the measuring instrument is reduced to onset of pulse desensitization and then increased.

INSTRUMENT CONTROL COMPUTER

The receivers utilize either a Rohde & Schwarz EZM Spectrum Monitor/Controller or contain an internal Spectrum Monitor/Controller to view and convert the receiver measurements to the field strength at an antenna or voltage developed at the LISN measurement port, which is then compared directly with the appropriate specification limit. This provides faster, more accurate readings by performing the conversions described under Sample Calculations within the Test Procedures section of this report. Results are printed in a graphic and/or tabular format, as appropriate. A personal computer is used to record all measurements made with the receivers.

The Spectrum Monitor provides a visual display of the signal being measured. In addition, the controller or a personal computer run automated data collection programs which control the receivers. This provides added accuracy since all site correction factors, such as cable loss and antenna factors are added automatically.

LINE IMPEDANCE STABILIZATION NETWORK (LISN)

Line conducted measurements utilize a fifty microhenry Line Impedance Stabilization Network as the monitoring point. The LISN used also contains a 250 uH CISPR adapter. This network provides for calibrated radio frequency noise measurements by the design of the internal low pass and high pass filters on the EUT and measurement ports, respectively.

FILTERS/ATTENUATORS

External filters and precision attenuators are often connected between the receiving antenna or LISN and the receiver. This eliminates saturation effects and non-linear operation due to high amplitude transient events.

ANTENNAS

A loop antenna is used below 30 MHz. For the measurement range 30 MHz to 1000 MHz either a combination of a biconical antenna and a log periodic or a bi-log antenna is used. Above 1000 MHz, horn antennas are used. The antenna calibration factors to convert the received voltage to an electric field strength are included with appropriate cable loss and amplifier gain factors to determine an overall site factor, which is then programmed into the test receivers or incorporated into the test software.

ANTENNA MAST AND EQUIPMENT TURNTABLE

The antennas used to measure the radiated electric field strength are mounted on a non-conductive antenna mast equipped with a motor-drive to vary the antenna height. Measurements below 30 MHz are made with the loop antenna at a fixed height of 1m above the ground plane.

ANSI C63.4:2003 specifies that the test height above ground for table mounted devices shall be 80 centimeters. Floor mounted equipment shall be placed on the ground plane if the device is normally used on a conductive floor or separated from the ground plane by insulating material from 3 to 12 mm if the device is normally used on a non-conductive floor. During radiated measurements, the EUT is positioned on a motorized turntable in conformance with this requirement.

INSTRUMENT CALIBRATION

All test equipment is regularly checked to ensure that performance is maintained in accordance with the manufacturer's specifications. All antennas are calibrated at regular intervals with respect to tuned half-wave dipoles. An exhibit of this report contains the list of test equipment used and calibration information.

TEST PROCEDURES

EUT AND CABLE PLACEMENT

The regulations require that interconnecting cables be connected to the available ports of the unit and that the placement of the unit and the attached cables simulate the worst case orientation that can be expected from a typical installation, so far as practicable. To this end, the position of the unit and associated cabling is varied within the guidelines of ANSI C63.4:2003, and the worst-case orientation is used for final measurements.

CONDUCTED EMISSIONS

Conducted emissions are measured at the plug end of the power cord supplied with the EUT. Excess power cord length is wrapped in a bundle between 30 and 40 centimeters in length near the center of the cord. Preliminary measurements are made to determine the highest amplitude emission relative to the specification limit for all the modes of operation. Placement of system components and varying of cable positions are performed in each mode. A final peak mode scan is then performed in the position and mode for which the highest emission was noted on all current carrying conductors of the power cord.

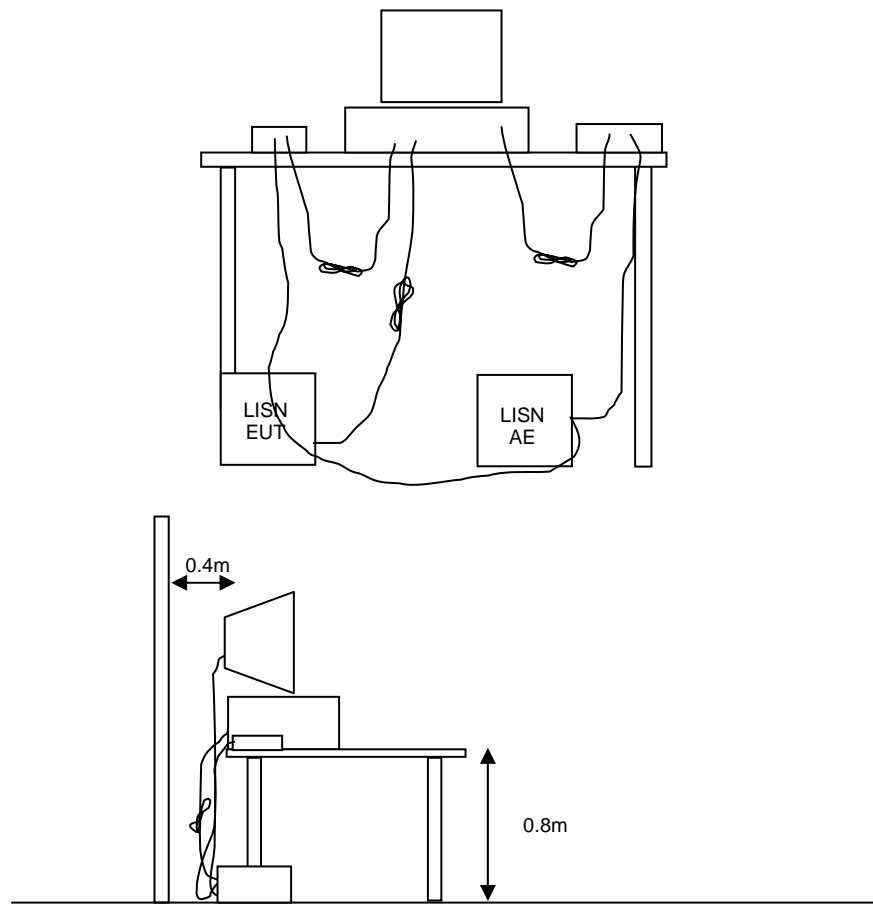

Figure 1 Typical Conducted Emissions Test Configuration

RADIATED EMISSIONS

A preliminary scan of the radiated emissions is performed in which all significant EUT frequencies are identified with the system in a nominal configuration. At least two scans are performed, one scan for each antenna polarization (horizontal and vertical; loop parallel and perpendicular to the EUT). During the preliminary scans, the EUT is rotated through 360°, the antenna height is varied (for measurements above 30 MHz) and cable positions are varied to determine the highest emission relative to the limit. Preliminary scans may be performed in a fully anechoic chamber for the purposes of identifying the frequencies of the highest emissions from the EUT.

A speaker is provided in the receiver to aid in discriminating between EUT and ambient emissions. Other methods used during the preliminary scan for EUT emissions involve scanning with near field magnetic loops, monitoring I/O cables with RF current clamps, and cycling power to the EUT.

Final maximization is a phase in which the highest amplitude emissions identified in the spectral search are viewed while the EUT azimuth angle is varied from 0 to 360 degrees relative to the receiving antenna. The azimuth, which results in the highest emission is then maintained while varying the antenna height from one to four meters (for measurements above 30 MHz, measurements below 30 MHz are made with the loop antenna at a fixed height of 1m). The result is the identification of the highest amplitude for each of the highest peaks. Each recorded level is corrected in the receiver using appropriate factors for cables, connectors, antennas, and preamplifier gain.

When testing above 18 GHz, the receive antenna is located at 1meter from the EUT and the antenna height is restricted to a maximum of 2.5 meters.

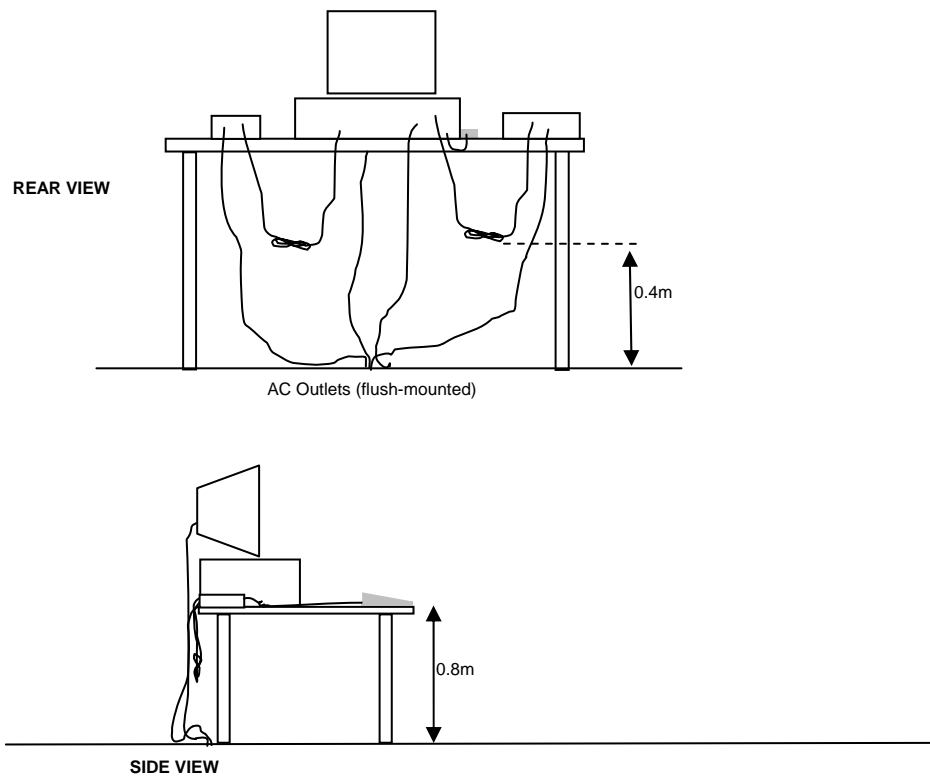

Typical Test Configuration for Radiated Field Strength Measurements

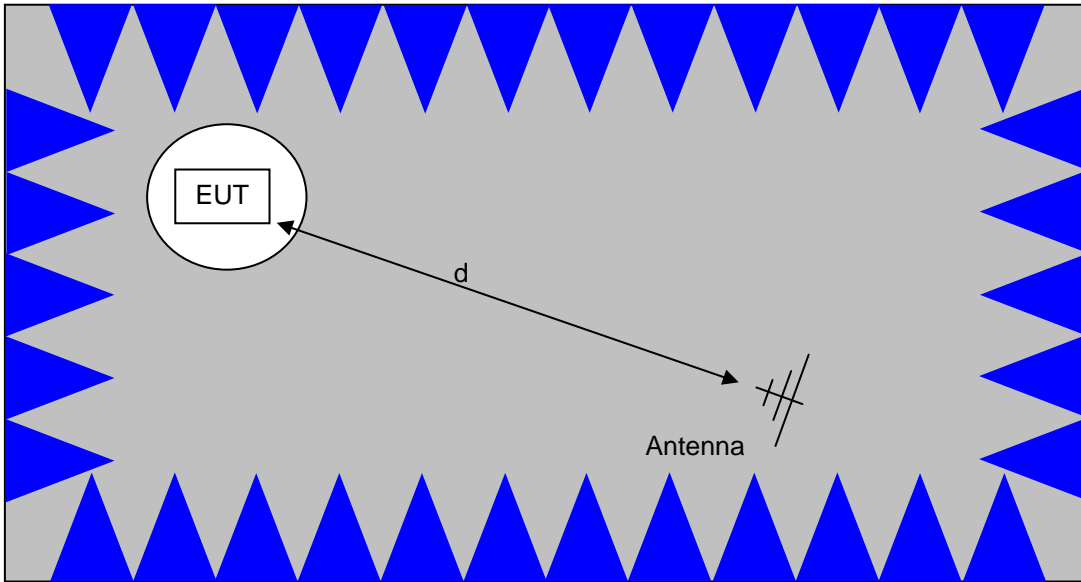

The anechoic materials on the walls and ceiling ensure compliance with the normalized site attenuation requirements of CISPR 16 / CISPR 22 / ANSI C63.4 for an alternate test site at the measurement distances used.

Floor-standing equipment is placed on the floor with insulating supports between the unit and the ground plane.

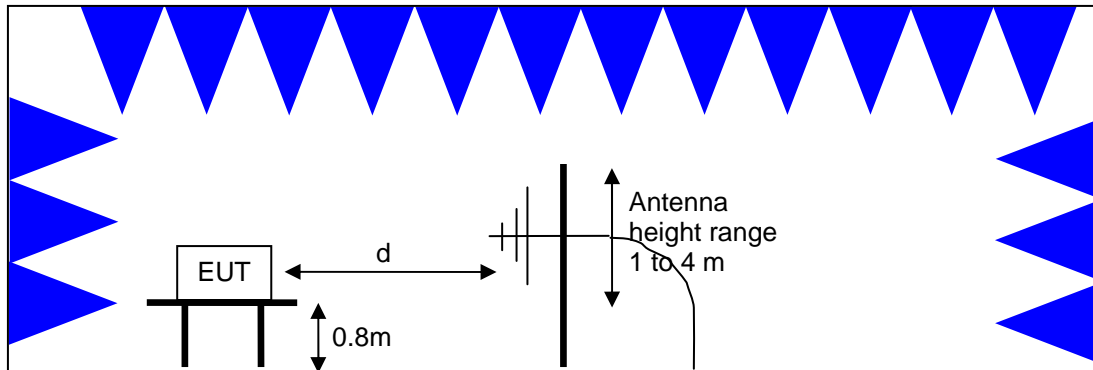

Test Configuration for Radiated Field Strength Measurements
Semi-Anechoic Chamber, Plan and Side Views

CONDUCTED EMISSIONS FROM ANTENNA PORT

Direct measurements of power, bandwidth and power spectral density are performed, where possible, with the antenna port of the EUT connected to either the power meter or spectrum analyzer via a suitable attenuator and/or filter. These are used to ensure that the front end of the measurement instrument is not overloaded by the fundamental transmission.

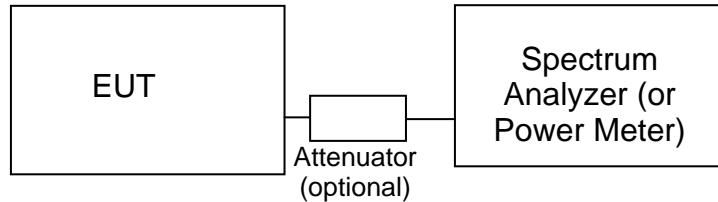
**Test Configuration for Antenna Port Measurements**

Measurement bandwidths (video and resolution) are set in accordance with the relevant standards and NTS Silicon Valley's test procedures for the type of radio being tested. When power measurements are made using a resolution bandwidth less than the signal bandwidth the power is calculated by summing the power across the signal bandwidth using either the analyzer channel power function or by capturing the trace data and calculating the power using software. In both cases the summed power is corrected to account for the equivalent noise bandwidth (ENBW) of the resolution bandwidth used.

If power averaging is used (typically for certain digital modulation techniques), the EUT is configured to transmit continuously. Power averaging is performed using either the built-in function of the analyzer or, if the analyzer does not feature power averaging, using external software. In both cases the average power is calculated over a number of sweeps (typically 100). When the EUT cannot be configured to continuously transmit then either the analyzer is configured to perform a gated sweep to ensure that the power is averaged over periods that the device is transmitting or power averaging is disabled and a max-hold feature is used.

If a power meter is used to make output power measurements the sensor head type (peak or average) is stated in the test data table.

BANDWIDTH MEASUREMENTS

The 6dB, 20dB and/or 26dB signal bandwidth is measured in using the bandwidths recommended by ANSI C63.4. When required, the 99% bandwidth is measured using the methods detailed in RSS GEN.

SPECIFICATION LIMITS AND SAMPLE CALCULATIONS

The limits for conducted emissions are given in units of microvolts, and the limits for radiated emissions are given in units of microvolts per meter at a specified test distance. Data is measured in the logarithmic form of decibels relative to one microvolt, or dB microvolts (dBuV). For radiated emissions, the measured data is converted to the field strength at the antenna in dB microvolts per meter (dBuV/m). The results are then converted to the linear forms of uV and uV/m for comparison to published specifications.

For reference, converting the specification limits from linear to decibel form is accomplished by taking the base ten logarithm, then multiplying by 20. These limits in both linear and logarithmic form are as follows:

CONDUCTED EMISSIONS SPECIFICATION LIMITS: FCC 15.207; FCC 15.107(a), RSS GEN

The table below shows the limits for the emissions on the AC power line from an intentional radiator and a receiver.

Frequency (MHz)	Average Limit (dBuV)	Quasi Peak Limit (dBuV)
0.150 to 0.500	Linear decrease on logarithmic frequency axis between 56.0 and 46.0	Linear decrease on logarithmic frequency axis between 66.0 and 56.0
0.500 to 5.000	46.0	56.0
5.000 to 30.000	50.0	60.0

GENERAL TRANSMITTER RADIATED EMISSIONS SPECIFICATION LIMITS

The table below shows the limits for the spurious emissions from transmitters that fall in restricted bands¹ (with the exception of transmitters operating under FCC Part 15 Subpart D and RSS 210 Annex 9), the limits for all emissions from a low power device operating under the general rules of RSS 310 (tables 3 and 4), RSS 210 (table 2) and FCC Part 15 Subpart C section 15.209.

Frequency Range (MHz)	Limit (uV/m)	Limit (dBuV/m @ 3m)
0.009-0.490	2400/F _{KHz} @ 300m	67.6-20*log ₁₀ (F _{KHz}) @ 300m
0.490-1.705	24000/F _{KHz} @ 30m	87.6-20*log ₁₀ (F _{KHz}) @ 30m
1.705 to 30	30 @ 30m	29.5 @ 30m
30 to 88	100 @ 3m	40 @ 3m
88 to 216	150 @ 3m	43.5 @ 3m
216 to 960	200 @ 3m	46.0 @ 3m
Above 960	500 @ 3m	54.0 @ 3m

RECEIVER RADIATED SPURIOUS EMISSIONS SPECIFICATION LIMITS

The table below shows the limits for the spurious emissions from receivers as detailed in FCC Part 15.109, RSS 210 Table 2, RSS GEN Table 1 and RSS 310 Table 3. Note that receivers operating outside of the frequency range 30 MHz – 960 MHz are exempt from the requirements of 15.109.

Frequency Range (MHz)	Limit (uV/m @ 3m)	Limit (dBuV/m @ 3m)
30 to 88	100	40
88 to 216	150	43.5
216 to 960	200	46.0
Above 960	500	54.0

¹ The restricted bands are detailed in FCC 15.203, RSS 210 Table 1 and RSS 310 Table 2

FCC 15.407 (a) OUTPUT POWER LIMITS

The table below shows the limits for output power and output power density. Where the signal bandwidth is less than 20 MHz the maximum output power is reduced to the power spectral density limit plus 10 times the log of the bandwidth (in MHz).

Operating Frequency (MHz)	Output Power	Power Spectral Density
5150 – 5250	50mW (17 dBm)	4 dBm/MHz
5250 – 5350	250 mW (24 dBm)	11 dBm/MHz
5725 – 5825	1 Watts (30 dBm)	17 dBm/MHz

For system using antennas with gains exceeding 6dBi, the output power and power spectral density limits are reduced by 1dB for every dB the antenna gain exceeds 6dBi. Fixed point-to-point applications using the 5725 – 5825 MHz band may use antennas with gains of up to 23dBi without this limitation. If the gain exceeds 23dBi then the output power limit of 1 Watt is reduced by 1dB for every dB the gain exceeds 23dBi.

The peak excursion envelope is limited to 13dB.

OUTPUT POWER LIMITS –LELAN DEVICES

The table below shows the limits for output power and output power density defined by RSS 210. Where the signal bandwidth is less than 20 MHz the maximum output power is reduced to the power spectral density limit plus 10 times the log of the bandwidth (in MHz).

Operating Frequency (MHz)	Output Power	Power Spectral Density
5150 – 5250	200mW (23 dBm) eirp	10 dBm/MHz eirp
5250 – 5350	250 mW (24 dBm) ² 1W (30dBm) eirp	11 dBm/MHz
5470 – 5725	250 mW (24 dBm) ³ 1W (30dBm) eirp	11 dBm/MHz
5725 – 5825	1 Watts (30 dBm) 4W eirp	17 dBm/MHz

In addition, the power spectral density limit shall be reduced by 1dB for every dB the highest power spectral density exceeds the “average” power spectral density) by more than 3dB. The “average” power spectral density is determined by dividing the output power by $10\log(\text{EBW})$ where EBW is the 99% power bandwidth.

Fixed point-to-point applications using the 5725 – 5825 MHz band may use antennas with gains of up to 23dBi without this limitation. If the gain exceeds 23dBi then the output power limit of 1 Watt is reduced by 1dB for every dB the gain exceeds 23dBi.

² If EIRP exceeds 500mW the device must employ TPC

³ If EIRP exceeds 500mW the device must employ TPC

SPURIOUS EMISSIONS LIMITS –UNII and LELAN DEVICES

The spurious emissions limits for signals below 1GHz are the FCC/RSS-GEN general limits. For emissions above 1GHz, signals in restricted bands are subject to the FCC/RSS GEN general limits. All other signals have a limit of –27dBm/MHz, which is a field strength of 68.3dBuV/m/MHz at a distance of 3m. This is an average limit so the peak value of the emission may not exceed –7dBm/MHz (88.3dBuV/m/MHz at a distance of 3m). For devices operating in the 5725-5850Mhz bands under the LELAN/UNII rules, the limit within 10Mhz of the allocated band is increased to –17dBm/MHz.

SAMPLE CALCULATIONS - CONDUCTED EMISSIONS

Receiver readings are compared directly to the conducted emissions specification limit (decibel form) as follows:

$$R_r - S = M$$

where:

R_r = Receiver Reading in dBuV

S = Specification Limit in dBuV

M = Margin to Specification in +/- dB

SAMPLE CALCULATIONS - RADIATED EMISSIONS

Receiver readings are compared directly to the specification limit (decibel form). The receiver internally corrects for cable loss, preamplifier gain, and antenna factor. The calculations are in the reverse direction of the actual signal flow, thus cable loss is added and the amplifier gain is subtracted. The Antenna Factor converts the voltage at the antenna coaxial connector to the field strength at the antenna elements.

A distance factor, when used for electric field measurements above 30MHz, is calculated by using the following formula:

$$F_d = 20 * \text{LOG}_{10} (D_m/D_s)$$

where:

F_d = Distance Factor in dB

D_m = Measurement Distance in meters

D_s = Specification Distance in meters

For electric field measurements below 30MHz the extrapolation factor is either determined by making measurements at multiple distances or a theoretical value is calculated using the formula:

$$F_d = 40 * \text{LOG}_{10} (D_m/D_s)$$

Measurement Distance is the distance at which the measurements were taken and Specification Distance is the distance at which the specification limits are based. The antenna factor converts the voltage at the antenna coaxial connector to the field strength at the antenna elements.

The margin of a given emission peak relative to the limit is calculated as follows:

$$R_c = R_r + F_d$$

and

$$M = R_c - L_s$$

where:

R_r = Receiver Reading in dBuV/m

F_d = Distance Factor in dB

R_c = Corrected Reading in dBuV/m

L_s = Specification Limit in dBuV/m

M = Margin in dB Relative to Spec

SAMPLE CALCULATIONS - FIELD STRENGTH TO EIRP CONVERSION

Where the radiated electric field strength is expressed in terms of the equivalent isotropic radiated power (eirp), or where a field strength measurement of output power is made in lieu of a direct measurement, the following formula is used to convert between eirp and field strength at a distance of d (meters) from the equipment under test:

$$E = \frac{1000000 \sqrt{30 P}}{d} \quad \text{microvolts per meter}$$

where P is the eirp (Watts)

For a measurement at 3m the conversion from a logarithmic value for field strength (dBuV/m) to an eirp power (dBm) is -95.3dB.

Appendix A Test Equipment Calibration Data

<u>Manufacturer</u>	<u>Description</u>	<u>Model #</u>	<u>Asset #</u>	<u>Cal Due</u>
Tx Bandedge, 03-Dec-12				
EMCO	Antenna, Horn, 1-18 GHz	3115	487	19-Jul-14
Rohde & Schwarz	EMI Test Receiver, 20 Hz-7 GHz	ESIB7	1630	31-May-13
Tx Spurious Emissions, 04-Dec-12				
EMCO	Antenna, Horn, 1-18 GHz	3115	487	19-Jul-14
Rohde & Schwarz	EMI Test Receiver, 20 Hz-40 GHz	ESIB40 (1088.7490.40)	2493	09-Dec-12
Radiated Emissions, BE, 1000 - 6,500 MHz, 05-Dec-12				
EMCO	Antenna, Horn, 1-18 GHz	3115	487	19-Jul-14
Rohde & Schwarz	EMI Test Receiver, 20 Hz-40 GHz	ESIB40 (1088.7490.40)	2493	09-Dec-12
Radiated Emissions, 1000 - 2,500 MHz, 07-Dec-12				
EMCO	Antenna, Horn, 1-18 GHz	3115	487	19-Jul-14
Rohde & Schwarz	EMI Test Receiver, 20 Hz-40 GHz	ESIB40 (1088.7490.40)	2493	09-Jan-13
Radiated Emissions, 1000 - 6,000 MHz, 10-Dec-12				
EMCO	Antenna, Horn, 1-18 GHz	3115	487	19-Jul-14
Rohde & Schwarz	EMI Test Receiver, 20 Hz-7 GHz	ESIB7	1538	06-Jan-13
Radiated Emissions, 1000 - 11,000 MHz, 12-Dec-12				
Hewlett Packard	Microwave Preamplifier, 1-26.5GHz	8449B	263	29-Mar-13
EMCO	Antenna, Horn, 1-18 GHz	3115	487	19-Jul-14
Hewlett Packard	SpecAn 9 kHz - 40 GHz, FT (SA40) Blue	8564E (84125C)	1393	01-May-13
Rohde & Schwarz	Power Meter, Single Channel, +1795+1796	NRVS	1534	28-Jun-13
Rohde & Schwarz	Power Sensor 100 uW - 10 Watts	NRV-Z53	1555	22-Feb-13
Micro-Tronics	Band Reject Filter, 2400-2500 MHz	BRM50702-02	2238	04-Oct-13
Conducted Emissions, 18-Dec-12				
EMCO	LISN, 10 kHz-100 MHz	3825/2	1293	16-Feb-13
Rohde & Schwarz	Pulse Limiter	ESH3 Z2	1401	15-May-13
Rohde & Schwarz	EMI Test Receiver, 20 Hz-7 GHz	ESIB7	1538	12-Dec-13
Com-Power	9KHz-30MHz, 50uH, 15Aac, 10Adc, max	LI-215A	2672	25-May-13

<u>Manufacturer</u>	<u>Description</u>	<u>Model #</u>	<u>Asset #</u>	<u>Cal Due</u>
Radiated Emissions, 1000 - 40000MHz, 18-Dec-12				
EMCO	Antenna, Horn, 1-18 GHz (SA40-Red)	3115	1142	23-Aug-14
Hewlett Packard	Microwave Preamplifier, 1-26.5GHz	8449B	2199	23-Feb-13
Hewlett Packard	SpecAn 9 kHz - 40 GHz, (SA40) Purple	8564E (84125C)	2415	10-Aug-13
Radiated Emissions, 1000 - 40,000 MHz, 19-Dec-12				
Narda West	High Pass Filter, 8 GHz	HPF 180	821	22-Mar-13
EMCO	Antenna, Horn, 1-18 GHz (SA40-Red)	3115	1142	23-Aug-14
Micro-Tronics	Band Reject Filter, 5150-5350 MHz	BRC50703-02	1729	02-Aug-13
Hewlett Packard	Microwave Preamplifier, 1-26.5GHz	8449B	2199	23-Feb-13
Hewlett Packard	SpecAn 9 kHz - 40 GHz, (SA40) Purple	8564E (84125C)	2415	10-Aug-13
Radiated Spurious Emissions, 1000 - 40,000 MHz, 20-Dec-12				
Narda West	High Pass Filter, 8 GHz	HPF 180	821	22-Mar-13
EMCO	Antenna, Horn, 1-18 GHz (SA40-Red)	3115	1142	23-Aug-14
Micro-Tronics	Band Reject Filter, 5470-5725 MHz	BRC50704-02	1730	02-Aug-13
Hewlett Packard	Microwave Preamplifier, 1-26.5GHz	8449B	2199	23-Feb-13
Hewlett Packard	SpecAn 9 kHz - 40 GHz, (SA40) Purple	8564E (84125C)	2415	10-Aug-13
Radiated Spurious Emissions, 1000 - 25,000 MHz, 21-Dec-12				
EMCO	Antenna, Horn, 1-18 GHz	3115	487	19-Jul-14
Hewlett Packard	Microwave Preamplifier, 1-26.5GHz	8449B	2199	23-Feb-13
Micro-Tronics	Band Reject Filter, 2400-2500 MHz	BRM50702-02	2249	11-Oct-13
Hewlett Packard	SpecAn 9 kHz - 40 GHz, (SA40) Purple	8564E (84125C)	2415	10-Aug-13
Rohde & Schwarz	EMI Test Receiver, 20 Hz-40 GHz	ESIB40 (1088.7490.40)	2493	09-Jan-13
Radiated Spurious Emissions, 1000 - 25,000 MHz, 26-Dec-12				
EMCO	Antenna, Horn, 1-18 GHz	3115	487	19-Jul-14
Hewlett Packard	Microwave Preamplifier, 1-26.5GHz	8449B	2199	23-Feb-13
Micro-Tronics	Band Reject Filter, 2400-2500 MHz	BRM50702-02	2249	11-Oct-13
Hewlett Packard	SpecAn 9 kHz - 40 GHz, (SA40) Purple	8564E (84125C)	2415	10-Aug-13
Hewlett Packard	Head (Inc W1-W4, 1946 , 1947) Purple	84125C	1772	01-May-13
A.H. Systems	Purple System Horn, 18-40GHz	SAS-574, p/n: 2581	2160	17-Apr-13

<u>Manufacturer</u>	<u>Description</u>	<u>Model #</u>	<u>Asset #</u>	<u>Cal Due</u>
Radiated Emissions, 30 - 15,000 MHz, 28-Dec-12				
EMCO	Antenna, Horn, 1-18 GHz	3115	487	19-Jul-14
Hewlett Packard	Preamplifier, 100 kHz - 1.3 GHz	8447D OPT 010	1826	18-May-13
Sunol Sciences	Biconilog, 30-3000 MHz	JB3	2197	07-Feb-14
Hewlett Packard	Microwave Preamplifier, 1-26.5GHz	8449B	2199	23-Feb-13
Micro-Tronics	Band Reject Filter, 5150-5350 MHz	BRC50703-02	2239	04-Oct-13
Micro-Tronics	Band Reject Filter, 5470-5725 MHz	BRC50704-02	2240	04-Oct-13
Micro-Tronics	Band Reject Filter, 5725-5875 MHz	BRC50705-02	2241	04-Oct-13
Micro-Tronics	Band Reject Filter, 2400-2500 MHz	BRM50702-02	2249	11-Oct-13
Hewlett Packard	SpecAn 9 kHz - 40 GHz, (SA40) Purple	8564E (84125C)	2415	10-Aug-13
Rohde & Schwarz	EMI Test Receiver, 20 Hz-40 GHz	ESIB40 (1088.7490.40)	2493	09-Jan-13
Radio Antenna Port (Power and Spurious Emissions), 28-Dec-12				
Agilent	PSA, Spectrum Analyzer	E4446A	2139	23-Feb-13
Radio Antenna Port (Power and Spurious Emissions), 31-Dec-12				
Agilent	PSA, Spectrum Analyzer	E4446A	2139	23-Feb-13
Radio Antenna Port (Power and Spurious Emissions), 04-Jan-13				
Agilent	PSA, Spectrum Analyzer	E4446A	2139	23-Feb-13
Radio Antenna Port (Power and Spurious Emissions), 05-Jan-13				
Agilent	PSA, Spectrum Analyzer	E4446A	2139	23-Feb-13
Radiated Emissions, 1000 - 26,500 MHz, 07-Jan-13				
Hewlett Packard	Microwave Preamplifier, 1-26.5GHz	8449B	785	09-Nov-13
EMCO	Antenna, Horn, 1-18GHz	3115	868	19-Jun-14
Hewlett Packard	SpecAn 30 Hz -40 GHz, SV (SA40) Red	8564E (84125C)	1148	14-Sep-13
Radio Antenna Port (Power and Spurious Emissions), 08-Jan-13				
Agilent	50GHz PSA Spectrum Analyzer	E4448A-M27	199979	15-Nov-13
Conducted Emissions, 18-Dec-12				
EMCO	LISN, 10 kHz-100 MHz	3825/2	1293	16-Feb-13
Rohde & Schwarz	Pulse Limiter	ESH3 Z2	1401	15-May-13

<u>Manufacturer</u>	<u>Description</u>	<u>Model #</u>	<u>Asset #</u>	<u>Cal Due</u>
Rohde & Schwarz	EMI Test Receiver, 20 Hz-7 GHz	ESIB7	1538	12-Dec-13
Com-Power	9KHz-30MHz, 50uH, 15Aac, 10Adc, max	LI-215A	2672	25-May-13
Radiated Emissions, Band edge, 09-Jan-13				
Rohde & Schwarz	Power Meter, Single Channel	NRVS	1422	13-Jan-13
EMCO	Antenna, Horn, 1-18 GHz	3115	1561	12-Jul-14
Rohde & Schwarz	EMI Test Receiver, 20 Hz-7 GHz	ESIB7	1756	21-May-13
Rohde & Schwarz	Power Sensor 100 uW - 10 Watts	NRV-Z53	1796	14-Jun-13
Radio Antenna Port (Power), 09-Jan-13				
Rohde & Schwarz	Power Meter, Dual Channel, DC to 40 GHz, 100 pW to 30 W, 9 kHz to 3 GHz, 200µV to 1000V	NRVD	1787	18-Dec-13
Rohde & Schwarz	Attenuator, 20 dB, 10W, DC-18 GHz	20dB, 10W, Type N	1795	14-Jun-13
Agilent	PSA, Spectrum Analyzer	E4446A	2139	23-Feb-13

Appendix B Test Data

T89578 Pages 29 - 181



EMC Test Data

Client:	Intel	Job Number:	J88901
Product:	Intel® Centrino® Advanced-N 6235	T-Log Number:	T89578
		Account Manager:	Christine Krebill
Contact:	Steve Hackett		
Emissions Standard(s):	FCC 15.247, 15.407, 15.209, RSS 210	Class:	B
Immunity Standard(s):	-	Environment:	Radio

EMC Test Data

For The

Intel

Product

Intel® Centrino® Advanced-N 6235

Date of Last Test: 1/10/2013

Client:	Intel	Job Number:	J88901
Product	Intel® Centrino® Advanced-N 6235	T-Log Number:	T89578
Contact:	Steve Hackett	Account Manger:	Christine Krebill
Emissions Standard(s):	FCC 15.247, 15.407, 15.209, RSS 210	Class:	B
Immunity Standard(s):	-	Environment:	Radio

Power vs. Data Rate

In normal operating modes the card uses power settings stored on EEPROM to set the output power. For a given nominal output power the actual transmit power normally is reduced as the data rate increases, therefore testing was performed at the data rate in the mode with highest power to determine compliance with the requirements.

The following power measurements, were made using an average power meter and the with the device configured in a continuous transmit mode on Chain 1 at the various data rates in each mode to verify the highest power mode:

Date of Test: 12/3/2012 Config. Used: 1
 Test Engineer: Mark Hill Config Change: None
 Test Location: FT#3 Host Unit Voltage 120V/60Hz

Chain 1, 2.4 GHz channel 6

Mode	Data Rate	Power (dBm)	Power setting
802.11b	1	16.2	26.5
	2	16.2	
	5.5	16.5	
	11	16.3	
802.11g	6	15.9	32.0
	9	15.8	
	12	15.8	
	18	15.8	
	24	15.7	
	36	15.7	
	48	15.7	
	54	15.6	
802.11n 20MHz	6.5	16.2	33.0
	13	16.2	
	19.5	16.2	
	26	16.1	
	39	16.1	
	52	16.0	
	58.5	16.0	
65	16.0		
802.11n 40MHz	13.5	16.3	33.0
	27	16.3	
	40.5	16.2	
	54	16.0	
	81	15.9	
	108	15.7	
	121.5	15.7	
	135	15.7	

Note : Power setting - the software power setting used during testing, included for reference only.



EMC Test Data

Client:	Intel	Job Number:	J88901
Product:	Intel® Centrino® Advanced-N 6235	T-Log Number:	T89578
Contact:	Steve Hackett	Account Manger:	Christine Krebill
Emissions Standard(s):	FCC 15.247, 15.407, 15.209, RSS 210	Class:	B
Immunity Standard(s):	-	Environment:	Radio

Chain 1, 5 GHz Channel 157

Mode	Data Rate	Power (dBm)	Power setting
802.11a	6	14.8	39.0
	9	14.7	
	12	14.7	
	18	14.8	
	24	14.7	
	36	14.7	
	48	14.7	
	54	14.7	
802.11n 20MHz	6.5	14.8	39.0
	13	14.7	
	19.5	14.8	
	26	14.8	
	39	14.8	
	52	14.7	
	58.5	14.6	
	65	14.5	
802.11n 40MHz	13.5	14.6	39.0
	27	14.5	
	40.5	14.5	
	54	14.4	
	81	14.4	
	108	14.3	
	121.5	14.3	
	135	14.4	

Note : Power setting - the software power setting used during testing, included for reference only.



EMC Test Data

Client: Intel	Job Number: J88901
Model: Intel® Centrino® Advanced-N 6235	T-Log Number: T89578
	Account Manager: Christine Krebill
Contact: Steve Hackett	
Standard: FCC 15.247, 15.407, 15.209, RSS 210	Class: N/A

RSS-210 (LELAN) and FCC 15.407(UNII) Antenna Port Measurements - CHAIN A Power, PSD, Peak Excursion, Bandwidth and Spurious Emissions

Test Specific Details

Objective: The objective of this test session is to perform final qualification testing of the EUT with respect to the specification listed above.

Date of Test: 1/3 & 1/6/2013
 Test Engineer: Rafael Varelas
 Test Location: FT Lab #4a

Config. Used: 1
 Config Change: None
 Host Unit Voltage 120V/60Hz

Summary of Results - Chain A

MAC Address: 001500B50432 DRTU Tool Version 1.5.6-0445 Driver version 15.3.1.2

Run #	Test Performed	Limit	Pass / Fail	Result / Margin
1	Power, 5150 - 5250MHz	15.407(a) (1), (2)	Pass	802.11a: 41.0 mW 802.11n20: 39.0 mW 802.11n40: 35.0 mW
1	PSD, 5150 - 5250MHz	15.407(a) (1), (2)	Pass	802.11a: 3.3 dBm/MHz 802.11n20: 2.7 dBm/MHz 802.11n40: -0.1 dBm/MHz
1	Power, 5250 - 5350MHz	15.407(a) (1), (2)	Pass	802.11a: 40.0 mW 802.11n20: 39.0 mW 802.11n40: 34.0 mW
1	PSD, 5250 - 5350MHz	15.407(a) (1), (2)	Pass	802.11a: 3.2 dBm/MHz 802.11n20: 2.8 dBm/MHz 802.11n40: -0.3 dBm/MHz
1	Power, 5470 - 5725MHz	15.407(a) (1), (2)	Pass	802.11a: 25.1 mW 802.11n20: 40.7 mW 802.11n40: 38.0 mW
1	PSD, 5470 - 5725MHz	15.407(a) (1), (2)	Pass	802.11a: 1.3 dBm/MHz 802.11n20: 2.8 dBm/MHz 802.11n40: 0.3 dBm/MHz
1	26dB Bandwidth	15.407 (Information only)	-	> 20MHz for all modes

Client: Intel	Job Number: J88901
Model: Intel® Centrino® Advanced-N 6235	T-Log Number: T89578
	Account Manager: Christine Krebill
Contact: Steve Hackett	
Standard: FCC 15.247, 15.407, 15.209, RSS 210	Class: N/A

Run #	Test Performed	Limit	Pass / Fail	Result / Margin
1	99% Bandwidth	RSS 210 (Information only)	N/A	802.11a: 29.9 MHz 802.11n20: 32.3 MHz 802.11n40: 56.4 MHz
2	Peak Excursion Envelope	15.407(a) (6) 13dB	Pass	8.7 dB
3	20dB Bandwidth	Remains out of 5600- 5650 MHz band	Pass	All are > 20dBc in the 5600-5650 MHz band
4	Antenna Conducted - Out of Band Spurious	15.407(b) -27dBm/MHz	Pass	All emissions below the -27dBm/MHz limit

General Test Configuration

When measuring the conducted emissions from the EUT's antenna port, the antenna port of the EUT was connected to the spectrum analyzer or power meter via a suitable attenuator to prevent overloading the measurement system. All measurements are corrected to allow for the external attenuators and cables used.

Ambient Conditions:

Temperature: 22.4 °C
Rel. Humidity: 39 %

Modifications Made During Testing

No modifications were made to the EUT during testing

Deviations From The Standard

No deviations were made from the requirements of the standard.



EMC Test Data

Client: Intel	Job Number: J88901
Model: Intel® Centrino® Advanced-N 6235	T-Log Number: T89578
	Account Manager: Christine Krebill
Contact: Steve Hackett	
Standard: FCC 15.247, 15.407, 15.209, RSS 210	Class: N/A

Run #1: Bandwidth, Output Power and Power Spectral Density - Single Chain Systems

Note 1:	Output power measured using a spectrum analyzer (see plots below). RBW=1MHz, VB=3 MHz, # of points in sweep $\geq 2 \times \text{span} / \text{RBW}$, RMS detector, power averaging on (transmitted signal was continuous) and power integration over 50 MHz for 20dB bandwidth and 80 MHz for 40dB bandwidth (method SA-1 of KDB 789033).
Note 2:	Measured using the same analyzer settings used for output power.
Note 3:	For RSS-210 the limit for the 5150 - 5250 MHz band accounts for the antenna gain as the maximum eirp allowed is 10dBm/MHz. The limits are also corrected for instances where the highest measured value of the PSD exceeds the average PSD (calculated from the measured power divided by the measured 99% bandwidth) by more than 3dB by the amount that the measured value exceeds the average by more than 3dB.
Note 4:	99% Bandwidth measured in accordance with RSS GEN - RB > 1% of span and VB $\geq 3 \times \text{RB}$
Note 5:	For MIMO systems the total output power and total PSD are calculated from the sum of the powers of the individual chains (in linear terms). The antenna gain used to determine the EIRP and limits for PSD/Output power depends on the operating mode of the MIMO device. If the signals are non-coherent between the transmit chains then the gain used to determine the limits is the highest gain of the individual chains and the EIRP is the sum of the products of gain and power on each chain. If the signals are coherent then the effective antenna gain is the sum (in linear terms) of the gains for each chain and the EIRP is the product of the effective gain and total power.

Single Chain Operation, 5150-5250MHz Band

Antenna Gain (dBi): 3.6

EIRP: 93.3 mW

19.7 dBm

Frequency (MHz)	Software Setting	Bandwidth		Output Power ¹ dBm		Power (Watts)	PSD ² dBm/MHz			Result
		26dB	99% ⁴	Measured	Limit		Measured	FCC Limit	RSS Limit ³	
802.11a										
5180	28.0	38.5	17.8	13.6	17.0	0.023	0.8	4.0	6.4	Pass
5200	32.5	43.3	26.0	15.4	17.0	0.035	2.5	4.0	6.4	Pass
5240	35.0	49.5	29.1	16.1	17.0	0.041	3.3	4.0	6.4	Pass
802.11n 20MHz										
5180	29.0	45.3	20.3	13.3	17.0	0.021	0.4	4.0	6.4	Pass
5200	33.0	59.5	27.8	15.9	17.0	0.039	2.7	4.0	6.4	Pass
5240	34.0	57.3	28.4	15.9	17.0	0.039	2.8	4.0	6.4	Pass
802.11n 40MHz										
5190	25.0	57.7	36.3	11.7	17.0	0.015	-3.7	4.0	6.4	Pass
5230	34.0	98.2	49.3	15.4	17.0	0.035	-0.1	4.0	6.4	Pass

Where 99% bandwidth is less than 20 MHz, RSS 210 limits total power thus the limit is recalculated below.

802.11a

5180	28.0	38.5	17.8	13.6	16.5	0.023	0.8	4.0	6.4	Pass
------	------	------	------	------	------	-------	-----	-----	-----	------

Client: Intel	Job Number: J88901
Model: Intel® Centrino® Advanced-N 6235	T-Log Number: T89578
	Account Manager: Christine Krebill
Contact: Steve Hackett	
Standard: FCC 15.247, 15.407, 15.209, RSS 210	Class: N/A

Single Chain Operation, 5250-5350 MHz Band
 Antenna Gain (dBi): 3.7 EIRP: 94.2 mW 19.7 dBm

Frequency (MHz)	Software Setting	Bandwidth		Output Power ¹ dBm		Power (Watts)	PSD ² dBm/MHz			Result
		26dB	99% ⁴	Measured	Limit		Measured	FCC Limit	RSS Limit ³	
802.11a										
5260	35.0	55.0	29.4	16.0	24.0	0.040	3.2	11.0	11.0	Pass
5300	32.5	43.0	25.2	14.3	24.0	0.027	1.4	11.0	11.0	Pass
5320	30.0	40.8	20.5	12.5	24.0	0.018	-0.2	11.0	11.0	Pass
802.11n 20MHz										
5260	36.0	54.1	31.2	15.9	24.0	0.039	2.8	11.0	11.0	Pass
5300	36.5	53.5	31.4	15.9	24.0	0.039	2.8	11.0	11.0	Pass
5320	30.0	41.8	19.8	14.9	24.0	0.031	1.7	11.0	11.0	Pass
802.11n 40MHz										
5270	36.0	93.7	54.8	15.4	24.0	0.034	-0.3	11.0	11.0	Pass
5310	25.5	55.2	36.3	11.7	24.0	0.015	-3.7	11.0	11.0	Pass

Where 99% bandwidth is less than 20 MHz, RSS 210 limits total power thus the limit is recalculated below.

802.11n20										
5320	30.0	41.8	19.8	14.9	24.0	0.031	1.7	11.0	11.0	Pass

Single Chain Operation, 5470- 5725 MHz Band
 Antenna Gain (dBi): 4.8 EIRP: 75.9 mW 18.8 dBm

Frequency (MHz)	Software Setting	Bandwidth		Output Power ¹ dBm		Power (Watts)	PSD ² dBm/MHz			Result
		26dB	99% ⁴	Measured	Limit		Measured	FCC Limit	RSS Limit ³	
802.11a										
5500	31.5	40.6	22.2	13.0	24.0	0.020	0.2	11.0	11.0	Pass
5580	37.5	46.9	29.9	14.0	24.0	0.025	1.3	11.0	11.0	Pass
5660	26.0	36.2	17.1	10.5	24.0	0.011	-1.7	11.0	11.0	Pass
5700	32.0	38.0	20.3	12.2	24.0	0.017	-0.7	11.0	11.0	Pass
802.11n 20MHz										
5500	31.5	41.9	21.0	14.1	24.0	0.026	1.2	11.0	11.0	Pass
5580	39.0	50.3	32.3	16.1	24.0	0.041	2.8	11.0	11.0	Pass
5660	26.0	32.6	18.1	9.8	24.0	0.010	-2.6	11.0	11.0	Pass
5700	31.5	41.1	18.7	13.5	24.0	0.022	0.4	11.0	11.0	Pass
802.11n 40MHz										
5510	27.5	56.5	36.3	11.1	24.0	0.013	-4.3	11.0	11.0	Pass
5550	39.0	97.2	56.4	15.8	24.0	0.038	0.3	11.0	11.0	Pass
5670	26.0	65.1	36.3	10.2	24.0	0.010	-4.7	11.0	11.0	Pass

Where 99% bandwidth is less than 20 MHz, RSS 210 limits total power thus the limit is recalculated below.

802.11n20										
5660	26.0	36.2	17.1	10.5	23.3	0.011	-1.7	11.0	11.0	Pass
802.11n20										
5660	26.0	32.6	18.1	9.8	23.6	0.010	1.7	11.0	9.5	Pass
5700	31.5	41.1	18.7	13.5	23.7	0.022	0.4	11.0	11.0	Pass

Client: Intel	Job Number: J88901
Model: Intel® Centrino® Advanced-N 6235	T-Log Number: T89578
	Account Manager: Christine Krebill
Contact: Steve Hackett	
Standard: FCC 15.247, 15.407, 15.209, RSS 210	Class: N/A

Run #2: Peak Excursion Measurement

802.11a: Device meets the requirement for the peak excursion

Peak Excursion(dB)			Peak Excursion(dB)			Peak Excursion(dB)		
Freq (MHz)	Value	Limit	Freq (MHz)	Value	Limit	Freq (MHz)	Value	Limit
5180	6.9	13.0	5260	7.4	13.0	5500	7.0	13.0
5200	7.7	13.0	5300	6.7	13.0	5580	7.4	13.0
5240	8.3	13.0	5320	7.0	13.0	5700	6.6	13.0

802.11n20: Device meets the requirement for the peak excursion

Peak Excursion(dB)			Peak Excursion(dB)			Peak Excursion(dB)		
Freq (MHz)	Value	Limit	Freq (MHz)	Value	Limit	Freq (MHz)	Value	Limit
5180	7.1	13.0	5260	8.2	13.0	5500	7.1	13.0
5200	8.2	13.0	5300	8.6	13.0	5580	8.7	13.0
5240	8.3	13.0	5320	7.2	13.0	5700	7.0	13.0

802.11n40: Device meets the requirement for the peak excursion

Peak Excursion(dB)			Peak Excursion(dB)			Peak Excursion(dB)		
Freq (MHz)	Value	Limit	Freq (MHz)	Value	Limit	Freq (MHz)	Value	Limit
5190	6.7	13.0	5270	7.7	13.0	5510	7.1	13.0
5230	7.8	13.0	5310	6.9	13.0	5550	7.7	13.0
						5670	7.3	13.0

Client: Intel	Job Number: J88901
Model: Intel® Centrino® Advanced-N 6235	T-Log Number: T89578
	Account Manager: Christine Krebill
Contact: Steve Hackett	
Standard: FCC 15.247, 15.407, 15.209, RSS 210	Class: N/A

Plots Showing Peak Excursion

Trace A: RBW = 1MHz, VBW = 3MHz, Peak hold

Trace B: Same settings as used for power/PSD measurements (RBW = 1 MHz, VBW = 3MHz, Integrated average power)

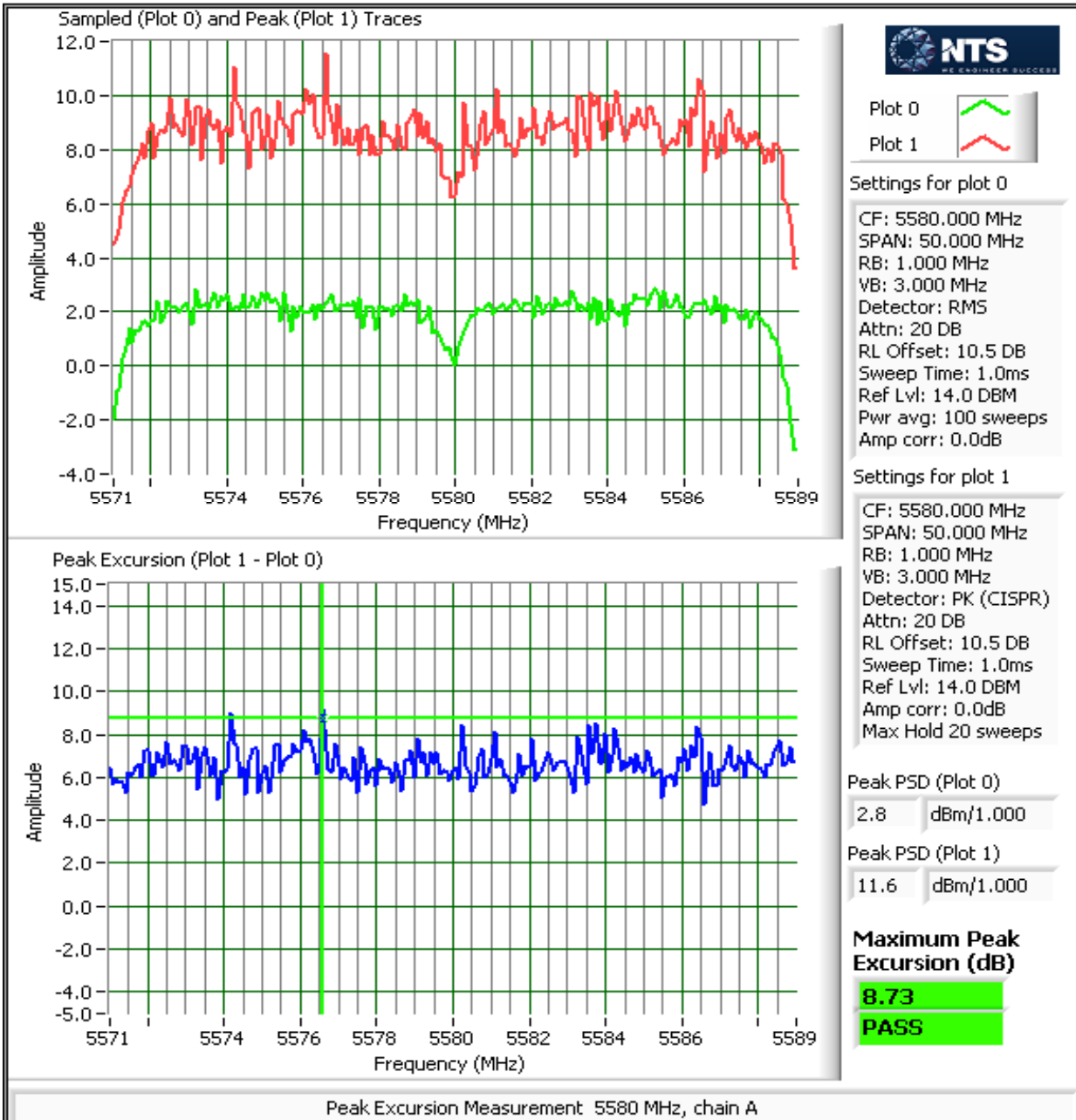

Client: Intel	Job Number: J88901
Model: Intel® Centrino® Advanced-N 6235	T-Log Number: T89578
	Account Manager: Christine Krebill
Contact: Steve Hackett	
Standard: FCC 15.247, 15.407, 15.209, RSS 210	Class: N/A

Run #3 : 20dB Signal Bandwidth on channels closest to 5600-5650 MHz band

Mode	Power Setting	Frequency (MHz)	Bandwidth (MHz) 20dB
802.11a	39.0	5580	38.40
	26.0	5660	19.34
802.11n 20MHz	39.0	5580	39.80
	26.0	5660	19.74
802.11n 40MHz	39.0	5550	74.90
	26.0	5670	38.64

Note 1: 99% bandwidth measured in accordance with RSS GEN, with RB > 1% of the span and VB > 3xRB

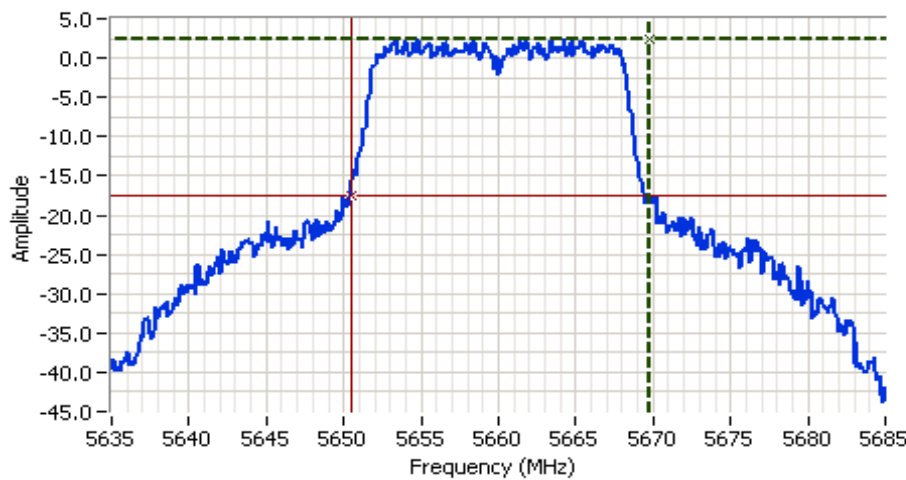

Analyzer Settings

Rohde&Schwarz,ESI
 CF: 5660.000 MHz
 SPAN: 50.000 MHz
 RB: 300 kHz
 VB: 1.000 MHz
 Detector: POS
 Attn: 20 DB
 RL Offset: 11.0 DB
 Sweep Time: 5.0ms
 Ref Lvl: 10.0 DBM

Comments

20dB BW: 19.339 MHz
 802.11a Chain A

Cursor 1	5669.7695	2.50		Delta Freq.	19.339
Cursor 2	5650.4309	-17.50		Delta Amplitude	20.00

Client: Intel	Job Number: J88901
Model: Intel® Centrino® Advanced-N 6235	T-Log Number: T89578
	Account Manager: Christine Krebill
Contact: Steve Hackett	
Standard: FCC 15.247, 15.407, 15.209, RSS 210	Class: N/A

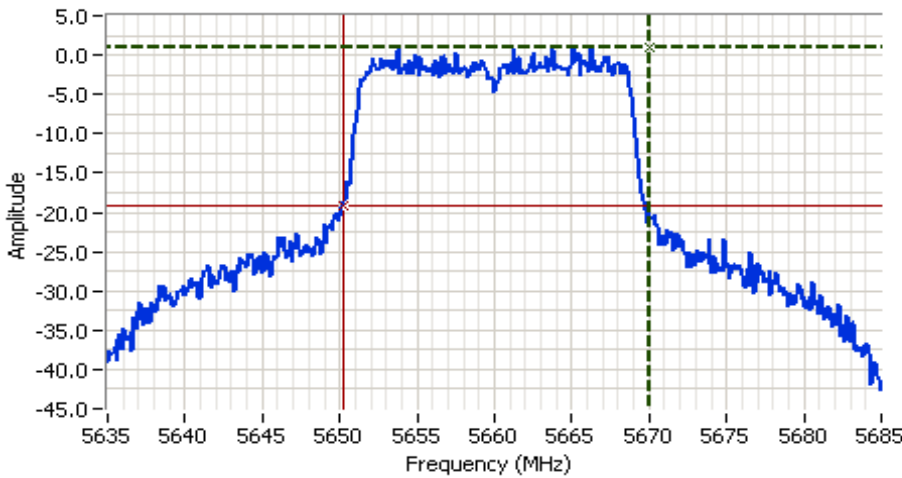

Analyzer Settings

Rohde&Schwarz,ESI
 CF: 5660.000 MHz
 SPAN: 50.000 MHz
 RB: 300 kHz
 VB: 1.000 MHz
 Detector: POS
 Attn: 20 DB
 RL Offset: 11.0 DB
 Sweep Time: 5.0ms
 Ref Lvl: 10.0 DBM

Comments

20dB BW: 19.739 MHz
 802.11n 20 MHz Chain A

Cursor 1	5669.9699	0.95	Delta Freq.	19.739
Cursor 2	5650.2305	-19.05	Delta Amplitude	20.00

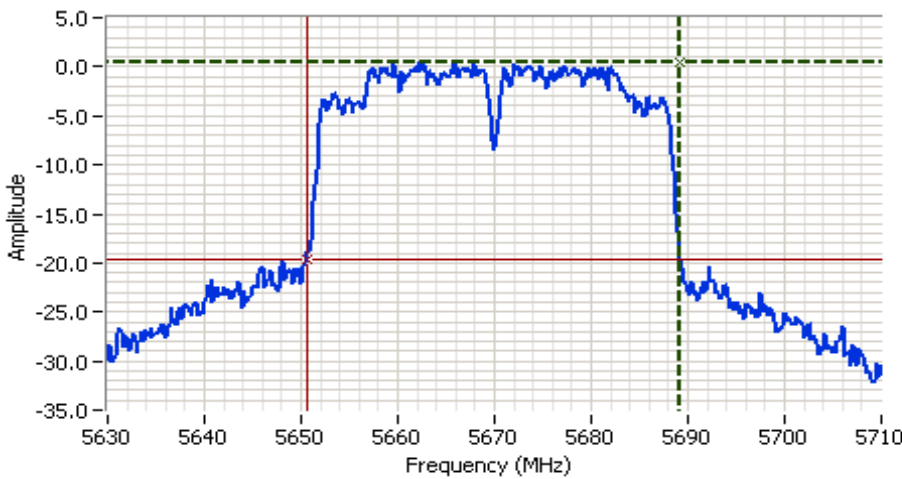

Analyzer Settings

Rohde&Schwarz,ESI
 CF: 5670.000 MHz
 SPAN: 80.000 MHz
 RB: 500 kHz
 VB: 2.000 MHz
 Detector: POS
 Attn: 20 DB
 RL Offset: 11.0 DB
 Sweep Time: 5.0ms
 Ref Lvl: 10.0 DBM

Comments

20dB BW: 38.637 MHz
 802.11n 40 MHz Chain A

Cursor 1	5689.1583	0.38	Delta Freq.	38.637
Cursor 2	5650.5210	-19.62	Delta Amplitude	20.00



Client: Intel	Job Number: J88901
Model: Intel® Centrino® Advanced-N 6235	T-Log Number: T89578
	Account Manager: Christine Krebill
Contact: Steve Hackett	
Standard: FCC 15.247, 15.407, 15.209, RSS 210	Class: N/A

Run #4: Out Of Band Spurious Emissions - Antenna Conducted
802.11a

Maximum Antenna Gain: 4.8 dBi (worst case for all 3 bands)
 Spurious Limit: -27.0 dBm/MHz eirp
 Limit Used On Plots ^{Note 1}: **-31.8** dBm/MHz Peak Limit (RB=VB=1MHz)

Note 1: The -27dBm/MHz limit is an eirp limit. The limit for antenna port conducted measurements is adjusted to take into consideration the maximum antenna gain (limit = -27dBm - antenna gain). Radiated field strength measurements for signals more than 50MHz from the bands and that are close to the limit are made to determine compliance as the antenna gain is not known at these frequencies.

Plots Showing Out-Of-Band - 802.11a Mode Emissions (RBW=VBW=1MHz)

Low channel, 5150 - 5250 MHz Band - 802.11a Mode

Compliance with the radiated limits for the restricted band immediately below 5150MHz is demonstrated through the radiated emissions tests.

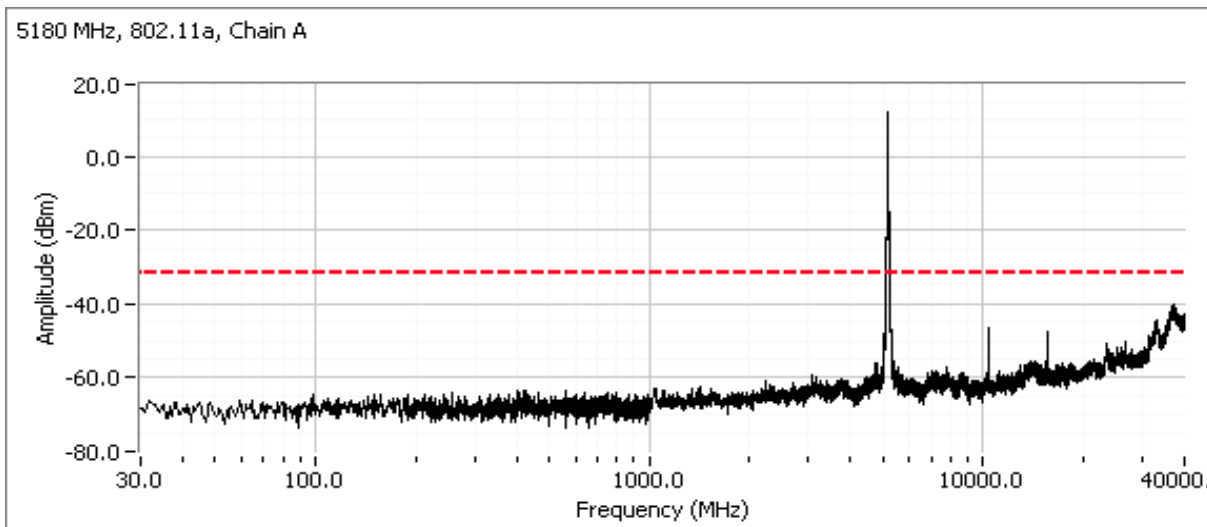

Client: Intel	Job Number: J88901
Model: Intel® Centrino® Advanced-N 6235	T-Log Number: T89578
	Account Manager: Christine Krebill
Contact: Steve Hackett	
Standard: FCC 15.247, 15.407, 15.209, RSS 210	Class: N/A

Center channel, 5150 - 5250 MHz Band - 802.11a Mode

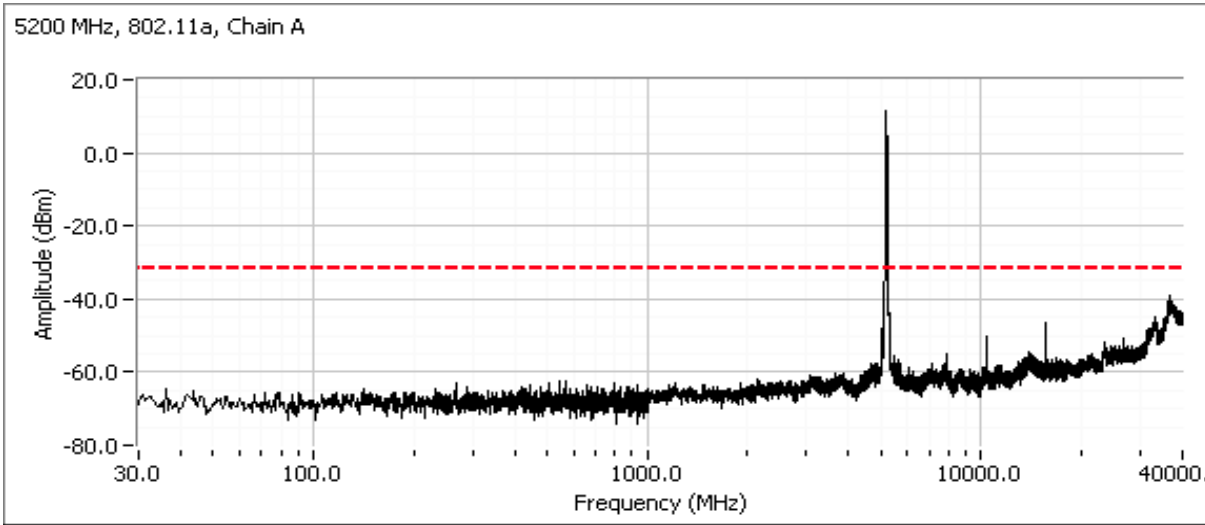

High channel, 5150 - 5250 MHz Band - 802.11a Mode

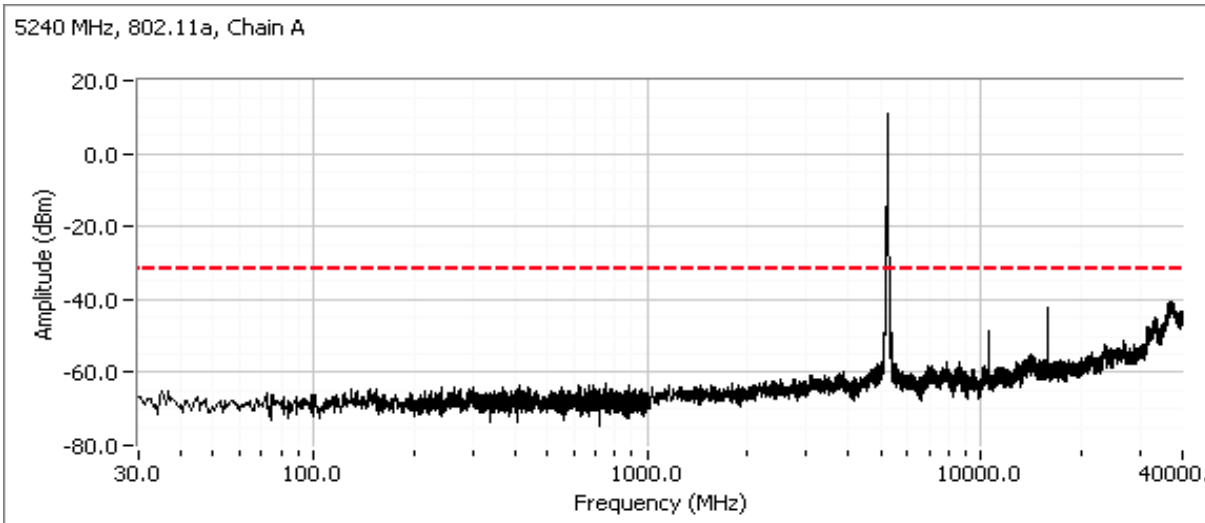

Client: Intel	Job Number: J88901
Model: Intel® Centrino® Advanced-N 6235	T-Log Number: T89578
	Account Manager: Christine Krebill
Contact: Steve Hackett	
Standard: FCC 15.247, 15.407, 15.209, RSS 210	Class: N/A

Low channel, 5250 - 5350 MHz Band - 802.11a Mode

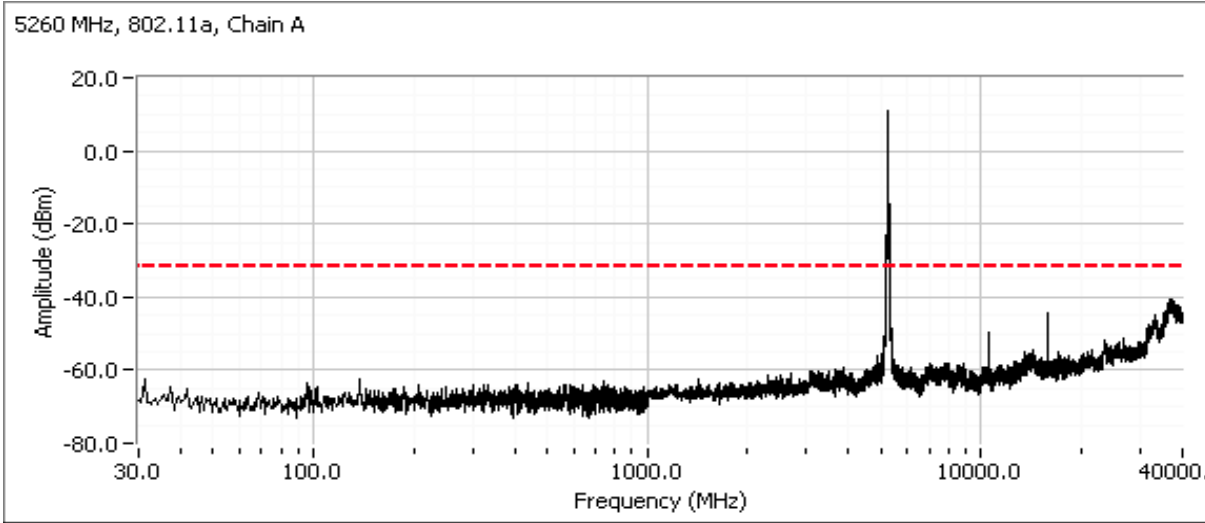

Center channel, 5250 - 5350 MHz Band - 802.11a Mode

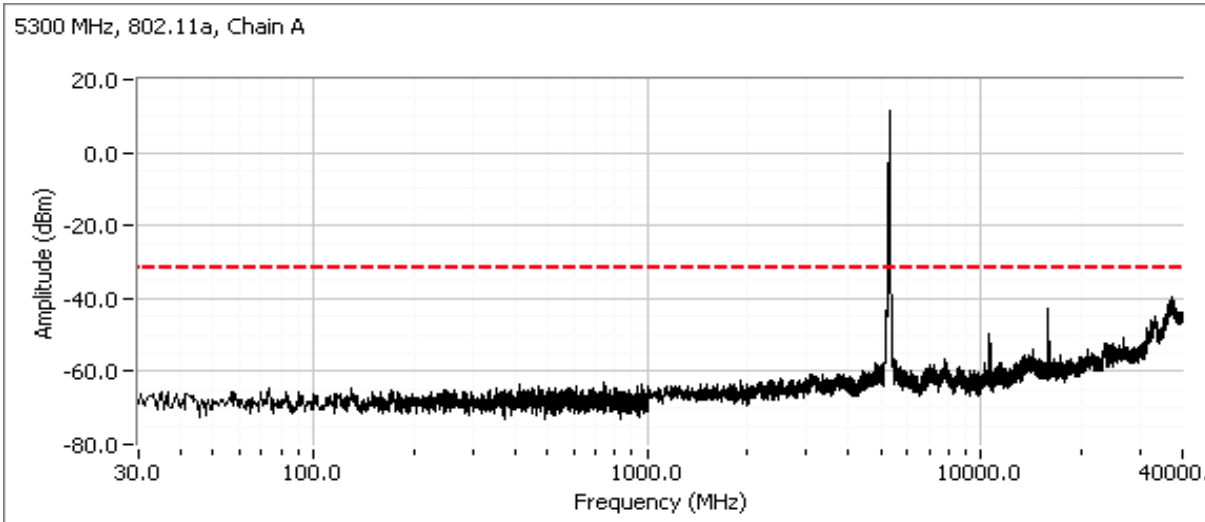

Client: Intel	Job Number: J88901
Model: Intel® Centrino® Advanced-N 6235	T-Log Number: T89578
	Account Manager: Christine Krebill
Contact: Steve Hackett	
Standard: FCC 15.247, 15.407, 15.209, RSS 210	Class: N/A

High channel, 5250 - 5350 MHz Band - 802.11a Mode

Compliance with the radiated limits for the restricted band immediately above 5350MHz is demonstrated through the radiated emissions tests.

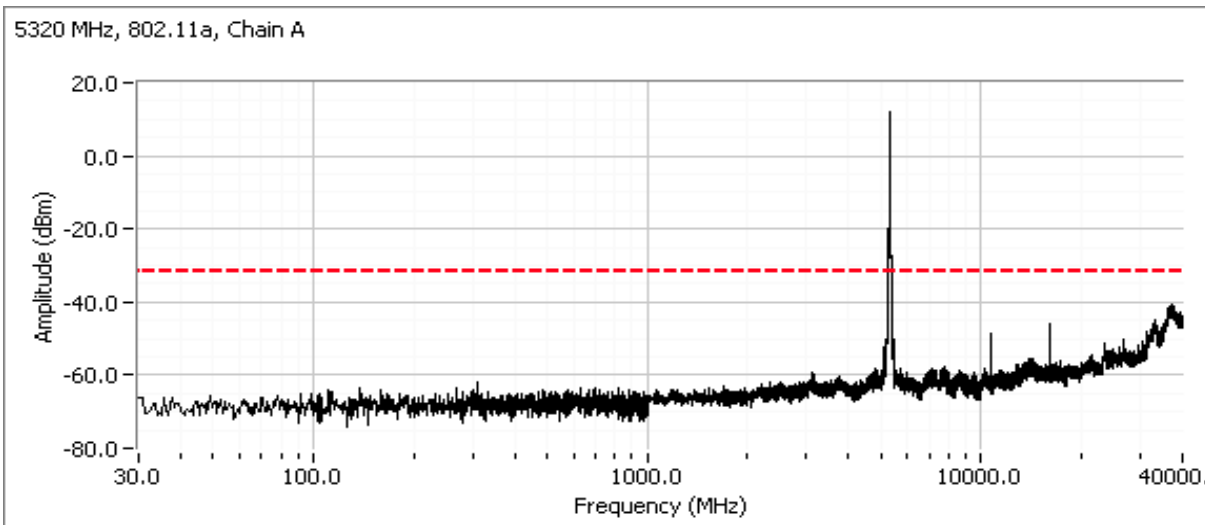

Low channel, 5470 - 5725 MHz Band - 802.11a Mode

Compliance with the radiated limits for the restricted band below 5460 MHz is demonstrated through the radiated emissions tests.

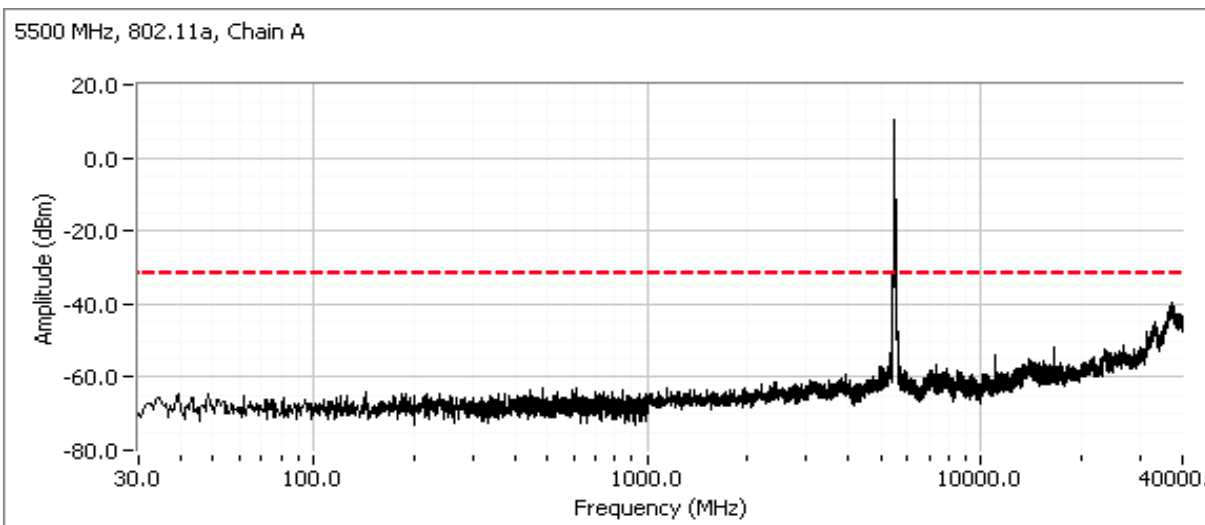

Client: Intel	Job Number: J88901
Model: Intel® Centrino® Advanced-N 6235	T-Log Number: T89578
	Account Manager: Christine Krebill
Contact: Steve Hackett	
Standard: FCC 15.247, 15.407, 15.209, RSS 210	Class: N/A

Center channel, 5470 - 5725 MHz Band - 802.11a Mode (20MHz channel use 5580 MHz, 40MHz channel use 5550 MHz)

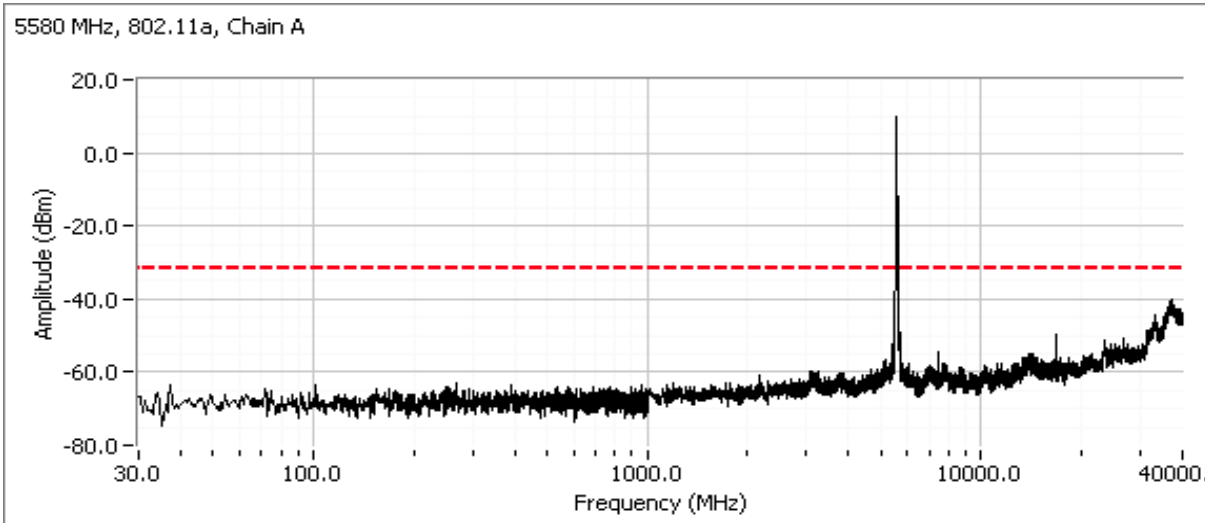

High channel, 5470 - 5725 MHz Band - 802.11a Mode

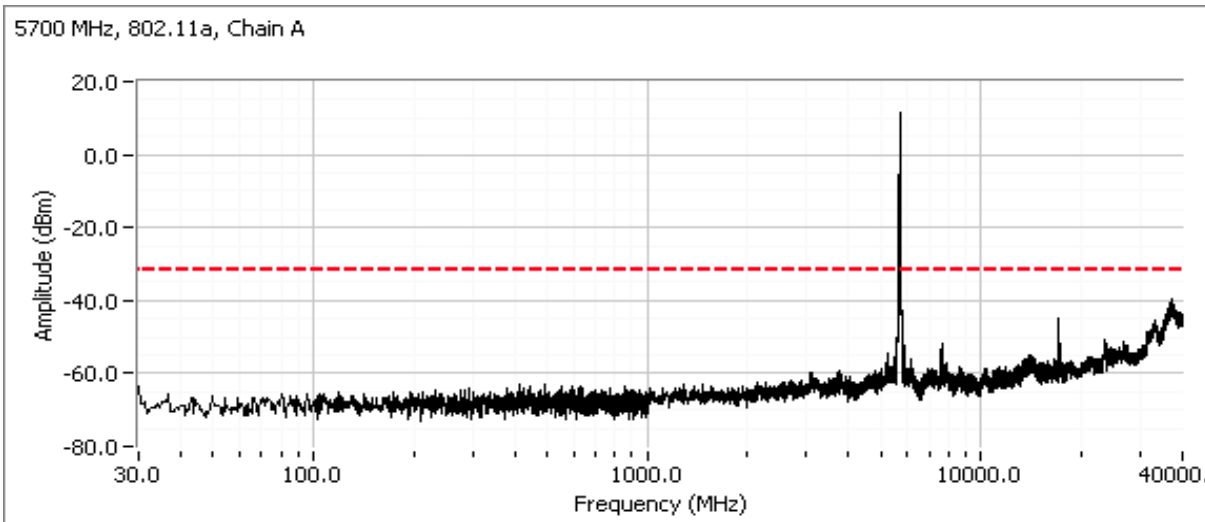

Client: Intel	Job Number: J88901
Model: Intel® Centrino® Advanced-N 6235	T-Log Number: T89578
	Account Manager: Christine Krebill
Contact: Steve Hackett	
Standard: FCC 15.247, 15.407, 15.209, RSS 210	Class: N/A

802.11n20 Mode

MIMO Devices: Antenna gain used is the effective gain calculated in the power section of this data sheet. The plots were obtained with a single chain transmitting and connected to the analyzer with the other chains terminated in 50 ohms.

Number of transmit chains: 2
 Maximum Antenna Gain: 4.8 dBi (worst case for all 3 bands)
 Spurious Limit: -27.0 dBm/MHz eirp
 Limit Used On Plots ^{Note 1}: -34.8 dBm/MHz Peak Limit (RB=VB=1MHz)

Note 1: The -27dBm/MHz limit is an eirp limit. The limit for antenna port conducted measurements is adjusted to take into consideration the maximum antenna gain (limit = -27dBm - antenna gain). Radiated field strength measurements for signals more than 50MHz from the bands and that are close to the limit are made to determine compliance as the antenna gain is not known at these frequencies.

Plots Showing Out-Of-Band - 802.11n - 20MHz Mode Emissions (RBW=VBW=1MHz)

Low channel, 5150 - 5250 MHz Band - 802.11n - 20MHz Mode

Compliance with the radiated limits for the restricted band immediately below 5150MHz is demonstrated through the radiated emissions tests.

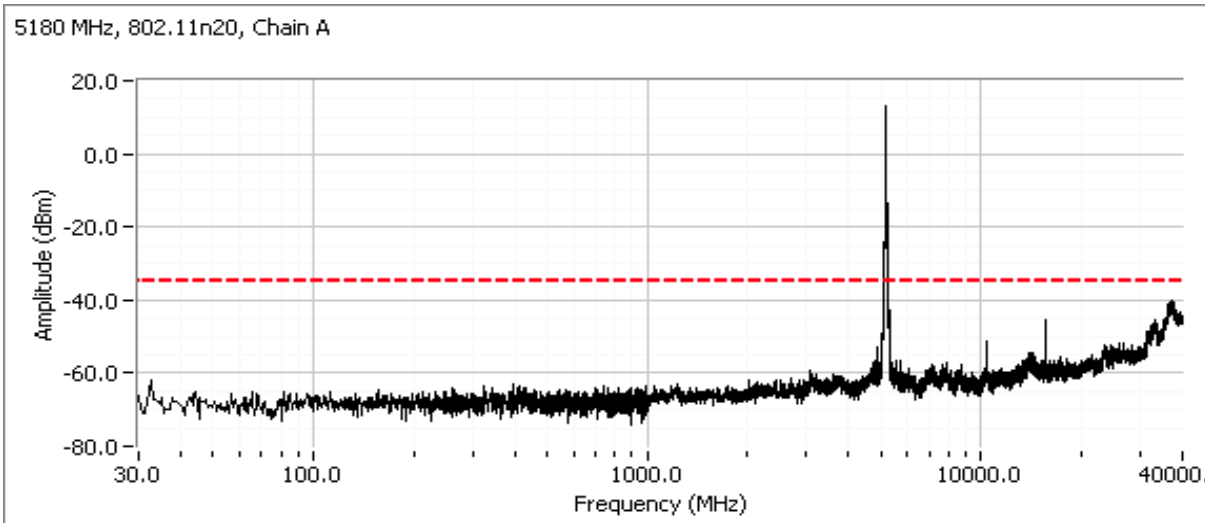

Client: Intel	Job Number: J88901
Model: Intel® Centrino® Advanced-N 6235	T-Log Number: T89578
	Account Manager: Christine Krebill
Contact: Steve Hackett	
Standard: FCC 15.247, 15.407, 15.209, RSS 210	Class: N/A

Center channel, 5150 - 5250 MHz Band - 802.11n - 20MHz Mode

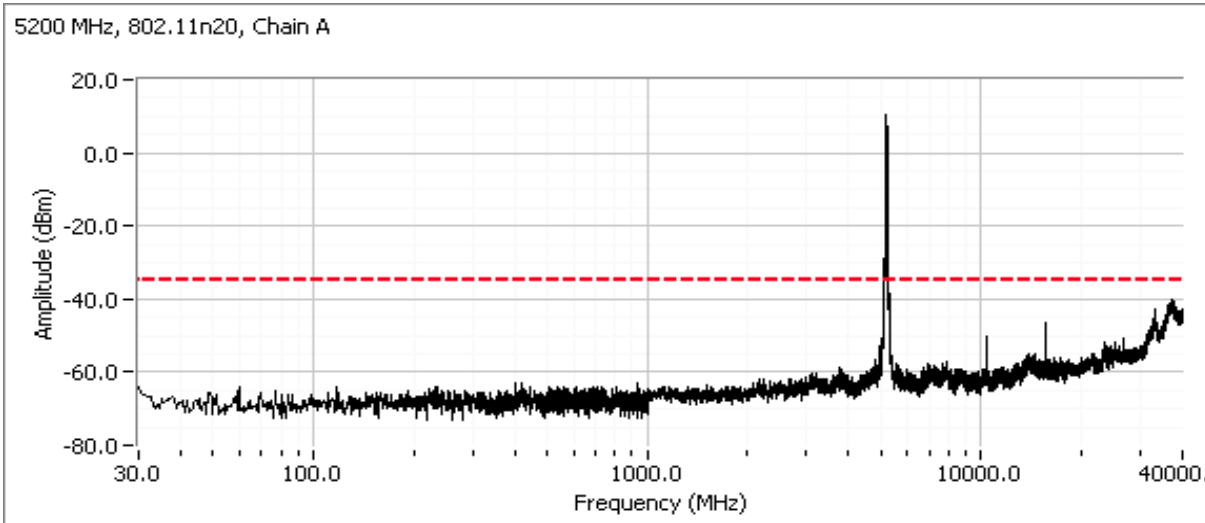

High channel, 5150 - 5250 MHz Band - 802.11n - 20MHz Mode

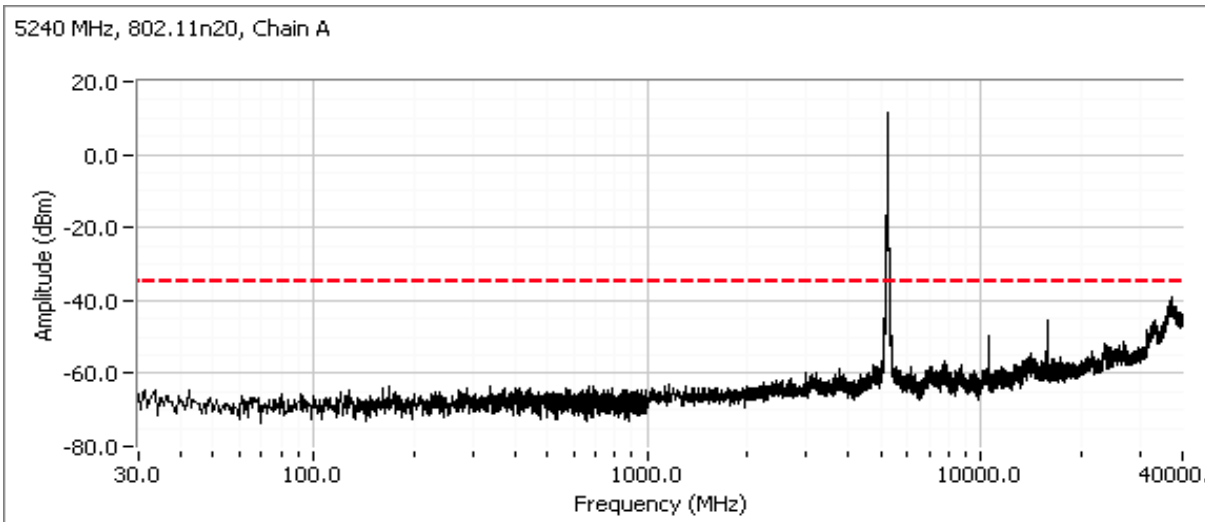

Client: Intel	Job Number: J88901
Model: Intel® Centrino® Advanced-N 6235	T-Log Number: T89578
	Account Manager: Christine Krebill
Contact: Steve Hackett	
Standard: FCC 15.247, 15.407, 15.209, RSS 210	Class: N/A

Low channel, 5250 - 5350 MHz Band - 802.11n - 20MHz Mode

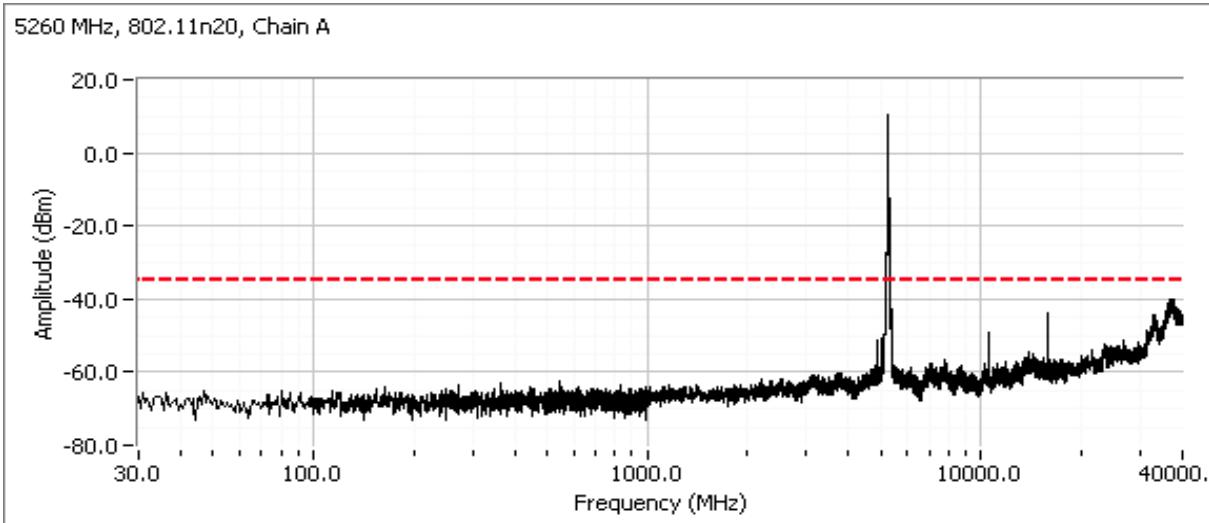

Center channel, 5250 - 5350 MHz Band - 802.11n - 20MHz Mode

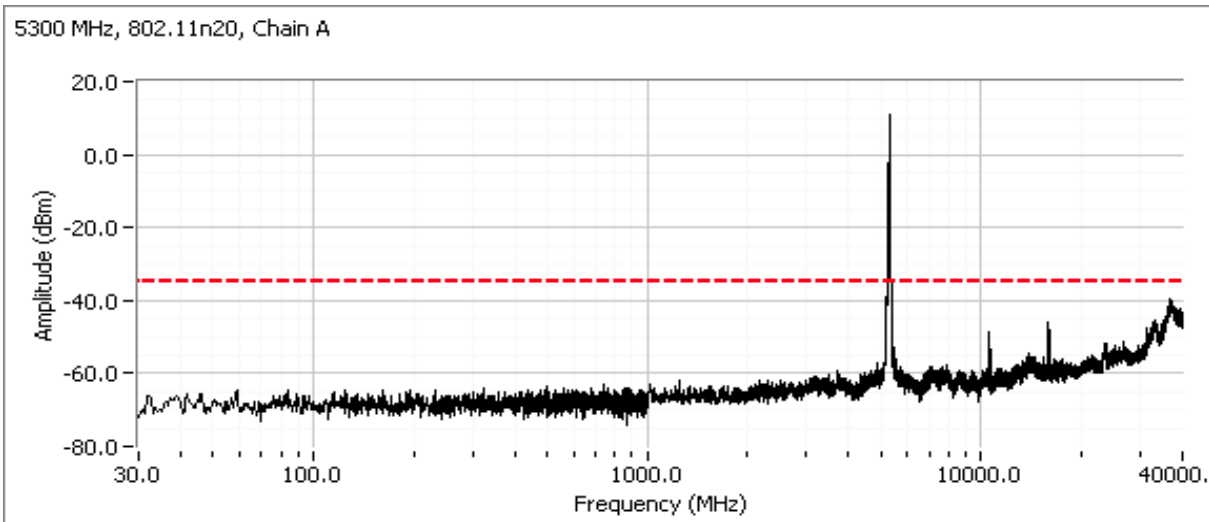

Client: Intel	Job Number: J88901
Model: Intel® Centrino® Advanced-N 6235	T-Log Number: T89578
	Account Manager: Christine Krebill
Contact: Steve Hackett	
Standard: FCC 15.247, 15.407, 15.209, RSS 210	Class: N/A

High channel, 5250 - 5350 MHz Band - 802.11n - 20MHz Mode

Compliance with the radiated limits for the restricted band immediately above 5350MHz is demonstrated through the radiated emissions tests.

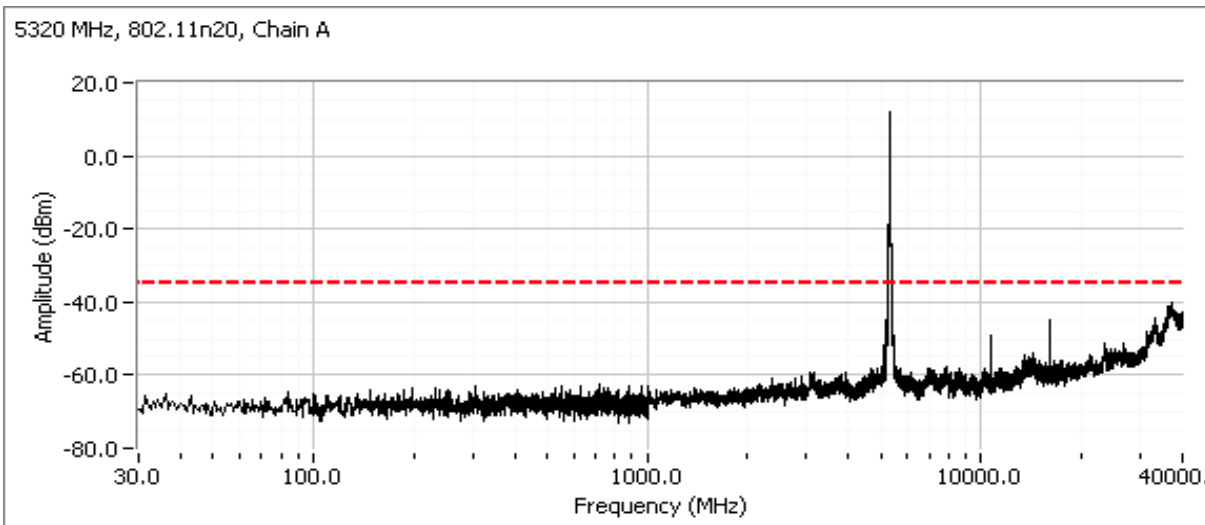

Low channel, 5470 - 5725 MHz Band - 802.11n - 20MHz Mode

Compliance with the radiated limits for the restricted band below 5460 MHz is demonstrated through the radiated emissions tests.

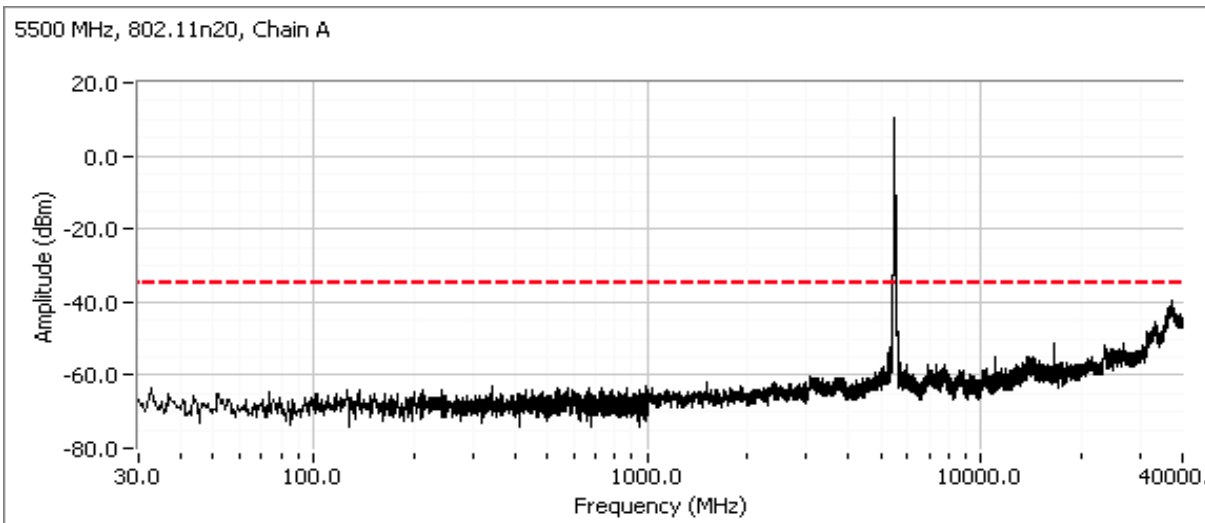

Client: Intel	Job Number: J88901
Model: Intel® Centrino® Advanced-N 6235	T-Log Number: T89578
	Account Manager: Christine Krebill
Contact: Steve Hackett	
Standard: FCC 15.247, 15.407, 15.209, RSS 210	Class: N/A

Center channel, 5470 - 5725 MHz Band - 802.11n - 20MHz Mode

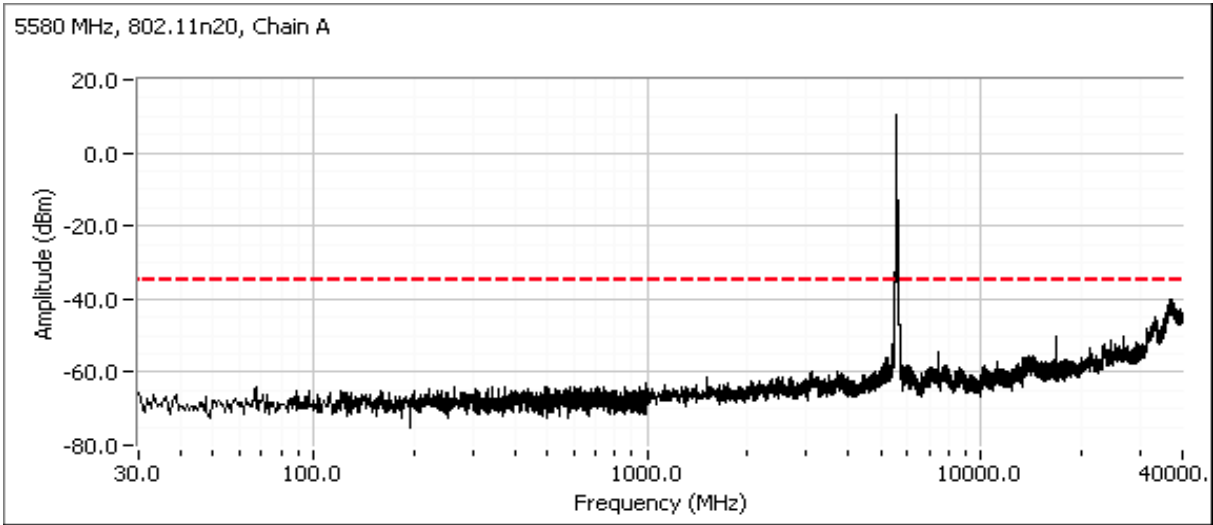

High channel, 5470 - 5725 MHz Band - 802.11n - 20MHz Mode

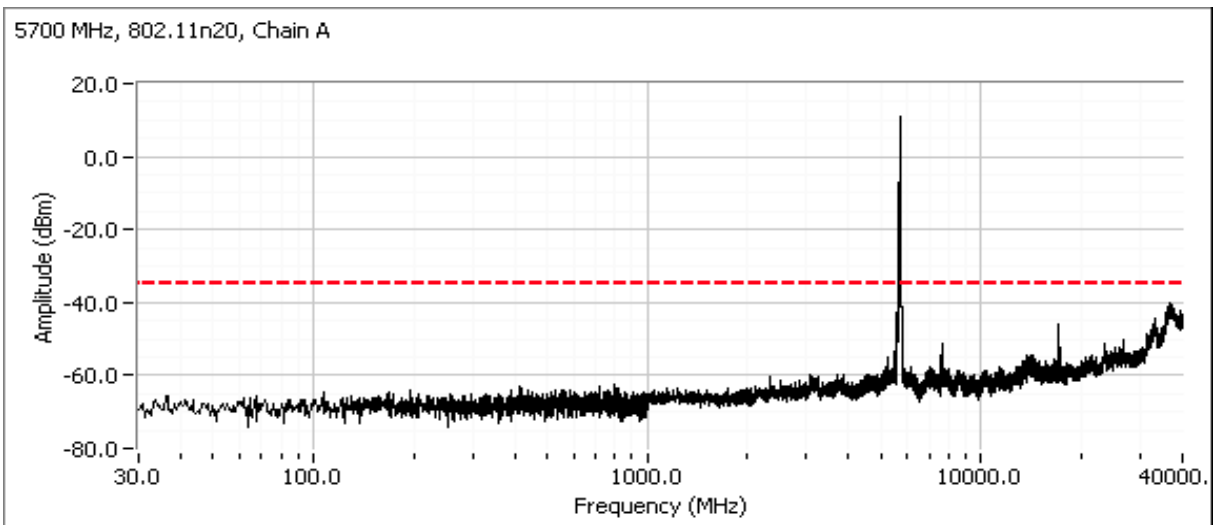

Client: Intel	Job Number: J88901
Model: Intel® Centrino® Advanced-N 6235	T-Log Number: T89578
	Account Manager: Christine Krebill
Contact: Steve Hackett	
Standard: FCC 15.247, 15.407, 15.209, RSS 210	Class: N/A

802.11n40 Mode

MIMO Devices: Antenna gain used is the effective gain calculated in the power section of this data sheet. The plots were obtained with a single chain transmitting and connected to the analyzer with the other chains terminated in 50 ohms.

Number of transmit chains: 2
 Maximum Antenna Gain: 4.8 dBi (worst case for all 3 bands)
 Spurious Limit: -27.0 dBm/MHz eirp
 Limit Used On Plots ^{Note 1}: -34.8 dBm/MHz Peak Limit (RB=VB=1MHz)

Note 1: The -27dBm/MHz limit is an eirp limit. The limit for antenna port conducted measurements is adjusted to take into consideration the maximum antenna gain (limit = -27dBm - antenna gain). Radiated field strength measurements for signals more than 50MHz from the bands and that are close to the limit are made to determine compliance as the antenna gain is not known at these frequencies.

Plots Showing Out-Of-Band - 802.11n - 40MHz Mode Emissions (RBW=VBW=1MHz)

Low channel, 5150 - 5250 MHz Band - 802.11n - 40MHz Mode

Compliance with the radiated limits for the restricted band immediately below 5150MHz is demonstrated through the radiated emissions tests.

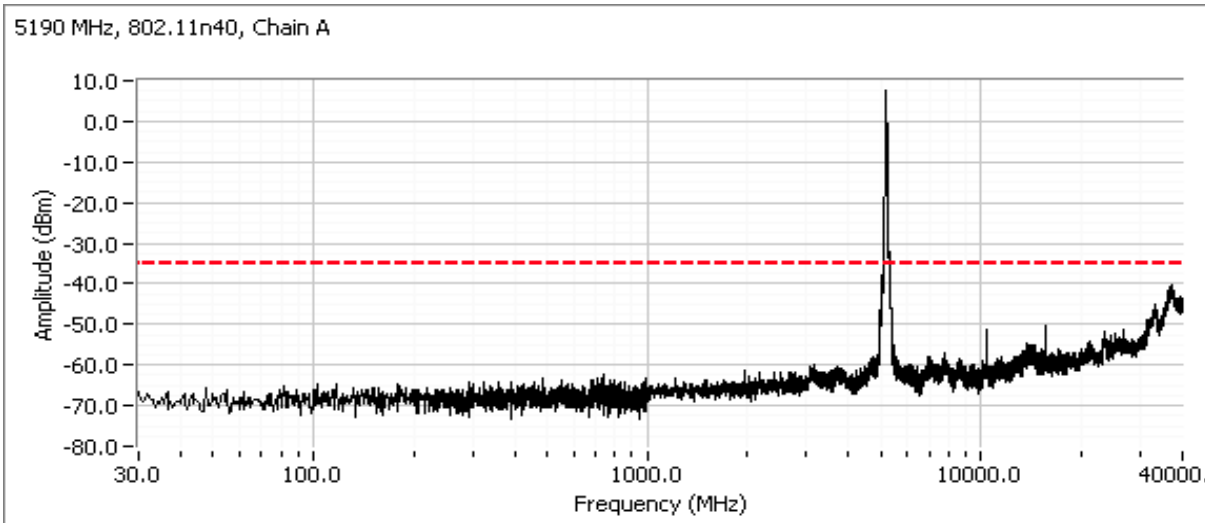

Client: Intel	Job Number: J88901
Model: Intel® Centrino® Advanced-N 6235	T-Log Number: T89578
	Account Manager: Christine Krebill
Contact: Steve Hackett	
Standard: FCC 15.247, 15.407, 15.209, RSS 210	Class: N/A

High channel, 5150 - 5250 MHz Band - 802.11n - 40MHz Mode

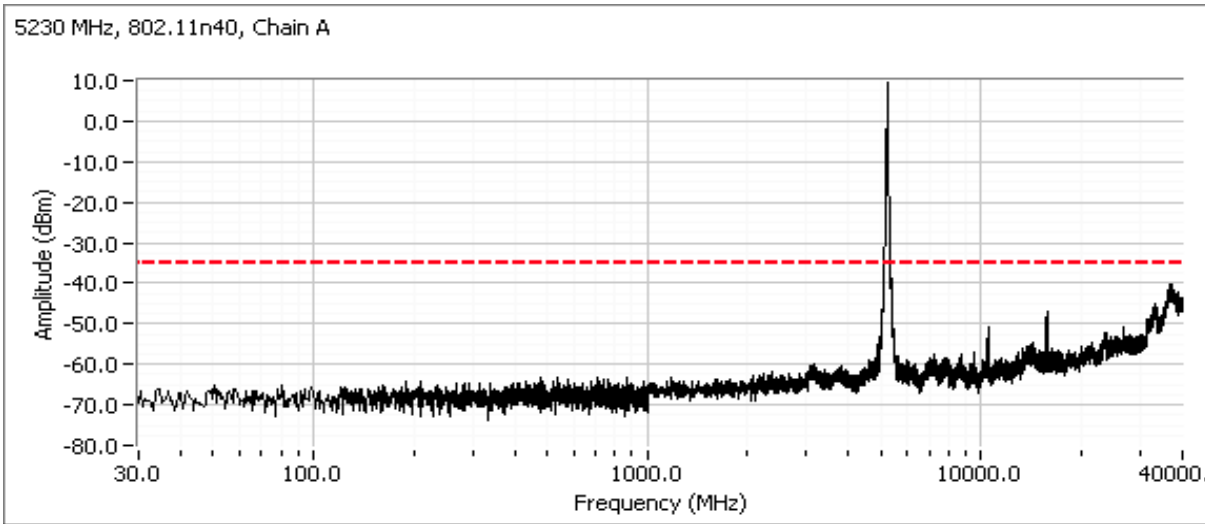

Low channel, 5250 - 5350 MHz Band - 802.11n - 40MHz Mode

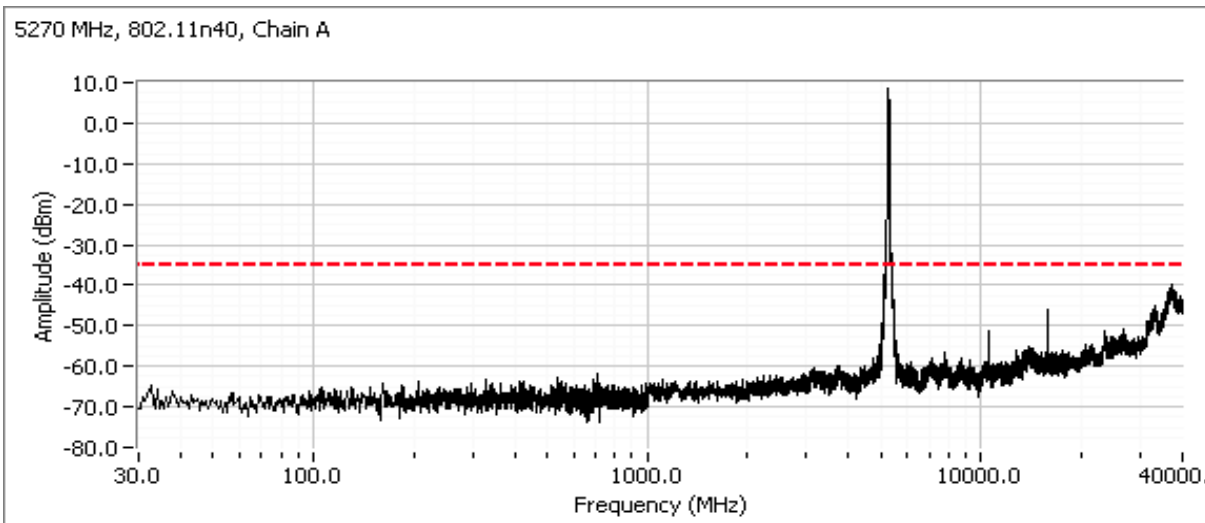

Client: Intel	Job Number: J88901
Model: Intel® Centrino® Advanced-N 6235	T-Log Number: T89578
	Account Manager: Christine Krebill
Contact: Steve Hackett	
Standard: FCC 15.247, 15.407, 15.209, RSS 210	Class: N/A

High channel, 5250 - 5350 MHz Band - 802.11n - 40MHz Mode

Compliance with the radiated limits for the restricted band immediately above 5350MHz is demonstrated through the radiated emissions tests.

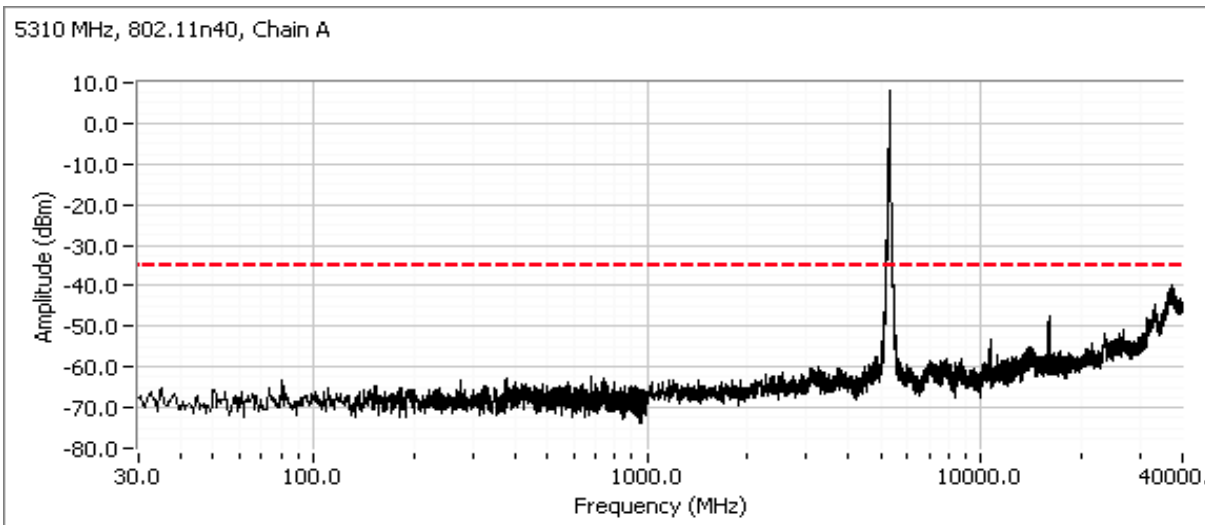

Low channel, 5470 - 5725 MHz Band - 802.11n - 40MHz Mode

Compliance with the radiated limits for the restricted band below 5460 MHz is demonstrated through the radiated emissions tests.

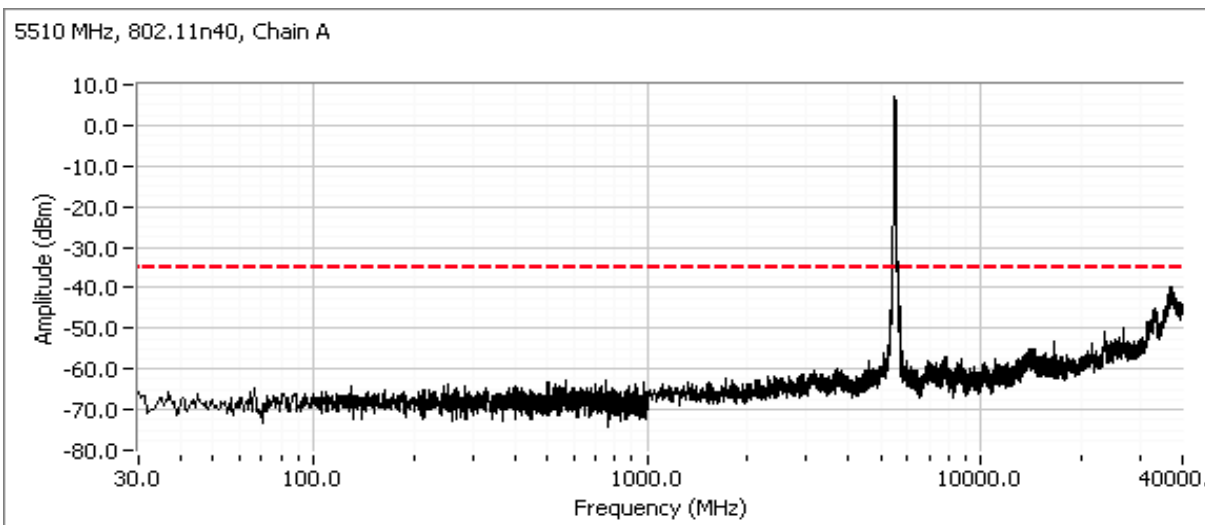

Client: Intel	Job Number: J88901
Model: Intel® Centrino® Advanced-N 6235	T-Log Number: T89578
	Account Manager: Christine Krebill
Contact: Steve Hackett	
Standard: FCC 15.247, 15.407, 15.209, RSS 210	Class: N/A

Center channel, 5470-5725MHz Band - 802.11n 40MHz Mode

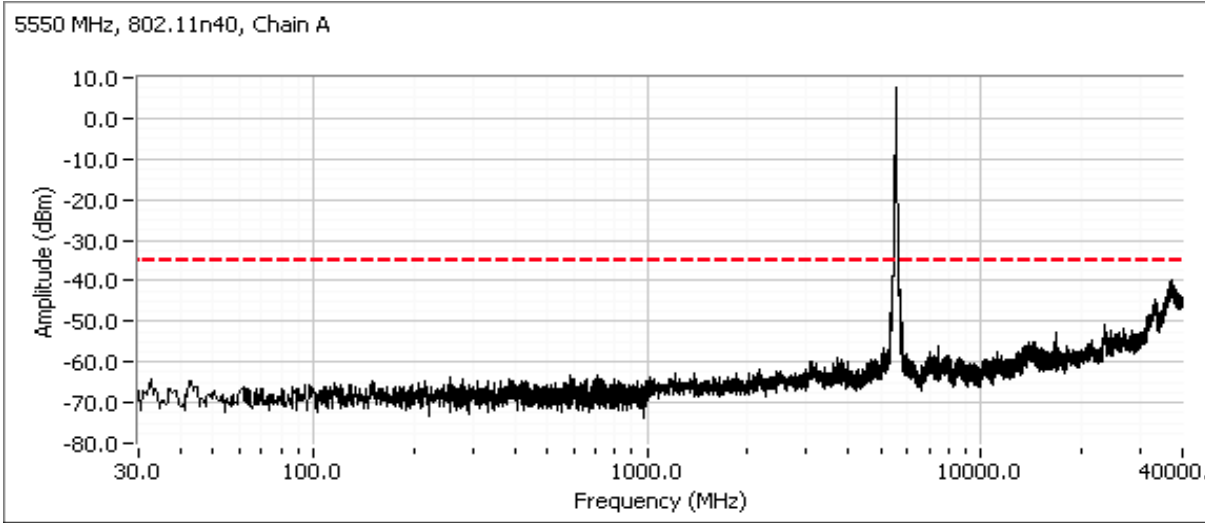

High channel, 5470 - 5725 MHz Band - 802.11n - 40MHz Mode

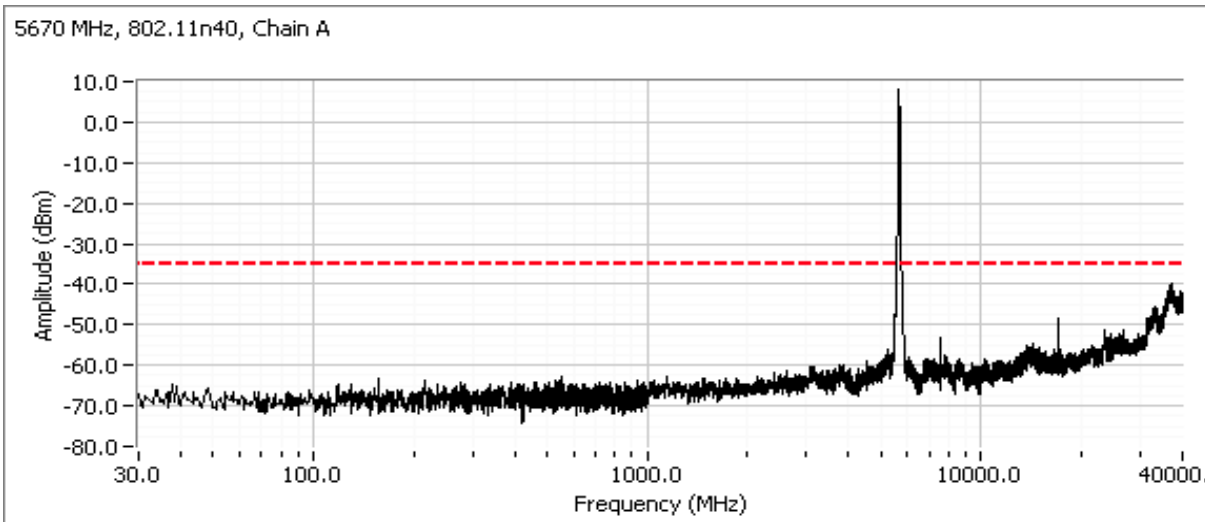

Client: Intel	Job Number: J88901
Model: Intel® Centrino® Advanced-N 6235	T-Log Number: T89578
	Account Manager: Christine Krebill
Contact: Steve Hackett	
Standard: FCC 15.247, 15.407, 15.209, RSS 210	Class: N/A

RSS-210 (LELAN) and FCC 15.407(UNII)
Antenna Port Measurements - CHAIN B
 Power, PSD, Peak Excursion, Bandwidth and Spurious Emissions

Test Specific Details

Objective: The objective of this test session is to perform final qualification testing of the EUT with respect to the specification listed above.

Date of Test: 1/4/2013	Config. Used: 1
Test Engineer: M. Birgani, D. Demirci	Config Change: -
Test Location: Lab #4A	Host Unit Voltage 120V/60Hz

General Test Configuration

When measuring the conducted emissions from the EUT's antenna port, the antenna port of the EUT was connected to the spectrum analyzer or power meter via a suitable attenuator to prevent overloading the measurement system. All measurements are corrected to allow for the external attenuators and cables used.

Ambient Conditions:

Temperature:	20-23 °C
Rel. Humidity:	35-40 %

Modifications Made During Testing

No modifications were made to the EUT during testing

Deviations From The Standard

No deviations were made from the requirements of the standard.



EMC Test Data

Client: Intel	Job Number: J88901
Model: Intel® Centrino® Advanced-N 6235	T-Log Number: T89578
	Account Manager: Christine Krebill
Contact: Steve Hackett	
Standard: FCC 15.247, 15.407, 15.209, RSS 210	Class: N/A

Summary of Results - Chain B

MAC Address: 001500B50432 DRTU Tool Version 1.5.6-0445 Driver version 15.3.1.2

Run #	Test Performed	Limit	Pass / Fail	Result / Margin
1	Power, 5150 - 5250MHz	15.407(a) (1), (2)	Pass	802.11a: 30.8 mW 802.11n20: 32.5 mW 802.11n40: 28.3 mW
1	PSD, 5150 - 5250MHz	15.407(a) (1), (2)	Pass	802.11a: 1.9 dBm/MHz 802.11n20: 2.1 dBm/MHz 802.11n40: -1.1 dBm/MHz
1	Power, 5250 - 5350MHz	15.407(a) (1), (2)	Pass	802.11a: 30.1 mW 802.11n20: 30.4 mW 802.11n40: 25.9 mW
1	PSD, 5250 - 5350MHz	15.407(a) (1), (2)	Pass	802.11a: 1.9 dBm/MHz 802.11n20: 1.6 dBm/MHz 802.11n40: -1.4 dBm/MHz
1	Power, 5470 - 5725MHz	15.407(a) (1), (2)	Pass	802.11a: 33.4 mW 802.11n20: 39.8 mW 802.11n40: 32.6 mW
1	PSD, 5470 - 5725MHz	15.407(a) (1), (2)	Pass	802.11a: 2.4 dBm/MHz 802.11n20: 2.9 dBm/MHz 802.11n40: -0.7 dBm/MHz
1	26dB Bandwidth	15.407 (Information only)	-	> 20MHz for all modes
1	99% Bandwidth	RSS 210 (Information only)	N/A	802.11a: 32.7 MHz 802.11n20: 33.9 MHz 802.11n40: 58.8 MHz
2	Peak Excursion Envelope	15.407(a) (6) 13dB	Pass	8.7 dB
3	20dB Bandwidth	Remains out of 5600- 5650 MHz band	Pass	All are > 20dBc in the 5600-5650 MHz band
4	Antenna Conducted - Out of Band Spurious	15.407(b) -27dBm/MHz	Pass	All emissions below the -27dBm/MHz limit

Client: Intel	Job Number: J88901
Model: Intel® Centrino® Advanced-N 6235	T-Log Number: T89578
	Account Manager: Christine Krebill
Contact: Steve Hackett	
Standard: FCC 15.247, 15.407, 15.209, RSS 210	Class: N/A

Run #1: Bandwidth, Output Power and Power Spectral Density - Single Chain Systems

Note 1:	Output power measured using a spectrum analyzer (see plots below). RBW=1MHz, VB=3 MHz, # of points in sweep $\geq 2 \times \text{span} / \text{RBW}$, RMS detector, power averaging on (transmitted signal was continuous) and power integration over 50 MHz for 20dB bandwidth and 80 MHz for 40dB bandwidth (method SA-1 of KDB 789033).
Note 2:	Measured using the same analyzer settings used for output power.
Note 3:	For RSS-210 the limit for the 5150 - 5250 MHz band accounts for the antenna gain as the maximum eirp allowed is 10dBm/MHz. The limits are also corrected for instances where the highest measured value of the PSD exceeds the average PSD (calculated from the measured power divided by the measured 99% bandwidth) by more than 3dB by the amount that the measured value exceeds the average by more than 3dB.
Note 4:	99% Bandwidth measured in accordance with RSS GEN - RB > 1% of span and VB $\geq 3 \times \text{RB}$
Note 5:	For MIMO systems the total output power and total PSD are calculated from the sum of the powers of the individual chains (in linear terms). The antenna gain used to determine the EIRP and limits for PSD/Output power depends on the operating mode of the MIMO device. If the signals are non-coherent between the transmit chains then the gain used to determine the limits is the highest gain of the individual chains and the EIRP is the sum of the products of gain and power on each chain. If the signals are coherent then the effective antenna gain is the sum (in linear terms) of the gains for each chain and the EIRP is the product of the effective gain and total power.

Single Chain Operation, 5150-5250MHz Band

Antenna Gain (dBi): 3.6

EIRP: 70.6 mW

18.5 dBm

Frequency (MHz)	Software Setting	Bandwidth		Output Power ¹ dBm		Power (Watts)	PSD ² dBm/MHz			Result
		26dB	99% ⁴	Measured	Limit		Measured	FCC Limit	RSS Limit ³	
802.11a										
5180	31.0	41.0	22.2	13.3	17.0	0.021	0.5	4.0	6.4	Pass
5200	37.0	51.8	31.0	14.9	17.0	0.031	1.9	4.0	6.4	Pass
5240	37.0	50.8	30.5	14.6	17.0	0.029	1.7	4.0	6.4	Pass
802.11n 20MHz										
5180	31.0	44.8	22.0	13.1	17.0	0.021	0.0	4.0	6.4	Pass
5200	39.0	57.6	33.9	15.1	17.0	0.033	2.1	4.0	6.4	Pass
5240	39.0	57.2	33.8	14.9	17.0	0.031	1.6	4.0	6.4	Pass
802.11n 40MHz										
5190	25.5	50.0	36.3	9.5	17.0	0.009	-6.2	4.0	6.4	Pass
5230	39.0	72.4	58.8	14.5	17.0	0.028	-1.1	4.0	6.4	Pass

Client: Intel	Job Number: J88901
Model: Intel® Centrino® Advanced-N 6235	T-Log Number: T89578
	Account Manager: Christine Krebill
Contact: Steve Hackett	
Standard: FCC 15.247, 15.407, 15.209, RSS 210	Class: N/A

Single Chain Operation, 5250-5350 MHz Band

Antenna Gain (dBi): 3.7 EIRP: 70.6 mW 18.5 dBm

Frequency (MHz)	Software Setting	Bandwidth		Output Power ¹ dBm		Power (Watts)	PSD ² dBm/MHz			Result
		26dB	99% ⁴	Measured	Limit		Measured	FCC Limit	RSS Limit ³	
802.11a										
5260	39.0	57.0	32.7	14.8	24.0	0.030	1.9	11.0	11.0	Pass
5300	37.0	56.9	30.4	14.4	24.0	0.027	1.4	11.0	11.0	Pass
5320	32.0	41.1	23.0	12.7	24.0	0.019	-0.3	11.0	11.0	Pass
802.11n 20MHz										
5260	39.0	57.6	33.9	14.8	24.0	0.030	1.6	11.0	11.0	Pass
5300	39.0	56.6	33.4	14.7	24.0	0.030	1.6	11.0	11.0	Pass
5320	33.0	44.9	25.6	13.1	24.0	0.020	-0.2	11.0	11.0	Pass
802.11n 40MHz										
5270	39.0	74.4	58.8	14.1	24.0	0.026	-1.4	11.0	11.0	Pass
5310	27.0	65.7	36.3	9.2	24.0	0.008	-6.3	11.0	11.0	Pass

Single Chain Operation, 5470- 5725 MHz Band

Antenna Gain (dBi): 4.8 EIRP: 100.9 mW 20.0 dBm

Frequency (MHz)	Software Setting	Bandwidth		Output Power ¹ dBm		Power (Watts)	PSD ² dBm/MHz			Result
		26dB	99% ⁴	Measured	Limit		Measured	FCC Limit	RSS Limit ³	
802.11a										
5500	34.5	43.6	25.5	14.7	24.0	0.029	1.7	11.0	11.0	Pass
5580	34.5	43.2	24.6	15.2	24.0	0.033	2.4	11.0	11.0	Pass
5660	26.0	31.5	17.1	11.3	24.0	0.013	-1.0	11.0	11.0	Pass
5700	32.0	40.1	19.5	13.6	24.0	0.023	0.8	11.0	11.0	Pass
802.11n 20MHz										
5500	31.0	42.0	19.1	13.2	24.0	0.021	0.0	11.0	11.0	Pass
5580	37.5	52.5	30.1	16.0	24.0	0.040	2.9	11.0	11.0	Pass
5660	26.0	32.6	18.1	10.7	24.0	0.012	-1.9	11.0	11.0	Pass
5700	30.5	42.2	18.6	12.9	24.0	0.019	-0.3	11.0	11.0	Pass
802.11n 40MHz										
5510	32.0	65.1	37.4	12.6	24.0	0.018	-3.0	11.0	11.0	Pass
5550	39.0	73.5	56.3	15.1	24.0	0.032	-0.5	11.0	11.0	Pass
5670	28.0	63.0	36.3	11.0	24.0	0.013	-4.1	11.0	11.0	Pass

Where 99% bandwidth is less than 20 MHz, RSS 210 limits total power thus the limit is recalculated below.

802.11a										
5660	26.0	31.5	17.1	11.3	23.3	0.013	-1.0	11.0	11.0	Pass
5700	32.0	40.1	19.5	13.6	23.9	0.023	0.8	11.0	11.0	Pass
802.11n20										
5500	31.0	42.0	19.1	13.2	23.8	0.021	0.0	11.0	11.0	Pass
5660	26.0	32.6	18.1	10.7	23.6	0.012	-1.9	11.0	11.0	Pass
5700	30.5	42.2	18.6	12.9	23.7	0.019	-0.3	11.0	11.0	Pass

Client: Intel	Job Number: J88901
Model: Intel® Centrino® Advanced-N 6235	T-Log Number: T89578
	Account Manager: Christine Krebill
Contact: Steve Hackett	
Standard: FCC 15.247, 15.407, 15.209, RSS 210	Class: N/A

Run #2: Peak Excursion Measurement

802.11a: Device meets the requirement for the peak excursion

Peak Excursion(dB)			Peak Excursion(dB)			Peak Excursion(dB)		
Freq	Value	Limit	Freq	Value	Limit	Freq	Value	Limit
(MHz)			(MHz)			(MHz)		
5180	7.3	13.0	5260	8.3	13.0	5500	8.1	13.0
5200	8.7	13.0	5300	8.0	13.0	5580	7.3	13.0
5240	7.8	13.0	5320	7.4	13.0	5700	7.5	13.0

802.11n20: Device meets the requirement for the peak excursion

Peak Excursion(dB)			Peak Excursion(dB)			Peak Excursion(dB)		
Freq	Value	Limit	Freq	Value	Limit	Freq	Value	Limit
(MHz)			(MHz)			(MHz)		
5180	7.3	13.0	5260	7.9	13.0	5500	7.1	13.0
5200	7.4	13.0	5300	8.3	13.0	5580	7.7	13.0
5240	8.2	13.0	5320	7.6	13.0	5700	6.9	13.0

802.11n40: Device meets the requirement for the peak excursion

Peak Excursion(dB)			Peak Excursion(dB)			Peak Excursion(dB)		
Freq	Value	Limit	Freq	Value	Limit	Freq	Value	Limit
(MHz)			(MHz)			(MHz)		
5190	7.5	13.0	5270	7.9	13.0	5510	7.4	13.0
5230	8.0	13.0	5310	7.0	13.0	5550	7.9	13.0
						5670	7.6	13.0

Client: Intel	Job Number: J88901
Model: Intel® Centrino® Advanced-N 6235	T-Log Number: T89578
	Account Manager: Christine Krebill
Contact: Steve Hackett	
Standard: FCC 15.247, 15.407, 15.209, RSS 210	Class: N/A

Plots Showing Peak Excursion

Trace A: RBW = 1MHz, VBW = 3MHz, Peak hold

Trace B: Same settings as used for power/PSD measurements (RBW = 1 MHz, VBW = 3MHz, Integrated average power)

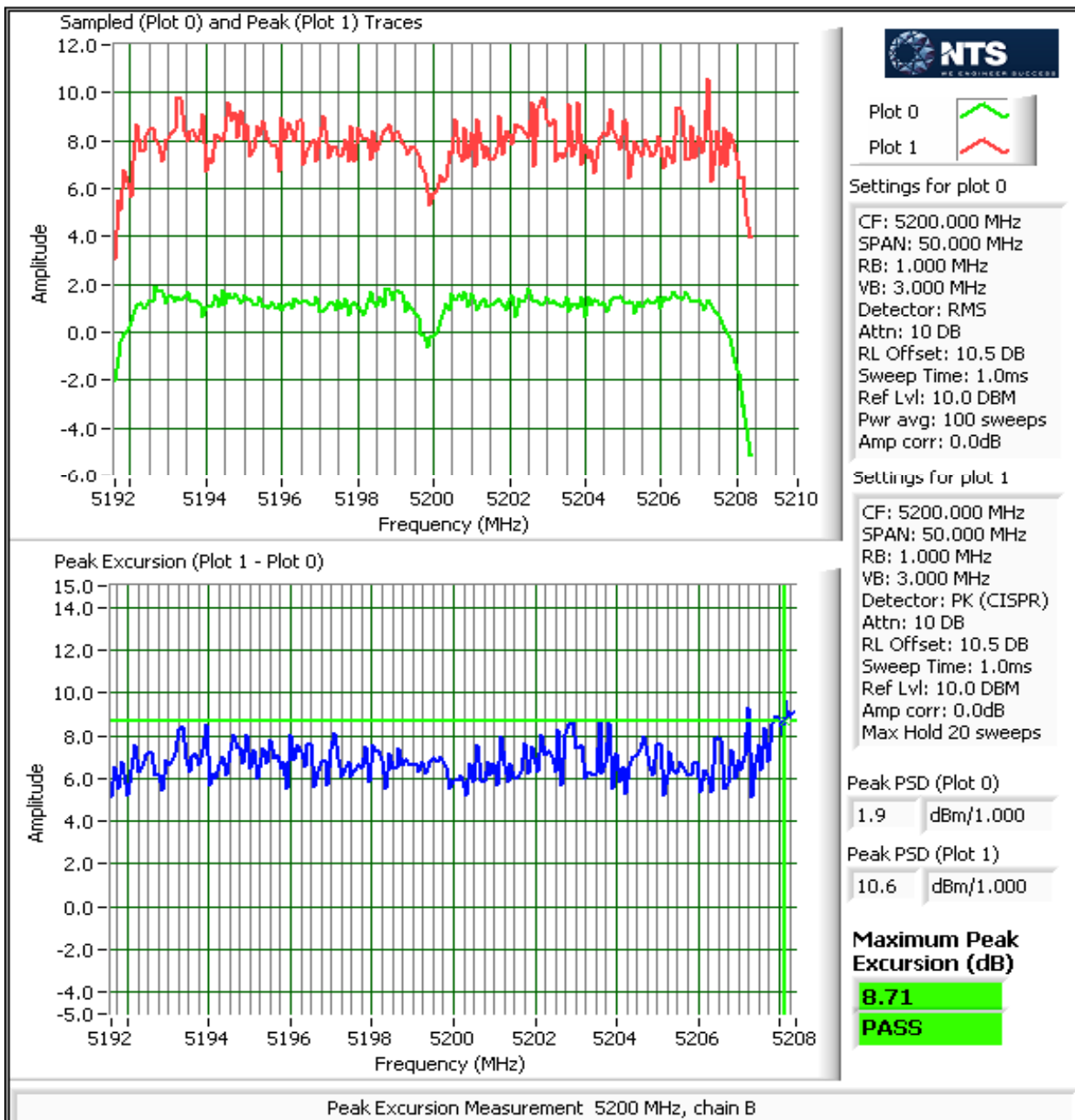

Client: Intel	Job Number: J88901
Model: Intel® Centrino® Advanced-N 6235	T-Log Number: T89578
	Account Manager: Christine Krebill
Contact: Steve Hackett	
Standard: FCC 15.247, 15.407, 15.209, RSS 210	Class: N/A

Run #3 : 20dB Signal Bandwidth on channels closest to 5600-5650 MHz band

Mode	Power Setting	Frequency (MHz)	Bandwidth (MHz) 20dB
802.11a	39.0	5580	38.40
	26.0	5660	19.24
802.11n 20MHz	39.0	5580	38.20
	26.0	5660	19.64
802.11n 40MHz	39.0	5550	68.90
	28.0	5670	38.48

Note 1: 20dB bandwidth measured with RB > 1% of the span and VB > 3xRB

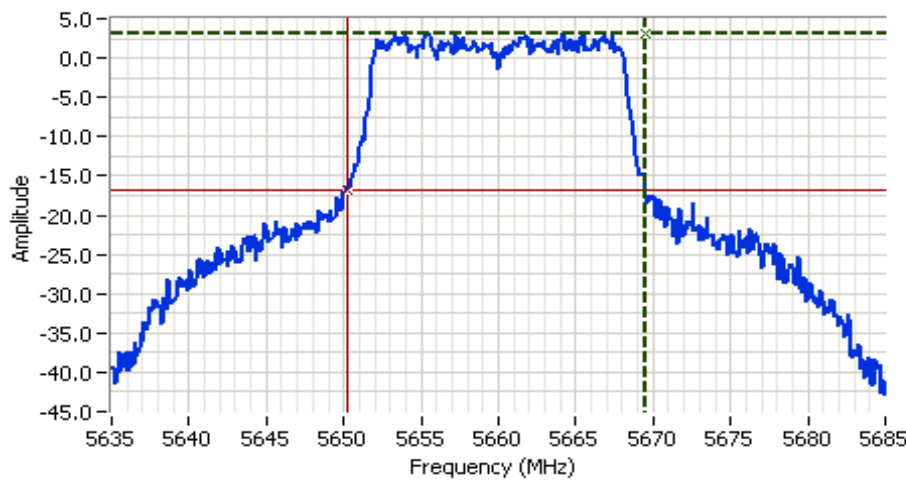

Analyzer Settings

Rohde&Schwarz,ESI
 CF: 5660.000 MHz
 SPAN: 50.000 MHz
 RB: 300 kHz
 VB: 1.000 MHz
 Detector: POS
 Attn: 20 DB
 RL Offset: 11.0 DB
 Sweep Time: 5.0ms
 Ref Lvl: 10.0 DBM

Comments

20dB BW: 19.238 MHz
 802.11a Chain B

Cursor 1	5669.4689	3.11		Delta Freq.	19.238
Cursor 2	5650.2305	-16.89		Delta Amplitude	20.00

Client: Intel	Job Number: J88901
Model: Intel® Centrino® Advanced-N 6235	T-Log Number: T89578
	Account Manager: Christine Krebill
Contact: Steve Hackett	
Standard: FCC 15.247, 15.407, 15.209, RSS 210	Class: N/A

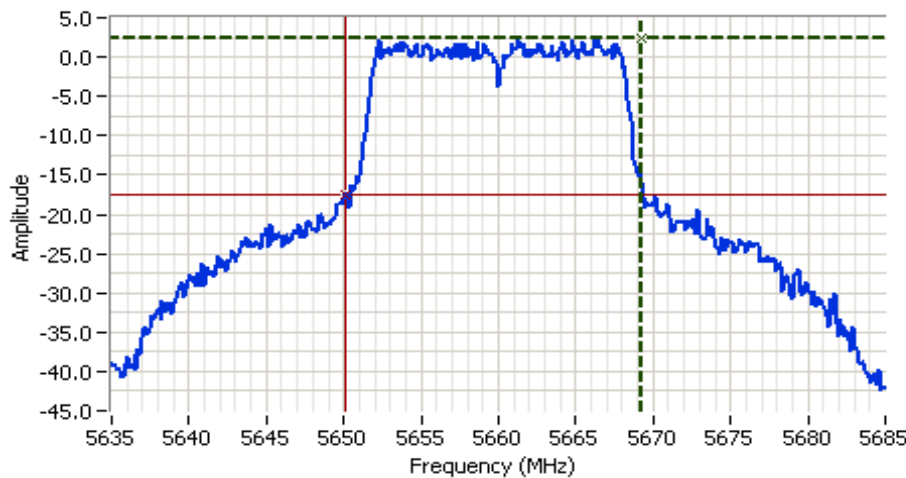
Analyzer Settings

Rohde&Schwarz,ESI
 CF: 5660.000 MHz
 SPAN: 50.000 MHz
 RB: 300 kHz
 VB: 1.000 MHz
 Detector: POS
 Attn: 20 DB
 RL Offset: 11.0 DB
 Sweep Time: 5.0ms
 Ref Lvl: 10.0 DBM

Comments

20dB BW: 19.138 MHz
 802.11n 20 MHz Chain B

Cursor 1	5669.2685	2.39	
Cursor 2	5650.1303	-17.61	

Delta Freq. 19.138

Delta Amplitude 20.00

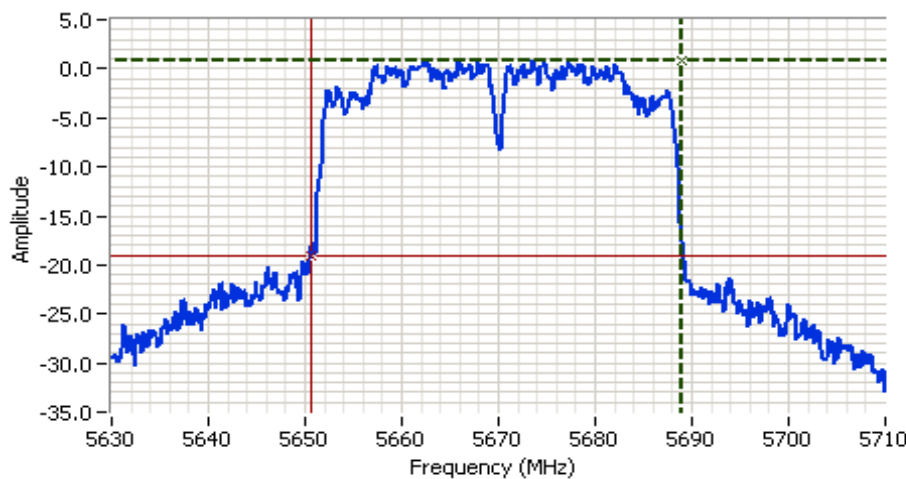
Analyzer Settings

Rohde&Schwarz,ESI
 CF: 5670.000 MHz
 SPAN: 80.000 MHz
 RB: 500 kHz
 VB: 2.000 MHz
 Detector: POS
 Attn: 20 DB
 RL Offset: 11.0 DB
 Sweep Time: 5.0ms
 Ref Lvl: 10.0 DBM

Comments

20dB BW: 38.477 MHz
 802.11n 40 MHz Chain B

Cursor 1	5688.9980	0.86	
Cursor 2	5650.5210	-19.14	

Delta Freq. 38.477

Delta Amplitude 20.00



Client: Intel	Job Number: J88901
Model: Intel® Centrino® Advanced-N 6235	T-Log Number: T89578
	Account Manager: Christine Krebill
Contact: Steve Hackett	
Standard: FCC 15.247, 15.407, 15.209, RSS 210	Class: N/A

Run #3: Out Of Band Spurious Emissions - Antenna Conducted
802.11a

Maximum Antenna Gain: 4.8 dBi (worst case for all 3 bands)
 Spurious Limit: -27.0 dBm/MHz eirp
 Limit Used On Plots ^{Note 1}: **-31.8** dBm/MHz Peak Limit (RB=VB=1MHz)

Note 1: The -27dBm/MHz limit is an eirp limit. The limit for antenna port conducted measurements is adjusted to take into consideration the maximum antenna gain (limit = -27dBm - antenna gain). Radiated field strength measurements for signals more than 50MHz from the bands and that are close to the limit are made to determine compliance as the antenna gain is not known at these frequencies.

Plots Showing Out-Of-Band - 802.11a Mode Emissions (RBW=VBW=1MHz)

Low channel, 5150 - 5250 MHz Band - 802.11a Mode

Compliance with the radiated limits for the restricted band immediately below 5150MHz is demonstrated through the radiated emissions tests.

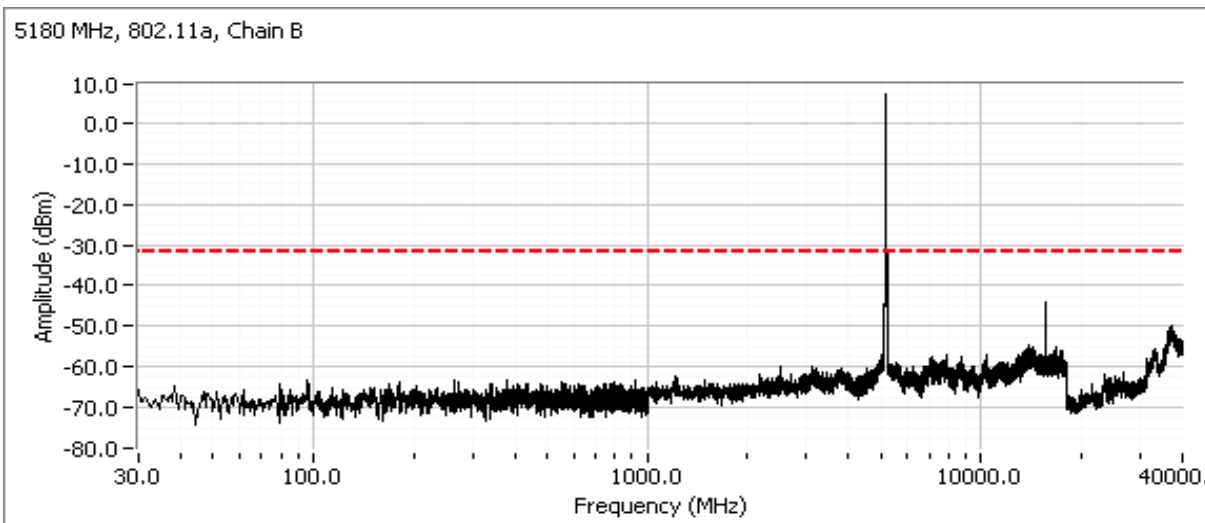

Client: Intel	Job Number: J88901
Model: Intel® Centrino® Advanced-N 6235	T-Log Number: T89578
	Account Manager: Christine Krebill
Contact: Steve Hackett	
Standard: FCC 15.247, 15.407, 15.209, RSS 210	Class: N/A

Center channel, 5150 - 5250 MHz Band - 802.11a Mode

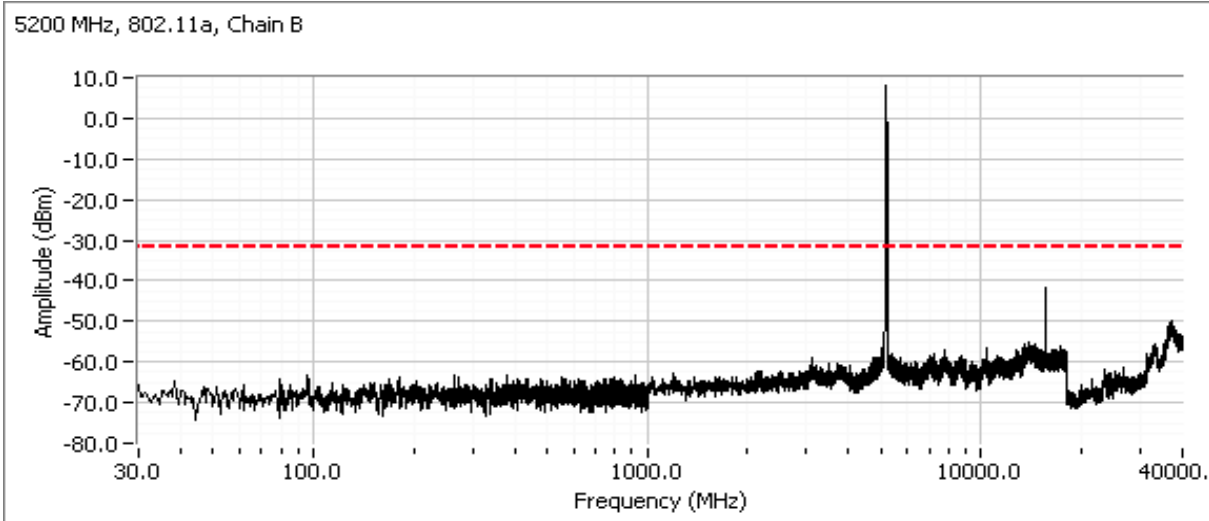

High channel, 5150 - 5250 MHz Band - 802.11a Mode

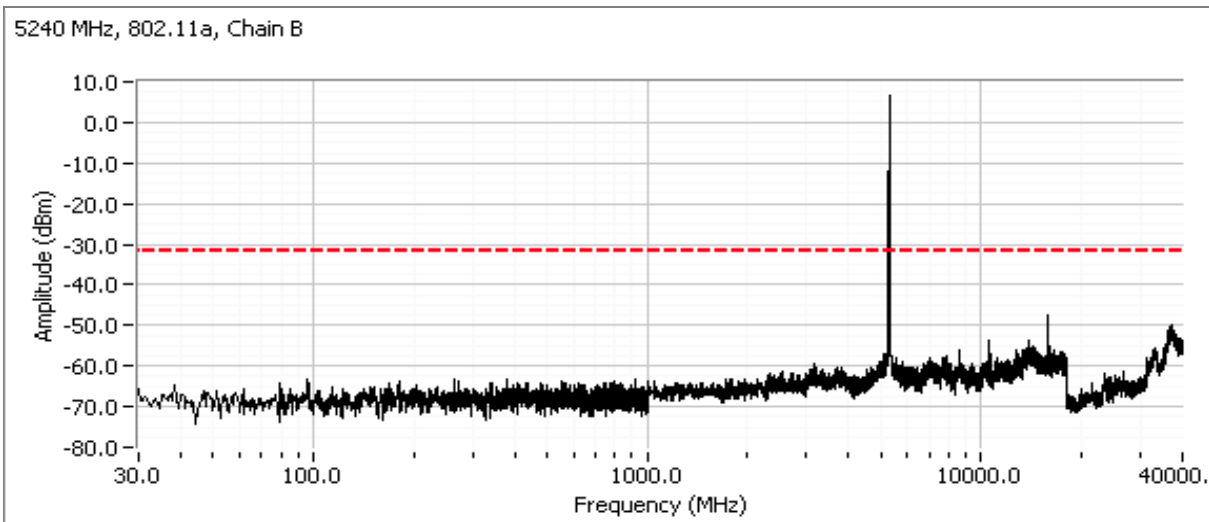

Client: Intel	Job Number: J88901
Model: Intel® Centrino® Advanced-N 6235	T-Log Number: T89578
	Account Manager: Christine Krebill
Contact: Steve Hackett	
Standard: FCC 15.247, 15.407, 15.209, RSS 210	Class: N/A

Low channel, 5250 - 5350 MHz Band - 802.11a Mode

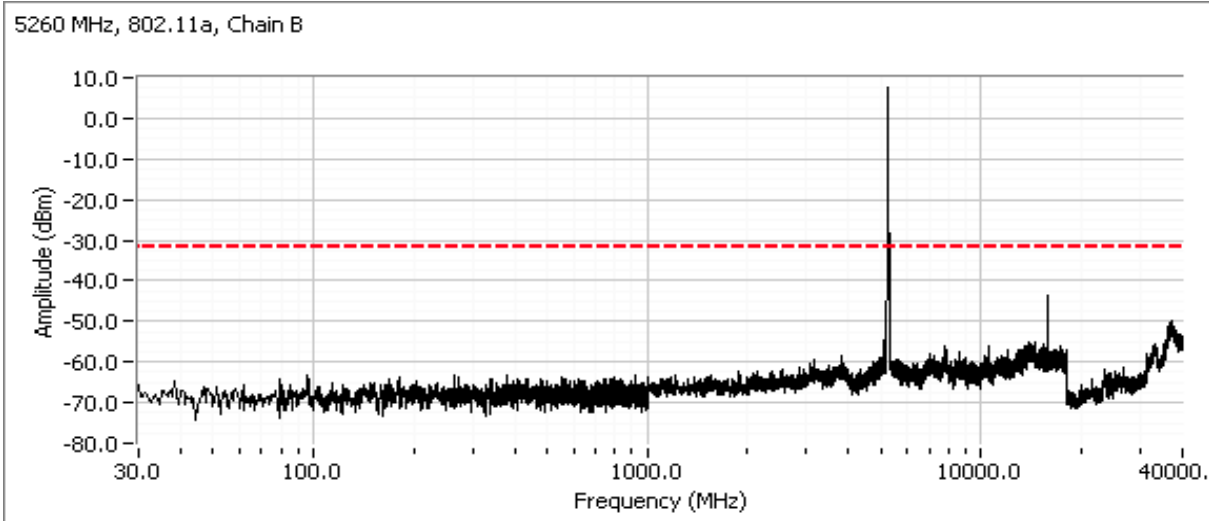

Center channel, 5250 - 5350 MHz Band - 802.11a Mode

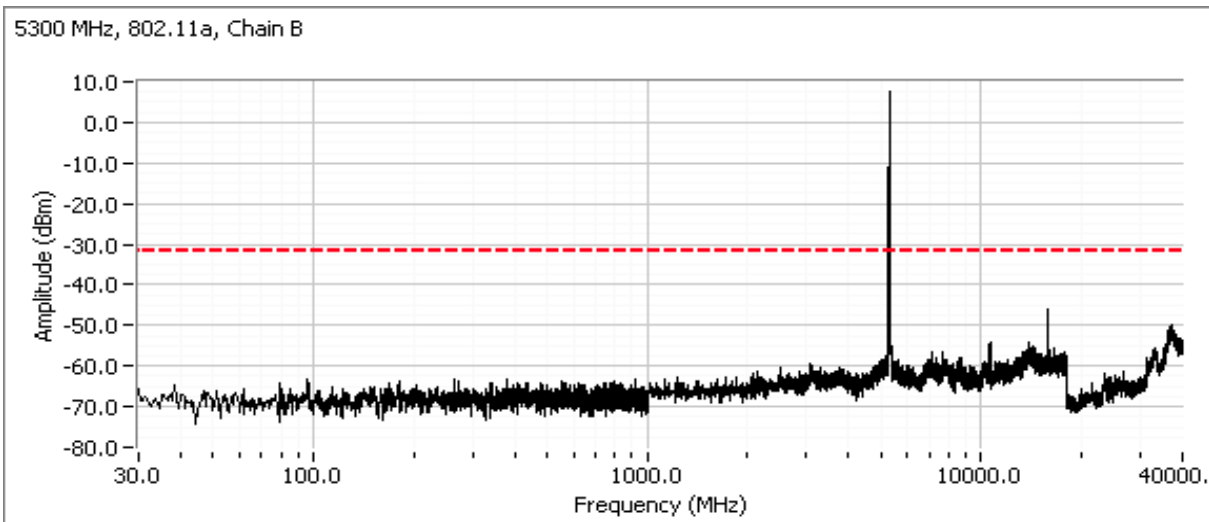

Client: Intel	Job Number: J88901
Model: Intel® Centrino® Advanced-N 6235	T-Log Number: T89578
	Account Manager: Christine Krebill
Contact: Steve Hackett	
Standard: FCC 15.247, 15.407, 15.209, RSS 210	Class: N/A

High channel, 5250 - 5350 MHz Band - 802.11a Mode

Compliance with the radiated limits for the restricted band immediately above 5350MHz is demonstrated through the radiated emissions tests.

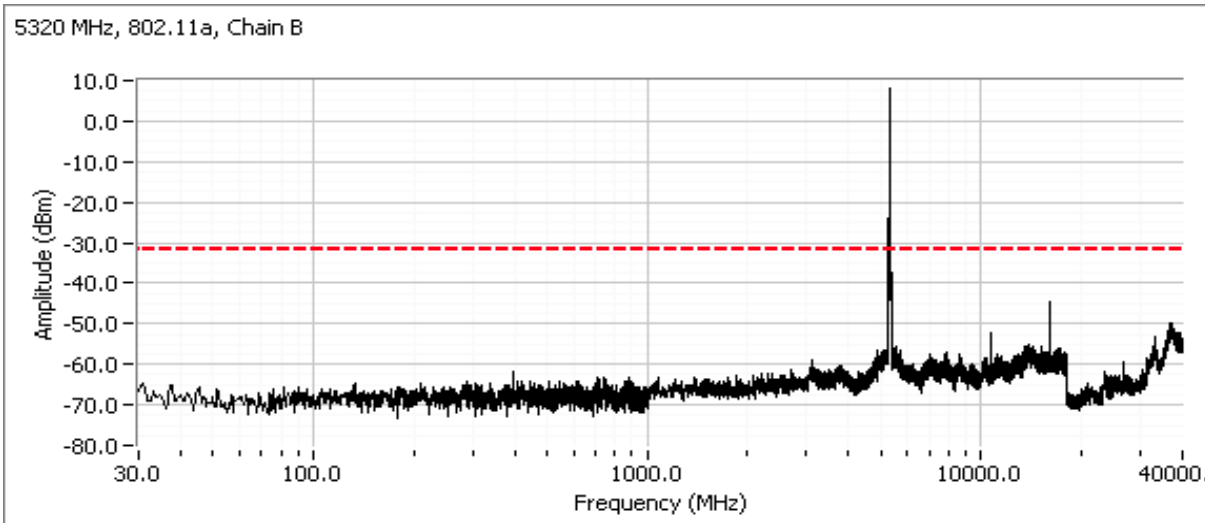

Low channel, 5470 - 5725 MHz Band - 802.11a Mode

Compliance with the radiated limits for the restricted band below 5460 MHz is demonstrated through the radiated emissions tests.

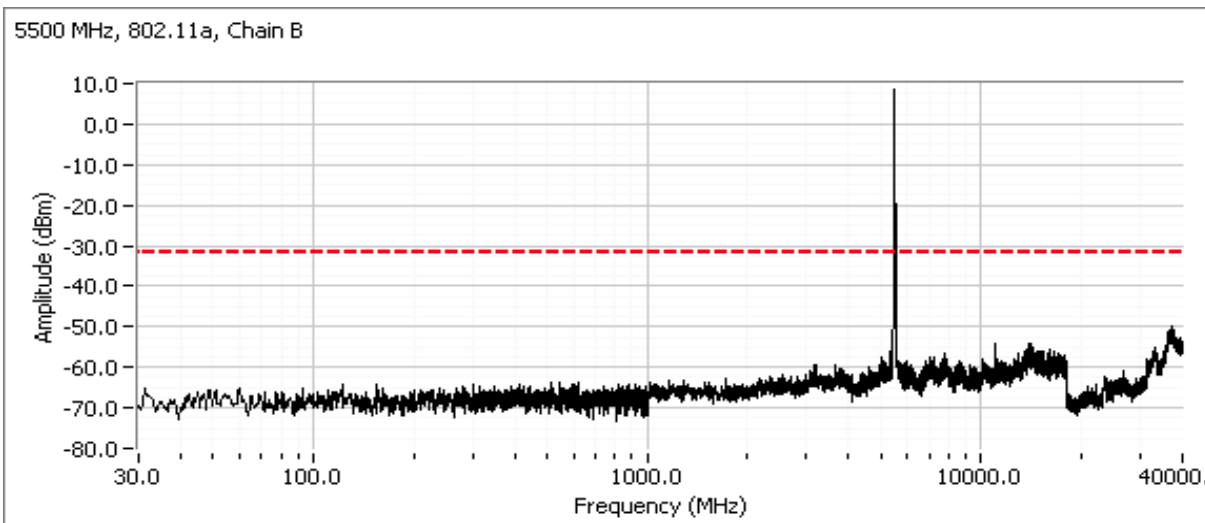

Client: Intel	Job Number: J88901
Model: Intel® Centrino® Advanced-N 6235	T-Log Number: T89578
	Account Manager: Christine Krebill
Contact: Steve Hackett	
Standard: FCC 15.247, 15.407, 15.209, RSS 210	Class: N/A

Center channel, 5470 - 5725 MHz Band - 802.11a Mode

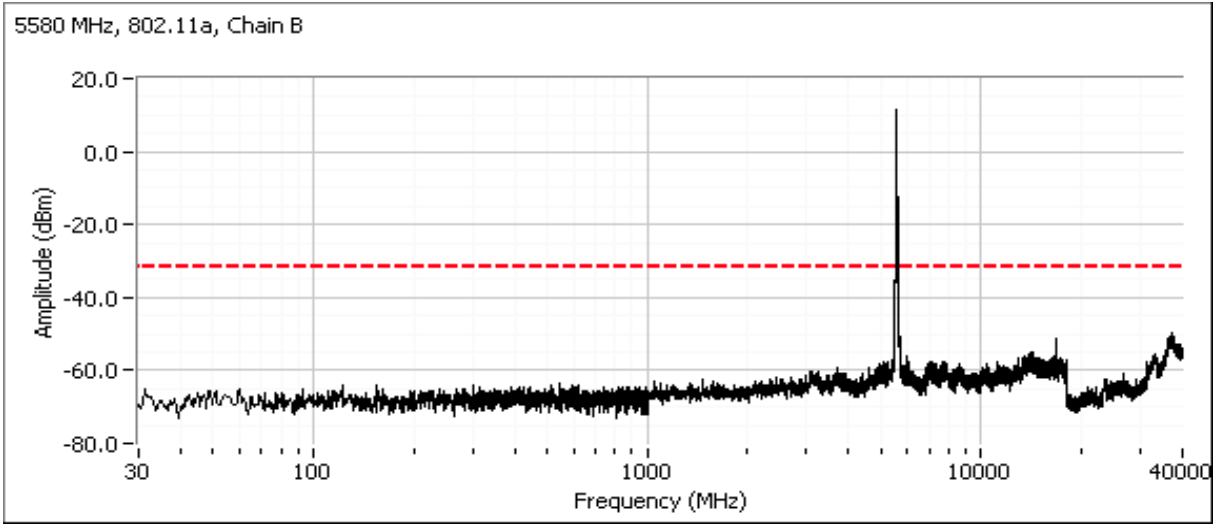

High channel, 5470 - 5725 MHz Band - 802.11a Mode

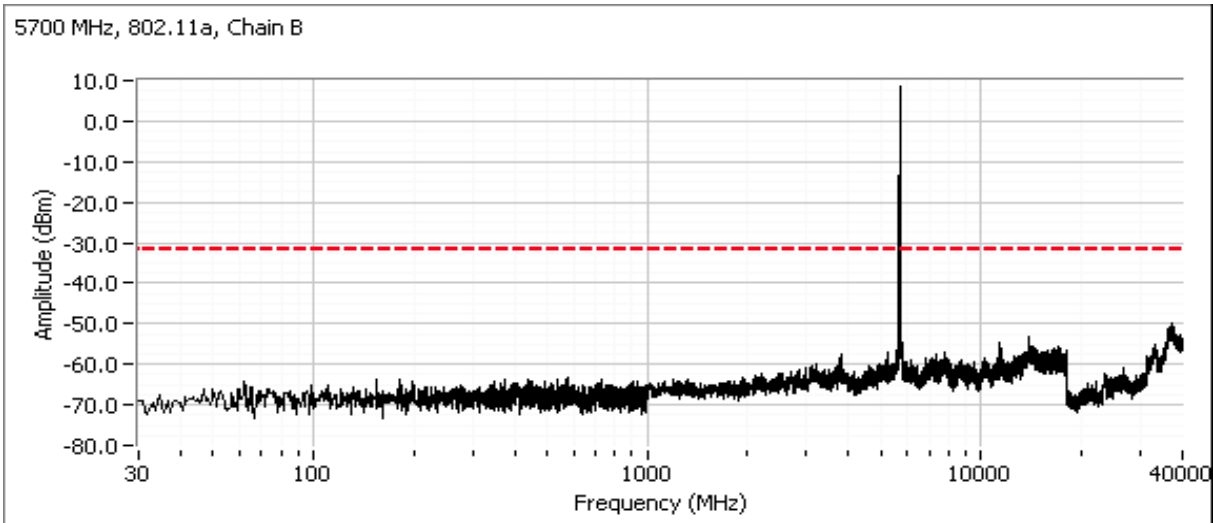

Client: Intel	Job Number: J88901
Model: Intel® Centrino® Advanced-N 6235	T-Log Number: T89578
	Account Manager: Christine Krebill
Contact: Steve Hackett	
Standard: FCC 15.247, 15.407, 15.209, RSS 210	Class: N/A

802.11n20 Mode

MIMO Devices: Antenna gain used is the effective gain calculated in the power section of this data sheet. The plots were obtained with a single chain transmitting and connected to the analyzer with the other chains terminated in 50 ohms.

Number of transmit chains: 2
 Maximum Antenna Gain: 4.8 dBi (worst case for all 3 bands)
 Spurious Limit: -27.0 dBm/MHz eirp
 Limit Used On Plots^{Note 1}: -34.8 dBm/MHz Peak Limit (RB=VB=1MHz)

Note 1: The -27dBm/MHz limit is an eirp limit. The limit for antenna port conducted measurements is adjusted to take into consideration the maximum antenna gain (limit = -27dBm - antenna gain). Radiated field strength measurements for signals more than 50MHz from the bands and that are close to the limit are made to determine compliance as the antenna gain is not known at these frequencies.

Plots Showing Out-Of-Band - 802.11n - 20MHz Mode Emissions (RBW=VBW=1MHz)

Low channel, 5150 - 5250 MHz Band - 802.11n - 20MHz Mode

Compliance with the radiated limits for the restricted band immediately below 5150MHz is demonstrated through the radiated emissions tests.

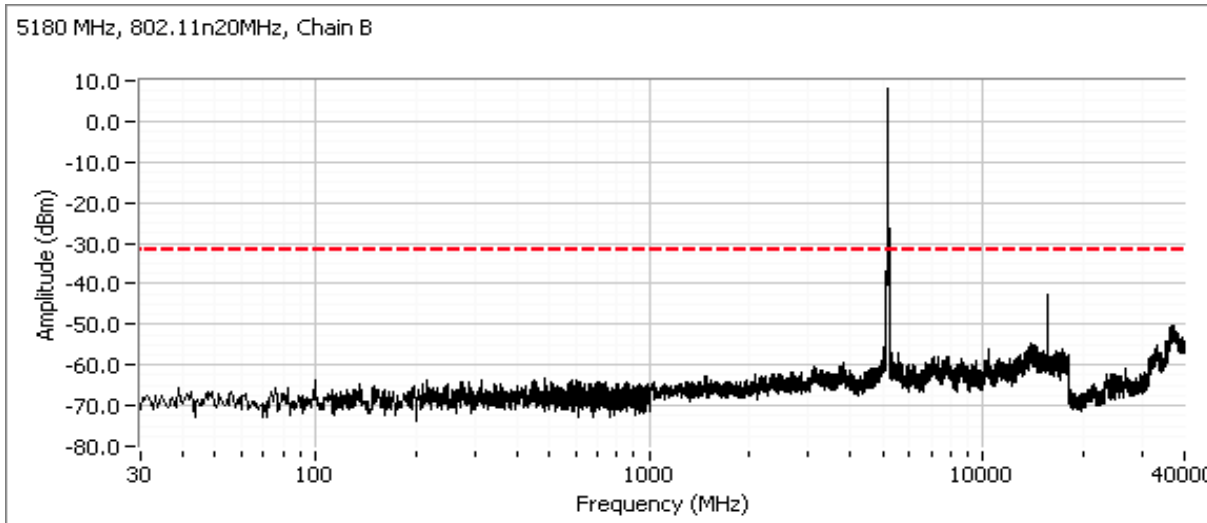

Client: Intel	Job Number: J88901
Model: Intel® Centrino® Advanced-N 6235	T-Log Number: T89578
	Account Manager: Christine Krebill
Contact: Steve Hackett	
Standard: FCC 15.247, 15.407, 15.209, RSS 210	Class: N/A

Center channel, 5150 - 5250 MHz Band - 802.11n - 20MHz Mode

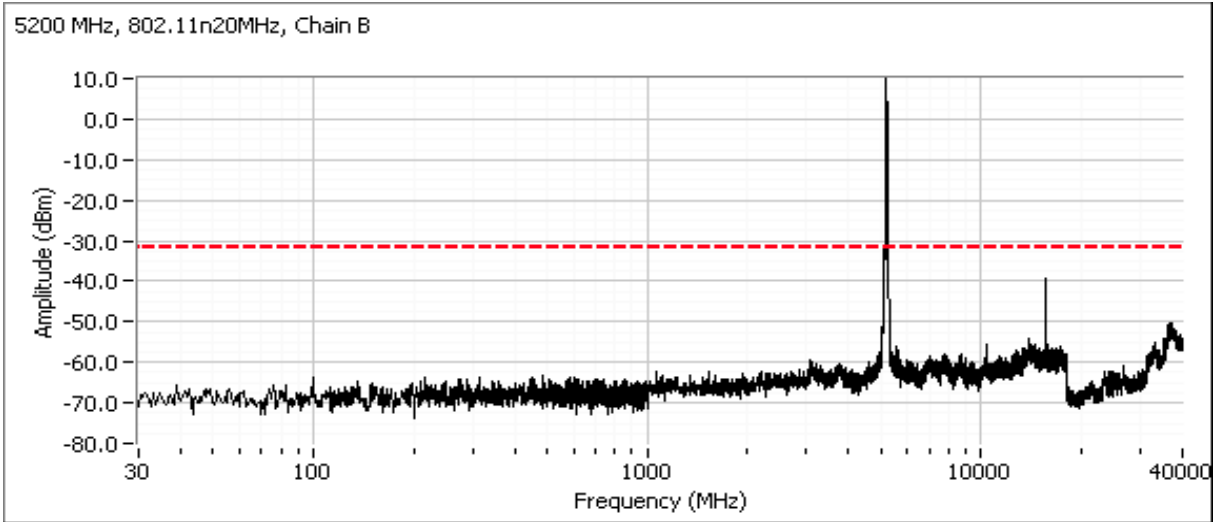

High channel, 5150 - 5250 MHz Band - 802.11n - 20MHz Mode

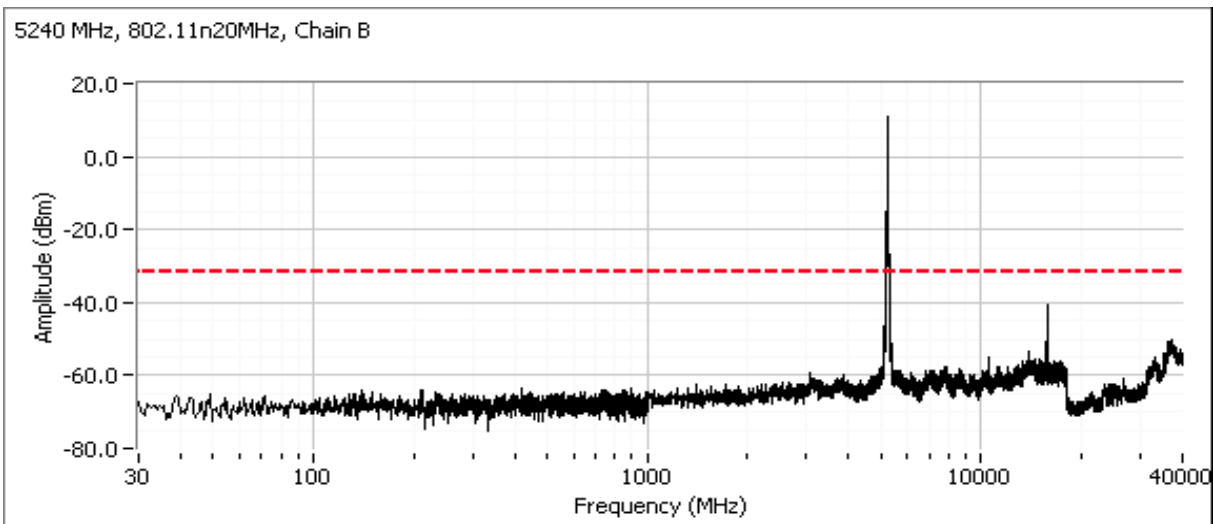

Client: Intel	Job Number: J88901
Model: Intel® Centrino® Advanced-N 6235	T-Log Number: T89578
	Account Manager: Christine Krebill
Contact: Steve Hackett	
Standard: FCC 15.247, 15.407, 15.209, RSS 210	Class: N/A

Low channel, 5250 - 5350 MHz Band - 802.11n - 20MHz Mode

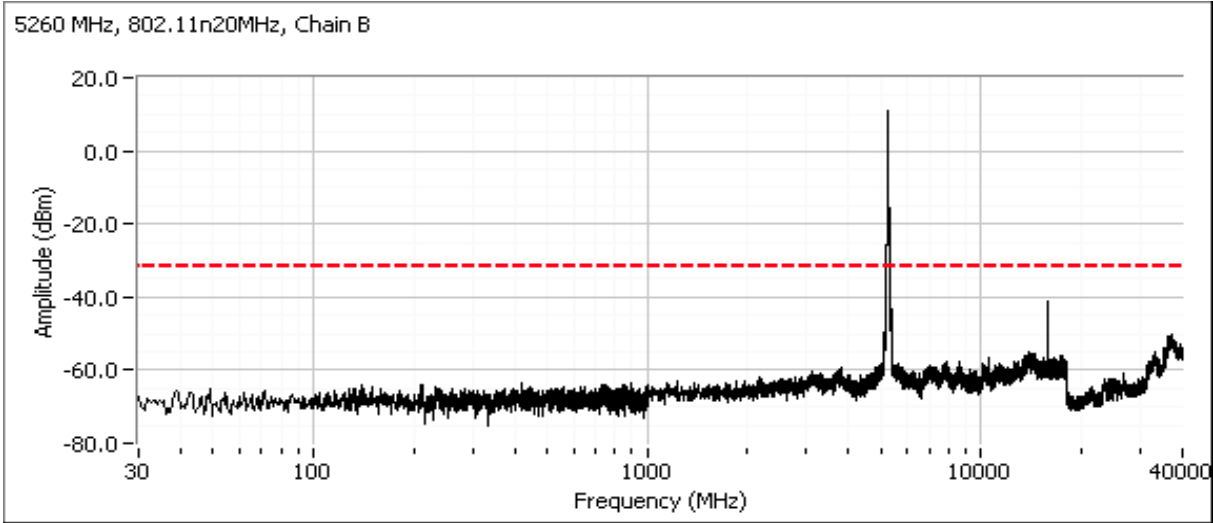

Center channel, 5250 - 5350 MHz Band - 802.11n - 20MHz Mode

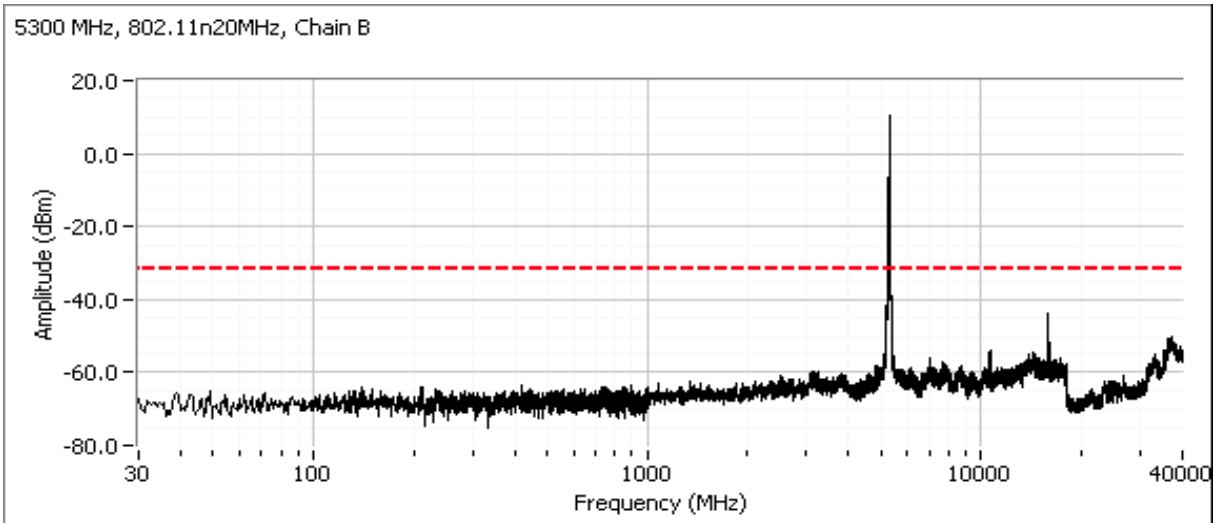

Client: Intel	Job Number: J88901
Model: Intel® Centrino® Advanced-N 6235	T-Log Number: T89578
	Account Manager: Christine Krebill
Contact: Steve Hackett	
Standard: FCC 15.247, 15.407, 15.209, RSS 210	Class: N/A

High channel, 5250 - 5350 MHz Band - 802.11n - 20MHz Mode

Compliance with the radiated limits for the restricted band immediately above 5350MHz is demonstrated through the radiated emissions tests.

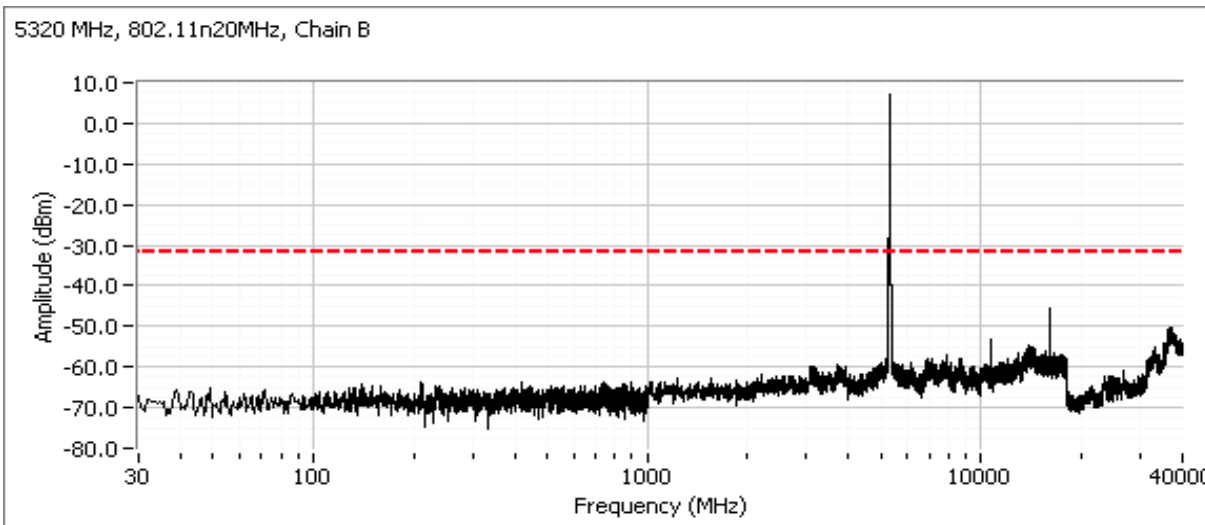

Low channel, 5470 - 5725 MHz Band - 802.11n - 20MHz Mode

Compliance with the radiated limits for the restricted band below 5460 MHz is demonstrated through the radiated emissions tests.

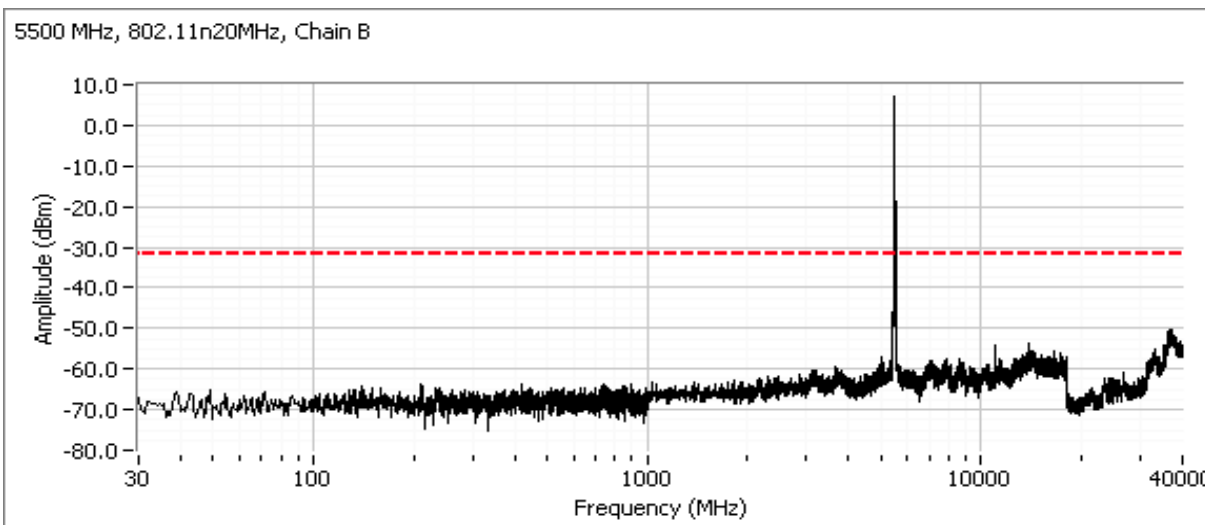

Client: Intel	Job Number: J88901
Model: Intel® Centrino® Advanced-N 6235	T-Log Number: T89578
	Account Manager: Christine Krebill
Contact: Steve Hackett	
Standard: FCC 15.247, 15.407, 15.209, RSS 210	Class: N/A

Center channel, 5470 - 5725 MHz Band - 802.11n - 20MHz Mode

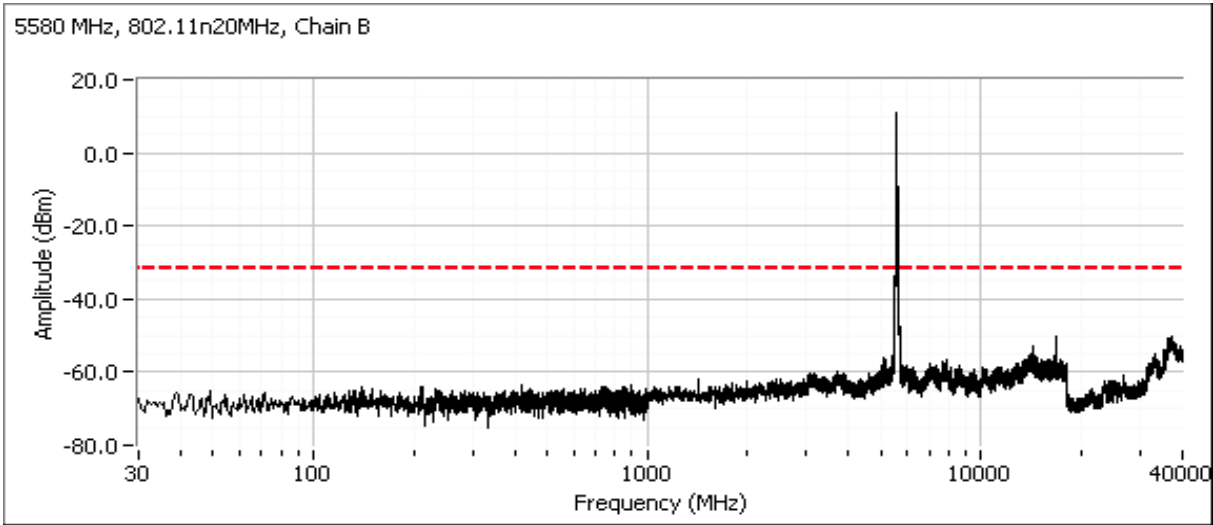

High channel, 5470 - 5725 MHz Band - 802.11n - 20MHz Mode

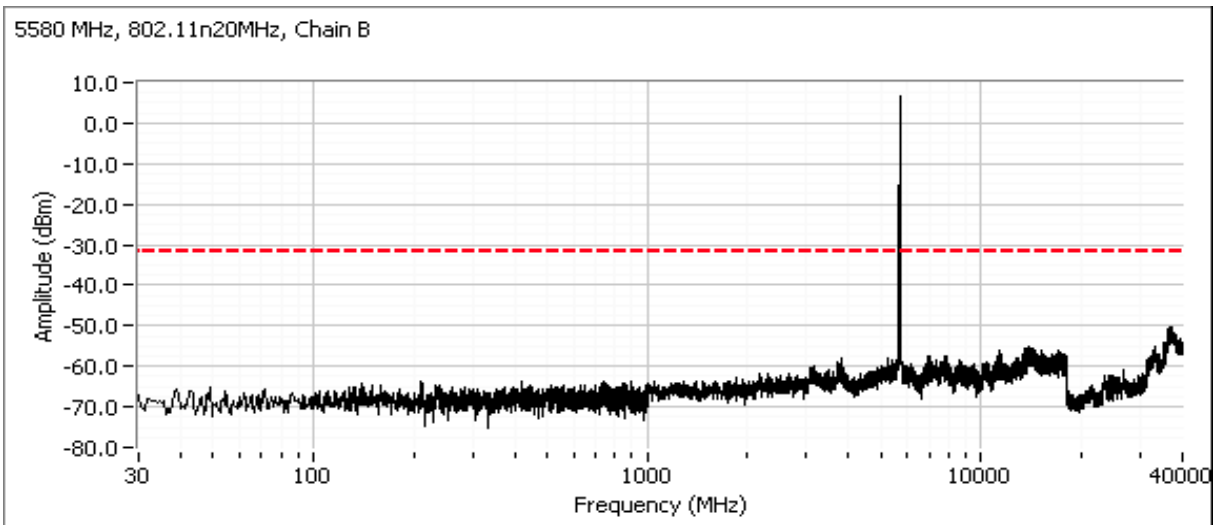

Client: Intel	Job Number: J88901
Model: Intel® Centrino® Advanced-N 6235	T-Log Number: T89578
	Account Manager: Christine Krebill
Contact: Steve Hackett	
Standard: FCC 15.247, 15.407, 15.209, RSS 210	Class: N/A

802.11n40 Mode

MIMO Devices: Antenna gain used is the effective gain calculated in the power section of this data sheet. The plots were obtained with a single chain transmitting and connected to the analyzer with the other chains terminated in 50 ohms.

Number of transmit chains: 2
 Maximum Antenna Gain: 4.8 dBi (worst case for all 3 bands)
 Spurious Limit: -27.0 dBm/MHz eirp
 Limit Used On Plots ^{Note 1}: -34.8 dBm/MHz Peak Limit (RB=VB=1MHz)

Note 1: The -27dBm/MHz limit is an eirp limit. The limit for antenna port conducted measurements is adjusted to take into consideration the maximum antenna gain (limit = -27dBm - antenna gain). Radiated field strength measurements for signals more than 50MHz from the bands and that are close to the limit are made to determine compliance as the antenna gain is not known at these frequencies.

Plots Showing Out-Of-Band - 802.11n - 40MHz Mode Emissions (RBW=VBW=1MHz)

Low channel, 5150 - 5250 MHz Band - 802.11n - 40MHz Mode

Compliance with the radiated limits for the restricted band immediately below 5150MHz is demonstrated through the radiated emissions tests.

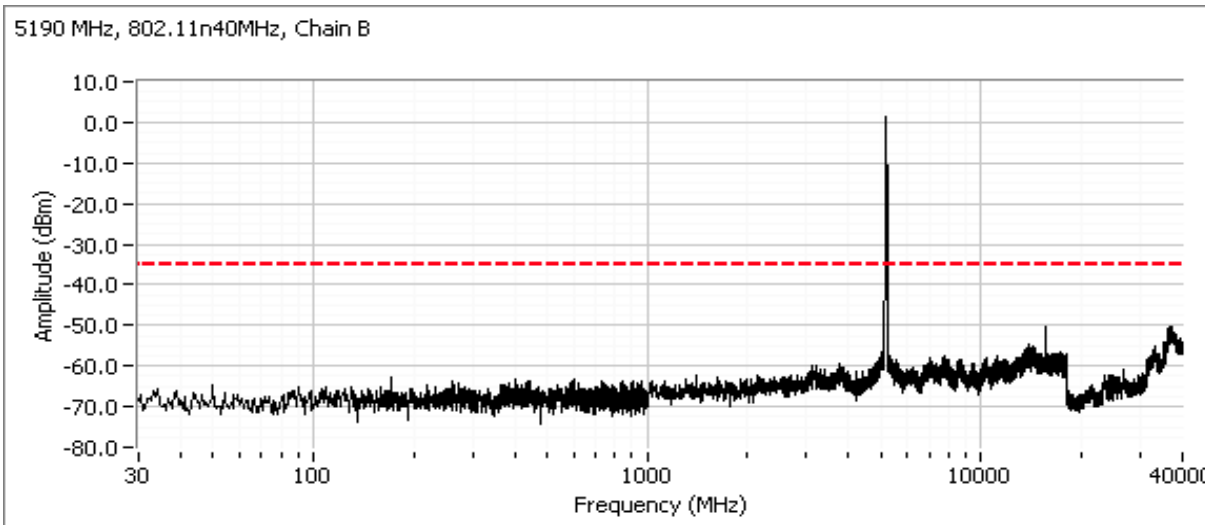

Client: Intel	Job Number: J88901
Model: Intel® Centrino® Advanced-N 6235	T-Log Number: T89578
	Account Manager: Christine Krebill
Contact: Steve Hackett	
Standard: FCC 15.247, 15.407, 15.209, RSS 210	Class: N/A

High channel, 5150 - 5250 MHz Band - 802.11n - 40MHz Mode

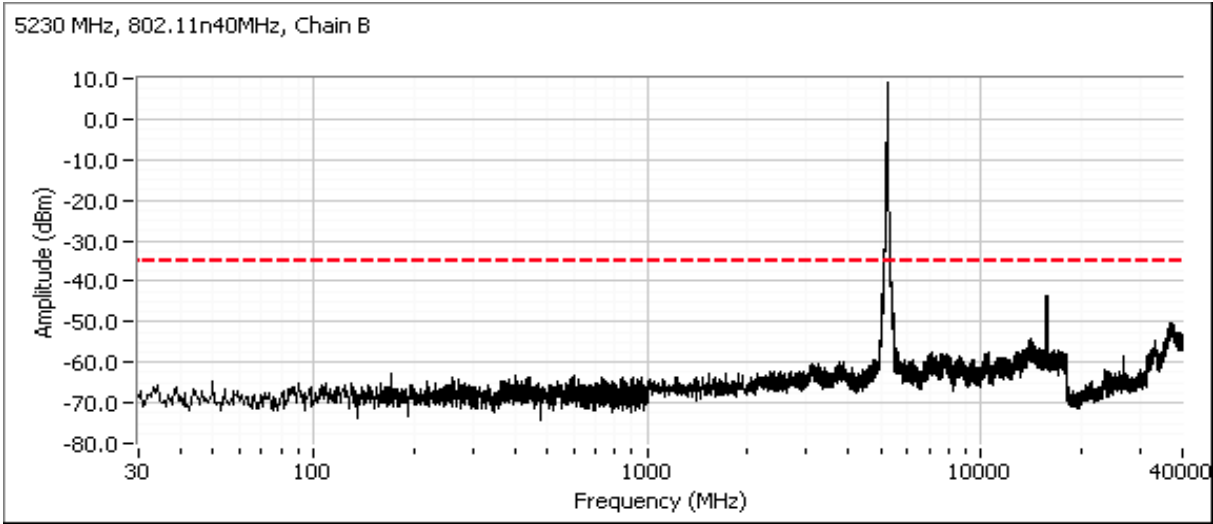

Low channel, 5250 - 5350 MHz Band - 802.11n - 40MHz Mode

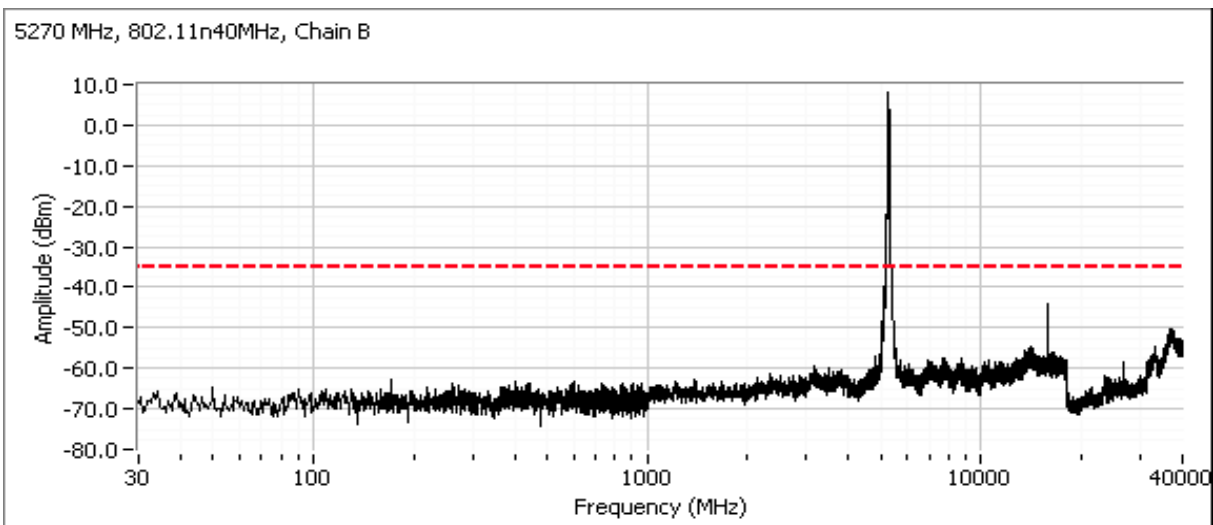

Client: Intel	Job Number: J88901
Model: Intel® Centrino® Advanced-N 6235	T-Log Number: T89578
	Account Manager: Christine Krebill
Contact: Steve Hackett	
Standard: FCC 15.247, 15.407, 15.209, RSS 210	Class: N/A

High channel, 5250 - 5350 MHz Band - 802.11n - 40MHz Mode

Compliance with the radiated limits for the restricted band immediately above 5350MHz is demonstrated through the radiated emissions tests.

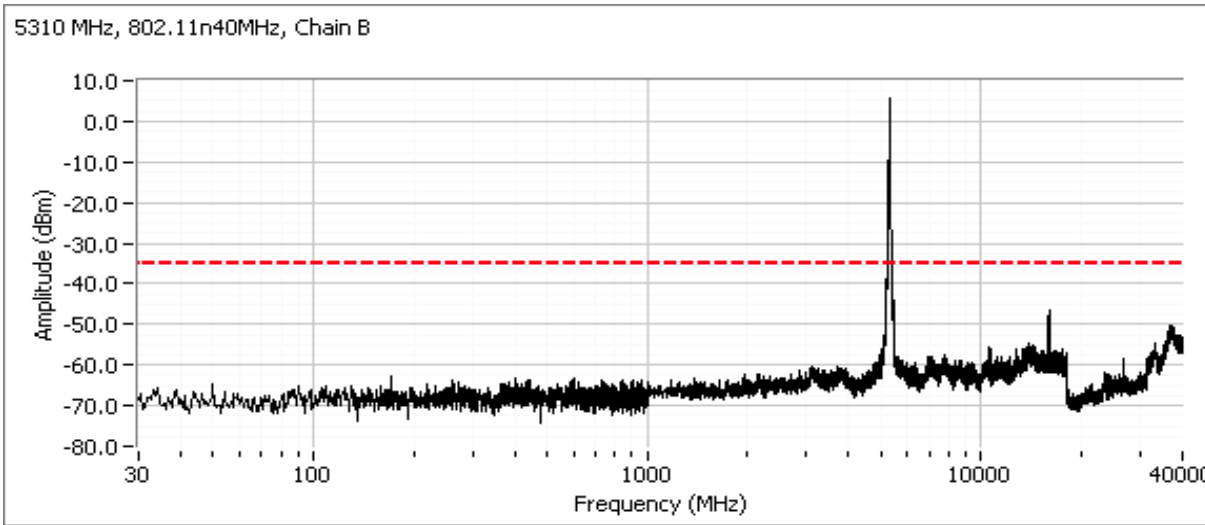

Low channel, 5470 - 5725 MHz Band - 802.11n - 40MHz Mode

Compliance with the radiated limits for the restricted band below 5460 MHz is demonstrated through the radiated emissions tests.

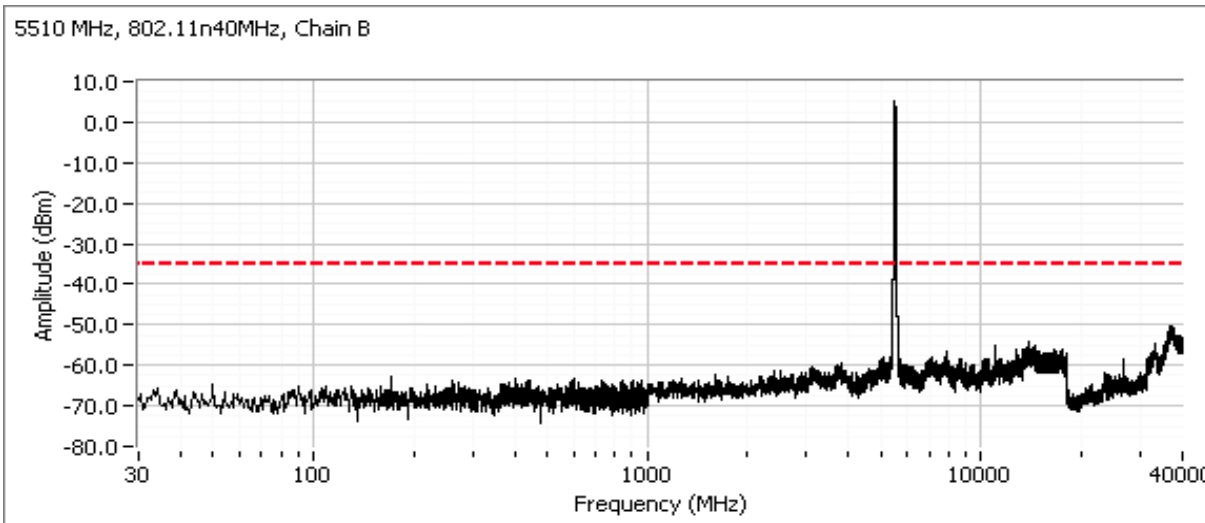

Client: Intel	Job Number: J88901
Model: Intel® Centrino® Advanced-N 6235	T-Log Number: T89578
	Account Manager: Christine Krebill
Contact: Steve Hackett	
Standard: FCC 15.247, 15.407, 15.209, RSS 210	Class: N/A

Center channel, 5470-5725MHz Band - 802.11n 40MHz Mode

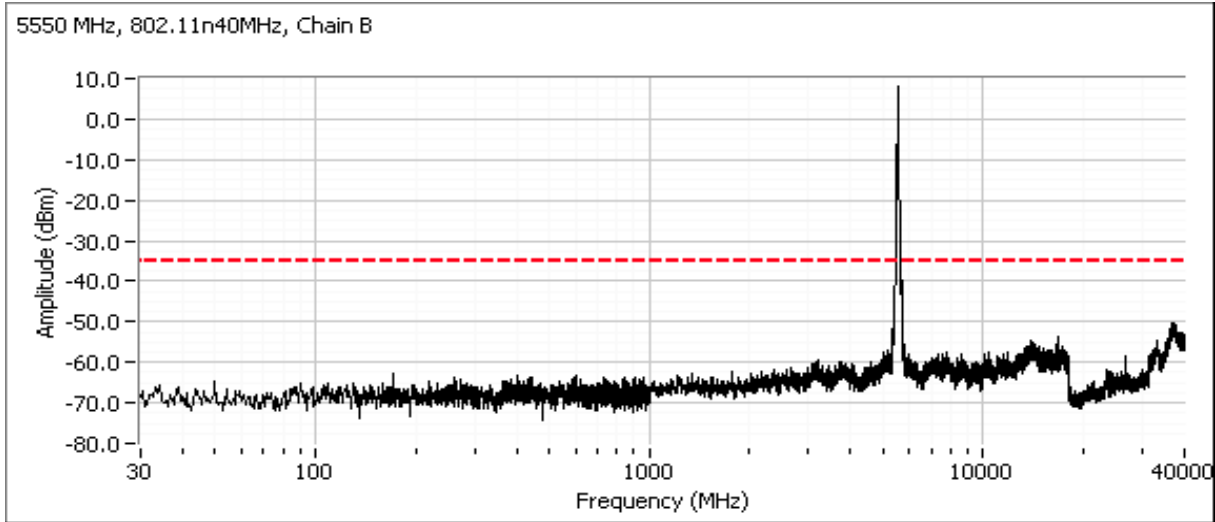

High channel, 5470 - 5725 MHz Band - 802.11n - 40MHz Mode

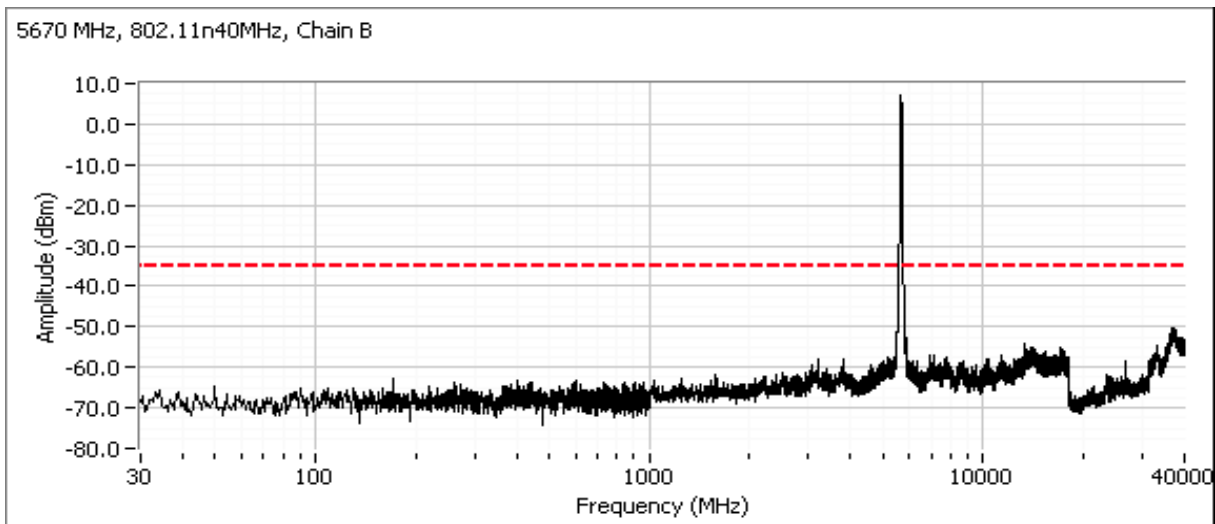

Client: Intel	Job Number: J88901
Model: Intel® Centrino® Advanced-N 6235	T-Log Number: T89578
	Account Manager: Christine Krebill
Contact: Steve Hackett	
Standard: FCC 15.247, 15.407, 15.209, RSS 210	Class: N/A

RSS-210 (LELAN) and FCC 15.407(UNII) Antenna Port Measurements - MIMO Mode (Chain A + B) Power, PSD, Peak Excursion, Bandwidth and Spurious Emissions

Test Specific Details

Objective: The objective of this test session is to perform final qualification testing of the EUT with respect to the specification listed above.

Date of Test: 1/4/2013
Test Engineer: J. Cadigal
Test Location: Lab #4A

Config. Used: 1
Config Change: -
Host Unit Voltage 120V/60Hz

Summary of Results

MAC Address: 001500B50432 DRTU Tool Version 1.5.6-0445 Driver version 15.3.1.2

Run #	Test Performed	Limit	Pass / Fail	Result / Margin
1	Power, 5150 - 5250MHz	15.407(a) (1), (2)	Pass	802.11n20: 38 mW 802.11n40: 37 mW
1	PSD, 5150 - 5250MHz	15.407(a) (1), (2)	Pass	802.11n20: 2.7 dBm/MHz 802.11n40: 0.4 dBm/MHz
1	Power, 5250 - 5350MHz	15.407(a) (1), (2)	Pass	802.11n20: 37 mW 802.11n40: 34 mW
1	PSD, 5250 - 5350MHz	15.407(a) (1), (2)	Pass	802.11n20: 6.6 dBm/MHz 802.11n40: 4.0 dBm/MHz
1	Power, 5470 - 5725MHz	15.407(a) (1), (2)	Pass	802.11n20: 45 mW 802.11n40: 40 mW
1	PSD, 5470 - 5725MHz	15.407(a) (1), (2)	Pass	802.11n20: 6.5 dBm/MHz 802.11n40: 4.0 dBm/MHz
1	26dB Bandwidth	15.407 (Information only)	-	> 20MHz for all modes (refer to single chain data)
1	99% Bandwidth	RSS 210 (Information only)	N/A	Refer to single chain data
2	Peak Excursion Envelope	15.407(a) (6) 13dB		Refer to single chain data
3	Antenna Conducted - Out of Band Spurious	15.407(b) -27dBm/MHz		Refer to single chain data

General Test Configuration

When measuring the conducted emissions from the EUT's antenna port, the antenna port of the EUT was connected to the spectrum analyzer or power meter via a suitable attenuator to prevent overloading the measurement system. All measurements are corrected to allow for the external attenuators and cables used.



EMC Test Data

Client: Intel	Job Number: J88901
Model: Intel® Centrino® Advanced-N 6235	T-Log Number: T89578
	Account Manager: Christine Krebill
Contact: Steve Hackett	
Standard: FCC 15.247, 15.407, 15.209, RSS 210	Class: N/A

Ambient Conditions:

Temperature: 20-23 °C
 Rel. Humidity: 35-40 %

Modifications Made During Testing

No modifications were made to the EUT during testing

Deviations From The Standard

No deviations were made from the requirements of the standard.

Run #1: Bandwidth, Output Power and Power Spectral Density - MIMO Systems

Note 1:	Output power measured using a spectrum analyzer (see plots below). RBW=1MHz, VB=3 MHz, # of points in sweep $\geq 2 \times \text{span} / \text{RBW}$, RMS detector, power averaging on (transmitted signal was continuous) and power integration over 50 MHz for 20dB bandwidth and 80 MHz for 40dB bandwidth (method SA-1 of KDB 789033).
Note 2:	Measured using the same analyzer settings used for output power.
Note 3:	For RSS-210 the limit for the 5150 - 5250 MHz band accounts for the antenna gain as the maximum eirp allowed is 10dBm/MHz. The limits are also corrected for instances where the highest measured value of the PSD exceeds the average PSD (calculated from the measured power divided by the measured 99% bandwidth) by more than 3dB by the amount that the measured value exceeds the average by more than 3dB.
Note 4:	99% Bandwidth measured in accordance with RSS GEN - RB > 1% of span and VB $\geq 3 \times \text{RB}$
Note 5:	For MIMO systems the total output power and total PSD are calculated from the sum of the powers of the individual chains (in linear terms). The antenna gain used to determine the EIRP and limits for PSD/Output power depends on the operating mode of the MIMO device. If the signals are non-coherent between the transmit chains then the gain used to determine the limits is the highest gain of the individual chains and the EIRP is the sum of the products of gain and power on each chain. If the signals are coherent then the effective antenna gain is the sum (in linear terms) of the gains for each chain and the EIRP is the product of the effective gain and total power.



EMC Test Data

Client: Intel	Job Number: J88901
Model: Intel® Centrino® Advanced-N 6235	T-Log Number: T89578
	Account Manager: Christine Krebill
Contact: Steve Hackett	
Standard: FCC 15.247, 15.407, 15.209, RSS 210	Class: N/A

MIMO Device - 5150-5250 MHz Band							
	Chain A	Chain B	Chain C	Coherent	Effective ⁵	EIRP (mW)	EIRP (dBm)
Antenna Gain (dBi):	3.6	3.6		No	3.6	86.6	19.4

Power (EBW = 26dB BW)										
Frequency (MHz)	Software Setting	26dB BW (MHz)	Measured Output Power ¹ dBm			Total		Limit (dBm)	Max Power (W)	Pass or Fail
			Chain A	Chain B	Chain C	mW	dBm			

20MHz Mode										
5180	28,31	38.5	12.7	12.9		37.8	15.8	17.0	0.038	PASS
5200	28,31	43.3	12.5	12.5		35.6	15.5	17.0		PASS
5240	29,31	49.5	12.8	12.5		37.1	15.7	17.0		PASS

40MHz Mode										
5190	30,32	57.7	12.9	12.6		37.5	15.7	17.0	0.037	PASS
5230	30,32	98.2	12.9	12.5		37.1	15.7	17.0		PASS

PSD										
Frequency (MHz)	99% ⁴ BW	Total Power	PSD ² dBm/MHz			Total PSD		Limit		Pass or Fail
			Chain A	Chain B	Chain C	mW/MHz	dBm/MHz	FCC	RSS 210 ³	

20MHz Mode										
5180	18.0	15.8	-0.4	-0.3		1.8	2.7	4.0	6.4	PASS
5200	18.4	15.5	-0.5	-0.7		1.7	2.4	4.0	6.4	PASS
5240	18.2	15.7	-0.3	-0.5		1.8	2.6	4.0	6.4	PASS

40MHz Mode										
5190	36.6	15.7	-2.4	-2.9		1.1	0.4	4.0	6.4	PASS
5230	36.6	15.7	-2.6	-3.0		1.0	0.2	4.0	6.4	PASS

Where 99% bandwidth is less than 20 MHz, RSS 210 limits total power thus the limit is recalculated below.

20MHz Mode		99% BW			RSS 210					
5180	28,31	18.0	12.7	12.9		37.8	15.8	16.6	0.038	PASS
5200	28,31	18.4	12.5	12.5		35.6	15.5	16.6		PASS
5240	29,31	18.2	12.8	12.5		37.1	15.7	16.6		PASS



EMC Test Data

Client: Intel	Job Number: J88901
Model: Intel® Centrino® Advanced-N 6235	T-Log Number: T89578
	Account Manager: Christine Krebill
Contact: Steve Hackett	
Standard: FCC 15.247, 15.407, 15.209, RSS 210	Class: N/A

MIMO Device - 5250-5350 MHz Band

	Chain A	Chain B	Chain C	Coherent	Effective ⁵	EIRP (mW)	EIRP (dBm)
Antenna Gain (dBi):	3.7	3.7		No	3.7	87.2	19.4

Power

Frequency (MHz)	Software Setting	26dB BW (MHz)	Measured Output Power ¹ dBm			Total		Limit (dBm)	Max Power (W)	Pass or Fail
			Chain A	Chain B	Chain C	mW	dBm			

20MHz Mode

5260	36,39	55.0	12.8	11.3		32.7	15.1	24.0	0.037	PASS
5300	36,39	43.0	12.8	11.9		34.3	15.4	24.0		PASS
5320	36.5,39	40.8	13.1	12.3		37.2	15.7	24.0		PASS

40MHz Mode

5270	37,39	93.7	13.3	11.0		34.1	15.3	24.0	0.034	PASS
5310	31,34.5	55.2	10.2	10.0		20.4	13.1	24.0		PASS

PSD

Frequency (MHz)	99% ⁴ BW	Total Power	PSD ² dBm/MHz			Total PSD		Limit		Pass or Fail
			Chain A	Chain B	Chain C	mW/MHz	dBm/MHz	FCC	RSS 210 ³	

20MHz Mode

5260	29.0	15.1	-1.6	-1.9		1.3	1.3	11.0	11.0	PASS
5300	28.9	15.4	-0.4	-1.2		1.7	2.2	11.0	11.0	PASS
5320	28.6	15.7	0.2	-0.5		1.9	2.9	11.0	11.0	PASS

40MHz Mode

5270	52.1	15.3	-2.3	-4.4		1.0	-0.2	11.0	11.0	PASS
5310	36.9	13.1	-5.0	-5.5		0.6	-2.2	11.0	11.0	PASS



EMC Test Data

Client: Intel	Job Number: J88901
Model: Intel® Centrino® Advanced-N 6235	T-Log Number: T89578
	Account Manager: Christine Krebill
Contact: Steve Hackett	
Standard: FCC 15.247, 15.407, 15.209, RSS 210	Class: N/A

MIMO Device - 5470-5725 MHz Band

	Chain A	Chain B	Chain C	Coherent	Effective ⁵	EIRP (mW)	EIRP (dBm)
Antenna Gain (dBi):	4.8	4.8		No	4.8	136.1	21.3

Power

Frequency (MHz)	Software Setting	26dB BW (MHz)	Measured Output Power ¹ dBm			Total		Limit (dBm)	Max Power (W)	Pass or Fail
			Chain A	Chain B	Chain C	mW	dBm			

20MHz Mode

5500	34,39	26.0	11.9	11.8		30.5	14.8	24.0	0.045	PASS
5580	38,39	26.0	13.4	13.7		45.1	16.5	24.0		PASS
5660	26,26	26.0	10.5	11.0		23.8	13.8	24.0		PASS
5700	36.5,37	26.0	11.6	12.4		31.9	15.0	24.0		PASS

40MHz Mode

5510	29.5,29.5	56.5	8.1	8.1		12.9	11.1	24.0	0.040	PASS
5550	37.5,38.5	97.2	12.6	13.4		39.8	16.0	24.0		PASS
5670	26,28	65.1	10.2	11.0		23.1	13.6	24.0		PASS

PSD

Frequency (MHz)	99% ⁴ BW	Total Power	PSD ² dBm/MHz			Total PSD		Limit		Pass or Fail
			Chain A	Chain B	Chain C	mW/MHz	dBm/MHz	FCC	RSS 210 ³	

20MHz Mode

5500	18.6	14.8	-1.2	-1.2		1.5	1.8	11.0	11.0	PASS
5580	25.6	16.5	0.2	0.6		2.2	3.4	11.0	11.0	PASS
5700	19.6	15.0	-1.3	-0.6		1.6	2.1	11.0	11.0	PASS

40MHz Mode

5510	36.2	11.1	-7.3	-7.3		0.4	-4.3	11.0	11.0	PASS
5550	45.9	16.0	-2.6	-2.0		1.2	0.7	11.0	11.0	PASS
5670	44.6	13.6	-0.5	-4.0		1.3	1.1	11.0	10.0	PASS



EMC Test Data

Client:	Intel	Job Number:	J88901
Model:	Intel® Centrino® Advanced-N 6235	T-Log Number:	T89578
Contact:	Steve Hackett	Account Manager:	Christine Krebill
Standard:	FCC 15.247, 15.407, 15.209, RSS 210	Class:	N/A

RSS 210 and FCC 15.407 (UNII) Radiated Spurious Emissions

Test Specific Details

Objective: The objective of this test session is to perform final qualification testing of the EUT with respect to the specification listed above.

General Test Configuration

The EUT and all local support equipment were located on the turntable for radiated spurious emissions testing. For radiated emissions testing the measurement antenna was located 3 meters from the EUT.

Ambient Conditions:

Temperature: 19 °C
Rel. Humidity: 44 %

Summary of Results

MAC Address: 001500B50405 DRTU Tool Version 1.5.6-0445 Driver version 15.3.1.2

Run #	Mode	Channel	Target Power	Measured Power	Test Performed	Limit	Result / Margin
Run # 1	802.11a Chain A	#36 5180MHz	14.5	13.1	Restricted Band Edge at 5150 MHz	15.209	52.5 dBµV/m @ 5150.0 MHz (-1.5 dB)
		#64 5320MHz	16.5	13.8	Restricted Band Edge at 5350 MHz	15.209	52.5 dBµV/m @ 5350.0 MHz (-1.5 dB)
		#100 5500MHz	16.0	13.6	Restricted Band Edge at 5460 MHz	15.209	52.9 dBµV/m @ 5459.9 MHz (-1.1 dB)
				13.6	Band Edge at 5470 MHz	15 E	67.1 dBµV/m @ 5469.0 MHz (-1.2 dB)
	#140 5700MHz	16.0	13.0	Band Edge at 5725 MHz	15 E	67.0 dBµV/m @ 5727.6 MHz (-1.3 dB)	
Run # 2	802.11n20 Chain A	#36 5180MHz	14.5	13.1	Restricted Band Edge at 5150 MHz	15.209	52.8 dBµV/m @ 5150.0 MHz (-1.2 dB)
		#64 5320MHz	16.5	13.5	Restricted Band Edge at 5350 MHz	15.209	52.3 dBµV/m @ 5350.0 MHz (-1.7 dB)
		#100 5500MHz	16.5	14.4	Restricted Band Edge at 5460 MHz	15.209	52.8 dBµV/m @ 5470.0 MHz (-1.2 dB)
				13.5	Band Edge at 5470 MHz	15 E	52.8 dBµV/m @ 5470.0 MHz (-1.2 dB)
	#140 5700MHz	16.0	12.2	Band Edge at 5725 MHz	15 E	65.7 dBµV/m @ 5725.4 MHz (-2.6 dB)	



EMC Test Data

Client:	Intel	Job Number:	J88901
Model:	Intel® Centrino® Advanced-N 6235	T-Log Number:	T89578
Contact:	Steve Hackett	Account Manager:	Christine Krebill
Standard:	FCC 15.247, 15.407, 15.209, RSS 210	Class:	N/A

Run #	Mode	Channel	Target Power	Measured Power	Test Performed	Limit	Result / Margin
Run # 3	802.11n40 Chain A	#38 5190MHz	11.5	10.2	Restricted Band Edge at 5150 MHz	15.209	52.9 dBµV/m @ 5150.0 MHz (-1.1 dB)
		#62 5310MHz	11.5	10.1	Restricted Band Edge at 5350 MHz	15.209	52.7 dBµV/m @ 5350.0 MHz (-1.3 dB)
		#102 5510MHz	14.5	10.7	Restricted Band Edge at 5460 MHz	15.209	52.1 dBµV/m @ 5460.0 MHz (-1.9 dB)
				10.7	Band Edge at 5470 MHz	15 E	68.2 dBµV/m @ 5469.2 MHz (-0.1 dB)
#134 5670MHz	16.0	14.4	Band Edge at 5725 MHz	15 E	68.0 dBµV/m @ 5725.1 MHz (-0.3 dB)		

Modifications Made During Testing

No modifications were made to the EUT during testing

Deviations From The Standard

No deviations were made from the requirements of the standard.

Test Procedure Comments:

Unless otherwise noted, average measurements above 1GHz were performed as documented in FCC KDB 789033 G) 6) d) Method VB

Note - the target and measured power are average powers (measured with average power sensor) and are used for reference purposes only. Power is set using " GAIN CONTROL" mode in the DRTU tool.

Antenna: connected
Duty Cycle: 99%



EMC Test Data

Client: Intel	Job Number: J88901
Model: Intel® Centrino® Advanced-N 6235	T-Log Number: T89578
	Account Manager: Christine Krebill
Contact: Steve Hackett	
Standard: FCC 15.247, 15.407, 15.209, RSS 210	Class: N/A

Run # 1, Band Edge Field Strength - 802.11a, Chain A
 Run # 1a, EUT on Channel #36 5180MHz

Date of Test: 12/7/2012
 Test Engineer: John Caizzi

Test Location: Chamber 5
 Config Change: none

Chain A	Power Settings		Software Setting
	Target (dBm)	Measured (dBm)	
Chain A	14.5	13.1	28.0

5150 MHz Band Edge Signal Radiated Field Strength

Frequency MHz	Level dB μ V/m	Pol v/h	FCC 15.209		Detector Pk/QP/Avg	Azimuth degrees	Height meters	Comments
			Limit	Margin				
5150.000	52.5	V	54.0	-1.5	AVG	167	1.09	
5147.270	67.7	V	74.0	-6.3	PK	167	1.09	
5150.000	51.8	H	54.0	-2.2	AVG	247	1.06	
5146.230	67.0	H	74.0	-7.0	PK	247	1.06	

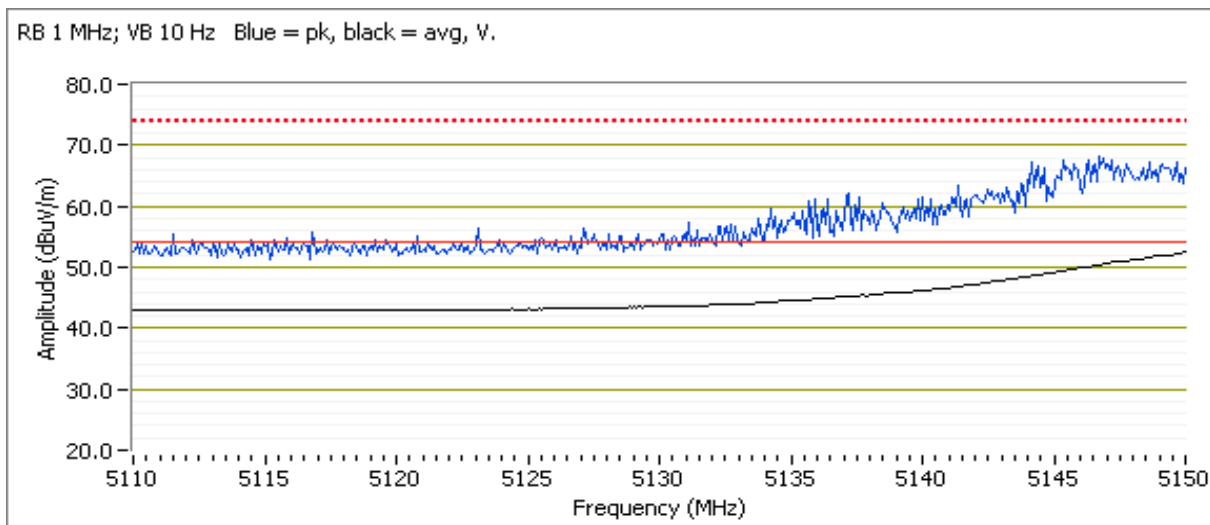



EMC Test Data

Client: Intel	Job Number: J88901
Model: Intel® Centrino® Advanced-N 6235	T-Log Number: T89578
	Account Manager: Christine Krebill
Contact: Steve Hackett	
Standard: FCC 15.247, 15.407, 15.209, RSS 210	Class: N/A

Run # 1b, EUT on Channel #64 5320MHz

Date of Test: 12/7/2012
 Test Engineer: John Caizzi

Test Location: Chamber 5
 Config Change: none

Chain A	Target (dBm)	Power Settings Measured (dBm)	Software Setting
	16.5	13.8	30.0

5350 MHz Band Edge Signal Radiated Field Strength

Frequency	Level	Pol	FCC 15.209		Detector	Azimuth	Height	Comments
MHz	dB μ V/m	v/h	Limit	Margin	Pk/QP/Avg	degrees	meters	
5350.000	52.5	V	54.0	-1.5	AVG	121	1.22	30.0
5351.280	69.3	V	74.0	-4.7	PK	121	1.22	30.0

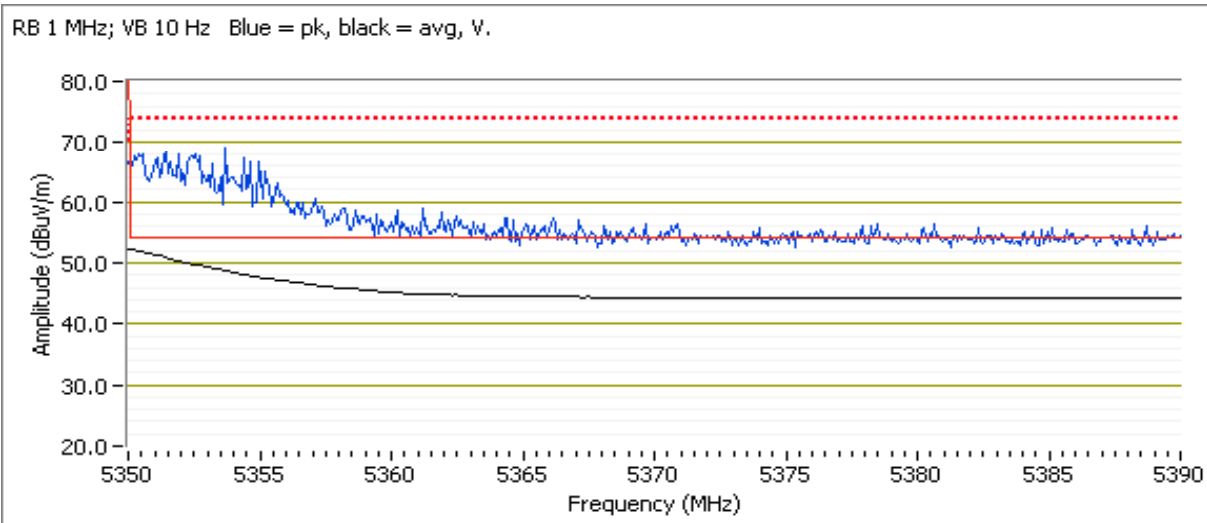



EMC Test Data

Client: Intel	Job Number: J88901
Model: Intel® Centrino® Advanced-N 6235	T-Log Number: T89578
	Account Manager: Christine Krebill
Contact: Steve Hackett	
Standard: FCC 15.247, 15.407, 15.209, RSS 210	Class: N/A

Run # 1c, EUT on Channel #100 5500MHz - 802.11a, Chain A

Date of Test: 12/9/2012
 Test Engineer: Rafael Varelas

Test Location: Chamber 5
 Config Change: none

Chain A	Power Settings		
	Target (dBm)	Measured (dBm)	Software Setting
Chain A	16.0	13.6	31.5

5460 MHz Restricted Band Edge Signal Radiated Field Strength

Frequency MHz	Level dB μ V/m	Pol v/h	FCC 15.209		Detector Pk/QP/Avg	Azimuth degrees	Height meters	Comments
			Limit	Margin				
5459.900	52.9	H	54.0	-1.1	AVG	288	1.0	POS; RB 1 MHz; VB: 10 Hz
5459.900	69.5	H	74.0	-4.5	PK	288	1.0	POS; RB 1 MHz; VB: 3 MHz
5460.000	52.7	V	54.0	-1.3	AVG	115	1.1	POS; RB 1 MHz; VB: 10 Hz
5459.780	69.0	V	74.0	-5.0	PK	115	1.1	POS; RB 1 MHz; VB: 3 MHz

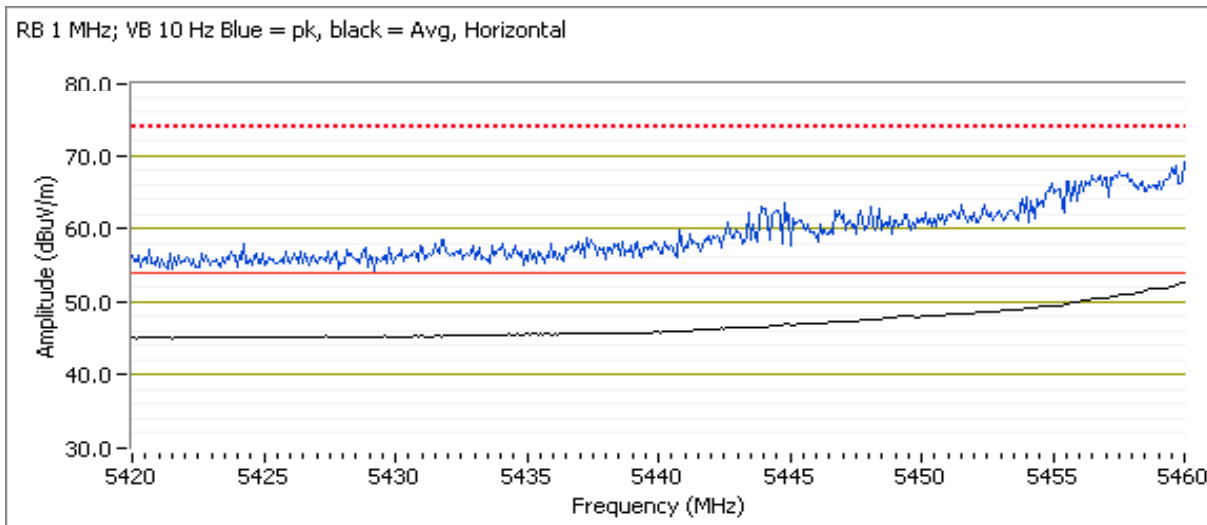



EMC Test Data

Client:	Intel	Job Number:	J88901
Model:	Intel® Centrino® Advanced-N 6235	T-Log Number:	T89578
Contact:	Steve Hackett	Account Manager:	Christine Krebill
Standard:	FCC 15.247, 15.407, 15.209, RSS 210	Class:	N/A

	Target (dBm)	Power Settings Measured (dBm)	Software Setting
Chain A	16.0	13.6	31.5

5460 - 5470 MHz Band Edge Radiated Field Strength

Frequency MHz	Level dBμV/m	Pol v/h	15 E		Detector Pk/QP/Avg	Azimuth degrees	Height meters	Comments
			Limit	Margin				
5468.980	67.1	V	68.3	-1.2	PK	115	1.1	POS; RB 1 MHz; VB: 3 MHz
5468.560	66.3	H	68.3	-2.0	PK	288	1.0	POS; RB 1 MHz; VB: 3 MHz

For emissions in the 5460-5470MHz frequency range the limit is -27dBm/MHz eirp (68.3dBuV/m). The measurement method required is a peak measurement (RB=1MHz, VB≥3MHz, peak detector).

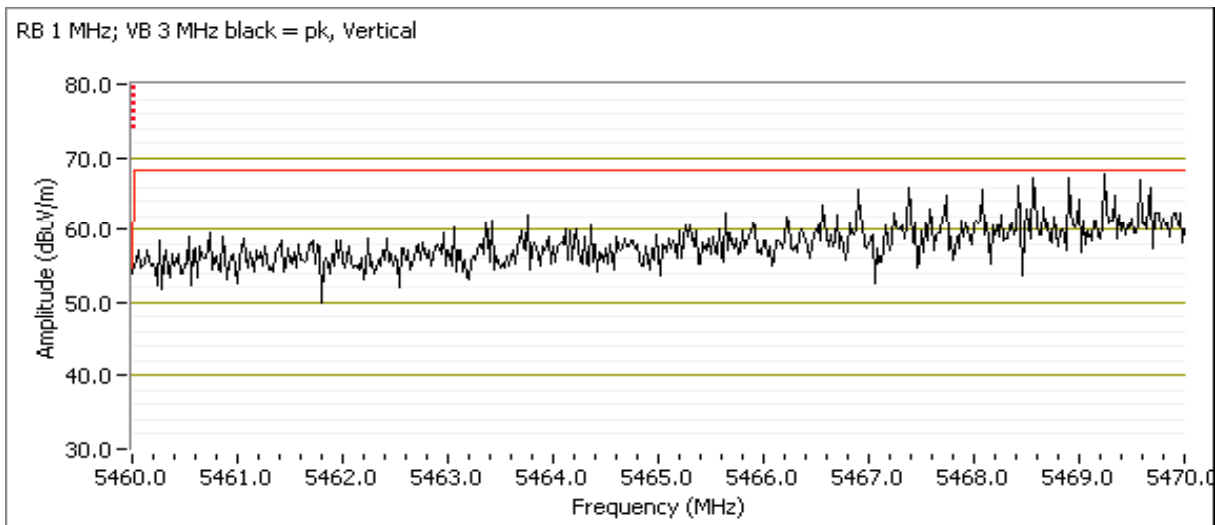



EMC Test Data

Client:	Intel	Job Number:	J88901
Model:	Intel® Centrino® Advanced-N 6235	T-Log Number:	T89578
Contact:	Steve Hackett	Account Manager:	Christine Krebill
Standard:	FCC 15.247, 15.407, 15.209, RSS 210	Class:	N/A

Run # 1d, EUT on Channel #140 5700MHz - 802.11a, Chain A

	Target (dBm)	Power Settings Measured (dBm)	Software Setting
Chain A	16.0	13.0	33.0

5725 MHz Band Edge Radiated Field Strength

Frequency	Level	Pol	15 E		Detector	Azimuth	Height	Comments
MHz	dB μ V/m	v/h	Limit	Margin	PK/QP/Avg	degrees	meters	
5727.570	67.0	V	68.3	-1.3	PK	61	1.0	POS; RB 1 MHz; VB: 3 MHz
5725.190	64.0	H	68.3	-4.3	PK	356	1.0	POS; RB 1 MHz; VB: 3 MHz

For emissions immediately above 5725 MHz the limit is -27dBm/MHz eirp (68.3dBuV/m). The measurement method required is a peak measurement (RB=1MHz, VB≥3MHz, peak detector).that a peak measurement was made.

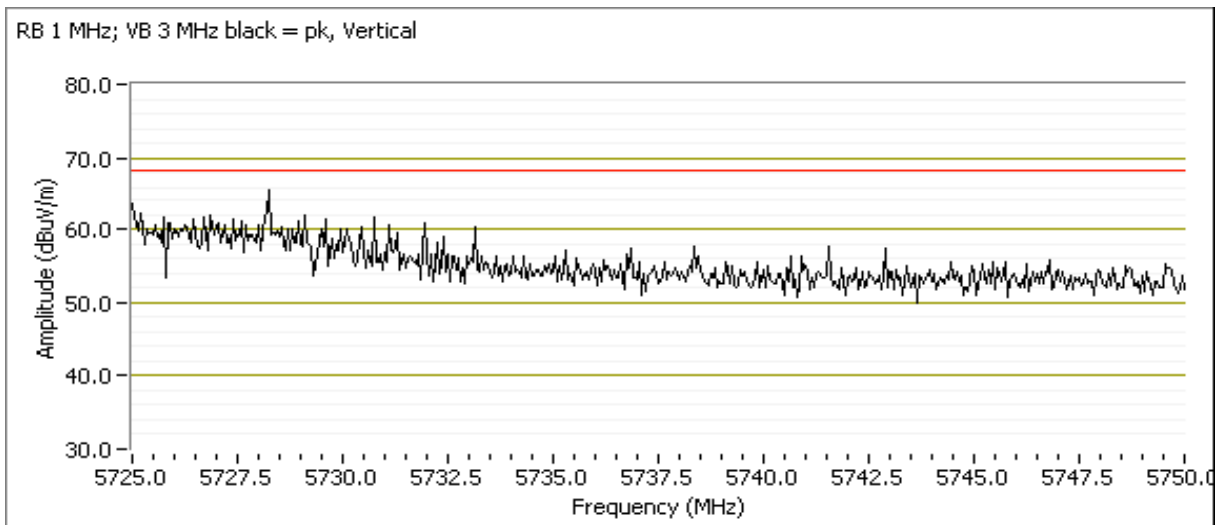



EMC Test Data

Client: Intel	Job Number: J88901
Model: Intel® Centrino® Advanced-N 6235	T-Log Number: T89578
	Account Manager: Christine Krebill
Contact: Steve Hackett	
Standard: FCC 15.247, 15.407, 15.209, RSS 210	Class: N/A

Run # 2, Band Edge Field Strength - 802.11n20, Chain A
 Run # 2a, EUT on Channel #36 5180MHz - 802.11n20, Chain A

Date of Test: 12/9/2012 Test Location: Chamber 5
 Test Engineer: Rafael Varelas Config Change: none

Chain A	Power Settings		
	Target (dBm)	Measured (dBm)	Software Setting
Chain A	14.5	13.1	29.0

5150 MHz Band Edge Signal Radiated Field Strength

Frequency	Level	Pol	FCC 15.209		Detector	Azimuth	Height	Comments
MHz	dB μ V/m	v/h	Limit	Margin	Pk/QP/Avg	degrees	meters	
5149.960	52.8	V	54.0	-1.2	AVG	169	1.0	B 1 MHz; VB: 10 Hz
5149.790	68.3	V	74.0	-5.7	PK	169	1.0	B 1 MHz; VB: 3 MHz
5150.000	51.8	H	54.0	-2.2	AVG	5	1.0	B 1 MHz; VB: 10 Hz
5147.230	67.8	H	74.0	-6.2	PK	5	1.0	B 1 MHz; VB: 3 MHz

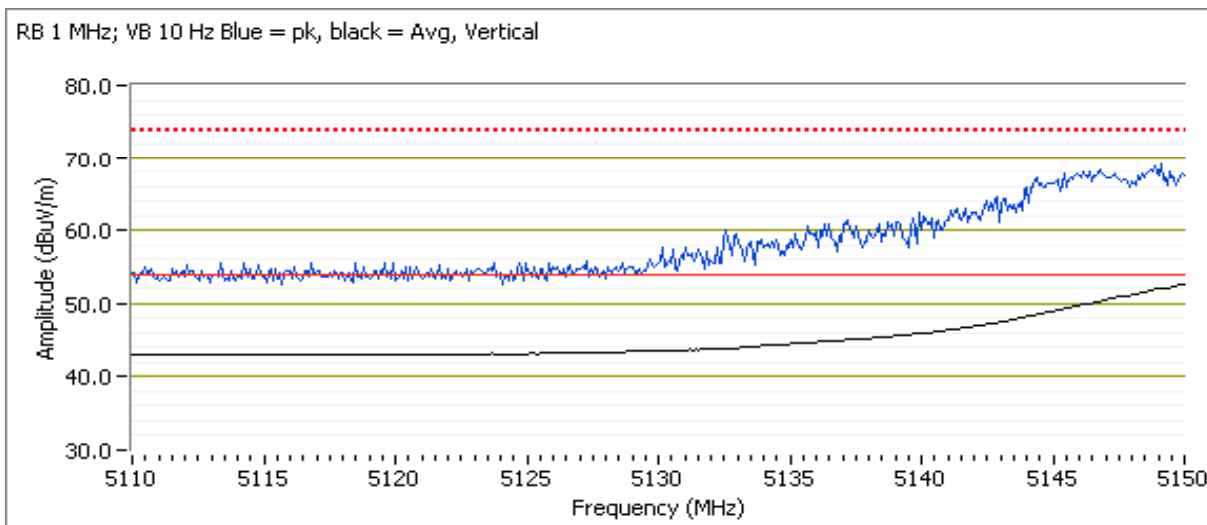



EMC Test Data

Client:	Intel	Job Number:	J88901
Model:	Intel® Centrino® Advanced-N 6235	T-Log Number:	T89578
Contact:	Steve Hackett	Account Manager:	Christine Krebill
Standard:	FCC 15.247, 15.407, 15.209, RSS 210	Class:	N/A

Run # 2b, EUT on Channel #64 5320MHz - 802.11n20, Chain A

	Target (dBm)	Power Settings Measured (dBm)	Software Setting
Chain A	16.5	13.5	30.0

5350 MHz Band Edge Signal Radiated Field Strength

Frequency MHz	Level dBμV/m	Pol v/h	FCC 15.209		Detector Pk/QP/Avg	Azimuth degrees	Height meters	Comments
			Limit	Margin				
5350.000	52.3	V	54.0	-1.7	AVG	68	1.0	B 1 MHz; VB: 10 Hz
5350.250	69.3	V	74.0	-4.7	PK	68	1.0	B 1 MHz; VB: 3 MHz
5350.020	52.1	H	54.0	-1.9	AVG	240	1.5	B 1 MHz; VB: 10 Hz
5351.890	70.1	H	74.0	-3.9	PK	240	1.5	B 1 MHz; VB: 3 MHz

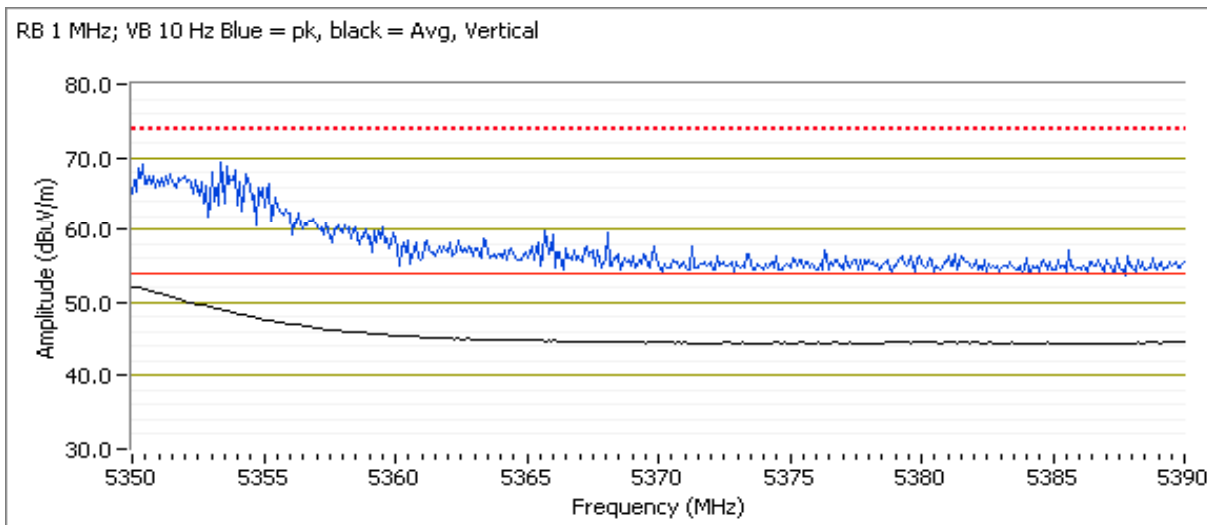



EMC Test Data

Client:	Intel	Job Number:	J88901
Model:	Intel® Centrino® Advanced-N 6235	T-Log Number:	T89578
Contact:	Steve Hackett	Account Manager:	Christine Krebill
Standard:	FCC 15.247, 15.407, 15.209, RSS 210	Class:	N/A

Run # 2c, EUT on Channel #100 5500MHz - 802.11n20, Chain A

	Target (dBm)	Power Settings Measured (dBm)	Software Setting
Chain A	16.5	13.5	31.5

5460 MHz Restricted Band Edge Signal Radiated Field Strength

Frequency	Level	Pol	FCC 15.209		Detector	Azimuth	Height	Comments
MHz	dB μ V/m	v/h	Limit	Margin	Pk/QP/Avg	degrees	meters	
5460.000	52.8	H	54.0	-1.2	AVG	284	1.0	B 1 MHz; VB: 10 Hz
5457.040	70.5	H	74.0	-3.5	PK	284	1.0	B 1 MHz; VB: 3 MHz
5460.000	52.3	V	54.0	-1.7	AVG	108	1.0	B 1 MHz; VB: 10 Hz
5459.740	70.9	V	74.0	-3.1	PK	108	1.0	B 1 MHz; VB: 3 MHz

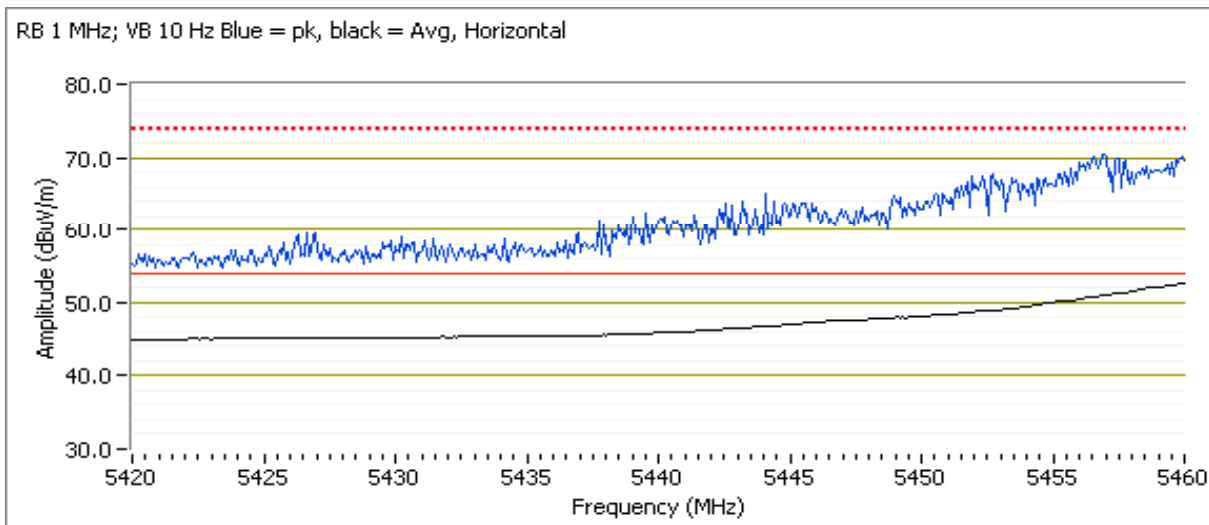

5460 - 5470 MHz Band Edge Radiated Field Strength

Frequency	Level	Pol	15.209		Detector	Azimuth	Height	Comments
MHz	dB μ V/m	v/h	Limit	Margin	Pk/QP/Avg	degrees	meters	
5469.980	50.5	H	54.0	-3.5	AVG	300	1.00	
5466.390	66.0	H	74.0	-8.0	PK	300	1.00	
5470.000	52.8	V	54.0	-1.2	AVG	300	1.00	
5468.760	68.3	V	74.0	-5.7	PK	300	1.00	

For emissions in the 5460-5470MHz frequency range the limit is -27dBm/MHz eirp (68.3dBuV/m). The measurement method required is a peak measurement (RB=1MHz, VB \geq 3MHz, peak detector).



EMC Test Data

Client:	Intel	Job Number:	J88901
Model:	Intel® Centrino® Advanced-N 6235	T-Log Number:	T89578
Contact:	Steve Hackett	Account Manager:	Christine Krebill
Standard:	FCC 15.247, 15.407, 15.209, RSS 210	Class:	N/A

Run # 2d, EUT on Channel #140 5700MHz - 802.11n20, Chain A

	Target (dBm)	Power Settings Measured (dBm)	Software Setting
Chain A	16.0	12.2	31.5

5725 MHz Band Edge Radiated Field Strength

Frequency	Level	Pol	15 E		Detector	Azimuth	Height	Comments
MHz	dBμV/m	v/h	Limit	Margin	Pk/QP/Avg	degrees	meters	
5725.350	65.7	V	68.3	-2.6	PK	209	1.00	POS; RB 1 MHz; VB: 3 MHz

For emissions immediately above 5725 MHz the limit is -27dBm/MHz eirp (68.3dBuV/m). The measurement method required is a peak measurement (RB=1MHz, VB≥3MHz, peak detector).that a peak measurement was made.

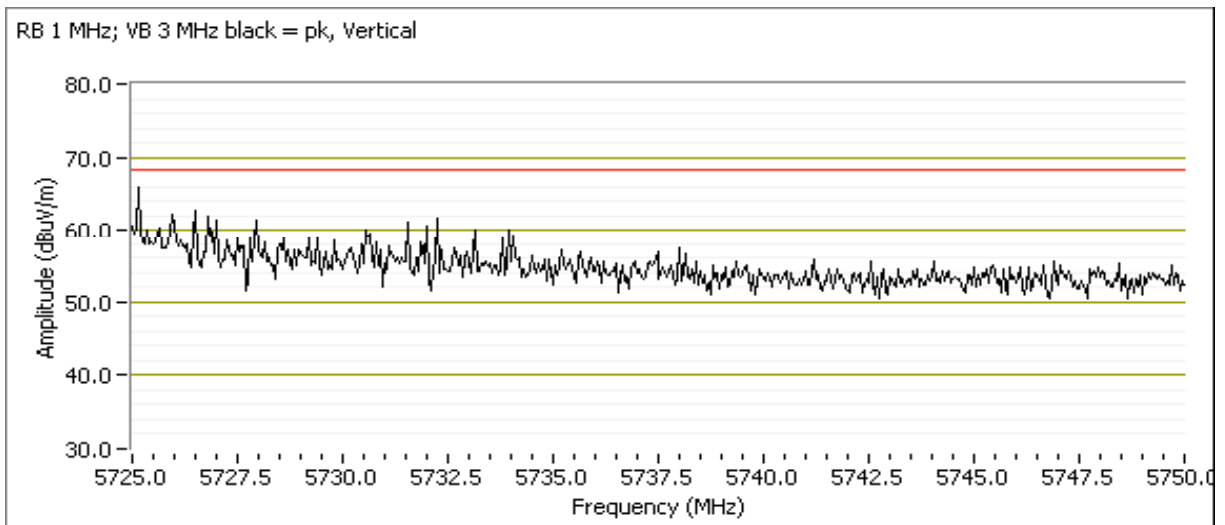



EMC Test Data

Client:	Intel	Job Number:	J88901
Model:	Intel® Centrino® Advanced-N 6235	T-Log Number:	T89578
Contact:	Steve Hackett	Account Manager:	Christine Krebill
Standard:	FCC 15.247, 15.407, 15.209, RSS 210	Class:	N/A

Run # 3, Band Edge Field Strength - 802.11n40, Chain A
 Run # 3a, EUT on Channel #38 5190MHz - 802.11n40, Chain A

Date of Test: 12/9/2012 Test Location: Chamber 5
 Test Engineer: Rafael Varelas Config Change: none

Chain A	Power Settings		
	Target (dBm)	Measured (dBm)	Software Setting
Chain A	11.5	10.2	25.0

5150 MHz Band Edge Signal Radiated Field Strength

Frequency MHz	Level dB μ V/m	Pol v/h	FCC 15.209		Detector Pk/QP/Avg	Azimuth degrees	Height meters	Comments
			Limit	Margin				
5149.990	52.9	V	54.0	-1.1	AVG	176	1.0	B 1 MHz; VB: 10 Hz
5149.810	65.8	V	74.0	-8.2	PK	176	1.0	B 1 MHz; VB: 3 MHz
5150.000	52.0	H	54.0	-2.0	AVG	31	1.0	B 1 MHz; VB: 10 Hz
5150.000	65.3	H	74.0	-8.7	PK	31	1.0	B 1 MHz; VB: 3 MHz

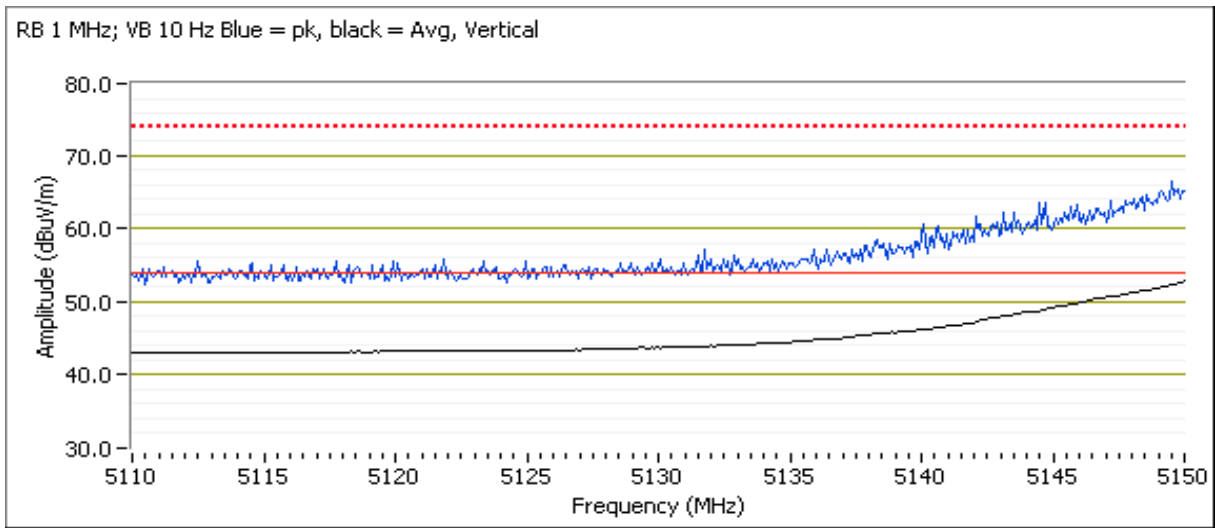



EMC Test Data

Client:	Intel	Job Number:	J88901
Model:	Intel® Centrino® Advanced-N 6235	T-Log Number:	T89578
Contact:	Steve Hackett	Account Manager:	Christine Krebill
Standard:	FCC 15.247, 15.407, 15.209, RSS 210	Class:	N/A

Run # 3b, EUT on Channel #62 5310MHz - 802.11n40, Chain A

	Target (dBm)	Power Settings Measured (dBm)	Software Setting
Chain A	11.5	10.1	25.5

5350 MHz Band Edge Signal Radiated Field Strength

Frequency MHz	Level dBμV/m	Pol v/h	FCC 15.209		Detector Pk/QP/Avg	Azimuth degrees	Height meters	Comments
			Limit	Margin				
5350.020	52.7	V	54.0	-1.3	AVG	116	1.0	B 1 MHz; VB: 10 Hz
5350.970	65.1	V	74.0	-8.9	PK	116	1.0	B 1 MHz; VB: 3 MHz
5350.010	51.4	H	54.0	-2.6	AVG	239	1.3	B 1 MHz; VB: 10 Hz
5350.310	64.0	H	74.0	-10.0	PK	239	1.3	B 1 MHz; VB: 3 MHz

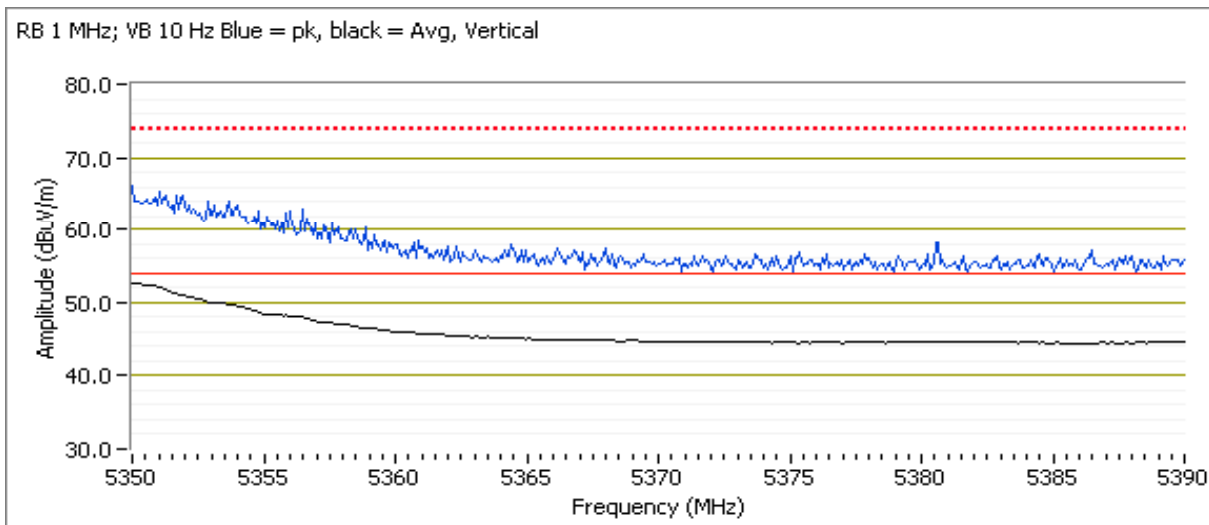



EMC Test Data

Client:	Intel	Job Number:	J88901
Model:	Intel® Centrino® Advanced-N 6235	T-Log Number:	T89578
Contact:	Steve Hackett	Account Manager:	Christine Krebill
Standard:	FCC 15.247, 15.407, 15.209, RSS 210	Class:	N/A

Run # 3c, EUT on Channel #102 5510MHz - 802.11n40, Chain A

	Target (dBm)	Power Settings Measured (dBm)	Software Setting
Chain A	14.5	10.7	27.5

5460 MHz Restricted Band Edge Signal Radiated Field Strength

Frequency	Level	Pol	FCC 15.209		Detector	Azimuth	Height	Comments
MHz	dB μ V/m	v/h	Limit	Margin	PK/QP/Avg	degrees	meters	
5460.000	52.1	V	54.0	-1.9	AVG	126	1.00	30.0
5459.680	65.0	V	74.0	-9.0	PK	126	1.00	30.0

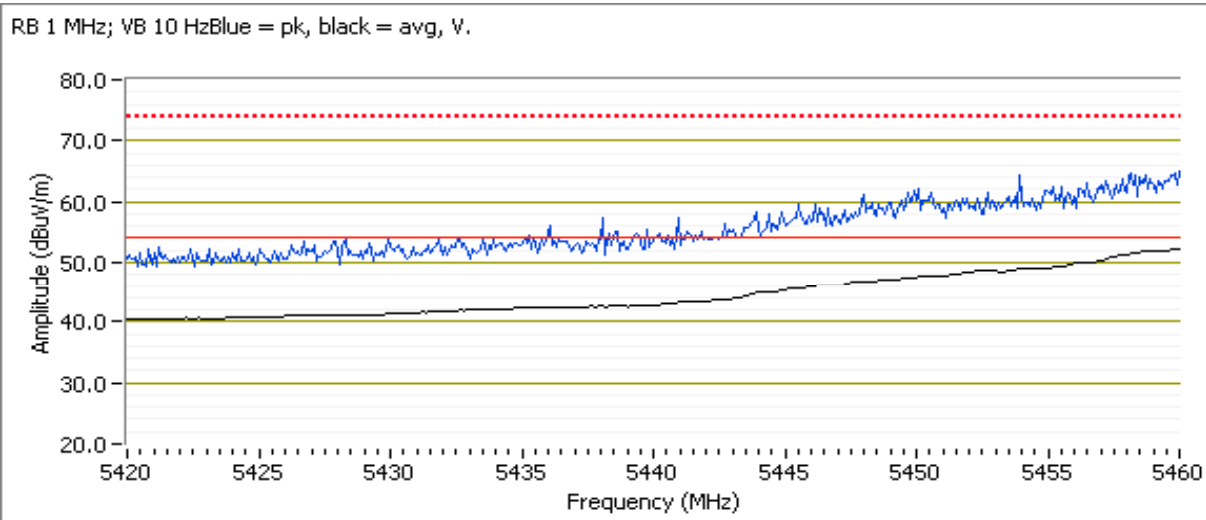



EMC Test Data

Client: Intel	Job Number: J88901
Model: Intel® Centrino® Advanced-N 6235	T-Log Number: T89578
	Account Manager: Christine Krebill
Contact: Steve Hackett	
Standard: FCC 15.247, 15.407, 15.209, RSS 210	Class: N/A

5460 - 5470 MHz Band Edge Radiated Field Strength

Frequency	Level	Pol	15 E		Detector	Azimuth	Height	Comments
MHz	dB μ V/m	v/h	Limit	Margin	PK/QP/Avg	degrees	meters	
5469.180	68.2	V	68.3	-0.1	PK	126	1.00	

For emissions in the 5460-5470MHz frequency range the limit is -27dBm/MHz eirp (68.3dBuV/m). The measurement method required is a peak measurement (RB=1MHz, VB \geq 3MHz, peak detector).

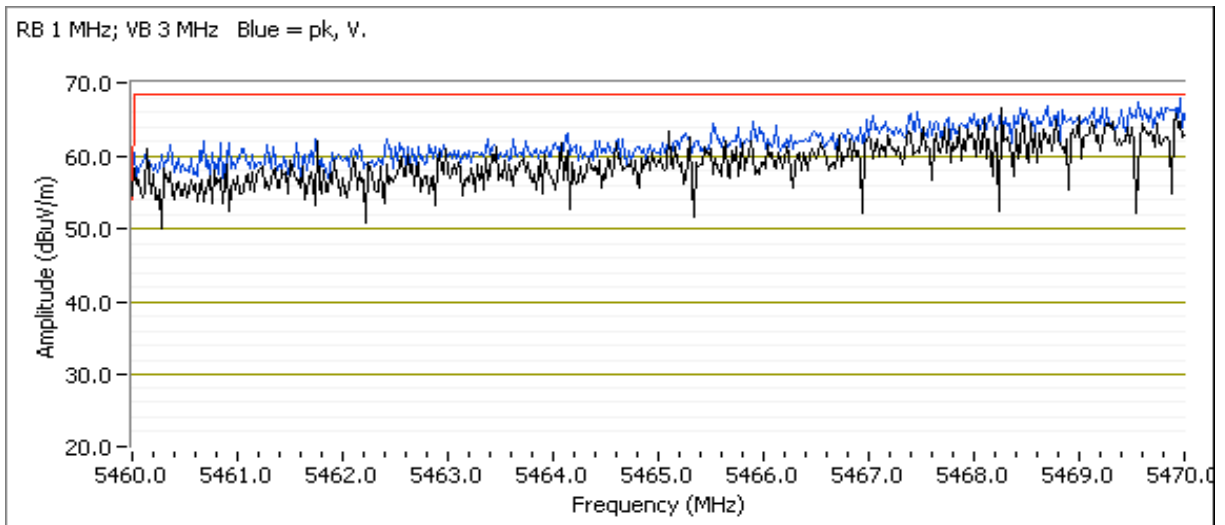



EMC Test Data

Client:	Intel	Job Number:	J88901
Model:	Intel® Centrino® Advanced-N 6235	T-Log Number:	T89578
Contact:	Steve Hackett	Account Manager:	Christine Krebill
Standard:	FCC 15.247, 15.407, 15.209, RSS 210	Class:	N/A

Run # 3d, EUT on Channel #134 5670MHz - 802.11n40, Chain A

	Target (dBm)	Power Settings Measured (dBm)	Software Setting
Chain A	16.0	14.4	38.0

5725 MHz Band Edge Radiated Field Strength

Frequency	Level	Pol	15 E		Detector	Azimuth	Height	Comments
MHz	dB μ V/m	v/h	Limit	Margin	Pk/QP/Avg	degrees	meters	
5725.050	68.0	V	68.3	-0.3	PK	210	1.0	Setting 38 15 E limit
5726.000	65.2	H	68.3	-3.1	PK	335	1.0	Setting 38 15 E limit

For emissions immediately above 5725 MHz the limit is -27dBm/MHz eirp (68.3dBuV/m). The measurement method required is a peak measurement (RB=1MHz, VB \geq 3MHz, peak detector).that a peak measurement was made.

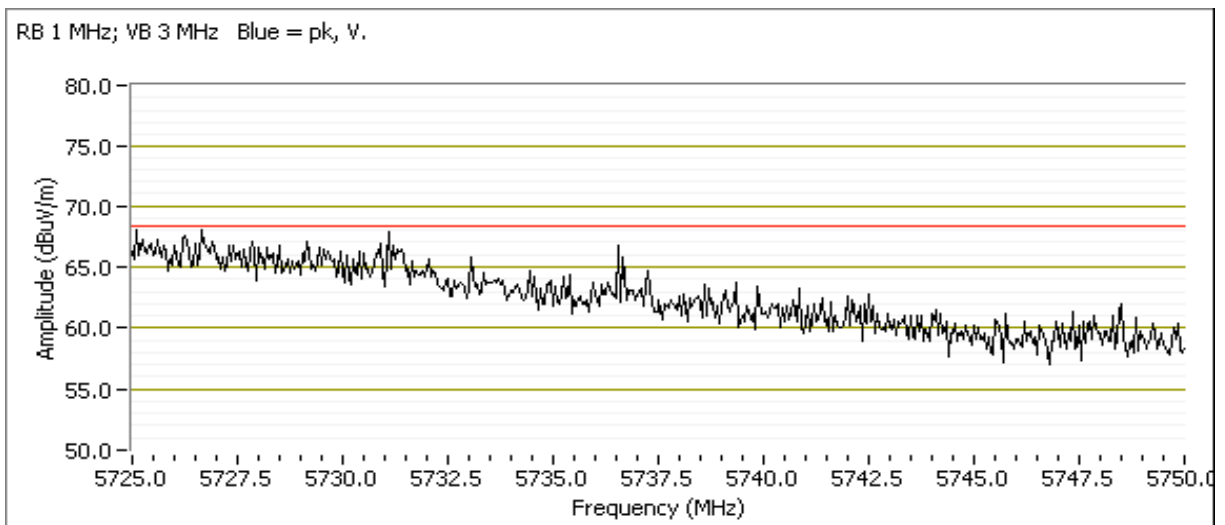



EMC Test Data

Client:	Intel	Job Number:	J88901
Model:	Intel® Centrino® Advanced-N 6235	T-Log Number:	T89578
Contact:	Steve Hackett	Account Manager:	Christine Krebill
Standard:	FCC 15.247, 15.407, 15.209, RSS 210	Class:	N/A

RSS 210 and FCC 15.407 (UNII) Radiated Spurious Emissions

Test Specific Details

Objective: The objective of this test session is to perform final qualification testing of the EUT with respect to the specification listed above.

General Test Configuration

The EUT and all local support equipment were located on the turntable for radiated spurious emissions testing. For radiated emissions testing the measurement antenna was located 3 meters from the EUT.

Ambient Conditions:

Temperature: 25 °C
Rel. Humidity: 38 %

Summary of Results

MAC Address: 001500B50405 DRTU Tool Version 1.5.6-0445 Driver version 15.3.1.2

Run #	Mode	Channel	Target Power	Measured Power	Test Performed	Limit	Result / Margin
Run # 1	802.11a Chain B	#36 5180MHz	15.5	13.4	Restricted Band Edge at 5150 MHz	15.209	52.6 dBµV/m @ 5150.0 MHz (-1.4 dB)
		#64 5320MHz	16.5	13.3	Restricted Band Edge at 5350 MHz	15.209	52.2 dBµV/m @ 5350.0 MHz (-1.8 dB)
		#100 5500MHz	16.0	14.5	Restricted Band Edge at 5460 MHz	15.209	52.7 dBµV/m @ 5459.9 MHz (-1.3 dB)
				14.5	Band Edge at 5470 MHz	15 E	67.4 dBµV/m @ 5467.2 MHz (-0.9 dB)
		#140 5700MHz	16.0	13.4	Band Edge at 5725 MHz	15 E	66.4 dBµV/m @ 5727.9 MHz (-1.9 dB)
Run # 2	802.11n20 Chain B	#36 5180MHz	15.0	13.4	Restricted Band Edge at 5150 MHz	15.209	52.8 dBµV/m @ 5150.0 MHz (-1.2 dB)
		#64 5320MHz	16.5	13.7	Restricted Band Edge at 5350 MHz	15.209	52.4 dBµV/m @ 5350.0 MHz (-1.6 dB)
		#100 5500MHz	16.5	13.4	Restricted Band Edge at 5460 MHz	15.209	52.9 dBµV/m @ 5460.0 MHz (-1.1 dB)
				13.4	Band Edge at 5470 MHz	15.209	51.3 dBµV/m @ 5470.0 MHz (-2.7 dB)
		#140 5700MHz	16.0	13.8	Band Edge at 5725 MHz	15.209	52.7 dBµV/m @ 5725.0 MHz (-1.3 dB)



EMC Test Data

Client:	Intel	Job Number:	J88901
Model:	Intel® Centrino® Advanced-N 6235	T-Log Number:	T89578
Contact:	Steve Hackett	Account Manager:	Christine Krebill
Standard:	FCC 15.247, 15.407, 15.209, RSS 210	Class:	N/A

Run #	Mode	Channel	Target Power	Measured Power	Test Performed	Limit	Result / Margin
Run # 3	802.11n40 Chain B	#38 5190MHz	11.5	10.4	Restricted Band Edge at 5150 MHz	15.209	52.8 dBµV/m @ 5150.0 MHz (-1.2 dB)
		#62 5310MHz	12.0	9.9	Restricted Band Edge at 5350 MHz	15.209	52.7 dBµV/m @ 5350.0 MHz (-1.3 dB)
		#102 5510MHz	14.5	13.0	Restricted Band Edge at 5460 MHz	15.209	52.3 dBµV/m @ 5460.0 MHz (-1.7 dB)
				13.0	Band Edge at 5470 MHz	15 E	67.8 dBµV/m @ 5469.7 MHz (-0.5 dB)
		#134 5670MHz	16.0	14.4	Band Edge at 5725 MHz	15 E	67.9 dBµV/m @ 5725.3 MHz (-0.4 dB)

Modifications Made During Testing

No modifications were made to the EUT during testing

Deviations From The Standard

No deviations were made from the requirements of the standard.

Test Procedure Comments:

Unless otherwise noted, average measurements above 1GHz were performed as documented in FCC KDB 789033 G) 6) d) Method VB

Note - the target and measured power are average powers (measured with average power sensor) and are used for reference purposes only. Power is set using " GAIN CONTROL" mode in the DRTU tool.

Antenna: connected
Duty Cycle: 99%



EMC Test Data

Client: Intel	Job Number: J88901
Model: Intel® Centrino® Advanced-N 6235	T-Log Number: T89578
	Account Manager: Christine Krebill
Contact: Steve Hackett	
Standard: FCC 15.247, 15.407, 15.209, RSS 210	Class: N/A

Run # 1, Band Edge Field Strength - 802.11a, Chain B
 Run # 1a, EUT on Channel #36 5180MHz - 802.11a, Chain B

Date of Test: 12/10/2012 Test Location: FT 4
 Test Engineer: Jack Liu Config Change: none

Chain B	Power Settings		
	Target (dBm)	Measured (dBm)	Software Setting
Chain B	15.5	13.4	31.0

5150 MHz Band Edge Signal Radiated Field Strength

Frequency MHz	Level dB μ V/m	Pol v/h	FCC 15.209		Detector Pk/QP/Avg	Azimuth degrees	Height meters	Comments
			Limit	Margin				
5150.000	52.6	V	54.0	-1.4	AVG	250	1.0	
5146.550	68.1	V	74.0	-5.9	PK	250	1.0	
5150.000	52.3	H	54.0	-1.7	AVG	115	1.0	
5147.760	67.9	H	74.0	-6.1	PK	115	1.0	

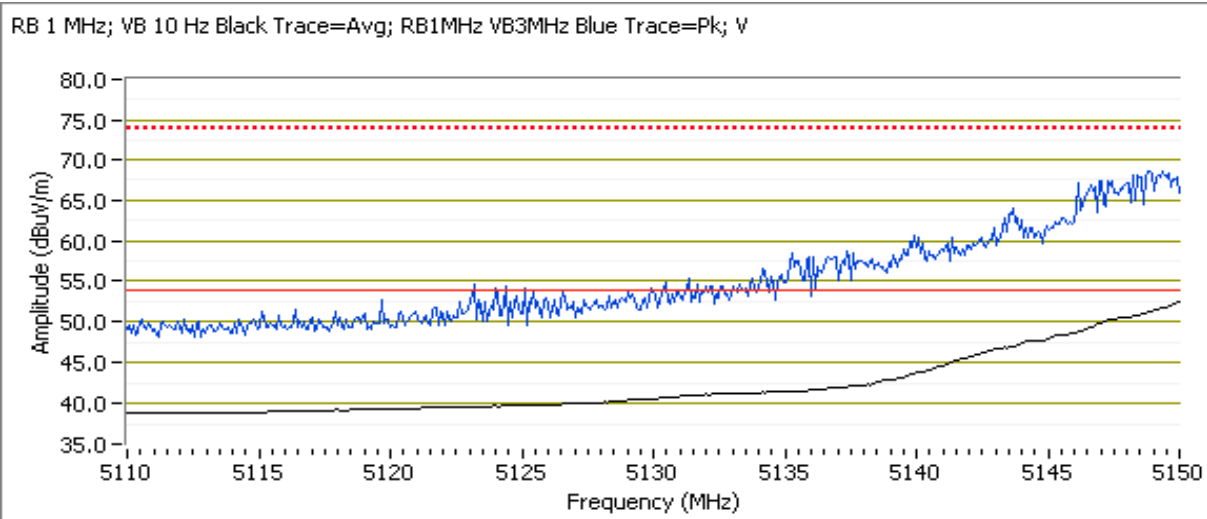



EMC Test Data

Client:	Intel	Job Number:	J88901
Model:	Intel® Centrino® Advanced-N 6235	T-Log Number:	T89578
Contact:	Steve Hackett	Account Manager:	Christine Krebill
Standard:	FCC 15.247, 15.407, 15.209, RSS 210	Class:	N/A

Run # 1b, EUT on Channel #64 5320MHz - 802.11a, Chain B

Date of Test: 12/10/2012

Test Location: FT 4

Test Engineer: Jack Liu

Config Change: none

Chain B	Target (dBm)	Power Settings	Software Setting
		Measured (dBm)	
		13.3	32.0

5350 MHz Band Edge Signal Radiated Field Strength

Frequency MHz	Level dB μ V/m	Pol v/h	FCC 15.209		Detector Pk/QP/Avg	Azimuth degrees	Height meters	Comments
			Limit	Margin				
5350.000	52.2	V	54.0	-1.8	AVG	240	1.0	Setting 32
5350.880	67.7	V	74.0	-6.3	PK	240	1.0	Setting 32
5350.000	50.9	H	54.0	-3.1	AVG	104	1.2	Setting 32
5352.890	65.8	H	74.0	-8.2	PK	104	1.2	Setting 32

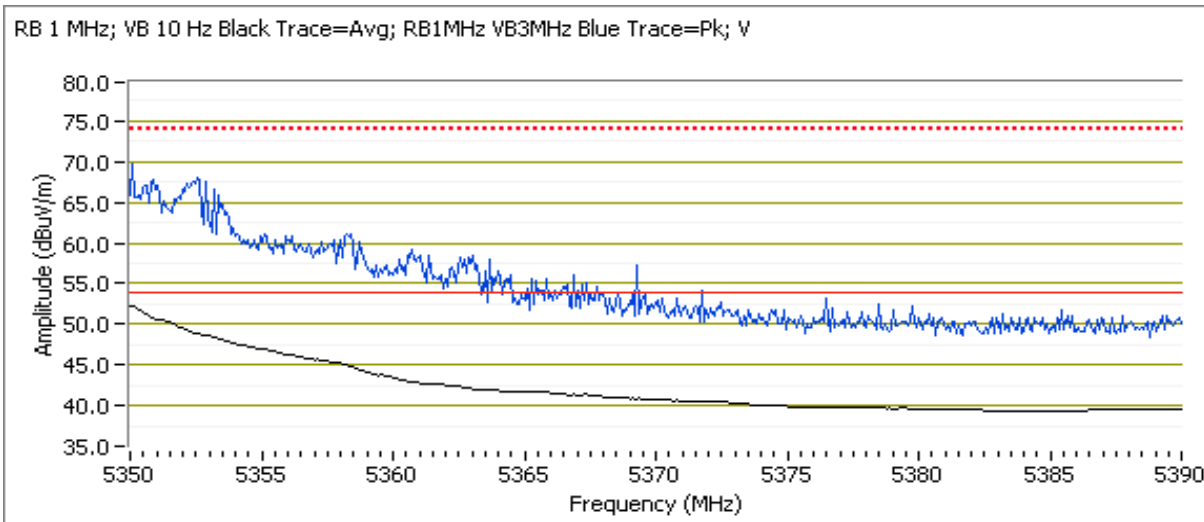



EMC Test Data

Client: Intel	Job Number: J88901
Model: Intel® Centrino® Advanced-N 6235	T-Log Number: T89578
Contact: Steve Hackett	Account Manager: Christine Krebill
Standard: FCC 15.247, 15.407, 15.209, RSS 210	Class: N/A

Run # 1c, EUT on Channel #100 5500MHz - 802.11a, Chain B

	Target (dBm)	Power Settings Measured (dBm)	Software Setting
Chain B	16.0	14.5	34.0

5460 MHz Restricted Band Edge Signal Radiated Field Strength

Frequency MHz	Level dB μ V/m	Pol v/h	FCC 15.209		Detector PK/QP/Avg	Azimuth degrees	Height meters	Comments
			Limit	Margin				
5459.920	52.7	V	54.0	-1.3	AVG	261	1.0	
5459.440	68.2	V	74.0	-5.8	PK	261	1.0	
5460.000	51.7	H	54.0	-2.3	AVG	106	1.1	
5459.200	68.7	H	74.0	-5.3	PK	106	1.1	

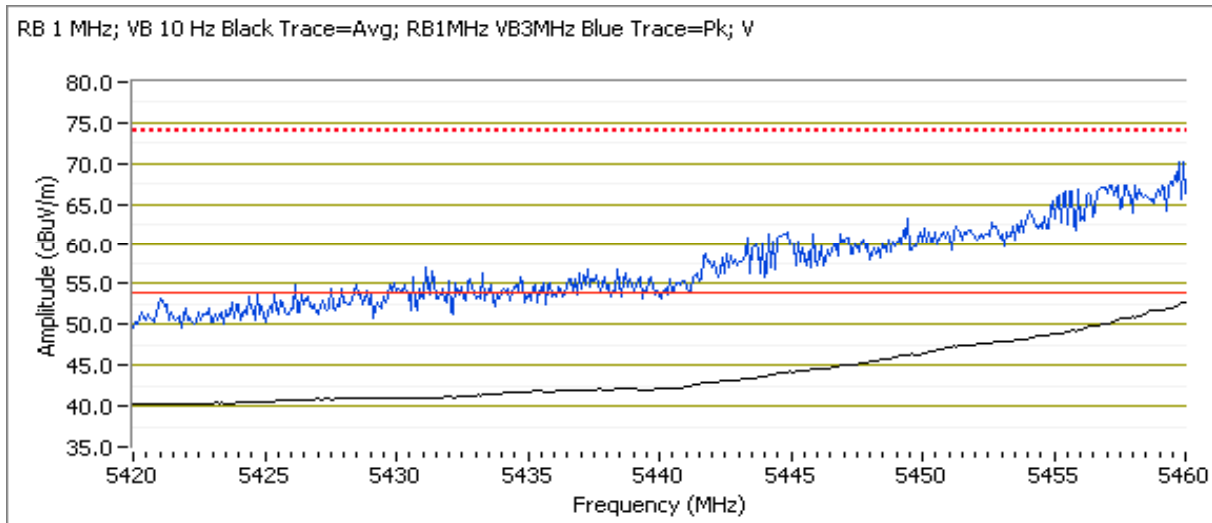



EMC Test Data

Client: Intel	Job Number: J88901
Model: Intel® Centrino® Advanced-N 6235	T-Log Number: T89578
	Account Manager: Christine Krebill
Contact: Steve Hackett	
Standard: FCC 15.247, 15.407, 15.209, RSS 210	Class: N/A

5460 - 5470 MHz Band Edge Radiated Field Strength

Frequency	Level	Pol	15 E		Detector	Azimuth	Height	Comments
MHz	dB μ V/m	v/h	Limit	Margin	Pk/QP/Avg	degrees	meters	
5467.190	67.4	H	68.3	-0.9	PK	106	1.0	

For emissions in the 5460-5470MHz frequency range the limit is -27dBm/MHz eirp (68.3dBuV/m). The measurement method required is a peak measurement (RB=1MHz, VB \geq 3MHz, peak detector).

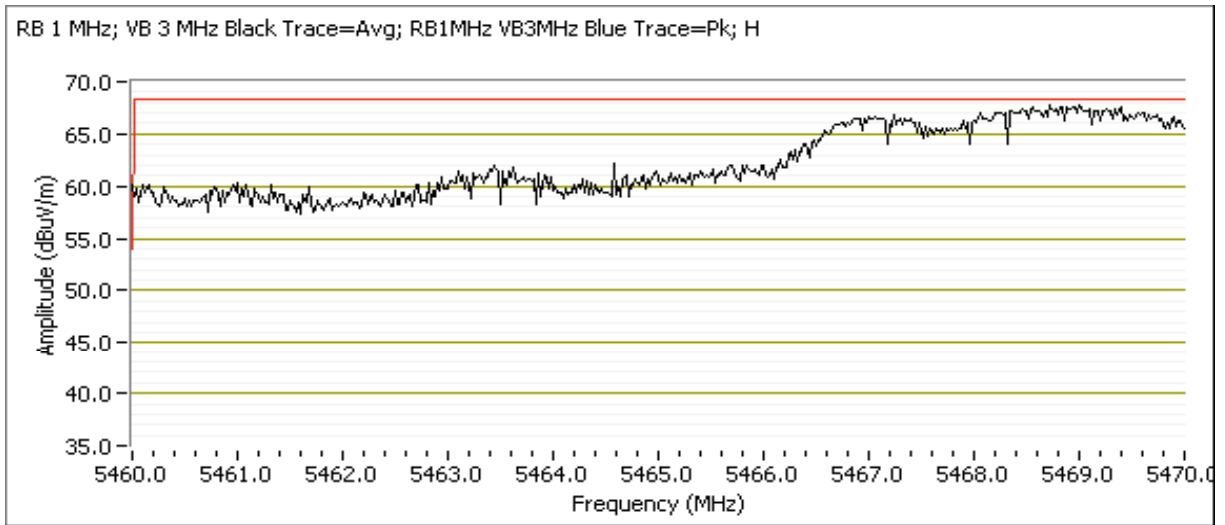



EMC Test Data

Client:	Intel	Job Number:	J88901
Model:	Intel® Centrino® Advanced-N 6235	T-Log Number:	T89578
Contact:	Steve Hackett	Account Manager:	Christine Krebill
Standard:	FCC 15.247, 15.407, 15.209, RSS 210	Class:	N/A

Run # 1d, EUT on Channel #140 5700MHz - 802.11a, Chain B

	Target (dBm)	Power Settings Measured (dBm)	Software Setting
Chain B	16.0	13.4	32.0

5725 MHz Band Edge Radiated Field Strength

Frequency	Level	Pol	15 E		Detector	Azimuth	Height	Comments
MHz	dBμV/m	v/h	Limit	Margin	Pk/QP/Avg	degrees	meters	
5727.860	66.4	H	68.3	-1.9	PK	108	1.0	

For emissions immediately above 5725 MHz the limit is -27dBm/MHz eirp (68.3dBuV/m). The measurement method required is a peak measurement (RB=1MHz, VB≥3MHz, peak detector).that a peak measurement was made.

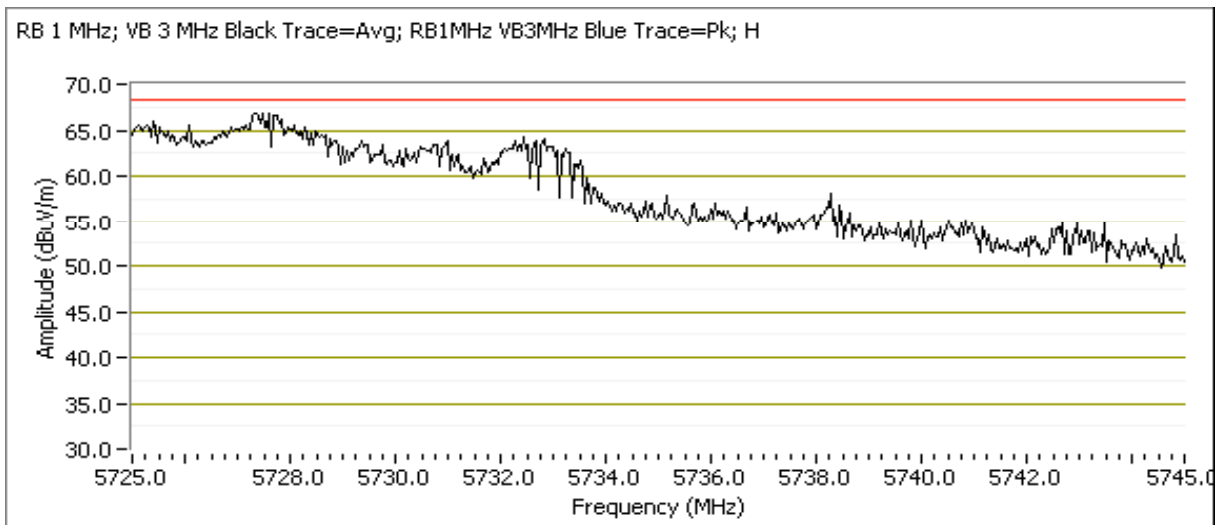



EMC Test Data

Client: Intel	Job Number: J88901
Model: Intel® Centrino® Advanced-N 6235	T-Log Number: T89578
	Account Manager: Christine Krebill
Contact: Steve Hackett	
Standard: FCC 15.247, 15.407, 15.209, RSS 210	Class: N/A

Run # 2, Band Edge Field Strength - 802.11n20, Chain B

Run # 2a, EUT on Channel #36 5180MHz - 802.11n20, Chain B

Date of Test: 12/10/2012

Test Location: FT Chamber #4

Test Engineer: Rafael Varelas

Config Change: none

Chain B	Power Settings		Software Setting
	Target (dBm)	Measured (dBm)	
Chain B	15.0	13.4	31.0

5150 MHz Band Edge Signal Radiated Field Strength

Frequency MHz	Level dB μ V/m	Pol v/h	FCC 15.209		Detector Pk/QP/Avg	Azimuth degrees	Height meters	Comments
			Limit	Margin				
5150.000	52.8	V	54.0	-1.2	AVG	250	1.0	
5148.850	68.9	V	74.0	-5.1	PK	250	1.0	
5150.000	50.3	H	54.0	-3.7	AVG	38	1.0	
5145.910	65.0	H	74.0	-9.0	PK	38	1.0	

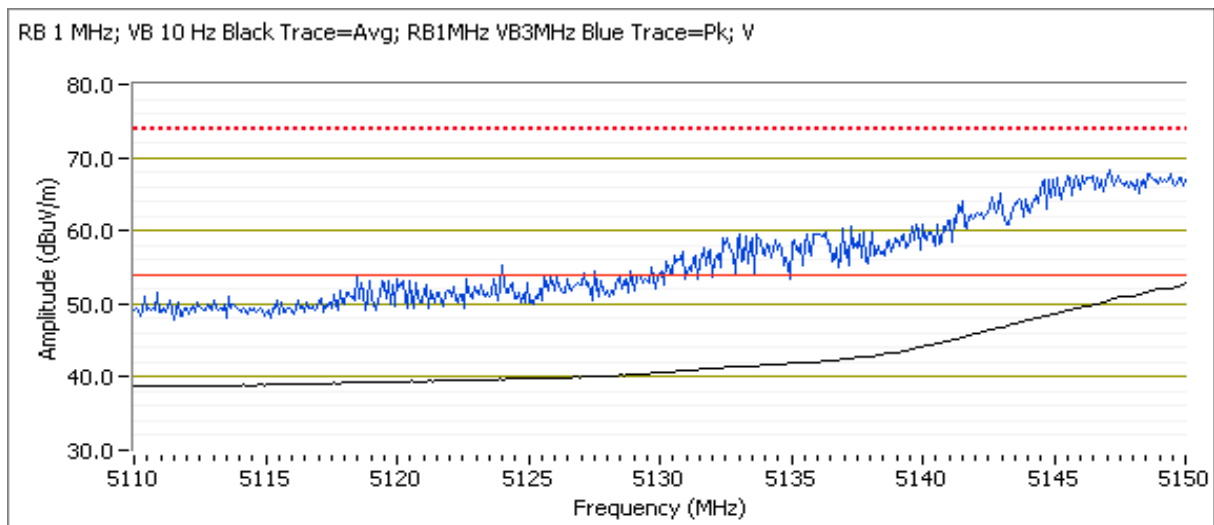



EMC Test Data

Client: Intel	Job Number: J88901
Model: Intel® Centrino® Advanced-N 6235	T-Log Number: T89578
	Account Manager: Christine Krebill
Contact: Steve Hackett	
Standard: FCC 15.247, 15.407, 15.209, RSS 210	Class: N/A

Run # 2b, EUT on Channel #64 5320MHz - 802.11n20, Chain B

Date of Test: 12/10/2012

Test Location: FT Chamber #4

Test Engineer: Rafael Varelas

Config Change: none

	Target (dBm)	Power Settings Measured (dBm)	Software Setting
Chain B	16.5	13.7	33.0

5350 MHz Band Edge Signal Radiated Field Strength

Frequency MHz	Level dBμV/m	Pol v/h	FCC 15.209		Detector Pk/QP/Avg	Azimuth degrees	Height meters	Comments
			Limit	Margin				
5350.040	52.4	V	54.0	-1.6	AVG	157	1.0	
5350.710	68.1	V	74.0	-5.9	PK	157	1.0	
5350.080	51.8	H	54.0	-2.2	AVG	118	1.0	
5352.650	65.7	H	74.0	-8.3	PK	118	1.0	

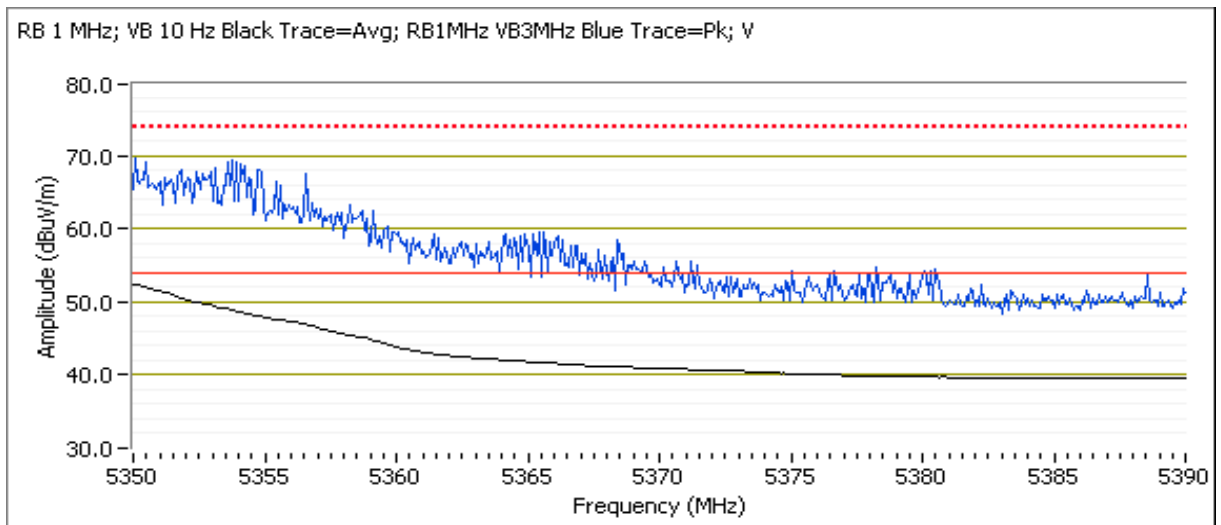



EMC Test Data

Client: Intel	Job Number: J88901
Model: Intel® Centrino® Advanced-N 6235	T-Log Number: T89578
Contact: Steve Hackett	Account Manager: Christine Krebill
Standard: FCC 15.247, 15.407, 15.209, RSS 210	Class: N/A

Run # 2c, EUT on Channel #100 5500MHz - 802.11n20, Chain B

	Target (dBm)	Power Settings Measured (dBm)	Software Setting
Chain B	16.5	13.4	31.0

5460 MHz Restricted Band Edge Signal Radiated Field Strength

Frequency	Level	Pol	FCC 15.209		Detector	Azimuth	Height	Comments
MHz	dB μ V/m	v/h	Limit	Margin	Pk/QP/Avg	degrees	meters	
5459.990	52.9	V	54.0	-1.1	AVG	261	1.0	
5457.440	70.6	V	74.0	-3.4	PK	261	1.0	
5460.000	52.1	H	54.0	-1.9	AVG	109	1.1	
5459.800	69.9	H	74.0	-4.1	PK	109	1.1	

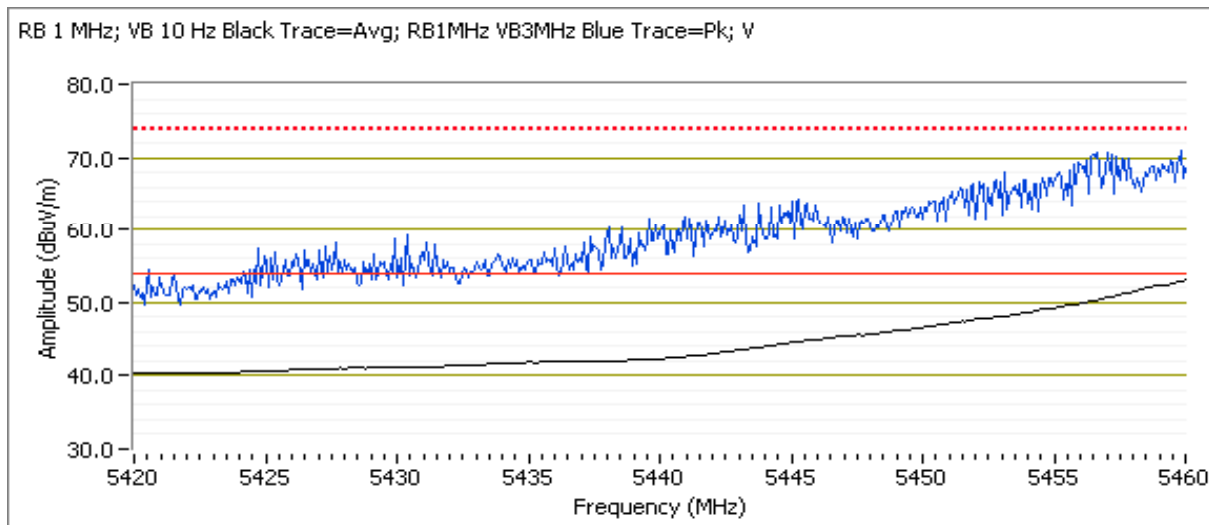

5460 - 5470 MHz Band Edge Radiated Field Strength

Frequency	Level	Pol	15.209		Detector	Azimuth	Height	Comments
MHz	dB μ V/m	v/h	Limit	Margin	Pk/QP/Avg	degrees	meters	
5469.990	51.3	V	54.0	-2.7	AVG	261	1.0	
5468.460	66.7	V	74.0	-7.3	PK	261	1.0	

For emissions in the 5460-5470MHz frequency range the limit is -27dBm/MHz eirp (68.3dBuV/m). The measurement method required is a peak measurement (RB=1MHz, VB \geq 3MHz, peak detector) or the 15.209 limits may be used.



EMC Test Data

Client:	Intel	Job Number:	J88901
Model:	Intel® Centrino® Advanced-N 6235	T-Log Number:	T89578
		Account Manager:	Christine Krebill
Contact:	Steve Hackett		
Standard:	FCC 15.247, 15.407, 15.209, RSS 210	Class:	N/A

Run # 2d, EUT on Channel #140 5700MHz - 802.11n20, Chain B

Date of Test: 12/11/2012

Test Location: FT Chamber #5

Test Engineer: Jack Liu

Config Change: none

	Target (dBm)	Power Settings	
		Measured (dBm)	Software Setting
Chain B	16.0	13.8	30.5

5725 MHz Band Edge Radiated Field Strength

Frequency MHz	Level dB μ V/m	Pol v/h	15.209		Detector Pk/QP/Avg	Azimuth degrees	Height meters	Comments
			Limit	Margin				
5725.000	52.7	H	54.0	-1.3	AVG	71	1.0	
5725.250	67.9	H	74.0	-6.1	PK	71	1.0	

For emissions immediately above 5725 MHz the limit is -27dBm/MHz eirp (68.3dBuV/m). The measurement method required is a peak measurement (RB=1MHz, VB \geq 3MHz, peak detector) or the 15.209 limits may be used.



EMC Test Data

Client:	Intel	Job Number:	J88901
Model:	Intel® Centrino® Advanced-N 6235	T-Log Number:	T89578
Contact:	Steve Hackett	Account Manager:	Christine Krebill
Standard:	FCC 15.247, 15.407, 15.209, RSS 210	Class:	N/A

Run # 3, Band Edge Field Strength - 802.11n40, Chain B

Run # 3a, EUT on Channel #38 5190MHz - 802.11n40, Chain B

Date of Test: 12/11/2012

Test Location: FT Chamber #5

Test Engineer: Jack Liu

Config Change: none

Chain B	Target (dBm)	Power Settings Measured (dBm)	Software Setting
	11.5	10.4	25.5

5150 MHz Band Edge Signal Radiated Field Strength

Frequency	Level	Pol	FCC 15.209		Detector	Azimuth	Height	Comments
MHz	dB μ V/m	v/h	Limit	Margin	Pk/QP/Avg	degrees	meters	
5150.000	52.8	V	54.0	-1.2	AVG	244	1.0	Setting 25.5
5149.680	65.5	V	74.0	-8.5	PK	244	1.0	Setting 25.5

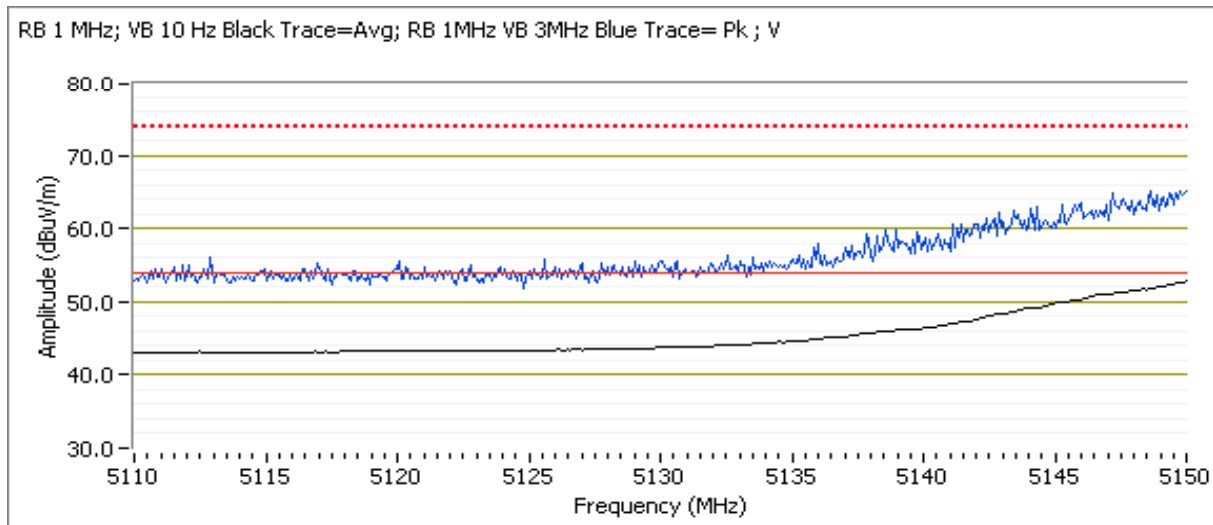



EMC Test Data

Client:	Intel	Job Number:	J88901
Model:	Intel® Centrino® Advanced-N 6235	T-Log Number:	T89578
Contact:	Steve Hackett	Account Manager:	Christine Krebill
Standard:	FCC 15.247, 15.407, 15.209, RSS 210	Class:	N/A

Run # 3b, EUT on Channel #62 5310MHz - 802.11n40, Chain B

Date of Test: 12/11/2012

Test Location: FT Chamber #5

Test Engineer: Jack Liu

Config Change: none

	Target (dBm)	Power Settings Measured (dBm)	Software Setting
Chain B	12.0	9.9	27.0

5350 MHz Band Edge Signal Radiated Field Strength

Frequency	Level	Pol	FCC 15.209		Detector	Azimuth	Height	Comments
MHz	dB μ V/m	v/h	Limit	Margin	Pk/QP/Avg	degrees	meters	
5350.000	52.7	H	54.0	-1.3	AVG	109	1.1	
5354.010	63.9	H	74.0	-10.1	PK	109	1.1	

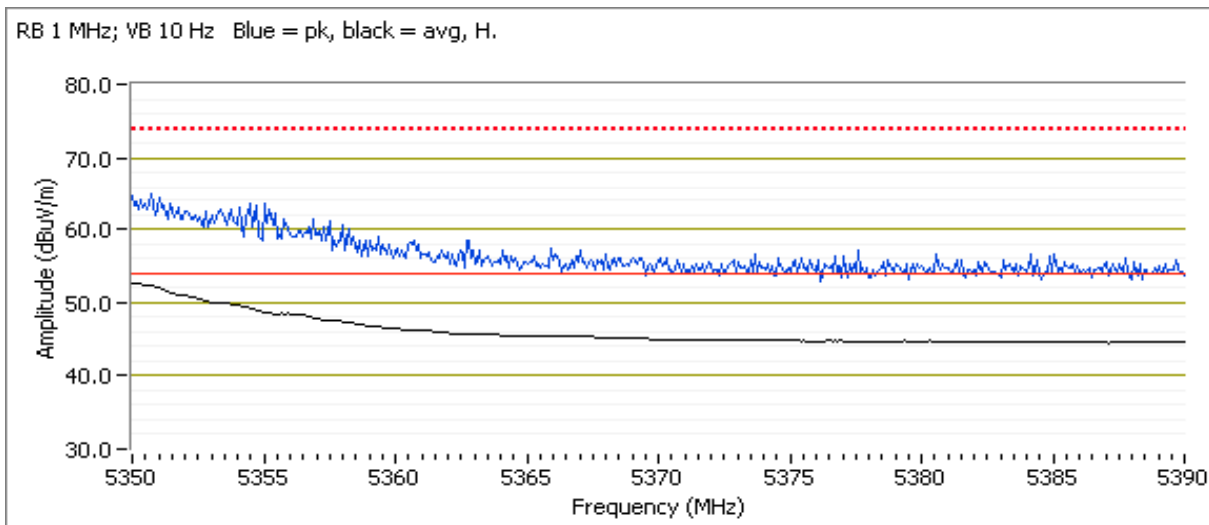



EMC Test Data

Client:	Intel	Job Number:	J88901
Model:	Intel® Centrino® Advanced-N 6235	T-Log Number:	T89578
Contact:	Steve Hackett	Account Manager:	Christine Krebill
Standard:	FCC 15.247, 15.407, 15.209, RSS 210	Class:	N/A

Run # 3c, EUT on Channel #102 5510MHz - 802.11n40, Chain B

Date of Test: 12/17/2012

Test Location: FT Chamber #5

Test Engineer: Joseph Cadigal

Config Change: none

	Power Settings		
	Target (dBm)	Measured (dBm)	Software Setting
Chain B	14.5	13.0	32.0

5460 MHz Restricted Band Edge Signal Radiated Field Strength

Frequency	Level	Pol	FCC 15.209		Detector	Azimuth	Height	Comments
MHz	dB μ V/m	v/h	Limit	Margin	Pk/QP/Avg	degrees	meters	
5460.000	52.3	V	54.0	-1.7	AVG	259	1.0	POS; RB 1 MHz; VB: 10 Hz
5459.040	63.6	V	74.0	-10.4	PK	259	1.0	POS; RB 1 MHz; VB: 3 MHz

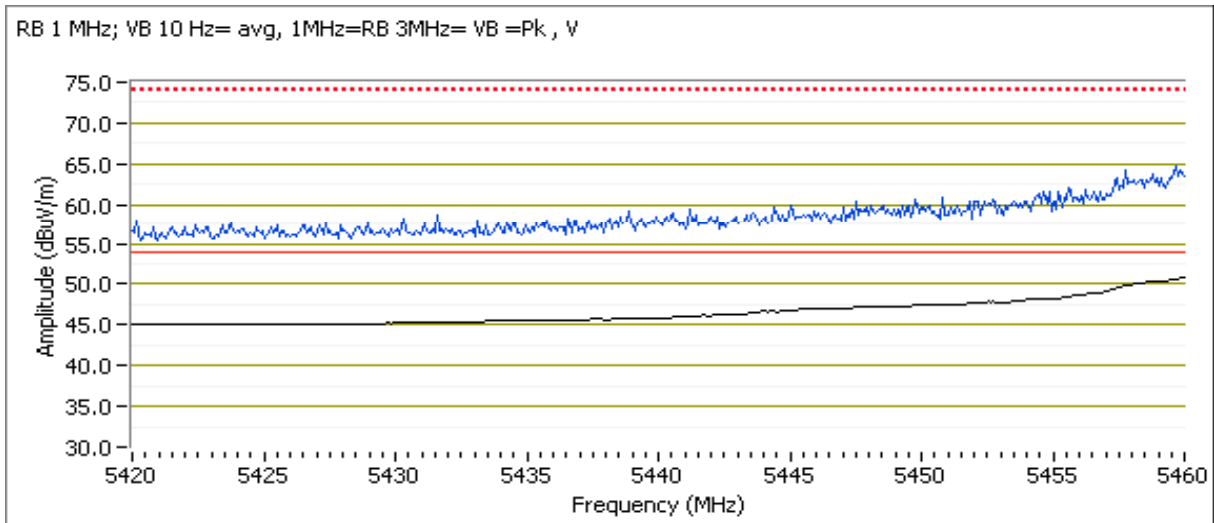



EMC Test Data

Client: Intel	Job Number: J88901
Model: Intel® Centrino® Advanced-N 6235	T-Log Number: T89578
	Account Manager: Christine Krebill
Contact: Steve Hackett	
Standard: FCC 15.247, 15.407, 15.209, RSS 210	Class: N/A

5460 - 5470 MHz Band Edge Radiated Field Strength

Frequency	Level	Pol	15 E		Detector	Azimuth	Height	Comments
MHz	dB μ V/m	v/h	Limit	Margin	PK/QP/Avg	degrees	meters	
5469.700	67.8	V	68.3	-0.5	PK	256	1.0	POS; RB 1 MHz; VB: 3 MHz

For emissions in the 5460-5470MHz frequency range the limit is -27dBm/MHz eirp (68.3dBuV/m). The measurement method required is a peak measurement (RB=1MHz, VB \geq 3MHz, peak detector).

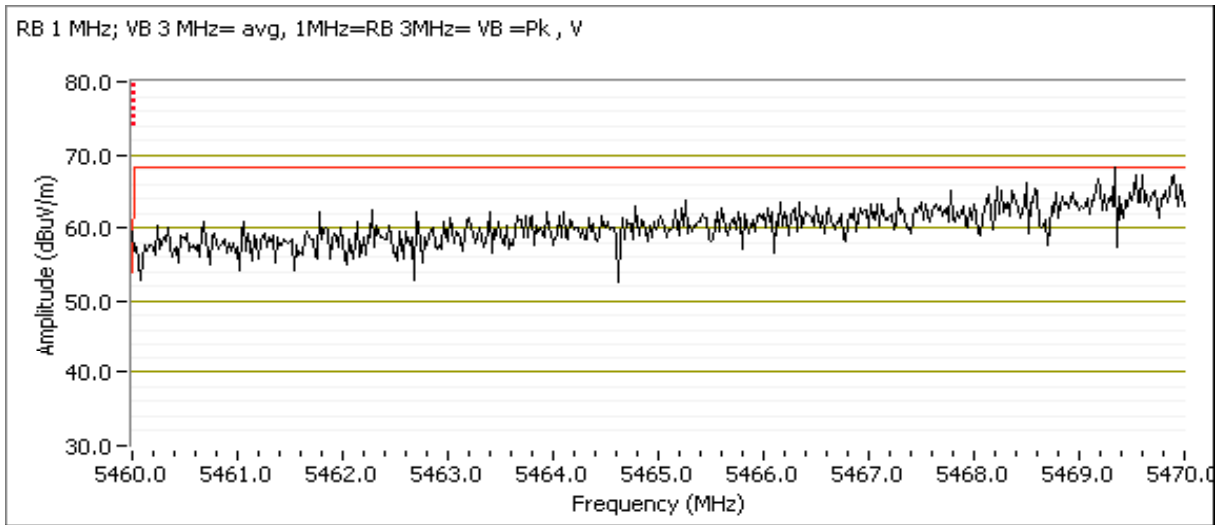



EMC Test Data

Client:	Intel	Job Number:	J88901
Model:	Intel® Centrino® Advanced-N 6235	T-Log Number:	T89578
Contact:	Steve Hackett	Account Manager:	Christine Krebill
Standard:	FCC 15.247, 15.407, 15.209, RSS 210	Class:	N/A

Run # 3d, EUT on Channel #134 5670MHz - 802.11n40, Chain B

	Target (dBm)	Power Settings Measured (dBm)	Software Setting
Chain B	16.0	14.4	38.0

5725 MHz Band Edge Radiated Field Strength

Frequency	Level	Pol	15 E		Detector	Azimuth	Height	Comments
MHz	dB μ V/m	v/h	Limit	Margin	Pk/QP/Avg	degrees	meters	
5725.250	67.9	V	68.3	-0.4	PK	203	1.0	POS; RB 1 MHz; VB: 3 MHz

For emissions immediately above 5725 MHz the limit is -27dBm/MHz eirp (68.3dBuV/m). The measurement method required is a peak measurement (RB=1MHz, VB \geq 3MHz, peak detector).that a peak measurement was made.

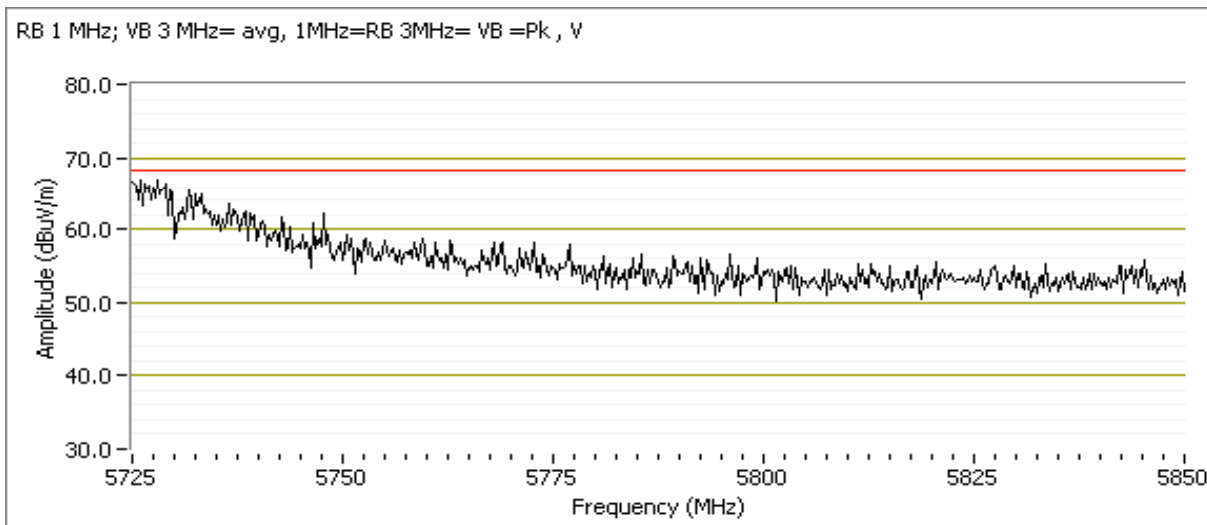



EMC Test Data

Client: Intel	Job Number: J88901
Model: Intel® Centrino® Advanced-N 6235	T-Log Number: T89578
	Account Manager: Christine Krebill
Contact: Steve Hackett	
Standard: FCC 15.247, 15.407, 15.209, RSS 210	Class: N/A

RSS 210 and FCC 15.407 (UNII) Radiated Spurious Emissions

Test Specific Details

Objective: The objective of this test session is to perform final qualification testing of the EUT with respect to the specification listed above.

General Test Configuration

The EUT and all local support equipment were located on the turntable for radiated spurious emissions testing. For radiated emissions testing the measurement antenna was located 3 meters from the EUT.

Ambient Conditions:

Temperature: 19 °C
Rel. Humidity: 40 %

Summary of Results

MAC Address: 001500B50405 DRTU Tool Version 1.5.6-0445 Driver version 15.3.1.2

Run #	Mode	Channel	Target Power	Measured Power	Test Performed	Limit	Result / Margin
Run # 1	802.11n20 Chain A+B	#36 5180MHz	A: 13.0 B: 13.0	A: 11.2 B: 12.0	Restricted Band Edge at 5150 MHz	15.209	52.6 dBµV/m @ 5150.0 MHz (-1.4 dB)
		#64 5320MHz	A: 13.5 B: 13.5	A: 13.2 B: 12.9	Restricted Band Edge at 5350 MHz		52.5 dBµV/m @ 5350.0 MHz (-1.5 dB)
		#100 5500MHz	A: 13.5 B: 13.5	A: 11.9 B: 11.8	Restricted Band Edge at 5460 MHz		52.1 dBµV/m @ 5460.0 MHz (-1.9 dB)
		#140 5700MHz	A: 13.5 B: 13.5	A: 11.9 B: 11.8	Band Edge at 5470 MHz	15 E	52.9 dBµV/m @ 5470.0 MHz (-1.1 dB)
			A: 11.5 B: 12.4	Band Edge at 5725 MHz	66.3 dBµV/m @ 5725.4 MHz (-2.0 dB)		



EMC Test Data

Client: Intel	Job Number: J88901
Model: Intel® Centrino® Advanced-N 6235	T-Log Number: T89578
Contact: Steve Hackett	Account Manager: Christine Krebill
Standard: FCC 15.247, 15.407, 15.209, RSS 210	Class: N/A

Run #	Mode	Channel	Target Power	Measured Power	Test Performed	Limit	Result / Margin
Run #2	802.11n40 Chain A+B	#38 5190MHz	A: 9.5 B: 9.5	A: 7.1 B: 8.3	Restricted Band Edge at 5150 MHz	15.209	53.0 dBµV/m @ 5150.0 MHz (-1.0 dB)
		#62 5310MHz	A: 10.0 B: 10.0	A: 10.0 B: 10.3	Restricted Band Edge at 5350 MHz		52.8 dBµV/m @ 5350.0 MHz (-1.2 dB)
		#102 5510MHz	A: 12.5 B: 12.5	A: 8.0 B: 8.4	Restricted Band Edge at 5460 MHz		52.5 dBµV/m @ 5460.0 MHz (-1.5 dB)
		15 E		A: 8.0 B: 8.4	A: 8.0 B: 8.4	Band Edge at 5470 MHz	67.7 dBµV/m @ 5469.8 MHz (-0.6 dB)
			#134 5670MHz	A: 13.5 B: 13.5	A:12.1 B:13.3	Band Edge at 5725 MHz	59.2 dBµV/m @ 5726.0 MHz (-9.1 dB)

Modifications Made During Testing

No modifications were made to the EUT during testing

Deviations From The Standard

No deviations were made from the requirements of the standard.

Test Procedure Comments:

Unless otherwise noted, average measurements above 1GHz were performed as documented in FCC KDB 789033 G) 6) d) Method VB

Note - the target and measured power are average powers (measured with average power sensor) and are used for reference purposes only. Power is set using " GAIN CONTROL" mode in the DRTU tool.

Antenna: connected
Duty Cycle: 99%



EMC Test Data

Client: Intel	Job Number: J88901
Model: Intel® Centrino® Advanced-N 6235	T-Log Number: T89578
	Account Manager: Christine Krebill
Contact: Steve Hackett	
Standard: FCC 15.247, 15.407, 15.209, RSS 210	Class: N/A

Run # 1, Band Edge Field Strength - 802.11n20, Chain A+B

Run # 1a, EUT on Channel #36, 5180MHz

Date of Test: 12/18/2012
 Test Engineer: John Caizzi

Test Location: Chamber 5
 Config Change: none

Chain	Power Settings								Software Setting
	Target (dBm)				Measured (dBm)				
	A	B	C	Total	A	B	C	Total	
	13.0	13.0		16.0	11.2	12.0		14.6	32.0, 34.0

5150 MHz Band Edge Signal Radiated Field Strength

Frequency	Level	Pol	FCC 15.209		Detector	Azimuth	Height	Comments
MHz	dB μ V/m	v/h	Limit	Margin	PK/QP/Avg	degrees	meters	
5150.000	52.6	V	54.0	-1.4	AVG	171	1.06	
5148.800	63.8	V	74.0	-10.2	PK	171	1.06	
5150.000	50.1	H	54.0	-3.9	AVG	45	1.08	
5147.760	62.3	H	74.0	-11.7	PK	45	1.08	

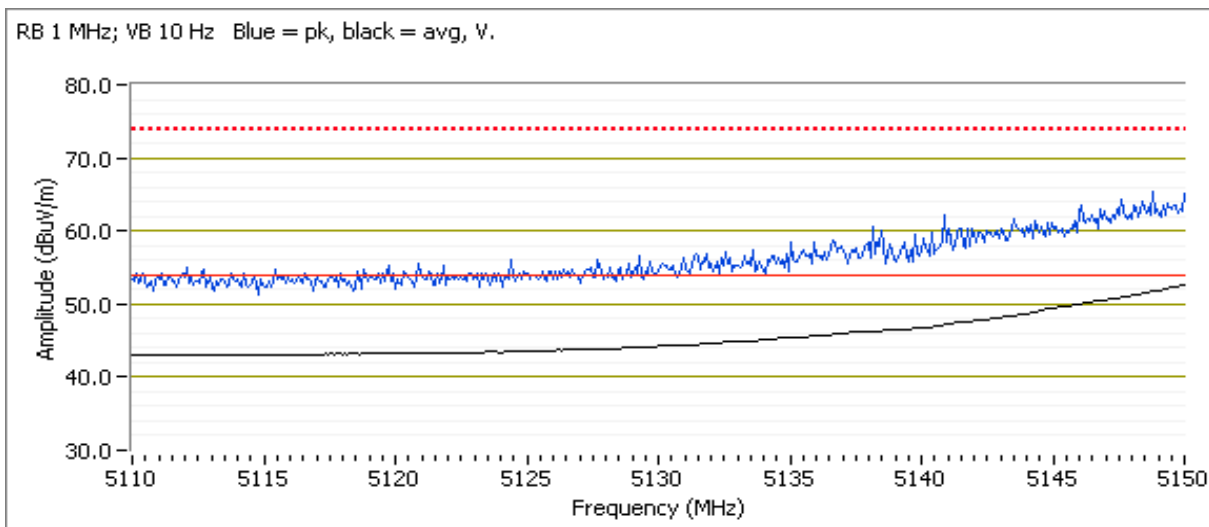



EMC Test Data

Client: Intel	Job Number: J88901
Model: Intel® Centrino® Advanced-N 6235	T-Log Number: T89578
	Account Manager: Christine Krebill
Contact: Steve Hackett	
Standard: FCC 15.247, 15.407, 15.209, RSS 210	Class: N/A

Run # 1b, EUT on Channel #64, 5320MHz.

Date of Test: 12/18/2012
 Test Engineer: John Caizzi

Test Location: Chamber 5
 Config Change: none

Chain	Target (dBm)				Power Settings Measured (dBm)				Software Setting
	A	B	C	Total	A	B	C	Total	
	13.5	13.5		16.5	13.2	12.9		16.1	36.5, 38.0

5350 MHz Band Edge Signal Radiated Field Strength

Frequency	Level	Pol	FCC 15.209		Detector	Azimuth	Height	Comments
MHz	dB μ V/m	v/h	Limit	Margin	Pk/QP/Avg	degrees	meters	
5350.000	52.5	V	54.0	-1.5	AVG	196	1.30	
5352.730	66.0	V	74.0	-8.0	PK	196	1.30	

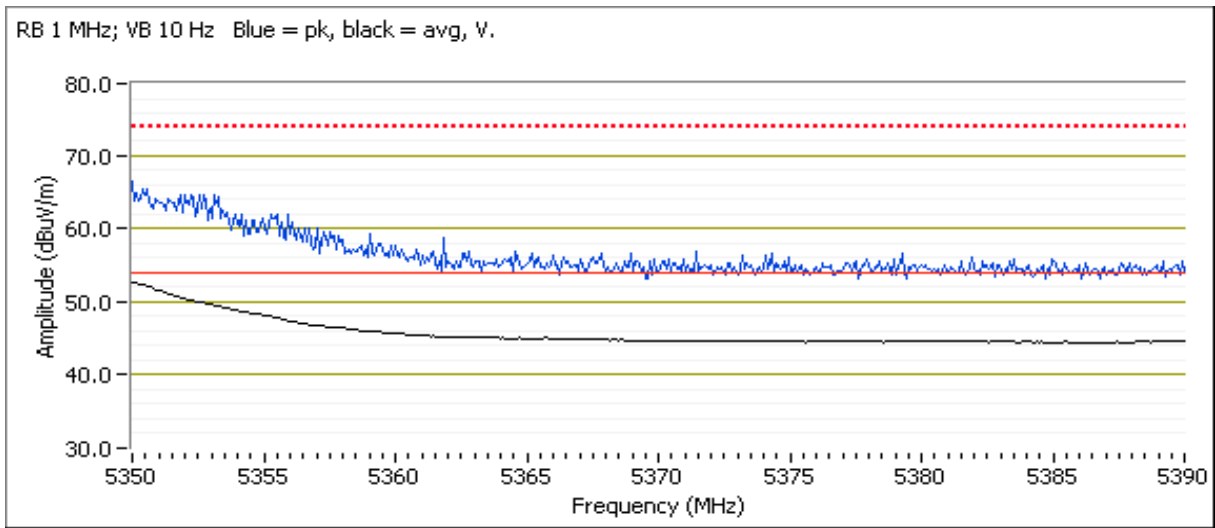



EMC Test Data

Client: Intel	Job Number: J88901
Model: Intel® Centrino® Advanced-N 6235	T-Log Number: T89578
	Account Manager: Christine Krebill
Contact: Steve Hackett	
Standard: FCC 15.247, 15.407, 15.209, RSS 210	Class: N/A

Run # 1c, EUT on Channel #100, 5500MHz.

Date of Test: 12/18/2012
 Test Engineer: John Caizzi

Test Location: Chamber 5
 Config Change: none

Chain	Power Settings								Software Setting
	Target (dBm)				Measured (dBm)				
	A	B	C	Total	A	B	C	Total	
	13.5	13.5		16.5	11.9	11.8		14.9	35.5, 34.5

5460 MHz Band Edge Radiated Field Strength

Frequency MHz	Level dB μ V/m	Pol v/h	15.209		Detector Pk/QP/Avg	Azimuth degrees	Height meters	Comments
			Limit	Margin				
5460.000	52.1	V	54.0	-1.9	AVG	134	1.40	
5459.840	65.8	V	74.0	-8.2	PK	134	1.40	
5460.000	52.1	H	54.0	-1.9	AVG	263	1.40	
5457.760	65.6	H	74.0	-8.4	PK	263	1.40	

For emissions in the restricted band immediately below 5460MHz the 15.209/RSS GEN limits apply.

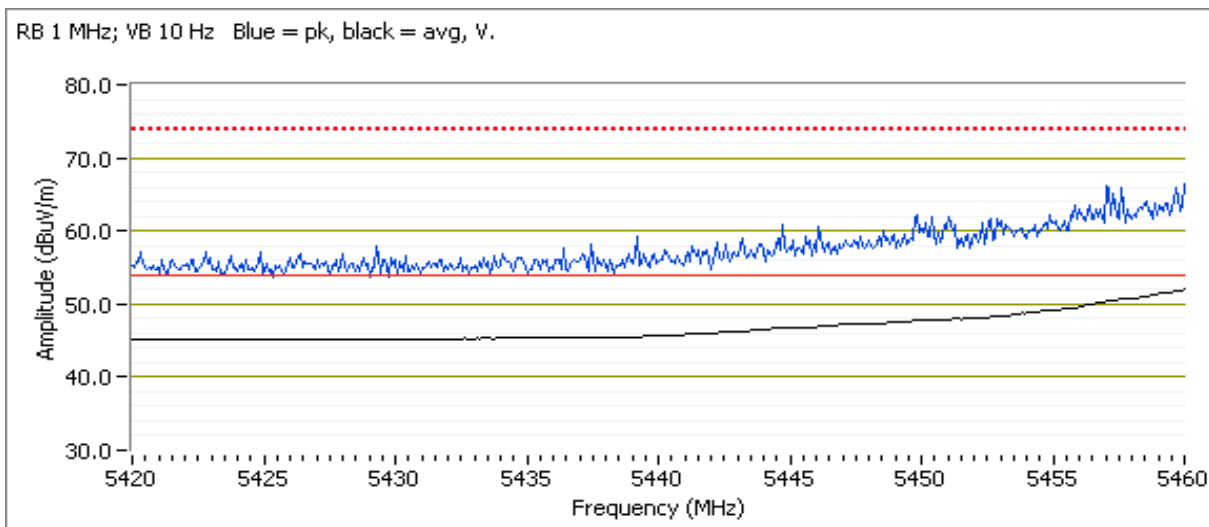



EMC Test Data

Client: Intel	Job Number: J88901
Model: Intel® Centrino® Advanced-N 6235	T-Log Number: T89578
	Account Manager: Christine Krebill
Contact: Steve Hackett	
Standard: FCC 15.247, 15.407, 15.209, RSS 210	Class: N/A

5460 - 5470 MHz Band Edge Radiated Field Strength

Frequency	Level	Pol	15 E		Detector	Azimuth	Height	Comments
MHz	dB μ V/m	v/h	Limit	Margin	Pk/QP/Avg	degrees	meters	
5469.840	67.1	V	68.3	-1.2	PK	130	1.40	

For emissions in the 5460-5470MHz frequency range, the limit is -27dBm/MHz eirp (68.3dBuV/m). This is a peak limit & the measurement method is RBW = 1 MHz, VBW > RBW or the restricted band limits of 15.209 may be used.

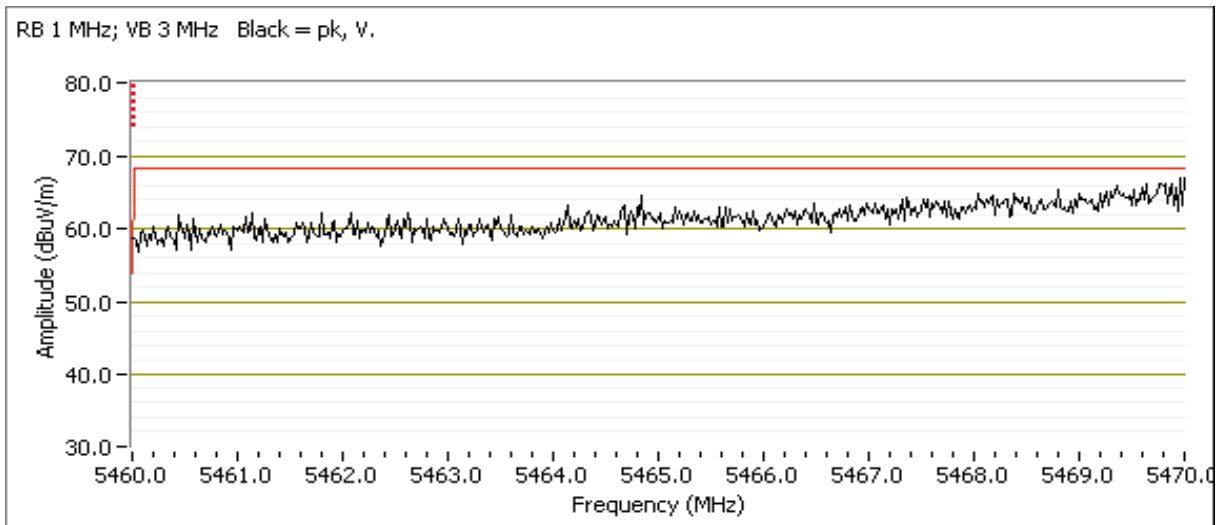



EMC Test Data

Client: Intel	Job Number: J88901
Model: Intel® Centrino® Advanced-N 6235	T-Log Number: T89578
	Account Manager: Christine Krebill
Contact: Steve Hackett	
Standard: FCC 15.247, 15.407, 15.209, RSS 210	Class: N/A

Run # 1d, EUT on Channel #140, 5700MHz.

Date of Test: 12/18/2012
 Test Engineer: John Caizzi

Test Location: Chamber 5
 Config Change: none

Chain	Power Settings								Software Setting
	Target (dBm)				Measured (dBm)				
	A	B	C	Total	A	B	C	Total	
	13.5	13.5		16.5	11.5	12.4		15.0	36.5, 36.5

5725 MHz Band Edge Radiated Field Strength

Frequency	Level	Pol	15 E		Detector	Azimuth	Height	Comments
MHz	dB μ V/m	v/h	Limit	Margin	Pk/QP/Avg	degrees	meters	
5725.400	66.3	V	68.3	-2.0	PK	127	1.37	36.5, 36.5, 15E

For emissions in the 5460-5470MHz frequency range, the limit is -27dBm/MHz eirp (68.3dBuV/m). This is a peak limit & the measurement method is RBW = 1 MHz, VBW > RBW or the restricted band limits of 15.209 may be used.

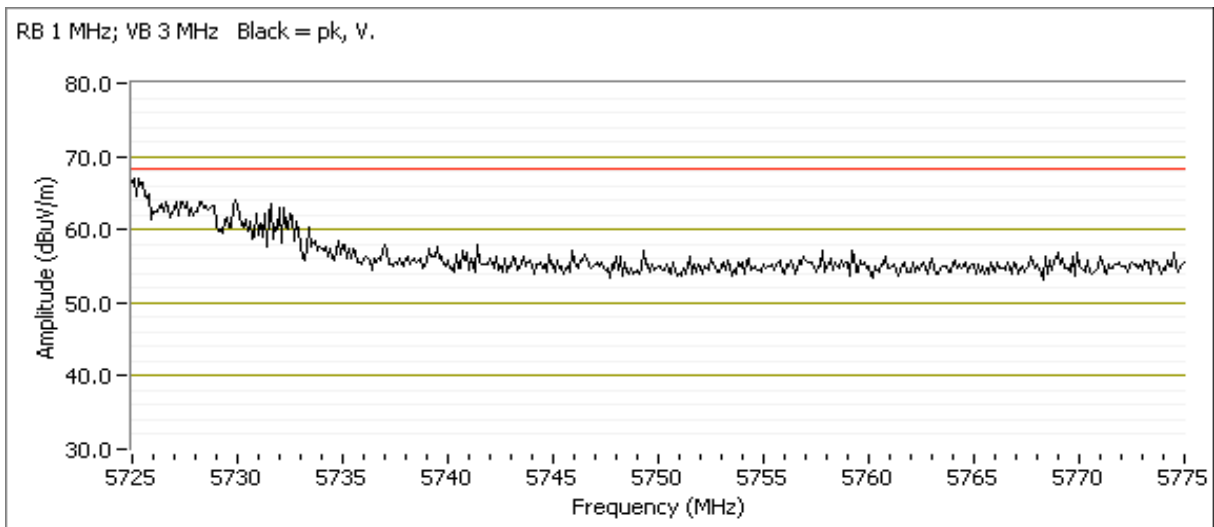



EMC Test Data

Client: Intel	Job Number: J88901
Model: Intel® Centrino® Advanced-N 6235	T-Log Number: T89578
	Account Manager: Christine Krebill
Contact: Steve Hackett	
Standard: FCC 15.247, 15.407, 15.209, RSS 210	Class: N/A

Run #2, Band Edge Field Strength - 802.11n40, Chain A+B

Run #2a, EUT on Channel #38, 5190MHz.

Date of Test: 12/18/2012
 Test Engineer: John Caizzi

Test Location: Chamber 5
 Config Change: none

Chain	Power Settings								
	Target (dBm)				Measured (dBm)				Software Setting
	A	B	C	Total	A	B	C	Total	
	9.5	9.5		12.5	7.1	8.3		10.8	27.5, 29.5

5150 MHz Band Edge Signal Radiated Field Strength

Frequency	Level	Pol	FCC 15.209		Detector	Azimuth	Height	Comments
MHz	dB μ V/m	v/h	Limit	Margin	PK/QP/Avg	degrees	meters	
5150.000	53.0	V	54.0	-1.0	AVG	155	1.40	
5150.000	66.7	V	74.0	-7.3	PK	155	1.40	
5150.000	49.9	H	54.0	-4.1	AVG	129	1.38	
5148.080	63.5	H	74.0	-10.5	PK	129	1.38	

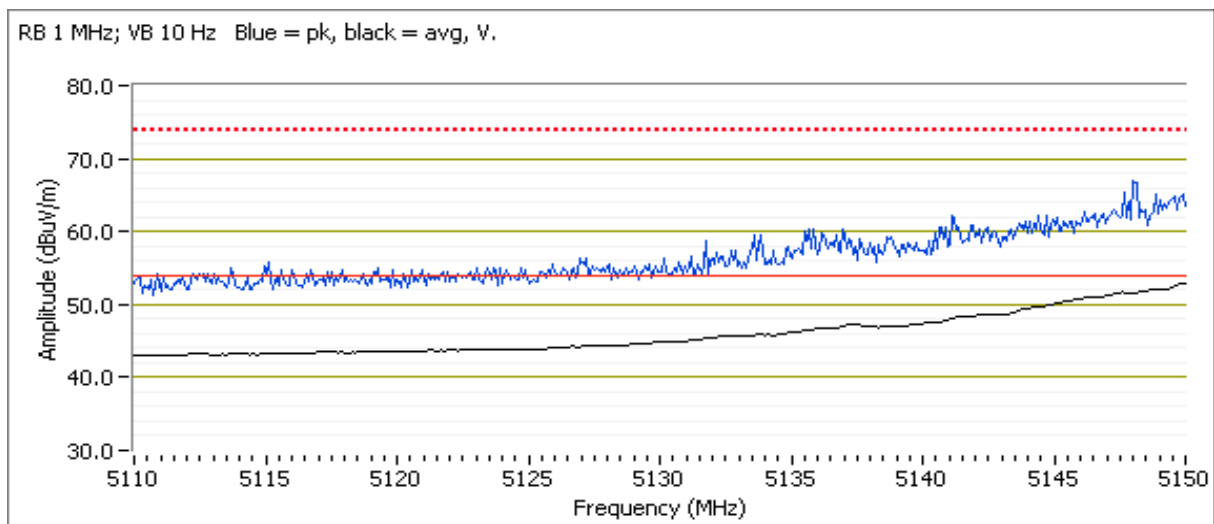



EMC Test Data

Client: Intel	Job Number: J88901
Model: Intel® Centrino® Advanced-N 6235	T-Log Number: T89578
	Account Manager: Christine Krebill
Contact: Steve Hackett	
Standard: FCC 15.247, 15.407, 15.209, RSS 210	Class: N/A

Run #2b, EUT on Channel #62, 5310MHz.

Date of Test: 12/18/2012
 Test Engineer: John Caizzi

Test Location: Chamber 5
 Config Change: none

Chain	Power Settings								Software Setting
	Target (dBm)				Measured (dBm)				
	A	B	C	Total	A	B	C	Total	
	10.0	10.0		13.0	10.0	10.3		13.2	32.0, 33.5

5350 MHz Band Edge Signal Radiated Field Strength

Frequency	Level	Pol	FCC 15.209		Detector	Azimuth	Height	Comments
MHz	dB μ V/m	v/h	Limit	Margin	Pk/QP/Avg	degrees	meters	
5350.000	52.8	V	54.0	-1.2	AVG	213	1.39	
5350.240	67.1	V	74.0	-6.9	PK	213	1.39	

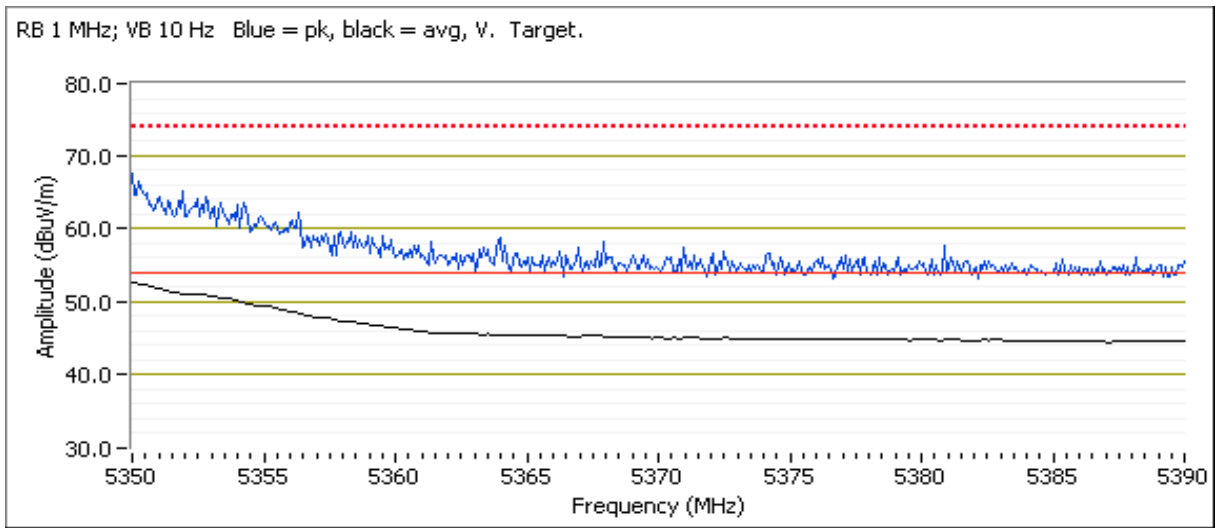



EMC Test Data

Client: Intel	Job Number: J88901
Model: Intel® Centrino® Advanced-N 6235	T-Log Number: T89578
	Account Manager: Christine Krebill
Contact: Steve Hackett	
Standard: FCC 15.247, 15.407, 15.209, RSS 210	Class: N/A

Run #2c, EUT on Channel #102, 5510MHz.

Chain	Target (dBm)				Power Settings Measured (dBm)				Software Setting
	A	B	C	Total	A	B	C	Total	
	12.5	12.5		15.5	8.0	8.4		11.2	32.0, 31.0

5460 MHz Band Edge Radiated Field Strength

Frequency	Level	Pol	15.209		Detector	Azimuth	Height	Comments
MHz	dB μ V/m	v/h	Limit	Margin	Pk/QP/Avg	degrees	meters	
5460.000	52.5	V	54.0	-1.5	AVG	131	1.41	
5458.960	66.2	V	74.0	-7.8	PK	131	1.41	

For emissions in the restricted band immediately below 5460 MHz, the 15.209/RSS GEN limits apply.

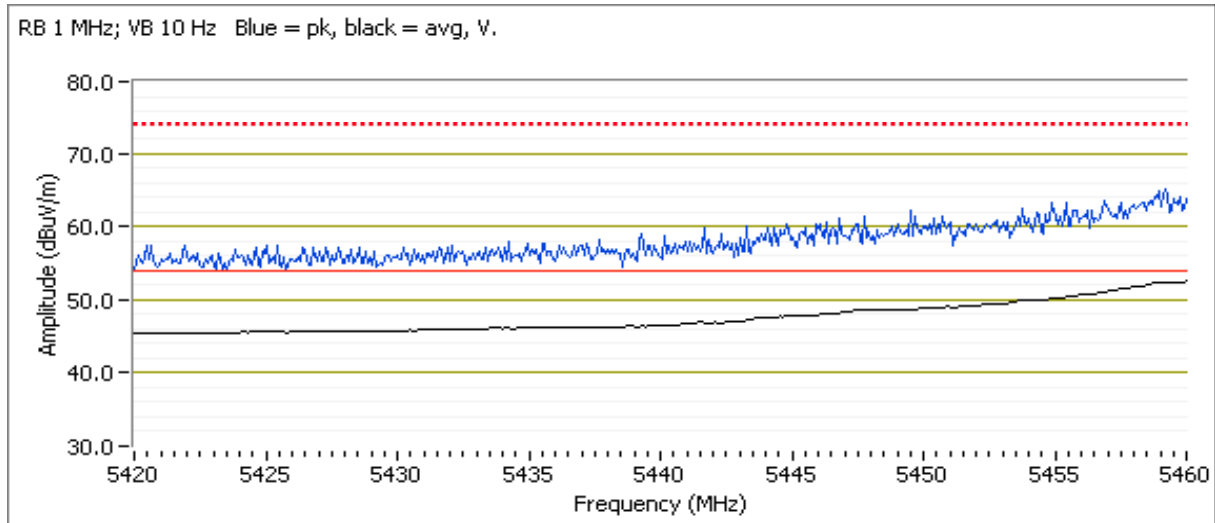



EMC Test Data

Client: Intel	Job Number: J88901
Model: Intel® Centrino® Advanced-N 6235	T-Log Number: T89578
	Account Manager: Christine Krebill
Contact: Steve Hackett	
Standard: FCC 15.247, 15.407, 15.209, RSS 210	Class: N/A

5460 - 5470 MHz Band Edge Radiated Field Strength

Frequency	Level	Pol	15 E		Detector	Azimuth	Height	Comments
MHz	dB μ V/m	v/h	Limit	Margin	Pk/QP/Avg	degrees	meters	
5469.760	67.7	H	68.3	-0.6	PK	360	1.0	32,31

For emissions in the 5460-5470MHz frequency range, the limit is -27dBm/MHz eirp (68.3dBuV/m). This is a peak limit & the measurement method is RBW = 1 MHz, VBW > RBW or the restricted band limits of 15.209 may be used.

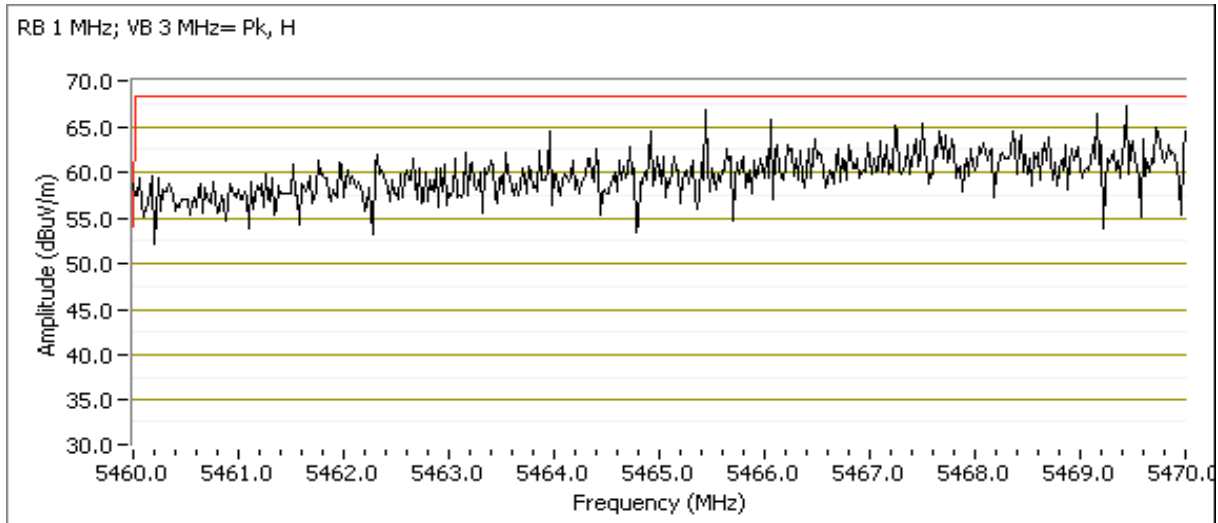



EMC Test Data

Client: Intel	Job Number: J88901
Model: Intel® Centrino® Advanced-N 6235	T-Log Number: T89578
	Account Manager: Christine Krebill
Contact: Steve Hackett	
Standard: FCC 15.247, 15.407, 15.209, RSS 210	Class: N/A

Run #2d, EUT on Channel #134 5670MHz - 802.11n40, Chain A+B

Chain	Power Settings								Software Setting
	Target (dBm)				Measured (dBm)				
	A	B	C	Total	A	B	C	Total	
	13.5	13.5		16.5	12.1	13.3		15.8	39.0, 39.0

5725 MHz Band Edge Radiated Field Strength

Frequency	Level	Pol	15 E		Detector	Azimuth	Height	Comments
MHz	dB μ V/m	v/h	Limit	Margin	Pk/QP/Avg	degrees	meters	
5726.000	59.2	H	68.3	-9.1	PK	56	1.0	POS; RB 1 MHz; VB: 3 MHz
5727.500	58.8	V	68.3	-9.5	PK	209	1.0	POS; RB 1 MHz; VB: 3 MHz

For emissions in the 5460-5470MHz frequency range, the limit is -27dBm/MHz eirp (68.3dBuV/m). This is a peak limit & the measurement method is RBW = 1 MHz, VBW > RBW or the restricted band limits of 15.209 may be used.

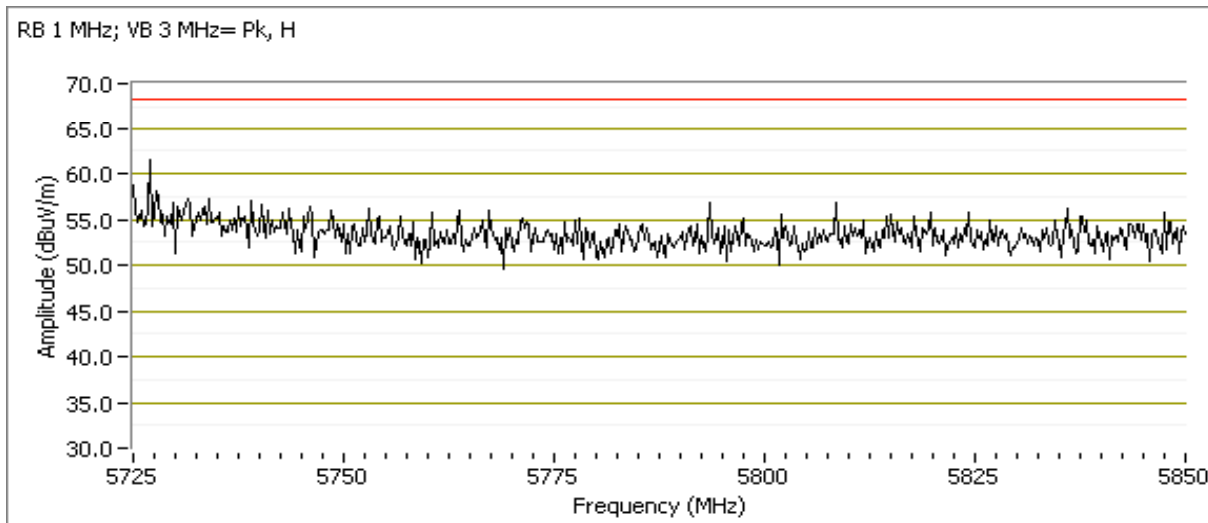



EMC Test Data

Client:	Intel	Job Number:	J88901
Model:	Intel® Centrino® Advanced-N 6235	T-Log Number:	T89578
Contact:	Steve Hackett	Account Manager:	Christine Krebill
Standard:	FCC 15.247, 15.407, 15.209, RSS 210	Class:	N/A

RSS 210 and FCC 15.407 (UNII) Radiated Spurious Emissions

Test Specific Details

Objective: The objective of this test session is to perform final qualification testing of the EUT with respect to the specification listed above.

General Test Configuration

The EUT and all local support equipment were located on the turntable for radiated spurious emissions testing. For radiated emissions testing the measurement antenna was located 3 meters from the EUT.

Ambient Conditions:

Temperature: 20 °C
Rel. Humidity: 40 %

Summary of Results

MAC Address: 001500B50405 DRTU Tool Version 1.5.6-0445 Driver version 15.3.1.2

Run #	Mode	Channel	Target Power	Measured Power	Test Performed	Limit	Result / Margin
Run #1	802.11a Chain A	#40 5200MHz	16.0	16.1	Radiated Emissions, 1 - 40 GHz	FCC 15.209 / 15 E	52.6 dBµV/m @ 1245.2 MHz (-15.7 dB)
	802.11a Chain B	#40 5200MHz	16.0	16.1			51.3 dBµV/m @ 1247.2 MHz (-17.0 dB)
	n20 Chain A+B	#40 5200MHz	A: 16.0 B: 16.0	A: 14.3 B: 13.5			57.1 dBµV/m @ 10400.8 MHz (-11.2 dB)
	n40 Chain A+B	#38 5190MHz	A: 16.0 B: 16.0	A: 13.9 B: 13.1			58.4 dBµV/m @ 10380.1 MHz (-9.9 dB)
	Worst case mode - top and bottom channels. As the worst case mode was 802.11n 40MHz, 5180MHz, with no "low channel", 5180 MHz in n20 mode was evaluated for the low channel and n40 5230MHz evaluated as high channel.						
	n20 Chain A+B	#36 5180MHz	A: 16.0 B: 16.0	A: 14.2 B: 13.6	Radiated Emissions, 1 - 40 GHz	FCC 15.209 / 15.247	45.7 dBµV/m @ 15538.9 MHz (-8.3 dB)
	n40 Chain A+B	#46 5230MHz	A: 16.0 B: 16.0	A: 13.8 B: 12.9			59.1 dBµV/m @ 10460.2 MHz (-9.2 dB)



EMC Test Data

Client:	Intel	Job Number:	J88901
Model:	Intel® Centrino® Advanced-N 6235	T-Log Number:	T89578
Contact:	Steve Hackett	Account Manager:	Christine Krebill
Standard:	FCC 15.247, 15.407, 15.209, RSS 210	Class:	N/A

Run #2	802.11a Chain A	#60 5300MHz	16.0	15.9	Radiated Emissions, 1 - 40 GHz	FCC 15.209 / 15 E	41.8 dBµV/m @ 10625.1 MHz (-12.2 dB)	
	802.11a Chain B	#60 5300MHz	16.0	16.0			43.2 dBµV/m @ 10600.1 MHz (-10.8 dB)	
	n20 Chain A+B	#60 5300MHz	A: 16.0 B: 16.0	A: 14.2 B: 13.2			45.3 dBµV/m @ 10601.2 MHz (-8.7 dB)	
	n40 Chain A+B	#62 5310MHz	A: 16.0 B: 16.0	A: 13.9 B: 13.0			45.3 dBµV/m @ 10619.7 MHz (-8.7 dB)	
	Worst case mode (802.11n20) - top and bottom channels.							
	802.11n20 Chain A + B	#52 5260MHz	A: 16.0 B: 16.0	A: 14.3 B: 14.6	Radiated Emissions, 1 - 40 GHz	FCC 15.209 / 15.247	55.6 dBµV/m @ 10520.5 MHz (-12.7 dB)	
	#64 5320MHz	A: 16.5 B: 16.5	A: 14.3 B: 13.3	44.2 dBµV/m @ 10639.9 MHz (-9.8 dB)				
Run #3	802.11a Chain A	#116 5580MHz	16.0	16.1	Radiated Emissions, 1 - 40 GHz	FCC 15.209 / 15 E	55.0 dBµV/m @ 1194.7 MHz (-19.0 dB)	
	802.11a Chain B	#116 5580MHz	16.0	16.0			54.7 dBµV/m @ 1195.7 MHz (-19.3 dB)	
	n20 Chain A+B	#116 5580MHz	A: 16.0 B: 16.0	A: 12.8 B: 13.9			44.4 dBµV/m @ 11159.9 MHz (-9.6 dB)	
	n40 Chain A+B	#110 5550MHz	A: 16.0 B: 16.0	A: 12.4 B: 13.5			42.5 dBµV/m @ 11100.1 MHz (-11.5 dB)	
	Worst case mode (802.11n20) - top and bottom channels.							
	802.11n20 Chain A+B	#100 5550MHz	A: 16.5 B: 16.5	A: 13.0 B: 13.4	Radiated Emissions, 1 - 40 GHz	FCC 15.209 / 15.247	41.2 dBµV/m @ 10999.3 MHz (-12.8 dB)	
	#140 5700MHz	A: 16.0 B: 16.0	A: 12.3 B: 13.0	42.4 dBµV/m @ 11400.2 MHz (-11.6 dB)				



EMC Test Data

Client:	Intel	Job Number:	J88901
Model:	Intel® Centrino® Advanced-N 6235	T-Log Number:	T89578
		Account Manager:	Christine Krebill
Contact:	Steve Hackett		
Standard:	FCC 15.247, 15.407, 15.209, RSS 210	Class:	N/A

Modifications Made During Testing

No modifications were made to the EUT during testing

Deviations From The Standard

No deviations were made from the requirements of the standard.

Note - the target and measured power are average powers (measured with average power sensor) and are used for reference purposes only. Power is set using " GAIN CONTROL" mode in the DRTU tool.

Test Procedure Comments:

Unless otherwise noted, average measurements above 1GHz were performed as documented in FCC KDB 789033 G) 6) d) Method VB

Antenna: antenna connected.
Duty Cycle: 99%



EMC Test Data

Client:	Intel	Job Number:	J88901
Model:	Intel® Centrino® Advanced-N 6235	T-Log Number:	T89578
Contact:	Steve Hackett	Account Manager:	Christine Krebill
Standard:	FCC 15.247, 15.407, 15.209, RSS 210	Class:	N/A

Run #1, Radiated Spurious Emissions, Center Channel 5.2GHz band, 1-40GHz, 802.11a, n20 and n40
 Date of Test: 12/18/2012 Test Location: FT Chamber#5
 Test Engineer: Joseph Cadigal Config Change: none

Run #1a: EUT on Channel #40 5200MHz 802.11a, Chain A

	Target (dBm)	Power Settings Measured (dBm)	Software Setting
Chain A	16.0	16.1	32.5

Spurious Radiated Emissions:

Frequency	Level	Pol	15.209 / 15E		Detector	Azimuth	Height	Comments
MHz	dB μ V/m	v/h	Limit	Margin	Pk/QP/Avg	degrees	meters	
1245.210	52.6	V	68.3	-15.7	PK	239	1.0	RB 1 MHz;VB 3 MHz;Peak
3174.430	41.7	H	68.3	-26.6	PK	129	2.0	RB 1 MHz;VB 3 MHz;Peak

- Note 1: For emissions in restricted bands, the limit of 15.209 was used which requires average and peak measurements.
- Note 2: For emissions outside of the restricted bands the limit is -27dBm/MHz eirp (68.3dBuV/m). The measurement method required is a peak measurement (RB=1MHz, VB \geq 3MHz, peak detector).
- Note 3: Scans made between 18 - 40GHz with the measurement antenna moved around the card and its antennas 20-50cm from the device indicated there were no significant emissions in this frequency range

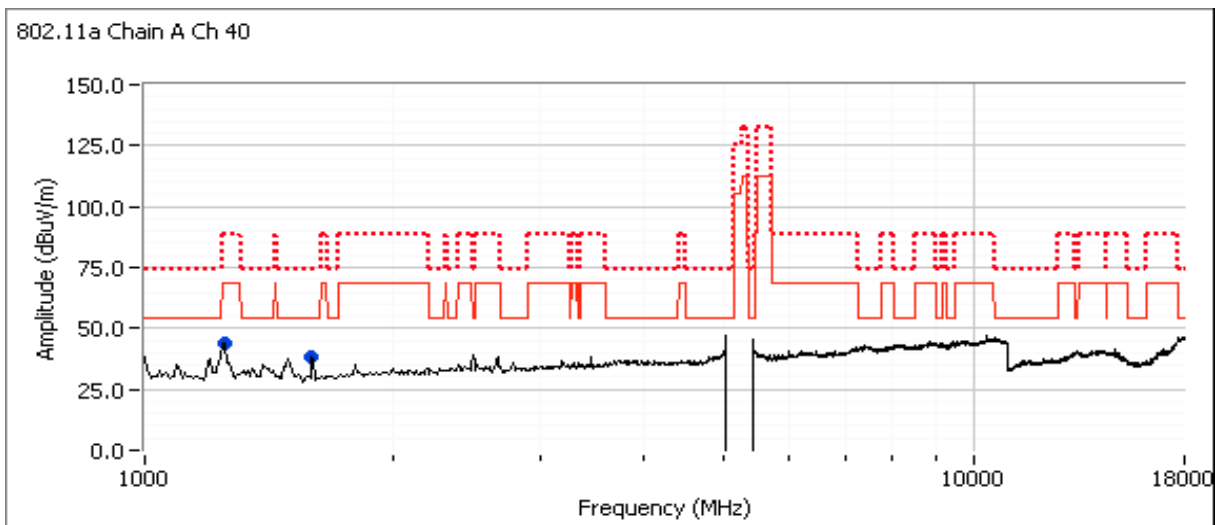



EMC Test Data

Client:	Intel	Job Number:	J88901
Model:	Intel® Centrino® Advanced-N 6235	T-Log Number:	T89578
Contact:	Steve Hackett	Account Manager:	Christine Krebill
Standard:	FCC 15.247, 15.407, 15.209, RSS 210	Class:	N/A

Run #1b: EUT on Channel #40 5200MHz 802.11a, Chain B

	Power Settings		
	Target (dBm)	Measured (dBm)	Software Setting
Chain B	16.0	16.1	37.0

Spurious Radiated Emissions:

Frequency MHz	Level dB μ V/m	Pol v/h	15.209 / 15E		Detector Pk/QP/Avg	Azimuth degrees	Height meters	Comments
			Limit	Margin				
1247.150	51.3	H	68.3	-17.0	PK	98	1.5	1Hz;VB 3 MHz;Peak
1593.940	30.0	V	54.0	-24.0	AVG	75	2.0	1Hz;VB 10 Hz;Peak
1594.270	43.5	V	74.0	-30.5	PK	75	2.0	1Hz;VB 3 MHz;Peak

- Note 1: For emissions in restricted bands, the limit of 15.209 was used which requires average and peak measurements.
- Note 2: For emissions outside of the restricted bands the limit is -27dBm/MHz eirp (68.3dB μ V/m). The measurement method required is a peak measurement (RB=1MHz, VB \geq 3MHz, peak detector).
- Note 3: Scans made between 18 - 40GHz with the measurement antenna moved around the card and its antennas 20-50cm from the device indicated there were no significant emissions in this frequency range

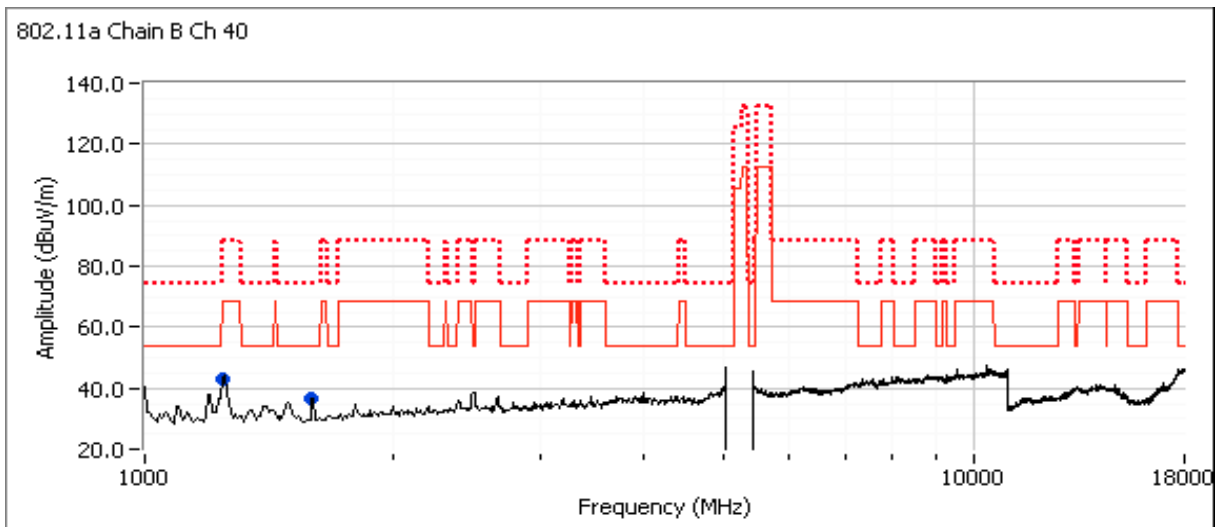



EMC Test Data

Client:	Intel	Job Number:	J88901
Model:	Intel® Centrino® Advanced-N 6235	T-Log Number:	T89578
Contact:	Steve Hackett	Account Manager:	Christine Krebill
Standard:	FCC 15.247, 15.407, 15.209, RSS 210	Class:	N/A

Run #1c: EUT on Channel #40 5200MHz n20 Chain A+B

Chain	Target (dBm)				Power Settings Measured (dBm)				Software Setting
	1	2	3	Total	1	2	3	Total	
	16.0	16.0		19.0	14.3	13.5		16.9	39.0, 39.0

Spurious Radiated Emissions:

Frequency	Level	Pol	15.209 / 15E		Detector	Azimuth	Height	Comments
MHz	dB μ V/m	v/h	Limit	Margin	Pk/QP/Avg	degrees	meters	
10400.070	55.5	H	68.3	-12.8	PK	224	1.3	RB 1 MHz;VB 3 MHz;Peak
10400.800	57.1	V	68.3	-11.2	PK	257	1.3	RB 1 MHz;VB 3 MHz;Peak
1194.460	52.4	V	74.0	-21.6	PK	223	1.0	RB 1 MHz;VB 3 MHz;Peak
1195.320	32.3	V	54.0	-21.7	AVG	223	1.0	RB 1 MHz;VB 10 Hz;Peak
1593.870	32.2	V	54.0	-21.8	AVG	354	1.0	RB 1 MHz;VB 10 Hz;Peak
1592.370	46.9	V	74.0	-27.1	PK	354	1.0	RB 1 MHz;VB 3 MHz;Peak

- Note 1: For emissions in restricted bands, the limit of 15.209 was used which requires average and peak measurements.
- Note 2: For emissions outside of the restricted bands the limit is -27dBm/MHz eirp (68.3dBuV/m). The measurement method required is a peak measurement (RB=1MHz, VB≥3MHz, peak detector).
- Note 3: Scans made between 18 - 40GHz with the measurement antenna moved around the card and its antennas 20-50cm from the device indicated there were no significant emissions in this frequency range

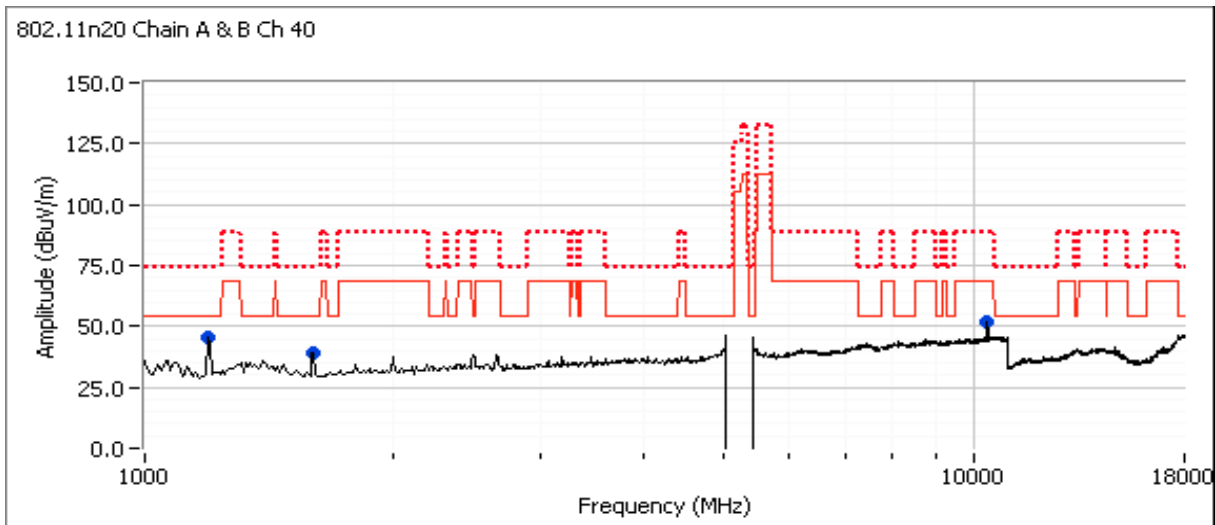



EMC Test Data

Client:	Intel	Job Number:	J88901
Model:	Intel® Centrino® Advanced-N 6235	T-Log Number:	T89578
Contact:	Steve Hackett	Account Manager:	Christine Krebill
Standard:	FCC 15.247, 15.407, 15.209, RSS 210	Class:	N/A

Run #1d: EUT on Channel #38 5190MHz n40 Chain A+B

Chain	Target (dBm)				Power Settings Measured (dBm)				Software Setting
	1	2	3	Total	1	2	3	Total	
	16.0	16.0		19.0	13.9	13.1		16.5	39.0, 39.0

Spurious Radiated Emissions:

Frequency	Level	Pol	15.209 / 15E		Detector	Azimuth	Height	Comments
MHz	dB μ V/m	v/h	Limit	Margin	Pk/QP/Avg	degrees	meters	
10380.130	58.4	V	68.3	-9.9	PK	148	1.00	RB 1 MHz;VB 3 MHz;Peak
10380.000	55.8	H	68.3	-12.5	PK	148	1.00	RB 1 MHz;VB 3 MHz;Peak
1194.520	52.0	V	74.0	-22.0	PK	160	1.0	RB 1 MHz;VB 3 MHz;Peak
1195.180	31.3	V	54.0	-22.7	AVG	160	1.0	RB 1 MHz;VB 10 Hz;Peak
1588.560	28.0	V	54.0	-26.0	AVG	326	1.0	RB 1 MHz;VB 10 Hz;Peak
1588.030	38.9	V	74.0	-35.1	PK	326	1.0	RB 1 MHz;VB 3 MHz;Peak

- Note 1: For emissions in restricted bands, the limit of 15.209 was used which requires average and peak measurements.
- Note 2: For emissions outside of the restricted bands the limit is -27dBm/MHz eirp (68.3dBuV/m). The measurement method required is a peak measurement (RB=1MHz, VB≥3MHz, peak detector).
- Note 3: Scans made between 18 - 40GHz with the measurement antenna moved around the card and its antennas 20-50cm from the device indicated there were no significant emissions in this frequency range

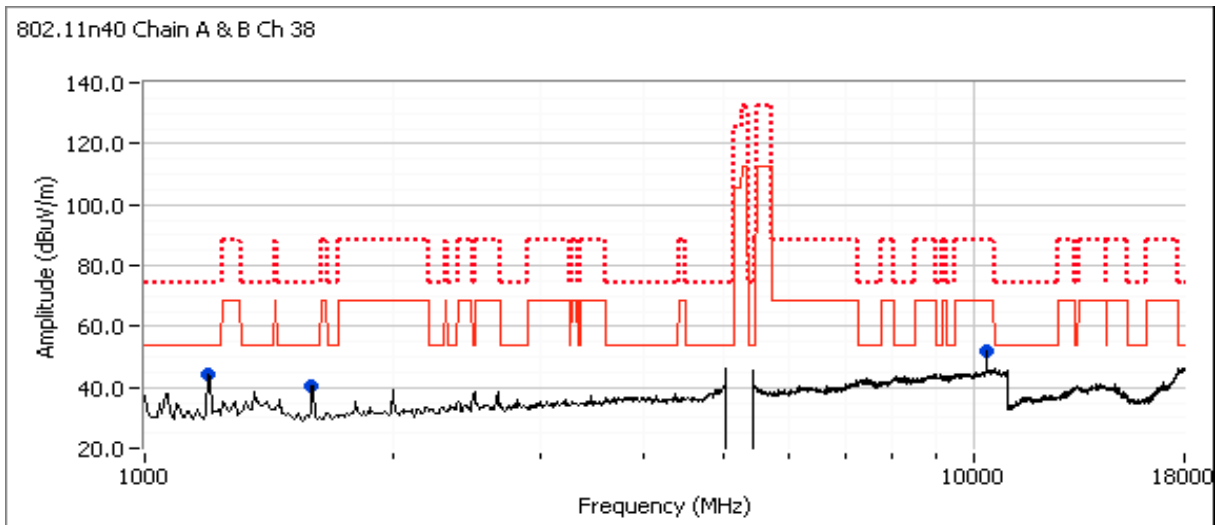

Client:	Intel	Job Number:	J88901
Model:	Intel® Centrino® Advanced-N 6235	T-Log Number:	T89578
Contact:	Steve Hackett	Account Manager:	Christine Krebill
Standard:	FCC 15.247, 15.407, 15.209, RSS 210	Class:	N/A

Run #1e: EUT on Channel #36 5180MHz Mode - 802.11n20, Chain A+B

Chain	Target (dBm)				Power Settings Measured (dBm)				Software Setting
	1	2	3	Total	1	2	3	Total	
		16.0	16.0		19.0	14.2	13.6		16.9

Spurious Radiated Emissions:

Frequency	Level	Pol	15.209 / 15E		Detector	Azimuth	Height	Comments
MHz	dB μ V/m	v/h	Limit	Margin	Pk/QP/Avg	degrees	meters	
10360.270	58.3	V	68.3	-10.0	PK	152	1.72	39.0, 39.0
1191.670	43.5	V	54.0	-10.5	PK	223	1.0	39.0, 39.0, not radio related.
1600.000	36.8	H	54.0	-17.2	PK	215	1.0	39.0, 39.0, not radio related.
15538.930	45.7	V	54.0	-8.3	AVG	112	1.00	39.0, 39.0
15542.730	57.7	V	74.0	-16.3	PK	112	1.00	39.0, 39.0

Note 1: For emissions in restricted bands, the limit of 15.209 was used which requires average and peak measurements.

Note 2: For emissions outside of the restricted bands the limit is -27dBm/MHz eirp (68.3dB μ V/m). The measurement method required is a peak measurement (RB=1MHz, VB \geq 3MHz, peak detector).

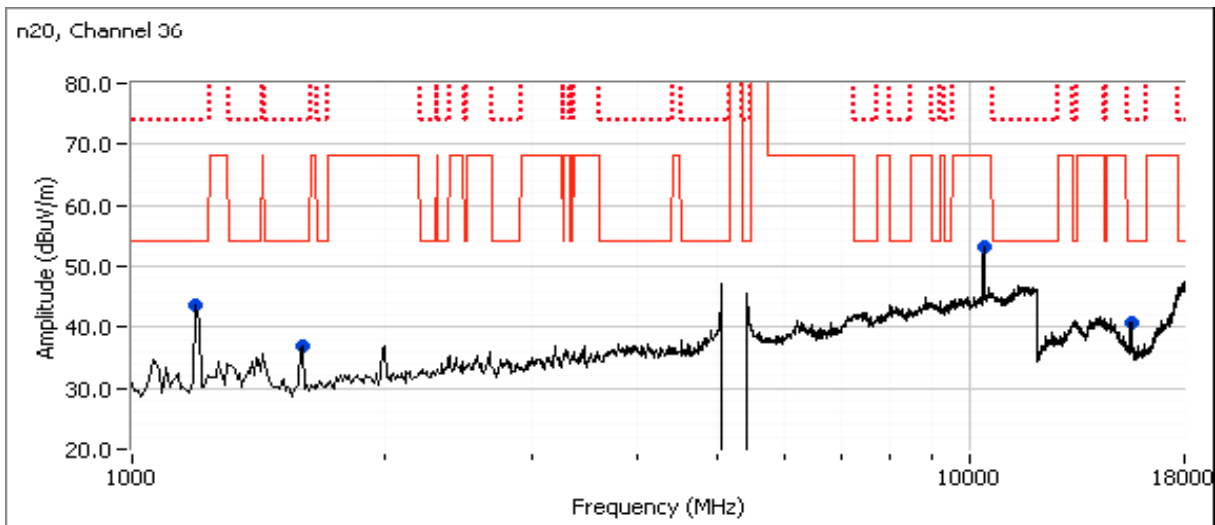

Client:	Intel	Job Number:	J88901
Model:	Intel® Centrino® Advanced-N 6235	T-Log Number:	T89578
Contact:	Steve Hackett	Account Manager:	Christine Krebill
Standard:	FCC 15.247, 15.407, 15.209, RSS 210	Class:	N/A

Run #1f: EUT on Channel #46 5230MHz - 802.11n40, Chain A+B

Chain	Target (dBm)				Power Settings Measured (dBm)				Software Setting
	1	2	3	Total	1	2	3	Total	
	16.0	16.0		19.0	13.8	12.9		16.4	39.0, 39.0

Spurious Radiated Emissions:

Frequency	Level	Pol	15.209 / 15E		Detector	Azimuth	Height	Comments
MHz	dBµV/m	v/h	Limit	Margin	Pk/QP/Avg	degrees	meters	
1200.000	45.8	V	54.0	-8.2	PK	228	1.0	39.0, 39.0, not radio related.
1600.000	40.0	V	54.0	-14.0	PK	33	1.0	39.0, 39.0, not radio related.
10460.200	59.1	V	68.3	-9.2	PK	149	1.68	39.0, 39.0
15702.470	42.3	V	54.0	-11.7	AVG	136	1.01	39.0, 39.0
15701.800	55.1	V	74.0	-18.9	PK	136	1.01	39.0, 39.0

- Note 1: For emissions in restricted bands, the limit of 15.209 was used which requires average and peak measurements.
- Note 2: For emissions outside of the restricted bands the limit is -27dBm/MHz eirp (68.3dBuV/m). The measurement method required is a peak measurement (RB=1MHz, VB≥3MHz, peak detector).

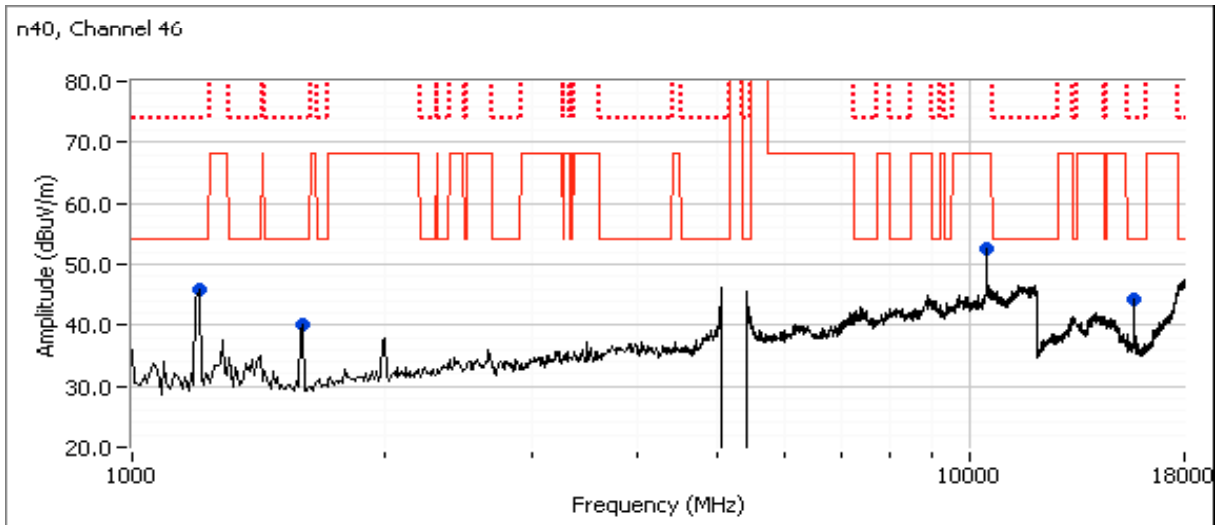



EMC Test Data

Client: Intel	Job Number: J88901
Model: Intel® Centrino® Advanced-N 6235	T-Log Number: T89578
	Account Manager: Christine Krebill
Contact: Steve Hackett	
Standard: FCC 15.247, 15.407, 15.209, RSS 210	Class: N/A

Run #2, Radiated Spurious Emissions, 1-40GHz, Center Channel 5250-5350MHz - 802.11a, n20, n40, Chain A, B

Date of Test: 12/19/2012
 Test Engineer: John Caizzi

Test Location: Chamber 5
 Config Change: none

Run #2a: EUT on Channel #60, 5300MHz, 802.11a, Chain A

Chain A	Target (dBm)	Power Settings Measured (dBm)	Software Setting
	16.0	15.9	32.5

Spurious Radiated Emissions:

Frequency MHz	Level dB μ V/m	Pol v/h	15.209 / 15E		Detector Pk/QP/Avg	Azimuth degrees	Height meters	Comments
			Limit	Margin				
1191.670	42.8	V	54.0	-11.2	Peak	157	1.0	Not radio related.
1591.670	39.7	V	54.0	-14.3	Peak	293	1.0	Not radio related.
10625.100	41.8	V	54.0	-12.2	AVG	101	1.0	RB 1 MHz;VB 10 Hz;Peak
10625.980	52.4	V	74.0	-21.6	PK	101	1.0	RB 1 MHz;VB 3 MHz;Peak

- Note 1: For emissions in restricted bands, the limit of 15.209 was used which requires average and peak measurements.
- Note 2: For emissions outside of the restricted bands the limit is -27dBm/MHz eirp (68.3dBuV/m). The measurement method required is a peak measurement (RB=1MHz, VB≥3MHz, peak detector).
- Note 3: Scans made between 18 - 40GHz with the measurement antenna moved around the card and its antennas 20-50cm from the device indicated there were no significant emissions in this frequency range

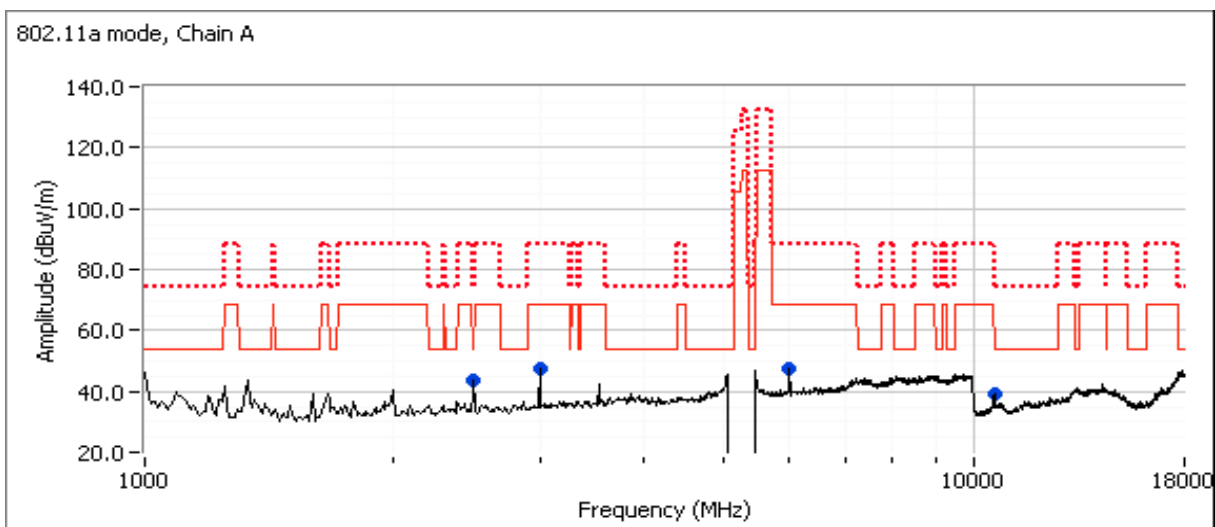



EMC Test Data

Client:	Intel	Job Number:	J88901
Model:	Intel® Centrino® Advanced-N 6235	T-Log Number:	T89578
Contact:	Steve Hackett	Account Manager:	Christine Krebill
Standard:	FCC 15.247, 15.407, 15.209, RSS 210	Class:	N/A

Run #2b: EUT on Channel #60 5300MHz 802.11a, Chain B

	Power Settings		
	Target (dBm)	Measured (dBm)	Software Setting
Chain B	16.0	16.0	37.0

Spurious Radiated Emissions:

Frequency	Level	Pol	15.209 / 15E		Detector	Azimuth	Height	Comments
MHz	dBuV/m	v/h	Limit	Margin	Pk/QP/Avg	degrees	meters	
1191.670	43.0	V	54.0	-11.0	Peak	145	1.0	Not radio related.
1591.670	40.2	V	54.0	-13.8	Peak	342	1.0	Not radio related.
10600.140	43.2	V	54.0	-10.8	AVG	111	1.70	
10602.000	55.2	V	74.0	-18.8	PK	111	1.70	

- Note 1: For emissions in restricted bands, the limit of 15.209 was used which requires average and peak measurements.
- Note 2: For emissions outside of the restricted bands the limit is -27dBm/MHz eirp (68.3dBuV/m). The measurement method required is a peak measurement (RB=1MHz, VB≥3MHz, peak detector).
- Note 3: Scans made between 18 - 40GHz with the measurement antenna moved around the card and its antennas 20-50cm from the device indicated there were no significant emissions in this frequency range

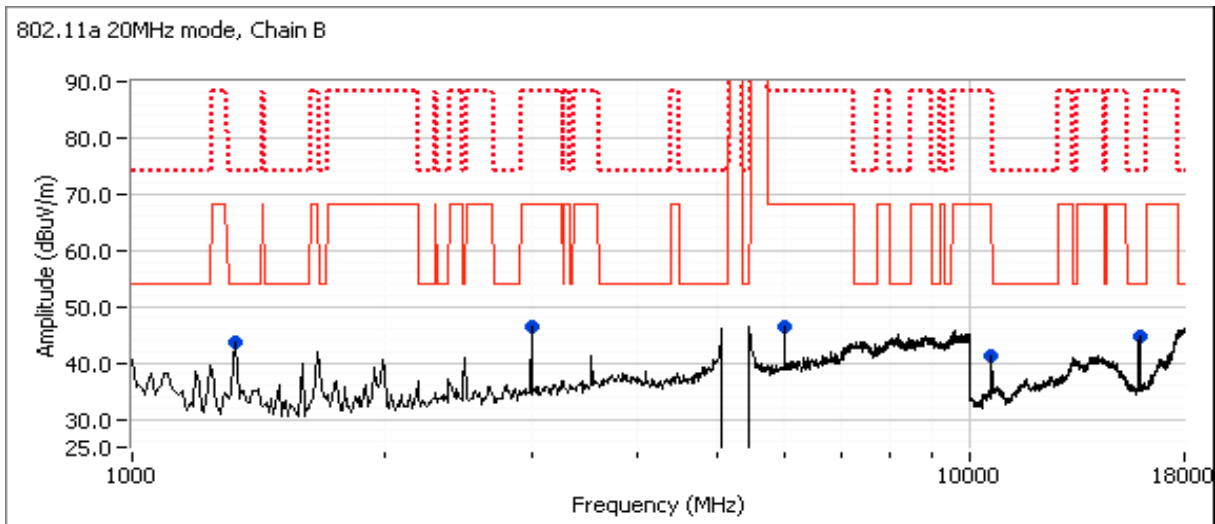



EMC Test Data

Client:	Intel	Job Number:	J88901
Model:	Intel® Centrino® Advanced-N 6235	T-Log Number:	T89578
Contact:	Steve Hackett	Account Manager:	Christine Krebill
Standard:	FCC 15.247, 15.407, 15.209, RSS 210	Class:	N/A

Run #2c: EUT on Channel #60 5300MHz n20 Chain A+B

Chain	Target (dBm)				Power Settings Measured (dBm)				Software Setting
	1	2	3	Total	1	2	3	Total	
		16.0	16.0		19.0	14.2	13.2		16.7

Spurious Radiated Emissions:

Frequency	Level	Pol	15.209 / 15E		Detector	Azimuth	Height	Comments
MHz	dB μ V/m	v/h	Limit	Margin	Pk/QP/Avg	degrees	meters	
1199.500	43.3	V	54.0	-10.7	Peak	209	1.0	Not radio related.
1597.160	39.0	V	54.0	-15.0	Peak	241	1.0	Not radio related.
10601.220	45.3	V	54.0	-8.7	AVG	147	1.2	RB 1 MHz;VB 10 Hz;Peak
10602.090	57.1	V	74.0	-16.9	PK	147	1.2	RB 1 MHz;VB 3 MHz;Peak
15923.330	41.1	V	54.0	-12.9	AVG	120	1.0	RB 1 MHz;VB 10 Hz;Peak
15923.330	48.1	V	74.0	-25.9	PK	120	1.0	RB 1 MHz;VB 3 MHz;Peak

- Note 1: For emissions in restricted bands, the limit of 15.209 was used which requires average and peak measurements.
- Note 2: For emissions outside of the restricted bands the limit is -27dBm/MHz eirp (68.3dBuV/m). The measurement method required is a peak measurement (RB=1MHz, VB≥3MHz, peak detector).
- Note 3: Scans made between 18 - 40GHz with the measurement antenna moved around the card and its antennas 20-50cm from the device indicated there were no significant emissions in this frequency range

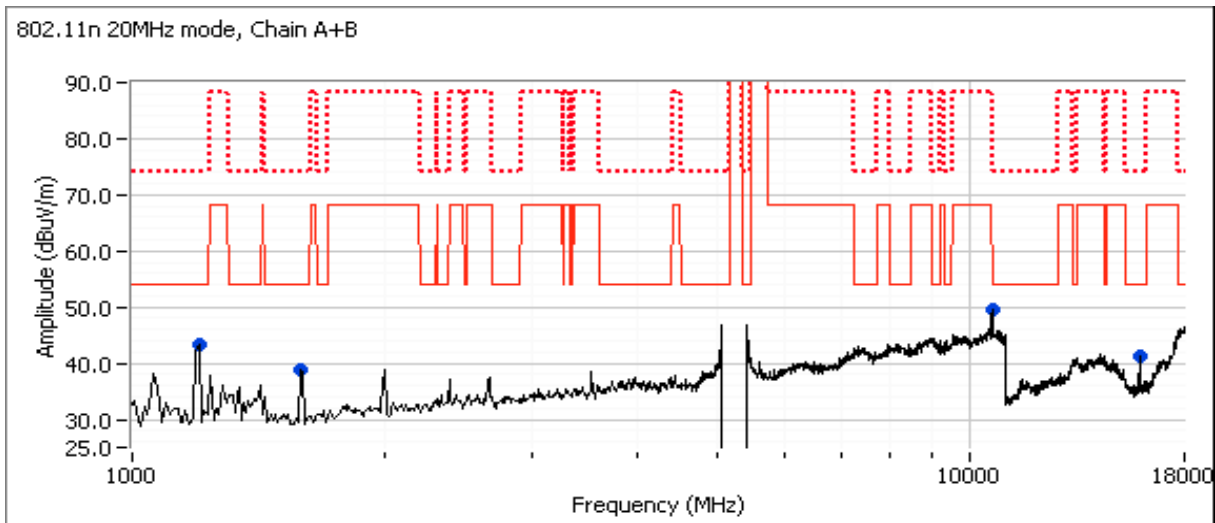



EMC Test Data

Client: Intel	Job Number: J88901
Model: Intel® Centrino® Advanced-N 6235	T-Log Number: T89578
	Account Manager: Christine Krebill
Contact: Steve Hackett	
Standard: FCC 15.247, 15.407, 15.209, RSS 210	Class: N/A

Run #2d: EUT on Channel #62 5310MHz n40 Chain A+B

Chain	Target (dBm)				Power Settings Measured (dBm)				Software Setting
	1	2	3	Total	1	2	3	Total	
	16.0	16.0		19.0	13.9	13.0		16.5	

Spurious Radiated Emissions:

Frequency	Level	Pol	15.209 / 15E		Detector	Azimuth	Height	Comments
MHz	dB μ V/m	v/h	Limit	Margin	Pk/QP/Avg	degrees	meters	
1191.670	44.3	V	54.0	-9.7	Peak	208	1.0	Not radio related.
1591.670	40.5	V	54.0	-13.5	Peak	349	1.0	Not radio related.
10619.700	45.3	V	54.0	-8.7	AVG	98	1.0	RB 1 MHz;VB 10 Hz;Peak
10620.440	59.7	V	74.0	-14.3	PK	98	1.0	RB 1 MHz;VB 3 MHz;Peak

- Note 1: For emissions in restricted bands, the limit of 15.209 was used which requires average and peak measurements.
- Note 2: For emissions outside of the restricted bands the limit is -27dBm/MHz eirp (68.3dBuV/m). The measurement method required is a peak measurement (RB=1MHz, VB≥3MHz, peak detector).
- Note 3: Scans made between 18 - 40GHz with the measurement antenna moved around the card and its antennas 20-50cm from the device indicated there were no significant emissions in this frequency range

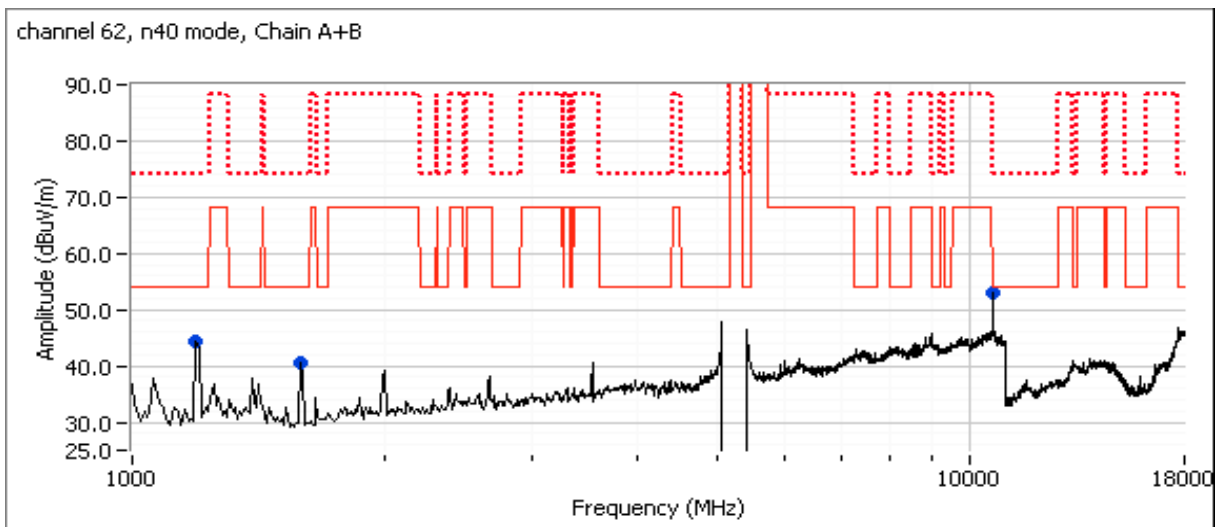



EMC Test Data

Client:	Intel	Job Number:	J88901
Model:	Intel® Centrino® Advanced-N 6235	T-Log Number:	T89578
Contact:	Steve Hackett	Account Manager:	Christine Krebill
Standard:	FCC 15.247, 15.407, 15.209, RSS 210	Class:	N/A

Run #2e: EUT on Channel 52 5260MHz 802.11n20, Chain A+B

Chain	Target (dBm)				Power Settings Measured (dBm)				Software Setting
	1	2	3	Total	1	2	3	Total	
	16.0	16.0		19.0	14.3	14.6		17.5	39,39

Spurious Radiated Emissions:

Frequency	Level	Pol	15.209 / 15E		Detector	Azimuth	Height	Comments
MHz	dB μ V/m	v/h	Limit	Margin	Pk/QP/Avg	degrees	meters	
10520.460	55.6	V	68.3	-12.7	PK	197	1.0	RB 1 MHz;VB 3 MHz;Peak
3534.680	42.2	V	68.3	-26.1	PK	65	1.0	RB 1 MHz;VB 3 MHz;Peak

Note 1: For emissions in restricted bands, the limit of 15.209 was used which requires average and peak measurements.

Note 2: For emissions outside of the restricted bands the limit is -27dBm/MHz eirp (68.3dB μ V/m). The measurement method required is a peak measurement (RB=1MHz, VB \geq 3MHz, peak detector).

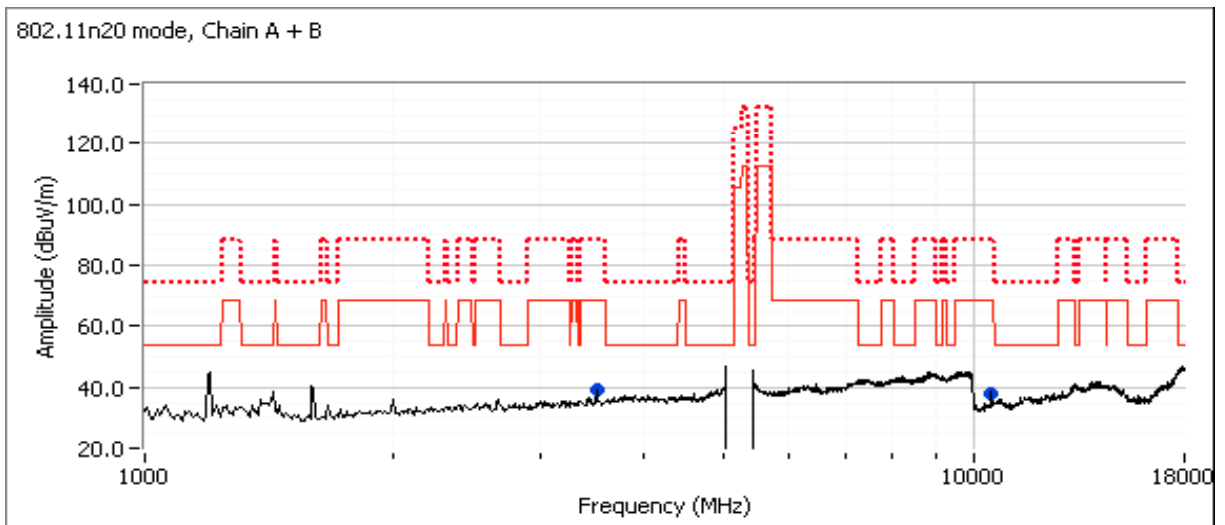



EMC Test Data

Client:	Intel	Job Number:	J88901
Model:	Intel® Centrino® Advanced-N 6235	T-Log Number:	T89578
Contact:	Steve Hackett	Account Manager:	Christine Krebill
Standard:	FCC 15.247, 15.407, 15.209, RSS 210	Class:	N/A

Run #2f: EUT on Channel 64 5320MHz 802.11n20, Chain A+B

Chain	Target (dBm)				Power Settings Measured (dBm)				Software Setting
	1	2	3	Total	1	2	3	Total	
	16.0	16.0		19.0	14.3	13.3		16.8	

Spurious Radiated Emissions:

Frequency	Level	Pol	15.209 / 15E		Detector	Azimuth	Height	Comments
MHz	dB μ V/m	v/h	Limit	Margin	Pk/QP/Avg	degrees	meters	
10639.870	44.2	H	54.0	-9.8	AVG	227	1.5	RB 1 MHz;VB 10 Hz;Peak
10639.860	56.6	H	74.0	-17.4	PK	227	1.5	RB 1 MHz;VB 3 MHz;Peak
3561.550	41.9	V	68.3	-26.4	PK	78	1.0	RB 1 MHz;VB 3 MHz;Peak
1986.360	41.2	V	68.3	-27.1	PK	139	1.0	RB 1 MHz;VB 3 MHz;Peak
15979.670	42.1	V	54.0	-11.9	AVG	149	1.0	RB 1 MHz;VB 10 Hz;Peak
15981.010	53.5	V	74.0	-20.5	PK	149	1.0	RB 1 MHz;VB 3 MHz;Peak
10633.630	42.4	V	54.0	-11.6	AVG	173	2.0	RB 1 MHz;VB 10 Hz;Peak
10631.580	53.6	V	74.0	-20.4	PK	173	2.0	RB 1 MHz;VB 3 MHz;Peak

Note 1: For emissions in restricted bands, the limit of 15.209 was used which requires average and peak measurements.

Note 2: For emissions outside of the restricted bands the limit is -27dBm/MHz eirp (68.3dBuV/m). The measurement method required is a peak measurement (RB=1MHz, VB≥3MHz, peak detector).

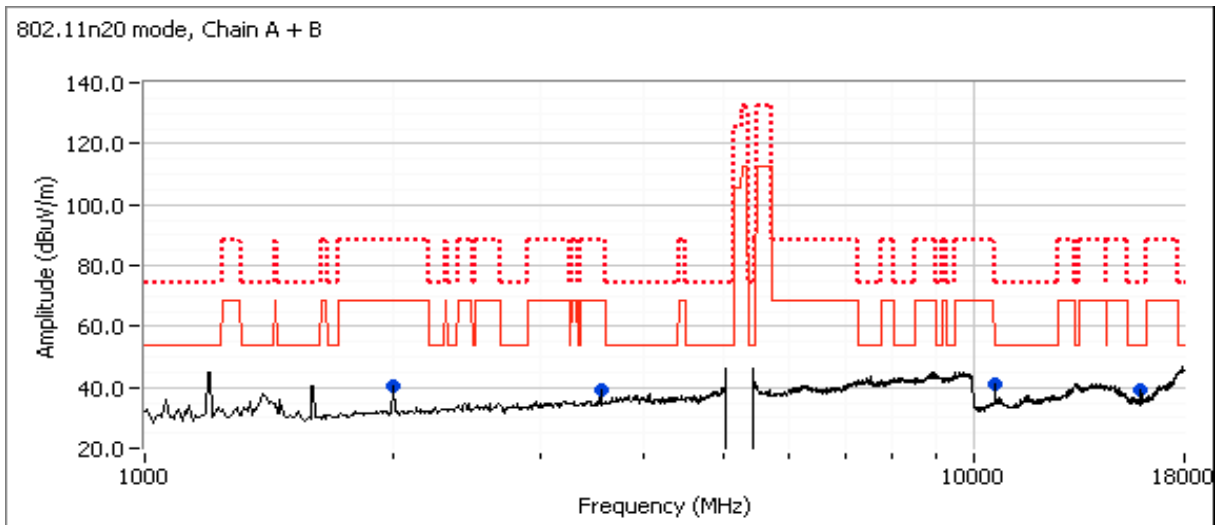



EMC Test Data

Client: Intel	Job Number: J88901
Model: Intel® Centrino® Advanced-N 6235	T-Log Number: T89578
	Account Manager: Christine Krebill
Contact: Steve Hackett	
Standard: FCC 15.247, 15.407, 15.209, RSS 210	Class: N/A

Run #3, Radiated Spurious Emissions, 1-40GHz, Center Channel 5470-5725MHz - 802.11a, n20, n40, Chain A, B
 Date of Test: 12/19/2012 & 12/20/12 Test Location: FT Chamber#5
 Test Engineer: Rafael Varelas & John Caizzi Config Change: None

Run #3a: EUT on Channel #116 5580MHz 802.11a, Chain A

	Power Settings		
	Target (dBm)	Measured (dBm)	Software Setting
Chain A	16.0	16.1	37.5

Spurious Radiated Emissions:

Frequency MHz	Level dB μ V/m	Pol v/h	15.209 / 15E		Detector Pk/QP/Avg	Azimuth degrees	Height meters	Comments
			Limit	Margin				
1194.670	55.0	V	74.0	-19.0	PK	139	1.0	RB 1 MHz;VB 3 MHz;Peak
1598.910	30.8	V	54.0	-23.2	AVG	0	1.0	RB 1 MHz;VB 10 Hz;Peak
1196.040	30.1	V	54.0	-23.9	AVG	139	1.0	RB 1 MHz;VB 10 Hz;Peak
1594.180	49.2	V	74.0	-24.8	PK	0	1.0	RB 1 MHz;VB 3 MHz;Peak

- Note 1: For emissions in restricted bands, the limit of 15.209 was used which requires average and peak measurements.
- Note 2: For emissions outside of the restricted bands the limit is -27dBm/MHz eirp (68.3dBuV/m). The measurement method required is a peak measurement (RB=1MHz, VB≥3MHz, peak detector).
- Note 3: Scans made between 18 - 40GHz with the measurement antenna moved around the card and its antennas 20-50cm from the device indicated there were no significant emissions in this frequency range

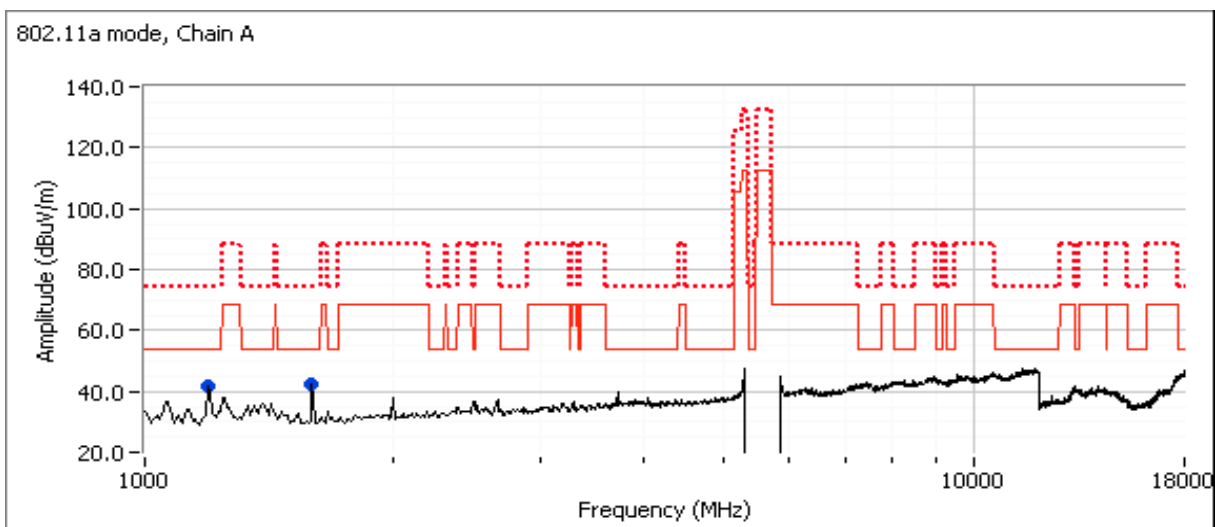



EMC Test Data

Client:	Intel	Job Number:	J88901
Model:	Intel® Centrino® Advanced-N 6235	T-Log Number:	T89578
Contact:	Steve Hackett	Account Manager:	Christine Krebill
Standard:	FCC 15.247, 15.407, 15.209, RSS 210	Class:	N/A

Run #3b: EUT on Channel #116 5580MHz 802.11a, Chain B

	Target (dBm)	Power Settings Measured (dBm)	Software Setting
Chain B	16.0	16.0	34.5

Spurious Radiated Emissions:

Frequency	Level	Pol	15.209 / 15E		Detector	Azimuth	Height	Comments
MHz	dB μ V/m	v/h	Limit	Margin	Pk/QP/Avg	degrees	meters	
1195.730	54.7	V	74.0	-19.3	PK	135	1.0	1Hz;VB 3 MHz;Peak
1195.860	30.3	V	54.0	-23.7	AVG	135	1.0	1Hz;VB 10 Hz;Peak
1598.300	29.7	V	54.0	-24.3	AVG	44	1.0	1Hz;VB 10 Hz;Peak
1595.630	48.0	V	74.0	-26.0	PK	44	1.0	1Hz;VB 3 MHz;Peak

- Note 1: For emissions in restricted bands, the limit of 15.209 was used which requires average and peak measurements.
- Note 2: For emissions outside of the restricted bands the limit is -27dBm/MHz eirp (68.3dBuV/m). The measurement method required is a peak measurement (RB=1MHz, VB≥3MHz, peak detector).
- Note 3: Scans made between 18 - 40GHz with the measurement antenna moved around the card and its antennas 20-50cm from the device indicated there were no significant emissions in this frequency range

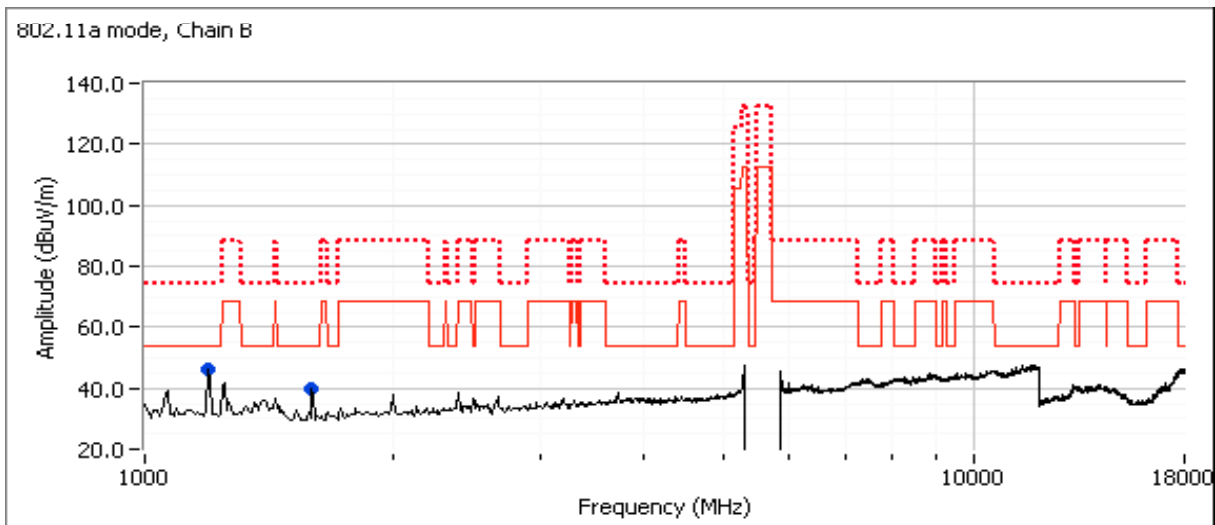



EMC Test Data

Client:	Intel	Job Number:	J88901
Model:	Intel® Centrino® Advanced-N 6235	T-Log Number:	T89578
Contact:	Steve Hackett	Account Manager:	Christine Krebill
Standard:	FCC 15.247, 15.407, 15.209, RSS 210	Class:	N/A

Run #3c: EUT on Channel #116 5580MHz n20 Chain A+B

Chain	Target (dBm)				Power Settings Measured (dBm)				Software Setting
	1	2	3	Total	1	2	3	Total	
	16.0	16.0		19.0	12.8	13.9		16.4	

Spurious Radiated Emissions:

Frequency	Level	Pol	15.209 / 15E		Detector	Azimuth	Height	Comments
MHz	dB μ V/m	v/h	Limit	Margin	Pk/QP/Avg	degrees	meters	
11159.880	44.4	V	54.0	-9.6	AVG	262	1.8	RB 1 MHz;VB 10 Hz;Peak
11156.210	55.3	V	74.0	-18.7	PK	262	1.8	RB 1 MHz;VB 3 MHz;Peak
1061.570	31.2	V	54.0	-22.8	AVG	249	1.4	RB 1 MHz;VB 10 Hz;Peak
1059.830	43.5	V	74.0	-30.5	PK	249	1.4	RB 1 MHz;VB 3 MHz;Peak
1195.310	30.9	V	54.0	-23.1	AVG	213	1.0	RB 1 MHz;VB 10 Hz;Peak
1195.380	54.2	V	74.0	-19.8	PK	213	1.0	RB 1 MHz;VB 3 MHz;Peak

- Note 1: For emissions in restricted bands, the limit of 15.209 was used which requires average and peak measurements.
- Note 2: For emissions outside of the restricted bands the limit is -27dBm/MHz eirp (68.3dBuV/m). The measurement method required is a peak measurement (RB=1MHz, VB≥3MHz, peak detector).
- Note 3: Scans made between 18 - 40GHz with the measurement antenna moved around the card and its antennas 20-50cm from the device indicated there were no significant emissions in this frequency range

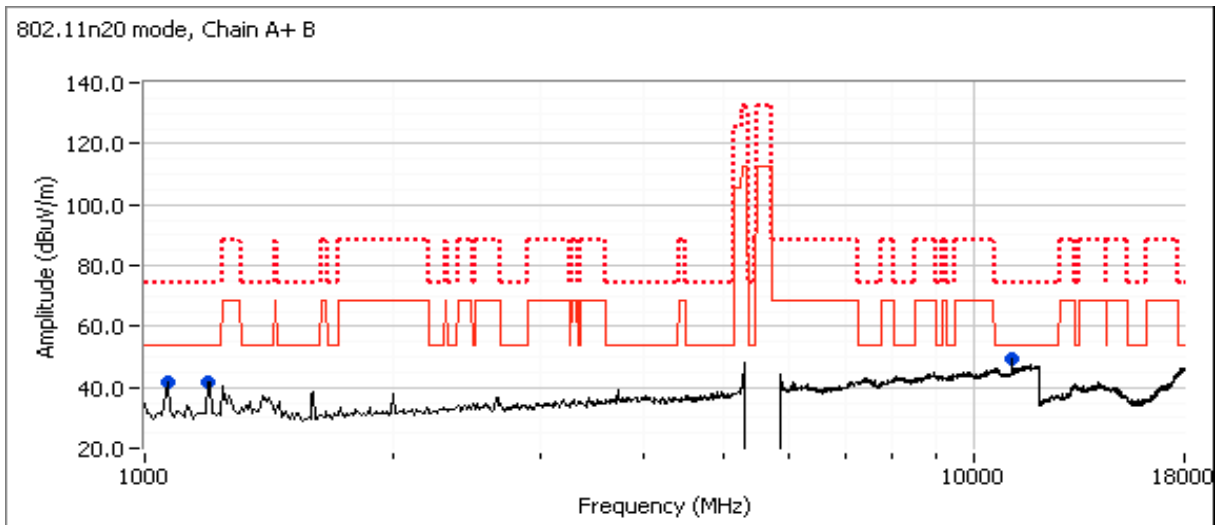



EMC Test Data

Client:	Intel	Job Number:	J88901
Model:	Intel® Centrino® Advanced-N 6235	T-Log Number:	T89578
Contact:	Steve Hackett	Account Manager:	Christine Krebill
Standard:	FCC 15.247, 15.407, 15.209, RSS 210	Class:	N/A

Run #3d: EUT on Channel #110 5550MHz n40 Chain A+B

Chain	Target (dBm)				Power Settings Measured (dBm)				Software Setting
	1	2	3	Total	1	2	3	Total	
	16.0	16.0		19.0	12.4	13.5		16.0	

Spurious Radiated Emissions:

Frequency	Level	Pol	15.209 / 15E		Detector	Azimuth	Height	Comments
MHz	dB μ V/m	v/h	Limit	Margin	Pk/QP/Avg	degrees	meters	
11100.120	42.5	V	54.0	-11.5	AVG	288	1.4	RB 1 MHz;VB 10 Hz;Peak
11084.920	54.1	V	74.0	-19.9	PK	288	1.4	RB 1 MHz;VB 3 MHz;Peak
1072.260	30.6	V	54.0	-23.4	AVG	286	1.6	RB 1 MHz;VB 10 Hz;Peak
1073.230	43.6	V	74.0	-30.4	PK	286	1.6	RB 1 MHz;VB 3 MHz;Peak
1196.360	31.0	V	54.0	-23.0	AVG	146	1.0	RB 1 MHz;VB 10 Hz;Peak
1194.660	55.3	V	74.0	-18.7	PK	146	1.0	RB 1 MHz;VB 3 MHz;Peak

- Note 1: For emissions in restricted bands, the limit of 15.209 was used which requires average and peak measurements.
- Note 2: For emissions outside of the restricted bands the limit is -27dBm/MHz eirp (68.3dBuV/m). The measurement method required is a peak measurement (RB=1MHz, VB \geq 3MHz, peak detector).
- Note 3: Scans made between 18 - 40GHz with the measurement antenna moved around the card and its antennas 20-50cm from the device indicated there were no significant emissions in this frequency range

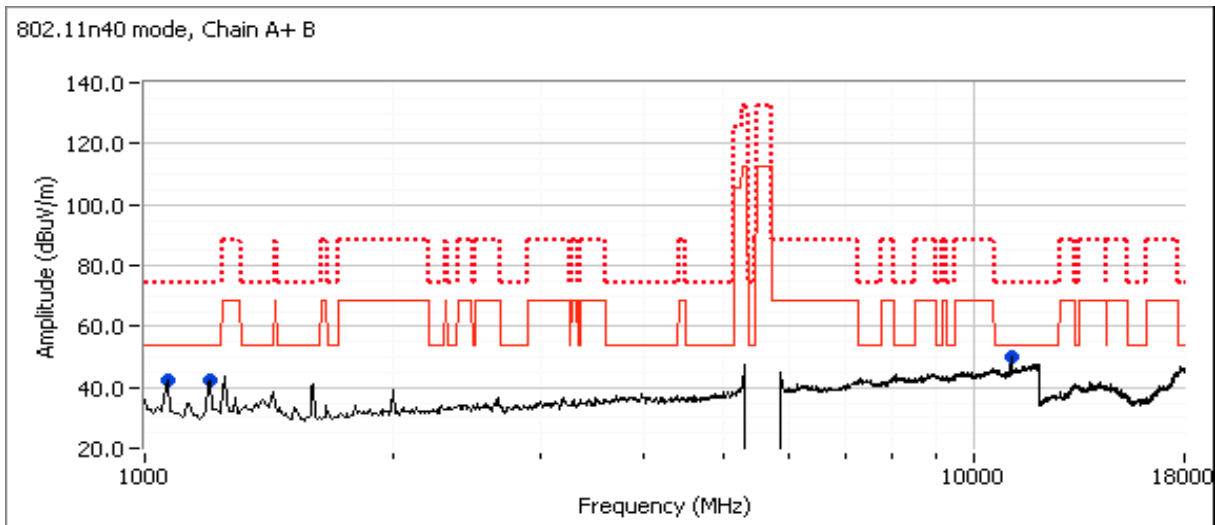

Client:	Intel	Job Number:	J88901
Model:	Intel® Centrino® Advanced-N 6235	T-Log Number:	T89578
Contact:	Steve Hackett	Account Manager:	Christine Krebill
Standard:	FCC 15.247, 15.407, 15.209, RSS 210	Class:	N/A

Run #3e: EUT on Channel #100, 5500MHz, 802.11n20, Chains A+B

Chain	Power Settings								Software Setting
	Target (dBm)				Measured (dBm)				
	1	2	3	Total	1	2	3	Total	
	16.5	16.5		19.5	13.0	13.4		16.2	39.0, 39.0

Spurious Radiated Emissions:

Frequency	Level	Pol	15.209 / 15E		Detector	Azimuth	Height	Comments
MHz	dB μ V/m	v/h	Limit	Margin	Pk/QP/Avg	degrees	meters	
10999.330	41.2	V	54.0	-12.8	AVG	118	1.11	
11000.470	52.9	V	74.0	-21.1	PK	118	1.11	
1191.670	44.5	V	54.0	-9.5	Peak	222	1.0	Not radio related.
1591.670	40.8	V	54.0	-13.2	Peak	243	1.0	Not radio related.

Note 1: For emissions in restricted bands, the limit of 15.209 was used which requires average and peak measurements.

Note 2: For emissions outside of the restricted bands the limit is -27dBm/MHz eirp (68.3dBuV/m). The measurement method required is a peak measurement (RB=1MHz, VB \geq 3MHz, peak detector).

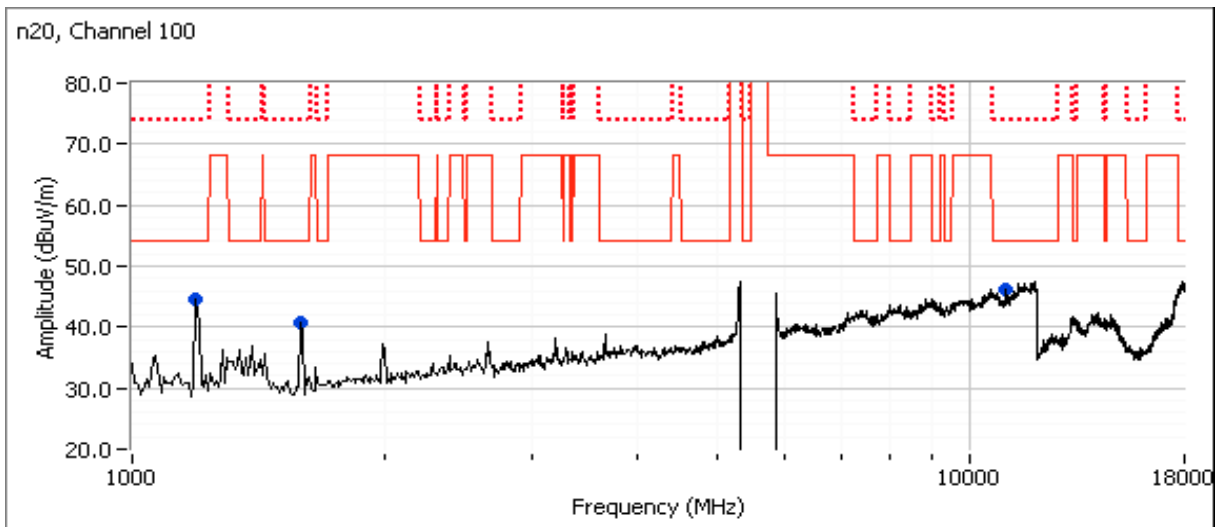



EMC Test Data

Client:	Intel	Job Number:	J88901
Model:	Intel® Centrino® Advanced-N 6235	T-Log Number:	T89578
Contact:	Steve Hackett	Account Manager:	Christine Krebill
Standard:	FCC 15.247, 15.407, 15.209, RSS 210	Class:	N/A

Run #3f: EUT on Channel #140, 5700MHz, 802.11n20, Chains A+B

Chain	Target (dBm)				Power Settings Measured (dBm)				Software Setting
	1	2	3	Total	1	2	3	Total	
	16.0	16.0		19.0	12.3	13.0		15.7	39.0, 39.0

Spurious Radiated Emissions:

Frequency	Level	Pol	15.209 / 15E		Detector	Azimuth	Height	Comments
MHz	dB μ V/m	v/h	Limit	Margin	Pk/QP/Avg	degrees	meters	
1191.670	44.7	V	54.0	-9.3	Peak	220	1.0	Not radio related.
1600.000	43.3	V	54.0	-10.7	Peak	116	1.0	Not radio related.
11400.200	42.4	V	54.0	-11.6	AVG	249	1.00	
11409.000	54.8	V	74.0	-19.2	PK	249	1.00	

Note 1: For emissions in restricted bands, the limit of 15.209 was used which requires average and peak measurements.

Note 2: For emissions outside of the restricted bands the limit is -27dBm/MHz eirp (68.3dBuV/m). The measurement method required is a peak measurement (RB=1MHz, VB \geq 3MHz, peak detector).

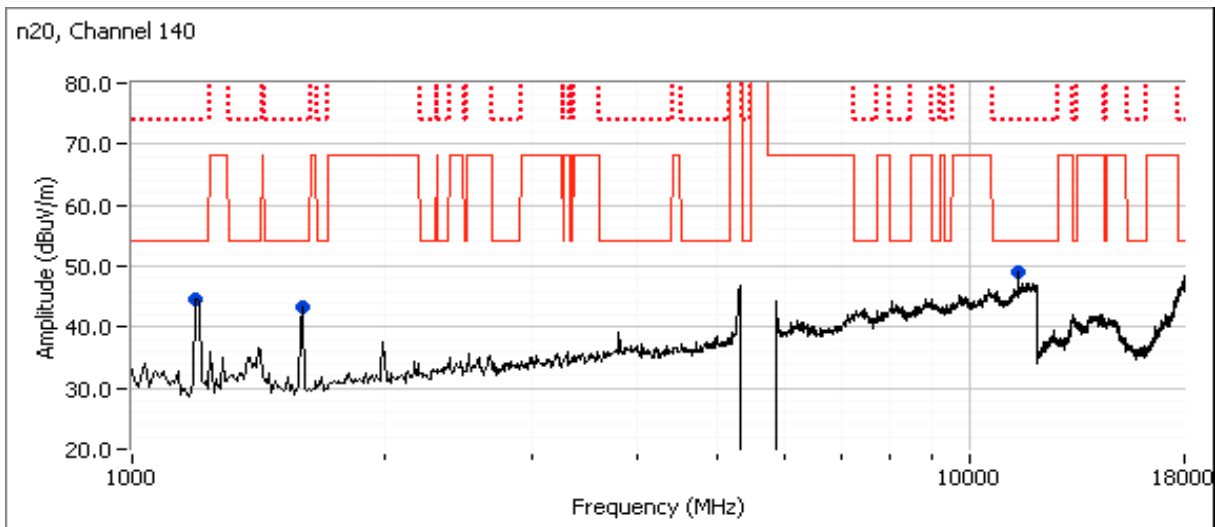



EMC Test Data

Client:	Intel	Job Number:	J88901
Model:	Intel® Centrino® Advanced-N 6235	T-Log Number:	T89578
Contact:	Steve Hackett	Account Manager:	Christine Krebill
Standard:	FCC 15.247, 15.407, 15.209, RSS 210	Class:	N/A

Summary of Results

MAC Address: 001500B50405 DRTU Tool Version 1.5.6-0445 Driver version 15.3.1.2

Run #	Mode	Channel	Power Setting	Measured Power	Test Performed	Limit	Result / Margin
1	BT 1Mb/s 802.11b	2402MHz 2412MHz	8.0 20.0	NA 12.4	Radiated Emissions 1- 10 GHz	FCC 15.247	52.8dBµV/m @ 4823.96MHz (-1.2 dB)
2	BT 1Mb/s 802.11b	2480MHz 2462MHz	8.0 23.5	NA 15.2		FCC 15.247	53.2dBµV/m @ 4923.98MHz (-0.8 dB)
3	BT 1Mb/s 802.11g	2402MHz 2412MHz	8.0 28.5	NA 14.5		FCC 15.247	46.6 dBµV/m @ 4824.0 MHz (-7.4 dB)
4	BT 1Mb/s 802.11g	2480MHz 2462MHz	8.0 28.0	NA 14.1		FCC 15.247	41.5 dBµV/m @ 4924.1 MHz (-12.5 dB)

WiFi mode for the following runs based on worst case mode from runs 1 through 4

5	BT 1Mb/s 802.11b	2402MHz 2437MHz	8.0 21.0	NA 13.3	Radiated Emissions 1- 10 GHz	FCC 15.247	53.3 dBµV/m @ 4874.0 MHz (-0.7 dB)
6	BT 1Mb/s 802.11b	2440MHz 2412MHz	8.0 20.5	NA 12.7		FCC 15.247	52.8 dBµV/m @ 4824.0 MHz (-1.2 dB)
7	BT 1Mb/s 802.11b	2440MHz 2462MHz	8.0 25.0	NA 16.6	Radiated Emissions 1- 10 GHz	FCC 15.247	51.2 dBµV/m @ 4924.0 MHz (-2.8 dB)
8	BT 1Mb/s 802.11b	2480MHz 2437MHz	8.0 23.0	NA 14.8		FCC 15.247	52.8 dBµV/m @ 4874.0 MHz (-1.2 dB)

WiFi mode and channel and Bluetooth channel based on the worst case mode from runs 1 through 8

9	BT 3Mb/s 802.11b	2402MHz 2412MHz	8.0 21.0	NA 13.1	Radiated Emissions 1- 10 GHz	FCC 15.247	52.7 dBµV/m @ 4824.0 MHz (-1.3 dB)
10	BTLE 802.11b	2402MHz 2412MHz	NA 22.0	NA 14.1		FCC 15.247	53.0 dBµV/m @ 4824.0 MHz (-1.0 dB)

WiFi mode - 802.11n 20MHz with both chains active at 16.5dBm per chain, center channel in each 5GHz band. Bluetooth on center channel, 1Mb/s mode

11	BT 1Mb/s 802.11n20	2440MHz 5200MHz	8.0 39.0 / 39.0	NA 14.3 / 13.5	Radiated Emissions 1- 15 GHz	FCC 15.247	58.5 dBµV/m @ 10399.7 MHz (-9.8 dB)
12	BT 1Mb/s 802.11n20	2440MHz 5300MHz		NA 14.2 / 13.2			45.8 dBµV/m @ 10600.7 MHz (-8.2 dB)
13	BT 1Mb/s 802.11n20	2440MHz 5580MHz		NA 12.8 / 13.9			46.4 dBµV/m @ 11159.7 MHz (-7.6 dB)
14	BT 1Mb/s 802.11n20	2440MHz 5785MHz		NA 11.2 / 11.1			47.9 dBµV/m @ 11569.8 MHz (-6.1 dB)



EMC Test Data

Client:	Intel	Job Number:	J88901
Model:	Intel® Centrino® Advanced-N 6235	T-Log Number:	T89578
Contact:	Steve Hackett	Account Manager:	Christine Krebill
Standard:	FCC 15.247, 15.407, 15.209, RSS 210	Class:	N/A

Run #1: 1-10GHz, 802.11b @ 2412 MHz Chain A, BT Basic Rate @ 2402 MHz Chain B
 Date of Test: 12/26/2012 & 12/27/2012 Test Location: FT chambers #5 & #4
 Test Engineer: M. Birgani & J. Caizzi Config Change: -

	Power Settings		
	Target (dBm)	Measured (dBm)	Software Setting
Chain A	16.5	12.4	20.0
Chain B	NA	5.5	8.0

Note - measured power in table above is average power using gated average power meter and is for reference only.

Preliminary Measurements (Peak versus average limit)

Frequency	Level	Pol	15.209/15.247		Detector	Azimuth	Height	Comments
MHz	dB μ V/m	v/h	Limit	Margin	PK/QP/Avg	degrees	meters	
4825.000	55.4	V	54.0	1.4	Pk	279	1.7	

Spurious Emissions excluding allocated band (final measurements at 3m)

Frequency	Level	Pol	15.209 / 15.247		Detector	Azimuth	Height	Comments
MHz	dB μ V/m	v/h	Limit	Margin	PK/QP/Avg	degrees	meters	
4823.960	52.8	V	54.0	-1.2	AVG	279	1.7	Setting: 20.0, 1Mbps (12.4dBm)
4823.990	55.4	V	74.0	-18.6	PK	279	1.7	Setting: 20.0, 1Mbps (12.4dBm)

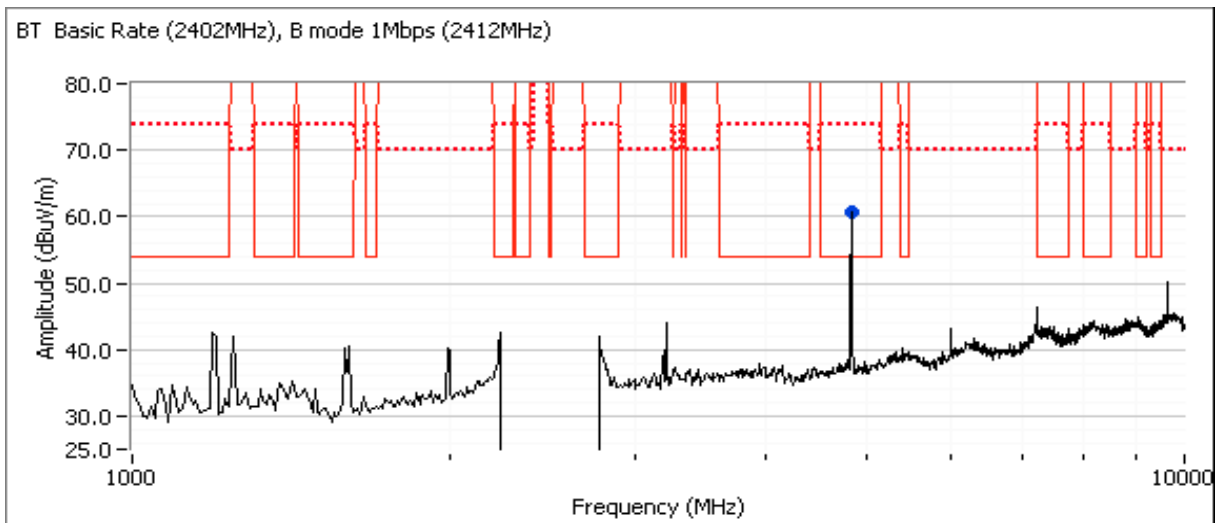



EMC Test Data

Client:	Intel	Job Number:	J88901
Model:	Intel® Centrino® Advanced-N 6235	T-Log Number:	T89578
Contact:	Steve Hackett	Account Manager:	Christine Krebill
Standard:	FCC 15.247, 15.407, 15.209, RSS 210	Class:	N/A

Preliminary Measurements (Peak versus average limit) at 20-30cm from EUT

Frequency	Level	Pol	15.209/15.247		Detector	Azimuth	Height	Comments
MHz	dB μ V/m	v/h	Limit	Margin	Pk/QP/Avg	degrees	meters	

Spurious Emissions near allocated band (final measurements at 3m)

Frequency	Level	Pol	15.209 / 15.247		Detector	Azimuth	Height	Comments
MHz	dB μ V/m	v/h	Limit	Margin	Pk/QP/Avg	degrees	meters	

Note 1: For emissions in restricted bands, the limit of 15.209 was used. For all other emissions, the limit was set 30dB below the level of the fundamental and measured in 100kHz.

Note 2: Signal is not in a restricted band but the more stringent restricted band limit was used.

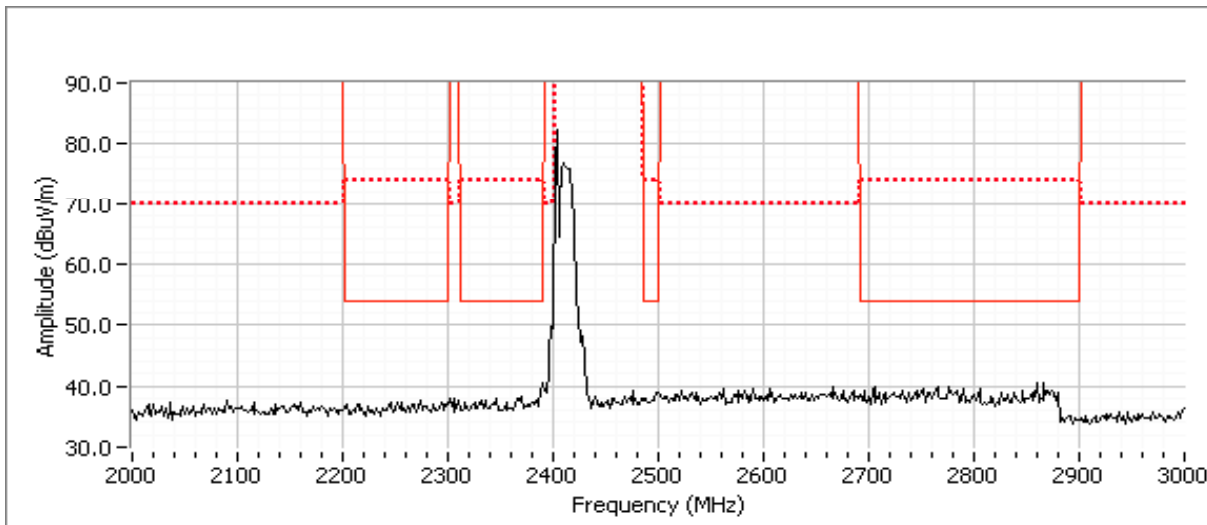



EMC Test Data

Client: Intel	Job Number: J88901
Model: Intel® Centrino® Advanced-N 6235	T-Log Number: T89578
	Account Manager: Christine Krebill
Contact: Steve Hackett	
Standard: FCC 15.247, 15.407, 15.209, RSS 210	Class: N/A

Run #2: 1-10GHz, 802.11b @ 2462 MHz Chain A, BT Basic Rate @ 2480 MHz Chain B
 Date of Test: 12/26/2012 & 12/27/2012 Test Location: FT chambers #5 & #4
 Test Engineer: M. Birgani & J. Caizzi Config Change: -

	Target (dBm)	Power Settings Measured (dBm)	Software Setting
Chain A	16.5	15.2	23.5
Chain B	NA		8.0

Note - measured power in table above is average power using gated average power meter and is for reference only.

Preliminary Measurements (Peak versus average limit)

Frequency	Level	Pol	15.209/15.247		Detector	Azimuth	Height	Comments
MHz	dB μ V/m	v/h	Limit	Margin	PK/QP/Avg	degrees	meters	
4925.000	55.7	V	54.0	1.7	Peak	63	1.0	

Spurious Emissions excluding allocated band (final measurements at 3m)

Frequency	Level	Pol	15.209 / 15.247		Detector	Azimuth	Height	Comments
MHz	dB μ V/m	v/h	Limit	Margin	PK/QP/Avg	degrees	meters	
4923.980	53.2	V	54.0	-0.8	AVG	63	1.0	Setting: 23.5 (15.2dBm)
4924.070	55.7	V	74.0	-18.3	PK	63	1.0	Setting: 23.5 (15.2dBm)

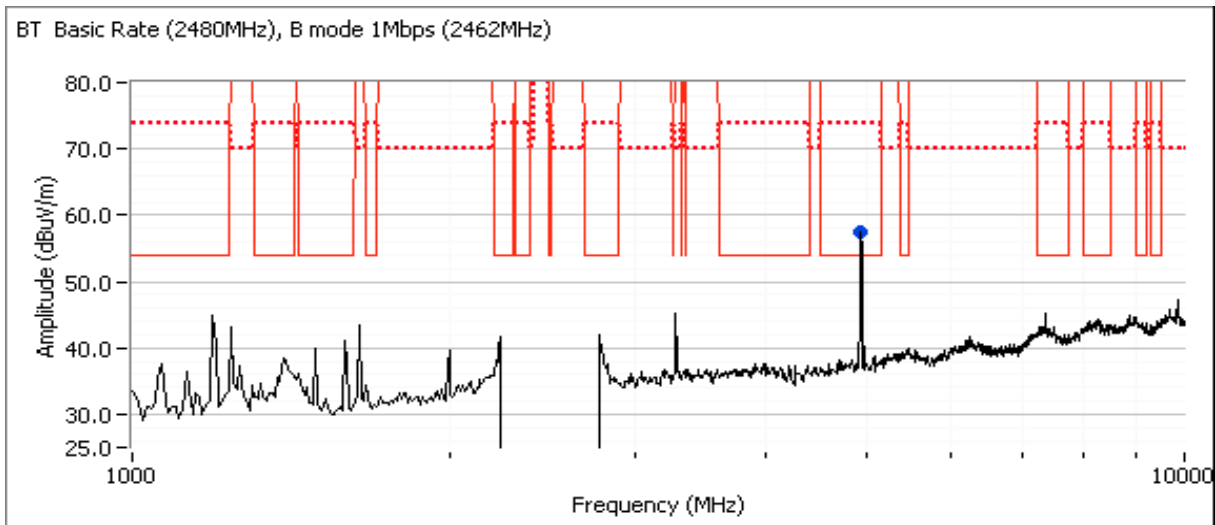



EMC Test Data

Client: Intel	Job Number: J88901
Model: Intel® Centrino® Advanced-N 6235	T-Log Number: T89578
	Account Manager: Christine Krebill
Contact: Steve Hackett	
Standard: FCC 15.247, 15.407, 15.209, RSS 210	Class: N/A

Preliminary Measurements (Peak versus average limit) at 20-30cm from EUT

Frequency	Level	Pol	15.209/15.247		Detector	Azimuth	Height	Comments
MHz	dB μ V/m	v/h	Limit	Margin	Pk/QP/Avg	degrees	meters	

Spurious Emissions near allocated band (final measurements at 3m)

Frequency	Level	Pol	15.209 / 15.247		Detector	Azimuth	Height	Comments
MHz	dB μ V/m	v/h	Limit	Margin	Pk/QP/Avg	degrees	meters	

Note 1: For emissions in restricted bands, the limit of 15.209 was used. For all other emissions, the limit was set 30dB below the level of the fundamental and measured in 100kHz.

Note 2: Signal is not in a restricted band but the more stringent restricted band limit was used.

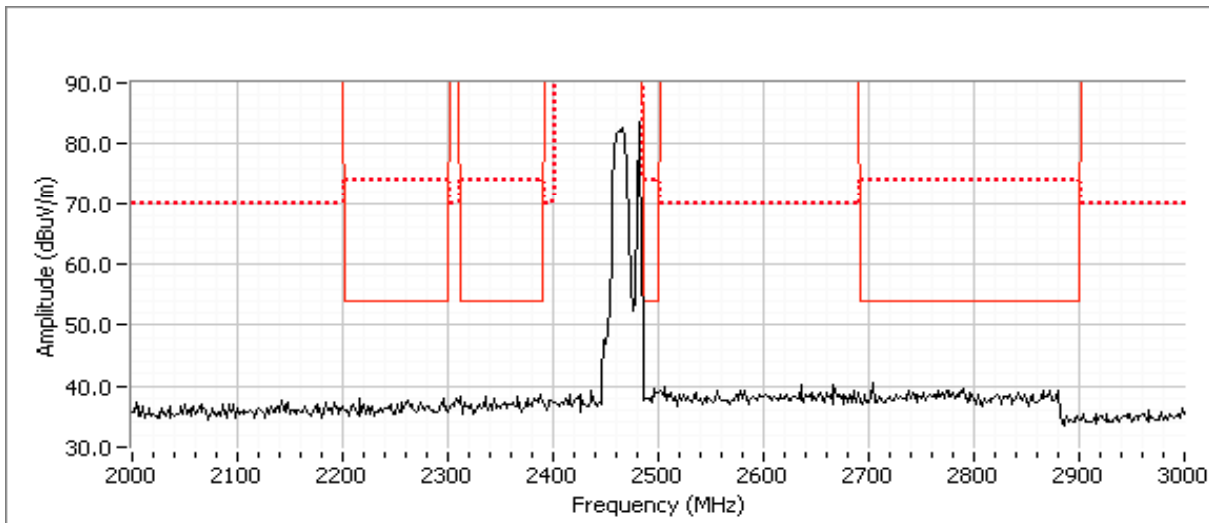



EMC Test Data

Client: Intel	Job Number: J88901
Model: Intel® Centrino® Advanced-N 6235	T-Log Number: T89578
	Account Manager: Christine Krebill
Contact: Steve Hackett	
Standard: FCC 15.247, 15.407, 15.209, RSS 210	Class: N/A

Run #3: 1-10GHz, 802.11g @ 2412 MHz Chain A, BT Basic Rate @ 2402 MHz Chain B
 Date of Test: 12/26/2012 Test Location: FT chamber #5
 Test Engineer: M. Birgani Config Change: -

	Power Settings		
	Target (dBm)	Measured (dBm)	Software Setting
Chain A	14.5	14.5	28.5
Chain B	NA		8.0

Note - measured power in table above is average power using gated average power meter and is for reference only.

Preliminary Measurements (Peak versus average limit)

Frequency	Level	Pol	15.209/15.247		Detector	Azimuth	Height	Comments
MHz	dB μ V/m	v/h	Limit	Margin	PK/QP/Avg	degrees	meters	
4825.000	49.1	V	54.0	-4.9	Peak	235	1.5	

Spurious Emissions excluding allocated band (final measurements at 3m)

Frequency	Level	Pol	15.209 / 15.247		Detector	Azimuth	Height	Comments
MHz	dB μ V/m	v/h	Limit	Margin	PK/QP/Avg	degrees	meters	
4824.000	46.6	V	54.0	-7.4	AVG	270	1.6	RB 1 MHz;VB 10 Hz;Peak
4824.870	58.7	V	74.0	-15.3	PK	270	1.6	RB 1 MHz;VB 3 MHz;Peak

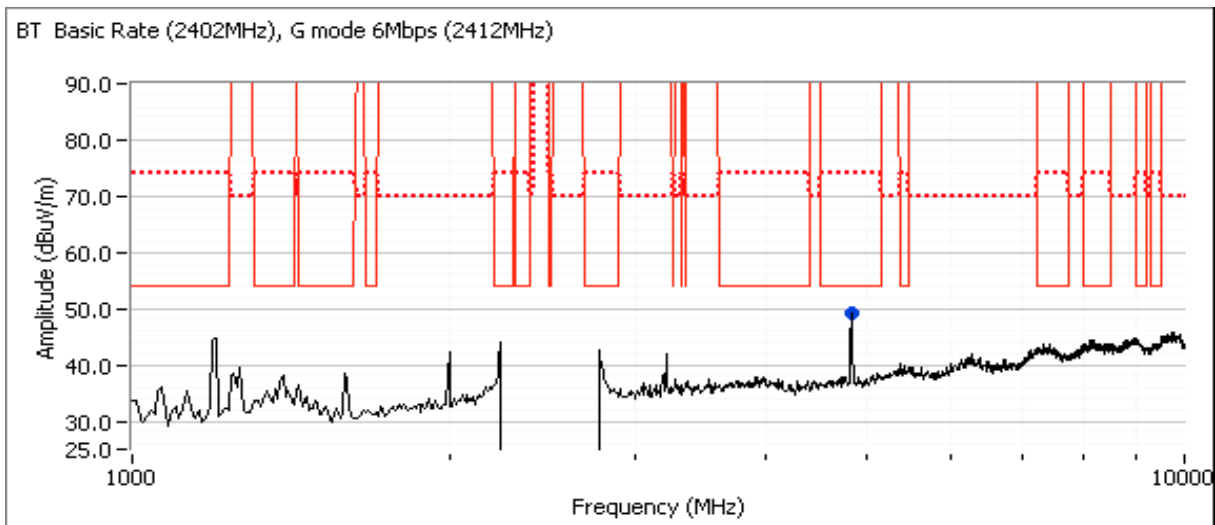



EMC Test Data

Client: Intel	Job Number: J88901
Model: Intel® Centrino® Advanced-N 6235	T-Log Number: T89578
	Account Manager: Christine Krebill
Contact: Steve Hackett	
Standard: FCC 15.247, 15.407, 15.209, RSS 210	Class: N/A

Preliminary Measurements (Peak versus average limit) at 20-30cm from EUT

Frequency	Level	Pol	15.209/15.247		Detector	Azimuth	Height	Comments
MHz	dB μ V/m	v/h	Limit	Margin	Pk/QP/Avg	degrees	meters	

Spurious Emissions near allocated band (final measurements at 3m)

Frequency	Level	Pol	15.209 / 15.247		Detector	Azimuth	Height	Comments
MHz	dB μ V/m	v/h	Limit	Margin	Pk/QP/Avg	degrees	meters	

Note 1: For emissions in restricted bands, the limit of 15.209 was used. For all other emissions, the limit was set 30dB below the level of the fundamental and measured in 100kHz.

Note 2: Signal is not in a restricted band but the more stringent restricted band limit was used.

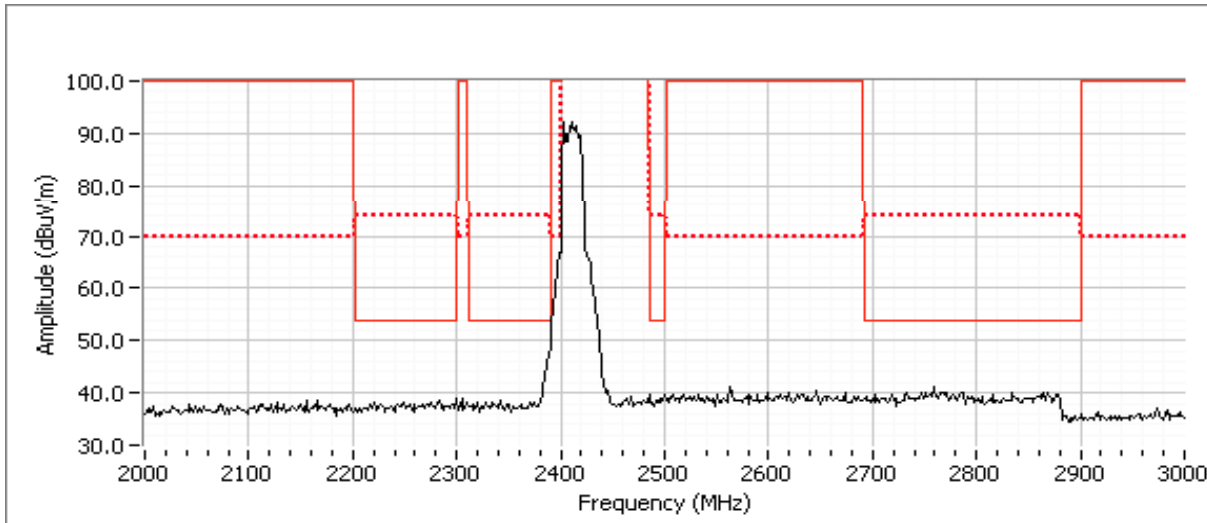



EMC Test Data

Client: Intel	Job Number: J88901
Model: Intel® Centrino® Advanced-N 6235	T-Log Number: T89578
	Account Manager: Christine Krebill
Contact: Steve Hackett	
Standard: FCC 15.247, 15.407, 15.209, RSS 210	Class: N/A

Run #4: 1-10GHz, 802.11g @ 2462 MHz Chain A, BT Basic Rate @ 2480 MHz Chain B
 Date of Test: 12/26/2012 Test Location: FT chamber #5
 Test Engineer: M. Birgani Config Change: -

	Power Settings		
	Target (dBm)	Measured (dBm)	Software Setting
Chain A	14.0	14.1	28.0
Chain B	NA		8.0

Note - measured power in table above is average power using gated average power meter and is for reference only.

Preliminary Measurements (Peak versus average limit)

Frequency	Level	Pol	15.209/15.247		Detector	Azimuth	Height	Comments
MHz	dB μ V/m	v/h	Limit	Margin	PK/QP/Avg	degrees	meters	
4925.000	46.7	V	54.0	-7.3	Peak	284	2.5	

Spurious Emissions excluding allocated band (final measurements at 3m)

Frequency	Level	Pol	15.209 / 15.247		Detector	Azimuth	Height	Comments
MHz	dB μ V/m	v/h	Limit	Margin	PK/QP/Avg	degrees	meters	
4924.130	41.5	V	54.0	-12.5	AVG	67	1.0	RB 1 MHz;VB 10 Hz;Peak
4920.400	53.2	V	74.0	-20.8	PK	67	1.0	RB 1 MHz;VB 3 MHz;Peak

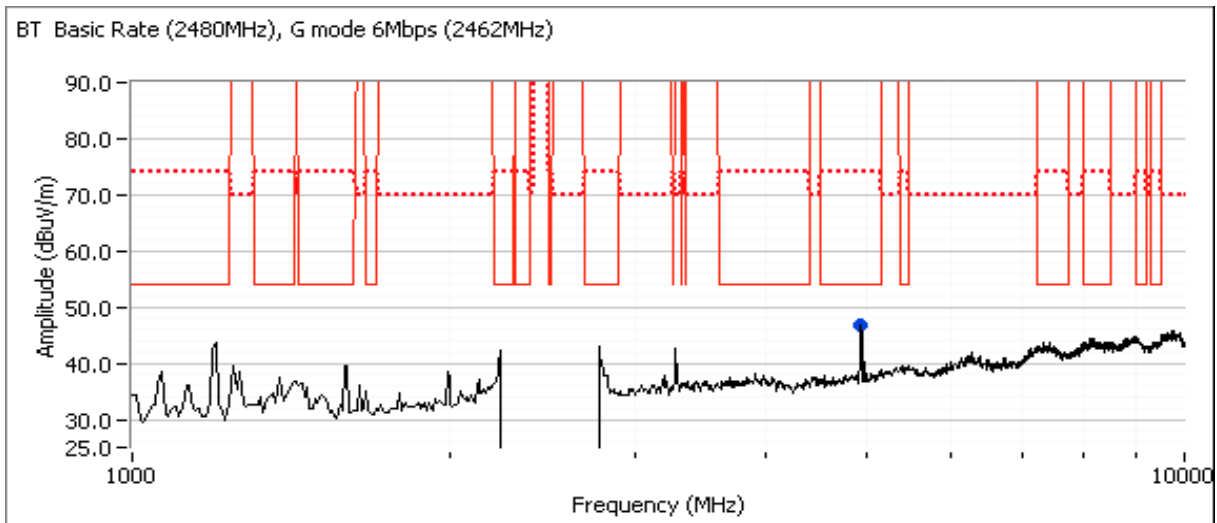



EMC Test Data

Client: Intel	Job Number: J88901
Model: Intel® Centrino® Advanced-N 6235	T-Log Number: T89578
	Account Manager: Christine Krebill
Contact: Steve Hackett	
Standard: FCC 15.247, 15.407, 15.209, RSS 210	Class: N/A

Preliminary Measurements (Peak versus average limit) at 20-30cm from EUT

Frequency	Level	Pol	15.209/15.247		Detector	Azimuth	Height	Comments
MHz	dB μ V/m	v/h	Limit	Margin	Pk/QP/Avg	degrees	meters	

Spurious Emissions near allocated band (final measurements at 3m)

Frequency	Level	Pol	15.209 / 15.247		Detector	Azimuth	Height	Comments
MHz	dB μ V/m	v/h	Limit	Margin	Pk/QP/Avg	degrees	meters	

Note 1: For emissions in restricted bands, the limit of 15.209 was used. For all other emissions, the limit was set 30dB below the level of the fundamental and measured in 100kHz.

Note 2: Signal is not in a restricted band but the more stringent restricted band limit was used.

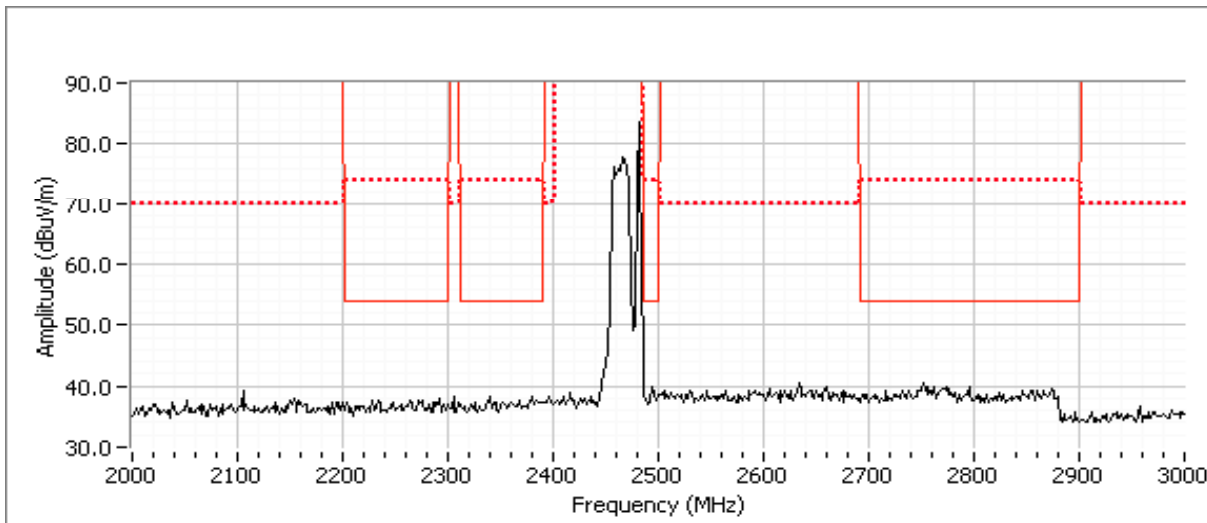



EMC Test Data

Client:	Intel	Job Number:	J88901
Model:	Intel® Centrino® Advanced-N 6235	T-Log Number:	T89578
Contact:	Steve Hackett	Account Manager:	Christine Krebill
Standard:	FCC 15.247, 15.407, 15.209, RSS 210	Class:	N/A

Run #5: 1-10GHz, 802.11b @ 2437 MHz Chain A, BT Basic Rate @ 2402 MHz Chain B
 Date of Test: 12/27/2012 Test Location: Chamber 4
 Test Engineer: M. Birgani Config Change: -

	Power Settings		
	Target (dBm)	Measured (dBm)	Software Setting
Chain A	16.0	13.3	21.0
Chain B	NA	NA	8.0

Note - measured power in table above is average power using gated average power meter and is for reference only.

Preliminary Measurements (Peak versus average limit)

Frequency	Level	Pol	15.209/15.247		Detector	Azimuth	Height	Comments
MHz	dB μ V/m	v/h	Limit	Margin	Pk/QP/Avg	degrees	meters	
4874.080	56.0	V	54.0	2.0	Peak	275	1.0	
4804.000	46.8	V	54.0	-7.2	Peak	273	1.0	

Spurious Emissions excluding allocated band (final measurements at 3m)

Frequency	Level	Pol	15.209 / 15.247		Detector	Azimuth	Height	Comments
MHz	dB μ V/m	v/h	Limit	Margin	Pk/QP/Avg	degrees	meters	
4874.030	53.3	V	54.0	-0.7	AVG	275	1.3	Setting: 21.0 (13.3dBm)
4873.990	56.0	V	74.0	-18.0	PK	275	1.3	Setting: 21.0 (13.3dBm)
4804.250	52.1	V	74.0	-21.9	PK	272	1.3	
4803.930	52.1	V	54.0	-1.9	AVG	272	1.3	Note 3

Note 3: Signal is only present when Bluetooth is enabled, average correction for hopping occupancy could be applied

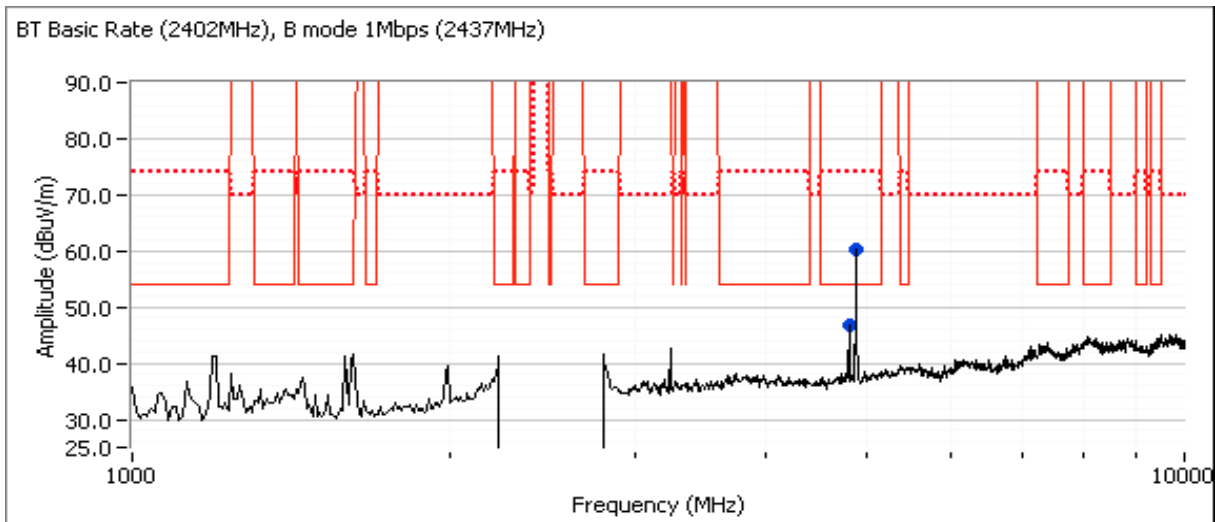



EMC Test Data

Client: Intel	Job Number: J88901
Model: Intel® Centrino® Advanced-N 6235	T-Log Number: T89578
	Account Manager: Christine Krebill
Contact: Steve Hackett	
Standard: FCC 15.247, 15.407, 15.209, RSS 210	Class: N/A

Preliminary Measurements (Peak versus average limit) at 20-30cm from EUT

Frequency	Level	Pol	15.209/15.247		Detector	Azimuth	Height	Comments
MHz	dB μ V/m	v/h	Limit	Margin	Pk/QP/Avg	degrees	meters	

Spurious Emissions near allocated band (final measurements at 3m)

Frequency	Level	Pol	15.209 / 15.247		Detector	Azimuth	Height	Comments
MHz	dB μ V/m	v/h	Limit	Margin	Pk/QP/Avg	degrees	meters	

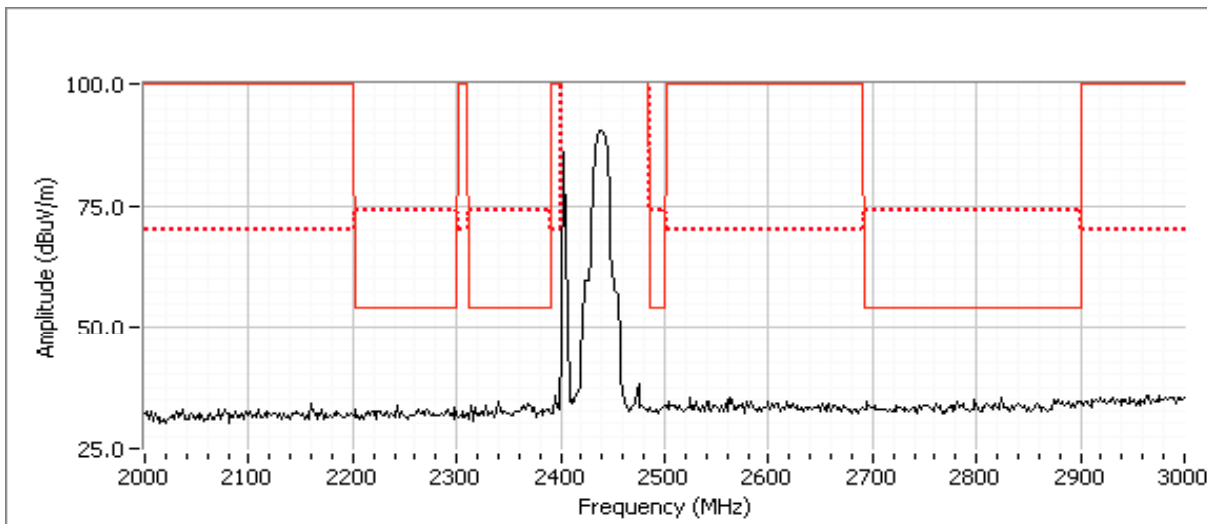



EMC Test Data

Client: Intel	Job Number: J88901
Model: Intel® Centrino® Advanced-N 6235	T-Log Number: T89578
	Account Manager: Christine Krebill
Contact: Steve Hackett	
Standard: FCC 15.247, 15.407, 15.209, RSS 210	Class: N/A

Run #6: 1-10GHz, 802.11b @ 2412 MHz Chain A, BT Basic Rate @ 2440 MHz Chain B
 Date of Test: 12/27/2012 Test Location: Chamber 4
 Test Engineer: M. Birgani Config Change: -

	Power Settings		
	Target (dBm)	Measured (dBm)	Software Setting
Chain A	16.5	12.7	20.5
Chain B	NA	5.8	8.0

Note - measured power in table above is average power using gated average power meter and is for reference only.

Preliminary Measurements (Peak versus average limit)

Frequency MHz	Level dB μ V/m	Pol v/h	15.209/15.247		Detector PK/QP/Avg	Azimuth degrees	Height meters	Comments
			Limit	Margin				
4824.060	59.8	V	54.0	5.8	Peak	240	2.5	
4879.990	42.9	V	54.0	-11.1	Peak	90	2.5	

Spurious Emissions excluding allocated band (final measurements at 3m)

Frequency MHz	Level dB μ V/m	Pol v/h	15.209 / 15.247		Detector PK/QP/Avg	Azimuth degrees	Height meters	Comments
			Limit	Margin				
4824.020	52.8	V	54.0	-1.2	AVG	272	2.3	Setting: 20.5 (12.7dBm)
4824.160	55.7	V	74.0	-18.3	PK	272	2.3	Setting: 20.5 (12.7dBm)
4879.990	47.2	V	54.0	-6.8	AVG	35	1.0	Note 3
4880.510	47.2	V	74.0	-26.8	PK	35	1.0	

Note 3: Signal is only present when Bluetooth is enabled, average correction for hopping occupancy could be applied

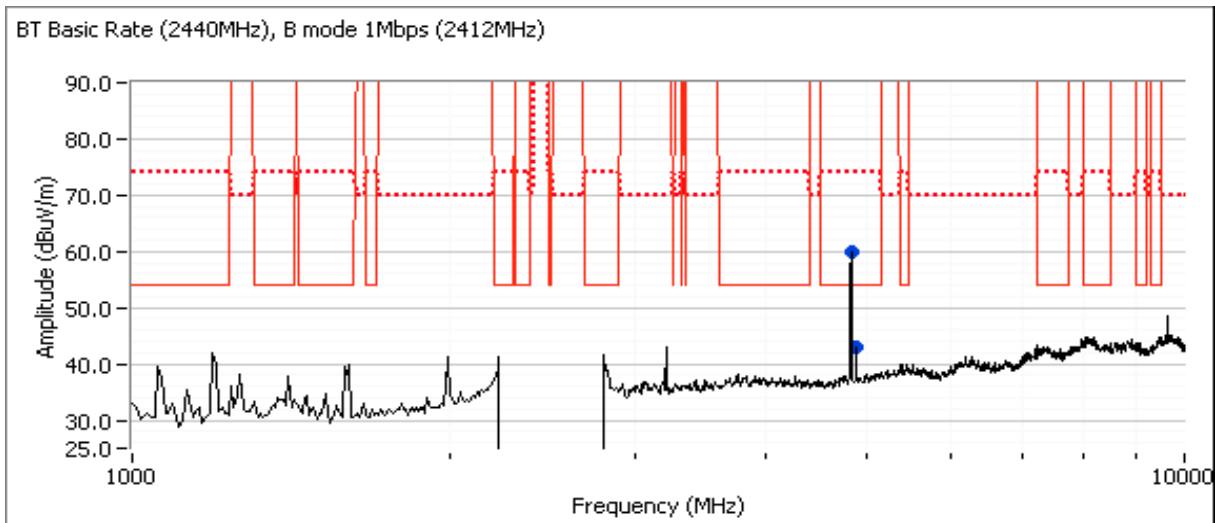



EMC Test Data

Client: Intel	Job Number: J88901
Model: Intel® Centrino® Advanced-N 6235	T-Log Number: T89578
	Account Manager: Christine Krebill
Contact: Steve Hackett	
Standard: FCC 15.247, 15.407, 15.209, RSS 210	Class: N/A

Preliminary Measurements (Peak versus average limit) at 20-30cm from EUT

Frequency	Level	Pol	15.209/15.247		Detector	Azimuth	Height	Comments
MHz	dB μ V/m	v/h	Limit	Margin	Pk/QP/Avg	degrees	meters	

Spurious Emissions near allocated band (final measurements at 3m)

Frequency	Level	Pol	15.209 / 15.247		Detector	Azimuth	Height	Comments
MHz	dB μ V/m	v/h	Limit	Margin	Pk/QP/Avg	degrees	meters	

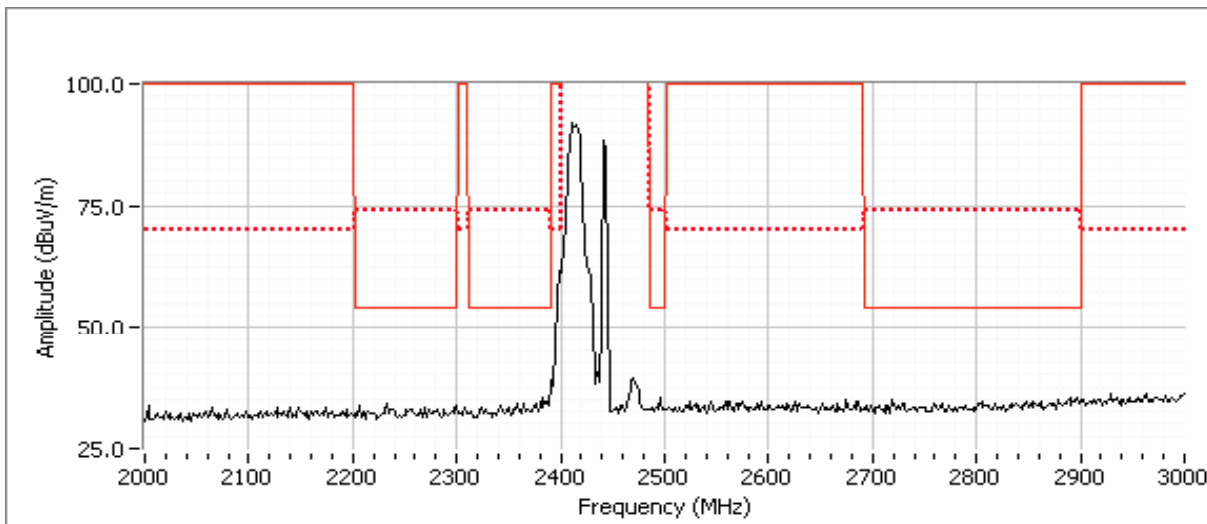



EMC Test Data

Client: Intel	Job Number: J88901
Model: Intel® Centrino® Advanced-N 6235	T-Log Number: T89578
	Account Manager: Christine Krebill
Contact: Steve Hackett	
Standard: FCC 15.247, 15.407, 15.209, RSS 210	Class: N/A

Run #7: 1-10GHz, 802.11b @ 2462 MHz Chain A, BT Basic Rate @ 2440 MHz Chain B
 Date of Test: 12/27/2012 Test Location: Chamber 4
 Test Engineer: Rafael Varelas Config Change: None

	Target (dBm)	Power Settings	
		Measured (dBm)	Software Setting
Chain A	16.5	16.6	25.0
Chain B	NA		8.0

Note - measured power in table above is average power, for reference only.

Preliminary Measurements (Peak versus average limit)

Frequency	Level	Pol	15.209/15.247		Detector	Azimuth	Height	Comments
MHz	dB μ V/m	v/h	Limit	Margin	PK/QP/Avg	degrees	meters	
4879.650	43.1	V	54.0	-10.9	Peak	277	1.9	
4923.960	56.1	V	54.0	2.1	Peak	79	1.9	

Spurious Emissions excluding allocated band (final measurements at 3m)

Frequency	Level	Pol	15.209 / 15.247		Detector	Azimuth	Height	Comments
MHz	dB μ V/m	v/h	Limit	Margin	PK/QP/Avg	degrees	meters	
4924.020	51.2	V	54.0	-2.8	AVG	298	1.0	RB 1 MHz;VB 10 Hz;Peak
4924.020	54.0	V	74.0	-20.0	PK	298	1.0	RB 1 MHz;VB 3 MHz;Peak
4880.010	39.1	V	54.0	-14.9	AVG	305	1.0	RB 1 MHz;VB 10 Hz;Peak
4879.420	47.8	V	74.0	-26.2	PK	305	1.0	RB 1 MHz;VB 3 MHz;Peak

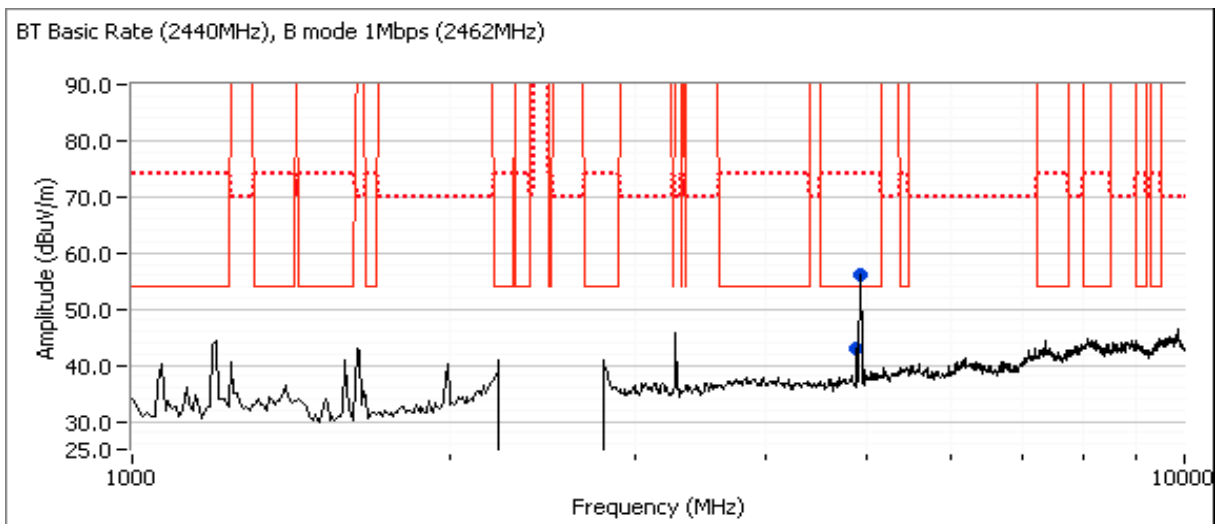



EMC Test Data

Client: Intel	Job Number: J88901
Model: Intel® Centrino® Advanced-N 6235	T-Log Number: T89578
	Account Manager: Christine Krebill
Contact: Steve Hackett	
Standard: FCC 15.247, 15.407, 15.209, RSS 210	Class: N/A

Preliminary Measurements (Peak versus average limit) at 20-30cm from EUT

Frequency	Level	Pol	15.209/15.247		Detector	Azimuth	Height	Comments
MHz	dB μ V/m	v/h	Limit	Margin	Pk/QP/Avg	degrees	meters	

Spurious Emissions near allocated band (final measurements at 3m)

Frequency	Level	Pol	15.209 / 15.247		Detector	Azimuth	Height	Comments
MHz	dB μ V/m	v/h	Limit	Margin	Pk/QP/Avg	degrees	meters	

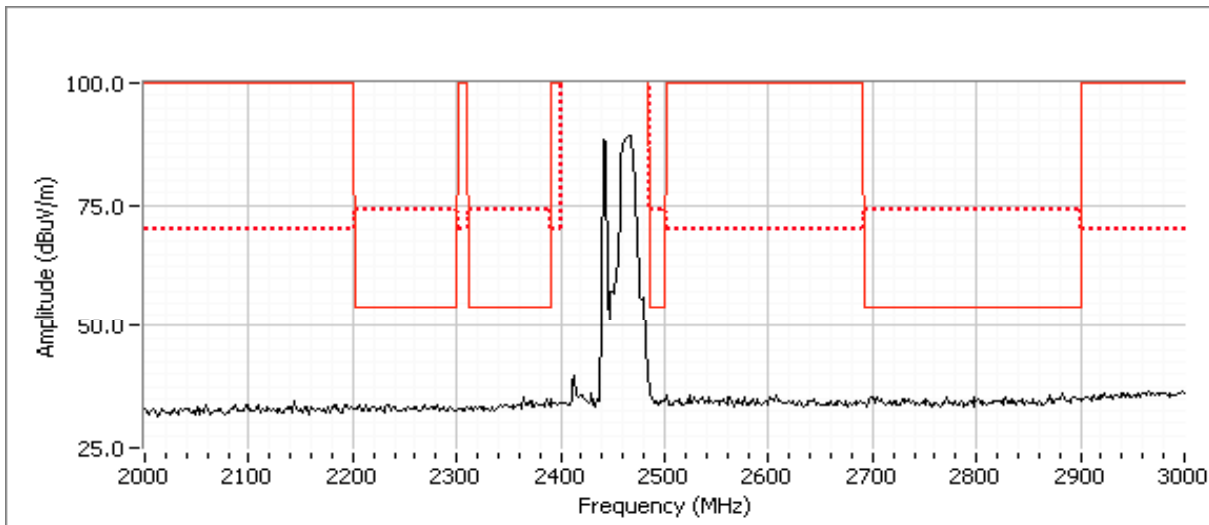



EMC Test Data

Client: Intel	Job Number: J88901
Model: Intel® Centrino® Advanced-N 6235	T-Log Number: T89578
	Account Manager: Christine Krebill
Contact: Steve Hackett	
Standard: FCC 15.247, 15.407, 15.209, RSS 210	Class: N/A

Run #8: 1-10GHz, 802.11b @ 2437 MHz Chain A, BT Basic Rate @ 2480 MHz Chain B
 Date of Test: 12/27/2012 Test Location: Chamber 4
 Test Engineer: Rafael Varelas Config Change: None

	Target (dBm)	Power Settings Measured (dBm)	Software Setting
Chain A	16.0	14.8	23.0
Chain B	NA		8.0

Note - measured power in table above is average power, for reference only.

Preliminary Measurements (Peak versus average limit)

Frequency	Level	Pol	15.209/15.247		Detector	Azimuth	Height	Comments
MHz	dB μ V/m	v/h	Limit	Margin	PK/QP/Avg	degrees	meters	
4874.030	55.0	V	54.0	1.0	Peak	273	2.5	

Spurious Emissions excluding allocated band (final measurements at 3m)

Frequency	Level	Pol	15.209 / 15.247		Detector	Azimuth	Height	Comments
MHz	dB μ V/m	v/h	Limit	Margin	PK/QP/Avg	degrees	meters	
4874.020	52.8	V	54.0	-1.2	AVG	272	1.2	Setting: 23, 1Mbps
4874.050	55.5	V	74.0	-18.5	PK	272	1.2	Setting: 23, 1Mbps

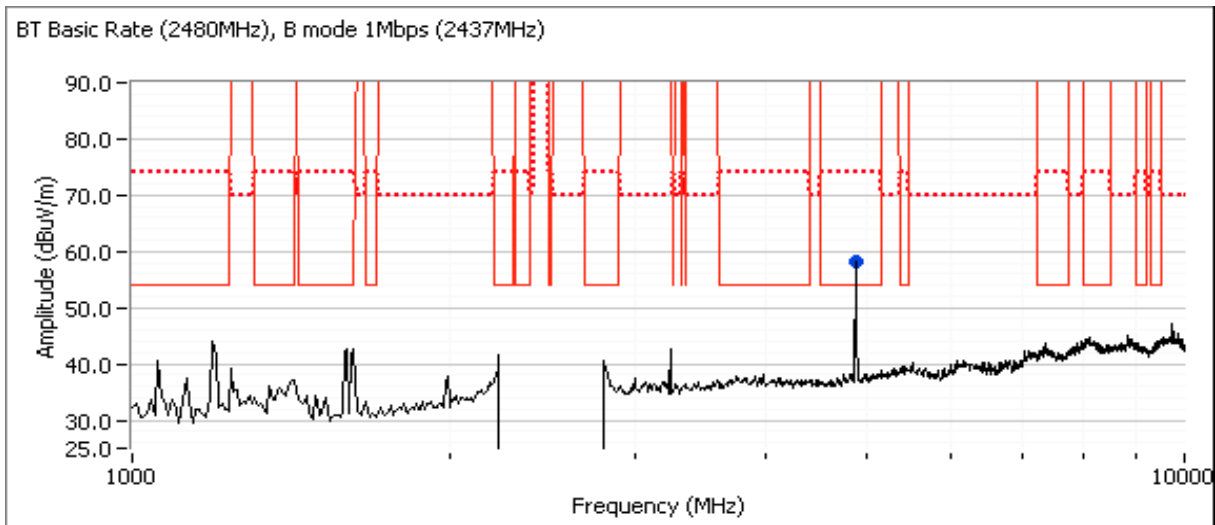



EMC Test Data

Client: Intel	Job Number: J88901
Model: Intel® Centrino® Advanced-N 6235	T-Log Number: T89578
	Account Manager: Christine Krebill
Contact: Steve Hackett	
Standard: FCC 15.247, 15.407, 15.209, RSS 210	Class: N/A

Preliminary Measurements (Peak versus average limit) at 20-30cm from EUT

Frequency	Level	Pol	15.209/15.247		Detector	Azimuth	Height	Comments
MHz	dB μ V/m	v/h	Limit	Margin	Pk/QP/Avg	degrees	meters	

Spurious Emissions near allocated band (final measurements at 3m)

Frequency	Level	Pol	15.209 / 15.247		Detector	Azimuth	Height	Comments
MHz	dB μ V/m	v/h	Limit	Margin	Pk/QP/Avg	degrees	meters	

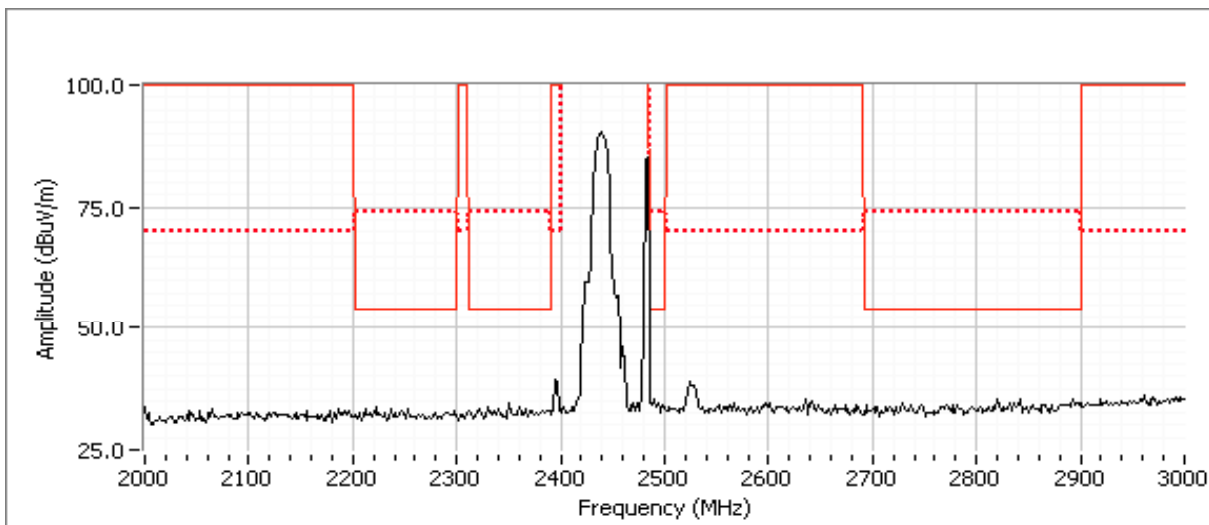



EMC Test Data

Client: Intel	Job Number: J88901
Model: Intel® Centrino® Advanced-N 6235	T-Log Number: T89578
	Account Manager: Christine Krebill
Contact: Steve Hackett	
Standard: FCC 15.247, 15.407, 15.209, RSS 210	Class: N/A

Run #9: 1-10GHz, 802.11b @ 2412 MHz Chain A, BT EDR Rate @ 2402 MHz Chain B
 Date of Test: 12/27/2012 Test Location: Chamber 4
 Test Engineer: Rafael Varelas Config Change: None

	Target (dBm)	Power Settings Measured (dBm)	Software Setting
Chain A	16.5	13.1	21.0
Chain B	NA		8.0

Note - measured power in table above is average power, for reference only.

Preliminary Measurements (Peak versus average limit)

Frequency	Level	Pol	15.209/15.247		Detector	Azimuth	Height	Comments
MHz	dB μ V/m	v/h	Limit	Margin	PK/QP/Avg	degrees	meters	
4824.030	55.2	V	54.0	1.2	Peak	271	2.5	

Spurious Emissions excluding allocated band (final measurements at 3m)

Frequency	Level	Pol	15.209 / 15.247		Detector	Azimuth	Height	Comments
MHz	dB μ V/m	v/h	Limit	Margin	PK/QP/Avg	degrees	meters	
4824.040	52.7	V	54.0	-1.3	AVG	277	2.3	Setting: 21.0, 1Mbps
4823.860	55.5	V	74.0	-18.5	PK	277	2.3	Setting: 21.0, 1Mbps

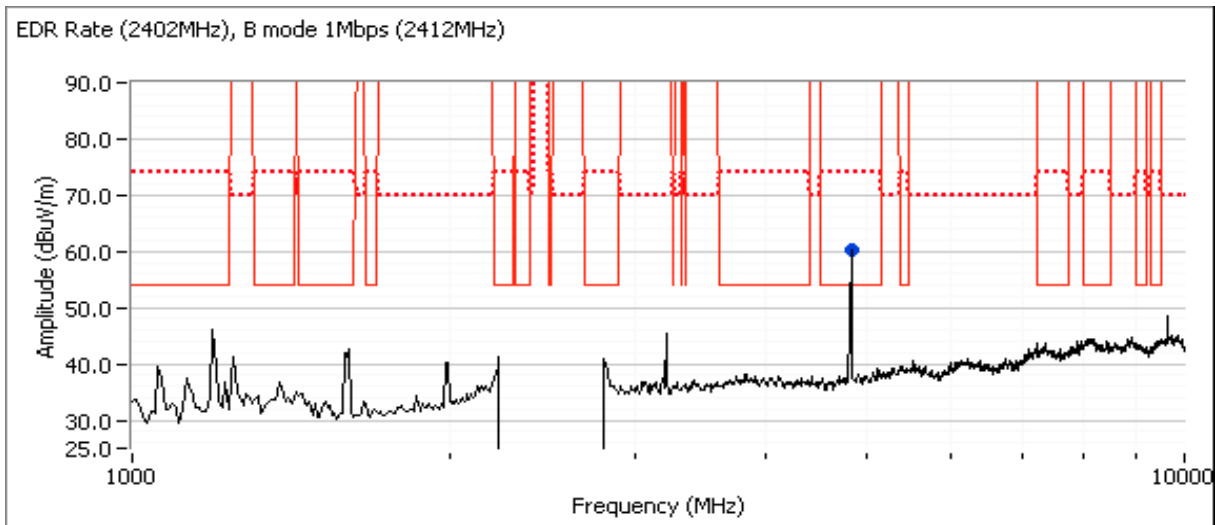



EMC Test Data

Client: Intel	Job Number: J88901
Model: Intel® Centrino® Advanced-N 6235	T-Log Number: T89578
	Account Manager: Christine Krebill
Contact: Steve Hackett	
Standard: FCC 15.247, 15.407, 15.209, RSS 210	Class: N/A

Preliminary Measurements (Peak versus average limit) at 20-30cm from EUT

Frequency	Level	Pol	15.209/15.247		Detector	Azimuth	Height	Comments
MHz	dB μ V/m	v/h	Limit	Margin	Pk/QP/Avg	degrees	meters	

Spurious Emissions near allocated band (final measurements at 3m)

Frequency	Level	Pol	15.209 / 15.247		Detector	Azimuth	Height	Comments
MHz	dB μ V/m	v/h	Limit	Margin	Pk/QP/Avg	degrees	meters	

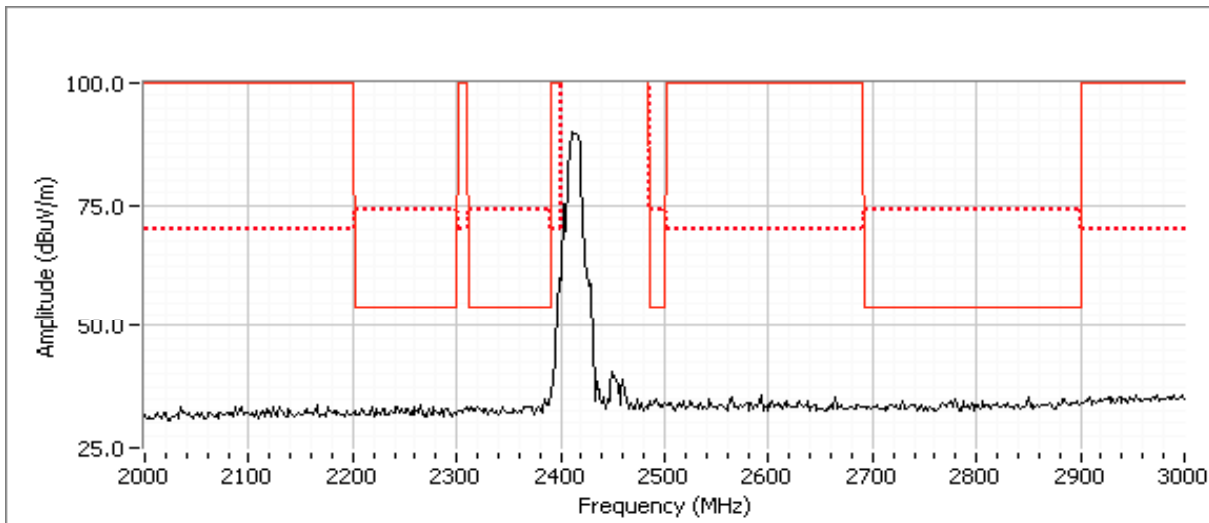



EMC Test Data

Client: Intel	Job Number: J88901
Model: Intel® Centrino® Advanced-N 6235	T-Log Number: T89578
	Account Manager: Christine Krebill
Contact: Steve Hackett	
Standard: FCC 15.247, 15.407, 15.209, RSS 210	Class: N/A

Run #10: 1-10GHz, 802.11b @ 2412 MHz Chain A, BTLE @ 2402 MHz Chain B
 Date of Test: 12/27/2012 Test Location: Chamber 4
 Test Engineer: Rafael Varelas Config Change: None

	Target (dBm)	Power Settings Measured (dBm)	Software Setting
Chain A	16.5	14.1	22.0
Chain B	NA		37bytes

Note - measured power in table above is average power, for reference only.

Preliminary Measurements (Peak versus average limit)

Frequency	Level	Pol	15.209/15.247		Detector	Azimuth	Height	Comments
MHz	dB μ V/m	v/h	Limit	Margin	PK/QP/Avg	degrees	meters	
4824.030	55.6	V	54.0	1.6	Peak	74	1.3	

Spurious Emissions excluding allocated band (final measurements at 3m)

Frequency	Level	Pol	15.209 / 15.247		Detector	Azimuth	Height	Comments
MHz	dB μ V/m	v/h	Limit	Margin	PK/QP/Avg	degrees	meters	
4824.040	53.0	V	54.0	-1.0	AVG	66	1.2	Setting: 22.0, 1Mbps
4824.190	55.9	V	74.0	-18.1	PK	66	1.2	Setting: 22.0, 1Mbps

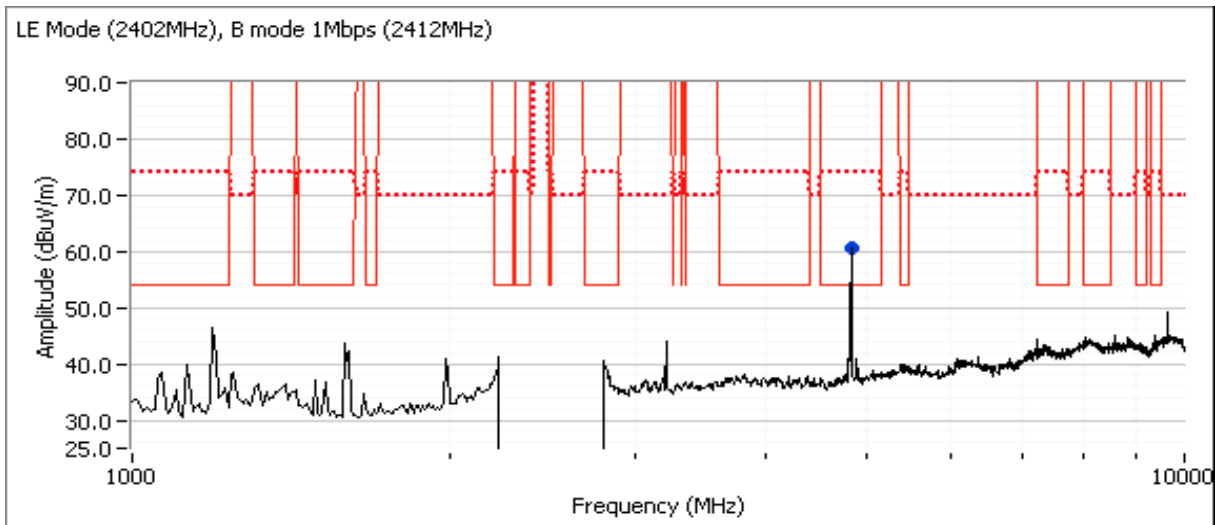



EMC Test Data

Client: Intel	Job Number: J88901
Model: Intel® Centrino® Advanced-N 6235	T-Log Number: T89578
Contact: Steve Hackett	Account Manager: Christine Krebill
Standard: FCC 15.247, 15.407, 15.209, RSS 210	Class: N/A

Preliminary Measurements (Peak versus average limit) at 20-30cm from EUT

Frequency	Level	Pol	15.209/15.247		Detector	Azimuth	Height	Comments
MHz	dB μ V/m	v/h	Limit	Margin	Pk/QP/Avg	degrees	meters	

Spurious Emissions near allocated band (final measurements at 3m)

Frequency	Level	Pol	15.209 / 15.247		Detector	Azimuth	Height	Comments
MHz	dB μ V/m	v/h	Limit	Margin	Pk/QP/Avg	degrees	meters	

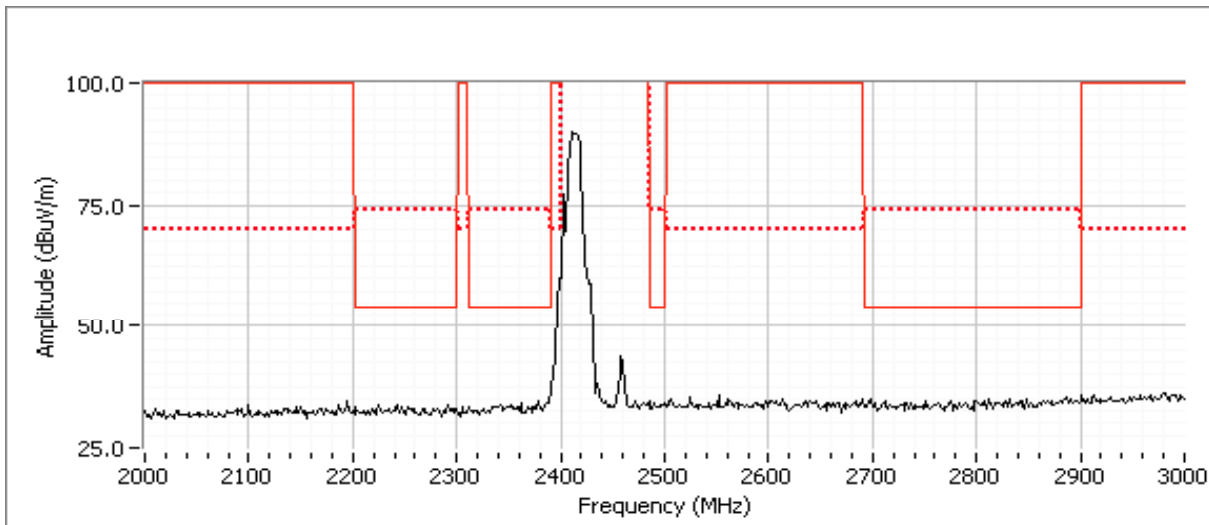



EMC Test Data

Client:	Intel	Job Number:	J88901
Model:	Intel® Centrino® Advanced-N 6235	T-Log Number:	T89578
Contact:	Steve Hackett	Account Manager:	Christine Krebill
Standard:	FCC 15.247, 15.407, 15.209, RSS 210	Class:	N/A

Run #11: 1-15GHz, 802.11n20 @ 5200 MHz Chain A+B, BT Basic Rate @ 2440 MHz Chain B

Date of Test: 12/28/2012
 Test Engineer: John Caizzi

Test Location: Chamber 5
 Config Change: none

	Power Settings		
	Target (dBm)	Measured (dBm)	Software Setting
Chain A	16.0	14.3	39.0
Chain B	16.0	13.5	39.0
Bluetooth	Max	NA	8 dBm

Note - measured power in table above is average power, for reference only.

Preliminary Measurements (Peak versus average limit)

Frequency	Level	Pol	15.209/15.247		Detector	Azimuth	Height	Comments
MHz	dB μ V/m	v/h	Limit	Margin	Pk/QP/Avg	degrees	meters	
10408.330	53.4	V	68.3	-14.9	Peak	69	1.0	

Spurious Emissions (final measurements at 3m)

Frequency	Level	Pol	15.209 / 15.247		Detector	Azimuth	Height	Comments
MHz	dB μ V/m	v/h	Limit	Margin	Pk/QP/Avg	degrees	meters	
10399.660	58.5	V	68.3	-9.8	PK	70	1.47	

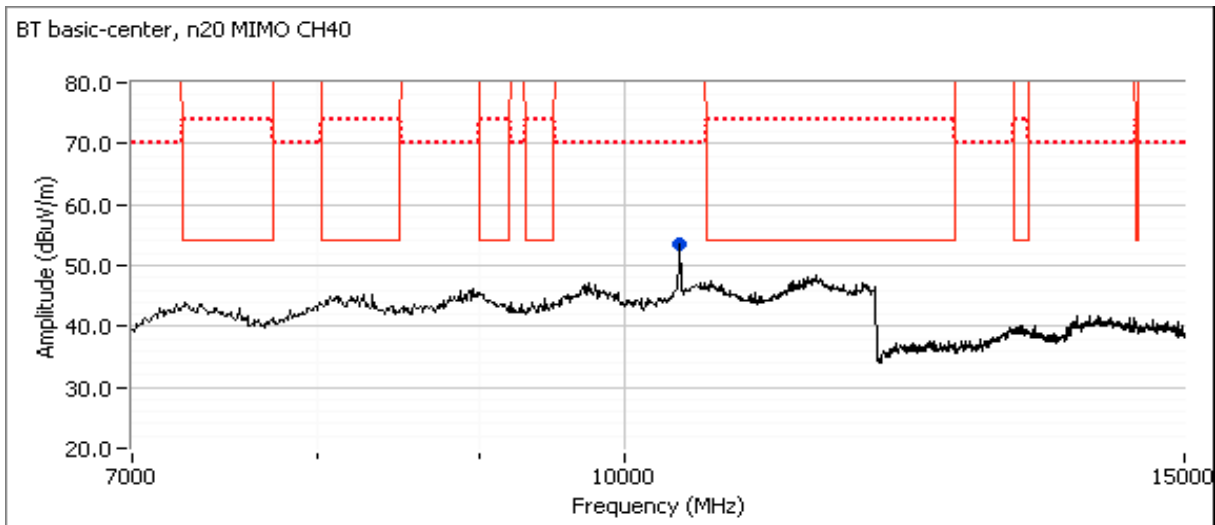



EMC Test Data

Client: Intel	Job Number: J88901
Model: Intel® Centrino® Advanced-N 6235	T-Log Number: T89578
	Account Manager: Christine Krebill
Contact: Steve Hackett	
Standard: FCC 15.247, 15.407, 15.209, RSS 210	Class: N/A

Preliminary Measurements (Peak versus average limit) at 20-30cm from EUT

Frequency	Level	Pol	15.209/15.247		Detector	Azimuth	Height	Comments
MHz	dB μ V/m	v/h	Limit	Margin	Pk/QP/Avg	degrees	meters	
1841.680	45.6	V	54.0	-8.4	Peak	0	1.0	
1925.850	42.5	V	74.0	-31.5	Peak	0	1.0	

Spurious Emissions (final measurements at 3m)

Frequency	Level	Pol	15.209 / 15.247		Detector	Azimuth	Height	Comments
MHz	dB μ V/m	v/h	Limit	Margin	Pk/QP/Avg	degrees	meters	
1840.190	32.8	V	54.0	-21.2	AVG	0	1.0	Note 1
1841.120	44.4	V	74.0	-29.6	PK	0	1.0	Note 1
1924.700	33.1	V	54.0	-20.9	AVG	0	1.0	Note 1
1924.360	45.9	V	74.0	-28.1	PK	0	1.0	Note 1

Note 1: Noise floor measurement. Could not find signals when maximizing.

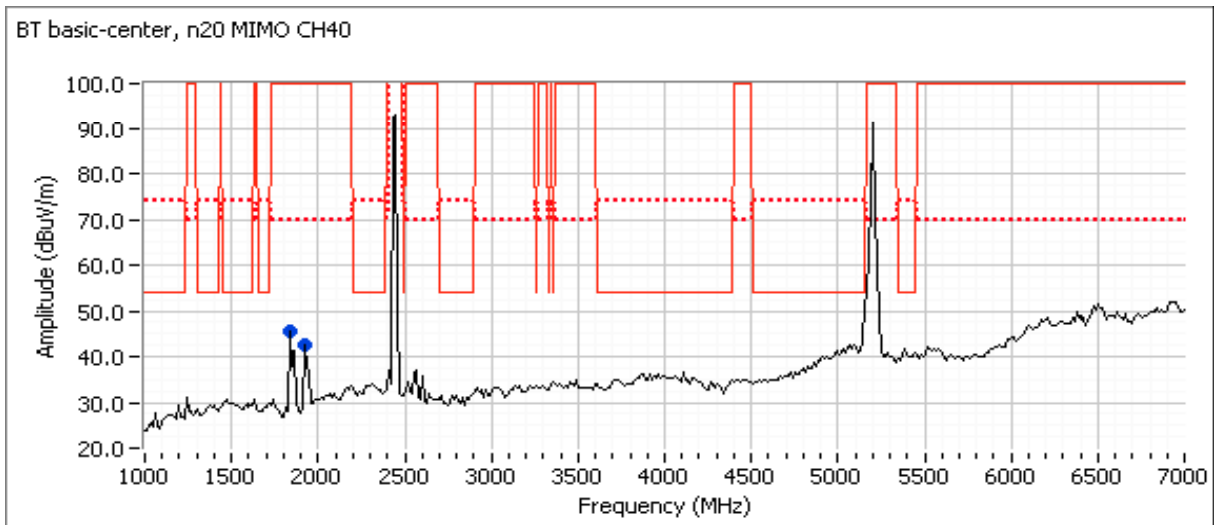



EMC Test Data

Client: Intel	Job Number: J88901
Model: Intel® Centrino® Advanced-N 6235	T-Log Number: T89578
	Account Manager: Christine Krebill
Contact: Steve Hackett	
Standard: FCC 15.247, 15.407, 15.209, RSS 210	Class: N/A

Run #12: 1-15GHz, 802.11n20 @ 5300 MHz Chain A+B, BT Basic Rate @ 2440 MHz Chain B

Date of Test: 12/28/2012
 Test Engineer: John Caizzi

Test Location: Chamber 5
 Config Change: none

	Power Settings		
	Target (dBm)	Measured (dBm)	Software Setting
Chain A	16.0	14.2	39.0
Chain B	16.0	13.2	39.0
Bluetooth	Max	NA	8 dBm

Note - measured power in table above is average power, for reference only.

Preliminary Measurements (Peak versus average limit)

Frequency	Level	Pol	15.209/15.247		Detector	Azimuth	Height	Comments
MHz	dB μ V/m	v/h	Limit	Margin	Pk/QP/Avg	degrees	meters	
10608.330	52.7	V	54.0	-1.3	Peak	127	1.0	

Spurious Emissions (final measurements at 3m)

Frequency	Level	Pol	15.209 / 15.247		Detector	Azimuth	Height	Comments
MHz	dB μ V/m	v/h	Limit	Margin	Pk/QP/Avg	degrees	meters	
10600.710	45.8	V	54.0	-8.2	AVG	116	1.00	
10603.870	57.6	V	74.0	-16.4	PK	116	1.00	

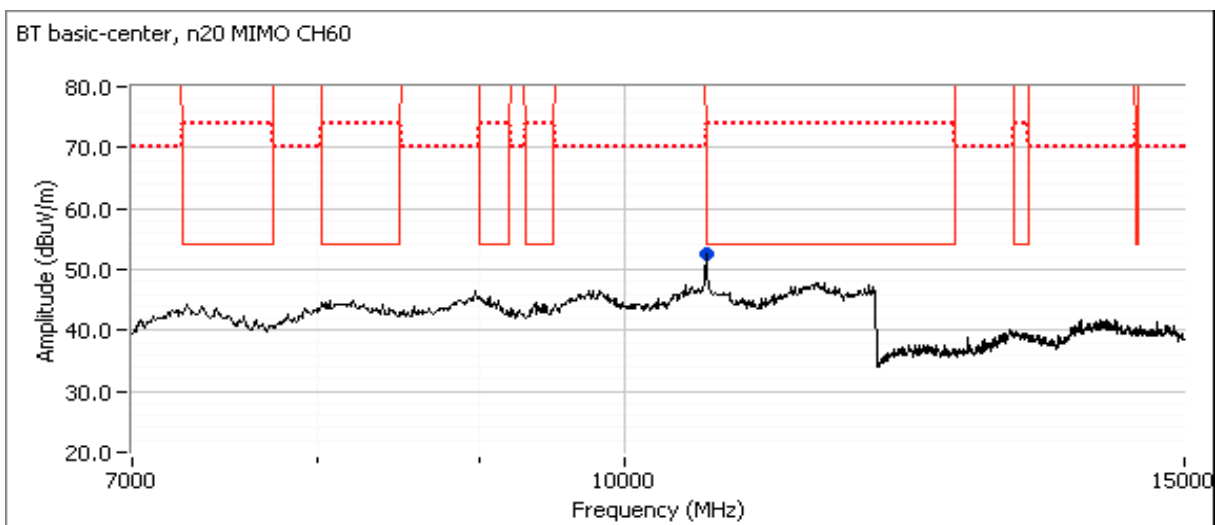



EMC Test Data

Client: Intel	Job Number: J88901
Model: Intel® Centrino® Advanced-N 6235	T-Log Number: T89578
	Account Manager: Christine Krebill
Contact: Steve Hackett	
Standard: FCC 15.247, 15.407, 15.209, RSS 210	Class: N/A

Preliminary Measurements (Peak versus average limit) at 20-30cm from EUT

Frequency	Level	Pol	15.209/15.247		Detector	Azimuth	Height	Comments
MHz	dB μ V/m	v/h	Limit	Margin	Pk/QP/Avg	degrees	meters	

Spurious Emissions (final measurements at 3m)

Frequency	Level	Pol	15.209 / 15.247		Detector	Azimuth	Height	Comments
MHz	dB μ V/m	v/h	Limit	Margin	Pk/QP/Avg	degrees	meters	

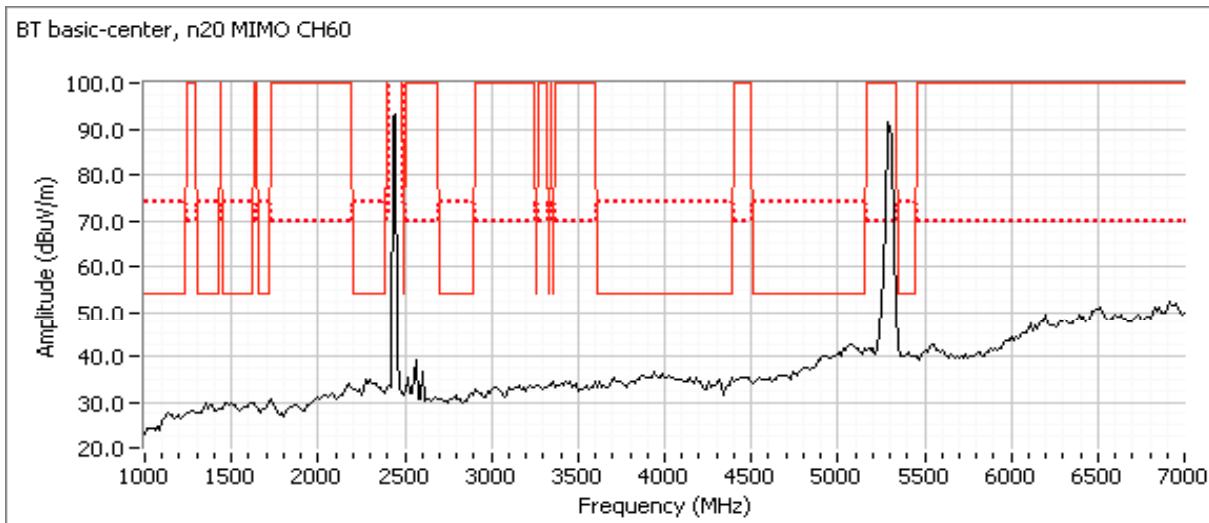



EMC Test Data

Client: Intel	Job Number: J88901
Model: Intel® Centrino® Advanced-N 6235	T-Log Number: T89578
	Account Manager: Christine Krebill
Contact: Steve Hackett	
Standard: FCC 15.247, 15.407, 15.209, RSS 210	Class: N/A

Run #13: 1-15GHz, 802.11n20 @ 5580 MHz Chain A+B, BT Basic Rate @ 2440 MHz Chain B

Date of Test: 12/28/2012
 Test Engineer: John Caizzi

Test Location: Chamber 5
 Config Change: none

	Power Settings		
	Target (dBm)	Measured (dBm)	Software Setting
Chain A	16.0	12.8	39.0
Chain B	16.0	13.9	39.0
Bluetooth	Max	NA	8 dBm

Note - measured power in table above is average power, for reference only.

Preliminary Measurements (Peak versus average limit)

Frequency	Level	Pol	15.209/15.247		Detector	Azimuth	Height	Comments
MHz	dB μ V/m	v/h	Limit	Margin	Pk/QP/Avg	degrees	meters	
11166.670	55.9	V	54.0	1.9	Peak	249	1.0	

Spurious Emissions (final measurements at 3m)

Frequency	Level	Pol	15.209 / 15.247		Detector	Azimuth	Height	Comments
MHz	dB μ V/m	v/h	Limit	Margin	Pk/QP/Avg	degrees	meters	
11159.670	46.4	V	54.0	-7.6	AVG	250	1.00	
11160.340	61.6	V	74.0	-12.4	PK	250	1.00	

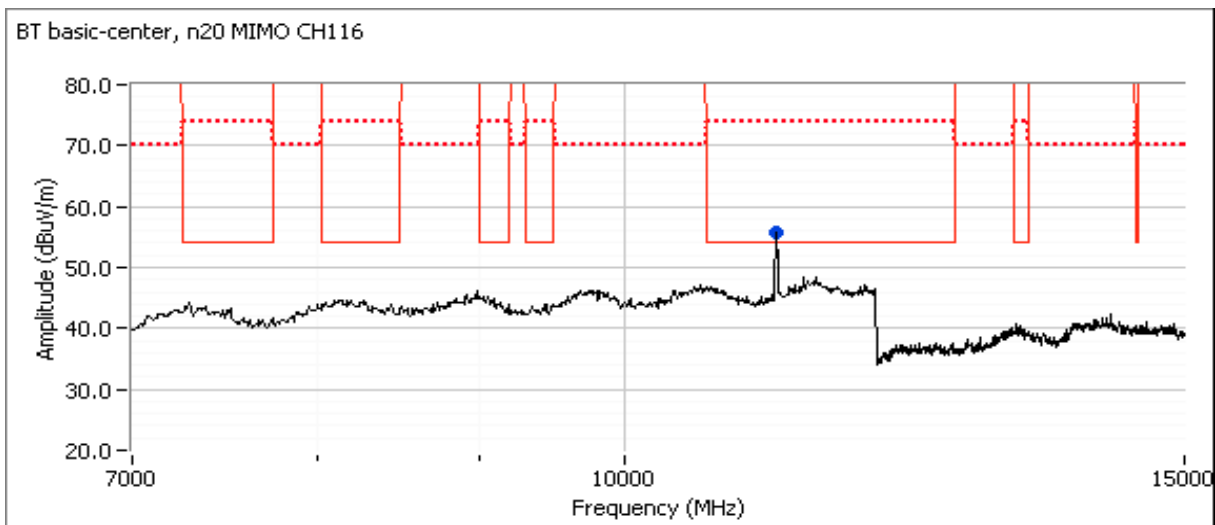



EMC Test Data

Client: Intel	Job Number: J88901
Model: Intel® Centrino® Advanced-N 6235	T-Log Number: T89578
	Account Manager: Christine Krebill
Contact: Steve Hackett	
Standard: FCC 15.247, 15.407, 15.209, RSS 210	Class: N/A

Preliminary Measurements (Peak versus average limit) at 20-30cm from EUT

Frequency	Level	Pol	15.209/15.247		Detector	Azimuth	Height	Comments
MHz	dB μ V/m	v/h	Limit	Margin	Pk/QP/Avg	degrees	meters	

Spurious Emissions (final measurements at 3m)

Frequency	Level	Pol	15.209 / 15.247		Detector	Azimuth	Height	Comments
MHz	dB μ V/m	v/h	Limit	Margin	Pk/QP/Avg	degrees	meters	

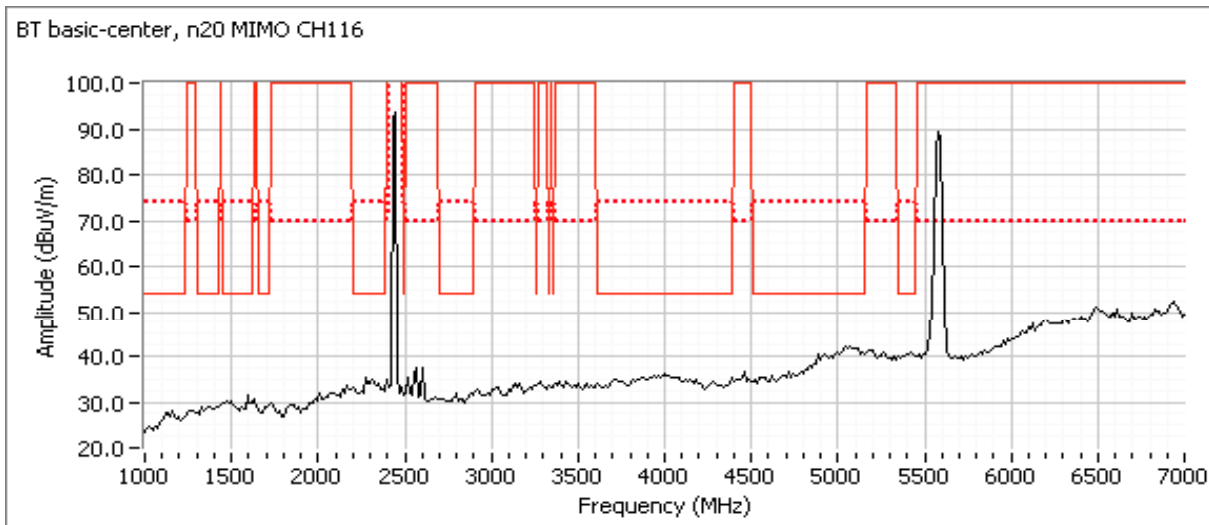



EMC Test Data

Client: Intel	Job Number: J88901
Model: Intel® Centrino® Advanced-N 6235	T-Log Number: T89578
	Account Manager: Christine Krebill
Contact: Steve Hackett	
Standard: FCC 15.247, 15.407, 15.209, RSS 210	Class: N/A

Run #14: 1-15GHz, 802.11n20 @ 5785 MHz Chain A+B, BT Basic Rate @ 2440 MHz Chain B

Date of Test: 12/28/2012
 Test Engineer: John Caizzi

Test Location: Chamber 5
 Config Change: none

	Power Settings		
	Target (dBm)	Measured (dBm)	Software Setting
Chain A	16.0	11.2	39.0
Chain B	16.0	11.1	39.0
Bluetooth	Max	NA	8 dBm

Note - measured power in table above is average power, for reference only.

Preliminary Measurements (Peak versus average limit)

Frequency	Level	Pol	15.209/15.247		Detector	Azimuth	Height	Comments
MHz	dB μ V/m	v/h	Limit	Margin	Pk/QP/Avg	degrees	meters	
11575.000	52.0	V	54.0	-2.0	Peak	72	1.0	

Spurious Emissions (final measurements at 3m)

Frequency	Level	Pol	15.209 / 15.247		Detector	Azimuth	Height	Comments
MHz	dB μ V/m	v/h	Limit	Margin	Pk/QP/Avg	degrees	meters	
11569.800	47.9	V	54.0	-6.1	AVG	131	1.33	
11570.470	60.9	V	74.0	-13.1	PK	131	1.33	

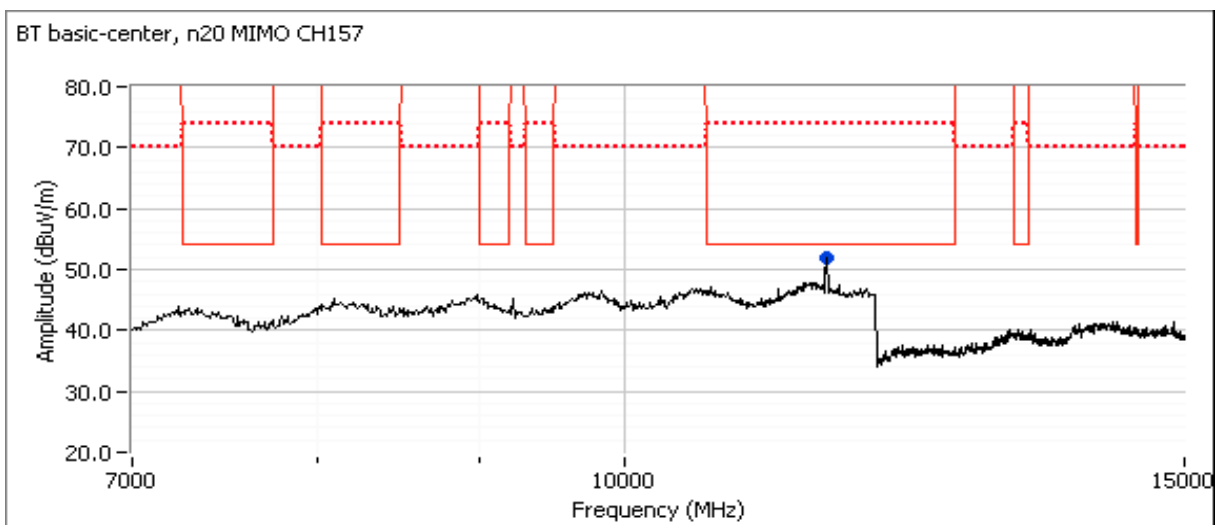



EMC Test Data

Client: Intel	Job Number: J88901
Model: Intel® Centrino® Advanced-N 6235	T-Log Number: T89578
Contact: Steve Hackett	Account Manager: Christine Krebill
Standard: FCC 15.247, 15.407, 15.209, RSS 210	Class: N/A

Preliminary Measurements (Peak versus average limit) at 20-30cm from EUT

Frequency	Level	Pol	15.209/15.247		Detector	Azimuth	Height	Comments
MHz	dB μ V/m	v/h	Limit	Margin	Pk/QP/Avg	degrees	meters	

Spurious Emissions (final measurements at 3m)

Frequency	Level	Pol	15.209 / 15.247		Detector	Azimuth	Height	Comments
MHz	dB μ V/m	v/h	Limit	Margin	Pk/QP/Avg	degrees	meters	

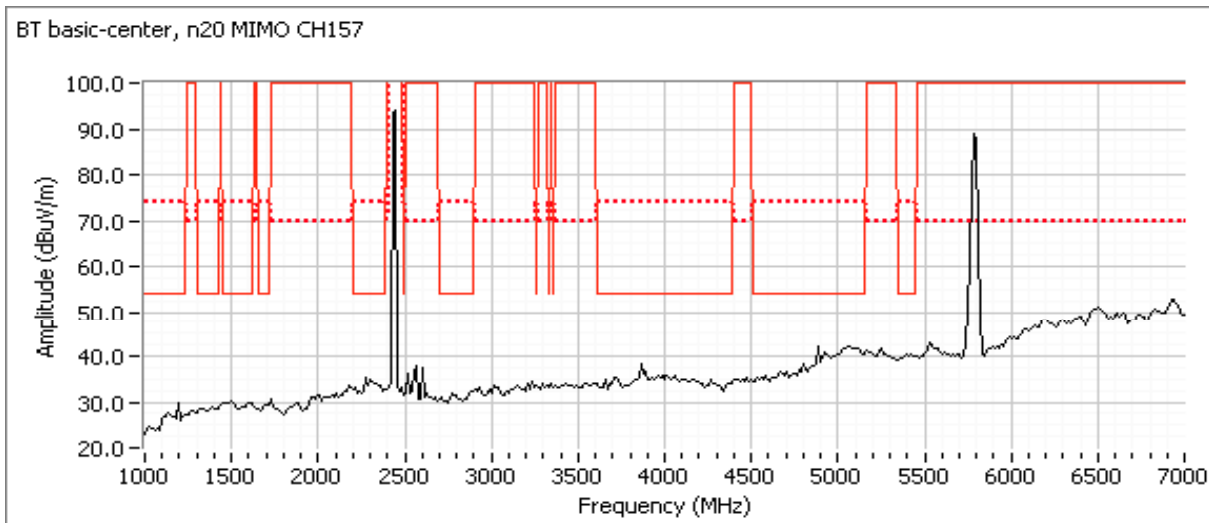



EMC Test Data

Client:	Intel	Job Number:	J88901
Model:	Intel® Centrino® Advanced-N 6235	T-Log Number:	T89578
Contact:	Steve Hackett	Account Manager:	Christine Krebill
Standard:	FCC 15.247, 15.407, 15.209, RSS 210	Class:	B

Radiated Emissions

(Elliott Laboratories Fremont Facility, Semi-Anechoic Chamber)

Test Specific Details

Objective: The objective of this test session is to perform final qualification testing of the EUT with respect to the specification listed above.

Date of Test: 12/28/2012
 Test Engineer: John Caizzi
 Test Location: Chamber 5

Config. Used: 1
 Config Change: none
 Host Unit Voltage 120V/60Hz

General Test Configuration

The EUT and any local support equipment were located on the turntable for radiated emissions testing. The test distance and extrapolation factor (if applicable) are detailed under each run description.

Ambient Conditions:

Temperature: 18 °C
 Rel. Humidity: 39 %

Summary of Results

MAC Address: 001500B50405 DRTU Tool Version 1.5.6-0445 Driver version 15.3.1.2

Run #	Test Performed	Limit	Result	Margin
1	Radiated Emissions 30 - 1000 MHz, Maximized	FCC 15.209 / RSS 210	Pass	29.0 dBµV/m @ 48.02 MHz (-11.0 dB)

Note - preliminary measurements indicated that the radiated emissions from the combination of test fixture and EUT were not affected by the modules operating frequency or mode (transmit versus receive mode). The system was therefore evaluated against the most stringent set of limits from FCC 15.247, FCC 15E and RSS 210 with the device operating at max power (16.5dBm) on Chain A at 2437MHz, 802.11b mode and max power (7dBm) on the top channel in Bluetooth mode (1Mb/s data rate).

Modifications Made During Testing

No modifications were made to the EUT during testing

Deviations From The Standard

No deviations were made from the requirements of the standard.

Client: Intel	Job Number: J88901
Model: Intel® Centrino® Advanced-N 6235	T-Log Number: T89578
Contact: Steve Hackett	Account Manager: Christine Krebill
Standard: FCC 15.247, 15.407, 15.209, RSS 210	Class: B

Run #1: Preliminary Radiated Emissions, 30 - 1000 MHz
 Configured to TX , 802.11b, 16.5dBm on Chain A (setting 26.0) on channel 6, Bluetooth 7dBm, 1Mb/s (setting 8.0)

Test Parameters for Preliminary Scan(s)			
Frequency Range	Prescan Distance	Limit Distance	Extrapolation Factor
30 - 1000 MHz	3	3	0.0

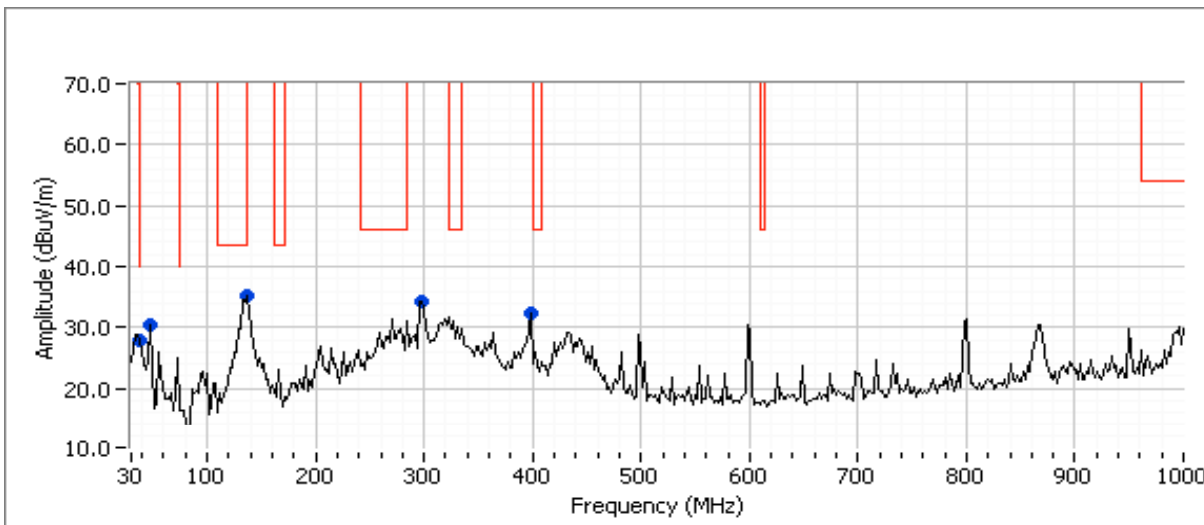

Preliminary peak readings captured during pre-scan

Frequency	Level	Pol	FCC 15.209 / RSS 210		Detector	Azimuth	Height	Comments
MHz	dBµV/m	v/h	Limit	Margin	Pk/QP/Avg	degrees	meters	
136.412	35.1	V	43.5	-8.4	Peak	129	1.0	
37.881	28.0	V	40.0	-12.0	Peak	335	1.0	
399.938	32.5	H	46.0	-13.5	Peak	322	1.0	
48.020	30.4	V	40.0	-9.6	Peak	263	1.0	Note 1
299.808	34.4	H	46.0	-11.6	Peak	33	1.0	Note 1

Preliminary quasi-peak readings (no manipulation of EUT interface cables)

Frequency	Level	Pol	FCC 15.209 / RSS 210		Detector	Azimuth	Height	Comments
MHz	dBµV/m	v/h	Limit	Margin	Pk/QP/Avg	degrees	meters	
48.020	29.0	V	40.0	-11.0	QP	304	1.00	Note 1
37.881	23.8	V	40.0	-16.2	QP	346	1.00	
399.938	25.2	H	46.0	-20.8	QP	327	1.00	
48.020	29.0	V	40.0	-11.0	QP	304	1.00	Note 1
136.412	32.1	V	43.5	-11.4	QP	140	1.00	
299.808	29.8	H	46.0	-16.2	QP	31	1.00	Note 1



EMC Test Data

Client:	Intel	Job Number:	J88901
Model:	Intel® Centrino® Advanced-N 6235	T-Log Number:	T89578
Contact:	Steve Hackett	Account Manager:	Christine Krebill
Standard:	FCC 15.247, 15.407, 15.209, RSS 210	Class:	B

Note 1: Emission is not in restricted band, but the more stringent restricted band limit was used.



EMC Test Data

Client: Intel	Job Number: J88901
Model: Intel® Centrino® Advanced-N 6235	T-Log Number: T89578
	Account Manager: Christine Krebill
Contact: Steve Hackett	
Standard: FCC 15.247, 15.407, 15.209, RSS 210	Class: B

Conducted Emissions

(Elliott Laboratories Fremont Facility, Semi-Anechoic Chamber)

Test Specific Details

Objective: The objective of this test session is to perform final qualification testing of the EUT with respect to the specification listed above.

Date of Test: 12/18/2012	Config. Used: 1
Test Engineer: Mark Hill	Config Change: -
Test Location: Fremont Chamber #4	EUT Voltage: 120V/60Hz

General Test Configuration

For tabletop equipment, the EUT was located on a wooden table inside the semi-anechoic chamber, 40 cm from a vertical coupling plane and 80cm from the LISN. A second LISN was used for all local support equipment. Remote support equipment was located outside of the semi-anechoic chamber. Any cables running to remote support equipment were routed through metal conduit and when possible passed through a ferrite clamp upon exiting the chamber.

Ambient Conditions:	Temperature:	19 °C
	Rel. Humidity:	41 %

Summary of Results

Run #	Test Performed	Limit	Result	Margin
1	CE, AC Power, 120V/60Hz	Class B	Pass	31.3 dB μ V @ 4.428 MHz (-24.7 dB)

Modifications Made During Testing

No modifications were made to the EUT during testing

Deviations From The Standard

No deviations were made from the requirements of the standard.



EMC Test Data

Client: Intel	Job Number: J88901
Model: Intel® Centrino® Advanced-N 6235	T-Log Number: T89578
	Account Manager: Christine Krebill
Contact: Steve Hackett	
Standard: FCC 15.247, 15.407, 15.209, RSS 210	Class: B

Run #1: AC Power Port Conducted Emissions, 0.15 - 30MHz, 120V/60Hz

Preliminary peak readings captured during pre-scan (peak readings vs. average limit)

Frequency MHz	Level dB μ V	AC Line	Class B		Detector QP/Ave	Comments
			Limit	Margin		
0.455	33.7	Neutral	46.8	-13.1	Peak	
0.471	33.1	Neutral	46.5	-13.4	Peak	
4.428	36.6	Neutral	46.0	-9.4	Peak	
5.983	37.4	Neutral	50.0	-12.6	Peak	
0.443	33.0	Line 1	47.0	-14.0	Peak	
0.473	32.5	Line 1	46.5	-14.0	Peak	
4.621	34.6	Line 1	46.0	-11.4	Peak	
13.329	38.9	Line 1	50.0	-11.1	Peak	

Final quasi-peak and average readings

Frequency MHz	Level dB μ V	AC Line	Class B		Detector QP/Ave	Comments
			Limit	Margin		
4.428	31.3	Neutral	56.0	-24.7	QP	QP (1.00s)
4.428	20.4	Neutral	46.0	-25.6	AVG	AVG (0.10s)
4.621	28.5	Line 1	56.0	-27.5	QP	QP (1.00s)
5.983	30.9	Neutral	60.0	-29.1	QP	QP (1.00s)
4.621	16.8	Line 1	46.0	-29.2	AVG	AVG (0.10s)
13.329	20.5	Line 1	50.0	-29.5	AVG	AVG (0.10s)
0.443	26.8	Line 1	57.0	-30.2	QP	QP (1.00s)
0.473	26.3	Line 1	56.5	-30.2	QP	QP (1.00s)
0.471	26.2	Neutral	56.5	-30.3	QP	QP (1.00s)
0.455	26.4	Neutral	56.8	-30.4	QP	QP (1.00s)
5.983	19.5	Neutral	50.0	-30.5	AVG	AVG (0.10s)
13.329	28.3	Line 1	60.0	-31.7	QP	QP (1.00s)
0.443	8.3	Line 1	47.0	-38.7	AVG	AVG (0.10s)
0.473	6.9	Line 1	46.5	-39.6	AVG	AVG (0.10s)
0.455	6.6	Neutral	46.8	-40.2	AVG	AVG (0.10s)
0.471	6.1	Neutral	46.5	-40.4	AVG	AVG (0.10s)

Client: Intel	Job Number: J88901
Model: Intel® Centrino® Advanced-N 6235	T-Log Number: T89578
	Account Manager: Christine Krebill
Contact: Steve Hackett	
Standard: FCC 15.247, 15.407, 15.209, RSS 210	Class: B

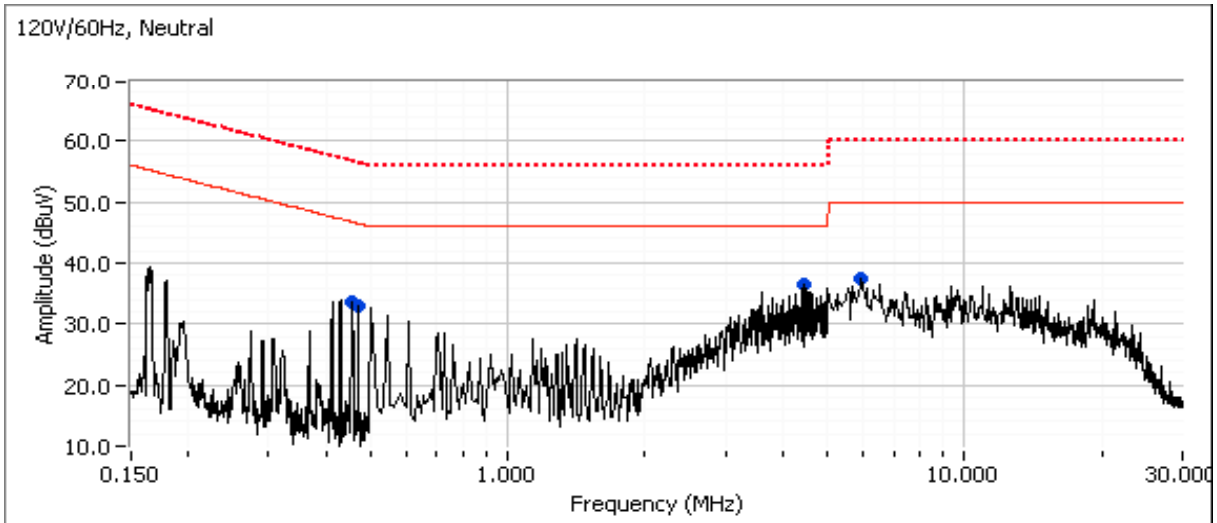
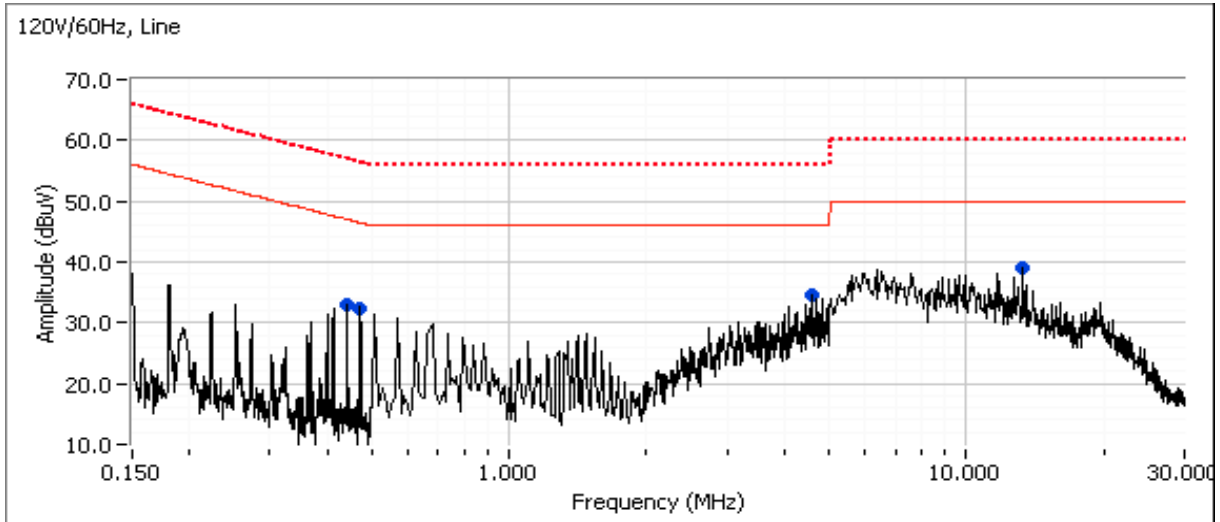

End of Report

This page is intentionally blank and marks the last page of this test report.