



*EMC Test Report*

*FCC Part 27  
(Class II Permissive Change)*

*Model: Intel® Centrino® Advanced-N + WiMAX 6250, model  
622ANXHMW*

FCC ID: PD9622ANXH

APPLICANT: Intel Corporation  
2111 NE 25th Avenue  
Hillsboro, OR 97124

TEST SITE(S): Elliott Laboratories  
684 West Maude Ave.  
Sunnvale, CA. 94085

REPORT DATE: June 28, 2010

FINAL TEST DATES: June 21, 2010

AUTHORIZED SIGNATORY:

A handwritten signature in black ink that reads "Mark Briggs". The signature is written in a cursive style and is positioned above a horizontal line.

Mark Briggs  
Staff Engineer  
Elliott Laboratories



Testing Cert #2016.01

Elliott Laboratories is accredited by the A2LA, certificate number 2016-01, to perform the test(s) listed in this report, except where noted otherwise. This report shall not be reproduced, except in its entirety, without the written approval of Elliott Laboratories

**REVISION HISTORY**

Rev#	Date	Comments	Modified By
-	June 28, 2010	First release	

**TABLE OF CONTENTS**

**REVISION HISTORY ..... 2**

**TABLE OF CONTENTS ..... 2**

**SCOPE..... 3**

**OBJECTIVE ..... 3**

**STATEMENT OF COMPLIANCE..... 4**

**DEVIATIONS FROM THE STANDARDS..... 4**

**TEST RESULTS SUMMARY ..... 5**

    FCC PART 27 (2496 – 2690 MHZ MOBILE DIGITAL STATIONS)..... 5

    MEASUREMENT UNCERTAINTIES..... 5

**EQUIPMENT UNDER TEST (EUT) DETAILS..... 6**

    GENERAL..... 6

    ENCLOSURE..... 6

    MODIFICATIONS..... 6

    SUPPORT EQUIPMENT..... 6

    EUT INTERFACE PORTS ..... 7

    EUT OPERATION ..... 7

**TEST SITE..... 8**

    GENERAL INFORMATION..... 8

**RF PORT MEASUREMENT PROCEDURES ..... 8**

    OUTPUT POWER..... 9

    BANDWIDTH MEASUREMENTS ..... 9

    CONDUCTED SPURIOUS EMISSIONS..... 9

    TRANSMITTER MASK MEASUREMENTS..... 9

**RADIATED EMISSIONS MEASUREMENTS..... 10**

    INSTRUMENTATION ..... 11

    FILTERS/ATTENUATORS ..... 11

    ANTENNAS..... 11

    ANTENNA MAST AND EQUIPMENT TURNTABLE..... 11

**SAMPLE CALCULATIONS ..... 12**

    SAMPLE CALCULATIONS - CONDUCTED SPURIOUS EMISSIONS ..... 12

    SAMPLE CALCULATIONS –RADIATED FIELD STRENGTH..... 12

    SAMPLE CALCULATIONS –RADIATED POWER..... 13

**APPENDIX A TEST EQUIPMENT CALIBRATION DATA ..... 1**

**APPENDIX B TEST DATA ..... 2**

## SCOPE

An electromagnetic emissions test has been performed on the Intel Corporation model Intel® Centrino® Advanced-N + WiMAX 6250, model 622ANXHMW, pursuant to the following rules:

- Code of Federal Regulations (CFR) Title 47 Part 2
- CFR 47 Part 27

Conducted and radiated emissions data has been collected, reduced, and analyzed within this report in accordance with measurement guidelines set forth in the following reference standards and as outlined in Elliott Laboratories test procedures:

ANSI C63.4:2003

ANSI TIA-603-C August 17, 2004

The intentional radiator above has been tested in a simulated typical installation to demonstrate compliance with the relevant Industry Canada performance and procedural standards.

Final system data was gathered in a mode that tended to maximize emissions by varying orientation of EUT, orientation of power and I/O cabling, antenna search height, and antenna polarization.

Every practical effort was made to perform an impartial test using appropriate test equipment of known calibration. All pertinent factors have been applied to reach the determination of compliance.

## OBJECTIVE

The primary objective of the manufacturer is compliance with the regulations outlined in the previous section.

Prior to marketing in the USA, all unlicensed transmitters and transceivers require certification. Receive-only devices operating between 30 MHz and 960 MHz are subject to either certification or a manufacturer's declaration of conformity, with all other receive-only devices exempt from the technical requirements.

Certification is a procedure where the manufacturer submits test data and technical information to a certification body and receives a certificate or grant of equipment authorization upon successful completion of the certification body's review of the submitted documents. Once the equipment authorization has been obtained, the label indicating compliance must be attached to all identical units, which are subsequently manufactured.

Maintenance of compliance is the responsibility of the manufacturer. Any modification of the product which may result in increased emissions should be checked to ensure compliance has been maintained (i.e., printed circuit board layout changes, different line filter, different power supply, harnessing or I/O cable changes, etc.).

### ***STATEMENT OF COMPLIANCE***

The tested sample of Intel Corporation model Intel® Centrino® Advanced-N + WiMAX 6250, model 622ANXHMW complied with the requirements of FCC Part 27.

Maintenance of compliance is the responsibility of the manufacturer. Any modifications to the product should be assessed to determine their potential impact on the compliance status of the device with respect to the standards detailed in this test report.

The test results recorded herein are based on a single type test of Intel Corporation model Intel® Centrino® Advanced-N + WiMAX 6250, model 622ANXHMW and therefore apply only to the tested sample. The sample was selected and prepared by Steve Hackett of Intel Corporation.

### ***DEVIATIONS FROM THE STANDARDS***

No deviations were made from the published requirements listed in the scope of this report.

**TEST RESULTS SUMMARY****FCC Part 27 (2496 – 2690 MHz Mobile Digital Stations)**

FCC	Description	Measured	Limit	Result (margin)
<b>Transmitter Modulation, output power and other characteristics</b>				
§2.1033 (c) (5) §27.5 (i) (2)	Frequency range(s)	Not evaluated - The values reported for the original certification remain unchanged by the proposed change.		
§2.1033 (c) (6) §2.1033 (c) (7) §2.1046 §27.50	RF power output at the antenna terminals	10MHz Channel: 0.229W 5MHz Channel: 0.269W	2 Watts 33 dBm	Pass (8.7dB)
§2.1033 (c) (4) §2.1047 §27.53(m)(4) (6)	Emission types	BPSK, QPSK, 8PSK, 16QAM, 64QAM (OFDM)	-	-
	Emission mask Note 1	< 5.5MHz from channel edge: -14.3dBm ≥ 5.5MHz from channel edge: -26.2 dBm	-13dBm -25dBm	Pass (1.3dB)
§2.1049 §27.53	99% Bandwidth Occupied Bandwidth	10MHz Channel: 9.2 MHz 5 MHz Channel: 4.6 MHz	-	-
<b>Transmitter spurious emissions (more than 5.5MHz from the band edge)</b>				
§2.1051 §2.1053 §2.1057 §27.53(m)(4) (6)	At the antenna terminals	< -40 dBm	-25 dBm	Pass (>15dB)
	Field strength	-35.3dBm @ 7775.6MHz	-25 dBm erp	Pass (10.3dB)
<b>Other details</b>				
§2.1055 §27.54	Frequency stability	Not evaluated - The values reported for the original certification remain unchanged by the proposed change.		
§2.1093	RF Exposure			
§2.1033 (c) (8)	Final radio frequency amplifying circuit's dc voltages / currents for normal operation.			
-	Antenna Gain			
Note 1 – The measurement at the channel edge is made in a reference bandwidth of at least 1% the emission bandwidth is used. For measurements more than 1MHz from the edge of the channel the measurement bandwidth is 1MHz. The adjacent channel power feature of the spectrum analyzer is used to integrate the power over the required measurement bandwidth(s). Results reported are worst case for both 5MHz and 10MHz bandwidths at 64 QAM.				

**MEASUREMENT UNCERTAINTIES**

ISO/IEC 17025 requires that an estimate of the measurement uncertainties associated with the emissions test results be included in the report. The measurement uncertainties given below are based on a 95% confidence level (based on a coverage factor (k=2) and were calculated in accordance with NAMAS document NIS 81 and M3003.

Measurement Type	Measurement Unit	Frequency Range	Expanded Uncertainty
RF power, conducted	dBm	25 to 7,000 MHz	± 0.52 dB
Conducted emission of transmitter	dBm	25 to 40,000 MHz	± 0.7 dB
Radiated emission (substitution method)	dBm	25 to 40,000 MHz	± 2.5 dB

**EQUIPMENT UNDER TEST (EUT) DETAILS****GENERAL**

The Intel Corporation model Intel® Centrino® Advanced-N + WiMAX 6250, model 622ANXHMW is a PCI express form factor (half-mini) card that is designed to provide a 2x2 802.11abgn and 1x2 802.16e interfaces for host systems such as laptop PCs. The electrical rating of the EUT is 3.3Vdc (via mini PCI bus).

The sample was received on June 21, 2010 and tested on June 21, 2010. The EUT consisted of the following component(s):

Company	Model	Description	MAC Address	FCC ID
Intel Corporation	622ANXHMW	2x2 802.11abgn PCIe card	0023150CD28C	PD9622ANXH

**ENCLOSURE**

The EUT has no enclosure. It is designed to be installed within the enclosure of a host computer.

**MODIFICATIONS**

No modifications were made to the EUT during the time the product was at Elliott.

**SUPPORT EQUIPMENT**

The following support equipment was used for spurious radiated emissions and all rf port measurements:

Company	Model	Description	Serial Number	FCC ID
Intel	MC/MMC Adapter PCB00153	Test fixture	AOI151034	N/A
Dell	-	Laptop PC	Prototype	None
Topward	-	DC Supply		N/A

**EUT INTERFACE PORTS**

The I/O cabling configuration for spurious radiated emissions and all rf port measurements was:

Port	Connected To	Description	Cable(s)	
			Shielded or Unshielded	Length(m)
Test fixture USB	Laptop USB	USB Cable	Shielded	0.8
Test fixture 3.3Vdc	Bench supply	2-wire	Unshielded	0.4

**EUT OPERATION**

During transmitter tests the EUT was being controlled by the Intel VATU tool and an external signal generator (PSG shown below) to operate in a transmit mode on the top, bottom or center channel as required. The signal generator was programmed to transmit a test vector pattern that was sent to the second receive port on the EUT. This test vector triggered a response from the EUT, at a data rate and modulation determined by the specific test vector (for these tests all EUT transmissions used 64 QAM modulation). The signal generator also provided a gate signal for the spectrum analyzer (PSA below) via the event output. This gating signal was used to ensure that the spectrum analyzer would sweep only when the EUT was transmitting. Nominal channel bandwidths of 5MHz and 10MHz were evaluated.

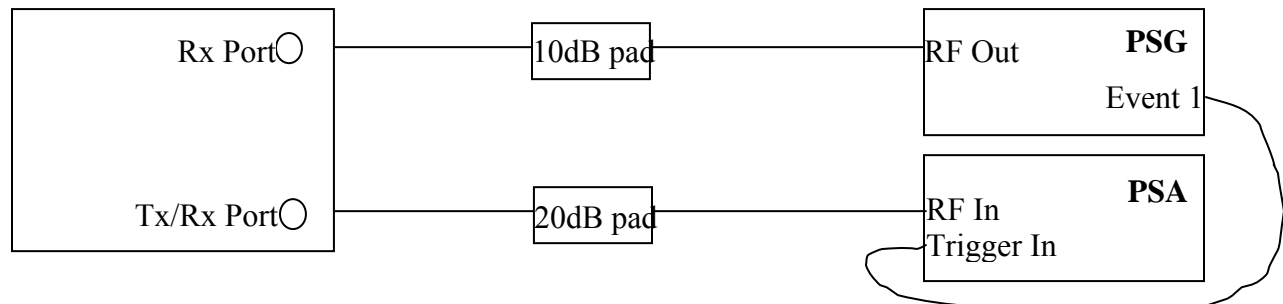

Radiated measurements were made with the transmit port of the EUT terminated into 50-ohms. Gating was not used for the radiated and conducted spurious measurements, rather the spectrum analyzer was set for a peak detector and used in a maximum hold mode to ensure all emissions were captured.

**TEST SITE****GENERAL INFORMATION**

Antenna port measurements were taken at the Elliott Laboratories test site located at 684 West Maude Ave, Sunnyvale, CA 94085-3518. Radiated spurious emissions measurements were taken at the Elliott Laboratories Anechoic Chambers and/or Open Area Test Site(s) listed below. The sites conform to the requirements of ANSI C63.4: 2003 *American National Standard for Methods of Measurement of Radio-Noise Emissions from Low-Voltage Electrical and Electronic Equipment in the Range of 9 kHz to 40 GHz* and CISPR 16-1-4:2007 - *Specification for radio disturbance and immunity measuring apparatus and methods Part 1-4: Radio disturbance and immunity measuring apparatus Ancillary equipment Radiated disturbances*. They are on file with the FCC and industry Canada.

Site	Registration Numbers		Location
	FCC	Canada	
SVOATS #2	90593	IC 2845A-2	684 West Maude Ave, Sunnyvale CA 94085-3518

In the case of Open Area Test Sites, ambient levels are at least 6 dB below the specification limits with the exception of predictable local TV, radio, and mobile communications traffic.

Considerable engineering effort has been expended to ensure that the facilities conform to all pertinent requirements.

**RF PORT MEASUREMENT PROCEDURES**

Conducted measurements are performed with the EUT's rf input/output connected to the input of a spectrum analyzer, power meter or modulation analyzer. When required an attenuator, filter and/or dc block is placed between the EUT and the spectrum analyzer to avoid overloading the front end of the measurement device. Measurements are corrected for the insertion loss of the attenuators and cables inserted between the rf port of the EUT and the measurement equipment.

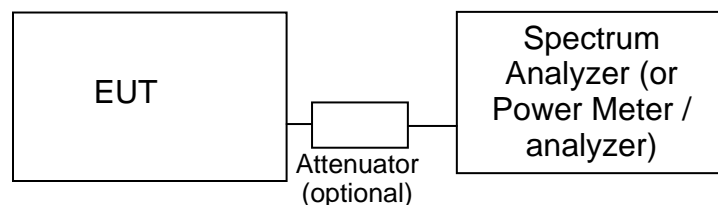
Test Configuration for Antenna Port Measurements

For devices with an integral antenna the output power and spurious emissions are measured as a field strength at a test distance of (typically) 3m and then converted to an eirp using a substitution measurement (refer to



*RADIATED EMISSIONS MEASUREMENTS*). All other measurements are made as detailed below but with the test equipment connected to a measurement antenna directed at the EUT.

#### *OUTPUT POWER*

Output power was measured using the channel power feature of the spectrum analyzer and an rms detector. Power measurements made directly on the rf power port are, when appropriate, converted to an EIRP by adding the gain of the highest gain antenna that can be used with the device under test, as specified by the manufacturer.

#### *BANDWIDTH MEASUREMENTS*

The 6dB, 20dB and/or 26dB signal bandwidth is measured in using the bandwidths recommended by ANSI C63.4. When required, the 99% bandwidth is measured using the methods detailed in RSS GEN. The measurement bandwidth is set to be at least 1% of the instrument's frequency span.

#### *CONDUCTED SPURIOUS EMISSIONS*

Initial scans are made using a peak detector (RBW=VBW) and using scan rates to ensure that the EUT transmits before the sweep moves out of each resolution bandwidth (for transmit mode measurements). Where the limits are expressed as an average power the spectrum analyzer is tuned to that frequency with a narrow span (wide enough to capture the emission and its sidebands) and the resolution and video bandwidths are adjusted as required by the reference measurement standards. For transmitter measurements the appropriate detector (average, peak, normal, sample, quasi-peak) is used when making measurements for licensed devices. For receiver conducted spurious measurements the detector is set to peak.

#### *TRANSMITTER MASK MEASUREMENTS*

The transmitter mask measurements are made using resolution bandwidths as specified in the pertinent rule part(s). Where narrower bandwidths are used the measurement is corrected to account for the reduced bandwidth by either using the adjacent channel power function of the spectrum analyzer to sum the power across the required measurement bandwidth. The frequency span of the analyzer is set to ensure the fundamental signal and all significant sidebands are displayed.

The top of the mask may be set by the total output power of the signal, the power of the un-modulated signal or the peak value of the signal in the reference bandwidth being used for the mask measurement.

## **RADIATED EMISSIONS MEASUREMENTS**

Receiver radiated spurious emissions measurements are made in accordance with ANSI C63.4:2003 by measuring the field strength of the emissions from the device at a specific test distance and comparing them to a field strength limit. Where the field strength limit is specified at a longer distance than the measurement distance the measurement is extrapolated to the limit distance.

Transmitter radiated spurious emissions are initially measured as a field strength. The eirp or erp limit as specified in the relevant rule part(s) is converted to a field strength at the test distance and the emissions from the EUT are then compared to that limit. Emissions within 20dB of this limit are the subjected to a substitution measurement.

All radiated emissions measurements are performed in two phases. A preliminary scan of emissions is conducted in either an anechoic chamber or on an OATS during which all significant EUT frequencies are identified with the system in a nominal configuration. At least two scans are performed across the complete frequency range of interest and at each operating frequency identified in the reference standard. One or more of these is with the antenna polarized vertically while the one or more of these is with the antenna polarized horizontally. Initial scans are made using a peak detector (RBW=VBW) and using scan rates to ensure that the EUT transmits before the sweep moves out of each resolution bandwidth (for transmit mode).

During the preliminary scans, the EUT is rotated through 360°, the antenna height is varied and cable positions are varied to determine the highest emission relative to the limit. For transmitter spurious emissions, where the limit is expressed as an effective radiated power, the eirp or erp is converted to a field strength limit.

Final measurements are made on an OATS or in a semi-anechoic chamber at the significant frequencies observed during the preliminary scan(s) using the same process of rotating the EUT and raising/lowering the measurement antenna to find the highest level of the emission. The field strength is recorded and, for receiver spurious emissions, compared to the field strength limit. For the final measurement the appropriate detectors (average, peak, normal, sample, quasi-peak) are used. For receiver measurements below 1GHz the detector is a Quasi-Peak detector, above 1GHz a peak detector is used and the peak value (RB=VB=1MHz) and average value (RB=1MHz, VB=10Hz) are recorded.

For transmitter spurious emissions, the radiated power of all emissions within 20dB of the calculated field strength limit are determined using a substitution measurement. The substitution measurement is made by replacing the EUT with an antenna of known gain (typically a dipole antenna or a double-ridged horn antenna), connected to a signal source. The output power of the signal generator is adjusted until the maximum field strength from the substitution antenna is similar to the field strength recorded from the EUT. The erp of the EUT is then calculated.

## **INSTRUMENTATION**

An EMI receiver as specified in CISPR 16-1-1 is used for radiated emissions measurements. The receivers used can measure over the frequency range of 9 kHz up to 7000 MHz. These receivers allow both ease of measurement and high accuracy to be achieved. The receivers have Peak, Average, and CISPR (Quasi-peak) detectors built into their design so no external adapters are necessary.

For measurements above the frequency range of the receivers and for all conducted measurements a spectrum analyzer is utilized because it provides visibility of the entire spectrum along with the precision and versatility required to support engineering analysis.

Measurement bandwidths for the test instruments are set in accordance with the requirements of the standards referenced in this document.

Software control is used to correct the measurements for transducer factors (e.g. antenna) and the insertion loss of cables, attenuators and other series elements to obtain the final measurement value. This provides faster, more accurate readings by performing the conversions described under Sample Calculations within the Test Procedures section of this report. Results are exported in a graphic and/or tabular format, as appropriate.

## **FILTERS/ATTENUATORS**

External filters and precision attenuators are often connected between the EUT antenna port or receiving antenna and the test receiver. This eliminates saturation effects and non-linear operation due to high amplitude transient events.

## **ANTENNAS**

A combination of biconical, log periodic or bi-log antennas are used to cover the range from 30 MHz to 1000 MHz. Broadband antennas or tuned dipole antennas are used over the entire 25 to 1000 MHz frequency range as the reference antenna for substitution measurements. Above 1000 MHz, a dual-ridge guide horn antenna or octave horn antenna are used as reference and measurement antennas.

The antenna calibration factors are included in site factors that are programmed into the test receivers and instrument control software when measuring the radiated field strength.

## **ANTENNA MAST AND EQUIPMENT TURNTABLE**

The antennas used to measure the radiated electric field strength are mounted on a non-conductive antenna mast equipped with a motor-drive to vary the antenna height.

Table mounted devices are placed on a non-conductive table at a height of 80 centimeters above the floor. Floor mounted equipment is placed on the ground plane if the device is normally used on a conductive floor or separated from the ground plane by insulating material from 3 to 12 mm if the device is normally used on a non-conductive floor. The EUT is positioned on a motorized turntable to allow it to be rotated during testing to determine the angle with the highest level of emissions.

**SAMPLE CALCULATIONS****SAMPLE CALCULATIONS - CONDUCTED SPURIOUS EMISSIONS**

Measurements are compared directly to the conducted emissions specification limit (decibel form). The calculation is as follows:

$$R_r - S = M$$

where:

$$\begin{aligned} R_r &= \text{Measured value in dBm} \\ S &= \text{Specification Limit in dBm} \\ M &= \text{Margin to Specification in +/- dB} \end{aligned}$$

**SAMPLE CALCULATIONS - RADIATED FIELD STRENGTH**

Measurements of radiated field strength are compared directly to the specification limit (decibel form). The receiver and/or control software corrects for cable loss, preamplifier gain, and antenna factor. The calculations are in the reverse direction of the actual signal flow, thus cable loss is added and the amplifier gain is subtracted. The Antenna Factor converts the voltage at the antenna coaxial connector to the field strength at the antenna elements.

A distance factor is used when measurements are made at a test distance that is different to the specified limit distance by using the following formula:

$$F_d = 20 * \text{LOG}_{10} (D_m/D_s)$$

where:

$$\begin{aligned} F_d &= \text{Distance Factor in dB} \\ D_m &= \text{Measurement Distance in meters} \\ D_s &= \text{Specification Distance in meters} \end{aligned}$$

For electric field measurements below 30MHz the extrapolation factor is either determined by making measurements at multiple distances or a theoretical value is calculated using the formula:

$$F_d = 40 * \text{LOG}_{10} (D_m/D_s)$$

The margin of a given emission peak relative to the limit is calculated as follows:

$$R_c = R_r + F_d$$

and

$$M = R_c - L_s$$

where:

$$\begin{aligned} R_r &= \text{Receiver Reading in dBuV/m} \\ F_d &= \text{Distance Factor in dB} \\ R_c &= \text{Corrected Reading in dBuV/m} \\ L_s &= \text{Specification Limit in dBuV/m} \\ M &= \text{Margin in dB Relative to Spec} \end{aligned}$$

**SAMPLE CALCULATIONS –RADIATED POWER**

The erp/eirp limits for transmitter spurious measurements are converted to a field strength in free space using the following formula:

$$E = \frac{\sqrt{30 P G}}{d}$$

where:

- E = Field Strength in V/m
- P = Power in Watts
- G = Gain of isotropic antenna (numeric gain) = 1
- D = measurement distance in meters

The field strength limit is then converted to decibel form (dBuV/m) and the margin of a given emission peak relative to the limit is calculated (refer to *SAMPLE CALCULATIONS –RADIATED FIELD STRENGTH*).

When substitution measurements are required (all signals with less than 20dB of margin relative to the calculated field strength limit) the eirp of the spurious emission is calculated using:

$$P_{EUT} = P_S - (E_S - E_{EUT})$$

and

$$P_S = G + P_{in}$$

where:

- $P_S$  = effective isotropic radiated power of the substitution antenna (dBm)
- $P_{in}$  = power input to the substitution antenna (dBm)
- G = gain of the substitution antenna (dBi)
- $E_S$  = field strength the substitution antenna (dBm) at eirp  $P_S$
- $E_{EUT}$  = field strength measured from the EUT

Where necessary the effective isotropic radiated power is converted to effective radiated power by subtracting the gain of a dipole (2.2dBi) from the eirp value.

**Appendix A Test Equipment Calibration Data****Radio Antenna Port (Power and Spurious Emissions), 21-Jun-10**

<b><u>Manufacturer</u></b>	<b><u>Description</u></b>	<b><u>Model</u></b>	<b><u>Asset #</u></b>	<b><u>Cal Due</u></b>
Hewlett Packard	SpecAn 9 KHz-26.5 GHz, Non-Program	8563E	284	1/29/2011
EMCO	Antenna, Horn, 1-18 GHz	3115	786	12/11/2011
EMCO	Biconical Antenna, 30-300 MHz	3110B	801	9/8/2011
Hewlett Packard	Microwave Preamplifier, 1-26.5GHz	8449B	870	8/19/2010
Rohde & Schwarz	Power Sensor, 1 uW-100 mW, DC-18 GHz, 50ohms	NRV-Z51	1070	5/17/2011
Rohde & Schwarz	Power Meter, Single Channel	NRVS	1290	10/22/2010
EMCO	Log Periodic Antenna, 0.2-2 GHz	3148	1595	7/23/2010
EMCO	Antenna, Horn, 1-18 GHz	3117	1662	5/4/2012
Hewlett Packard	Head (Inc W1-W4, 1946, 1947) Purple	84125C	1772	5/6/2011
Hewlett Packard	Microwave Preamplifier, 1-26.5GHz	8449B	1780	9/17/2010
Hewlett Packard	Preamplifier, 100 kHz - 1.3 GHz	8447D OPT 010	1826	5/27/2011
Agilent	PSG Vector Signal Generator (250kHz - 20GHz)	E8267C	1877	3/24/2011
Agilent	PSA, Spectrum Analyzer, (installed options, 111, 115, 123, 1DS, B7J, HYX,	E4446A	2139	1/6/2011

## *Appendix B Test Data*

T79723 18 Pages



## EMC Test Data

Client:	Intel Corporation	Job Number:	J79662
Model:	622ANXHMW	T-Log Number:	T79723
		Account Manager:	Christine Krebill
Contact:	Steve Hackett		-
Emissions Standard(s):	FCC Part 15	Class:	B
Immunity Standard(s):	-	Environment:	Radio

# EMC Test Data

For The

## Intel Corporation

Model

622ANXHMW

Date of Last Test: 6/22/2010



Client:	Intel Corporation	Job Number:	J79662
Model:	622ANXHMW	T-Log Number:	T79723
Contact:	Steve Hackett	Account Manager:	Christine Krebill
Standard:	FCC Part 15	Class:	N/A

## FCC Part 27 Power, Occupied Bandwidth, Frequency Stability and Spurious Emissions

### Test Specific Details

Objective: The objective of this test session is to perform engineering evaluation testing of the EUT with respect to the specification listed above.

### Summary of Results

Sample #1: WFM: 0023150CD28C; VATU Tool Version 5.0.0.1

Run #	Bandwidth	Modulation	Test Performed	Limit	Pass / Fail	Result / Margin
1	5MHz	64QAM	Output Power	2W eirp for mobile	Pass	24.3 dBm
1	10MHz	64QAM		2W for user stations	Pass	23.6 dBm
1	5MHz	64QAM	Spectral Mask	2.525MHz from Fc= -13.0dBm	Pass	-21.0 dBm
				4.0MHz from Fc= -13.0dBm		-14.3 dBm
				8.5MHz from Fc= -25.0dBm		-31.7 dBm
1	10MHz	64QAM	Spectral Mask	5.05MHz from Fc= -13.0dBm	Pass	-23.0 dBm
				6.5MHz from Fc= -13.0dBm		-18.2 dBm
				11.0MHz from Fc= -25.0dBm		-26.2 dBm
2	5MHz	64QAM	Spurious Emissions (Conducted)	-25.0dBm	Pass	All > 20dB below the limit
2	10MHz	64QAM			Pass	
2	5MHz	64QAM	99% Occupied	N/A	-	4.69 MHz
2	10MHz	64QAM	Bandwidth		-	9.29 MHz
5	5MHz	64QAM	Spurious emissions (radiated)	-25.0dBm	Pass	-35.3dBm @ 7775.6MHz (-10.3dB)
5	10MHz	64QAM		-25.0dBm		

### General Test Configuration

With the exception of the radiated spurious emissions tests, all measurements are made with the EUT's rf port connected to the measurement instrument via an attenuator or dc-block if necessary. All amplitude measurements are adjusted to account for the attenuation between EUT and measuring instrument. For frequency stability measurements the EUT was placed inside an environmental chamber.

Radiated measurements are made with the EUT located on a non-conductive table, 3m from the measurement antenna.

**Ambient Conditions:**                      Temperature:            19 °C  
    Rel. Humidity:        38 %

### Modifications Made During Testing

No modifications were made to the EUT during testing

### Deviations From The Standard

No deviations were made from the requirements of the standard.

Client:	Intel Corporation	Job Number:	J79662
Model:	622ANXHMW	T-Log Number:	T79723
Contact:	Steve Hackett	Account Manager:	Christine Krebill
Standard:	FCC Part 15	Class:	N/A

**Run #1: Output Power and Mask**  
 Date: 6/21/2010      Engineer: David W. Bare      Location: Environ #1  
 Cable Loss: 1.0 dB      Attenuator: 10.0 dB      Total Loss: 11.0 dB  
 Cable ID(s): EL435      Attenuator IDs: 1847

**Signal bandwidth:** 5 MHz      Original power = 24.3 dBm

ATT Setting <sup>2</sup>	Frequency (MHz)	Output Power		Mask (Amplitude and limit at each step) dBm		
		(dBm) <sup>1</sup>	mW	Ref BW = 50 kHz	Ref BW = 1 MHz	Ref BW = 1 MHz
				2.525MHz from Fc	4MHz from Fc	8.5MHz from Fc

PSG Waveform file: DQ4\_12\_UQ64\_56\_5M

20.75	2498.5	24.31	269.8	-21.0	-13.0	-14.3	-13.0	-32.9	-25.0
19.75	2593.0	24.31	269.8	-21.1	-13.0	-14.8	-13.0	-31.9	-25.0
17.50	2687.5	24.32	270.4	-21.5	-13.0	-15.1	-13.0	-31.7	-25.0

**Signal bandwidth:** 10 MHz      Original power = 23.6 dBm

ATT Setting <sup>2</sup>	Frequency (MHz)	Output Power		Mask (Amplitude and limit at each step) dBm		
		(dBm) <sup>1</sup>	mW	Ref BW = 100 kHz	Ref BW = 1 MHz	Ref BW = 1 MHz
				5.05MHz from Fc	6.5MHz from Fc	11MHz from Fc

PSG Waveform file: DQ4\_12\_UQ64\_56\_10M

21.25	2501.0	23.64	231.2	-23.0	-13.0	-18.2	-13.0	-26.5	-25.0
20.00	2593.0	23.64	231.2	-23.2	-13.0	-18.8	-13.0	-26.4	-25.0
18.00	2685.0	23.60	229.1	-23.6	-13.0	-18.6	-13.0	-26.2	-25.0

- Note 1:** Output power measured using a spectrum analyzer (see plots below) with RB > 1% of the emission bandwidth and VB at least 3xRB (for 5Mhz channels RB=51kHz, VB = 300kHz and for 10MHz channels RB=100kHz, VB=300kHz). A sample detector and power averaging are enabled to measure the average power over 100 sweeps. The analyzer was gated to ensure it only swept when the EUT was transmitting to ensure the measurement and mask measurements are not including period where the EUT is not transmitting at full power.
- Note 2:** Power setting - the software power setting used during testing, included for reference only.
- Note 3:** Mask measurements are made at the transition points in the mask (channel edge, channel edge + 1 MHz and channel edge + 5.5 MHz). The analyzer is configured to make the measurements at a frequency offset by 1/2 of the reference bandwidth from the transition point and integrate the power across the reference bandwidth around that frequency (so that the total power across the reference bandwidth immediately adjacent to the transition point is measured)
- Note 4:** The limit is taken from FCC Part 27.53 (l)(4) for mobile digital stations. The attenuation factor shall be not less than 43 + 10 log (P) dB at the channel edge and 55 + 10 log (P) dB at 5.5 MHz from the channel edges. The measurement bandwidth required is 1MHz, except for the 1 MHz bands immediately outside and adjacent to the frequency block where the measurement bandwidth shall be at least one percent of the emission bandwidth. The rule part also allows for a narrower resolution bandwidth provided the measured power is integrated over the full required measurement bandwidth (i.e. 1 MHz or 1 percent of emission bandwidth, as specified).
- Note 5:** See second plot for each waveform/frequency that fails the mask requirement at target power.

Client:	Intel Corporation	Job Number:	J79662
Model:	622ANXHMW	T-Log Number:	T79723
Contact:	Steve Hackett	Account Manager:	Christine Krebill
Standard:	FCC Part 15	Class:	N/A

DO4\_12\_UQ64\_56\_5M

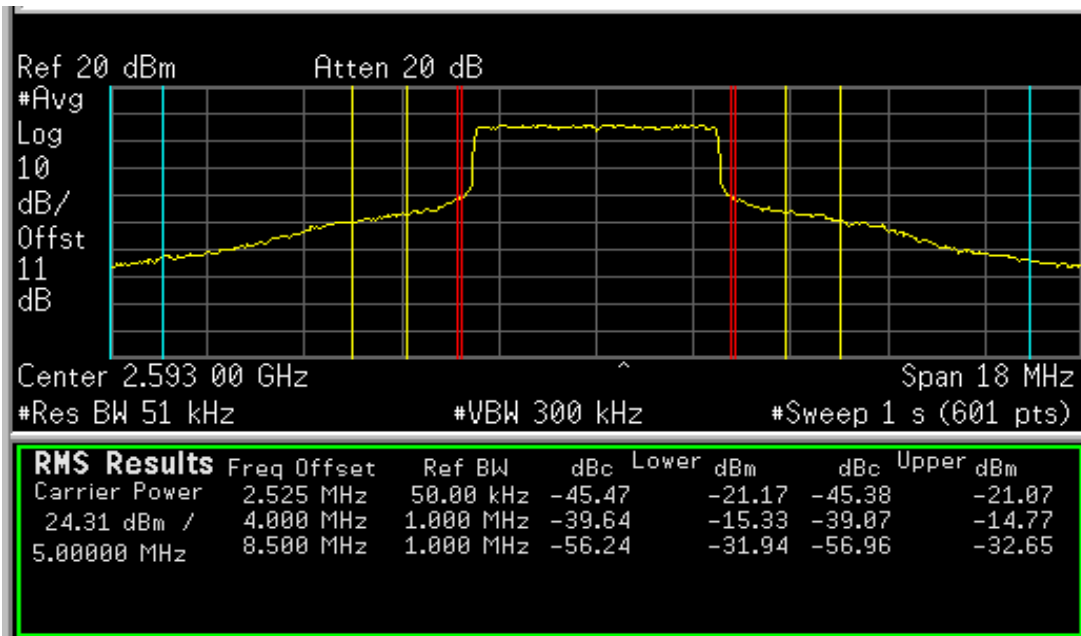
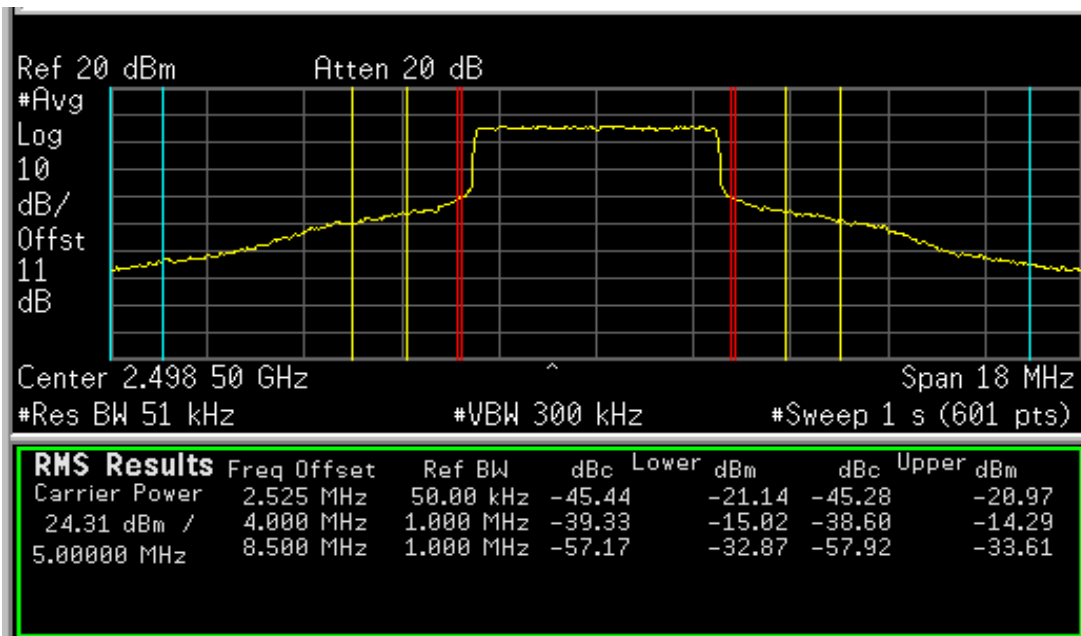

Client:	Intel Corporation	Job Number:	J79662
Model:	622ANXHMW	T-Log Number:	T79723
Contact:	Steve Hackett	Account Manager:	Christine Krebill
Standard:	FCC Part 15	Class:	N/A

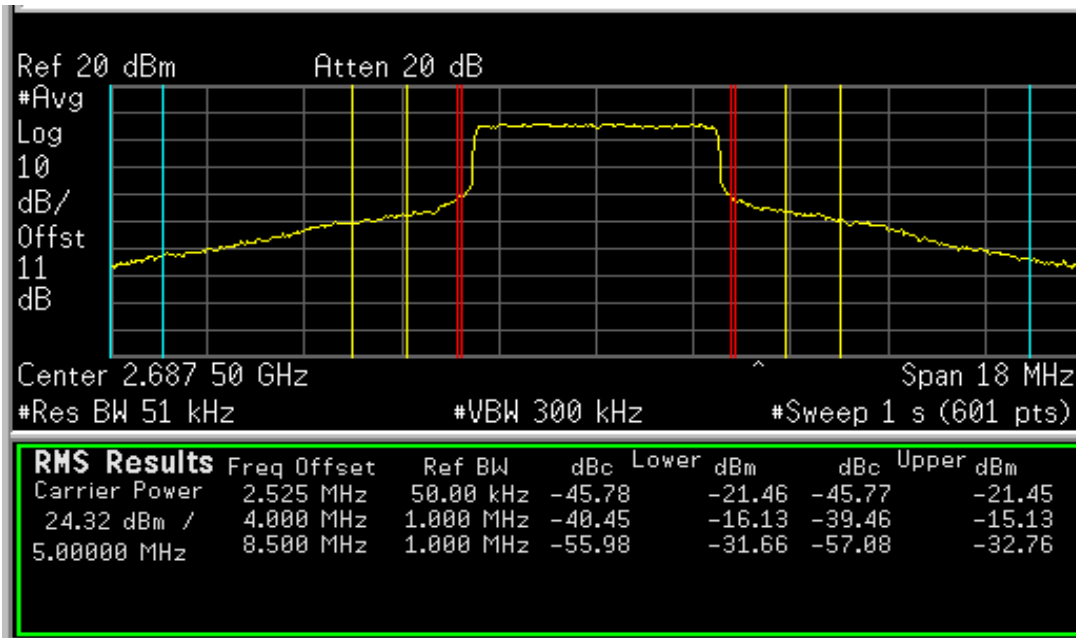

DQ4\_12\_UQ64\_56\_10M

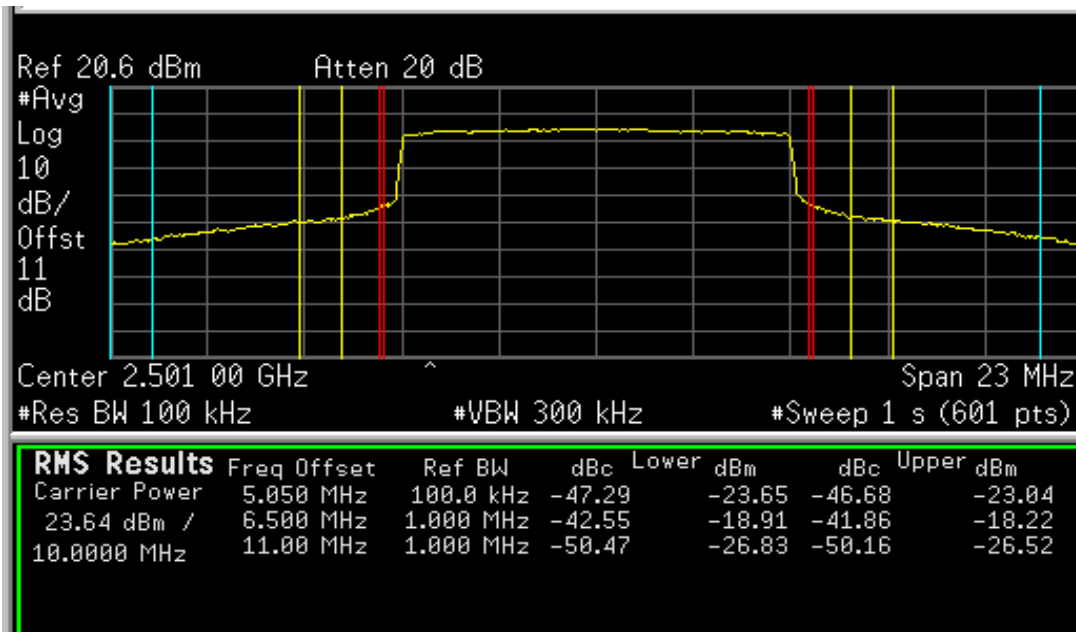

Client:	Intel Corporation	Job Number:	J79662
Model:	622ANXHMW	T-Log Number:	T79723
Contact:	Steve Hackett	Account Manager:	Christine Krebill
Standard:	FCC Part 15	Class:	N/A

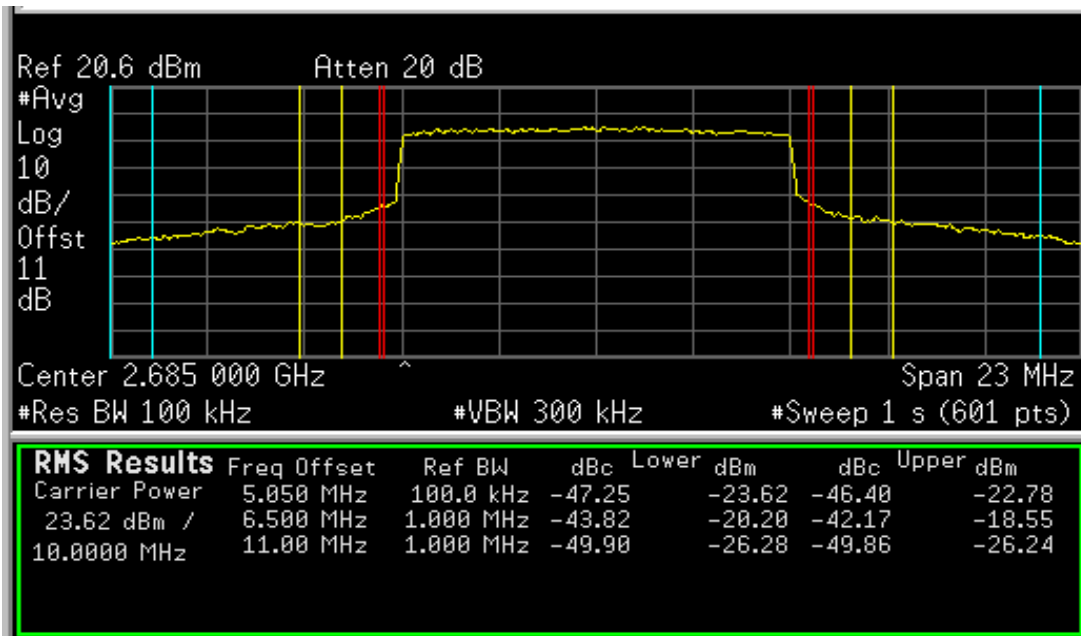
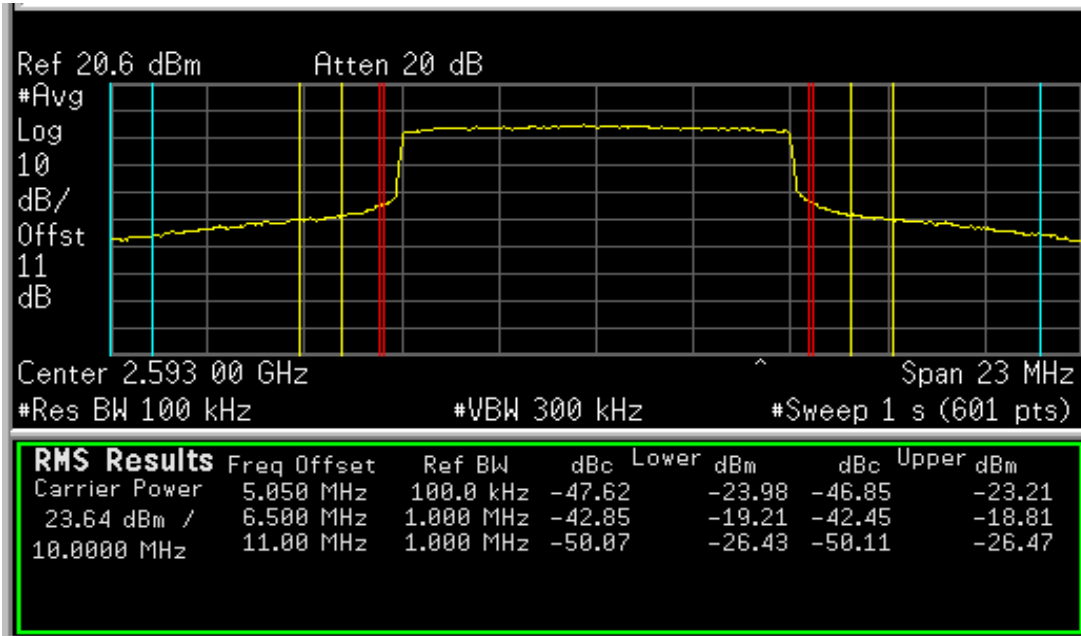

Client: Intel Corporation	Job Number: J79662
Model: 622ANXHMW	T-Log Number: T79723
Contact: Steve Hackett	Account Manager: Christine Krebill
Standard: FCC Part 15	Class: N/A

**Run #2: Out of Band Spurious Emissions, Conducted**

Date of Test: 6/21/2010  
 Test Engineer: David W. Bare  
 Test Location: Environ #1

Mode/Waveform	Frequency (MHz)	Limit	Result
DQ4_12_UQ64_56_10M	2501.0	-25 dBm	Pass
DQ4_12_UQ64_56_10M	2593.0	-25 dBm	Pass
DQ4_12_UQ64_56_10M	2685.0	-25 dBm	Pass
DQ4_12_UQ64_56_5M	2498.5	-25 dBm	Pass
DQ4_12_UQ64_56_5M	2593.0	-25 dBm	Pass
DQ4_12_UQ64_56_5M	2687.5	-25 dBm	Pass

The limit is taken from FCC Part 27.53 (l)(4)  $-55 + 10 \log (P)$

Measurements are made with RB=VB=1MHz, peak detector and max hold. Signals above the limit using these settings are re-measured with RB=VB=1MHz, sample detector and rms averaging enabled, analyzer gated to only sweep when the device is transmitting. The EUT was set to the power level determined in Run #1 for each mode and frequency.

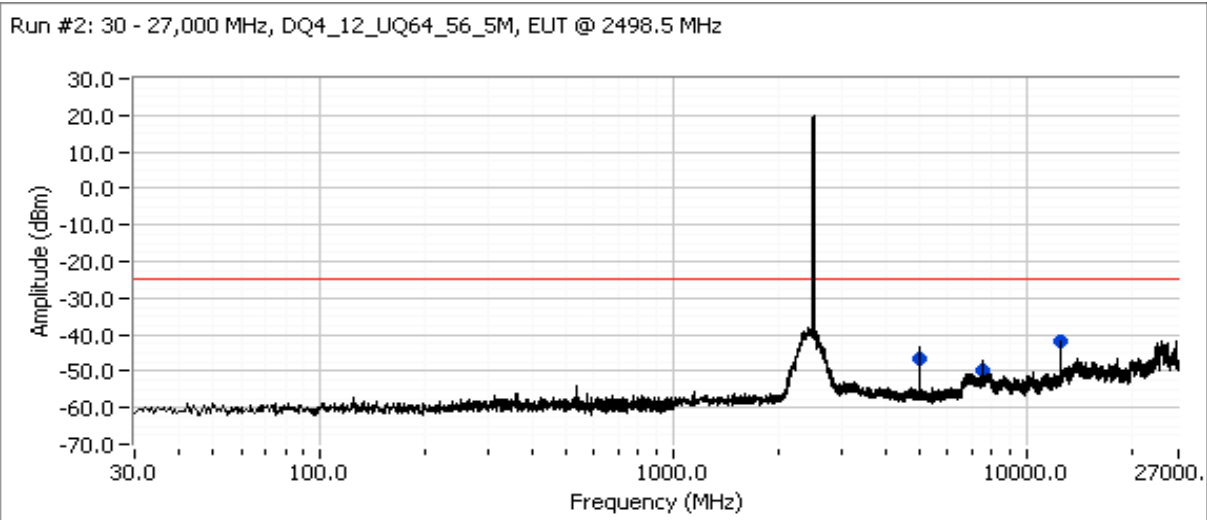

Client:	Intel Corporation	Job Number:	J79662
Model:	622ANXHMW	T-Log Number:	T79723
Contact:	Steve Hackett	Account Manager:	Christine Krebill
Standard:	FCC Part 15	Class:	N/A

Run #2: 30 - 27,000 MHz, DQ4\_12\_UQ64\_56\_5M, EUT @ 2593 MHz

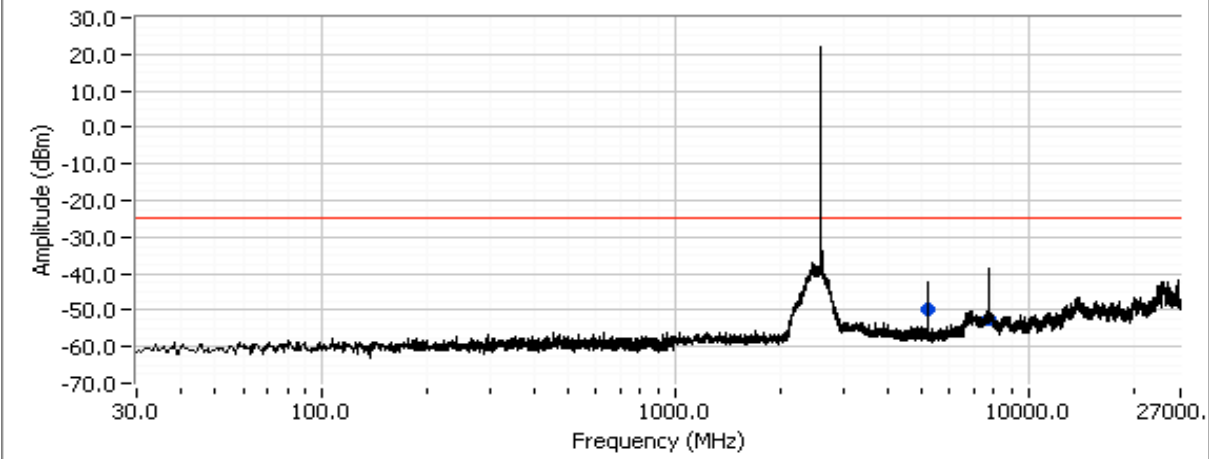

Run #2: 30 - 27,000 MHz, DQ4\_12\_UQ64\_56\_5M, EUT @ 2687.5 MHz

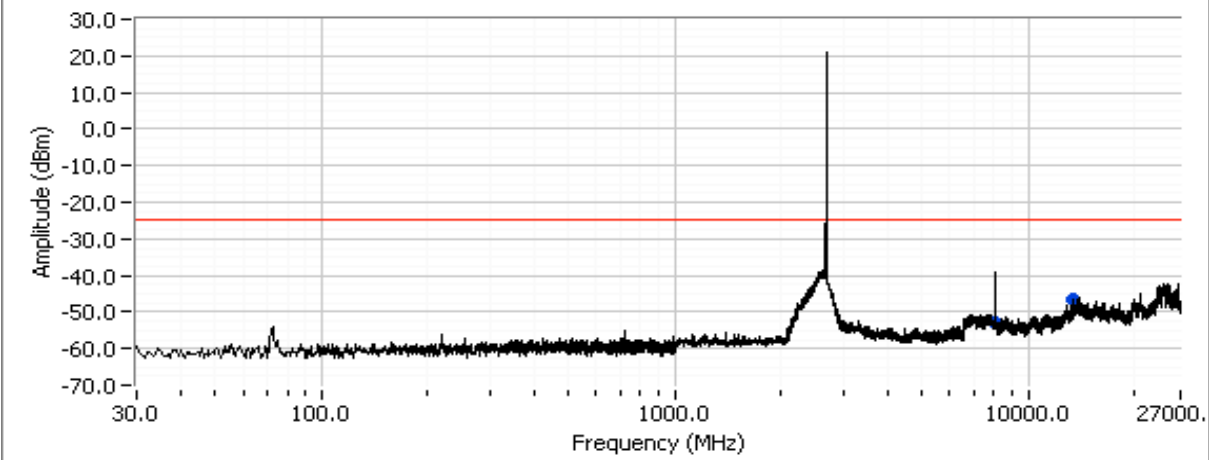

Client: Intel Corporation	Job Number: J79662
Model: 622ANXHMW	T-Log Number: T79723
Contact: Steve Hackett	Account Manager: Christine Krebill
Standard: FCC Part 15	Class: N/A

Run #2: 30 - 27,000 MHz, DQ4\_12\_UQ64\_56\_10M, EUT @ 2501 MHz

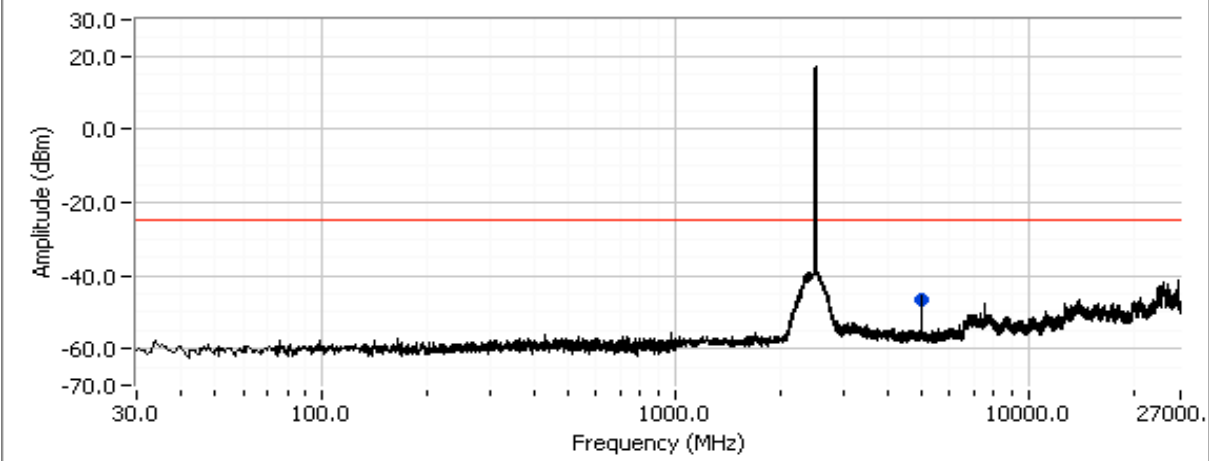

Run #2: 30 - 27,000 MHz, DQ4\_12\_UQ64\_56\_10M, EUT @ 2593 MHz

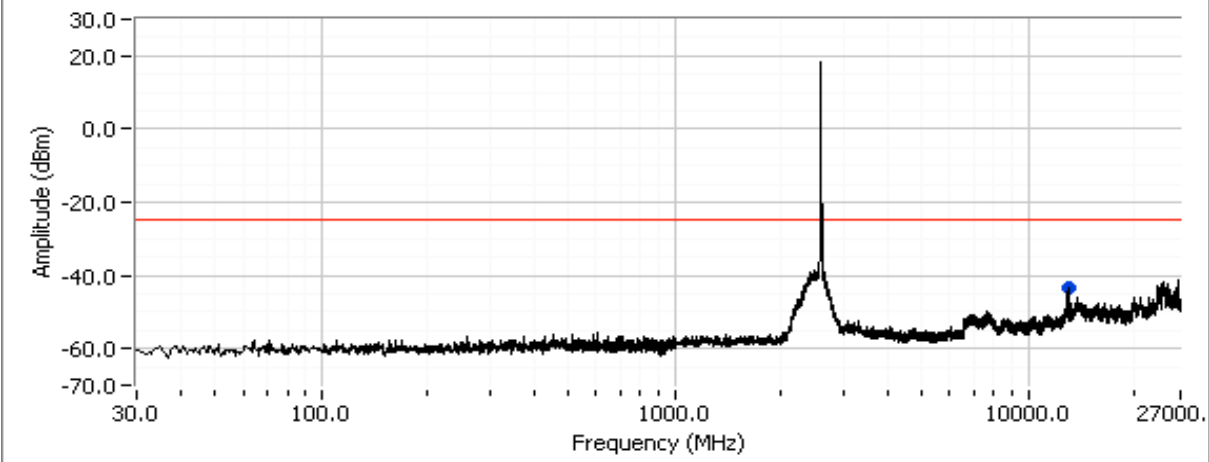



Client:	Intel Corporation	Job Number:	J79662
Model:	622ANXHMW	T-Log Number:	T79723
Contact:	Steve Hackett	Account Manager:	Christine Krebill
Standard:	FCC Part 15	Class:	N/A

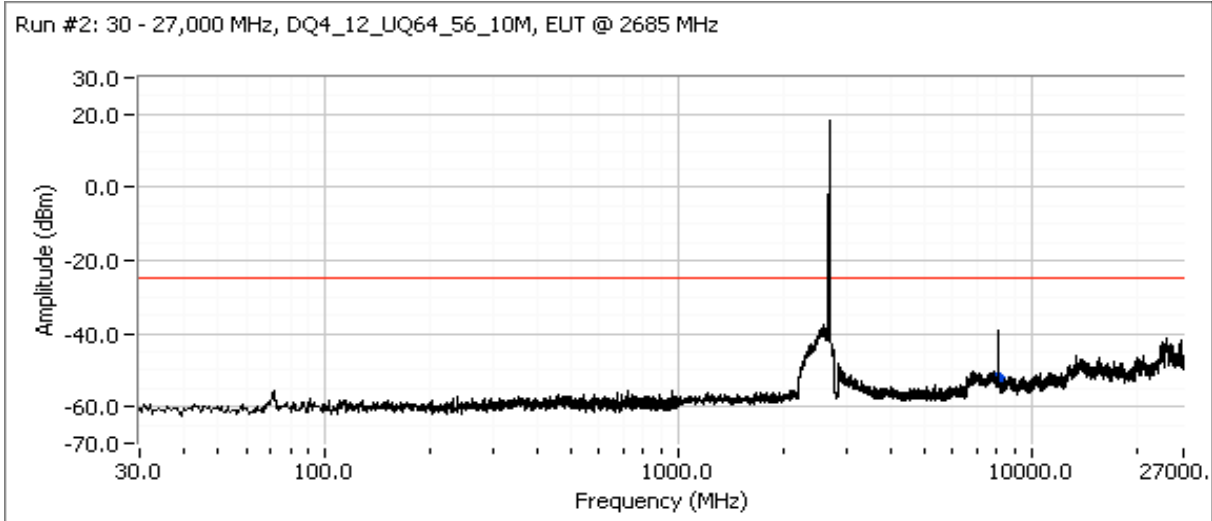

Peak readings

Frequency MHz	Level dBμV	Port	Part 27		Detector QP/Ave	Comments
			Limit	Margin		
8063.060	-52.9	RF Port	-25.0	-27.9	Peak	DQ4_12_UQ64_56_5M, EUT @ 2687.5 MHz
13439.690	-46.6	RF Port	-25.0	-21.6	Peak	DQ4_12_UQ64_56_5M, EUT @ 2687.5 MHz
5185.970	-51.0	RF Port	-25.0	-26.0	Peak	DQ4_12_UQ64_56_5M, EUT @ 2593 MHz
7778.600	-51.9	RF Port	-25.0	-26.9	Peak	DQ4_12_UQ64_56_5M, EUT @ 2593 MHz
4996.600	-46.7	RF Port	-25.0	-21.7	Peak	DQ4_12_UQ64_56_5M, EUT @ 2498.5 MHz
7496.030	-49.8	RF Port	-25.0	-24.8	Peak	DQ4_12_UQ64_56_5M, EUT @ 2498.5 MHz
12490.060	-41.6	RF Port	-25.0	-16.6	Peak	DQ4_12_UQ64_56_5M, EUT @ 2498.5 MHz
4998.480	-46.6	RF Port	-25.0	-21.6	Peak	DQ4_12_UQ64_56_10M, EUT @ 2501 MHz
12964.790	-43.3	RF Port	-25.0	-18.3	Peak	DQ4_12_UQ64_56_10M, EUT @ 2593 MHz
8056.030	-52.7	RF Port	-25.0	-27.7	Peak	DQ4_12_UQ64_56_10M, EUT @ 2685 MHz

Client: Intel Corporation	Job Number: J79662
Model: 622ANXHMW	T-Log Number: T79723
Contact: Steve Hackett	Account Manager: Christine Krebill
Standard: FCC Part 15	Class: N/A

**Run #3: Signal Bandwidth**

Date: 6/21/2010      Engineer: David W. Bare      Location: Environ #1

Waveform	Power Setting	Frequency (MHz)	Resolution Bandwidth	Bandwidth (MHz)	
				26dB	99%
DQ4_12_UQ64_56_5M	17.50	2687.5	300kHz	-	4.69
DQ64_UQ4_12_21s_10M	21.25	2501.0	300kHz	-	9.29

Note 1: 99% bandwidth measured in accordance with RSS GEN, with RB > 1% of the span and VB > 3xRB

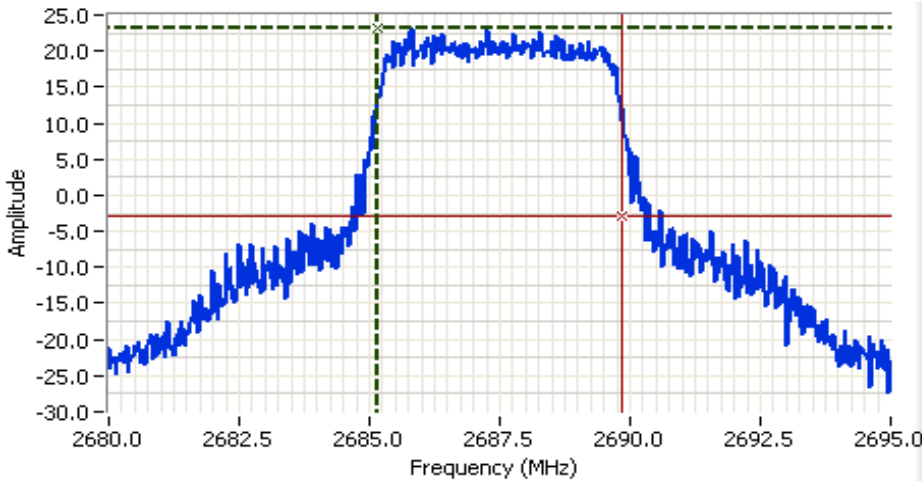

**Analyzer Settings**  
 Agilent Technologies, E4446A  
 CF: 2687.500 MHz  
 SPAN: 15.000 MHz  
 RB: 300 kHz  
 VB: 1.000 MHz  
 Detector: POS  
 Attn: 30 DB  
 RL Offset: 11.0 DB  
 Sweep Time: 100.0ms  
 Ref Lvl: 30.0 DBM

**Comments**  
 99% power BW: 4.692 MHz  
 DQ4\_12\_UQ64\_56\_5M

Cursor 1    2685.1414    23.08        Delta Freq.    4.692

Cursor 2    2689.8336    -2.92        Delta Amplitude    26.00



Client: Intel Corporation	Job Number: J79662
Model: 622ANXHMW	T-Log Number: T79723
Contact: Steve Hackett	Account Manager: Christine Krebill
Standard: FCC Part 15	Class: N/A

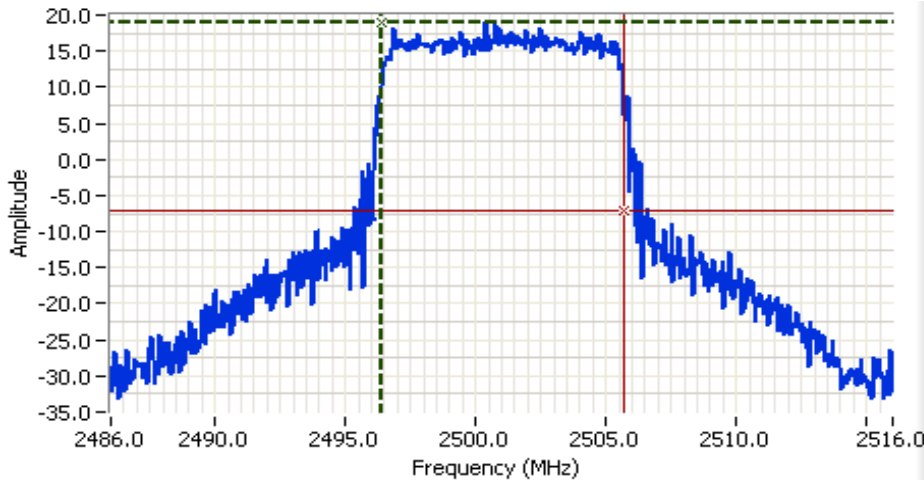

**Analyzer Settings**  
 Agilent Technologies, E4446A  
 CF: 2501.000 MHz  
 SPAN: 30.000 MHz  
 RB: 300 kHz  
 VB: 1.000 MHz  
 Detector: POS  
 Attn: 20 DB  
 RL Offset: 11.0 DB  
 Sweep Time: 100.0ms  
 Ref Lvl: 20.0 DBM

**Comments**  
 99% power BW: 9.285 MHz  
 DQ4\_12\_UQ64\_56\_10M

Cursor 1	2496.3827	18.91	+	-	+	-	+	-	Delta Freq.	9.285
Cursor 2	2505.6672	-7.09	+	-	+	-	+	-	Delta Amplitude	26.00



**Run #4: Out of Band Spurious Emissions, Radiated**

The limit is taken from FCC Part 27.53 (l)(4) -55 + 10 log (P)  
 Conducted limit (dBm): -25  
 Approximate field strength limit @ 3m: 70.2

**Run #4a - Preliminary measurements - chamber scans**

Date: 6/21/2010      Engineer: David W. Bare      Location: Chamber #2

Frequency MHz	Level dBµV/m	Pol v/h	FCC Part 27		Detector Pk/QP/Avg	Azimuth degrees	Height meters	Comments	Channel
			Limit	Margin					
7779.060	48.7	V	70.2	-21.5	Peak	150	1.7	DQ4_12_UQ64_56_5M	2593
3000.070	46.8	V	70.2	-23.4	Peak	96	1.7	DQ4_12_UQ64_56_5M	2687.5
6000.070	46.5	V	70.2	-23.7	Peak	113	1.7	DQ4_12_UQ64_56_5M	2687.5
6000.010	46.4	V	70.2	-23.8	Peak	109	1.7	DQ4_12_UQ64_56_5M	2593
6000.070	45.7	V	70.2	-24.5	Peak	119	1.7	DQ4_12_UQ64_56_10M	2501
7503.070	45.7	V	70.2	-24.5	Peak	168	1.7	DQ4_12_UQ64_56_10M	2501
1598.290	45.6	V	70.2	-24.6	Peak	203	1.7	DQ4_12_UQ64_56_10M	2501
3000.070	45.5	V	70.2	-24.7	Peak	89	1.7	DQ4_12_UQ64_56_5M	2593
3000.070	45.5	V	70.2	-24.7	Peak	93	1.7	DQ4_12_UQ64_56_10M	2501



# Radio Test Data

Client:	Intel Corporation	Job Number:	J79662
Model:	622ANXHMW	T-Log Number:	T79723
Contact:	Steve Hackett	Account Manager:	Christine Krebill
Standard:	FCC Part 15	Class:	N/A

Run #4a - Preliminary measurements - chamber scans cont'

Frequency MHz	Level dB $\mu$ V/m	Pol v/h	FCC Part 27		Detector Pk/QP/Avg	Azimuth degrees	Height meters	Comments	Channel
			Limit	Margin					
1850.080	45.3	V	70.2	-24.9	Peak	175	1.7	DQ4_12_UQ64_56_5M	2498.5
1000.000	45.1	V	70.2	-25.1	Peak	145	1.7	DQ4_12_UQ64_56_5M	2687.5
1000.050	45.0	H	70.2	-25.2	Peak	165	1.7	DQ4_12_UQ64_56_5M	2593
1000.000	44.9	H	70.2	-25.3	Peak	151	1.7	DQ4_12_UQ64_56_5M	2498.5
7779.060	44.9	V	70.2	-25.3	Peak	151	1.7	DQ4_12_UQ64_56_10M	2593
8062.500	44.5	H	70.2	-25.7	Peak	359	1.7	DQ4_12_UQ64_56_5M	2687.5
1000.000	44.5	H	70.2	-25.7	Peak	152	1.7	DQ4_12_UQ64_56_10M	2685
1598.290	44.4	V	70.2	-25.8	Peak	112	1.7	DQ4_12_UQ64_56_5M	2593
8055.050	44.2	V	70.2	-26.0	Peak	48	1.7	DQ4_12_UQ64_56_10M	2685
7495.550	44.0	V	70.2	-26.2	Peak	151	1.7	DQ4_12_UQ64_56_5M	2498.5
1598.290	43.6	V	70.2	-26.6	Peak	206	1.7	DQ4_12_UQ64_56_10M	2593
1000.000	43.4	H	70.2	-26.8	Peak	139	1.7	DQ4_12_UQ64_56_10M	2501
1598.200	43.2	V	70.2	-27.0	Peak	67	1.7	DQ4_12_UQ64_56_5M	2687.5
1000.000	42.7	V	70.2	-27.5	Peak	120	1.7	DQ4_12_UQ64_56_10M	2593
6000.610	39.2	V	70.2	-31.0	Peak	354	1.7	DQ4_12_UQ64_56_5M	2498.5
6000.660	38.2	V	70.2	-32.0	Peak	277	1.7	DQ4_12_UQ64_56_10M	2685
6000.010	37.6	H	70.2	-32.6	Peak	9	1.7	DQ4_12_UQ64_56_10M	2593
3000.050	37.1	V	70.2	-33.1	Peak	235	1.7	DQ4_12_UQ64_56_10M	2593
3000.350	37.0	H	70.2	-33.2	Peak	65	1.7	DQ4_12_UQ64_56_5M	2498.5
3000.050	37.0	V	70.2	-33.2	Peak	344	1.7	DQ4_12_UQ64_56_10M	2685
797.916	36.5	H	70.2	-33.7	Peak	91	1.7	DQ4_12_UQ64_56_5M	2498.5
699.539	34.5	V	70.2	-35.7	Peak	179	1.7	DQ4_12_UQ64_56_5M	2498.5
798.099	29.7	H	70.2	-40.5	Peak	82	1.7	DQ4_12_UQ64_56_10M	2685
699.700	28.1	H	70.2	-42.1	Peak	141	1.7	DQ4_12_UQ64_56_10M	2685

- Note 1: The field strength limit in the tables above was calculated from the erp/eirp limit detailed in the standard using the free space propagation equation:  $E = \sqrt{(30PG)/d}$ . This limit is conservative - it does not consider the presence of the ground plane and, for erp limits, the dipole gain (2.2dBi) has not been included. The erp or eirp for all signals with less than 20dB of margin relative to this field strength limit is determined using substitution measurements.
- Note 2: Measurements are made with the antenna port terminated.
- Note 3: Based on the preliminary measurements, the emissions below 1 GHz are very low and unrelated to the transmit frequency and modulation, therefore scans of the additional channels in each modulation were restricted to 1-18 GHz.
- Note 4: Based on the near field scan from 18-27 GHz, the emissions above 18 GHz are so low that even at 50cm from the EUT nothing was detected above the noise floor of the test equipment, therefore scans of the additional channels in each modulation were not necessary for this frequency band.

Client: Intel Corporation	Job Number: J79662
Model: 622ANXHMW	T-Log Number: T79723
Contact: Steve Hackett	Account Manager: Christine Krebill
Standard: FCC Part 15	Class: N/A

Run #4a: 30 - 18,000 MHz, EUT @ 2498.5 MHz (DQ4\_12\_UQ64\_56\_5M)

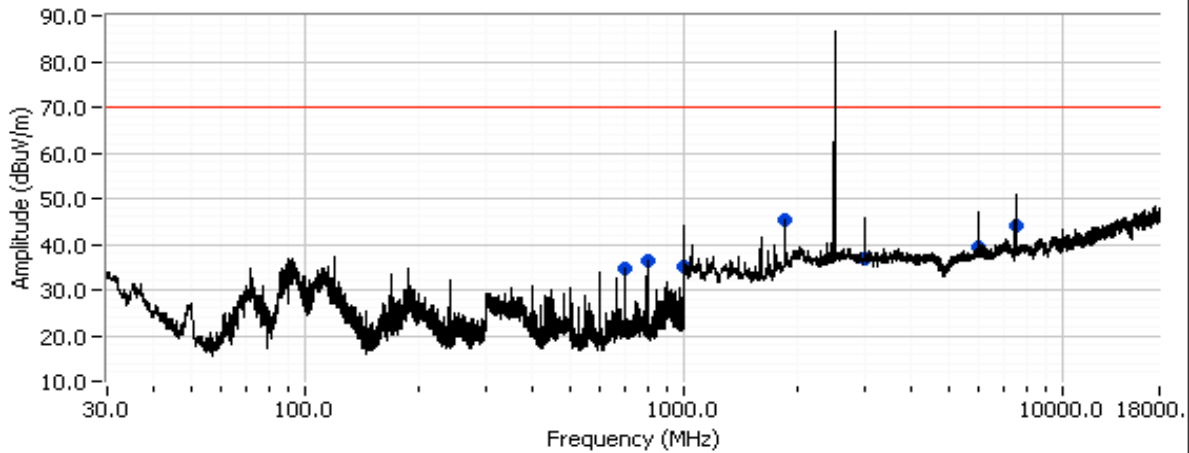

Run #4a: 1,000 - 18,000 MHz, EUT @ 2593 MHz (DQ4\_12\_UQ64\_56\_5M)

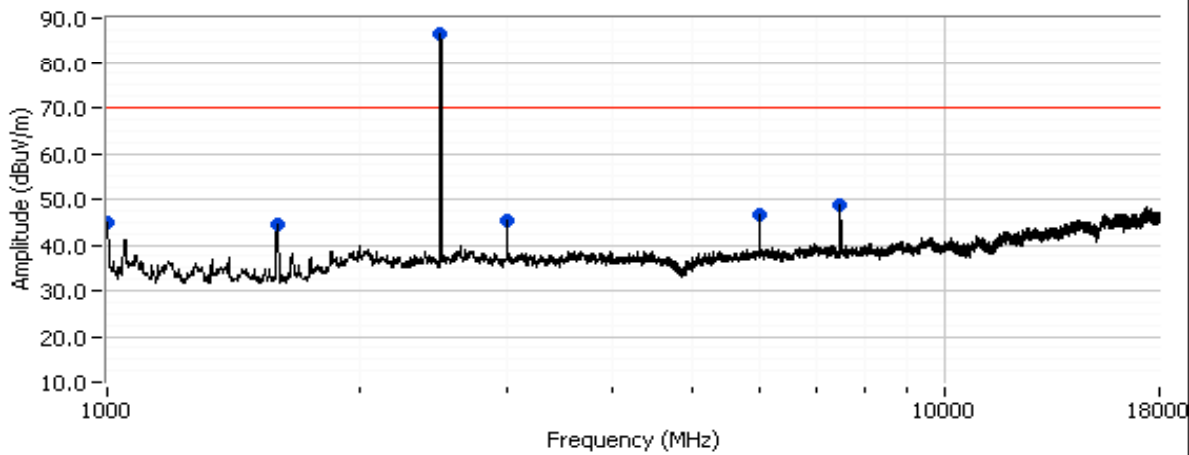

Client: Intel Corporation	Job Number: J79662
Model: 622ANXHMW	T-Log Number: T79723
Contact: Steve Hackett	Account Manager: Christine Krebill
Standard: FCC Part 15	Class: N/A

Run #4a: 1,000 - 18,000 MHz, EUT @ 2687.5 MHz (DQ4\_12\_UQ64\_56\_5M)

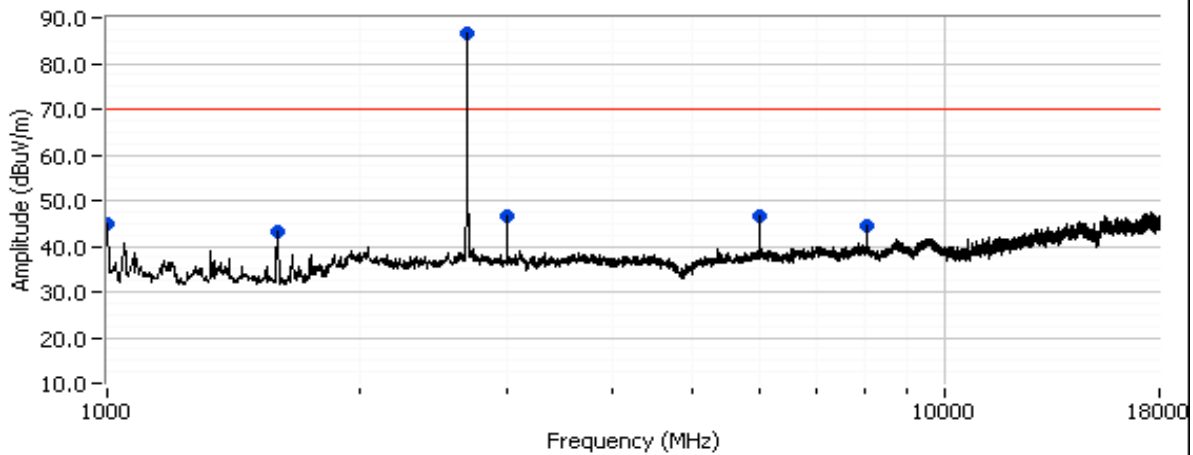

Run #4a: 1,000 - 18,000 MHz, EUT @ 2501 MHz (DQ4\_12\_UQ64\_56\_10M)

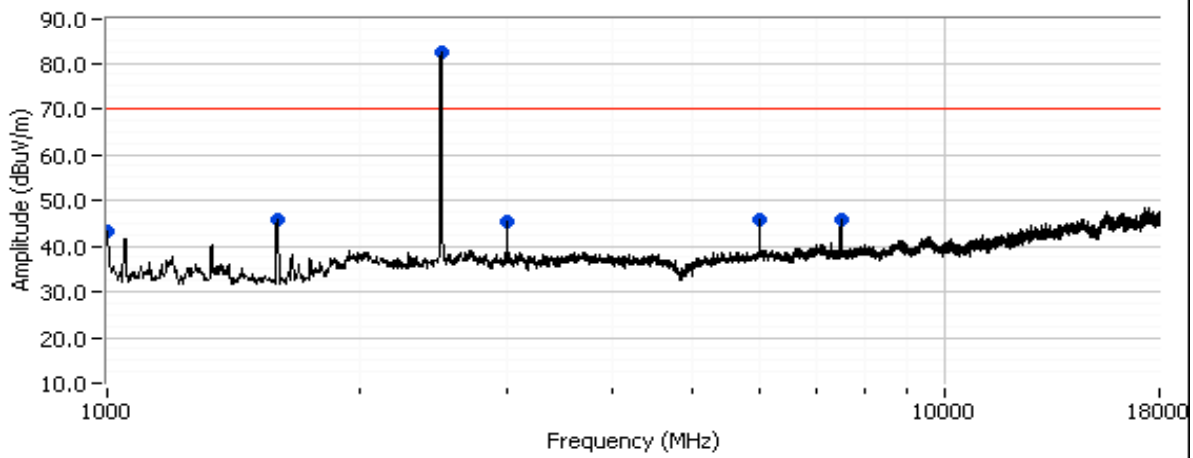

Client: Intel Corporation	Job Number: J79662
Model: 622ANXHMW	T-Log Number: T79723
Contact: Steve Hackett	Account Manager: Christine Krebill
Standard: FCC Part 15	Class: N/A

Run #4a: 1,000 - 18,000 MHz, EUT @ 2593 MHz (DQ4\_12\_UQ64\_56\_10M)

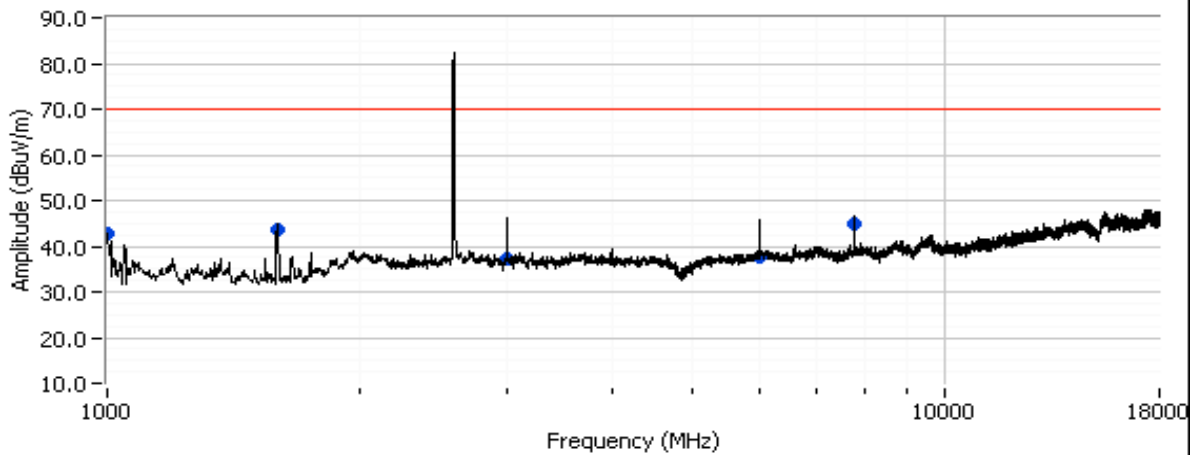

Run #4a: 30 - 18,000 MHz, EUT @ 2685 MHz (DQ4\_12\_UQ64\_56\_10M)

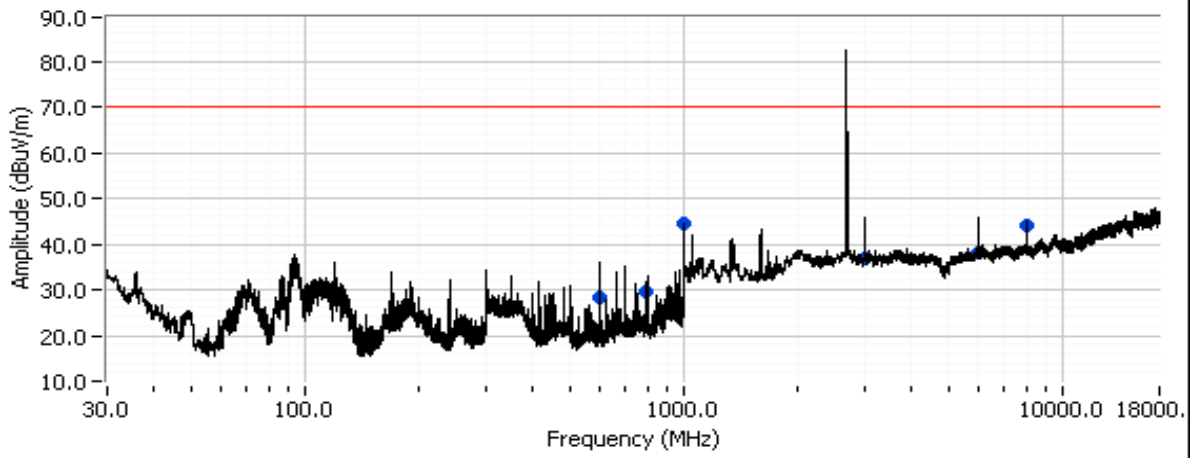

Client: Intel Corporation	Job Number: J79662
Model: 622ANXHMW	T-Log Number: T79723
Contact: Steve Hackett	Account Manager: Christine Krebill
Standard: FCC Part 15	Class: N/A

Run #4a: 18,000 - 27,000 MHz, EUT @ 2687.5 MHz (DQ4\_12\_UQ64\_56\_5M), 50cm from EUT

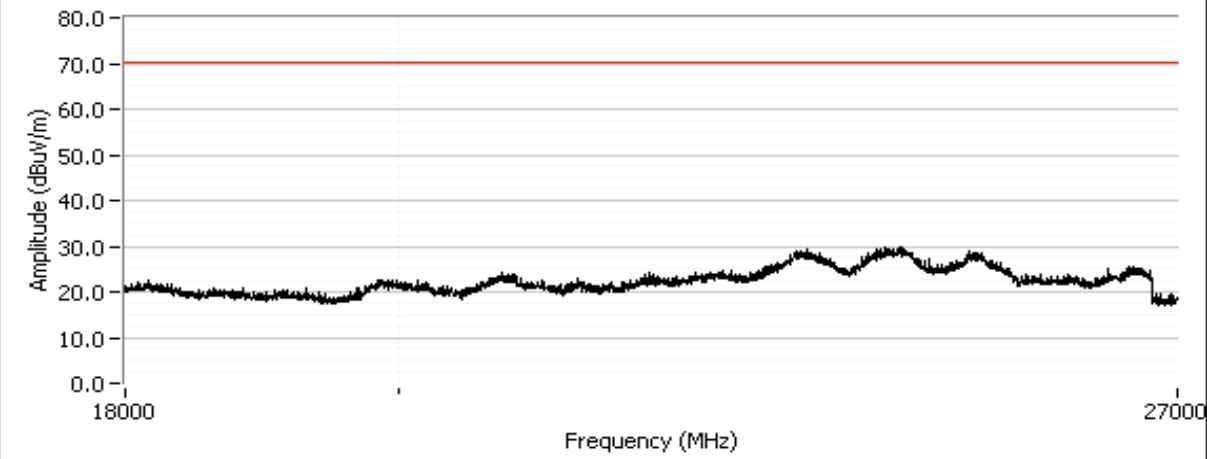

**Run #4b: - OATS EUT Field Strength Measurements and Substitution Measurements**

Date: 6/21/2010      Engineer: Rafael Varelas      Location: SV OATS #2

**EUT Field Strength**

Frequency MHz	Level dB $\mu$ V/m	Pol v/h	FCC Part 27		Detector Pk/QP/Avg	Azimuth degrees	Height meters	Comments	Channel
			Limit	Margin					
7775.580	64.3	V	70.2	-5.9	PK	152	1.4	DQ4_12_UQ64_56_5M	2593
1596.320	55.5	V	70.2	-14.7	PK	219	1.0	DQ4_12_UQ64_56_10M	2501
3000.150	52.7	V	70.2	-17.5	PK	113	1.0	DQ4_12_UQ64_56_10M	2501
3000.120	52.5	V	70.2	-17.7	PK	116	1.0	DQ4_12_UQ64_56_5M	2687.5
3000.450	51.8	V	70.2	-18.4	PK	113	1.1	DQ4_12_UQ64_56_5M	2593
6000.710	51.4	V	70.2	-18.8	PK	127	1.0	DQ4_12_UQ64_56_10M	2501
6000.730	51.3	V	70.2	-18.9	PK	130	1.0	DQ4_12_UQ64_56_5M	2593
6000.530	50.5	V	70.2	-19.7	PK	130	1.0	DQ4_12_UQ64_56_5M	2687.5
7506.270	48.5	V	70.2	-21.7	PK	211	1.0	DQ4_12_UQ64_56_10M	2501

Note 1: The field strength limit in the tables above was calculated from the erp/eirp limit detailed in the standard using the free space propagation equation:  $E = \sqrt{(30PG)/d}$ . This limit is conservative - it does not consider the presence of the ground plane and, for erp limits, the dipole gain (2.2dBi) has not been included. The erp or eirp for all signals with less than 20dB of margin relative to this field strength limit is determined using substitution measurements.

Note 2: Measurements are made with the antenna port terminated.





# Radio Test Data

Client:	Intel Corporation	Job Number:	J79662
Model:	622ANXHMW	T-Log Number:	T79723
Contact:	Steve Hackett	Account Manager:	Christine Krebill
Standard:	FCC Part 15	Class:	N/A

## Substitution measurements

### Vertical

Frequency MHz	Substitution measurements			Site Factor <sup>4</sup>	EUT measurements			eirp Limit dBm	erp Limit dBm	Margin dB
	Pin <sup>1</sup>	Gain <sup>2</sup>	FS <sup>3</sup>		FS <sup>5</sup>	eirp (dBm)	erp (dBm)			
7775.580	-13.5	12.0	95.9	97.4	64.3	-33.1	-35.3		-25.0	-10.3
1596.320	-11.0	5.9	92.0	97.1	55.5	-41.6	-43.8		-25.0	-18.8
3000.150	-11.6	6.3	92.4	97.7	52.7	-45.0	-47.2		-25.0	-22.2
6000.710	-12.9	9.9	93.7	96.7	51.4	-45.3	-47.5		-25.0	-22.5

- Note 1: Pin is the input power (dBm) to the substitution antenna
- Note 2: Gain is the gain (dBi) for the substitution antenna.
- Note 3: FS is the field strength (dBuV/m) measured from the substitution antenna.
- Note 4: Site Factor - this is the site factor to convert from a field strength in dBuV/m to an eirp in dBm.
- Note 5: EUT field strength as measured during initial run.