



EMC Test Report

*Application for Grant of Equipment Authorization
Class II Permissive Change/Reassessment
pursuant to*

*Industry Canada RSS-Gen Issue 2 / RSS 210 Issue 7
FCC Part 15, Subpart E*

Model: Intel Centrino Advanced-N 6200

IC CERTIFICATION #: 1000M-622ANHU and 1000M-622ANH
FCC ID: PD9622ANHU and PD9622ANH

APPLICANT: Intel Corporation
2111 NE 25th Avenue
Hillsboro, OR 97124

TEST SITE(S): Elliott Laboratories
41039 Boyce Road.
Fremont, CA. 94538-2435

IC SITE REGISTRATION #: 2845B-4, 2845B-5

REPORT DATE: April 14, 2010

FINAL TEST DATES: March 12 to April 1, 2010

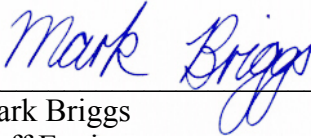
AUTHORIZED SIGNATORY: 
Mark Briggs
Staff Engineer
Elliott Laboratories.



Testing Cert #2016-01

Elliott Laboratories is accredited by the A2LA, certificate number 2016-01, to perform the test(s) listed in this report, except where noted otherwise. This report shall not be reproduced, except in its entirety, without the written approval of Elliott Laboratories

REVISION HISTORY

Revision #	Date	Comments	Modified By
-		First release	

TABLE OF CONTENTS

REVISION HISTORY	2
TABLE OF CONTENTS	3
SCOPE.....	4
OBJECTIVE.....	5
STATEMENT OF COMPLIANCE.....	5
DEVIATIONS FROM THE STANDARDS.....	6
TEST RESULTS SUMMARY	6
UNII / LELAN DEVICES	6
GENERAL REQUIREMENTS APPLICABLE TO ALL BANDS	7
MEASUREMENT UNCERTAINTIES.....	8
EQUIPMENT UNDER TEST (EUT) DETAILS.....	9
GENERAL.....	9
OTHER EUT DETAILS.....	9
ENCLOSURE.....	9
MODIFICATIONS.....	9
SUPPORT EQUIPMENT.....	9
EUT INTERFACE PORTS	10
EUT OPERATION	10
TEST SITE.....	11
GENERAL INFORMATION.....	11
CONDUCTED EMISSIONS CONSIDERATIONS	11
RADIATED EMISSIONS CONSIDERATIONS	11
MEASUREMENT INSTRUMENTATION	11
RECEIVER SYSTEM	11
INSTRUMENT CONTROL COMPUTER	12
LINE IMPEDANCE STABILIZATION NETWORK (LISN).....	12
FILTERS/ATTENUATORS	12
ANTENNAS.....	12
ANTENNA MAST AND EQUIPMENT TURNTABLE.....	13
INSTRUMENT CALIBRATION.....	13
TEST PROCEDURES	14
EUT AND CABLE PLACEMENT	14
CONDUCTED EMISSIONS.....	14
RADIATED EMISSIONS.....	15
SPECIFICATION LIMITS AND SAMPLE CALCULATIONS.....	17
GENERAL TRANSMITTER RADIATED EMISSIONS SPECIFICATION LIMITS	17
RECEIVER RADIATED SPURIOUS EMISSIONS SPECIFICATION LIMITS	18
FCC 15.407 (A) OUTPUT POWER LIMITS.....	18
OUTPUT POWER LIMITS –LELAN DEVICES.....	19
OUTPUT POWER AND SPURIOUS LIMITS –UNII AND LELAN DEVICES	19
SAMPLE CALCULATIONS - CONDUCTED EMISSIONS	20
SAMPLE CALCULATIONS - RADIATED EMISSIONS.....	20
SAMPLE CALCULATIONS - FIELD STRENGTH TO EIRP CONVERSION.....	21
APPENDIX A TEST EQUIPMENT CALIBRATION DATA	1
APPENDIX B TEST DATA	2
APPENDIX C PHOTOGRAPHS OF TEST CONFIGURATIONS.....	3
APPENDIX D THEORY OF OPERATION.....	3
APPENDIX E SCHEMATICS.....	3
APPENDIX F RF EXPOSURE INFORMATION	3

SCOPE

An electromagnetic emissions test has been performed on the Intel Corporation Intel Centrino Advanced-N 6200, pursuant to the following rules:

Industry Canada RSS-Gen Issue 2
RSS 210 Issue 7 “Low-power Licence-exempt Radiocommunication Devices (All Frequency Bands): Category I Equipment”
RSS 310 Issue 2 “Low-power Licence-exempt Radiocommunication Devices (All Frequency Bands): Category II Equipment”
FCC Part 15, Subpart E requirements for UNII Devices (using FCC DA 02-2138, August 30, 2002)

Conducted and radiated emissions data has been collected, reduced, and analyzed within this report in accordance with measurement guidelines set forth in the following reference standards and as outlined in Elliott Laboratories test procedures:

ANSI C63.4:2003
FCC UNII test procedure 2002-08 DA-02-2138, August 2002

The intentional radiator above has been tested in a simulated typical installation to demonstrate compliance with the relevant Industry Canada performance and procedural standards.

Final system data was gathered in a mode that tended to maximize emissions by varying orientation of EUT, orientation of power and I/O cabling, antenna search height, and antenna polarization.

Every practical effort was made to perform an impartial test using appropriate test equipment of known calibration. All pertinent factors have been applied to reach the determination of compliance.

OBJECTIVE

The primary objective of the manufacturer is compliance with the regulations outlined in the previous section.

Prior to marketing in the USA, all unlicensed transmitters and transceivers require certification. Receive-only devices operating between 30 MHz and 960 MHz are subject to either certification or a manufacturer's declaration of conformity, with all other receive-only devices exempt from the technical requirements.

Prior to marketing in Canada, Class I transmitters, receivers and transceivers require certification. Class II devices are required to meet the appropriate technical requirements but are exempt from certification requirements.

Certification is a procedure where the manufacturer submits test data and technical information to a certification body and receives a certificate or grant of equipment authorization upon successful completion of the certification body's review of the submitted documents. Once the equipment authorization has been obtained, the label indicating compliance must be attached to all identical units, which are subsequently manufactured.

Maintenance of compliance is the responsibility of the manufacturer. Any modification of the product which may result in increased emissions should be checked to ensure compliance has been maintained (i.e., printed circuit board layout changes, different line filter, different power supply, harnessing or I/O cable changes, etc.).

STATEMENT OF COMPLIANCE

The tested sample of Intel Corporation Intel Centrino Advanced-N 6200 complied with the requirements of the following regulations:

- Industry Canada RSS-Gen Issue 2
- RSS 210 Issue 7 "Low-power Licence-exempt Radiocommunication Devices (All Frequency Bands): Category I Equipment"
- RSS 310 Issue 2 "Low-power Licence-exempt Radiocommunication Devices (All Frequency Bands): Category II Equipment"
- FCC Part 15, Subpart E requirements for UNII Devices

Maintenance of compliance is the responsibility of the manufacturer. Any modifications to the product should be assessed to determine their potential impact on the compliance status of the device with respect to the standards detailed in this test report.

The test results recorded herein are based on a single type test of Intel Corporation Intel Centrino Advanced-N 6200 and therefore apply only to the tested sample. The sample was selected and prepared by Steve Hackett of Intel Corporation.

DEVIATIONS FROM THE STANDARDS

No deviations were made from the published requirements listed in the scope of this report.

TEST RESULTS SUMMARY**UNII / LELAN DEVICES****Operation in the 5.15 – 5.25 GHz Band**

FCC Rule Part	RSS Rule Part	Description	Measured Value / Comments	Limit / Requirement	Result
15.407(e)		Indoor operation only	Indoor operation – limited to indoor systems		
15.407(a)(1)		26dB Bandwidth	The proposed changes to the digital circuits do not affect the characteristics of the device with respect to output power, bandwidth, power density or other measurements made at the antenna port.		
15.407(a)(1)	A9.2(1)	Output Power			
15.407(a)(1)	-	Power Spectral Density			
-	A9.5(2)				
15.407(b)(2)	A9.3	Spurious Emissions above 1GHz	51.7dB μ V/m @ 5150.0MHz (-2.3dB)	Refer to pages 17 and 19	Complies

Operation in the 5.25 – 5.35 GHz Band

FCC Rule Part	RSS Rule Part	Description	Measured Value / Comments	Limit / Requirement	Result (margin)
15.407(a)(2)		26dB Bandwidth	The proposed changes to the digital circuits do not affect the characteristics of the device with respect to output power, bandwidth, power density or other measurements made at the antenna port.		
15.407(a)(2)	A9.2(2)	Output Power			
15.407(a)(2)	-	Power Spectral Density			
-	A9.2(2) / A9.5(2)	Power Spectral Density			
-	A9.5(2)	Peak Spectral Density			
15.407(b)(2)	A9.3	Spurious Emissions above 1GHz	47.4dB μ V/m @ 5350.0MHz (-6.6dB)	Refer to pages 17 and 19	Complies

Operation in the 5.47 – 5.725 GHz Band

FCC Rule Part	RSS Rule Part	Description	Measured Value / Comments	Limit / Requirement	Result (margin)
15.407(a)(2)		26dB Bandwidth	The proposed changes to the digital circuits do not affect the characteristics of the device with respect to output power, bandwidth, power density or other measurements made at the antenna port.		
15.407(a)(2)	A9.2(2)	Output Power			
15.407(a)(2)		Power Spectral Density			
	A9.2(2) / A9.5(2)	Power Spectral Density			
15.407(b)(2)	A9.3	Spurious Emissions above 1GHz	51.5dB μ V/m @ 5460.0MHz (-2.5dB)	Refer to pages 17 and 19	Complies

Requirements for all U-NII/LELAN bands

FCC Rule Part	RSS Rule Part	Description	Measured Value / Comments	Limit / Requirement	Result
15.407	A9.5a	Modulation			
15.407(b)(5) / 15.209	A9.3	Spurious Emissions below 1GHz	The spurious emissions below 1GHz were evaluated for the digital device. The proposed changes did not affect these emissions.		
15.407(a)(6)	-	Peak Excursion Ratio	The proposed changes to the digital circuits do not affect the characteristics of the device with respect to the peak excursion measurement made at the antenna port.		
	A9.5 (3)	Channel Selection	Spurious emissions tested at outermost channels in each band	Device was tested on the top, bottom and center channels in each band	N/A
15			Measurements on three channels in each band		
15.407 (c)	A9.5(4)	Operation in the absence of information to transmit	The proposed changes to the digital circuits do not affect these characteristics of the device as detailed in the original filing for certification.		
15.407 (g)	A9.5 (5)	Frequency Stability			
15.407 (h1)	A9.4	Transmit Power Control			
15.407 (h2)	A9.4	Dynamic frequency Selection (device without radar detection)	The proposed changes to the digital circuits do not affect the DFS measurements for channel closing time and channel move time for a slave device. The data provided in the original filing remains representative of the device so no measurements were made.		
	A9.9g	User Manual information	No changes are proposed to the user manual information as detailed in the original filing for certification.		

GENERAL REQUIREMENTS APPLICABLE TO ALL BANDS

FCC Rule Part	RSS Rule part	Description	Measured Value / Comments	Limit / Requirement	Result (margin)
15.203	-	RF Connector	No changes to the rf connectors are proposed.		
15.109	RSS GEN 7.2.3 Table 1	Receiver spurious emissions	49.7dB μ V/m @ 6986.7MHz (-4.3dB)	Refer to page 18	Complies
15.207	RSS GEN Table 2	AC Conducted Emissions	The proposed changes to the digital circuits do not affect the values originally reported for AC conducted emissions.		
15.247 (b)(5) / 15.407 (f)	RSS 102	RF Exposure Requirements	No change in power rating or antenna gain are proposed. The maximum eirp and, therefore, the MPE evaluation, remains unchanged from that previously reported.		
-	RSP 100 RSS GEN 7.1.5	User Manual	No changes to the user manual are proposed.		
-	RSP 100 RSS GEN 4.4.1	99% Bandwidth	The proposed changes to the digital circuits do not affect the bandwidth of the signal as previously reported.		

MEASUREMENT UNCERTAINTIES

ISO/IEC 17025 requires that an estimate of the measurement uncertainties associated with the emissions test results be included in the report. The measurement uncertainties given below are based on a 95% confidence level and were calculated in accordance with UKAS document LAB 34.

Measurement Type	Frequency Range (MHz)	Calculated Uncertainty (dB)
Conducted Emissions	0.15 to 30	± 2.4
Radiated Emissions	0.015 to 30	± 3.0
Radiated Emissions	30 to 1000	± 3.6
Radiated Emissions	1000 to 40000	± 6.0

EQUIPMENT UNDER TEST (EUT) DETAILS**GENERAL**

The Intel Corporation Intel Centrino Advanced-N 6200 is a 2x2 802.11abgn mini PCI express module. The device is sold under two different model numbers in Canada, one having a full modular approval (622ANHMW) and the other a limited modular approval (622ANHU). There are no hardware or firmware differences between the two model numbers. It is only the scope of the certification that is different.

The sample was received on March 12, 2010 and tested on March 12 to April 1, 2010. The EUT consisted of the following component(s):

Company	Model	Description	Serial Number	FCC ID
Intel Corporation	622ANHU	2x2 802.11abgn mini PCI express module	MAC Address 0023146851DC	FCC:PD9622ANHU IC:1000M-622ANHU
	622ANHMW			FCC:PD9622ANH IC:1000M-622ANH

OTHER EUT DETAILS

The device was tested with the Universe PIFA antennas evaluated in the original filing. The antenna specifications are provided below for reference.

Frequency Band	Gain (dBi)	
	Main	Aux
2400-2500 MHz	3.24	
5150-5350 MHz	3.73	
5470-5725 MHz	4.77	
5725-5850 MHz	4.97	

ENCLOSURE

The EUT has no enclosure. It is designed to be installed within the enclosure of a host computer.

MODIFICATIONS

No modifications were made to the EUT during the time the product was at Elliott.

SUPPORT EQUIPMENT

The following equipment was used as support equipment for testing:

Company	Model	Description	Serial Number	FCC ID
Dell	-	Laptop	Prototype	N/A
Intel	Mini PCIE extender card	Extender card	None	N/A

EUT INTERFACE PORTS

The I/O cabling configuration during testing was as follows:

Port	Connected To	Description	Cable(s)	
			Shielded/Unshielded	Length(m)
Laptop Adapter	AC power	-	Unshielded	1.0
Extender mini PCI	Laptop mini PCI bus	Ribbon	Unshielded	1.0
Extender dc power	DC power supply	2-wires	Unshielded	1.0

EUT OPERATION

For measurements on the spurious emissions from the transmitter the EUT was operating on the specified channel at the specified output power using one or both chains, as detailed in the test descriptions, with a > 99% duty cycle. Worst case modes and transmitter chains were selected based on the original test data for spurious emissions.

The output power for all spurious measurements away from the band edges was at, or above, the maximum power rating in each band. For band edge measurements the output power was set at or above either the rated power in each band or, in some cases, to the maximum nominal operating power (as programmed into the EEPROM) plus +1.5dB to account for the worst case tolerance in output power from the programmed power stored in EEPROM. The EEPROM power is always lower than the maximum rated power by at least 1.5dB. All target powers are measured with an average power meter and, therefore, do not exactly correlate with the powers listed in the grant which are measured in accordance with the FCC procedures based on the U-NII power measurement methods. The original report includes information correlating the average power (measured with a power meter) to the reported average power (measured using a spectrum analyzer).

For receiver spurious the device was in receive mode and tested on the center channel in each band.

TEST SITE**GENERAL INFORMATION**

Final test measurements were taken on «FinalDate» at the test sites listed below. Pursuant to section 2.948 of the FCC's Rules and section 3.3 of RSP-100, construction, calibration, and equipment data has been filed with the Commission and with industry Canada.

Site	Registration Numbers		Location
	FCC	Canada	
Chamber 3	769238	2845B-3	41039 Boyce Road Fremont, CA 94538-2435
Chamber 4	211948	2845B-4	
Chamber 5	211948	2845B-5	

ANSI C63.4:2003 recommends that ambient noise at the test site be at least 6 dB below the allowable limits. Ambient levels are below this requirement of predictable local TV, radio, and mobile communications traffic. The test site(s) contain separate areas for radiated and conducted emissions testing. Considerable engineering effort has been expended to ensure that the facilities conform to all pertinent requirements of ANSI C63.4:2003.

CONDUCTED EMISSIONS CONSIDERATIONS

Conducted emissions testing is performed in conformance with ANSI C63.4:2003. Measurements are made with the EUT connected to the public power network through a nominal, standardized RF impedance, which is provided by a line impedance stabilization network, known as a LISN. A LISN is inserted in series with each current-carrying conductor in the EUT power cord.

RADIATED EMISSIONS CONSIDERATIONS

The FCC has determined that radiation measurements made in a shielded enclosure are not suitable for determining levels of radiated emissions. Radiated measurements are performed in an open field environment or in a semi-anechoic chamber. The test sites are maintained free of conductive objects within the CISPR defined elliptical area incorporated in ANSI C63.4:2003 guidelines and meet the Normalized Site Attenuation (NSA) requirements of ANSI C63.4:2003.

MEASUREMENT INSTRUMENTATION**RECEIVER SYSTEM**

An EMI receiver as specified in CISPR 16-1-1 is used for emissions measurements. The receivers used can measure over the frequency range of 9 kHz up to 2000 MHz. These receivers allow both ease of measurement and high accuracy to be achieved. The receivers have Peak, Average, and CISPR (Quasi-peak) detectors built into their design so no external adapters are necessary. The receiver automatically sets the required bandwidth for the CISPR detector used during measurements. If the repetition frequency of the signal being measured is below 20Hz, peak measurements are made in lieu of Quasi-Peak measurements.

For measurements above the frequency range of the receivers, a spectrum analyzer is utilized because it provides visibility of the entire spectrum along with the precision and versatility required to support engineering analysis. Average measurements above 1000MHz are performed on the spectrum analyzer using the linear-average method with a resolution bandwidth of 1 MHz and a video bandwidth of 10 Hz, unless the signal is pulsed in which case the average (or video) bandwidth of the measuring instrument is reduced to onset of pulse desensitization and then increased.

INSTRUMENT CONTROL COMPUTER

The receivers utilize either a Rohde & Schwarz EZM Spectrum Monitor/Controller or contain an internal Spectrum Monitor/Controller to view and convert the receiver measurements to the field strength at an antenna or voltage developed at the LISN measurement port, which is then compared directly with the appropriate specification limit. This provides faster, more accurate readings by performing the conversions described under Sample Calculations within the Test Procedures section of this report. Results are printed in a graphic and/or tabular format, as appropriate. A personal computer is used to record all measurements made with the receivers.

The Spectrum Monitor provides a visual display of the signal being measured. In addition, the controller or a personal computer run automated data collection programs which control the receivers. This provides added accuracy since all site correction factors, such as cable loss and antenna factors are added automatically.

LINE IMPEDANCE STABILIZATION NETWORK (LISN)

Line conducted measurements utilize a fifty microhenry Line Impedance Stabilization Network as the monitoring point. The LISN used also contains a 250 uH CISPR adapter. This network provides for calibrated radio frequency noise measurements by the design of the internal low pass and high pass filters on the EUT and measurement ports, respectively.

FILTERS/ATTENUATORS

External filters and precision attenuators are often connected between the receiving antenna or LISN and the receiver. This eliminates saturation effects and non-linear operation due to high amplitude transient events.

ANTENNAS

A loop antenna is used below 30 MHz. For the measurement range 30 MHz to 1000 MHz either a combination of a biconical antenna and a log periodic or a bi-log antenna is used. Above 1000 MHz, horn antennas are used. The antenna calibration factors to convert the received voltage to an electric field strength are included with appropriate cable loss and amplifier gain factors to determine an overall site factor, which is then programmed into the test receivers or incorporated into the test software.

ANTENNA MAST AND EQUIPMENT TURNTABLE

The antennas used to measure the radiated electric field strength are mounted on a non-conductive antenna mast equipped with a motor-drive to vary the antenna height. Measurements below 30 MHz are made with the loop antenna at a fixed height of 1m above the ground plane.

ANSI C63.4:2003 specifies that the test height above ground for table mounted devices shall be 80 centimeters. Floor mounted equipment shall be placed on the ground plane if the device is normally used on a conductive floor or separated from the ground plane by insulating material from 3 to 12 mm if the device is normally used on a non-conductive floor. During radiated measurements, the EUT is positioned on a motorized turntable in conformance with this requirement.

INSTRUMENT CALIBRATION

All test equipment is regularly checked to ensure that performance is maintained in accordance with the manufacturer's specifications. All antennas are calibrated at regular intervals with respect to tuned half-wave dipoles. An exhibit of this report contains the list of test equipment used and calibration information.

TEST PROCEDURES

EUT AND CABLE PLACEMENT

The regulations require that interconnecting cables be connected to the available ports of the unit and that the placement of the unit and the attached cables simulate the worst case orientation that can be expected from a typical installation, so far as practicable. To this end, the position of the unit and associated cabling is varied within the guidelines of ANSI C63.4:2003, and the worst-case orientation is used for final measurements.

CONDUCTED EMISSIONS

Conducted emissions are measured at the plug end of the power cord supplied with the EUT. Excess power cord length is wrapped in a bundle between 30 and 40 centimeters in length near the center of the cord. Preliminary measurements are made to determine the highest amplitude emission relative to the specification limit for all the modes of operation. Placement of system components and varying of cable positions are performed in each mode. A final peak mode scan is then performed in the position and mode for which the highest emission was noted on all current carrying conductors of the power cord.

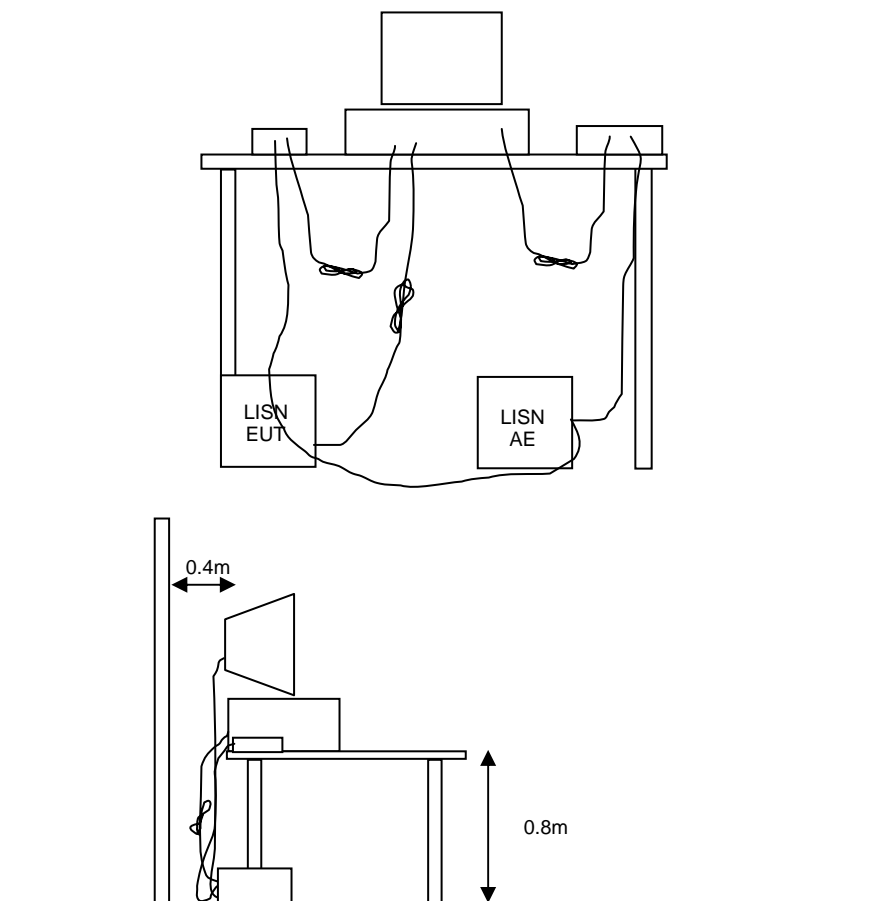

RADIATED EMISSIONS

A preliminary scan of the radiated emissions is performed in which all significant EUT frequencies are identified with the system in a nominal configuration. At least two scans are performed, one scan for each antenna polarization (horizontal and vertical; loop parallel and perpendicular to the EUT). During the preliminary scans, the EUT is rotated through 360°, the antenna height is varied (for measurements above 30 MHz) and cable positions are varied to determine the highest emission relative to the limit. Preliminary scans may be performed in a fully anechoic chamber for the purposes of identifying the frequencies of the highest emissions from the EUT.

A speaker is provided in the receiver to aid in discriminating between EUT and ambient emissions. Other methods used during the preliminary scan for EUT emissions involve scanning with near field magnetic loops, monitoring I/O cables with RF current clamps, and cycling power to the EUT.

Final maximization is a phase in which the highest amplitude emissions identified in the spectral search are viewed while the EUT azimuth angle is varied from 0 to 360 degrees relative to the receiving antenna. The azimuth, which results in the highest emission is then maintained while varying the antenna height from one to four meters (for measurements above 30 MHz, measurements below 30 MHz are made with the loop antenna at a fixed height of 1m). The result is the identification of the highest amplitude for each of the highest peaks. Each recorded level is corrected in the receiver using appropriate factors for cables, connectors, antennas, and preamplifier gain.

When testing above 18 GHz, the receive antenna is located at 1 meter from the EUT and the antenna height is restricted to a maximum of 2.5 meters.

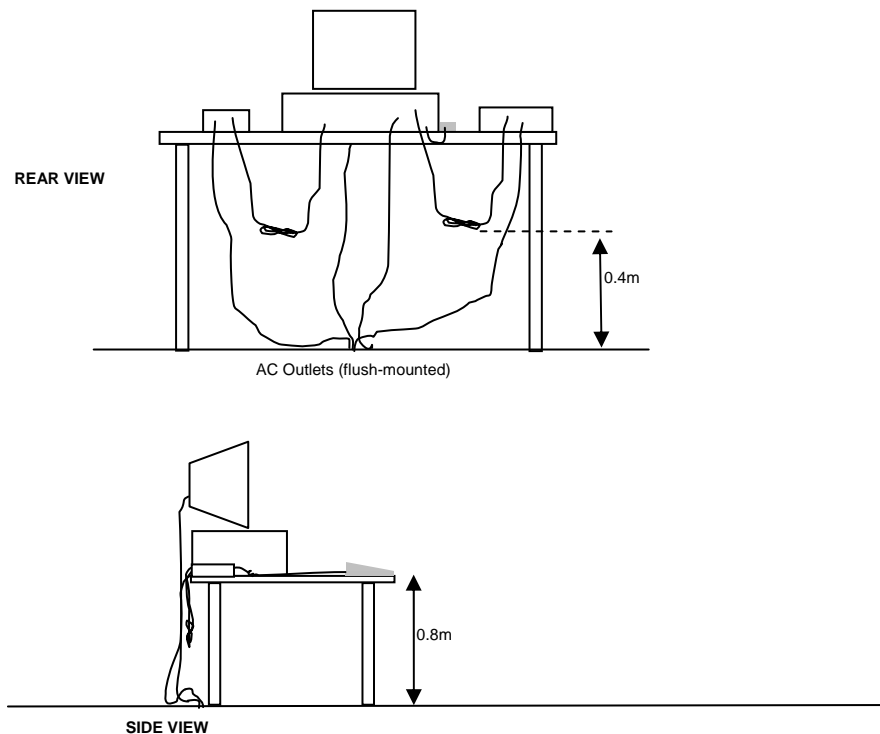

Typical Test Configuration for Radiated Field Strength Measurements

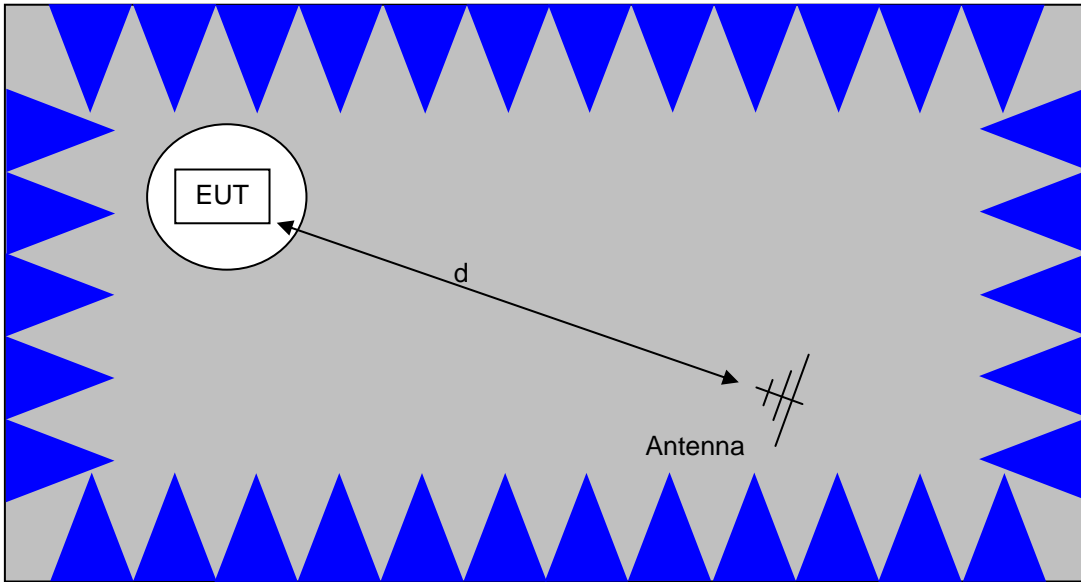

The anechoic materials on the walls and ceiling ensure compliance with the normalized site attenuation requirements of CISPR 16 / CISPR 22 / ANSI C63.4 for an alternate test site at the measurement distances used.

Floor-standing equipment is placed on the floor with insulating supports between the unit and the ground plane.

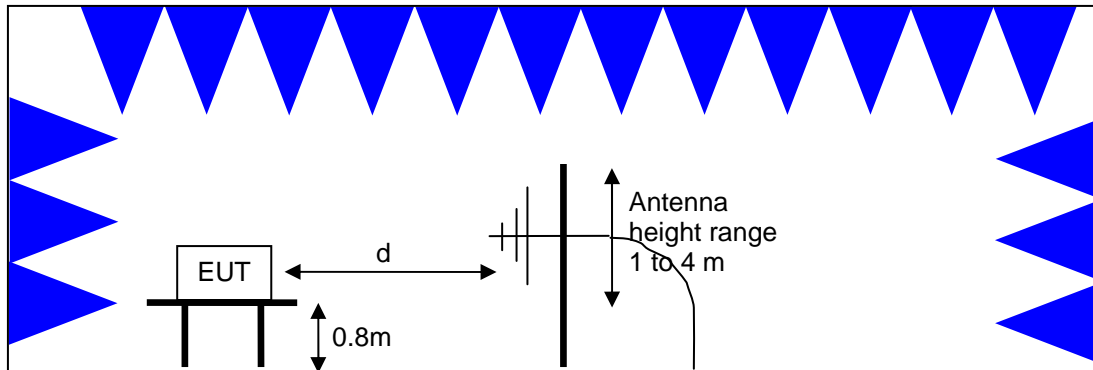

Test Configuration for Radiated Field Strength Measurements
Semi-Anechoic Chamber, Plan and Side Views

SPECIFICATION LIMITS AND SAMPLE CALCULATIONS

The limits for conducted emissions are given in units of microvolts, and the limits for radiated emissions are given in units of microvolts per meter at a specified test distance. Data is measured in the logarithmic form of decibels relative to one microvolt, or dB microvolts (dBuV). For radiated emissions, the measured data is converted to the field strength at the antenna in dB microvolts per meter (dBuV/m). The results are then converted to the linear forms of uV and uV/m for comparison to published specifications.

For reference, converting the specification limits from linear to decibel form is accomplished by taking the base ten logarithm, then multiplying by 20. These limits in both linear and logarithmic form are as follows:

GENERAL TRANSMITTER RADIATED EMISSIONS SPECIFICATION LIMITS

The table below shows the limits for the spurious emissions from transmitters that fall in restricted bands¹ (with the exception of transmitters operating under FCC Part 15 Subpart D and RSS 210 Annex 9), the limits for all emissions from a low power device operating under the general rules of RSS 310 (tables 3 and 4), RSS 210 (table 2) and FCC Part 15 Subpart C section 15.209.

Frequency Range (MHz)	Limit (uV/m)	Limit (dBuV/m @ 3m)
0.009-0.490	$2400/F_{\text{KHz}} @ 300\text{m}$	$67.6-20*\log_{10}(F_{\text{KHz}}) @ 300\text{m}$
0.490-1.705	$24000/F_{\text{KHz}} @ 30\text{m}$	$87.6-20*\log_{10}(F_{\text{KHz}}) @ 30\text{m}$
1.705 to 30	30 @ 30m	29.5 @ 30m
30 to 88	100 @ 3m	40 @ 3m
88 to 216	150 @ 3m	43.5 @ 3m
216 to 960	200 @ 3m	46.0 @ 3m
Above 960	500 @ 3m	54.0 @ 3m

¹ The restricted bands are detailed in FCC 15.203, RSS 210 Table 1 and RSS 310 Table 2

RECEIVER RADIATED SPURIOUS EMISSIONS SPECIFICATION LIMITS

The table below shows the limits for the spurious emissions from receivers as detailed in FCC Part 15.109, RSS 210 Table 2, RSS GEN Table 1 and RSS 310 Table 3. Note that receivers operating outside of the frequency range 30 MHz – 960 MHz are exempt from the requirements of 15.109.

Frequency Range (MHz)	Limit (uV/m @ 3m)	Limit (dBuV/m @ 3m)
30 to 88	100	40
88 to 216	150	43.5
216 to 960	200	46.0
Above 960	500	54.0

FCC 15.407 (a) OUTPUT POWER LIMITS

The table below shows the limits for output power and output power density. Where the signal bandwidth is less than 20 MHz the maximum output power is reduced to the power spectral density limit plus 10 times the log of the bandwidth (in MHz).

Operating Frequency (MHz)	Output Power	Power Spectral Density
5150 - 5250	50mW (17 dBm)	4 dBm/MHz
5250 - 5350	250 mW (24 dBm)	11 dBm/MHz
5725 – 5825	1 Watts (30 dBm)	17 dBm/MHz

For system using antennas with gains exceeding 6dBi, the output power and power spectral density limits are reduced by 1dB for every dB the antenna gain exceeds 6dBi. Fixed point-to-point applications using the 5725 – 5825 MHz band may use antennas with gains of up to 23dBi without this limitation. If the gain exceeds 23dBi then the output power limit of 1 Watt is reduced by 1dB for every dB the gain exceeds 23dBi.

The peak excursion envelope is limited to 13dB.

OUTPUT POWER LIMITS –LELAN DEVICES

The table below shows the limits for output power and output power density defined by RSS 210. Where the signal bandwidth is less than 20 MHz the maximum output power is reduced to the power spectral density limit plus 10 times the log of the bandwidth (in MHz).

Operating Frequency (MHz)	Output Power	Power Spectral Density
5150 - 5250	200mW (23 dBm) eirp	10 dBm/MHz eirp
5250 - 5350	250 mW (24 dBm) ² 1W (30dBm) eirp	11 dBm/MHz
5470 - 5725	250 mW (24 dBm) ³ 1W (30dBm) eirp	11 dBm/MHz
5725 – 5825	1 Watts (30 dBm) 4W eirp	17 dBm/MHz

In addition, the power spectral density limit shall be reduced by 1dB for every dB the highest power spectral density exceeds the “average” power spectral density) by more than 3dB. The “average” power spectral density is determined by dividing the output power by $10\log(\text{EBW})$ where EBW is the 99% power bandwidth.

Fixed point-to-point applications using the 5725 – 5825 MHz band may use antennas with gains of up to 23dBi without this limitation. If the gain exceeds 23dBi then the output power limit of 1 Watt is reduced by 1dB for every dB the gain exceeds 23dBi.

OUTPUT POWER AND SPURIOUS LIMITS –UNII and LELAN DEVICES

The spurious emissions limits for signals below 1GHz are the FCC/RSS-GEN general limits. For emissions above 1GHz, signals in restricted bands are subject to the FCC/RSS GEN general limits. All other signals have a limit of -27dBm/MHz , which is a field strength of 68.3dBuV/m/MHz at a distance of 3m. This is an average limit so the peak value of the emission may not exceed -7dBm/MHz (68.3dBuV/m/MHz at a distance of 3m). For devices operating in the 5725-5850Mhz bands under the LELAN/UNII rules, the limit within 10Mhz of the allocated band is increased to -17dBm/MHz .

² If EIRP exceeds 500mW the device must employ TPC

³ If EIRP exceeds 500mW the device must employ TPC

SAMPLE CALCULATIONS - CONDUCTED EMISSIONS

Receiver readings are compared directly to the conducted emissions specification limit (decibel form) as follows:

$$R_r - S = M$$

where:

R_r = Receiver Reading in dBuV

S = Specification Limit in dBuV

M = Margin to Specification in +/- dB

SAMPLE CALCULATIONS - RADIATED EMISSIONS

Receiver readings are compared directly to the specification limit (decibel form). The receiver internally corrects for cable loss, preamplifier gain, and antenna factor. The calculations are in the reverse direction of the actual signal flow, thus cable loss is added and the amplifier gain is subtracted. The Antenna Factor converts the voltage at the antenna coaxial connector to the field strength at the antenna elements.

A distance factor, when used for electric field measurements above 30MHz, is calculated by using the following formula:

$$F_d = 20 * \text{LOG}_{10} (D_m/D_s)$$

where:

F_d = Distance Factor in dB

D_m = Measurement Distance in meters

D_s = Specification Distance in meters

For electric field measurements below 30MHz the extrapolation factor is either determined by making measurements at multiple distances or a theoretical value is calculated using the formula:

$$F_d = 40 * \text{LOG}_{10} (D_m/D_s)$$

Measurement Distance is the distance at which the measurements were taken and Specification Distance is the distance at which the specification limits are based. The antenna factor converts the voltage at the antenna coaxial connector to the field strength at the antenna elements.

The margin of a given emission peak relative to the limit is calculated as follows:

$$R_c = R_r + F_d$$

and

$$M = R_c - L_s$$

where:

R_r = Receiver Reading in dBuV/m

F_d = Distance Factor in dB

R_c = Corrected Reading in dBuV/m

L_s = Specification Limit in dBuV/m

M = Margin in dB Relative to Spec

SAMPLE CALCULATIONS - FIELD STRENGTH TO EIRP CONVERSION

Where the radiated electric field strength is expressed in terms of the equivalent isotropic radiated power (eirp), or where a field strength measurement of output power is made in lieu of a direct measurement, the following formula is used to convert between eirp and field strength at a distance of 3m from the equipment under test:

$$E = \frac{1000000 \sqrt{30 P}}{3} \text{ microvolts per meter}$$

where P is the eirp (Watts)

Appendix A Test Equipment Calibration Data

<u>Manufacturer</u>	<u>Description</u>	<u>Model</u>	<u>Asset #</u>	<u>Cal Due</u>
Hewlett Packard	Microwave Preamplifier, 1-26.5GHz	8449B	785	6/3/2010
EMCO	Antenna, Horn, 1-18 GHz (SA40-Red)	3115	1142	7/15/2010
Rohde & Schwarz	Power Meter, Single Channel	NRVS	1290	10/22/2010
Hewlett Packard	High Pass filter, 8.2 GHz (Blue System)	P/N 84300-80039 (84125C)	1392	6/22/2010
Hewlett Packard	SpecAn 9 kHz - 40 GHz, FT (SA40) Blue	8564E (84125C)	1393	4/10/2010
Rohde & Schwarz	EMI Test Receiver, 20 Hz-7 GHz	ESIB7	1538	10/15/2010
Sunol Sciences	Biconilog, 30-3000 MHz	JB3	1549	6/4/2010
EMCO	Antenna, Horn, 1-18 GHz	3115	1561	6/10/2010
Hewlett Packard	Preamplifier, 100 kHz - 1.3 GHz	8447E	1606	4/30/2010
Micro-Tronics	Band Reject Filter, 2400-2500 MHz	BRM50702-02	1683	7/29/2010
Micro-Tronics	Band Reject Filter, 5725-5875 MHz	BRC50705-02	1728	2/1/2011
Micro-Tronics	Band Reject Filter, 5150-5350 MHz	BRC50703-02	1729	9/25/2010
Micro-Tronics	Band Reject Filter, 5470-5725 MHz	BRC50704-02	1730	9/25/2010
Hewlett Packard	SpecAn 9 kHz - 40 GHz, (SA40) Purple	8564E (84125C)	1771	9/30/2010
Hewlett Packard	Microwave Preamplifier, 1-26.5GHz	8449B	1780	9/17/2010
Rohde & Schwarz	Pwr Sensor 300 uW - 30 Watts (+ 25dB pad)	NRV-Z54	1788	6/9/2010
Rohde & Schwarz	Attenuator, 25 dB, 30W, DC-18 GHz	25dB, 30W, Type N	1794	6/9/2010

Appendix B Test Data

T78805 30 Pages

Client:	Intel Corporation	Job Number:	J78599
Model:	Puma Peak 2x2	T-Log Number:	T78676
		Account Manager:	Christine Krebill
Contact:	Steve Hackett		-
Emissions Standard(s):	FCC 15E, FCC 15C, FCC 15B	Class:	B
Immunity Standard(s):	-	Environment:	-

EMC Test Data

For The

Intel Corporation

Model

Puma Peak 2x2

Date of Last Test: 4/1/2010

Client:	Intel Corporation	Job Number:	J78599
Model:	Puma Peak 2x2	T-Log Number:	T78676
Contact:	Steve Hackett	Account Manager:	Christine Krebill
Standard:	FCC 15E, FCC 15C, FCC 15B	Class:	N/A

FCC 15 E Radiated Emissions - Band Edge Measurements

Test Specific Details

Objective: The objective of this test session is to perform engineering evaluation testing of the EUT with respect to the specification listed above.

General Test Configuration

The EUT was installed into a test fixture such that the EUT was exposed (i.e. outside of a host PC).

For radiated emissions testing the measurement antenna was located 3 meters from the EUT.

Summary of Results

MAC Address: 0023146851DC CRTU Tool Version 5.15.36.0 Driver version 13.0.0.91

Run #	Mode	Channel	Target Power	Measured Power	Test Performed	Limit	Result / Margin
Run #1	802.11a Chain A	#36 5180MHz	16.5	16.5	Restricted Band Edge at 5150 MHz	15.209	51.7dB μ V/m @ 5150.0MHz (-2.3dB)
	802.11a Chain A	#64 5320MHz	16.5		Restricted Band Edge at 5350 MHz	15.209	Original testing showed Chain B worst case.
	802.11a Chain A	#100 5500MHz	16.4		Band Edges at 5460 MHz/5470 MHz	15.209	
Run # 2	802.11a Chain B	#36 5180MHz	16.4	16.3	Restricted Band Edge at 5150 MHz	15.209	47.9dB μ V/m @ 5150.0MHz (-6.1dB)
	802.11a Chain B	#64 5320MHz	16.3	16.7	Restricted Band Edge at 5350 MHz	15.209	47.1dB μ V/m @ 5350.5MHz (-6.9dB)
	802.11a Chain B	#100 5500MHz	16.6	16.7	Band Edge at 5460 MHz	15.209	41.5dB μ V/m @ 5460.0MHz (-12.5dB)
				16.7	Restricted Band Edge at 5470 MHz	15 E	48.9dB μ V/m @ 5470.0MHz (-19.4dB)
Run # 3	n20 Chain A	#36 5180MHz	16.5		Restricted Band Edge at 5150 MHz	15.209	Original testing showed Chain B worst case
	n20 Chain A	#64 5320MHz	16.4	16.4	Restricted Band Edge at 5350 MHz	15.209	43.3dB μ V/m @ 5350.1MHz (-10.7dB)
	n20 Chain A	#100 5500MHz	16.6		Band Edges at 5460 MHz/5470 MHz	15.209	Original testing showed Chain B worst case and
Run # 4	n20 Chain B	#36 5180MHz	16.5	16.4	Restricted Band Edge at 5150 MHz	15.209	49.0dB μ V/m @ 5148.5MHz (-5.0dB)
	n20 Chain B	#64 5320MHz	16.6	16.5	Restricted Band Edge at 5350 MHz	15.209	45.5dB μ V/m @ 5350.4MHz (-8.5dB)
	n20 Chain B	#100 5500MHz	16.6	16.5	Restricted Band Edge at 5460 MHz	15.209	42.7dB μ V/m @ 5460.0MHz (-11.3dB)
				16.5	Restricted Band Edge at 5470 MHz	15 E	49.9dB μ V/m @ 5740.0MHz (-18.4dB)

Client:	Intel Corporation	Job Number:	J78599
Model:	Puma Peak 2x2	T-Log Number:	T78676
Contact:	Steve Hackett	Account Manager:	Christine Krebill
Standard:	FCC 15E, FCC 15C, FCC 15B	Class:	N/A

MAC Address: 0023146851DC CRTU Tool Version 5.15.36.0 Driver version 13.0.0.91

Run #	Mode	Channel	Target Power	Measured Power	Test Performed	Limit	Result / Margin
Run # 5	n40 Chain A	#38 5190MHz	12.0	12.2	Restricted Band Edge at 5150 MHz	15.209	48.4dB μ V/m @ 5149.9MHz (-5.6dB)
	n40 Chain A	#62 5310MHz	12.5	12.6	Restricted Band Edge at 5350 MHz	15.209	47.4dB μ V/m @ 5350.0MHz (-6.6dB)
	n40 Chain A	#102 5510MHz	16.6	16.7	Restricted Band Edge at 5460 MHz	15.209	50.0dB μ V/m @ 5459.9MHz (-4.0dB)
					Restricted Band Edge at 5470 MHz	15 E	58.0dB μ V/m @ 5470.0MHz (-10.3dB)
Run # 6	n40 Chain B	#38 5190MHz	11.5	11.7	Restricted Band Edge at 5150 MHz	15.209	46.0dB μ V/m @ 5150.0MHz (-8.0dB)
		#62 5310MHz	12.5	12.8	Restricted Band Edge at 5350 MHz	15.209	46.5dB μ V/m @ 5350.8MHz (-7.5dB)
		#102 5510MHz	14.5	14.6	Restricted Band Edge at 5460 MHz	15.209	45.5dB μ V/m @ 5460.0MHz (-8.5dB)
					Restricted Band Edge at 5470 MHz	15 E	54.2dB μ V/m @ 5469.6MHz (-14.1dB)

Note - the target and measured power are average powers (measured with average power sensor) and are used for reference purposes only. Power is set using "Set TX Power Manually" mode (run #s 1 - 4) and gain control (runs 5 and 6) in the CRTU tool.

Ambient Conditions:

Rel. Humidity: 18.7 %
Temperature: 39 °C

Modifications Made During Testing

No modifications were made to the EUT during testing

Deviations From The Standard

No deviations were made from the requirements of the standard.

Marker Delta Measurements

Three sets of marker deltas are measured using the following settings: RB=VB=100kHz; RB=1MHz,VB=1MHz; RB=1MHz, VB=10Hz. Marker deltas are made conducted (analyzer connected to EUT rf port a 20dB pad) for single chain operation and radiated (at a distance of ~ 50cm) for MIMO modes.

The fundamental field strength is always measured at a 3m test distance.

Client: Intel Corporation	Job Number: J78599
Model: Puma Peak 2x2	T-Log Number: T78676
Contact: Steve Hackett	Account Manager: Christine Krebill
Standard: FCC 15E, FCC 15C, FCC 15B	Class: N/A

Run #1, Band Edge Field Strength - 802.11a, Chain A
Run #1a, EUT on Channel #36 5180MHz - 802.11a, Chain A

Date of Test: 3/13/2010 Test Location: Chamber #4
 Test Engineer: Suhaila Khushzad Config Change: none

Chain	Power Settings		
	Target (dBm)	Measured (dBm)	Software Setting
A	16.5	16.5	17.0

Fundamental Signal Field Strength

Frequency	Level	Pol	15.209 / 15.247		Detector	Azimuth	Height	Comments
MHz	dBuV/m	v/h	Limit	Margin	PK/QP/Avg	degrees	meters	
5173.000	94.0	H	-	-	AVG	216	1.0	RB 1 MHz; VB: 10 Hz
5173.800	102.8	H	-	-	PK	216	1.0	RB 1 MHz; VB: 1 MHz
5172.930	96.5	V	-	-	AVG	206	1.0	RB 1 MHz; VB: 10 Hz
5173.330	104.6	V	-	-	PK	206	1.0	RB 1 MHz; VB: 1 MHz

5150 MHz Band Edge Signal Radiated Field Strength - Marker Delta

	H	V		Limit	Detector
Fundamental emission level @ 3m in 1MHz RBW:	102.8	104.6	Peak Measurement (RB=VB=1MHz)		
Fundamental emission level @ 3m in 1MHz RBW:	94.0	96.5	Average Measurement (RB=1MHz, VB=10Hz)		
<i>Delta Marker - 100kHz</i>		<i>44.3 dB</i>		<- this can only be used if band edge signal is highest within 2MHz of band edge.	
Calculated Band-Edge Measurement (Peak):	60.3 dBuV/m		Margin	Level	Limit
Calculated Band-Edge Measurement (Avg):	52.2 dBuV/m		-2.3	51.7	54
<i>Delta Marker - 1MHz/1MHz:</i>		<i>39.7 dB</i>		Avg	
<i>Delta Marker - 1MHz/10Hz:</i>		<i>44.8 dB</i>		Pk	
Calculated Band-Edge Measurement (Peak):	64.9 dBuV/m		Using 100kHz delta value		
Calculated Band-Edge Measurement (Avg):	51.7 dBuV/m		Using 1MHz delta value		

Frequency	Level	Pol	FCC 15.209		Detector	Azimuth	Height	Comments
MHz	dBuV/m	v/h	Limit	Margin	PK/QP/Avg	degrees	meters	
5150.000	51.7	-	54.0	-2.3	Avg	-	-	Using 1MHz delta value

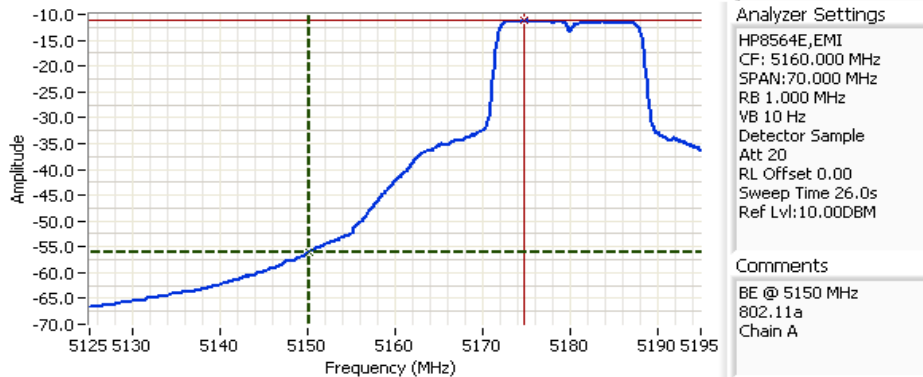

Analyzer Settings
 HP8564E,EMI
 CF: 5160.000 MHz
 SPAN:70.000 MHz
 RB 1.000 MHz
 VB 10 Hz
 Detector Sample
 Att 20
 RL Offset 0.00
 Sweep Time 26.0s
 Ref Lvl:10.00DBM

Comments
 BE @ 5150 MHz
 802.11a
 Chain A

Cursor 1	5150.0835	-56.00	Delta Freq.	24.733
Cursor 2	5174.8169	-11.17	Delta Amplitude	44.83



Client: Intel Corporation	Job Number: J78599
Model: Puma Peak 2x2	T-Log Number: T78676
Contact: Steve Hackett	Account Manager: Christine Krebill
Standard: FCC 15E, FCC 15C, FCC 15B	Class: N/A

Run # 2, Band Edge Field Strength - 802.11a, Chain B

Run # 2a, EUT on Channel #36 5180MHz - 802.11a, Chain B

Date of Test: 3/13/2010

Test Location: Chamber #4

Test Engineer: Suhaila Khushzad

Config Change: none

Chain	Power Settings		
	Target (dBm)	Measured (dBm)	Software Setting
B	16.4	16.3	17.0

Fundamental Signal Field Strength

Frequency	Level	Pol	15.209 / 15.247		Detector	Azimuth	Height	Comments
MHz	dBuV/m	v/h	Limit	Margin	PK/QP/Avg	degrees	meters	
5173.530	94.7	V	-	-	AVG	170	1.5	RB 1 MHz; VB: 10 Hz
5173.530	102.7	V	-	-	PK	170	1.5	RB 1 MHz; VB: 1 MHz
5176.530	95.4	H	-	-	AVG	94	1.0	RB 1 MHz; VB: 10 Hz
5173.600	103.7	H	-	-	PK	94	1.0	RB 1 MHz; VB: 1 MHz

5150 MHz Band Edge Signal Radiated Field Strength - Marker Delta

	H	V					
Fundamental emission level @ 3m in 1MHz RBW:	103.7	102.7	Peak Measurement (RB=VB=1MHz)				
Fundamental emission level @ 3m in 1MHz RBW:	95.4	94.7	Average Measurement (RB=1MHz, VB=10Hz)				
<i>Delta Marker - 100kHz</i>		47.2 dB		-< this can only be used if band edge signal is highest within 2MHz of band edge.			
Calculated Band-Edge Measurement (Peak):	56.5 dBuV/m						
Calculated Band-Edge Measurement (Avg):	48.2 dBuV/m		Margin	Level	Limit	Detector	
<i>Delta Marker - 1MHz/1MHz:</i>		42.0 dB		-6.1	47.9	54	Avg
<i>Delta Marker - 1MHz/10Hz:</i>		47.5 dB		-17.5	56.5	74	Pk
Calculated Band-Edge Measurement (Peak):	61.7 dBuV/m		Using 100kHz delta value				
Calculated Band-Edge Measurement (Avg):	47.9 dBuV/m		Using 1MHz delta value				

Frequency	Level	Pol	FCC 15.209		Detector	Azimuth	Height	Comments
MHz	dBuV/m	v/h	Limit	Margin	PK/QP/Avg	degrees	meters	
5150.000	47.9	-	54.0	-6.1	Avg	-	-	Using 1MHz delta value

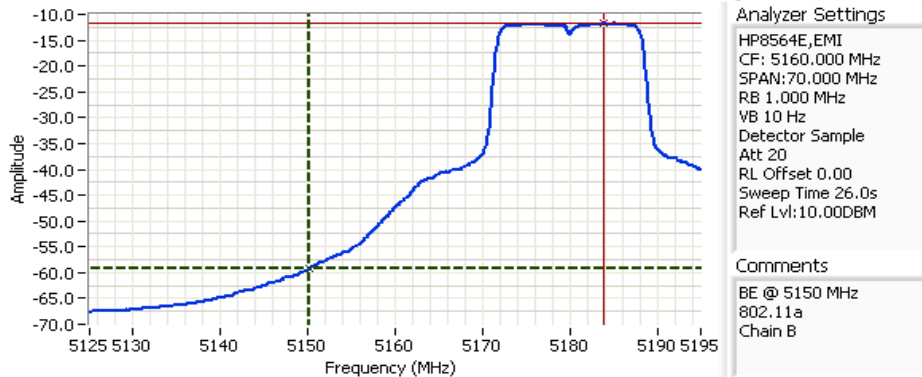

Analyzer Settings
 HP8564E,EMI
 CF: 5160.000 MHz
 SPAN:70.000 MHz
 RB 1.000 MHz
 VB 10 Hz
 Detector Sample
 Att 20
 RL Offset 0.00
 Sweep Time 26.0s
 Ref Lvl:10.00DBM

Comments
 BE @ 5150 MHz
 802.11a
 Chain B

Cursor 1	5150.0835	-59.33	Delta Freq.	33.716
Cursor 2	5183.7998	-11.83	Delta Amplitude	47.50



Client:	Intel Corporation	Job Number:	J78599
Model:	Puma Peak 2x2	T-Log Number:	T78676
Contact:	Steve Hackett	Account Manager:	Christine Krebill
Standard:	FCC 15E, FCC 15C, FCC 15B	Class:	N/A

Run # 2b, EUT on Channel #64 5320MHz - 802.11a, Chain B
 Date of Test: 3/13/2010 Test Location: Chamber #4
 Test Engineer: Suhaila Khushzad Config Change: none

Chain	Power Settings		
	Target (dBm)	Measured (dBm)	Software Setting
B	16.3	16.7	17.0

Fundamental Signal Field Strength

Frequency	Level	Pol	15.209 / 15.247		Detector	Azimuth	Height	Comments
MHz	dBuV/m	v/h	Limit	Margin	PK/QP/Avg	degrees	meters	
5313.070	93.9	V	-	-	AVG	123	1.0	RB 1 MHz; VB: 10 Hz
5313.000	101.9	V	-	-	PK	123	1.0	RB 1 MHz; VB: 1 MHz
5316.530	97.1	H	-	-	AVG	113	1.0	RB 1 MHz; VB: 10 Hz
5313.400	105.7	H	-	-	PK	113	1.0	RB 1 MHz; VB: 1 MHz

5350 MHz Band Edge Signal Radiated Field Strength - Marker Delta

	H	V				
Fundamental emission level @ 3m in 1MHz RBW:	105.7	101.9	Peak Measurement (RB=VB=1MHz)			
Fundamental emission level @ 3m in 1MHz RBW:	97.1	93.9	Average Measurement (RB=1MHz, VB=10Hz)			
<i>Delta Marker - 100kHz</i>	50.0 dB		<i><- this can only be used if band edge signal is highest within 2MHz of band edge.</i>			
Calculated Band-Edge Measurement (Peak):	55.7 dBuV/m					
Calculated Band-Edge Measurement (Avg):	47.1 dBuV/m	Margin	Level	Limit	Detector	
<i>Delta Marker - 1MHz/1MHz:</i>	45.8 dB	-6.9	47.1	54	Avg	
<i>Delta Marker - 1MHz/10Hz:</i>	49.7 dB	-18.3	55.7	74	Pk	
Calculated Band-Edge Measurement (Peak):	59.9 dBuV/m	Using 100kHz delta value				
Calculated Band-Edge Measurement (Avg):	47.4 dBuV/m	Using 100kHz delta value				

Frequency	Level	Pol	FCC 15.209		Detector	Azimuth	Height	Comments
MHz	dBuV/m	v/h	Limit	Margin	PK/QP/Avg	degrees	meters	
5350.500	47.1	-	54.0	-6.9	Avg	-	-	Using 100kHz delta value

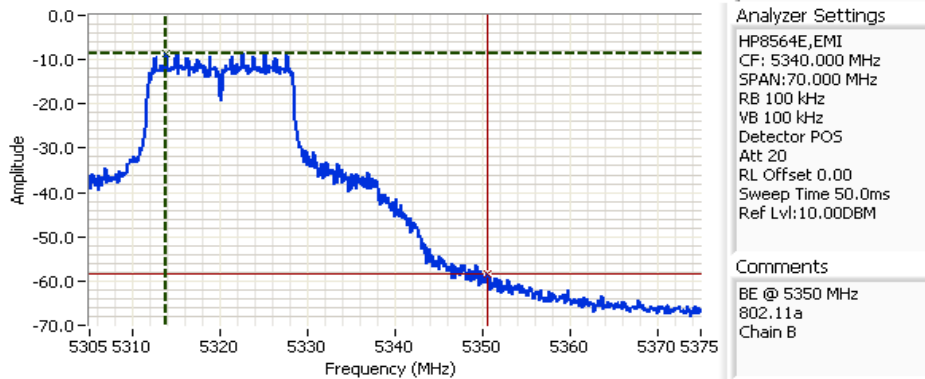

Analyzer Settings
 HP8564E, EMI
 CF: 5340.000 MHz
 SPAN: 70.000 MHz
 RB 100 kHz
 VB 100 kHz
 Detector POS
 Att 20
 RL Offset 0.00
 Sweep Time 50.0ms
 Ref Lvl: 10.00DBM

Comments
 BE @ 5350 MHz
 802.11a
 Chain B

Cursor 1	5313.7500	-8.50	Delta Freq.	36.750
Cursor 2	5350.5000	-58.50	Delta Amplitude	50.00



Client:	Intel Corporation	Job Number:	J78599
Model:	Puma Peak 2x2	T-Log Number:	T78676
Contact:	Steve Hackett	Account Manager:	Christine Krebill
Standard:	FCC 15E, FCC 15C, FCC 15B	Class:	N/A

Run # 2c, EUT on Channel #100 5500MHz - 802.11a, Chain B

Chain	Power Settings		
	Target (dBm)	Measured (dBm)	Software Setting
B	16.6	16.7	17.0

Fundamental Signal Field Strength

Frequency	Level	Pol	15.209 / 15.247		Detector	Azimuth	Height	Comments
MHz	dB μ V/m	v/h	Limit	Margin	PK/QP/Avg	degrees	meters	
5494.900	98.2	H	-	-	AVG	108	1.0	RB 1 MHz; VB: 10 Hz
5493.400	106.2	H	-	-	PK	108	1.0	RB 1 MHz; VB: 1 MHz
5493.470	94.6	V	-	-	AVG	129	1.1	RB 1 MHz; VB: 10 Hz
5493.470	102.9	V	-	-	PK	129	1.1	RB 1 MHz; VB: 1 MHz

5460 MHz Restricted Band Edge Signal Radiated Field Strength - Marker Delta

	H	V				
Fundamental emission level @ 3m in 1MHz RBW:	106.2		Peak Measurement (RB=VB=1MHz)			
Fundamental emission level @ 3m in 1MHz RBW:	98.2		Average Measurement (RB=1MHz, VB=10Hz)			
<i>Delta Marker - 100kHz</i>	55.8 dB		<- this can only be used if band edge signal is highest within 2MHz of band edge.			
Calculated Band-Edge Measurement (Peak):	50.4 dB μ V/m					
Calculated Band-Edge Measurement (Avg):	42.4 dB μ V/m		Margin	Level	Limit	Detector
<i>Delta Marker - 1MHz/1MHz:</i>	48.5 dB		-12.5	41.5	54	Avg
<i>Delta Marker - 1MHz/10Hz:</i>	56.7 dB		-23.6	50.4	74	Pk
Calculated Band-Edge Measurement (Peak):	57.7 dB μ V/m		Using 100kHz delta value			
Calculated Band-Edge Measurement (Avg):	41.5 dB μ V/m		Using 1MHz delta value			

Frequency	Level	Pol	FCC 15.209		Detector	Azimuth	Height	Comments
MHz	dB μ V/m	v/h	Limit	Margin	PK/QP/Avg	degrees	meters	
5460.000	41.5	-	54.0	-12.5	Avg	-	-	Using 1MHz delta value

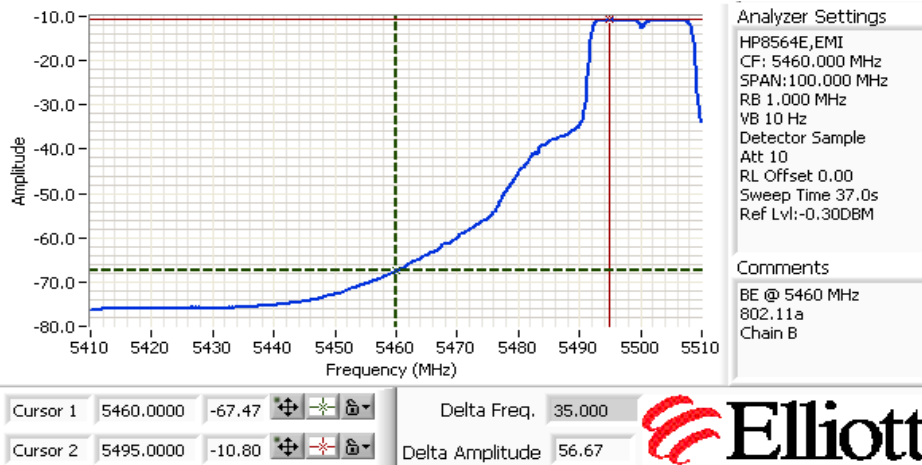

Client: Intel Corporation	Job Number: J78599
Model: Puma Peak 2x2	T-Log Number: T78676
Contact: Steve Hackett	Account Manager: Christine Krebill
Standard: FCC 15E, FCC 15C, FCC 15B	Class: N/A

5470 MHz Band Edge Signal Radiated Field Strength - Marker Delta

	H	V	
Fundamental emission level @ 3m in 1MHz RBW:	106.2		Peak Measurement (RB=VB=1MHz)
Fundamental emission level @ 3m in 1MHz RBW:	98.2		Average Measurement (RB=1MHz, VB=10Hz)
<i>Delta Marker - 100kHz</i>	<i>49.0 dB</i>		<- this can only be used if band edge signal is highest within 2MHz of band edge.
Calculated Band-Edge Measurement (Peak):	57.2 dBuV/m		
Calculated Band-Edge Measurement (Avg):	49.2 dBuV/m		
<i>Delta Marker - 1MHz/1MHz:</i>	<i>41.8 dB</i>		Margin
<i>Delta Marker - 1MHz/10Hz:</i>	<i>49.3 dB</i>		Level
Calculated Band-Edge Measurement (Peak):	64.4 dBuV/m		Limit
Calculated Band-Edge Measurement (Avg):	48.9 dBuV/m		Detector

Frequency	Level	Pol	FCC 15E		Detector	Azimuth	Height	Comments
MHz	dBuV/m	v/h	Limit	Margin	Pk/QP/Avg	degrees	meters	
5470.000	48.9	-	68.3	-19.4	Avg	-	-	Using 1MHz delta value

Note - average limit is equivalent to -27dBm eirp.

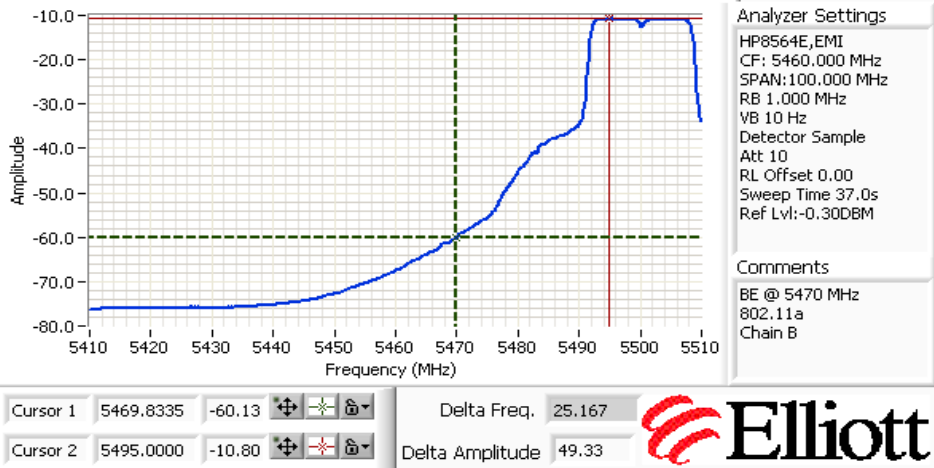

Client: Intel Corporation	Job Number: J78599
Model: Puma Peak 2x2	T-Log Number: T78676
Contact: Steve Hackett	Account Manager: Christine Krebill
Standard: FCC 15E, FCC 15C, FCC 15B	Class: N/A

Run # 3b, EUT on Channel #64 5320MHz - n20, Chain A

Date of Test: 3/14/2010 Test Location: FT Chamber #4
 Test Engineer: Rafael Varelas Config Change: none

Chain	Power Settings		
	Target (dBm)	Measured (dBm)	Software Setting
A	16.4	16.4	18.0

Fundamental Signal Field Strength

Frequency	Level	Pol	15.209 / 15.247		Detector	Azimuth	Height	Comments
MHz	dBuV/m	v/h	Limit	Margin	PK/QP/Avg	degrees	meters	
5314.470	93.8	H	-	-	AVG	218	1.0	RB 1 MHz; VB: 10 Hz
5316.030	101.8	H	-	-	PK	218	1.0	RB 1 MHz; VB: 1 MHz
5314.400	94.0	V	-	-	AVG	47	1.0	RB 1 MHz; VB: 10 Hz
5315.870	102.1	V	-	-	PK	47	1.0	RB 1 MHz; VB: 1 MHz

5350 MHz Band Edge Signal Radiated Field Strength - Marker Delta

	H	V				
Fundamental emission level @ 3m in 1MHz RBW:	101.8	102.1	Peak Measurement (RB=VB=1MHz)			
Fundamental emission level @ 3m in 1MHz RBW:	93.8	94.0	Average Measurement (RB=1MHz, VB=10Hz)			
<i>Delta Marker - 100kHz</i>	50.7 dB		<i><- this can only be used if band edge signal is highest within 2MHz of band edge.</i>			
Calculated Band-Edge Measurement (Peak):	51.4 dBuV/m		Margin	Level	Limit	Detector
Calculated Band-Edge Measurement (Avg):	43.3 dBuV/m		-10.7	43.3	54	Avg
<i>Delta Marker - 1MHz/1MHz:</i>	<i>44.7 dB</i>		-22.6	51.4	74	Pk
<i>Delta Marker - 1MHz/10Hz:</i>	<i>50.3 dB</i>					
Calculated Band-Edge Measurement (Peak):	57.4 dBuV/m		Using 100kHz delta value			
Calculated Band-Edge Measurement (Avg):	43.7 dBuV/m		Using 100kHz delta value			

Frequency	Level	Pol	FCC 15.209		Detector	Azimuth	Height	Comments
MHz	dBuV/m	v/h	Limit	Margin	PK/QP/Avg	degrees	meters	
5350.133	43.3	-	54.0	-10.7	Avg	-	-	Using 100kHz delta value

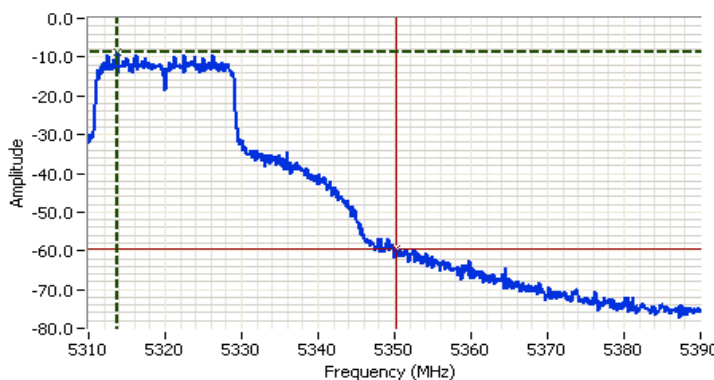

Analyzer Settings

HP8564E,EMI
 CF: 5350.000 MHz
 SPAN:80.000 MHz
 RB 100 kHz
 VB 100 kHz
 Detector POS
 Att 10
 RL Offset 0.00
 Sweep Time 50.0ms
 Ref Lvl:-0.20dBm

Comments

BE @ 5350 MHz
 802.11 n20
 Chain A

Cursor 1	5313.7334	-8.70	
Cursor 2	5350.1333	-59.37	

Delta Freq. 36.400
 Delta Amplitude 50.67



Client:	Intel Corporation	Job Number:	J78599
Model:	Puma Peak 2x2	T-Log Number:	T78676
Contact:	Steve Hackett	Account Manager:	Christine Krebill
Standard:	FCC 15E, FCC 15C, FCC 15B	Class:	N/A

Run # 4, Band Edge Field Strength - n20, Chain B

Run # 4a, EUT on Channel #36 5180MHz - n20, Chain B

Date of Test: 3/14/2010

Test Location: FT Chamber #4

Test Engineer: Rafael Varelas

Config Change: none

Chain	Power Settings		
	Target (dBm)	Measured (dBm)	Software Setting
B	16.5	16.4	17.0

Fundamental Signal Field Strength

Frequency	Level	Pol	15.209 / 15.247		Detector	Azimuth	Height	Comments
MHz	dBuV/m	v/h	Limit	Margin	PK/QP/Avg	degrees	meters	
5185.330	96.2	H	-	-	AVG	122	1.1	RB 1 MHz; VB: 10 Hz
5185.100	103.5	H	-	-	PK	122	1.1	RB 1 MHz; VB: 1 MHz
5182.900	94.7	V	-	-	AVG	150	1.5	RB 1 MHz; VB: 10 Hz
5177.100	102.4	V	-	-	PK	150	1.5	RB 1 MHz; VB: 1 MHz

5150 MHz Band Edge Signal Radiated Field Strength - Marker Delta

	H	V	
Fundamental emission level @ 3m in 1MHz RBW:	103.5	102.4	Peak Measurement (RB=VB=1MHz)
Fundamental emission level @ 3m in 1MHz RBW:	96.2	94.7	Average Measurement (RB=1MHz, VB=10Hz)
<i>Delta Marker - 100kHz</i>	47.2 dB		-< this can only be used if band edge signal is highest within 2MHz of band edge.
Calculated Band-Edge Measurement (Peak):	56.3 dBuV/m		
Calculated Band-Edge Measurement (Avg):	49.0 dBuV/m	Margin	Level
<i>Delta Marker - 1MHz/1MHz:</i>	40.8 dB	-5.0	49.0
<i>Delta Marker - 1MHz/10Hz:</i>	47.0 dB	-17.7	56.3
Calculated Band-Edge Measurement (Peak):	62.7 dBuV/m		74
Calculated Band-Edge Measurement (Avg):	49.2 dBuV/m		PK

Frequency	Level	Pol	FCC 15.209		Detector	Azimuth	Height	Comments
MHz	dBuV/m	v/h	Limit	Margin	PK/QP/Avg	degrees	meters	
5148.533	49.0	-	54.0	-5.0	Avg	-	-	Using 100kHz delta value

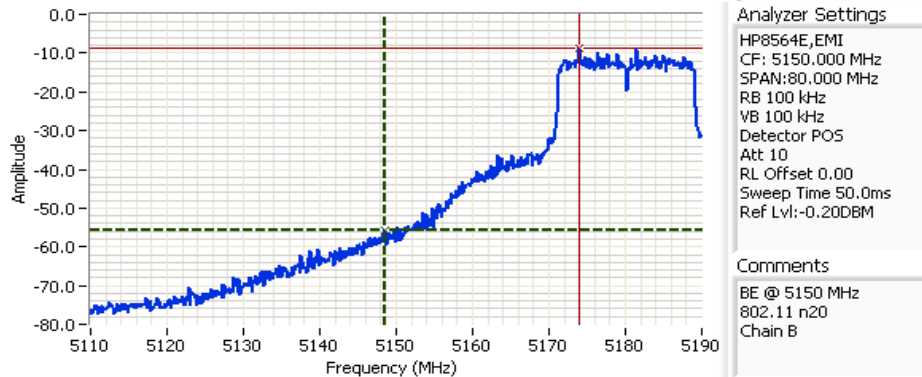

Analyzer Settings
 HP8564E,EMI
 CF: 5150.000 MHz
 SPAN:80.000 MHz
 RB 100 kHz
 VB 100 kHz
 Detector POS
 Att 10
 RL Offset 0.00
 Sweep Time 50.0ms
 Ref Lvl:-0.20DBM

Comments
 BE @ 5150 MHz
 802.11 n20
 Chain B

Cursor 1	5148.5332	-55.70	+	-	Delta Freq.	25.467
Cursor 2	5174.0000	-8.53	+	-	Delta Amplitude	47.17



Client:	Intel Corporation	Job Number:	J78599
Model:	Puma Peak 2x2	T-Log Number:	T78676
Contact:	Steve Hackett	Account Manager:	Christine Krebill
Standard:	FCC 15E, FCC 15C, FCC 15B	Class:	N/A

Run # 4b, EUT on Channel #64 5320MHz - n20, Chain B

Date of Test: 3/14/2010 Test Location: FT Chamber #4
 Test Engineer: Rafael Varelas Config Change: none

Chain	Power Settings		
	Target (dBm)	Measured (dBm)	Software Setting
B	16.6	16.5	17.0

Fundamental Signal Field Strength

Frequency	Level	Pol	15.209 / 15.247		Detector	Azimuth	Height	Comments
MHz	dBuV/m	v/h	Limit	Margin	PK/QP/Avg	degrees	meters	
5313.000	94.8	V	-	-	AVG	168	1.5	RB 1 MHz; VB: 10 Hz
5313.170	102.6	V	-	-	PK	168	1.5	RB 1 MHz; VB: 1 MHz
5314.270	96.7	H	-	-	AVG	123	1.0	RB 1 MHz; VB: 10 Hz
5315.170	104.5	H	-	-	PK	123	1.0	RB 1 MHz; VB: 1 MHz

5350 MHz Band Edge Signal Radiated Field Strength - Marker Delta

	H	V				
Fundamental emission level @ 3m in 1MHz RBW:	104.5	102.6	Peak Measurement (RB=VB=1MHz)			
Fundamental emission level @ 3m in 1MHz RBW:	96.7	94.8	Average Measurement (RB=1MHz, VB=10Hz)			
<i>Delta Marker - 100kHz</i>	51.2 dB		<- this can only be used if band edge signal is highest within 2MHz of band edge.			
Calculated Band-Edge Measurement (Peak):	53.3 dBuV/m		Margin	Level	Limit	Detector
Calculated Band-Edge Measurement (Avg):	45.5 dBuV/m		-8.5	45.5	54	Avg
<i>Delta Marker - 1MHz/1MHz:</i>	45.0 dB		-20.7	53.3	74	Pk
<i>Delta Marker - 1MHz/10Hz:</i>	50.8 dB					
Calculated Band-Edge Measurement (Peak):	59.5 dBuV/m		Using 100kHz delta value			
Calculated Band-Edge Measurement (Avg):	45.9 dBuV/m		Using 100kHz delta value			

Frequency	Level	Pol	FCC 15.209		Detector	Azimuth	Height	Comments
MHz	dBuV/m	v/h	Limit	Margin	PK/QP/Avg	degrees	meters	
5350.399	45.5	-	54.0	-8.5	Avg	-	-	Using 100kHz delta value

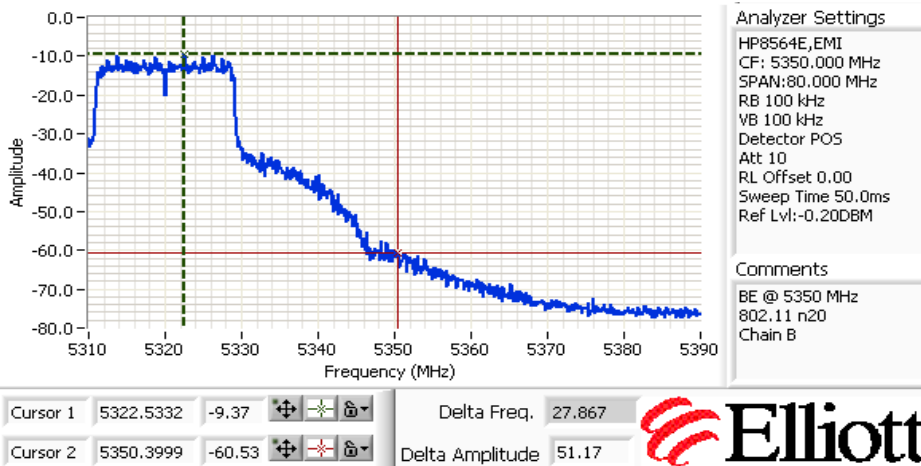

Client:	Intel Corporation	Job Number:	J78599
Model:	Puma Peak 2x2	T-Log Number:	T78676
Contact:	Steve Hackett	Account Manager:	Christine Krebill
Standard:	FCC 15E, FCC 15C, FCC 15B	Class:	N/A

Run # 4c, EUT on Channel #100 5500MHz - n20, Chain B

Chain	Target (dBm)	Power Settings	
		Measured (dBm)	Software Setting
B	16.6	16.5	17.0

Fundamental Signal Field Strength

Frequency MHz	Level dB μ V/m	Pol v/h	15.209 / 15.247		Detector PK/QP/Avg	Azimuth degrees	Height meters	Comments
			Limit	Margin				
5494.300	94.4	V	-	-	AVG	125	1.5	RB 1 MHz; VB: 10 Hz
5494.630	102.2	V	-	-	PK	125	1.5	RB 1 MHz; VB: 1 MHz
5494.500	98.2	H	-	-	AVG	107	1.0	RB 1 MHz; VB: 10 Hz
5496.300	107.2	H	-	-	PK	107	1.0	RB 1 MHz; VB: 1 MHz

5460 MHz Restricted Band Edge Signal Radiated Field Strength - Marker Delta

	H	V		Margin	Level	Limit	Detector
Fundamental emission level @ 3m in 1MHz RBW:	107.2	102.2					
Fundamental emission level @ 3m in 1MHz RBW:	98.2	94.4					
<i>Delta Marker - 100kHz</i>		<i>53.2 dB</i>					
Calculated Band-Edge Measurement (Peak):		54.0 dB μ V/m					
Calculated Band-Edge Measurement (Avg):		45.0 dB μ V/m					
<i>Delta Marker - 1MHz/1MHz:</i>		<i>47.7 dB</i>		-11.3	42.7	54	Avg
<i>Delta Marker - 1MHz/10Hz:</i>		<i>55.5 dB</i>		-20.0	54.0	74	Pk
Calculated Band-Edge Measurement (Peak):		59.5 dB μ V/m					
Calculated Band-Edge Measurement (Avg):		42.7 dB μ V/m					

Peak Measurement (RB=VB=1MHz)
Average Measurement (RB=1MHz, VB=10Hz)
-< this can only be used if band edge signal is highest within 2MHz of band edge.

Frequency MHz	Level dB μ V/m	Pol v/h	FCC 15.209		Detector PK/QP/Avg	Azimuth degrees	Height meters	Comments
			Limit	Margin				
5460.000	42.7	-	54.0	-11.3	Avg	-	-	Using 1MHz delta value

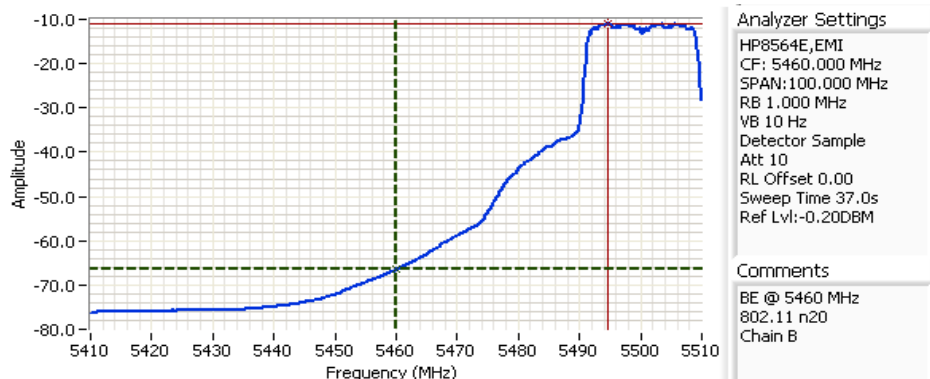

Analyzer Settings
 HP8564E,EMI
 CF: 5460.000 MHz
 SPAN:100.000 MHz
 RB 1.000 MHz
 VB 10 Hz
 Detector Sample
 Att 10
 RL Offset 0.00
 Sweep Time 37.0s
 Ref Lvl:-0.20DBM

Comments
 BE @ 5460 MHz
 802.11 n20
 Chain B

Cursor 1	5460.0000	-66.53	Delta Freq.	34.667
Cursor 2	5494.6665	-11.03	Delta Amplitude	55.50



Client: Intel Corporation	Job Number: J78599
Model: Puma Peak 2x2	T-Log Number: T78676
Contact: Steve Hackett	Account Manager: Christine Krebill
Standard: FCC 15E, FCC 15C, FCC 15B	Class: N/A

5470 MHz Band Edge Signal Radiated Field Strength - Marker Delta

	H	V	
Fundamental emission level @ 3m in 1MHz RBW:	107.2	102.2	Peak Measurement (RB=VB=1MHz)
Fundamental emission level @ 3m in 1MHz RBW:	98.2	94.4	Average Measurement (RB=1MHz, VB=10Hz)
<i>Delta Marker - 100kHz</i>	48.3 dB		<- this can only be used if band edge signal is highest within 2MHz of band edge.
Calculated Band-Edge Measurement (Peak):	58.9 dBuV/m		
Calculated Band-Edge Measurement (Avg):	49.9 dBuV/m		
<i>Delta Marker - 1MHz/1MHz:</i>	41.3 dB		Margin
<i>Delta Marker - 1MHz/10Hz:</i>	47.8 dB		Level
Calculated Band-Edge Measurement (Peak):	65.9 dBuV/m		Limit
Calculated Band-Edge Measurement (Avg):	50.4 dBuV/m		Detector

Frequency	Level	Pol	FCC 15E		Detector	Azimuth	Height	Comments
MHz	dBuV/m	v/h	Limit	Margin	Pk/QP/Avg	degrees	meters	
5740.000	49.9	-	68.3	-18.4	Avg	-	-	Using 100kHz delta value

Note - average limit is equivalent to -27dBm eirp.

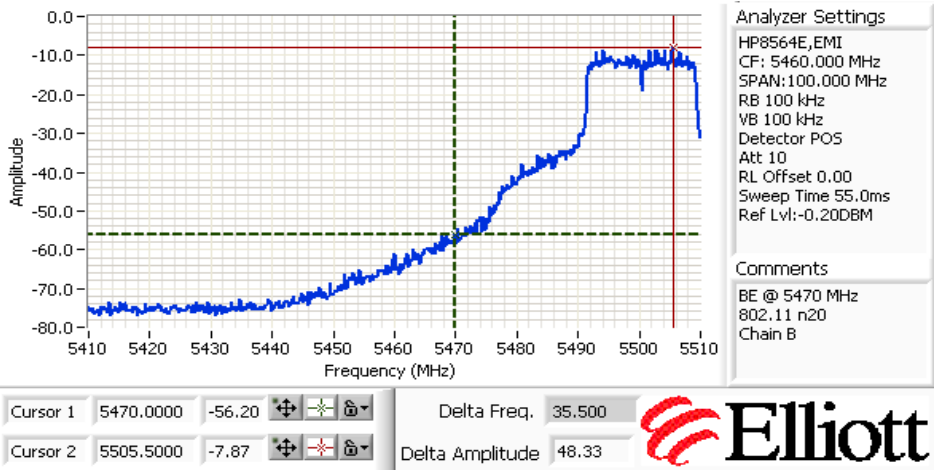

Client:	Intel Corporation	Job Number:	J78599
Model:	Puma Peak 2x2	T-Log Number:	T78676
Contact:	Steve Hackett	Account Manager:	Christine Krebill
Standard:	FCC 15E, FCC 15C, FCC 15B	Class:	N/A

Run # 5, Band Edge Field Strength - n40, Chain A

Run # 5a, EUT on Channel #38 5190MHz - n40, Chain A

Date of Test: 3/31/2010

Test Location: Chamber #5

Test Engineer: Suhaila Khushzad

Config Change: none

	Power Settings		
	Target (dBm)	Measured (dBm)	Software Setting
Chain A	12.0	12.2	23.0

Fundamental Signal Field Strength

Frequency	Level	Pol	15.209 / 15.247		Detector	Azimuth	Height	Comments
MHz	dBuV/m	v/h	Limit	Margin	PK/QP/Avg	degrees	meters	
5192.530	88.5	H	-	-	AVG	212	1.0	RB 1 MHz; VB: 10 Hz
5200.130	96.5	H	-	-	PK	212	1.0	RB 1 MHz; VB: 1 MHz
5200.730	89.2	V	-	-	AVG	146	1.4	RB 1 MHz; VB: 10 Hz
5200.270	97.7	V	-	-	PK	146	1.4	RB 1 MHz; VB: 1 MHz

5150 MHz Band Edge Signal Radiated Field Strength - Marker Delta

	H	V	
Fundamental emission level @ 3m in 1MHz RBW:	96.5	97.7	Peak Measurement (RB=VB=1MHz)
Fundamental emission level @ 3m in 1MHz RBW:	88.5	89.2	Average Measurement (RB=1MHz, VB=10Hz)
<i>Delta Marker - 100kHz</i>	40.8 dB		-< this can only be used if band edge signal is highest within 2MHz of band edge.
Calculated Band-Edge Measurement (Peak):	56.9 dBuV/m		
Calculated Band-Edge Measurement (Avg):	48.4 dBuV/m	Margin	Level
<i>Delta Marker - 1MHz/1MHz:</i>	34.7 dB	-5.6	48.4
<i>Delta Marker - 1MHz/10Hz:</i>	39.2 dB	-17.1	56.9
Calculated Band-Edge Measurement (Peak):	63.0 dBuV/m		74
Calculated Band-Edge Measurement (Avg):	50.0 dBuV/m		Pk

Frequency	Level	Pol	FCC 15.209		Detector	Azimuth	Height	Comments
MHz	dBuV/m	v/h	Limit	Margin	PK/QP/Avg	degrees	meters	
5149.910	48.4	-	54.0	-5.6	Avg	-	-	Using 100kHz delta value

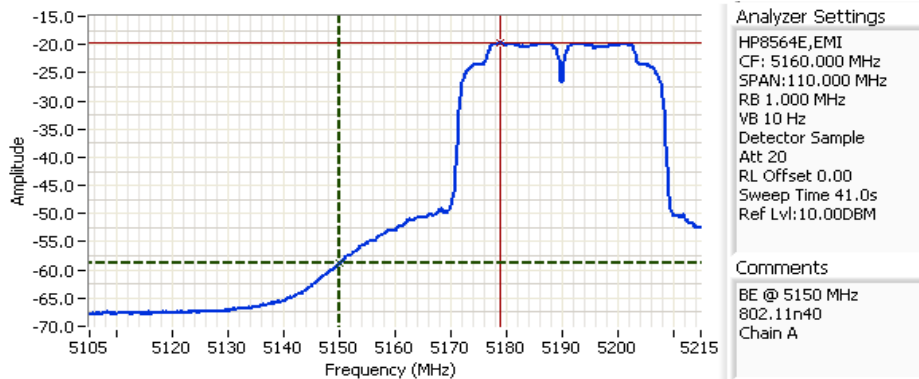

Analyzer Settings
 HP8564E,EMI
 CF: 5160.000 MHz
 SPAN: 110.000 MHz
 RB 1.000 MHz
 VB 10 Hz
 Detector Sample
 Att 20
 RL Offset 0.00
 Sweep Time 41.0s
 Ref Lvl: 10.00DBM

Comments
 BE @ 5150 MHz
 802.11n40
 Chain A

Cursor 1	5149.9165	-58.83	Delta Freq.	28.967
Cursor 2	5178.8833	-19.67	Delta Amplitude	39.17



Client:	Intel Corporation	Job Number:	J78599
Model:	Puma Peak 2x2	T-Log Number:	T78676
Contact:	Steve Hackett	Account Manager:	Christine Krebill
Standard:	FCC 15E, FCC 15C, FCC 15B	Class:	N/A

Run # 5b, EUT on Channel #62 5310MHz - n40, Chain A

Date of Test: 4/1/2010 Test Location: FT Chamber #4
 Test Engineer: Rafael Varelas Config Change: none

	Target (dBm)	Power Settings Measured (dBm)	Software Setting
Chain A	12.5	12.6	24.5

Fundamental Signal Field Strength

Frequency	Level	Pol	15.209 / 15.247		Detector	Azimuth	Height	Comments
MHz	dBuV/m	v/h	Limit	Margin	PK/QP/Avg	degrees	meters	
5307.330	88.2	V	-	-	AVG	210	1.0	RB 1 MHz; VB: 10 Hz
5299.470	96.3	V	-	-	PK	210	1.0	RB 1 MHz; VB: 1 MHz
5298.800	89.2	H	-	-	AVG	219	1.0	RB 1 MHz; VB: 10 Hz
5299.930	97.0	H	-	-	PK	219	1.0	RB 1 MHz; VB: 1 MHz

5350 MHz Band Edge Signal Radiated Field Strength - Marker Delta

	H	V		
Fundamental emission level @ 3m in 1MHz RBW:	97.0	96.3	Peak Measurement (RB=VB=1MHz)	
Fundamental emission level @ 3m in 1MHz RBW:	89.2	88.2	Average Measurement (RB=1MHz, VB=10Hz)	
<i>Delta Marker - 100kHz</i>		<i>41.2 dB</i>	-< this can only be used if band edge signal is highest within 2MHz of band edge.	
Calculated Band-Edge Measurement (Peak):	55.8 dBuV/m			
Calculated Band-Edge Measurement (Avg):	48.0 dBuV/m			
<i>Delta Marker - 1MHz/1MHz:</i>		<i>40.2 dB</i>		
	-6.6	47.4	54	Avg
<i>Delta Marker - 1MHz/10Hz:</i>		<i>41.8 dB</i>		
	-18.2	55.8	74	Pk
Calculated Band-Edge Measurement (Peak):	56.8 dBuV/m		Using 100kHz delta value	
Calculated Band-Edge Measurement (Avg):	47.4 dBuV/m		Using 1MHz delta value	

Frequency	Level	Pol	FCC 15.209		Detector	Azimuth	Height	Comments
MHz	dBuV/m	v/h	Limit	Margin	PK/QP/Avg	degrees	meters	
5350.000	47.4	-	54.0	-6.6	Avg	-	-	Using 1MHz delta value

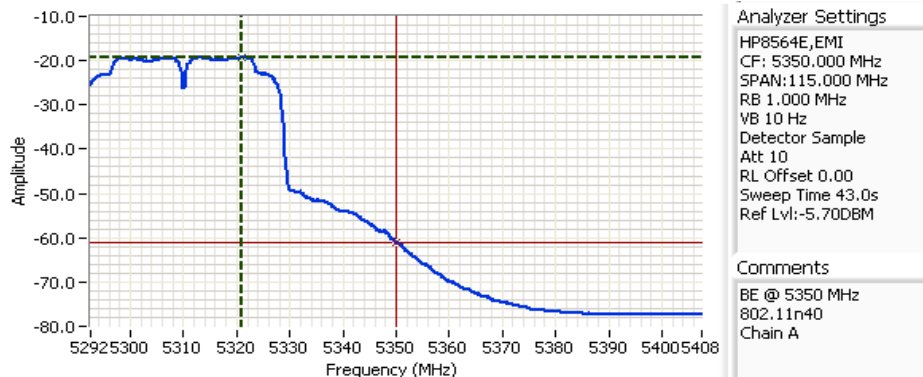

Analyzer Settings
 HP8564E,EMI
 CF: 5350.000 MHz
 SPAN: 115.000 MHz
 RB 1.000 MHz
 VB 10 Hz
 Detector Sample
 Att 10
 RL Offset 0.00
 Sweep Time 43.0s
 Ref Lvl: -5.70DBM

Comments
 BE @ 5350 MHz
 802.11n40
 Chain A

Cursor 1	5320.8667	-19.20	Delta Freq.	29.133
Cursor 2	5350.0000	-61.03	Delta Amplitude	41.83



Client: Intel Corporation	Job Number: J78599
Model: Puma Peak 2x2	T-Log Number: T78676
Contact: Steve Hackett	Account Manager: Christine Krebill
Standard: FCC 15E, FCC 15C, FCC 15B	Class: N/A

Run # 5c, EUT on Channel #102 5510MHz - n40, Chain A

Date of Test: 3/14/2010 Test Location: FT Chamber #4
 Test Engineer: Rafael Varelas Config Change: none

Chain	Power Settings		
	Target (dBm)	Measured (dBm)	Software Setting
A	16.6	16.7	17.0

Fundamental Signal Field Strength

Frequency	Level	Pol	15.209 / 15.247		Detector	Azimuth	Height	Comments
MHz	dBuV/m	v/h	Limit	Margin	PK/QP/Avg	degrees	meters	
5507.470	93.0	H	-	-	AVG	326	1.0	RB 1 MHz; VB: 10 Hz
5505.870	100.9	H	-	-	PK	326	1.0	RB 1 MHz; VB: 1 MHz
5513.330	91.9	V	-	-	AVG	133	1.0	RB 1 MHz; VB: 10 Hz
5520.130	100.0	V	-	-	PK	133	1.0	RB 1 MHz; VB: 1 MHz

5460 MHz Restricted Band Edge Signal Radiated Field Strength - Marker Delta

	H	V				
Fundamental emission level @ 3m in 1MHz RBW:	100.9	100.0	Peak Measurement (RB=VB=1MHz)			
Fundamental emission level @ 3m in 1MHz RBW:	93.0	91.9	Average Measurement (RB=1MHz, VB=10Hz)			
<i>Delta Marker - 100kHz</i>	39.0 dB		-< this can only be used if band edge signal is highest within 2MHz of band edge.			
Calculated Band-Edge Measurement (Peak):	61.9 dBuV/m					
Calculated Band-Edge Measurement (Avg):	54.0 dBuV/m	Margin	Level	Limit	Detector	
<i>Delta Marker - 1MHz/1MHz:</i>	39.7 dB	-4.0	50.0	54	Avg	
<i>Delta Marker - 1MHz/10Hz:</i>	43.0 dB	-12.8	61.2	74	Pk	
Calculated Band-Edge Measurement (Peak):	61.2 dBuV/m	Using 1MHz delta value				
Calculated Band-Edge Measurement (Avg):	50.0 dBuV/m	Using 1MHz delta value				

Frequency	Level	Pol	FCC 15.209		Detector	Azimuth	Height	Comments
MHz	dBuV/m	v/h	Limit	Margin	PK/QP/Avg	degrees	meters	
5459.910	50.0	-	54.0	-4.0	Avg	-	-	Using 1MHz delta value

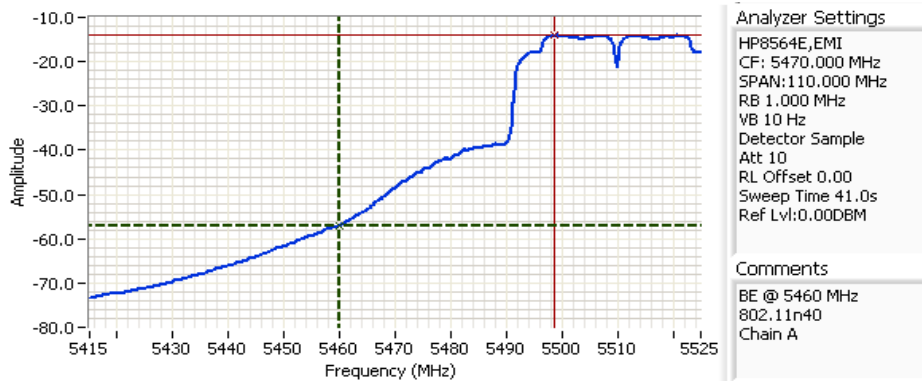

Analyzer Settings
 HP8564E, EMI
 CF: 5470.000 MHz
 SPAN: 110.000 MHz
 RB 1.000 MHz
 VB 10 Hz
 Detector Sample
 Att 10
 RL Offset 0.00
 Sweep Time 41.0s
 Ref Lvl: 0.00DBM

Comments
 BE @ 5460 MHz
 802.11n40
 Chain A

Cursor 1	5459.9165	-57.00	Delta Freq.	38.867
Cursor 2	5498.7832	-14.00	Delta Amplitude	43.00



Client: Intel Corporation	Job Number: J78599
Model: Puma Peak 2x2	T-Log Number: T78676
Contact: Steve Hackett	Account Manager: Christine Krebill
Standard: FCC 15E, FCC 15C, FCC 15B	Class: N/A

5470 MHz Band Edge Signal Radiated Field Strength - Marker Delta

	H	V	
Fundamental emission level @ 3m in 1MHz RBW:	100.9	100.0	Peak Measurement (RB=VB=1MHz)
Fundamental emission level @ 3m in 1MHz RBW:	93.0	91.9	Average Measurement (RB=1MHz, VB=10Hz)
<i>Delta Marker - 100kHz</i>	35.0 dB		<- this can only be used if band edge signal is highest within 2MHz of band edge.
Calculated Band-Edge Measurement (Peak):	65.9 dBuV/m		
Calculated Band-Edge Measurement (Avg):	58.0 dBuV/m		
<i>Delta Marker - 1MHz/1MHz:</i>	31.0 dB		Margin
<i>Delta Marker - 1MHz/10Hz:</i>	34.5 dB		Level
Calculated Band-Edge Measurement (Peak):	69.9 dBuV/m		Limit
Calculated Band-Edge Measurement (Avg):	58.5 dBuV/m		Detector

Frequency	Level	Pol	FCC 15E		Detector	Azimuth	Height	Comments
MHz	dB μ V/m	v/h	Limit	Margin	Pk/QP/Avg	degrees	meters	
5470.000	58.0	-	68.3	-10.3	Avg	-	-	Using 100kHz delta value

Note - average limit is equivalent to -27dBm eirp.

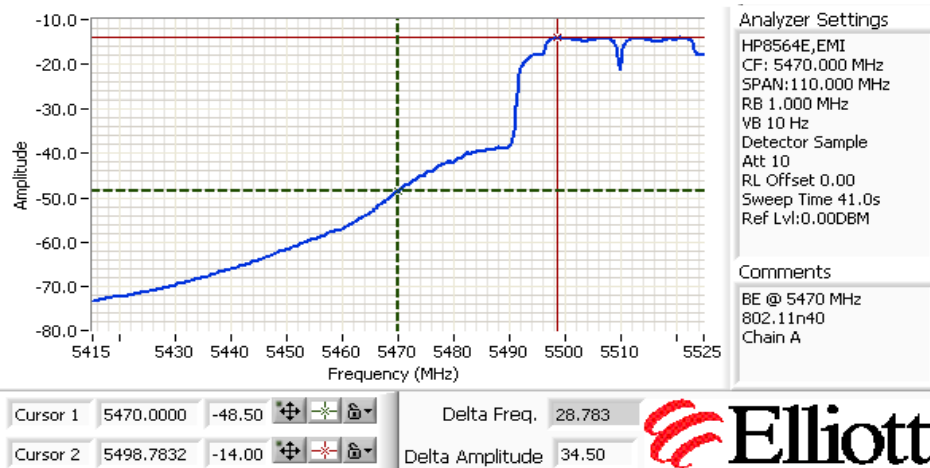

Client:	Intel Corporation	Job Number:	J78599
Model:	Puma Peak 2x2	T-Log Number:	T78676
Contact:	Steve Hackett	Account Manager:	Christine Krebill
Standard:	FCC 15E, FCC 15C, FCC 15B	Class:	N/A

Run # 6, Band Edge Field Strength - n40, Chain B

Run # 6a, EUT on Channel #38 5190MHz - n40, Chain B

Date of Test: 4/1/2010 Test Location: FT Chamber #4
 Test Engineer: Rafael Varelas Config Change: none

	Power Settings		
	Target (dBm)	Measured (dBm)	Software Setting
Chain B	11.5	11.7	21.0

Fundamental Signal Field Strength

Frequency	Level	Pol	15.209 / 15.247		Detector	Azimuth	Height	Comments
MHz	dBuV/m	v/h	Limit	Margin	PK/QP/Avg	degrees	meters	
5192.870	89.5	H	-	-	AVG	95	1.1	RB 1 MHz; VB: 10 Hz
5193.530	97.9	H	-	-	PK	95	1.1	RB 1 MHz; VB: 1 MHz
5192.600	88.6	V	-	-	AVG	197	1.5	RB 1 MHz; VB: 10 Hz
5193.400	96.6	V	-	-	PK	197	1.5	RB 1 MHz; VB: 1 MHz

5150 MHz Band Edge Signal Radiated Field Strength - Marker Delta

	H	V				
Fundamental emission level @ 3m in 1MHz RBW:	97.9	96.6	Peak Measurement (RB=VB=1MHz)			
Fundamental emission level @ 3m in 1MHz RBW:	89.5	88.6	Average Measurement (RB=1MHz, VB=10Hz)			
<i>Delta Marker - 100kHz</i>	43.5 dB		<i><- this can only be used if band edge signal is highest within 2MHz of band edge.</i>			
Calculated Band-Edge Measurement (Peak):	54.4 dBuV/m		Margin	Level	Limit	Detector
Calculated Band-Edge Measurement (Avg):	46.0 dBuV/m		-8.0	46.0	54	Avg
<i>Delta Marker - 1MHz/1MHz:</i>	38.7 dB		-19.6	54.4	74	Pk
<i>Delta Marker - 1MHz/10Hz:</i>	42.2 dB					
Calculated Band-Edge Measurement (Peak):	59.2 dBuV/m		Using 100kHz delta value			
Calculated Band-Edge Measurement (Avg):	47.3 dBuV/m		Using 100kHz delta value			

Frequency	Level	Pol	FCC 15.209		Detector	Azimuth	Height	Comments
MHz	dBuV/m	v/h	Limit	Margin	PK/QP/Avg	degrees	meters	
5150.000	46.0	-	54.0	-8.0	Avg	-	-	Using 100kHz delta value

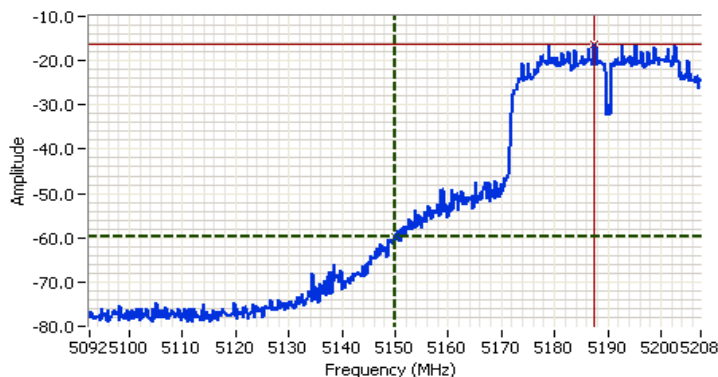

Analyzer Settings

HP8564E,EMI
 CF: 5150.000 MHz
 SPAN: 115.000 MHz
 RB 100 kHz
 VB 100 kHz
 Detector POS
 Att 10
 RL Offset 0.00
 Sweep Time 63.0ms
 Ref Lvl: -6.60DBM

Comments

BE @ 5150 MHz
 802.11n40
 Chain B

Cursor 1	5150.0000	-59.77	Delta Freq.	37.567
Cursor 2	5187.5669	-16.27	Delta Amplitude	43.50



Client:	Intel Corporation	Job Number:	J78599
Model:	Puma Peak 2x2	T-Log Number:	T78676
Contact:	Steve Hackett	Account Manager:	Christine Krebill
Standard:	FCC 15E, FCC 15C, FCC 15B	Class:	N/A

Run # 6b, EUT on Channel #62 5310MHz - n40, Chain B

Date of Test: 4/1/2010 Test Location: FT Chamber #4
 Test Engineer: Rafael Varelas Config Change: none

	Target (dBm)	Power Settings Measured (dBm)	Software Setting
Chain B	12.5	12.8	22.0

Fundamental Signal Field Strength

Frequency	Level	Pol	15.209 / 15.247		Detector	Azimuth	Height	Comments
MHz	dBuV/m	v/h	Limit	Margin	Pk/QP/Avg	degrees	meters	
5321.400	90.3	H	-	-	AVG	126	1.2	RB 1 MHz; VB: 10 Hz
5321.130	98.4	H	-	-	PK	126	1.2	RB 1 MHz; VB: 1 MHz
5321.330	85.8	V	-	-	AVG	240	1.0	RB 1 MHz; VB: 10 Hz
5320.270	94.2	V	-	-	PK	240	1.0	RB 1 MHz; VB: 1 MHz

5350 MHz Band Edge Signal Radiated Field Strength - Marker Delta

	H	V		Margin	Level	Limit	Detector
Fundamental emission level @ 3m in 1MHz RBW:	98.4	94.2					Peak Measurement (RB=VB=1MHz)
Fundamental emission level @ 3m in 1MHz RBW:	90.3	85.8					Average Measurement (RB=1MHz, VB=10Hz)
<i>Delta Marker - 100kHz</i>	43.8 dB						<- this can only be used if band edge signal is highest within 2MHz of band edge.
Calculated Band-Edge Measurement (Peak):	54.6 dBuV/m						
Calculated Band-Edge Measurement (Avg):	46.5 dBuV/m						
<i>Delta Marker - 1MHz/1MHz:</i>	39.8 dB			-7.5	46.5	54	Avg
<i>Delta Marker - 1MHz/10Hz:</i>	42.7 dB			-19.4	54.6	74	Pk
Calculated Band-Edge Measurement (Peak):	58.6 dBuV/m						Using 100kHz delta value
Calculated Band-Edge Measurement (Avg):	47.6 dBuV/m						Using 100kHz delta value

Frequency	Level	Pol	FCC 15.209		Detector	Azimuth	Height	Comments
MHz	dBuV/m	v/h	Limit	Margin	Pk/QP/Avg	degrees	meters	
5350.766	46.5	-	54.0	-7.5	Avg	-	-	Using 100kHz delta value

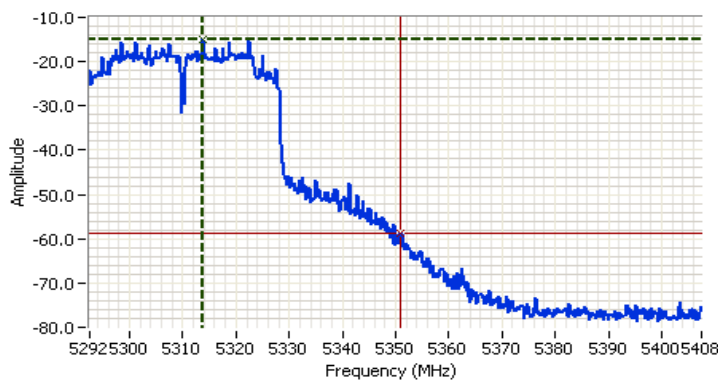

Analyzer Settings
 HP8564E,EMI
 CF: 5350.000 MHz
 SPAN: 115.000 MHz
 RB 100 kHz
 VB 100 kHz
 Detector POS
 Att 10
 RL Offset 0.00
 Sweep Time 63.0ms
 Ref Lvl:-6.60DBM

Comments
 BE @ 5350 MHz
 802.11n40
 Chain B

Cursor 1	5313.7749	-14.93		Delta Freq.	36.992
Cursor 2	5350.7666	-58.77		Delta Amplitude	43.83



Client:	Intel Corporation	Job Number:	J78599
Model:	Puma Peak 2x2	T-Log Number:	T78676
Contact:	Steve Hackett	Account Manager:	Christine Krebill
Standard:	FCC 15E, FCC 15C, FCC 15B	Class:	N/A

Run # 6c, EUT on Channel #102 5510MHz - n40, Chain B

	Target (dBm)	Power Settings Measured (dBm)	Software Setting
Chain B	14.5	14.6	26.0

Fundamental Signal Field Strength

Frequency	Level	Pol	15.209 / 15.247		Detector	Azimuth	Height	Comments
MHz	dB μ V/m	v/h	Limit	Margin	PK/QP/Avg	degrees	meters	
5521.470	93.2	V	-	-	AVG	173	1.1	RB 1 MHz; VB: 10 Hz
5520.470	101.4	V	-	-	PK	173	1.1	RB 1 MHz; VB: 1 MHz
5512.870	93.0	H	-	-	AVG	117	1.0	RB 1 MHz; VB: 10 Hz
5520.470	101.1	H	-	-	PK	117	1.0	RB 1 MHz; VB: 1 MHz

5460 MHz Restricted Band Edge Signal Radiated Field Strength - Marker Delta

	H	V				
Fundamental emission level @ 3m in 1MHz RBW:	101.1	101.4	Peak Measurement (RB=VB=1MHz)			
Fundamental emission level @ 3m in 1MHz RBW:	93.0	93.2	Average Measurement (RB=1MHz, VB=10Hz)			
<i>Delta Marker - 100kHz</i>	45.0 dB		-< this can only be used if band edge signal is highest within 2MHz of band edge.			
Calculated Band-Edge Measurement (Peak):	56.4 dB μ V/m					
Calculated Band-Edge Measurement (Avg):	48.2 dB μ V/m	Margin	Level	Limit	Detector	
<i>Delta Marker - 1MHz/1MHz:</i>	42.0 dB	-8.5	45.5	54	Avg	
<i>Delta Marker - 1MHz/10Hz:</i>	47.7 dB	-17.6	56.4	74	Pk	
Calculated Band-Edge Measurement (Peak):	59.4 dB μ V/m	Using 100kHz delta value				
Calculated Band-Edge Measurement (Avg):	45.5 dB μ V/m	Using 1MHz delta value				

Frequency	Level	Pol	FCC 15.209		Detector	Azimuth	Height	Comments
MHz	dB μ V/m	v/h	Limit	Margin	PK/QP/Avg	degrees	meters	
5460.000	45.5	-	54.0	-8.5	Avg	-	-	Using 1MHz delta value

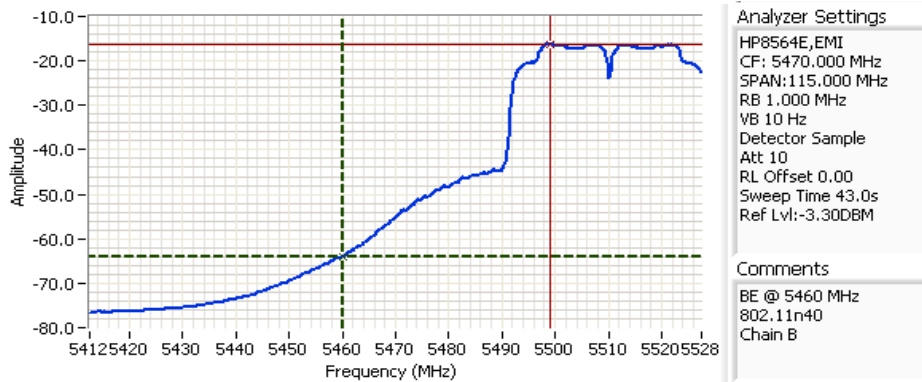

Analyzer Settings

HP8564E,EMI
 CF: 5470.000 MHz
 SPAN: 115.000 MHz
 RB 1.000 MHz
 VB 10 Hz
 Detector Sample
 Att 10
 RL Offset 0.00
 Sweep Time 43.0s
 Ref Lvl: -3.30DBM

Comments

BE @ 5460 MHz
 802.11n40
 Chain B

Cursor 1	5460.0332	-63.97	Delta Freq.	39.100
Cursor 2	5499.1333	-16.30	Delta Amplitude	47.67



Client:	Intel Corporation	Job Number:	J78599
Model:	Puma Peak 2x2	T-Log Number:	T78676
Contact:	Steve Hackett	Account Manager:	Christine Krebill
Standard:	FCC 15E, FCC 15C, FCC 15B	Class:	N/A

5470 MHz Band Edge Signal Radiated Field Strength - Marker Delta

	H	V	
Fundamental emission level @ 3m in 1MHz RBW:	101.1	101.4	Peak Measurement (RB=VB=1MHz)
Fundamental emission level @ 3m in 1MHz RBW:	93.0	93.2	Average Measurement (RB=1MHz, VB=10Hz)
<i>Delta Marker - 100kHz</i>	39.0 dB		<- this can only be used if band edge signal is highest within 2MHz of band edge.
Calculated Band-Edge Measurement (Peak):	62.4 dBuV/m		
Calculated Band-Edge Measurement (Avg):	54.2 dBuV/m		Margin
<i>Delta Marker - 1MHz/1MHz:</i>	<i>35.5 dB</i>		Level
<i>Delta Marker - 1MHz/10Hz:</i>	<i>38.8 dB</i>		Limit
Calculated Band-Edge Measurement (Peak):	65.9 dBuV/m		Detector
Calculated Band-Edge Measurement (Avg):	54.4 dBuV/m		

Frequency	Level	Pol	FCC 15E		Detector	Azimuth	Height	Comments
MHz	dB μ V/m	v/h	Limit	Margin	Pk/QP/Avg	degrees	meters	
5469.616	54.2	-	68.3	-14.1	Avg	-	-	Using 100kHz delta value

Note - average limit is equivalent to -27dBm eirp.

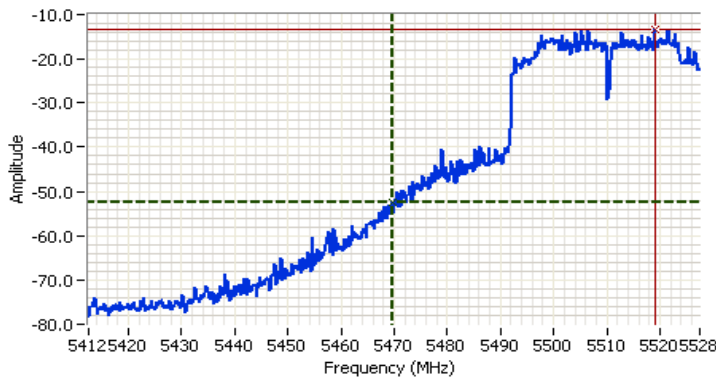

Analyzer Settings

HP8564E, EMI
 CF: 5470.000 MHz
 SPAN: 115.000 MHz
 RB 100 kHz
 VB 100 kHz
 Detector POS
 Att 10
 RL Offset 0.00
 Sweep Time 63.0ms
 Ref Lvl: -3.30DBM

Comments

BE @ 5470 MHz
 802.11n40
 Chain B

Cursor 1	5469.6167	-52.30	
Cursor 2	5519.0669	-13.30	

Delta Freq. 49.450
Delta Amplitude 39.00



Client:	Intel Corporation	Job Number:	J78599
Model:	Puma Peak 2x2	T-Log Number:	T78676
		Account Manager:	Christine Krebill
Contact:	Steve Hackett		
Standard:	FCC 15E, FCC 15C, FCC 15B	Class:	N/A

RSS 210 / FCC 15.247 (DTS) / FCC 15 E (NII) Transmitter and Receiver Radiated Spurious Emissions

Test Specific Details

Objective: The objective of this test session is to perform engineering evaluation testing of the EUT with respect to the specification listed above.

General Test Configuration

The EUT was installed into a test fixture such that the EUT was exposed (i.e. outside of a host PC). For radiated emissions testing the measurement antenna was located 3 meters from the EUT.

Ambient Conditions:
 Temperature: 19.2 °C
 Rel. Humidity: 41 %

Summary of Results

MAC Address: 0023146851DC CRTU Tool Version 5.15.36.0 Driver version 13.0.0.91

Run #	Mode	Channel	Target Power	Measured Power	Test Performed	Limit	Result / Margin
-------	------	---------	--------------	----------------	----------------	-------	-----------------

5150 - 5250/5250 - 5350 MHz UNII (LELAN) Bands - verified that the changes had no significant effect on the spurious emissions away from the restricted band edges by evaluating 802.11n mode on channel 60 (5300MHz) for Chains A and B. 5300MHz was chosen as it is the lowest channel in the two bands that has a second harmonic falling into a restricted band. The results indicated that the margins for both chains were no worse than those in the original filing (11.1dB for Chain A and 10.4dB For Chain B)

Run #4	n20 Chain A+B	#60 5300MHz	16.8	16.9	Radiated Emissions, 1 - 40 GHz	FCC 15.209 / 15 E	59.5dBµV/m @ 1328.9MHz (-14.5dB)
Run # 5	n20 Chain A	#60 5300MHz	16.4	16.4	Radiated Emissions, 1 - 40 GHz	FCC 15.209 / 15 E	38.3dBµV/m @ 15895.6MHz (-15.7dB)
	n20 Chain B	#60 5300MHz	16.5	16.7			39.2dBµV/m @ 15906.7MHz (-14.8dB)

5470-5725 MHz UNII (LELAN) Band - verified that the changes had no significant effect on the spurious emissions away from the restricted band edges by evaluating 802.11n mode on channel 118 (5590MHz). The results indicated that the margins for both chains were within 1dB of the margin reported in the original filing (6.0dB).

Run # 6	n40 Chain A+B	#118 5590MHz	16.6	16.5	Radiated Emissions, 1 - 40 GHz	FCC 15.209 / 15 E	48.6dBµV/m @ 7453.4MHz (-5.4dB)
---------	---------------	--------------	------	------	--------------------------------	-------------------	---------------------------------

Receiver spurious emissions:

Run # 7	Rx Chain A+B	#48 5240MHz	-	-	Radiated Emissions, 1 - 12 GHz	RSS 210	49.7dBµV/m @ 6986.7MHz (-4.3dB)
		#60 5300 MHz	-	-			45.9dBµV/m @ 3000.4MHz (-8.1dB)
		#120 5600MHz	-	-			47.8dBµV/m @ 6000.7MHz (-6.2dB)

Client:	Intel Corporation	Job Number:	J78599
Model:	Puma Peak 2x2	T-Log Number:	T78676
		Account Manager:	Christine Krebill
Contact:	Steve Hackett		
Standard:	FCC 15E, FCC 15C, FCC 15B	Class:	N/A

Deviations From The Standard

Radiated spurious emissions were measured only to 40 GHz when the device was operating on the - channel in the #159 5795MHzest 5 GHz band (5725-5850 MHz). The requirement would be to test to 40GHz for all channels. The measurements for the #159 5795MHzest channel showed there were no significant emissions above 18 GHz, therefore measurements above 18 GHz were considered unnecessary for the remaining 5GHz channels.

Modifications Made During Testing

No modifications were made to the EUT during testing

Client:	Intel Corporation	Job Number:	J78599
Model:	Puma Peak 2x2	T-Log Number:	T78676
Contact:	Steve Hackett	Account Manager:	Christine Krebill
Standard:	FCC 15E, FCC 15C, FCC 15B	Class:	N/A

Run #s 1-3 were evaluating spurious emissions in the DTS bands, refer to DTS test report

Run #4, Radiated Spurious Emissions, 1-40GHz, n20, Chain A+B

Date of Test: 3/15/2010

Test Location: FT Chamber #4

Test Engineer: Rafael Varelas

Config Change: None

For emissions in restricted bands, the limit of 15.209 was used. For all other emissions, the limit is -27dBm eirp (68.3dBuV/m @3m). As the power measured is average power this is considered an average limit so the peak limit would be 88.3dBuV/m at 3m.

Run #4a: EUT on Channel #60 5300MHz - n20, Chain A+B

Chain	Target (dBm)				Power Settings Measured (dBm)				Software Setting
	A	B	C	Total	A	B	C	Total	
	13.8	13.8		16.8	13.6	14.1		16.9	13.5

Spurious Radiated Emissions:

Frequency	Level	Pol	15.209 / 15E		Detector	Azimuth	Height	Comments
MHz	dBuV/m	v/h	Limit	Margin	Pk/QP/Avg	degrees	meters	
1328.870	59.5	V	74.0	-14.5	PK	80	1.0	
1328.440	35.1	V	54.0	-18.9	AVG	80	1.0	
15903.110	36.8	V	54.0	-17.2	AVG	172	1.0	
15906.410	48.1	V	74.0	-25.9	PK	172	1.0	
10600.780	37.6	V	54.0	-16.4	AVG	183	1.0	
10600.520	50.3	V	74.0	-23.7	PK	183	1.0	
2998.330	47.4	V	68.3	-20.9	Peak	104	1.0	
5995.830	47.5	V	68.3	-20.8	Peak	104	1.0	
7065.830	48.7	V	68.3	-19.6	Peak	182	1.9	

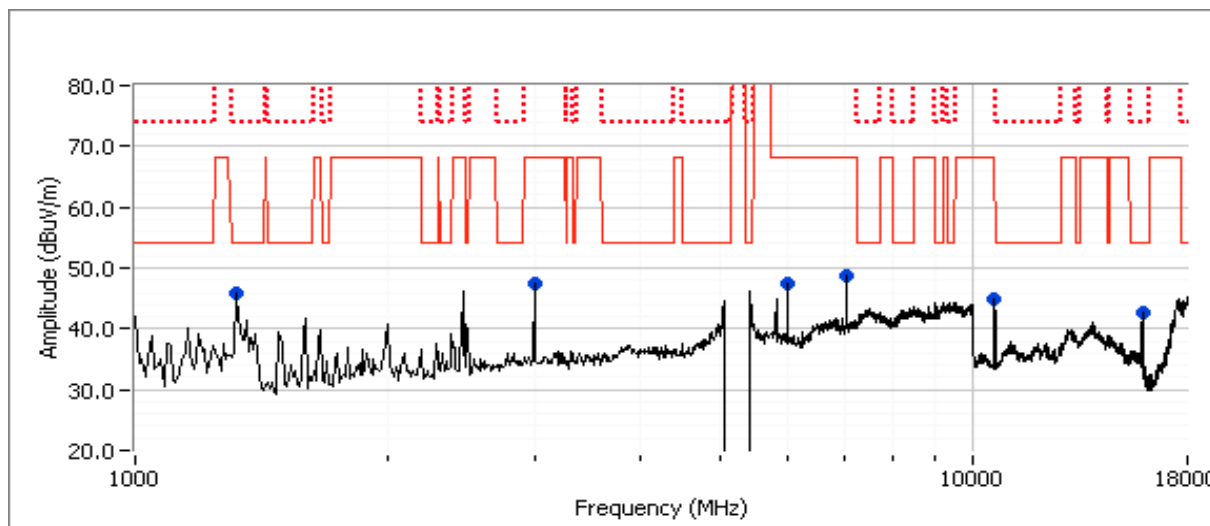

Client:	Intel Corporation	Job Number:	J78599
Model:	Puma Peak 2x2	T-Log Number:	T78676
Contact:	Steve Hackett	Account Manager:	Christine Krebill
Standard:	FCC 15E, FCC 15C, FCC 15B	Class:	N/A

Run # 5, Radiated Spurious Emissions, 1-40GHz, n20, Chain A, Chain B

Date of Test: 3/15/2010 Test Location: FT Chamber #4
 Test Engineer: Rafael Varelas Config Change: None

For emissions in restricted bands, the limit of 15.209 was used. For all other emissions, the limit is -27dBm eirp (68.3dBuV/m @3m). As the power measured is average power this is considered an average limit so the peak limit would be 88.3dBuV/m at 3m.

Run # 5a: EUT on Channel #60 5300MHz - n20, Chain A

Chain	Power Settings								Software Setting
	Target (dBm)				Measured (dBm)				
	A	B	C	Total	A	B	C	Total	
	16.4			16.4	16.4			16.4	17.5

Spurious Radiated Emissions:

Frequency MHz	Level dB μ V/m	Pol v/h	15.209 / 15E		Detector PK/QP/Avg	Azimuth degrees	Height meters	Comments
			Limit	Margin				
15895.580	38.3	V	54.0	-15.7	AVG	271	1.1	
15901.280	50.8	V	74.0	-23.2	PK	271	1.1	
10599.550	38.8	V	68.3	-29.5	AVG	198	1.2	
10599.080	52.3	V	88.3	-36.0	PK	198	1.2	
2998.330	48.4	V	68.3	-19.9	Peak	85	1.0	
5995.830	47.7	V	68.3	-20.6	Peak	97	1.0	
7065.830	49.0	V	68.3	-19.3	Peak	182	1.0	
1328.600	35.7	V	54.0	-18.3	AVG	86	1.0	
1330.020	58.0	V	74.0	-16.0	PK	86	1.0	

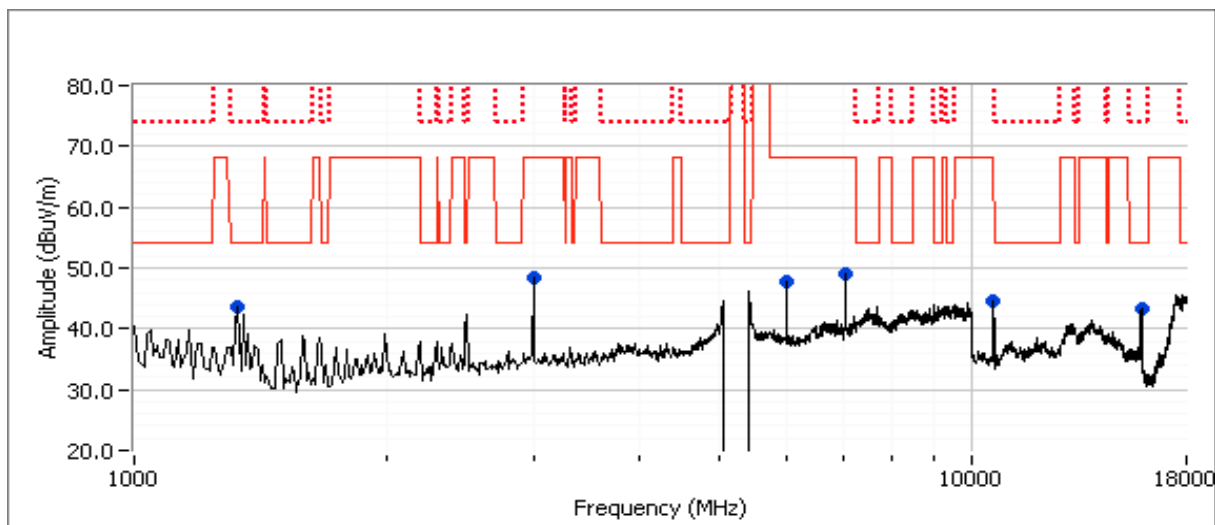

Client:	Intel Corporation	Job Number:	J78599
Model:	Puma Peak 2x2	T-Log Number:	T78676
Contact:	Steve Hackett	Account Manager:	Christine Krebill
Standard:	FCC 15E, FCC 15C, FCC 15B	Class:	N/A

Run # 5b: EUT on Channel #60 5300MHz - n20, Chain B

Chain	Target (dBm)				Power Settings Measured (dBm)				Software Setting
	A	B	C	Total	A	B	C	Total	
	16.5			16.5	16.7			16.7	17.0

Spurious Radiated Emissions:

Frequency MHz	Level dB μ V/m	Pol v/h	15.209 / 15E		Detector Pk/QP/Avg	Azimuth degrees	Height meters	Comments
			Limit	Margin				
15906.670	39.2	V	54.0	-14.8	Peak	194	1.0	
1331.080	34.5	V	54.0	-19.5	AVG	81	1.0	
1330.050	56.5	V	74.0	-17.5	PK	81	1.0	
10600.000	40.0	V	68.3	-28.3	Peak	189	1.0	
2998.330	47.2	V	68.3	-21.1	Peak	83	1.6	
5995.830	47.7	V	68.3	-20.6	Peak	140	1.0	
7065.830	50.2	V	68.3	-18.1	Peak	175	1.3	

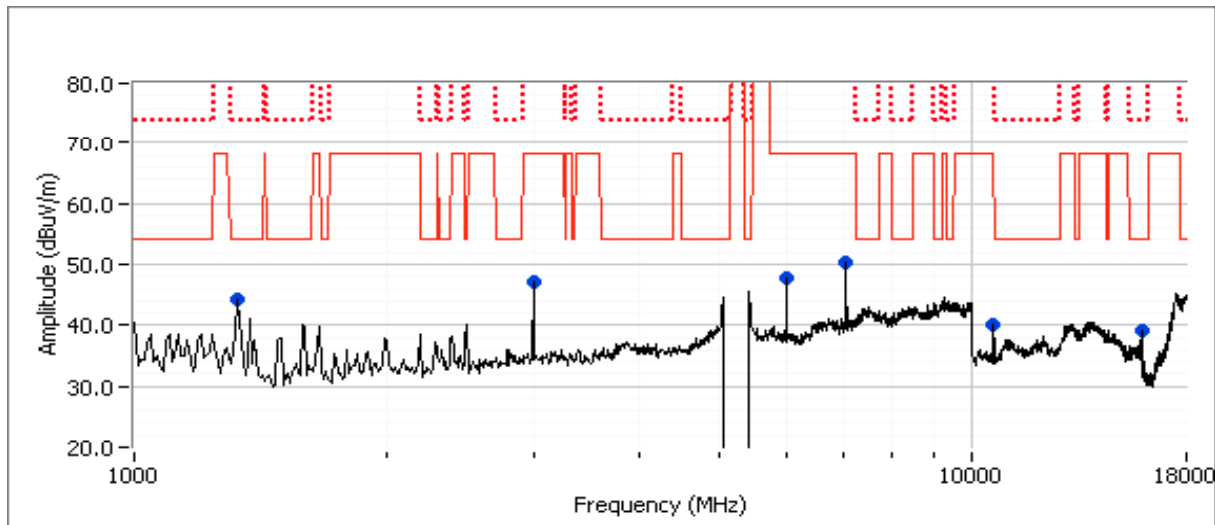

Client:	Intel Corporation	Job Number:	J78599
Model:	Puma Peak 2x2	T-Log Number:	T78676
Contact:	Steve Hackett	Account Manager:	Christine Krebill
Standard:	FCC 15E, FCC 15C, FCC 15B	Class:	N/A

Run # 6, Radiated Spurious Emissions, 1-40GHz, n40, Chain A+B

Date of Test: 3/15/2010 Test Location: FT Chamber #4
 Test Engineer: Rafael Varelas Config Change: None

For emissions in restricted bands, the limit of 15.209 was used. For all other emissions, the limit is -27dBm eirp (68.3dBuV/m @3m). As the power measured is average power this is considered an average limit so the peak limit would be 88.3dBuV/m at 3m.

Run # 6a: EUT on Channel #118 5590MHz - n40, Chain A+B

Chain	Power Settings								Software Setting
	Target (dBm)				Measured (dBm)				
	A	B	C	Total	A	B	C	Total	
	13.6	13.6		16.6	13.2	13.7		16.5	12.0

Spurious Radiated Emissions:

Frequency MHz	Level dB μ V/m	Pol v/h	15.209 / 15E		Detector PK/QP/Avg	Azimuth degrees	Height meters	Comments
			Limit	Margin				
7453.380	48.6	V	54.0	-5.4	AVG	176	1.1	
7453.430	52.8	V	74.0	-21.2	PK	176	1.1	
1598.310	35.0	V	54.0	-19.0	AVG	105	1.4	
1598.160	52.0	V	74.0	-22.0	PK	105	1.4	
11180.710	35.6	V	54.0	-18.4	AVG	200	1.0	
11180.140	49.5	V	74.0	-24.5	PK	200	1.0	
2998.330	47.1	V	68.3	-21.2	Peak	258	1.0	
5995.830	46.4	V	68.3	-21.9	Peak	136	1.0	

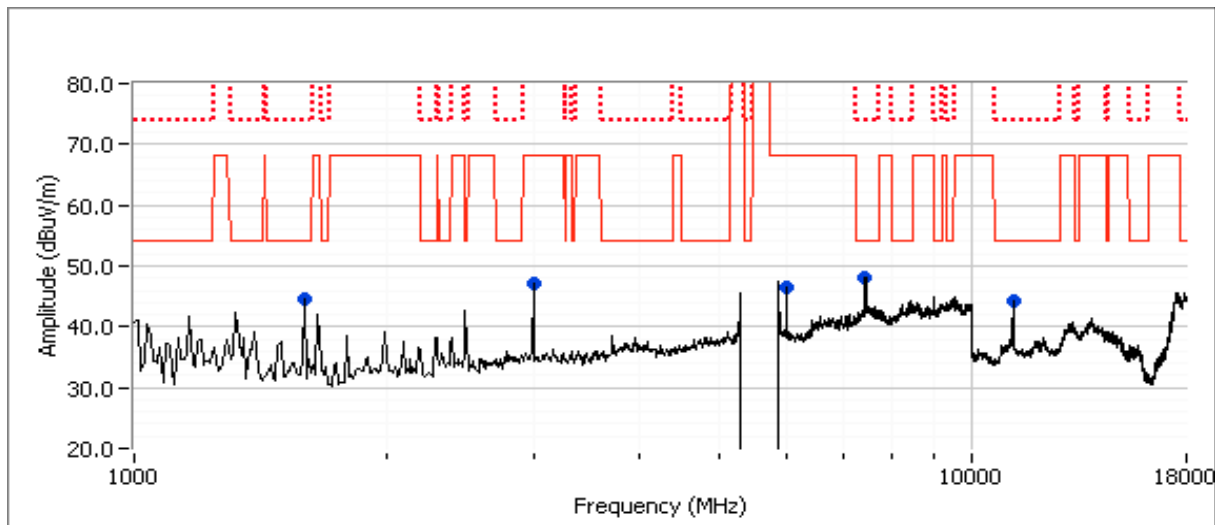

Client:	Intel Corporation	Job Number:	J78599
Model:	Puma Peak 2x2	T-Log Number:	T78676
		Account Manager:	Christine Krebill
Contact:	Steve Hackett		
Standard:	FCC 15E, FCC 15C, FCC 15B	Class:	N/A

Run # 7, Radiated Spurious Emissions, 1-40GHz, Rx, Chain A+B

Date of Test: 3/15/2010 Test Location: FT Chamber #4
 Test Engineer: Rafael Varelas Config Change: None

Run # 7a: EUT on Channel #6 2437MHz - Rx, Chain A+B - DTS Band, refer to DTS report

Run # 7b: EUT on Channel #48 5240MHz - Rx, Chain A+B

Spurious Radiated Emissions:

Frequency MHz	Level dB μ V/m	Pol v/h	15.209 / 15E		Detector Pk/QP/Avg	Azimuth degrees	Height meters	Comments
			Limit	Margin				
3000.360	47.3	V	54.0	-6.7	AVG	95	1.0	
6000.730	47.4	V	54.0	-6.6	AVG	95	1.0	
6986.660	49.7	V	54.0	-4.3	AVG	176	1.9	
3000.260	51.3	V	74.0	-22.7	PK	95	1.0	
6000.770	50.5	V	74.0	-23.5	PK	95	1.0	
6986.640	52.8	V	74.0	-21.2	PK	176	1.9	

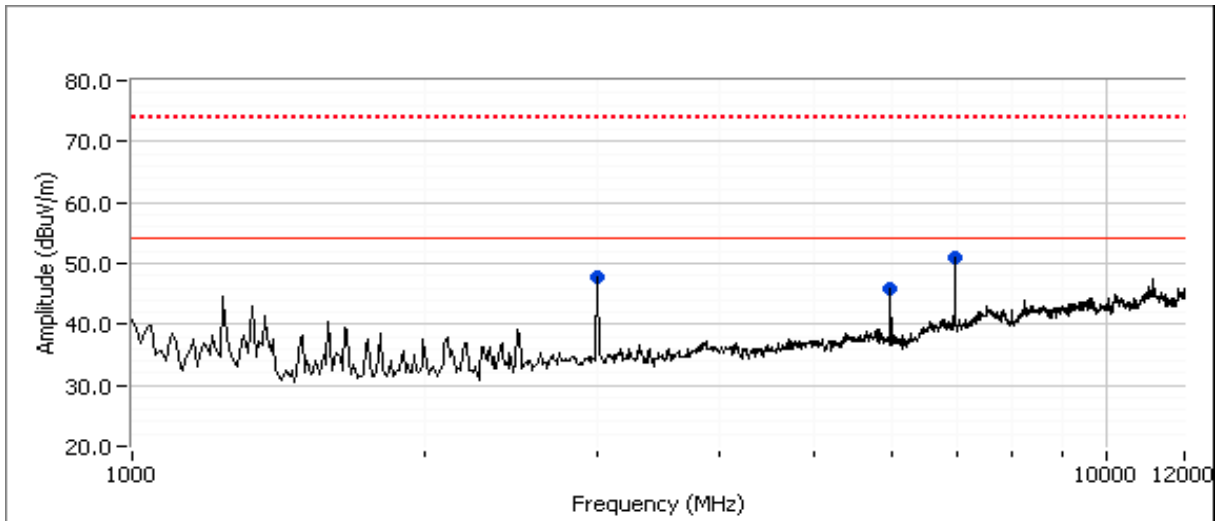

Client:	Intel Corporation	Job Number:	J78599
Model:	Puma Peak 2x2	T-Log Number:	T78676
Contact:	Steve Hackett	Account Manager:	Christine Krebill
Standard:	FCC 15E, FCC 15C, FCC 15B	Class:	N/A

Run # 7c: EUT on Channel #60 5300 MHz - Rx, Chain A+B

Spurious Radiated Emissions:

Frequency MHz	Level dB μ V/m	Pol v/h	15.209 / 15E		Detector PK/QP/Avg	Azimuth degrees	Height meters	Comments
			Limit	Margin				
1322.870	27.6	V	54.0	-26.4	AVG	295	1.0	
3000.370	45.9	V	54.0	-8.1	AVG	248	1.0	
6000.700	43.0	V	54.0	-11.0	AVG	254	1.6	
1323.540	45.3	V	74.0	-28.7	PK	295	1.0	
3000.300	50.4	V	74.0	-23.6	PK	248	1.0	
6000.800	50.2	V	74.0	-23.8	PK	254	1.6	

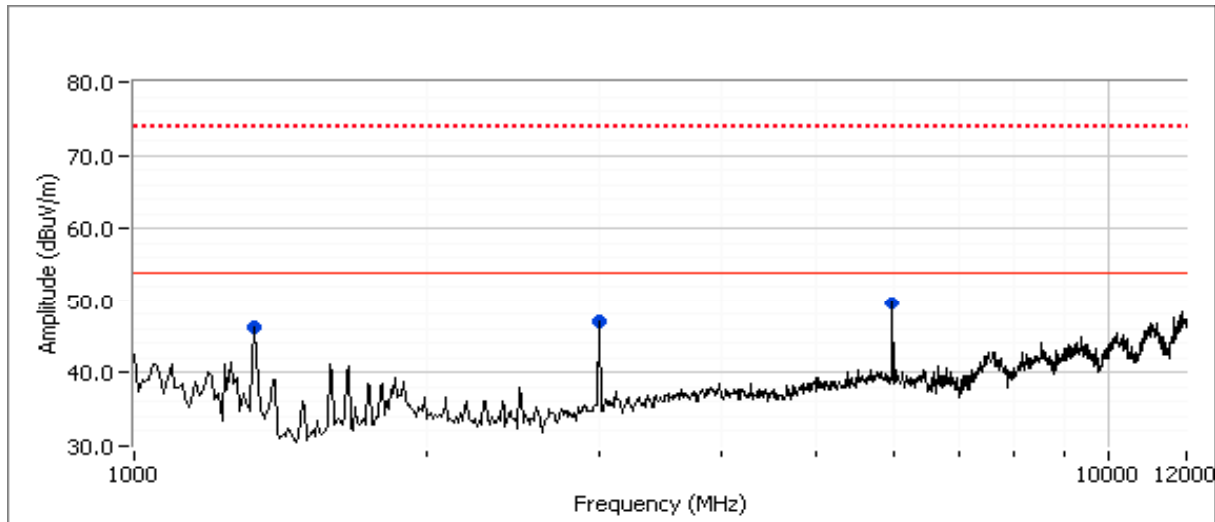

Client:	Intel Corporation	Job Number:	J78599
Model:	Puma Peak 2x2	T-Log Number:	T78676
Contact:	Steve Hackett	Account Manager:	Christine Krebill
Standard:	FCC 15E, FCC 15C, FCC 15B	Class:	N/A

Run # 7d: EUT on Channel #120 5600MHz - Rx, Chain A+B

Spurious Radiated Emissions:

Frequency MHz	Level dB μ V/m	Pol v/h	15.209 / 15E		Detector PK/QP/Avg	Azimuth degrees	Height meters	Comments
			Limit	Margin				
1327.920	32.2	V	54.0	-21.8	AVG	288	1.0	
3000.360	45.9	V	54.0	-8.1	AVG	247	1.0	
6000.720	47.8	V	54.0	-6.2	AVG	268	1.5	
1328.460	56.4	V	74.0	-17.6	PK	288	1.0	
3000.370	50.3	V	74.0	-23.7	PK	247	1.0	
6000.740	51.5	V	74.0	-22.5	PK	268	1.5	

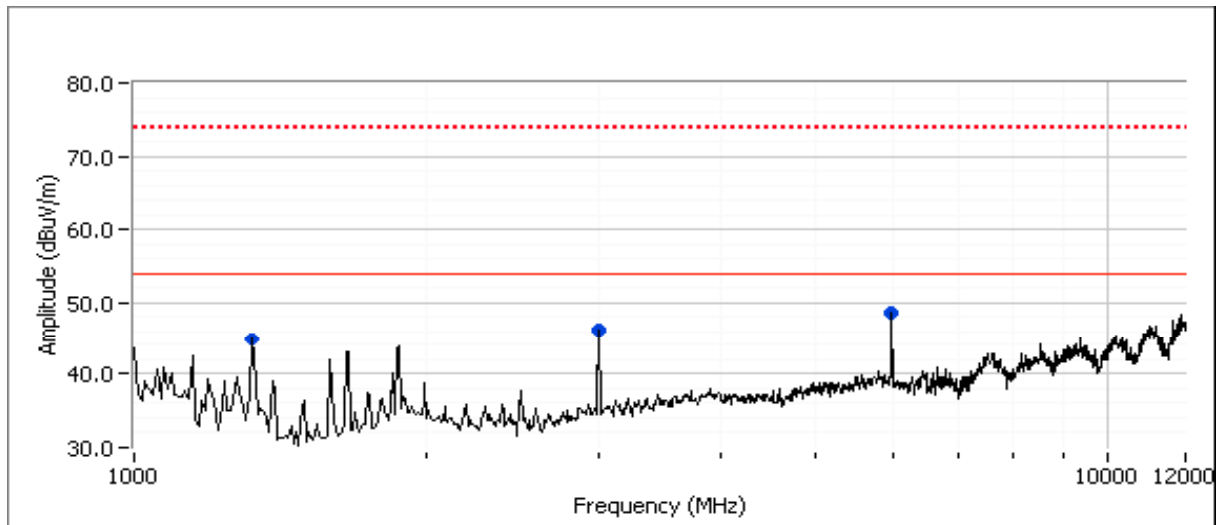

Appendix C Photographs of Test Configurations

Uploaded as a separate exhibit

Appendix D Theory of Operation

Uploaded as a separate exhibit (ANHU application only) – contains detailed information about the BIOS Lock mechanisms.

Appendix E Schematics

Uploaded as a separate exhibit – contains detailed information about the proposed changes.

Appendix F RF Exposure Information

Uploaded as a separate exhibit. Note that the rf exposure calculation is taken from the original filing. The antennas evaluated as part of this permissive change are of lower gain, therefore the original evaluation represents the worst case MPE calculation for the device.