



*EMC Test Report*

*Industry Canada RSS-Gen Issue 2 / RSS 210 Issue 7  
FCC Part 15, Subpart E*

*Model: Intel® Centrino® Advanced-N 6230 (model  
62230HMM)*

IC CERTIFICATION #: 1000M-62230ANH and 1000M-62230ANHU  
FCC ID: PD962230ANH and PD962230ANHU

APPLICANT: Intel Corporation  
100 Center Point Circle Suite 200  
Columbia, SC 29210

TEST SITE(S): Elliott Laboratories  
41039 Boyce Road.  
Fremont, CA. 94538-2435

IC SITE REGISTRATION #: 2845B-4, 2845B-7

REPORT DATE: October 11, 2010

FINAL TEST DATES: September 22, 23, 24, 27, 28, 30, October 4, and  
5, 2010

AUTHORIZED SIGNATORY:

Mark Briggs  
Staff Engineer  
Elliott Laboratories



Testing Cert #2016.01

Elliott Laboratories is accredited by the A2LA, certificate number 2016-01, to perform the test(s) listed in this report, except where noted otherwise. This report shall not be reproduced, except in its entirety, without the written approval of Elliott Laboratories

**REVISION HISTORY**

Rev#	Date	Comments	Modified By
-	10-11-2010	First release	

**TABLE OF CONTENTS**

<b>REVISION HISTORY .....</b>	<b>2</b>
<b>TABLE OF CONTENTS .....</b>	<b>3</b>
<b>SCOPE.....</b>	<b>4</b>
<b>OBJECTIVE .....</b>	<b>4</b>
<b>STATEMENT OF COMPLIANCE.....</b>	<b>5</b>
<b>DEVIATIONS FROM THE STANDARDS.....</b>	<b>5</b>
<b>TEST RESULTS SUMMARY .....</b>	<b>6</b>
UNII / LELAN DEVICES .....	6
GENERAL REQUIREMENTS APPLICABLE TO ALL BANDS.....	8
ADDITIONAL MEASUREMENTS.....	8
MEASUREMENT UNCERTAINTIES.....	9
<b>EQUIPMENT UNDER TEST (EUT) DETAILS.....</b>	<b>10</b>
GENERAL.....	10
ANTENNA SYSTEM .....	10
ENCLOSURE.....	10
MODIFICATIONS.....	10
SUPPORT EQUIPMENT .....	11
EUT INTERFACE PORTS .....	11
EUT OPERATION .....	11
<b>TEST SITE.....</b>	<b>13</b>
GENERAL INFORMATION.....	13
CONDUCTED EMISSIONS CONSIDERATIONS .....	13
RADIATED EMISSIONS CONSIDERATIONS .....	13
<b>MEASUREMENT INSTRUMENTATION .....</b>	<b>14</b>
RECEIVER SYSTEM .....	14
INSTRUMENT CONTROL COMPUTER .....	14
LINE IMPEDANCE STABILIZATION NETWORK (LISN).....	14
FILTERS/ATTENUATORS .....	15
ANTENNAS.....	15
ANTENNA MAST AND EQUIPMENT TURNTABLE .....	15
INSTRUMENT CALIBRATION.....	15
<b>TEST PROCEDURES .....</b>	<b>16</b>
EUT AND CABLE PLACEMENT .....	16
CONDUCTED EMISSIONS.....	16
RADIATED EMISSIONS.....	16
RADIATED EMISSIONS.....	17
CONDUCTED EMISSIONS FROM ANTENNA PORT .....	20
BANDWIDTH MEASUREMENTS .....	20
SPECIFICATION LIMITS AND SAMPLE CALCULATIONS .....	21
CONDUCTED EMISSIONS SPECIFICATION LIMITS: FCC 15.207; FCC 15.107(A), RSS GEN .....	21
GENERAL TRANSMITTER RADIATED EMISSIONS SPECIFICATION LIMITS .....	22
RECEIVER RADIATED SPURIOUS EMISSIONS SPECIFICATION LIMITS .....	22
FCC 15.407 (A) OUTPUT POWER LIMITS.....	23
OUTPUT POWER LIMITS –LELAN DEVICES.....	23
SPURIOUS EMISSIONS LIMITS –UNII AND LELAN DEVICES .....	24
SAMPLE CALCULATIONS - CONDUCTED EMISSIONS .....	24
SAMPLE CALCULATIONS - RADIATED EMISSIONS.....	24
SAMPLE CALCULATIONS - FIELD STRENGTH TO EIRP CONVERSION.....	25
<b>APPENDIX A TEST EQUIPMENT CALIBRATION DATA .....</b>	<b>1</b>
<b>APPENDIX B TEST DATA .....</b>	<b>3</b>

## SCOPE

An electromagnetic emissions test has been performed on the Intel Corporation model Intel® Centrino® Advanced-N 6230 (model 62230HMW), pursuant to the following rules:

- Industry Canada RSS-Gen Issue 2
- RSS 210 Issue 7 “Low-power Licence-exempt Radiocommunication Devices (All Frequency Bands): Category I Equipment”
- FCC Part 15, Subpart E requirements for UNII Devices (using FCC DA 02-2138, August 30, 2002)

Conducted and radiated emissions data has been collected, reduced, and analyzed within this report in accordance with measurement guidelines set forth in the following reference standards and as outlined in Elliott Laboratories test procedures:

- ANSI C63.4:2003
- FCC UNII test procedure 2002-08 DA-02-2138, August 2002

The intentional radiator above has been tested in a simulated typical installation to demonstrate compliance with the relevant Industry Canada performance and procedural standards.

Final system data was gathered in a mode that tended to maximize emissions by varying orientation of EUT, orientation of power and I/O cabling, antenna search height, and antenna polarization.

Every practical effort was made to perform an impartial test using appropriate test equipment of known calibration. All pertinent factors have been applied to reach the determination of compliance.

## OBJECTIVE

The primary objective of the manufacturer is compliance with the regulations outlined in the previous section.

Prior to marketing in the USA, all unlicensed transmitters and transceivers require certification. Receive-only devices operating between 30 MHz and 960 MHz are subject to either certification or a manufacturer’s declaration of conformity, with all other receive-only devices exempt from the technical requirements.

Prior to marketing in Canada, Class I transmitters, receivers and transceivers require certification. Class II devices are required to meet the appropriate technical requirements but are exempt from certification requirements.

Certification is a procedure where the manufacturer submits test data and technical information to a certification body and receives a certificate or grant of equipment authorization upon successful completion of the certification body's review of the submitted documents. Once the equipment authorization has been obtained, the label indicating compliance must be attached to all identical units, which are subsequently manufactured.

Maintenance of compliance is the responsibility of the manufacturer. Any modification of the product which may result in increased emissions should be checked to ensure compliance has been maintained (i.e., printed circuit board layout changes, different line filter, different power supply, harnessing or I/O cable changes, etc.).

### **STATEMENT OF COMPLIANCE**

The tested sample of Intel Corporation model Intel® Centrino® Advanced-N 6230 (model 62230HMW) complied with the requirements of the following regulations:

RSS 210 Issue 7 "Low-power Licence-exempt Radiocommunication Devices (All Frequency Bands): Category I Equipment"  
FCC Part 15, Subpart E requirements for UNII Devices

Maintenance of compliance is the responsibility of the manufacturer. Any modifications to the product should be assessed to determine their potential impact on the compliance status of the device with respect to the standards detailed in this test report.

The test results recorded herein are based on a single type test of Intel Corporation model Intel® Centrino® Advanced-N 6230 (model 62230HMW) and therefore apply only to the tested sample. The sample was selected and prepared by Steve Hackett of Intel Corporation.

### **DEVIATIONS FROM THE STANDARDS**

No deviations were made from the published requirements listed in the scope of this report.

**TEST RESULTS SUMMARY****UNII / LELAN DEVICES****Operation in the 5.15 – 5.25 GHz Band**

FCC Rule Part	RSS Rule Part	Description	Measured Value / Comments	Limit / Requirement	Result
15.407(e)		Indoor operation only	Intended for indoor hosts only	N/A	Complies
15.407(a)(2)		26dB Bandwidth	> 20MHz	N/A – limits output power if < 20MHz	N/A
15.407(a)(1)	A9.2(1)	Output Power	802.11a: 42 mW n20MHz: 45 mW n40MHz: 44 mW (Max eirp: 95.5mW)	17dBm	Complies
15.407(a)(1)	-	Power Spectral Density	3.7 dBm/MHz	4 dBm/MHz	Complies
-	A9.5(2)			6.4 dBm/MHz	Complies

**Operation in the 5.25 – 5.35 GHz Band**

FCC Rule Part	RSS Rule Part	Description	Measured Value / Comments	Limit / Requirement	Result (margin)
15.407(a)(2)		26dB Bandwidth	> 20MHz	N/A – limits output power if < 20MHz	N/A
15.407(a)(2)	A9.2(2)	Output Power	802.11a: 44 mW n 20MHz: 46 mW n40MHz: 40 mW (Max eirp: 102.3mW)	17dBm (50mW)	Complies
15.407(a)(2)	-	Power Spectral Density	4.0 dBm/MHz	11 dBm/MHz	Complies
-	A9.2(2) / A9.5(2)	Power Spectral Density		11 dBm / MHz <sup>1</sup>	Complies

**Operation in the 5.47 – 5.725 GHz Band**

FCC Rule Part	RSS Rule Part	Description	Measured Value / Comments	Limit / Requirement	Result (margin)
15.407(a)(2)		26dB Bandwidth	> 20MHz	N/A – limits output power if < 20MHz	N/A
15.407(a)(2)	A9.2(2)	Output Power	802.11a: 45 mW n 20MHz: 44 mW n40MHz: 44 mW (Max eirp: 134.9mW)	24 dBm / 250mW (eirp < 30dBm)	Complies
15.407(a)(2)		Power Spectral Density	4.2 dBm/MHz	11 dBm/MHz	Complies
	A9.2(2) / A9.5(2)	Power Spectral Density		11 dBm / MHz <sup>2</sup>	Complies
KDB 443999	A9	Non-operation in 5600 – 5650 MHz sub band	Device cannot operate in the 5600 – 5650 MHz band – client device with passive scanning in this band.		Complies

<sup>1</sup> Reduced from 11dBm because highest value exceeded the average value by more than 3dB<sup>2</sup> Reduced from 11dBm because highest value exceeded the average value by more than 3dB

**Requirements for all U-NII/LELAN bands**

FCC Rule Part	RSS Rule Part	Description	Measured Value / Comments	Limit / Requirement	Result
15.407	A9.5a	Modulation	Digital Modulation is used	Digital modulation is required	Complies
15.407(b)(5) / 15.209	A9.3	Spurious Emissions below 1GHz	41.2dB $\mu$ V/m @ 662.52MHz	Refer to page 24	Complies (-4.8dB)
15.407(b)(5) / 15.209	A9.3	Spurious Emissions above 1GHz	53.0dB $\mu$ V/m @ 5460.0MHz		Complies (-1.0dB)
15.407(a)(6)	-	Peak Excursion Ratio	9.9 dB	< 13dB	Complies
	A9.5 (3)	Channel Selection	Spurious emissions tested at outermost channels in each band	Device was tested on the top, bottom and center channels in each band	Complies
15			Measurements on three channels in each band		Complies
15.407 (c)	A9.5(4)	Operation in the absence of information to transmit	Operation is discontinued in the absence of information (Operational Description page 9)	Device shall automatically discontinue operation in the absence of information to transmit	Complies
15.407 (g)	A9.5 (5)	Frequency Stability	Frequency stability is better than 20ppm (Operational Description page 9)	Signal shall remain in-band.	Complies
15.407 (h2)	A9.4	Dynamic frequency Selection (device without radar detection)	Refer to separate test report		
	A9.9g	User Manual information	Refer to pages 11 and 12 of the user's manual	Warning about satellite systems	Complies

**GENERAL REQUIREMENTS APPLICABLE TO ALL BANDS**

FCC Rule Part	RSS Rule part	Description	Measured Value / Comments	Limit / Requirement	Result (margin)
15.203	-	RF Connector	Unique	Integral or unique connector required	Complies
15.109	RSS GEN 7.2.3 Table 1	Receiver spurious emissions	41.2dB $\mu$ V/m @ 662.52MHz	Refer to page 22	Complies (-4.8dB)
15.207	RSS GEN Table 2	AC Conducted Emissions	40.6dB $\mu$ V @ 14.758MHz	Refer to page 21	Complies (-9.4dB)
15.247 (b) (5) 15.407 (f)	RSS 102	RF Exposure Requirements	Refer to MPE calculations, RSS 102 declaration and User Manual pages 8, 12	Refer to OET 65, FCC Part 1 and RSS 102	Complies
-	RSP 100 RSS GEN 7.1.5	User Manual	Refer to pages 11 and 12 of the user's manual	Statement required regarding non-interference	Complies
-	RSP 100 RSS GEN 7.1.5	User Manual	Not applicable, antenna is integral to host systems.	Statement for products with detachable antenna	N/A
-	RSP 100 RSS GEN 4.4.1	99% Bandwidth	802.11a: 17.1 MHz n20MHz: 18.1 MHz n40MHz: 36.4 MHz	Information only	N/A

**ADDITIONAL MEASUREMENTS**

As both Bluetooth and 802.11 transmissions can occur simultaneously, radiated spurious measurements were made with both Bluetooth and 802.11 devices transmitting simultaneously.

FCC Rule Part	RSS Rule part	Description	Measured Value / Comments	Limit / Requirement	Result (margin)
15.2109	RSS 210	Spurious emissions	45.1dB $\mu$ V/m @ 11199.8MHz	15.209 in restricted bands, all others < -20dBc	Complies (-8.9dB)
Signal was actually second harmonic of 802.11 signal and not an inter-modulation product, but this was the highest level signal observed with both Bluetooth and Wi-Fi transmitters operational simultaneously.					



**MEASUREMENT UNCERTAINTIES**

ISO/IEC 17025 requires that an estimate of the measurement uncertainties associated with the emissions test results be included in the report. The measurement uncertainties given below are based on a 95% confidence level and were calculated in accordance with UKAS document LAB 34.

Measurement Type	Measurement Unit	Frequency Range	Expanded Uncertainty
RF power, conducted (power meter)	dBm	25 to 7000 MHz	± 0.52 dB
RF power, conducted (Spectrum analyzer)	dBm	25 to 7000 MHz	± 0.7 dB
Conducted emission of transmitter	dBm	25 to 26500 MHz	± 0.7 dB
Conducted emission of receiver	dBm	25 to 26500 MHz	± 0.7 dB
Radiated emission (substitution method)	dBm	25 to 26500 MHz	± 2.5 dB
Radiated emission (field strength)	dB $\mu$ V/m	25 to 1000 MHz	± 3.6 dB
		1000 to 40000 MHz	± 6.0 dB
Conducted Emissions (AC Power)	dB $\mu$ V	0.15 to 30 MHz	± 2.4 dB

**EQUIPMENT UNDER TEST (EUT) DETAILS****GENERAL**

The Intel Corporation model Intel® Centrino® Advanced-N 6230 (model 62230HMMW) is a PCIe half mini card form factor Bluetooth/IEEE 802.11a/b/g/n wireless network adapter. The card supports MIMO (2x2) for 802.11n modes and MISO (1x2) for 802.11a/b/g modes. Bluetooth only operation mode is a 1x1. When Bluetooth is operational then 802.11b/g/n modes operate as SISO (1x1). 802.11a/n modes still operate as MIMO (2x2) with Bluetooth operational.

The card is sold under two different FCC/IC ID numbers (see table below). The ID's ending in "U" are intended to allow user install conditions and host systems must be provided with a BIOS locking feature that prevents installation of unauthorized devices.

For radio testing purposes the card was installed in a test fixture that exposed all sides of the card. For digital device testing for certification under equipment code JBP the card was installed inside a laptop PC.

The sample was received on September 13, 2010 and tested on September 22, 23, 24, 27, 28, 30, October 4, and 5, 2010. The EUT consisted of the following component(s):

Manufacturer	Model	Description	MAC Address	FCC ID and Canada UPN
Intel Corporation	62230ANHMMW	PCIe Half Mini Card form factor Bluetooth / IEEE 802.11a/b/g/n wireless network adapter	00150079AD10	PD962230ANH PD962230ANHU 1000M-62230ANH
	62230ANHU			1000M-62230ANHU

**ANTENNA SYSTEM**

The EUT antenna is a two-antenna PIFA antenna system – Shanghai Universe Communication Electron Co., Ltd. The antenna connects to the EUT via a non-standard antenna connector, thereby meeting the requirements of FCC 15.203.

**ENCLOSURE**

The EUT does not have an enclosure as it is designed to be installed within the enclosure of a host computer or system.

**MODIFICATIONS**

No modifications were made to the EUT during the time the product was at Elliott.

**SUPPORT EQUIPMENT**

The following equipment was used as support equipment for testing:

Company	Model	Description	Serial Number	FCC ID
Intel Corporation	-	Test Fixture	D9164573K0B0	N/A
DELL	Latitude D520	Laptop PC	HM9383J	N/A
Agilent	E3610A	DC Supply	MY4001740	N/A

**EUT INTERFACE PORTS**

The I/O cabling configuration during testing was as follows:

Port	Connected To	Description	Cable(s)	
			Shielded or Unshielded	Length(m)
Laptop USB	Fixture USB	USB cable	Shielded	
Laptop Mini PCI	Fixture PCIe	Ribbon	unshielded	
DC Power	Fixture DC power	2-wire	unshielded	

**EUT OPERATION**

The EUT was installed into a test fixture that exposed all sides of the card. The test fixture interfaced to a laptop computer and dc power supply. The laptop computer was used to configure the EUT to continuously transmit at a specified output power or continuously receive on the channel specified in the test data. For transmit mode measurements the system was configured to operate in each of the available operating modes – 802.11a, 802.11b, 802.11g, 802.11n (20 MHz channel bandwidth) and 802.11n (40MHz channel bandwidth), Bluetooth 1Mb/s and Bluetooth 3Mb/s. In addition radiated spurious tests were repeated with the device operating in both Bluetooth and 802.11 modes to determine if any spurious emissions due to inter-modulation products were created.

The data rates used when evaluating the WiFi transmitter were the lowest data rates for each 802.11 mode – 1Mb/s for 802.11b, 6Mb/s for 802.11a and 802.11g, 6.5MB/s for 802.11n (20MHz), and 13 Mb/s for 802.11n (40MHz). The device operates at its maximum output power at the lowest data rate (this was confirmed through separate measurements – refer to test data for actual measurements).

The field strength at the band edges was evaluated for each mode and on each chain individually on the lowest and highest channels at the rated power for the channel under test. Where the power at the edge channels was lower than the power at the center channels additional measurements were made at the adjacent channels. MIMO and SISO modes were fully evaluated.

Spurious emissions measurements at frequencies away from the band edges were made at the highest power rating for the band in each mode. For 802.11n modes both chains were active (MIMO mode) but with each chain at the highest power rating per chain (MIMO power setting) to cover both modes of operation at the same time.

Bluetooth operation was evaluated at both 1Mb/s and 3Mb/s data rates. 2Mb/s data rate was found, through preliminary testing, to produce emissions similar to those for 3Mb/s.

Receiver spurious emissions in 802.11 modes were evaluated in single chain and multi-chain modes. Bluetooth receiver spurious were evaluated for single chain only as MISO is not supported for Bluetooth.

The PC was using the Intel test utility DRTU Version 1.2.12-0197 and the device driver was version 14.0.0.39.

**TEST SITE****GENERAL INFORMATION**

Final test measurements were taken at the test sites listed below. Pursuant to section 2.948 of the FCC's Rules and section 3.3 of RSP-100, construction, calibration, and equipment data has been filed with the Commission and with industry Canada.

Site	Registration Numbers		Location
	FCC	Canada	
Chamber 4	211948	2845B-4	41039 Boyce Road Fremont, CA 94538-2435
Chamber 7	A2LA accreditation	2845B-7	

ANSI C63.4:2003 recommends that ambient noise at the test site be at least 6 dB below the allowable limits. Ambient levels are below this requirement. The test site(s) contain separate areas for radiated and conducted emissions testing. Considerable engineering effort has been expended to ensure that the facilities conform to all pertinent requirements of ANSI C63.4:2003.

**CONDUCTED EMISSIONS CONSIDERATIONS**

Conducted emissions testing is performed in conformance with ANSI C63.4:2003. Measurements are made with the EUT connected to the public power network through a nominal, standardized RF impedance, which is provided by a line impedance stabilization network, known as a LISN. A LISN is inserted in series with each current-carrying conductor in the EUT power cord.

**RADIATED EMISSIONS CONSIDERATIONS**

The FCC has determined that radiation measurements made in a shielded enclosure are not suitable for determining levels of radiated emissions. Radiated measurements are performed in an open field environment or in a semi-anechoic chamber. The test sites are maintained free of conductive objects within the CISPR defined elliptical area incorporated in ANSI C63.4:2003 guidelines and meet the Normalized Site Attenuation (NSA) requirements of ANSI C63.4:2003.

## **MEASUREMENT INSTRUMENTATION**

### **RECEIVER SYSTEM**

An EMI receiver as specified in CISPR 16-1-1 is used for emissions measurements. The receivers used can measure over the frequency range of 9 kHz up to 2000 MHz. These receivers allow both ease of measurement and high accuracy to be achieved. The receivers have Peak, Average, and CISPR (Quasi-peak) detectors built into their design so no external adapters are necessary. The receiver automatically sets the required bandwidth for the CISPR detector used during measurements. If the repetition frequency of the signal being measured is below 20Hz, peak measurements are made in lieu of Quasi-Peak measurements.

For measurements above the frequency range of the receivers, a spectrum analyzer is utilized because it provides visibility of the entire spectrum along with the precision and versatility required to support engineering analysis. Average measurements above 1000MHz are performed on the spectrum analyzer using the linear-average method with a resolution bandwidth of 1 MHz and a video bandwidth of 10 Hz, unless the signal is pulsed in which case the average (or video) bandwidth of the measuring instrument is reduced to onset of pulse desensitization and then increased.

### **INSTRUMENT CONTROL COMPUTER**

The receivers utilize either a Rohde & Schwarz EZM Spectrum Monitor/Controller or contain an internal Spectrum Monitor/Controller to view and convert the receiver measurements to the field strength at an antenna or voltage developed at the LISN measurement port, which is then compared directly with the appropriate specification limit. This provides faster, more accurate readings by performing the conversions described under Sample Calculations within the Test Procedures section of this report. Results are printed in a graphic and/or tabular format, as appropriate. A personal computer is used to record all measurements made with the receivers.

The Spectrum Monitor provides a visual display of the signal being measured. In addition, the controller or a personal computer run automated data collection programs which control the receivers. This provides added accuracy since all site correction factors, such as cable loss and antenna factors are added automatically.

### **LINE IMPEDANCE STABILIZATION NETWORK (LISN)**

Line conducted measurements utilize a fifty microhenry Line Impedance Stabilization Network as the monitoring point. The LISN used also contains a 250 uH CISPR adapter. This network provides for calibrated radio frequency noise measurements by the design of the internal low pass and high pass filters on the EUT and measurement ports, respectively.

### *FILTERS/ATTENUATORS*

External filters and precision attenuators are often connected between the receiving antenna or LISN and the receiver. This eliminates saturation effects and non-linear operation due to high amplitude transient events.

### *ANTENNAS*

A loop antenna is used below 30 MHz. For the measurement range 30 MHz to 1000 MHz either a combination of a biconical antenna and a log periodic or a bi-log antenna is used. Above 1000 MHz, horn antennas are used. The antenna calibration factors to convert the received voltage to an electric field strength are included with appropriate cable loss and amplifier gain factors to determine an overall site factor, which is then programmed into the test receivers or incorporated into the test software.

### *ANTENNA MAST AND EQUIPMENT TURNTABLE*

The antennas used to measure the radiated electric field strength are mounted on a non-conductive antenna mast equipped with a motor-drive to vary the antenna height. Measurements below 30 MHz are made with the loop antenna at a fixed height of 1m above the ground plane.

ANSI C63.4:2003 specifies that the test height above ground for table mounted devices shall be 80 centimeters. Floor mounted equipment shall be placed on the ground plane if the device is normally used on a conductive floor or separated from the ground plane by insulating material from 3 to 12 mm if the device is normally used on a non-conductive floor. During radiated measurements, the EUT is positioned on a motorized turntable in conformance with this requirement.

### *INSTRUMENT CALIBRATION*

All test equipment is regularly checked to ensure that performance is maintained in accordance with the manufacturer's specifications. All antennas are calibrated at regular intervals with respect to tuned half-wave dipoles. An exhibit of this report contains the list of test equipment used and calibration information.

## TEST PROCEDURES

### EUT AND CABLE PLACEMENT

The regulations require that interconnecting cables be connected to the available ports of the unit and that the placement of the unit and the attached cables simulate the worst case orientation that can be expected from a typical installation, so far as practicable. To this end, the position of the unit and associated cabling is varied within the guidelines of ANSI C63.4:2003, and the worst-case orientation is used for final measurements.

### CONDUCTED EMISSIONS

Conducted emissions are measured at the plug end of the power cord supplied with the EUT. Excess power cord length is wrapped in a bundle between 30 and 40 centimeters in length near the center of the cord. Preliminary measurements are made to determine the highest amplitude emission relative to the specification limit for all the modes of operation. Placement of system components and varying of cable positions are performed in each mode. A final peak mode scan is then performed in the position and mode for which the highest emission was noted on all current carrying conductors of the power cord.

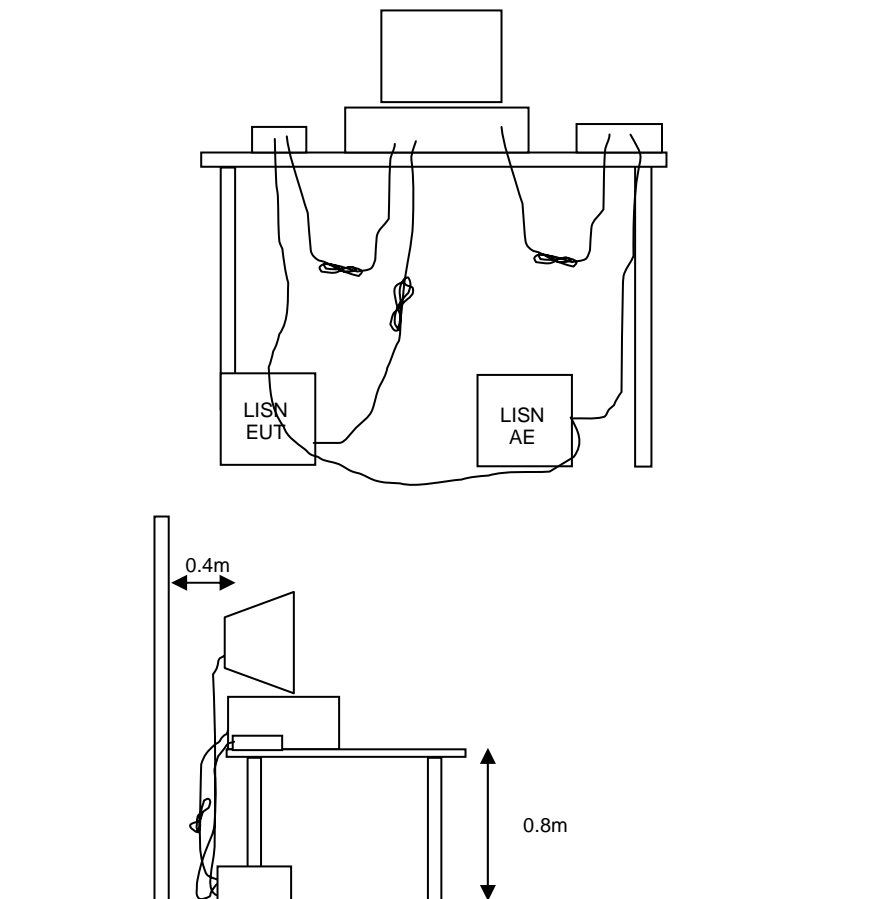



---

**RADIATED EMISSIONS**

A preliminary scan of the radiated emissions is performed in which all significant EUT frequencies are identified with the system in a nominal configuration. At least two scans are performed, one scan for each antenna polarization (horizontal and vertical; loop parallel and perpendicular to the EUT). During the preliminary scans, the EUT is rotated through 360°, the antenna height is varied (for measurements above 30 MHz) and cable positions are varied to determine the highest emission relative to the limit. Preliminary scans may be performed in a fully anechoic chamber for the purposes of identifying the frequencies of the highest emissions from the EUT.

A speaker is provided in the receiver to aid in discriminating between EUT and ambient emissions. Other methods used during the preliminary scan for EUT emissions involve scanning with near field magnetic loops, monitoring I/O cables with RF current clamps, and cycling power to the EUT.

Final maximization is a phase in which the highest amplitude emissions identified in the spectral search are viewed while the EUT azimuth angle is varied from 0 to 360 degrees relative to the receiving antenna. The azimuth, which results in the highest emission is then maintained while varying the antenna height from one to four meters (for measurements above 30 MHz, measurements below 30 MHz are made with the loop antenna at a fixed height of 1m). The result is the identification of the highest amplitude for each of the highest peaks. Each recorded level is corrected in the receiver using appropriate factors for cables, connectors, antennas, and preamplifier gain.

When testing above 18 GHz, the receive antenna is located at 1 meter from the EUT and the antenna height is restricted to a maximum of 2.5 meters.

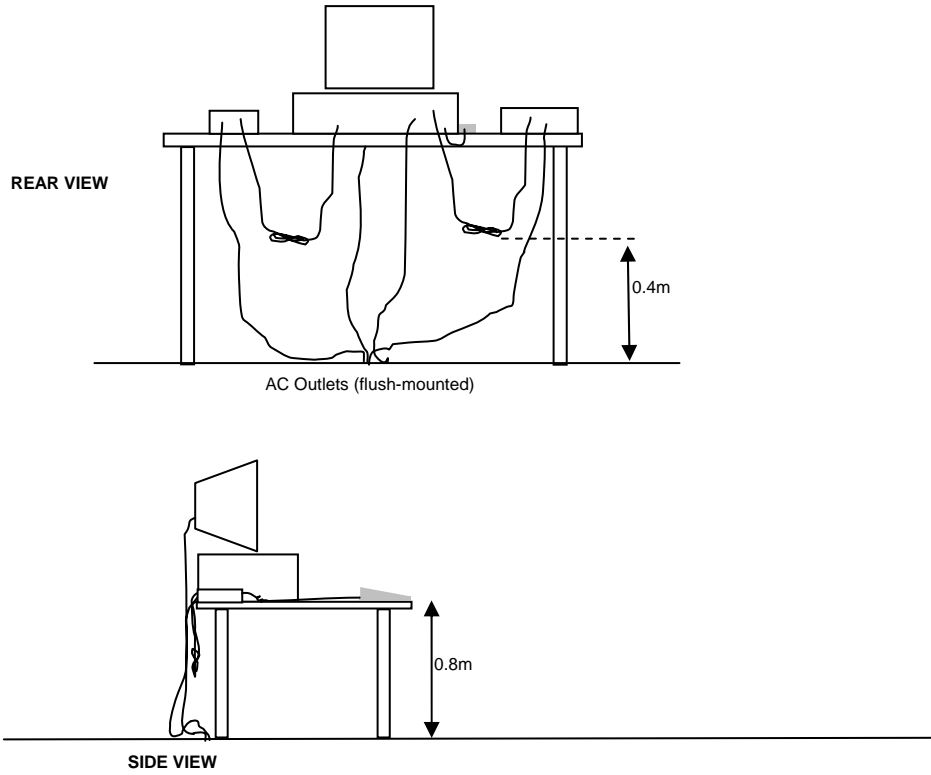

Typical Test Configuration for Radiated Field Strength Measurements

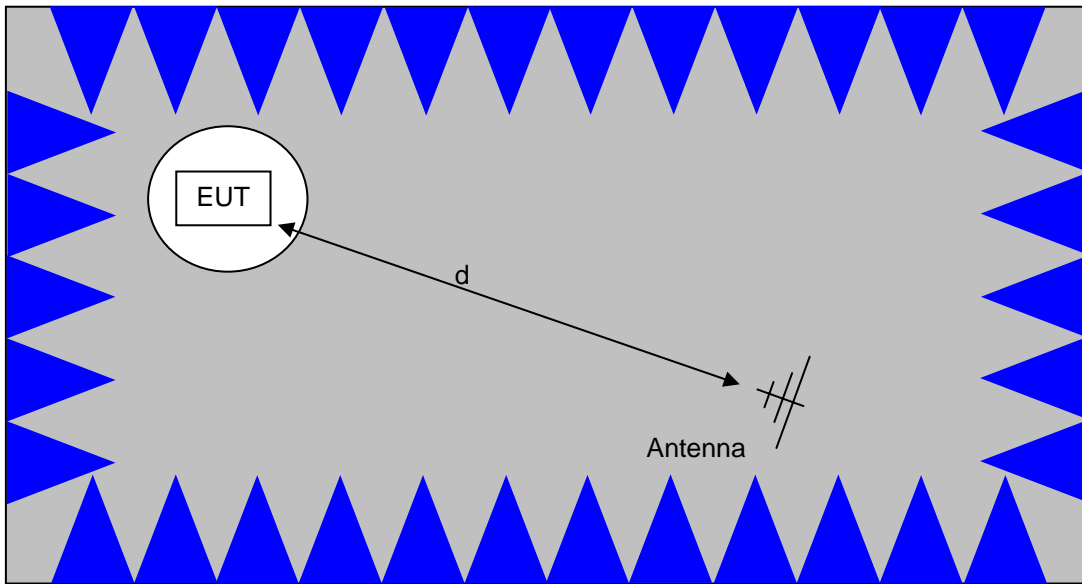

The anechoic materials on the walls and ceiling ensure compliance with the normalized site attenuation requirements of CISPR 16 / CISPR 22 / ANSI C63.4 for an alternate test site at the measurement distances used.

Floor-standing equipment is placed on the floor with insulating supports between the unit and the ground plane.

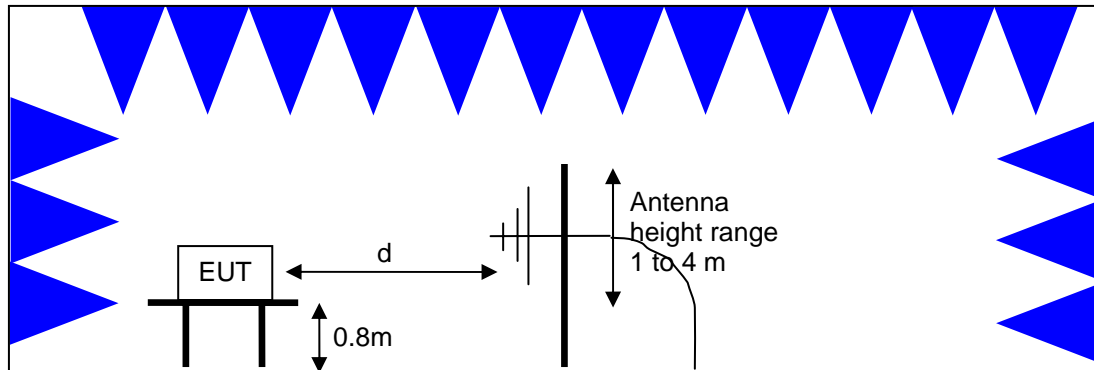

Test Configuration for Radiated Field Strength Measurements  
Semi-Anechoic Chamber, Plan and Side Views

**CONDUCTED EMISSIONS FROM ANTENNA PORT**

Direct measurements of power, bandwidth and power spectral density are performed, where possible, with the antenna port of the EUT connected to either the power meter or spectrum analyzer via a suitable attenuator and/or filter. These are used to ensure that the front end of the measurement instrument is not overloaded by the fundamental transmission.

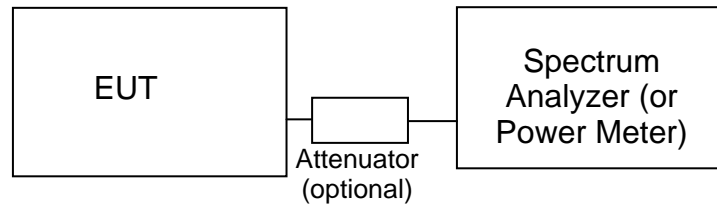
**Test Configuration for Antenna Port Measurements**

Measurement bandwidths (video and resolution) are set in accordance with the relevant standards and Elliott's test procedures for the type of radio being tested. When power measurements are made using a resolution bandwidth less than the signal bandwidth the power is calculated by summing the power across the signal bandwidth using either the analyzer channel power function or by capturing the trace data and calculating the power using software. In both cases the summed power is corrected to account for the equivalent noise bandwidth (ENBW) of the resolution bandwidth used.

If power averaging is used (typically for certain digital modulation techniques), the EUT is configured to transmit continuously. Power averaging is performed using either the built-in function of the analyzer or, if the analyzer does not feature power averaging, using external software. In both cases the average power is calculated over a number of sweeps (typically 100). When the EUT cannot be configured to continuously transmit then either the analyzer is configured to perform a gated sweep to ensure that the power is averaged over periods that the device is transmitting or power averaging is disabled and a max-hold feature is used.

If a power meter is used to make output power measurements the sensor head type (peak or average) is stated in the test data table.

**BANDWIDTH MEASUREMENTS**

The 6dB, 20dB and/or 26dB signal bandwidth is measured in using the bandwidths recommended by ANSI C63.4. When required, the 99% bandwidth is measured using the methods detailed in RSS GEN.

**SPECIFICATION LIMITS AND SAMPLE CALCULATIONS**

The limits for conducted emissions are given in units of microvolts, and the limits for radiated emissions are given in units of microvolts per meter at a specified test distance. Data is measured in the logarithmic form of decibels relative to one microvolt, or dB microvolts (dBuV). For radiated emissions, the measured data is converted to the field strength at the antenna in dB microvolts per meter (dBuV/m). The results are then converted to the linear forms of uV and uV/m for comparison to published specifications.

For reference, converting the specification limits from linear to decibel form is accomplished by taking the base ten logarithm, then multiplying by 20. These limits in both linear and logarithmic form are as follows:

**CONDUCTED EMISSIONS SPECIFICATION LIMITS: FCC 15.207; FCC 15.107(a), RSS GEN**

The table below shows the limits for the emissions on the AC power line from an intentional radiator and a receiver.

Frequency (MHz)	Average Limit (dBuV)	Quasi Peak Limit (dBuV)
0.150 to 0.500	Linear decrease on logarithmic frequency axis between 56.0 and 46.0	Linear decrease on logarithmic frequency axis between 66.0 and 56.0
0.500 to 5.000	46.0	56.0
5.000 to 30.000	50.0	60.0

**GENERAL TRANSMITTER RADIATED EMISSIONS SPECIFICATION LIMITS**

The table below shows the limits for the spurious emissions from transmitters that fall in restricted bands<sup>3</sup> (with the exception of transmitters operating under FCC Part 15 Subpart D and RSS 210 Annex 9), the limits for all emissions from a low power device operating under the general rules of RSS 310 (tables 3 and 4), RSS 210 (table 2) and FCC Part 15 Subpart C section 15.209.

Frequency Range (MHz)	Limit (uV/m)	Limit (dBuV/m @ 3m)
0.009-0.490	2400/F <sub>KHz</sub> @ 300m	67.6-20*log <sub>10</sub> (F <sub>KHz</sub> ) @ 300m
0.490-1.705	24000/F <sub>KHz</sub> @ 30m	87.6-20*log <sub>10</sub> (F <sub>KHz</sub> ) @ 30m
1.705 to 30	30 @ 30m	29.5 @ 30m
30 to 88	100 @ 3m	40 @ 3m
88 to 216	150 @ 3m	43.5 @ 3m
216 to 960	200 @ 3m	46.0 @ 3m
Above 960	500 @ 3m	54.0 @ 3m

**RECEIVER RADIATED SPURIOUS EMISSIONS SPECIFICATION LIMITS**

The table below shows the limits for the spurious emissions from receivers as detailed in FCC Part 15.109, RSS 210 Table 2, RSS GEN Table 1 and RSS 310 Table 3. Note that receivers operating outside of the frequency range 30 MHz – 960 MHz are exempt from the requirements of 15.109.

Frequency Range (MHz)	Limit (uV/m @ 3m)	Limit (dBuV/m @ 3m)
30 to 88	100	40
88 to 216	150	43.5
216 to 960	200	46.0
Above 960	500	54.0

<sup>3</sup> The restricted bands are detailed in FCC 15.203, RSS 210 Table 1 and RSS 310 Table 2

*FCC 15.407 (a) OUTPUT POWER LIMITS*

The table below shows the limits for output power and output power density. Where the signal bandwidth is less than 20 MHz the maximum output power is reduced to the power spectral density limit plus 10 times the log of the bandwidth (in MHz).

Operating Frequency (MHz)	Output Power	Power Spectral Density
5150 – 5250	50mW (17 dBm)	4 dBm/MHz
5250 – 5350	250 mW (24 dBm)	11 dBm/MHz
5725 – 5825	1 Watts (30 dBm)	17 dBm/MHz

For system using antennas with gains exceeding 6dBi, the output power and power spectral density limits are reduced by 1dB for every dB the antenna gain exceeds 6dBi. Fixed point-to-point applications using the 5725 – 5825 MHz band may use antennas with gains of up to 23dBi without this limitation. If the gain exceeds 23dBi then the output power limit of 1 Watt is reduced by 1dB for every dB the gain exceeds 23dBi.

The peak excursion envelope is limited to 13dB.

*OUTPUT POWER LIMITS –LELAN DEVICES*

The table below shows the limits for output power and output power density defined by RSS 210. Where the signal bandwidth is less than 20 MHz the maximum output power is reduced to the power spectral density limit plus 10 times the log of the bandwidth (in MHz).

Operating Frequency (MHz)	Output Power	Power Spectral Density
5150 – 5250	200mW (23 dBm) eirp	10 dBm/MHz eirp
5250 – 5350	250 mW (24 dBm) <sup>4</sup> 1W (30dBm) eirp	11 dBm/MHz
5470 – 5725	250 mW (24 dBm) <sup>5</sup> 1W (30dBm) eirp	11 dBm/MHz
5725 – 5825	1 Watts (30 dBm) 4W eirp	17 dBm/MHz

In addition, the power spectral density limit shall be reduced by 1dB for every dB the highest power spectral density exceeds the “average” power spectral density ) by more than 3dB. The “average” power spectral density is determined by dividing the output power by  $10\log(\text{EBW})$  where EBW is the 99% power bandwidth.

Fixed point-to-point applications using the 5725 – 5825 MHz band may use antennas with gains of up to 23dBi without this limitation. If the gain exceeds 23dBi then the output power limit of 1 Watt is reduced by 1dB for every dB the gain exceeds 23dBi.

<sup>4</sup> If EIRP exceeds 500mW the device must employ TPC

<sup>5</sup> If EIRP exceeds 500mW the device must employ TPC

**SPURIOUS EMISSIONS LIMITS –UNII and LELAN DEVICES**

The spurious emissions limits for signals below 1GHz are the FCC/RSS-GEN general limits. For emissions above 1GHz, signals in restricted bands are subject to the FCC/RSS GEN general limits. All other signals have a limit of  $-27\text{dBm/MHz}$ , which is a field strength of  $68.3\text{dBuV/m/MHz}$  at a distance of 3m. This is an average limit so the peak value of the emission may not exceed  $-7\text{dBm/MHz}$  ( $68.3\text{dBuV/m/MHz}$  at a distance of 3m). For devices operating in the 5725-5850Mhz bands under the LELAN/UNII rules, the limit within 10Mhz of the allocated band is increased to  $-17\text{dBm/MHz}$ .

**SAMPLE CALCULATIONS - CONDUCTED EMISSIONS**

Receiver readings are compared directly to the conducted emissions specification limit (decibel form) as follows:

$$R_r - S = M$$

where:

$R_r$  = Receiver Reading in dBuV

$S$  = Specification Limit in dBuV

$M$  = Margin to Specification in +/- dB

**SAMPLE CALCULATIONS - RADIATED EMISSIONS**

Receiver readings are compared directly to the specification limit (decibel form). The receiver internally corrects for cable loss, preamplifier gain, and antenna factor. The calculations are in the reverse direction of the actual signal flow, thus cable loss is added and the amplifier gain is subtracted. The Antenna Factor converts the voltage at the antenna coaxial connector to the field strength at the antenna elements.

A distance factor, when used for electric field measurements above 30MHz, is calculated by using the following formula:

$$F_d = 20 * \text{LOG}_{10} (D_m/D_s)$$

where:

$F_d$  = Distance Factor in dB

$D_m$  = Measurement Distance in meters

$D_s$  = Specification Distance in meters

For electric field measurements below 30MHz the extrapolation factor is either determined by making measurements at multiple distances or a theoretical value is calculated using the formula:

$$F_d = 40 * \text{LOG}_{10} (D_m/D_s)$$

Measurement Distance is the distance at which the measurements were taken and Specification Distance is the distance at which the specification limits are based. The antenna factor converts the voltage at the antenna coaxial connector to the field strength at the antenna elements.



The margin of a given emission peak relative to the limit is calculated as follows:

$$R_c = R_r + F_d$$

and

$$M = R_c - L_s$$

where:

$R_r$  = Receiver Reading in dBuV/m

$F_d$  = Distance Factor in dB

$R_c$  = Corrected Reading in dBuV/m

$L_s$  = Specification Limit in dBuV/m

$M$  = Margin in dB Relative to Spec

#### *SAMPLE CALCULATIONS - FIELD STRENGTH TO EIRP CONVERSION*

Where the radiated electric field strength is expressed in terms of the equivalent isotropic radiated power (eirp), or where a field strength measurement of output power is made in lieu of a direct measurement, the following formula is used to convert between eirp and field strength at a distance of d (meters) from the equipment under test:

$$E = \frac{1000000 \sqrt{30 P}}{d} \quad \text{microvolts per meter}$$

where P is the eirp (Watts)

For a measurement at 3m the conversion from a logarithmic value for field strength (dBuV/m) to an eirp power (dBm) is -95.3dB.

**Appendix A Test Equipment Calibration Data****Radiated Emissions, 1000 - 40,000 MHz, 22-Sep-10**

<u>Manufacturer</u>	<u>Description</u>	<u>Model</u>	<u>Asset #</u>	<u>Cal Due</u>
EMCO	Antenna, Horn, 1-18 GHz	3115	487	7/6/2012
Hewlett Packard	Microwave Preamplifier, 1-26.5GHz	8449B	870	6/25/2011
Micro-Tronics	Band Reject Filter, 5725-5875 MHz	BRC50705-02	1728	2/1/2011
Hewlett Packard	SpecAn 9 kHz - 40 GHz, (SA40) Purple	8564E (84125C)	1771	8/26/2011
Hewlett Packard	Head (Inc W1-W4, 1946, 1947) Purple	84125C	1772	5/6/2011
A.H. Systems	Blue System Horn, 18-40GHz	SAS-574, p/n: 2581	2159	3/18/2011

**Radio Antenna Port (Bandedge), 23-Sep-10**

<u>Manufacturer</u>	<u>Description</u>	<u>Model</u>	<u>Asset #</u>	<u>Cal Due</u>
EMCO	Antenna, Horn, 1-18 GHz	3115	786	12/11/2011
Hewlett Packard	SpecAn 9 kHz - 40 GHz, FT (SA40) Blue	8564E (84125C)	1393	4/14/2011

**5GHz Bandedges, 23-Sep-10**

<u>Manufacturer</u>	<u>Description</u>	<u>Model</u>	<u>Asset #</u>	<u>Cal Due</u>
EMCO	Antenna, Horn, 1-18 GHz	3115	786	12/11/2011
Hewlett Packard	SpecAn 9 kHz - 40 GHz, FT (SA40) Blue	8564E (84125C)	1393	4/14/2011

**UNII Spurious Emissions, 27-Sep-10**

<u>Manufacturer</u>	<u>Description</u>	<u>Model</u>	<u>Asset #</u>	<u>Cal Due</u>
Hewlett Packard	Microwave Preamplifier, 1-26.5GHz	8449B	263	12/15/2010
EMCO	Antenna, Horn, 1-18 GHz	3115	786	12/11/2011
Narda West	High Pass Filter, 8 GHz	HPF 180	821	3/29/2011
Hewlett Packard	SpecAn 9 kHz - 40 GHz, FT (SA40) Blue	8564E (84125C)	1393	4/14/2011
Micro-Tronics	Band Reject Filter, 5470-5725 MHz	BRC50704-02	1730	9/3/2011

**UNII Bandedge, MIMO, 28-Sep-10**

<u>Manufacturer</u>	<u>Description</u>	<u>Model</u>	<u>Asset #</u>	<u>Cal Due</u>
EMCO	Antenna, Horn, 1-18 GHz	3115	786	12/11/2011
Rohde & Schwarz	Power Meter, Single Channel	NRVS	1290	10/22/2010
Hewlett Packard	SpecAn 9 kHz - 40 GHz, FT (SA40) Blue	8564E (84125C)	1393	4/14/2011
Rohde & Schwarz	Power Sensor 100 uW - 10 Watts	NRV-Z53	1555	2/5/2011
Rohde & Schwarz	Attenuator, 20 dB, 50 ohm, 10W, DC-18 GHz	20dB, 10W, Type N	1556	2/5/2011

**Conducted Emissions - AC Power Ports, 28-Sep-10**

<u>Manufacturer</u>	<u>Description</u>	<u>Model</u>	<u>Asset #</u>	<u>Cal Due</u>
Rohde & Schwarz	Pulse Limiter	ESH3 Z2	372	2/3/2011
Solar Electronics	LISN	8028-50-TS-24-BNC support	904	3/2/2011
EMCO	LISN, 10 kHz-100 MHz	3825/2	1292	3/12/2011
Hewlett Packard	EMC Spectrum Analyzer, 9 KHz - 22 GHz	8593EM	1319	10/19/2010
Rohde & Schwarz	Test Receiver, 9 kHz-2750 MHz	ESCS 30	1337	11/11/2010

**Radiated Emissions, 30 - 1,000 MHz, 28-Sep-10**

<u>Manufacturer</u>	<u>Description</u>	<u>Model</u>	<u>Asset #</u>	<u>Cal Due</u>
Hewlett Packard	EMC Spectrum Analyzer, 9 KHz - 22 GHz	8593EM	1319	10/19/2010
Rohde & Schwarz	Test Receiver, 9 kHz-2750 MHz	ESCS 30	1337	11/11/2010
Sunol Sciences	Biconilog, 30-3000 MHz	JB3	1548	6/24/2012
Com-Power Corp.	Preamplifier, 30-1000 MHz	PAM-103	2234	5/19/2011

**RE, Wi-Fi & BT Simultaneous Tx, 30-Sep-10**

<u>Manufacturer</u>	<u>Description</u>	<u>Model</u>	<u>Asset #</u>	<u>Cal Due</u>
Hewlett Packard	Microwave Preamplifier, 1-26.5GHz	8449B	263	12/15/2010
EMCO	Antenna, Horn, 1-18 GHz	3115	786	12/11/2011
Rohde & Schwarz	Power Meter, Single Channel	NRVS	1290	10/22/2010
Hewlett Packard	SpecAn 9 kHz - 40 GHz, FT (SA40) Blue	8564E (84125C)	1393	4/14/2011
Rohde & Schwarz	Power Sensor 100 uW - 10 Watts	NRV-Z53	1555	2/5/2011
Rohde & Schwarz	Attenuator, 20 dB , 50 ohm, 10W, DC-18 GHz	20dB, 10W, Type N	1556	2/5/2011
Micro-Tronics	Band Reject Filter, 2400-2500 MHz	BRM50702-02	1683	8/10/2011

**Radiated Emissions, 04,05,06-Oct-10**

<u>Manufacturer</u>	<u>Description</u>	<u>Model</u>	<u>Asset #</u>	<u>Cal Due</u>
Rohde & Schwarz	Power Meter, Single Channel	NRVS	1290	10/22/2010
Rohde & Schwarz	Power Sensor 100 uW - 10 Watts	NRV-Z53	1555	2/5/2011
EMCO	Antenna, Horn, 1-18 GHz	3115	1561	6/22/2012
Hewlett Packard	SpecAn 9 kHz - 40 GHz, (SA40) Purple	8564E (84125C)	1771	8/26/2011

### *Appendix B Test Data*

T80540		
AC Conducted Emissions		84 Pages
Radiated Spurious Emissions		
T80759		59 Pages
Antenna Port Measurements		
T80540		
Radiated Spurious Emissions – simultaneous transmissions from Bluetooth and Wi-Fi transceivers		30 Pages



## EMC Test Data

Client:	Intel Corporation	Job Number:	J80398
Model:	Intel® Centrino® Advanced-N 6230	T-Log Number:	T80540
		Account Manager:	Christine Krebill
Contact:	Steve Hackett		-
Emissions Standard(s):	FCC 15.247	Class:	B
Immunity Standard(s):	-	Environment:	-

# EMC Test Data

For The

## Intel Corporation

Model

**Intel® Centrino® Advanced-N 6230**

Date of Last Test: 10/6/2010

Client:	Intel Corporation	Job Number:	J80398
Model:	Intel® Centrino® Advanced-N 6230	T-Log Number:	T80540
Contact:	Steve Hackett	Account Manager:	Christine Krebill
Standard:	FCC 15.247	Class:	B

**Conducted Emissions**

*(Elliott Laboratories Fremont Facility, Semi-Anechoic Chamber)*

**Test Specific Details**

Objective: The objective of this test session is to perform final qualification testing of the EUT with respect to the specification listed above.

Date of Test: 9/28/2010	Config. Used: Modular Test
Test Engineer: Rafael Varelas	Config Change: None
Test Location: FT Chamber #7	Host Unit Voltage 120V/60Hz

**General Test Configuration**

The test fixture was located on a wooden table inside the semi-anechoic chamber, 40 cm from a vertical coupling plane and 80cm from the LISN. A second LISN was used for all local support equipment.

**Ambient Conditions:**

Temperature:	21.9 °C
Rel. Humidity:	42 %

**Summary of Results**

MAC Address: 00150079AD1A DRTU Tool Version 1.2.12-0197 Driver version 14.0.0.39

Run #	Test Performed	Limit	Result	Margin
1	CE, AC Power, 120V/60Hz	RSS 210 / 15.207	Pass	40.6dBµV @ 14.758MHz (-9.4dB)

**Modifications Made During Testing**

No modifications were made to the EUT during testing

**Deviations From The Standard**

No deviations were made from the requirements of the standard.

Client:	Intel Corporation	Job Number:	J80398
Model:	Intel® Centrino® Advanced-N 6230	T-Log Number:	T80540
Contact:	Steve Hackett	Account Manager:	Christine Krebill
Standard:	FCC 15.247	Class:	B

**Run #1: AC Power Port Conducted Emissions, 0.15 - 30MHz, 120V/50Hz**

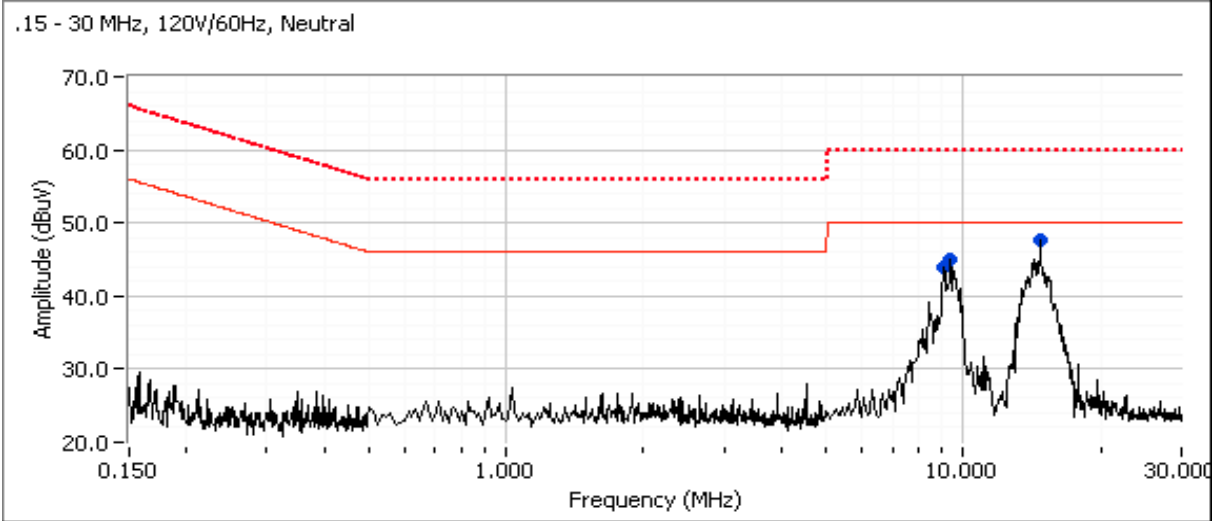
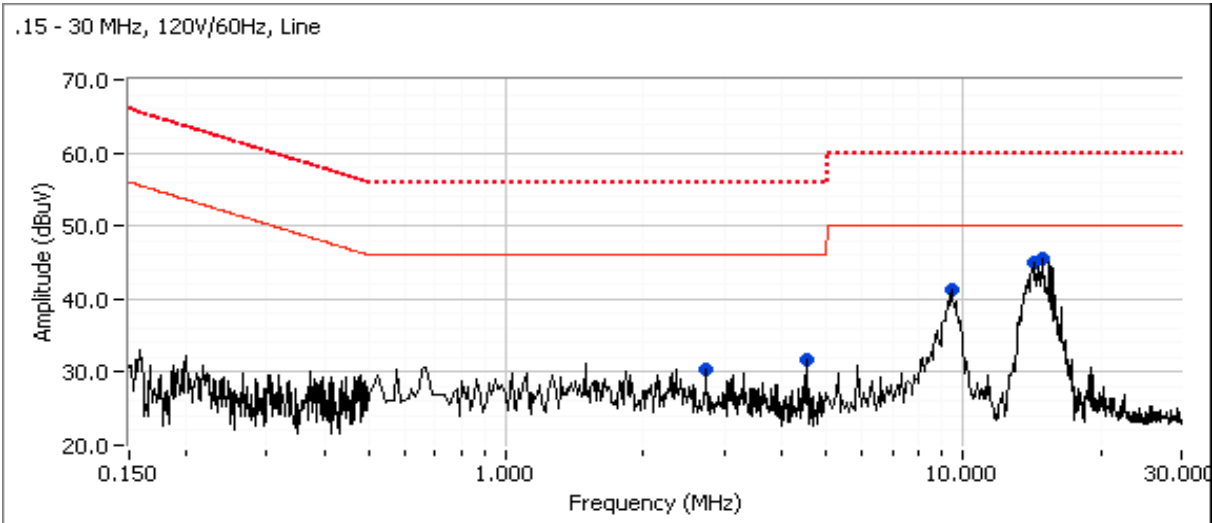

Client:	Intel Corporation	Job Number:	J80398
Model:	Intel® Centrino® Advanced-N 6230	T-Log Number:	T80540
Contact:	Steve Hackett	Account Manager:	Christine Krebill
Standard:	FCC 15.247	Class:	B

**Preliminary peak readings captured during pre-scan (peak readings vs. average limit)**

Frequency MHz	Level dB $\mu$ V	AC Line	Class B		Detector QP/Ave	Comments
			Limit	Margin		
2.739	30.4	Line 1	46.0	-15.6	Peak	
4.528	31.8	Line 1	46.0	-14.2	Peak	
9.571	41.2	Line 1	50.0	-8.8	Peak	
14.272	44.9	Line 1	50.0	-5.1	Peak	
14.925	45.4	Line 1	50.0	-4.6	Peak	
9.073	44.0	Neutral	50.0	-6.0	Peak	
9.336	44.9	Neutral	50.0	-5.1	Peak	
14.758	47.7	Neutral	50.0	-2.3	Peak	

**Final quasi-peak and average readings**

Frequency MHz	Level dB $\mu$ V	AC Line	Class B		Detector QP/Ave	Comments
			Limit	Margin		
<b>14.758</b>	<b>40.6</b>	Neutral	50.0	<b>-9.4</b>	AVG	AVG (0.100s)
14.272	40.1	Line 1	50.0	-9.9	AVG	AVG (0.100s)
14.925	35.7	Line 1	50.0	-14.3	AVG	AVG (0.100s)
14.272	44.8	Line 1	60.0	-15.2	QP	QP (1.000s)
9.336	34.6	Neutral	50.0	-15.4	AVG	AVG (0.100s)
14.758	44.6	Neutral	60.0	-15.4	QP	QP (1.000s)
9.073	32.7	Neutral	50.0	-17.3	AVG	AVG (0.100s)
9.571	32.6	Line 1	50.0	-17.4	AVG	AVG (0.100s)
14.925	42.4	Line 1	60.0	-17.6	QP	QP (1.000s)
9.073	39.9	Neutral	60.0	-20.1	QP	QP (1.000s)
9.336	39.7	Neutral	60.0	-20.3	QP	QP (1.000s)
9.571	37.9	Line 1	60.0	-22.1	QP	QP (1.000s)



Client:	Intel Corporation	Job Number:	J80398
Model:	Intel® Centrino® Advanced-N 6230	T-Log Number:	T80540
Contact:	Steve Hackett	Account Manager:	Christine Krebill
Standard:	FCC 15.247	Class:	B

## Radiated Emissions 30-1000 MHz, Wireless Module (FCC 15.247/RSS 210)

*(Elliott Laboratories Fremont Facility, Semi-Anechoic Chamber)*

### Test Specific Details

Objective: The objective of this test session is to perform final qualification testing of the EUT with respect to the specification listed above.

Date of Test: 9/28/2010	Config. Used: Modular Test
Test Engineer: Rafael Varelas	Config Change: None
Test Location: FT Chamber #7	Host Unit Voltage 120V/60Hz

### General Test Configuration

The EUT and any local support equipment were located on the turntable for radiated emissions testing.

The test distance and extrapolation factor (if applicable) are detailed under each run description.

Note, preliminary testing indicates that the emissions were maximized by orientation of the EUT and elevation of the measurement antenna. Maximizing testing indicated that the emissions were maximized by orientation of the EUT, elevation of the measurement antenna, and manipulation of the EUT's interface cables.

### Ambient Conditions:

Temperature:	21.9 °C
Rel. Humidity:	42 %

### Summary of Results

**MAC Address: 00150079AD1A DRTU Tool Version 1.2.12-0197 Driver version 14.0.0.39**

Run #	Test Performed	Limit	Result	Margin
1	Radiated Emissions 30 - 1000 MHz	FCC 15.209 / RSS 210	Pass	41.2dBµV/m @ 662.52MHz (-4.8dB)

**Note - preliminary measurements indicated that the radiated emissions from the combination of test fixture and EUT were not affected by the modules operating frequency or mode (transmit versus receive mode). The system was therefore evaluated against the most stringent set of limits from FCC 15.247, FCC 15E and RSS 210 with the device operating at max power (16.5dBm) on Chain A at 2437MHz, 802.11b mode and max power (7dBm) on the top channel in Bluetooth mode (1Mb/s data**

### Modifications Made During Testing

No modifications were made to the EUT during testing

### Deviations From The Standard

No deviations were made from the requirements of the standard.

Client:	Intel Corporation	Job Number:	J80398
Model:	Intel® Centrino® Advanced-N 6230	T-Log Number:	T80540
Contact:	Steve Hackett	Account Manager:	Christine Krebill
Standard:	FCC 15.247	Class:	B

**Run #1: Preliminary Radiated Emissions, 30 - 1000 MHz**

Configured to TX , 802.11b 16.5dBm on each chain (settings 23.5) on channel 6, Bluetooth 7dBm, 1Mb/s (settings 8.0)

Frequency Range	Test Distance	Limit Distance	Extrapolation Factor
30 - 1000 MHz	3	3	0.0

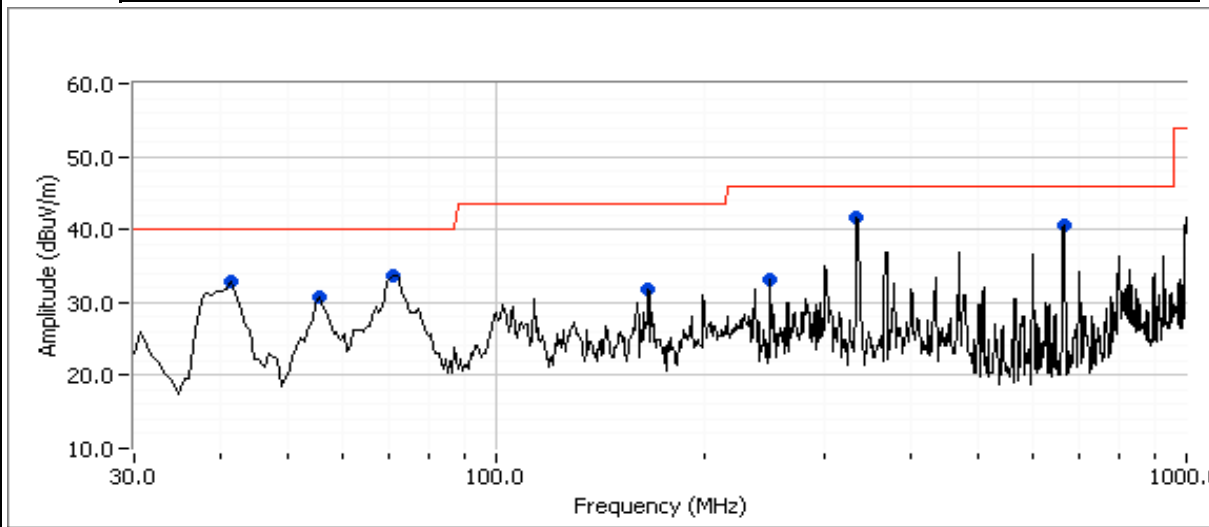

**Preliminary peak readings captured during pre-scan**

Frequency	Level	Pol	FCC 15.209 / RSS 210		Detector	Azimuth	Height	Comments
MHz	dBμV/m	v/h	Limit	Margin	Pk/QP/Avg	degrees	meters	
39.869	33.0	V	40.0	-7.0	Peak	185	2.5	
55.317	30.8	V	40.0	-9.2	Peak	333	1.0	
70.276	33.6	V	40.0	-6.4	Peak	40	1.0	
166.249	31.8	V	43.5	-11.7	Peak	202	1.0	
250.000	33.1	H	46.0	-12.9	Peak	154	1.5	
299.217	36.3	H	46.0	-9.7	Peak	172	1.0	
332.857	41.7	H	46.0	-4.3	Peak	116	1.0	
662.560	40.5	V	46.0	-5.5	Peak	44	1.0	

**Maximized quasi-peak readings (includes manipulation of EUT interface cables)**

Frequency	Level	Pol	FCC 15.209 / RSS 210		Detector	Azimuth	Height	Comments
MHz	dBμV/m	v/h	Limit	Margin	Pk/QP/Avg	degrees	meters	
662.515	41.2	V	46.0	-4.8	QP	44	1.0	QP (1.000s)
332.857	36.9	H	46.0	-9.1	QP	116	1.0	QP (1.000s)
39.869	29.7	V	40.0	-10.3	QP	185	2.5	QP (1.000s)
70.276	29.3	V	40.0	-10.7	QP	40	1.0	QP (1.000s)
55.317	27.1	V	40.0	-12.9	QP	333	1.0	QP (1.000s)
166.249	27.3	V	43.5	-16.2	QP	202	1.0	QP (1.000s)

Client:	Intel Corporation	Job Number:	J80398
Model:	Intel® Centrino® Advanced-N 6230	T-Log Number:	T80540
Contact:	Steve Hackett	Account Manager:	Christine Krebill
Standard:	FCC 15.247	Class:	N/A

## RSS 210 and FCC 15.407 (UNII) Radiated Spurious Emissions - Band Edges

### Summary of Results

MAC Address: **00150079AD1A** DRTU Tool Version **1.2.12-0197 New tool from 9/14** Driver version **14.0.0.39**

Run #	Mode	Channel	Power Setting	Measured Power	Test Performed	Limit	Result / Margin
Run #1	n40 Chain A	#38 5190MHz	16.5	<b>12.5</b>	Restricted Band Edge at 5150 MHz	15.209	52.5dBµV/m @ 5150.0MHz (-1.5dB)
Run #1	n40 Chain A	#62 5310MHz	16.5	<b>11.5</b>	Restricted Band Edge at 5350 MHz	15.209	52.2dBµV/m @ 5350.0MHz (-1.8dB)
Run #1	n40 Chain A	#102 5510MHz	16.5	<b>15.8</b>	Restricted Band Edge at 5460 MHz	15.209	53.0dBµV/m @ 5460.0MHz (-1.0dB)
					Band Edge at 5470 MHz	15 E	60.5dBµV/m @ 5470.0MHz (-7.8dB)
Run #1	n40 Chain A	#134 5670MHz	16.5	16.5	Band Edge at 5725 MHz	15 E	47.6dBµV/m @ 5725.0MHz (-20.7dB)
Run # 2	n20 Chain A	#36 5180MHz	16.5	<b>15.9</b>	Restricted Band Edge at 5150 MHz	15.209	51.6dBµV/m @ 5150.0MHz (-2.4dB)
Run # 2	n20 Chain A	#64 5320MHz	16.5	16.7	Restricted Band Edge at 5350 MHz	15.209	48.7dBµV/m @ 5350.0MHz (-5.3dB)
Run # 2	n20 Chain A	#100 5500MHz	16.5	16.7	Restricted Band Edge at 5460 MHz	15.209	44.3dBµV/m @ 5460.0MHz (-9.7dB)
					Band Edge at 5470 MHz	15 E	50.4dBµV/m @ 5470.0MHz (-17.9dB)
Run # 2	n20 Chain A	#140 5700MHz	16.5	16.7	Band Edge at 5725 MHz	15 E	54.6dBµV/m @ 5725.0MHz (-13.7dB)
Run # 3	802.11a Chain A	#36 5180MHz	16.5	16.5	Restricted Band Edge at 5150 MHz	15.209	50.1dBµV/m @ 5150.0MHz (-3.9dB)
Run # 3	802.11a Chain A	#64 5320MHz	16.5	16.7	Restricted Band Edge at 5350 MHz	15.209	48.5dBµV/m @ 5350.0MHz (-5.5dB)
Run # 3	802.11a Chain A	#100 5500MHz	16.5	16.6	Restricted Band Edge at 5460 MHz	15.209	44.2dBµV/m @ 5459.9MHz (-9.8dB)
					Band Edge at 5470 MHz	15 E	50.7dBµV/m @ 5470.0MHz (-17.6dB)
Run # 3	802.11a Chain A	#140 5700MHz	16.5	16.7	Band Edge at 5725 MHz	15 E	51.1dBµV/m @ 5725.0MHz (-17.2dB)

Note - the target and measured power are average powers (measured with average power sensor) and are used for reference purposes only. Power is set using "**GAIN CONTROL**" mode in the DRTU tool.

Client:	Intel Corporation	Job Number:	J80398
Model:	Intel® Centrino® Advanced-N 6230	T-Log Number:	T80540
		Account Manager:	Christine Krebill
Contact:	Steve Hackett		
Standard:	FCC 15.247	Class:	N/A

## Test Specific Details

Objective: The objective of this test session is to perform engineering evaluation testing of the EUT with respect to the specification listed above.

## General Test Configuration

The EUT was installed into a test fixture such that the EUT was exposed (i.e. outside of a host PC).  
 For radiated emissions testing the measurement antenna was located 3 meters from the EUT.

## Ambient Conditions:

Rel. Humidity: 15 - 55 %  
 Temperature: 18 - 25 °C

## Modifications Made During Testing

No modifications were made to the EUT during testing

## Deviations From The Standard

No deviations were made from the requirements of the standard.

## Marker Delta Measurements

Three sets of marker deltas are measured using the following settings: RB=VB=100kHz; RB=1MHz,VB=1MHz; RB=1MHz, VB=10Hz.  
 Marker deltas are made conducted (analyzer connected to EUT rf port a 20dB pad) for single chain operation.  
 The fundamental field strength is always measured at a 3m test distance.

Client: Intel Corporation	Job Number: J80398
Model: Intel® Centrino® Advanced-N 6230	T-Log Number: T80540
Contact: Steve Hackett	Account Manager: Christine Krebill
Standard: FCC 15.247	Class: N/A

**Run #1, Band Edge Field Strength - n40, Chain A**

**Run #1a, EUT on Channel #38 5190MHz - n40, Chain A**

Date of Test: 9/22/2010

Test Location: FT Chamber#7

Test Engineer: Joseph Cadigal

Config Change: none

	Power Settings		
	Target (dBm)	Measured (dBm)	Software Setting
Chain A	16.5	12.5	21.0

**Fundamental Signal Field Strength**

Frequency	Level	Pol	15.209 / 15.247		Detector	Azimuth	Height	Comments
MHz	dBuV/m	v/h	Limit	Margin	Pk/QP/Avg	degrees	meters	
5193.000	90.9	V	-	-	AVG	184	1.0	RB 1 MHz;VB 10 Hz;Pk
5193.670	98.7	V	-	-	PK	184	1.0	RB 1 MHz;VB 3 MHz;Pk
5193.070	91.3	H	-	-	AVG	304	1.0	RB 1 MHz;VB 10 Hz;Pk
5191.400	99.2	H	-	-	PK	304	1.0	RB 1 MHz;VB 3 MHz;Pk

**5150 MHz Band Edge Signal Radiated Field Strength - Marker Delta**

	H	V	
Fundamental emission level @ 3m in 1MHz RBW:	99.2	98.7	Peak Measurement (RB=VB=1MHz)
Fundamental emission level @ 3m in 1MHz RBW:	91.3	90.9	Average Measurement (RB=1MHz, VB=10Hz)
<i>Delta Marker - 100kHz</i>	<b>38.8 dB</b>		<- this can only be used if band edge signal is highest within 2MHz of band edge.
Calculated Band-Edge Measurement (Peak):	60.4 dBuV/m		
Calculated Band-Edge Measurement (Avg):	52.5 dBuV/m	Margin	Level
<i>Delta Marker - 1MHz/1MHz:</i>	34.0 dB	-1.5	52.5
<i>Delta Marker - 1MHz/10Hz:</i>	38.3 dB	-13.6	60.4
Calculated Band-Edge Measurement (Peak):	65.2 dBuV/m		74
Calculated Band-Edge Measurement (Avg):	53.0 dBuV/m		

Frequency	Level	Pol	FCC 15.209		Detector	Azimuth	Height	Comments
MHz	dBuV/m	v/h	Limit	Margin	Pk/QP/Avg	degrees	meters	
<b>5150.000</b>	<b>52.5</b>	-	54.0	<b>-1.5</b>	Avg	-	-	Using 100kHz delta value

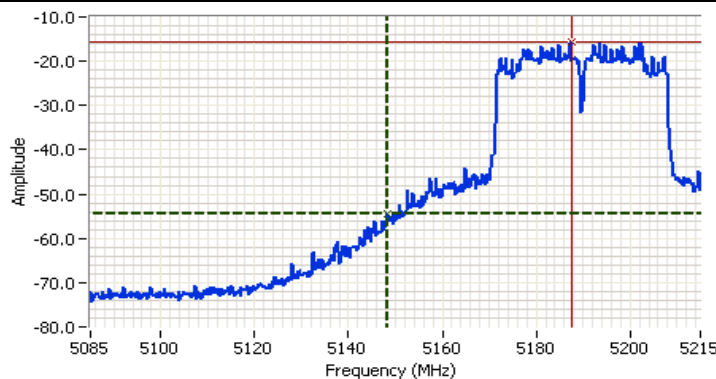

**Analyzer Settings**  
 HP8564E,EMICF: 5150.000 MHz  
 SPAN: 130.000 MHz  
 RB: 100 kHz  
 VB: 100 kHz  
 Detector: POS  
 Attn: 10 DB  
 RL Offset: 0.0 DB  
 Sweep Time: 72.0ms  
 Ref Lvl: 0.0 DBM

**Comments**  
 BE @ 5150 MHz  
 802.11n40  
 Chain A

Cursor 1	5148.2666	-54.50	
Cursor 2	5187.4834	-15.67	

Delta Freq. 39.217  
 Delta Amplitude 38.83



Client: Intel Corporation	Job Number: J80398
Model: Intel® Centrino® Advanced-N 6230	T-Log Number: T80540
Contact: Steve Hackett	Account Manager: Christine Krebill
Standard: FCC 15.247	Class: N/A

### Run #1b, EUT on Channel #62 5310MHz - n40, Chain A

Date of Test: 9/22/2010      Test Location: FT Chamber #7  
 Test Engineer: Joseph Cadigal      Config Change: none

	Target (dBm)	Power Settings Measured (dBm)	Software Setting
Chain A	16.5	11.5	21.0

### Fundamental Signal Field Strength

Frequency	Level	Pol	15.209 / 15.247		Detector	Azimuth	Height	Comments
MHz	dBuV/m	v/h	Limit	Margin	Pk/QP/Avg	degrees	meters	
5312.730	89.4	V	-	-	AVG	305	1.0	RB 1 MHz;VB 10 Hz;Pk
5316.870	97.2	V	-	-	PK	305	1.0	RB 1 MHz;VB 3 MHz;Pk
5307.000	93.0	H	-	-	AVG	305	1.3	RB 1 MHz;VB 10 Hz;Pk
5303.670	101.1	H	-	-	PK	305	1.3	RB 1 MHz;VB 3 MHz;Pk

### 5350 MHz Band Edge Signal Radiated Field Strength - Marker Delta

	H	V				
Fundamental emission level @ 3m in 1MHz RBW:	101.1	97.2	Peak Measurement (RB=VB=1MHz)			
Fundamental emission level @ 3m in 1MHz RBW:	93.0	89.4	Average Measurement (RB=1MHz, VB=10Hz)			
Delta Marker - 100kHz	39.5 dB		-< this can only be used if band edge signal is highest within 2MHz of band edge.			
Calculated Band-Edge Measurement (Peak):	61.6 dBuV/m					
Calculated Band-Edge Measurement (Avg):	53.5 dBuV/m		Margin	Level	Limit	Detector
Delta Marker - 1MHz/1MHz:	36.2 dB		-1.8	52.2	54	Avg
Delta Marker - 1MHz/10Hz:	40.8 dB		-12.4	61.6	74	Pk
Calculated Band-Edge Measurement (Peak):	64.9 dBuV/m		Using 100kHz delta value			
Calculated Band-Edge Measurement (Avg):	52.2 dBuV/m		Using 1MHz delta value			

Frequency	Level	Pol	FCC 15.209		Detector	Azimuth	Height	Comments
MHz	dBuV/m	v/h	Limit	Margin	Pk/QP/Avg	degrees	meters	
5350.000	52.2	-	54.0	-1.8	Avg	-	-	Using 1MHz delta value

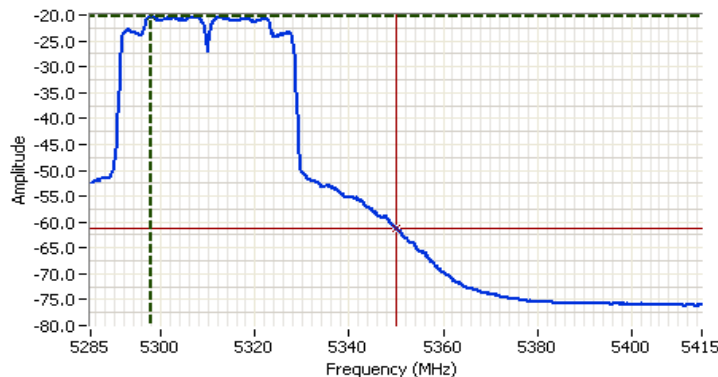

**Analyzer Settings**  
 HP8564E,EMICF: 5350.000 MHz  
 SPAN: 130.000 MHz  
 RB: 1.000 MHz  
 VB: 10 Hz  
 Detector: Sample  
 Attn: 10 DB  
 RL Offset: 0.0 DB  
 Sweep Time: 49.0s  
 Ref Lvl: 0.0 DBM

**Comments**  
 BE @ 5350 MHz  
 802.11n40  
 Chain A

Cursor 1	5297.7832	-20.33	
Cursor 2	5350.0000	-61.17	

Delta Freq. 52.217  
 Delta Amplitude 40.83



Client:	Intel Corporation	Job Number:	J80398
Model:	Intel® Centrino® Advanced-N 6230	T-Log Number:	T80540
Contact:	Steve Hackett	Account Manager:	Christine Krebill
Standard:	FCC 15.247	Class:	N/A

### Run #1c, EUT on Channel #102 5510MHz - n40, Chain A

	Target (dBm)	Power Settings Measured (dBm)	Software Setting
Chain A	16.5	15.8	28.5

### Fundamental Signal Field Strength

Frequency	Level	Pol	15.209 / 15.247		Detector	Azimuth	Height	Comments
MHz	dBμV/m	v/h	Limit	Margin	Pk/QP/Avg	degrees	meters	
5513.130	94.2	V	-	-	AVG	177	1.0	RB 1 MHz;VB 10 Hz;Pk
5517.330	102.5	V	-	-	PK	177	1.0	RB 1 MHz;VB 3 MHz;Pk
5497.530	94.3	H	-	-	AVG	224	1.0	RB 1 MHz;VB 10 Hz;Pk
5497.270	102.7	H	-	-	PK	224	1.0	RB 1 MHz;VB 3 MHz;Pk

### 5460 MHz Restricted Band Edge Signal Radiated Field Strength - Marker Delta

	H	V				
Fundamental emission level @ 3m in 1MHz RBW:	102.7	102.5	Peak Measurement (RB=VB=1MHz)			
Fundamental emission level @ 3m in 1MHz RBW:	94.3	94.2	Average Measurement (RB=1MHz, VB=10Hz)			
Delta Marker - 100kHz	40.0 dB		<- this can only be used if band edge signal is highest within 2MHz of band edge.			
Calculated Band-Edge Measurement (Peak):	62.7 dBμV/m					
Calculated Band-Edge Measurement (Avg):	54.3 dBμV/m		Margin	Level	Limit	Detector
Delta Marker - 1MHz/1MHz:	35.5 dB		-1.0	53.0	54	Avg
Delta Marker - 1MHz/10Hz:	41.3 dB		-11.3	62.7	74	Pk
Calculated Band-Edge Measurement (Peak):	67.2 dBμV/m		Using 100kHz delta value			
Calculated Band-Edge Measurement (Avg):	53.0 dBμV/m		Using 1MHz delta value			

Frequency	Level	Pol	FCC 15.209		Detector	Azimuth	Height	Comments
MHz	dBμV/m	v/h	Limit	Margin	Pk/QP/Avg	degrees	meters	
5460.000	53.0	-	54.0	-1.0	Avg	-	-	Using 1MHz delta value

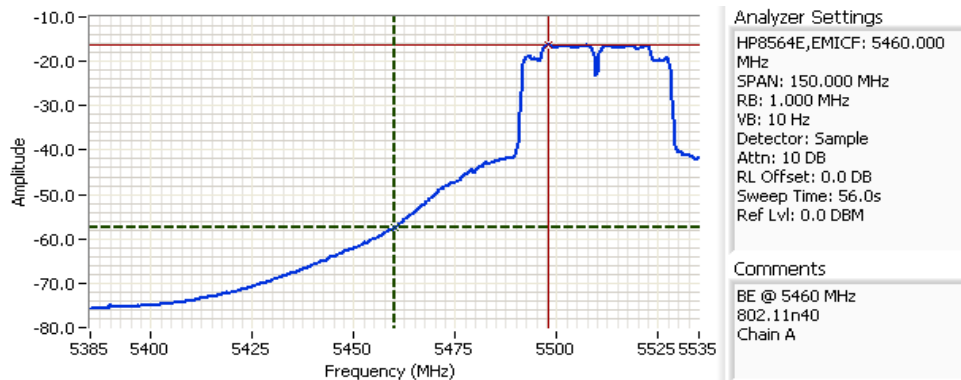

Analyzer Settings  
 HP8564E,EMICF: 5460.000 MHz  
 SPAN: 150.000 MHz  
 RB: 1.000 MHz  
 VB: 10 Hz  
 Detector: Sample  
 Attn: 10 DB  
 RL Offset: 0.0 DB  
 Sweep Time: 56.0s  
 Ref Lvl: 0.0 DBM

Comments  
 BE @ 5460 MHz  
 802.11n40  
 Chain A

Cursor 1	5460.0000	-57.50	
Cursor 2	5497.7500	-16.17	

Delta Freq. 37.750  
 Delta Amplitude 41.33



Client: Intel Corporation	Job Number: J80398
Model: Intel® Centrino® Advanced-N 6230	T-Log Number: T80540
Contact: Steve Hackett	Account Manager: Christine Krebill
Standard: FCC 15.247	Class: N/A

### 5470 MHz Band Edge Signal Radiated Field Strength - Marker Delta

	H	V	
Fundamental emission level @ 3m in 1MHz RBW:	102.7	102.5	Peak Measurement (RB=VB=1MHz)
Fundamental emission level @ 3m in 1MHz RBW:	94.3	94.2	Average Measurement (RB=1MHz, VB=10Hz)
<i>Delta Marker - 100kHz</i>	<b>33.8 dB</b>		<- this can only be used if band edge signal is highest within 2MHz of band edge.
Calculated Band-Edge Measurement (Peak):	68.9 dBuV/m		
Calculated Band-Edge Measurement (Avg):	60.5 dBuV/m		
			Margin
<i>Delta Marker - 1MHz/1MHz:</i>	31.0 dB		-7.8
<i>Delta Marker - 1MHz/10Hz:</i>	33.7 dB		60.5
Calculated Band-Edge Measurement (Peak):	71.7 dBuV/m		68.3
Calculated Band-Edge Measurement (Avg):	60.6 dBuV/m		88.3
			Avg
			Pk
			Using 100kHz delta value
			Using 100kHz delta value

Frequency	Level	Pol	FCC 15E		Detector	Azimuth	Height	Comments
MHz	dBuV/m	v/h	Limit	Margin	Pk/QP/Avg	degrees	meters	
5470.000	60.5	-	68.3	-7.8	Avg	-	-	Using 100kHz delta value

Note - average limit is equivalent to -27dBm eirp.

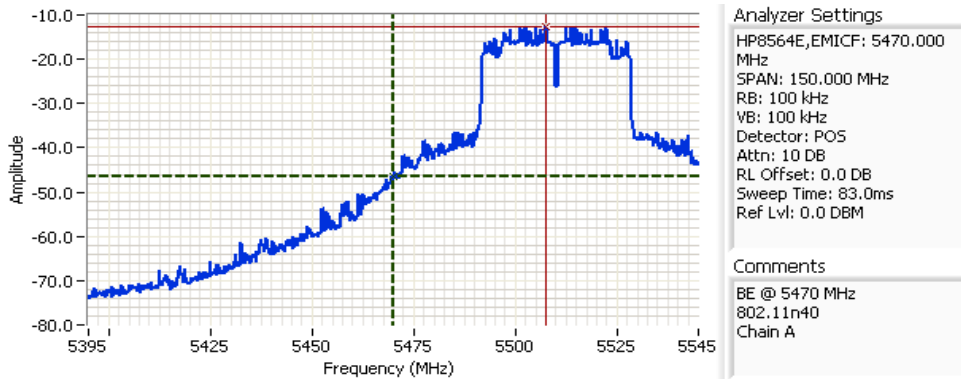

Cursor 1 5470.0000 -46.33 Delta Freq. 37.500

Cursor 2 5507.5000 -12.50 Delta Amplitude 33.83



Client: Intel Corporation	Job Number: J80398
Model: Intel® Centrino® Advanced-N 6230	T-Log Number: T80540
Contact: Steve Hackett	Account Manager: Christine Krebill
Standard: FCC 15.247	Class: N/A

### Run #1d, EUT on Channel #134 5670MHz - n40, Chain A

	Target (dBm)	Power Settings Measured (dBm)	Software Setting
Chain A	16.5	16.5	29.5

### Fundamental Signal Field Strength

Frequency	Level	Pol	15.209 / 15.247		Detector	Azimuth	Height	Comments
MHz	dBuV/m	v/h	Limit	Margin	Pk/QP/Avg	degrees	meters	
5657.730	94.9	V	-	-	AVG	209	1.0	RB 1 MHz;VB 10 Hz;Pk
5657.800	103.4	V	-	-	PK	209	1.0	RB 1 MHz;VB 3 MHz;Pk
5661.930	93.8	H	-	-	AVG	346	1.0	RB 1 MHz;VB 10 Hz;Pk
5664.000	102.3	H	-	-	PK	346	1.0	RB 1 MHz;VB 3 MHz;Pk

### 5725 MHz Restricted Band Edge Signal Radiated Field Strength - Marker Delta

	H	V				
Fundamental emission level @ 3m in 1MHz RBW:	102.3	103.4	Peak Measurement (RB=VB=1MHz)			
Fundamental emission level @ 3m in 1MHz RBW:	93.8	94.9	Average Measurement (RB=1MHz, VB=10Hz)			
Delta Marker - 100kHz	47.3 dB		<- this can only be used if band edge signal is highest within 2MHz of band edge.			
Calculated Band-Edge Measurement (Peak):	56.1 dBuV/m					
Calculated Band-Edge Measurement (Avg):	47.6 dBuV/m	Margin	Level	Limit	Detector	
Delta Marker - 1MHz/1MHz:	42.2 dB	-20.7	47.6	68.3	Avg	
Delta Marker - 1MHz/10Hz:	46.7 dB	-32.2	56.1	88.3	Pk	
Calculated Band-Edge Measurement (Peak):	61.2 dBuV/m	Using 100kHz delta value				
Calculated Band-Edge Measurement (Avg):	48.2 dBuV/m	Using 100kHz delta value				

Frequency	Level	Pol	FCC 15E		Detector	Azimuth	Height	Comments
MHz	dBuV/m	v/h	Limit	Margin	Pk/QP/Avg	degrees	meters	
5725.000	47.6	-	68.3	-20.7	Avg	-	-	Using 100kHz delta value

Note - average limit is equivalent to -27dBm eirp.

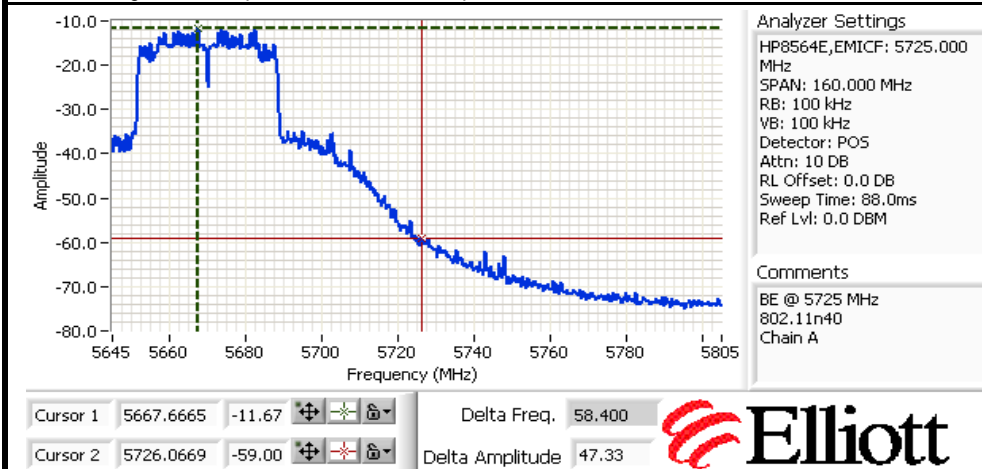

Client: Intel Corporation	Job Number: J80398
Model: Intel® Centrino® Advanced-N 6230	T-Log Number: T80540
Contact: Steve Hackett	Account Manager: Christine Krebill
Standard: FCC 15.247	Class: N/A

**Run # 2, Band Edge Field Strength - n20, Chain A**

**Run # 2a, EUT on Channel #36 5180MHz - n20, Chain A**

Date of Test: 9/22/2010

Test Location: FT Chamber#7

Test Engineer: Joseph Cadigal

Config Change: none

	Power Settings		
	Target (dBm)	Measured (dBm)	Software Setting
Chain A	16.5	15.9	24.5

**Fundamental Signal Field Strength**

Frequency	Level	Pol	15.209 / 15.247		Detector	Azimuth	Height	Comments
MHz	dBuV/m	v/h	Limit	Margin	Pk/QP/Avg	degrees	meters	
5173.030	96.3	V	-	-	AVG	183	1.0	RB 1 MHz;VB 10 Hz;Pk
5173.270	104.4	V	-	-	PK	183	1.0	RB 1 MHz;VB 3 MHz;Pk
5173.070	98.4	H	-	-	AVG	305	1.4	RB 1 MHz;VB 10 Hz;Pk
5174.530	106.7	H	-	-	PK	305	1.4	RB 1 MHz;VB 3 MHz;Pk

**5150 MHz Band Edge Signal Radiated Field Strength - Marker Delta**

	H	V	
Fundamental emission level @ 3m in 1MHz RBW:	106.7	104.4	Peak Measurement (RB=VB=1MHz)
Fundamental emission level @ 3m in 1MHz RBW:	98.4	96.3	Average Measurement (RB=1MHz, VB=10Hz)
Delta Marker - 100kHz	46.5 dB		-< this can only be used if band edge signal is highest within 2MHz of band edge.
Calculated Band-Edge Measurement (Peak):	60.2 dBuV/m		
Calculated Band-Edge Measurement (Avg):	51.9 dBuV/m		
Delta Marker - 1MHz/1MHz:	41.0 dB		Margin
Delta Marker - 1MHz/10Hz:	46.8 dB		Level
Calculated Band-Edge Measurement (Peak):	65.7 dBuV/m		Limit
Calculated Band-Edge Measurement (Avg):	51.6 dBuV/m		Detector

Frequency	Level	Pol	FCC 15.209		Detector	Azimuth	Height	Comments
MHz	dBuV/m	v/h	Limit	Margin	Pk/QP/Avg	degrees	meters	
5150.000	51.6	-	54.0	-2.4	Avg	-	-	Using 1MHz delta value

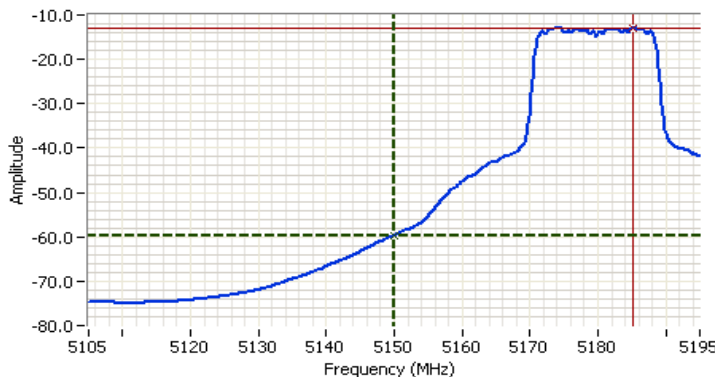

**Analyzer Settings**  
 HP8564E,EMICF: 5150.000 MHz  
 SPAN: 90.000 MHz  
 RB: 1.000 MHz  
 VB: 10 Hz  
 Detector: Sample  
 Attn: 10 DB  
 RL Offset: 0.0 DB  
 Sweep Time: 34.0s  
 Ref Lvl: 0.0 DBM

**Comments**  
 BE @ 5150 MHz  
 802.11n20  
 Chain A

Cursor 1	5150.0000	-59.67	
Cursor 2	5185.1001	-12.83	

Delta Freq. 35.100  
 Delta Amplitude 46.83



Client:	Intel Corporation	Job Number:	J80398
Model:	Intel® Centrino® Advanced-N 6230	T-Log Number:	T80540
Contact:	Steve Hackett	Account Manager:	Christine Krebill
Standard:	FCC 15.247	Class:	N/A

**Run # 2b, EUT on Channel #64 5320MHz - n20, Chain A**

Date of Test: 9/22/2010      Test Location: FT Chamber #7  
 Test Engineer: Joseph Cadigal      Config Change: none

	Power Settings		
	Target (dBm)	Measured (dBm)	Software Setting
Chain A	16.5	16.7	26.5

**Fundamental Signal Field Strength**

Frequency	Level	Pol	15.209 / 15.247		Detector	Azimuth	Height	Comments
MHz	dBuV/m	v/h	Limit	Margin	Pk/QP/Avg	degrees	meters	
5313.130	95.5	V	-	-	AVG	163	1.0	RB 1 MHz;VB 10 Hz;Pk
5315.200	103.5	V	-	-	PK	163	1.0	RB 1 MHz;VB 3 MHz;Pk
5313.070	98.7	H	-	-	AVG	348	1.4	RB 1 MHz;VB 10 Hz;Pk
5312.930	106.5	H	-	-	PK	348	1.4	RB 1 MHz;VB 3 MHz;Pk

**5350 MHz Band Edge Signal Radiated Field Strength - Marker Delta**

		H	V				
Fundamental emission level @ 3m in 1MHz RBW:		106.5	103.5	Peak Measurement (RB=VB=1MHz)			
Fundamental emission level @ 3m in 1MHz RBW:		98.7	95.5	Average Measurement (RB=1MHz, VB=10Hz)			
Delta Marker - 100kHz		50.0 dB		<- this can only be used if band edge signal is highest within 2MHz of band edge.			
Calculated Band-Edge Measurement (Peak):		56.5 dBuV/m					
Calculated Band-Edge Measurement (Avg):		48.7 dBuV/m		Margin	Level	Limit	Detector
Delta Marker - 1MHz/1MHz:		41.7 dB		-5.3	48.7	54	Avg
Delta Marker - 1MHz/10Hz:		50.0 dB		-17.5	56.5	74	Pk
Calculated Band-Edge Measurement (Peak):		64.8 dBuV/m		Using 100kHz delta value			
Calculated Band-Edge Measurement (Avg):		48.7 dBuV/m		Using 1MHz delta value			

Frequency	Level	Pol	FCC 15.209		Detector	Azimuth	Height	Comments
MHz	dBuV/m	v/h	Limit	Margin	Pk/QP/Avg	degrees	meters	
5350.000	48.7	-	54.0	-5.3	Avg	-	-	Using 1MHz delta value

Client: Intel Corporation	Job Number: J80398
Model: Intel® Centrino® Advanced-N 6230	T-Log Number: T80540
Contact: Steve Hackett	Account Manager: Christine Krebill
Standard: FCC 15.247	Class: N/A

**Run # 2c, EUT on Channel #100 5500MHz - n20, Chain A**

	Target (dBm)	Power Settings Measured (dBm)	Software Setting
Chain A	16.5	16.7	28.0

**Fundamental Signal Field Strength**

Frequency	Level	Pol	15.209 / 15.247		Detector	Azimuth	Height	Comments
MHz	dBuV/m	v/h	Limit	Margin	Pk/QP/Avg	degrees	meters	
5506.830	95.8	V	-	-	AVG	42	1.0	RB 1 MHz;VB 10 Hz;Pk
5507.700	104.0	V	-	-	PK	42	1.0	RB 1 MHz;VB 3 MHz;Pk
5493.170	98.1	H	-	-	AVG	224	1.0	RB 1 MHz;VB 10 Hz;Pk
5493.230	106.1	H	-	-	PK	224	1.0	RB 1 MHz;VB 3 MHz;Pk

**5460 MHz Restricted Band Edge Signal Radiated Field Strength - Marker Delta**

	H	V				
Fundamental emission level @ 3m in 1MHz RBW:	106.1	104.0	Peak Measurement (RB=VB=1MHz)			
Fundamental emission level @ 3m in 1MHz RBW:	98.1	95.8	Average Measurement (RB=1MHz, VB=10Hz)			
Delta Marker - 100kHz	53.5 dB		<- this can only be used if band edge signal is highest within 2MHz of band edge.			
Calculated Band-Edge Measurement (Peak):	52.6 dBuV/m					
Calculated Band-Edge Measurement (Avg):	44.6 dBuV/m	Margin	Level	Limit	Detector	
Delta Marker - 1MHz/1MHz:	45.8 dB	-9.7	44.3	54	Avg	
Delta Marker - 1MHz/10Hz:	<b>53.8 dB</b>	-21.4	52.6	74	Pk	
Calculated Band-Edge Measurement (Peak):	60.3 dBuV/m	Using 100kHz delta value				
Calculated Band-Edge Measurement (Avg):	44.3 dBuV/m	Using 1MHz delta value				

Frequency	Level	Pol	FCC 15.209		Detector	Azimuth	Height	Comments
MHz	dBuV/m	v/h	Limit	Margin	Pk/QP/Avg	degrees	meters	
<b>5460.000</b>	<b>44.3</b>	-	54.0	<b>-9.7</b>	Avg	-	-	Using 1MHz delta value

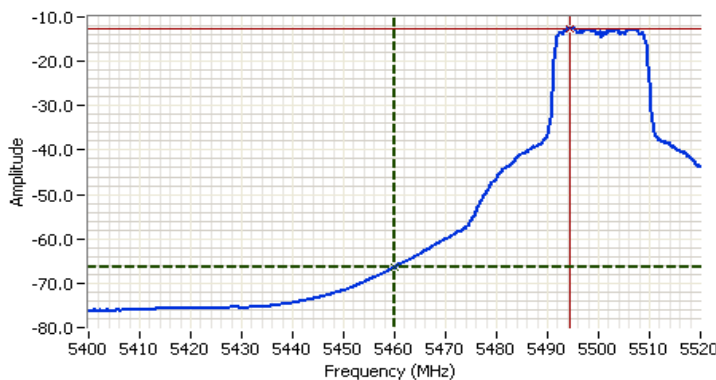

**Analyzer Settings**  
 HP8564E,EMICF: 5460.000 MHz  
 SPAN: 120.000 MHz  
 RB: 1.000 MHz  
 VB: 10 Hz  
 Detector: Sample  
 Attn: 10 DB  
 RL Offset: 0.0 DB  
 Sweep Time: 45.0s  
 Ref Lvl: 0.0 DBM

**Comments**  
 BE @ 5460 MHz  
 802.11n20  
 Chain A

Cursor 1	5460.0000	-66.33	
Cursor 2	5494.3999	-12.50	

Delta Freq. 34.400  
 Delta Amplitude 53.83



Client: Intel Corporation	Job Number: J80398
Model: Intel® Centrino® Advanced-N 6230	T-Log Number: T80540
Contact: Steve Hackett	Account Manager: Christine Krebill
Standard: FCC 15.247	Class: N/A

### 5470 MHz Band Edge Signal Radiated Field Strength - Marker Delta

	H	V	
Fundamental emission level @ 3m in 1MHz RBW:	106.1	104.0	Peak Measurement (RB=VB=1MHz)
Fundamental emission level @ 3m in 1MHz RBW:	98.1	95.8	Average Measurement (RB=1MHz, VB=10Hz)
<i>Delta Marker - 100kHz</i>	<b>47.7 dB</b>		<- this can only be used if band edge signal is highest within 2MHz of band edge.
Calculated Band-Edge Measurement (Peak):	58.4 dBuV/m		
Calculated Band-Edge Measurement (Avg):	50.4 dBuV/m		
			Margin    Level    Limit    Detector
<i>Delta Marker - 1MHz/1MHz:</i>	41.7 dB		-17.9    50.4    68.3    Avg
<i>Delta Marker - 1MHz/10Hz:</i>	47.2 dB		-29.9    58.4    88.3    Pk
Calculated Band-Edge Measurement (Peak):	64.4 dBuV/m		Using 100kHz delta value
Calculated Band-Edge Measurement (Avg):	50.9 dBuV/m		Using 100kHz delta value

Frequency	Level	Pol	FCC 15E		Detector	Azimuth	Height	Comments
MHz	dBuV/m	v/h	Limit	Margin	Pk/QP/Avg	degrees	meters	
5470.000	50.4	-	68.3	-17.9	Avg	-	-	Using 100kHz delta value

Note - average limit is equivalent to -27dBm eirp.

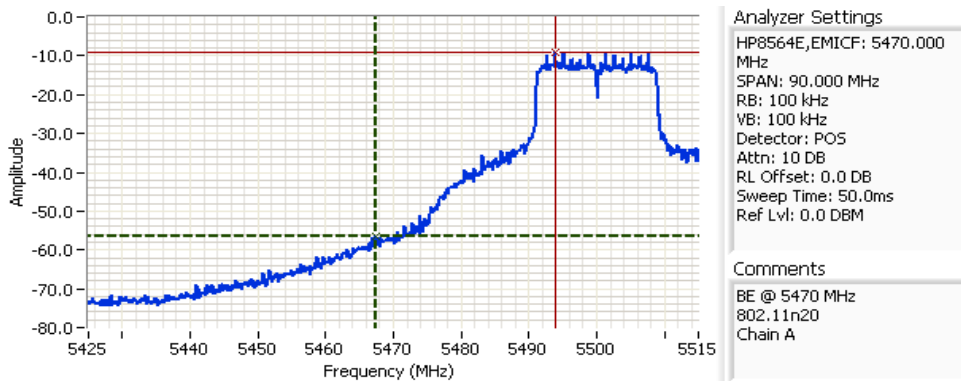

Cursor 1	5467.4502	-56.67	Delta Freq.	26.400
Cursor 2	5493.8501	-9.00	Delta Amplitude	47.67



Client: Intel Corporation	Job Number: J80398
Model: Intel® Centrino® Advanced-N 6230	T-Log Number: T80540
Contact: Steve Hackett	Account Manager: Christine Krebill
Standard: FCC 15.247	Class: N/A

### Run # 2d, EUT on Channel #140 5700MHz - n20, Chain A

	Target (dBm)	Power Settings Measured (dBm)	Software Setting
Chain A	16.5	16.7	29.0

### Fundamental Signal Field Strength

Frequency MHz	Level dBμV/m	Pol v/h	15.209 / 15.247		Detector Pk/QP/Avg	Azimuth degrees	Height meters	Comments
			Limit	Margin				
5693.000	95.9	V	-	-	AVG	212	1.0	RB 1 MHz;VB 10 Hz;Pk
5693.170	104.4	V	-	-	PK	212	1.0	RB 1 MHz;VB 3 MHz;Pk
5705.430	95.5	H	-	-	AVG	302	1.4	RB 1 MHz;VB 10 Hz;Pk
5706.430	103.8	H	-	-	PK	302	1.4	RB 1 MHz;VB 3 MHz;Pk

### 5725 MHz Restricted Band Edge Signal Radiated Field Strength - Marker Delta

	H	V		Margin	Level	Limit	Detector
Fundamental emission level @ 3m in 1MHz RBW:	103.8	104.4					
Fundamental emission level @ 3m in 1MHz RBW:	95.5	95.9					
Delta Marker - 100kHz	39.3 dB						
Calculated Band-Edge Measurement (Peak):	65.1 dBμV/m						
Calculated Band-Edge Measurement (Avg):	56.6 dBμV/m						
Delta Marker - 1MHz/1MHz:	34.2 dB			-13.7	54.6	68.3	Avg
Delta Marker - 1MHz/10Hz:	41.3 dB			-23.2	65.1	88.3	Pk
Calculated Band-Edge Measurement (Peak):	70.2 dBμV/m						Using 100kHz delta value
Calculated Band-Edge Measurement (Avg):	54.6 dBμV/m						Using 1MHz delta value

Peak Measurement (RB=VB=1MHz)  
 Average Measurement (RB=1MHz, VB=10Hz)  
 <- this can only be used if band edge signal is highest within 2MHz of band edge.

Frequency MHz	Level dBμV/m	Pol v/h	FCC 15E		Detector Pk/QP/Avg	Azimuth degrees	Height meters	Comments
			Limit	Margin				
5725.000	54.6	-	68.3	-13.7	Avg	-	-	Using 1MHz delta value

Note - average limit is equivalent to -27dBm eirp.

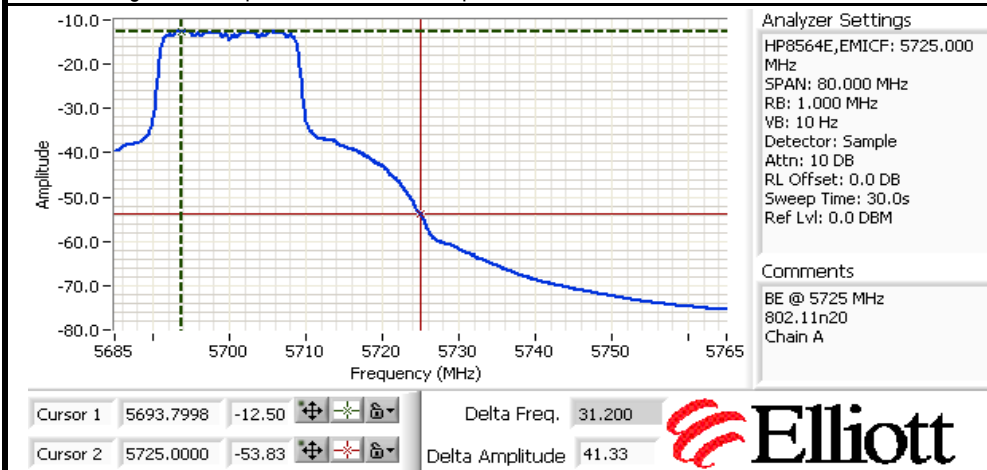

Client: Intel Corporation	Job Number: J80398
Model: Intel® Centrino® Advanced-N 6230	T-Log Number: T80540
Contact: Steve Hackett	Account Manager: Christine Krebill
Standard: FCC 15.247	Class: N/A

**Run # 3, Band Edge Field Strength - 802.11a, Chain A**  
**Run # 3a, EUT on Channel #36 5180MHz - 802.11a, Chain A**  
 Date of Test: 9/23/2010  
 Test Engineer: Mark H

Test Location: FT#7  
 Config Change: none

	Power Settings		
	Target (dBm)	Measured (dBm)	Software Setting
Chain A	16.5	16.5	24.5

### Fundamental Signal Field Strength

Frequency	Level	Pol	15.209 / 15.247		Detector	Azimuth	Height	Comments
MHz	dBuV/m	v/h	Limit	Margin	PK/QP/Avg	degrees	meters	
5186.830	97.0	V	-	-	AVG	192	1.0	RB 1 MHz;VB 10 Hz;Pk
5186.800	105.0	V	-	-	PK	192	1.0	RB 1 MHz;VB 3 MHz;Pk
5173.030	97.8	H	-	-	AVG	342	1.0	RB 1 MHz;VB 10 Hz;Pk
5173.630	105.8	H	-	-	PK	342	1.0	RB 1 MHz;VB 3 MHz;Pk

### 5150 MHz Band Edge Signal Radiated Field Strength - Marker Delta

	H	V	
Fundamental emission level @ 3m in 1MHz RBW:	105.8	105.0	Peak Measurement (RB=VB=1MHz)
Fundamental emission level @ 3m in 1MHz RBW:	97.8	97.0	Average Measurement (RB=1MHz, VB=10Hz)
Delta Marker - 100kHz	47.6 dB		-< this can only be used if band edge signal is highest within 2MHz of band edge.
Calculated Band-Edge Measurement (Peak):	58.2 dBuV/m		
Calculated Band-Edge Measurement (Avg):	50.2 dBuV/m	Margin	Level
Delta Marker - 1MHz/1MHz:	42.7 dB	-3.9	50.1
Delta Marker - 1MHz/10Hz:	47.7 dB	-15.8	58.2
Calculated Band-Edge Measurement (Peak):	63.1 dBuV/m	Using 100kHz delta value	
Calculated Band-Edge Measurement (Avg):	50.1 dBuV/m	Using 1MHz delta value	

Frequency	Level	Pol	FCC 15.209		Detector	Azimuth	Height	Comments
MHz	dBuV/m	v/h	Limit	Margin	PK/QP/Avg	degrees	meters	
5150.000	50.1	-	54.0	-3.9	Avg	-	-	Using 1MHz delta value

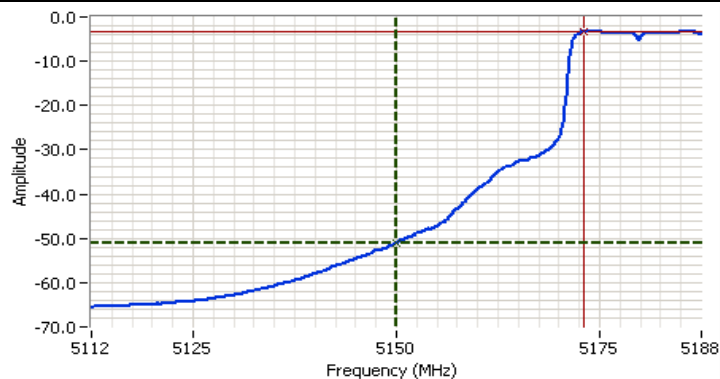

**Analyzer Settings**  
 HP8564E,EMICF: 5150.000  
 MHz  
 SPAN: 75.000 MHz  
 RB: 1.000 MHz  
 VB: 10 Hz  
 Detector: Sample  
 Attn: 10 DB  
 RL Offset: 10.0 DB  
 Sweep Time: 28.0s  
 Ref Lvl: 9.9 DBM

**Comments**  
 BE @ 5150 MHz  
 802.11a  
 Chain A

Cursor 1	5150.0000	-50.93	Delta Freq.	23.000
Cursor 2	5173.0000	-3.27	Delta Amplitude	47.67



Client: Intel Corporation	Job Number: J80398
Model: Intel® Centrino® Advanced-N 6230	T-Log Number: T80540
Contact: Steve Hackett	Account Manager: Christine Krebill
Standard: FCC 15.247	Class: N/A

### Run # 3b, EUT on Channel #64 5320MHz - 802.11a, Chain A

Date of Test: 9/23/2010      Test Location: FT#7  
 Test Engineer: Mark H      Config Change: none

	Target (dBm)	Power Settings Measured (dBm)	Software Setting
Chain A	16.5	16.7	26.0

### Fundamental Signal Field Strength

Frequency	Level	Pol	15.209 / 15.247		Detector	Azimuth	Height	Comments
MHz	dBuV/m	v/h	Limit	Margin	Pk/QP/Avg	degrees	meters	
5313.100	94.8	V	-	-	AVG	148	1.3	RB 1 MHz;VB 10 Hz;Pk
5313.770	102.9	V	-	-	PK	148	1.3	RB 1 MHz;VB 3 MHz;Pk
5313.170	99.5	H	-	-	AVG	307	1.0	RB 1 MHz;VB 10 Hz;Pk
5313.370	107.9	H	-	-	PK	307	1.0	RB 1 MHz;VB 3 MHz;Pk

### 5350 MHz Band Edge Signal Radiated Field Strength - Marker Delta

	H	V				
Fundamental emission level @ 3m in 1MHz RBW:	107.9	102.9	Peak Measurement (RB=VB=1MHz)			
Fundamental emission level @ 3m in 1MHz RBW:	99.5	94.8	Average Measurement (RB=1MHz, VB=10Hz)			
Delta Marker - 100kHz	50.5 dB		<- this can only be used if band edge signal is highest within 2MHz of band edge.			
Calculated Band-Edge Measurement (Peak):	57.4 dBuV/m					
Calculated Band-Edge Measurement (Avg):	49.0 dBuV/m	Margin	Level	Limit	Detector	
Delta Marker - 1MHz/1MHz:	45.5 dB	-5.5	48.5	54	Avg	
Delta Marker - 1MHz/10Hz:	51.0 dB	-16.6	57.4	74	Pk	
Calculated Band-Edge Measurement (Peak):	62.4 dBuV/m	Using 100kHz delta value				
Calculated Band-Edge Measurement (Avg):	48.5 dBuV/m	Using 1MHz delta value				

Frequency	Level	Pol	FCC 15.209		Detector	Azimuth	Height	Comments
MHz	dBuV/m	v/h	Limit	Margin	Pk/QP/Avg	degrees	meters	
5350.000	48.5	-	54.0	-5.5	Avg	-	-	Using 1MHz delta value

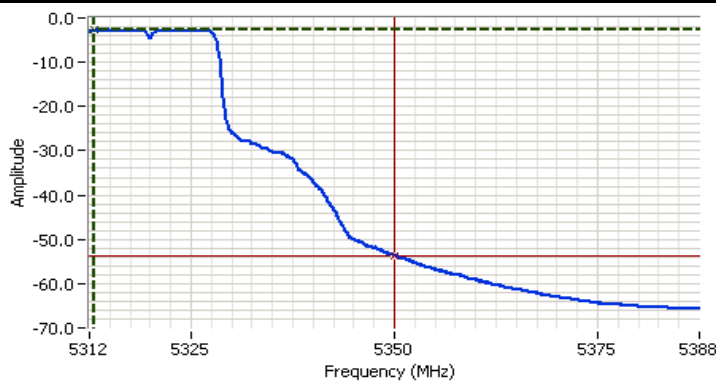

Analyzer Settings  
 HP8564E,EMICF: 5350.000  
 MHz  
 SPAN: 75.000 MHz  
 RB: 1.000 MHz  
 VB: 10 Hz  
 Detector: Sample  
 Attn: 10 DB  
 RL Offset: 10.0 DB  
 Sweep Time: 28.0s  
 Ref Lvl: 10.0 DBM

Comments  
 BE @ 5350 MHz  
 802.11a  
 Chain A

Cursor 1	5313.1250	-2.67	Delta Freq.	36.875
Cursor 2	5350.0000	-53.67	Delta Amplitude	51.00





Client: Intel Corporation	Job Number: J80398
Model: Intel® Centrino® Advanced-N 6230	T-Log Number: T80540
Contact: Steve Hackett	Account Manager: Christine Krebill
Standard: FCC 15.247	Class: N/A

**Run # 3c, EUT on Channel #100 5500MHz - 802.11a, Chain A**

	Target (dBm)	Power Settings Measured (dBm)	Software Setting
Chain A	16.5	16.6	27.5

**Fundamental Signal Field Strength**

Frequency MHz	Level dBμV/m	Pol v/h	15.209 / 15.247		Detector Pk/QP/Avg	Azimuth degrees	Height meters	Comments
			Limit	Margin				
5492.970	98.7	V	-	-	AVG	177	1.0	RB 1 MHz;VB 10 Hz;Pk
5493.730	106.7	V	-	-	PK	177	1.0	RB 1 MHz;VB 3 MHz;Pk
5493.200	99.0	H	-	-	AVG	225	1.0	RB 1 MHz;VB 10 Hz;Pk
5492.900	107.2	H	-	-	PK	225	1.0	RB 1 MHz;VB 3 MHz;Pk

**5460 MHz Restricted Band Edge Signal Radiated Field Strength - Marker Delta**

	H	V		Margin	Level	Limit	Detector
Fundamental emission level @ 3m in 1MHz RBW:	107.2	106.7					
Fundamental emission level @ 3m in 1MHz RBW:	99.0	98.7					
Delta Marker - 100kHz	51.7 dB						
Calculated Band-Edge Measurement (Peak):	55.5 dBuV/m						
Calculated Band-Edge Measurement (Avg):	47.3 dBuV/m						
Delta Marker - 1MHz/1MHz:	48.5 dB			-9.8	44.2	54	Avg
Delta Marker - 1MHz/10Hz:	54.8 dB			-18.5	55.5	74	Pk
Calculated Band-Edge Measurement (Peak):	58.7 dBuV/m						Using 100kHz delta value
Calculated Band-Edge Measurement (Avg):	44.2 dBuV/m						Using 1MHz delta value

Peak Measurement (RB=VB=1MHz)  
 Average Measurement (RB=1MHz, VB=10Hz)  
 <- this can only be used if band edge signal is highest within 2MHz of band edge.

Frequency MHz	Level dBμV/m	Pol v/h	FCC 15.209		Detector Pk/QP/Avg	Azimuth degrees	Height meters	Comments
			Limit	Margin				
5459.870	44.2	-	54.0	-9.8	Avg	-	-	Using 1MHz delta value

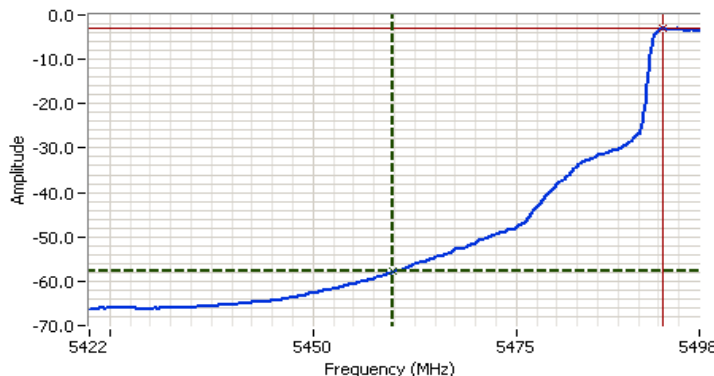

**Analyzer Settings**  
 HP8564E,EMICF: 5460.000 MHz  
 SPAN: 75.000 MHz  
 RB: 1.000 MHz  
 VB: 10 Hz  
 Detector: Sample  
 Attn: 10 DB  
 RL Offset: 10.0 DB  
 Sweep Time: 28.0s  
 Ref Lvl: 9.8 DBM

**Comments**  
 BE @ 5460 MHz  
 802.11a  
 Chain A

Cursor 1	5459.8750	-57.87	
Cursor 2	5493.0000	-3.03	

Delta Freq. 33.125  
 Delta Amplitude 54.83



Client: Intel Corporation	Job Number: J80398
Model: Intel® Centrino® Advanced-N 6230	T-Log Number: T80540
	Account Manager: Christine Krebill
Contact: Steve Hackett	
Standard: FCC 15.247	Class: N/A

### 5470 MHz Band Edge Signal Radiated Field Strength - Marker Delta

	H	V	
Fundamental emission level @ 3m in <b>1MHz RBW</b> :	107.2	106.7	Peak Measurement (RB=VB=1MHz)
Fundamental emission level @ 3m in <b>1MHz RBW</b> :	99.0	98.7	Average Measurement (RB=1MHz, VB=10Hz)
<i>Delta Marker - 100kHz</i>	46.7 dB		<- this can only be used if band edge signal is highest within 2MHz of band edge.
Calculated Band-Edge Measurement (Peak):	60.5 dBuV/m		
Calculated Band-Edge Measurement (Avg):	52.3 dBuV/m		Margin
<i>Delta Marker - 1MHz/1MHz:</i>	42.5 dB	-17.6	Level
<i>Delta Marker - 1MHz/10Hz:</i>	<b>48.3 dB</b>	-27.8	Limit
Calculated Band-Edge Measurement (Peak):	64.7 dBuV/m	50.7	68.3
Calculated Band-Edge Measurement (Avg):	50.7 dBuV/m	60.5	88.3
			Avg
			Pk
			Using 100kHz delta value
			Using 1MHz delta value

Frequency	Level	Pol	FCC 15E		Detector	Azimuth	Height	Comments
MHz	dBuV/m	v/h	Limit	Margin	Pk/QP/Avg	degrees	meters	
5470.000	50.7	-	68.3	<b>-17.6</b>	Avg	-	-	Using 1MHz delta value

Note - average limit is equivalent to -27dBm eirp.

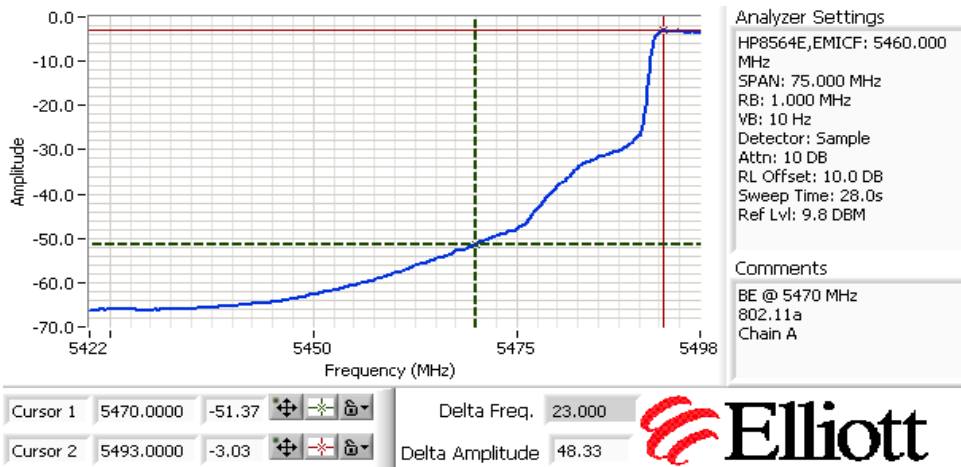

Client: Intel Corporation	Job Number: J80398
Model: Intel® Centrino® Advanced-N 6230	T-Log Number: T80540
Contact: Steve Hackett	Account Manager: Christine Krebill
Standard: FCC 15.247	Class: N/A

### Run # 3d, EUT on Channel #140 5700MHz - 802.11a, Chain A

	Target (dBm)	Power Settings Measured (dBm)	Software Setting
Chain A	16.5	16.7	28.5

### Fundamental Signal Field Strength

Frequency MHz	Level dBμV/m	Pol v/h	15.209 / 15.247		Detector Pk/QP/Avg	Azimuth degrees	Height meters	Comments
			Limit	Margin				
5693.070	97.4	V	-	-	AVG	200	1.0	RB 1 MHz;VB 10 Hz;Pk
5693.030	105.7	V	-	-	PK	200	1.0	RB 1 MHz;VB 3 MHz;Pk
5693.200	95.6	H	-	-	AVG	230	1.0	RB 1 MHz;VB 10 Hz;Pk
5694.230	105.0	H	-	-	PK	230	1.0	RB 1 MHz;VB 3 MHz;Pk

### 5725 MHz Restricted Band Edge Signal Radiated Field Strength - Marker Delta

	H	V		Margin	Level	Limit	Detector
Fundamental emission level @ 3m in 1MHz RBW:	105.0	105.7					Peak Measurement (RB=VB=1MHz)
Fundamental emission level @ 3m in 1MHz RBW:	95.6	97.4					Average Measurement (RB=1MHz, VB=10Hz)
Delta Marker - 100kHz	44.5 dB						-< this can only be used if band edge signal is highest within 2MHz of band edge.
Calculated Band-Edge Measurement (Peak):	61.2 dBuV/m						
Calculated Band-Edge Measurement (Avg):	52.9 dBuV/m						
Delta Marker - 1MHz/1MHz:	34.8 dB			-17.2	51.1	68.3	Avg
Delta Marker - 1MHz/10Hz:	46.3 dB			-27.1	61.2	88.3	Pk
Calculated Band-Edge Measurement (Peak):	70.9 dBuV/m						Using 100kHz delta value
Calculated Band-Edge Measurement (Avg):	51.1 dBuV/m						Using 1MHz delta value

Frequency MHz	Level dBμV/m	Pol v/h	FCC 15E		Detector Pk/QP/Avg	Azimuth degrees	Height meters	Comments
			Limit	Margin				
5725.000	51.1	-	68.3	-17.2	Avg	-	-	Using 1MHz delta value

Note - average limit is equivalent to -27dBm eirp.

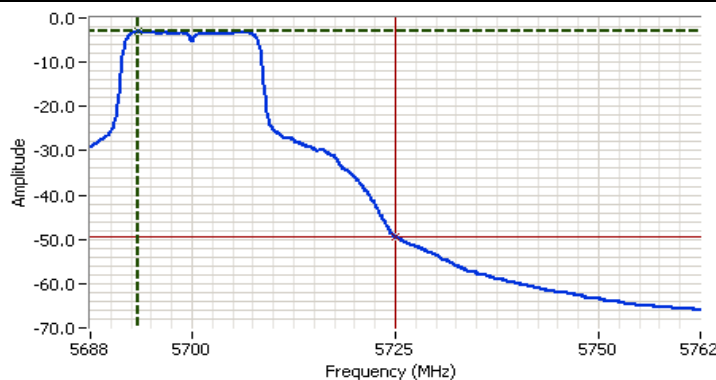

**Analyzer Settings**

HP8564E,EMICF: 5725.000 MHz  
 SPAN: 75.000 MHz  
 RB: 1.000 MHz  
 VB: 10 Hz  
 Detector: Sample  
 Attn: 10 DB  
 RL Offset: 10.0 DB  
 Sweep Time: 28.0s  
 Ref Lvl: 9.8 DBM

---

**Comments**

BE @ 5725 MHz  
 802.11a  
 Chain A

Cursor 1	5693.3750	-3.03	
Cursor 2	5725.0000	-49.37	

Delta Freq. 31.625  
 Delta Amplitude 46.33



Client:	Intel Corporation	Job Number:	J80398
Model:	Intel® Centrino® Advanced-N 6230	T-Log Number:	T80540
Contact:	Steve Hackett	Account Manager:	Christine Krebill
Standard:	FCC 15.247	Class:	N/A

## RSS 210 and FCC 15.407 (UNII) Radiated Spurious Emissions - Band Edges

### Summary of Results

MAC Address: 00150079AD1A DRTU Tool Version 1.2.12-0197 New tool from 9/14 Driver version 14.0.0.39

Run #	Mode	Channel	Power Setting	Measured Power	Test Performed	Limit	Result / Margin
Run #1	n40 Chain B	#38 5190MHz	16.5	13.1	Restricted Band Edge at 5150 MHz	15.209	52.8dBµV/m @ 5148.7MHz (-1.2dB)
	n40 Chain B	#62 5310MHz	16.5	13.0	Restricted Band Edge at 5350 MHz	15.209	51.8dBµV/m @ 5350.0MHz (-2.2dB)
	n40 Chain B	#102 5510MHz	16.5	15.7	Restricted Band Edge at 5460 MHz	15.209	51.4dBµV/m @ 5460.0MHz (-2.6dB)
					Band Edge at 5470 MHz	15 E	57.8dBµV/m @ 5468.3MHz (-10.5dB)
n40 Chain B	#134 5670MHz	16.5	16.6	Band Edge at 5725 MHz	15 E	50.3dBµV/m @ 5725.0MHz (-18.0dB)	
Run #2	n20 Chain B	#36 5180MHz	16.5	16.7	Restricted Band Edge at 5150 MHz	15.209	52.4dBµV/m @ 5150.0MHz (-1.6dB)
	n20 Chain B	#64 5320MHz	16.5	16.6	Restricted Band Edge at 5350 MHz	15.209	48.1dBµV/m @ 5350.0MHz (-5.9dB)
	n20 Chain B	#100 5500MHz	16.5	16.7	Restricted Band Edge at 5460 MHz	15.209	46.0dBµV/m @ 5459.8MHz (-8.0dB)
					Band Edge at 5470 MHz	15 E	52.3dBµV/m @ 5469.8MHz (-16.0dB)
n20 Chain B	#140 5700MHz	16.5	16.6	Band Edge at 5725 MHz	15 E	56.7dBµV/m @ 5725.0MHz (-11.6dB)	
Run #3	802.11a Chain B	#36 5180MHz	16.5	16.5	Restricted Band Edge at 5150 MHz	15.209	51.0dBµV/m @ 5149.3MHz (-3.0dB)
	802.11a Chain B	#64 5320MHz	16.5	16.8	Restricted Band Edge at 5350 MHz	15.209	46.6dBµV/m @ 5350.0MHz (-7.4dB)
	802.11a Chain B	#100 5500MHz	16.5	16.7	Restricted Band Edge at 5460 MHz	15.209	44.6dBµV/m @ 5460.0MHz (-9.4dB)
					Band Edge at 5470 MHz	15 E	50.8dBµV/m @ 5470.0MHz (-17.5dB)
802.11a Chain B	#140 5700MHz	16.5	16.7	Band Edge at 5725 MHz	15 E	50.8dBµV/m @ 5725.0MHz (-17.5dB)	

Note - the target and measured power are average powers (measured with average power sensor) and are used for reference purposes only. Power is set using " **GAIN CONTROL**" mode in the DRTU tool.

Client:	Intel Corporation	Job Number:	J80398
Model:	Intel® Centrino® Advanced-N 6230	T-Log Number:	T80540
		Account Manager:	Christine Krebill
Contact:	Steve Hackett		
Standard:	FCC 15.247	Class:	N/A

**Test Specific Details**

Objective: The objective of this test session is to perform engineering evaluation testing of the EUT with respect to the

**General Test Configuration**

The EUT was installed into a test fixture such that the EUT was exposed (i.e. outside of a host PC).  
For radiated emissions testing the measurement antenna was located 3 meters from the EUT.

**Ambient Conditions:**

Rel. Humidity:	15 - 55 %
Temperature:	18 - 25 °C

**Modifications Made During Testing**

No modifications were made to the EUT during testing

**Deviations From The Standard**

No deviations were made from the requirements of the standard.

**Marker Delta Measurements**

Three sets of marker deltas are measured using the following settings: RB=VB=100kHz; RB=1MHz,VB=1MHz; RB=1MHz, VB=10Hz.  
Marker deltas are made conducted (analyzer connected to EUT rf port a 20dB pad) for single chain operation.  
The fundamental field strength is always measured at a 3m test distance.

Client: Intel Corporation	Job Number: J80398
Model: Intel® Centrino® Advanced-N 6230	T-Log Number: T80540
Contact: Steve Hackett	Account Manager: Christine Krebill
Standard: FCC 15.247	Class: N/A

**Run #1, Band Edge Field Strength - n40, Chain B**  
 Date of Test: 9/23/2010 Test Location: Chamber #7  
 Test Engineer: Mehran Birgani Config Change: None

**Run #1a, EUT on Channel #38 5190MHz - n40, Chain B**

	Target (dBm)	Power Settings Measured (dBm)	Software Setting
Chain B	16.5	13.1	20.5

**Fundamental Signal Field Strength**

Frequency	Level	Pol	15.209 / 15.247		Detector	Azimuth	Height	Comments
MHz	dBuV/m	v/h	Limit	Margin	Pk/QP/Avg	degrees	meters	
5202.330	91.7	V	-	-	AVG	324	1.0	
5197.330	99.8	V	-	-	PK	324	1.0	
5177.530	92.2	H	-	-	AVG	114	1.0	
5187.670	100.6	H	-	-	PK	114	1.0	

**5150 MHz Band Edge Signal Radiated Field Strength - Marker Delta**

	H	V				
Fundamental emission level @ 3m in 1MHz RBW:	100.9	99.8	Peak Measurement (RB=VB=1MHz)			
Fundamental emission level @ 3m in 1MHz RBW:	92.6	91.7	Average Measurement (RB=1MHz, VB=10Hz)			
Delta Marker - 100kHz	39.8 dB		-< this can only be used if band edge signal is highest within 2MHz of band edge.			
Calculated Band-Edge Measurement (Peak):	61.1 dBuV/m		Margin	Level	Limit	Detector
Calculated Band-Edge Measurement (Avg):	52.8 dBuV/m		-1.2	52.8	54	Avg
Delta Marker - 1MHz/1MHz:	34.5 dB		-12.9	61.1	74	Pk
Delta Marker - 1MHz/10Hz:	38.7 dB					
Calculated Band-Edge Measurement (Peak):	66.4 dBuV/m		Using 100kHz delta value			
Calculated Band-Edge Measurement (Avg):	53.9 dBuV/m		Using 100kHz delta value			

Frequency	Level	Pol	FCC 15.209		Detector	Azimuth	Height	Comments
MHz	dBuV/m	v/h	Limit	Margin	Pk/QP/Avg	degrees	meters	
5148.700	52.8	-	54.0	-1.2	Avg	-	-	Using 100kHz delta value

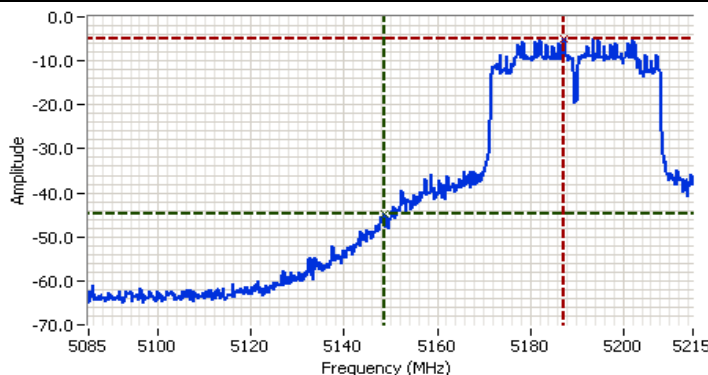

**Analyzer Settings**  
 HP8564E,EMICF: 5150.000 MHz  
 SPAN: 130.000 MHz  
 RB: 100 kHz  
 VB: 100 kHz  
 Detector: POS  
 Attn: 20 DB  
 RL Offset: 0.0 DB  
 Sweep Time: 72.0ms  
 Ref Lvl: 7.2 DBM

**Comments**  
 BE @ 5150 MHz  
 802.11n 40MHz  
 Chain B  
 100k

Cursor 1	5148.7002	-44.80	
Cursor 2	5187.2666	-4.97	

Delta Freq. 38.566  
 Delta Amplitude 39.83



Client: Intel Corporation	Job Number: J80398
Model: Intel® Centrino® Advanced-N 6230	T-Log Number: T80540
Contact: Steve Hackett	Account Manager: Christine Krebill
Standard: FCC 15.247	Class: N/A

### Run #1b, EUT on Channel #62 5310MHz - n40, Chain B

	Target (dBm)	Power Settings Measured (dBm)	Software Setting
Chain B	16.5	13.0	21.5

### Fundamental Signal Field Strength

Frequency MHz	Level dBμV/m	Pol v/h	15.209 / 15.247		Detector Pk/QP/Avg	Azimuth degrees	Height meters	Comments
			Limit	Margin				
5313.000	91.5	V	-	-	AVG	306	1.0	
5302.200	99.6	V	-	-	PK	306	1.0	
5307.000	89.6	H	-	-	AVG	258	1.0	
5308.530	97.9	H	-	-	PK	258	1.0	

### 5350 MHz Band Edge Signal Radiated Field Strength - Marker Delta

	H	V		Margin	Level	Limit	Detector
Fundamental emission level @ 3m in 1MHz RBW:	97.9	99.6					Peak Measurement (RB=VB=1MHz)
Fundamental emission level @ 3m in 1MHz RBW:	89.6	91.5					Average Measurement (RB=1MHz, VB=10Hz)
Delta Marker - 100kHz	39.3 dB						<- this can only be used if band edge signal is highest within 2MHz of band edge.
Calculated Band-Edge Measurement (Peak):	60.3 dBuV/m						
Calculated Band-Edge Measurement (Avg):	52.2 dBuV/m						
Delta Marker - 1MHz/1MHz:	36.7 dB			-2.2	51.8	54	Avg
Delta Marker - 1MHz/10Hz:	39.7 dB			-13.7	60.3	74	Pk
Calculated Band-Edge Measurement (Peak):	62.9 dBuV/m						Using 100kHz delta value
Calculated Band-Edge Measurement (Avg):	51.8 dBuV/m						Using 1MHz delta value

Frequency MHz	Level dBμV/m	Pol v/h	FCC 15.209		Detector Pk/QP/Avg	Azimuth degrees	Height meters	Comments
			Limit	Margin				
5350.000	51.8	-	54.0	-2.2	Avg	-	-	Using 1MHz delta value

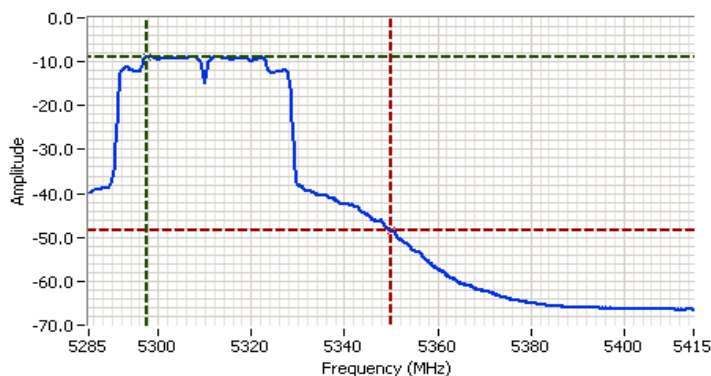

**Analyzer Settings**  
 HP8564E,EMICF: 5350.000 MHz  
 SPAN: 130.000 MHz  
 RB: 1.000 MHz  
 VB: 10 Hz  
 Detector: Sample  
 Attn: 20 DB  
 RL Offset: 0.0 DB  
 Sweep Time: 49.0s  
 Ref Lvl: 6.3 DBM

**Comments**  
 BE @ 5350 MHz  
 802.11n 40MHz  
 Chain B  
 Average

Cursor 1	5297.5669	-8.87	
Cursor 2	5350.0000	-48.53	

Delta Freq. 52.433  
 Delta Amplitude 39.67



Client: Intel Corporation	Job Number: J80398
Model: Intel® Centrino® Advanced-N 6230	T-Log Number: T80540
Contact: Steve Hackett	Account Manager: Christine Krebill
Standard: FCC 15.247	Class: N/A

**Run #1c, EUT on Channel #102 5510MHz - n40, Chain B**

	Target (dBm)	Power Settings Measured (dBm)	Software Setting
Chain B	16.5	15.7	26.5

**Fundamental Signal Field Strength**

Frequency	Level	Pol	15.209 / 15.247		Detector	Azimuth	Height	Comments
MHz	dB $\mu$ V/m	v/h	Limit	Margin	Pk/QP/Avg	degrees	meters	
5497.600	92.6	V	-	-	AVG	265	1.0	
5497.270	101.3	V	-	-	PK	265	1.0	
5513.130	94.2	H	-	-	AVG	110	1.0	
5508.000	102.3	H	-	-	PK	110	1.0	

**5460 MHz Restricted Band Edge Signal Radiated Field Strength - Marker Delta**

	H	V				
Fundamental emission level @ 3m in 1MHz RBW:	102.3	101.3	Peak Measurement (RB=VB=1MHz)			
Fundamental emission level @ 3m in 1MHz RBW:	94.2	92.6	Average Measurement (RB=1MHz, VB=10Hz)			
Delta Marker - 100kHz	41.2 dB		-< this can only be used if band edge signal is highest within 2MHz of band edge.			
Calculated Band-Edge Measurement (Peak):	61.1 dB $\mu$ V/m					
Calculated Band-Edge Measurement (Avg):	53.0 dB $\mu$ V/m		Margin	Level	Limit	Detector
Delta Marker - 1MHz/1MHz:	38.7 dB		-2.6	51.4	54	Avg
Delta Marker - 1MHz/10Hz:	42.8 dB		-12.9	61.1	74	Pk
Calculated Band-Edge Measurement (Peak):	63.6 dB $\mu$ V/m		Using 100kHz delta value			
Calculated Band-Edge Measurement (Avg):	51.4 dB $\mu$ V/m		Using 1MHz delta value			

Frequency	Level	Pol	FCC 15.209		Detector	Azimuth	Height	Comments
MHz	dB $\mu$ V/m	v/h	Limit	Margin	Pk/QP/Avg	degrees	meters	
5460.000	51.4	-	54.0	-2.6	Avg	-	-	Using 1MHz delta value

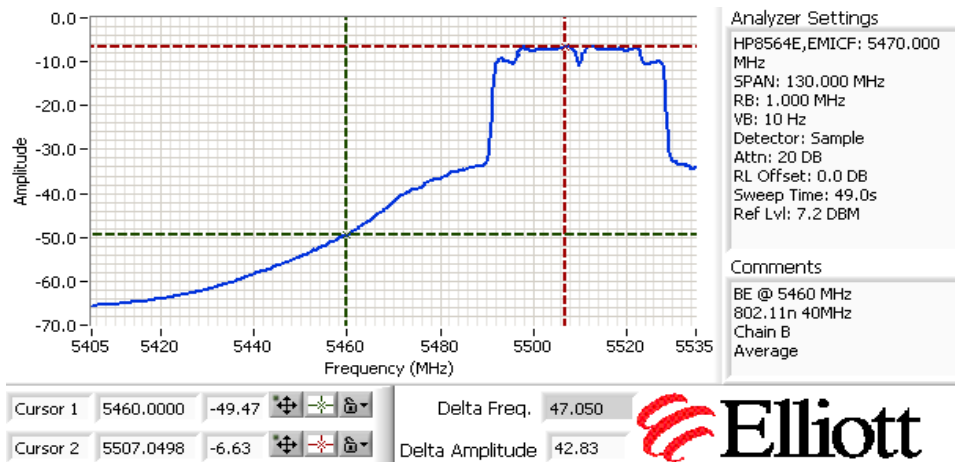



Client: Intel Corporation	Job Number: J80398
Model: Intel® Centrino® Advanced-N 6230	T-Log Number: T80540
Contact: Steve Hackett	Account Manager: Christine Krebill
Standard: FCC 15.247	Class: N/A

### 5470 MHz Band Edge Signal Radiated Field Strength - Marker Delta

	H	V	
Fundamental emission level @ 3m in <b>1MHz RBW</b> :	102.3	101.3	Peak Measurement (RB=VB=1MHz)
Fundamental emission level @ 3m in <b>1MHz RBW</b> :	93.8	92.6	Average Measurement (RB=1MHz, VB=10Hz)
<i>Delta Marker - 100kHz</i>	<b>36.0 dB</b>		<- this can only be used if band edge signal is highest within 2MHz of band edge.
Calculated Band-Edge Measurement (Peak):	66.3 dBuV/m		
Calculated Band-Edge Measurement (Avg):	57.8 dBuV/m		Margin
<i>Delta Marker - 1MHz/1MHz:</i>	32.7 dB		Level
<i>Delta Marker - 1MHz/10Hz:</i>	35.3 dB		Limit
Calculated Band-Edge Measurement (Peak):	69.6 dBuV/m		Detector
Calculated Band-Edge Measurement (Avg):	58.5 dBuV/m		

Frequency	Level	Pol	FCC 15E		Detector	Azimuth	Height	Comments
MHz	dBuV/m	v/h	Limit	Margin	Pk/QP/Avg	degrees	meters	
<b>5468.266</b>	<b>57.8</b>	-	68.3	<b>-10.5</b>	Avg	-	-	Using 100kHz delta value

Note - average limit is equivalent to -27dBm eirp.

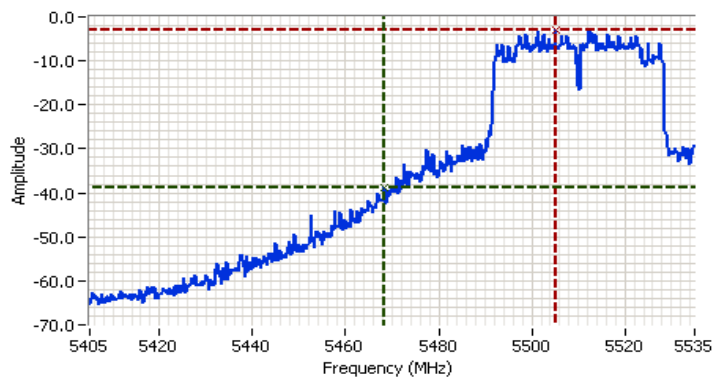

**Analyzer Settings**

HP8564E,EMICF: 5470.000 MHz  
 SPAN: 130.000 MHz  
 RB: 100 kHz  
 VB: 100 kHz  
 Detector: POS  
 Attn: 20 DB  
 RL Offset: 0.0 DB  
 Sweep Time: 72.0ms  
 Ref Lvl: 7.2 DBM

**Comments**

BE @ 5470 MHz  
 802.11n 40MHz  
 Chain B  
 100k

Cursor 1	5468.2666	-38.97	Delta Freq.	36.833
Cursor 2	5505.1001	-2.97	Delta Amplitude	36.00



Client: Intel Corporation	Job Number: J80398
Model: Intel® Centrino® Advanced-N 6230	T-Log Number: T80540
Contact: Steve Hackett	Account Manager: Christine Krebill
Standard: FCC 15.247	Class: N/A

**Run #1d, EUT on Channel #134 5670MHz - n40, Chain B**

	Target (dBm)	Power Settings Measured (dBm)	Software Setting
Chain B	16.5	16.6	30.0

**Fundamental Signal Field Strength**

Frequency	Level	Pol	15.209 / 15.247		Detector	Azimuth	Height	Comments
MHz	dBuV/m	v/h	Limit	Margin	PK/QP/Avg	degrees	meters	
5682.330	95.6	V	-	-	AVG	305	1.0	
5667.800	104.3	V	-	-	PK	305	1.0	
5657.870	94.1	H	-	-	AVG	106	1.0	
5662.200	103.1	H	-	-	PK	106	1.0	

**5725 MHz Restricted Band Edge Signal Radiated Field Strength - Marker Delta**

	H	V				
Fundamental emission level @ 3m in 1MHz RBW:	103.1	104.3	Peak Measurement (RB=VB=1MHz)			
Fundamental emission level @ 3m in 1MHz RBW:	94.1	95.6	Average Measurement (RB=1MHz, VB=10Hz)			
<i>Delta Marker - 100kHz</i>	45.2 dB		-< this can only be used if band edge signal is highest within 2MHz of band edge.			
Calculated Band-Edge Measurement (Peak):	59.1 dBuV/m					
Calculated Band-Edge Measurement (Avg):	50.4 dBuV/m	Margin	Level	Limit	Detector	
<i>Delta Marker - 1MHz/1MHz:</i>	40.8 dB	-18.0	50.3	68.3	Avg	
<i>Delta Marker - 1MHz/10Hz:</i>	<b>45.3 dB</b>	-29.2	59.1	88.3	Pk	
Calculated Band-Edge Measurement (Peak):	63.5 dBuV/m	Using 100kHz delta value				
Calculated Band-Edge Measurement (Avg):	50.3 dBuV/m	Using 1MHz delta value				

Frequency	Level	Pol	FCC 15E		Detector	Azimuth	Height	Comments
MHz	dBuV/m	v/h	Limit	Margin	PK/QP/Avg	degrees	meters	
<b>5725.000</b>	<b>50.3</b>	-	68.3	<b>-18.0</b>	Avg	-	-	Using 1MHz delta value

Note - average limit is equivalent to -27dBm eirp.

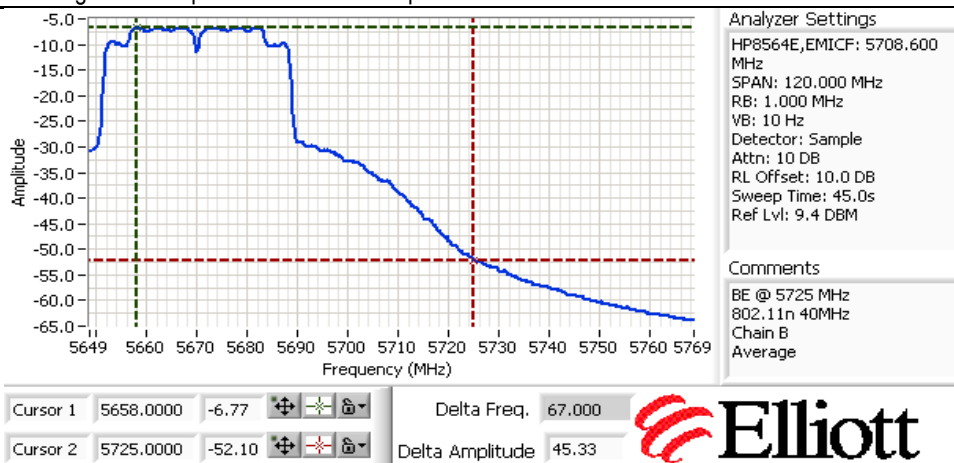

Client: Intel Corporation	Job Number: J80398
Model: Intel® Centrino® Advanced-N 6230	T-Log Number: T80540
Contact: Steve Hackett	Account Manager: Christine Krebill
Standard: FCC 15.247	Class: N/A

### Run # 2, Band Edge Field Strength - n20, Chain B

Date of Test: 9/23/2010

Test Location: Chamber #7

Test Engineer: Mehran Birgani

Config Change: None

### Run # 2a, EUT on Channel #36 5180MHz - n20, Chain B

	Target (dBm)	Power Settings Measured (dBm)	Software Setting
Chain B	16.5	16.7	25.0

### Fundamental Signal Field Strength

Frequency	Level	Pol	15.209 / 15.247		Detector	Azimuth	Height	Comments
MHz	dBuV/m	v/h	Limit	Margin	Pk/QP/Avg	degrees	meters	
5185.330	99.1	V	-	-	AVG	313	1.0	
5186.200	107.3	V	-	-	PK	313	1.0	
5172.800	98.2	H	-	-	AVG	112	1.0	
5174.000	106.5	H	-	-	PK	112	1.0	

### 5150 MHz Band Edge Signal Radiated Field Strength - Marker Delta

	H	V				
Fundamental emission level @ 3m in 1MHz RBW:	106.5	107.3	Peak Measurement (RB=VB=1MHz)			
Fundamental emission level @ 3m in 1MHz RBW:	98.2	99.1	Average Measurement (RB=1MHz, VB=10Hz)			
Delta Marker - 100kHz	45.8 dB		-< this can only be used if band edge signal is highest within 2MHz of band edge.			
Calculated Band-Edge Measurement (Peak):	61.5 dBuV/m					
Calculated Band-Edge Measurement (Avg):	53.3 dBuV/m	Margin	Level	Limit	Detector	
Delta Marker - 1MHz/1MHz:	41.5 dB	-1.6	52.4	54	Avg	
Delta Marker - 1MHz/10Hz:	46.7 dB	-12.5	61.5	74	Pk	
Calculated Band-Edge Measurement (Peak):	65.8 dBuV/m	Using 100kHz delta value				
Calculated Band-Edge Measurement (Avg):	52.4 dBuV/m	Using 1MHz delta value				

Frequency	Level	Pol	FCC 15.209		Detector	Azimuth	Height	Comments
MHz	dBuV/m	v/h	Limit	Margin	Pk/QP/Avg	degrees	meters	
5150.000	52.4	-	54.0	-1.6	Avg	-	-	Using 1MHz delta value

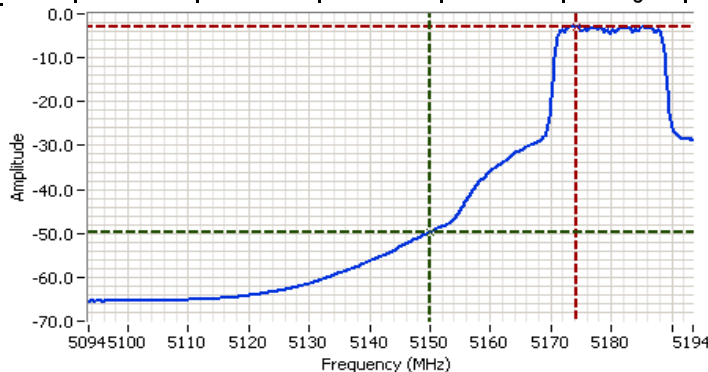

Analyzer Settings  
 HP8564E,EMICF: 5143.500 MHz  
 SPAN: 100.000 MHz  
 RB: 1.000 MHz  
 VB: 10 Hz  
 Detector: Sample  
 Attn: 10 DB  
 RL Offset: 10.0 DB  
 Sweep Time: 37.0s  
 Ref Lvl: 9.7 DBM

#### Comments

BE @ 5150 MHz  
 802.11n 20MHz  
 Chain B  
 Average

Cursor 1	5150.0000	-49.63	
Cursor 2	5174.1665	-2.97	

Delta Freq. 24.167  
 Delta Amplitude 46.67



Client: Intel Corporation	Job Number: J80398
Model: Intel® Centrino® Advanced-N 6230	T-Log Number: T80540
Contact: Steve Hackett	Account Manager: Christine Krebill
Standard: FCC 15.247	Class: N/A

### Run # 2b, EUT on Channel #64 5320MHz - n20, Chain B

	Target (dBm)	Power Settings Measured (dBm)	Software Setting
Chain B	16.5	16.6	26.0

### Fundamental Signal Field Strength

Frequency	Level	Pol	15.209 / 15.247		Detector	Azimuth	Height	Comments
MHz	dBμV/m	v/h	Limit	Margin	Pk/QP/Avg	degrees	meters	
5313.270	97.9	V	-	-	AVG	278	1.0	
5313.670	106.3	V	-	-	PK	278	1.0	
5313.370	98.3	H	-	-	AVG	150	1.0	
5315.230	106.5	H	-	-	PK	150	1.0	

### 5350 MHz Band Edge Signal Radiated Field Strength - Marker Delta

	H	V				
Fundamental emission level @ 3m in 1MHz RBW:	106.5	106.3	Peak Measurement (RB=VB=1MHz)			
Fundamental emission level @ 3m in 1MHz RBW:	98.3	97.9	Average Measurement (RB=1MHz, VB=10Hz)			
Delta Marker - 100kHz	50.0 dB		-< this can only be used if band edge signal is highest within 2MHz of band edge.			
Calculated Band-Edge Measurement (Peak):	56.5 dBuV/m					
Calculated Band-Edge Measurement (Avg):	48.3 dBuV/m		Margin	Level	Limit	Detector
Delta Marker - 1MHz/1MHz:	41.8 dB		-5.9	48.1	54	Avg
Delta Marker - 1MHz/10Hz:	50.2 dB		-17.5	56.5	74	Pk
Calculated Band-Edge Measurement (Peak):	64.7 dBuV/m		Using 100kHz delta value			
Calculated Band-Edge Measurement (Avg):	48.1 dBuV/m		Using 1MHz delta value			

Frequency	Level	Pol	FCC 15.209		Detector	Azimuth	Height	Comments
MHz	dBμV/m	v/h	Limit	Margin	Pk/QP/Avg	degrees	meters	
5350.000	48.1	-	54.0	-5.9	Avg	-	-	Using 1MHz delta value

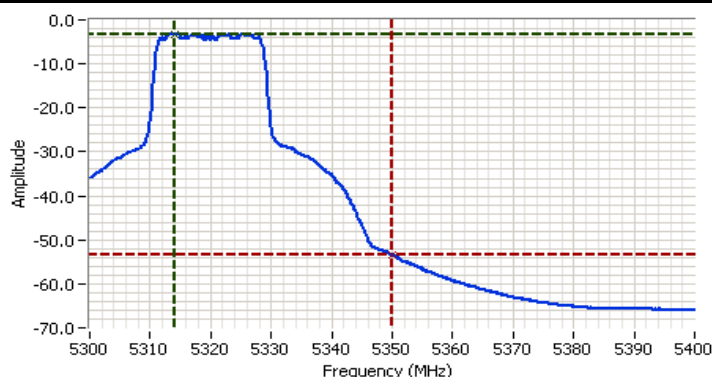

Analyzer Settings  
 HP8564E,EMICF: 5350.000 MHz  
 SPAN: 100.000 MHz  
 RB: 1.000 MHz  
 VB: 10 Hz  
 Detector: Sample  
 Attn: 10 DB  
 RL Offset: 10.0 DB  
 Sweep Time: 37.0s  
 Ref Lvl: 9.7 DBM

Comments  
 BE @ 5350 MHz  
 802.11n 20MHz  
 Chain B  
 Average

Cursor 1	5314.0000	-3.30	Delta Freq.	36.000
Cursor 2	5350.0000	-53.47	Delta Amplitude	50.17



Client: Intel Corporation	Job Number: J80398
Model: Intel® Centrino® Advanced-N 6230	T-Log Number: T80540
Contact: Steve Hackett	Account Manager: Christine Krebill
Standard: FCC 15.247	Class: N/A

### Run # 2c, EUT on Channel #100 5500MHz - n20, Chain B

	Target (dBm)	Power Settings Measured (dBm)	Software Setting
Chain B	16.5	16.7	28.0

### Fundamental Signal Field Strength

Frequency	Level	Pol	15.209 / 15.247		Detector	Azimuth	Height	Comments
MHz	dBμV/m	v/h	Limit	Margin	Pk/QP/Avg	degrees	meters	
5492.970	96.4	V	-	-	AVG	265	1.0	
5493.200	105.3	V	-	-	PK	265	1.0	
5492.900	98.8	H	-	-	AVG	109	1.0	
5493.100	107.6	H	-	-	PK	109	1.0	

### 5460 MHz Restricted Band Edge Signal Radiated Field Strength - Marker Delta

	H	V		Margin	Level	Limit	Detector
Fundamental emission level @ 3m in 1MHz RBW:	107.6	105.3					Peak Measurement (RB=VB=1MHz)
Fundamental emission level @ 3m in 1MHz RBW:	98.8	96.4					Average Measurement (RB=1MHz, VB=10Hz)
Delta Marker - 100kHz	52.8 dB						<- this can only be used if band edge signal is highest within 2MHz of band edge.
Calculated Band-Edge Measurement (Peak):	54.8 dBuV/m						
Calculated Band-Edge Measurement (Avg):	46.0 dBuV/m						
Delta Marker - 1MHz/1MHz:	45.2 dB			-8.0	46.0	54	Avg
Delta Marker - 1MHz/10Hz:	52.8 dB			-19.2	54.8	74	Pk
Calculated Band-Edge Measurement (Peak):	62.4 dBuV/m						Using 100kHz delta value
Calculated Band-Edge Measurement (Avg):	46.0 dBuV/m						Using 1MHz delta value

Frequency	Level	Pol	FCC 15.209		Detector	Azimuth	Height	Comments
MHz	dBμV/m	v/h	Limit	Margin	Pk/QP/Avg	degrees	meters	
5459.834	46.0	-	54.0	-8.0	Avg	-	-	Using 1MHz delta value

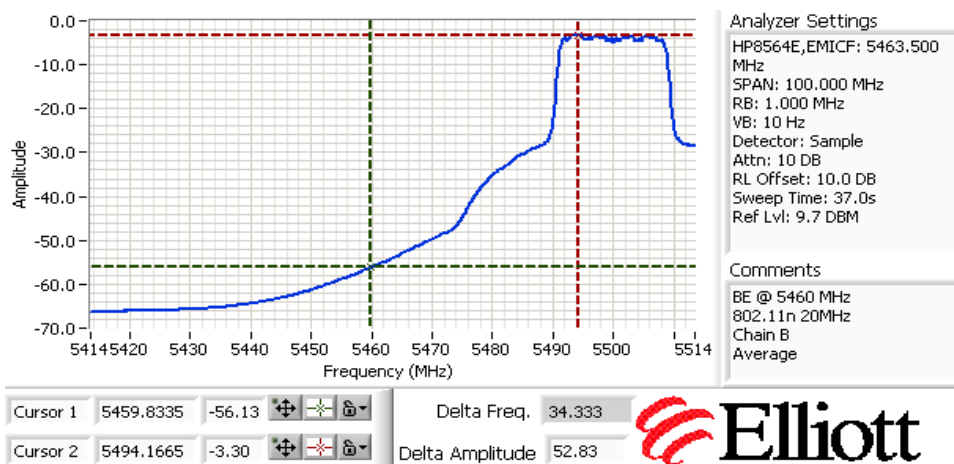

Client: Intel Corporation	Job Number: J80398
Model: Intel® Centrino® Advanced-N 6230	T-Log Number: T80540
Contact: Steve Hackett	Account Manager: Christine Krebill
Standard: FCC 15.247	Class: N/A

### 5470 MHz Band Edge Signal Radiated Field Strength - Marker Delta

	H	V				
Fundamental emission level @ 3m in 1MHz RBW:	107.6	105.3	Peak Measurement (RB=VB=1MHz)			
Fundamental emission level @ 3m in 1MHz RBW:	98.8	96.4	Average Measurement (RB=1MHz, VB=10Hz)			
Delta Marker - 100kHz	46.3 dB		<- this can only be used if band edge signal is highest within 2MHz of band edge.			
Calculated Band-Edge Measurement (Peak):	61.3 dBuV/m					
Calculated Band-Edge Measurement (Avg):	52.5 dBuV/m		Margin	Level	Limit	Detector
Delta Marker - 1MHz/1MHz:	46.7 dB		-16.0	52.3	68.3	Avg
Delta Marker - 1MHz/10Hz:	<b>46.5 dB</b>		-27.4	60.9	88.3	Pk
Calculated Band-Edge Measurement (Peak):	60.9 dBuV/m		Using 1MHz delta value			
Calculated Band-Edge Measurement (Avg):	52.3 dBuV/m		Using 1MHz delta value			

Frequency	Level	Pol	FCC 15E		Detector	Azimuth	Height	Comments
MHz	dBuV/m	v/h	Limit	Margin	Pk/QP/Avg	degrees	meters	
5469.834	52.3	-	68.3	-16.0	Avg	-	-	Using 1MHz delta value

Note - average limit is equivalent to -27dBm eirp.

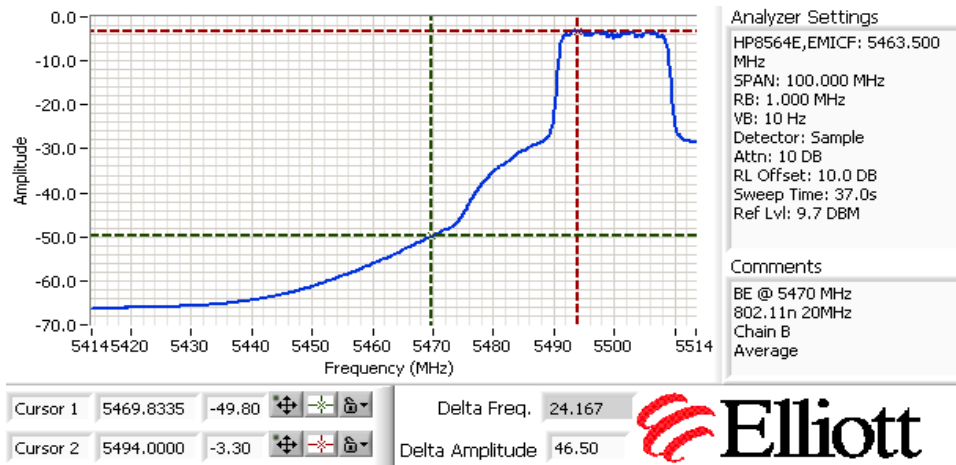

Client: Intel Corporation	Job Number: J80398
Model: Intel® Centrino® Advanced-N 6230	T-Log Number: T80540
Contact: Steve Hackett	Account Manager: Christine Krebill
Standard: FCC 15.247	Class: N/A

### Run # 2d, EUT on Channel #140 5700MHz - n20, Chain B

	Target (dBm)	Power Settings Measured (dBm)	Software Setting
Chain B	16.5	16.6	29.0

### Fundamental Signal Field Strength

Frequency	Level	Pol	15.209 / 15.247		Detector	Azimuth	Height	Comments
MHz	dB $\mu$ V/m	v/h	Limit	Margin	Pk/QP/Avg	degrees	meters	
5692.970	98.0	V	-	-	AVG	306	1.0	
5694.700	106.5	V	-	-	PK	306	1.0	
5693.130	96.2	H	-	-	AVG	97	1.0	
5693.630	104.7	H	-	-	PK	97	1.0	

### 5725 MHz Restricted Band Edge Signal Radiated Field Strength - Marker Delta

	H	V		Level	Limit	Detector
Fundamental emission level @ 3m in 1MHz RBW:	104.7	106.5				
Fundamental emission level @ 3m in 1MHz RBW:	96.2	98.0				
Delta Marker - 100kHz	39.2 dB					
Calculated Band-Edge Measurement (Peak):	67.3 dB $\mu$ V/m					
Calculated Band-Edge Measurement (Avg):	58.8 dB $\mu$ V/m		Margin			
Delta Marker - 1MHz/1MHz:	34.0 dB		-11.6	56.7	68.3	Avg
Delta Marker - 1MHz/10Hz:	41.3 dB		-21.0	67.3	88.3	Pk
Calculated Band-Edge Measurement (Peak):	72.5 dB $\mu$ V/m		Using 100kHz delta value			
Calculated Band-Edge Measurement (Avg):	56.7 dB $\mu$ V/m		Using 1MHz delta value			

Peak Measurement (RB=VB=1MHz)  
Average Measurement (RB=1MHz, VB=10Hz)  
-< this can only be used if band edge signal is highest within 2MHz of band edge.

Frequency	Level	Pol	FCC 15E		Detector	Azimuth	Height	Comments
MHz	dB $\mu$ V/m	v/h	Limit	Margin	Pk/QP/Avg	degrees	meters	
5725.000	56.7	-	68.3	-11.6	Avg	-	-	Using 1MHz delta value

Note - average limit is equivalent to -27dBm eirp.

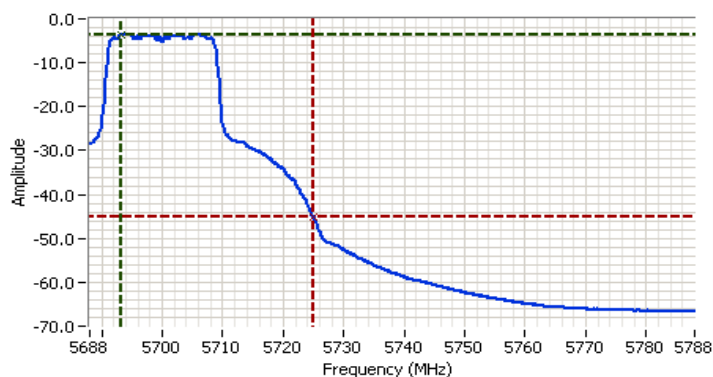

Analyzer Settings  
HP8564E,EMICF: 5738.000 MHz  
SPAN: 100.000 MHz  
RB: 1.000 MHz  
VB: 10 Hz  
Detector: Sample  
Attn: 10 DB  
RL Offset: 10.0 DB  
Sweep Time: 37.0s  
Ref Lvl: 9.7 DBM

Comments  
BE @ 5725 MHz  
802.11n 20MHz  
Chain B  
Average

Cursor 1	5693.1665	-3.63		
Cursor 2	5725.0000	-44.97		

Delta Freq. 31.833  
Delta Amplitude 41.33



Client: Intel Corporation	Job Number: J80398
Model: Intel® Centrino® Advanced-N 6230	T-Log Number: T80540
Contact: Steve Hackett	Account Manager: Christine Krebill
Standard: FCC 15.247	Class: N/A

**Run # 3, Band Edge Field Strength - 802.11a, Chain B**

**Run # 3a, EUT on Channel #36 5180MHz - 802.11a, Chain B**

Date of Test: 9/23/2010

Test Location: Chamber #7

Test Engineer: Mehran Birgani

Config Change: None

	Power Settings		
	Target (dBm)	Measured (dBm)	Software Setting
Chain B	16.5	16.5	24.5

**Fundamental Signal Field Strength**

Frequency	Level	Pol	15.209 / 15.247		Detector	Azimuth	Height	Comments
MHz	dBuV/m	v/h	Limit	Margin	Pk/QP/Avg	degrees	meters	
5186.530	98.7	V	-	-	AVG	314	1.0	
5186.100	106.7	V	-	-	PK	314	1.0	
5172.970	99.0	H	-	-	AVG	108	1.0	
5174.070	107.6	H	-	-	PK	108	1.0	

**5150 MHz Band Edge Signal Radiated Field Strength - Marker Delta**

	H	V	
Fundamental emission level @ 3m in 1MHz RBW:	107.6	106.7	Peak Measurement (RB=VB=1MHz)
Fundamental emission level @ 3m in 1MHz RBW:	99.0	98.7	Average Measurement (RB=1MHz, VB=10Hz)
<i>Delta Marker - 100kHz</i>	<b>48.0 dB</b>		<- this can only be used if band edge signal is highest within 2MHz of band edge.
Calculated Band-Edge Measurement (Peak):	59.6 dBuV/m		
Calculated Band-Edge Measurement (Avg):	51.0 dBuV/m	Margin	Level
<i>Delta Marker - 1MHz/1MHz:</i>	42.7 dB	-3.0	51.0
<i>Delta Marker - 1MHz/10Hz:</i>	47.8 dB	-14.4	59.6
Calculated Band-Edge Measurement (Peak):	64.9 dBuV/m		74
Calculated Band-Edge Measurement (Avg):	51.2 dBuV/m		Pk
			Using 100kHz delta value
			Using 100kHz delta value

Frequency	Level	Pol	FCC 15.209		Detector	Azimuth	Height	Comments
MHz	dBuV/m	v/h	Limit	Margin	Pk/QP/Avg	degrees	meters	
<b>5149.334</b>	<b>51.0</b>	-	54.0	<b>-3.0</b>	Avg	-	-	Using 100kHz delta value

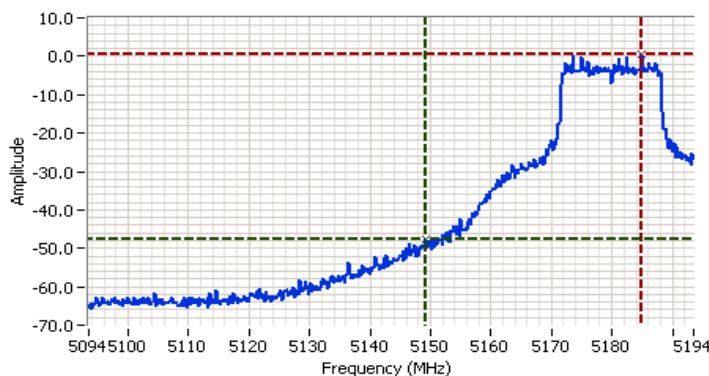

**Analyzer Settings**  
 HP8564E,EMICF: 5143.500  
 MHz  
 SPAN: 100.000 MHz  
 RB: 100 kHz  
 VB: 100 kHz  
 Detector: POS  
 Attn: 10 DB  
 RL Offset: 10.0 DB  
 Sweep Time: 55.0ms  
 Ref Lvl: 9.7 DBM

**Comments**  
 BE @ 5150 MHz  
 802.11a  
 Chain B  
 100k

Cursor 1	5149.3335	-47.63	+	-	Delta Freq.	35.667
Cursor 2	5185.0000	0.37	+	-	Delta Amplitude	48.00





Client:	Intel Corporation	Job Number:	J80398
Model:	Intel® Centrino® Advanced-N 6230	T-Log Number:	T80540
Contact:	Steve Hackett	Account Manager:	Christine Krebill
Standard:	FCC 15.247	Class:	N/A

### Run # 3b, EUT on Channel #64 5320MHz - 802.11a, Chain B

Date of Test: 9/23/2010      Test Location: FT #7  
 Test Engineer: Mark Hill      Config Change: none

	Target (dBm)	Power Settings Measured (dBm)	Software Setting
Chain B	16.5	16.8	25.5

### Fundamental Signal Field Strength

Frequency	Level	Pol	15.209 / 15.247		Detector	Azimuth	Height	Comments
MHz	dBuV/m	v/h	Limit	Margin	Pk/QP/Avg	degrees	meters	
5313.070	97.9	V	-	-	AVG	306	1.0	
5313.800	106.2	V	-	-	PK	306	1.0	
5313.030	98.1	H	-	-	AVG	148	1.0	
5313.700	106.4	H	-	-	PK	148	1.0	

### 5350 MHz Band Edge Signal Radiated Field Strength - Marker Delta

	H	V				
Fundamental emission level @ 3m in 1MHz RBW:	106.4	106.2	Peak Measurement (RB=VB=1MHz)			
Fundamental emission level @ 3m in 1MHz RBW:	98.1	97.9	Average Measurement (RB=1MHz, VB=10Hz)			
<i>Delta Marker - 100kHz</i>	<b>51.5 dB</b>		<b>&lt;- this can only be used if band edge signal is highest within 2MHz of band edge.</b>			
Calculated Band-Edge Measurement (Peak):	54.9 dBuV/m		Margin	Level	Limit	Detector
Calculated Band-Edge Measurement (Avg):	46.6 dBuV/m		-7.4	46.6	54	Avg
<i>Delta Marker - 1MHz/1MHz:</i>	45.0 dB		-19.1	54.9	74	Pk
<i>Delta Marker - 1MHz/10Hz:</i>	51.2 dB					
Calculated Band-Edge Measurement (Peak):	61.4 dBuV/m		Using 100kHz delta value			
Calculated Band-Edge Measurement (Avg):	46.9 dBuV/m		Using 100kHz delta value			

Frequency	Level	Pol	FCC 15.209		Detector	Azimuth	Height	Comments
MHz	dBuV/m	v/h	Limit	Margin	Pk/QP/Avg	degrees	meters	
5350.000	46.6	-	54.0	-7.4	Avg	-	-	Using 100kHz delta value

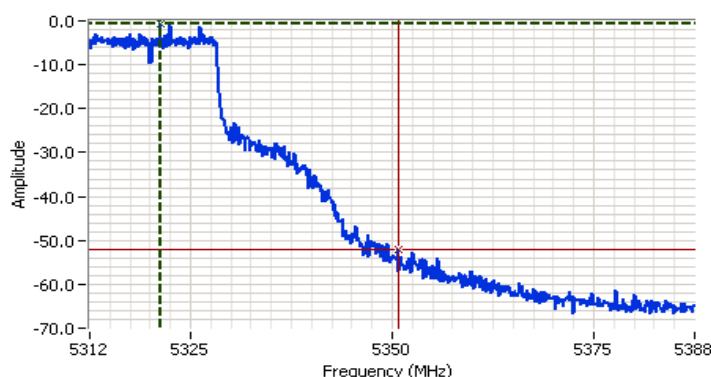

**Analyzer Settings**  
 HP8564E,EMICF: 5350.000 MHz  
 SPAN: 75.000 MHz  
 RB: 100 kHz  
 VB: 100 kHz  
 Detector: POS  
 Attn: 10 DB  
 RL Offset: 10.0 DB  
 Sweep Time: 50.0ms  
 Ref Lvl: 9.7 DBM

**Comments**  
 BE @ 5350 MHz  
 802.11a  
 Chain B

Cursor 1	5321.2500	-0.63	
Cursor 2	5350.7500	-52.13	

Delta Freq. 29,500  
 Delta Amplitude 51.50



Client: Intel Corporation	Job Number: J80398
Model: Intel® Centrino® Advanced-N 6230	T-Log Number: T80540
Contact: Steve Hackett	Account Manager: Christine Krebill
Standard: FCC 15.247	Class: N/A

### Run # 3c, EUT on Channel #100 5500MHz - 802.11a, Chain B

	Target (dBm)	Power Settings Measured (dBm)	Software Setting
Chain B	16.5	16.7	27.5

### Fundamental Signal Field Strength

Frequency	Level	Pol	15.209 / 15.247		Detector	Azimuth	Height	Comments
MHz	dBμV/m	v/h	Limit	Margin	Pk/QP/Avg	degrees	meters	
5492.930	96.0	V	-	-	AVG	265	1.0	
5493.700	104.1	V	-	-	PK	265	1.0	
5493.070	99.1	H	-	-	AVG	110	1.0	
5493.530	107.4	H	-	-	PK	110	1.0	

### 5460 MHz Restricted Band Edge Signal Radiated Field Strength - Marker Delta

	H	V		Margin	Level	Limit	Detector
Fundamental emission level @ 3m in 1MHz RBW:	107.4	104.1					
Fundamental emission level @ 3m in 1MHz RBW:	99.1	96.0					
Delta Marker - 100kHz	54.3 dB						
Calculated Band-Edge Measurement (Peak):	53.1 dBuV/m						
Calculated Band-Edge Measurement (Avg):	44.8 dBuV/m						
Delta Marker - 1MHz/1MHz:	46.8 dB			-9.4	44.6	54	Avg
Delta Marker - 1MHz/10Hz:	54.5 dB			-20.9	53.1	74	Pk
Calculated Band-Edge Measurement (Peak):	60.6 dBuV/m						Using 100kHz delta value
Calculated Band-Edge Measurement (Avg):	44.6 dBuV/m						Using 1MHz delta value

Peak Measurement (RB=VB=1MHz)  
 Average Measurement (RB=1MHz, VB=10Hz)  
 <- this can only be used if band edge signal is highest within 2MHz of band edge.

Frequency	Level	Pol	FCC 15.209		Detector	Azimuth	Height	Comments
MHz	dBμV/m	v/h	Limit	Margin	Pk/QP/Avg	degrees	meters	
5460.000	44.6	-	54.0	-9.4	Avg	-	-	Using 1MHz delta value

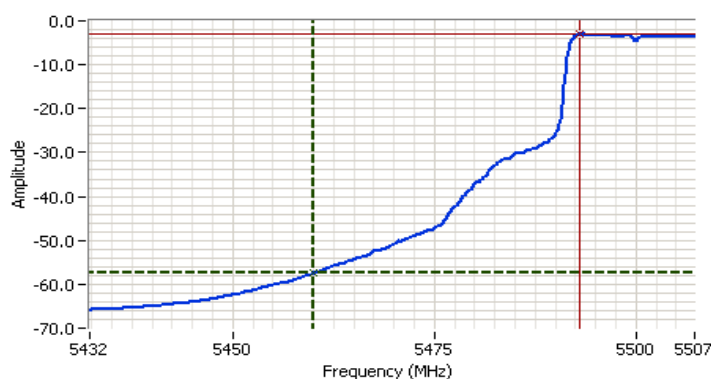

**Analyzer Settings**  
 HP8564E,EMICF: 5469.750 MHz  
 SPAN: 75.000 MHz  
 RB: 1.000 MHz  
 VB: 10 Hz  
 Detector: Sample  
 Attn: 10 DB  
 RL Offset: 10.0 DB  
 Sweep Time: 28.0s  
 Ref Lvl: 10.0 DBM

**Comments**  
 BE @ 5460 MHz  
 802.11a  
 Chain B

Cursor 1	5460.0000	-57.50	Delta Freq.	33.000
Cursor 2	5493.0000	-3.00	Delta Amplitude	54.50



Client: Intel Corporation	Job Number: J80398
Model: Intel® Centrino® Advanced-N 6230	T-Log Number: T80540
	Account Manager: Christine Krebill
Contact: Steve Hackett	
Standard: FCC 15.247	Class: N/A

### 5470 MHz Band Edge Signal Radiated Field Strength - Marker Delta

	H	V	
Fundamental emission level @ 3m in <b>1MHz RBW</b> :	107.4	104.1	Peak Measurement (RB=VB=1MHz)
Fundamental emission level @ 3m in <b>1MHz RBW</b> :	99.1	96.0	Average Measurement (RB=1MHz, VB=10Hz)
<i>Delta Marker - 100kHz</i>	<b>48.3 dB</b>		<- this can only be used if band edge signal is highest within 2MHz of band edge.
Calculated Band-Edge Measurement (Peak):	59.1 dBuV/m		
Calculated Band-Edge Measurement (Avg):	50.8 dBuV/m		
<i>Delta Marker - 1MHz/1MHz:</i>	43.7 dB		Margin
<i>Delta Marker - 1MHz/10Hz:</i>	47.8 dB		Level
Calculated Band-Edge Measurement (Peak):	63.7 dBuV/m		Limit
Calculated Band-Edge Measurement (Avg):	51.3 dBuV/m		Detector

Frequency	Level	Pol	FCC 15E		Detector	Azimuth	Height	Comments
MHz	dBuV/m	v/h	Limit	Margin	Pk/QP/Avg	degrees	meters	
5470.000	50.8	-	68.3	-17.5	Avg	-	-	Using 100kHz delta value

Note - average limit is equivalent to -27dBm eirp.

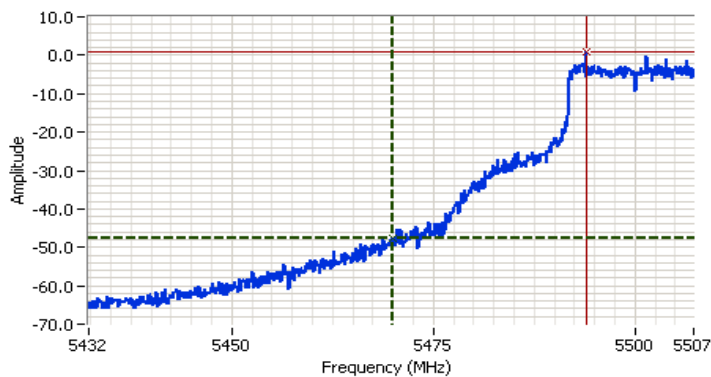

**Analyzer Settings**  
 HP8564E,EMICF: 5469.750 MHz  
 SPAN: 75.000 MHz  
 RB: 100 kHz  
 VB: 100 kHz  
 Detector: POS  
 Attn: 10 DB  
 RL Offset: 10.0 DB  
 Sweep Time: 50.0ms  
 Ref Lvl: 10.0 DBM

**Comments**  
 BE @ 5470 MHz  
 802.11a  
 Chain B

Cursor 1	5470.0000	-47.50	Delta Freq.	23.875
Cursor 2	5493.8750	0.83	Delta Amplitude	48.33



Client: Intel Corporation	Job Number: J80398
Model: Intel® Centrino® Advanced-N 6230	T-Log Number: T80540
Contact: Steve Hackett	Account Manager: Christine Krebill
Standard: FCC 15.247	Class: N/A

### Run # 3d, EUT on Channel #140 5700MHz - 802.11a, Chain B

	Target (dBm)	Power Settings Measured (dBm)	Software Setting
Chain B	16.5	16.7	28.5

### Fundamental Signal Field Strength

Frequency MHz	Level dBμV/m	Pol v/h	15.209 / 15.247		Detector Pk/QP/Avg	Azimuth degrees	Height meters	Comments
			Limit	Margin				
5693.130	96.1	V	-	-	AVG	186	1.1	
5693.730	104.7	V	-	-	PK	186	1.1	
5693.070	97.1	H	-	-	AVG	100	1.6	
5693.800	105.6	H	-	-	PK	100	1.6	

### 5725 MHz Restricted Band Edge Signal Radiated Field Strength - Marker Delta

	H	V		Margin	Level	Limit	Detector
Fundamental emission level @ 3m in 1MHz RBW:	105.6	104.7					Peak Measurement (RB=VB=1MHz)
Fundamental emission level @ 3m in 1MHz RBW:	97.1	96.1					Average Measurement (RB=1MHz, VB=10Hz)
Delta Marker - 100kHz	44.0 dB						-< this can only be used if band edge signal is highest within 2MHz of band edge.
Calculated Band-Edge Measurement (Peak):	61.6 dBμV/m						
Calculated Band-Edge Measurement (Avg):	53.1 dBμV/m						
Delta Marker - 1MHz/1MHz:	39.2 dB			-17.5	50.8	68.3	Avg
Delta Marker - 1MHz/10Hz:	46.3 dB			-26.7	61.6	88.3	Pk
Calculated Band-Edge Measurement (Peak):	66.4 dBμV/m						Using 100kHz delta value
Calculated Band-Edge Measurement (Avg):	50.8 dBμV/m						Using 1MHz delta value

Frequency MHz	Level dBμV/m	Pol v/h	FCC 15E		Detector Pk/QP/Avg	Azimuth degrees	Height meters	Comments
			Limit	Margin				
5725.000	50.8	-	68.3	-17.5	Avg	-	-	Using 1MHz delta value

Note - average limit is equivalent to -27dBm eirp.

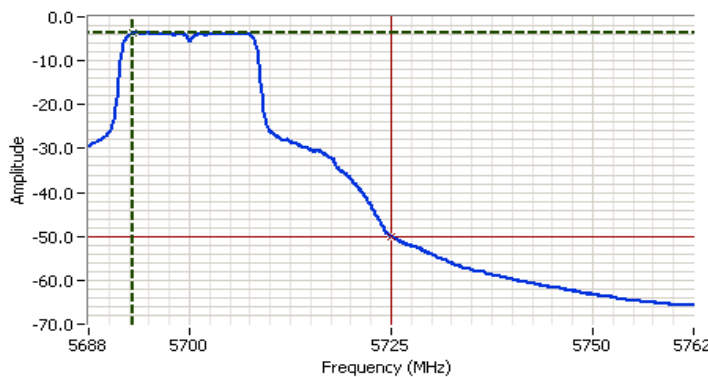

**Analyzer Settings**  
 HP8564E,EMICF: 5725.000  
 MHz  
 SPAN: 75.000 MHz  
 RB: 1.000 MHz  
 VB: 10 Hz  
 Detector: Sample  
 Attn: 10 DB  
 RL Offset: 10.0 DB  
 Sweep Time: 28.0s  
 Ref Lvl: 10.0 DBM

**Comments**  
 BE @ 5725 MHz  
 802.11a  
 Chain B

Cursor 1	5692.8750	-3.67	Delta Freq.	32.125
Cursor 2	5725.0000	-50.00	Delta Amplitude	46.33



Client:	Intel Corporation	Job Number:	J80398
Model:	Intel® Centrino® Advanced-N 6230	T-Log Number:	T80540
Contact:	Steve Hackett	Account Manager:	Christine Krebill
Standard:	FCC 15.247	Class:	N/A

## RSS 210 and FCC 15.407 (UNII) Radiated Spurious Emissions - Band Edges

### Summary of Results

MAC Address: 00150079AD1A DRTU Tool Version 1.2.12-0197 New tool from 9/14 Driver version 14.0.0.39

Run #	Mode	Channel	Power Setting	Measured Power	Test Performed	Limit	Result / Margin
Run #1	n40 Chain A+B	#38 5190MHz	A: 13.5 B: 13.5	<b>A: 10.8</b> <b>B: 10.7</b>	Restricted Band Edge at 5150 MHz	15.209	<b>52.7dBµV/m @ 5150.0MHz (-1.3dB)</b>
Run #1	n40 Chain A+B	#62 5310MHz	A: 13.5 B: 13.5	<b>A: 13.0</b> <b>B: 12.9</b>	Restricted Band Edge at 5350 MHz	15.209	52.7dBµV/m @ 5350.1MHz (-1.3dB)
Run #1	n40 Chain A+B	#102 5510MHz	A: 13.5 B: 13.5	A: 13.5 B: 13.5	Restricted Band Edge at 5460 MHz	15.209	52.3dBµV/m @ 5457.5MHz (-1.7dB)
					Band Edge at 5470 MHz	15 E	55.3dBµV/m @ 5470.0MHz (-13.0dB)
Run #1	n40 Chain A+B	#134 5670MHz	A: 13.5 B: 13.5	A: 13.5 B: 13.5	Band Edge at 5725 MHz	15 E	51.0dBµV/m @ 5744.8MHz (-17.3dB)
Run # 2	n20 Chain A+B	#36 5180MHz	A: 13.5 B: 13.5	A: 13.5 B: 13.5	Restricted Band Edge at 5150 MHz	15.209	51.0dBµV/m @ 5149.3MHz (-3.0dB)
Run # 2	n20 Chain A+B	#64 5320MHz	A: 13.5 B: 13.5	A: 13.5 B: 13.5	Restricted Band Edge at 5350 MHz	15.209	50.3dBµV/m @ 5350.4MHz (-3.7dB)
Run # 2	n20 Chain A+B	#100 5500MHz	A: 13.5 B: 13.5	A: 13.5 B: 13.5	Restricted Band Edge at 5460 MHz	15.209	50.3dBµV/m @ 5457.9MHz (-3.7dB)
					Band Edge at 5470 MHz	15 E	50.8dBµV/m @ 5469.5MHz (-17.5dB)
Run # 2	n20 Chain A+B	#140 5700MHz	A: 13.5 B: 13.5	A: 13.5 B: 13.5	Band Edge at 5725 MHz	15 E	51.1dBµV/m @ 5725.0MHz (-17.2dB)

Note - the target and measured power are average powers (measured with average power sensor) and are used for reference purposes only. Power is set using " **GAIN CONTROL**" mode in the DRTU tool.

### Test Specific Details

Objective: The objective of this test session is to perform engineering evaluation testing of the EUT with respect to the specification listed above.

### General Test Configuration

The EUT was installed into a test fixture such that the EUT was exposed (i.e. outside of a host PC).  
For radiated emissions testing the measurement antenna was located 3 meters from the EUT.

Client:	Intel Corporation	Job Number:	J80398
Model:	Intel® Centrino® Advanced-N 6230	T-Log Number:	T80540
		Account Manager:	Christine Krebill
Contact:	Steve Hackett		
Standard:	FCC 15.247	Class:	N/A

**Ambient Conditions:**

Rel. Humidity: 15 - 55 %  
 Temperature: 18 - 25 °C

**Modifications Made During Testing**

No modifications were made to the EUT during testing

**Deviations From The Standard**

No deviations were made from the requirements of the standard.

Client:	Intel Corporation	Job Number:	J80398
Model:	Intel® Centrino® Advanced-N 6230	T-Log Number:	T80540
Contact:	Steve Hackett	Account Manager:	Christine Krebill
Standard:	FCC 15.247	Class:	N/A

**Run #1, Band Edge Field Strength - n40, Chain A+B**  
**Run #1a, EUT on Channel #38 5190MHz - n40, Chain A+B**  
 Date of Test: 9/27/2010      Test Location: FT Chamber#7  
 Test Engineer: Rafael Varelas      Config Change: none

Chain	Target (dBm)				Power Settings Measured (dBm)				Software Setting
	A	B	C	Total	A	B	C	Total	
	13.5	13.5		16.5	10.8	10.7		13.8	23.5/22.5

**Fundamental Signal Field Strength**

Frequency	Level	Pol	15.209 / 15.247		Detector	Azimuth	Height	Comments
MHz	dBµV/m	v/h	Limit	Margin	Pk/QP/Avg	degrees	meters	
5192.470	89.1	V	-	-	AVG	183	1.2	RB 1 MHz;VB 10 Hz;Pk
5182.270	99.2	V	-	-	PK	183	1.2	RB 1 MHz;VB 3 MHz;Pk
5192.470	91.5	H	-	-	AVG	114	1.1	RB 1 MHz;VB 10 Hz;Pk
5193.930	100.9	H	-	-	PK	114	1.1	RB 1 MHz;VB 3 MHz;Pk

**5150 MHz Band Edge Signal Radiated Field Strength - Direct Measurement**

Frequency	Level	Pol	FCC 15.209		Detector	Azimuth	Height	Comments
MHz	dBµV/m	v/h	Limit	Margin	Pk/QP/Avg	degrees	meters	
5149.980	52.7	H	54.0	-1.3	AVG	111	1.2	RB 1 MHz;VB 10 Hz;Pk
5148.620	65.1	H	74.0	-8.9	PK	111	1.2	RB 1 MHz;VB 3 MHz;Pk
5149.920	52.5	V	54.0	-1.5	AVG	183	1.2	RB 1 MHz;VB 10 Hz;Pk
5149.420	64.0	V	74.0	-10.0	PK	183	1.2	RB 1 MHz;VB 3 MHz;Pk

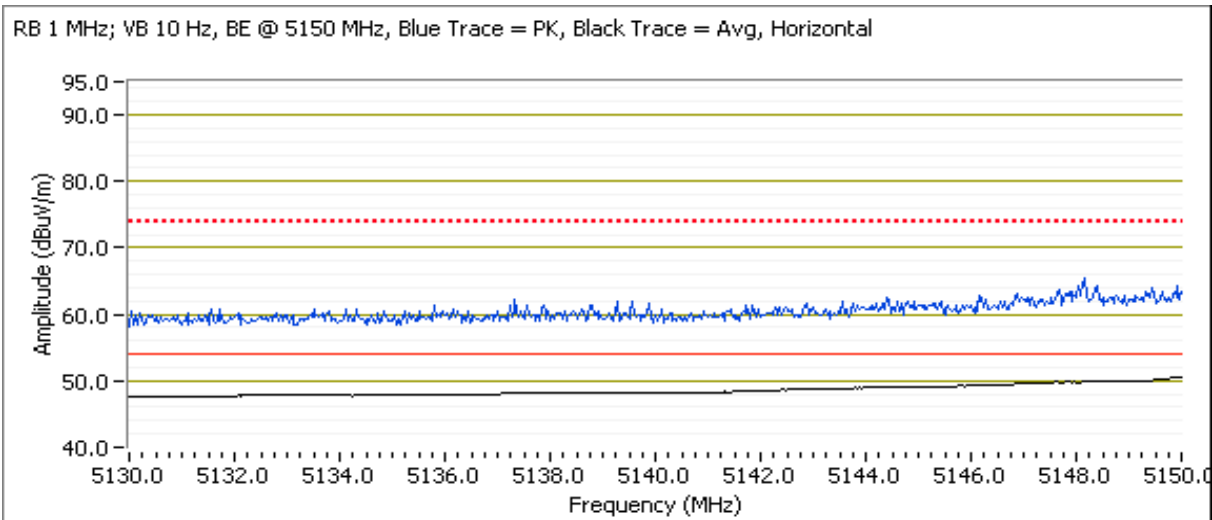

Client:	Intel Corporation	Job Number:	J80398
Model:	Intel® Centrino® Advanced-N 6230	T-Log Number:	T80540
Contact:	Steve Hackett	Account Manager:	Christine Krebill
Standard:	FCC 15.247	Class:	N/A

**Run #1b, EUT on Channel #62 5310MHz - n40, Chain A+B**  
 Date of Test: 9/27/2010      Test Location: FT Chamber#7  
 Test Engineer: Rafael Varelas      Config Change: none

Chain	Target (dBm)				Power Settings Measured (dBm)				Software Setting
	A	B	C	Total	A	B	C	Total	
	13.5	13.5		16.5	13.0	12.9		16.0	27.0/26.5

**Fundamental Signal Field Strength**

Frequency	Level	Pol	15.209 / 15.247		Detector	Azimuth	Height	Comments
MHz	dBμV/m	v/h	Limit	Margin	Pk/QP/Avg	degrees	meters	
5312.530	92.4	H	-	-	AVG	118	1.0	RB 1 MHz;VB 10 Hz;Pk
5313.130	102.6	H	-	-	PK	118	1.0	RB 1 MHz;VB 3 MHz;Pk
5307.130	91.4	V	-	-	AVG	207	1.0	RB 1 MHz;VB 10 Hz;Pk
5302.330	101.3	V	-	-	PK	207	1.0	RB 1 MHz;VB 3 MHz;Pk

**5350 MHz Band Edge Signal Radiated Field Strength - Direct Measurement**

Frequency	Level	Pol	FCC 15.209		Detector	Azimuth	Height	Comments
MHz	dBμV/m	v/h	Limit	Margin	Pk/QP/Avg	degrees	meters	
5350.060	52.7	H	54.0	-1.3	AVG	112	1.0	RB 1 MHz;VB 10 Hz;Pk
5350.620	65.6	H	74.0	-8.4	PK	112	1.0	RB 1 MHz;VB 3 MHz;Pk
5350.000	52.0	V	54.0	-2.0	AVG	150	1.3	RB 1 MHz;VB 10 Hz;Pk
5351.480	65.0	V	74.0	-9.0	PK	150	1.3	RB 1 MHz;VB 3 MHz;Pk

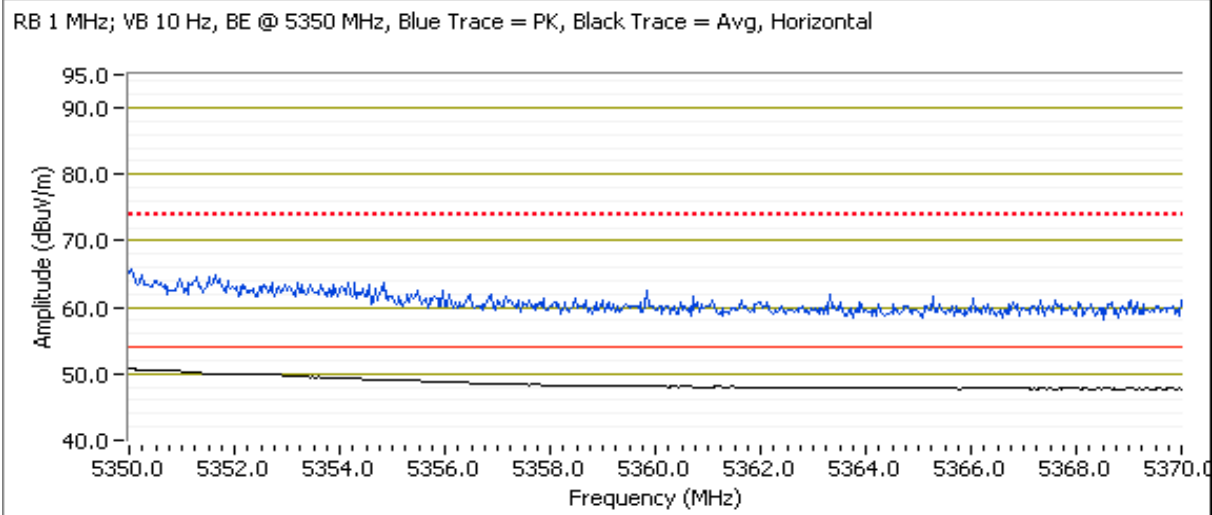



Client:	Intel Corporation	Job Number:	J80398
Model:	Intel® Centrino® Advanced-N 6230	T-Log Number:	T80540
Contact:	Steve Hackett	Account Manager:	Christine Krebill
Standard:	FCC 15.247	Class:	N/A

### Run #1c, EUT on Channel #102 5510MHz - n40, Chain A+B

Chain	Target (dBm)				Power Settings Measured (dBm)				Software Setting
	A	B	C	Total	A	B	C	Total	
	13.5	13.5		16.5	13.5	13.5		16.5	28.5 / 28.0

### Fundamental Signal Field Strength

Frequency	Level	Pol	15.209 / 15.247		Detector	Azimuth	Height	Comments
MHz	dBμV/m	v/h	Limit	Margin	Pk/QP/Avg	degrees	meters	
5512.400	92.1	H	112.3	-20.2	AVG	108	1.18	
5517.930	102.2	H	132.3	-30.1	PK	108	1.18	
5513.130	91.7	V	112.3	-20.6	AVG	155	1.17	
5513.870	101.5	V	132.3	-30.8	PK	155	1.17	

### 5460 MHz Band Edge Signal Radiated Field Strength - Direct Measurement

Frequency	Level	Pol	FCC 15.209		Detector	Azimuth	Height	Comments
MHz	dBμV/m	v/h	Limit	Margin	Pk/QP/Avg	degrees	meters	
5457.500	52.3	V	54.0	-1.7	AVG	158	1.41	
5457.670	65.0	V	74.0	-9.0	PK	158	1.41	
5458.670	52.1	H	54.0	-1.9	AVG	110	1.17	
5457.900	64.6	H	74.0	-9.4	PK	110	1.17	

RB 1 MHz; VB 10 Hz Blue trace = pk, black = avg, vertical

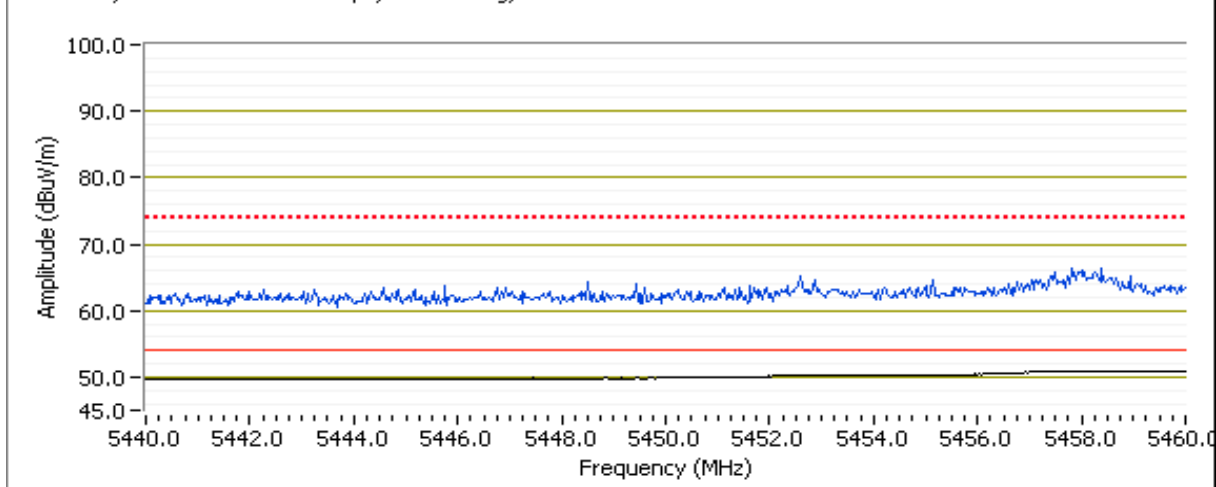

Client:	Intel Corporation	Job Number:	J80398
Model:	Intel® Centrino® Advanced-N 6230	T-Log Number:	T80540
Contact:	Steve Hackett	Account Manager:	Christine Krebill
Standard:	FCC 15.247	Class:	N/A

### 5470 MHz Band Edge Signal Radiated Field Strength - Direct Measurement

Frequency MHz	Level dB $\mu$ V/m	Pol v/h	FCC 15.209		Detector Pk/QP/Avg	Azimuth degrees	Height meters	Comments
			Limit	Margin				
5469.950	55.3	H	68.3	-13.0	AVG	111	1.13	
5469.730	67.0	H	88.3	-21.3	PK	111	1.13	
5469.870	55.0	V	68.3	-13.3	AVG	158	1.41	
5467.120	67.6	V	88.3	-20.7	PK	158	1.41	

RB 1 MHz; VB 10 Hz Blue trace = pk, black = avg, horizontal

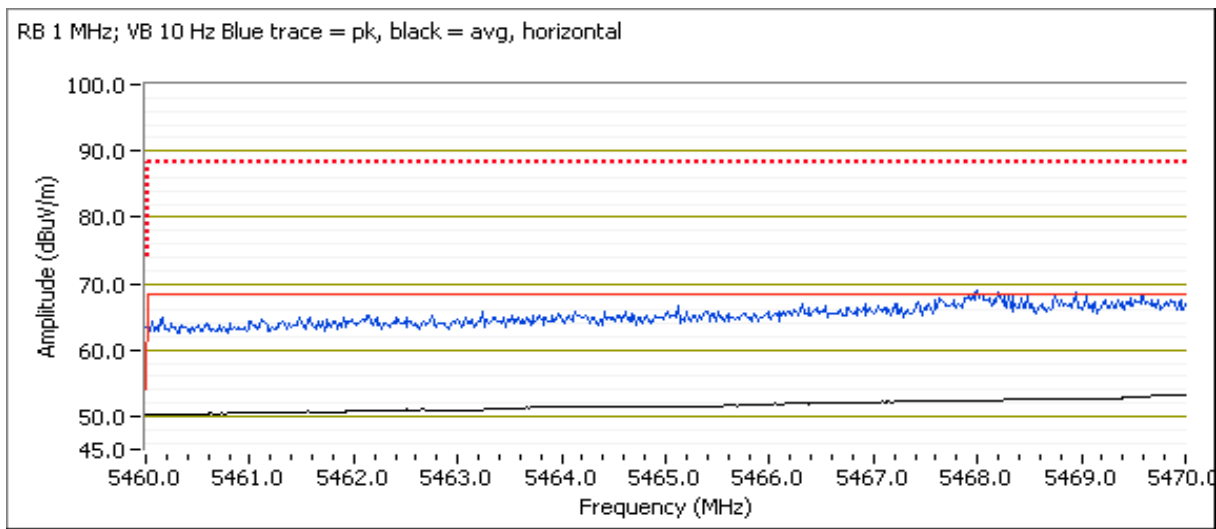

Client:	Intel Corporation	Job Number:	J80398
Model:	Intel® Centrino® Advanced-N 6230	T-Log Number:	T80540
Contact:	Steve Hackett	Account Manager:	Christine Krebill
Standard:	FCC 15.247	Class:	N/A

**Run #1d, EUT on Channel #134 5670MHz - n40, Chain A+B**

Chain	Target (dBm)				Power Settings Measured (dBm)				Software Setting
	A	B	C	Total	A	B	C	Total	
	13.5	13.5		16.5	13.5	13.5		16.5	29.5 / 29.0

**5725 MHz Band Edge Signal Radiated Field Strength - Direct Measurement**

Frequency	Level	Pol	FCC 15.209		Detector	Azimuth	Height	Comments
MHz	dB $\mu$ V/m	v/h	Limit	Margin	Pk/QP/Avg	degrees	meters	
5744.830	51.0	V	68.3	-17.3	AVG	87	1.90	
5727.670	62.2	V	88.3	-26.1	PK	87	1.90	
5730.470	51.0	H	68.3	-17.3	AVG	312	2.07	
5733.400	61.7	H	88.3	-26.6	PK	312	2.07	

Note - average limit is equivalent to -27dBm eirp.

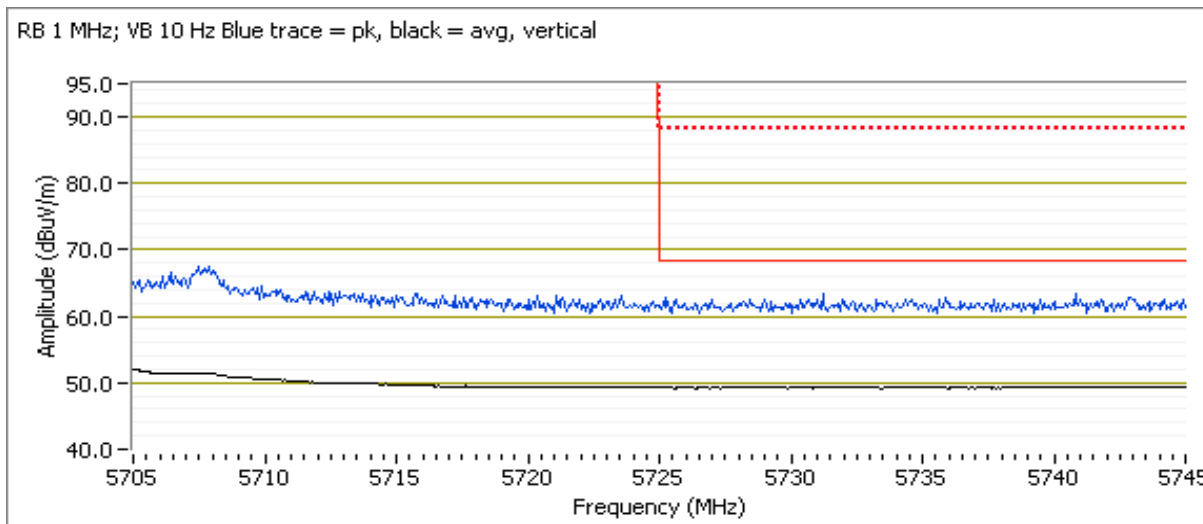

Client:	Intel Corporation	Job Number:	J80398
Model:	Intel® Centrino® Advanced-N 6230	T-Log Number:	T80540
Contact:	Steve Hackett	Account Manager:	Christine Krebill
Standard:	FCC 15.247	Class:	N/A

**Run # 2, Band Edge Field Strength - n20, Chain A+B**  
**Run # 2a, EUT on Channel #36 5180MHz - n20, Chain A+B**

Date of Test: 9/28/2010  
 Test Engineer: John Caizzi

Test Location: FT7  
 Config Change: none

Chain	Power Settings								Software Setting
	Target (dBm)				Measured (dBm)				
	A	B	C	Total	A	B	C	Total	
	13.5	13.5		16.5	13.5	13.5		16.5	25.0 / 24.0

**Fundamental Signal Field Strength**

Frequency	Level	Pol	15.209 / 15.247		Detector	Azimuth	Height	Comments
MHz	dBμV/m	v/h	Limit	Margin	Pk/QP/Avg	degrees	meters	
5185.930	95.0	V	105.3	-10.3	AVG	156	1.25	
5182.470	105.1	V	125.3	-20.2	PK	156	1.25	
5187.330	95.6	H	105.3	-9.7	AVG	108	1.16	
5185.800	105.5	H	125.3	-19.8	PK	108	1.16	

**5150 MHz Band Edge Signal Radiated Field Strength - Direct Measurement**

Frequency	Level	Pol	FCC 15.209		Detector	Azimuth	Height	Comments
MHz	dBμV/m	v/h	Limit	Margin	Pk/QP/Avg	degrees	meters	
5149.270	51.0	V	54.0	-3.0	AVG	142	1.48	
5149.800	62.1	V	74.0	-11.9	PK	142	1.48	
5149.030	50.8	H	54.0	-3.2	AVG	256	1.27	
5143.900	61.9	H	74.0	-12.1	PK	256	1.27	

RB 1 MHz; VB 10 Hz Blue trace = pk, black = avg, vertical

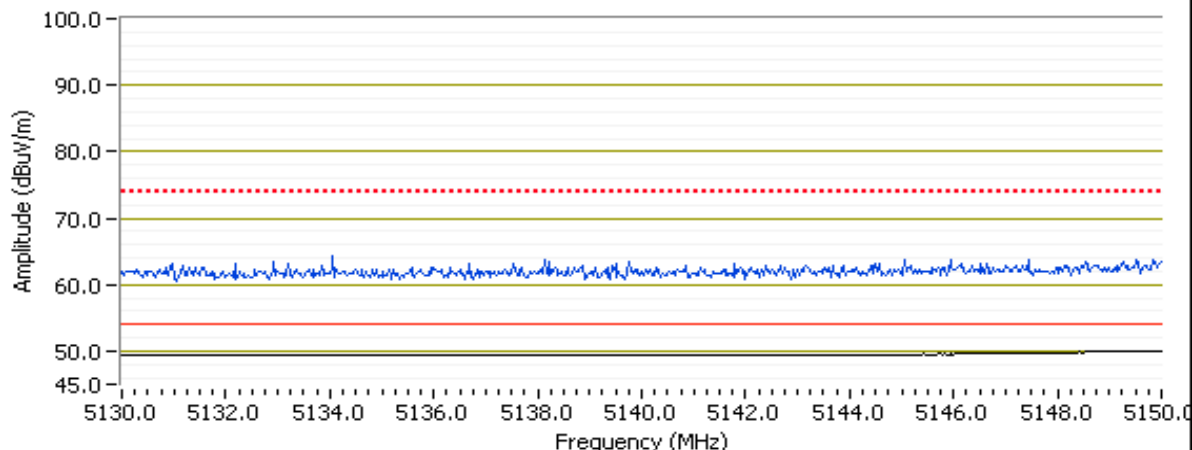

Client:	Intel Corporation	Job Number:	J80398
Model:	Intel® Centrino® Advanced-N 6230	T-Log Number:	T80540
Contact:	Steve Hackett	Account Manager:	Christine Krebill
Standard:	FCC 15.247	Class:	N/A

**Run # 2b, EUT on Channel #64 5320MHz - n20, Chain A+B**

Date of Test: 9/28/2010  
 Test Engineer: John Caizzi

Test Location: FT7  
 Config Change: none

Chain	Target (dBm)				Power Settings Measured (dBm)				Software Setting
	A	B	C	Total	A	B	C	Total	
	13.5	13.5		16.5	13.5	13.5		16.5	25.5 / 24.5

**5350 MHz Band Edge Signal Radiated Field Strength - Direct Measurement**

Frequency	Level	Pol	FCC 15.209		Detector	Azimuth	Height	Comments
MHz	dBμV/m	v/h	Limit	Margin	Pk/QP/Avg	degrees	meters	
5350.400	50.3	H	54.0	-3.7	AVG	123	1.41	
5350.970	61.0	H	74.0	-13.0	PK	123	1.41	
5355.830	50.1	V	54.0	-3.9	AVG	240	2.25	
5353.170	61.9	V	74.0	-12.1	PK	240	2.25	

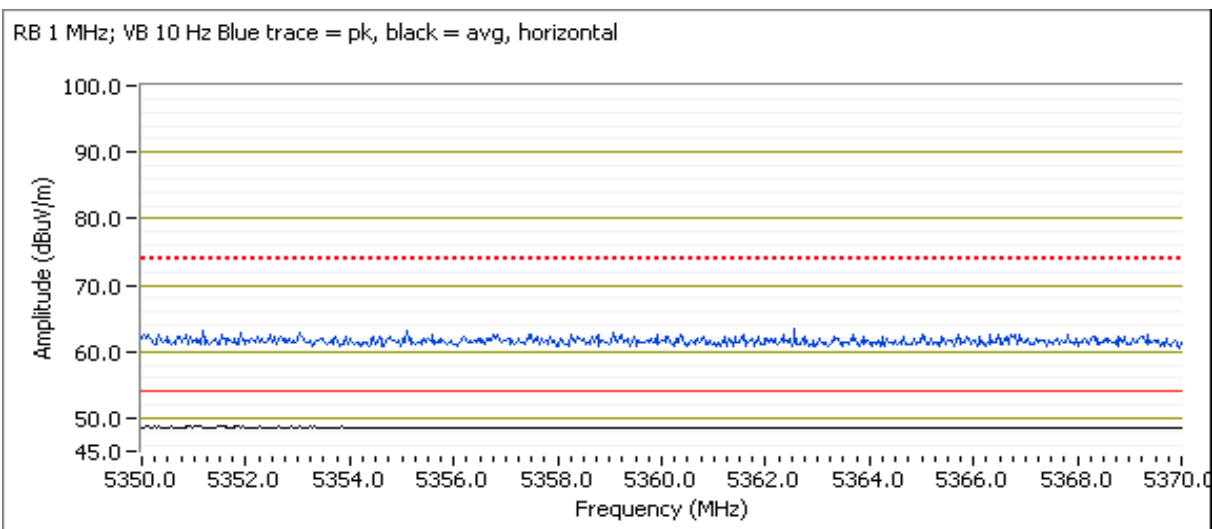

Client:	Intel Corporation	Job Number:	J80398
Model:	Intel® Centrino® Advanced-N 6230	T-Log Number:	T80540
Contact:	Steve Hackett	Account Manager:	Christine Krebill
Standard:	FCC 15.247	Class:	N/A

**Run # 2c, EUT on Channel #100 5500MHz - n20, Chain A+B**

Chain	Target (dBm)				Power Settings Measured (dBm)				Software Setting
	A	B	C	Total	A	B	C	Total	
	13.5	13.5		16.5	13.5	13.5		16.5	28.0 / 28.0

**5460 MHz Band Edge Signal Radiated Field Strength - Direct Measurement**

Frequency	Level	Pol	FCC 15.209		Detector	Azimuth	Height	Comments
MHz	dBµV/m	v/h	Limit	Margin	Pk/QP/Avg	degrees	meters	
5457.930	50.3	V	54.0	-3.7	AVG	0	1.31	
5449.370	62.6	V	74.0	-11.4	PK	0	1.31	
5448.700	50.3	H	54.0	-3.7	AVG	358	2.11	
5447.830	61.5	H	74.0	-12.5	PK	358	2.11	

RB 1 MHz; VB 10 Hz Blue trace = pk, black trace = avg, vertical

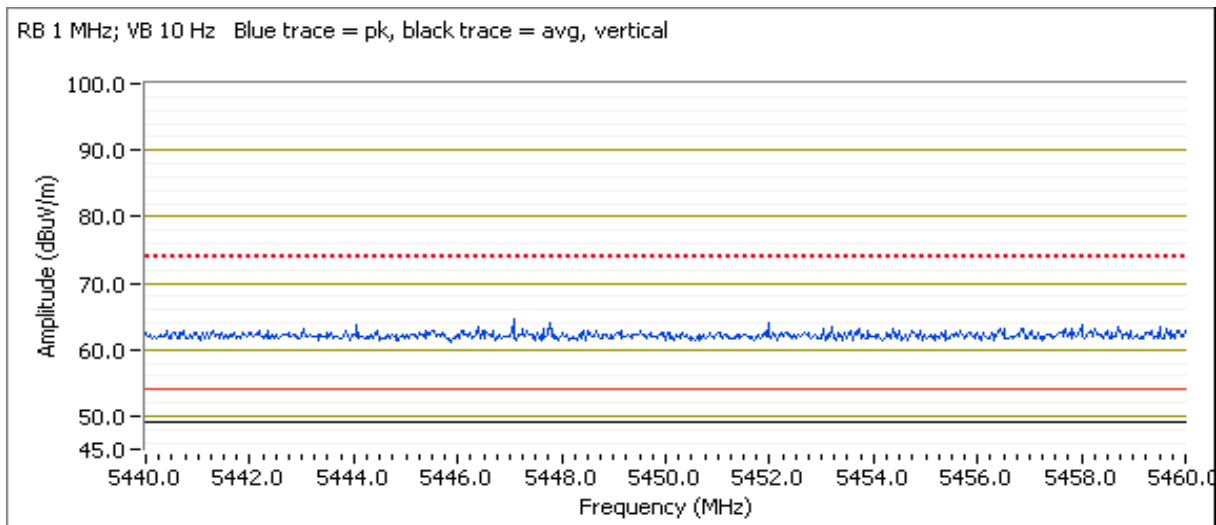

Client:	Intel Corporation	Job Number:	J80398
Model:	Intel® Centrino® Advanced-N 6230	T-Log Number:	T80540
Contact:	Steve Hackett	Account Manager:	Christine Krebill
Standard:	FCC 15.247	Class:	N/A

### 5470 MHz Band Edge Signal Radiated Field Strength - Direct Measurement

Frequency MHz	Level dBµV/m	Pol v/h	FCC 15.209		Detector Pk/QP/Avg	Azimuth degrees	Height meters	Comments
			Limit	Margin				
5469.530	50.8	V	68.3	-17.5	AVG	0	1.31	
5465.030	62.3	V	88.3	-26.0	PK	0	1.31	
5467.400	50.5	H	68.3	-17.8	AVG	358	2.11	
5461.680	61.7	H	88.3	-26.6	PK	358	2.11	

Note - average limit is equivalent to -27dBm eirp.

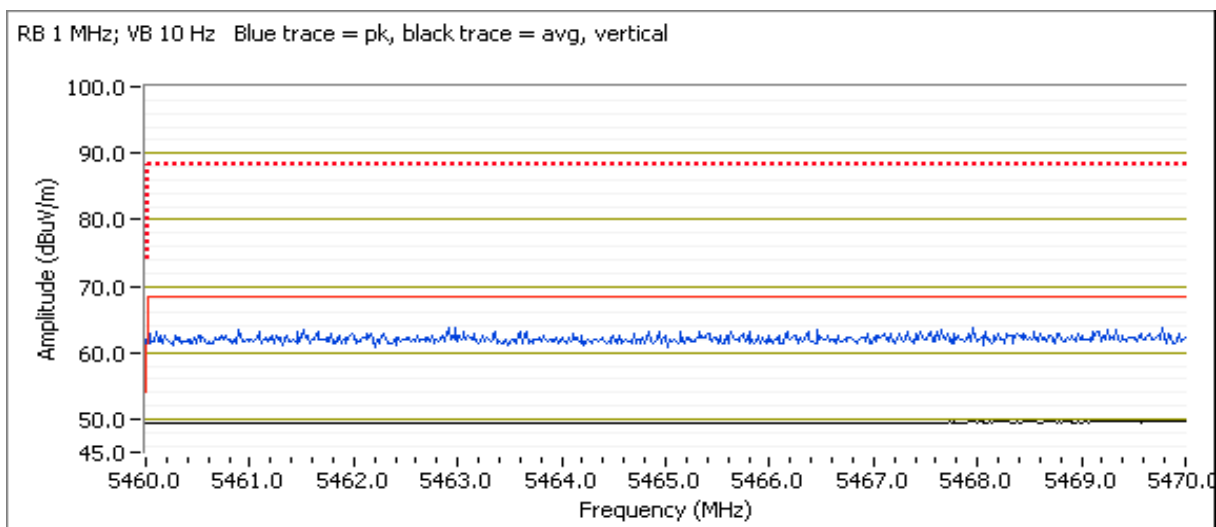

Client:	Intel Corporation	Job Number:	J80398
Model:	Intel® Centrino® Advanced-N 6230	T-Log Number:	T80540
Contact:	Steve Hackett	Account Manager:	Christine Krebill
Standard:	FCC 15.247	Class:	N/A

**Run # 2d, EUT on Channel #140 5700MHz - n20, Chain A+B**

Chain	Target (dBm)				Power Settings Measured (dBm)				Software Setting
	A	B	C	Total	A	B	C	Total	
	13.5	13.5		16.5	13.5	13.5		16.5	29.0 / 29.0

**5725 MHz Band Edge Signal Radiated Field Strength - Direct Measurement**

Frequency	Level	Pol	FCC 15.209		Detector	Azimuth	Height	Comments
MHz	dB $\mu$ V/m	v/h	Limit	Margin	Pk/QP/Avg	degrees	meters	
5725.000	51.1	V	68.3	-17.2	AVG	342	1.21	
5736.230	62.4	V	88.3	-25.9	PK	342	1.21	
5725.170	51.1	H	68.3	-17.2	AVG	50	1.68	
5735.600	62.1	H	88.3	-26.2	PK	50	1.68	

Note - average limit is equivalent to -27dBm eirp.

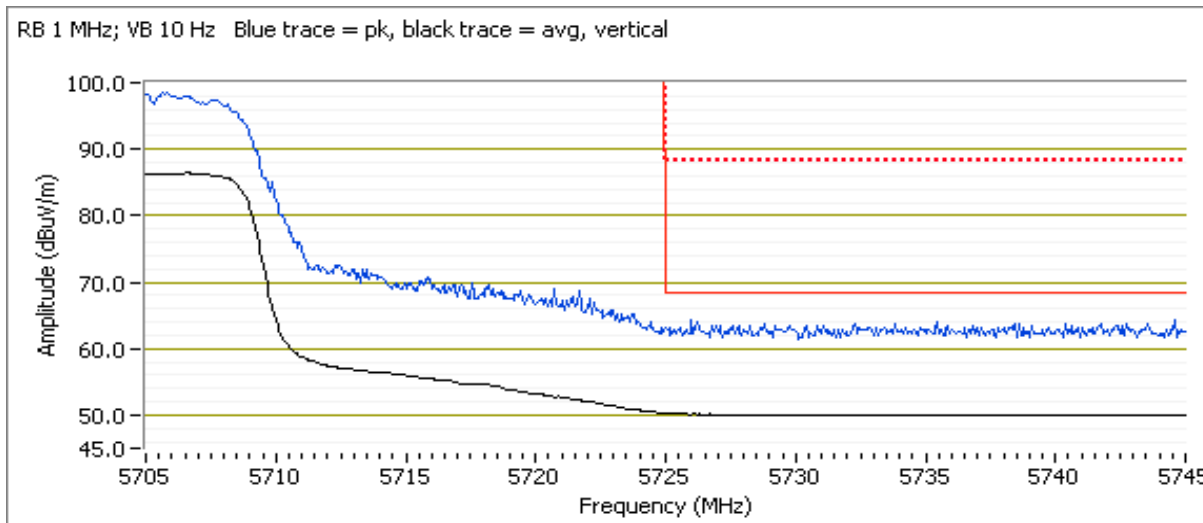



Client:	Intel Corporation	Job Number:	J80398
Model:	Intel® Centrino® Advanced-N 6230	T-Log Number:	T80540
Contact:	Steve Hackett	Account Manager:	Christine Krebill
Standard:	FCC 15.247	Class:	N/A

## RSS 210 and FCC 15.407 (UNII) Radiated Spurious Emissions

### Summary of Results

MAC Address: 00150079AD1A DRTU Tool Version 1.2.12-0197 New tool from 9/14 Driver version 14.0.0.39

Run #	Mode	Channel	Target power	Measured Power	Test Performed	Limit	Result / Margin
-------	------	---------	--------------	----------------	----------------	-------	-----------------

Scans on center channel in all three OFDM modes in each operating band were used to determine the worst case. Note that for n20 and n40 mode the output power was set to 16.5dBm per chain, the maximum power per chain in MIMO mode would be 13.5dBm, however as the single chain power could be 16.5dBm the scans were run at the higher single-chain power level but with both chains active to cover both MIMO and MISO modes.

Run #1 (5150-5250MHz Band)	802.11a Chain A	#40 5200MHz	16.5	16.5	Radiated Emissions, 1 - 40 GHz	FCC 15.209 / 15 E	41.7dBµV/m @ 1192.6MHz (-12.3dB)
	802.11a Chain B	#40 5200MHz	16.5	16.6			41.5dBµV/m @ 1192.6MHz (-12.5dB)
	n20 Chain A+B	#40 5200MHz	A: 16.5 B: 16.5	A: 16.7 B: 16.6			41.2dBµV/m @ 1192.4MHz (-12.8dB)
	n40 Chain A+B	#38 5190MHz	A: 16.5 B: 16.5	A: 16.6 B: 16.6			<b>44.1dBµV/m @ 1192.6MHz (-9.9dB)</b>
	Worst case mode - top and bottom channels. As the worst case mode was 802.11n 40MHz 5180MHz with no "low channel" 5180 MHz in n20 mode was evaluated for the low channel and n40 5230MHz evaluated as high channel.						
n20 / n40 Chain A+B	#38 5180MHz	A: 16.5 B: 16.5	A: 16.6 B: 16.6	Radiated Emissions, 1 - 40 GHz	FCC 15.209 / 15 E	33.0dBµV/m @ 2323.1MHz (-21.0dB)	
	#46 5230MHz	A: 16.5 B: 16.5	A: 16.5 B: 16.6			43.0dBµV/m @ 2323.9MHz (-11.0dB)	
Run #2 (5250-5350MHz Band)	802.11a Chain A	#60 5300MHz	16.5	16.6	Radiated Emissions, 1 - 40 GHz	FCC 15.209 / 15 E	43.4dBµV/m @ 1192.5MHz (-10.6dB)
	802.11a Chain B	#60 5300MHz	16.5	16.6			43.5dBµV/m @ 1192.5MHz (-10.5dB)
	n20 Chain A+B	#60 5300MHz	A: 16.5 B: 16.5	A: 16.7 B: 16.6			37.0dBµV/m @ 2322.7MHz (-17.0dB)
	n40 Chain A+B	#62 5310MHz	A: 16.5 B: 16.5	A: 16.6 B: 16.6			37.8dBµV/m @ 2331.5MHz (-16.2dB)
	Worst case mode (802.11a) - top and bottom channels.						
802.11a Chain A	#52 5260MHz	16.5	16.6	Radiated Emissions, 1 - 40 GHz	FCC 15.209 / 15 E	42.5dBµV/m @ 2325.4MHz (-11.5dB)	
	#48 5320MHz	16.5	16.5			41.4dBµV/m @ 2331.9MHz (-12.6dB)	
	802.11a Chain B	#52 5260MHz	16.5	16.7	Radiated Emissions, 1 - 40 GHz	FCC 15.209 / 15 E	41.4dBµV/m @ 2331.5MHz (-12.6dB)
		#48 5320MHz	16.5	16.7			41.2dBµV/m @ 2331.7MHz (-12.8dB)

Client:	Intel Corporation	Job Number:	J80398
Model:	Intel® Centrino® Advanced-N 6230	T-Log Number:	T80540
Contact:	Steve Hackett	Account Manager:	Christine Krebill
Standard:	FCC 15.247	Class:	N/A

Run #	Mode	Channel	Target power	Measured Power	Test Performed	Limit	Result / Margin	
Run #3 (5470-5725MHz Band)	802.11a Chain A	#116 5580MHz	16.5	16.6	Radiated Emissions, 1 - 40 GHz	FCC 15.209 / 15 E	37.3dBµV/m @ 2322.9MHz (-16.7dB)	
	802.11a Chain B	#116 5580MHz	16.5	16.6			37.6dBµV/m @ 2323.2MHz (-16.4dB)	
	n20 Chain A+B	#116 5580MHz	A: 16.5 B: 16.5	A: 16.6 B: 16.6			41.8dBµV/m @ 2323.0MHz (-12.2dB)	
	n40 Chain A+B	#110 5550MHz	A: 16.5 B: 16.5	A: 16.5 B: 16.5			43.7dBµV/m @ 1192.6MHz (-10.3dB)	
	Worst case mode - top and bottom channels.							
	n40 Chain A+B	#102 5510MHz #134 5670MHz	A: 16.5 B: 16.5 A: 16.5 B: 16.5	A: 16.5 B: 16.5 A: 16.6 B: 16.6	Radiated Emissions, 1 - 40 GHz	FCC 15.209 / 15 E	42.5dBµV/m @ 1192.6MHz (-11.5dB) 45.3dBµV/m @ 11399.4MHz (-8.7dB)	

### Receive mode

Run #4	Receive Chain A, Chain B, Chain A+B	#40 5200MHz	Chain A	-	Radiated Emissions, 1 - 18 GHz	RSS 210	40.7dBµV/m @ 2324.2MHz (-13.3dB)
			Chain B	-			<b>41.0dBµV/m @ 2322.8MHz (-13.0dB)</b>
			Chain A+B	-			38.4dBµV/m @ 2330.0MHz (-15.6dB)
		#60 5300MHz	Chain A	-	Radiated Emissions, 1 - 18 GHz	RSS 210	38.1dBµV/m @ 2986.3MHz (-15.9dB)
			Chain B	-			38.0dBµV/m @ 2331.7MHz (-16.0dB)
			Chain A+B	-			35.8dBµV/m @ 2986.4MHz (-18.2dB)
		#116 5580MHz	Chain A	-	Radiated Emissions, 1 - 18 GHz	RSS 210	39.2dBµV/m @ 2322.7MHz (-14.8dB)
			Chain B	-			38.5dBµV/m @ 2988.2MHz (-15.5dB)
			Chain A+B	-			39.4dBµV/m @ 2326.2MHz (-14.6dB)

Note - the target and measured power are average powers (measured with average power sensor) and are used for reference purposes only. Power is set using " **GAIN CONTROL**" mode in the DRTU tool.

Client:	Intel Corporation	Job Number:	J80398
Model:	Intel® Centrino® Advanced-N 6230	T-Log Number:	T80540
		Account Manager:	Christine Krebill
Contact:	Steve Hackett		
Standard:	FCC 15.247	Class:	N/A

**Test Specific Details**

Objective: The objective of this test session is to perform engineering evaluation testing of the EUT with respect to the specification listed above.

**General Test Configuration**

The EUT was installed into a test fixture such that the EUT was exposed (i.e. outside of a host PC).  
For radiated emissions testing the measurement antenna was located 3 meters from the EUT.

**Ambient Conditions:**

Rel. Humidity: 15 - 55 %  
Temperature: 18 - 25 °C

**Modifications Made During Testing**

No modifications were made to the EUT during testing.

**Deviations From The Standard**

No deviations were made from the requirements of the standard.

**Run #1, Radiated Spurious Emissions, 1-40GHz, Center Channel 5150-5250MHz - 802.11a, n20, n40, Chain A, B**

Date of Test: 9/24/2010                      Test Location: Chamber #7  
Test Engineer: Mehran Birgani                      Config Change: None

For emissions in restricted bands, the limit of 15.209 was used. For all other emissions, the limit is -27dBm eirp (68.3dBuV/m @3m). As the power measured is average power this is considered an average limit so the peak limit would be 88.3dBuV/m at 3m.

Client:	Intel Corporation	Job Number:	J80398
Model:	Intel® Centrino® Advanced-N 6230	T-Log Number:	T80540
Contact:	Steve Hackett	Account Manager:	Christine Krebill
Standard:	FCC 15.247	Class:	N/A

**Run #1a: Channel #40 5200MHz - 802.11a, Chain A**

	Target (dBm)	Power Settings Measured (dBm)	Software Setting
Chain A	16.5	16.5	25.0

**Spurious Radiated Emissions:**

Frequency MHz	Level dB $\mu$ V/m	Pol v/h	15.209 / 15E		Detector Pk/QP/Avg	Azimuth degrees	Height meters	Comments
			Limit	Margin				
1192.550	41.7	V	54.0	-12.3	AVG	154	1.0	
2331.440	40.7	V	54.0	-13.3	AVG	39	1.0	
2329.470	58.1	V	74.0	-15.9	PK	39	1.0	
1192.680	44.2	V	74.0	-29.8	PK	154	1.0	

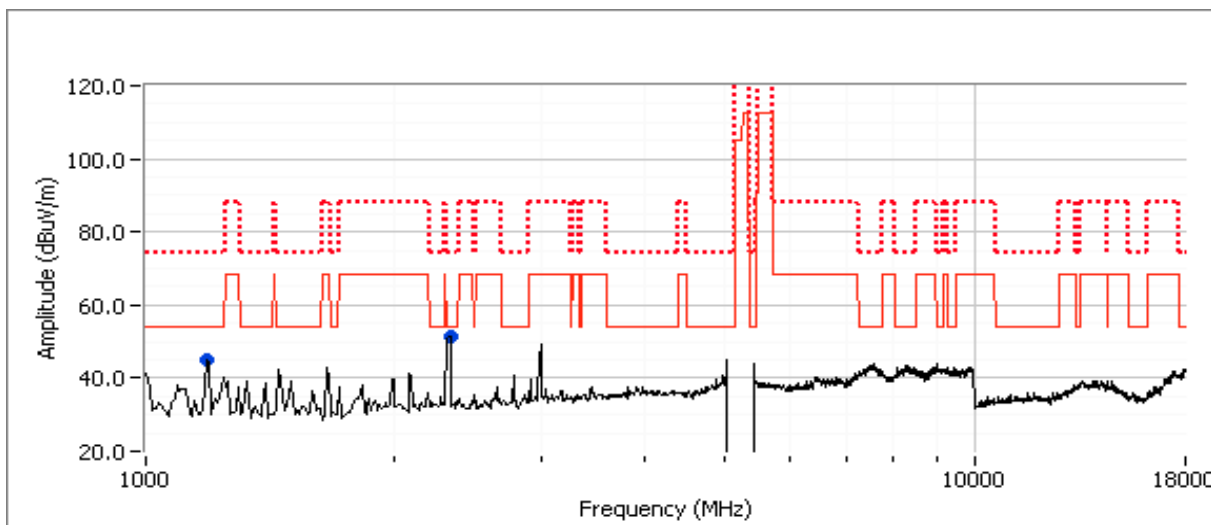

Client:	Intel Corporation	Job Number:	J80398
Model:	Intel® Centrino® Advanced-N 6230	T-Log Number:	T80540
Contact:	Steve Hackett	Account Manager:	Christine Krebill
Standard:	FCC 15.247	Class:	N/A

**Run #1b: Channel #40 5200MHz - 802.11a,Chain B**

	Target (dBm)	Power Settings Measured (dBm)	Software Setting
Chain B	16.5	16.6	24.0

**Spurious Radiated Emissions:**

Frequency MHz	Level dB $\mu$ V/m	Pol v/h	15.209 / 15E		Detector PK/QP/Avg	Azimuth degrees	Height meters	Comments
			Limit	Margin				
1192.550	41.5	V	54.0	-12.5	AVG	156	1.0	
2322.890	41.2	V	54.0	-12.8	AVG	229	1.0	
2321.830	58.6	V	74.0	-15.4	PK	229	1.0	
1192.650	44.2	V	74.0	-29.8	PK	156	1.0	

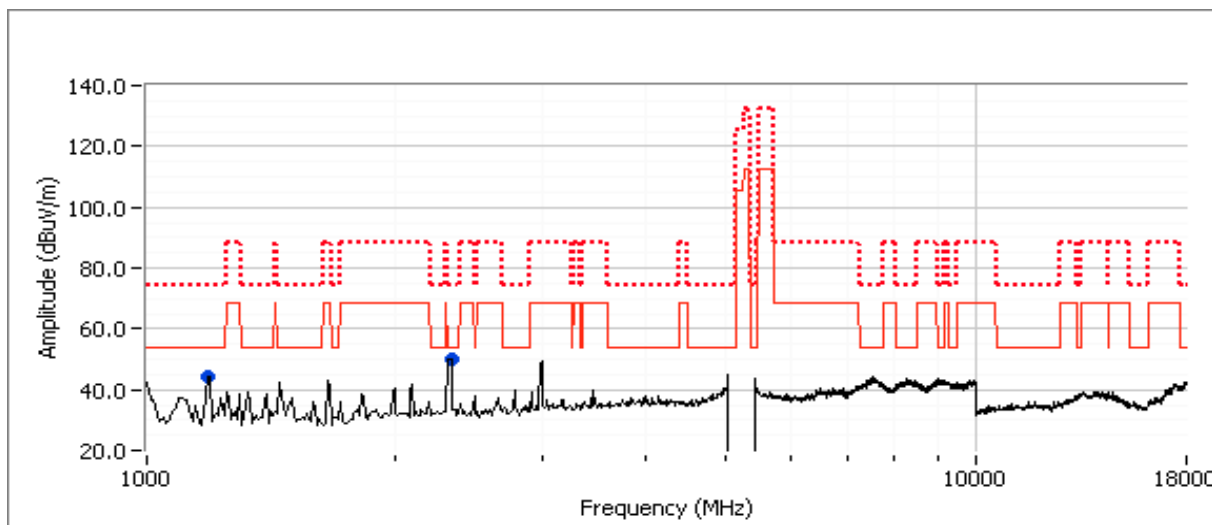

Client: Intel Corporation	Job Number: J80398
Model: Intel® Centrino® Advanced-N 6230	T-Log Number: T80540
	Account Manager: Christine Krebill
Contact: Steve Hackett	
Standard: FCC 15.247	Class: N/A

**Run #1c: Channel #40 5200MHz - 802.11n20,Chain A + B**

Date of Test: 9/24/2010

Test Location: Chamber #7

Test Engineer: Joseph Cadigal

Config Change: None

Chain	Power Settings								Software Setting
	Target (dBm)				Measured (dBm)				
	A	B	C	Total	A	B	C	Total	
	16.5	16.5		19.5	16.7	16.6		19.7	31.0, 29.5

**Spurious Radiated Emissions:**

Frequency MHz	Level dBµV/m	Pol v/h	15.209 / 15E		Detector Pk/QP/Avg	Azimuth degrees	Height meters	Comments
			Limit	Margin				
1192.370	41.2	V	54.0	-12.8	AVG	83	2.0	RB 1 MHz;VB 10 Hz;Pk
2331.510	36.7	V	54.0	-17.3	AVG	35	1.0	RB 1 MHz;VB 10 Hz;Pk
2331.590	53.3	V	74.0	-20.7	PK	35	1.0	RB 1 MHz;VB 3 MHz;Pk
2986.200	38.6	V	68.3	-29.7	AVG	126	1.0	RB 1 MHz;VB 10 Hz;Pk
1192.490	44.0	V	74.0	-30.0	PK	83	2.0	RB 1 MHz;VB 3 MHz;Pk
2985.070	56.4	V	88.3	-31.9	PK	126	1.0	RB 1 MHz;VB 3 MHz;Pk

Note 2: Scans made between 18 - 40GHz with the measurement antenna moved around the card and its antennas 20-50cm from the device indicated there were no significant emissions in this frequency range

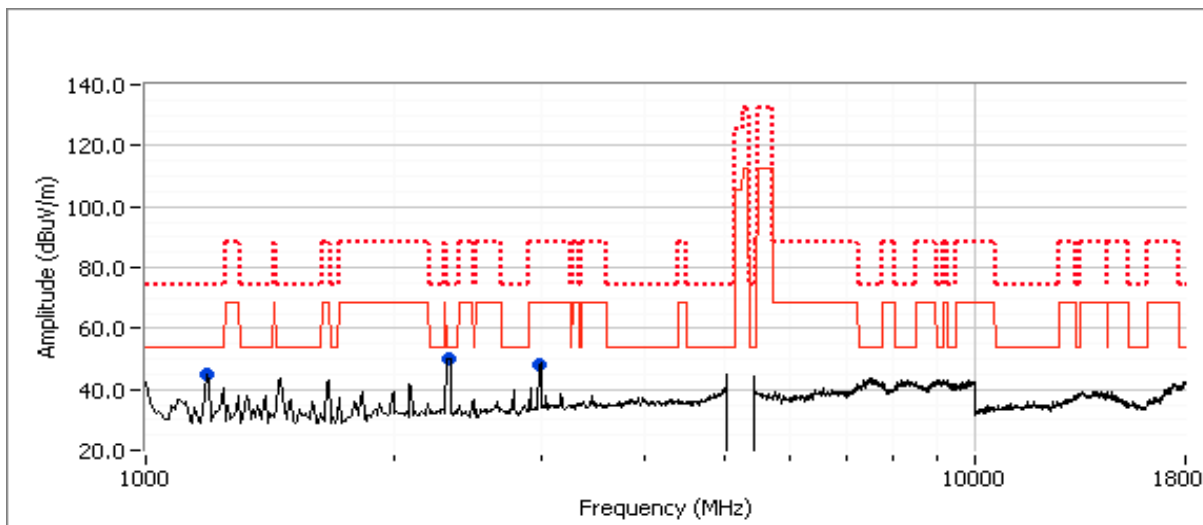

Client:	Intel Corporation	Job Number:	J80398
Model:	Intel® Centrino® Advanced-N 6230	T-Log Number:	T80540
Contact:	Steve Hackett	Account Manager:	Christine Krebill
Standard:	FCC 15.247	Class:	N/A

**Run #1d: Channel #38 5190MHz - 802.11n40, Chain A+B**

Chain	Power Settings								Software Setting
	Target (dBm)				Measured (dBm)				
	A	B	C	Total	A	B	C	Total	
	16.5	16.5		19.5	16.6	16.6		19.6	32.0, 31.0

**Spurious Radiated Emissions:**

Frequency	Level	Pol	15.209 / 15E		Detector	Azimuth	Height	Comments
MHz	dBμV/m	v/h	Limit	Margin	Pk/QP/Avg	degrees	meters	
1192.560	44.1	V	54.0	-9.9	AVG	110	2.0	
2331.690	36.0	V	54.0	-18.0	AVG	69	1.0	
2333.200	52.7	V	74.0	-21.3	PK	69	1.0	
1192.540	46.0	V	74.0	-28.0	PK	110	2.0	
2986.650	40.0	V	68.3	-28.3	AVG	140	1.0	
2985.230	57.8	V	88.3	-30.5	PK	140	1.0	

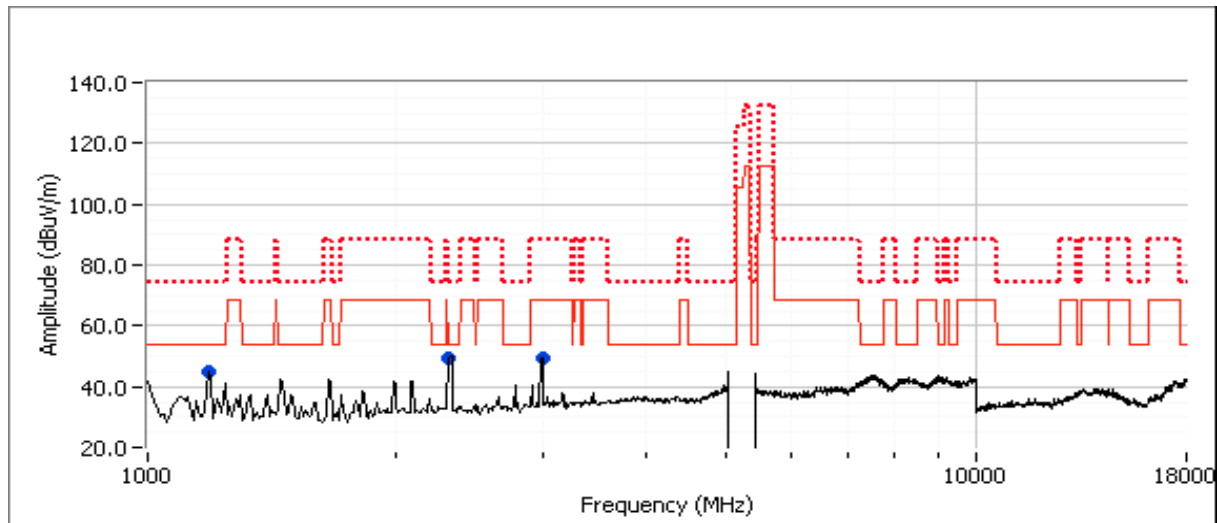

Client:	Intel Corporation	Job Number:	J80398
Model:	Intel® Centrino® Advanced-N 6230	T-Log Number:	T80540
Contact:	Steve Hackett	Account Manager:	Christine Krebill
Standard:	FCC 15.247	Class:	N/A

**Run #1e: Channel #36 5180MHz - 802.11n20,Chain A + B**

Chain	Target (dBm)				Measured (dBm)				Software Setting
	A	B	C	Total	A	B	C	Total	
	16.5	16.5		19.5	16.6	16.6		19.6	32.0, 31.0

**Spurious Radiated Emissions:**

Frequency	Level	Pol	15.209 / 15E		Detector	Azimuth	Height	Comments
MHz	dB $\mu$ V/m	v/h	Limit	Margin	Pk/QP/Avg	degrees	meters	
2323.110	33.0	V	54.0	-21.0	AVG	4	2.5	
2321.980	48.7	V	74.0	-25.3	PK	4	2.5	

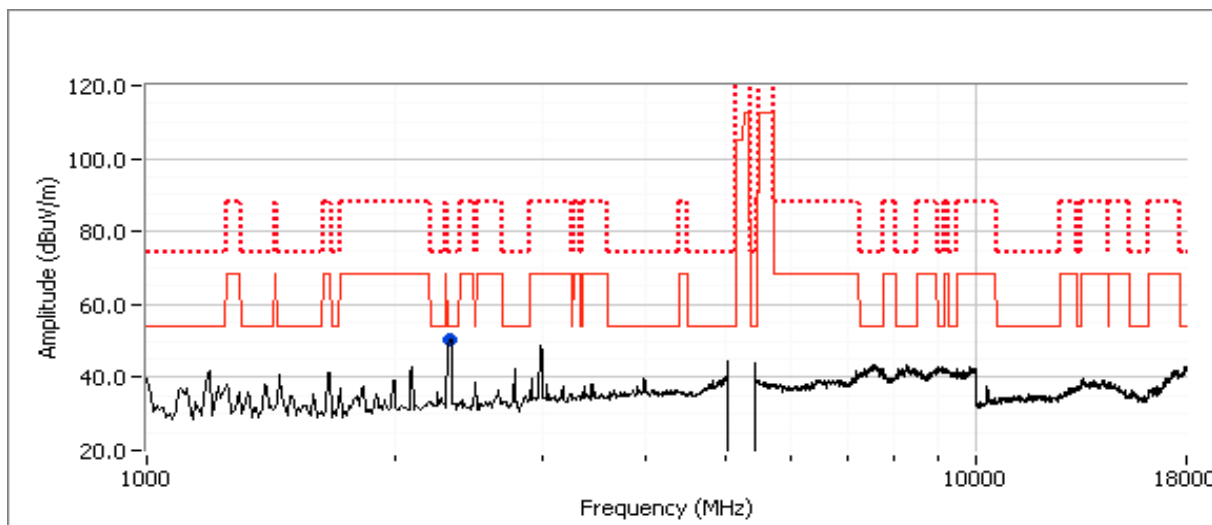



Client:	Intel Corporation	Job Number:	J80398
Model:	Intel® Centrino® Advanced-N 6230	T-Log Number:	T80540
Contact:	Steve Hackett	Account Manager:	Christine Krebill
Standard:	FCC 15.247	Class:	N/A

**Run #1f: Channel #46 5230MHz - 802.11n40,Chain A + B**

Chain	Target (dBm)				Power Settings Measured (dBm)				Software Setting
	A	B	C	Total	A	B	C	Total	
	16.5	16.5		19.5	16.5	16.6		19.6	33.0, 32.5

**Spurious Radiated Emissions:**

Frequency	Level	Pol	15.209 / 15E		Detector	Azimuth	Height	Comments
MHz	dBμV/m	v/h	Limit	Margin	Pk/QP/Avg	degrees	meters	
2323.940	43.0	V	54.0	-11.0	AVG	6	1.0	
2323.640	60.7	V	74.0	-13.3	PK	6	1.0	

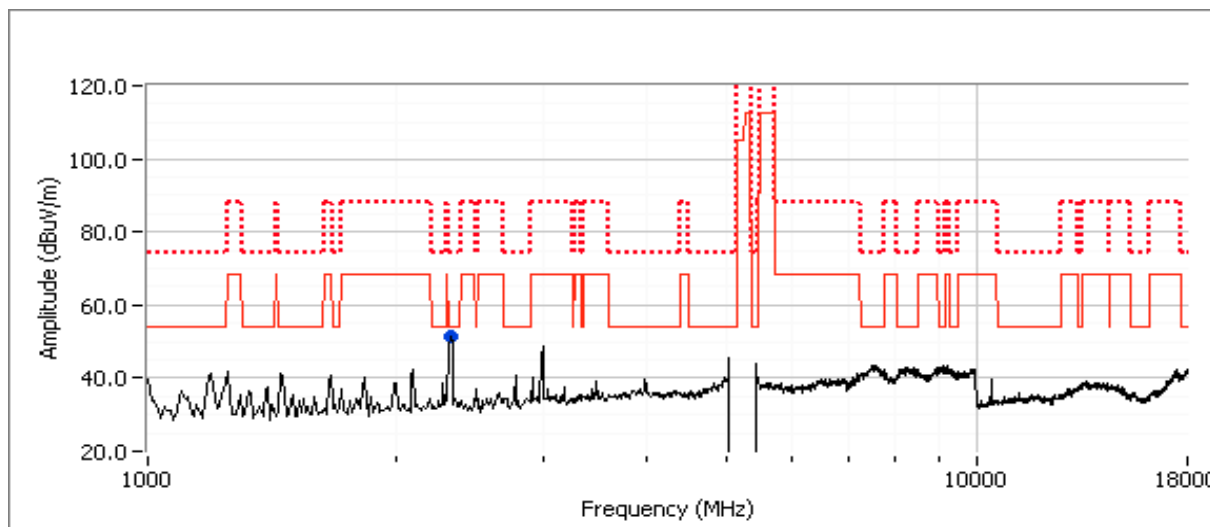

Client:	Intel Corporation	Job Number:	J80398
Model:	Intel® Centrino® Advanced-N 6230	T-Log Number:	T80540
Contact:	Steve Hackett	Account Manager:	Christine Krebill
Standard:	FCC 15.247	Class:	N/A

**Run #2, Radiated Spurious Emissions, 1-40GHz, Center Channel 5250-5350MHz - 802.11a, n20, n40, Chain A, B**

Date of Test: 9/23/2010

Test Location: FT Chamber#7

Test Engineer: Joseph Cadigal

Config Change: none

For emissions in restricted bands, the limit of 15.209 was used. For all other emissions, the limit is -27dBm eirp (68.3dBuV/m @3m). As the power measured is average power this is considered an average limit so the peak limit would be 88.3dBuV/m at 3m.

**Run #2a: Channel #60 5300MHz - 802.11a,Chain A**

	Target (dBm)	Power Settings Measured (dBm)	Software Setting
Chain A	16.5	16.6	26.5

**Spurious Radiated Emissions:**

Frequency MHz	Level dBuV/m	Pol v/h	15.209 / 15E		Detector PK/QP/Avg	Azimuth degrees	Height meters	Comments
			Limit	Margin				
1192.530	43.4	V	54.0	-10.6	AVG	110	2.0	
2331.800	36.4	V	54.0	-17.6	AVG	69	1.0	
2331.510	52.9	V	74.0	-21.1	PK	69	1.0	
1192.570	45.9	V	74.0	-28.1	PK	110	2.0	
2986.370	40.1	V	68.3	-28.2	AVG	140	1.0	
2985.090	58.0	V	88.3	-30.3	PK	140	1.0	

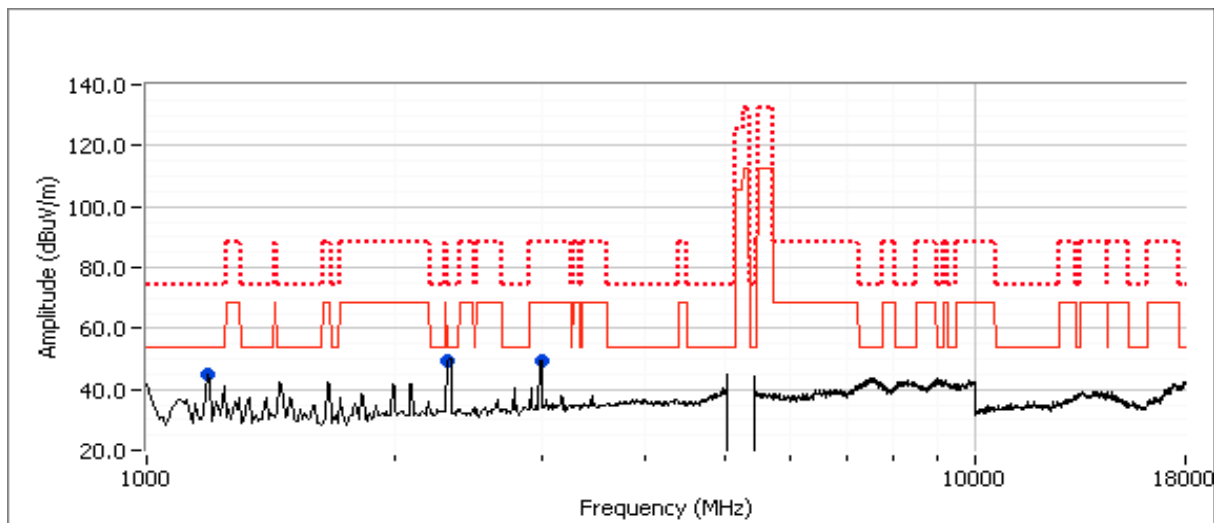

Client:	Intel Corporation	Job Number:	J80398
Model:	Intel® Centrino® Advanced-N 6230	T-Log Number:	T80540
Contact:	Steve Hackett	Account Manager:	Christine Krebill
Standard:	FCC 15.247	Class:	N/A

**Run #2b: Channel #60 5300MHz - 802.11a,Chain B**

	Target (dBm)	Power Settings Measured (dBm)	Software Setting
Chain B	16.5	16.6	25.0

**Spurious Radiated Emissions:**

Frequency MHz	Level dBμV/m	Pol v/h	15.209 / 15E		Detector PK/QP/Avg	Azimuth degrees	Height meters	Comments
			Limit	Margin				
1192.540	43.5	V	54.0	-10.5	AVG	109	2.0	
2331.670	36.4	V	54.0	-17.6	AVG	46	1.0	
2333.090	53.9	V	74.0	-20.1	PK	46	1.0	
1192.560	45.6	V	74.0	-28.4	PK	109	2.0	
2997.550	38.1	V	68.3	-30.2	AVG	147	1.0	
2997.160	55.4	V	88.3	-32.9	PK	147	1.0	

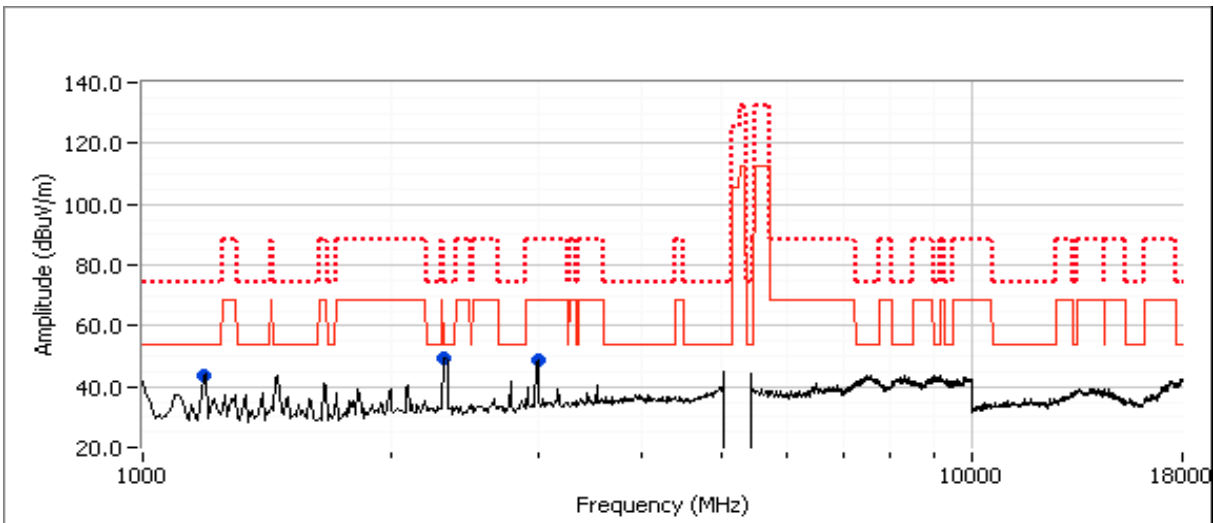

Client:	Intel Corporation	Job Number:	J80398
Model:	Intel® Centrino® Advanced-N 6230	T-Log Number:	T80540
Contact:	Steve Hackett	Account Manager:	Christine Krebill
Standard:	FCC 15.247	Class:	N/A

**Run #2c: Channel #60 5300MHz - 802.11n20,Chain A + B**

Chain	Power Settings								Software Setting
	Target (dBm)				Measured (dBm)				
	A	B	C	Total	A	B	C	Total	
	16.5	16.5		19.5	16.7	16.6		19.7	31.0, 31.0

**Spurious Radiated Emissions:**

Frequency MHz	Level dBμV/m	Pol v/h	15.209 / 15E		Detector Pk/QP/Avg	Azimuth degrees	Height meters	Comments
			Limit	Margin				
2331.980	34.0	V	54.0	-20.0	AVG	49	1.0	
2333.120	50.2	V	74.0	-23.8	PK	49	1.0	
10638.470	27.5	V	54.0	-26.5	AVG	208	1.0	
2998.360	38.7	V	68.3	-29.6	AVG	144	1.0	
2998.010	56.6	V	88.3	-31.7	PK	144	1.0	
10639.790	39.4	V	74.0	-34.6	PK	208	1.0	

Note 2: Scans made between 18 - 40GHz with the measurement antenna moved around the card and its antennas 20-50cm from the device indicated there were no significant emissions in this frequency range

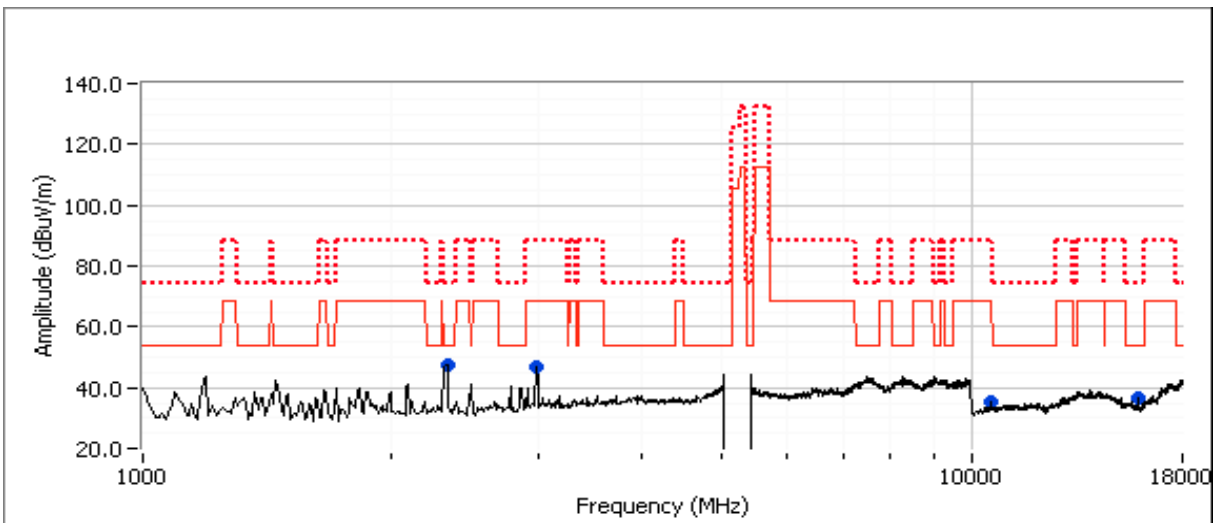

Client:	Intel Corporation	Job Number:	J80398
Model:	Intel® Centrino® Advanced-N 6230	T-Log Number:	T80540
Contact:	Steve Hackett	Account Manager:	Christine Krebill
Standard:	FCC 15.247	Class:	N/A

**Run #2d: Channel #62 5310MHz - 802.11n40, Chain A+B**

Chain	Power Settings								Software Setting
	Target (dBm)				Measured (dBm)				
	A	B	C	Total	A	B	C	Total	
	16.5	16.5		19.5	16.6	16.6		19.6	31.0, 32.0

**Spurious Radiated Emissions:**

Frequency	Level	Pol	15.209 / 15E		Detector	Azimuth	Height	Comments
MHz	dB $\mu$ V/m	v/h	Limit	Margin	Pk/QP/Avg	degrees	meters	
<b>2322.700</b>	<b>37.0</b>	V	54.0	<b>-17.0</b>	AVG	211	1.5	
2323.190	54.2	V	74.0	-19.8	PK	211	1.5	
15903.550	32.8	V	54.0	-21.2	AVG	170	1.0	
10611.870	27.7	V	54.0	-26.3	AVG	284	1.0	
15904.060	44.2	V	74.0	-29.8	PK	170	1.0	
2986.430	38.4	V	68.3	-29.9	AVG	148	1.0	
2986.550	55.7	V	88.3	-32.6	PK	148	1.0	
10612.410	38.5	V	74.0	-35.5	PK	284	1.0	

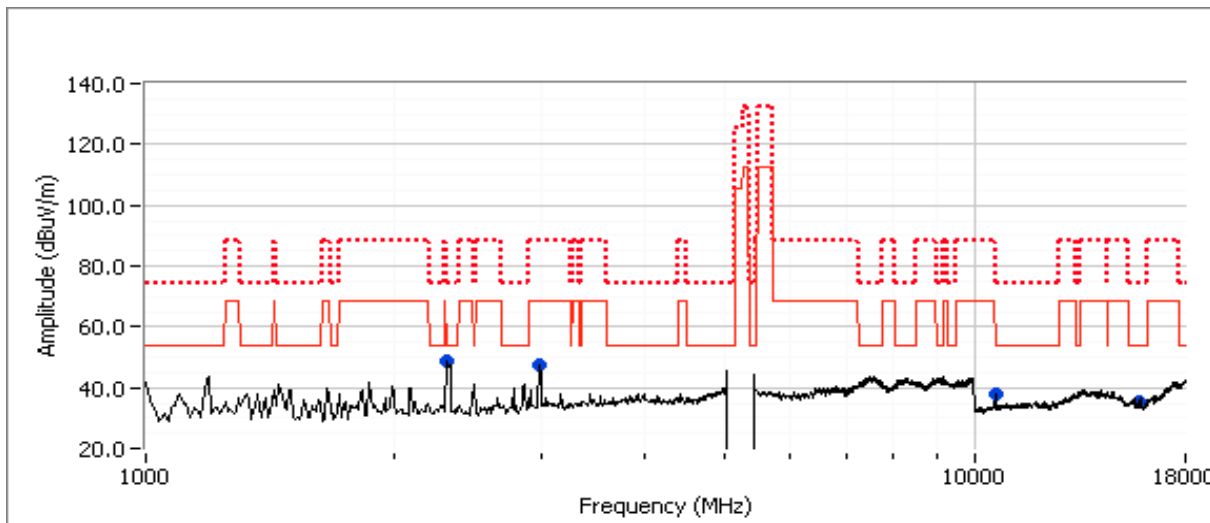

Client:	Intel Corporation	Job Number:	J80398
Model:	Intel® Centrino® Advanced-N 6230	T-Log Number:	T80540
Contact:	Steve Hackett	Account Manager:	Christine Krebill
Standard:	FCC 15.247	Class:	N/A

**Run #2e: Channel #52 5260MHz - 802.11a,Chain A**

	Target (dBm)	Power Settings Measured (dBm)	Software Setting
Chain A	16.5	16.6	26.0

**Spurious Radiated Emissions:**

Frequency	Level	Pol	15.209 / 15E		Detector	Azimuth	Height	Comments
MHz	dB $\mu$ V/m	v/h	Limit	Margin	Pk/QP/Avg	degrees	meters	
2325.400	42.5	V	54.0	-11.5	AVG	46	1.0	
2322.200	60.7	V	74.0	-13.3	PK	46	1.0	

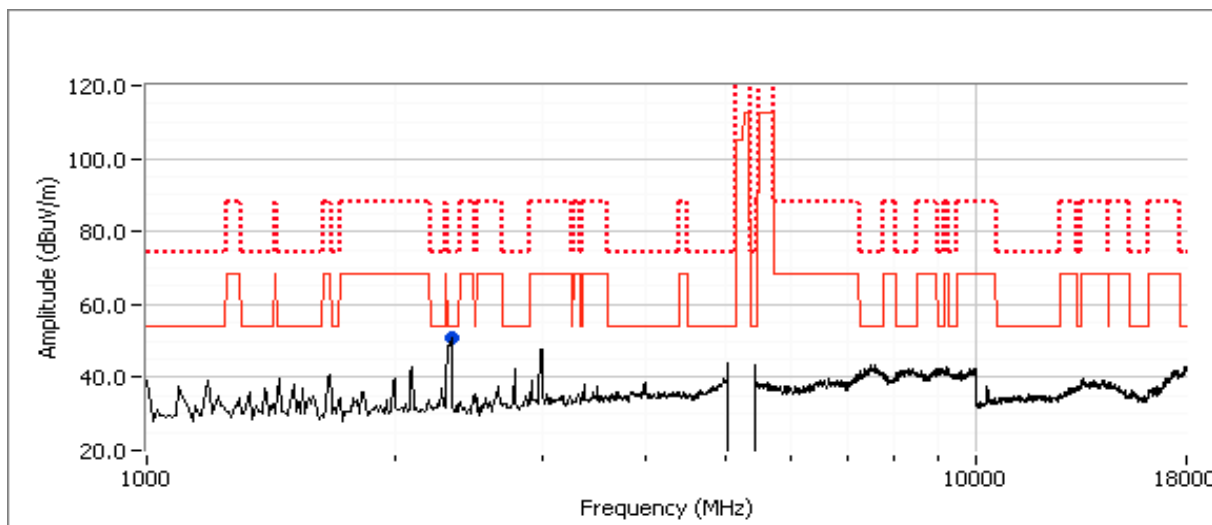

Client:	Intel Corporation	Job Number:	J80398
Model:	Intel® Centrino® Advanced-N 6230	T-Log Number:	T80540
Contact:	Steve Hackett	Account Manager:	Christine Krebill
Standard:	FCC 15.247	Class:	N/A

**Run #2f: Channel #64 5320MHz - 802.11a, Chain A**

Date of Test: 9/24/2010

Test Location: FT Chamber#7

Test Engineer: Joseph Cadigal

Config Change: none

	Power Settings		
	Target (dBm)	Measured (dBm)	Software Setting
Chain A	16.5	16.5	26.5

**Spurious Radiated Emissions:**

Frequency MHz	Level dB $\mu$ V/m	Pol v/h	15.209 / 15E		Detector Pk/QP/Avg	Azimuth degrees	Height meters	Comments
			Limit	Margin				
2331.900	41.4	V	54.0	-12.6	AVG	43	1.0	
2332.100	59.1	V	74.0	-14.9	PK	43	1.0	
2986.210	36.2	V	68.3	-32.1	AVG	165	1.0	
2985.370	52.8	V	88.3	-35.5	PK	165	1.0	

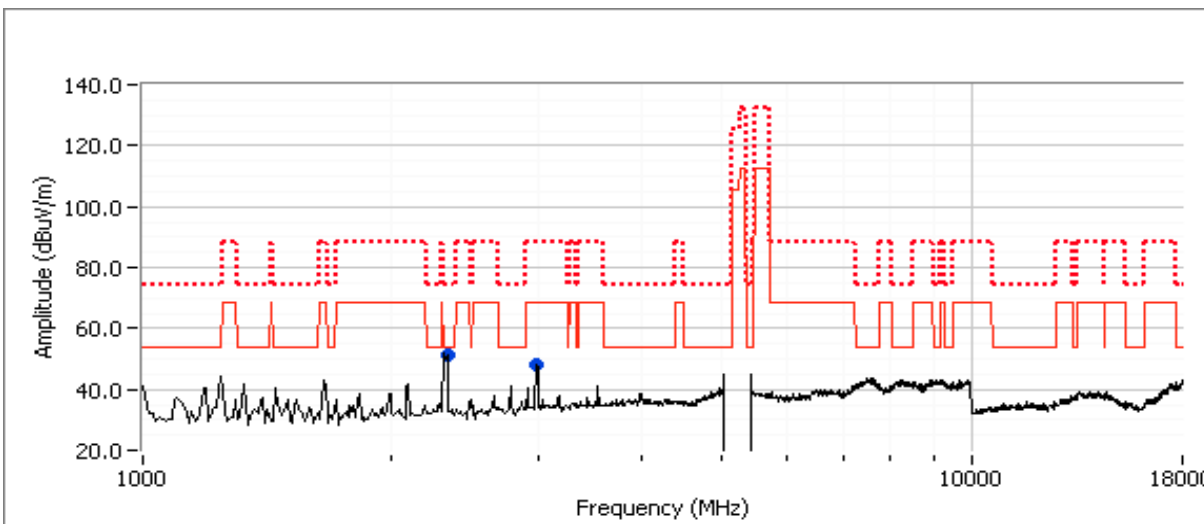

Client:	Intel Corporation	Job Number:	J80398
Model:	Intel® Centrino® Advanced-N 6230	T-Log Number:	T80540
Contact:	Steve Hackett	Account Manager:	Christine Krebill
Standard:	FCC 15.247	Class:	N/A

**Run #2g: Channel #52 5260MHz - 802.11a,Chain B**

	Target (dBm)	Power Settings Measured (dBm)	Software Setting
Chain B	16.5	16.7	26.0

**Spurious Radiated Emissions:**

Frequency MHz	Level dB $\mu$ V/m	Pol v/h	15.209 / 15E		Detector Pk/QP/Avg	Azimuth degrees	Height meters	Comments
			Limit	Margin				
<b>2331.500</b>	<b>41.4</b>	V	54.0	<b>-12.6</b>	AVG	50	1.0	
2331.760	59.8	V	74.0	-14.2	PK	50	1.0	
2993.500	39.5	V	68.3	-28.8	AVG	154	1.0	
2991.850	56.5	V	88.3	-31.8	PK	154	1.0	

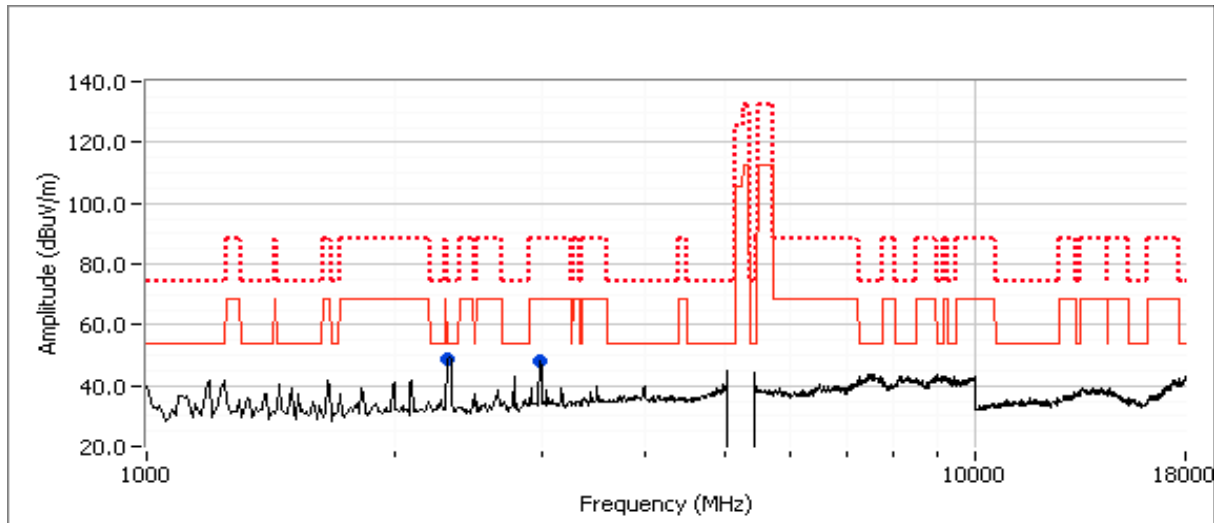



Client:	Intel Corporation	Job Number:	J80398
Model:	Intel® Centrino® Advanced-N 6230	T-Log Number:	T80540
Contact:	Steve Hackett	Account Manager:	Christine Krebill
Standard:	FCC 15.247	Class:	N/A

**Run #2h: Channel #64 5320MHz - 802.11a,Chain B**

	Target (dBm)	Power Settings Measured (dBm)	Software Setting
Chain B	16.5	16.7	26.0

**Spurious Radiated Emissions:**

Frequency MHz	Level dB $\mu$ V/m	Pol v/h	15.209 / 15E		Detector Pk/QP/Avg	Azimuth degrees	Height meters	Comments
			Limit	Margin				
<b>2331.650</b>	<b>41.2</b>	V	54.0	<b>-12.8</b>	AVG	45	1.0	
2331.850	59.0	V	74.0	-15.0	PK	45	1.0	
2986.300	40.1	V	68.3	-28.2	AVG	148	1.0	
2984.910	57.8	V	88.3	-30.5	PK	148	1.0	

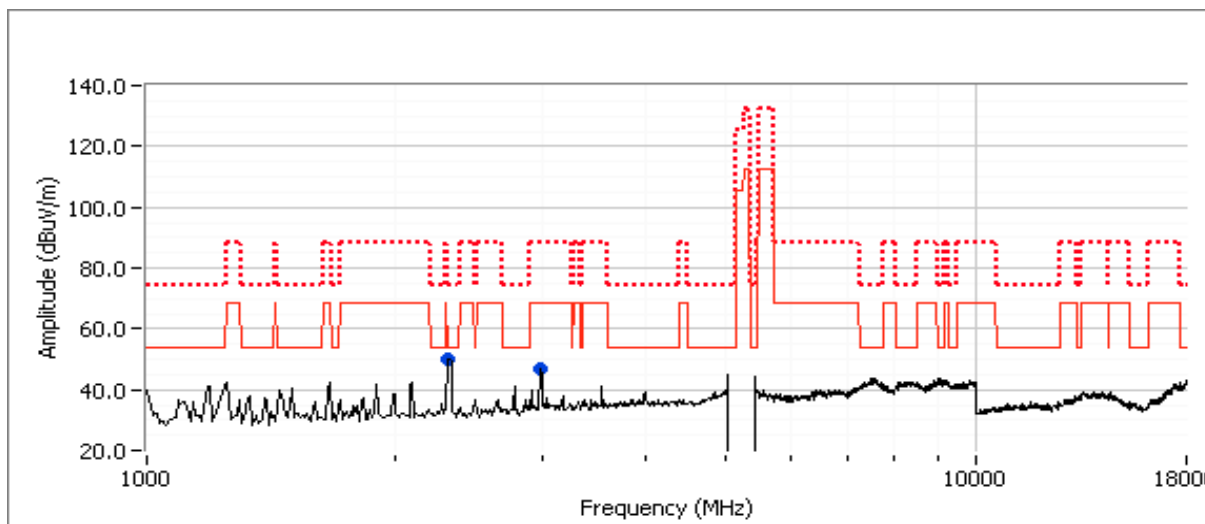

Client:	Intel Corporation	Job Number:	J80398
Model:	Intel® Centrino® Advanced-N 6230	T-Log Number:	T80540
Contact:	Steve Hackett	Account Manager:	Christine Krebill
Standard:	FCC 15.247	Class:	N/A

**Run #3, Radiated Spurious Emissions, 1-40GHz, Center Channel 5470-5725MHz - 802.11a, n20, n40, Chain A, B**

Date of Test: 9/24/2010

Test Location: FT Chamber#7

Test Engineer: Joseph Cadigal

Config Change: none

For emissions in restricted bands, the limit of 15.209 was used. For all other emissions, the limit is -27dBm eirp (68.3dBuV/m @3m). As the power measured is average power this is considered an average limit so the peak limit would be 88.3dBuV/m at 3m.

**Run #3a: Channel #116 5580MHz - 802.11a,Chain A**

	Power Settings		
	Target (dBm)	Measured (dBm)	Software Setting
Chain A	16.5	16.6	28.5

**Spurious Radiated Emissions:**

Frequency MHz	Level dBuV/m	Pol v/h	15.209 / 15E		Detector PK/QP/Avg	Azimuth degrees	Height meters	Comments
			Limit	Margin				
2322.920	37.3	V	54.0	-16.7	AVG	0	2.0	
2321.940	54.6	V	74.0	-19.4	PK	0	2.0	
2998.360	37.4	V	68.3	-30.9	AVG	160	1.0	
2998.080	54.2	V	88.3	-34.1	PK	160	1.0	

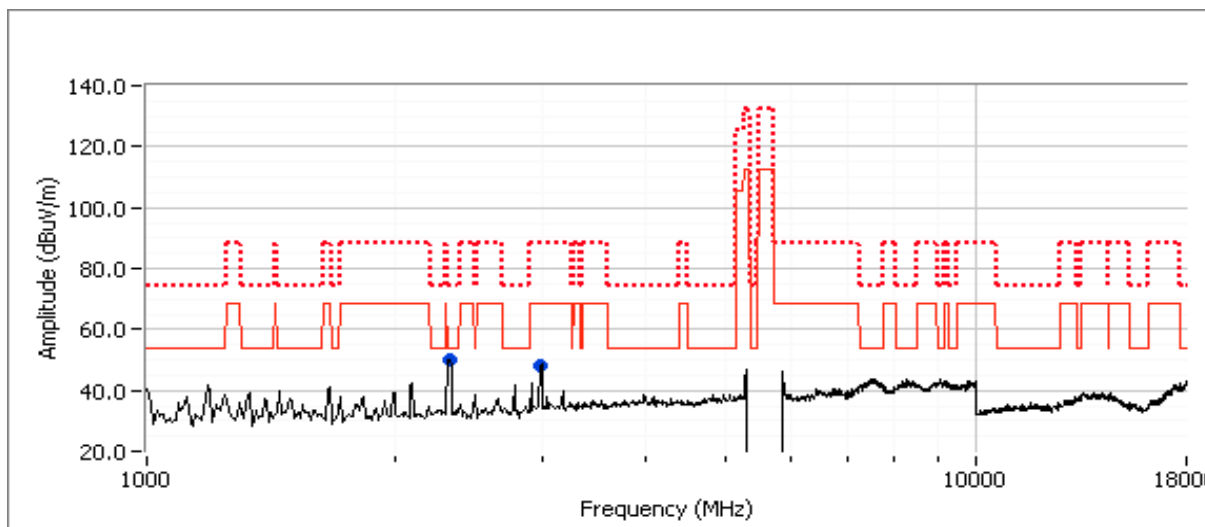

Client:	Intel Corporation	Job Number:	J80398
Model:	Intel® Centrino® Advanced-N 6230	T-Log Number:	T80540
Contact:	Steve Hackett	Account Manager:	Christine Krebill
Standard:	FCC 15.247	Class:	N/A

**Run #3b: Channel #116 5580MHz - 802.11a,Chain B**

	Power Settings		
	Target (dBm)	Measured (dBm)	Software Setting
Chain B	16.5	16.6	28.0

**Spurious Radiated Emissions:**

Frequency MHz	Level dB $\mu$ V/m	Pol v/h	15.209 / 15E		Detector PK/QP/Avg	Azimuth degrees	Height meters	Comments
			Limit	Margin				
<b>2323.180</b>	<b>37.6</b>	V	54.0	<b>-16.4</b>	AVG	211	1.5	
2323.420	55.1	V	74.0	-18.9	PK	211	1.5	
2986.210	35.7	V	68.3	-32.6	AVG	165	1.0	
2984.950	52.6	V	88.3	-35.7	PK	165	1.0	

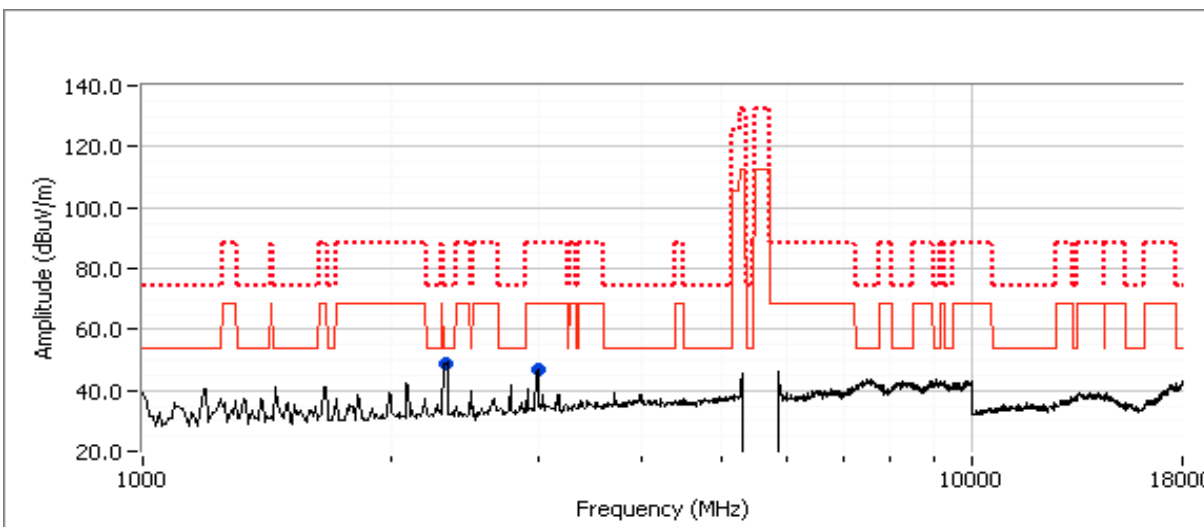

Client:	Intel Corporation	Job Number:	J80398
Model:	Intel® Centrino® Advanced-N 6230	T-Log Number:	T80540
Contact:	Steve Hackett	Account Manager:	Christine Krebill
Standard:	FCC 15.247	Class:	N/A

**Run #3c: Channel #116 5580MHz - 802.11n20,Chain A + B**

Chain	Power Settings								Software Setting
	Target (dBm)				Measured (dBm)				
	A	B	C	Total	A	B	C	Total	
	16.5	16.5		19.5	16.6	16.6		19.6	33.0, 33.0

**Spurious Radiated Emissions:**

Frequency	Level	Pol	15.209 / 15E		Detector	Azimuth	Height	Comments
MHz	dB $\mu$ V/m	v/h	Limit	Margin	Pk/QP/Avg	degrees	meters	
<b>2323.030</b>	<b>41.8</b>	V	54.0	<b>-12.2</b>	AVG	0	1.0	
2321.940	59.4	V	74.0	-14.6	PK	0	1.0	
2998.100	36.3	V	68.3	-32.0	AVG	161	1.0	
2998.270	53.2	V	88.3	-35.1	PK	161	1.0	
11141.110	28.9	V	54.0	-25.1	AVG	197	1.5	
11140.800	40.0	V	74.0	-34.0	PK	197	1.5	

Note 2: Scans made between 18 - 40GHz with the measurement antenna moved around the card and its antennas 20-50cm from the device indicated there were no significant emissions in this frequency range

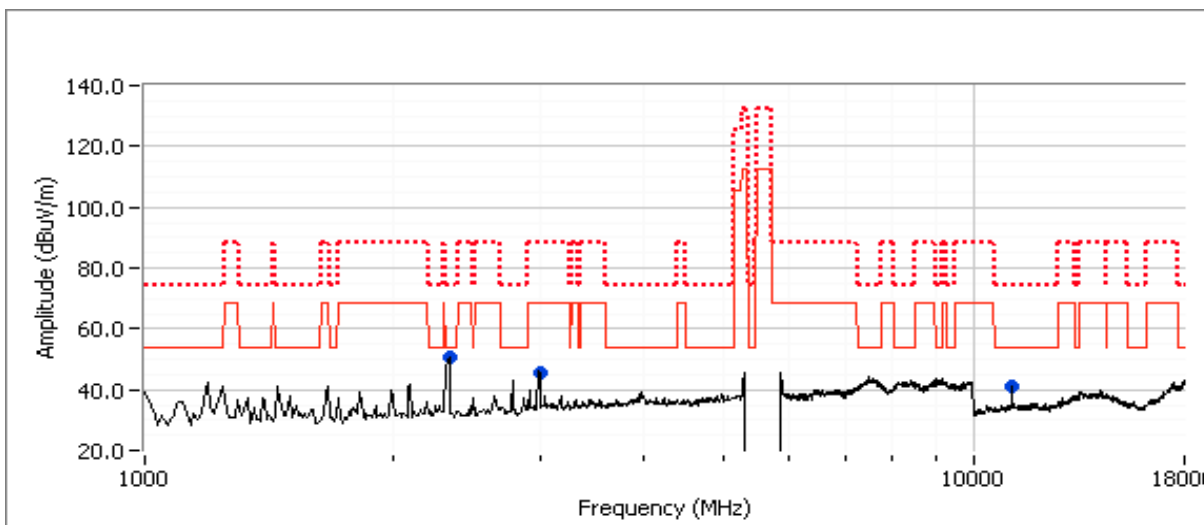

Client:	Intel Corporation	Job Number:	J80398
Model:	Intel® Centrino® Advanced-N 6230	T-Log Number:	T80540
Contact:	Steve Hackett	Account Manager:	Christine Krebill
Standard:	FCC 15.247	Class:	N/A

**Run #3d: Channel #110 5550MHz - 802.11n40, Chain A+B**

Chain	Power Settings								Software Setting
	Target (dBm)				Measured (dBm)				
	A	B	C	Total	A	B	C	Total	
	16.5	16.5		19.5	16.5	16.5		19.5	34.5, 33.5

**Spurious Radiated Emissions:**

Frequency MHz	Level dB $\mu$ V/m	Pol v/h	15.209 / 15E		Detector Pk/QP/Avg	Azimuth degrees	Height meters	Comments
			Limit	Margin				
11100.270	42.6	V	54.0	-11.4	AVG	162	2.0	
11107.330	53.3	V	74.0	-20.7	PK	162	2.0	
1192.550	43.7	V	54.0	-10.3	AVG	213	1.1	
1192.500	46.0	V	74.0	-28.0	PK	213	1.1	
2325.400	41.7	V	54.0	-12.3	AVG	3	1.0	
2330.600	59.8	V	74.0	-14.2	PK	3	1.0	

Note 1

Scans made between 18 - 40GHz with the measurement antenna moved around the card and its antennas 20-50cm from the device indicated there were no significant emissions in this frequency range

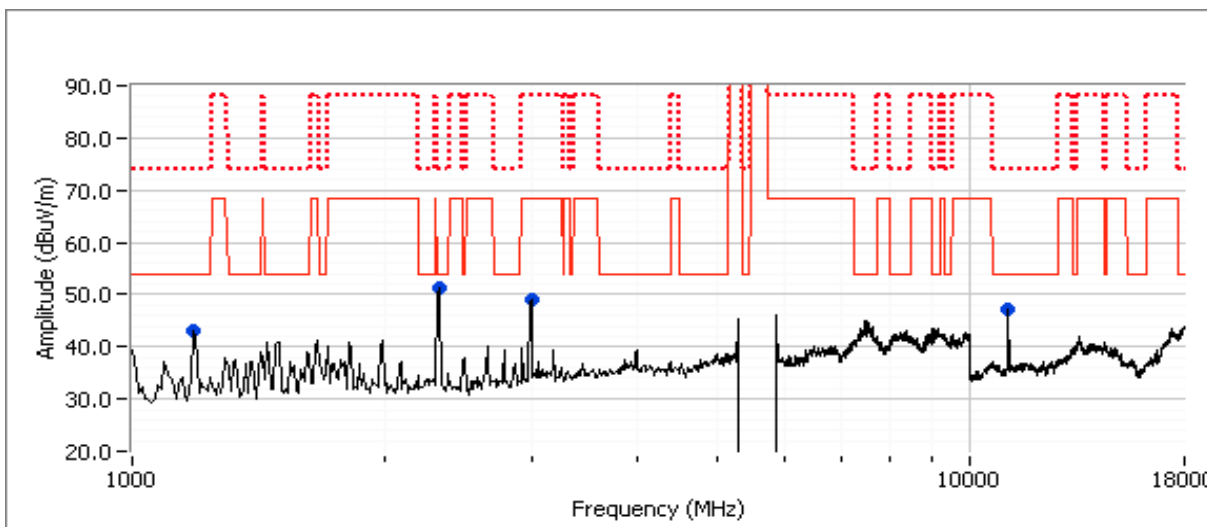

Client:	Intel Corporation	Job Number:	J80398
Model:	Intel® Centrino® Advanced-N 6230	T-Log Number:	T80540
Contact:	Steve Hackett	Account Manager:	Christine Krebill
Standard:	FCC 15.247	Class:	N/A

**Run #3e: Channel #102 5510 MHz - 802.11n40, Chain A + B**

Chain	Power Settings								Software Setting
	Target (dBm)				Measured (dBm)				
	A	B	C	Total	A	B	C	Total	
	16.5	16.5		19.5	16.5	16.5		19.5	33.0, 34.0

**Spurious Radiated Emissions:**

Frequency	Level	Pol	15.209 / 15E		Detector	Azimuth	Height	Comments
MHz	dB $\mu$ V/m	v/h	Limit	Margin	Pk/QP/Avg	degrees	meters	
<b>1192.570</b>	<b>42.5</b>	V	54.0	<b>-11.5</b>	AVG	216	1.1	
2331.900	41.4	V	54.0	-12.6	AVG	3	1.0	
2993.010	39.6	V	68.3	-28.7	AVG	151	1.0	
11006.310	40.1	V	54.0	-13.9	AVG	162	1.1	
1192.440	44.8	V	74.0	-29.2	PK	216	1.1	
2331.230	59.5	V	74.0	-14.5	PK	3	1.0	
2993.210	57.0	V	88.3	-31.3	PK	151	1.0	
11006.310	50.9	V	74.0	-23.1	PK	162	1.1	

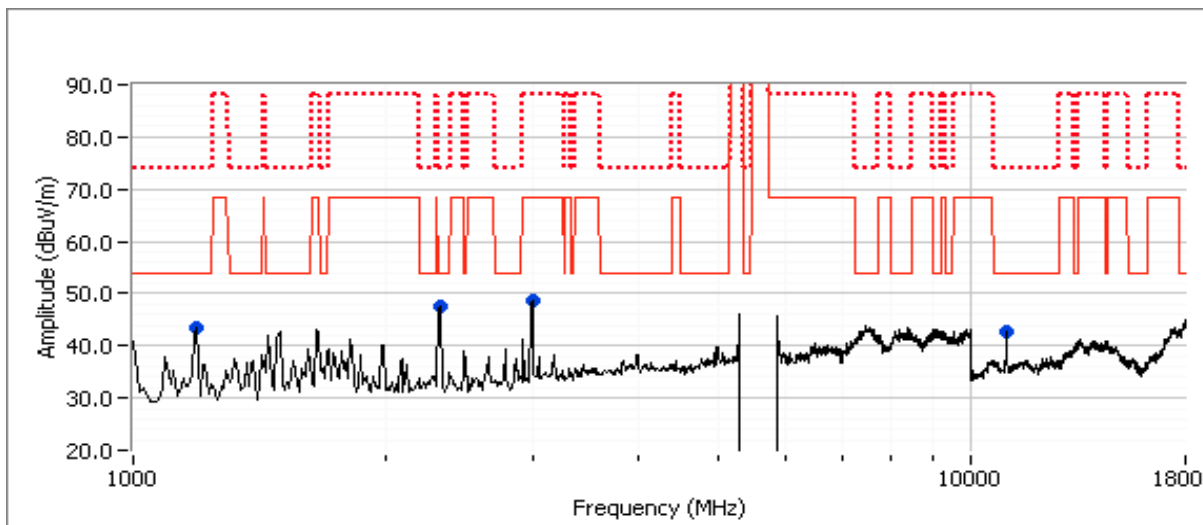

Client:	Intel Corporation	Job Number:	J80398
Model:	Intel® Centrino® Advanced-N 6230	T-Log Number:	T80540
Contact:	Steve Hackett	Account Manager:	Christine Krebill
Standard:	FCC 15.247	Class:	N/A

**Run #3f: Channel #140 5700MHz - 802.11n20,Chain A + B**

Chain	Power Settings								Software Setting
	Target (dBm)				Measured (dBm)				
	A	B	C	Total	A	B	C	Total	
	16.5	16.5		19.5	16.6	16.6		19.6	35.5, 35.0

**Spurious Radiated Emissions:**

Frequency	Level	Pol	15.209 / 15E		Detector	Azimuth	Height	Comments
MHz	dBμV/m	v/h	Limit	Margin	Pk/QP/Avg	degrees	meters	
2330.740	40.6	V	54.0	-13.4	AVG	0	1.0	
<b>11399.380</b>	<b>45.3</b>	V	54.0	<b>-8.7</b>	AVG	169	1.0	
2323.910	58.0	V	74.0	-16.0	PK	0	1.0	
11400.380	56.2	V	74.0	-17.8	PK	169	1.0	

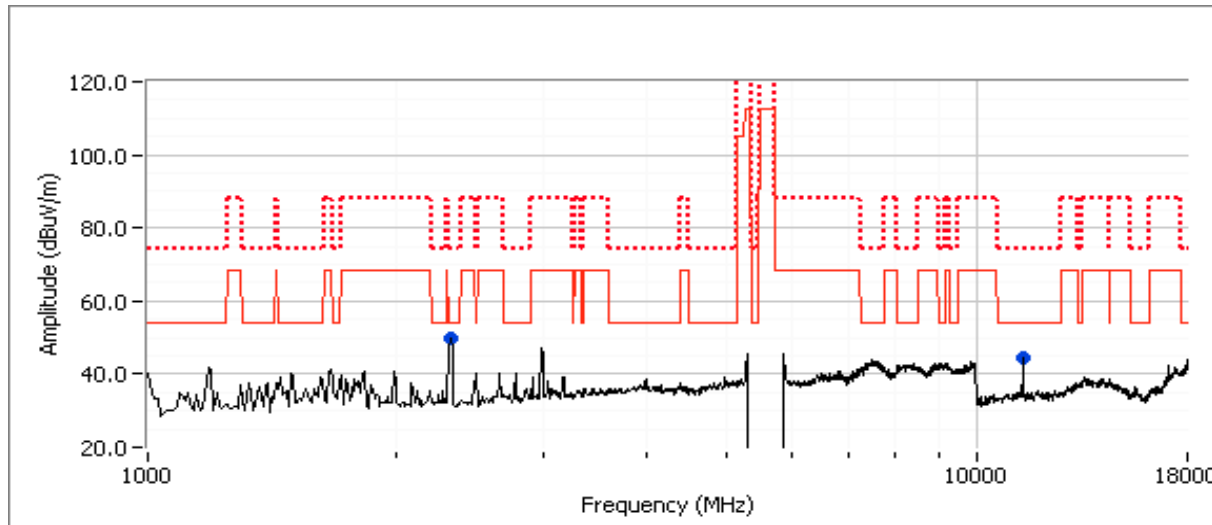

Client:	Intel Corporation	Job Number:	J80398
Model:	Intel® Centrino® Advanced-N 6230	T-Log Number:	T80540
Contact:	Steve Hackett	Account Manager:	Christine Krebill
Standard:	FCC 15.247	Class:	N/A

**Run #4, Radiated Spurious Emissions, 1-40GHz, Receive, Chain A, B, A+B**

Date of Test: 9/27/2010      Test Location: Chamber #7  
 Test Engineer: Mehran Birgani      Config Change: None

For emissions in restricted bands, the limit of 15.209 was used. For all other emissions, the limit is -27dBm eirp (68.3dBuV/m @3m). As the power measured is average power this is considered an average limit so the peak limit would be 88.3dBuV/m at 3m.

**Run #4a: EUT on Channel #40 5200MHz - Receive, Chain A**

**Spurious Radiated Emissions:**

Frequency MHz	Level dBuV/m	Pol v/h	15.209 / 15E		Detector Pk/QP/Avg	Azimuth degrees	Height meters	Comments
			Limit	Margin				
1000.010	34.4	V	54.0	-19.6	AVG	120	1.0	
<b>2324.150</b>	<b>40.7</b>	V	54.0	<b>-13.3</b>	AVG	293	1.0	
2998.610	39.1	V	54.0	-14.9	AVG	128	1.0	
1000.030	50.9	V	74.0	-23.1	PK	120	1.0	
2322.000	58.4	V	74.0	-15.6	PK	293	1.0	
2999.650	57.4	V	74.0	-16.6	PK	128	1.0	

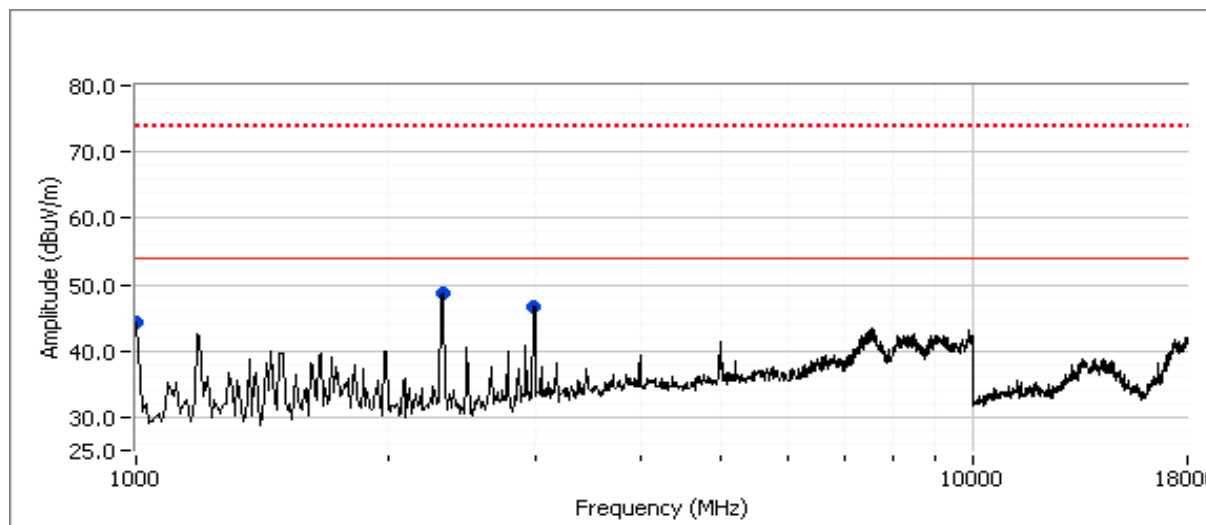



Client:	Intel Corporation	Job Number:	J80398
Model:	Intel® Centrino® Advanced-N 6230	T-Log Number:	T80540
Contact:	Steve Hackett	Account Manager:	Christine Krebill
Standard:	FCC 15.247	Class:	N/A

**Run #4b: EUT on Channel #40 5200MHz - Receive, Chain B**

Date of Test: 9/27/2010      Test Location: Chamber #7  
 Test Engineer: Joseph Cadigal      Config Change: None

**Spurious Radiated Emissions:**

Frequency MHz	Level dB $\mu$ V/m	Pol v/h	15.209 / 15E		Detector Pk/QP/Avg	Azimuth degrees	Height meters	Comments
			Limit	Margin				
2322.830	41.0	V	54.0	-13.0	AVG	352	1.0	
2997.670	39.3	V	54.0	-14.7	AVG	133	1.0	
2324.360	58.8	V	74.0	-15.2	PK	352	1.0	
2990.270	57.1	V	74.0	-16.9	PK	133	1.0	

Note 1: Scans made between 18 - 40GHz with the measurement antenna moved around the card and its antennas 20-50cm from the device indicated there were no significant emissions in this frequency range

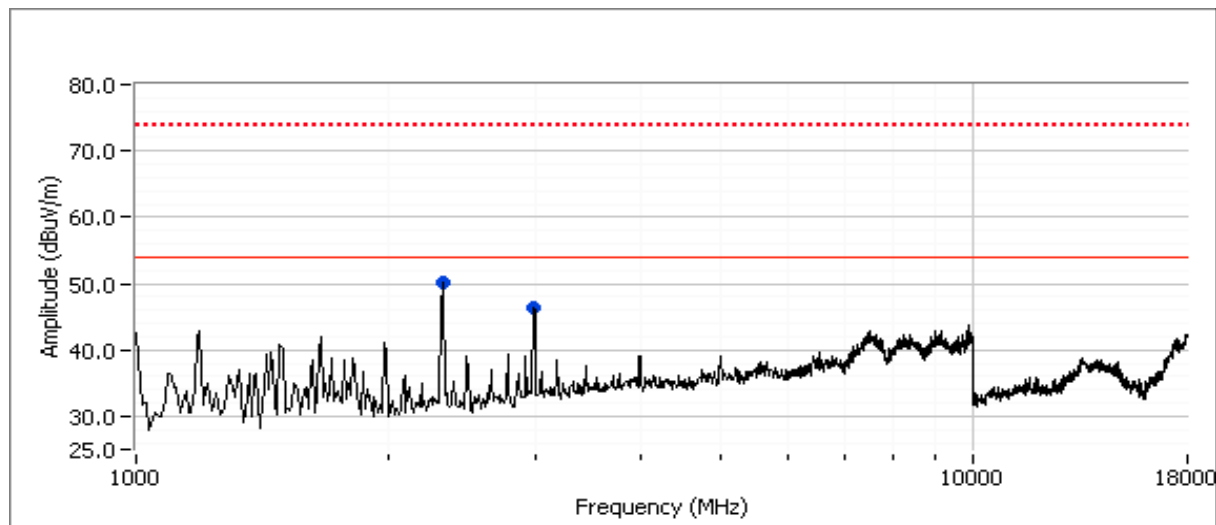

Client:	Intel Corporation	Job Number:	J80398
Model:	Intel® Centrino® Advanced-N 6230	T-Log Number:	T80540
Contact:	Steve Hackett	Account Manager:	Christine Krebill
Standard:	FCC 15.247	Class:	N/A

**Run #4c: EUT on Channel #40 5200MHz - Receive, Chain A+B**

**Spurious Radiated Emissions:**

Frequency MHz	Level dB $\mu$ V/m	Pol v/h	15.209 / 15E		Detector Pk/QP/Avg	Azimuth degrees	Height meters	Comments
			Limit	Margin				
<b>2330.020</b>	<b>38.4</b>	V	54.0	<b>-15.6</b>	AVG	300	1.0	RB 1 MHz;VB 10 Hz;Pk
2986.600	37.9	V	54.0	-16.1	AVG	156	1.0	RB 1 MHz;VB 10 Hz;Pk
2329.650	55.5	V	74.0	-18.5	PK	300	1.0	RB 1 MHz;VB 3 MHz;Pk
2986.310	55.2	V	74.0	-18.8	PK	156	1.0	RB 1 MHz;VB 3 MHz;Pk

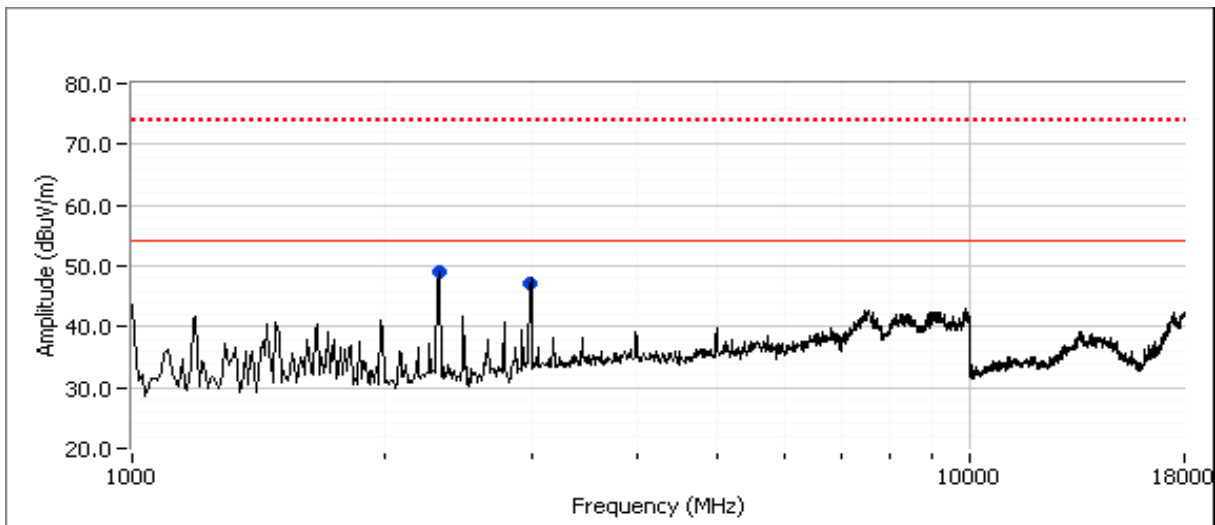

Client:	Intel Corporation	Job Number:	J80398
Model:	Intel® Centrino® Advanced-N 6230	T-Log Number:	T80540
Contact:	Steve Hackett	Account Manager:	Christine Krebill
Standard:	FCC 15.247	Class:	N/A

**Run #4d: EUT on Channel #60 5300MHz - Receive, Chain A**

**Spurious Radiated Emissions:**

Frequency MHz	Level dB $\mu$ V/m	Pol v/h	15.209 / 15E		Detector Pk/QP/Avg	Azimuth degrees	Height meters	Comments
			Limit	Margin				
<b>2986.300</b>	<b>38.1</b>	V	54.0	<b>-15.9</b>	AVG	158	1.0	RB 1 MHz;VB 10 Hz;Pk
2986.500	55.2	V	74.0	-18.8	PK	158	1.0	RB 1 MHz;VB 3 MHz;Pk
2331.850	33.7	V	54.0	-20.3	AVG	357	1.0	RB 1 MHz;VB 10 Hz;Pk
2333.040	49.7	V	74.0	-24.3	PK	357	1.0	RB 1 MHz;VB 3 MHz;Pk

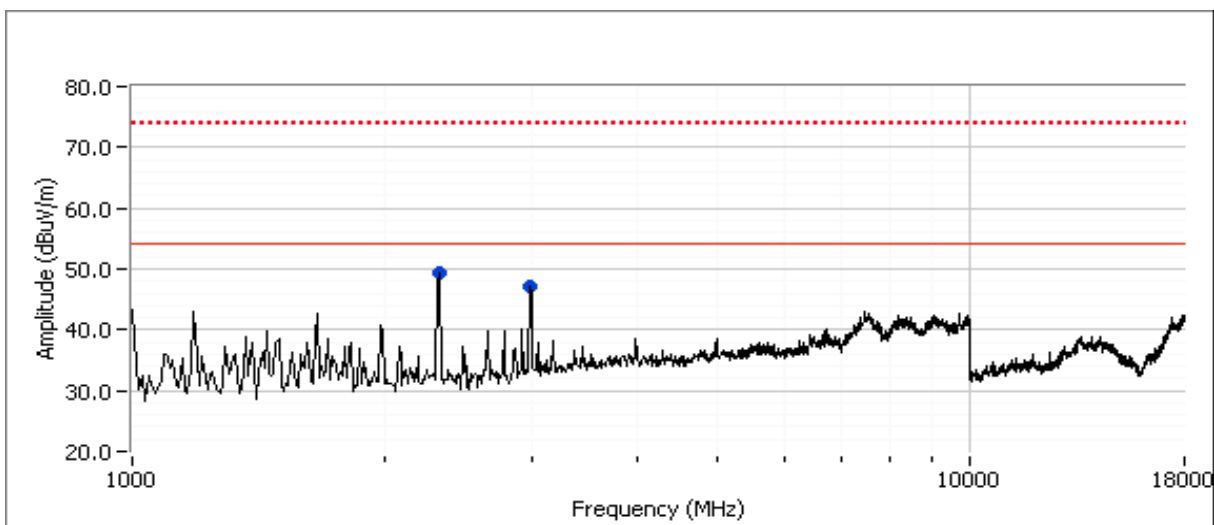

Client: Intel Corporation	Job Number: J80398
Model: Intel® Centrino® Advanced-N 6230	T-Log Number: T80540
	Account Manager: Christine Krebill
Contact: Steve Hackett	
Standard: FCC 15.247	Class: N/A

**Run #4e: EUT on Channel #60 5300MHz - Receive, Chain B**

**Spurious Radiated Emissions:**

Frequency MHz	Level dB $\mu$ V/m	Pol v/h	15.209 / 15E		Detector Pk/QP/Avg	Azimuth degrees	Height meters	Comments
			Limit	Margin				
<b>2331.700</b>	<b>38.0</b>	V	54.0	<b>-16.0</b>	AVG	305	1.0	RB 1 MHz;VB 10 Hz;Pk
2987.140	37.9	V	54.0	-16.1	AVG	129	1.0	RB 1 MHz;VB 10 Hz;Pk
2987.250	55.7	V	74.0	-18.3	PK	129	1.0	RB 1 MHz;VB 3 MHz;Pk
2329.570	54.8	V	74.0	-19.2	PK	305	1.0	RB 1 MHz;VB 3 MHz;Pk

Note 1: Scans made between 18 - 40GHz with the measurement antenna moved around the card and its antennas 20-50cm from the device indicated there were no significant emissions in this frequency range

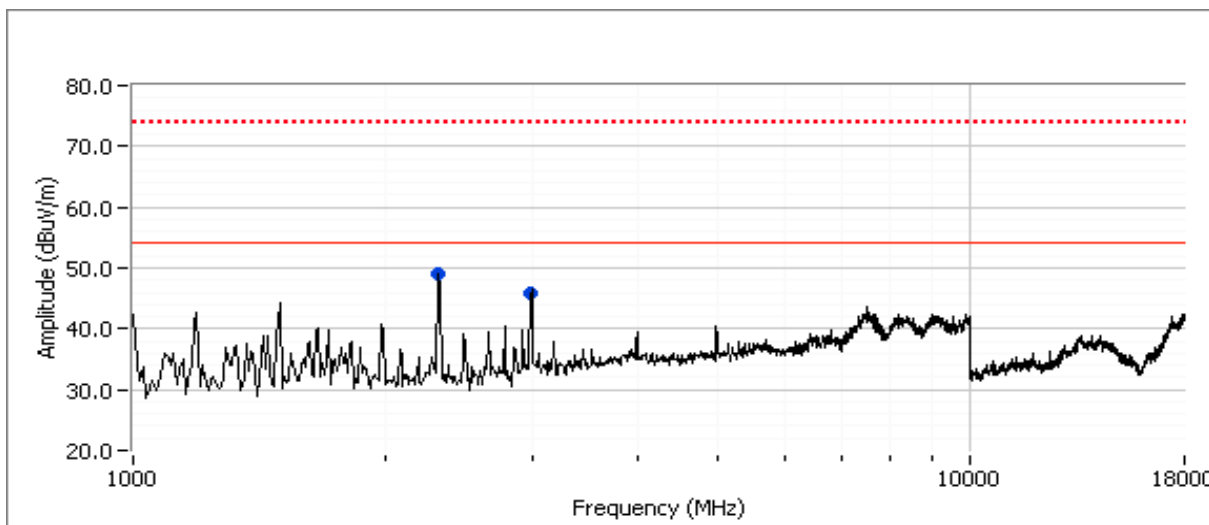

Client:	Intel Corporation	Job Number:	J80398
Model:	Intel® Centrino® Advanced-N 6230	T-Log Number:	T80540
Contact:	Steve Hackett	Account Manager:	Christine Krebill
Standard:	FCC 15.247	Class:	N/A

**Run #4f: EUT on Channel #60 5300MHz - Receive, Chain A+B**

**Spurious Radiated Emissions:**

Frequency MHz	Level dB $\mu$ V/m	Pol v/h	15.209 / 15E		Detector Pk/QP/Avg	Azimuth degrees	Height meters	Comments
			Limit	Margin				
2986.410	35.8	V	54.0	-18.2	AVG	115	1.0	RB 1 MHz;VB 10 Hz;Pk
2331.380	34.5	V	54.0	-19.5	AVG	287	1.0	RB 1 MHz;VB 10 Hz;Pk
2985.560	53.0	V	74.0	-21.0	PK	115	1.0	RB 1 MHz;VB 3 MHz;Pk
2332.050	50.8	V	74.0	-23.2	PK	287	1.0	RB 1 MHz;VB 3 MHz;Pk

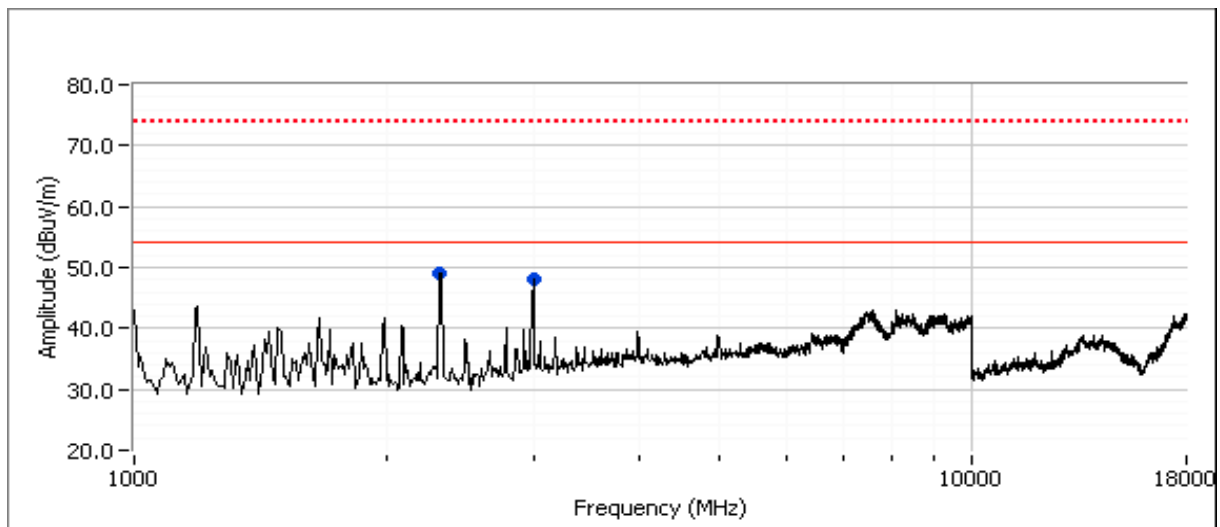

Client: Intel Corporation	Job Number: J80398
Model: Intel® Centrino® Advanced-N 6230	T-Log Number: T80540
	Account Manager: Christine Krebill
Contact: Steve Hackett	
Standard: FCC 15.247	Class: N/A

**Run #4g: EUT on Channel #116 5580MHz - Receive, Chain A**

**Spurious Radiated Emissions:**

Frequency MHz	Level dB $\mu$ V/m	Pol v/h	15.209 / 15E		Detector Pk/QP/Avg	Azimuth degrees	Height meters	Comments
			Limit	Margin				
2322.670	39.2	V	54.0	-14.8	AVG	55	1.0	RB 1 MHz;VB 10 Hz;Pk
2986.530	38.5	V	54.0	-15.5	AVG	140	1.0	RB 1 MHz;VB 10 Hz;Pk
2985.190	56.2	V	74.0	-17.8	PK	140	1.0	RB 1 MHz;VB 3 MHz;Pk
2323.290	56.2	V	74.0	-17.8	PK	55	1.0	RB 1 MHz;VB 3 MHz;Pk

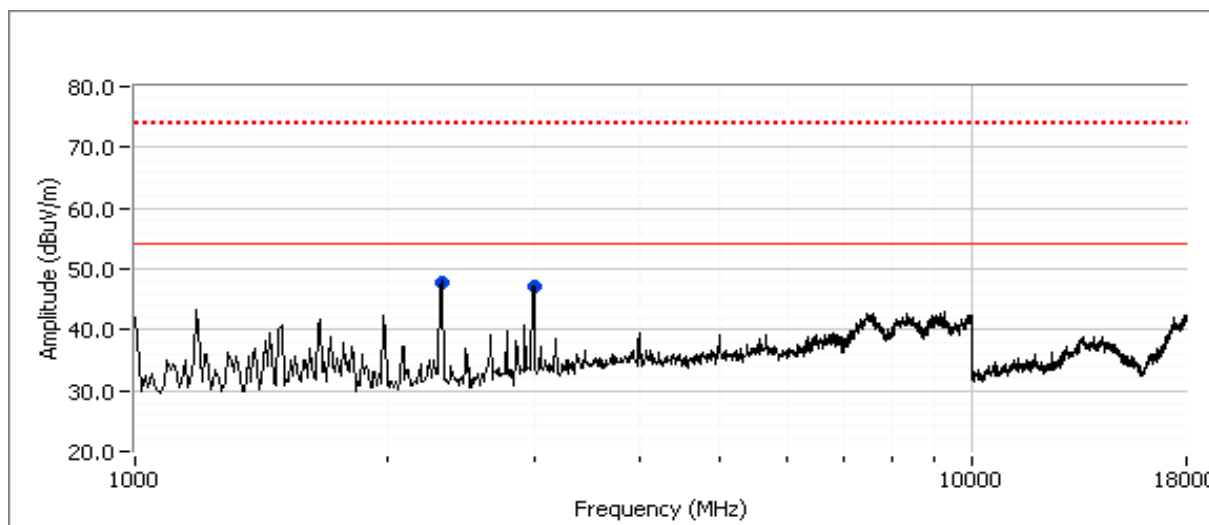

Client:	Intel Corporation	Job Number:	J80398
Model:	Intel® Centrino® Advanced-N 6230	T-Log Number:	T80540
Contact:	Steve Hackett	Account Manager:	Christine Krebill
Standard:	FCC 15.247	Class:	N/A

**Run #4h: EUT on Channel #116 5580MHz - Receive, Chain B**

**Spurious Radiated Emissions:**

Frequency MHz	Level dB $\mu$ V/m	Pol v/h	15.209 / 15E		Detector Pk/QP/Avg	Azimuth degrees	Height meters	Comments
			Limit	Margin				
2988.240	38.5	V	54.0	-15.5	AVG	127	1.0	RB 1 MHz;VB 10 Hz;Pk
2328.890	37.0	V	54.0	-17.0	AVG	304	1.0	RB 1 MHz;VB 10 Hz;Pk
2988.680	56.2	V	74.0	-17.8	PK	127	1.0	RB 1 MHz;VB 3 MHz;Pk
2328.820	53.4	V	74.0	-20.6	PK	304	1.0	RB 1 MHz;VB 3 MHz;Pk

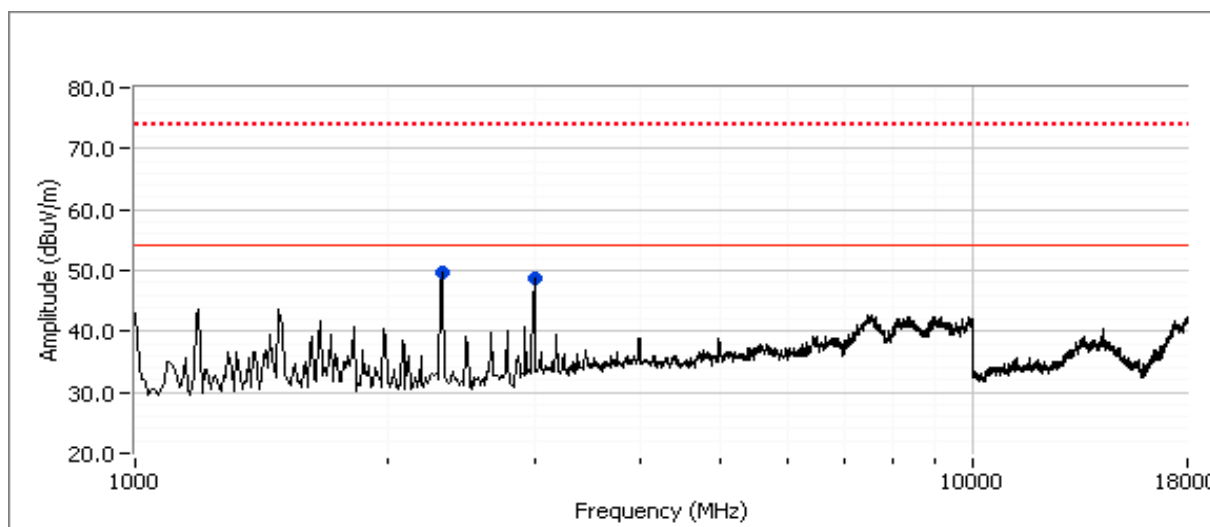

Client:	Intel Corporation	Job Number:	J80398
Model:	Intel® Centrino® Advanced-N 6230	T-Log Number:	T80540
Contact:	Steve Hackett	Account Manager:	Christine Krebill
Standard:	FCC 15.247	Class:	N/A

**Run #4i: EUT on Channel #116 5580MHz - Receive, Chain A+B**

**Spurious Radiated Emissions:**

Frequency MHz	Level dB $\mu$ V/m	Pol v/h	15.209 / 15E		Detector Pk/QP/Avg	Azimuth degrees	Height meters	Comments
			Limit	Margin				
2326.230	39.4	V	54.0	-14.6	AVG	300	1.0	RB 1 MHz;VB 10 Hz;Pk
2998.560	38.6	V	54.0	-15.4	AVG	154	1.0	RB 1 MHz;VB 10 Hz;Pk
2326.780	56.7	V	74.0	-17.3	PK	300	1.0	RB 1 MHz;VB 3 MHz;Pk
2999.970	55.8	V	74.0	-18.2	PK	154	1.0	RB 1 MHz;VB 3 MHz;Pk

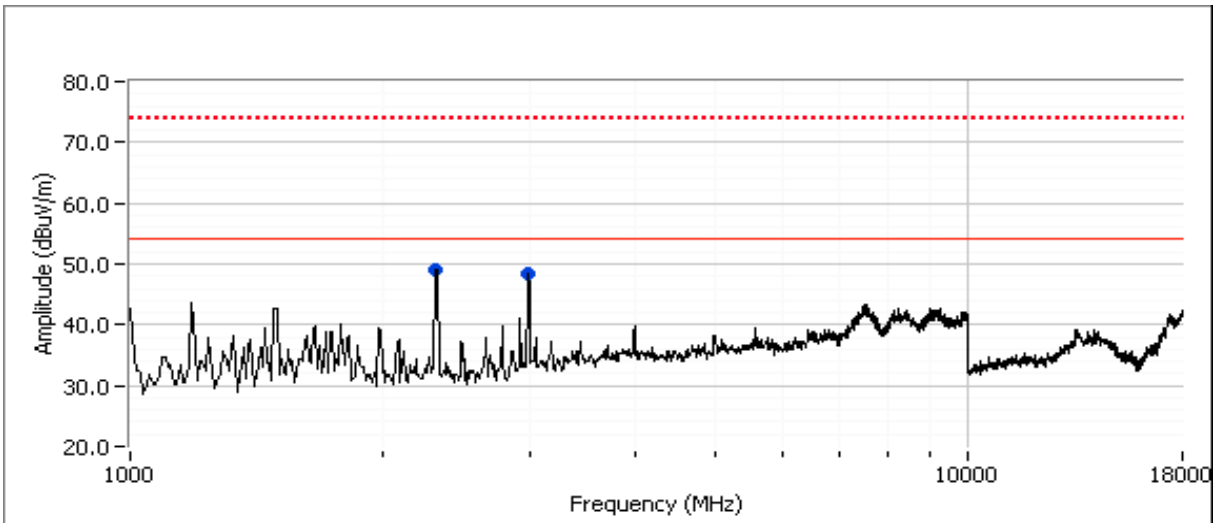





# EMC Test Data

Client:	Intel Corporation	Job Number:	J80398
Model:	Intel® Centrino® Advanced-N 6230	T-Log Number:	T80759
		Account Manager:	Christine Krebill
Contact:	Steve Hackett		-
Emissions Standard(s):	FCC 15.247	Class:	B
Immunity Standard(s):	-	Environment:	-

## EMC Test Data

For The

## Intel Corporation

Model

**Intel® Centrino® Advanced-N 6230**

Date of Last Test:

Client:	Intel Corporation	Job Number:	J80398
Model:	Intel® Centrino® Advanced-N 6230	T-Log Number:	T80759
		Account Manager:	Christine Krebill
Contact:	Steve Hackett		
Standard:	FCC 15.247	Class:	N/A

**RSS-210 (LELAN) and FCC 15.407(UNII)  
Antenna Port Measurements - CHAIN A  
Power, PSD, Peak Excursion, Bandwidth and Spurious Emissions**

**Test Specific Details**

Objective: The objective of this test session is to perform final qualification testing of the EUT with respect to the specification listed above.

Date of Test: 10/4/2010  
Test Engineer: Rafael Varelas  
Test Location: FT Lab #4

Config. Used: 1  
Config Change: none  
Host Unit Voltage 120V/60Hz

**Summary of Results - Chain A**

Run #	Test Performed	Limit	Pass / Fail	Result / Margin
1	Power, 5150 - 5250MHz	15.407(a) (1), (2)	Pass	802.11a: 42 mW 802.11n 20MHz: 45 mW 802.11n n40MHz: 44 mW
1	PSD, 5150 - 5250MHz	15.407(a) (1), (2)	Pass	802.11a: 3.9 dBm/MHz 802.11n 20MHz: 3.7 dBm/MHz 802.11n n40MHz: 1.1 dBm/MHz
1	Power, 5250 - 5350MHz	15.407(a) (1), (2)	Pass	802.11a: 44 mW 802.11n 20MHz: 46 mW 802.11n n40MHz: 40 mW
1	PSD, 5250 - 5350MHz	15.407(a) (1), (2)	Pass	802.11a: 4.0 dBm/MHz 802.11n 20MHz: 3.9 dBm/MHz 802.11n n40MHz: 0.8 dBm/MHz
1	Power, 5470 - 5725MHz	15.407(a) (1), (2)	Pass	802.11a: 45 mW 802.11n 20MHz: 44 mW 802.11n n40MHz: 44 mW
1	PSD, 5470 - 5725MHz	15.407(a) (1), (2)	Pass	802.11a: 4.2 dBm/MHz 802.11n 20MHz: 3.5 dBm/MHz 802.11n n40MHz: 1.4 dBm/MHz
1	26dB Bandwidth	15.407 (Information only)	-	> 20MHz for all modes
1	99% Bandwidth	RSS 210 (Information only)	N/A	802.11a: 17.1 MHz 802.11n 20MHz: 18.1 MHz 802.11n n40MHz: 36.4 MHz
2	Peak Excursion Envelope	15.407(a) (6) 13dB	Pass	9.6dB
3	Antenna Conducted - Out of Band Spurious	15.407(b) -27dBm/MHz	Pass	All emissions below the -27dBm/MHz limit

Client:	Intel Corporation	Job Number:	J80398
Model:	Intel® Centrino® Advanced-N 6230	T-Log Number:	T80759
		Account Manager:	Christine Krebill
Contact:	Steve Hackett		
Standard:	FCC 15.247	Class:	N/A

**General Test Configuration**

When measuring the conducted emissions from the EUT's antenna port, the antenna port of the EUT was connected to the spectrum analyzer or power meter via a suitable attenuator to prevent overloading the measurement system. All measurements are corrected to allow for the external attenuators and cables used.

**Ambient Conditions:**

Temperature: 22.4 °C  
 Rel. Humidity: 39 %

**Modifications Made During Testing**

No modifications were made to the EUT during testing

**Deviations From The Standard**

No deviations were made from the requirements of the standard.

Client:	Intel Corporation	Job Number:	J80398
Model:	Intel® Centrino® Advanced-N 6230	T-Log Number:	T80759
Contact:	Steve Hackett	Account Manager:	Christine Krebill
Standard:	FCC 15.247	Class:	N/A

**Run #1: Bandwidth, Output Power and Power Spectral Density - Single Chain Systems**

Note 1:	Output power measured using a spectrum analyzer (see plots below). RBW=1MHz, VB=3 MHz, sample detector, power averaging on (transmitted signal was continuous) and power integration over <b>80 MHz</b> (method 1 of DA-02-2138A1).
Note 2:	Measured using the same analyzer settings used for output power.
Note 3:	For RSS-210 the limit for the 5150 - 5250 MHz band accounts for the antenna gain as the maximum eirp allowed is 10dBm/MHz. The limits are also corrected for instances where the highest measured value of the PSD exceeds the average PSD (calculated from the measured power divided by the measured 99% bandwidth) by more than 3dB by the amount that the measured value exceeds the average by more than 3dB.
Note 4:	99% Bandwidth measured in accordance with RSS GEN - RB > 1% of span and VB >=3xRB

**Single Chain Operation, 5150-5250MHz Band**

Antenna Gain (dBi): 3.6      EIRP: 95.5 mW      19.8 dBm

Frequency (MHz)	Software Setting	Bandwidth		Output Power <sup>1</sup> dBm		Power (Watts)	PSD <sup>2</sup> dBm/MHz			Result
		26dB	99% <sup>4</sup>	Measured	Limit		Measured	FCC Limit	RSS Limit <sup>3</sup>	
<b>802.11a</b>										
5180	24.5	32.8	17.0	16.2	17.0	0.042	3.9	4.0	6.4	Pass
5200	24.5	33.2	17.0	16.2	17.0	0.042	3.7	4.0	6.4	Pass
5240	24.5	33.7	17.0	15.9	17.0	0.039	3.4	4.0	6.4	Pass
<b>802.11n 20MHz</b>										
5180	24.0	30.8	18.1	15.9	17.0	0.039	3.0	4.0	6.4	Pass
5200	25.0	36.2	18.1	16.5	17.0	0.045	3.7	4.0	6.4	Pass
5240	25.5	36.6	18.1	16.4	17.0	0.044	3.6	4.0	6.4	Pass
<b>802.11n 40MHz</b>										
5190	21.0	39.3	36.3	12.8	17.0	0.019	-2.5	4.0	6.4	Pass
5230	26.0	52.0	36.3	16.4	17.0	0.044	1.1	4.0	6.4	Pass

Client: Intel Corporation	Job Number: J80398
Model: Intel® Centrino® Advanced-N 6230	T-Log Number: T80759
	Account Manager: Christine Krebill
Contact: Steve Hackett	
Standard: FCC 15.247	Class: N/A

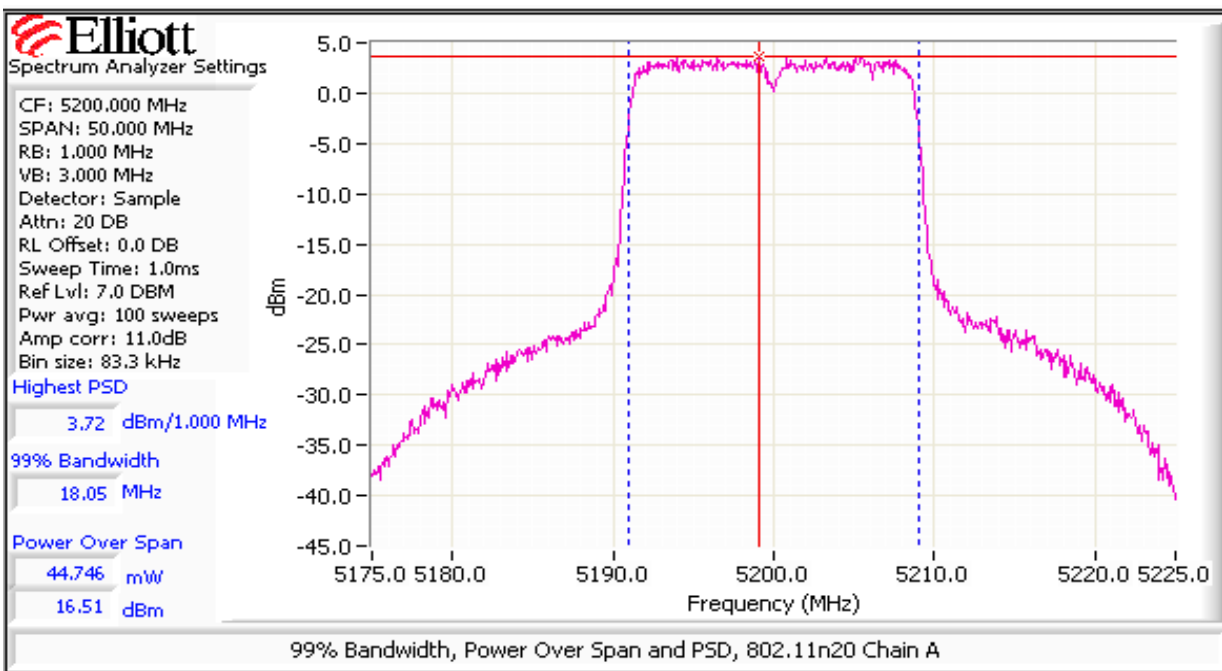
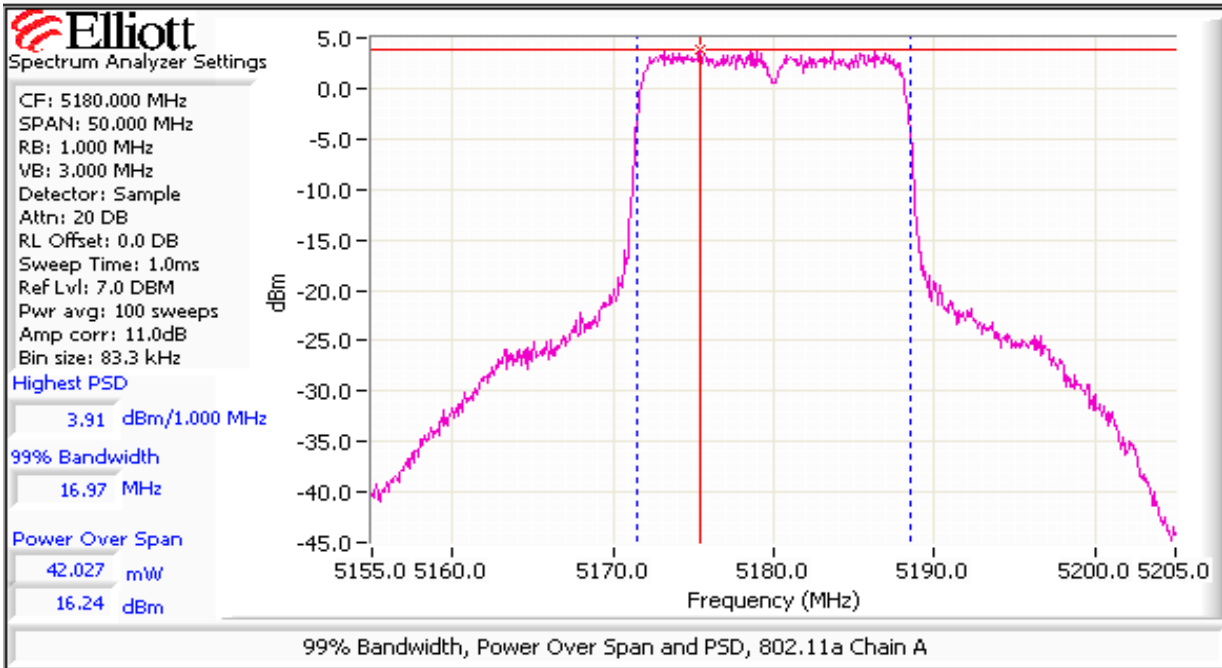

Client: Intel Corporation	Job Number: J80398
Model: Intel® Centrino® Advanced-N 6230	T-Log Number: T80759
	Account Manager: Christine Krebill
Contact: Steve Hackett	
Standard: FCC 15.247	Class: N/A

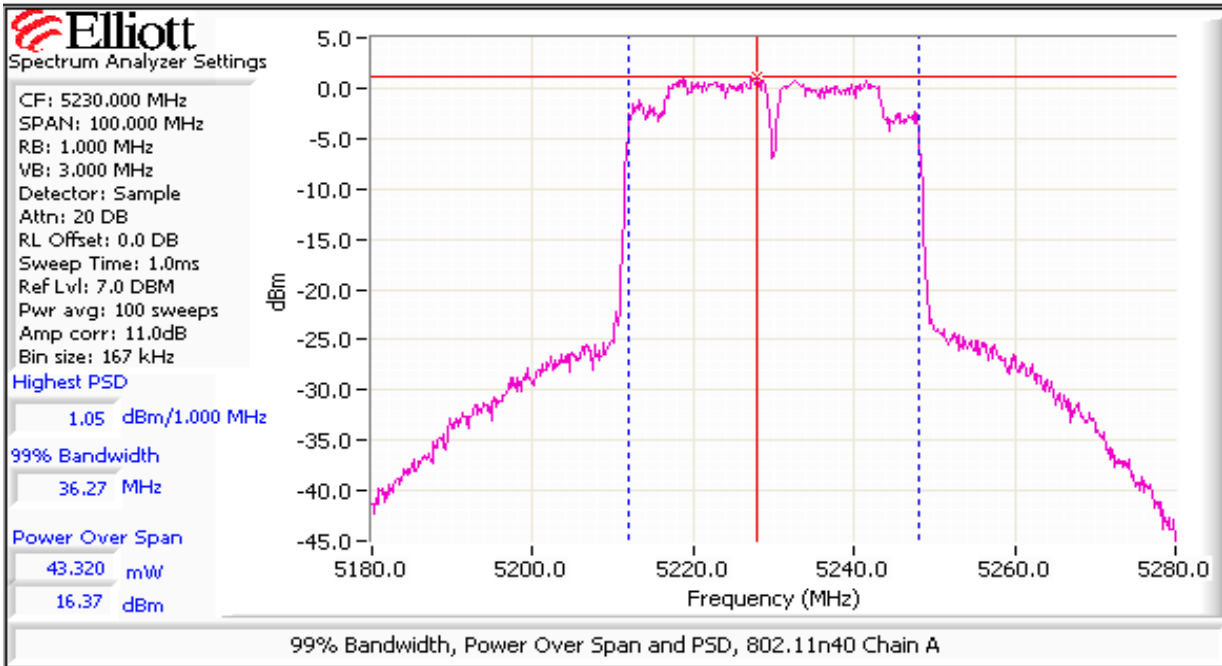

Client:	Intel Corporation	Job Number:	J80398
Model:	Intel® Centrino® Advanced-N 6230	T-Log Number:	T80759
Contact:	Steve Hackett	Account Manager:	Christine Krebill
Standard:	FCC 15.247	Class:	N/A

### Single Chain Operation, 5250-5350 MHz Band

Antenna Gain (dBi): 3.7      EIRP: 102.3 mW      20.1 dBm

Frequency (MHz)	Software Setting	Bandwidth		Output Power <sup>1</sup> dBm		Power (Watts)	PSD <sup>2</sup> dBm/MHz			Result
		26dB	99% <sup>4</sup>	Measured	Limit		Measured	FCC Limit	RSS Limit <sup>3</sup>	
<b>802.11a</b>										
5260	25.0	32.5	17.0	15.9	24.0	0.039	3.6	11.0	11.0	Pass
5300	25.5	35.3	17.0	16.3	24.0	0.043	4.0	11.0	11.0	Pass
5320	25.5	34.4	17.0	16.4	24.0	0.044	4.0	11.0	11.0	Pass
<b>802.11n 20MHz</b>										
5260	25.5	35.8	18.1	16.1	24.0	0.041	3.4	11.0	11.0	Pass
5300	26.0	36.8	18.1	16.6	24.0	0.046	3.7	11.0	11.0	Pass
5320	26.0	34.9	18.1	16.6	24.0	0.046	3.9	11.0	11.0	Pass
<b>802.11n 40MHz</b>										
5270	26.5	62.3	36.4	16.0	24.0	0.040	0.8	11.0	11.0	Pass
5310	20.5	39.3	36.1	11.5	24.0	0.014	-3.8	11.0	11.0	Pass

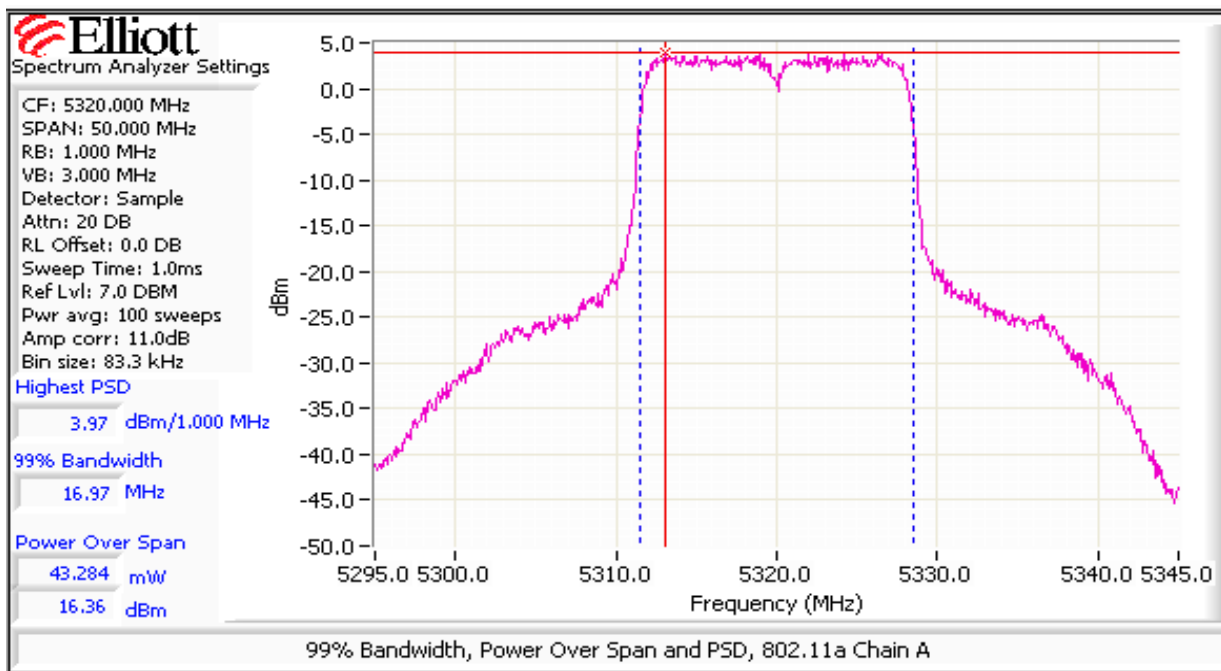

Client: Intel Corporation	Job Number: J80398
Model: Intel® Centrino® Advanced-N 6230	T-Log Number: T80759
	Account Manager: Christine Krebill
Contact: Steve Hackett	
Standard: FCC 15.247	Class: N/A

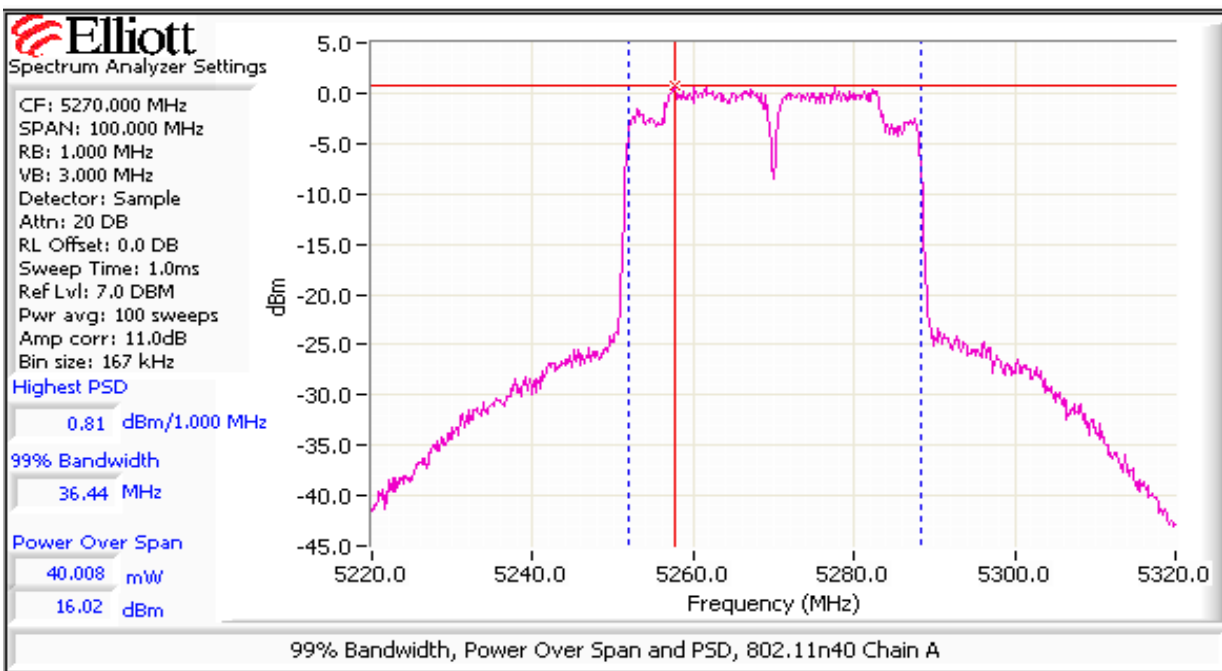
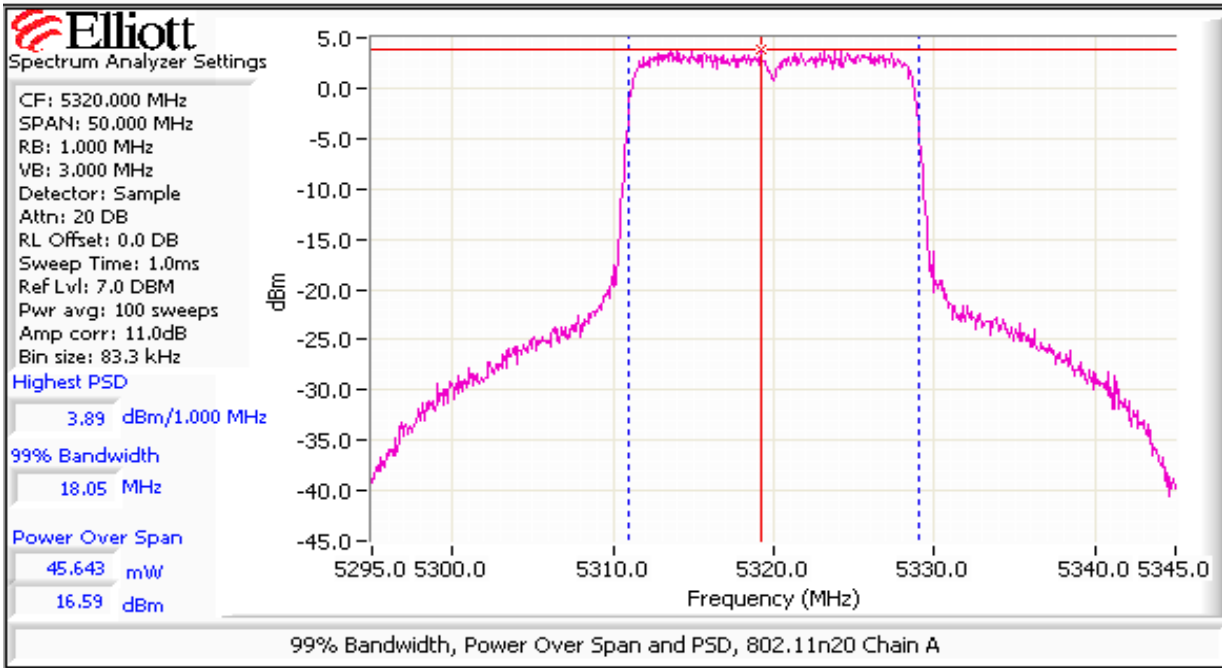



Client:	Intel Corporation	Job Number:	J80398
Model:	Intel® Centrino® Advanced-N 6230	T-Log Number:	T80759
Contact:	Steve Hackett	Account Manager:	Christine Krebill
Standard:	FCC 15.247	Class:	N/A

### Single Chain Operation, 5470- 5725 MHz Band

Antenna Gain (dBi): 4.8      EIRP: 134.9 mW      21.3 dBm

Frequency (MHz)	Software Setting	Bandwidth		Output Power <sup>1</sup> dBm		Power (Watts)	PSD <sup>2</sup> dBm/MHz			Result
		26dB	99% <sup>4</sup>	Measured	Limit		Measured	FCC Limit	RSS Limit <sup>3</sup>	
<b>802.11a</b>										
5500	27.5	33.5	17.0	16.4	24.0	0.044	3.9	11.0	11.0	Pass
5580	28.0	35.6	17.0	16.5	24.0	0.045	3.8	11.0	11.0	Pass
5700	28.5	35.0	17.1	16.5	24.0	0.045	4.2	11.0	11.0	Pass
<b>802.11n 20MHz</b>										
5500	27.5	36.0	18.1	16.4	24.0	0.044	3.5	11.0	11.0	Pass
5580	28.0	36.6	18.1	16.4	24.0	0.044	3.5	11.0	11.0	Pass
5700	28.5	39.1	18.1	16.3	24.0	0.043	3.4	11.0	11.0	Pass
<b>802.11n 40MHz</b>										
5510	27.5	53.7	36.3	15.5	24.0	0.035	0.3	11.0	11.0	Pass
5550	29.0	60.0	36.4	16.5	24.0	0.045	1.4	11.0	11.0	Pass
5670	29.5	67.8	36.4	16.4	24.0	0.044	1.2	11.0	11.0	Pass

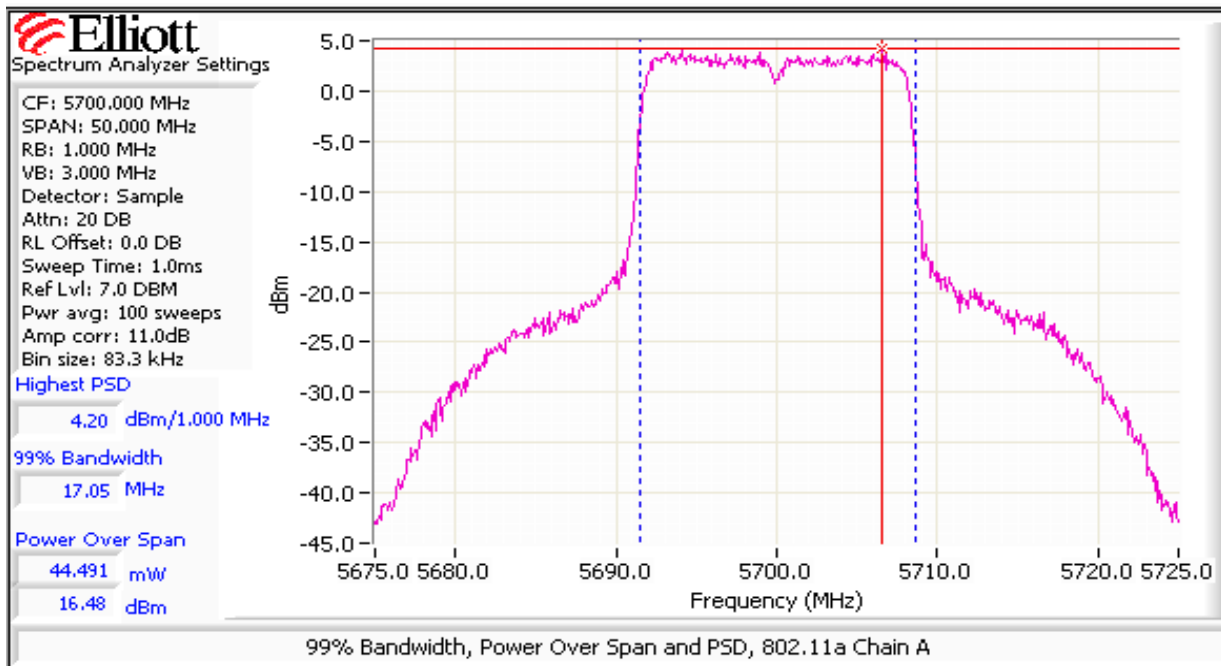

Client: Intel Corporation	Job Number: J80398
Model: Intel® Centrino® Advanced-N 6230	T-Log Number: T80759
	Account Manager: Christine Krebill
Contact: Steve Hackett	
Standard: FCC 15.247	Class: N/A

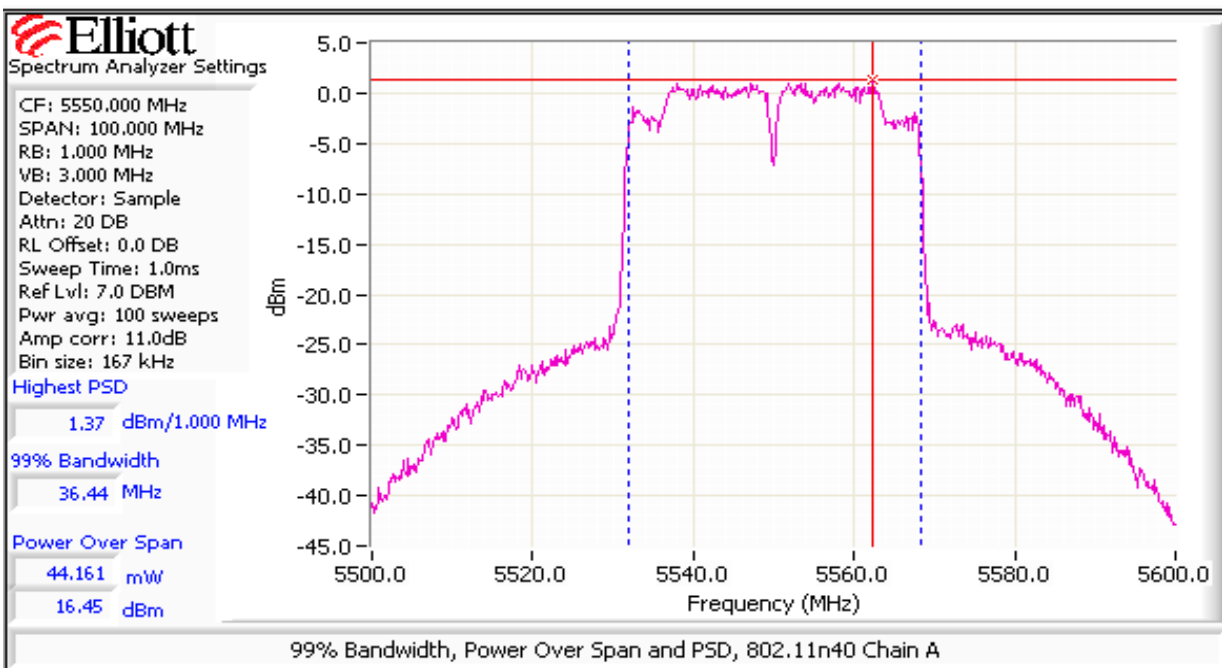
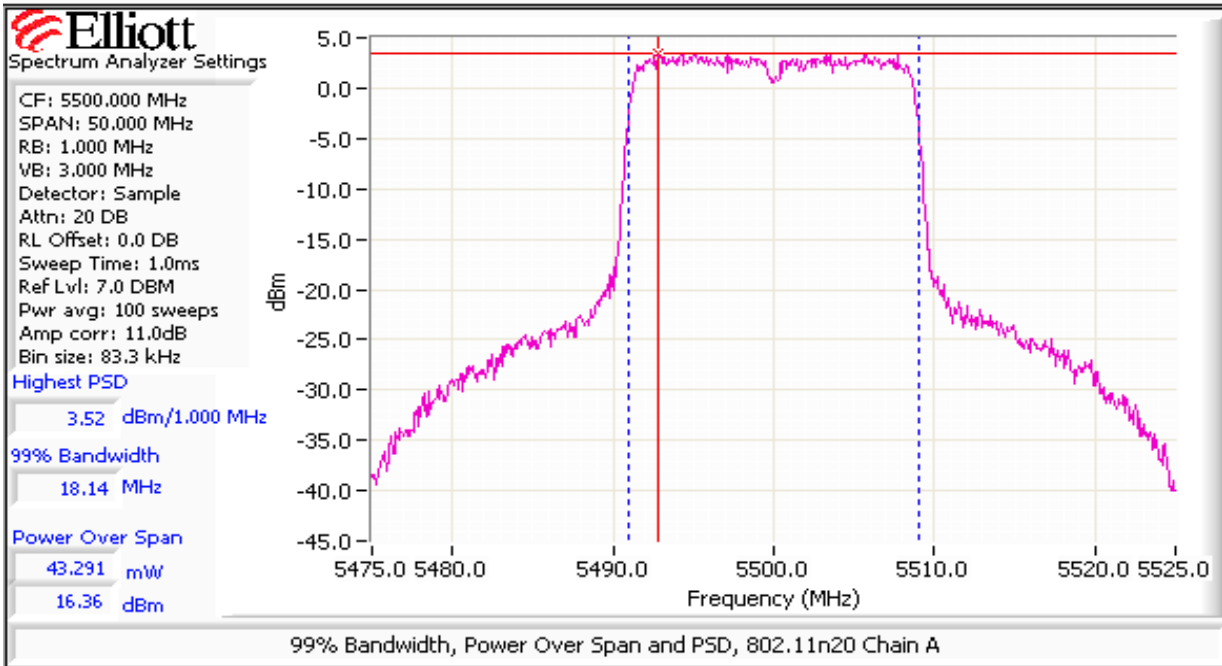

Client:	Intel Corporation	Job Number:	J80398
Model:	Intel® Centrino® Advanced-N 6230	T-Log Number:	T80759
Contact:	Steve Hackett	Account Manager:	Christine Krebill
Standard:	FCC 15.247	Class:	N/A

**Run #2: Peak Excursion Measurement**

**802.11a: Device meets the requirement for the peak excursion**

Peak Excursion(dB)			Peak Excursion(dB)			Peak Excursion(dB)		
Freq	Value	Limit	Freq	Value	Limit	Freq	Value	Limit
(MHz)			(MHz)			(MHz)		
5180	7.8	13.0	5260	7.7	13.0	5500	7.9	13.0
5200	8.0	13.0	5300	8.1	13.0	5580	8.0	13.0
5240	8.3	13.0	5320	7.8	13.0	5700	7.5	13.0

**n 20MHz: Device meets the requirement for the peak excursion**

Peak Excursion(dB)			Peak Excursion(dB)			Peak Excursion(dB)		
Freq	Value	Limit	Freq	Value	Limit	Freq	Value	Limit
(MHz)			(MHz)			(MHz)		
5180	9.1	13.0	5260	9.0	13.0	5500	7.9	13.0
5200	7.9	13.0	5300	8.5	13.0	5580	8.1	13.0
5240	8.2	13.0	5320	8.6	13.0	5700	8.5	13.0

**n 40MHz: Device meets the requirement for the peak excursion**

Peak Excursion(dB)			Peak Excursion(dB)			Peak Excursion(dB)		
Freq	Value	Limit	Freq	Value	Limit	Freq	Value	Limit
(MHz)			(MHz)			(MHz)		
5190	8.4	13.0	5270	9.6	13.0	5510	8.4	13.0
5230	8.2	13.0	5310	9.4	13.0	5550	8.0	13.0
						5670	8.7	13.0

Client: Intel Corporation	Job Number: J80398
Model: Intel® Centrino® Advanced-N 6230	T-Log Number: T80759
	Account Manager: Christine Krebill
Contact: Steve Hackett	
Standard: FCC 15.247	Class: N/A

### Plots Showing Peak Excursion

Trace A: RBW = 1MHz, VBW = 3MHz, Peak hold

Trace B: Same settings as used for power/PSD measurements (RBW = 1 MHz, VBW = 3MHz, Integrated average power)

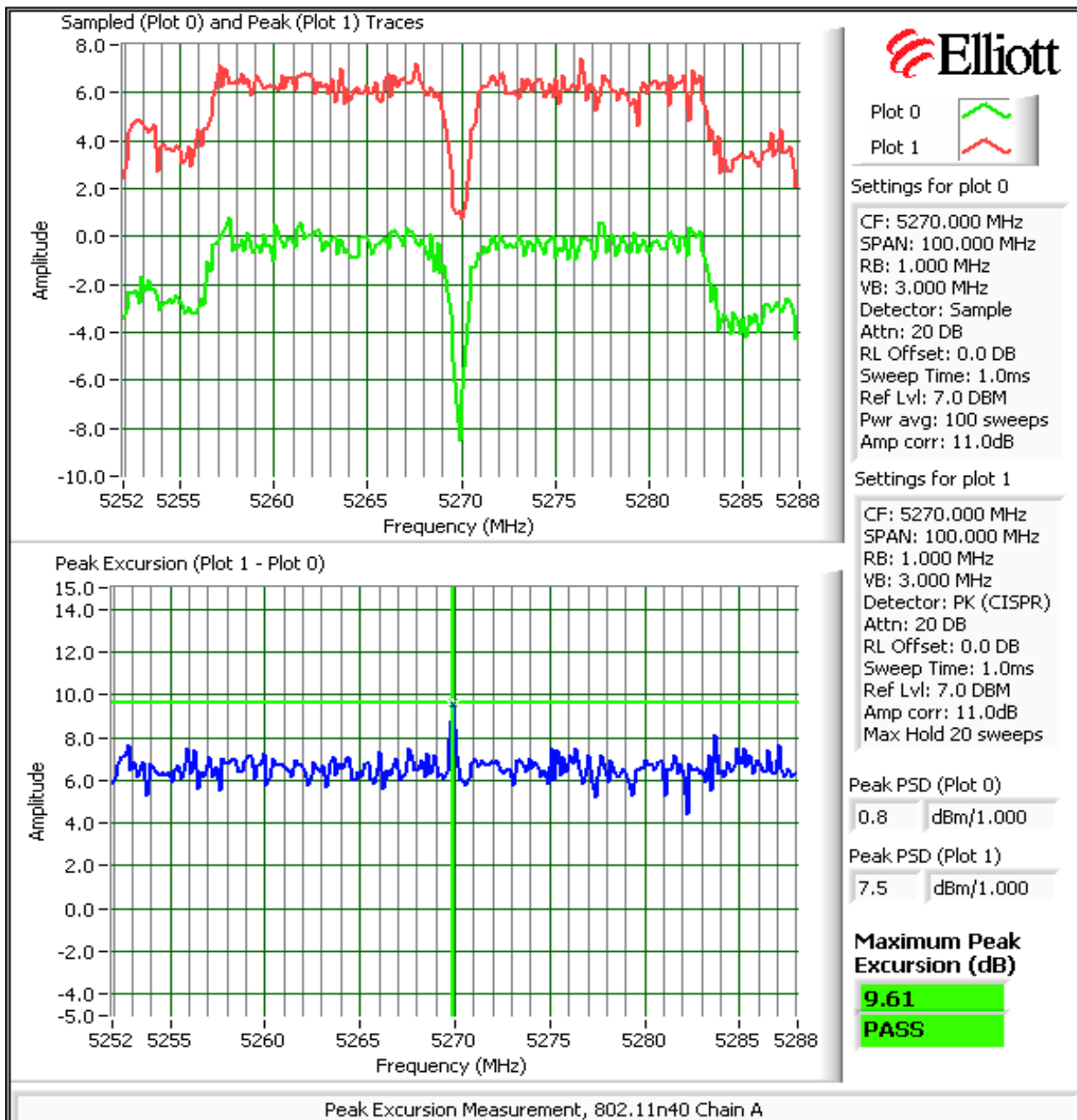

Client:	Intel Corporation	Job Number:	J80398
Model:	Intel® Centrino® Advanced-N 6230	T-Log Number:	T80759
Contact:	Steve Hackett	Account Manager:	Christine Krebill
Standard:	FCC 15.247	Class:	N/A

**Run #3: Out Of Band Spurious Emissions - Antenna Conducted**  
**802.11a**

Maximum Antenna Gain: 4.8 dBi (worst case for all 3 bands)  
 Spurious Limit: -27.0 dBm/MHz eirp  
 Limit Used On Plots <sup>Note 1</sup>: **-31.8** dBm/MHz Average Limit (RB=1MHz, VB=10Hz)  
**-11.8** dBm/MHz Peak Limit (RB=VB=1MHz)

**Plots Showing Out-Of-Band - 802.11a Mode Emissions (RBW=VBW=1MHz)**

**Low channel, 5150 - 5250 MHz Band - 802.11a Mode**

Compliance with the radiated limits for the restricted band immediately below 5150MHz is demonstrated through the radiated emissions tests.

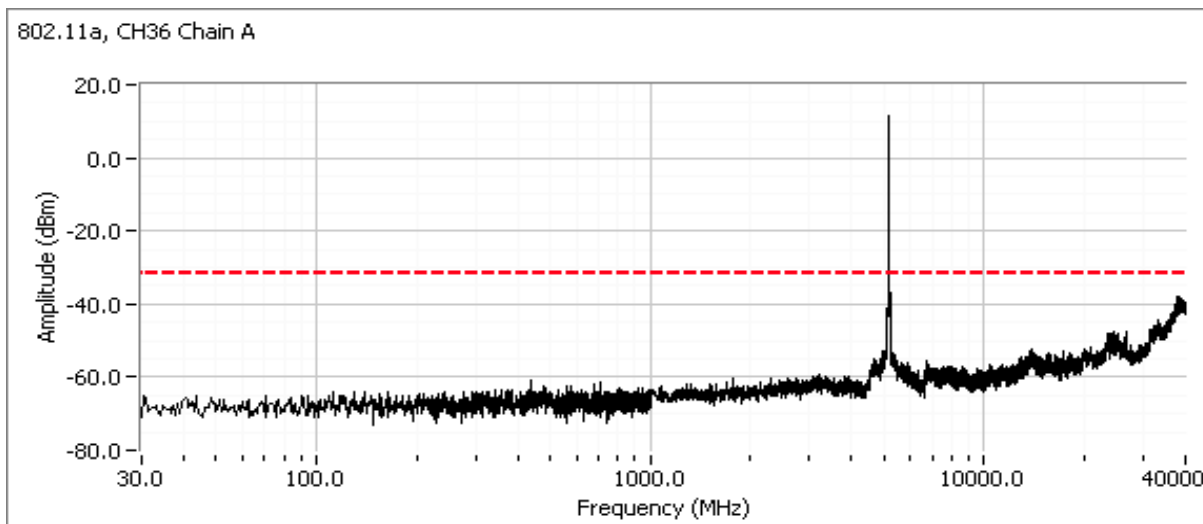

Client: Intel Corporation	Job Number: J80398
Model: Intel® Centrino® Advanced-N 6230	T-Log Number: T80759
	Account Manager: Christine Krebill
Contact: Steve Hackett	
Standard: FCC 15.247	Class: N/A

**Center channel, 5150 - 5250 MHz Band - 802.11a Mode**

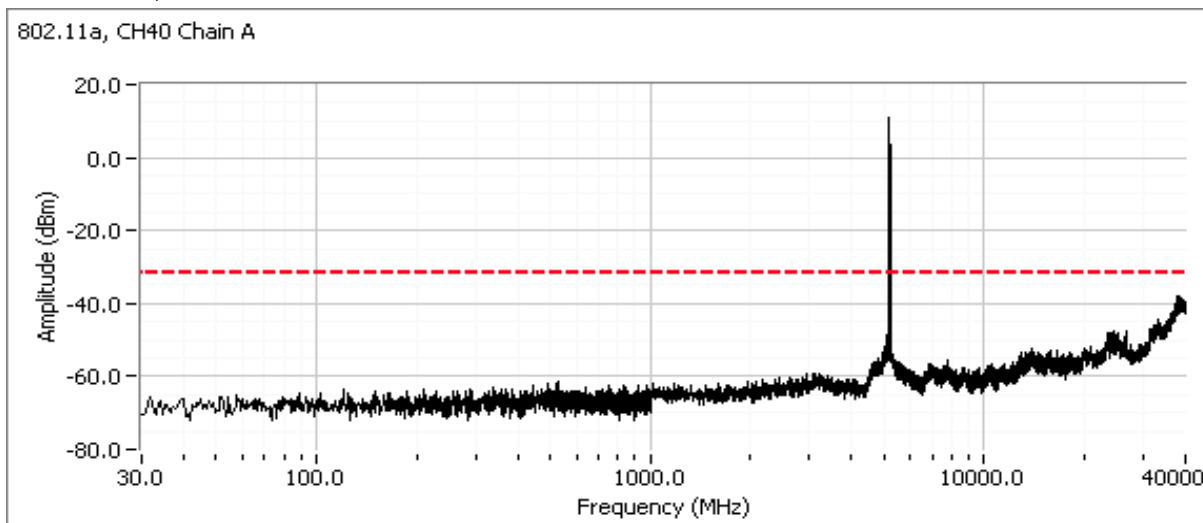

**High channel, 5150 - 5250 MHz Band - 802.11a Mode**

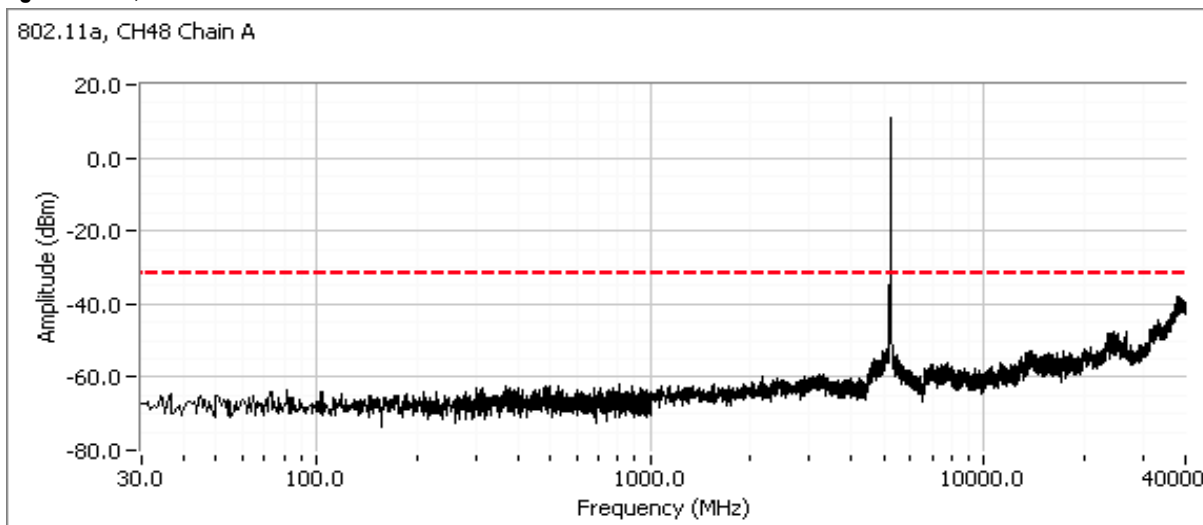

Client: Intel Corporation	Job Number: J80398
Model: Intel® Centrino® Advanced-N 6230	T-Log Number: T80759
	Account Manager: Christine Krebill
Contact: Steve Hackett	
Standard: FCC 15.247	Class: N/A

**Low channel, 5250 - 5350 MHz Band - 802.11a Mode**

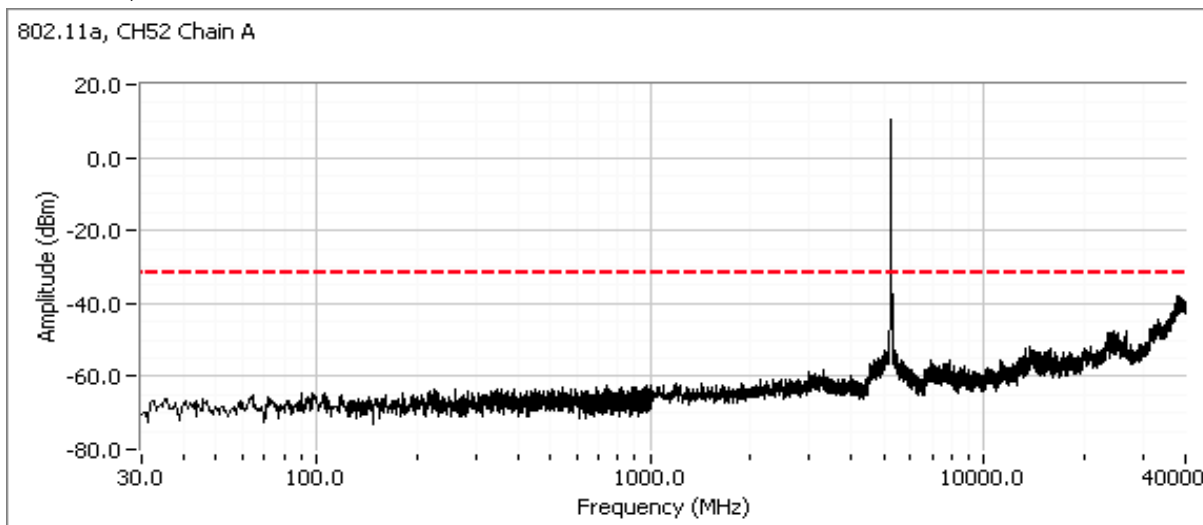

**Center channel, 5250 - 5350 MHz Band - 802.11a Mode**

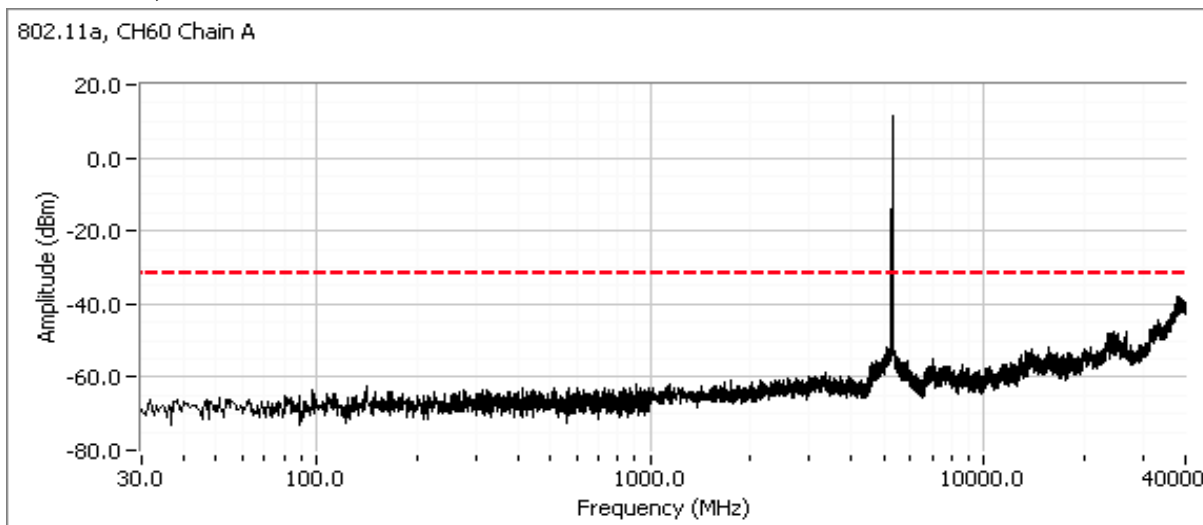

Client: Intel Corporation	Job Number: J80398
Model: Intel® Centrino® Advanced-N 6230	T-Log Number: T80759
	Account Manager: Christine Krebill
Contact: Steve Hackett	
Standard: FCC 15.247	Class: N/A

**High channel, 5250 - 5350 MHz Band - 802.11a Mode**

Compliance with the radiated limits for the restricted band immediately above 5350MHz is demonstrated through the radiated emissions tests.

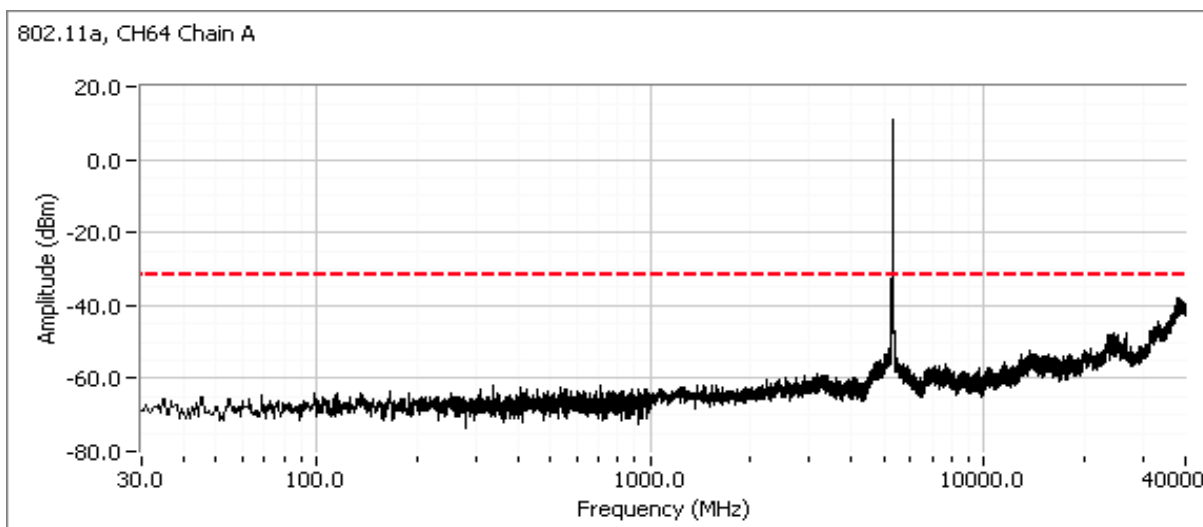

**Low channel, 5470 - 5725 MHz Band - 802.11a Mode**

Compliance with the radiated limits for the restricted band below 5460 MHz is demonstrated through the radiated emissions tests.

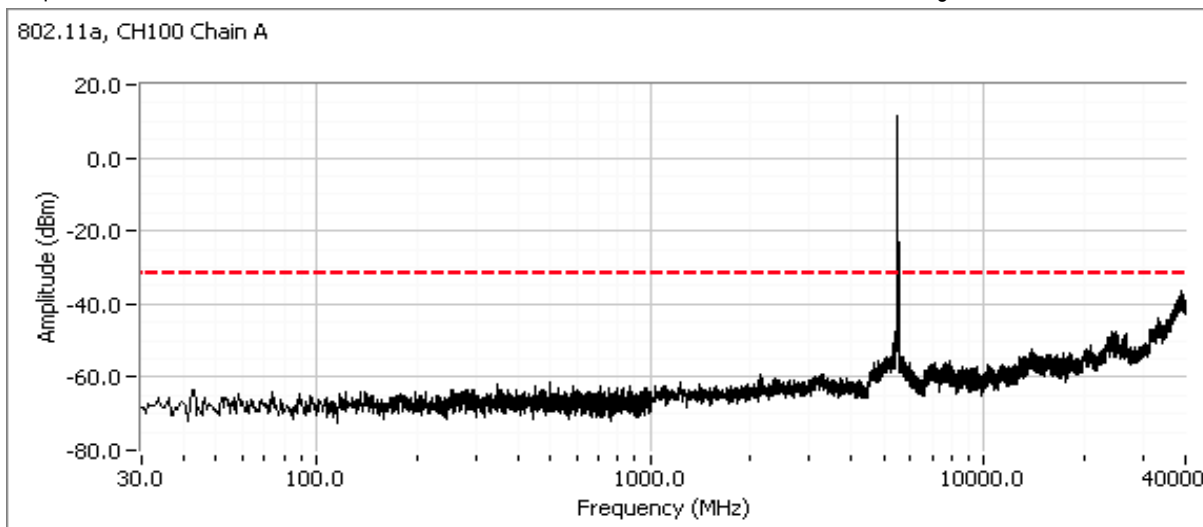



Client: Intel Corporation	Job Number: J80398
Model: Intel® Centrino® Advanced-N 6230	T-Log Number: T80759
	Account Manager: Christine Krebill
Contact: Steve Hackett	
Standard: FCC 15.247	Class: N/A

**Center channel, 5470 - 5725 MHz Band - 802.11a Mode (20MHz channel use 5580 MHz, 40MHz channel use 5550 MHz)**

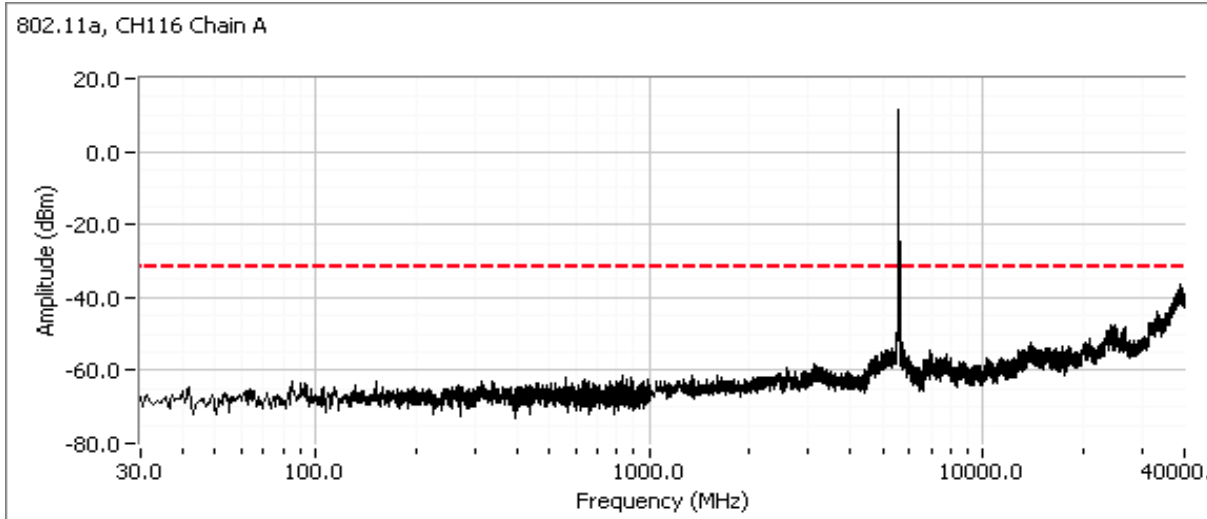

**High channel, 5470 - 5725 MHz Band - 802.11a Mode**

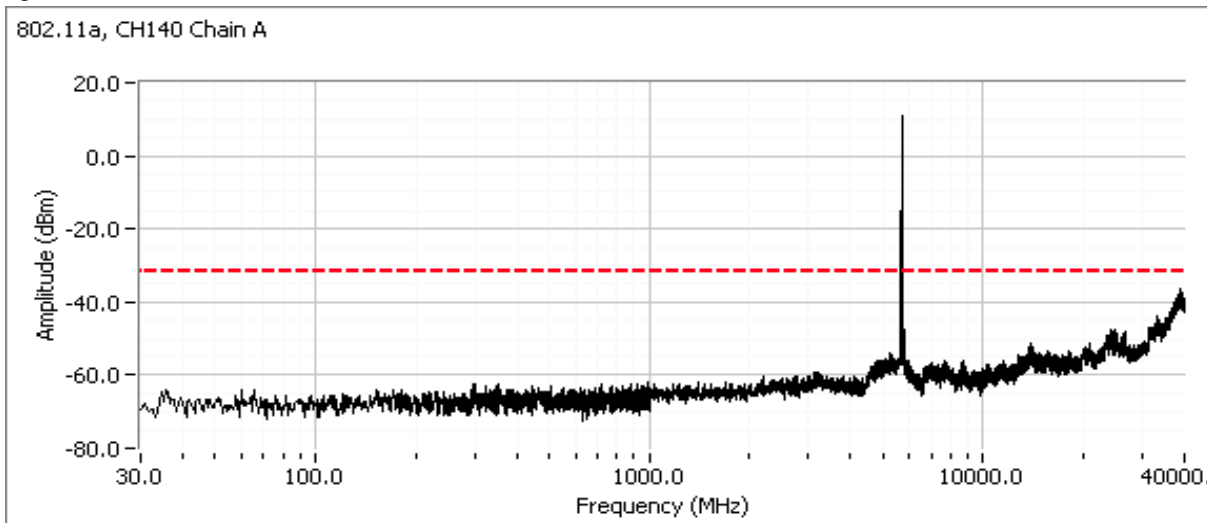

Client:	Intel Corporation	Job Number:	J80398
Model:	Intel® Centrino® Advanced-N 6230	T-Log Number:	T80759
Contact:	Steve Hackett	Account Manager:	Christine Krebill
Standard:	FCC 15.247	Class:	N/A

### 802.11n Modes - n 20MHz

**MIMO Devices:** Antenna gain used is the effective gain calculated in the power section of this data sheet. The plots were obtained with all chains transmitting simultaneously and connected to the analyzer via a combiner. Unused ports of the combiner were terminated in the appropriate load (50 ohms).

Number of transmit chains:	2
Maximum Antenna Gain:	4.8 dBi (worst case for all 3 bands)
Spurious Limit:	-27.0 dBm/MHz eirp
Limit Used On Plots <sup>Note 1:</sup>	-34.8 dBm/MHz Average Limit (RB=1MHz, VB=10Hz)
	-14.8 dBm/MHz Peak Limit (RB=VB=1MHz)

- Note 1: The -27dBm/MHz limit is an eirp limit. The limit for antenna port conducted measurements is adjusted to take into consideration the maximum antenna gain (limit = -27dBm - antenna gain). Radiated field strength measurements for signals more than 50MHz from the bands and that are close to the limit are made to determine compliance as the antenna gain is not known at these frequencies.
- Note 2: All spurious signals below 1GHz are measured during the radiated emissions test.

### Plots Showing Out-Of-Band - 802.11n - 20MHz Mode Emissions (RBW=VBW=1MHz)

#### Low channel, 5150 - 5250 MHz Band - 802.11n - 20MHz Mode

Compliance with the radiated limits for the restricted band immediately below 5150MHz is demonstrated through the radiated emissions tests.

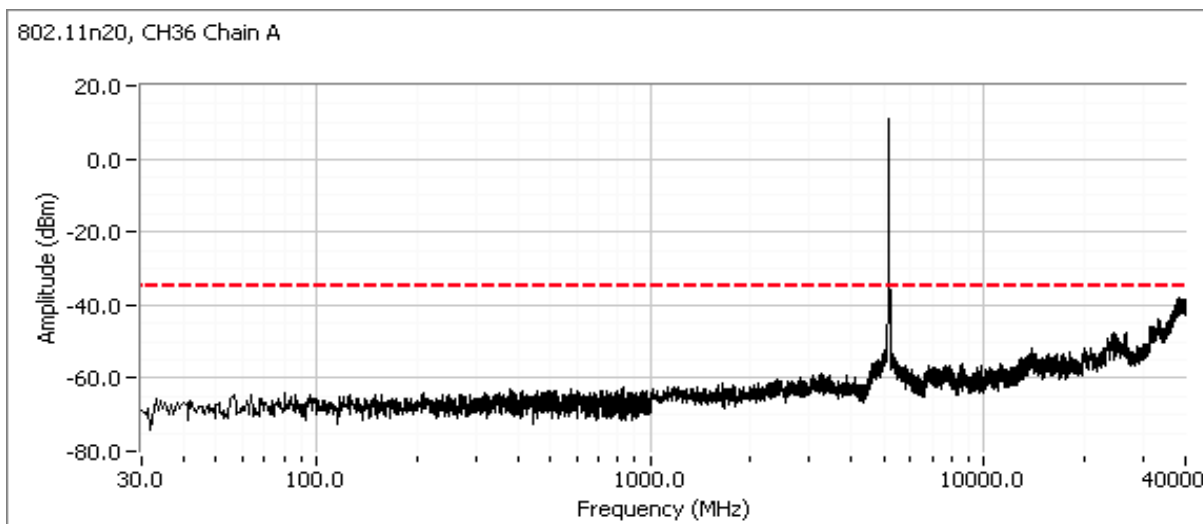

Client: Intel Corporation	Job Number: J80398
Model: Intel® Centrino® Advanced-N 6230	T-Log Number: T80759
	Account Manager: Christine Krebill
Contact: Steve Hackett	
Standard: FCC 15.247	Class: N/A

**Center channel, 5150 - 5250 MHz Band - 802.11n - 20MHz Mode**

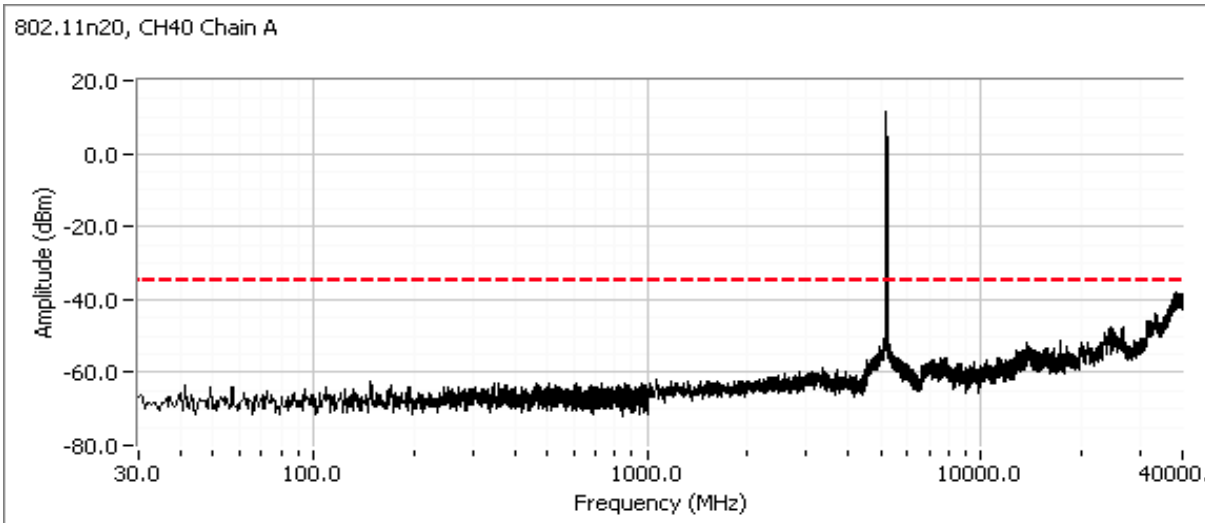

**High channel, 5150 - 5250 MHz Band - 802.11n - 20MHz Mode**

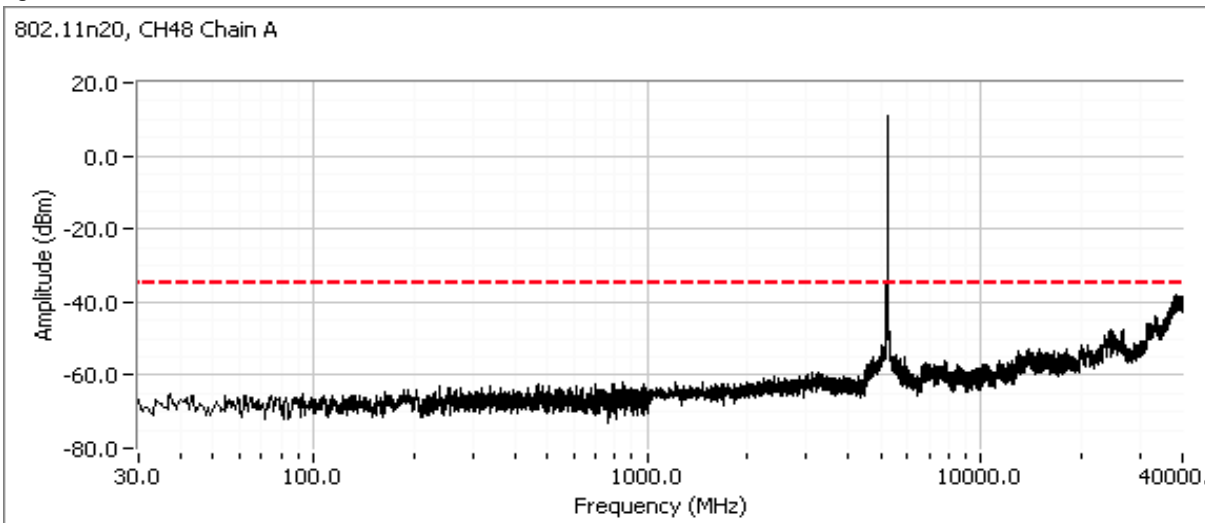

Client: Intel Corporation	Job Number: J80398
Model: Intel® Centrino® Advanced-N 6230	T-Log Number: T80759
	Account Manager: Christine Krebill
Contact: Steve Hackett	
Standard: FCC 15.247	Class: N/A

**Low channel, 5250 - 5350 MHz Band - 802.11n - 20MHz Mode**

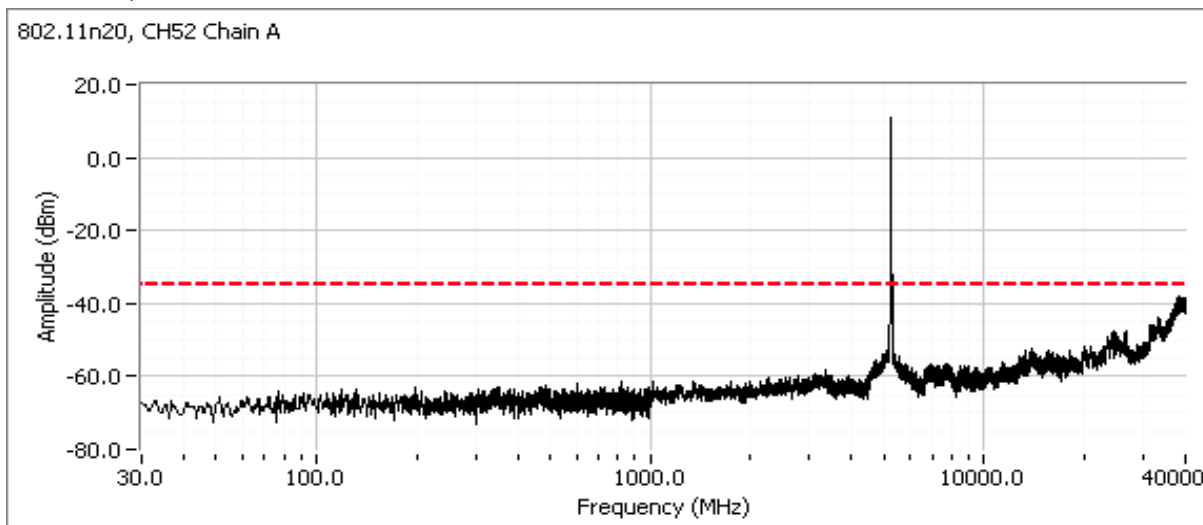

**Center channel, 5250 - 5350 MHz Band - 802.11n - 20MHz Mode**

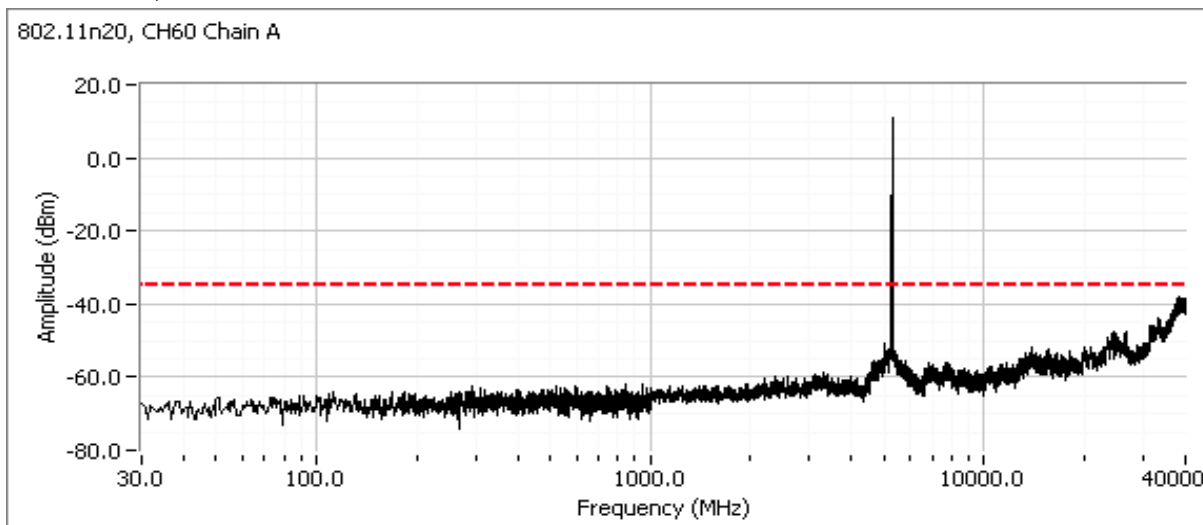

Client: Intel Corporation	Job Number: J80398
Model: Intel® Centrino® Advanced-N 6230	T-Log Number: T80759
	Account Manager: Christine Krebill
Contact: Steve Hackett	
Standard: FCC 15.247	Class: N/A

**High channel, 5250 - 5350 MHz Band - 802.11n - 20MHz Mode**

Compliance with the radiated limits for the restricted band immediately above 5350MHz is demonstrated through the radiated emissions tests.

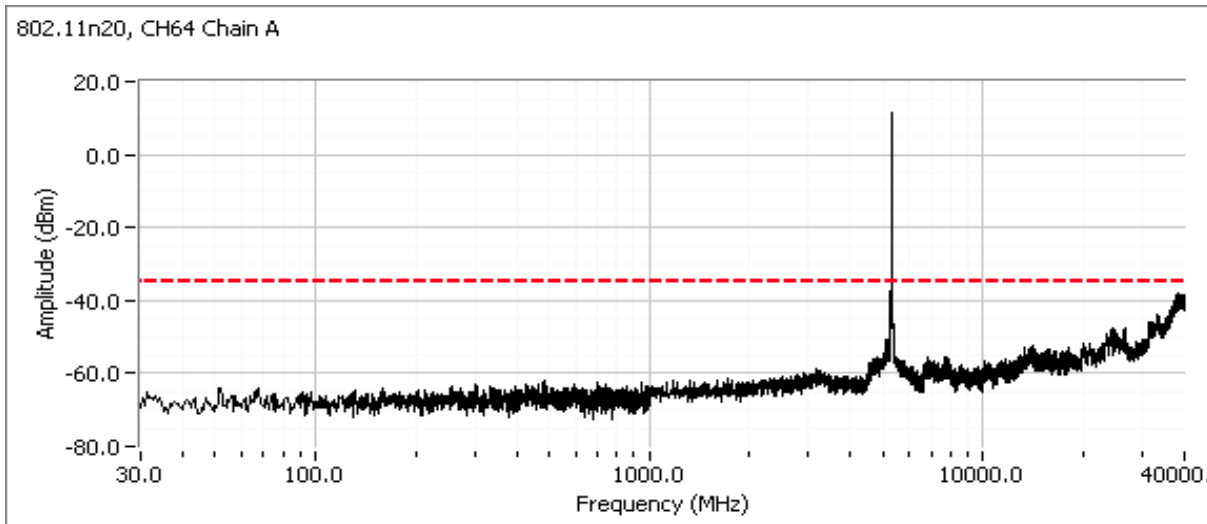

**Low channel, 5470 - 5725 MHz Band - 802.11n - 20MHz Mode**

Compliance with the radiated limits for the restricted band below 5460 MHz is demonstrated through the radiated emissions tests.

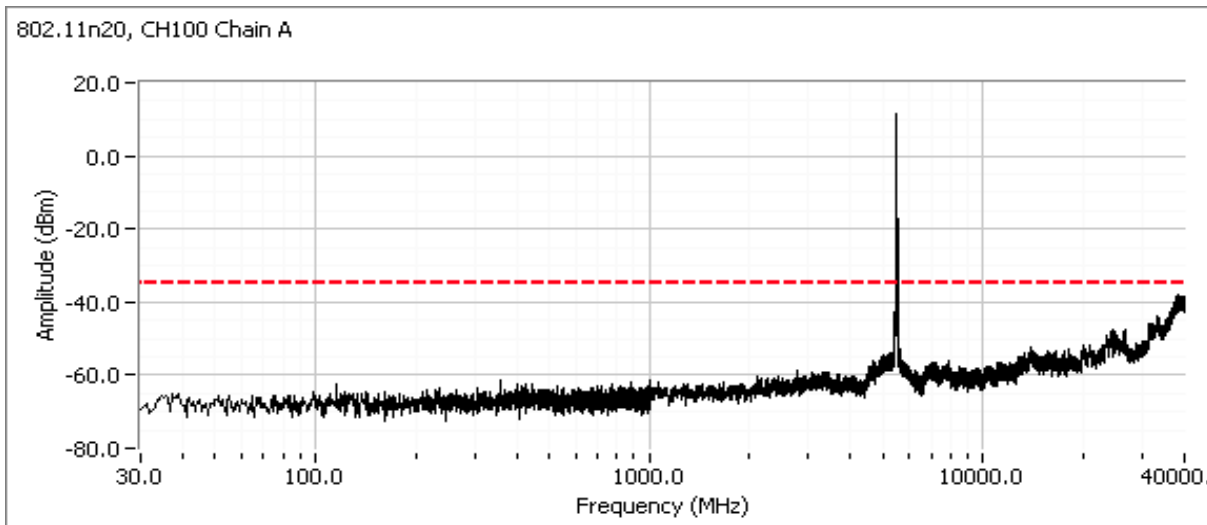

Client: Intel Corporation	Job Number: J80398
Model: Intel® Centrino® Advanced-N 6230	T-Log Number: T80759
	Account Manager: Christine Krebill
Contact: Steve Hackett	
Standard: FCC 15.247	Class: N/A

**Center channel, 5470 - 5725 MHz Band - 802.11n - 20MHz Mode (use 5580 MHz)**

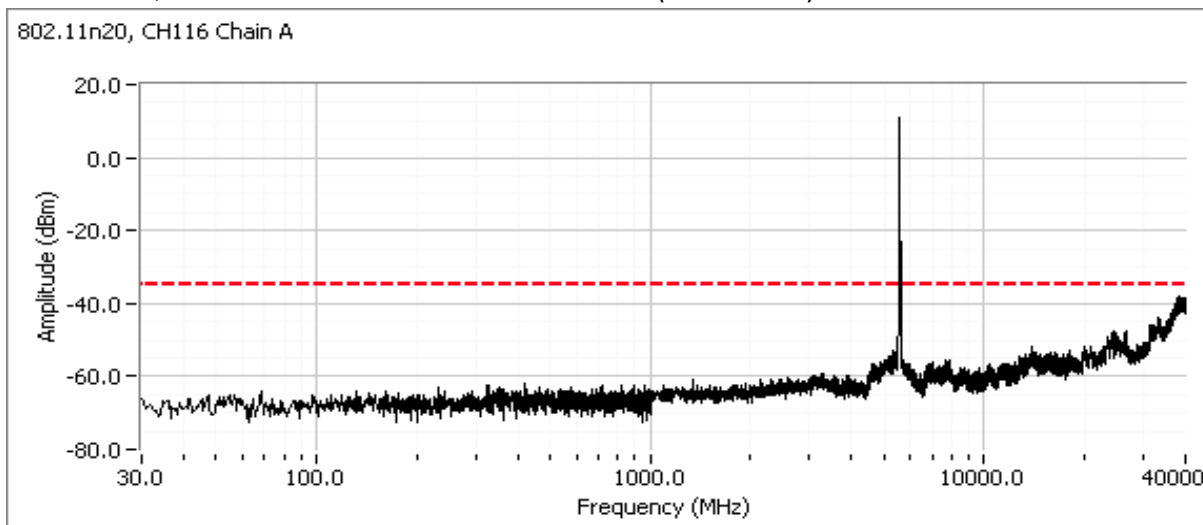

**High channel, 5470 - 5725 MHz Band - 802.11n - 20MHz Mode**

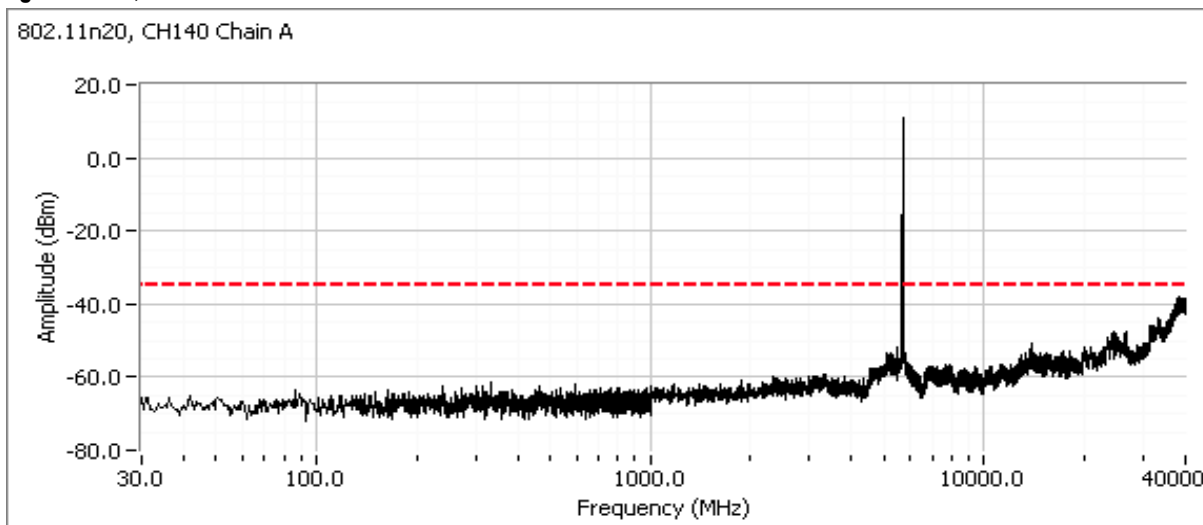

Client:	Intel Corporation	Job Number:	J80398
Model:	Intel® Centrino® Advanced-N 6230	T-Log Number:	T80759
Contact:	Steve Hackett	Account Manager:	Christine Krebill
Standard:	FCC 15.247	Class:	N/A

**Plots Showing Out-Of-Band - 802.11n - 40MHz Mode Emissions (RBW=VBW=1MHz)**

**Low channel, 5150 - 5250 MHz Band - 802.11n - 40MHz Mode**

Compliance with the radiated limits for the restricted band immediately below 5150MHz is demonstrated through the radiated emissions tests.

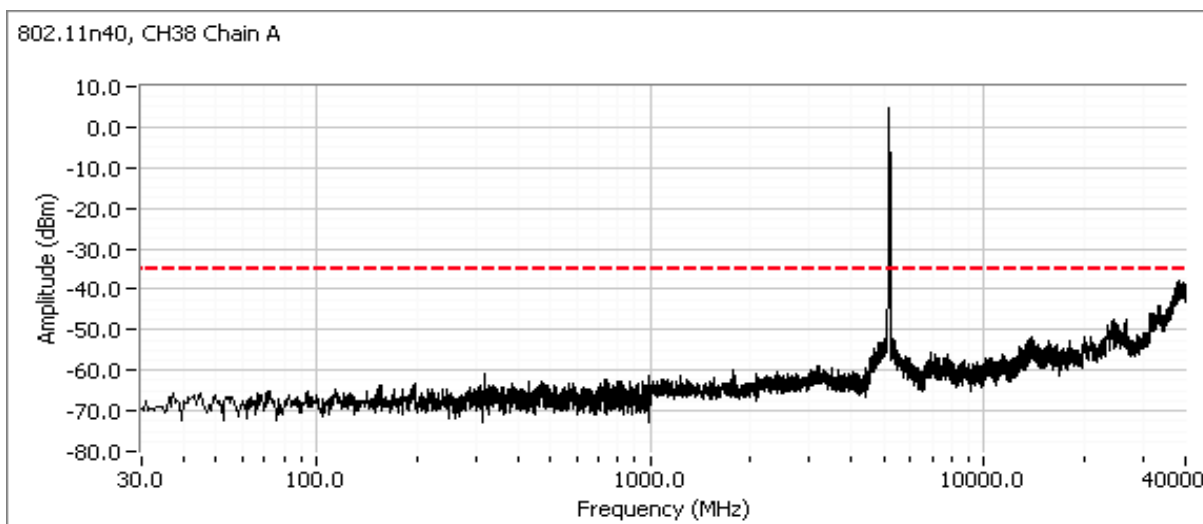

**High channel, 5150 - 5250 MHz Band - 802.11n - 40MHz Mode**

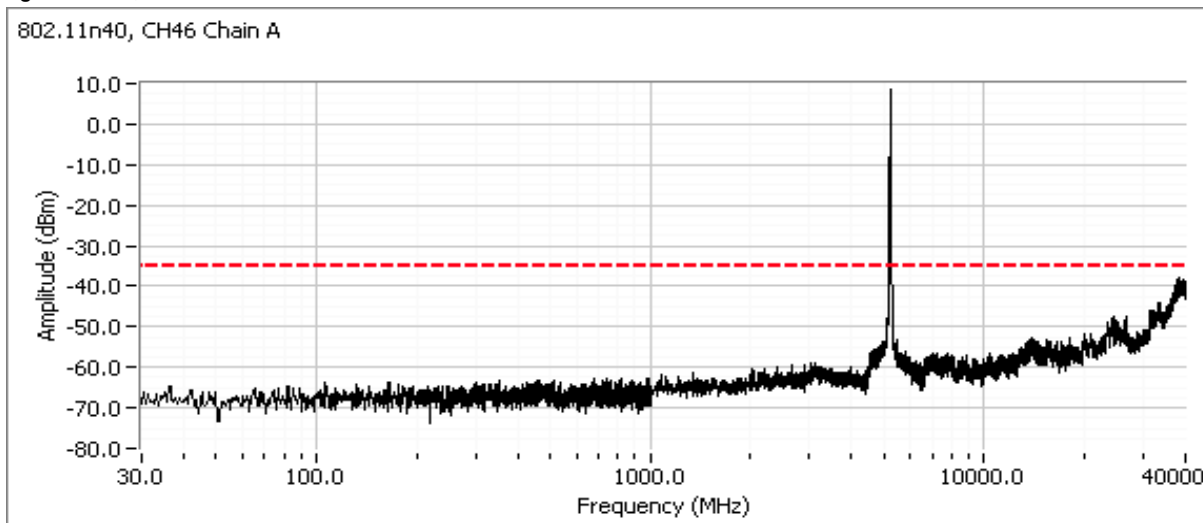

Client: Intel Corporation	Job Number: J80398
Model: Intel® Centrino® Advanced-N 6230	T-Log Number: T80759
	Account Manager: Christine Krebill
Contact: Steve Hackett	
Standard: FCC 15.247	Class: N/A

**Low channel, 5250 - 5350 MHz Band - 802.11n - 40MHz Mode**

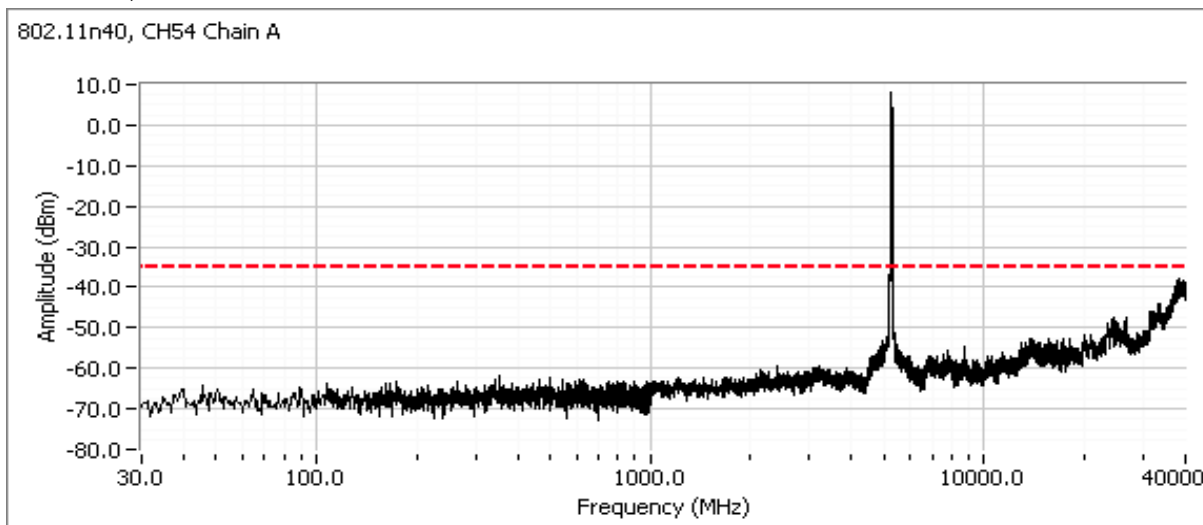

**High channel, 5250 - 5350 MHz Band - 802.11n - 40MHz Mode**

Compliance with the radiated limits for the restricted band immediately above 5350MHz is demonstrated through the radiated emissions tests.

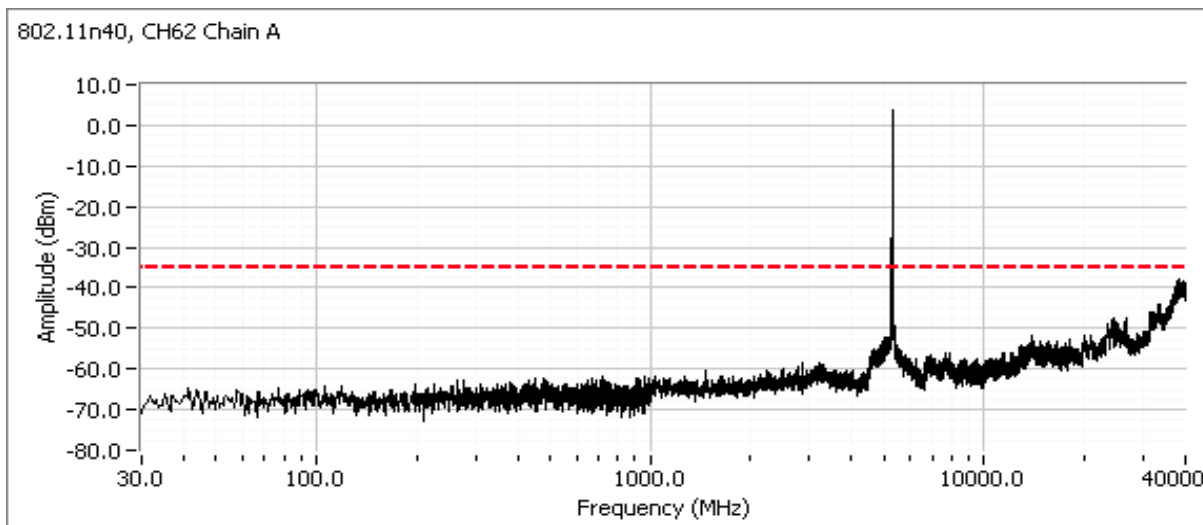



Client: Intel Corporation	Job Number: J80398
Model: Intel® Centrino® Advanced-N 6230	T-Log Number: T80759
	Account Manager: Christine Krebill
Contact: Steve Hackett	
Standard: FCC 15.247	Class: N/A

**Low channel, 5470 - 5725 MHz Band - 802.11n - 40MHz Mode**

Compliance with the radiated limits for the restricted band below 5460 MHz is demonstrated through the radiated emissions tests.

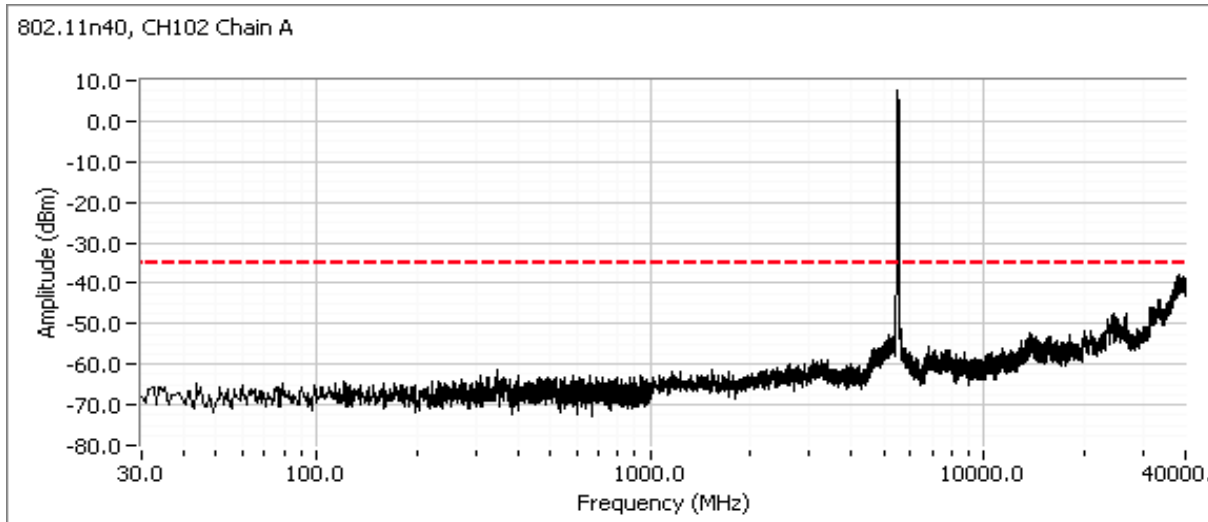

**Center channel, 5470-5725MHz Band - 802.11n 40MHz Mode (20MHz channel use 5580MHz, 40MHz channel use 5550MHz)**

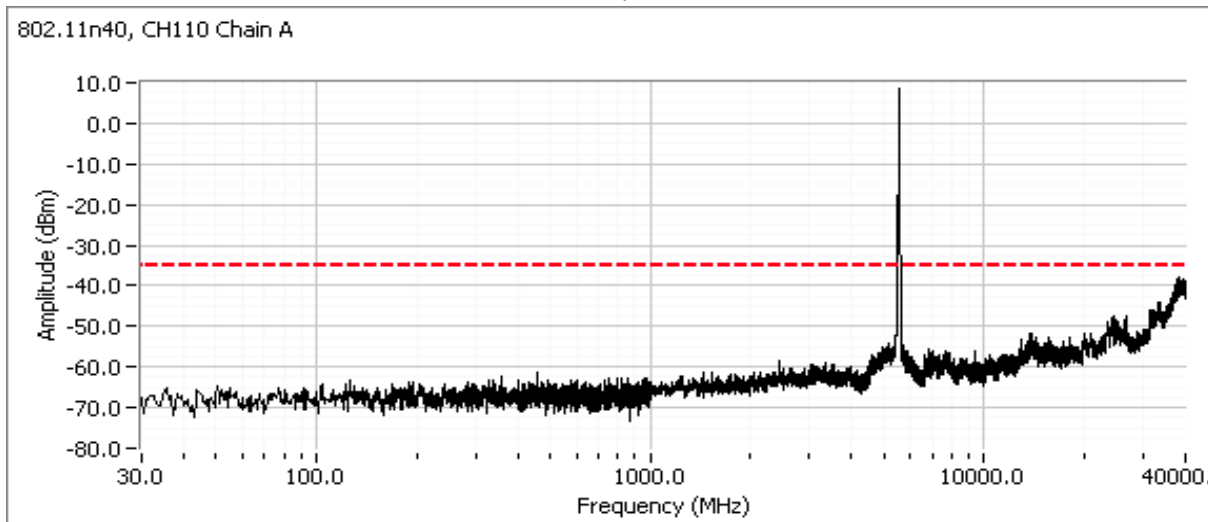

Client: Intel Corporation	Job Number: J80398
Model: Intel® Centrino® Advanced-N 6230	T-Log Number: T80759
	Account Manager: Christine Krebill
Contact: Steve Hackett	
Standard: FCC 15.247	Class: N/A

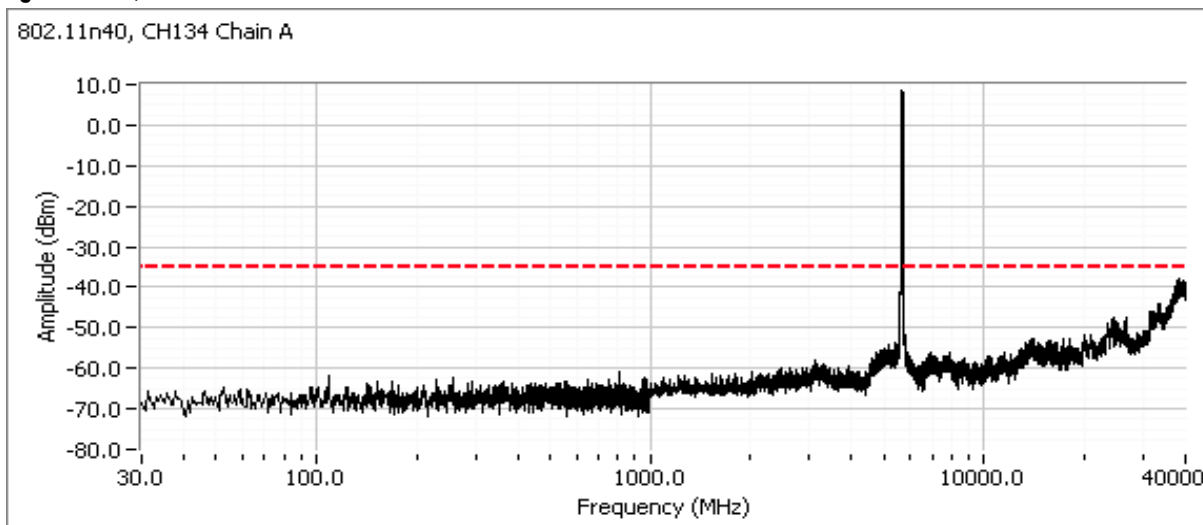
**High channel, 5470 - 5725 MHz Band - 802.11n - 40MHz Mode**

Client:	Intel Corporation	Job Number:	J80398
Model:	Intel® Centrino® Advanced-N 6230	T-Log Number:	T80759
		Account Manager:	Christine Krebill
Contact:	Steve Hackett		
Standard:	FCC 15.247	Class:	N/A

**RSS-210 (LELAN) and FCC 15.407(UNII)  
Antenna Port Measurements - Chain B  
Power, PSD, Peak Excursion, Bandwidth and Spurious Emissions**

**Test Specific Details**

Objective: The objective of this test session is to perform final qualification testing of the EUT with respect to the specification listed above.

**Summary of Results - Chain B**

Run #	Test Performed	Limit	Pass / Fail	Result / Margin
1	Power, 5150 - 5250MHz	15.407(a) (1), (2)	PASS	802.11a: 39 mW 802.11n 20MHz: 40 mW 802.11n n40MHz: 38 mW
1	PSD, 5150 - 5250MHz	15.407(a) (1), (2)	PASS	802.11a: 3.6 dBm/MHz 802.11n 20MHz: 3.4 dBm/MHz 802.11n n40MHz: 0.6 dBm/MHz
1	Power, 5250 - 5350MHz	15.407(a) (1), (2)	PASS	802.11a: 39 mW 802.11n 20MHz: 37 mW 802.11n n40MHz: 33 mW
1	PSD, 5250 - 5350MHz	15.407(a) (1), (2)	PASS	802.11a: 3.4 dBm/MHz 802.11n 20MHz: 2.8 dBm/MHz 802.11n n40MHz: 0.1 dBm/MHz
1	Power, 5470 - 5725MHz	15.407(a) (1), (2)	PASS	802.11a: 37 mW 802.11n 20MHz: 37 mW 802.11n n40MHz: 38 mW
1	PSD, 5470 - 5725MHz	15.407(a) (1), (2)	PASS	802.11a: 3.1 dBm/MHz 802.11n 20MHz: 3.1 dBm/MHz 802.11n n40MHz: 0.5 dBm/MHz
1	26dB Bandwidth	15.407 (Information only)	-	> 20MHz for all modes
1	99% Bandwidth	RSS 210 (Information only)	N/A	802.11a: 17.1 MHz 802.11n 20MHz: 18.1 MHz 802.11n n40MHz: 36.4 MHz
2	Peak Excursion Envelope	15.407(a) (6) 13dB	PASS	9.9dB
3	Antenna Conducted - Out of Band Spurious	15.407(b) -27dBm/MHz	PASS	All emissions below the -27dBm/MHz limit

Client:	Intel Corporation	Job Number:	J80398
Model:	Intel® Centrino® Advanced-N 6230	T-Log Number:	T80759
		Account Manager:	Christine Krebill
Contact:	Steve Hackett		
Standard:	FCC 15.247	Class:	N/A

**General Test Configuration**

When measuring the conducted emissions from the EUT's antenna port, the antenna port of the EUT was connected to the spectrum analyzer or power meter via a suitable attenuator to prevent overloading the measurement system. All measurements are corrected to allow for the external attenuators and cables used.

**Ambient Conditions:**

Temperature:	18-23 °C
Rel. Humidity:	40-50 %

**Modifications Made During Testing**

No modifications were made to the EUT during testing

**Deviations From The Standard**

No deviations were made from the requirements of the standard.

Date of Test: 10/4/2010	Config. Used: -
Test Location: Lab #4	Config Change: -
Test Engineer: John Caizzi	Host Unit Voltage 120V/60Hz
Test Engineer: Mehran Birgani	
Test Engineer: Joseph Cadigal	
Test Engineer: Rafael Varelas	

Client:	Intel Corporation	Job Number:	J80398
Model:	Intel® Centrino® Advanced-N 6230	T-Log Number:	T80759
Contact:	Steve Hackett	Account Manager:	Christine Krebill
Standard:	FCC 15.247	Class:	N/A

### Run #1: Bandwidth, Output Power and Power Spectral Density - Single Chain Systems

Note 1:	Output power measured using a spectrum analyzer (see plots below). RBW=1MHz, VB=3 MHz, sample detector, power averaging on (transmitted signal was continuous) and power integration over 100MHz for 802.11n 40MHz and 50MHz for 802.11a and 802.11n 20MHz (method 1 of DA-02-2138A1).
Note 2:	Measured using the same analyzer settings used for output power.
Note 3:	For RSS-210 the limit for the 5150 - 5250 MHz band accounts for the antenna gain as the maximum eirp allowed is 10dBm/MHz. The limits are also corrected for instances where the highest measured value of the PSD exceeds the average PSD (calculated from the measured power divided by the measured 99% bandwidth) by more than 3dB by the amount that the measured value exceeds the average by more than 3dB.
Note 4:	99% Bandwidth measured in accordance with RSS GEN - RB > 1% of span and VB >=3xRB

### Single Chain Operation, 5150-5250MHz Band

Antenna Gain (dBi): 3.6 EIRP: 89.1 mW 19.5 dBm

Frequency (MHz)	Software Setting	Bandwidth		Output Power <sup>1</sup> dBm		Power (Watts)	PSD <sup>2</sup> dBm/MHz			Result
		26dB	99% <sup>4</sup>	Measured	Limit		Measured	FCC Limit	RSS Limit <sup>3</sup>	
<b>802.11a</b>										
5180	24.0	32.5	17.0	15.9	17.0	0.039	3.6	4.0	6.4	Pass
5200	24.0	31.4	17.0	15.8	17.0	0.038	3.2	4.0	6.4	Pass
5240	24.5	32.4	17.0	15.7	17.0	0.037	3.4	4.0	6.4	Pass
<b>802.11n 20MHz</b>										
5180	24.5	27.9	18.1	16.0	17.0	0.040	3.2	4.0	6.4	Pass
5200	24.5	36.5	18.1	16.0	17.0	0.040	3.4	4.0	6.4	Pass
5240	25.0	35.6	18.1	15.9	17.0	0.039	3.2	4.0	6.4	Pass
<b>802.11n 40MHz</b>										
5190	21.0	39.3	36.3	12.7	17.0	0.019	-2.7	4.0	6.4	Pass
5230	26.0	54.8	36.4	15.8	17.0	0.038	0.6	4.0	6.4	Pass

### Single Chain Operation, 5250-5350 MHz Band

Antenna Gain (dBi): 3.7 EIRP: 91.2 mW 19.6 dBm

Frequency (MHz)	Software Setting	Bandwidth		Output Power <sup>1</sup> dBm		Power (Watts)	PSD <sup>2</sup> dBm/MHz			Result
		26dB	99% <sup>4</sup>	Measured	Limit		Measured	FCC Limit	RSS Limit <sup>3</sup>	
<b>802.11a</b>										
5260	24.5	29.4	17.0	15.3	24.0	0.034	2.8	11.0	11.0	Pass
5300	25.0	29.2	17.0	15.4	24.0	0.035	3.1	11.0	11.0	Pass
5320	25.5	23.8	17.0	15.9	24.0	0.039	3.4	11.0	11.0	Pass
<b>802.11n 20MHz</b>										
5260	25.0	34.1	18.1	15.4	24.0	0.035	2.8	11.0	11.0	Pass
5300	25.0	30.9	18.1	15.3	24.0	0.034	2.8	11.0	11.0	Pass
5320	25.5	30.8	18.1	15.7	24.0	0.037	2.8	11.0	11.0	Pass
<b>802.11n 40MHz</b>										
5270	26.0	53.2	36.4	15.2	24.0	0.033	0.1	11.0	11.0	Pass
5310	22.0	39.4	36.1	12.4	24.0	0.017	-2.4	11.0	11.0	Pass

Client: Intel Corporation	Job Number: J80398
Model: Intel® Centrino® Advanced-N 6230	T-Log Number: T80759
	Account Manager: Christine Krebill
Contact: Steve Hackett	
Standard: FCC 15.247	Class: N/A

### Single Chain Operation, 5470- 5725 MHz Band

Antenna Gain (dBi): 4.8      EIRP: 112.2 mW      20.5 dBm

Frequency (MHz)	Software Setting	Bandwidth		Output Power <sup>1</sup> dBm		Power (Watts)	PSD <sup>2</sup> dBm/MHz			Result
		26dB	99% <sup>4</sup>	Measured	Limit		Measured	FCC Limit	RSS Limit <sup>3</sup>	
<b>802.11a</b>										
5500	27.5	29.6	17.0	15.6	24.0	0.036	3.0	11.0	11.0	Pass
5580	28.0	32.9	17.1	<b>15.7</b>	24.0	0.037	3.0	11.0	11.0	Pass
5700	28.5	31.8	17.1	15.5	24.0	0.035	3.1	11.0	11.0	Pass
<b>802.11n 20MHz</b>										
5500	27.5	36.8	18.1	15.6	24.0	0.036	2.9	11.0	11.0	Pass
5580	28.0	36.1	18.1	<b>15.7</b>	24.0	0.037	3.1	11.0	11.0	Pass
5700	28.5	36.0	17.1	15.5	24.0	0.035	3.1	11.0	11.0	Pass
<b>802.11n 40MHz</b>										
5510	27.5	53.4	36.3	14.8	24.0	0.030	-0.4	11.0	11.0	Pass
5550	29.0	59.2	36.4	<b>15.8</b>	24.0	0.038	0.5	11.0	11.0	Pass
5670	29.5	55.8	36.4	15.6	24.0	0.036	0.2	11.0	11.0	Pass

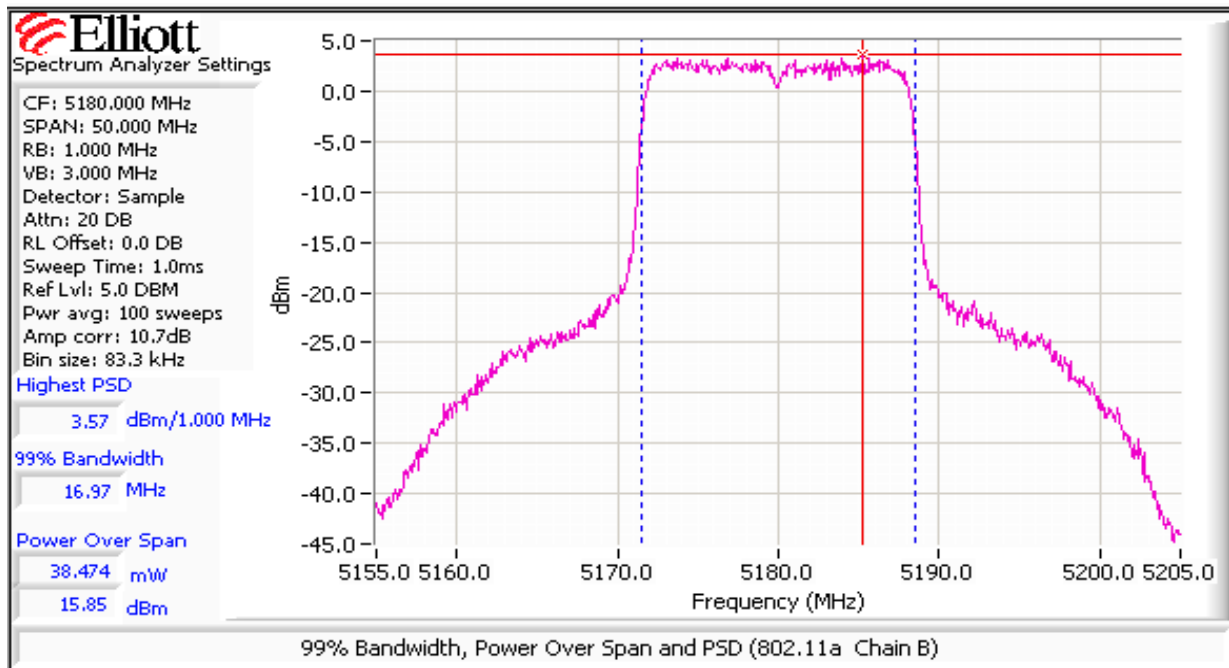

Client: Intel Corporation	Job Number: J80398
Model: Intel® Centrino® Advanced-N 6230	T-Log Number: T80759
	Account Manager: Christine Krebill
Contact: Steve Hackett	
Standard: FCC 15.247	Class: N/A

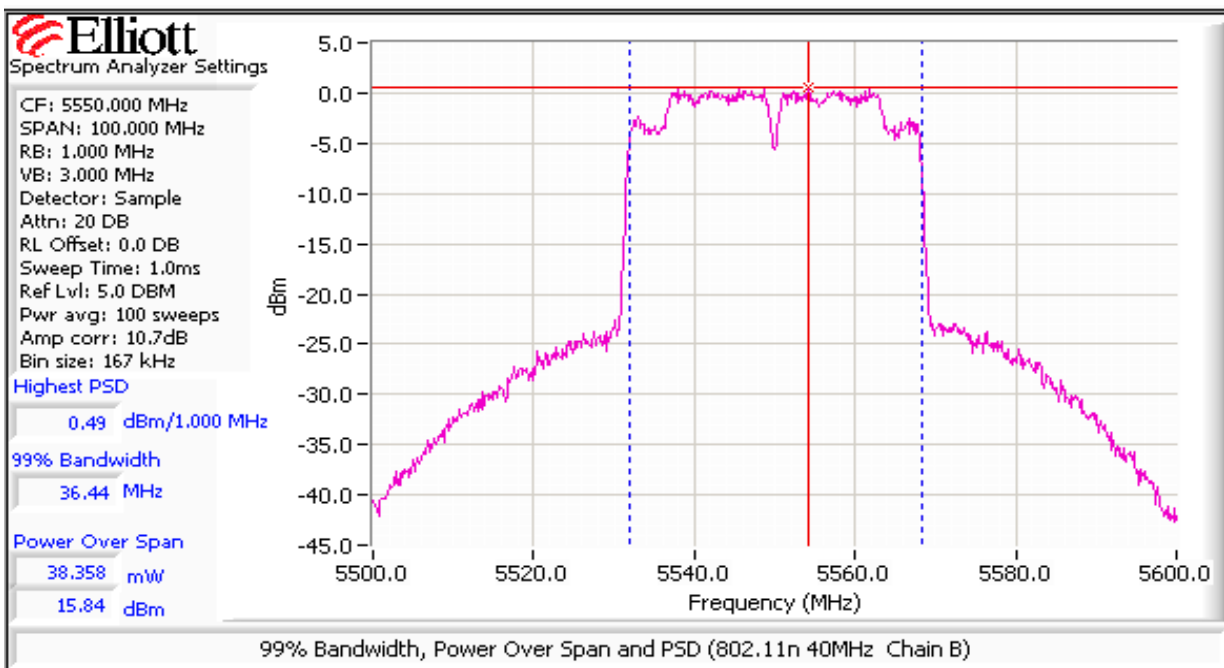
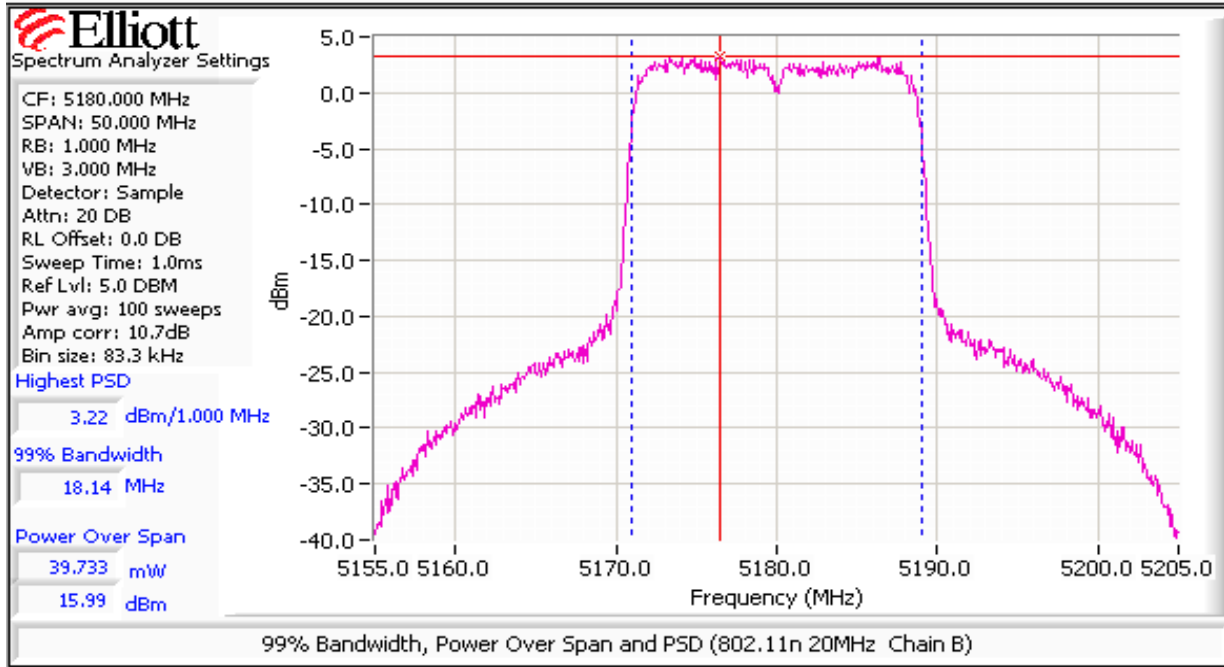

Client: Intel Corporation	Job Number: J80398
Model: Intel® Centrino® Advanced-N 6230	T-Log Number: T80759
	Account Manager: Christine Krebill
Contact: Steve Hackett	
Standard: FCC 15.247	Class: N/A

**Run #2: Peak Excursion Measurement**

**802.11a: Device meets the requirement for the peak excursion**

Peak Excursion(dB)			Peak Excursion(dB)			Peak Excursion(dB)		
Freq (MHz)	Value	Limit	Freq (MHz)	Value	Limit	Freq (MHz)	Value	Limit
5180	8.6	13.0	5260	8.0	13.0	5500	8.1	13.0
5200	8.2	13.0	5300	8.5	13.0	5580	7.6	13.0
5240	7.7	13.0	5320	8.1	13.0	5700	8.3	13.0

**n 20MHz: Device meets the requirement for the peak excursion**

Peak Excursion(dB)			Peak Excursion(dB)			Peak Excursion(dB)		
Freq (MHz)	Value	Limit	Freq (MHz)	Value	Limit	Freq (MHz)	Value	Limit
5180	7.8	13.0	5260	8.6	13.0	5500	7.9	13.0
5200	9.9	13.0	5300	8.1	13.0	5580	7.8	13.0
5240	9.3	13.0	5320	7.9	13.0	5700	8.3	13.0

**n 40MHz: Device meets the requirement for the peak excursion**

Peak Excursion(dB)			Peak Excursion(dB)			Peak Excursion(dB)		
Freq (MHz)	Value	Limit	Freq (MHz)	Value	Limit	Freq (MHz)	Value	Limit
5190	9.1	13.0	5270	8.1	13.0	5510	8.7	13.0
5230	9.0	13.0	5310	8.3	13.0	5550	8.5	13.0
						5670	8.8	13.0



Client: Intel Corporation	Job Number: J80398
Model: Intel® Centrino® Advanced-N 6230	T-Log Number: T80759
	Account Manager: Christine Krebill
Contact: Steve Hackett	
Standard: FCC 15.247	Class: N/A

### Plots Showing Peak Excursion

Trace A: RBW = 1MHz, VBW = 3MHz, Peak hold

Trace B: Same settings as used for power/PSD measurements (RBW = 1 MHz, VBW = 3MHz, Integrated average power)

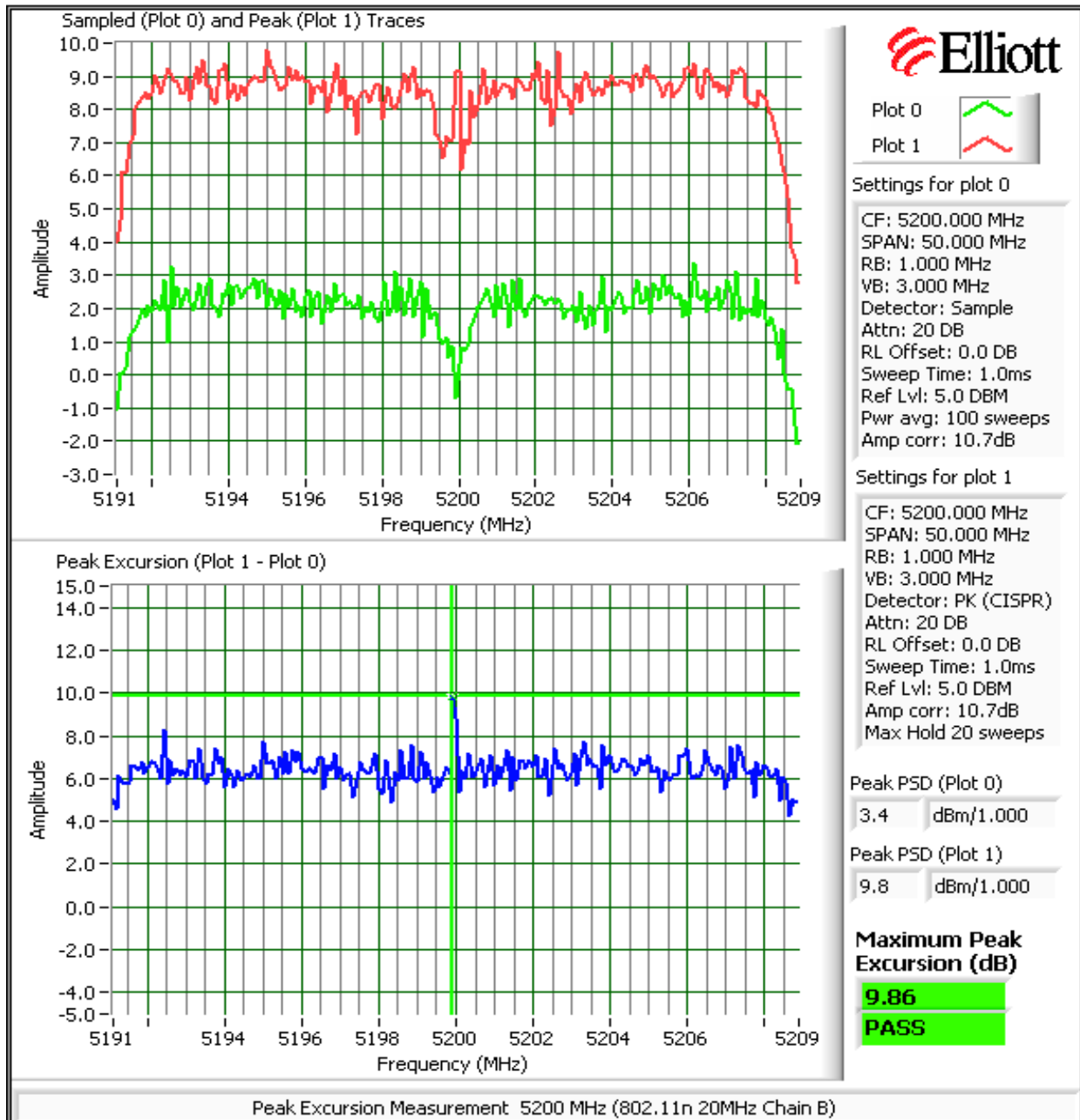

Client:	Intel Corporation	Job Number:	J80398
Model:	Intel® Centrino® Advanced-N 6230	T-Log Number:	T80759
Contact:	Steve Hackett	Account Manager:	Christine Krebill
Standard:	FCC 15.247	Class:	N/A

**Run #3: Out Of Band Spurious Emissions - Antenna Conducted**  
**802.11a**

Maximum Antenna Gain: 4.8 dBi (worst case for all 3 bands)  
 Spurious Limit: -27.0 dBm/MHz eirp  
 Limit Used On Plots <sup>Note 1</sup>: **-31.8 dBm/MHz** Average Limit (RB=1MHz, VB=10Hz)  
**-11.8 dBm/MHz** Peak Limit (RB=VB=1MHz)

**Plots Showing Out-Of-Band - 802.11a Mode Emissions (RBW=VBW=1MHz)**

**Low channel, 5150 - 5250 MHz Band - 802.11a Mode**

Compliance with the radiated limits for the restricted band immediately below 5150MHz is demonstrated through the radiated emissions tests.

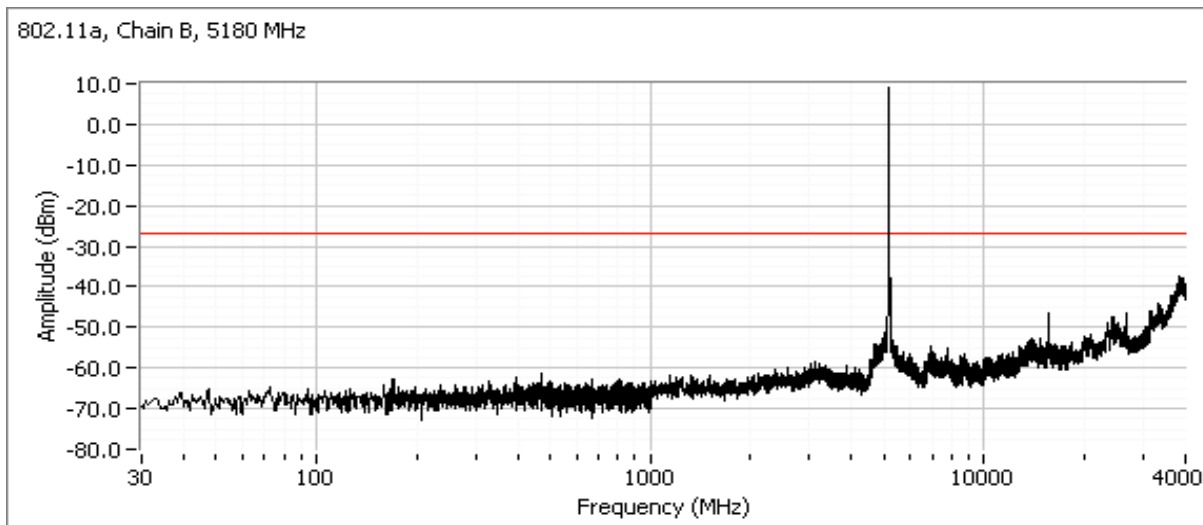

Client: Intel Corporation	Job Number: J80398
Model: Intel® Centrino® Advanced-N 6230	T-Log Number: T80759
	Account Manager: Christine Krebill
Contact: Steve Hackett	
Standard: FCC 15.247	Class: N/A

**Center channel, 5150 - 5250 MHz Band - 802.11a Mode**

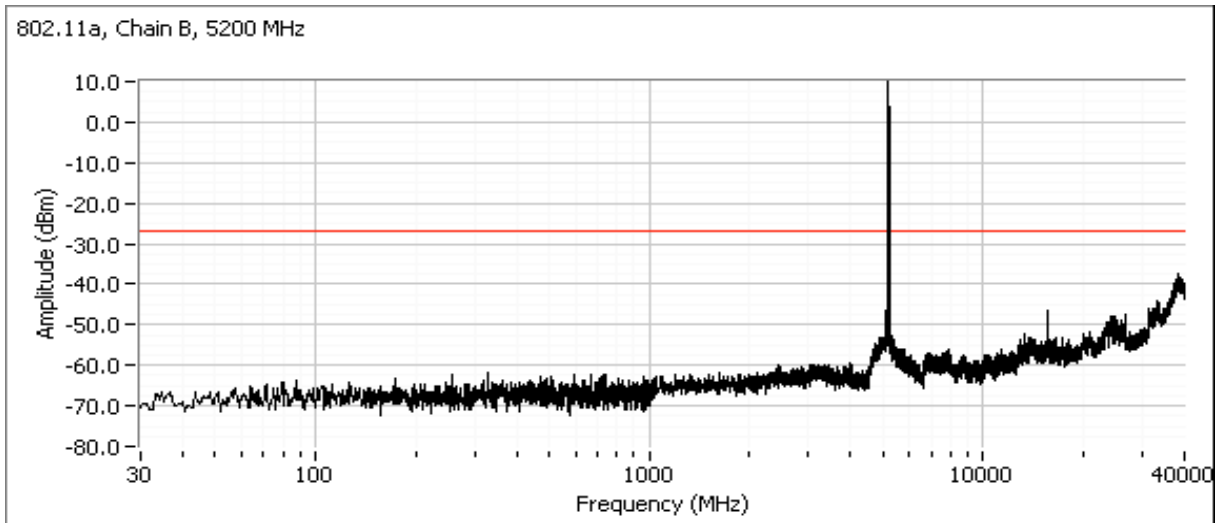

**High channel, 5150 - 5250 MHz Band - 802.11a Mode**

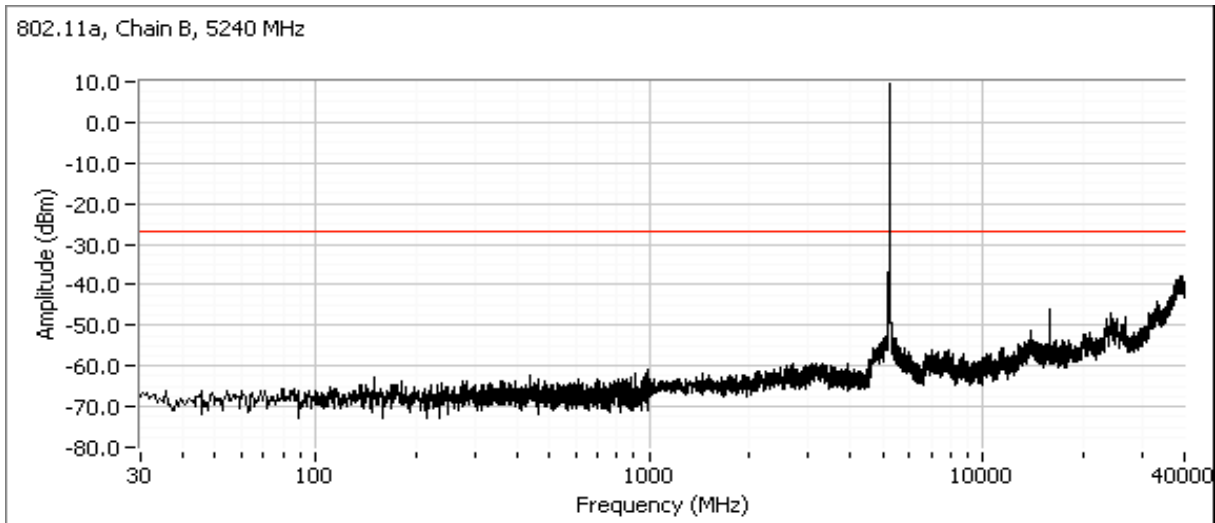

Client: Intel Corporation	Job Number: J80398
Model: Intel® Centrino® Advanced-N 6230	T-Log Number: T80759
	Account Manager: Christine Krebill
Contact: Steve Hackett	
Standard: FCC 15.247	Class: N/A

**Low channel, 5250 - 5350 MHz Band - 802.11a Mode**

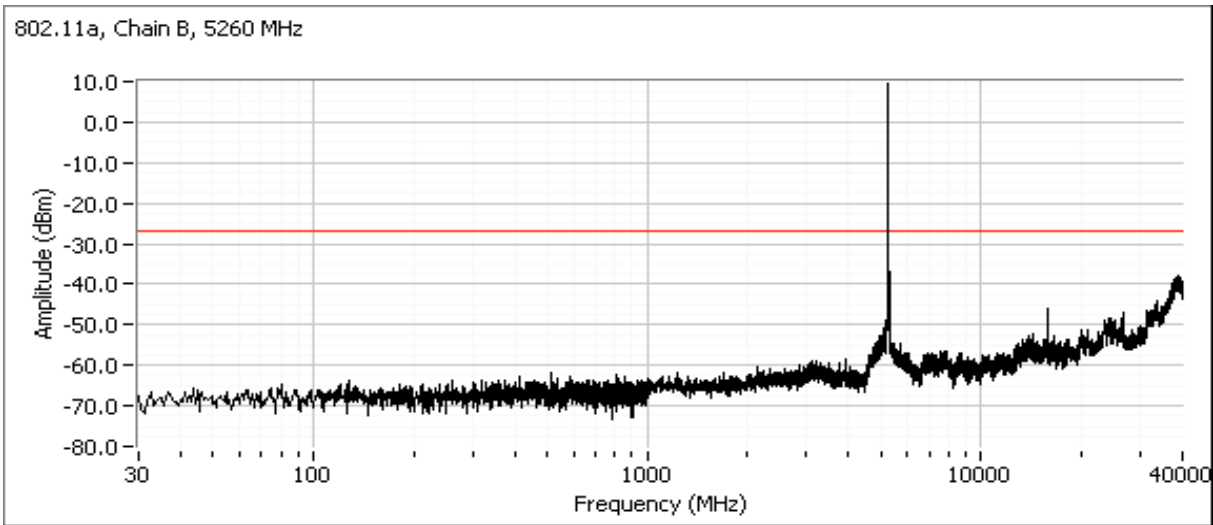

**Center channel, 5250 - 5350 MHz Band - 802.11a Mode**

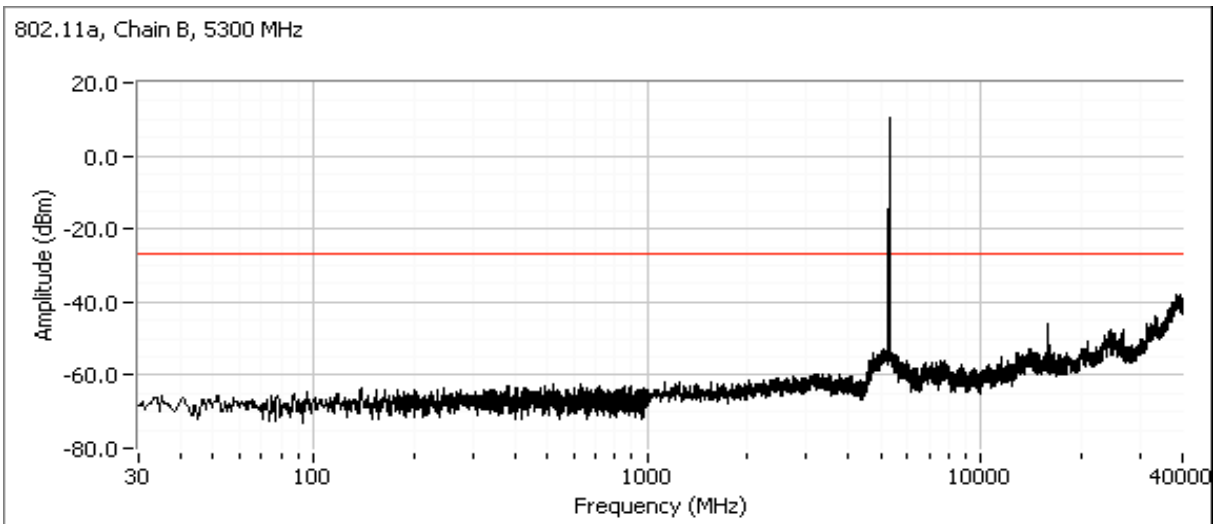

Client: Intel Corporation	Job Number: J80398
Model: Intel® Centrino® Advanced-N 6230	T-Log Number: T80759
	Account Manager: Christine Krebill
Contact: Steve Hackett	
Standard: FCC 15.247	Class: N/A

**High channel, 5250 - 5350 MHz Band - 802.11a Mode**

Compliance with the radiated limits for the restricted band immediately above 5350MHz is demonstrated through the radiated emissions tests.

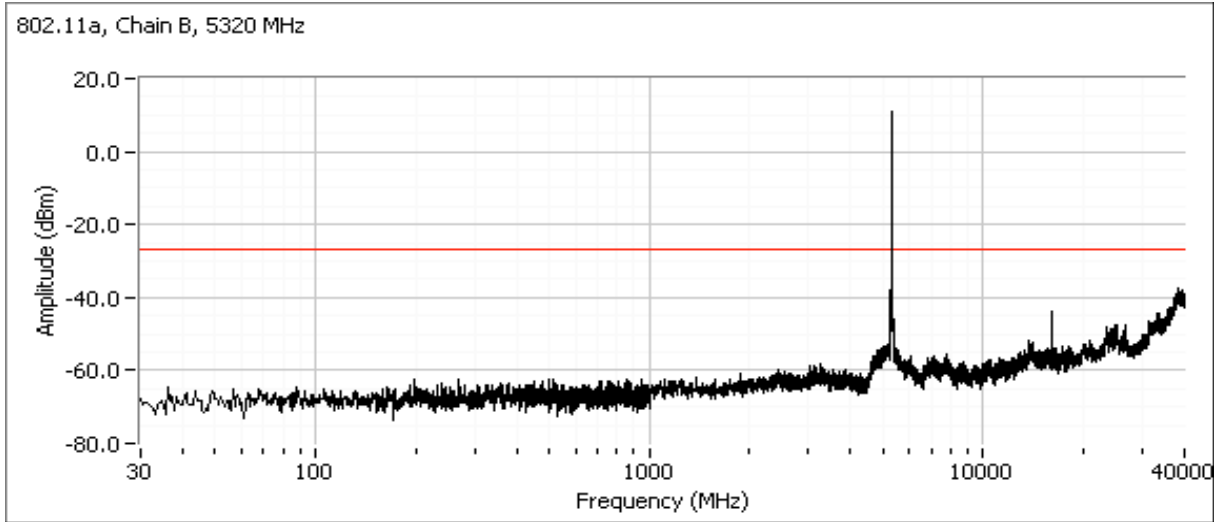

**Low channel, 5470 - 5725 MHz Band - 802.11a Mode**

Compliance with the radiated limits for the restricted band below 5460 MHz is demonstrated through the radiated emissions tests.

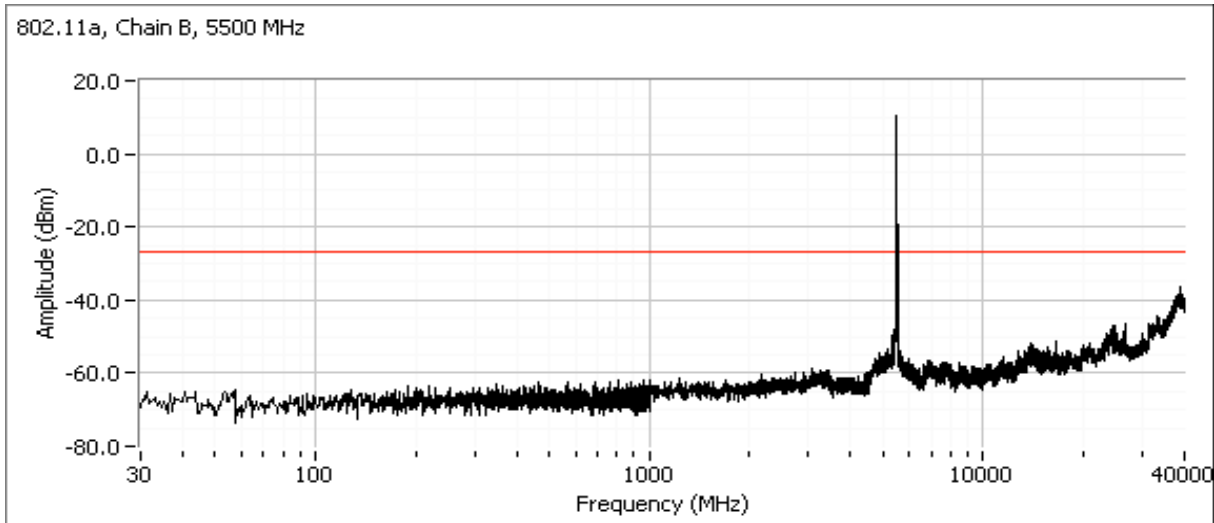

Client: Intel Corporation	Job Number: J80398
Model: Intel® Centrino® Advanced-N 6230	T-Log Number: T80759
	Account Manager: Christine Krebill
Contact: Steve Hackett	
Standard: FCC 15.247	Class: N/A

**Center channel, 5470 - 5725 MHz Band - 802.11a Mode (20MHz channel use 5580 MHz, 40MHz channel use 5550 MHz)**

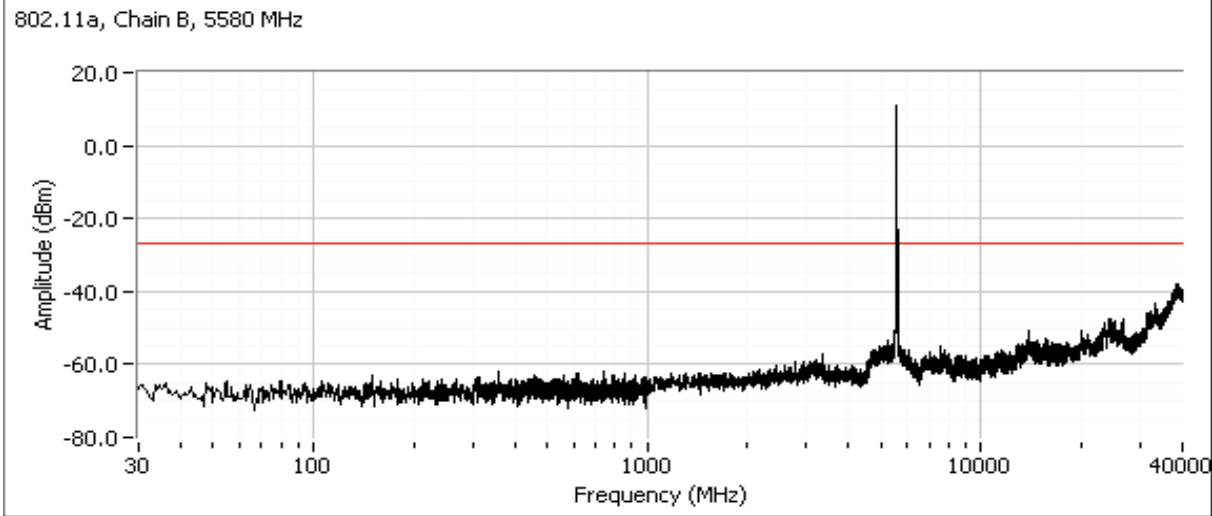

**High channel, 5470 - 5725 MHz Band - 802.11a Mode**

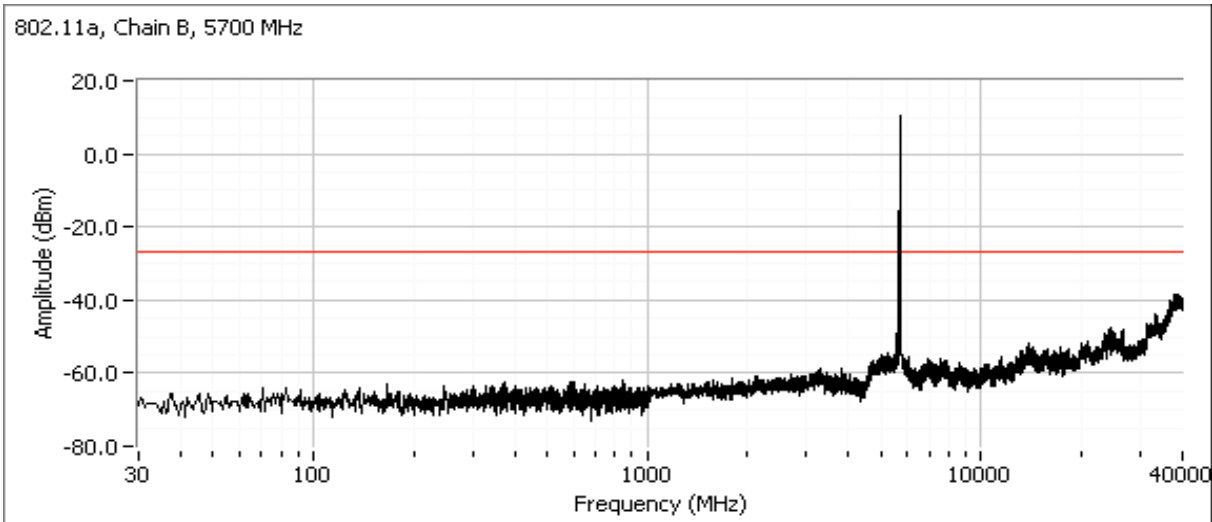

Client:	Intel Corporation	Job Number:	J80398
Model:	Intel® Centrino® Advanced-N 6230	T-Log Number:	T80759
Contact:	Steve Hackett	Account Manager:	Christine Krebill
Standard:	FCC 15.247	Class:	N/A

### 802.11n Modes - n 20MHz

Number of transmit chains:	2
Maximum Antenna Gain:	4.8 dBi (worst case for all 3 bands)
Spurious Limit:	-27.0 dBm/MHz eirp
Limit Used On Plots <sup>Note 1</sup> :	-34.8 dBm/MHz Average Limit (RB=1MHz, VB=10Hz)
	-14.8 dBm/MHz Peak Limit (RB=VB=1MHz)

Note 1: The -27dBm/MHz limit is an eirp limit. The limit for antenna port conducted measurements is adjusted to take into consideration the maximum antenna gain (limit = -27dBm - antenna gain). Radiated field strength measurements for signals more than 50MHz from the bands and that are close to the limit are made to determine compliance as the antenna gain is not known at these frequencies.

Note 2: All spurious signals below 1GHz are measured during the radiated emissions test.

### Plots Showing Out-Of-Band - 802.11n - 20MHz Mode Emissions (RBW=VBW=1MHz)

#### Low channel, 5150 - 5250 MHz Band - 802.11n - 20MHz Mode

Compliance with the radiated limits for the restricted band immediately below 5150MHz is demonstrated through the radiated emissions tests.

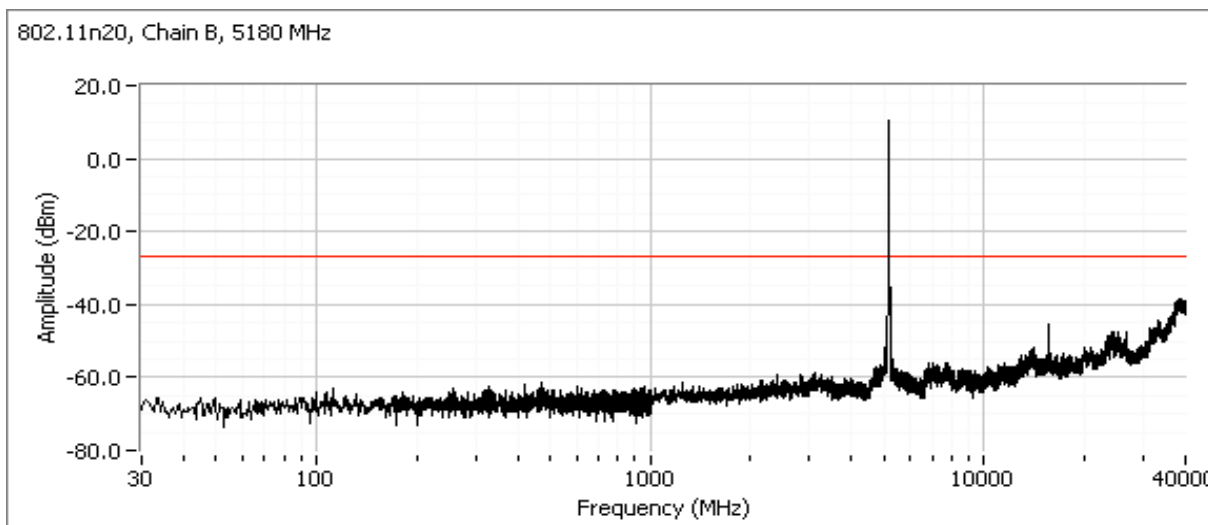

Client: Intel Corporation	Job Number: J80398
Model: Intel® Centrino® Advanced-N 6230	T-Log Number: T80759
	Account Manager: Christine Krebill
Contact: Steve Hackett	
Standard: FCC 15.247	Class: N/A

**Center channel, 5150 - 5250 MHz Band - 802.11n - 20MHz Mode**

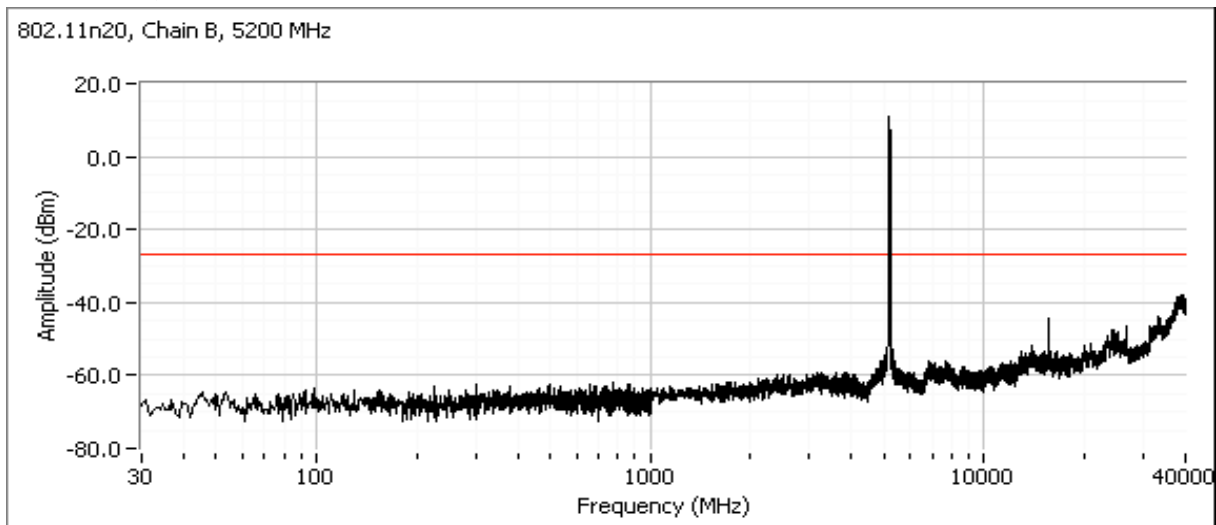

**High channel, 5150 - 5250 MHz Band - 802.11n - 20MHz Mode**

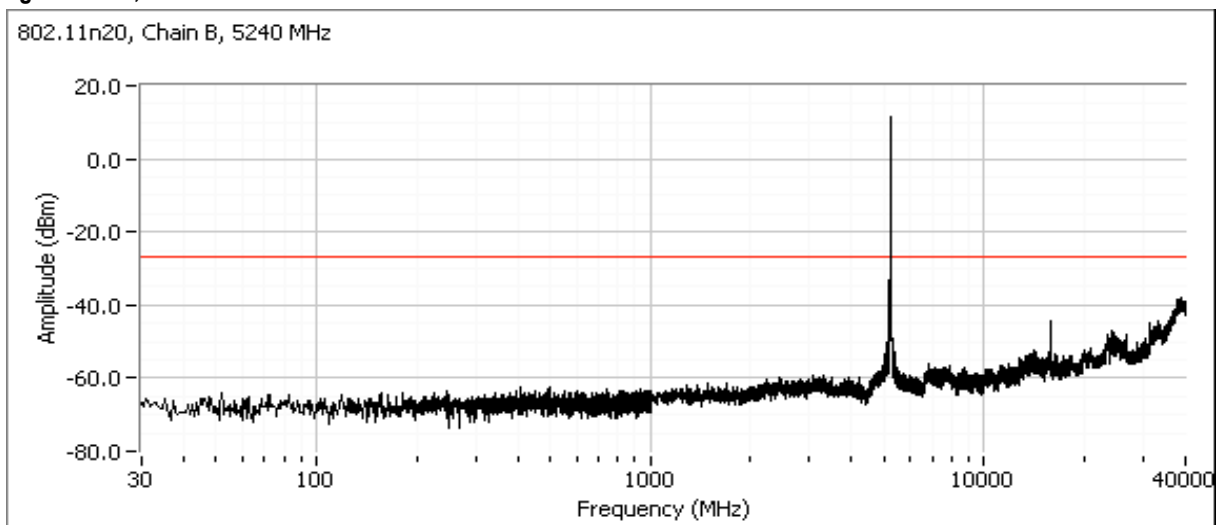



Client: Intel Corporation	Job Number: J80398
Model: Intel® Centrino® Advanced-N 6230	T-Log Number: T80759
	Account Manager: Christine Krebill
Contact: Steve Hackett	
Standard: FCC 15.247	Class: N/A

**Low channel, 5250 - 5350 MHz Band - 802.11n - 20MHz Mode**

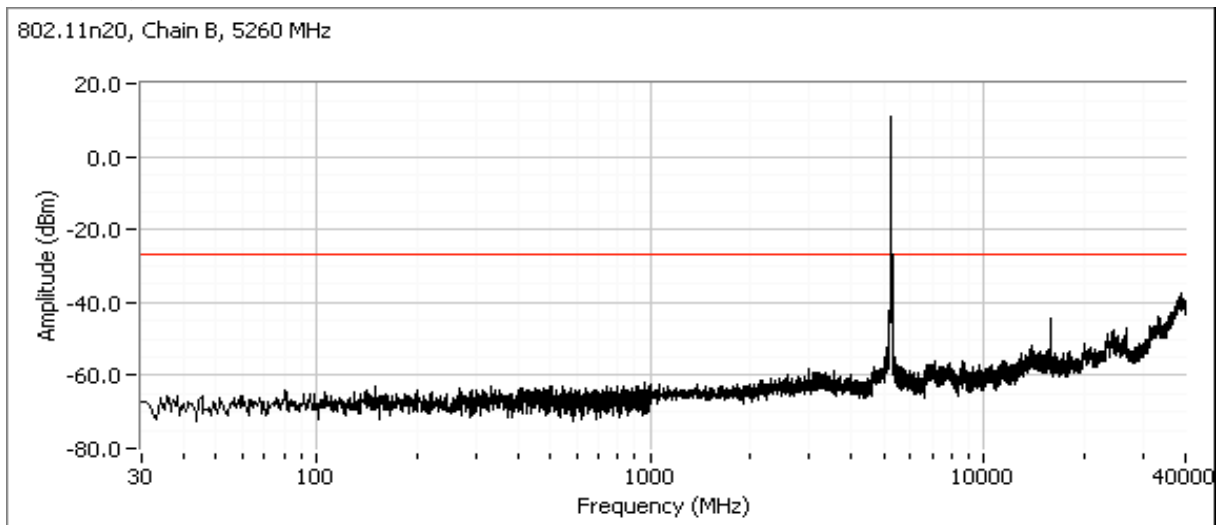

**Center channel, 5250 - 5350 MHz Band - 802.11n - 20MHz Mode**

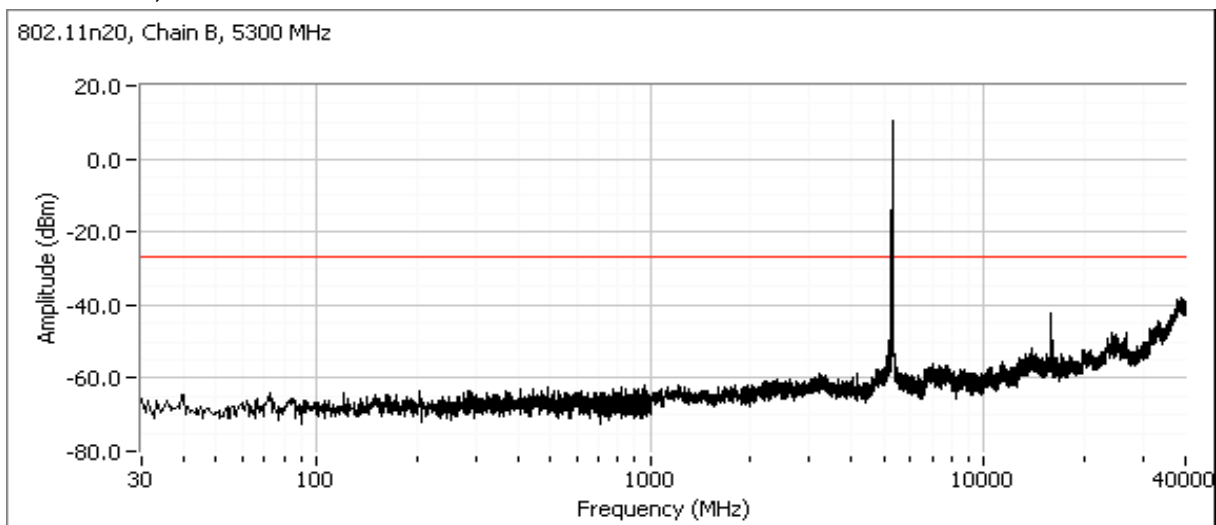

Client: Intel Corporation	Job Number: J80398
Model: Intel® Centrino® Advanced-N 6230	T-Log Number: T80759
	Account Manager: Christine Krebill
Contact: Steve Hackett	
Standard: FCC 15.247	Class: N/A

**High channel, 5250 - 5350 MHz Band - 802.11n - 20MHz Mode**

Compliance with the radiated limits for the restricted band immediately above 5350MHz is demonstrated through the radiated emissions tests.

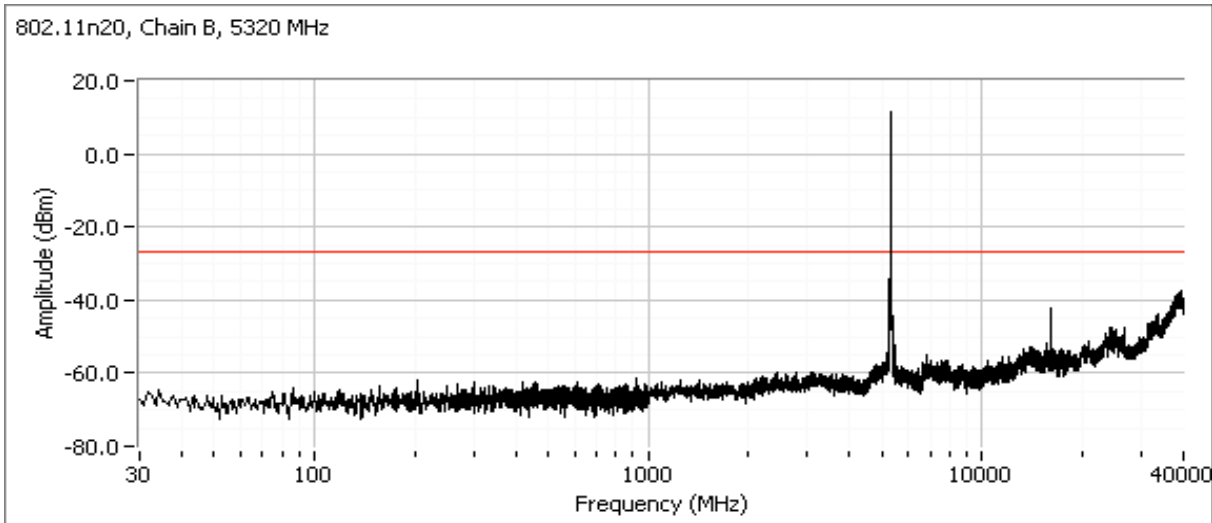

Client: Intel Corporation	Job Number: J80398
Model: Intel® Centrino® Advanced-N 6230	T-Log Number: T80759
	Account Manager: Christine Krebill
Contact: Steve Hackett	
Standard: FCC 15.247	Class: N/A

**Low channel, 5470 - 5725 MHz Band - 802.11n - 20MHz Mode**

Compliance with the radiated limits for the restricted band below 5460 MHz is demonstrated through the radiated emissions tests.

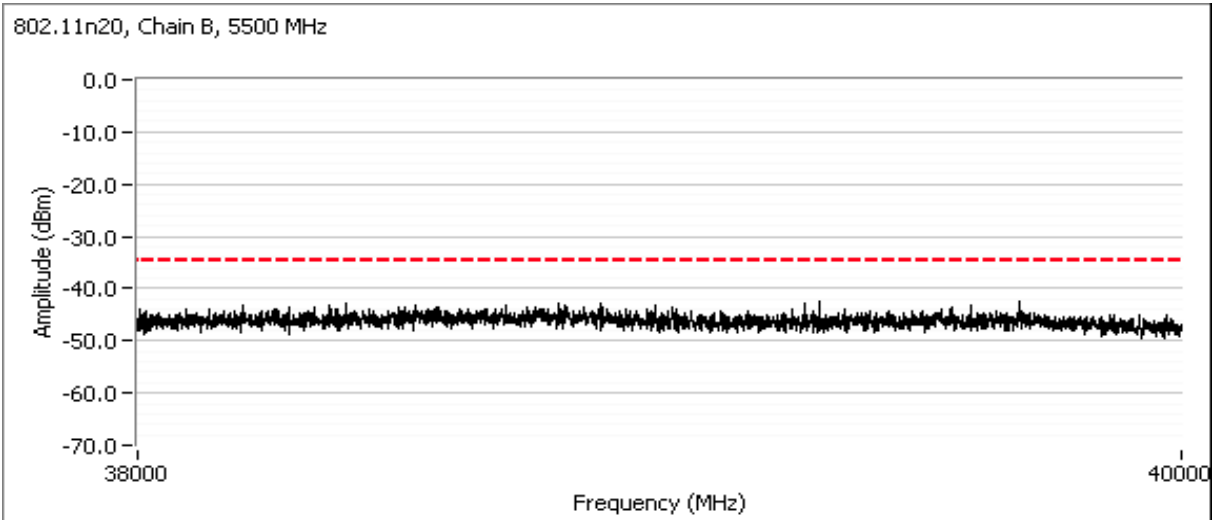
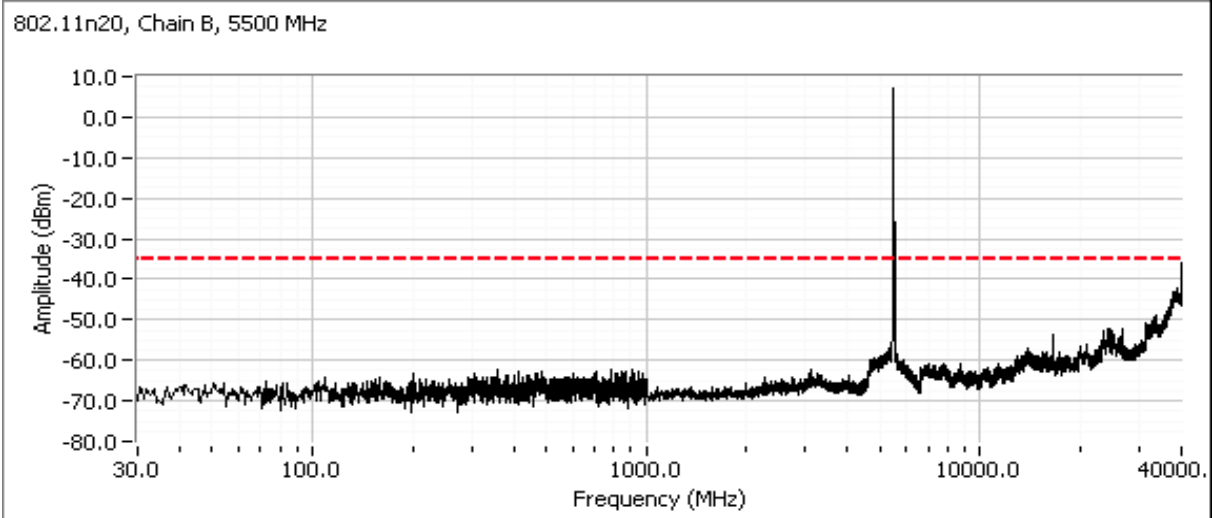

Client: Intel Corporation	Job Number: J80398
Model: Intel® Centrino® Advanced-N 6230	T-Log Number: T80759
	Account Manager: Christine Krebill
Contact: Steve Hackett	
Standard: FCC 15.247	Class: N/A

**Center channel, 5470 - 5725 MHz Band - 802.11n - 20MHz Mode**

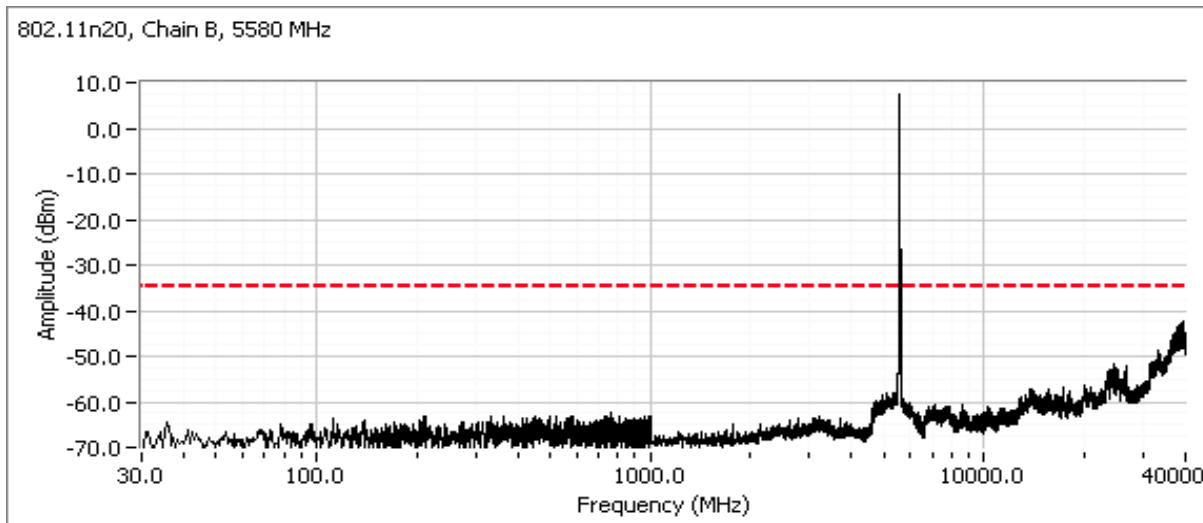

**High channel, 5470 - 5725 MHz Band - 802.11n - 20MHz Mode**

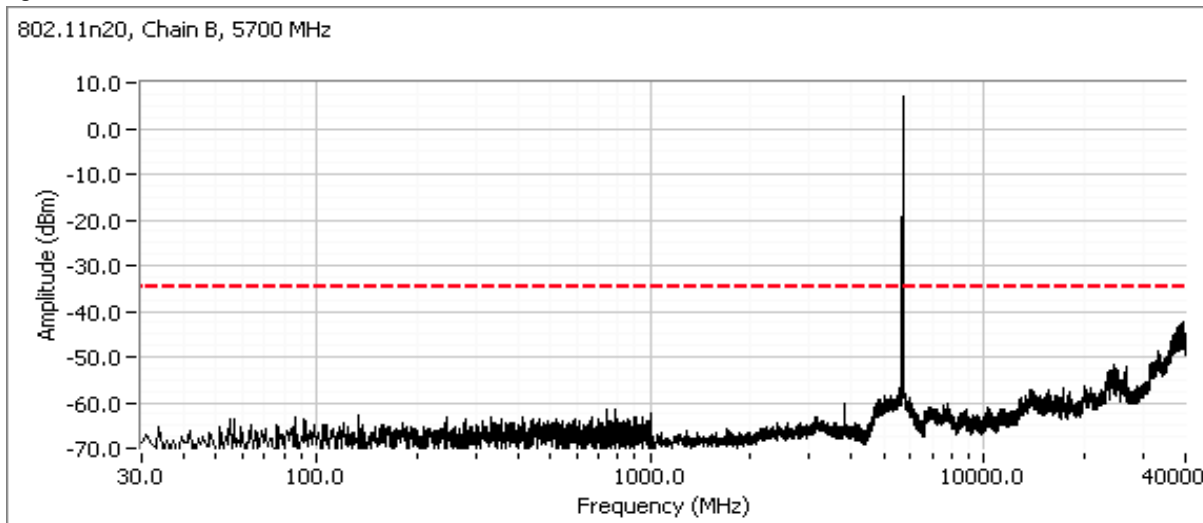

Client: Intel Corporation	Job Number: J80398
Model: Intel® Centrino® Advanced-N 6230	T-Log Number: T80759
	Account Manager: Christine Krebill
Contact: Steve Hackett	
Standard: FCC 15.247	Class: N/A

**Plots Showing Out-Of-Band - 802.11n - 40MHz Mode Emissions (RBW=VBW=1MHz)**

**Low channel, 5150 - 5250 MHz Band - 802.11n - 40MHz Mode**

Compliance with the radiated limits for the restricted band immediately below 5150MHz is demonstrated through the radiated emissions tests.

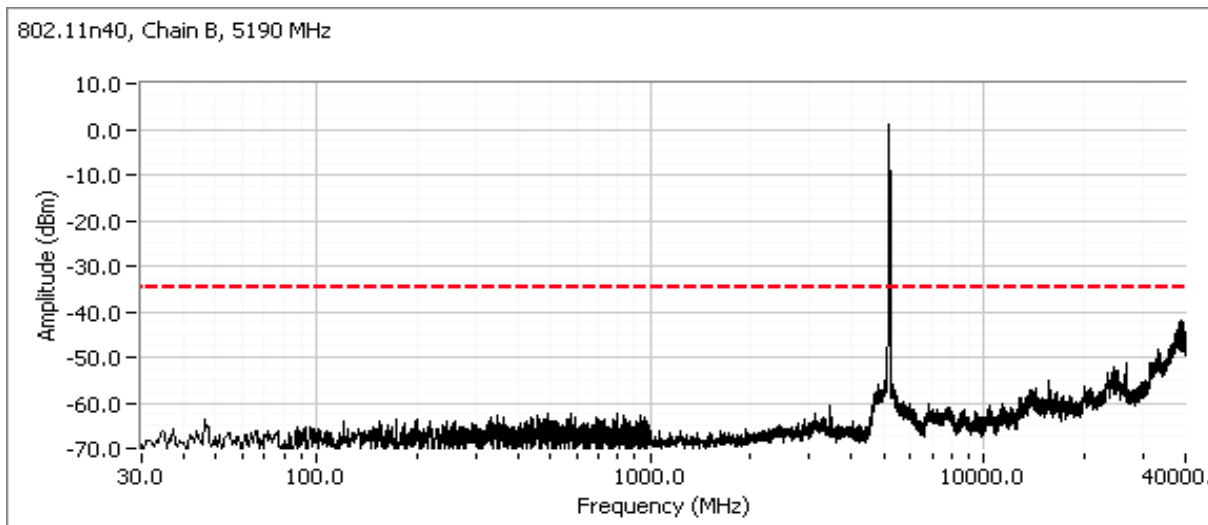

**High channel, 5150 - 5250 MHz Band - 802.11n - 40MHz Mode**

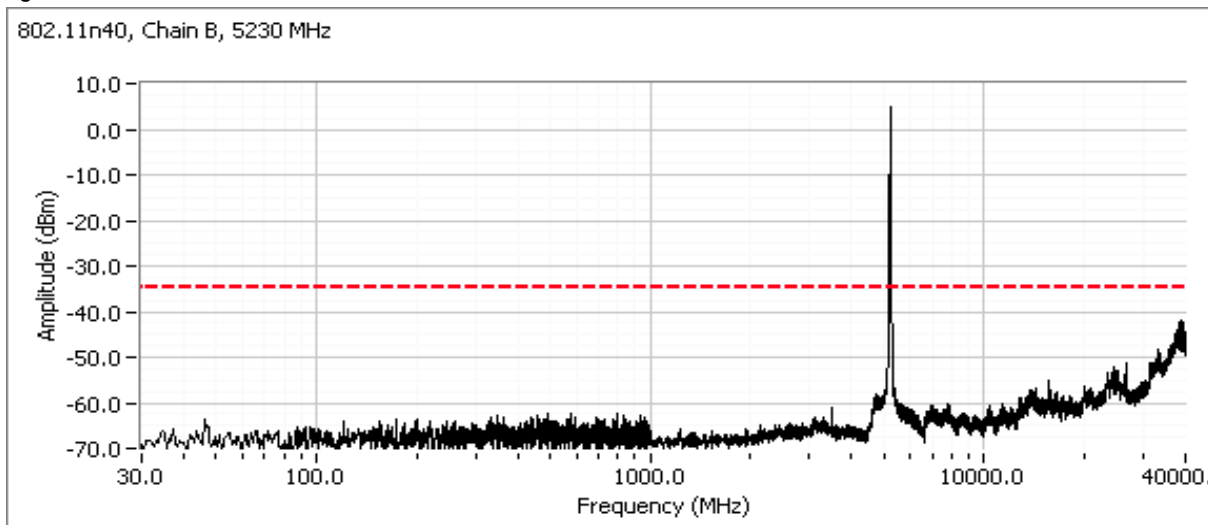

Client: Intel Corporation	Job Number: J80398
Model: Intel® Centrino® Advanced-N 6230	T-Log Number: T80759
	Account Manager: Christine Krebill
Contact: Steve Hackett	
Standard: FCC 15.247	Class: N/A

**Low channel, 5250 - 5350 MHz Band - 802.11n - 40MHz Mode**

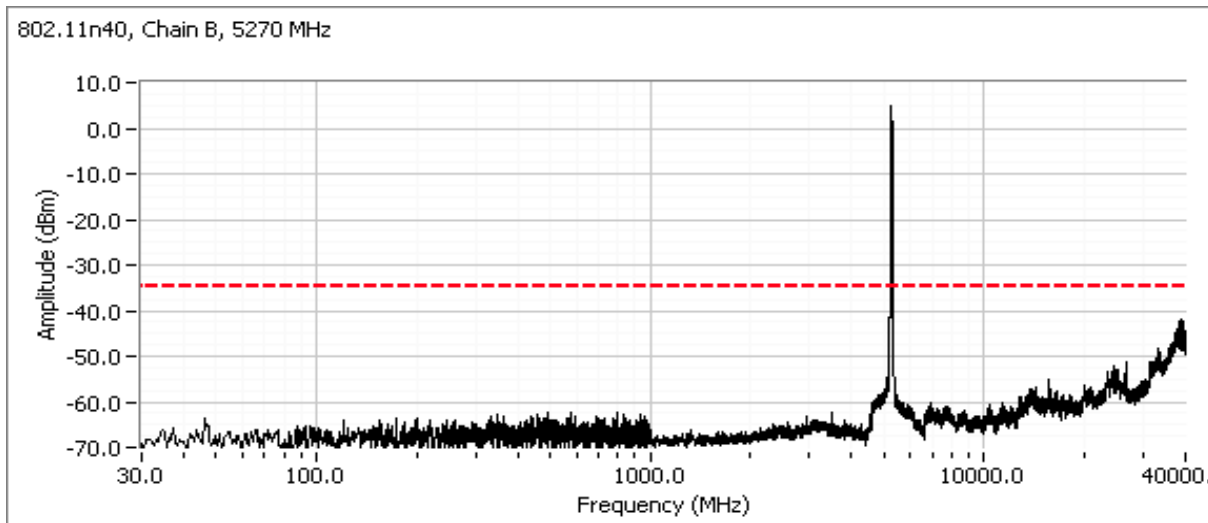

**High channel, 5250 - 5350 MHz Band - 802.11n - 40MHz Mode**

Compliance with the radiated limits for the restricted band immediately above 5350MHz is demonstrated through the radiated emissions tests.

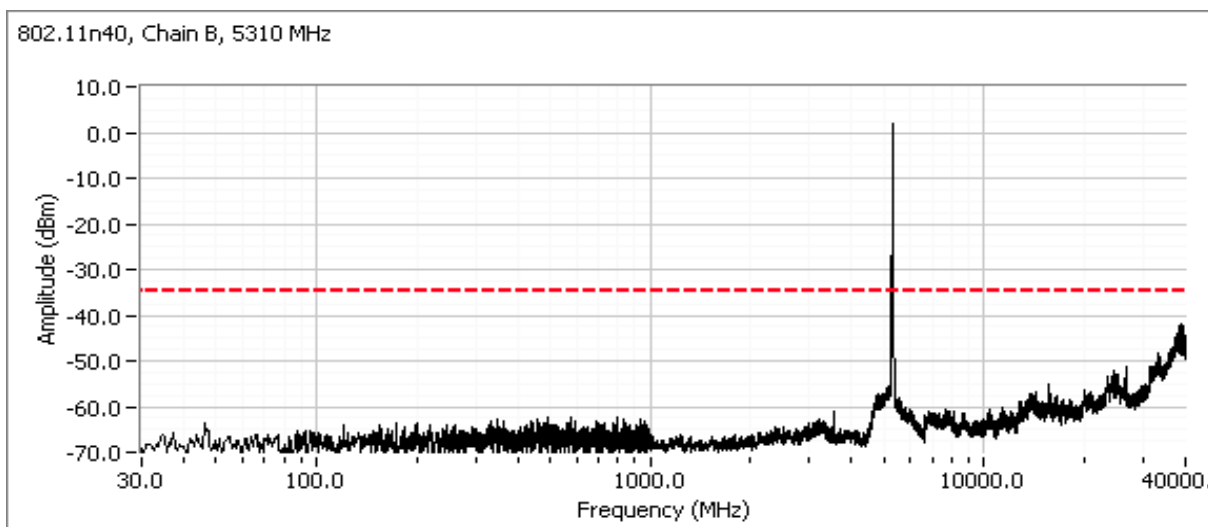

Client: Intel Corporation	Job Number: J80398
Model: Intel® Centrino® Advanced-N 6230	T-Log Number: T80759
	Account Manager: Christine Krebill
Contact: Steve Hackett	
Standard: FCC 15.247	Class: N/A

**Low channel, 5470 - 5725 MHz Band - 802.11n - 40MHz Mode**

Compliance with the radiated limits for the restricted band below 5460 MHz is demonstrated through the radiated emissions tests.

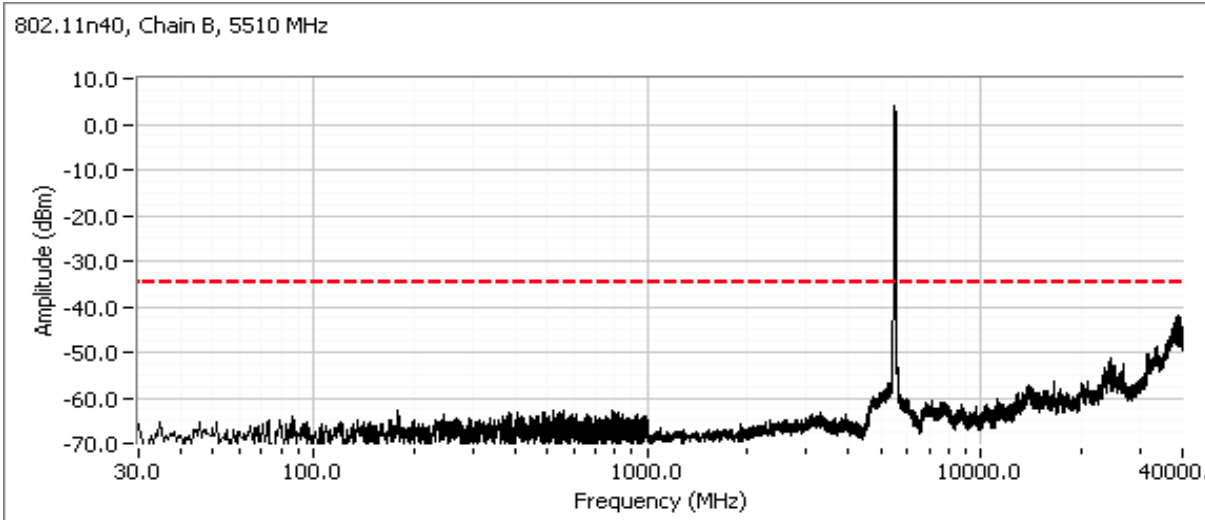

**Center channel, 5470-5725MHz Band, 802.11n 40MHz Mode**

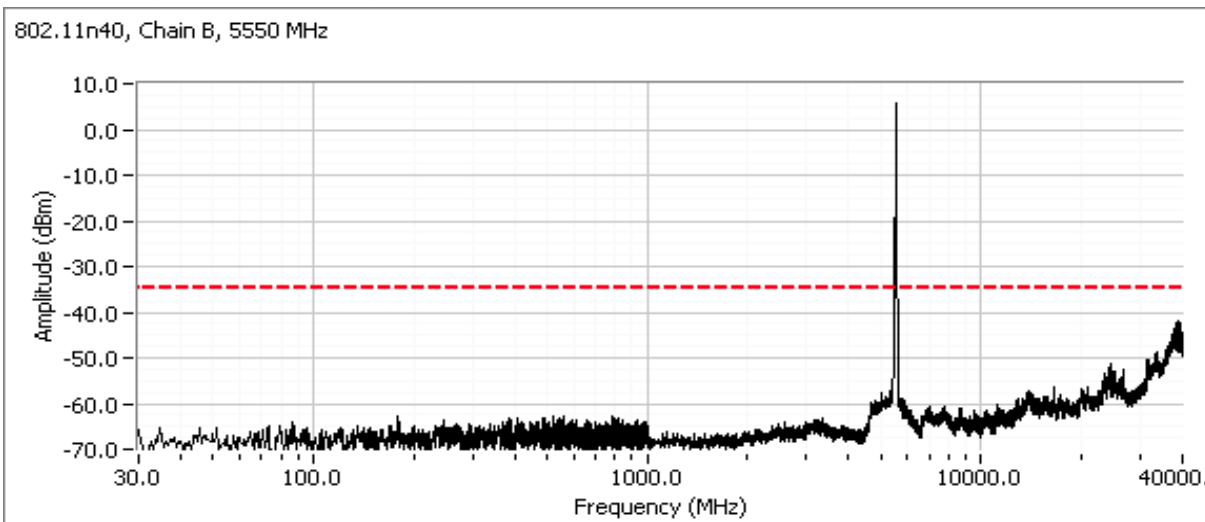

Client: Intel Corporation	Job Number: J80398
Model: Intel® Centrino® Advanced-N 6230	T-Log Number: T80759
	Account Manager: Christine Krebill
Contact: Steve Hackett	
Standard: FCC 15.247	Class: N/A

**High channel, 5470 - 5725 MHz Band - 802.11n - 40MHz Mode**

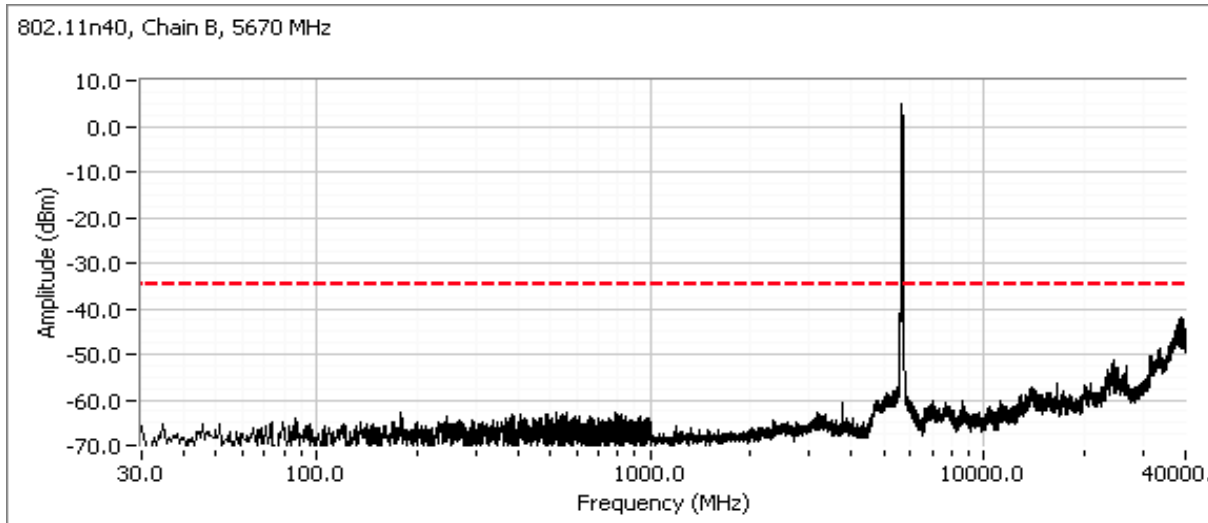



Client:	Intel Corporation	Job Number:	J80398
Model:	Intel® Centrino® Advanced-N 6230	T-Log Number:	T80759
		Account Manager:	Christine Krebill
Contact:	Steve Hackett		
Standard:	FCC 15.247	Class:	N/A

**RSS-210 (LELAN) and FCC 15.407(UNII)  
Antenna Port Measurements - MIMO Mode (Chain A+B)  
Power, PSD, Peak Excursion, Bandwidth and Spurious Emissions**

**Test Specific Details**

Objective: The objective of this test session is to perform final qualification testing of the EUT with respect to the specification listed above.

Date of Test: 10/5/2010  
Test Engineer: Rafael Varelas  
Test Location: FT Lab #4

Config. Used: 1  
Config Change: none  
Host Unit Voltage 120V/60Hz

**Summary of Results**

Run #	Test Performed	Limit	Pass / Fail	Result / Margin
1	Power, 5150 - 5250MHz	15.407(a) (1), (2)	Pass	802.11n 20MHz: 42.8 mW 802.11n n40MHz: 43.3 mW
1	PSD, 5150 - 5250MHz	15.407(a) (1), (2)	Pass	802.11n 20MHz: 3.6 dBm/MHz 802.11n n40MHz: 1.5 dBm/MHz
1	Power, 5250 - 5350MHz	15.407(a) (1), (2)	Pass	802.11n 20MHz: 39.9 mW 802.11n n40MHz: 36 mW
1	PSD, 5250 - 5350MHz	15.407(a) (1), (2)	Pass	802.11n 20MHz: 3.4 dBm/MHz 802.11n n40MHz: 0.4 dBm/MHz
1	Power, 5470 - 5725MHz	15.407(a) (1), (2)	Pass	802.11n 20MHz: 39.5 mW 802.11n n40MHz: 41.8 mW
1	PSD, 5470 - 5725MHz	15.407(a) (1), (2)	Pass	802.11n 20MHz: 3.6 dBm/MHz 802.11n n40MHz: 1.2 dBm/MHz
1	26dB Bandwidth	15.407 (Information only)	-	> 20MHz for all modes (refer to single chain data)
1	99% Bandwidth	RSS 210 (Information only)	N/A	Refer to single chain data
2	Peak Excursion Envelope	15.407(a) (6) 13dB		Refer to single chain data
3	Antenna Conducted - Out of Band Spurious	15.407(b) -27dBm/MHz		Refer to single chain data

**General Test Configuration**

When measuring the conducted emissions from the EUT's antenna port, the antenna port of the EUT was connected to the spectrum analyzer or power meter via a suitable attenuator to prevent overloading the measurement system. All measurements are corrected to allow for the external attenuators and cables used.

Client:	Intel Corporation	Job Number:	J80398
Model:	Intel® Centrino® Advanced-N 6230	T-Log Number:	T80759
Contact:	Steve Hackett	Account Manager:	Christine Krebill
Standard:	FCC 15.247	Class:	N/A

**Ambient Conditions:**

Temperature: 22.4 °C  
Rel. Humidity: 38 %

**Modifications Made During Testing**

No modifications were made to the EUT during testing

**Deviations From The Standard**

No deviations were made from the requirements of the standard.

**Run #1: Bandwidth, Output Power and Power Spectral Density - MIMO Systems**

Note 1:	Output power measured using a peak power meter
Note 1:	Output power measured using a spectrum analyzer (see plots below). RBW=1MHz, VB=3 MHz, sample detector, power averaging on (transmitted signal was continuous) and power integration over bandwidth > EBW (method 1 of DA-02-2138A1).
Note 2:	Measured using the same analyzer settings used for output power.
Note 3:	For RSS-210 the limit for the 5150 - 5250 MHz band accounts for the antenna gain as the maximum eirp allowed is 10dBm/MHz. The limits are also corrected for instances where the highest measured value of the PSD exceeds the average PSD (calculated from the measured power divided by the measured 99% bandwidth) by more than 3dB by the amount that the measured value exceeds the average by more than 3dB.
Note 4:	99% Bandwidth measured in accordance with RSS GEN - RB > 1% of span and VB >=3xRB
Note 5:	For MIMO systems the total output power and total PSD are calculated from the sum of the powers of the individual chains (in linear terms). The antenna gain used to determine the EIRP and limits for PSD/Output power depends on the operating mode of the MIMO device. If the signals are non-coherent between the transmit chains then the gain used to determine the limits is the highest gain of the individual chains and the EIRP is the sum of the products of gain and power on each chain. If the signals are coherent then the effective antenna gain is the sum (in linear terms) of the gains for each chain and the EIRP is the product of the effective gain and total power.

Client:	Intel Corporation	Job Number:	J80398
Model:	Intel® Centrino® Advanced-N 6230	T-Log Number:	T80759
Contact:	Steve Hackett	Account Manager:	Christine Krebill
Standard:	FCC 15.247	Class:	N/A

**MIMO Device - 5150-5250 MHz Band**

	Chain 1	Chain 2	Chain 3	Coherent	Effective <sup>5</sup>	EIRP (mW)	EIRP (dBm)
Antenna Gain (dBi):	3.6	3.6		No	3.6	98.0	19.9

**Power**

Frequency (MHz)	Software Setting	26dB BW (MHz)	Measured Output Power <sup>1</sup> dBm			Total		Limit (dBm)	Max Power (W)	Pass or Fail
			Chain 1	Chain 2	Chain 3	mW	dBm			

**20MHz Mode**

5180	26.0/25.5	21.3	13.3	13.3		42.8	16.3	17.0	0.043	PASS
5200	26.0/25.5	21.2	13.2	13.2		41.8	16.2	17.0		PASS
5240	26.0/25.5	21.0	13.0	12.9		39.5	16.0	17.0		PASS

**40MHz Mode**

5190	23.5/23.0	39.0	10.0	10.8		22.0	13.4	17.0	0.043	PASS
5230	27.5/27.0	41.8	13.4	13.3		43.3	16.4	17.0		PASS

**PSD**

Frequency (MHz)	99% <sup>4</sup> BW	Total Power	PSD <sup>2</sup> dBm/MHz			Total PSD		Limit		Pass or Fail
			Chain 1	Chain 2	Chain 3	mW/MHz	dBm/MHz	FCC	RSS 210 <sup>3</sup>	

**20MHz Mode**

5180	18.0	16.3	0.8	0.4		2.3	3.6	4.0	6.4	PASS
5200	18.0	16.2	0.5	0.6		2.3	3.6	4.0	6.4	PASS
5240	18.0	16.0	0.4	0.5		2.2	3.5	4.0	6.4	PASS

**40MHz Mode**

5190	36.3	13.4	-4.9	-4.5		0.7	-1.7	4.0	6.4	PASS
5230	36.3	16.4	-1.6	-1.5		1.4	1.5	4.0	6.4	PASS

Client: Intel Corporation	Job Number: J80398
Model: Intel® Centrino® Advanced-N 6230	T-Log Number: T80759
	Account Manager: Christine Krebill
Contact: Steve Hackett	
Standard: FCC 15.247	Class: N/A

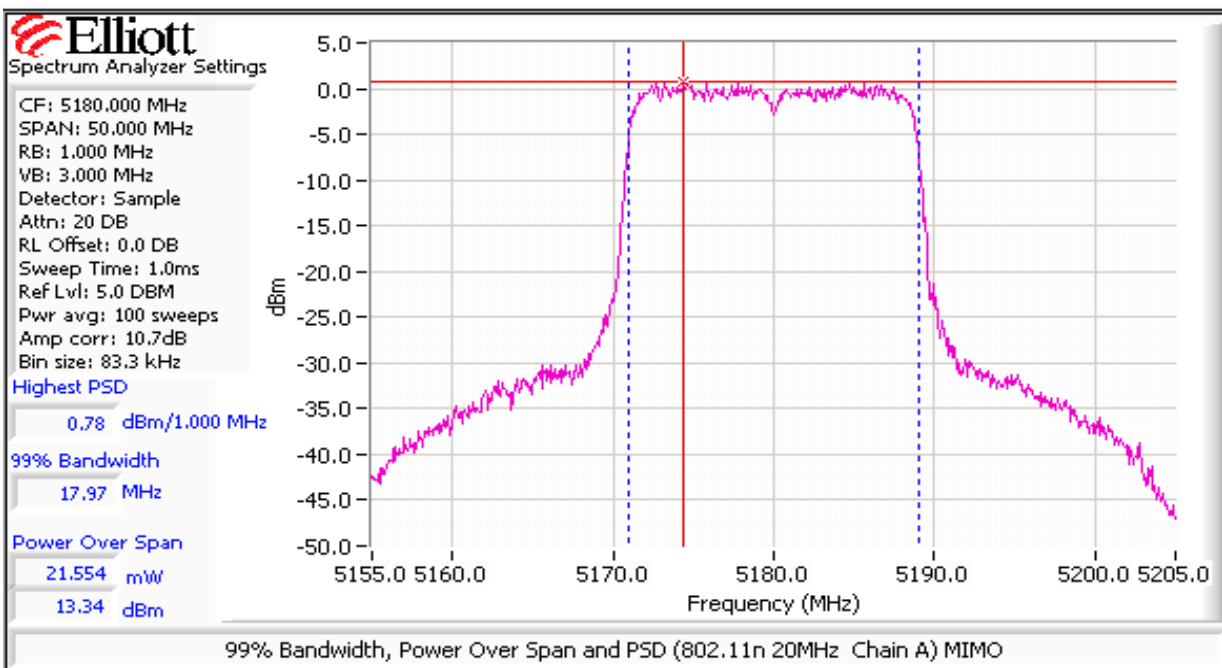
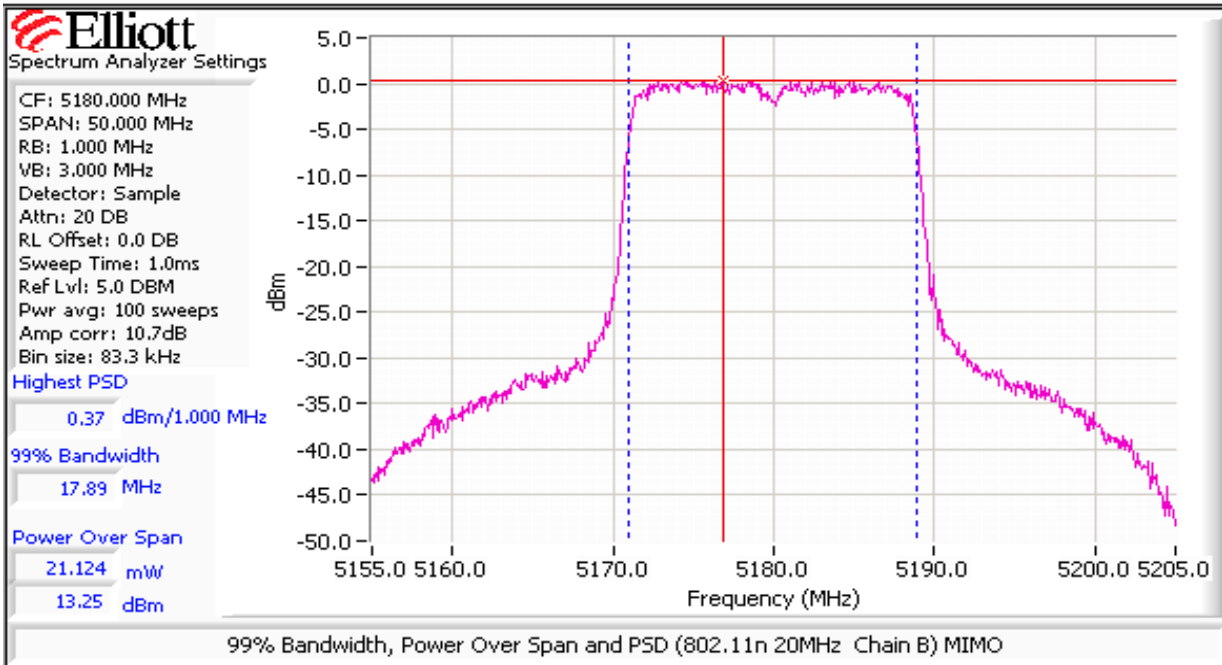

Client: Intel Corporation	Job Number: J80398
Model: Intel® Centrino® Advanced-N 6230	T-Log Number: T80759
	Account Manager: Christine Krebill
Contact: Steve Hackett	
Standard: FCC 15.247	Class: N/A

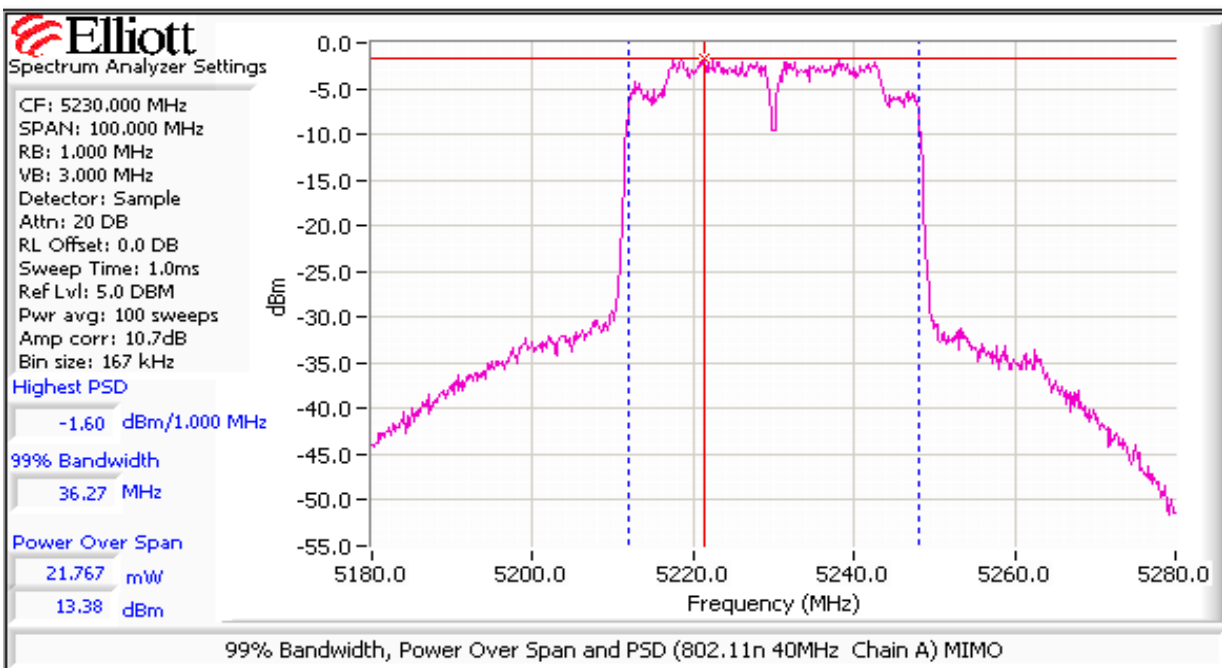
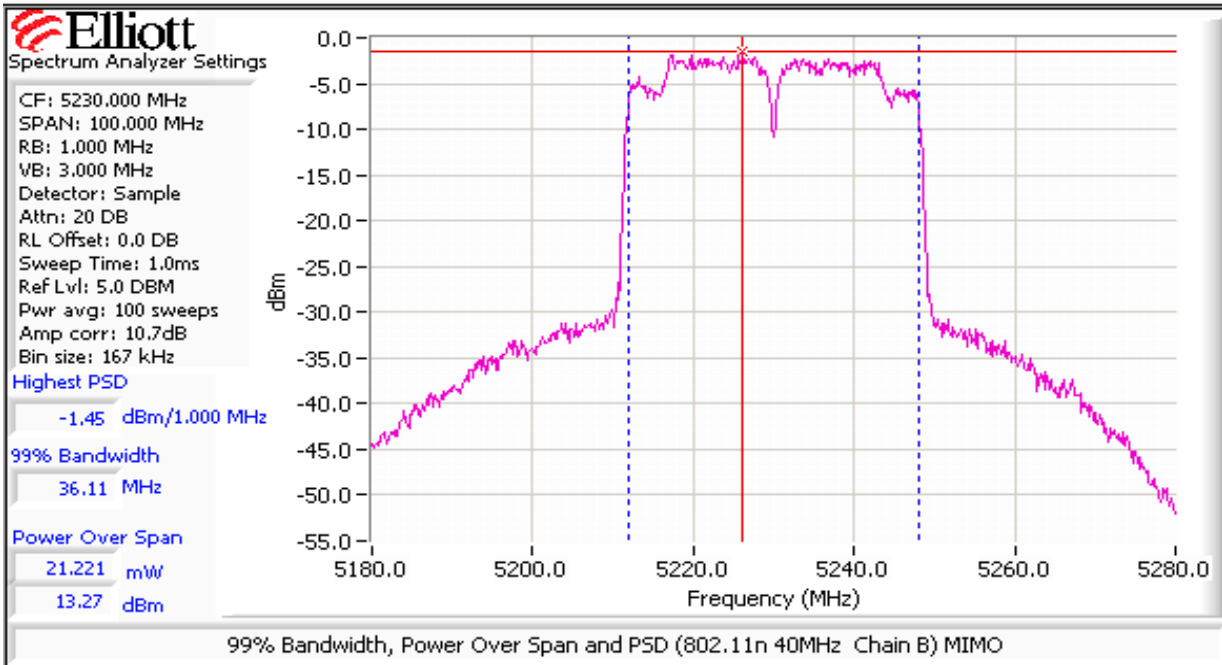

Client:	Intel Corporation	Job Number:	J80398
Model:	Intel® Centrino® Advanced-N 6230	T-Log Number:	T80759
Contact:	Steve Hackett	Account Manager:	Christine Krebill
Standard:	FCC 15.247	Class:	N/A

### MIMO Device - 5250-5350 MHz Band

	Chain 1	Chain 2	Chain 3	Coherent	Effective <sup>5</sup>	EIRP (mW)	EIRP (dBm)
Antenna Gain (dBi):	3.7	3.7		No	3.7	93.6	19.7

### Power

Frequency (MHz)	Software Setting	26dB BW (MHz)	Measured Output Power <sup>1</sup> dBm			Total		Limit (dBm)	Max Power (W)	Pass or Fail
			Chain 1	Chain 2	Chain 3	mW	dBm			

#### 20MHz Mode

5260	26.0/25.5	21.3	12.7	12.5		36.4	15.6	24.0	0.040	PASS
5300	26.5/26.0	21.3	13.2	12.6		39.1	15.9	24.0		PASS
5320	26.5/26.5	21.7	12.9	13.1		39.9	16.0	24.0		PASS

#### 40MHz Mode

5270	27.5/27.0	40.3	12.6	12.5		36.0	15.6	24.0	0.036	PASS
5310	27.0/26.5	39.0	12.4	12.3		34.4	15.4	24.0		PASS

### PSD

Frequency (MHz)	99% <sup>4</sup> BW	Total Power	PSD <sup>2</sup> dBm/MHz			Total PSD		Limit		Pass or Fail
			Chain 1	Chain 2	Chain 3	mW/MHz	dBm/MHz	FCC	RSS 210 <sup>3</sup>	

#### 20MHz Mode

5260	18.0	15.6	0.0	-0.1		2.0	3.0	11.0	11.0	PASS
5300	18.0	15.9	0.4	-0.1		2.1	3.2	11.0	11.0	PASS
5320	18.0	16.0	0.3	0.4		2.2	3.4	11.0	11.0	PASS

#### 40MHz Mode

5270	36.3	15.6	-2.7	-2.5		1.1	0.4	11.0	11.0	PASS
5310	36.1	15.4	-2.6	-3.0		1.1	0.2	11.0	11.0	PASS

Client: Intel Corporation	Job Number: J80398
Model: Intel® Centrino® Advanced-N 6230	T-Log Number: T80759
	Account Manager: Christine Krebill
Contact: Steve Hackett	
Standard: FCC 15.247	Class: N/A

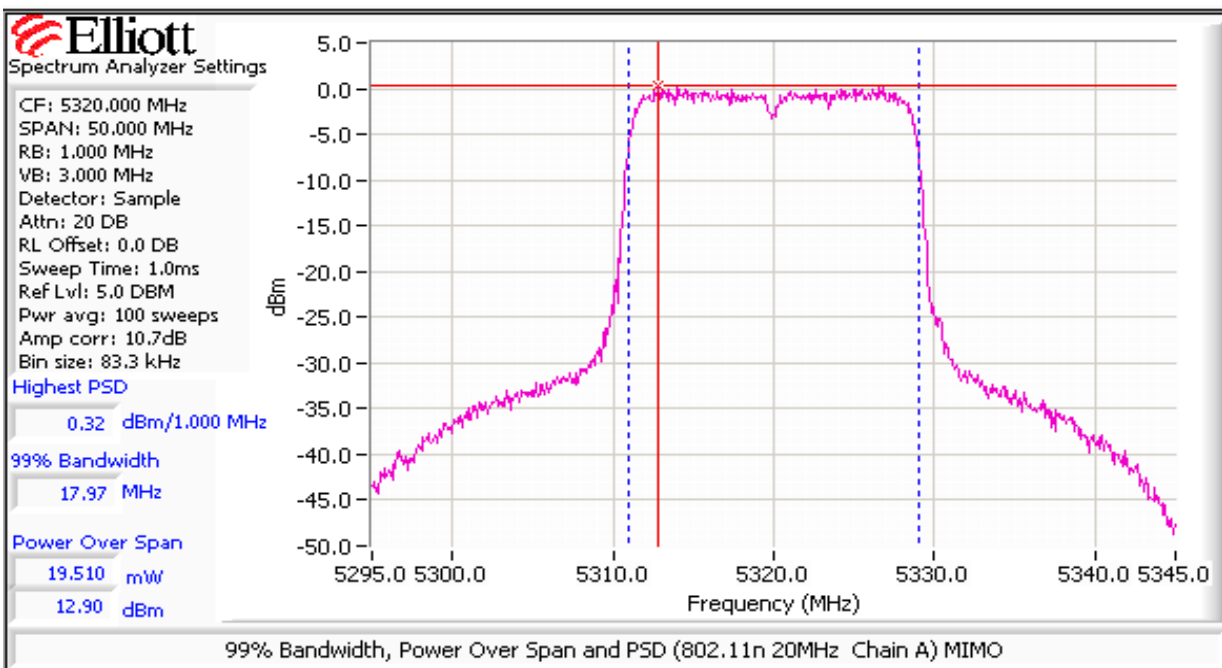
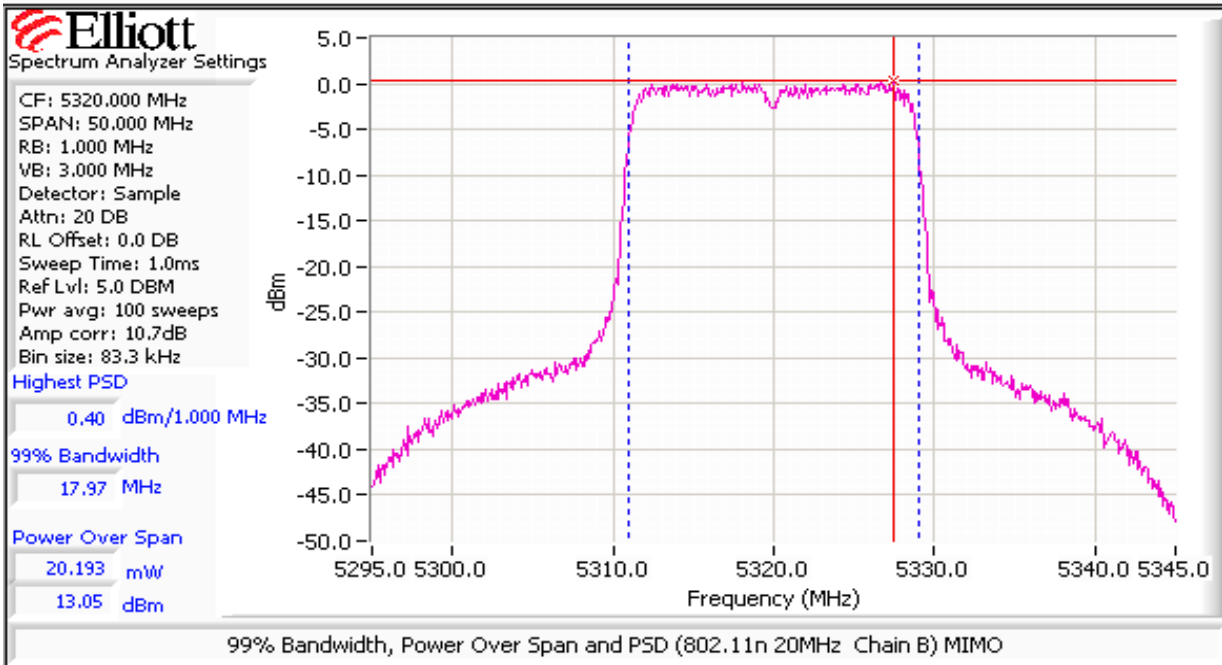

Client: Intel Corporation	Job Number: J80398
Model: Intel® Centrino® Advanced-N 6230	T-Log Number: T80759
	Account Manager: Christine Krebill
Contact: Steve Hackett	
Standard: FCC 15.247	Class: N/A

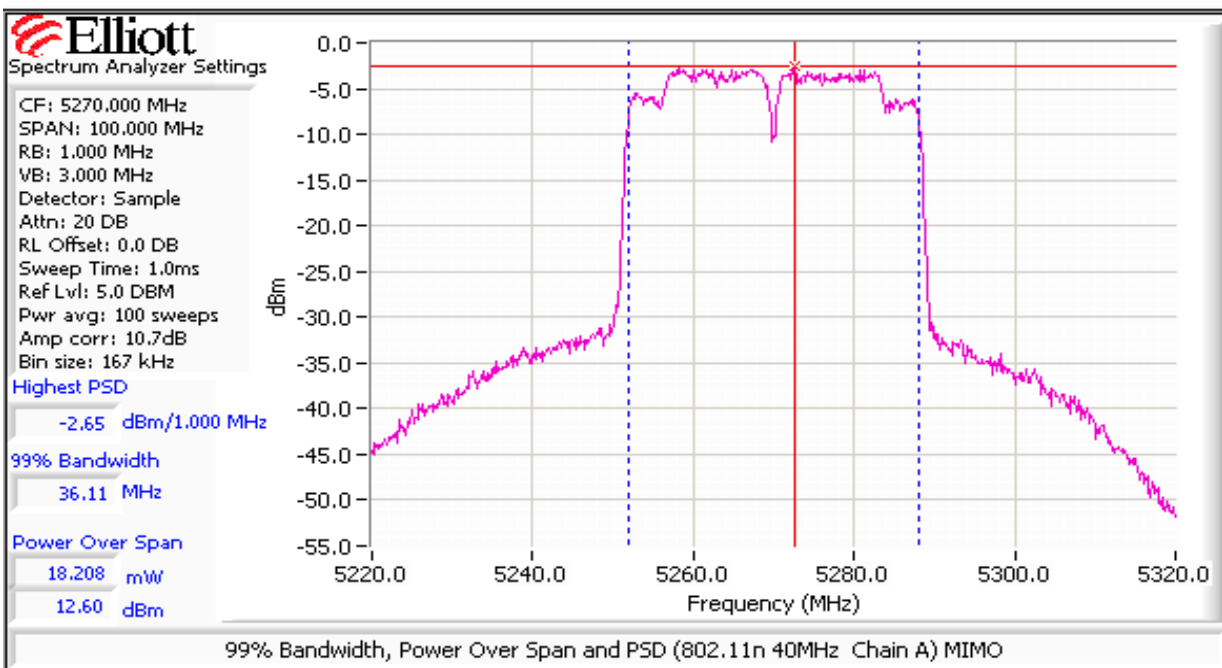
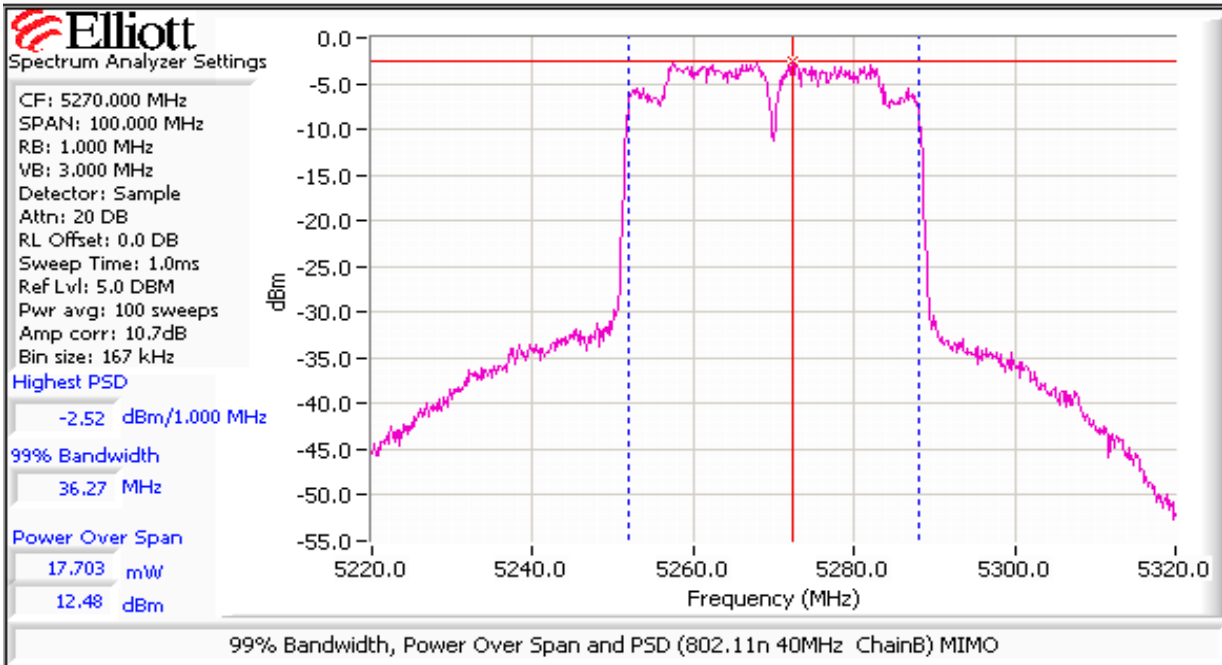



Client:	Intel Corporation	Job Number:	J80398
Model:	Intel® Centrino® Advanced-N 6230	T-Log Number:	T80759
		Account Manager:	Christine Krebill
Contact:	Steve Hackett		
Standard:	FCC 15.247	Class:	N/A

### MIMO Device - 5470-5725 MHz Band

	Chain 1	Chain 2	Chain 3	Coherent	Effective <sup>5</sup>	EIRP (mW)	EIRP (dBm)
Antenna Gain (dBi):	4.8	4.8		No	4.8	119.3	20.8

### Power

Frequency (MHz)	Software Setting	26dB BW (MHz)	Measured Output Power <sup>1</sup> dBm			Total		Limit (dBm)	Max Power (W)	Pass or Fail
			Chain 1	Chain 2	Chain 3	mW	dBm			

### 20MHz Mode

5500	28.5/28.5	24.0	12.7	13.2		39.5	16.0	24.0	0.040	PASS
5580	29.0/29.0	23.1	12.7	13.2		39.5	16.0	24.0		PASS
5700	29.5/29.0	21.1	12.4	12.4		34.8	15.4	24.0		PASS

### 40MHz Mode

5510	30.0/29.5	42.3	13.1	13.0		40.4	16.1	24.0	0.042	PASS
5550	30.5/30.0	50.2	13.2	13.2		41.8	16.2	24.0		PASS
5670	30.5/30.0	39.0	12.6	12.8		37.3	15.7	24.0		PASS

### PSD

Frequency (MHz)	99% <sup>4</sup> BW	Total Power	PSD <sup>2</sup> dBm/MHz			Total PSD		Limit		Pass or Fail
			Chain 1	Chain 2	Chain 3	mW/MHz	dBm/MHz	FCC	RSS 210 <sup>3</sup>	

### 20MHz Mode

5500	18.0	16.0	0.2	0.8		2.2	3.5	11.0	11.0	PASS
5580	18.0	16.0	0.3	0.9		2.3	3.6	11.0	11.0	PASS
5700	18.0	15.4	-0.2	-0.3		1.9	2.8	11.0	11.0	PASS

### 40MHz Mode

5510	36.3	16.1	-2.0	-2.0		1.3	1.0	11.0	11.0	PASS
5550	36.3	16.2	-2.0	-1.6		1.3	1.2	11.0	11.0	PASS
5670	36.3	15.7	-2.7	-2.5		1.1	0.4	11.0	11.0	PASS

Client: Intel Corporation	Job Number: J80398
Model: Intel® Centrino® Advanced-N 6230	T-Log Number: T80759
	Account Manager: Christine Krebill
Contact: Steve Hackett	
Standard: FCC 15.247	Class: N/A

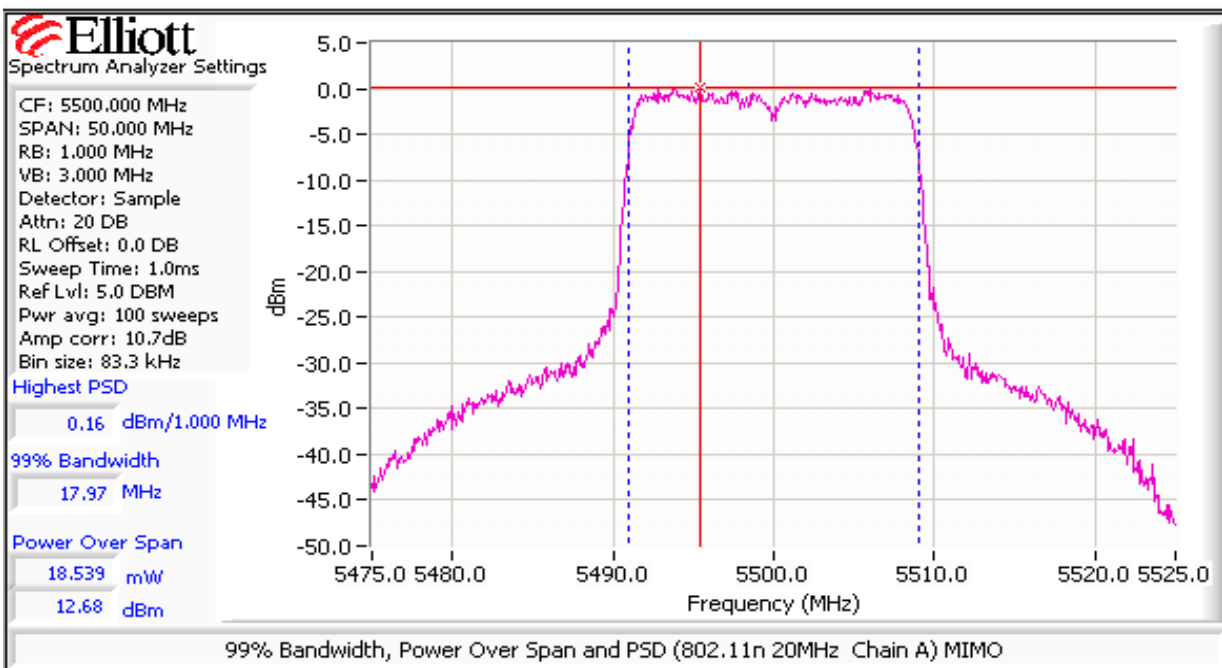
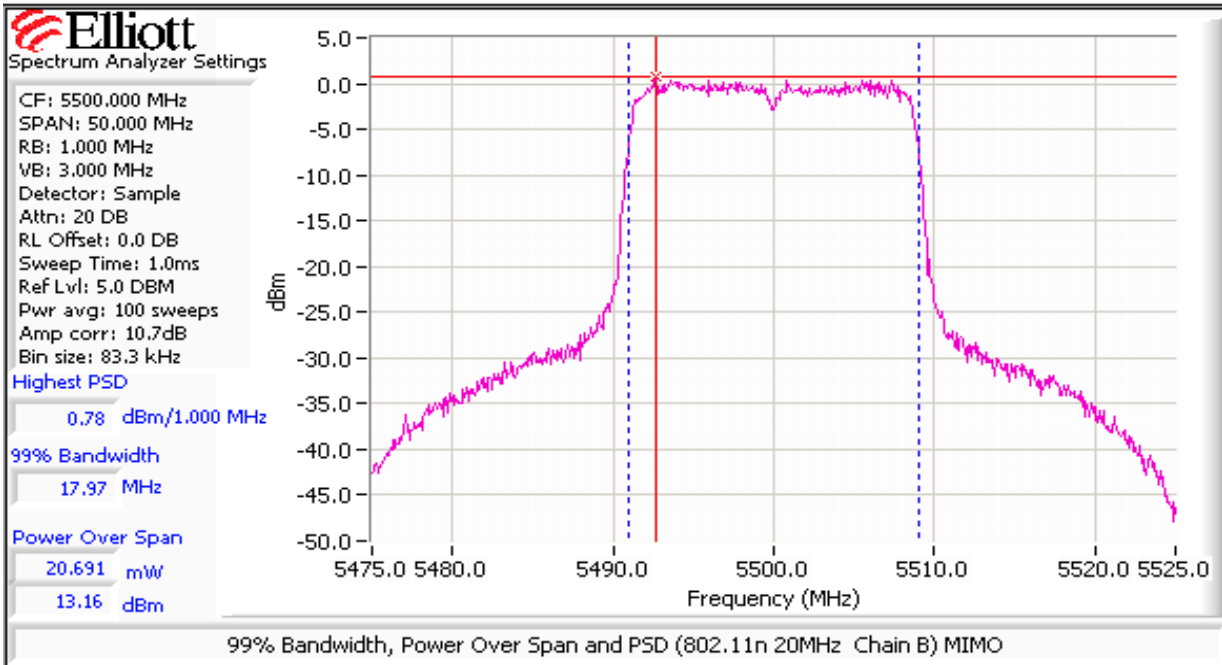

Client: Intel Corporation	Job Number: J80398
Model: Intel® Centrino® Advanced-N 6230	T-Log Number: T80759
	Account Manager: Christine Krebill
Contact: Steve Hackett	
Standard: FCC 15.247	Class: N/A

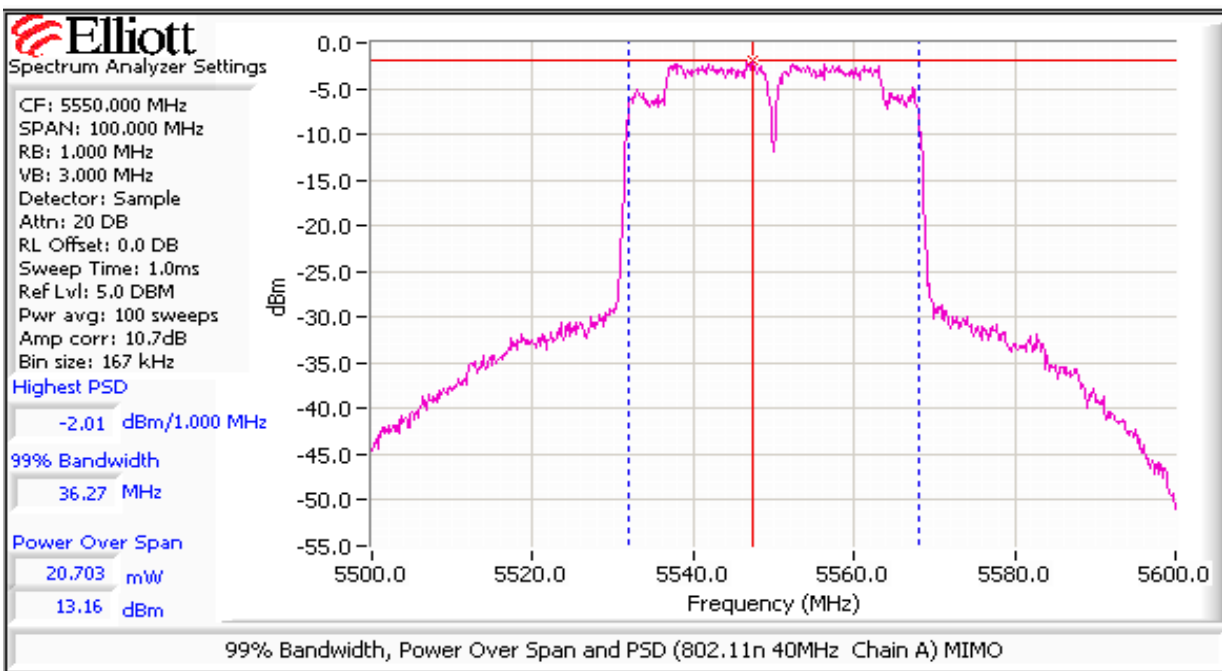
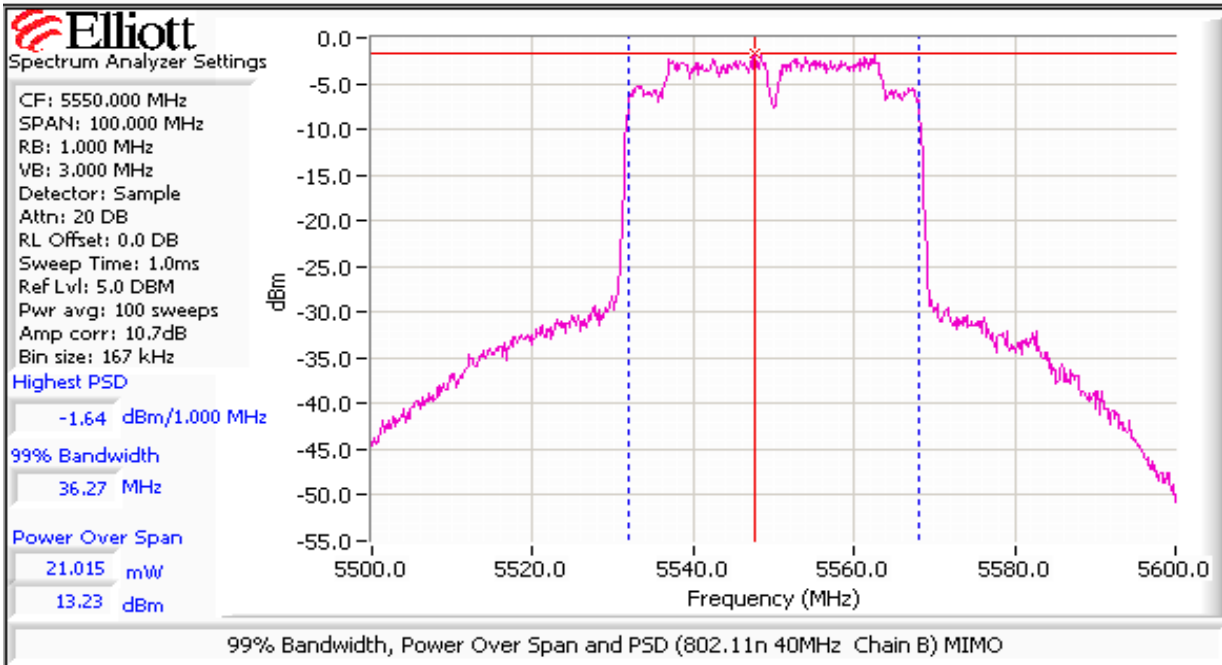



## EMC Test Data

Client:	Intel Corporation	Job Number:	J80398
Model:	Intel® Centrino® Advanced-N 6230	T-Log Number:	T80540
		Account Manager:	Christine Krebill
Contact:	Steve Hackett		-
Emissions Standard(s):	FCC 15.247	Class:	B
Immunity Standard(s):	-	Environment:	-

# EMC Test Data

For The

## Intel Corporation

Model

**Intel® Centrino® Advanced-N 6230**

Date of Last Test: 10/6/2010

Client:	Intel Corporation	Job Number:	J80398
Model:	Intel® Centrino® Advanced-N 6230	T-Log Number:	T80540
Contact:	Steve Hackett	Account Manager:	Christine Krebill
Standard:	FCC 15.247	Class:	N/A

## RSS 210 and FCC 15.247 (DSS) Radiated Spurious Emissions 802.11bgn and Bluetooth - Transmitter Mode

### Test Specific Details

Objective: The objective of this test session is to perform engineering evaluation testing of the EUT with respect to the specification listed above.

### General Test Configuration

The EUT was installed into a test fixture such that the EUT was exposed (i.e. outside of a host PC).  
For conducted emissions testing the measurement antenna port.

### Summary of Results

For Bluetooth: Tx is chain B, Rx is chain B. For WiFi, only Chain A is used for transmit in the 2.4GHz band, both chains used in 5GHz bands.

MAC Address: 00150079AD1A DRTU Tool Version 1.2.12-0197 New tool from 9/14 Driver version 14.0.0.39

Run #	Mode	Channel	Target Power	Measured Power	Test Performed	Limit	Result / Margin
1	BT 1Mb/s 802.11b	2402MHz 2412MHz	7dBm 16.5dBm	4.4 16.5	Radiated Emissions 1- 10 GHz	FCC 15.247	48.0dBµV/m @ 4824.0MHz (-6.0dB)
2	BT 1Mb/s 802.11b	2480MHz 2462MHz	7dBm 16.5dBm	5.3 16.6		FCC 15.247	<b>48.4dBµV/m @ 2360.0MHz (-5.6dB)</b>
3	BT 1Mb/s 802.11g	2402MHz 2412MHz	7dBm 16.5dBm	4.4 16.3		FCC 15.247	46.0dBµV/m @ 2281.9MHz (-8.0dB)
4	BT 1Mb/s 802.11g	2480MHz 2462MHz	7dBm 16.5dBm	5.3 16.9		FCC 15.247	46.6dBµV/m @ 2360.0MHz (-7.4dB)
WiFi mode for the following runs based on worst case mode from runs 1 through 4							
5	BT 1Mb/s 802.11b	2402MHz 2437MHz	7dBm 16.5dBm	4.3 16.6	Radiated Emissions 1- 10 GHz	FCC 15.247	46.8dBµV/m @ 2282.0MHz (-7.2dB)
6	BT 1Mb/s 802.11b	2440MHz 2412MHz	7dBm 16.5dBm	5.4 16.5		FCC 15.247	<b>49.3dBµV/m @ 2320.0MHz (-4.7dB)</b>
7	BT 1Mb/s 802.11b	2440MHz 2462MHz	7dBm 16.5dBm	5.4 16.6	Radiated Emissions 1- 10 GHz	FCC 15.247	47.8dBµV/m @ 2320.0MHz (-6.2dB)
8	BT 1Mb/s 802.11b	2480MHz 2437MHz	7dBm 16.5dBm	5.1 16.6		FCC 15.247	48.9dBµV/m @ 2360.0MHz (-5.1dB)
WiFi mode and channel and Bluetooth channel based on the worst case mode from runs 1 through 8							
9	BT 3Mb/s 802.11b	2440 MHz 2412 MHz	7dBm 16.5dBm	1.4 16.5	Radiated Emissions 1- 10 GHz	FCC 15.247	<b>46.4dBµV/m @ 2383.9MHz (-7.6dB)</b>

Client:	Intel Corporation	Job Number:	J80398
Model:	Intel® Centrino® Advanced-N 6230	T-Log Number:	T80540
Contact:	Steve Hackett	Account Manager:	Christine Krebill
Standard:	FCC 15.247	Class:	N/A

WiFi mode - 802.11n 20MHz with both chains active at 16.5dBm per chain, center channel in each 5GHz band. Bluetooth on center channel, 1Mb/s mode

Run #	Mode	Channel	Target Power	Measured Power	Test Performed	Limit	Result / Margin
10	BT <b>1Mb/s</b> 802.11n20	2440MHz 5200MHz	7dBm 16.5/16.5	5.4 16.6/16.7	Radiated Emissions 1- 15 GHz	FCC 15.247	41.9dBµV/m @ 2280.0MHz (-12.1dB)
11	BT <b>1Mb/s</b> 802.11n20	2440MHz 5300MHz	7dBm 16.5/16.5	5.4 16.7/16.5		FCC 15.247	37.2dBµV/m @ 10600.0MHz (-16.8dB)
12	BT <b>1Mb/s</b> 802.11n20	2440MHz 5600MHz	7dBm 16.5/16.5	5.4 16.5/16.5		FCC 15.247	<b>45.1dBµV/m @ 11199.8MHz (-8.9dB)</b>
13	BT <b>1Mb/s</b> 802.11n20	2440MHz 5785MHz	7dBm 16.5/16.5	5.4 16.5/16.7		FCC 15.247	44.7dBµV/m @ 11570.7MHz (-9.3dB)

### Modifications Made During Testing

No modifications were made to the EUT during testing

### Deviations From The Standard

No deviations were made from the requirements of the standard.

### Notes:

Bluetooth uses a frequency hopping algorithm that means that the device, during normal operation, is only on a specific channel for a short period of time. The average correction factor is calculated as follows:

A maximum length packet has a duration of 5 time slots.

The hopping rate is 1600 hops/second so the maximum dwell time is 5/1600 seconds, or 3.125ms.

With a minimum of 20 hopping channels a channel will not be used more than 4 times in any 100ms period.

The maximum dwell time in a 100ms period is  $4 \times 3.125\text{ms} = 12.5\text{ms}$ .

The average correction factor is, therefore,  $20\log(12.5/100) = -18\text{dB}$

As this is a hopping radio the correction factor can be applied to the average value of the signal provided the average value was measured with the device continuously transmitting. DA 00-0705 permits the use of the average correction on the **measured average** value for frequency hopping radios.

All measurements in this data sheet do not include the average correction factor.

Client:	Intel Corporation	Job Number:	J80398
Model:	Intel® Centrino® Advanced-N 6230	T-Log Number:	T80540
Contact:	Steve Hackett	Account Manager:	Christine Krebill
Standard:	FCC 15.247	Class:	N/A

**Run # 1, Rainbow Peak 2x2: 1-10GHz, 802.11b @ 2412 MHz Chain A, BT Basic Rate @ 2402 MHz Chain B**

	Target (dBm)	Power Settings Measured (dBm)	Software Setting
Chain A	16.5	16.5	24.5
Chain B	7.0	4.4	8.0

**Spurious Radiated Emissions, 1 - 10GHz excluding the allocated band:**

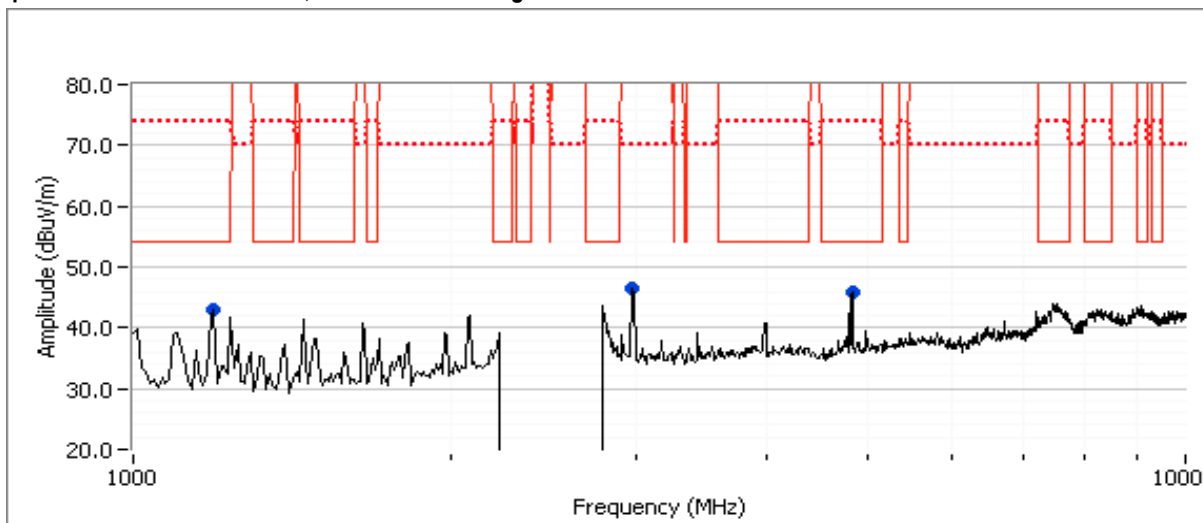

**Preliminary Measurements (Peak versus average limit)**

Frequency	Level	Pol	15.209/15.247		Detector	Azimuth	Height	Comments
MHz	dBuV/m	v/h	Limit	Margin	Pk/QP/Avg	degrees	meters	
4822.500	46.0	V	54.0	-8.0	Peak	154	1.0	
1192.500	42.9	V	54.0	-11.1	Peak	82	1.5	
2980.000	46.4	V	70.0	-23.6	Peak	154	1.0	

**Final measurements at 3m**

Frequency	Level	Pol	15.209/15.247		Detector	Azimuth	Height	Comments
MHz	dBuV/m	v/h	Limit	Margin	Pk/QP/Avg	degrees	meters	
4824.000	48.0	V	54.0	-6.0	AVG	153	1.16	
4823.900	50.8	V	74.0	-23.2	PK	153	1.16	
1192.530	42.9	V	54.0	-11.1	AVG	92	1.64	
1192.550	45.6	V	74.0	-28.4	PK	92	1.64	

Client:	Intel Corporation	Job Number:	J80398
Model:	Intel® Centrino® Advanced-N 6230	T-Log Number:	T80540
Contact:	Steve Hackett	Account Manager:	Christine Krebill
Standard:	FCC 15.247	Class:	N/A

### Spurious Radiated Emissions, 2 - 3GHz

Preliminary Scan at ~ 20cm from the product to identify potential signals (Peak versus average limit)

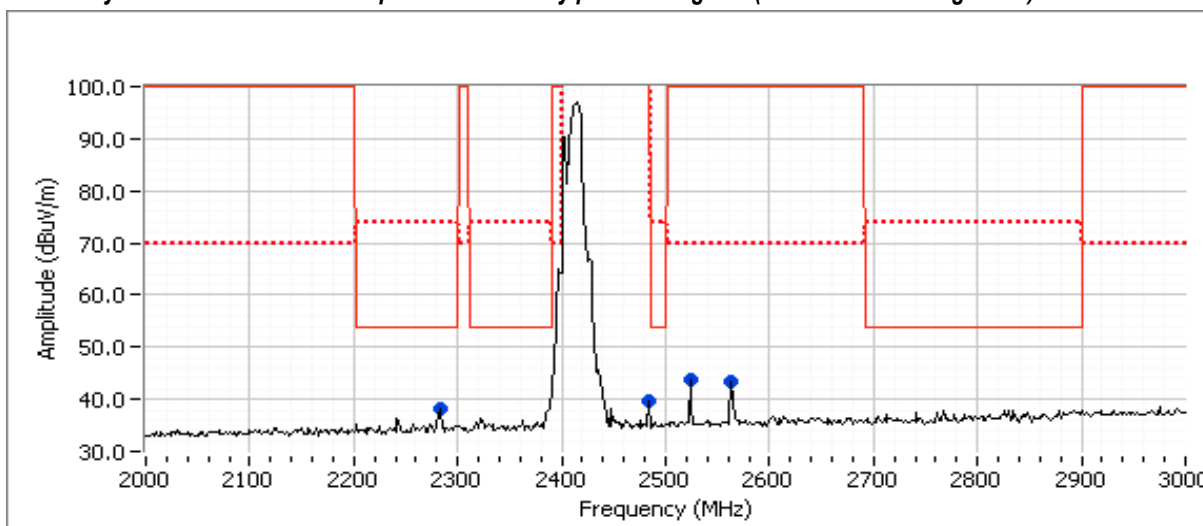

### Preliminary measurements at ~ 20cm, RB=1MHz, VB=100kHz

Frequency	Level	Pol	15.209/15.247		Detector	Azimuth	Height	Comments
MHz	dBuV/m	v/h	Limit	Margin	Pk/QP/Avg	degrees	meters	
2283.330	38.3	H	54.0	-15.7	Peak	321	1.0	
2483.330	39.8	H	120.0	-80.2	Peak	4	1.0	In band
2523.330	43.6	H	70.0	-26.4	Peak	0	1.0	Non-restricted band
2563.330	43.4	H	70.0	-26.6	Peak	212	1.0	Non-restricted band

### Final measurements at 3m

Frequency	Level	Pol	15.209/15.247		Detector	Azimuth	Height	Comments
MHz	dBuV/m	v/h	Limit	Margin	Pk/QP/Avg	degrees	meters	
2281.900	46.0	H	54.0	-8.0	AVG	69	2.18	Note 2
2282.130	55.6	H	74.0	-18.4	PK	69	2.18	Note 2

Note 1: For emissions in restricted bands, the limit of 15.209 was used. For all other emissions, the limit is -30dBc for peak measurements in a measurement bandwidth of 100kHz.

Note 2: Signal is only present when Bluetooth is enabled, average correction for hopping occupancy could be applied



Client:	Intel Corporation	Job Number:	J80398
Model:	Intel® Centrino® Advanced-N 6230	T-Log Number:	T80540
Contact:	Steve Hackett	Account Manager:	Christine Krebill
Standard:	FCC 15.247	Class:	N/A

**Run # 2, Rainbow Peak 2x2: 1-10GHz, 802.11b @ 2462 MHz Chain A, BT Basic Rate @ 2480 MHz Chain B**

	Power Settings		
	Target (dBm)	Measured (dBm)	Software Setting
Chain A	16.5	16.6	23.5
Chain B	7.0	5.3	8.0

**Spurious Radiated Emissions, 1 - 10GHz excluding the allocated band:**

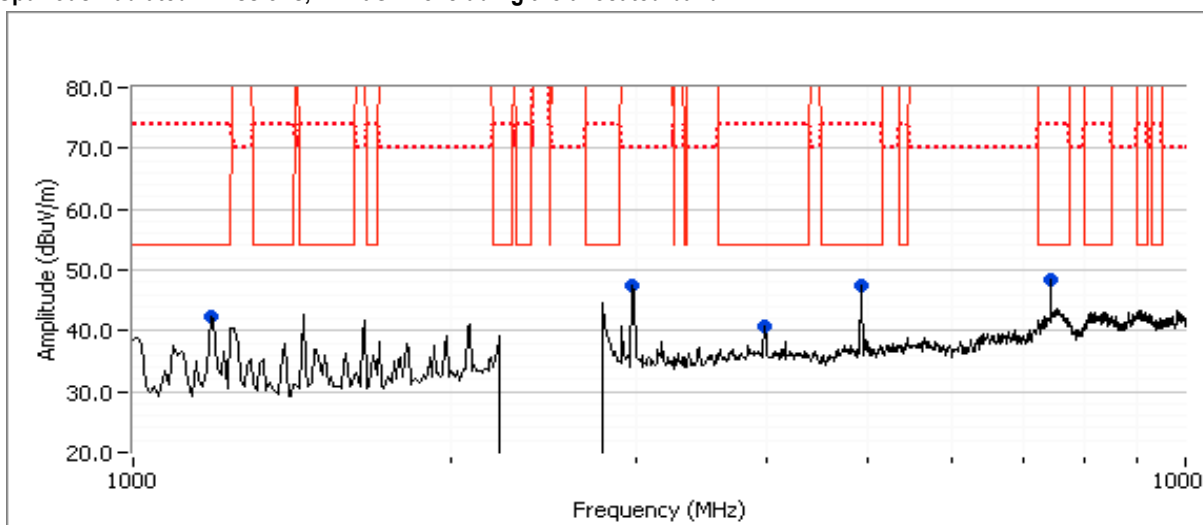

**Preliminary Measurements (Peak versus average limit)**

Frequency	Level	Pol	15.209/15.247		Detector	Azimuth	Height	Comments
MHz	dBuV/m	v/h	Limit	Margin	Pk/QP/Avg	degrees	meters	
7439.170	48.3	V	54.0	-5.7	Peak	167	2.0	
4914.170	47.5	V	54.0	-6.5	Peak	209	2.5	
1183.330	42.3	V	54.0	-11.7	Peak	97	2.0	
3979.170	40.8	V	54.0	-13.2	Peak	146	1.0	
2980.000	47.4	V	70.0	-22.6	Peak	153	1.0	

**Final measurements at 3m**

Frequency	Level	Pol	15.209/15.247		Detector	Azimuth	Height	Comments
MHz	dBuV/m	v/h	Limit	Margin	Pk/QP/Avg	degrees	meters	
<b>4924.000</b>	<b>46.8</b>	V	54.0	<b>-7.2</b>	AVG	212	2.48	
7439.940	46.5	V	54.0	-7.5	AVG	166	2.00	
4923.890	50.0	V	74.0	-24.0	PK	212	2.48	
7440.500	53.1	V	74.0	-20.9	PK	166	2.00	

Client:	Intel Corporation	Job Number:	J80398
Model:	Intel® Centrino® Advanced-N 6230	T-Log Number:	T80540
Contact:	Steve Hackett	Account Manager:	Christine Krebill
Standard:	FCC 15.247	Class:	N/A

### Spurious Radiated Emissions, 2 - 3GHz

Preliminary Scan at ~ 20cm from the product to identify potential signals (Peak versus average limit)

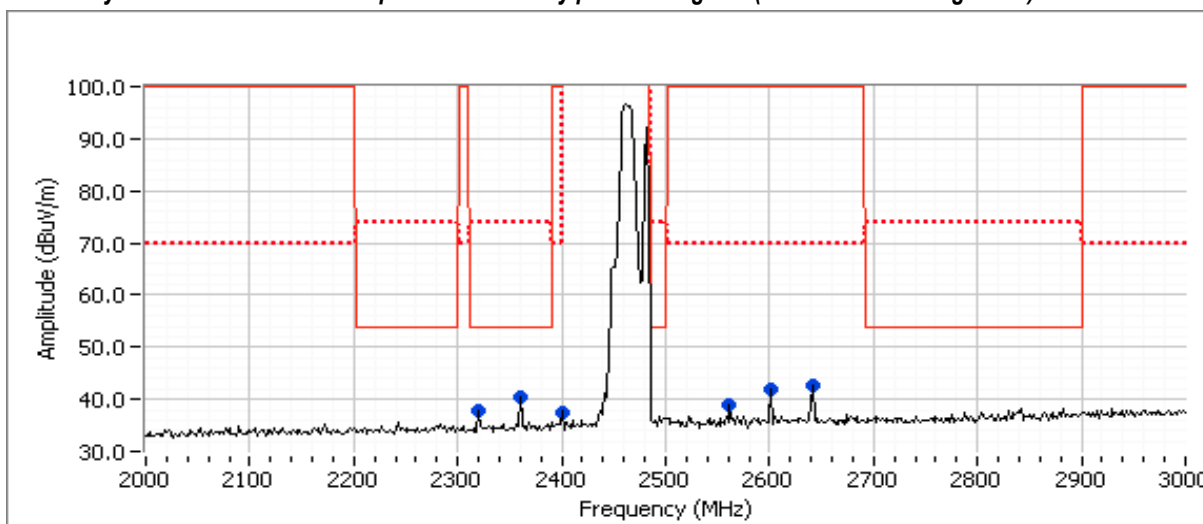

### Preliminary measurements at ~ 20cm, RB=1MHz, VB=100kHz

Frequency	Level	Pol	15.209/15.247		Detector	Azimuth	Height	Comments
MHz	dBuV/m	v/h	Limit	Margin	Pk/QP/Avg	degrees	meters	
2320.000	37.9	H	54.0	-16.1	Peak	185	1.0	
2360.000	40.3	H	54.0	-13.7	Peak	338	1.0	
2400.000	37.4	H	70.0	-32.6	Peak	352	1.0	Non-restricted band
2561.670	39.1	H	70.0	-30.9	Peak	75	1.0	Non-restricted band
2601.670	42.1	H	70.0	-27.9	Peak	144	1.0	Non-restricted band
2641.670	42.5	H	70.0	-27.5	Peak	147	1.0	Non-restricted band

### Final measurements at 3m

Frequency	Level	Pol	15.209/15.247		Detector	Azimuth	Height	Comments
MHz	dBuV/m	v/h	Limit	Margin	Pk/QP/Avg	degrees	meters	
2320.070	46.3	H	54.0	-7.7	AVG	345	1.25	Note 2
2319.830	56.6	H	74.0	-17.4	PK	345	1.25	Note 2
2360.020	48.4	H	54.0	-5.6	AVG	70	1.27	Note 2
2360.000	57.2	H	74.0	-16.8	PK	70	1.27	Note 2

Note 1: For emissions in restricted bands, the limit of 15.209 was used. For all other emissions, the limit is -30dBc for peak measurements in a measurement bandwidth of 100kHz.

Note 2: Signal is only present when Bluetooth is enabled, average correction for hopping occupancy could be applied

Client:	Intel Corporation	Job Number:	J80398
Model:	Intel® Centrino® Advanced-N 6230	T-Log Number:	T80540
Contact:	Steve Hackett	Account Manager:	Christine Krebill
Standard:	FCC 15.247	Class:	N/A

**Run # 3, Rainbow Peak 2x2: 1-10GHz, 802.11g @ 2412 MHz Chain A, BT Basic Rate @ 2402 MHz Chain B  
Spurious Radiated Emissions, 1 - 10GHz excluding the allocated band:**

	Target (dBm)	Power Settings Measured (dBm)	Software Setting
Chain A	16.5	16.3	31.0
Chain B	7.0	4.4	8.0

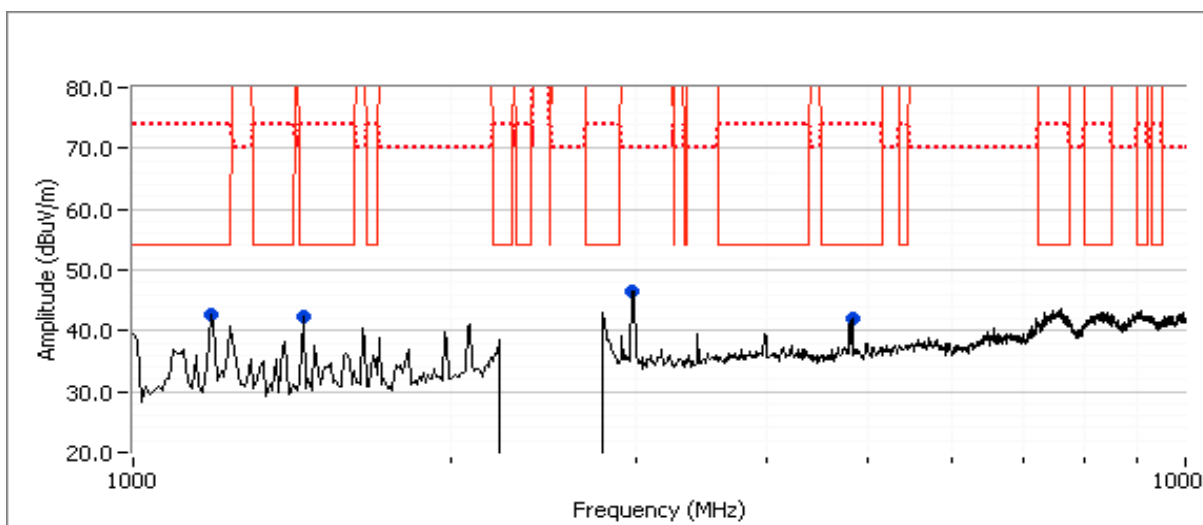

**Preliminary Measurements (Peak versus average limit)**

Frequency	Level	Pol	15.209/15.247		Detector	Azimuth	Height	Comments
MHz	dBuV/m	v/h	Limit	Margin	Pk/QP/Avg	degrees	meters	
1183.330	42.8	V	54.0	-11.2	Peak	102	2.0	
1449.170	42.5	H	54.0	-11.5	Peak	138	1.5	
4822.500	42.1	V	54.0	-11.9	Peak	283	2.0	
2980.000	46.4	V	70.0	-23.6	Peak	153	1.0	

**Final measurements at 3m**

Frequency	Level	Pol	15.209/15.247		Detector	Azimuth	Height	Comments
MHz	dBuV/m	v/h	Limit	Margin	Pk/QP/Avg	degrees	meters	
1457.590	43.2	H	54.0	-10.8	AVG	132	1.33	
1457.600	45.4	H	74.0	-28.6	PK	132	1.33	
1192.560	42.5	V	54.0	-11.5	AVG	89	1.99	
1192.600	44.8	V	74.0	-29.2	PK	89	1.99	
4823.900	40.7	V	54.0	-13.3	AVG	153	1.18	
4826.970	52.1	V	74.0	-21.9	PK	153	1.18	

Client:	Intel Corporation	Job Number:	J80398
Model:	Intel® Centrino® Advanced-N 6230	T-Log Number:	T80540
Contact:	Steve Hackett	Account Manager:	Christine Krebill
Standard:	FCC 15.247	Class:	N/A

### Spurious Radiated Emissions, 2 - 3GHz

Preliminary Scan at ~ 20cm from the product to identify potential signals (Peak versus average limit)

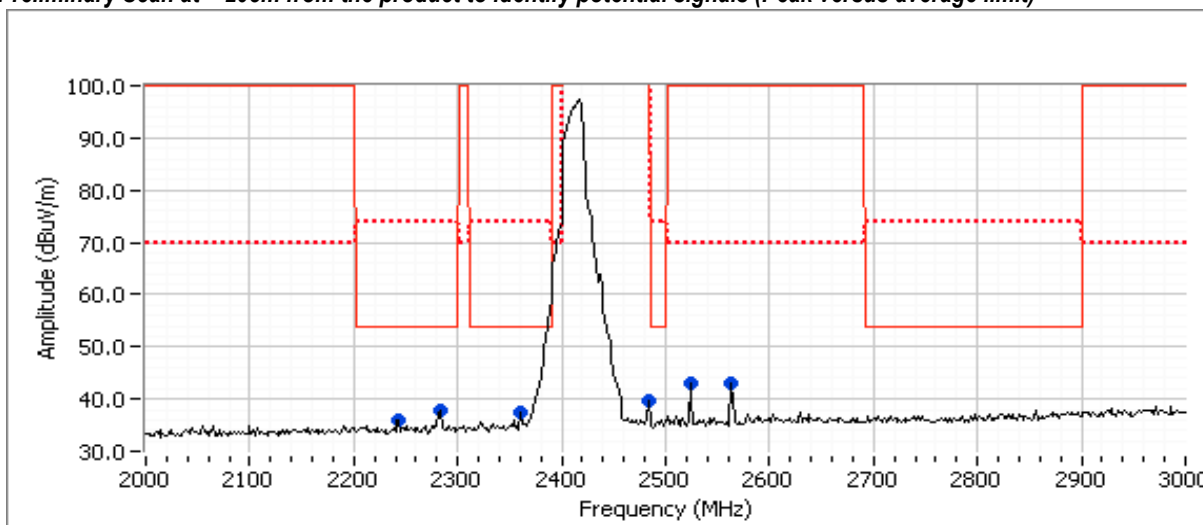

### Preliminary measurements at ~ 20cm, RB=1MHz, VB=100kHz

Frequency	Level	Pol	15.209/15.247		Detector	Azimuth	Height	Comments
MHz	dBuV/m	v/h	Limit	Margin	Pk/QP/Avg	degrees	meters	
2243.330	36.1	V	54.0	-17.9	Peak	42	1.0	
2283.330	37.7	H	54.0	-16.3	Peak	306	1.0	
2360.000	37.3	H	54.0	-16.7	Peak	358	1.0	
2483.330	39.6	H	120.0	-80.4	Peak	10	1.0	In-band
2523.330	43.2	H	70.0	-26.8	Peak	31	1.0	Non-restricted band
2563.330	43.1	H	70.0	-26.9	Peak	20	1.0	Non-restricted band

### Final measurements at 3m

Frequency	Level	Pol	15.209/15.247		Detector	Azimuth	Height	Comments
MHz	dBuV/m	v/h	Limit	Margin	Pk/QP/Avg	degrees	meters	
2241.910	45.2	V	54.0	-8.8	AVG	163	1.42	Note 2
2241.860	55.3	V	74.0	-18.7	PK	163	1.42	Note 2
2281.910	46.0	H	54.0	-8.0	AVG	70	2.27	Note 2
2281.960	55.5	H	74.0	-18.5	PK	70	2.27	Note 2
2362.170	44.9	H	54.0	-9.1	AVG	66	1.19	Note 2
2361.080	55.1	H	74.0	-18.9	PK	66	1.19	Note 2

Note 1: For emissions in restricted bands, the limit of 15.209 was used. For all other emissions, the limit is -30dBc for peak measurements in a measurement bandwidth of 100kHz.

Note 2: Signal is only present when Bluetooth is enabled, average correction for hopping occupancy could be applied

Client:	Intel Corporation	Job Number:	J80398
Model:	Intel® Centrino® Advanced-N 6230	T-Log Number:	T80540
Contact:	Steve Hackett	Account Manager:	Christine Krebill
Standard:	FCC 15.247	Class:	N/A

**Run # 4, Rainbow Peak 2x2: 1-10GHz, 802.11g @ 2462 MHz Chain A, BT Basic Rate @ 2480 MHz Chain B**

	Target (dBm)	Power Settings Measured (dBm)	Software Setting
Chain A	16.5	16.9	29.5
Chain B	7.0	5.3	8.0

**Spurious Radiated Emissions, 1 - 10GHz excluding the allocated band:**

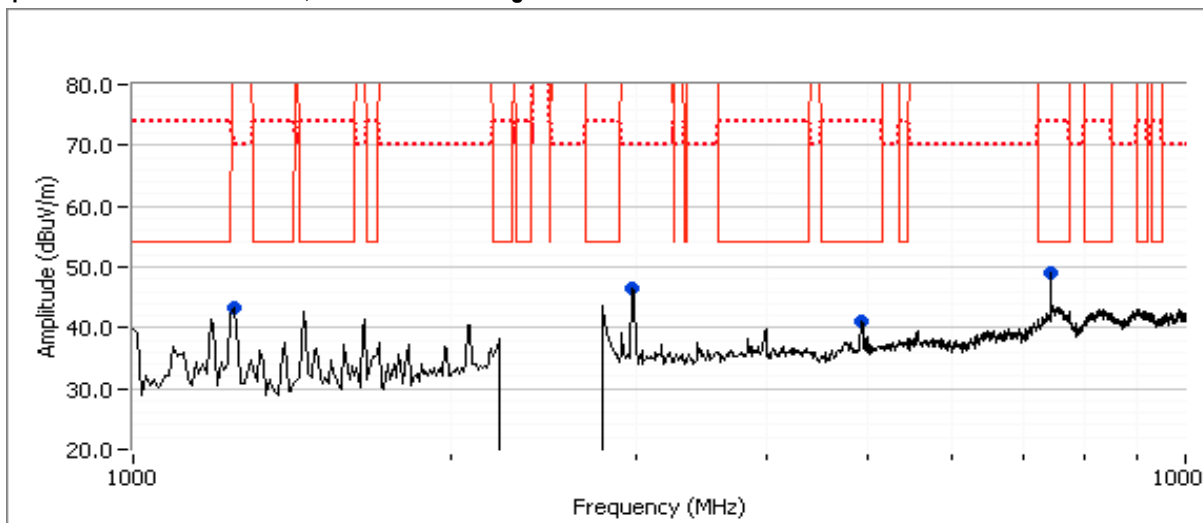

**Preliminary Measurements (Peak versus average limit)**

Frequency	Level	Pol	15.209/15.247		Detector	Azimuth	Height	Comments
MHz	dBuV/m	v/h	Limit	Margin	Pk/QP/Avg	degrees	meters	
7439.170	49.2	V	54.0	-4.8	Peak	174	1.5	
4923.330	41.1	V	54.0	-12.9	Peak	181	2.5	
2980.000	46.6	V	70.0	-23.4	Peak	160	1.0	
1247.500	43.4	H	70.0	-26.6	Peak	152	1.5	

**Final measurements at 3m**

Frequency	Level	Pol	15.209/15.247		Detector	Azimuth	Height	Comments
MHz	dBuV/m	v/h	Limit	Margin	Pk/QP/Avg	degrees	meters	
7440.020	45.8	V	54.0	-8.2	AVG	178	1.52	
7439.570	52.7	V	74.0	-21.3	PK	178	1.52	

Note: 7440MHz is directly related to the Bluetooth signal and was observed during the Bluetooth only spurious measurements.

Client:	Intel Corporation	Job Number:	J80398
Model:	Intel® Centrino® Advanced-N 6230	T-Log Number:	T80540
Contact:	Steve Hackett	Account Manager:	Christine Krebill
Standard:	FCC 15.247	Class:	N/A

### Spurious Radiated Emissions, 2 - 3GHz

*Preliminary Scan at ~ 20cm from the product to identify potential signals (Peak versus average limit)*

No preamplifier used for these scans

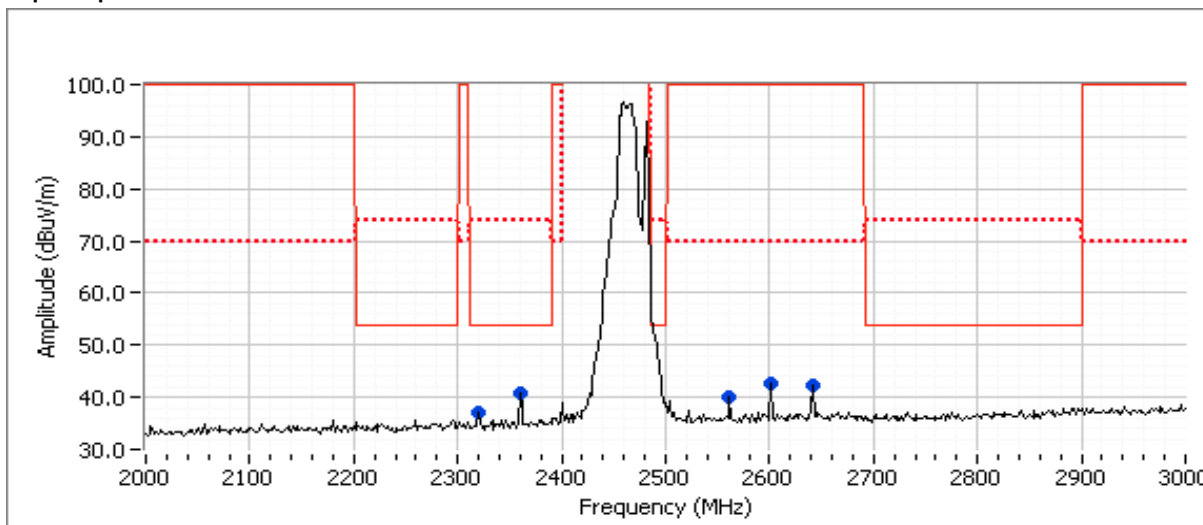

### Preliminary measurements at ~ 20cm, RB=1MHz, VB=100kHz

Frequency	Level	Pol	15.209/15.247		Detector	Azimuth	Height	Comments
MHz	dBuV/m	v/h	Limit	Margin	Pk/QP/Avg	degrees	meters	
2320.000	37.2	H	54.0	-16.8	Peak	317	1.0	
2360.000	40.7	H	54.0	-13.3	Peak	347	1.0	
2561.670	39.9	H	70.0	-30.1	Peak	205	1.0	Non-restricted band
2601.670	42.6	H	70.0	-27.4	Peak	144	1.0	Non-restricted band
2641.670	42.4	H	70.0	-27.6	Peak	173	1.0	Non-restricted band

### Final measurements at 3m

Frequency	Level	Pol	15.209/15.247		Detector	Azimuth	Height	Comments
MHz	dBuV/m	v/h	Limit	Margin	Pk/QP/Avg	degrees	meters	
2324.470	44.5	H	54.0	-9.5	AVG	236	1.0	
<b>2360.040</b>	<b>46.6</b>	H	54.0	<b>-7.4</b>	AVG	326	1.0	
2323.600	57.6	H	74.0	-16.4	PK	236	1.0	
2359.450	56.2	H	74.0	-17.8	PK	326	1.0	

Note 1:	For emissions in restricted bands, the limit of 15.209 was used. For all other emissions, the limit is -30dBc for peak measurements in a measurement bandwidth of 100kHz.
Note 2:	Signal is only present when Bluetooth is enabled, average correction for hopping occupancy could be applied
Note 3:	Signal is present when Bluetooth is disabled (powered off)

Client:	Intel Corporation	Job Number:	J80398
Model:	Intel® Centrino® Advanced-N 6230	T-Log Number:	T80540
Contact:	Steve Hackett	Account Manager:	Christine Krebill
Standard:	FCC 15.247	Class:	N/A

**Run # 5, Rainbow Peak 2x2: 1-10GHz, 802.11b @ 2437 MHz Chain A, BT Basic Rate @ 2402 MHz Chain B**

	Target (dBm)	Power Settings Measured (dBm)	Software Setting
Chain A	16.5	16.6	23.5
Chain B	7.0	4.3	8.0

**Spurious Radiated Emissions, 1 - 10GHz excluding the allocated band:**  
Preamplifier and notch filter used for these scans

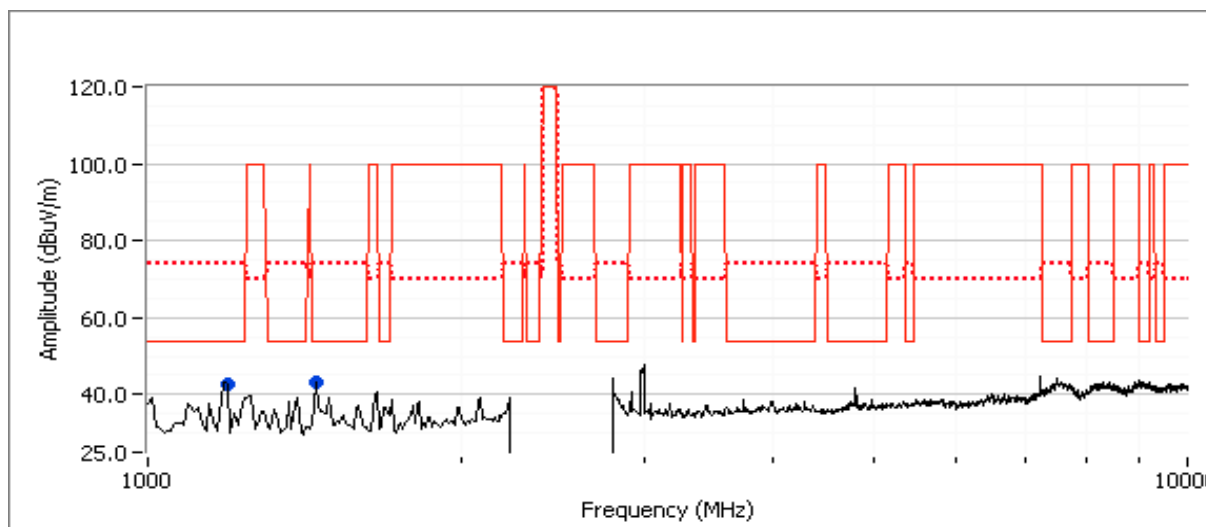

**Preliminary Measurements (Peak versus average limit)**

Frequency	Level	Pol	15.209/15.247		Detector	Azimuth	Height	Comments
MHz	dBuV/m	v/h	Limit	Margin	Pk/QP/Avg	degrees	meters	
1457.620	43.2	H	54.0	-10.8	Peak	130	1.5	
1199.820	42.6	V	54.0	-11.4	Peak	96	2.0	

**Final measurements at 3m**

Frequency	Level	Pol	15.209/15.247		Detector	Azimuth	Height	Comments
MHz	dBuV/m	v/h	Limit	Margin	Pk/QP/Avg	degrees	meters	
1200.140	40.1	V	54.0	-13.9	AVG	100	2.0	
<b>1457.570</b>	<b>43.0</b>	H	54.0	<b>-11.0</b>	AVG	127	1.4	
1199.950	44.7	V	74.0	-29.3	PK	100	2.0	
1457.490	45.1	H	74.0	-28.9	PK	127	1.4	

Note: 4804MHz is directly related to the Bluetooth signal and was observed during the Bluetooth only spurious measurements.

Client:	Intel Corporation	Job Number:	J80398
Model:	Intel® Centrino® Advanced-N 6230	T-Log Number:	T80540
Contact:	Steve Hackett	Account Manager:	Christine Krebill
Standard:	FCC 15.247	Class:	N/A

### Spurious Radiated Emissions, 2 - 3GHz

*Preliminary Scan at ~ 20cm from the product to identify potential signals (Peak versus average limit)*

No preamplifier used for these scans

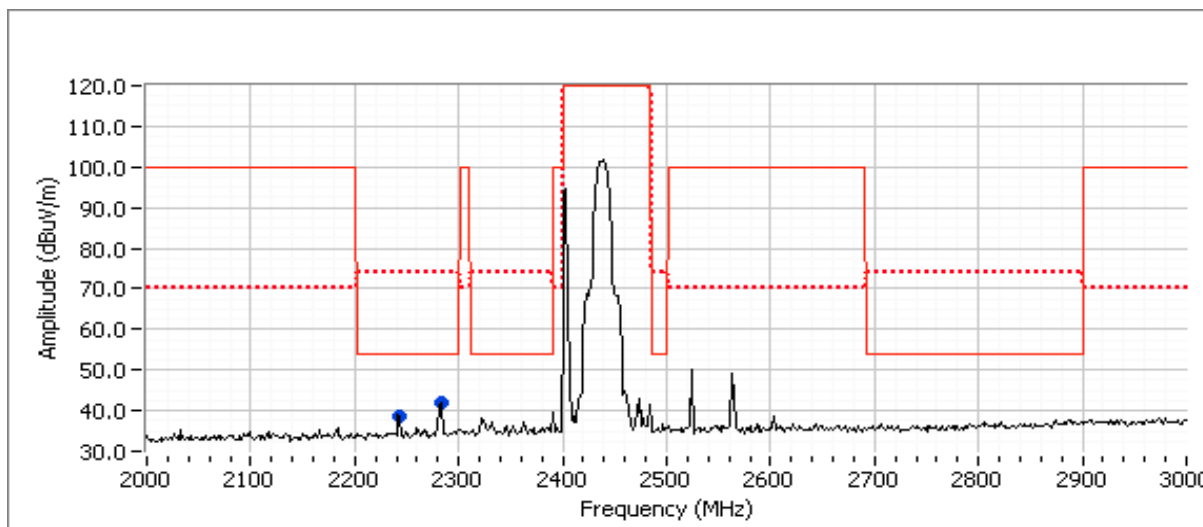

### Preliminary measurements at ~ 20cm, RB=1MHz, VB=100kHz

Frequency MHz	Level dBuV/m	Pol v/h	15.209/15.247		Detector Pk/QP/Avg	Azimuth degrees	Height meters	Comments
			Limit	Margin				
2283.330	41.8	V	54.0	-12.2	Peak	180	1.0	5
2243.330	38.7	V	54.0	-15.3	Peak	180	1.0	5

### Final measurements at 3m

Frequency MHz	Level dBuV/m	Pol v/h	15.209/15.247		Detector Pk/QP/Avg	Azimuth degrees	Height meters	Comments
			Limit	Margin				
2281.990	46.8	H	54.0	-7.2	AVG	70	1.0	RB 1 MHz;VB 10 Hz;Pk
2282.150	56.7	H	74.0	-17.3	PK	70	1.0	RB 1 MHz;VB 3 MHz;Pk
2242.060	46.7	H	54.0	-7.3	AVG	68	1.0	RB 1 MHz;VB 10 Hz;Pk
2241.580	56.3	H	74.0	-17.7	PK	68	1.0	RB 1 MHz;VB 3 MHz;Pk
2282.000	45.9	V	54.0	-8.1	AVG	105	1.2	RB 1 MHz;VB 10 Hz;Pk
2282.210	56.1	V	74.0	-17.9	PK	105	1.2	RB 1 MHz;VB 3 MHz;Pk

Note 1:	For emissions in restricted bands, the limit of 15.209 was used. For all other emissions, the limit is -30dBc for peak measurements in a measurement bandwidth of 100kHz.
Note 2:	Signal is only present when Bluetooth is enabled, average correction for hopping occupancy could be applied
Note 3:	Signal is present when Bluetooth is disabled (powered off)



Client:	Intel Corporation	Job Number:	J80398
Model:	Intel® Centrino® Advanced-N 6230	T-Log Number:	T80540
Contact:	Steve Hackett	Account Manager:	Christine Krebill
Standard:	FCC 15.247	Class:	N/A

**Run # 6, Rainbow Peak 2x2: 1-10GHz, 802.11b @ 2412 MHz Chain A, BT Basic Rate @ 2440 MHz Chain B**

	Target (dBm)	Power Settings Measured (dBm)	Software Setting
Chain A	16.5	16.5	23.5
Chain B	7.0	5.4	8.0

**Spurious Radiated Emissions, 1 - 10GHz excluding the allocated band:**  
**Preamplifier and notch filter used for these scans**

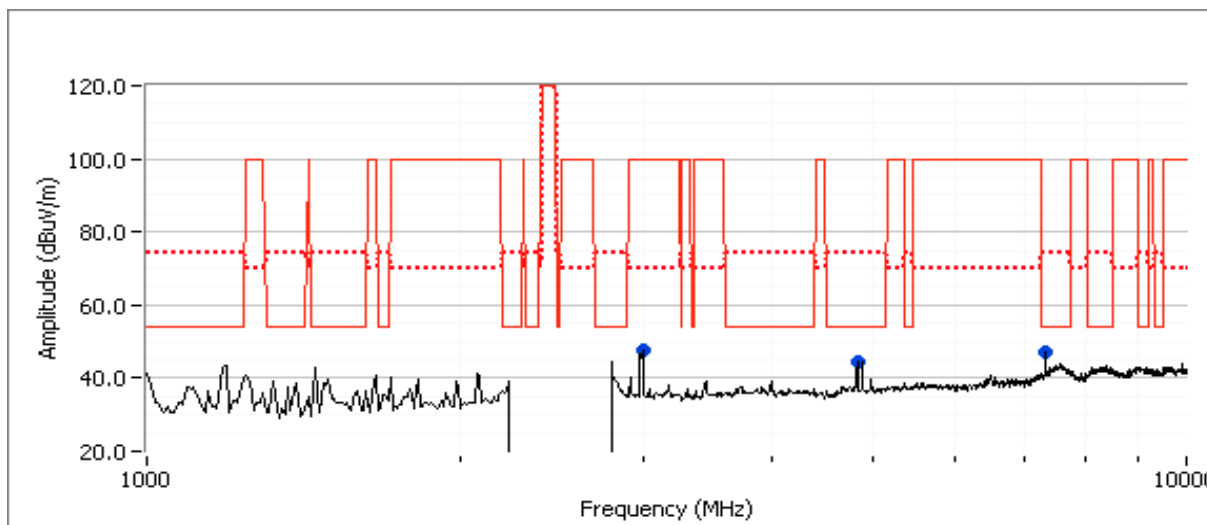

**Preliminary Measurements (Peak versus average limit)**

Frequency	Level	Pol	15.209/15.247		Detector	Azimuth	Height	Comments
MHz	dBuV/m	v/h	Limit	Margin	Pk/QP/Avg	degrees	meters	
2998.330	47.9	V	70.0	-22.1	Peak	141	1.0	
4823.990	44.6	V	54.0	-9.4	Peak	149	1.0	
7316.670	47.1	V	54.0	-6.9	Peak	165	1.9	

**Final measurements at 3m**

Frequency	Level	Pol	15.209/15.247		Detector	Azimuth	Height	Comments
MHz	dBuV/m	v/h	Limit	Margin	Pk/QP/Avg	degrees	meters	
4823.980	44.9	V	54.0	-9.1	AVG	149	1.3	RB 1 MHz;VB 10 Hz;Pk
4823.900	48.4	V	74.0	-25.6	PK	149	1.3	RB 1 MHz;VB 3 MHz;Pk
7319.940	43.6	V	54.0	-10.4	AVG	170	2.0	RB 1 MHz;VB 10 Hz;Pk
7319.350	51.4	V	74.0	-22.6	PK	170	2.0	RB 1 MHz;VB 3 MHz;Pk

Note: 7320 MHz is directly related to the Bluetooth signal and was observed during the Bluetooth only spurio us measurements.

Client:	Intel Corporation	Job Number:	J80398
Model:	Intel® Centrino® Advanced-N 6230	T-Log Number:	T80540
Contact:	Steve Hackett	Account Manager:	Christine Krebill
Standard:	FCC 15.247	Class:	N/A

### Spurious Radiated Emissions, 2 - 3GHz

*Preliminary Scan at ~ 20cm from the product to identify potential signals (Peak versus average limit)*

No preamplifier used for these scans

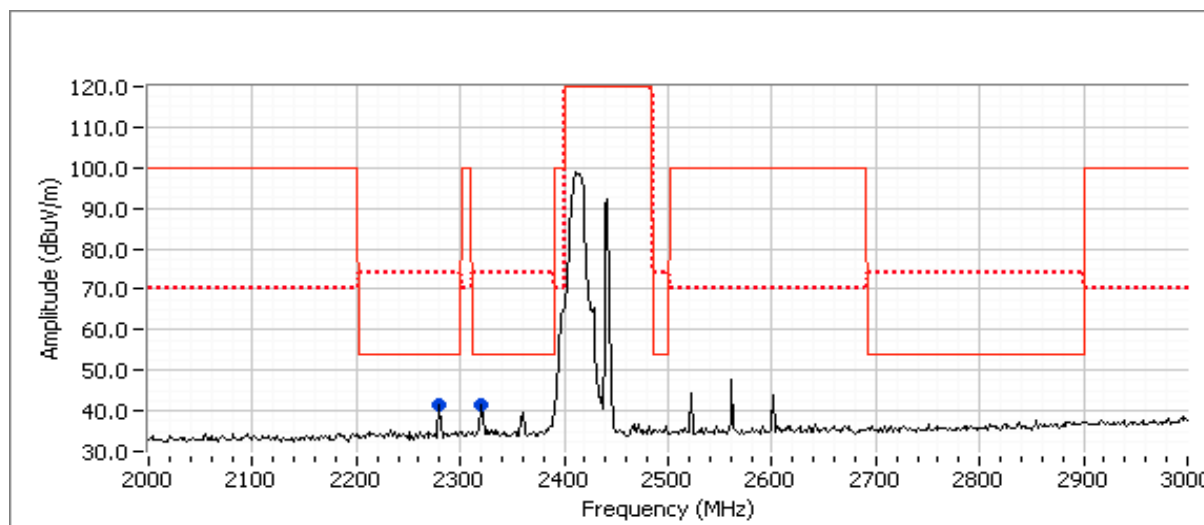

### Preliminary measurements at ~ 20cm, RB=1MHz, VB=100kHz

Frequency	Level	Pol	15.209/15.247		Detector	Azimuth	Height	Comments
MHz	dBuV/m	v/h	Limit	Margin	Pk/QP/Avg	degrees	meters	
2320.000	40.1	-	54.0	-13.9	Peak	180	1.0	
2280.000	39.0	-	54.0	-15.0	Peak	180	1.0	

### Final measurements at 3m

Frequency	Level	Pol	15.209/15.247		Detector	Azimuth	Height	Comments
MHz	dBuV/m	v/h	Limit	Margin	Pk/QP/Avg	degrees	meters	
2319.970	49.3	H	54.0	-4.7	AVG	70	1.2	RB 1 MHz;VB 10 Hz;Pk
2319.990	57.3	H	74.0	-16.7	PK	70	1.2	RB 1 MHz;VB 3 MHz;Pk
2279.960	46.8	H	54.0	-7.2	AVG	70	1.9	RB 1 MHz;VB 10 Hz;Pk
2279.780	55.9	H	74.0	-18.1	PK	70	1.9	RB 1 MHz;VB 3 MHz;Pk
2319.980	46.7	V	54.0	-7.3	AVG	104	1.0	RB 1 MHz;VB 10 Hz;Pk
2319.800	56.2	V	74.0	-17.8	PK	104	1.0	RB 1 MHz;VB 3 MHz;Pk

Note 1: For emissions in restricted bands, the limit of 15.209 was used. For all other emissions, the limit is -30dBc for peak measurements in a measurement bandwidth of 100kHz.

Note 2: Signal is only present when Bluetooth is enabled, average correction for hopping occupancy could be applied

Note 3: Signal is present when Bluetooth is disabled (powered off)

Client:	Intel Corporation	Job Number:	J80398
Model:	Intel® Centrino® Advanced-N 6230	T-Log Number:	T80540
Contact:	Steve Hackett	Account Manager:	Christine Krebill
Standard:	FCC 15.247	Class:	N/A

**Run # 7, Rainbow Peak 2x2: 1-10GHz, 802.11b @ 2462 MHz Chain A, BT Basic Rate @ 2440 MHz Chain B**

	Target (dBm)	Power Settings Measured (dBm)	Software Setting
Chain A	16.5	16.6	23.5
Chain B	7.0	5.4	8.0

**Spurious Radiated Emissions, 1 - 10GHz excluding the allocated band:**  
Preamplifier and notch filter used for these scans

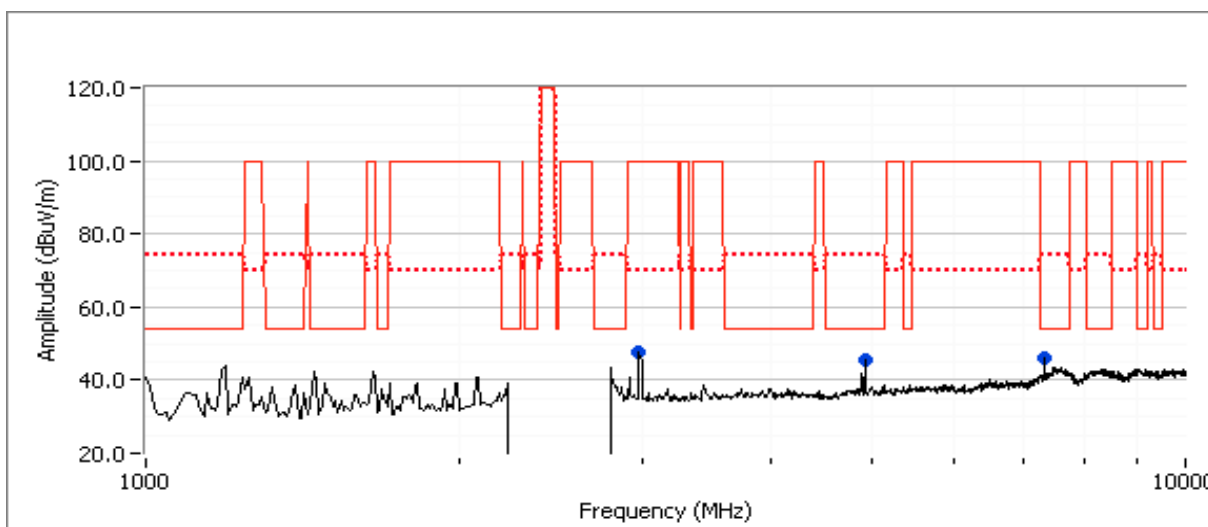

**Preliminary Measurements (Peak versus average limit)**

Frequency	Level	Pol	15.209/15.247		Detector	Azimuth	Height	Comments
MHz	dBuV/m	v/h	Limit	Margin	Pk/QP/Avg	degrees	meters	
2980.000	47.7	V	70.0	-22.3	Peak	141	1.0	
4923.860	45.3	V	54.0	-8.7	Peak	166	1.6	
7322.500	46.3	V	54.0	-7.7	Peak	182	1.6	

**Final measurements at 3m**

Frequency	Level	Pol	15.209/15.247		Detector	Azimuth	Height	Comments
MHz	dBuV/m	v/h	Limit	Margin	Pk/QP/Avg	degrees	meters	
4923.980	47.6	V	54.0	-6.4	AVG	166	1.7	RB 1 MHz;VB 10 Hz;Pk
4923.940	50.3	V	74.0	-23.7	PK	166	1.7	RB 1 MHz;VB 3 MHz;Pk
7320.050	41.2	V	54.0	-12.8	AVG	201	2.0	RB 1 MHz;VB 10 Hz;Pk
7320.180	49.5	V	74.0	-24.5	PK	201	2.0	RB 1 MHz;VB 3 MHz;Pk

Note: 7320 MHz is directly related to the Bluetooth signal and was observed during the Bluetooth only spurio us measurements.

Client:	Intel Corporation	Job Number:	J80398
Model:	Intel® Centrino® Advanced-N 6230	T-Log Number:	T80540
Contact:	Steve Hackett	Account Manager:	Christine Krebill
Standard:	FCC 15.247	Class:	N/A

### Spurious Radiated Emissions, 2 - 3GHz

*Preliminary Scan at ~ 20cm from the product to identify potential signals (Peak versus average limit)*

No preamplifier used for these scans

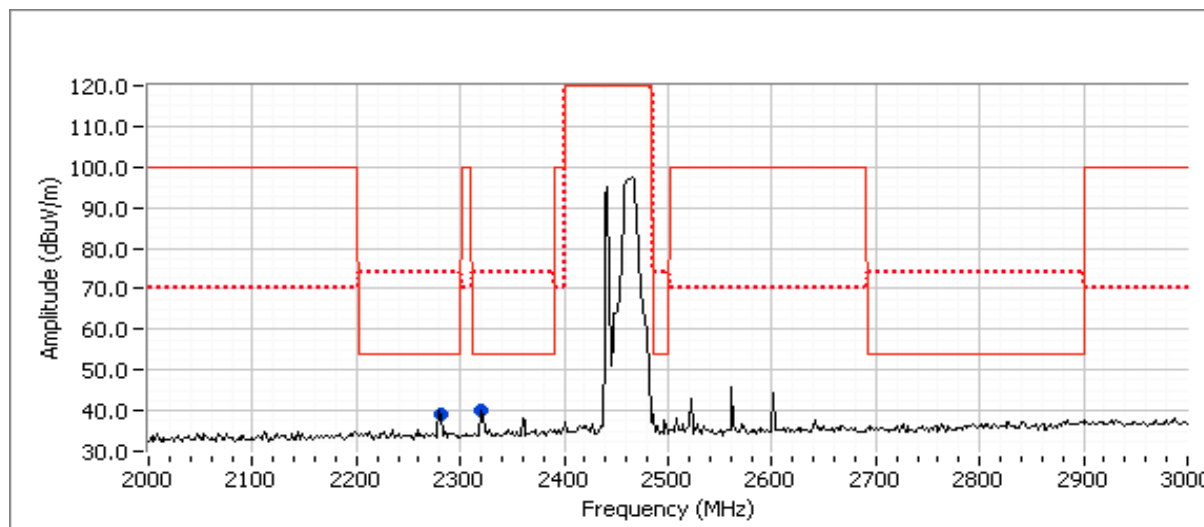

### Preliminary measurements at ~ 20cm, RB=1MHz, VB=100kHz

Frequency MHz	Level dBuV/m	Pol v/h	15.209/15.247		Detector Pk/QP/Avg	Azimuth degrees	Height meters	Comments
			Limit	Margin				
2320.000	40.1	H	54.0	-13.9	Peak	180	1.0	
2288.500	39.0	H	54.0	-15.0	Peak	180	1.0	

### Final measurements at 3m

Frequency MHz	Level dBuV/m	Pol v/h	15.209/15.247		Detector Pk/QP/Avg	Azimuth degrees	Height meters	Comments
			Limit	Margin				
2319.980	47.8	H	54.0	-6.2	AVG	72	1.2	
2279.930	46.7	H	54.0	-7.3	AVG	69	1.0	
2320.040	45.8	V	54.0	-8.2	AVG	100	1.0	
2279.930	45.2	V	54.0	-8.8	AVG	101	1.0	
2320.230	57.3	H	74.0	-16.7	PK	72	1.2	
2284.230	56.0	H	74.0	-18.0	PK	69	1.0	
2324.580	55.8	V	74.0	-18.2	PK	100	1.0	
2280.470	55.3	V	74.0	-18.7	PK	101	1.0	

Note 1: For emissions in restricted bands, the limit of 15.209 was used. For all other emissions, the limit is -30dBc for peak measurements in a measurement bandwidth of 100kHz.

Note 2: Signal is only present when Bluetooth is enabled, average correction for hopping occupancy could be applied

Note 3: Signal is present when Bluetooth is disabled (powered off)

Client:	Intel Corporation	Job Number:	J80398
Model:	Intel® Centrino® Advanced-N 6230	T-Log Number:	T80540
Contact:	Steve Hackett	Account Manager:	Christine Krebill
Standard:	FCC 15.247	Class:	N/A

**Run # 8, Rainbow Peak 2x2: 1-10GHz, 802.11b @ 2437 MHz Chain A, BT Basic Rate @ 2480 MHz Chain B**

	Target (dBm)	Power Settings Measured (dBm)	Software Setting
Chain A	16.5	16.6	23.5
Chain B	7.0	5.1	8.0

**Spurious Radiated Emissions, 1 - 10GHz excluding the allocated band:**  
**Preamplifier and notch filter used for these scans**

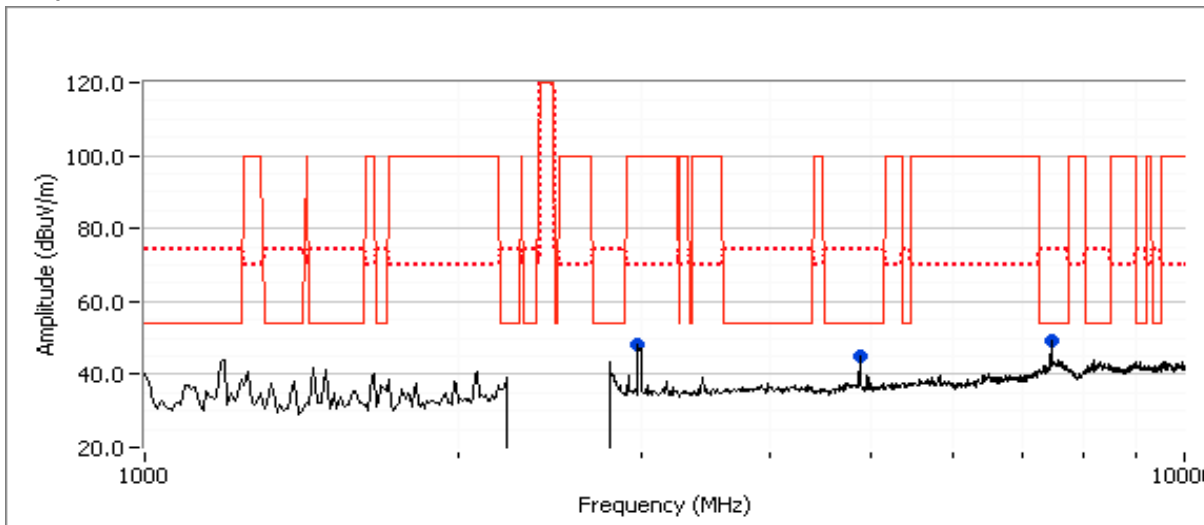

**Preliminary Measurements (Peak versus average limit)**

Frequency	Level	Pol	15.209/15.247		Detector	Azimuth	Height	Comments
MHz	dBuV/m	v/h	Limit	Margin	Pk/QP/Avg	degrees	meters	
2980.000	48.4	V	70.0	-21.6	Peak	148	1.0	
4873.880	45.0	V	54.0	-9.0	Peak	148	1.3	
7439.170	49.5	V	54.0	-4.5	Peak	166	2.2	

**Final measurements at 3m**

Frequency	Level	Pol	15.209/15.247		Detector	Azimuth	Height	Comments
MHz	dBuV/m	v/h	Limit	Margin	Pk/QP/Avg	degrees	meters	
4874.020	45.2	V	54.0	-8.8	AVG	146	1.2	RB 1 MHz;VB 10 Hz;Pk
4874.030	49.0	V	74.0	-25.0	PK	146	1.2	RB 1 MHz;VB 3 MHz;Pk
7440.000	44.9	V	54.0	-9.1	AVG	167	1.5	RB 1 MHz;VB 10 Hz;Pk
7440.270	52.2	V	74.0	-21.8	PK	167	1.5	RB 1 MHz;VB 3 MHz;Pk

Note: 7320 MHz is directly related to the Bluetooth signal and was observed during the Bluetooth only spurio us measurements.

Client:	Intel Corporation	Job Number:	J80398
Model:	Intel® Centrino® Advanced-N 6230	T-Log Number:	T80540
Contact:	Steve Hackett	Account Manager:	Christine Krebill
Standard:	FCC 15.247	Class:	N/A

### Spurious Radiated Emissions, 2 - 3GHz

*Preliminary Scan at ~ 20cm from the product to identify potential signals (Peak versus average limit)*

No preamplifier used for these scans

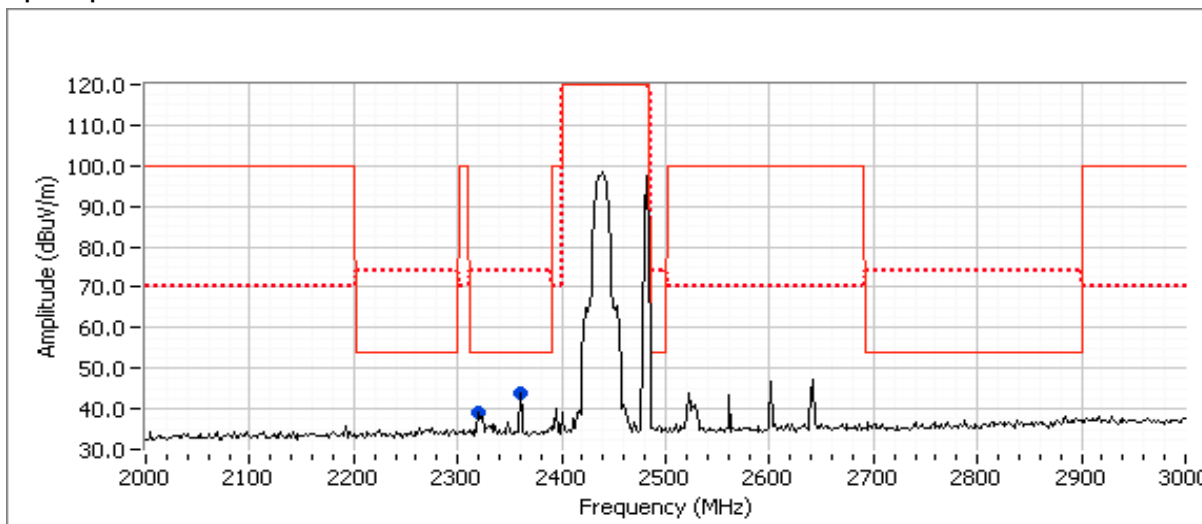

### Preliminary measurements at ~ 20cm, RB=1MHz, VB=100kHz

Frequency	Level	Pol	15.209/15.247		Detector	Azimuth	Height	Comments
MHz	dBuV/m	v/h	Limit	Margin	Pk/QP/Avg	degrees	meters	
2360.000	43.8	-	54.0	-10.2	Peak	180	1.0	
2320.000	39.2	-	54.0	-14.8	Peak	180	1.0	

### Final measurements at 3m

Frequency	Level	Pol	15.209/15.247		Detector	Azimuth	Height	Comments
MHz	dBuV/m	v/h	Limit	Margin	Pk/QP/Avg	degrees	meters	
2360.020	48.9	H	54.0	-5.1	AVG	328	1.0	
2319.980	47.9	H	54.0	-6.1	AVG	69	1.3	
2359.980	46.7	V	54.0	-7.3	AVG	107	1.0	
2320.040	45.7	V	54.0	-8.3	AVG	104	1.0	
2320.230	57.3	H	74.0	-16.7	PK	69	1.3	
2360.430	56.7	V	74.0	-17.3	PK	107	1.0	
2360.100	56.6	H	74.0	-17.4	PK	328	1.0	
2324.580	55.6	V	74.0	-18.4	PK	104	1.0	

Note 1: For emissions in restricted bands, the limit of 15.209 was used. For all other emissions, the limit is -30dBc for peak measurements in a measurement bandwidth of 100kHz.

Note 2: Signal is only present when Bluetooth is enabled, average correction for hopping occupancy could be applied

Note 3: Signal is present when Bluetooth is disabled (powered off)

Client:	Intel Corporation	Job Number:	J80398
Model:	Intel® Centrino® Advanced-N 6230	T-Log Number:	T80540
Contact:	Steve Hackett	Account Manager:	Christine Krebill
Standard:	FCC 15.247	Class:	N/A

**Run # 9, Rainbow Peak 2x2: 1-10GHz, 802.11b @ 2412 MHz Chain A, BT EDR @ 2440 MHz Chain B**

	Target (dBm)	Power Settings Measured (dBm)	Software Setting
Chain A	16.5	16.5	23.5
Chain B	7.0	1.4	8.0

**Spurious Radiated Emissions, 1 - 10GHz excluding the allocated band:**  
**Preamplifier and notch filter used for these scans**

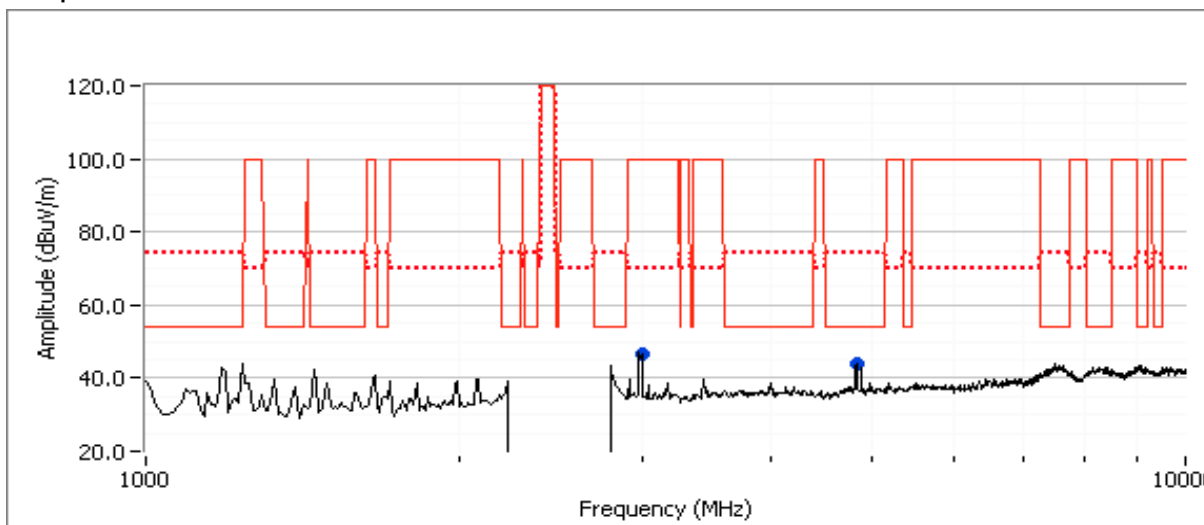

**Preliminary Measurements (Peak versus average limit)**

Frequency	Level	Pol	15.209/15.247		Detector	Azimuth	Height	Comments
MHz	dBuV/m	v/h	Limit	Margin	Pk/QP/Avg	degrees	meters	
2998.330	46.7	V	70.0	-23.3	Peak	130	1.0	
4823.990	44.0	V	54.0	-10.0	Peak	134	1.6	

**Final measurements at 3m**

Frequency	Level	Pol	15.209/15.247		Detector	Azimuth	Height	Comments
MHz	dBuV/m	v/h	Limit	Margin	Pk/QP/Avg	degrees	meters	
4824.030	43.1	V	54.0	-10.9	AVG	131	1.0	RB 1 MHz;VB 10 Hz;Pk
4823.990	47.7	V	74.0	-26.3	PK	131	1.0	RB 1 MHz;VB 3 MHz;Pk

Note: 4924 MHz is directly related to the WiFi (802.11b) signal and was observed during the 802.11b mode spurious measurements.

Client:	Intel Corporation	Job Number:	J80398
Model:	Intel® Centrino® Advanced-N 6230	T-Log Number:	T80540
Contact:	Steve Hackett	Account Manager:	Christine Krebill
Standard:	FCC 15.247	Class:	N/A

### Spurious Radiated Emissions, 2 - 3GHz

*Preliminary Scan at ~ 20cm from the product to identify potential signals (Peak versus average limit)*

No preamplifier used for these scans

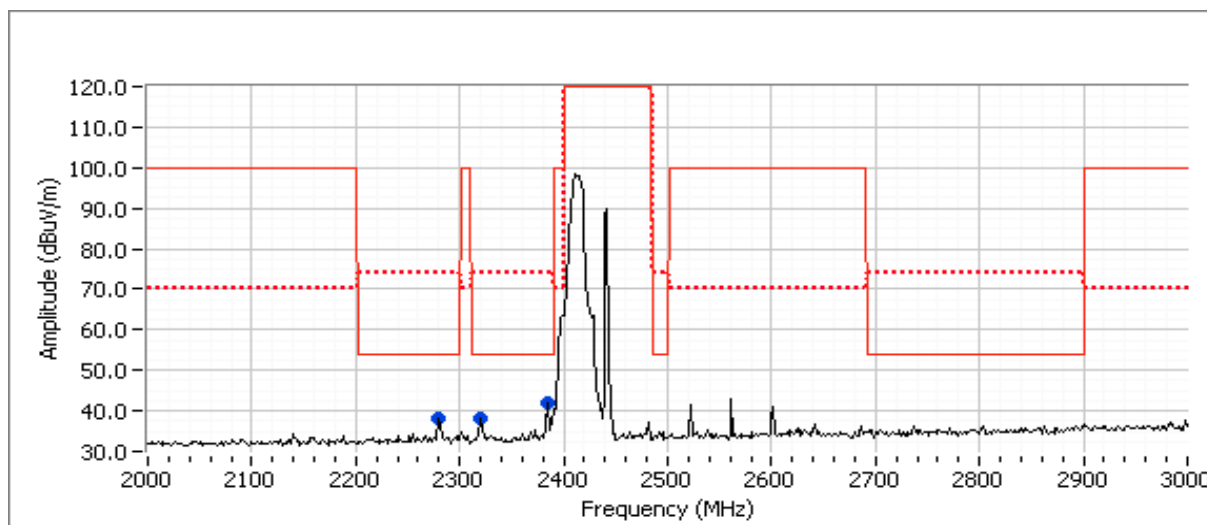

### Preliminary measurements at ~ 20cm, RB=1MHz, VB=100kHz

Frequency	Level	Pol	15.209/15.247		Detector	Azimuth	Height	Comments
MHz	dBuV/m	v/h	Limit	Margin	Pk/QP/Avg	degrees	meters	
2385.000	42.2	V	54.0	-11.8	Peak	192	1.0	
2320.000	38.2	V	54.0	-15.8	Peak	192	1.0	
2280.000	38.2	V	54.0	-15.8	Peak	192	1.0	

### Final measurements at 3m

Frequency	Level	Pol	15.209/15.247		Detector	Azimuth	Height	Comments
MHz	dBuV/m	v/h	Limit	Margin	Pk/QP/Avg	degrees	meters	
2383.860	46.4	H	54.0	-7.6	AVG	350	1.0	RB 1 MHz;VB 10 Hz;Pk
2384.460	59.4	H	74.0	-14.6	PK	350	1.0	RB 1 MHz;VB 3 MHz;Pk
2319.970	46.4	H	54.0	-7.6	AVG	3	1.1	RB 1 MHz;VB 10 Hz;Pk
2320.330	56.0	H	74.0	-18.0	PK	3	1.1	RB 1 MHz;VB 3 MHz;Pk
2279.900	44.6	H	54.0	-9.4	AVG	68	1.0	RB 1 MHz;VB 10 Hz;Pk
2279.060	55.4	H	74.0	-18.6	PK	68	1.0	RB 1 MHz;VB 3 MHz;Pk
2384.170	45.9	V	54.0	-8.1	AVG	205	1.5	RB 1 MHz;VB 10 Hz;Pk
2386.600	59.7	V	74.0	-14.3	PK	205	1.5	RB 1 MHz;VB 3 MHz;Pk

Note 1:	For emissions in restricted bands, the limit of 15.209 was used. For all other emissions, the limit is -30dBc for peak measurements in a measurement bandwidth of 100kHz.
Note 2:	Signal is only present when Bluetooth is enabled, average correction for hopping occupancy could be applied
Note 3:	Signal is present when Bluetooth is disabled (powered off)



Client:	Intel Corporation	Job Number:	J80398
Model:	Intel® Centrino® Advanced-N 6230	T-Log Number:	T80540
Contact:	Steve Hackett	Account Manager:	Christine Krebill
Standard:	FCC 15.247	Class:	N/A

**Run # 10, Rainbow Peak 2x2: 1-15GHz, 802.11n20 @ 5200 MHz Chain A and B, BT Basic Rate @ 2440 MHz Chain B**

	Target (dBm)	Power Settings Measured (dBm)	Software Setting
WiFi A	16.5	16.6	31.5
WiFi B	16.5	16.7	30.5
Bluetooth	7.0	5.4	8.0

**Spurious Radiated Emissions, 7 - 15GHz:**  
 Preamplifier and high pass filter used for these scans

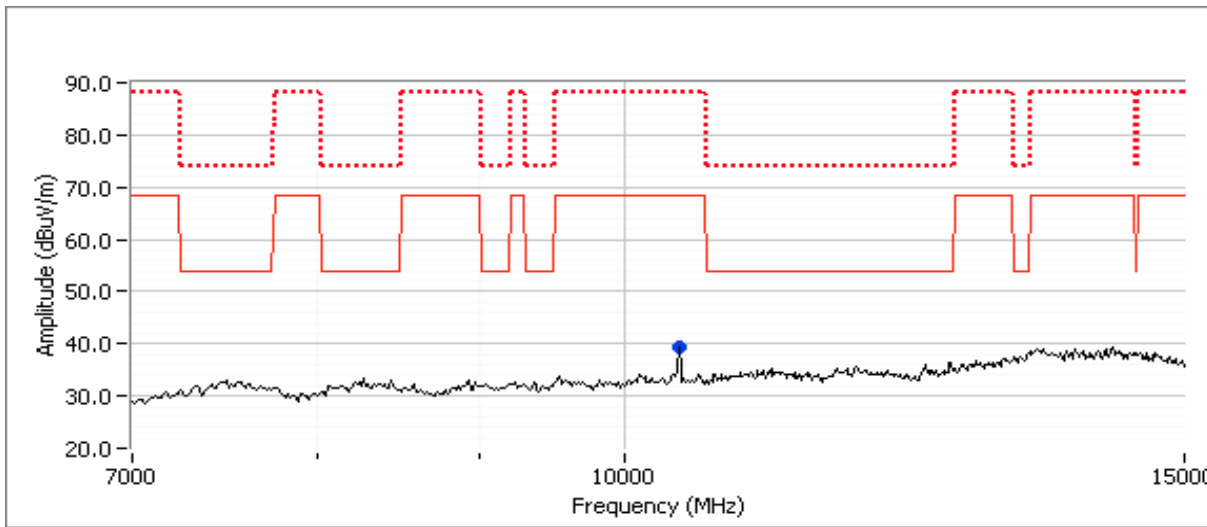

**Preliminary Measurements (Peak versus average limit)**

Frequency	Level	Pol	15.209/15.247/15E		Detector	Azimuth	Height	Comments
MHz	dBμV/m	v/h	Limit	Margin	Pk/QP/Avg	degrees	meters	
10400.000	39.4	V	68.3	-28.9	Peak	198	1.3	

Client:	Intel Corporation	Job Number:	J80398
Model:	Intel® Centrino® Advanced-N 6230	T-Log Number:	T80540
Contact:	Steve Hackett	Account Manager:	Christine Krebill
Standard:	FCC 15.247	Class:	N/A

### Spurious Radiated Emissions, 1 - 7GHz (Scans from 1 - 3.5GHz and 3.5 - 7GHz)

*Preliminary Scan at ~ 20cm from the product (card and antenna) to identify potential signals (Peak versus average limit)*

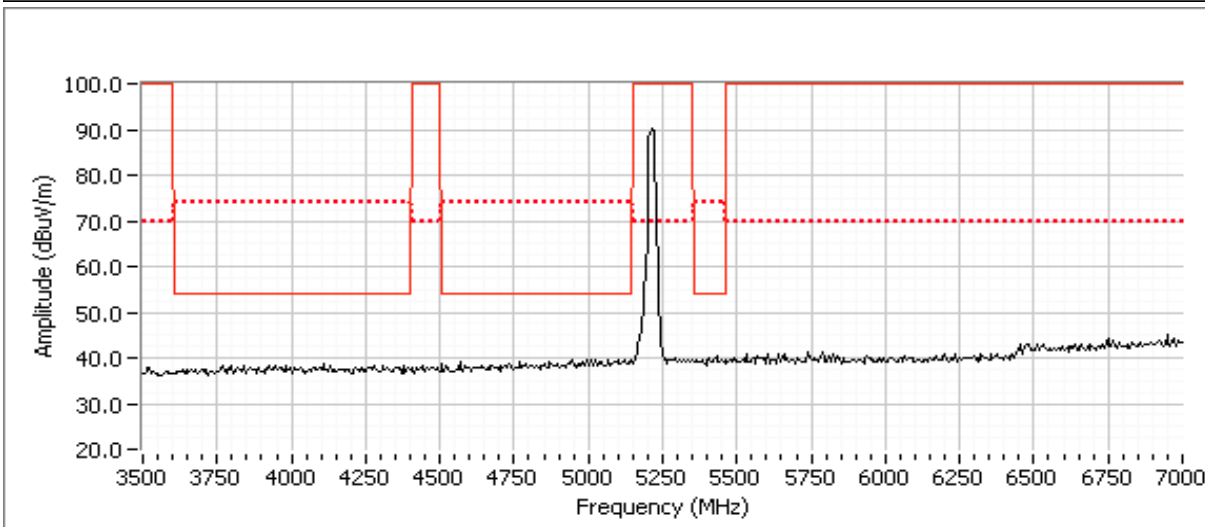
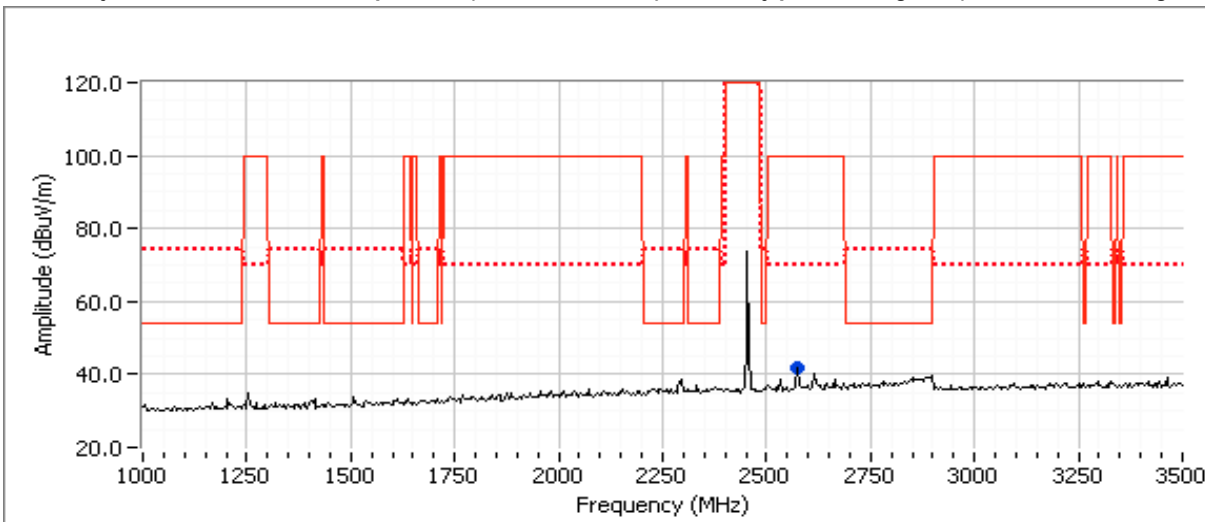

Client:	Intel Corporation	Job Number:	J80398
Model:	Intel® Centrino® Advanced-N 6230	T-Log Number:	T80540
Contact:	Steve Hackett	Account Manager:	Christine Krebill
Standard:	FCC 15.247	Class:	N/A

### Spurious Radiated Emissions, 1 - 7GHz (Scans from 1 - 3.5GHz and 3.5 - 7GHz)

#### Preliminary measurements at ~ 20cm, RB=1MHz, VB=100kHz

Frequency	Level	Pol	15.209/15.247		Detector	Azimuth	Height	Comments
MHz	dBμV/m	v/h	Limit	Margin	Pk/QP/Avg	degrees	meters	
2560.000	40.1	V	100.0	-59.9	Peak	360	1.0	

#### Final measurements at 3m

Frequency	Level	Pol	15.209/15.247		Detector	Azimuth	Height	Comments
MHz	dBμV/m	v/h	Limit	Margin	Pk/QP/Avg	degrees	meters	
<b>2280.000</b>	<b>41.9</b>	H	54.0	<b>-12.1</b>	AVG	0	1.2	RB 1 MHz;VB 10 Hz;Pk Note 2
2320.000	41.7	V	54.0	-12.3	AVG	77	1.3	RB 1 MHz;VB 10 Hz;Pk Note 2
2360.000	39.6	V	54.0	-14.4	AVG	77	1.2	RB 1 MHz;VB 10 Hz;Pk Note 2
2320.000	39.4	H	54.0	-14.6	AVG	206	1.3	RB 1 MHz;VB 10 Hz;Pk Note 2
2360.000	38.1	H	54.0	-15.9	AVG	39	1.2	RB 1 MHz;VB 10 Hz;Pk Note 2
2280.000	37.8	V	54.0	-16.2	AVG	140	1.0	RB 1 MHz;VB 10 Hz;Pk Note 2
2320.000	55.0	V	74.0	-19.0	PK	77	1.3	RB 1 MHz;VB 3 MHz;Pk Note 2
2560.000	50.6	H	70.0	-19.4	PK	168	1.4	RB 1 MHz;VB 3 MHz;Pk Note 2
2560.000	46.9	V	70.0	-23.1	PK	216	1.9	RB 1 MHz;VB 3 MHz;Pk Note 2
2280.000	46.8	H	74.0	-27.2	PK	0	1.2	RB 1 MHz;VB 3 MHz;Pk Note 2
2320.000	46.2	H	74.0	-27.8	PK	206	1.3	RB 1 MHz;VB 3 MHz;Pk Note 2
2360.000	45.4	V	74.0	-28.6	PK	77	1.2	RB 1 MHz;VB 3 MHz;Pk Note 2
2360.000	44.3	H	74.0	-29.7	PK	39	1.2	RB 1 MHz;VB 3 MHz;Pk Note 2
2280.000	44.0	V	74.0	-30.0	PK	140	1.0	RB 1 MHz;VB 3 MHz;Pk Note 2
2560.000	46.3	H	100.0	-53.7	AVG	168	1.4	RB 1 MHz;VB 10 Hz;Pk Note 2
2560.000	40.5	V	100.0	-59.5	AVG	216	1.9	RB 1 MHz;VB 10 Hz;Pk Note 2

Note 1: For emissions in restricted bands, the limit of 15.209 was used. For all other emissions, the limit is -30dBc for peak measurements in a measurement bandwidth of 100kHz.

Note 2: Signal is only present when Bluetooth is enabled, average correction for hopping occupancy could be applied

Client:	Intel Corporation	Job Number:	J80398
Model:	Intel® Centrino® Advanced-N 6230	T-Log Number:	T80540
Contact:	Steve Hackett	Account Manager:	Christine Krebill
Standard:	FCC 15.247	Class:	N/A

**Run # 11, Rainbow Peak 2x2: 1-15GHz, 802.11n20 @ 5300 MHz Chain A and B, BT Basic Rate @ 2440 MHz Chain B**

	Target (dBm)	Power Settings Measured (dBm)	Software Setting
WiFi A	16.5	16.7	32.0
WiFi B	16.5	16.5	31.0
Bluetooth	7.0	5.4	8.0

**Spurious Radiated Emissions, 7 - 15GHz:**  
 Preamplifier and high pass filter used for these scans

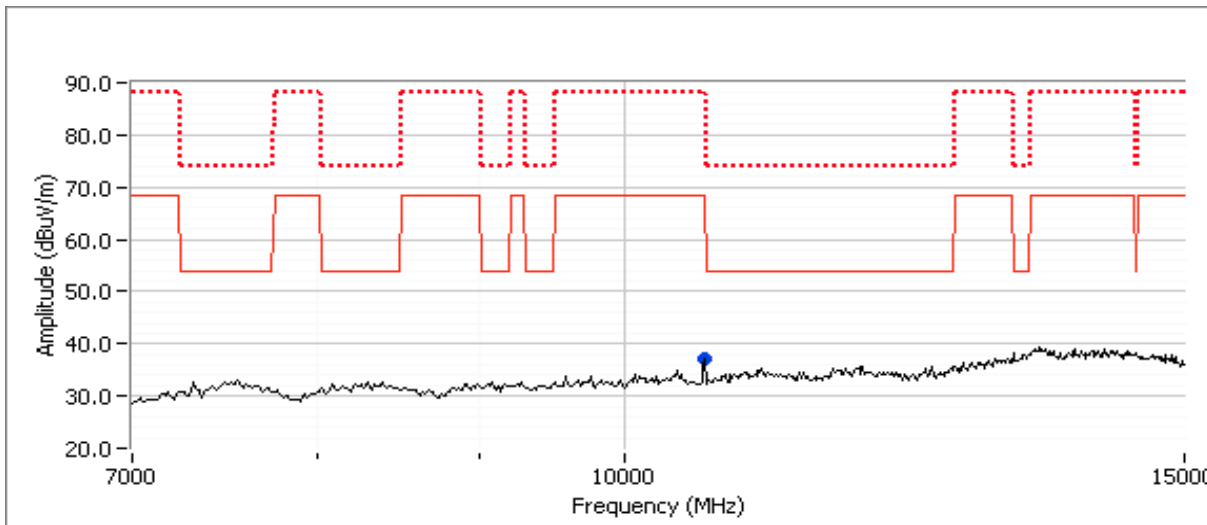

**Preliminary Measurements (Peak versus average limit)**

Frequency	Level	Pol	15.209/15.247/15E		Detector	Azimuth	Height	Comments
MHz	dBμV/m	v/h	Limit	Margin	Pk/QP/Avg	degrees	meters	
<b>10600.000</b>	<b>37.2</b>	V	54.0	<b>-16.8</b>	Peak	182	1.0	

Client:	Intel Corporation	Job Number:	J80398
Model:	Intel® Centrino® Advanced-N 6230	T-Log Number:	T80540
Contact:	Steve Hackett	Account Manager:	Christine Krebill
Standard:	FCC 15.247	Class:	N/A

### Spurious Radiated Emissions, 1 - 7GHz (Scans from 1 - 3.5GHz and 3.5 - 7GHz)

*Preliminary Scan at ~ 20cm from the product (card and antenna) to identify potential signals (Peak versus average limit)*

No preamplifier used for these scans

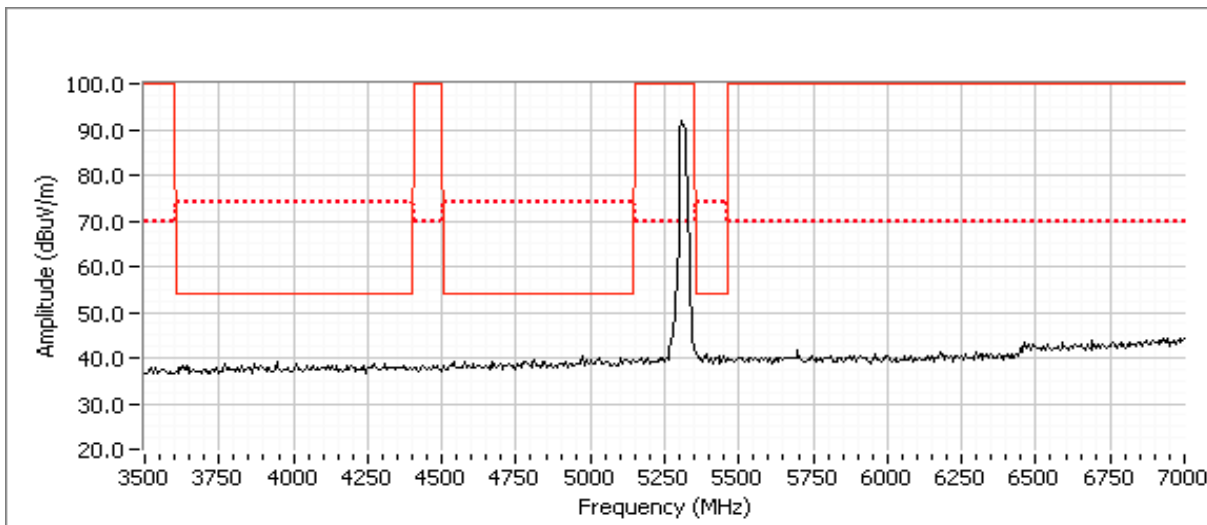
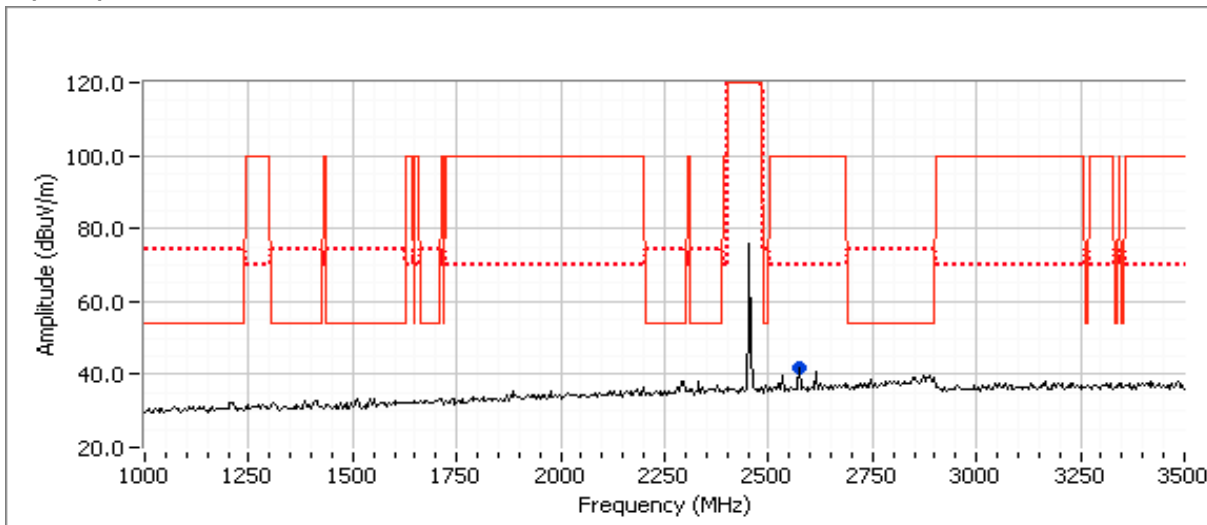

Note 1: The emissions observed above the noise floor are the same as those observed with the Wi-Fi radio at 5200 MHz (Run 10) and are unaffected when the Wi-Fi radio is disabled (powered off). Additional measurements were therefore not necessary.

Client:	Intel Corporation	Job Number:	J80398
Model:	Intel® Centrino® Advanced-N 6230	T-Log Number:	T80540
Contact:	Steve Hackett	Account Manager:	Christine Krebill
Standard:	FCC 15.247	Class:	N/A

**Run # 12, Rainbow Peak 2x2: 1-15GHz, 802.11n20 @ 5600 MHz Chain A and B, BT Basic Rate @ 2440 MHz Chain B**

	Target (dBm)	Power Settings Measured (dBm)	Software Setting
WiFi A	16.5	16.5	34.0
WiFi B	16.5	16.5	34.0
Bluetooth	7.0	5.4	8.0

**Spurious Radiated Emissions, 7 - 15GHz:**  
 Preamplifier and high pass filter used for these scans

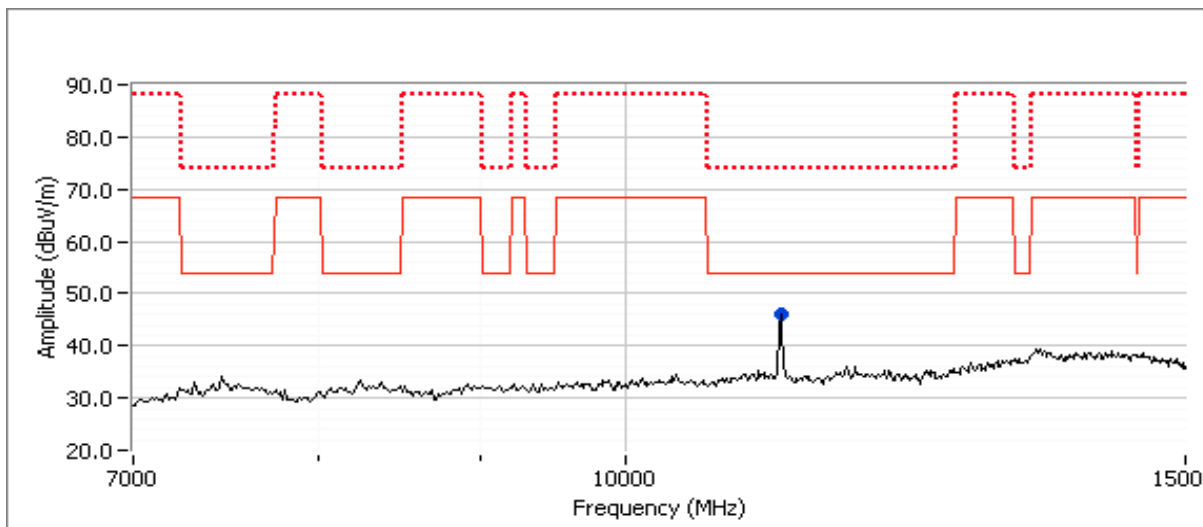

**Preliminary Measurements (Peak versus average limit)**

Frequency	Level	Pol	15.209/15.247/15E		Detector	Azimuth	Height	Comments
MHz	dBuV/m	v/h	Limit	Margin	Pk/QP/Avg	degrees	meters	
11200.340	46.0	V	54.0	-8.0	Peak	188	1.0	

**Final measurements at 3m**

Frequency	Level	Pol	15.209/15.247/15E		Detector	Azimuth	Height	Comments
MHz	dBuV/m	v/h	Limit	Margin	Pk/QP/Avg	degrees	meters	
11199.810	45.1	V	54.0	-8.9	AVG	157	1.9	RB 1 MHz;VB 10 Hz;Pk
11200.110	61.2	V	74.0	-12.8	PK	157	1.9	RB 1 MHz;VB 3 MHz;Pk

Client:	Intel Corporation	Job Number:	J80398
Model:	Intel® Centrino® Advanced-N 6230	T-Log Number:	T80540
Contact:	Steve Hackett	Account Manager:	Christine Krebill
Standard:	FCC 15.247	Class:	N/A

### Spurious Radiated Emissions, 1 - 7GHz (Scans from 1 - 3.5GHz and 3.5 - 7GHz)

*Preliminary Scan at ~ 20cm from the product (card and antenna) to identify potential signals (Peak versus average limit)*

No preamplifier used for these scans

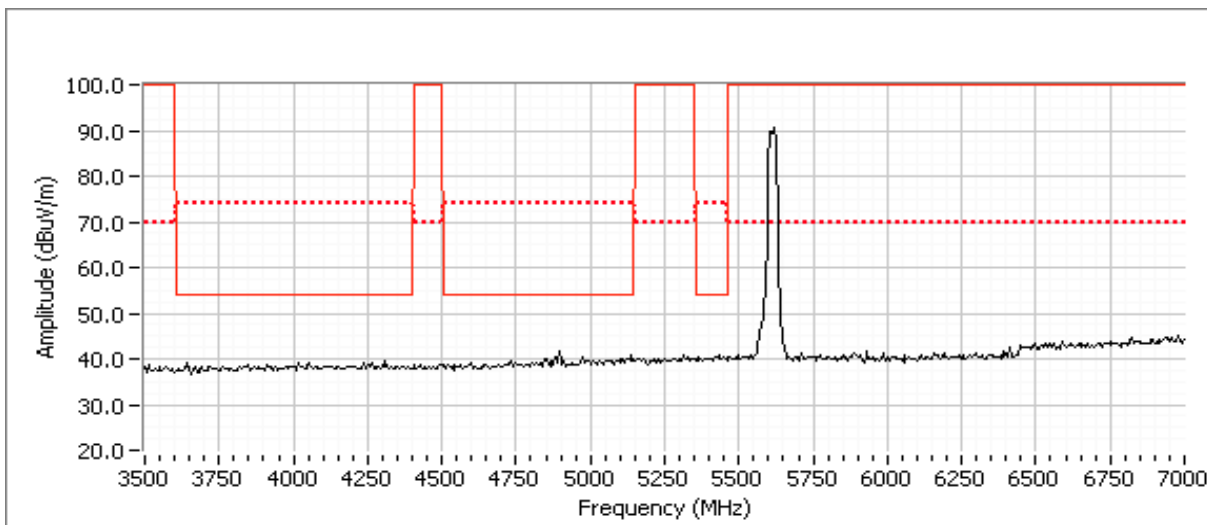
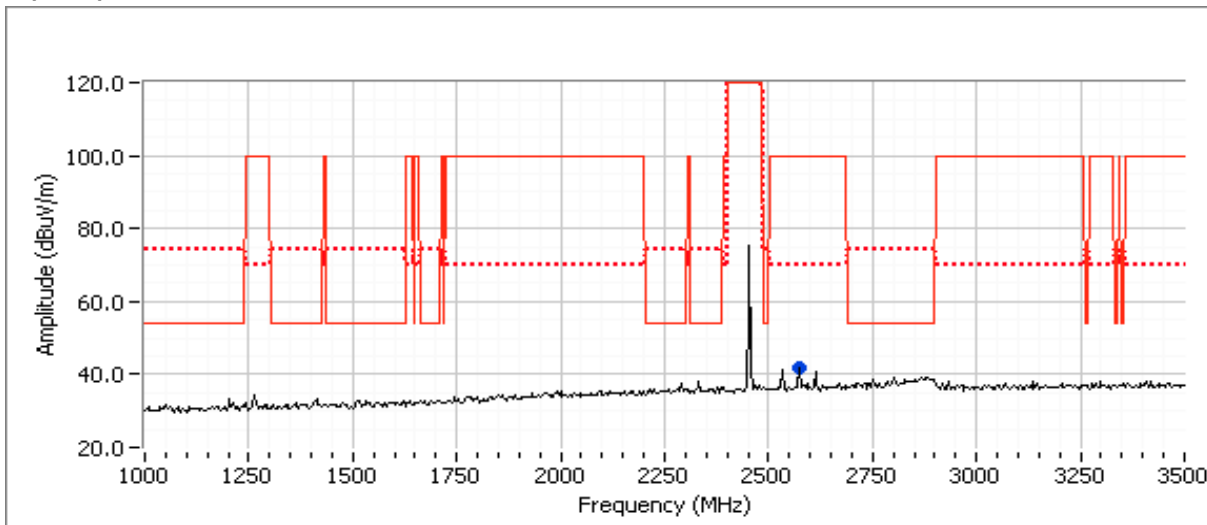

Note 1: The emissions observed above the noise floor are the same as those observed with the Wi-Fi radio at 5200 MHz (Run 10) and are unaffected when the Wi-Fi radio is disabled (powered off). Additional measurements were therefore not necessary.

Client:	Intel Corporation	Job Number:	J80398
Model:	Intel® Centrino® Advanced-N 6230	T-Log Number:	T80540
Contact:	Steve Hackett	Account Manager:	Christine Krebill
Standard:	FCC 15.247	Class:	N/A

**Run # 13, Rainbow Peak 2x2: 1-15GHz, 802.11n20 @ 5785 MHz Chain A and B, BT Basic Rate @ 2440 MHz Chain B**

	Target (dBm)	Power Settings Measured (dBm)	Software Setting
WiFi A	16.5	16.5	35.0
WiFi B	16.5	16.7	34.5
Bluetooth	7.0	5.4	8.0

**Spurious Radiated Emissions, 7 - 15GHz:**  
 Preamplifier and high pass filter used for these scans

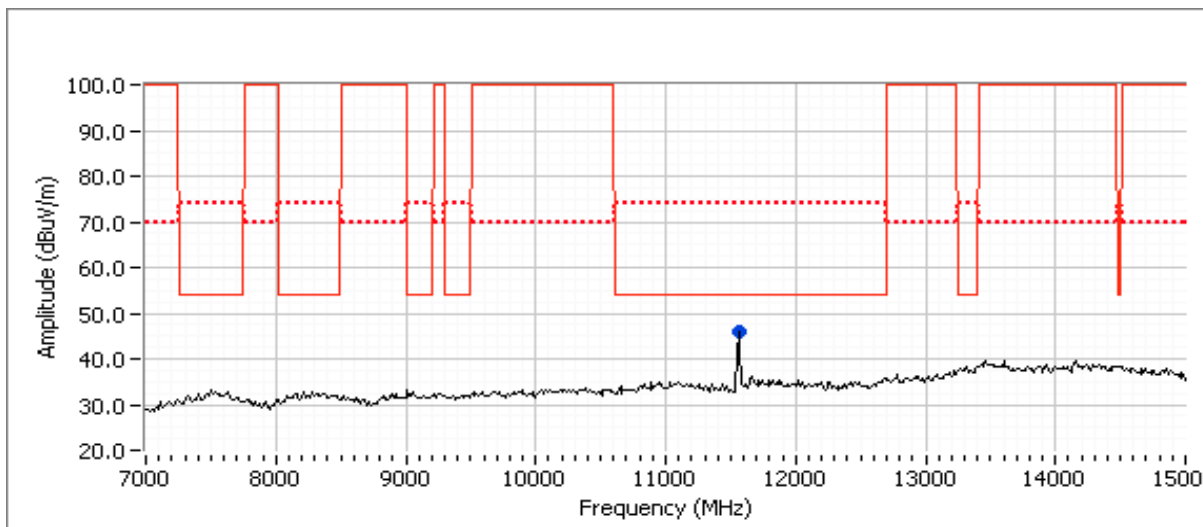

**Preliminary Measurements (Peak versus average limit)**

Frequency	Level	Pol	15.209/15.247/15E		Detector	Azimuth	Height	Comments
MHz	dBμV/m	v/h	Limit	Margin	Pk/QP/Avg	degrees	meters	
11570.410	45.9	V	54.0	-8.1	Peak	187	1.0	

**Final measurements at 3m**

Frequency	Level	Pol	15.209/15.247/15E		Detector	Azimuth	Height	Comments
MHz	dBμV/m	v/h	Limit	Margin	Pk/QP/Avg	degrees	meters	
<b>11570.680</b>	<b>44.7</b>	V	54.0	<b>-9.3</b>	AVG	192	1.4	RB 1 MHz;VB 10 Hz;Pk
11570.280	57.8	V	74.0	-16.2	PK	192	1.4	RB 1 MHz;VB 3 MHz;Pk



Client:	Intel Corporation	Job Number:	J80398
Model:	Intel® Centrino® Advanced-N 6230	T-Log Number:	T80540
Contact:	Steve Hackett	Account Manager:	Christine Krebill
Standard:	FCC 15.247	Class:	N/A

### Spurious Radiated Emissions, 1 - 7GHz (Scans from 1 - 3.5GHz and 3.5 - 7GHz)

*Preliminary Scan at ~ 20cm from the product (card and antenna) to identify potential signals (Peak versus average limit)*

No preamplifier used for these scans

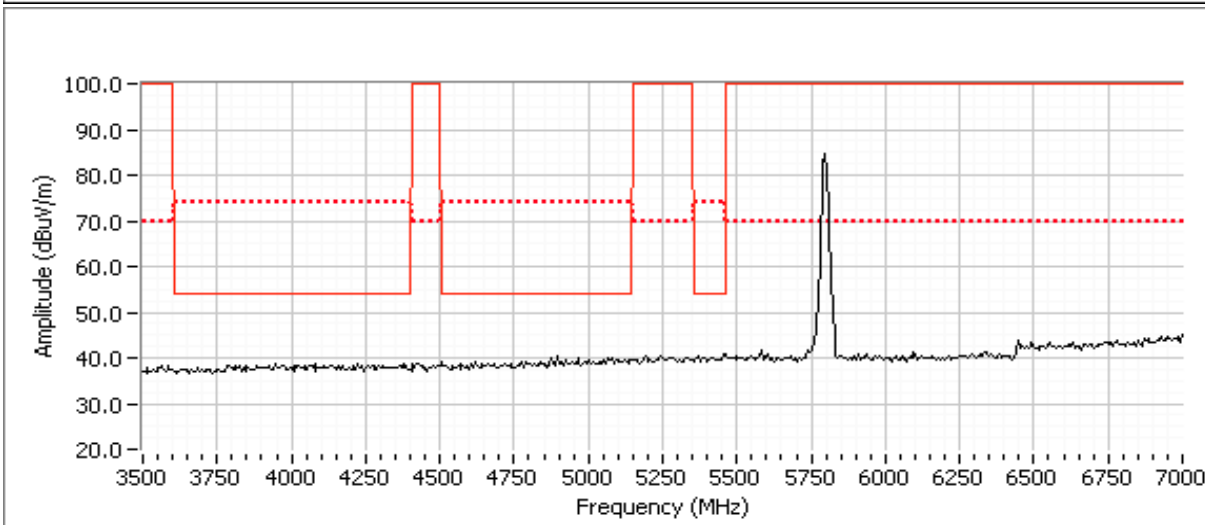
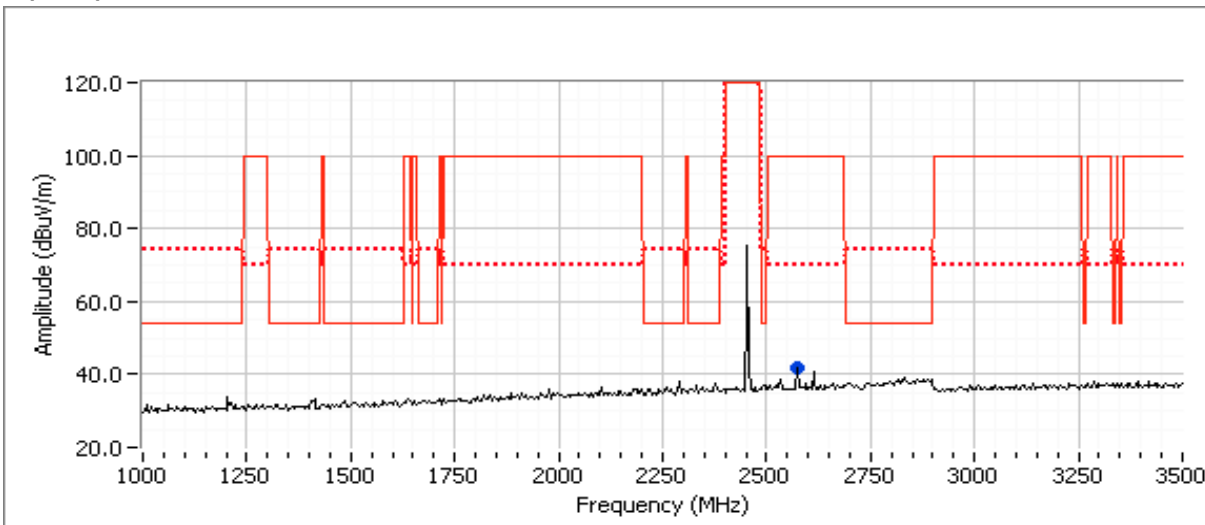

Note 1: The emissions observed above the noise floor are the same as those observed with the Wi-Fi radio at 5200 MHz (Run 10) and are unaffected when the Wi-Fi radio is disabled (powered off). Additional measurements were therefore not necessary.