



EMC Test Report

*Industry Canada RSS-Gen Issue 2 / RSS 210 Issue 7
FCC Part 15 Subpart C*

*Model: Intel® Centrino® Advanced-N 6230 (model
62230HMM)*

IC CERTIFICATION #: 1000M-62230ANH and 1000M-62230ANHU
FCC ID: PD962230ANH and PD962230ANHU

APPLICANT: Intel Corporation
100 Center Point Circle Suite 200
Columbia, SC 29210

TEST SITE(S): Elliott Laboratories
41039 Boyce Road.
Fremont, CA. 94538-2435

IC SITE REGISTRATION #: 2845B-4, 2845B-7

REPORT DATE: October 11, 2010

FINAL TEST DATES: September 13-17, 20, 21, 28, 29, 30, October 1
and 4, 2010

AUTHORIZED SIGNATORY:

A handwritten signature in blue ink that reads "Mark Briggs".

Mark Briggs
Staff Engineer
Elliott Laboratories



Testing Cert #2016.01

Elliott Laboratories is accredited by the A2LA, certificate number 2016-01, to perform the test(s) listed in this report, except where noted otherwise. This report shall not be reproduced, except in its entirety, without the written approval of Elliott Laboratories

REVISION HISTORY

Rev#	Date	Comments	Modified By
1	10-11-2010	First release	

TABLE OF CONTENTS

REVISION HISTORY	2
TABLE OF CONTENTS	3
SCOPE.....	4
OBJECTIVE	4
STATEMENT OF COMPLIANCE.....	5
DEVIATIONS FROM THE STANDARDS.....	5
TEST RESULTS SUMMARY	6
DIGITAL TRANSMISSION SYSTEMS (2400 – 2483.5MHZ).....	6
DIGITAL TRANSMISSION SYSTEMS (5725 –5850 MHZ).....	6
GENERAL REQUIREMENTS APPLICABLE TO ALL BANDS.....	7
ADDITIONAL MEASUREMENTS.....	7
MEASUREMENT UNCERTAINTIES.....	8
EQUIPMENT UNDER TEST (EUT) DETAILS.....	9
GENERAL.....	9
ANTENNA SYSTEM	9
ENCLOSURE.....	9
MODIFICATIONS.....	9
SUPPORT EQUIPMENT.....	10
EUT INTERFACE PORTS	10
EUT OPERATION	10
TEST SITE.....	12
GENERAL INFORMATION.....	12
CONDUCTED EMISSIONS CONSIDERATIONS	12
RADIATED EMISSIONS CONSIDERATIONS	12
MEASUREMENT INSTRUMENTATION	13
RECEIVER SYSTEM	13
INSTRUMENT CONTROL COMPUTER	13
LINE IMPEDANCE STABILIZATION NETWORK (LISN).....	13
FILTERS/ATTENUATORS	14
ANTENNAS.....	14
ANTENNA MAST AND EQUIPMENT TURNTABLE.....	14
INSTRUMENT CALIBRATION.....	14
TEST PROCEDURES	15
EUT AND CABLE PLACEMENT	15
CONDUCTED EMISSIONS.....	15
RADIATED EMISSIONS.....	15
RADIATED EMISSIONS.....	16
BANDWIDTH MEASUREMENTS	19
SPECIFICATION LIMITS AND SAMPLE CALCULATIONS	19
CONDUCTED EMISSIONS SPECIFICATION LIMITS: FCC 15.207; FCC 15.107(A), RSS GEN	19
GENERAL TRANSMITTER RADIATED EMISSIONS SPECIFICATION LIMITS	20
RECEIVER RADIATED SPURIOUS EMISSIONS SPECIFICATION LIMITS	20
OUTPUT POWER LIMITS – DIGITAL TRANSMISSION SYSTEMS	21
TRANSMIT MODE SPURIOUS RADIATED EMISSIONS LIMITS – FHSS AND DTS SYSTEMS.....	21
SAMPLE CALCULATIONS - CONDUCTED EMISSIONS	21
SAMPLE CALCULATIONS - RADIATED EMISSIONS.....	22
APPENDIX A TEST EQUIPMENT CALIBRATION DATA	1
APPENDIX B TEST DATA	4

SCOPE

An electromagnetic emissions test has been performed on the Intel Corporation model Intel® Centrino® Advanced-N 6230 (model 62230HMW), pursuant to the following rules:

- Industry Canada RSS-Gen Issue 2
- RSS 210 Issue 7 “Low-power Licence-exempt Radiocommunication Devices (All Frequency Bands): Category I Equipment”
- FCC Part 15 Subpart C

Conducted and radiated emissions data has been collected, reduced, and analyzed within this report in accordance with measurement guidelines set forth in the following reference standards and as outlined in Elliott Laboratories test procedures:

- ANSI C63.4:2003
- FCC DTS Measurement Procedure KDB558074, March 2005

The intentional radiator above has been tested in a simulated typical installation to demonstrate compliance with the relevant Industry Canada performance and procedural standards.

Final system data was gathered in a mode that tended to maximize emissions by varying orientation of EUT, orientation of power and I/O cabling, antenna search height, and antenna polarization.

Every practical effort was made to perform an impartial test using appropriate test equipment of known calibration. All pertinent factors have been applied to reach the determination of compliance.

OBJECTIVE

The primary objective of the manufacturer is compliance with the regulations outlined in the previous section.

Prior to marketing in the USA, all unlicensed transmitters and transceivers require certification. Receive-only devices operating between 30 MHz and 960 MHz are subject to either certification or a manufacturer’s declaration of conformity, with all other receive-only devices exempt from the technical requirements.

Prior to marketing in Canada, Class I transmitters, receivers and transceivers require certification. Class II devices are required to meet the appropriate technical requirements but are exempt from certification requirements.

Certification is a procedure where the manufacturer submits test data and technical information to a certification body and receives a certificate or grant of equipment authorization upon successful completion of the certification body’s review of the submitted documents. Once the equipment authorization has been obtained, the label indicating compliance must be attached to all identical units, which are subsequently manufactured.

Maintenance of compliance is the responsibility of the manufacturer. Any modification of the product which may result in increased emissions should be checked to ensure compliance has been maintained (i.e., printed circuit board layout changes, different line filter, different power supply, harnessing or I/O cable changes, etc.).

STATEMENT OF COMPLIANCE

The tested sample of Intel Corporation model Intel® Centrino® Advanced-N 6230 (model 62230HMW) complied with the requirements of the following regulations:

Industry Canada RSS-Gen Issue 2

RSS 210 Issue 7 "Low-power Licence-exempt Radiocommunication Devices (All Frequency Bands): Category I Equipment"

FCC Part 15 Subpart C

Maintenance of compliance is the responsibility of the manufacturer. Any modifications to the product should be assessed to determine their potential impact on the compliance status of the device with respect to the standards detailed in this test report.

The test results recorded herein are based on a single type test of Intel Corporation model Intel® Centrino® Advanced-N 6230 (model 62230HMW) and therefore apply only to the tested sample. The sample was selected and prepared by Steve Hackett of Intel Corporation.

DEVIATIONS FROM THE STANDARDS

No deviations were made from the published requirements listed in the scope of this report.

TEST RESULTS SUMMARY**DIGITAL TRANSMISSION SYSTEMS (2400 – 2483.5MHz)**

FCC Rule Part	RSS Rule Part	Description	Measured Value / Comments	Limit / Requirement	Result
15.247(a)	RSS 210 A8.2	Digital Modulation	Systems uses OFDM / DSSS techniques	System must utilize digital transmission technology	Complies
15.247 (a) (2)	RSS 210 A8.2 (1)	6dB Bandwidth	10.0 MHz	>500kHz	Complies
15.247 (b) (3)	RSS 210 A8.2 (4)	Output Power (multipoint systems)	802.11b: 49 mW 802.11g: 38 mW n20: 41 mW n40: 34 mW EIRP max = 102mW	1 Watt, EIRP limited to 4 Watts.	Complies
15.247(d)	RSS 210 A8.2 (2)	Power Spectral Density	-6.9 dBm / 3kHz	8dBm/3kHz	Complies
15.247(c)	RSS 210 A8.5	Antenna Port Spurious Emissions 30MHz – 25 GHz	All spurious more than -30dBc.	< -30dBc ^{Note 2}	Complies
15.247(c) / 15.209	RSS 210 A8.5	Radiated Spurious Emissions 30MHz – 25 GHz	53.0dBμV/m @ 2390.0MHz	15.207 in restricted bands, all others <-30dBc ^{Note 2}	Complies (-1.0dB)
Note 1: EIRP calculated using antenna gain of 3.2 dBi for the highest EIRP system.					
Note 2: Limit of -30dBc used because the power was measured using the UNII test procedure (maximum power averaged over a transmission burst).					

DIGITAL TRANSMISSION SYSTEMS (5725 –5850 MHz)

FCC Rule Part	RSS Rule Part	Description	Measured Value / Comments	Limit / Requirement	Result
15.247(a)	RSS 210 A8.2	Digital Modulation	Systems uses OFDM techniques	System must utilize digital transmission technology	Complies
15.247 (a) (2)	RSS 210 A8.2 (1)	6dB Bandwidth	16.3MHz	>500kHz	Complies
15.247 (b)	RSS 210 A8.2 (4)	Output Power (multipoint systems)	802.11a: 39.8 mW n20: 39.8 mW n40: 246 mW EIRP = 0.778 W ^{Note 1}	1 Watt, EIRP limited to 4 Watts.	Complies
15.247(d)	RSS 210 A8.2 (2)	Power Spectral Density	-7.7 dBm / 3kHz	Maximum permitted is 8dBm/3kHz	Complies
15.247(c)	RSS 210 A8.5	Antenna Port Spurious Emissions – 30MHz – 40 GHz	All spurious emissions < -20dBc for n40 mode and below -30dBc for 802.11a and n20 modes.	< -20dBc < -30dBc ^{Note 2}	Complies
15.247(c) / 15.209	RSS 210 A8.5 Table 2, 3	Radiated Spurious Emissions 30MHz – 40 GHz	49.4dBμV/m @ 11650.5MHz	15.207 in restricted bands, all others < -20dBc / <-30dBc ²	Complies (-4.6dB)
Note 1: EIRP calculated using antenna gain of 5.0 dBi for the highest EIRP system.					
Note 2: Limit of -30dBc used for 802.11a and 802.11n 20MHz modes because the power was measured using the UNII test procedure (maximum power averaged over a transmission burst). The limit for 802.11n 40MHz mode was -20dBc because the power measurements are peak power measurements.					

GENERAL REQUIREMENTS APPLICABLE TO ALL BANDS

FCC Rule Part	RSS Rule part	Description	Measured Value / Comments	Limit / Requirement	Result (margin)
15.203	-	RF Connector	Unique	Integral or unique connector required	Complies
15.109	RSS GEN 7.2.3 Table 1	Receiver spurious emissions	41.2dB μ V/m @ 662.52MHz	Refer to page 20	Complies (-4.8dB)
15.207	RSS GEN Table 2	AC Conducted Emissions	40.6dB μ V @ 14.758MHz	Refer to page 19	Complies (-9.4dB)
15.247 (b) (5) 15.407 (f)	RSS 102	RF Exposure Requirements	Refer to MPE calculations, RSS 102 declaration and User Manual pages 8, 12	Refer to OET 65, FCC Part 1 and RSS 102	Complies
-	RSP 100 RSS GEN 7.1.5	User Manual	Refer to pages 11 and 12 of the user's manual	Statement required regarding non-interference	Complies
-	RSP 100 RSS GEN 7.1.5	User Manual	Not applicable, antenna is integral to host systems.	Statement for products with detachable antenna	N/A
-	RSP 100 RSS GEN 4.4.1	99% Bandwidth (2400-2483.5MHz)	802.11b: 13.6 MHz 802.11g: 17.1 MHz n20: 18.3 MHz n40: 36.6 MHz	Information only	N/A
		99% Bandwidth (5725-5850 MHz)	802.11a: 17.6MHz n20: 18.7 MHz n40: 38.8 MHz		

ADDITIONAL MEASUREMENTS

As both Bluetooth and 802.11 transmissions can occur simultaneously, radiated spurious measurements were made with both Bluetooth and 802.11 devices transmitting simultaneously.

FCC Rule Part	RSS Rule part	Description	Measured Value / Comments	Limit / Requirement	Result (margin)
15.2109	RSS 210	Spurious emissions	49.3dB μ V/m @ 2320.0MHz	15.209 in restricted bands, all others < -20dBc	Complies (-4.7dB)

MEASUREMENT UNCERTAINTIES

ISO/IEC 17025 requires that an estimate of the measurement uncertainties associated with the emissions test results be included in the report. The measurement uncertainties given below are based on a 95% confidence level and were calculated in accordance with UKAS document LAB 34.

Measurement Type	Measurement Unit	Frequency Range	Expanded Uncertainty
RF power, conducted (power meter)	dBm	25 to 7000 MHz	± 0.52 dB
RF power, conducted (Spectrum analyzer)	dBm	25 to 7000 MHz	± 0.7 dB
Conducted emission of transmitter	dBm	25 to 26500 MHz	± 0.7 dB
Conducted emission of receiver	dBm	25 to 26500 MHz	± 0.7 dB
Radiated emission (substitution method)	dBm	25 to 26500 MHz	± 2.5 dB
Radiated emission (field strength)	dB μ V/m	25 to 1000 MHz	± 3.6 dB
		1000 to 40000 MHz	± 6.0 dB
Conducted Emissions (AC Power)	dB μ V	0.15 to 30 MHz	± 2.4 dB

EQUIPMENT UNDER TEST (EUT) DETAILS**GENERAL**

The Intel Corporation model Intel® Centrino® Advanced-N 6230 (model 62230HMW) is a PCIe half mini card form factor Bluetooth/IEEE 802.11a/b/g/n wireless network adapter. The card supports MIMO (2x2) for 802.11n modes and MISO (1x2) for 802.11a/b/g modes. Bluetooth only operation mode is a 1x1. When Bluetooth is operational then 802.11b/g/n modes operate as SISO (1x1). 802.11a/n modes still operate as MIMO (2x2) with Bluetooth operational.

The card is sold under two different FCC/IC ID numbers (see table below). The ID's ending in "U" are intended to allow user install conditions and host systems must be provided with a BIOS locking feature that prevents installation of unauthorized devices.

For radio testing purposes the card was installed in a test fixture that exposed all sides of the card. For digital device testing for certification under equipment code JBP the card was installed inside a laptop PC.

The sample was received on September 13, 2010 and tested on September 13-17, 20, 21, 28, 29, 30, October 1 and 4, 2010. The EUT consisted of the following component(s):

Manufacturer	Model	Description	MAC Address	FCC ID and Canada UPN
Intel Corporation	62230ANHMW	PCIe Half Mini Card form factor Bluetooth / IEEE 802.11a/b/g/n wireless network adapter	00150079AD10	PD962230ANH PD962230ANHU 1000M-62230ANH
	62230ANHU			1000M-62230ANHU

ANTENNA SYSTEM

The EUT antenna is a two-antenna PIFA antenna system – Shanghai Universe Communication Electron Co., Ltd. The antenna connects to the EUT via a non-standard antenna connector, thereby meeting the requirements of FCC 15.203.

ENCLOSURE

The EUT does not have an enclosure as it is designed to be installed within the enclosure of a host computer or system.

MODIFICATIONS

No modifications were made to the EUT during the time the product was at Elliott.

SUPPORT EQUIPMENT

The following equipment was used as support equipment for testing:

Company	Model	Description	Serial Number	FCC ID
Intel Corporation	-	Test Fixture	D9164573K0B0	N/A
DELL	Latitude D520	Laptop PC	HM9383J	N/A
Agilent	E3610A	DC Supply	MY4001740	N/A

EUT INTERFACE PORTS

The I/O cabling configuration during testing was as follows:

Port	Connected To	Description	Cable(s)	
			Shielded or Unshielded	Length(m)
Laptop USB	Fixture USB	USB cable	Shielded	
Laptop Mini PCI	Fixture PCIe	Ribbon	unshielded	
DC Power	Fixture DC power	2-wire	unshielded	

EUT OPERATION

The EUT was installed into a test fixture that exposed all sides of the card. The test fixture interfaced to a laptop computer and dc power supply. The laptop computer was used to configure the EUT to continuously transmit at a specified output power or continuously receive on the channel specified in the test data. For transmit mode measurements the system was configured to operate in each of the available operating modes – 802.11a, 802.11b, 802.11g, 802.11n (20 MHz channel bandwidth) and 802.11n (40MHz channel bandwidth), Bluetooth 1Mb/s and Bluetooth 3Mb/s. In addition radiated spurious tests were repeated with the device operating in both Bluetooth and 802.11 modes to determine if any spurious emissions due to inter-modulation products were created.

The data rates used when evaluating the WiFi transmitter were the lowest data rates for each 802.11 mode – 1Mb/s for 802.11b, 6Mb/s for 802.11a and 802.11g, 6.5MB/s for 802.11n (20MHz), and 13 Mb/s for 802.11n (40MHz). The device operates at its maximum output power at the lowest data rate (this was confirmed through separate measurements – refer to test data for actual measurements).

The field strength at the band edges was evaluated for each mode and on each chain individually on the lowest and highest channels at the rated power for the channel under test. Where the power at the edge channels was lower than the power at the center channels additional measurements were made at the adjacent channels. MIMO and SISO modes were fully evaluated.

Spurious emissions measurements at frequencies away from the band edges were made at the highest power rating for the band in each mode. For 802.11n modes both chains were active (MIMO mode) but with each chain at the highest power rating per chain (MIMO power setting) to cover both modes of operation at the same time.

Bluetooth operation was evaluated at both 1Mb/s and 3Mb/s data rates. 2Mb/s data rate was found, through preliminary testing, to produce emissions similar to those for 3Mb/s.

Receiver spurious emissions in 802.11 modes were evaluated in single chain and multi-chain modes. Bluetooth receiver spurious were evaluated for single chain only as MISO is not supported for Bluetooth.

The PC was using the Intel test utility DRTU Version 1.2.12-0197 and the device driver was version 14.0.0.39.

TEST SITE**GENERAL INFORMATION**

Final test measurements were taken at the test sites listed below. Pursuant to section 2.948 of the FCC's Rules and section 3.3 of RSP-100, construction, calibration, and equipment data has been filed with the Commission and with industry Canada.

Site	Registration Numbers		Location
	FCC	Canada	
Chamber 4	211948	2845B-4	41039 Boyce Road Fremont, CA 94538-2435
Chamber 7	A2LA accreditation	2845B-7	

ANSI C63.4:2003 recommends that ambient noise at the test site be at least 6 dB below the allowable limits. Ambient levels are below this requirement. The test site(s) contain separate areas for radiated and conducted emissions testing. Considerable engineering effort has been expended to ensure that the facilities conform to all pertinent requirements of ANSI C63.4:2003.

CONDUCTED EMISSIONS CONSIDERATIONS

Conducted emissions testing is performed in conformance with ANSI C63.4:2003. Measurements are made with the EUT connected to the public power network through a nominal, standardized RF impedance, which is provided by a line impedance stabilization network, known as a LISN. A LISN is inserted in series with each current-carrying conductor in the EUT power cord.

RADIATED EMISSIONS CONSIDERATIONS

The FCC has determined that radiation measurements made in a shielded enclosure are not suitable for determining levels of radiated emissions. Radiated measurements are performed in an open field environment or in a semi-anechoic chamber. The test sites are maintained free of conductive objects within the CISPR defined elliptical area incorporated in ANSI C63.4:2003 guidelines and meet the Normalized Site Attenuation (NSA) requirements of ANSI C63.4:2003.

MEASUREMENT INSTRUMENTATION

RECEIVER SYSTEM

An EMI receiver as specified in CISPR 16-1-1 is used for emissions measurements. The receivers used can measure over the frequency range of 9 kHz up to 2000 MHz. These receivers allow both ease of measurement and high accuracy to be achieved. The receivers have Peak, Average, and CISPR (Quasi-peak) detectors built into their design so no external adapters are necessary. The receiver automatically sets the required bandwidth for the CISPR detector used during measurements. If the repetition frequency of the signal being measured is below 20Hz, peak measurements are made in lieu of Quasi-Peak measurements.

For measurements above the frequency range of the receivers, a spectrum analyzer is utilized because it provides visibility of the entire spectrum along with the precision and versatility required to support engineering analysis. Average measurements above 1000MHz are performed on the spectrum analyzer using the linear-average method with a resolution bandwidth of 1 MHz and a video bandwidth of 10 Hz, unless the signal is pulsed in which case the average (or video) bandwidth of the measuring instrument is reduced to onset of pulse desensitization and then increased.

INSTRUMENT CONTROL COMPUTER

The receivers utilize either a Rohde & Schwarz EZM Spectrum Monitor/Controller or contain an internal Spectrum Monitor/Controller to view and convert the receiver measurements to the field strength at an antenna or voltage developed at the LISN measurement port, which is then compared directly with the appropriate specification limit. This provides faster, more accurate readings by performing the conversions described under Sample Calculations within the Test Procedures section of this report. Results are printed in a graphic and/or tabular format, as appropriate. A personal computer is used to record all measurements made with the receivers.

The Spectrum Monitor provides a visual display of the signal being measured. In addition, the controller or a personal computer run automated data collection programs which control the receivers. This provides added accuracy since all site correction factors, such as cable loss and antenna factors are added automatically.

LINE IMPEDANCE STABILIZATION NETWORK (LISN)

Line conducted measurements utilize a fifty microhenry Line Impedance Stabilization Network as the monitoring point. The LISN used also contains a 250 uH CISPR adapter. This network provides for calibrated radio frequency noise measurements by the design of the internal low pass and high pass filters on the EUT and measurement ports, respectively.

FILTERS/ATTENUATORS

External filters and precision attenuators are often connected between the receiving antenna or LISN and the receiver. This eliminates saturation effects and non-linear operation due to high amplitude transient events.

ANTENNAS

A loop antenna is used below 30 MHz. For the measurement range 30 MHz to 1000 MHz either a combination of a biconical antenna and a log periodic or a bi-log antenna is used. Above 1000 MHz, horn antennas are used. The antenna calibration factors to convert the received voltage to an electric field strength are included with appropriate cable loss and amplifier gain factors to determine an overall site factor, which is then programmed into the test receivers or incorporated into the test software.

ANTENNA MAST AND EQUIPMENT TURNTABLE

The antennas used to measure the radiated electric field strength are mounted on a non-conductive antenna mast equipped with a motor-drive to vary the antenna height. Measurements below 30 MHz are made with the loop antenna at a fixed height of 1m above the ground plane.

ANSI C63.4:2003 specifies that the test height above ground for table mounted devices shall be 80 centimeters. Floor mounted equipment shall be placed on the ground plane if the device is normally used on a conductive floor or separated from the ground plane by insulating material from 3 to 12 mm if the device is normally used on a non-conductive floor. During radiated measurements, the EUT is positioned on a motorized turntable in conformance with this requirement.

INSTRUMENT CALIBRATION

All test equipment is regularly checked to ensure that performance is maintained in accordance with the manufacturer's specifications. All antennas are calibrated at regular intervals with respect to tuned half-wave dipoles. An exhibit of this report contains the list of test equipment used and calibration information.

TEST PROCEDURES

EUT AND CABLE PLACEMENT

The regulations require that interconnecting cables be connected to the available ports of the unit and that the placement of the unit and the attached cables simulate the worst case orientation that can be expected from a typical installation, so far as practicable. To this end, the position of the unit and associated cabling is varied within the guidelines of ANSI C63.4:2003, and the worst-case orientation is used for final measurements.

CONDUCTED EMISSIONS

Conducted emissions are measured at the plug end of the power cord supplied with the EUT. Excess power cord length is wrapped in a bundle between 30 and 40 centimeters in length near the center of the cord. Preliminary measurements are made to determine the highest amplitude emission relative to the specification limit for all the modes of operation. Placement of system components and varying of cable positions are performed in each mode. A final peak mode scan is then performed in the position and mode for which the highest emission was noted on all current carrying conductors of the power cord.

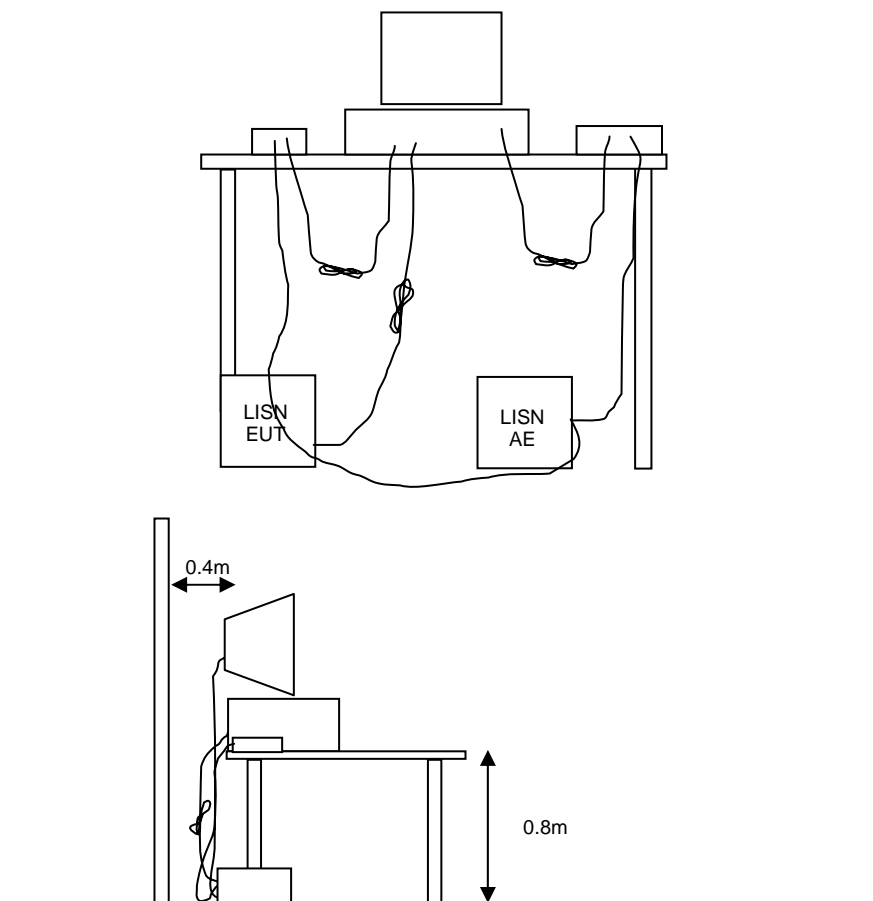

RADIATED EMISSIONS

A preliminary scan of the radiated emissions is performed in which all significant EUT frequencies are identified with the system in a nominal configuration. At least two scans are performed, one scan for each antenna polarization (horizontal and vertical; loop parallel and perpendicular to the EUT). During the preliminary scans, the EUT is rotated through 360°, the antenna height is varied (for measurements above 30 MHz) and cable positions are varied to determine the highest emission relative to the limit. Preliminary scans may be performed in a fully anechoic chamber for the purposes of identifying the frequencies of the highest emissions from the EUT.

A speaker is provided in the receiver to aid in discriminating between EUT and ambient emissions. Other methods used during the preliminary scan for EUT emissions involve scanning with near field magnetic loops, monitoring I/O cables with RF current clamps, and cycling power to the EUT.

Final maximization is a phase in which the highest amplitude emissions identified in the spectral search are viewed while the EUT azimuth angle is varied from 0 to 360 degrees relative to the receiving antenna. The azimuth, which results in the highest emission is then maintained while varying the antenna height from one to four meters (for measurements above 30 MHz, measurements below 30 MHz are made with the loop antenna at a fixed height of 1m). The result is the identification of the highest amplitude for each of the highest peaks. Each recorded level is corrected in the receiver using appropriate factors for cables, connectors, antennas, and preamplifier gain.

When testing above 18 GHz, the receive antenna is located at 1 meter from the EUT and the antenna height is restricted to a maximum of 2.5 meters.

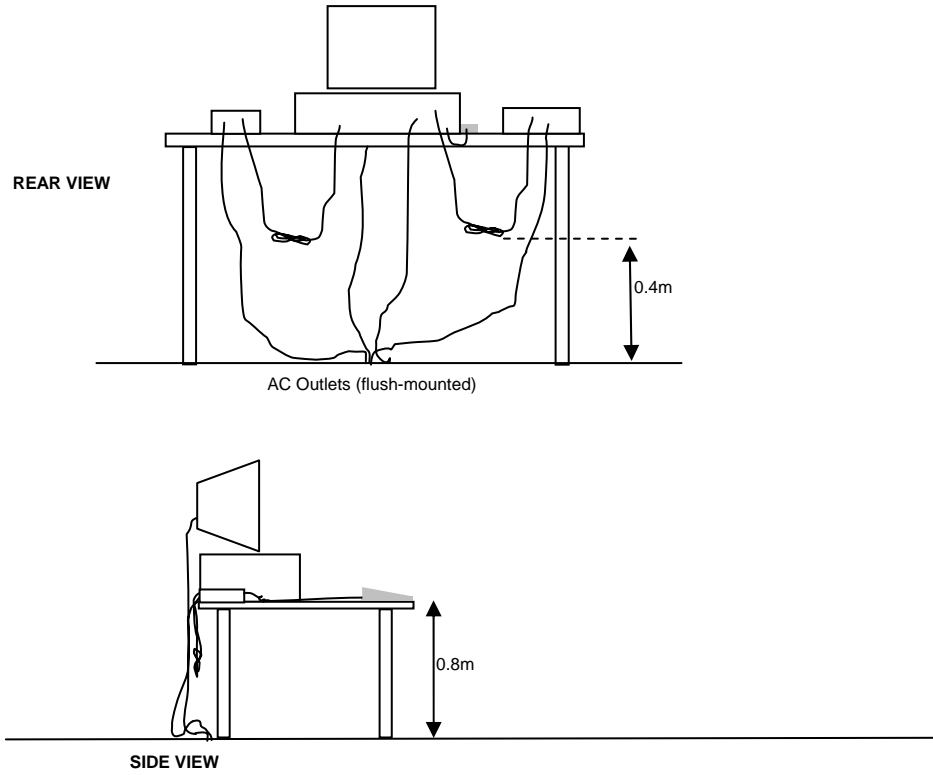

Typical Test Configuration for Radiated Field Strength Measurements

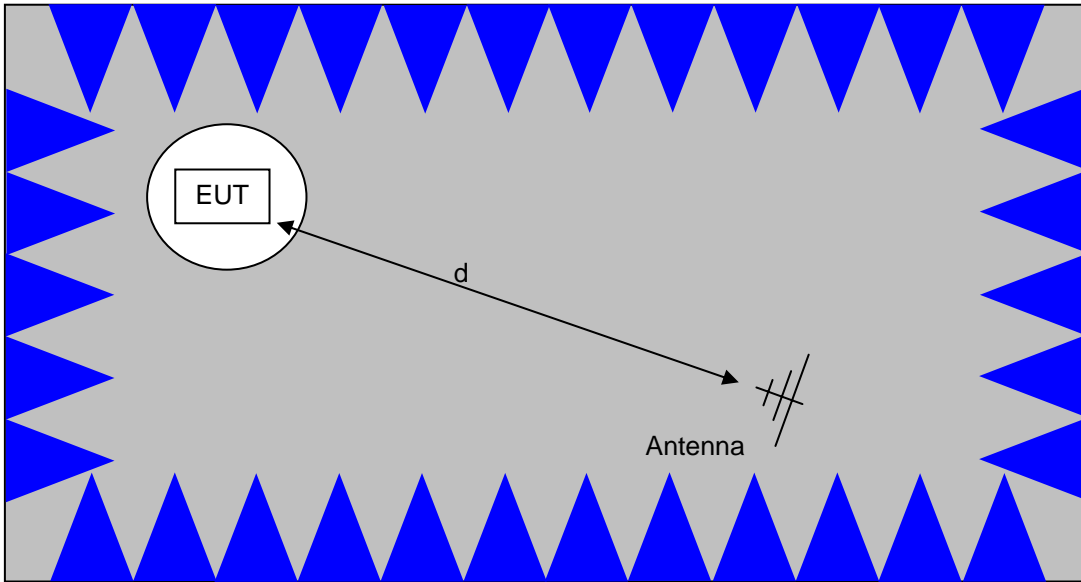

The anechoic materials on the walls and ceiling ensure compliance with the normalized site attenuation requirements of CISPR 16 / CISPR 22 / ANSI C63.4 for an alternate test site at the measurement distances used.

Floor-standing equipment is placed on the floor with insulating supports between the unit and the ground plane.

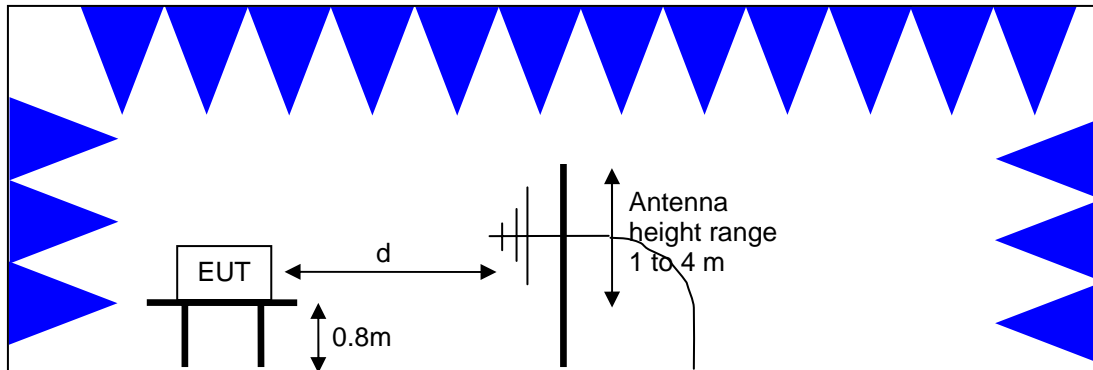

Test Configuration for Radiated Field Strength Measurements
Semi-Anechoic Chamber, Plan and Side Views

BANDWIDTH MEASUREMENTS

The 6dB, 20dB and/or 26dB signal bandwidth is measured in using the bandwidths recommended by ANSI C63.4. When required, the 99% bandwidth is measured using the methods detailed in RSS GEN.

SPECIFICATION LIMITS AND SAMPLE CALCULATIONS

The limits for conducted emissions are given in units of microvolts, and the limits for radiated emissions are given in units of microvolts per meter at a specified test distance. Data is measured in the logarithmic form of decibels relative to one microvolt, or dB microvolts (dBuV). For radiated emissions, the measured data is converted to the field strength at the antenna in dB microvolts per meter (dBuV/m). The results are then converted to the linear forms of uV and uV/m for comparison to published specifications.

For reference, converting the specification limits from linear to decibel form is accomplished by taking the base ten logarithm, then multiplying by 20. These limits in both linear and logarithmic form are as follows:

CONDUCTED EMISSIONS SPECIFICATION LIMITS: FCC 15.207; FCC 15.107(a), RSS GEN

The table below shows the limits for the emissions on the AC power line from an intentional radiator and a receiver.

Frequency (MHz)	Average Limit (dBuV)	Quasi Peak Limit (dBuV)
0.150 to 0.500	Linear decrease on logarithmic frequency axis between 56.0 and 46.0	Linear decrease on logarithmic frequency axis between 66.0 and 56.0
0.500 to 5.000	46.0	56.0
5.000 to 30.000	50.0	60.0

GENERAL TRANSMITTER RADIATED EMISSIONS SPECIFICATION LIMITS

The table below shows the limits for the spurious emissions from transmitters that fall in restricted bands¹ (with the exception of transmitters operating under FCC Part 15 Subpart D and RSS 210 Annex 9), the limits for all emissions from a low power device operating under the general rules of RSS 310 (tables 3 and 4), RSS 210 (table 2) and FCC Part 15 Subpart C section 15.209.

Frequency Range (MHz)	Limit (uV/m)	Limit (dBuV/m @ 3m)
0.009-0.490	2400/F _{KHz} @ 300m	67.6-20*log ₁₀ (F _{KHz}) @ 300m
0.490-1.705	24000/F _{KHz} @ 30m	87.6-20*log ₁₀ (F _{KHz}) @ 30m
1.705 to 30	30 @ 30m	29.5 @ 30m
30 to 88	100 @ 3m	40 @ 3m
88 to 216	150 @ 3m	43.5 @ 3m
216 to 960	200 @ 3m	46.0 @ 3m
Above 960	500 @ 3m	54.0 @ 3m

RECEIVER RADIATED SPURIOUS EMISSIONS SPECIFICATION LIMITS

The table below shows the limits for the spurious emissions from receivers as detailed in FCC Part 15.109, RSS 210 Table 2, RSS GEN Table 1 and RSS 310 Table 3. Note that receivers operating outside of the frequency range 30 MHz – 960 MHz are exempt from the requirements of 15.109.

Frequency Range (MHz)	Limit (uV/m @ 3m)	Limit (dBuV/m @ 3m)
30 to 88	100	40
88 to 216	150	43.5
216 to 960	200	46.0
Above 960	500	54.0

¹ The restricted bands are detailed in FCC 15.203, RSS 210 Table 1 and RSS 310 Table 2

OUTPUT POWER LIMITS – DIGITAL TRANSMISSION SYSTEMS

The table below shows the limits for output power and output power density. Where the signal bandwidth is less than 20 MHz the maximum output power is reduced to the power spectral density limit plus 10 times the log of the bandwidth (in MHz).

Operating Frequency (MHz)	Output Power	Power Spectral Density
902 – 928	1 Watt (30 dBm)	8 dBm/3kHz
2400 – 2483.5	1 Watt (30 dBm)	8 dBm/3kHz
5725 – 5850	1 Watt (30 dBm)	8 dBm/3kHz

The maximum permitted output power is reduced by 1dB for every dB the antenna gain exceeds 6dBi. Fixed point-to-point applications using the 5725 – 5850 MHz band are not subject to this restriction.

TRANSMIT MODE SPURIOUS RADIATED EMISSIONS LIMITS – FHSS and DTS SYSTEMS

The limits for unwanted (spurious) emissions from the transmitter falling in the restricted bands are those specified in the general limits sections of FCC Part 15 and RSS 210. All other unwanted (spurious) emissions shall be at least 20dB below the level of the highest in-band signal level (30dB if the power is measured using the sample detector/power averaging method).

SAMPLE CALCULATIONS - CONDUCTED EMISSIONS

Receiver readings are compared directly to the conducted emissions specification limit (decibel form) as follows:

$$R_r - S = M$$

where:

R_r = Receiver Reading in dBuV

S = Specification Limit in dBuV

M = Margin to Specification in +/- dB

SAMPLE CALCULATIONS - RADIATED EMISSIONS

Receiver readings are compared directly to the specification limit (decibel form). The receiver internally corrects for cable loss, preamplifier gain, and antenna factor. The calculations are in the reverse direction of the actual signal flow, thus cable loss is added and the amplifier gain is subtracted. The Antenna Factor converts the voltage at the antenna coaxial connector to the field strength at the antenna elements.

A distance factor, when used for electric field measurements above 30MHz, is calculated by using the following formula:

$$F_d = 20 * \text{LOG}_{10} (D_m/D_s)$$

where:

$$F_d = \text{Distance Factor in dB}$$

$$D_m = \text{Measurement Distance in meters}$$

$$D_s = \text{Specification Distance in meters}$$

For electric field measurements below 30MHz the extrapolation factor is either determined by making measurements at multiple distances or a theoretical value is calculated using the formula:

$$F_d = 40 * \text{LOG}_{10} (D_m/D_s)$$

Measurement Distance is the distance at which the measurements were taken and Specification Distance is the distance at which the specification limits are based. The antenna factor converts the voltage at the antenna coaxial connector to the field strength at the antenna elements.

The margin of a given emission peak relative to the limit is calculated as follows:

$$R_c = R_r + F_d$$

and

$$M = R_c - L_s$$

where:

$$R_r = \text{Receiver Reading in dBuV/m}$$

$$F_d = \text{Distance Factor in dB}$$

$$R_c = \text{Corrected Reading in dBuV/m}$$

$$L_s = \text{Specification Limit in dBuV/m}$$

$$M = \text{Margin in dB Relative to Spec}$$

Appendix A Test Equipment Calibration Data**Radio Antenna Port (Bandedge), 13,14-Sep-10**

<u>Manufacturer</u>	<u>Description</u>	<u>Model</u>	<u>Asset #</u>	<u>Cal Due</u>
EMCO	Antenna, Horn, 1-18 GHz (SA40-Red)	3115	1142	8/2/2012
Hewlett Packard	SpecAn 9 kHz - 40 GHz, (SA40) Purple	8564E (84125C)	1771	8/26/2011

Radio Antenna Port (Bandedge), 15-Sep-10

<u>Manufacturer</u>	<u>Description</u>	<u>Model</u>	<u>Asset #</u>	<u>Cal Due</u>
Hewlett Packard	SpecAn 9 kHz - 40 GHz, FT (SA40) Blue	8564E (84125C)	1393	4/14/2011
EMCO	Antenna, Horn, 1-18 GHz	3115	1561	6/22/2012

Radio Antenna Port (Bandedge), 16-Sep-10

<u>Manufacturer</u>	<u>Description</u>	<u>Model</u>	<u>Asset #</u>	<u>Cal Due</u>
EMCO	Antenna, Horn, 1-18GHz	3115	868	6/8/2012
Hewlett Packard	SpecAn 9 kHz - 40 GHz, (SA40) Purple	8564E (84125C)	1771	8/26/2011

Radio (Spurious Emissions), 16-Sep-10

<u>Manufacturer</u>	<u>Description</u>	<u>Model</u>	<u>Asset #</u>	<u>Cal Due</u>
Rohde & Schwarz	Power Meter, Single Channel	NRVS	1290	10/22/2010
EMCO	Antenna, Horn, 1-18 GHz	3115	1561	6/22/2012
Hewlett Packard	SpecAn 9 kHz - 40 GHz, (SA40) Purple	8564E (84125C)	1771	8/26/2011
Rohde & Schwarz	Attenuator, 20 dB, 10W, DC-18 GHz	20dB, 10W, Type N	1795	6/2/2011
Rohde & Schwarz	Power Sensor 100 uW - 10 Watts	NRV-Z53	1796	6/2/2011

Radiated Emissions, DTS Bandedge, 17-Sep-10

<u>Manufacturer</u>	<u>Description</u>	<u>Model</u>	<u>Asset #</u>	<u>Cal Due</u>
EMCO	Antenna, Horn, 1-18 GHz	3115	487	7/6/2012
Hewlett Packard	SpecAn 9 kHz - 40 GHz, (SA40) Purple	8564E (84125C)	1771	8/26/2011
Rohde & Schwarz	Power Sensor 100 uW - 10 Watts	NRV-Z53	1555	2/5/2011
Rohde & Schwarz	Attenuator, 20 dB , 50 ohm, 10W, DC-18 GHz	20dB, 10W, Type N	1556	2/5/2011
Rohde & Schwarz	Power Meter, Dual Channel	NRVD	1787	12/4/2010

DTS Spurs, 20-Sep-10

<u>Manufacturer</u>	<u>Description</u>	<u>Model</u>	<u>Asset #</u>	<u>Cal Due</u>
EMCO	Antenna, Horn, 1-18 GHz	3115	487	7/6/2012
Hewlett Packard	Microwave Preamplifier, 1- 26.5GHz	8449B	870	6/25/2011
Micro-Tronics	Band Reject Filter, 2400-2500 MHz	BRM50702-02	1683	8/10/2011
Hewlett Packard	SpecAn 9 kHz - 40 GHz, (SA40) Purple	8564E (84125C)	1771	8/26/2011

Radiated Emissions, 1000 - 26,500 MHz, 20-Sep-10

<u>Manufacturer</u>	<u>Description</u>	<u>Model</u>	<u>Asset #</u>	<u>Cal Due</u>
EMCO	Antenna, Horn, 1-18 GHz	3115	487	7/6/2012
Hewlett Packard	Microwave Preamplifier, 1-26.5GHz	8449B	870	6/25/2011
Rohde & Schwarz	Power Sensor 100 uW - 10 Watts	NRV-Z53	1555	2/5/2011
Rohde & Schwarz	Attenuator, 20 dB , 50 ohm, 10W, DC-18 GHz	20dB, 10W, Type N	1556	2/5/2011
Micro-Tronics	Band Reject Filter, 2400-2500 MHz	BRM50702-02	1683	8/10/2011
Hewlett Packard	SpecAn 9 kHz - 40 GHz, (SA40) Purple	8564E (84125C)	1771	8/26/2011
Hewlett Packard	Head (Inc W1-W4, 1946, 1947) Purple	84125C	1772	5/6/2011
Rohde & Schwarz	Power Meter, Dual Channel	NRVD	1787	12/4/2010
A.H. Systems	Blue System Horn, 18-40GHz	SAS-574, p/n: 2581	2159	3/18/2011

Radiated Emissions, 1000 - 40,000 MHz, 21-Sep-10

<u>Manufacturer</u>	<u>Description</u>	<u>Model</u>	<u>Asset #</u>	<u>Cal Due</u>
EMCO	Antenna, Horn, 1-18 GHz	3115	487	7/6/2012
Hewlett Packard	Microwave Preamplifier, 1-26.5GHz	8449B	870	6/25/2011
Micro-Tronics	Band Reject Filter, 5725-5875 MHz	BRC50705-02	1728	2/1/2011
Hewlett Packard	SpecAn 9 kHz - 40 GHz, (SA40) Purple	8564E (84125C)	1771	8/26/2011
Hewlett Packard	Head (Inc W1-W4, 1946, 1947) Purple	84125C	1772	5/6/2011
A.H. Systems	Blue System Horn, 18-40GHz	SAS-574, p/n: 2581	2159	3/18/2011

Conducted Emissions - AC Power Ports, 28-Sep-10

<u>Manufacturer</u>	<u>Description</u>	<u>Model</u>	<u>Asset #</u>	<u>Cal Due</u>
Rohde & Schwarz	Pulse Limiter	ESH3 Z2	372	2/3/2011
Solar Electronics	LISN	8028-50-TS-24-BNC support	904	3/2/2011
EMCO	LISN, 10 kHz-100 MHz	3825/2	1292	3/12/2011
Hewlett Packard	EMC Spectrum Analyzer, 9 KHz - 22 GHz	8593EM	1319	10/19/2010
Rohde & Schwarz	Test Receiver, 9 kHz-2750 MHz	ESCS 30	1337	11/11/2010

Radiated Emissions, 30 - 1,000 MHz, 28-Sep-10

<u>Manufacturer</u>	<u>Description</u>	<u>Model</u>	<u>Asset #</u>	<u>Cal Due</u>
Hewlett Packard	EMC Spectrum Analyzer, 9 KHz - 22 GHz	8593EM	1319	10/19/2010
Rohde & Schwarz	Test Receiver, 9 kHz-2750 MHz	ESCS 30	1337	11/11/2010
Sunol Sciences	Biconilog, 30-3000 MHz	JB3	1548	6/24/2012
Com-Power Corp.	Preamplifier, 30-1000 MHz	PAM-103	2234	5/19/2011

Radio Antenna Port (Power and Spurious Emissions), 28-Sep-10

<u>Manufacturer</u>	<u>Description</u>	<u>Model</u>	<u>Asset #</u>	<u>Cal Due</u>
Rohde & Schwarz	Power Meter, Single Channel	NRVS	1290	10/22/2010
Hewlett Packard	SpecAn 9 kHz - 40 GHz, FT (SA40) Blue	8564E (84125C)	1393	4/14/2011
Rohde & Schwarz	Power Sensor 100 uW - 2 Watts (w/ 20 dB pad, SN BJ5155)	NRV-Z32	1536	9/13/2011
Rohde & Schwarz	Power Sensor 100 uW - 10 Watts	NRV-Z53	1555	2/5/2011
Rohde & Schwarz	Attenuator, 20 dB , 50 ohm, 10W, DC-18 GHz	20dB, 10W, Type N	1556	2/5/2011

RE, Wi-Fi & BT Simultaneous Tx, 30-Sep-10

<u>Manufacturer</u>	<u>Description</u>	<u>Model</u>	<u>Asset #</u>	<u>Cal Due</u>
Hewlett Packard	Microwave Preamplifier, 1-26.5GHz	8449B	263	12/15/2010
EMCO	Antenna, Horn, 1-18 GHz	3115	786	12/11/2011
Rohde & Schwarz	Power Meter, Single Channel	NRVS	1290	10/22/2010
Hewlett Packard	SpecAn 9 kHz - 40 GHz, FT (SA40) Blue	8564E (84125C)	1393	4/14/2011
Rohde & Schwarz	Power Sensor 100 uW - 10 Watts	NRV-Z53	1555	2/5/2011
Rohde & Schwarz	Attenuator, 20 dB , 50 ohm, 10W, DC-18 GHz	20dB, 10W, Type N	1556	2/5/2011
Micro-Tronics	Band Reject Filter, 2400-2500 MHz	BRM50702-02	1683	8/10/2011

Radio Spurious and Power, 01-Oct-10

<u>Manufacturer</u>	<u>Description</u>	<u>Model</u>	<u>Asset #</u>	<u>Cal Due</u>
Hewlett Packard	SpecAn 9 KHz-26.5 GHz, Non-Program	8563E	284	1/29/2011
EMCO	Antenna, Horn, 1-18GHz	3115	868	6/8/2012
Rohde & Schwarz	Power Meter, Single Channel	NRVS	1290	10/22/2010
Rohde & Schwarz	Power Sensor 100 uW - 10 Watts	NRV-Z53	1555	2/5/2011
Hewlett Packard	Microwave Preamplifier, 1-26.5GHz	8449B	2199	1/11/2011

Radiated Emissions, 0, 05, 06-Oct-10

<u>Manufacturer</u>	<u>Description</u>	<u>Model</u>	<u>Asset #</u>	<u>Cal Due</u>
Rohde & Schwarz	Power Meter, Single Channel	NRVS	1290	10/22/2010
Rohde & Schwarz	Power Sensor 100 uW - 10 Watts	NRV-Z53	1555	2/5/2011
EMCO	Antenna, Horn, 1-18 GHz	3115	1561	6/22/2012
Hewlett Packard	SpecAn 9 kHz - 40 GHz, (SA40) Purple	8564E (84125C)	1771	8/26/2011

Appendix B Test Data

T80540		
AC Conducted Emissions		83 Pages
Radiated Spurious Emissions		
T80759		
Antenna Port Measurements		74 Pages
T80540		
Radiated Spurious Emissions – simultaneous transmissions from Bluetooth and Wi-Fi transceivers		30 Pages



EMC Test Data

Client:	Intel Corporation	Job Number:	J80398
Model:	Intel® Centrino® Advanced-N 6230	T-Log Number:	T80540
		Account Manager:	Christine Krebill
Contact:	Steve Hackett		-
Emissions Standard(s):	FCC 15.247	Class:	B
Immunity Standard(s):	-	Environment:	-

EMC Test Data

For The

Intel Corporation

Model

Intel® Centrino® Advanced-N 6230

Date of Last Test: 10/6/2010

Client:	Intel Corporation	Job Number:	J80398
Model:	Intel® Centrino® Advanced-N 6230	T-Log Number:	T80540
		Account Manager:	Christine Krebill
Contact:	Steve Hackett		
Standard:	FCC 15.247	Class:	B

Conducted Emissions

(Elliott Laboratories Fremont Facility, Semi-Anechoic Chamber)

Test Specific Details

Objective: The objective of this test session is to perform final qualification testing of the EUT with respect to the specification listed above.

Date of Test: 9/28/2010	Config. Used: Modular Test
Test Engineer: Rafael Varelas	Config Change: None
Test Location: FT Chamber #7	Host Unit Voltage 120V/60Hz

General Test Configuration

The test fixture was located on a wooden table inside the semi-anechoic chamber, 40 cm from a vertical coupling plane and 80cm from the LISN. A second LISN was used for all local support equipment.

Ambient Conditions:

Temperature:	21.9 °C
Rel. Humidity:	42 %

Summary of Results

MAC Address: 00150079AD1A DRTU Tool Version 1.2.12-0197 Driver version 14.0.0.39

Run #	Test Performed	Limit	Result	Margin
1	CE, AC Power, 120V/60Hz	RSS 210 / 15.207	Pass	40.6dBµV @ 14.758MHz (-9.4dB)

Modifications Made During Testing

No modifications were made to the EUT during testing

Deviations From The Standard

No deviations were made from the requirements of the standard.

Client: Intel Corporation	Job Number: J80398
Model: Intel® Centrino® Advanced-N 6230	T-Log Number: T80540
Contact: Steve Hackett	Account Manager: Christine Krebill
Standard: FCC 15.247	Class: B

Run #1: AC Power Port Conducted Emissions, 0.15 - 30MHz, 120V/50Hz

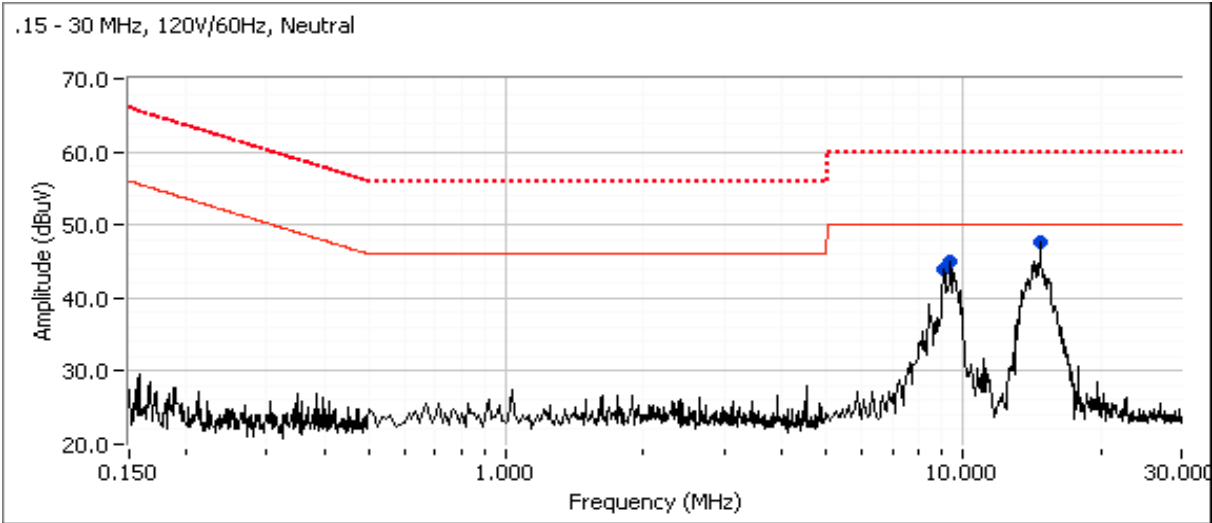
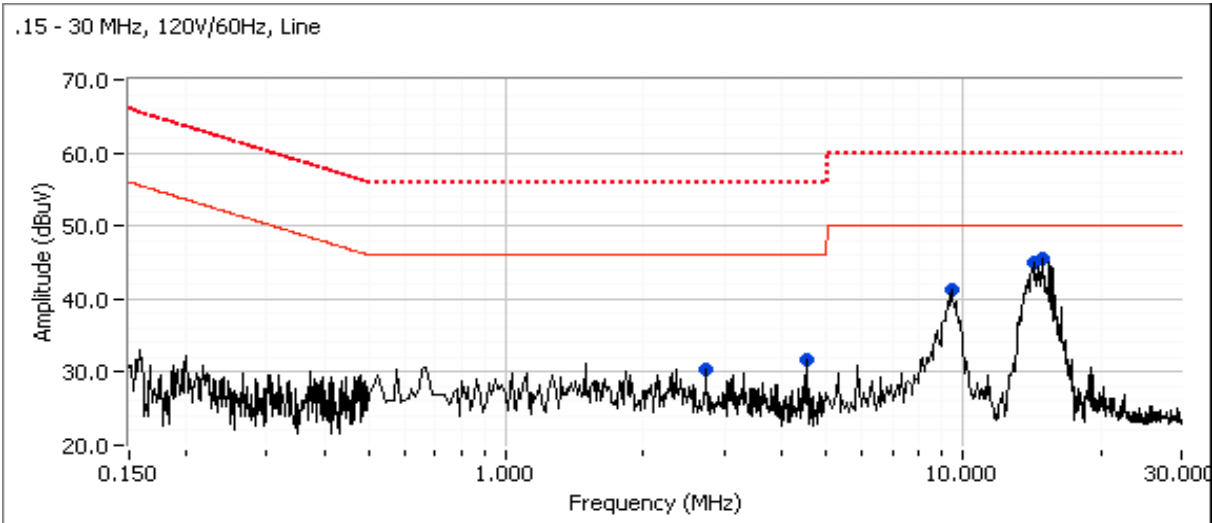

Client:	Intel Corporation	Job Number:	J80398
Model:	Intel® Centrino® Advanced-N 6230	T-Log Number:	T80540
Contact:	Steve Hackett	Account Manager:	Christine Krebill
Standard:	FCC 15.247	Class:	B

Preliminary peak readings captured during pre-scan (peak readings vs. average limit)

Frequency MHz	Level dB μ V	AC Line	Class B		Detector QP/Ave	Comments
			Limit	Margin		
2.739	30.4	Line 1	46.0	-15.6	Peak	
4.528	31.8	Line 1	46.0	-14.2	Peak	
9.571	41.2	Line 1	50.0	-8.8	Peak	
14.272	44.9	Line 1	50.0	-5.1	Peak	
14.925	45.4	Line 1	50.0	-4.6	Peak	
9.073	44.0	Neutral	50.0	-6.0	Peak	
9.336	44.9	Neutral	50.0	-5.1	Peak	
14.758	47.7	Neutral	50.0	-2.3	Peak	

Final quasi-peak and average readings

Frequency MHz	Level dB μ V	AC Line	Class B		Detector QP/Ave	Comments
			Limit	Margin		
14.758	40.6	Neutral	50.0	-9.4	AVG	AVG (0.100s)
14.272	40.1	Line 1	50.0	-9.9	AVG	AVG (0.100s)
14.925	35.7	Line 1	50.0	-14.3	AVG	AVG (0.100s)
14.272	44.8	Line 1	60.0	-15.2	QP	QP (1.000s)
9.336	34.6	Neutral	50.0	-15.4	AVG	AVG (0.100s)
14.758	44.6	Neutral	60.0	-15.4	QP	QP (1.000s)
9.073	32.7	Neutral	50.0	-17.3	AVG	AVG (0.100s)
9.571	32.6	Line 1	50.0	-17.4	AVG	AVG (0.100s)
14.925	42.4	Line 1	60.0	-17.6	QP	QP (1.000s)
9.073	39.9	Neutral	60.0	-20.1	QP	QP (1.000s)
9.336	39.7	Neutral	60.0	-20.3	QP	QP (1.000s)
9.571	37.9	Line 1	60.0	-22.1	QP	QP (1.000s)

Client:	Intel Corporation	Job Number:	J80398
Model:	Intel® Centrino® Advanced-N 6230	T-Log Number:	T80540
Contact:	Steve Hackett	Account Manager:	Christine Krebill
Standard:	FCC 15.247	Class:	B

Radiated Emissions 30-1000 MHz, Wireless Module (FCC 15.247/RSS 210)

(Elliott Laboratories Fremont Facility, Semi-Anechoic Chamber)

Test Specific Details

Objective: The objective of this test session is to perform final qualification testing of the EUT with respect to the specification listed above.

Date of Test: 9/28/2010	Config. Used: Modular Test
Test Engineer: Rafael Varelas	Config Change: None
Test Location: FT Chamber #7	Host Unit Voltage 120V/60Hz

General Test Configuration

The EUT and any local support equipment were located on the turntable for radiated emissions testing.

The test distance and extrapolation factor (if applicable) are detailed under each run description.

Note, preliminary testing indicates that the emissions were maximized by orientation of the EUT and elevation of the measurement antenna. Maximized testing indicated that the emissions were maximized by orientation of the EUT, elevation of the measurement antenna, and manipulation of the EUT's interface cables.

Ambient Conditions:

Temperature:	21.9 °C
Rel. Humidity:	42 %

Summary of Results

MAC Address: 00150079AD1A DRTU Tool Version 1.2.12-0197 Driver version 14.0.0.39

Run #	Test Performed	Limit	Result	Margin
1	Radiated Emissions 30 - 1000 MHz	FCC 15.209 / RSS 210	Pass	41.2dBµV/m @ 662.52MHz (-4.8dB)

Note - preliminary measurements indicated that the radiated emissions from the combination of test fixture and EUT were not affected by the modules operating frequency or mode (transmit versus receive mode). The system was therefore evaluated against the most stringent set of limits from FCC 15.247, FCC 15E and RSS 210 with the device operating at max power (16.5dBm) on Chain A at 2437MHz, 802.11b mode and max power (7dBm) on the top channel in Bluetooth mode (1Mb/s data

Modifications Made During Testing

No modifications were made to the EUT during testing

Deviations From The Standard

No deviations were made from the requirements of the standard.

Client:	Intel Corporation	Job Number:	J80398
Model:	Intel® Centrino® Advanced-N 6230	T-Log Number:	T80540
Contact:	Steve Hackett	Account Manager:	Christine Krebill
Standard:	FCC 15.247	Class:	B

Run #1: Preliminary Radiated Emissions, 30 - 1000 MHz

Configured to TX , 802.11b 16.5dBm on each chain (settings 23.5) on channel 6, Bluetooth 7dBm, 1Mb/s (settings 8.0)

Frequency Range	Test Distance	Limit Distance	Extrapolation Factor
30 - 1000 MHz	3	3	0.0

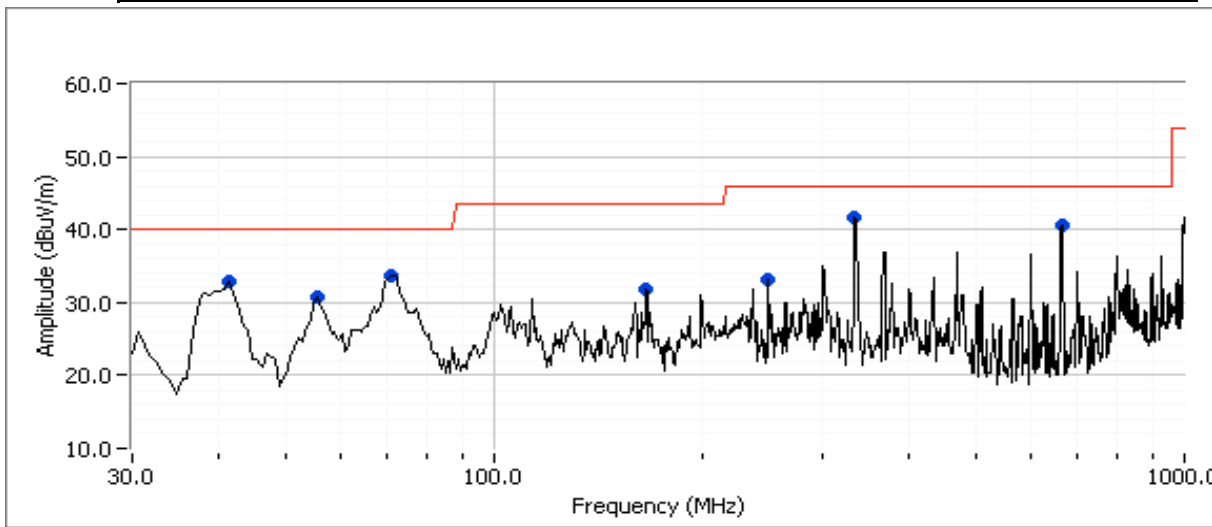

Preliminary peak readings captured during pre-scan

Frequency	Level	Pol	FCC 15.209 / RSS 210		Detector	Azimuth	Height	Comments
MHz	dBuV/m	v/h	Limit	Margin	Pk/QP/Avg	degrees	meters	
39.869	33.0	V	40.0	-7.0	Peak	185	2.5	
55.317	30.8	V	40.0	-9.2	Peak	333	1.0	
70.276	33.6	V	40.0	-6.4	Peak	40	1.0	
166.249	31.8	V	43.5	-11.7	Peak	202	1.0	
250.000	33.1	H	46.0	-12.9	Peak	154	1.5	
299.217	36.3	H	46.0	-9.7	Peak	172	1.0	
332.857	41.7	H	46.0	-4.3	Peak	116	1.0	
662.560	40.5	V	46.0	-5.5	Peak	44	1.0	

Maximized quasi-peak readings (includes manipulation of EUT interface cables)

Frequency	Level	Pol	FCC 15.209 / RSS 210		Detector	Azimuth	Height	Comments
MHz	dBuV/m	v/h	Limit	Margin	Pk/QP/Avg	degrees	meters	
662.515	41.2	V	46.0	-4.8	QP	44	1.0	QP (1.000s)
332.857	36.9	H	46.0	-9.1	QP	116	1.0	QP (1.000s)
39.869	29.7	V	40.0	-10.3	QP	185	2.5	QP (1.000s)
70.276	29.3	V	40.0	-10.7	QP	40	1.0	QP (1.000s)
55.317	27.1	V	40.0	-12.9	QP	333	1.0	QP (1.000s)
166.249	27.3	V	43.5	-16.2	QP	202	1.0	QP (1.000s)

Client:	Intel Corporation	Job Number:	J80398
Model:	Intel® Centrino® Advanced-N 6230	T-Log Number:	T80540
Contact:	Steve Hackett	Account Manager:	Christine Krebill
Standard:	FCC 15.247	Class:	N/A

RSS 210 and FCC 15.247 (DTS) Radiated Spurious Emissions (Band Edge)

Summary of Results

MAC Address: 00150079AD1A DRTU Tool Version 1.2.12-0197 New tool from 9/14 Driver version 14.0.0.39

Run #	Mode	Channel	Target Power	Measured Power	Test Performed	Limit	Result / Margin
Run # 1	n40 Chain A	#3 2422MHz	16.5	10.5	Restricted Band Edge at 2400 MHz	15.209	52.6dBµV/m @ 2390.0MHz (-1.4dB)
		#9 2452MHz	16.5	10.1	Restricted Band Edge at 2483.5 MHz	15.209	52.4dBµV/m @ 2483.5MHz (-1.6dB)
Run # 2	n40 Chain A	#4 2427MHz	16.5	10.5	Restricted Band Edge at 2400 MHz	15.209	52.3dBµV/m @ 2390.0MHz (-1.7dB)
		#8 2447MHz	16.5	10.2	Restricted Band Edge at 2483.5 MHz	15.209	52.9dBµV/m @ 2483.5MHz (-1.1dB)
Run # 3	n40 Chain A	#5 2432MHz	16.5	12.5	Restricted Band Edge at 2400 MHz	15.209	53.0dBµV/m @ 2390.0MHz (-1.0dB)
		#7 2442MHz	16.5	11.2	Restricted Band Edge at 2483.5 MHz	15.209	52.0dBµV/m @ 2483.5MHz (-2.0dB)
Run # 4	n40 Chain A	#6 2437MHz	16.5	13.5	Restricted Band Edge at 2400 MHz	15.209	49.9dBµV/m @ 2390.0MHz (-4.1dB)
			16.5	13.5	Restricted Band Edge at 2483.5 MHz	15.209	51.9dBµV/m @ 2483.5MHz (-2.1dB)
Run # 5	n20 Chain A	#1 2412MHz	16.5	12.9	Restricted Band Edge at 2400 MHz	15.209	52.4dBµV/m @ 2390.0MHz (-1.6dB)
		#11 2462MHz	16.5	12.4	Restricted Band Edge at 2483.5 MHz	15.209	50.8dBµV/m @ 2483.5MHz (-3.2dB)
Run # 6	802.11g Chain A	#1 2412MHz	16.5	14.1	Restricted Band Edge at 2400 MHz	15.209	51.9dBµV/m @ 2390.0MHz (-2.1dB)
			16.5	13.9	Restricted Band Edge at 2483.5 MHz	15.209	52.8dBµV/m @ 2483.5MHz (-1.2dB)
Run # 7	802.11b Chain A	#1 2412MHz	16.5	16.5	Restricted Band Edge at 2400 MHz	15.209	50.7dBµV/m @ 2389.6MHz (-3.3dB)
			16.5	16.9	Restricted Band Edge at 2483.5 MHz	15.209	49.3dBµV/m @ 2485.3MHz (-4.7dB)
Run # 8	802.11n20 Chain A	#2 2417MHz	16.5	15.7	Restricted Band Edge at 2400 MHz	16.209	52.7dBµV/m @ 2390.0MHz (-1.3dB)
			16.5	15.8	Restricted Band Edge at 2483.5 MHz	15.209	52.4dBµV/m @ 2390.0MHz (-1.6dB)

Note - the target and measured power are average powers (measured with average power sensor) and are used for reference purposes only. Power is set using " **GAIN CONTROL**" mode in the DRTU tool.

Client:	Intel Corporation	Job Number:	J80398
Model:	Intel® Centrino® Advanced-N 6230	T-Log Number:	T80540
		Account Manager:	Christine Krebill
Contact:	Steve Hackett		
Standard:	FCC 15.247	Class:	N/A

Test Specific Details

Objective: The objective of this test session is to perform engineering evaluation testing of the EUT with respect to the specification listed above.

General Test Configuration

The EUT was installed into a test fixture such that the EUT was exposed (i.e. outside of a host PC).
For radiated emissions testing the measurement antenna was located 3 meters from the EUT.

Ambient Conditions:

Rel. Humidity: 15 - 55 %
Temperature: 18 - 25 °C

Modifications Made During Testing

No modifications were made to the EUT during testing

Deviations From The Standard

No deviations were made from the requirements of the standard.

Marker Delta Measurements

Three sets of marker deltas are measured using the following settings: RB=VB=100kHz; RB=1MHz,VB=1MHz; RB=1MHz, VB=10Hz.
Marker deltas are made conducted (analyzer connected to EUT rf port a 20dB pad) for single chain operation.
The fundamental field strength is always measured at a 3m test distance.

Client: Intel Corporation	Job Number: J80398
Model: Intel® Centrino® Advanced-N 6230	T-Log Number: T80540
Contact: Steve Hackett	Account Manager: Christine Krebill
Standard: FCC 15.247	Class: N/A

Run # 1, Band Edge Field Strength - n40, Chain A

Date of Test: 9/14/2010

Test Location: FT Chamber#7

Test Engineer: Joseph Cadigal

Config Change: none

Run # 1a, EUT on Channel #3 2422MHz - n40, Chain A

	Target (dBm)	Power Settings Measured (dBm)	Software Setting
Chain A	16.5	10.5	20.0

Fundamental Signal Field Strength

Frequency	Level	Pol	15.209 / 15.247		Detector	Azimuth	Height	Comments
MHz	dBμV/m	v/h	Limit	Margin	Pk/QP/Avg	degrees	meters	
2434.730	91.8	H	-	-	AVG	252	1.0	
2420.070	99.8	H	-	-	PK	252	1.0	
2419.130	86.6	V	-	-	AVG	217	2.1	
2416.000	94.7	V	-	-	PK	217	2.1	

2390 MHz Band Edge Signal Radiated Field Strength - Marker Delta

	H	V				
Fundamental emission level @ 3m in 1MHz RBW:	99.8	94.7	Peak Measurement (RB=VB=1MHz)			
Fundamental emission level @ 3m in 1MHz RBW:	91.8	86.6	Average Measurement (RB=1MHz, VB=10Hz)			
Delta Marker - 100kHz	37.0 dB		<- this can only be used if band edge signal is highest within 2MHz of band edge.			
Calculated Band-Edge Measurement (Peak):	62.8 dBuV/m					
Calculated Band-Edge Measurement (Avg):	54.8 dBuV/m					
Delta Marker - 1MHz/1MHz:	-1.4	52.6	54	Avg	Margin	Level
Delta Marker - 1MHz/10Hz:	-11.2	62.8	74	Pk		
Calculated Band-Edge Measurement (Peak):	64.0 dBuV/m		Using 100kHz delta value			
Calculated Band-Edge Measurement (Avg):	52.6 dBuV/m		Using 1MHz delta value			

Frequency	Level	Pol	FCC 15.209		Detector	Azimuth	Height	Comments
MHz	dBμV/m	v/h	Limit	Margin	Pk/QP/Avg	degrees	meters	
2390.000	52.6	-	54.0	-1.4	Avg	-	-	Using 1MHz delta value

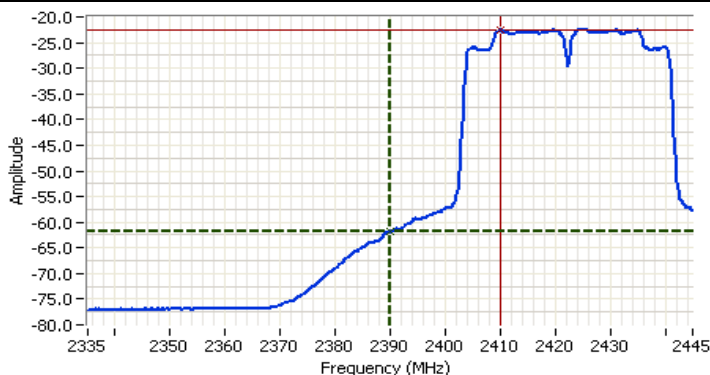

Analyzer Settings
 HP8564E,EMICF: 2390.000 MHz
 SPAN: 110.000 MHz
 RB: 1.000 MHz
 VB: 10 Hz
 Detector: Sample
 Attn: 10 DB
 RL Offset: 0.0 DB
 Sweep Time: 41.0s
 Ref Lvl: 0.0 DBM

Comments
 BE @ 2390 MHz
 802.11n40
 Chain A

Cursor 1	2390.0000	-61.83		
Cursor 2	2409.9834	-22.67		

Delta Freq. 19.983
 Delta Amplitude 39.17



Client: Intel Corporation	Job Number: J80398
Model: Intel® Centrino® Advanced-N 6230	T-Log Number: T80540
Contact: Steve Hackett	Account Manager: Christine Krebill
Standard: FCC 15.247	Class: N/A

Run # 1b, EUT on Channel #9 2452MHz - n40, Chain A

	Target (dBm)	Power Settings Measured (dBm)	Software Setting
Chain A	16.5	10.0	21.0

Fundamental Signal Field Strength

Frequency	Level	Pol	15.209 / 15.247		Detector	Azimuth	Height	Comments
MHz	dBuV/m	v/h	Limit	Margin	Pk/QP/Avg	degrees	meters	
2449.000	89.4	V	-	-	AVG	189	1.6	
2440.870	98.2	V	-	-	PK	189	1.6	
2443.930	90.1	H	-	-	AVG	254	1.0	
2440.600	101.2	H	-	-	PK	254	1.0	

2483.5 MHz Band Edge Signal Radiated Field Strength - Marker Delta

	H	V	
Fundamental emission level @ 3m in 1MHz RBW :	101.2	98.2	Peak Measurement (RB=VB=1MHz)
Fundamental emission level @ 3m in 1MHz RBW :	90.1	89.4	Average Measurement (RB=1MHz, VB=10Hz)
<i>Delta Marker - 100kHz</i>	35.2 dB		-< this can only be used if band edge signal is highest within 2MHz of band edge.
Calculated Band-Edge Measurement (Peak):	66.0 dBuV/m		
Calculated Band-Edge Measurement (Avg):	54.9 dBuV/m	Margin	Level
<i>Delta Marker - 1MHz/1MHz:</i>	34.0 dB	-1.6	52.4
<i>Delta Marker - 1MHz/10Hz:</i>	37.7 dB	-8.0	66.0
Calculated Band-Edge Measurement (Peak):	67.2 dBuV/m	Using 100kHz delta value	
Calculated Band-Edge Measurement (Avg):	52.4 dBuV/m	Using 1MHz delta value	

Frequency	Level	Pol	FCC 15.209		Detector	Azimuth	Height	Comments
MHz	dBuV/m	v/h	Limit	Margin	Pk/QP/Avg	degrees	meters	
2483.500	52.4	-	54.0	-1.6	Avg	-	-	Using 1MHz delta value

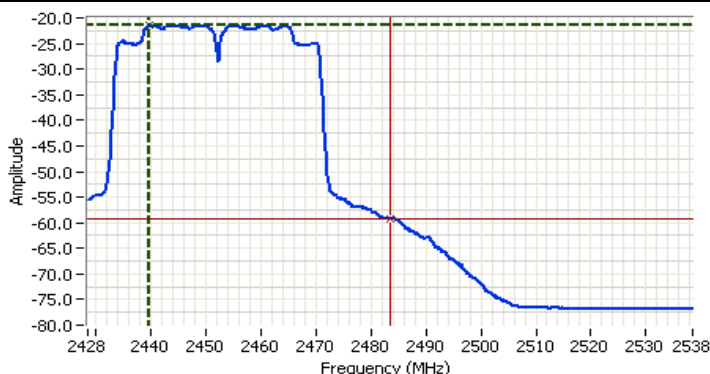

Analyzer Settings
 HP8564E,EMICF: 2483.500
 MHz
 SPAN: 110.000 MHz
 RB: 1.000 MHz
 VB: 10 Hz
 Detector: Sample
 Attn: 10 DB
 RL Offset: 0.0 DB
 Sweep Time: 41.0s
 Ref Lvl: 0.0 DBM

Comments
 BE @ 2483.5 MHz
 802.11n40
 Chain A

Cursor 1	2439.6833	-21.50	
Cursor 2	2483.5000	-59.17	

Delta Freq. 43.817
 Delta Amplitude 37.67



Client: Intel Corporation	Job Number: J80398
Model: Intel® Centrino® Advanced-N 6230	T-Log Number: T80540
Contact: Steve Hackett	Account Manager: Christine Krebill
Standard: FCC 15.247	Class: N/A

Run # 2, Band Edge Field Strength - n40, Chain A

Date of Test: 9/13/2010

Test Location: FT Chamber#5

Test Engineer: Joseph Cadigal

Config Change: none

Run # 2a, EUT on Channel #4 2427MHz - n40, Chain A

	Target (dBm)	Power Settings Measured (dBm)	Software Setting
Chain A	16.5	10.5	21.0

Fundamental Signal Field Strength

Frequency	Level	Pol	15.209 / 15.247		Detector	Azimuth	Height	Comments
MHz	dBμV/m	v/h	Limit	Margin	Pk/QP/Avg	degrees	meters	
2419.000	87.7	V	-	-	AVG	244	1.6	
2420.870	96.0	V	-	-	PK	244	1.6	
2439.530	93.1	H	-	-	AVG	249	1.0	
2434.070	101.3	H	-	-	PK	249	1.0	

2390 MHz Band Edge Signal Radiated Field Strength - Marker Delta

	H	V					
Fundamental emission level @ 3m in 1MHz RBW:	101.3	96.0	Peak Measurement (RB=VB=1MHz)				
Fundamental emission level @ 3m in 1MHz RBW:	93.1	87.7	Average Measurement (RB=1MHz, VB=10Hz)				
Delta Marker - 100kHz			38.7 dB				
Calculated Band-Edge Measurement (Peak):			62.6 dBμV/m				
Calculated Band-Edge Measurement (Avg):			54.4 dBμV/m	Margin	Level	Limit	Detector
Delta Marker - 1MHz/1MHz:			36.3 dB	-1.7	52.3	54	Avg
Delta Marker - 1MHz/10Hz:			40.8 dB	-11.4	62.6	74	Pk
Calculated Band-Edge Measurement (Peak):			65.0 dBμV/m				
Calculated Band-Edge Measurement (Avg):			52.3 dBμV/m				

<- this can only be used if band edge signal is highest within 2MHz of band edge.

Frequency	Level	Pol	FCC 15.209		Detector	Azimuth	Height	Comments
MHz	dBμV/m	v/h	Limit	Margin	Pk/QP/Avg	degrees	meters	
2390.000	52.3	-	54.0	-1.7	Avg	-	-	Using 1MHz delta value

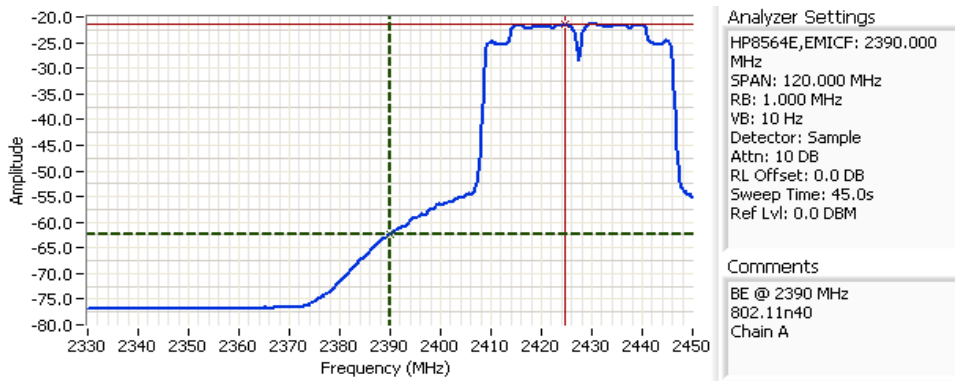

Cursor 1 2390.0000 -62.33  Delta Freq. 34.600

Cursor 2 2424.6001 -21.50  Delta Amplitude 40.83



Client: Intel Corporation	Job Number: J80398
Model: Intel® Centrino® Advanced-N 6230	T-Log Number: T80540
Contact: Steve Hackett	Account Manager: Christine Krebill
Standard: FCC 15.247	Class: N/A

Run # 2b, EUT on Channel #8 2447MHz - n40, Chain A

Date of Test: 9/29/2010 Test Location: FT Chamber#5
 Test Engineer: Mehran Birgani Config Change: none

	Target (dBm)	Power Settings Measured (dBm)	Software Setting
Chain A	16.5	10.2	21.0

Fundamental Signal Field Strength

Frequency	Level	Pol	15.209 / 15.247		Detector	Azimuth	Height	Comments
MHz	dBuV/m	v/h	Limit	Margin	Pk/QP/Avg	degrees	meters	
2444.670	89.7	V	-	-	AVG	202	1.5	
2449.930	98.8	V	-	-	PK	202	1.5	
2450.200	94.4	H	-	-	AVG	256	1.0	
2450.270	103.9	H	-	-	PK	256	1.0	

2483.5 MHz Band Edge Signal Radiated Field Strength - Marker Delta

	H	V	
Fundamental emission level @ 3m in 1MHz RBW:	103.9	98.8	Peak Measurement (RB=VB=1MHz)
Fundamental emission level @ 3m in 1MHz RBW:	94.4	89.7	Average Measurement (RB=1MHz, VB=10Hz)
Delta Marker - 100kHz	38.5 dB		-< this can only be used if band edge signal is highest within 2MHz of band edge.
Calculated Band-Edge Measurement (Peak):	65.4 dBuV/m		
Calculated Band-Edge Measurement (Avg):	55.9 dBuV/m	Margin	Level
Delta Marker - 1MHz/1MHz:	35.0 dB	-1.1	52.9
Delta Marker - 1MHz/10Hz:	41.5 dB	-8.6	65.4
Calculated Band-Edge Measurement (Peak):	68.9 dBuV/m	Using 100kHz delta value	
Calculated Band-Edge Measurement (Avg):	52.9 dBuV/m	Using 1MHz delta value	

Frequency	Level	Pol	FCC 15.209		Detector	Azimuth	Height	Comments
MHz	dBuV/m	v/h	Limit	Margin	Pk/QP/Avg	degrees	meters	
2483.500	52.9	-	54.0	-1.1	Avg	-	-	Using 1MHz delta value



Analyzer Settings

HP8564E
 CF: 2485.300 MHz
 SPAN: 120.000 MHz
 RB: 1.000 MHz
 VB: 10 Hz
 Detector: Sample
 Attn: 20 DB
 RL Offset: 1.0 DB
 Sweep Time: 30.0s
 Ref Lvl: 5.2 DBM

Comments

BE @ 2483.5 MHz
 802.11n 40MHz
 Chain A - Average

Cursor 1	2434.8999	-8.97
Cursor 2	2483.5000	-50.47

Delta Freq. 48.600
 Delta Amplitude 41.50



Client: Intel Corporation	Job Number: J80398
Model: Intel® Centrino® Advanced-N 6230	T-Log Number: T80540
Contact: Steve Hackett	Account Manager: Christine Krebill
Standard: FCC 15.247	Class: N/A

Run # 3, Band Edge Field Strength - n40, Chain A

Date of Test: 9/15/2010

Test Location: FT Chamber #7

Test Engineer: Joseph Cadigal

Config Change: none

Run # 3a, EUT on Channel #5 2432MHz - n40, Chain A

	Target (dBm)	Power Settings Measured (dBm)	Software Setting
Chain A	16.5	12.5	23.5

Fundamental Signal Field Strength

Frequency	Level	Pol	15.209 / 15.247		Detector	Azimuth	Height	Comments
MHz	dBuV/m	v/h	Limit	Margin	Pk/QP/Avg	degrees	meters	
2419.670	91.9	V	-	-	AVG	186	1.8	
2419.530	100.0	V	-	-	PK	186	1.8	
2444.600	95.3	H	-	-	AVG	252	1.0	
2444.670	103.4	H	-	-	PK	252	1.0	

2390 MHz Band Edge Signal Radiated Field Strength - Marker Delta

	H	V				
Fundamental emission level @ 3m in 1MHz RBW:	103.4	100.0	Peak Measurement (RB=VB=1MHz)			
Fundamental emission level @ 3m in 1MHz RBW:	95.3	91.9	Average Measurement (RB=1MHz, VB=10Hz)			
Delta Marker - 100kHz	40.5 dB		-< this can only be used if band edge signal is highest within 2MHz of band edge.			
Calculated Band-Edge Measurement (Peak):	62.9 dBuV/m					
Calculated Band-Edge Measurement (Avg):	54.8 dBuV/m	Margin	Level	Limit	Detector	
Delta Marker - 1MHz/1MHz:	38.0 dB	-1.0	53.0	54	Avg	
Delta Marker - 1MHz/10Hz:	42.3 dB	-11.1	62.9	74	Pk	
Calculated Band-Edge Measurement (Peak):	65.4 dBuV/m	Using 100kHz delta value				
Calculated Band-Edge Measurement (Avg):	53.0 dBuV/m	Using 1MHz delta value				

Frequency	Level	Pol	FCC 15.209		Detector	Azimuth	Height	Comments
MHz	dBuV/m	v/h	Limit	Margin	Pk/QP/Avg	degrees	meters	
2390.000	53.0	-	54.0	-1.0	Avg	-	-	Using 1MHz delta value

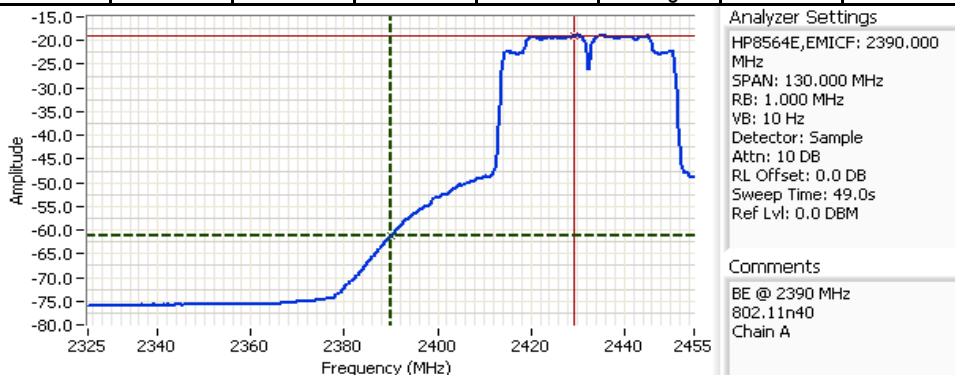

Cursor 1	2390.0000	-61.33		
Cursor 2	2429.2166	-19.00		

Delta Freq.	39.217
Delta Amplitude	42.33



Client: Intel Corporation	Job Number: J80398
Model: Intel® Centrino® Advanced-N 6230	T-Log Number: T80540
Contact: Steve Hackett	Account Manager: Christine Krebill
Standard: FCC 15.247	Class: N/A

Run # 3b, EUT on Channel #7 2442MHz - n40, Chain A

	Target (dBm)	Power Settings Measured (dBm)	Software Setting
Chain A	16.5	11.2	22.5

Fundamental Signal Field Strength

Frequency	Level	Pol	15.209 / 15.247		Detector	Azimuth	Height	Comments
MHz	dBμV/m	v/h	Limit	Margin	Pk/QP/Avg	degrees	meters	
2445.130	89.5	V	-	-	AVG	186	1.1	
2445.800	97.6	V	-	-	PK	186	1.1	
2443.490	93.8	H	-	-	AVG	250	1.0	
2443.300	102.1	H	-	-	PK	250	1.0	

2483.5 MHz Band Edge Signal Radiated Field Strength - Marker Delta

	H	V				
Fundamental emission level @ 3m in 1MHz RBW:	102.1	97.6	Peak Measurement (RB=VB=1MHz)			
Fundamental emission level @ 3m in 1MHz RBW:	93.8	89.5	Average Measurement (RB=1MHz, VB=10Hz)			
Delta Marker - 100kHz	40.7 dB		-< this can only be used if band edge signal is highest within 2MHz of band edge.			
Calculated Band-Edge Measurement (Peak):	61.4 dBuV/m					
Calculated Band-Edge Measurement (Avg):	53.1 dBuV/m		Margin	Level	Limit	Detector
Delta Marker - 1MHz/1MHz:	38.5 dB		-2.0	52.0	54	Avg
Delta Marker - 1MHz/10Hz:	41.8 dB		-12.6	61.4	74	Pk
Calculated Band-Edge Measurement (Peak):	63.6 dBuV/m		Using 100kHz delta value			
Calculated Band-Edge Measurement (Avg):	52.0 dBuV/m		Using 1MHz delta value			

Frequency	Level	Pol	FCC 15.209		Detector	Azimuth	Height	Comments
MHz	dBμV/m	v/h	Limit	Margin	Pk/QP/Avg	degrees	meters	
2483.500	52.0	-	54.0	-2.0	Avg	-	-	Using 1MHz delta value

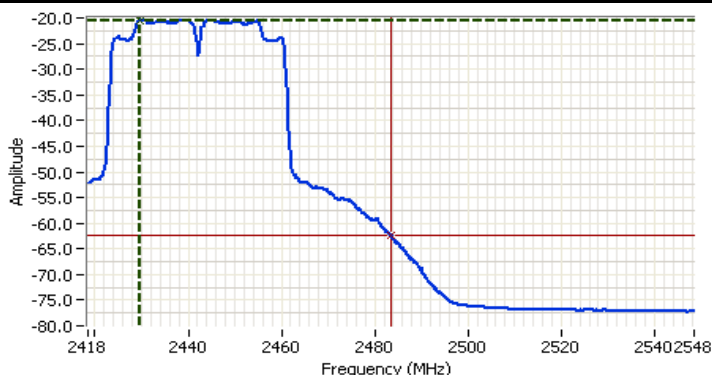

Analyzer Settings
 HP8564E, EMICF: 2483.500 MHz
 SPAN: 130.000 MHz
 RB: 1.000 MHz
 VB: 10 Hz
 Detector: Sample
 Attn: 10 DB
 RL Offset: 0.0 DB
 Sweep Time: 49.0s
 Ref Lvl: 0.0 DBM

Comments
 BE @ 2483.5 MHz
 802.11n40
 Chain A

Cursor 1	2429.5500	-20.50	
Cursor 2	2483.5000	-62.33	

Delta Freq. 53.950
 Delta Amplitude 41.83



Client: Intel Corporation	Job Number: J80398
Model: Intel® Centrino® Advanced-N 6230	T-Log Number: T80540
Contact: Steve Hackett	Account Manager: Christine Krebill
Standard: FCC 15.247	Class: N/A

Run # 4, Band Edge Field Strength - n40, Chain A

Date of Test: 9/15/2010

Test Location: FT Chamber#7

Test Engineer: Joseph Cadigal

Config Change: none

EUT on Channel #6 2437MHz - n40, Chain A

	Target (dBm)	Power Settings Measured (dBm)	Software Setting
Chain A	16.5		24.5

Fundamental Signal Field Strength

Frequency	Level	Pol	15.209 / 15.247		Detector	Azimuth	Height	Comments
MHz	dBuV/m	v/h	Limit	Margin	Pk/QP/Avg	degrees	meters	
2449.470	96.4	V	-	-	AVG	344	1.0	
2449.800	104.8	V	-	-	PK	344	1.0	
2440.200	96.6	H	-	-	AVG	269	1.0	
2449.730	104.8	H	-	-	PK	269	1.0	

2390 MHz Band Edge Signal Radiated Field Strength - Marker Delta

	H	V				
Fundamental emission level @ 3m in 1MHz RBW:	104.8	104.8	Peak Measurement (RB=VB=1MHz)			
Fundamental emission level @ 3m in 1MHz RBW:	96.6	96.4	Average Measurement (RB=1MHz, VB=10Hz)			
Delta Marker - 100kHz	46.7 dB		-< this can only be used if band edge signal is highest within 2MHz of band edge.			
Calculated Band-Edge Measurement (Peak):	58.1 dBuV/m					
Calculated Band-Edge Measurement (Avg):	49.9 dBuV/m		Margin	Level	Limit	Detector
Delta Marker - 1MHz/1MHz:	39.7 dB		-4.1	49.9	54	Avg
Delta Marker - 1MHz/10Hz:	46.5 dB		-15.9	58.1	74	Pk
Calculated Band-Edge Measurement (Peak):	65.1 dBuV/m		Using 100kHz delta value			
Calculated Band-Edge Measurement (Avg):	50.1 dBuV/m		Using 100kHz delta value			

Frequency	Level	Pol	FCC 15.209		Detector	Azimuth	Height	Comments
MHz	dBuV/m	v/h	Limit	Margin	Pk/QP/Avg	degrees	meters	
2390.000	49.9	-	54.0	-4.1	Avg	-	-	Using 100kHz delta value

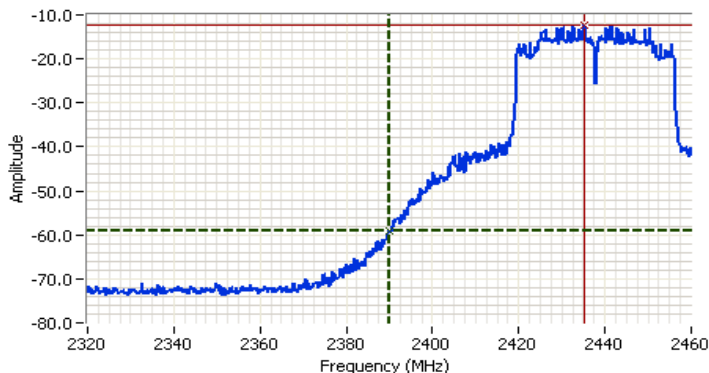

Analyzer Settings

HP8564E,EMICF: 2390.000 MHz
 SPAN: 140.000 MHz
 RB: 100 kHz
 VB: 100 kHz
 Detector: POS
 Attn: 10 DB
 RL Offset: 0.0 DB
 Sweep Time: 77.0ms
 Ref Lvl: 0.0 DBM

Comments

BE @ 2390 MHz
 802.11n40
 Chain A

Cursor 1	2390.0000	-59.00	
Cursor 2	2435.2666	-12.33	

Delta Freq.	45.267
Delta Amplitude	46.67



Client:	Intel Corporation	Job Number:	J80398
Model:	Intel® Centrino® Advanced-N 6230	T-Log Number:	T80540
Contact:	Steve Hackett	Account Manager:	Christine Krebill
Standard:	FCC 15.247	Class:	N/A

2483.5 MHz Band Edge Signal Radiated Field Strength - Marker Delta

	H	V	
Fundamental emission level @ 3m in 1MHz RBW :	104.8	104.8	Peak Measurement (RB=VB=1MHz)
Fundamental emission level @ 3m in 1MHz RBW :	96.6	96.4	Average Measurement (RB=1MHz, VB=10Hz)
<i>Delta Marker - 100kHz</i>	43.5 dB		<- this can only be used if band edge signal is highest within 2MHz of band edge.
Calculated Band-Edge Measurement (Peak):	61.3 dBuV/m		
Calculated Band-Edge Measurement (Avg):	53.1 dBuV/m		Margin
<i>Delta Marker - 1MHz/1MHz:</i>	38.3 dB	-2.1	Level
<i>Delta Marker - 1MHz/10Hz:</i>	44.7 dB	-12.7	Limit
Calculated Band-Edge Measurement (Peak):	66.5 dBuV/m		Detector
Calculated Band-Edge Measurement (Avg):	51.9 dBuV/m		

Frequency	Level	Pol	FCC 15.209		Detector	Azimuth	Height	Comments
MHz	dBuV/m	v/h	Limit	Margin	Pk/QP/Avg	degrees	meters	
2483.500	51.9	-	54.0	-2.1	Avg	-	-	Using 1MHz delta value

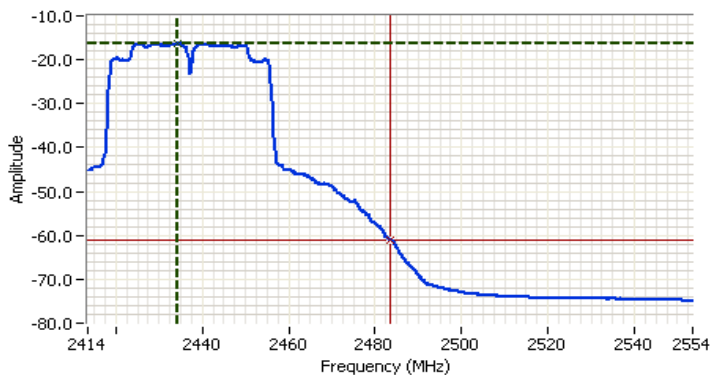

Analyzer Settings
 HP8564E,EMICF: 2483.500 MHz
 SPAN: 140.000 MHz
 RB: 1.000 MHz
 VB: 10 Hz
 Detector: Sample
 Attn: 10 DB
 RL Offset: 0.0 DB
 Sweep Time: 52.0s
 Ref Lvl: 0.0 DBM

Comments
 BE @ 2483.5 MHz
 802.11n40
 Chain A

Cursor 1	2434.2666	-16.33	+	-	↔
Cursor 2	2483.5000	-61.00	+	-	↔

Delta Freq. 49.233
 Delta Amplitude 44.67



Client: Intel Corporation	Job Number: J80398
Model: Intel® Centrino® Advanced-N 6230	T-Log Number: T80540
Contact: Steve Hackett	Account Manager: Christine Krebill
Standard: FCC 15.247	Class: N/A

Run # 5, Band Edge Field Strength - n20, Chain A

Date of Test: 9/15/2010

Test Location: FT Chamber#7

Test Engineer: Joseph Cadigal

Config Change: none

Run # 5a, EUT on Channel #1 2412MHz - n20, Chain A

	Target (dBm)	Power Settings Measured (dBm)	Software Setting
Chain A	16.5	12.9	24.0

Fundamental Signal Field Strength

Frequency	Level	Pol	15.209 / 15.247		Detector	Azimuth	Height	Comments
MHz	dBuV/m	v/h	Limit	Margin	Pk/QP/Avg	degrees	meters	
2415.000	98.3	V	-	-	AVG	202	1.0	
2415.500	106.3	V	-	-	PK	202	1.0	
2415.270	100.1	H	-	-	AVG	320	1.0	
2414.070	108.2	H	-	-	PK	320	1.0	

2390 MHz Band Edge Signal Radiated Field Strength - Marker Delta

	H	V				
Fundamental emission level @ 3m in 1MHz RBW:	108.2	106.3	Peak Measurement (RB=VB=1MHz)			
Fundamental emission level @ 3m in 1MHz RBW:	100.1	98.3	Average Measurement (RB=1MHz, VB=10Hz)			
Delta Marker - 100kHz	47.0 dB		<- this can only be used if band edge signal is highest within 2MHz of band edge.			
Calculated Band-Edge Measurement (Peak):	61.2 dBuV/m		Margin	Level	Limit	Detector
Calculated Band-Edge Measurement (Avg):	53.1 dBuV/m		-1.6	52.4	54	Avg
Delta Marker - 1MHz/1MHz:	37.5 dB		-12.8	61.2	74	Pk
Delta Marker - 1MHz/10Hz:	47.7 dB		Using 100kHz delta value			
Calculated Band-Edge Measurement (Peak):	70.7 dBuV/m		Using 1MHz delta value			
Calculated Band-Edge Measurement (Avg):	52.4 dBuV/m					

Frequency	Level	Pol	FCC 15.209		Detector	Azimuth	Height	Comments
MHz	dBuV/m	v/h	Limit	Margin	Pk/QP/Avg	degrees	meters	
2390.000	52.4	-	54.0	-1.6	Avg	-	-	Using 1MHz delta value

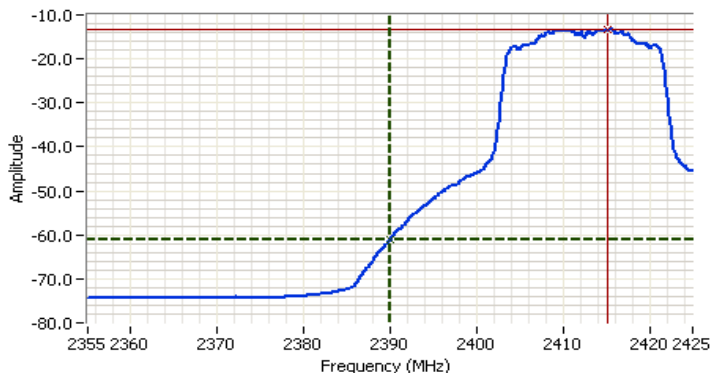

Analyzer Settings
 HP8564E,EMICF: 2390.000 MHz
 SPAN: 70.000 MHz
 RB: 1.000 MHz
 VB: 10 Hz
 Detector: Sample
 Attn: 10 DB
 RL Offset: 0.0 DB
 Sweep Time: 26.0s
 Ref Lvl: 0.0 DBM

Comments
 BE @ 2390 MHz
 802.11n20
 Chain A

Cursor 1	2390.0000	-61.00	Delta Freq.	25.200
Cursor 2	2415.2000	-13.33	Delta Amplitude	47.67



Client: Intel Corporation	Job Number: J80398
Model: Intel® Centrino® Advanced-N 6230	T-Log Number: T80540
Contact: Steve Hackett	Account Manager: Christine Krebill
Standard: FCC 15.247	Class: N/A

Run # 5b, EUT on Channel #11 2462MHz - n20, Chain A

	Target (dBm)	Power Settings Measured (dBm)	Software Setting
Chain A	16.5	12.4	23.5

Fundamental Signal Field Strength

Frequency	Level	Pol	15.209 / 15.247		Detector	Azimuth	Height	Comments
MHz	dBμV/m	v/h	Limit	Margin	Pk/QP/Avg	degrees	meters	
2465.230	97.3	V	-	-	AVG	344	1.0	
2465.430	105.5	V	-	-	PK	344	1.0	
2465.130	96.6	H	-	-	AVG	320	1.0	
2465.300	104.9	H	-	-	PK	320	1.0	

2483.5 MHz Band Edge Signal Radiated Field Strength - Marker Delta

	H	V				
Fundamental emission level @ 3m in 1MHz RBW:	104.9	105.5	Peak Measurement (RB=VB=1MHz)			
Fundamental emission level @ 3m in 1MHz RBW:	96.6	97.3	Average Measurement (RB=1MHz, VB=10Hz)			
<i>Delta Marker - 100kHz</i>	46.5 dB		<- this can only be used if band edge signal is highest within 2MHz of band edge.			
Calculated Band-Edge Measurement (Peak):	59.0 dBuV/m		Margin	Level	Limit	Detector
Calculated Band-Edge Measurement (Avg):	50.8 dBuV/m		-3.2	50.8	54	Avg
<i>Delta Marker - 1MHz/1MHz:</i>	37.2 dB		-15.0	59.0	74	Pk
<i>Delta Marker - 1MHz/10Hz:</i>	46.3 dB					
Calculated Band-Edge Measurement (Peak):	68.3 dBuV/m		Using 100kHz delta value			
Calculated Band-Edge Measurement (Avg):	51.0 dBuV/m		Using 100kHz delta value			

Frequency	Level	Pol	FCC 15.209		Detector	Azimuth	Height	Comments
MHz	dBμV/m	v/h	Limit	Margin	Pk/QP/Avg	degrees	meters	
2483.500	50.8	-	54.0	-3.2	Avg	-	-	Using 100kHz delta value

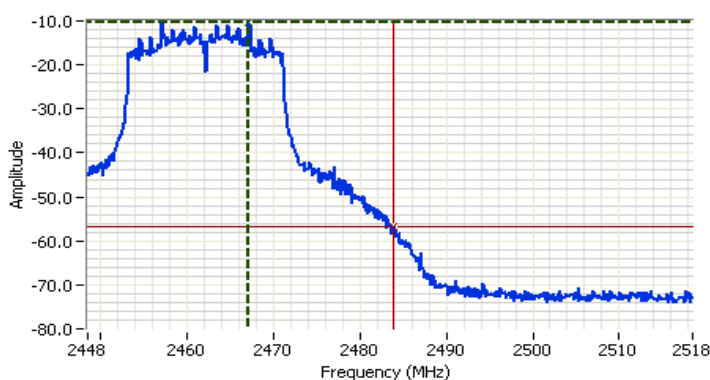

Analyzer Settings
 HP8564E,EMICF: 2483.500 MHz
 SPAN: 70.000 MHz
 RB: 100 kHz
 VB: 100 kHz
 Detector: POS
 Attn: 10 DB
 RL Offset: 0.0 DB
 Sweep Time: 50.0ms
 Ref Lvl: 0.0 DBM

Comments
 BE @ 2483.5 MHz
 802.11n20
 Chain A

Cursor 1	2467.1667	-10.17	
Cursor 2	2483.8501	-56.67	

Delta Freq. 16.683
 Delta Amplitude 46.50



Client: Intel Corporation	Job Number: J80398
Model: Intel® Centrino® Advanced-N 6230	T-Log Number: T80540
Contact: Steve Hackett	Account Manager: Christine Krebill
Standard: FCC 15.247	Class: N/A

Run # 6, Band Edge Field Strength - 802.11g, Chain A

Date of Test: 9/15/2010

Test Location: FT Chamber #7

Test Engineer: Joseph Cadigal

Config Change: none

Run # 6a, EUT on Channel #1 2412MHz - 802.11g, Chain A

	Target (dBm)	Power Settings Measured (dBm)	Software Setting
Chain A	16.5	14.1	25.5

Fundamental Signal Field Strength

Frequency	Level	Pol	15.209 / 15.247		Detector	Azimuth	Height	Comments
MHz	dBuV/m	v/h	Limit	Margin	Pk/QP/Avg	degrees	meters	
2414.470	97.6	V	-	-	AVG	344	1.0	
2413.630	105.8	V	-	-	PK	344	1.0	
2416.300	101.1	H	-	-	AVG	268	1.0	
2415.030	109.2	H	-	-	PK	268	1.0	

2390 MHz Band Edge Signal Radiated Field Strength - Marker Delta

	H	V				
Fundamental emission level @ 3m in 1MHz RBW:	109.2	105.8	Peak Measurement (RB=VB=1MHz)			
Fundamental emission level @ 3m in 1MHz RBW:	101.1	97.6	Average Measurement (RB=1MHz, VB=10Hz)			
Delta Marker - 100kHz	48.2 dB		-< this can only be used if band edge signal is highest within 2MHz of band edge.			
Calculated Band-Edge Measurement (Peak):	61.0 dBuV/m					
Calculated Band-Edge Measurement (Avg):	52.9 dBuV/m		Margin	Level	Limit	Detector
Delta Marker - 1MHz/1MHz:	38.8 dB		-2.1	51.9	54	Avg
Delta Marker - 1MHz/10Hz:	49.2 dB		-13.0	61.0	74	Pk
Calculated Band-Edge Measurement (Peak):	70.4 dBuV/m		Using 100kHz delta value			
Calculated Band-Edge Measurement (Avg):	51.9 dBuV/m		Using 1MHz delta value			

Frequency	Level	Pol	FCC 15.209		Detector	Azimuth	Height	Comments
MHz	dBuV/m	v/h	Limit	Margin	Pk/QP/Avg	degrees	meters	
2390.000	51.9	-	54.0	-2.1	Avg	-	-	Using 1MHz delta value

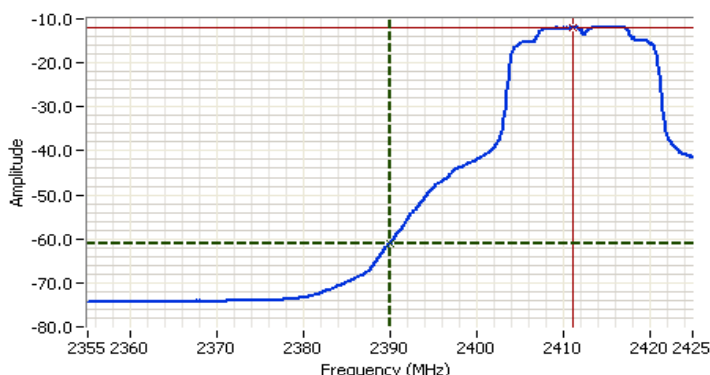

Analyzer Settings
 HP8564E,EMICF: 2390.000 MHz
 SPAN: 70.000 MHz
 RB: 1.000 MHz
 VB: 10 Hz
 Detector: Sample
 Attn: 10 DB
 RL Offset: 0.0 DB
 Sweep Time: 26.0s
 Ref Lvl: 0.0 DBM

Comments
 BE @ 2390 MHz
 802.11g
 Chain A

Cursor 1	2390.0000	-61.00	
Cursor 2	2411.1167	-11.83	

Delta Freq. 21.117
 Delta Amplitude 49.17



Client: Intel Corporation	Job Number: J80398
Model: Intel® Centrino® Advanced-N 6230	T-Log Number: T80540
Contact: Steve Hackett	Account Manager: Christine Krebill
Standard: FCC 15.247	Class: N/A

Run # 6b, EUT on Channel #11 2462MHz - 802.11g, Chain A

Fundamental Signal Field Strength

Frequency	Level	Pol	15.209 / 15.247		Detector	Azimuth	Height	Comments
MHz	dBuV/m	v/h	Limit	Margin	Pk/QP/Avg	degrees	meters	
2464.170	98.8	V	120.0	-21.2	AVG	344	1.0	
2465.230	106.9	V	120.0	-13.1	PK	344	1.0	
2460.540	100.0	H	120.0	-20.0	AVG	268	1.0	
2463.450	107.9	H	120.0	-12.1	PK	268	1.0	

2483.5 MHz Band Edge Signal Radiated Field Strength - Marker Delta

	H	V				
Fundamental emission level @ 3m in 1MHz RBW :	107.9	106.9	Peak Measurement (RB=VB=1MHz)			
Fundamental emission level @ 3m in 1MHz RBW :	100.0	98.8	Average Measurement (RB=1MHz, VB=10Hz)			
<i>Delta Marker - 100kHz</i>	46.3 dB		<- this can only be used if band edge signal is highest within 2MHz of band edge.			
Calculated Band-Edge Measurement (Peak):	61.6 dBuV/m					
Calculated Band-Edge Measurement (Avg):	53.7 dBuV/m		Margin	Level	Limit	Detector
<i>Delta Marker - 1MHz/1MHz:</i>	37.3 dB		-1.2	52.8	54	Avg
<i>Delta Marker - 1MHz/10Hz:</i>	47.2 dB		-12.4	61.6	74	Pk
Calculated Band-Edge Measurement (Peak):	dBuV/m		Using 100kHz delta value			
Calculated Band-Edge Measurement (Avg):	52.8 dBuV/m		Using 1MHz delta value			

Frequency	Level	Pol	FCC 15.209		Detector	Azimuth	Height	Comments
MHz	dBuV/m	v/h	Limit	Margin	Pk/QP/Avg	degrees	meters	
2483.500	52.8	-	54.0	-1.2	Avg	-	-	Using 1MHz delta value

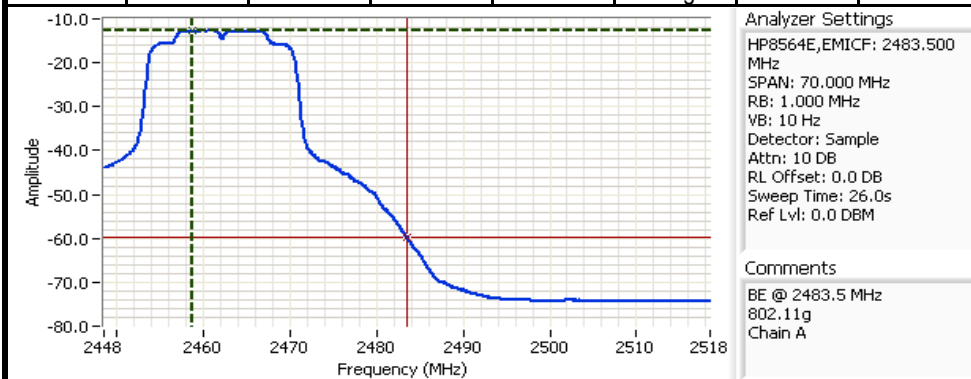

Analyzer Settings
 HP8564E,EMICF: 2483.500 MHz
 SPAN: 70.000 MHz
 RB: 1.000 MHz
 VB: 10 Hz
 Detector: Sample
 Attn: 10 DB
 RL Offset: 0.0 DB
 Sweep Time: 26.0s
 Ref Lvl: 0.0 DBM

Comments
 BE @ 2483.5 MHz
 802.11g
 Chain A

Cursor 1	2458.7666	-12.67	+	-	+	-
Cursor 2	2483.5000	-59.83	+	-	+	-

Delta Freq. 24.733
 Delta Amplitude 47.17



Client: Intel Corporation	Job Number: J80398
Model: Intel® Centrino® Advanced-N 6230	T-Log Number: T80540
Contact: Steve Hackett	Account Manager: Christine Krebill
Standard: FCC 15.247	Class: N/A

Run # 7, Band Edge Field Strength - 802.11b, Chain A

Date of Test: 9/15/2010

Test Location: FT Chamber #7

Test Engineer: Rafael Varelas

Config Change: none

Run # 7a, EUT on Channel #1 2412MHz - 802.11b, Chain A

	Power Settings		
	Target (dBm)	Measured (dBm)	Software Setting
Chain A	16.5	16.5	23.0

Fundamental Signal Field Strength

Frequency	Level	Pol	15.209 / 15.247		Detector	Azimuth	Height	Comments
MHz	dBuV/m	v/h	Limit	Margin	Pk/QP/Avg	degrees	meters	
2413.830	108.7	H	120.0	-11.3	AVG	267	1.1	
2413.200	112.1	H	120.0	-7.9	PK	267	1.1	
2410.370	103.4	V	120.0	-16.6	AVG	202	1.0	
2413.130	106.7	V	120.0	-13.3	PK	202	1.0	

2390 MHz Band Edge Signal Radiated Field Strength - Marker Delta

	H	V				
Fundamental emission level @ 3m in 1MHz RBW:	112.1	106.7	Peak Measurement (RB=VB=1MHz)			
Fundamental emission level @ 3m in 1MHz RBW:	108.7	103.4	Average Measurement (RB=1MHz, VB=10Hz)			
Delta Marker - 100kHz	56.8 dB		-< this can only be used if band edge signal is highest within 2MHz of band edge.			
Calculated Band-Edge Measurement (Peak):	55.3 dBuV/m					
Calculated Band-Edge Measurement (Avg):	51.9 dBuV/m	Margin	Level	Limit	Detector	
Delta Marker - 1MHz/1MHz:	49.0 dB	-3.3	50.7	54	Avg	
Delta Marker - 1MHz/10Hz:	58.0 dB	-18.7	55.3	74	Pk	
Calculated Band-Edge Measurement (Peak):	63.1 dBuV/m	Using 100kHz delta value				
Calculated Band-Edge Measurement (Avg):	50.7 dBuV/m	Using 1MHz delta value				

Frequency	Level	Pol	FCC 15.209		Detector	Azimuth	Height	Comments
MHz	dBuV/m	v/h	Limit	Margin	Pk/QP/Avg	degrees	meters	
2389.566	50.7	-	54.0	-3.3	Avg	-	-	Using 1MHz delta value

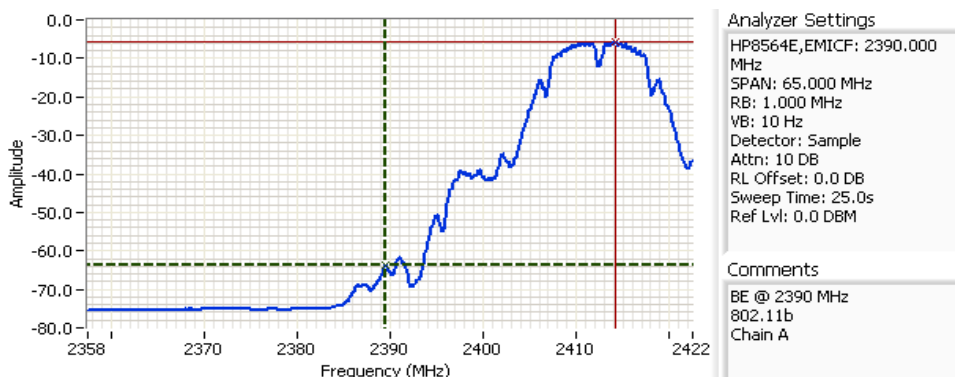

Cursor 1	2389.5667	-63.67	
Cursor 2	2414.2666	-5.67	

Delta Freq. 24.700
Delta Amplitude 58.00



Client: Intel Corporation	Job Number: J80398
Model: Intel® Centrino® Advanced-N 6230	T-Log Number: T80540
Contact: Steve Hackett	Account Manager: Christine Krebill
Standard: FCC 15.247	Class: N/A

Run # 7b, EUT on Channel #11 2462MHz - 802.11b, Chain A

	Target (dBm)	Power Settings Measured (dBm)	Software Setting
Chain A	16.5	16.9	23.5

Fundamental Signal Field Strength

Frequency	Level	Pol	15.209 / 15.247		Detector	Azimuth	Height	Comments
MHz	dBuV/m	v/h	Limit	Margin	Pk/QP/Avg	degrees	meters	
2463.800	104.6	V	120.0	-15.4	AVG	344	1.0	
2461.200	107.9	V	120.0	-12.1	PK	344	1.0	
2460.300	107.8	H	120.0	-12.2	AVG	266	1.0	
2460.700	111.0	H	120.0	-9.0	PK	266	1.0	

2483.5 MHz Band Edge Signal Radiated Field Strength - Marker Delta

	H	V				
Fundamental emission level @ 3m in 1MHz RBW:	111.0	107.9	Peak Measurement (RB=VB=1MHz)			
Fundamental emission level @ 3m in 1MHz RBW:	107.8	104.6	Average Measurement (RB=1MHz, VB=10Hz)			
Delta Marker - 100kHz	58.5 dB		<- this can only be used if band edge signal is highest within 2MHz of band edge.			
Calculated Band-Edge Measurement (Peak):	52.5 dBuV/m					
Calculated Band-Edge Measurement (Avg):	49.3 dBuV/m		Margin	Level	Limit	Detector
Delta Marker - 1MHz/1MHz:	47.0 dB		-4.7	49.3	54	Avg
Delta Marker - 1MHz/10Hz:	57.0 dB		-21.5	52.5	74	Pk
Calculated Band-Edge Measurement (Peak):	64.0 dBuV/m		Using 100kHz delta value			
Calculated Band-Edge Measurement (Avg):	50.8 dBuV/m		Using 100kHz delta value			

Frequency	Level	Pol	FCC 15.209		Detector	Azimuth	Height	Comments
MHz	dBuV/m	v/h	Limit	Margin	Pk/QP/Avg	degrees	meters	
2485.340	49.3	-	54.0	-4.7	Avg	-	-	Using 100kHz delta value

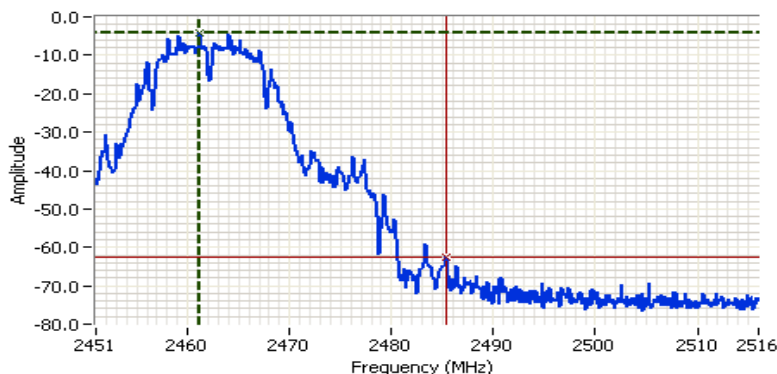

Analyzer Settings
 HP8564E,EMICF: 2483.500 MHz
 SPAN: 65.000 MHz
 RB: 100 kHz
 VB: 100 kHz
 Detector: Normal
 Attn: 10 DB
 RL Offset: 0.0 DB
 Sweep Time: 50.0ms
 Ref Lvl: 0.0 DBM

Comments
 BE @ 2483.5 MHz
 802.11b
 Chain A

Cursor 1	2461.0750	-4.17	+	-	+	-
Cursor 2	2485.3416	-62.67	+	-	+	-

Delta Freq. 24.267
 Delta Amplitude 58.50



Client: Intel Corporation	Job Number: J80398
Model: Intel® Centrino® Advanced-N 6230	T-Log Number: T80540
Contact: Steve Hackett	Account Manager: Christine Krebill
Standard: FCC 15.247	Class: N/A

Run # 8, Band Edge Field Strength - 802.11n20MHz, Chain A

Date of Test: 9/17/2010

Test Location: FT Chamber #7

Test Engineer: Rafael Varelas

Config Change: none

Run # 8a, EUT on Channel #2 2417MHz - 802.11n20MHz, Chain A

	Target (dBm)	Power Settings Measured (dBm)	Software Setting
Chain A	16.5	15.7	28.0

Fundamental Signal Field Strength

Frequency	Level	Pol	15.209 / 15.247		Detector	Azimuth	Height	Comments
MHz	dBuV/m	v/h	Limit	Margin	Pk/QP/Avg	degrees	meters	
2413.770	103.2	H	120.0	-16.8	AVG	357	1.0	
2413.070	111.4	H	120.0	-8.6	PK	357	1.0	
2413.970	98.9	V	120.0	-21.1	AVG	204	1.2	
2412.670	107.4	V	120.0	-12.6	PK	204	1.2	

2390 MHz Band Edge Signal Radiated Field Strength - Marker Delta

	H	V				
Fundamental emission level @ 3m in 1MHz RBW:	111.4	107.4	Peak Measurement (RB=VB=1MHz)			
Fundamental emission level @ 3m in 1MHz RBW:	103.2	98.9	Average Measurement (RB=1MHz, VB=10Hz)			
Delta Marker - 100kHz	48.7 dB		<- this can only be used if band edge signal is highest within 2MHz of band edge.			
Calculated Band-Edge Measurement (Peak):	62.7 dBuV/m					
Calculated Band-Edge Measurement (Avg):	54.5 dBuV/m		Margin	Level	Limit	Detector
Delta Marker - 1MHz/1MHz:	40.5 dB		-1.3	52.7	54	Avg
Delta Marker - 1MHz/10Hz:	50.5 dB		-11.3	62.7	74	Pk
Calculated Band-Edge Measurement (Peak):	70.9 dBuV/m		Using 100kHz delta value			
Calculated Band-Edge Measurement (Avg):	52.7 dBuV/m		Using 1MHz delta value			

Frequency	Level	Pol	FCC 15.209		Detector	Azimuth	Height	Comments
MHz	dBuV/m	v/h	Limit	Margin	Pk/QP/Avg	degrees	meters	
2390.000	52.7	-	54.0	-1.3	Avg	-	-	Using 1MHz delta value

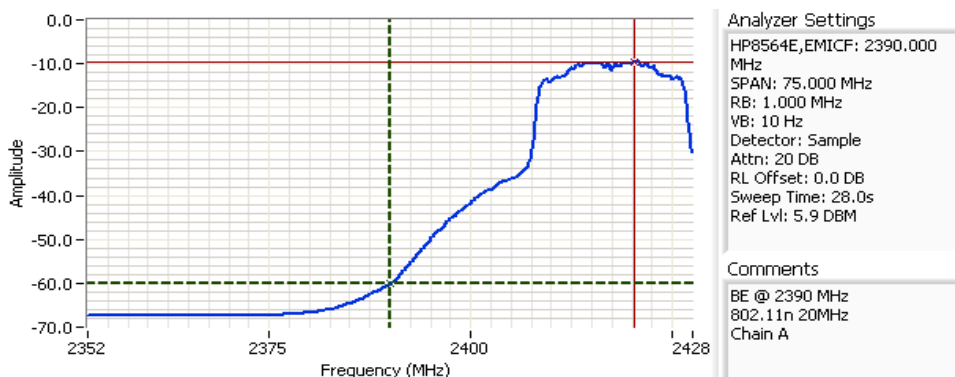

Analyzer Settings
 HP8564E,EMICF: 2390.000 MHz
 SPAN: 75.000 MHz
 RB: 1.000 MHz
 VB: 10 Hz
 Detector: Sample
 Attn: 20 DB
 RL Offset: 0.0 DB
 Sweep Time: 28.0s
 Ref Lvl: 5.9 DBM

Comments
 BE @ 2390 MHz
 802.11n 20MHz
 Chain A

Cursor 1	2390.0000	-60.10	
Cursor 2	2420.2500	-9.60	

Delta Freq. 30.250
 Delta Amplitude 50.50



Client: Intel Corporation	Job Number: J80398
Model: Intel® Centrino® Advanced-N 6230	T-Log Number: T80540
Contact: Steve Hackett	Account Manager: Christine Krebill
Standard: FCC 15.247	Class: N/A

Run # 8b, EUT on Channel #10 2457MHz - 802.11n20MHz, Chain A

	Target (dBm)	Power Settings Measured (dBm)	Software Setting
Chain A	16.5	15.8	28.0

Fundamental Signal Field Strength

Frequency	Level	Pol	15.209 / 15.247		Detector	Azimuth	Height	Comments
MHz	dBμV/m	v/h	Limit	Margin	PK/QP/Avg	degrees	meters	
2460.000	102.1	H	120.0	-17.9	AVG	14	1.0	
2459.000	110.1	H	120.0	-9.9	PK	14	1.0	
2460.270	99.8	V	120.0	-20.2	AVG	345	1.0	
2461.430	108.1	V	120.0	-11.9	PK	345	1.0	

2483.5 MHz Band Edge Signal Radiated Field Strength - Marker Delta

	H	V		Margin	Level	Limit	Detector
Fundamental emission level @ 3m in 1MHz RBW:	110.1	108.1					Peak Measurement (RB=VB=1MHz)
Fundamental emission level @ 3m in 1MHz RBW:	102.1	99.8					Average Measurement (RB=1MHz, VB=10Hz)
Delta Marker - 100kHz	48.7 dB						<- this can only be used if band edge signal is highest within 2MHz of band edge.
Calculated Band-Edge Measurement (Peak):	61.4 dBuV/m						
Calculated Band-Edge Measurement (Avg):	53.4 dBuV/m						
Delta Marker - 1MHz/1MHz:	39.7 dB			-1.6	52.4	54	Avg
Delta Marker - 1MHz/10Hz:	49.7 dB			-12.6	61.4	74	Pk
Calculated Band-Edge Measurement (Peak):	70.4 dBuV/m						Using 100kHz delta value
Calculated Band-Edge Measurement (Avg):	52.4 dBuV/m						Using 1MHz delta value

Frequency	Level	Pol	FCC 15.209		Detector	Azimuth	Height	Comments
MHz	dBμV/m	v/h	Limit	Margin	PK/QP/Avg	degrees	meters	
2483.500	52.4	-	54.0	-1.6	Avg	-	-	Using 1MHz delta value

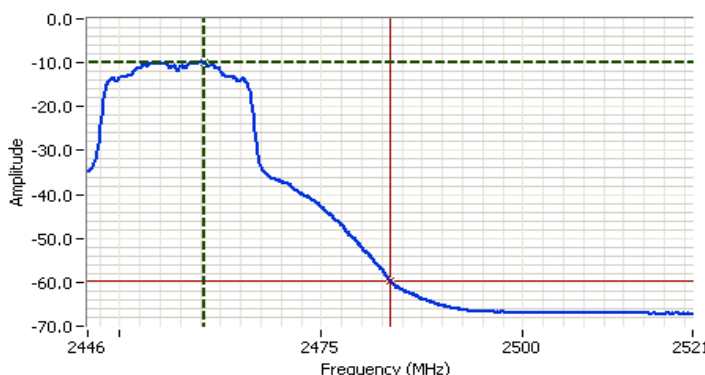

Analyzer Settings
 HP8564E,EMICF: 2483.500 MHz
 SPAN: 75.000 MHz
 RB: 1.000 MHz
 VB: 10 Hz
 Detector: Sample
 Attn: 20 DB
 RL Offset: 0.0 DB
 Sweep Time: 28.0s
 Ref Lvl: 5.9 DBM

Comments
 BE @ 2483.5 MHz
 802.11n 20MHz
 Chain A

Cursor 1	2460.3750	-9.93	
Cursor 2	2483.5000	-59.60	

Delta Freq. 23.125
 Delta Amplitude 49.67



Client:	Intel Corporation	Job Number:	J80398
Model:	Intel® Centrino® Advanced-N 6230	T-Log Number:	T80540
Contact:	Steve Hackett	Account Manager:	Christine Krebill
Standard:	FCC 15.247	Class:	N/A

RSS 210 and FCC 15.247 (DTS) Radiated Spurious Emissions (Band Edge)

Summary of Results

MAC Address: 00150079AD1A DRTU Tool Version 1.2.12-0197 New tool from 9/14 Driver version 14.0.0.39

Run #	Mode	Channel	Target Power	Measured Power	Test Performed	Limit	Result / Margin
Run # 1	n40 Chain B	#3 2422MHz	16.5	9.1	Restricted Band Edge at 2400 MHz	15.209	52.9dBµV/m @ 2389.3MHz (-1.1dB)
		#9 2452MHz	16.5	10.1	Restricted Band Edge at 2483.5 MHz	15.209	53.0dBµV/m @ 2484.2MHz (-1.0dB)
Run # 2	n40 Chain B	#4 2427MHz	16.5	9.5	Restricted Band Edge at 2400 MHz	15.209	52.2dBµV/m @ 2390.0MHz (-1.8dB)
		#8 2447MHz	16.5	9.9	Restricted Band Edge at 2483.5 MHz	15.209	53.0dBµV/m @ 2483.5MHz (-1.0dB)
Run # 3	n40 Chain B	#5 2432MHz	16.5	11.9	Restricted Band Edge at 2400 MHz	15.209	52.2dBµV/m @ 2389.6MHz (-1.8dB)
		#7 2442MHz	16.5	11.4	Restricted Band Edge at 2483.5 MHz	15.209	52.9dBµV/m @ 2483.5MHz (-1.1dB)
Run # 4	n40 Chain B	#6 2437MHz	16.5	12.6	Restricted Band Edge at 2400 MHz	16.209	48.9dBµV/m @ 2390.0MHz (-5.1dB)
			16.5	12.6	Restricted Band Edge at 2483.5 MHz	16.209	52.1dBµV/m @ 2483.5MHz (-1.9dB)
Run # 5	n20 Chain B	#1 2412MHz	16.5	12.4	Restricted Band Edge at 2400 MHz	16.209	52.0dBµV/m @ 2390.0MHz (-2.0dB)
			16.5	12.3	Restricted Band Edge at 2483.5 MHz	16.209	52.6dBµV/m @ 2483.5MHz (-1.4dB)
Run # 6	802.11g Chain B	#1 2412MHz	16.5	13.8	Restricted Band Edge at 2400 MHz	16.209	52.1dBµV/m @ 2390.0MHz (-1.9dB)
			16.5	13.4	Restricted Band Edge at 2483.5 MHz	16.209	51.9dBµV/m @ 2483.5MHz (-2.1dB)
Run # 7	802.11b Chain B	#1 2412MHz	16.5	16.7	Restricted Band Edge at 2400 MHz	15.209	49.4dBµV/m @ 2389.9MHz (-4.6dB)
			16.5	16.7	Restricted Band Edge at 2483.5 MHz	15.209	48.1dBµV/m @ 2483.5MHz (-5.9dB)
Run # 8	802.11n20 Chain B	#2 2417MHz	16.5	16.2	Restricted Band Edge at 2400 MHz	16.209	49.5dBµV/m @ 2390.0MHz (-4.5dB)
			16.5	16.3	Restricted Band Edge at 2483.5 MHz	15.209	52.5dBµV/m @ 2483.5MHz (-1.5dB)

Note - the target and measured power are average powers (measured with average power sensor) and are used for reference purposes only. Power is set using " **GAIN CONTROL**" mode in the DRTU tool.

Client:	Intel Corporation	Job Number:	J80398
Model:	Intel® Centrino® Advanced-N 6230	T-Log Number:	T80540
		Account Manager:	Christine Krebill
Contact:	Steve Hackett		
Standard:	FCC 15.247	Class:	N/A

Test Specific Details

Objective: The objective of this test session is to perform engineering evaluation testing of the EUT with respect to the specification listed above.

General Test Configuration

The EUT was installed into a test fixture such that the EUT was exposed (i.e. outside of a host PC).
For radiated emissions testing the measurement antenna was located 3 meters from the EUT.

Ambient Conditions:

Rel. Humidity: 15 - 55 %
Temperature: 18 - 25 °C

Modifications Made During Testing

No modifications were made to the EUT during testing

Deviations From The Standard

No deviations were made from the requirements of the standard.

Marker Delta Measurements

Three sets of marker deltas are measured using the following settings: RB=VB=100kHz; RB=1MHz,VB=1MHz; RB=1MHz, VB=10Hz.
Marker deltas are made conducted (analyzer connected to EUT rf port a 20dB pad) for single chain operation.
The fundamental field strength is always measured at a 3m test distance.

Client: Intel Corporation	Job Number: J80398
Model: Intel® Centrino® Advanced-N 6230	T-Log Number: T80540
Contact: Steve Hackett	Account Manager: Christine Krebill
Standard: FCC 15.247	Class: N/A

Run # 1, Band Edge Field Strength - n40, Chain B

Date of Test: 9/15/2010

Test Location: FT Chamber #7

Test Engineer: Rafael Varelas

Config Change: none

Run # 1a, EUT on Channel #3 2422MHz - n40, Chain B

	Target (dBm)	Power Settings Measured (dBm)	Software Setting
Chain B	16.5	9.1	21.5

Fundamental Signal Field Strength

Frequency	Level	Pol	15.209 / 15.247		Detector	Azimuth	Height	Comments
MHz	dBμV/m	v/h	Limit	Margin	Pk/QP/Avg	degrees	meters	
2434.730	91.4	H	-	-	AVG	238	1.0	
2432.600	99.6	H	-	-	PK	238	1.0	
2410.000	88.5	V	-	-	AVG	231	1.0	
2410.870	96.6	V	-	-	PK	231	1.0	

2390 MHz Band Edge Signal Radiated Field Strength - Marker Delta

	H	V	
Fundamental emission level @ 3m in 1MHz RBW:	99.6	96.6	Peak Measurement (RB=VB=1MHz)
Fundamental emission level @ 3m in 1MHz RBW:	91.4	88.5	Average Measurement (RB=1MHz, VB=10Hz)
Delta Marker - 100kHz	38.3 dB		-< this can only be used if band edge signal is highest within 2MHz of band edge.
Calculated Band-Edge Measurement (Peak):	61.3 dBuV/m		
Calculated Band-Edge Measurement (Avg):	53.1 dBuV/m		Margin
Delta Marker - 1MHz/1MHz:	34.2 dB		-1.1
Delta Marker - 1MHz/10Hz:	38.5 dB		52.9
Calculated Band-Edge Measurement (Peak):	65.4 dBuV/m		54
Calculated Band-Edge Measurement (Avg):	52.9 dBuV/m		74
			Level
			Limit
			Detector
			Avg
			Pk
			Using 100kHz delta value
			Using 1MHz delta value

Frequency	Level	Pol	FCC 15.209		Detector	Azimuth	Height	Comments
MHz	dBμV/m	v/h	Limit	Margin	Pk/QP/Avg	degrees	meters	
2389.266	52.9	-	54.0	-1.1	Avg	-	-	Using 1MHz delta value

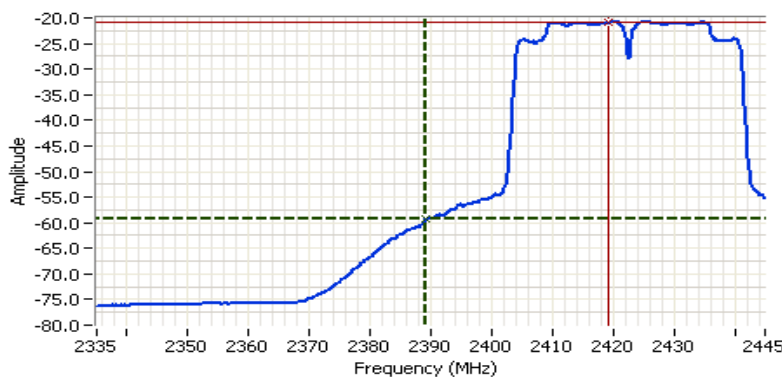

Analyzer Settings
 HP8564E,EMICF: 2390.000
 MHz
 SPAN: 110.000 MHz
 RB: 1.000 MHz
 VB: 10 Hz
 Detector: Sample
 Attn: 10 DB
 RL Offset: 0.0 DB
 Sweep Time: 41.0s
 Ref Lvl: -1.0 DBM

Comments
 BE @ 2390 MHz
 802.11n 40MHz
 Chain B

Cursor 1	2389.2666	-59.33	Delta Freq.	30.067
Cursor 2	2419.3333	-20.83	Delta Amplitude	38.50



Client:	Intel Corporation	Job Number:	J80398
Model:	Intel® Centrino® Advanced-N 6230	T-Log Number:	T80540
Contact:	Steve Hackett	Account Manager:	Christine Krebill
Standard:	FCC 15.247	Class:	N/A

Run # 1b, EUT on Channel #9 2452MHz - n40, Chain B

	Target (dBm)	Power Settings Measured (dBm)	Software Setting
Chain B	16.5	10.1	22.5

Fundamental Signal Field Strength

Frequency	Level	Pol	15.209 / 15.247		Detector	Azimuth	Height	Comments
MHz	dBuV/m	v/h	Limit	Margin	Pk/QP/Avg	degrees	meters	
2439.670	89.7	H	-	-	AVG	239	1.0	
2440.600	98.0	H	-	-	PK	239	1.0	
2439.930	89.3	V	-	-	AVG	322	1.0	
2445.870	97.8	V	-	-	PK	322	1.0	

2483.5 MHz Band Edge Signal Radiated Field Strength - Marker Delta

	H	V				
Fundamental emission level @ 3m in 1MHz RBW:	98.0	97.8	Peak Measurement (RB=VB=1MHz)			
Fundamental emission level @ 3m in 1MHz RBW:	89.7	89.3	Average Measurement (RB=1MHz, VB=10Hz)			
Delta Marker - 100kHz	33.7 dB		<- this can only be used if band edge signal is highest within 2MHz of band edge.			
Calculated Band-Edge Measurement (Peak):	64.3 dBuV/m					
Calculated Band-Edge Measurement (Avg):	56.0 dBuV/m		Margin	Level	Limit	Detector
Delta Marker - 1MHz/1MHz:	32.8 dB		-1.0	53.0	54	Avg
Delta Marker - 1MHz/10Hz:	36.7 dB		-9.7	64.3	74	Pk
Calculated Band-Edge Measurement (Peak):	65.2 dBuV/m		Using 100kHz delta value			
Calculated Band-Edge Measurement (Avg):	53.0 dBuV/m		Using 1MHz delta value			

Frequency	Level	Pol	FCC 15.209		Detector	Azimuth	Height	Comments
MHz	dBuV/m	v/h	Limit	Margin	Pk/QP/Avg	degrees	meters	
2484.166	53.0	-	54.0	-1.0	Avg	-	-	Using 1MHz delta value

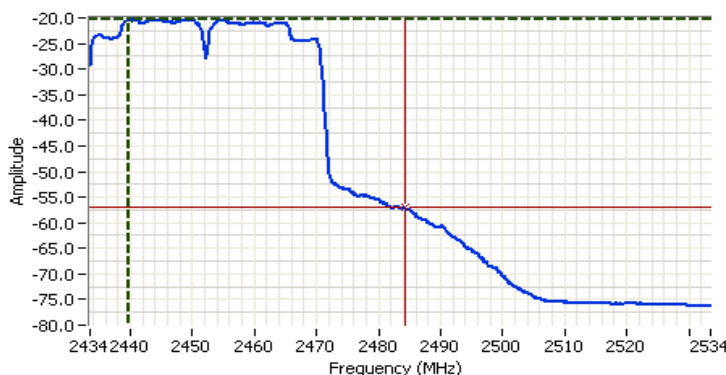

Analyzer Settings
 HP8564E,EMICF: 2483.500
 MHz
 SPAN: 100.000 MHz
 RB: 1.000 MHz
 VB: 10 Hz
 Detector: Sample
 Attn: 10 DB
 RL Offset: 0.0 DB
 Sweep Time: 37.0s
 Ref Lvl: -1.0 DBM

Comments
 BE @ 2483.5 MHz
 802.11n 40MHz
 Chain B

Cursor 1	2439.6667	-20.33	Delta Freq.	44.500
Cursor 2	2484.1667	-57.00	Delta Amplitude	36.67



Client: Intel Corporation	Job Number: J80398
Model: Intel® Centrino® Advanced-N 6230	T-Log Number: T80540
Contact: Steve Hackett	Account Manager: Christine Krebill
Standard: FCC 15.247	Class: N/A

Run # 2, Band Edge Field Strength - n40, Chain B

Date of Test: 9/16/2010

Test Location: Chamber #7

Test Engineer: Mehran Birgani/R. Varelas

Config Change: none

Run # 2a, EUT on Channel #4 2427MHz - n40, Chain B

	Target (dBm)	Power Settings Measured (dBm)	Software Setting
Chain B	16.5	9.5	22.0

Fundamental Signal Field Strength

Frequency	Level	Pol	15.209 / 15.247		Detector	Azimuth	Height	Comments
MHz	dBuV/m	v/h	Limit	Margin	Pk/QP/Avg	degrees	meters	
2419.670	93.2	H	-	-	AVG	233	1.0	
2421.530	101.9	H	-	-	PK	233	1.0	
2414.870	89.3	V	-	-	AVG	218	1.0	
2416.530	98.1	V	-	-	PK	218	1.0	

2390 MHz Band Edge Signal Radiated Field Strength - Marker Delta

	H	V				
Fundamental emission level @ 3m in 1MHz RBW:	101.9	98.1	Peak Measurement (RB=VB=1MHz)			
Fundamental emission level @ 3m in 1MHz RBW:	93.2	89.3	Average Measurement (RB=1MHz, VB=10Hz)			
Delta Marker - 100kHz	38.2 dB		<- this can only be used if band edge signal is highest within 2MHz of band edge.			
Calculated Band-Edge Measurement (Peak):	63.7 dBuV/m					
Calculated Band-Edge Measurement (Avg):	55.0 dBuV/m	Margin	Level	Limit	Detector	
Delta Marker - 1MHz/1MHz:	37.7 dB	-1.8	52.2	54	Avg	
Delta Marker - 1MHz/10Hz:	41.0 dB	-10.3	63.7	74	Pk	
Calculated Band-Edge Measurement (Peak):	64.2 dBuV/m	Using 100kHz delta value				
Calculated Band-Edge Measurement (Avg):	52.2 dBuV/m	Using 1MHz delta value				

Frequency	Level	Pol	FCC 15.209		Detector	Azimuth	Height	Comments
MHz	dBuV/m	v/h	Limit	Margin	Pk/QP/Avg	degrees	meters	
2390.000	52.2	-	54.0	-1.8	Avg	-	-	Using 1MHz delta value

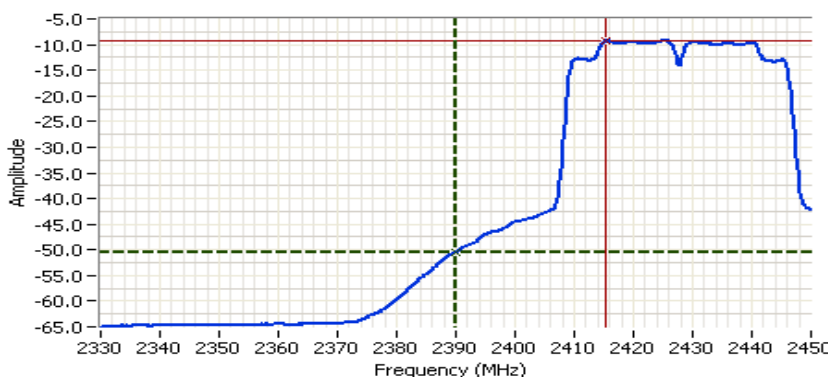

Analyzer Settings

HP8564E
 CF: 2390.000 MHz
 SPAN: 120.000 MHz
 RB: 1.000 MHz
 VB: 10 Hz
 Detector: Sample
 Attn: 20 DB
 RL Offset: 1.0 DB
 Sweep Time: 30.0s
 Ref Lvl: 10.8 DBM

Comments

BE @ 2390 MHz
 802.11n 40MHz
 Chain B

Cursor 1 2390.0000 -50.37 Delta Freq. 25.200

Cursor 2 2415.2000 -9.37 Delta Amplitude 41.00



Client: Intel Corporation	Job Number: J80398
Model: Intel® Centrino® Advanced-N 6230	T-Log Number: T80540
Contact: Steve Hackett	Account Manager: Christine Krebill
Standard: FCC 15.247	Class: N/A

Run # 2b, EUT on Channel #8 2447MHz - n40, Chain B

	Target (dBm)	Power Settings Measured (dBm)	Software Setting
Chain B	16.5	9.9	22.5

Fundamental Signal Field Strength

Frequency MHz	Level dBμV/m	Pol v/h	15.209 / 15.247		Detector Pk/QP/Avg	Azimuth degrees	Height meters	Comments
			Limit	Margin				
2434.870	92.8	H	-	-	AVG	230	1.0	
2435.200	101.6	H	-	-	PK	230	1.0	
2434.930	89.1	V	-	-	AVG	214	1.0	
2435.600	97.8	V	-	-	PK	214	1.0	

2483.5 MHz Band Edge Signal Radiated Field Strength - Marker Delta

	H	V				
Fundamental emission level @ 3m in 1MHz RBW:	101.6	97.8	Peak Measurement (RB=VB=1MHz)			
Fundamental emission level @ 3m in 1MHz RBW:	92.8	89.1	Average Measurement (RB=1MHz, VB=10Hz)			
Delta Marker - 100kHz	39.7 dB		<- this can only be used if band edge signal is highest within 2MHz of band edge.			
Calculated Band-Edge Measurement (Peak):	61.9 dBuV/m					
Calculated Band-Edge Measurement (Avg):	53.1 dBuV/m		Margin	Level	Limit	Detector
Delta Marker - 1MHz/1MHz:	34.0 dB		-1.0	53.0	54	Avg
Delta Marker - 1MHz/10Hz:	39.8 dB		-12.1	61.9	74	Pk
Calculated Band-Edge Measurement (Peak):	67.6 dBuV/m		Using 100kHz delta value			
Calculated Band-Edge Measurement (Avg):	53.0 dBuV/m		Using 1MHz delta value			

Frequency MHz	Level dBμV/m	Pol v/h	FCC 15.209		Detector Pk/QP/Avg	Azimuth degrees	Height meters	Comments
			Limit	Margin				
2483.500	53.0	-	54.0	-1.0	Avg	-	-	Using 1MHz delta value

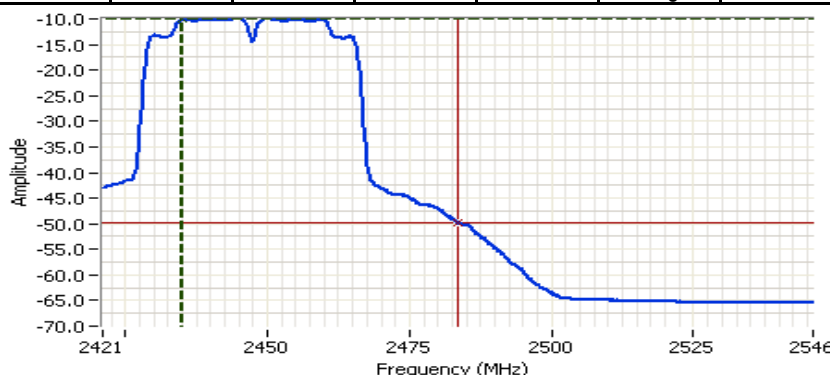

Analyzer Settings
 HP8564E
 CF: 2483.500 MHz
 SPAN: 125.000 MHz
 RB: 1.000 MHz
 VB: 10 Hz
 Detector: Sample
 Attn: 20 DB
 RL Offset: 0.0 DB
 Sweep Time: 32.0s
 Ref Lvl: 10.0 DBM

Comments
 BE @ 2483.5 MHz
 802.11n 40MHz
 Chain B

Cursor 1	2434.9583	-10.00	
Cursor 2	2483.5000	-49.83	

Delta Freq. 48.542
 Delta Amplitude 39.83



Client: Intel Corporation	Job Number: J80398
Model: Intel® Centrino® Advanced-N 6230	T-Log Number: T80540
Contact: Steve Hackett	Account Manager: Christine Krebill
Standard: FCC 15.247	Class: N/A

Run # 3, Band Edge Field Strength - n40, Chain B

Date of Test: 9/16/2010

Test Location: Chamber #7

Test Engineer: Mehran Birgani/R. Varelas

Config Change: none

Run # 3a, EUT on Channel #5 2432MHz - n40, Chain B

	Target (dBm)	Power Settings Measured (dBm)	Software Setting
Chain B	16.5	11.9	24.0

Fundamental Signal Field Strength

Frequency	Level	Pol	15.209 / 15.247		Detector	Azimuth	Height	Comments
MHz	dBuV/m	v/h	Limit	Margin	Pk/QP/Avg	degrees	meters	
2420.000	95.4	H	-	-	AVG	236	1.0	
2420.730	104.3	H	-	-	PK	236	1.0	
2419.870	91.6	V	-	-	AVG	217	1.0	
2420.400	100.4	V	-	-	PK	217	1.0	

2483.5 MHz Band Edge Signal Radiated Field Strength - Marker Delta

	H	V				
Fundamental emission level @ 3m in 1MHz RBW:	104.3	100.4	Peak Measurement (RB=VB=1MHz)			
Fundamental emission level @ 3m in 1MHz RBW:	95.4	91.6	Average Measurement (RB=1MHz, VB=10Hz)			
Delta Marker - 100kHz	43.2 dB		<- this can only be used if band edge signal is highest within 2MHz of band edge.			
Calculated Band-Edge Measurement (Peak):	61.1 dBuV/m		Margin	Level	Limit	Detector
Calculated Band-Edge Measurement (Avg):	52.2 dBuV/m		-1.8	52.2	54	Avg
Delta Marker - 1MHz/1MHz:	39.2 dB		-12.9	61.1	74	Pk
Delta Marker - 1MHz/10Hz:	43.0 dB					
Calculated Band-Edge Measurement (Peak):	65.1 dBuV/m		Using 100kHz delta value			
Calculated Band-Edge Measurement (Avg):	52.4 dBuV/m		Using 100kHz delta value			

Frequency	Level	Pol	FCC 15.209		Detector	Azimuth	Height	Comments
MHz	dBuV/m	v/h	Limit	Margin	Pk/QP/Avg	degrees	meters	
2389.583	52.2	-	54.0	-1.8	Avg	-	-	Using 100kHz delta value

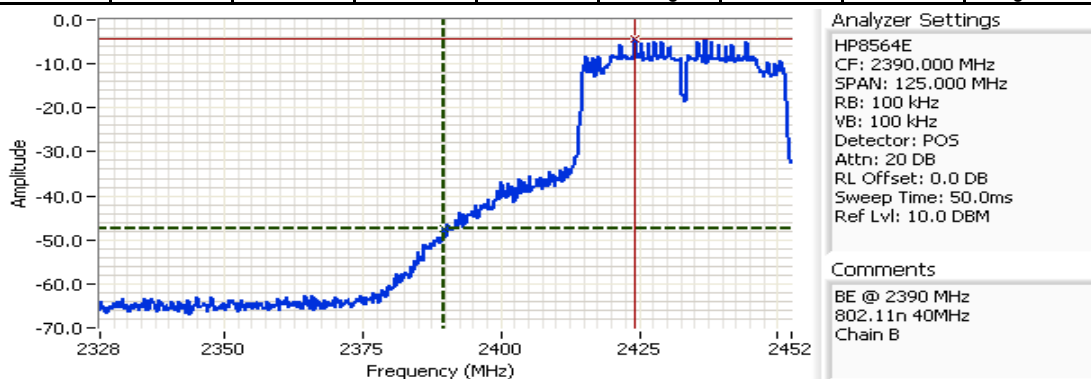

Analyzer Settings
 HP8564E
 CF: 2390.000 MHz
 SPAN: 125.000 MHz
 RB: 100 kHz
 VB: 100 kHz
 Detector: POS
 Attn: 20 DB
 RL Offset: 0.0 DB
 Sweep Time: 50.0ms
 Ref Lvl: 10.0 DBM

Comments
 BE @ 2390 MHz
 802.11n 40MHz
 Chain B

Cursor 1	2389.5833	-47.50	Delta Freq.	34.583
Cursor 2	2424.1667	-4.33	Delta Amplitude	43.17



Client: Intel Corporation	Job Number: J80398
Model: Intel® Centrino® Advanced-N 6230	T-Log Number: T80540
Contact: Steve Hackett	Account Manager: Christine Krebill
Standard: FCC 15.247	Class: N/A

Run # 3b, EUT on Channel #7 2442MHz - n40, Chain B

	Target (dBm)	Power Settings Measured (dBm)	Software Setting
Chain B	16.5	11.4	23.5

Fundamental Signal Field Strength

Frequency	Level	Pol	15.209 / 15.247		Detector	Azimuth	Height	Comments
MHz	dB μ V/m	v/h	Limit	Margin	Pk/QP/Avg	degrees	meters	
2429.800	94.6	H	-	-	AVG	231	1.0	
2431.530	103.6	H	-	-	PK	231	1.0	
2429.930	90.7	V	-	-	AVG	214	1.0	
2430.730	99.2	V	-	-	PK	214	1.0	

2483.5 MHz Band Edge Signal Radiated Field Strength - Marker Delta

	H	V				
Fundamental emission level @ 3m in 1MHz RBW:	103.6	99.2	Peak Measurement (RB=VB=1MHz)			
Fundamental emission level @ 3m in 1MHz RBW:	94.6	90.7	Average Measurement (RB=1MHz, VB=10Hz)			
Delta Marker - 100kHz	41.7 dB		<- this can only be used if band edge signal is highest within 2MHz of band edge.			
Calculated Band-Edge Measurement (Peak):	61.9 dB μ V/m					
Calculated Band-Edge Measurement (Avg):	52.9 dB μ V/m		Margin	Level	Limit	Detector
Delta Marker - 1MHz/1MHz:	37.3 dB		-1.1	52.9	54	Avg
Delta Marker - 1MHz/10Hz:	41.7 dB		-12.1	61.9	74	Pk
Calculated Band-Edge Measurement (Peak):	66.3 dB μ V/m		Using 100kHz delta value			
Calculated Band-Edge Measurement (Avg):	52.9 dB μ V/m		Using 1MHz delta value			

Frequency	Level	Pol	FCC 15.209		Detector	Azimuth	Height	Comments
MHz	dB μ V/m	v/h	Limit	Margin	Pk/QP/Avg	degrees	meters	
2483.500	52.9	-	54.0	-1.1	Avg	-	-	Using 1MHz delta value

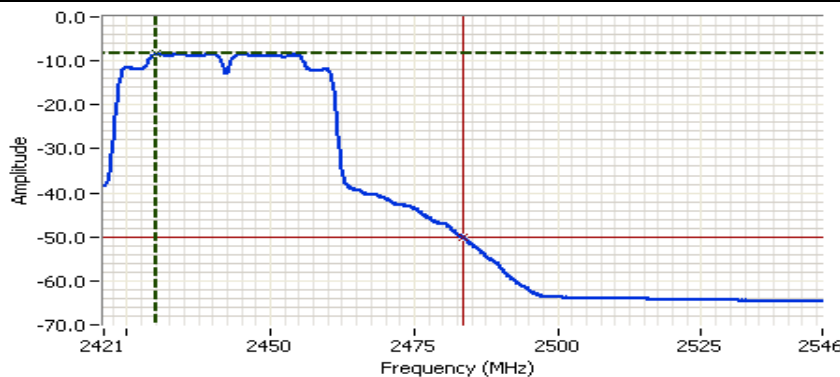

Analyzer Settings
 HP8564E
 CF: 2483.500 MHz
 SPAN: 125.000 MHz
 RB: 1.000 MHz
 VB: 10 Hz
 Detector: Sample
 Attn: 20 DB
 RL Offset: 0.0 DB
 Sweep Time: 32.0s
 Ref Lvl: 10.0 DBM

Comments
 BE @ 2483.5 MHz
 802.11n 40MHz
 Chain B

Cursor 1	2429.9583	-8.33	
Cursor 2	2483.5000	-50.00	

Delta Freq. 53.542
 Delta Amplitude 41.67



Client: Intel Corporation	Job Number: J80398
Model: Intel® Centrino® Advanced-N 6230	T-Log Number: T80540
Contact: Steve Hackett	Account Manager: Christine Krebill
Standard: FCC 15.247	Class: N/A

Run # 4, Band Edge Field Strength - n40, Chain B

Date of Test: 9/16/2010

Test Location: Chamber #7

Test Engineer: Mehran Birgani/R. Varelas

Config Change: none

EUT on Channel #6 2437MHz - n40, Chain B

	Target (dBm)	Power Settings Measured (dBm)	Software Setting
Chain B	16.5	12.6	25.0

Fundamental Signal Field Strength

Frequency	Level	Pol	15.209 / 15.247		Detector	Azimuth	Height	Comments
MHz	dBuV/m	v/h	Limit	Margin	Pk/QP/Avg	degrees	meters	
2424.870	96.6	H	-	-	AVG	234	1.0	
2425.330	105.3	H	-	-	PK	234	1.0	
2424.870	92.5	V	-	-	AVG	215	1.3	
2425.070	101.3	V	-	-	PK	215	1.3	

2390 MHz Band Edge Signal Radiated Field Strength - Marker Delta

	H	V	
Fundamental emission level @ 3m in 1MHz RBW:	105.3	101.3	Peak Measurement (RB=VB=1MHz)
Fundamental emission level @ 3m in 1MHz RBW:	96.6	92.5	Average Measurement (RB=1MHz, VB=10Hz)
Delta Marker - 100kHz	47.7 dB		-< this can only be used if band edge signal is highest within 2MHz of band edge.
Calculated Band-Edge Measurement (Peak):	57.6 dBuV/m		
Calculated Band-Edge Measurement (Avg):	48.9 dBuV/m	Margin	Level
Delta Marker - 1MHz/1MHz:	41.3 dB	-5.1	48.9
Delta Marker - 1MHz/10Hz:	47.2 dB	-16.4	57.6
Calculated Band-Edge Measurement (Peak):	64.0 dBuV/m		74
Calculated Band-Edge Measurement (Avg):	49.4 dBuV/m		

Frequency	Level	Pol	FCC 15.209		Detector	Azimuth	Height	Comments
MHz	dBuV/m	v/h	Limit	Margin	Pk/QP/Avg	degrees	meters	
2390.000	48.9	-	54.0	-5.1	Avg	-	-	Using 100kHz delta value

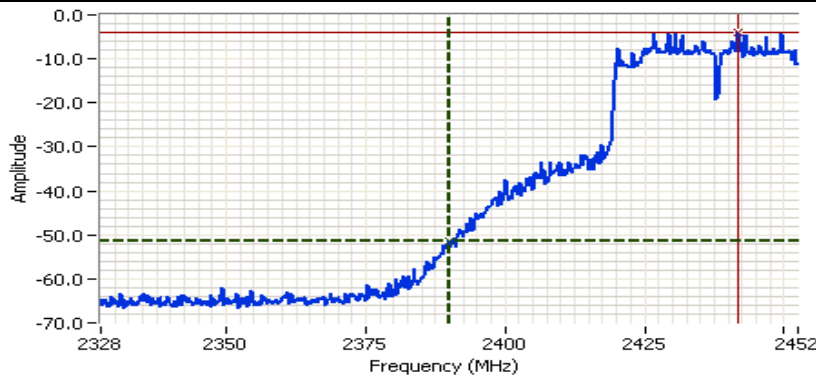

Analyzer Settings
 HP8564E
 CF: 2390.000 MHz
 SPAN: 125.000 MHz
 RB: 100 kHz
 VB: 100 kHz
 Detector: POS
 Attn: 20 DB
 RL Offset: 0.0 DB
 Sweep Time: 50.0ms
 Ref Lvl: 4.8 DBM

Comments
 BE @ 2390 MHz
 802.11n 40MHz
 Chain B

Cursor 1	2390.0000	-51.53	Delta Freq.	51.875
Cursor 2	2441.8750	-3.87	Delta Amplitude	47.67



Client: Intel Corporation	Job Number: J80398
Model: Intel® Centrino® Advanced-N 6230	T-Log Number: T80540
	Account Manager: Christine Krebill
Contact: Steve Hackett	
Standard: FCC 15.247	Class: N/A

2483.5 MHz Band Edge Signal Radiated Field Strength - Marker Delta

	H	V				
Fundamental emission level @ 3m in 1MHz RBW:	105.3	101.3	Peak Measurement (RB=VB=1MHz)			
Fundamental emission level @ 3m in 1MHz RBW:	96.6	92.5	Average Measurement (RB=1MHz, VB=10Hz)			
Delta Marker - 100kHz	44.0 dB		<- this can only be used if band edge signal is highest within 2MHz of band edge.			
Calculated Band-Edge Measurement (Peak):	61.3 dBuV/m					
Calculated Band-Edge Measurement (Avg):	52.6 dBuV/m		Margin	Level	Limit	Detector
Delta Marker - 1MHz/1MHz:	39.2 dB		-1.9	52.1	54	Avg
Delta Marker - 1MHz/10Hz:	44.5 dB		-12.7	61.3	74	Pk
Calculated Band-Edge Measurement (Peak):	66.1 dBuV/m		Using 100kHz delta value			
Calculated Band-Edge Measurement (Avg):	52.1 dBuV/m		Using 1MHz delta value			

Frequency	Level	Pol	FCC 15.209		Detector	Azimuth	Height	Comments
MHz	dBuV/m	v/h	Limit	Margin	Pk/QP/Avg	degrees	meters	
2483.500	52.1	-	54.0	-1.9	Avg	-	-	Using 1MHz delta value

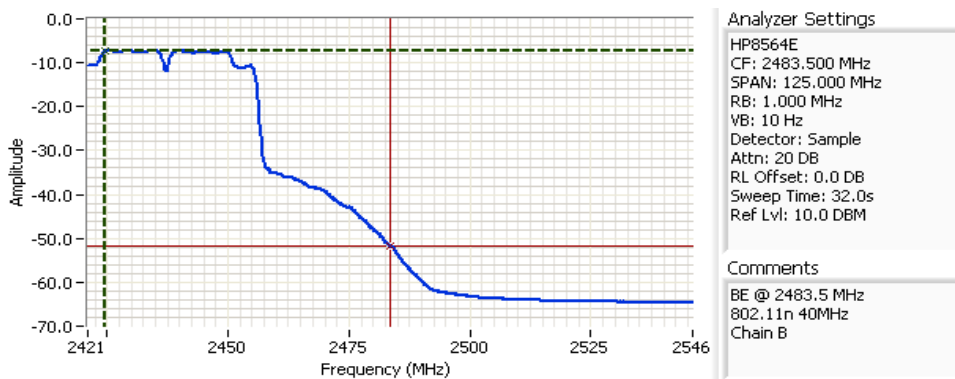

Cursor 1: 2424.5417, -7.17
 Cursor 2: 2483.5000, -51.67
 Delta Freq: 58.958
 Delta Amplitude: 44.50

Client: Intel Corporation	Job Number: J80398
Model: Intel® Centrino® Advanced-N 6230	T-Log Number: T80540
Contact: Steve Hackett	Account Manager: Christine Krebill
Standard: FCC 15.247	Class: N/A

Run # 5, Band Edge Field Strength - n20, Chain B

Date of Test: 9/16/2010

Test Location: FT Chamber #7

Test Engineer: Rafael Varelas

Config Change: none

Run # 5a, EUT on Channel #1 2412MHz - n20, Chain B

	Target (dBm)	Power Settings Measured (dBm)	Software Setting
Chain B	16.5	12.4	25.0

Fundamental Signal Field Strength

Frequency	Level	Pol	15.209 / 15.247		Detector	Azimuth	Height	Comments
MHz	dBuV/m	v/h	Limit	Margin	Pk/QP/Avg	degrees	meters	
2415.030	98.8	H	-	-	AVG	234	1.0	
2415.500	108.0	H	-	-	PK	234	1.0	
2415.170	97.3	V	-	-	AVG	70	1.0	
2416.670	106.3	V	-	-	PK	70	1.0	

2390 MHz Band Edge Signal Radiated Field Strength - Marker Delta

	H	V				
Fundamental emission level @ 3m in 1MHz RBW:	108.0	106.3	Peak Measurement (RB=VB=1MHz)			
Fundamental emission level @ 3m in 1MHz RBW:	98.8	97.3	Average Measurement (RB=1MHz, VB=10Hz)			
Delta Marker - 100kHz	46.7 dB		<- this can only be used if band edge signal is highest within 2MHz of band edge.			
Calculated Band-Edge Measurement (Peak):	61.3 dBuV/m					
Calculated Band-Edge Measurement (Avg):	52.1 dBuV/m	Margin	Level	Limit	Detector	
Delta Marker - 1MHz/1MHz:	35.8 dB	-2.0	52.0	54	Avg	
Delta Marker - 1MHz/10Hz:	46.8 dB	-12.7	61.3	74	Pk	
Calculated Band-Edge Measurement (Peak):	72.2 dBuV/m	Using 100kHz delta value				
Calculated Band-Edge Measurement (Avg):	52.0 dBuV/m	Using 1MHz delta value				

Frequency	Level	Pol	FCC 15.209		Detector	Azimuth	Height	Comments
MHz	dBuV/m	v/h	Limit	Margin	Pk/QP/Avg	degrees	meters	
2390.000	52.0	-	54.0	-2.0	Avg	-	-	Using 1MHz delta value

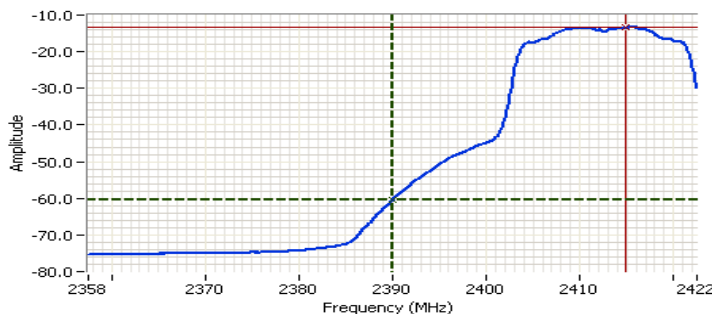

Analyzer Settings
 HP8564E
 CF: 2390.000 MHz
 SPAN: 65.000 MHz
 RB: 1.000 MHz
 VB: 10 Hz
 Detector: Sample
 Attn: 10 DB
 RL Offset: 0.0 DB
 Sweep Time: 17.0s
 Ref Lvl: -2.3 DBM

Comments
 BE @ 2390 MHz
 802.11n 20MHz
 Chain B

Cursor 1	2390.0000	-60.30		
Cursor 2	2414.8083	-13.47		

Delta Freq. 24.808
 Delta Amplitude 46.83



Client: Intel Corporation	Job Number: J80398
Model: Intel® Centrino® Advanced-N 6230	T-Log Number: T80540
Contact: Steve Hackett	Account Manager: Christine Krebill
Standard: FCC 15.247	Class: N/A

Run # 5b, EUT on Channel #11 2462MHz - n20, Chain B

	Target (dBm)	Power Settings Measured (dBm)	Software Setting
Chain B	16.5	12.3	25.0

Fundamental Signal Field Strength

Frequency MHz	Level dBμV/m	Pol v/h	15.209 / 15.247		Detector Pk/QP/Avg	Azimuth degrees	Height meters	Comments
			Limit	Margin				
2458.930	97.6	H	-	-	AVG	234	1.0	
2465.670	106.3	H	-	-	PK	234	1.0	
2458.770	92.7	V	-	-	AVG	70	1.0	
2459.900	101.4	V	-	-	PK	70	1.0	

2483.5 MHz Band Edge Signal Radiated Field Strength - Marker Delta

	H	V		Margin	Level	Limit	Detector
Fundamental emission level @ 3m in 1MHz RBW:	106.3	101.4					
Fundamental emission level @ 3m in 1MHz RBW:	97.6	92.7					
Delta Marker - 100kHz	44.7 dB						
Calculated Band-Edge Measurement (Peak):	61.6 dBuV/m						
Calculated Band-Edge Measurement (Avg):	52.9 dBuV/m						
Delta Marker - 1MHz/1MHz:	35.8 dB			-1.4	52.6	54	Avg
Delta Marker - 1MHz/10Hz:	45.0 dB			-12.4	61.6	74	Pk
Calculated Band-Edge Measurement (Peak):	70.5 dBuV/m						Using 100kHz delta value
Calculated Band-Edge Measurement (Avg):	52.6 dBuV/m						Using 1MHz delta value

Frequency MHz	Level dBμV/m	Pol v/h	FCC 15.209		Detector Pk/QP/Avg	Azimuth degrees	Height meters	Comments
			Limit	Margin				
2483.500	52.6	-	54.0	-1.4	Avg	-	-	Using 1MHz delta value

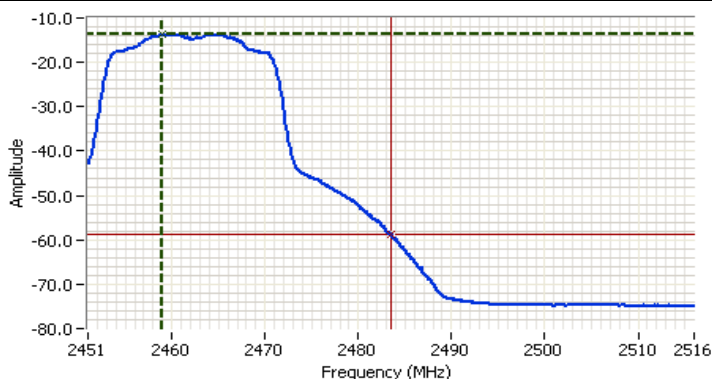

Analyzer Settings

HP8564E
 CF: 2483.500 MHz
 SPAN: 65.000 MHz
 RB: 1.000 MHz
 VB: 10 Hz
 Detector: Sample
 Attn: 10 DB
 RL Offset: 0.0 DB
 Sweep Time: 17.0s
 Ref Lvl: -2.3 DBM

Comments

BE @ 2483.5 MHz
 802.11n 20MHz
 Chain B

Cursor 1	2458.9084	-13.80	
Cursor 2	2483.5000	-58.80	

Delta Freq. 24.592
 Delta Amplitude 45.00



Client: Intel Corporation	Job Number: J80398
Model: Intel® Centrino® Advanced-N 6230	T-Log Number: T80540
Contact: Steve Hackett	Account Manager: Christine Krebill
Standard: FCC 15.247	Class: N/A

Run # 6, Band Edge Field Strength - 802.11g, Chain B

Date of Test: 9/16/2010

Test Location: FT Chamber #7

Test Engineer: Rafael Varelas

Config Change: none

Run # 6a, EUT on Channel #1 2412MHz - 802.11g, Chain B

	Target (dBm)	Power Settings Measured (dBm)	Software Setting
Chain B	16.5	13.8	26.5

Fundamental Signal Field Strength

Frequency	Level	Pol	15.209 / 15.247		Detector	Azimuth	Height	Comments
MHz	dBuV/m	v/h	Limit	Margin	Pk/QP/Avg	degrees	meters	
2415.730	100.4	H	-	-	AVG	235	1.0	
2415.200	109.0	H	-	-	PK	235	1.0	
2414.570	98.8	V	-	-	AVG	70	1.0	
2415.030	107.4	V	-	-	PK	70	1.0	

2390 MHz Band Edge Signal Radiated Field Strength - Marker Delta

	H	V				
Fundamental emission level @ 3m in 1MHz RBW:	109.0	107.4	Peak Measurement (RB=VB=1MHz)			
Fundamental emission level @ 3m in 1MHz RBW:	100.4	98.8	Average Measurement (RB=1MHz, VB=10Hz)			
Delta Marker - 100kHz	47.7 dB		<- this can only be used if band edge signal is highest within 2MHz of band edge.			
Calculated Band-Edge Measurement (Peak):	61.3 dBuV/m					
Calculated Band-Edge Measurement (Avg):	52.7 dBuV/m		Margin	Level	Limit	Detector
Delta Marker - 1MHz/1MHz:	37.3 dB		-1.9	52.1	54	Avg
Delta Marker - 1MHz/10Hz:	48.3 dB		-12.7	61.3	74	Pk
Calculated Band-Edge Measurement (Peak):	71.7 dBuV/m		Using 100kHz delta value			
Calculated Band-Edge Measurement (Avg):	52.1 dBuV/m		Using 1MHz delta value			

Frequency	Level	Pol	FCC 15.209		Detector	Azimuth	Height	Comments
MHz	dBuV/m	v/h	Limit	Margin	Pk/QP/Avg	degrees	meters	
2390.000	52.1	-	54.0	-1.9	Avg	-	-	Using 1MHz delta value

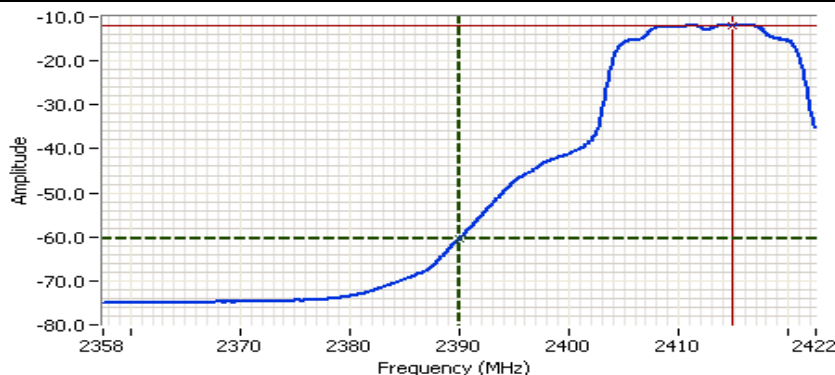

Analyzer Settings
 HP8564E
 CF: 2390.000 MHz
 SPAN: 65.000 MHz
 RB: 1.000 MHz
 VB: 10 Hz
 Detector: Sample
 Attn: 10 DB
 RL Offset: 0.0 DB
 Sweep Time: 17.0s
 Ref Lvl: -2.3 DBM

Comments
 BE @ 2390 MHz
 802.11g
 Chain B

Cursor 1	2390.0000	-60.30	
Cursor 2	2414.9167	-11.97	

Delta Freq. 24.917
 Delta Amplitude 48.33



Client: Intel Corporation	Job Number: J80398
Model: Intel® Centrino® Advanced-N 6230	T-Log Number: T80540
Contact: Steve Hackett	Account Manager: Christine Krebill
Standard: FCC 15.247	Class: N/A

Run # 6b, EUT on Channel #11 2462MHz - 802.11g, Chain B

	Target (dBm)	Power Settings Measured (dBm)	Software Setting
Chain B	16.5	13.4	26.0

Fundamental Signal Field Strength

Frequency	Level	Pol	15.209 / 15.247		Detector	Azimuth	Height	Comments
MHz	dBuV/m	v/h	Limit	Margin	Pk/QP/Avg	degrees	meters	
2460.300	98.9	H	-	-	AVG	232	1.0	
2458.270	107.7	H	-	-	PK	232	1.0	
2457.870	94.0	V	-	-	AVG	70	1.0	
2457.930	102.7	V	-	-	PK	70	1.0	

2483.5 MHz Band Edge Signal Radiated Field Strength - Marker Delta

	H	V		Margin	Level	Limit	Detector
Fundamental emission level @ 3m in 1MHz RBW:	107.7	102.7					
Fundamental emission level @ 3m in 1MHz RBW:	98.9	94.0					
Delta Marker - 100kHz	44.8 dB						
Calculated Band-Edge Measurement (Peak):	62.9 dBuV/m						
Calculated Band-Edge Measurement (Avg):	54.1 dBuV/m						
Delta Marker - 1MHz/1MHz:	40.0 dB			-2.1	51.9	54	Avg
Delta Marker - 1MHz/10Hz:	47.0 dB			-11.1	62.9	74	Pk
Calculated Band-Edge Measurement (Peak):	67.7 dBuV/m						Using 100kHz delta value
Calculated Band-Edge Measurement (Avg):	51.9 dBuV/m						Using 1MHz delta value

Peak Measurement (RB=VB=1MHz)
Average Measurement (RB=1MHz, VB=10Hz)
-< this can only be used if band edge signal is highest within 2MHz of band edge.

Frequency	Level	Pol	FCC 15.209		Detector	Azimuth	Height	Comments
MHz	dBuV/m	v/h	Limit	Margin	Pk/QP/Avg	degrees	meters	
2483.500	51.9	-	54.0	-2.1	Avg	-	-	Using 1MHz delta value

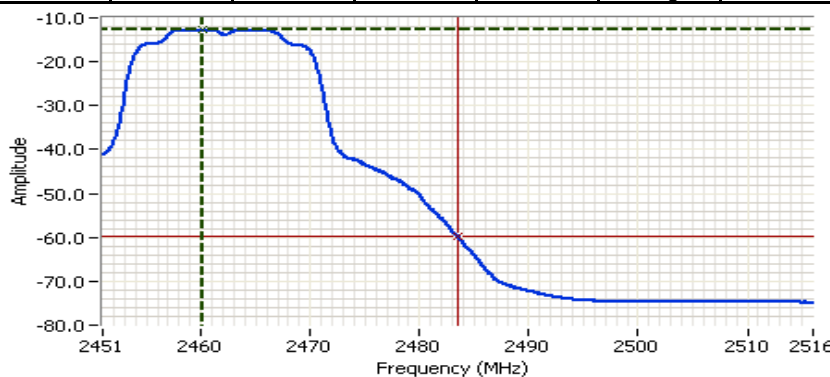

Analyzer Settings
HP8564E
CF: 2483.500 MHz
SPAN: 65.000 MHz
RB: 1.000 MHz
VB: 10 Hz
Detector: Sample
Attn: 10 DB
RL Offset: 0.0 DB
Sweep Time: 17.0s
Ref Lvl: -2.3 DBM

Comments
BE @ 2483.5 MHz
802.11g
Chain B

Cursor 1	2460.1001	-12.80	
Cursor 2	2483.5000	-59.80	

Delta Freq. 23.400
Delta Amplitude 47.00



Client: Intel Corporation	Job Number: J80398
Model: Intel® Centrino® Advanced-N 6230	T-Log Number: T80540
Contact: Steve Hackett	Account Manager: Christine Krebill
Standard: FCC 15.247	Class: N/A

Run # 7, Band Edge Field Strength - 802.11b, Chain B

Date of Test: 9/16/2010

Test Location: FT Chamber #7

Test Engineer: Rafael Varelas

Config Change: none

Run # 7a, EUT on Channel #1 2412MHz - 802.11b, Chain B

	Target (dBm)	Power Settings Measured (dBm)	Software Setting
Chain B	16.5	16.7	24.5

Fundamental Signal Field Strength

Frequency MHz	Level dBuV/m	Pol v/h	15.209 / 15.247		Detector	Azimuth degrees	Height meters	Comments
			Limit	Margin				
2413.900	103.6	V	-	-	AVG	70	1.0	
2413.230	107.6	V	-	-	PK	70	1.0	
2413.930	104.9	H	-	-	AVG	235	1.0	
2413.630	108.9	H	-	-	PK	235	1.0	

2390 MHz Band Edge Signal Radiated Field Strength - Marker Delta

	H	V				
Fundamental emission level @ 3m in 1MHz RBW:	108.9	107.6	Peak Measurement (RB=VB=1MHz)			
Fundamental emission level @ 3m in 1MHz RBW:	104.9	103.6	Average Measurement (RB=1MHz, VB=10Hz)			
Delta Marker - 100kHz	55.5 dB		<- this can only be used if band edge signal is highest within 2MHz of band edge.			
Calculated Band-Edge Measurement (Peak):	53.4 dBuV/m					
Calculated Band-Edge Measurement (Avg):	49.4 dBuV/m		Margin	Level	Limit	Detector
Delta Marker - 1MHz/1MHz:	45.8 dB		-4.6	49.4	54	Avg
Delta Marker - 1MHz/10Hz:	55.2 dB		-20.6	53.4	74	Pk
Calculated Band-Edge Measurement (Peak):	63.1 dBuV/m		Using 100kHz delta value			
Calculated Band-Edge Measurement (Avg):	49.7 dBuV/m		Using 100kHz delta value			

Frequency MHz	Level dBuV/m	Pol v/h	FCC 15.209		Detector	Azimuth degrees	Height meters	Comments
			Limit	Margin				
2389.892	49.4	-	54.0	-4.6	Avg	-	-	Using 100kHz delta value

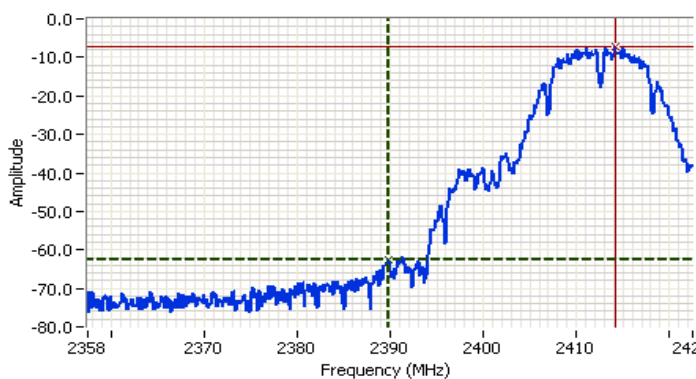

Analyzer Settings

HP8564E
 CF: 2390.000 MHz
 SPAN: 65.000 MHz
 RB: 100 kHz
 VB: 100 kHz
 Detector: POS
 Attn: 10 DB
 RL Offset: 0.0 DB
 Sweep Time: 50.0ms
 Ref Lvl: -2.4 DBM

Comments

BE @ 2390 MHz
 802.11b
 Chain B

Cursor 1	2389.8916	-62.73	Delta Freq.	24.267
Cursor 2	2414.1584	-7.23	Delta Amplitude	55.50



Client: Intel Corporation	Job Number: J80398
Model: Intel® Centrino® Advanced-N 6230	T-Log Number: T80540
Contact: Steve Hackett	Account Manager: Christine Krebill
Standard: FCC 15.247	Class: N/A

Run # 7b, EUT on Channel #11 2462MHz - 802.11b, Chain B

	Target (dBm)	Power Settings Measured (dBm)	Software Setting
Chain B	16.5	16.7	24.5

Fundamental Signal Field Strength

Frequency	Level	Pol	15.209 / 15.247		Detector	Azimuth	Height	Comments
MHz	dBuV/m	v/h	Limit	Margin	Pk/QP/Avg	degrees	meters	
2459.530	98.7	V	-	-	AVG	69	1.0	
2460.770	102.6	V	-	-	PK	69	1.0	
2460.300	104.1	H	-	-	AVG	235	1.0	
2460.700	108.1	H	-	-	PK	235	1.0	

2483.5 MHz Band Edge Signal Radiated Field Strength - Marker Delta

	H	V				
Fundamental emission level @ 3m in 1MHz RBW:	108.1	102.6	Peak Measurement (RB=VB=1MHz)			
Fundamental emission level @ 3m in 1MHz RBW:	104.1	98.7	Average Measurement (RB=1MHz, VB=10Hz)			
Delta Marker - 100kHz	55.2 dB		<- this can only be used if band edge signal is highest within 2MHz of band edge.			
Calculated Band-Edge Measurement (Peak):	52.9 dBuV/m					
Calculated Band-Edge Measurement (Avg):	48.9 dBuV/m		Margin	Level	Limit	Detector
Delta Marker - 1MHz/1MHz:	45.3 dB		-5.9	48.1	54	Avg
Delta Marker - 1MHz/10Hz:	56.0 dB		-21.1	52.9	74	Pk
Calculated Band-Edge Measurement (Peak):	62.8 dBuV/m		Using 100kHz delta value			
Calculated Band-Edge Measurement (Avg):	48.1 dBuV/m		Using 1MHz delta value			

Frequency	Level	Pol	FCC 15.209		Detector	Azimuth	Height	Comments
MHz	dBuV/m	v/h	Limit	Margin	Pk/QP/Avg	degrees	meters	
2483.500	48.1	-	54.0	-5.9	Avg	-	-	Using 1MHz delta value

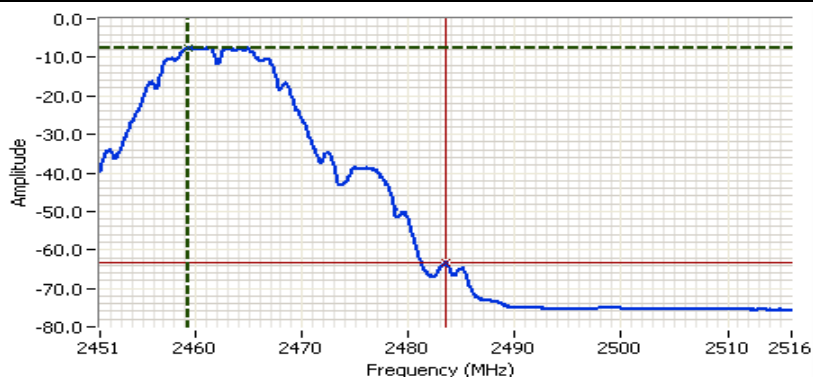

Analyzer Settings
 HP8564E
 CF: 2483.500 MHz
 SPAN: 65.000 MHz
 RB: 1.000 MHz
 VB: 10 Hz
 Detector: Sample
 Attn: 10 DB
 RL Offset: 0.0 DB
 Sweep Time: 17.0s
 Ref Lvl: -2.4 DBM

Comments
 BE @ 2483.5 MHz
 802.11b
 Chain B

Cursor 1	2459.3416	-7.40	Delta Freq.	24.158
Cursor 2	2483.5000	-63.40	Delta Amplitude	56.00



Client: Intel Corporation	Job Number: J80398
Model: Intel® Centrino® Advanced-N 6230	T-Log Number: T80540
Contact: Steve Hackett	Account Manager: Christine Krebill
Standard: FCC 15.247	Class: N/A

Run # 8, Band Edge Field Strength - 802.11n20MHz, Chain B

Date of Test: 10/5/2010

Test Location: FT Chamber #4

Test Engineer: Mehran Birgani

Config Change: None

Run # 8a, EUT on Channel #2 2417MHz - 802.11n20MHz, Chain B

	Target (dBm)	Power Settings Measured (dBm)	Software Setting
Chain B	16.5	16.2	29.5

Fundamental Signal Field Strength

Frequency	Level	Pol	15.209 / 15.247		Detector	Azimuth	Height	Comments
MHz	dBuV/m	v/h	Limit	Margin	Pk/QP/Avg	degrees	meters	
2420.070	97.8	V	-	-	AVG	267	1.0	
2421.400	106.1	V	-	-	PK	267	1.0	
2413.830	101.7	H	-	-	AVG	236	1.2	
2413.200	110.2	H	-	-	PK	236	1.2	

2390 MHz Band Edge Signal Radiated Field Strength - Marker Delta

	H	V				
Fundamental emission level @ 3m in 1MHz RBW:	110.2	106.1	Peak Measurement (RB=VB=1MHz)			
Fundamental emission level @ 3m in 1MHz RBW:	101.7	97.8	Average Measurement (RB=1MHz, VB=10Hz)			
Delta Marker - 100kHz	51.0 dB		-< this can only be used if band edge signal is highest within 2MHz of band edge.			
Calculated Band-Edge Measurement (Peak):	59.2 dBuV/m					
Calculated Band-Edge Measurement (Avg):	50.7 dBuV/m	Margin	Level	Limit	Detector	
Delta Marker - 1MHz/1MHz:	40.8 dB	-4.5	49.5	54	Avg	
Delta Marker - 1MHz/10Hz:	52.2 dB	-14.8	59.2	74	Pk	
Calculated Band-Edge Measurement (Peak):	69.4 dBuV/m	Using 100kHz delta value				
Calculated Band-Edge Measurement (Avg):	49.5 dBuV/m	Using 1MHz delta value				

Frequency	Level	Pol	FCC 15.209		Detector	Azimuth	Height	Comments
MHz	dBuV/m	v/h	Limit	Margin	Pk/QP/Avg	degrees	meters	
2390.000	49.5	-	54.0	-4.5	Avg	-	-	Using 1MHz delta value

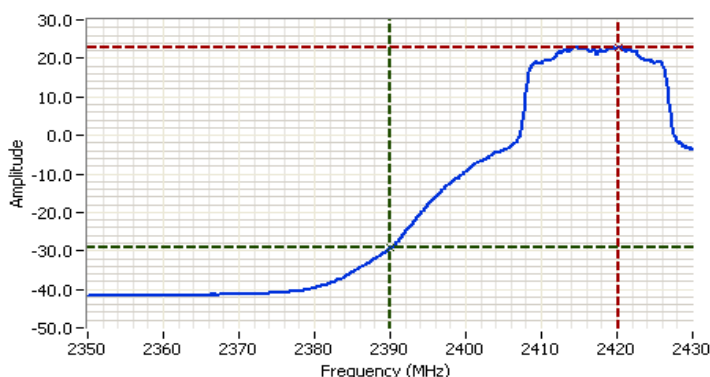

Analyzer Settings
 HP8564E, EMICF: 2390.000 MHz
 SPAN: 80.000 MHz
 RB: 1.000 MHz
 VB: 10 Hz
 Detector: Sample
 Attn: 20 DB
 RL Offset: 23.0 DB
 Sweep Time: 30.0s
 Ref Lvl: 33.0 DBM

Comments
 BE @ 2390 MHz
 802.11n 20MHz
 Chain B

Cursor 1	2390.0000	-29.33	
Cursor 2	2420.1333	22.83	

Delta Freq. 30.133
 Delta Amplitude 52.17



Client: Intel Corporation	Job Number: J80398
Model: Intel® Centrino® Advanced-N 6230	T-Log Number: T80540
Contact: Steve Hackett	Account Manager: Christine Krebill
Standard: FCC 15.247	Class: N/A

Run # 8b, EUT on Channel #10 2457MHz - 802.11n20MHz, Chain B

	Target (dBm)	Power Settings Measured (dBm)	Software Setting
Chain B	16.5	16.3	29.5

Fundamental Signal Field Strength

Frequency	Level	Pol	15.209 / 15.247		Detector	Azimuth	Height	Comments
MHz	dBuV/m	v/h	Limit	Margin	PK/QP/Avg	degrees	meters	
2460.270	95.7	V	-	-	AVG	245	1.0	
2461.530	103.8	V	-	-	PK	245	1.0	
2460.030	102.3	H	-	-	AVG	248	1.0	
2461.330	110.6	H	-	-	PK	248	1.0	

2483.5 MHz Band Edge Signal Radiated Field Strength - Marker Delta

	H	V		Margin	Level	Limit	Detector
Fundamental emission level @ 3m in 1MHz RBW:	110.6	103.8					
Fundamental emission level @ 3m in 1MHz RBW:	102.3	95.7					
Delta Marker - 100kHz	47.5 dB						
Calculated Band-Edge Measurement (Peak):	63.1 dBuV/m						
Calculated Band-Edge Measurement (Avg):	54.8 dBuV/m						
Delta Marker - 1MHz/1MHz:	39.5 dB			-1.5	52.5	54	Avg
Delta Marker - 1MHz/10Hz:	49.8 dB			-10.9	63.1	74	Pk
Calculated Band-Edge Measurement (Peak):	71.1 dBuV/m						Using 100kHz delta value
Calculated Band-Edge Measurement (Avg):	52.5 dBuV/m						Using 1MHz delta value

Peak Measurement (RB=VB=1MHz)
Average Measurement (RB=1MHz, VB=10Hz)
<- this can only be used if band edge signal is highest within 2MHz of band edge.

Frequency	Level	Pol	FCC 15.209		Detector	Azimuth	Height	Comments
MHz	dBuV/m	v/h	Limit	Margin	PK/QP/Avg	degrees	meters	
2483.500	52.5	-	54.0	-1.5	Avg	-	-	Using 1MHz delta value

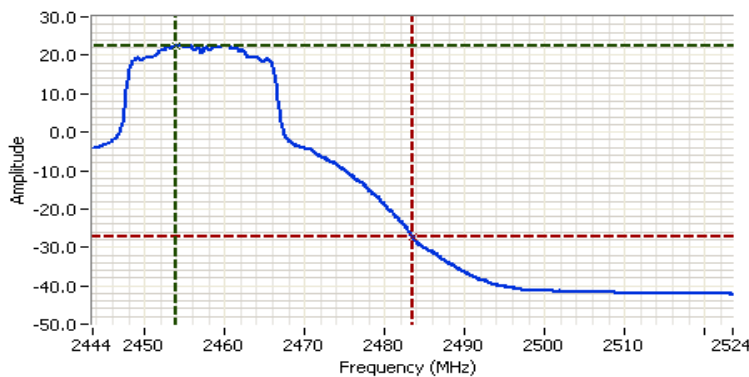

Analyzer Settings
HP8564E,EMICF: 2483.500 MHz
SPAN: 80.000 MHz
RB: 1.000 MHz
VB: 10 Hz
Detector: Sample
Attn: 20 DB
RL Offset: 23.0 DB
Sweep Time: 30.0s
Ref Lvl: 28.2 DBM

Comments
BE @ 2483.5 MHz
802.11n 20MHz
Chain B

Cursor 1	2453.8999	22.53	
Cursor 2	2483.5000	-27.30	

Delta Freq. 29.600
Delta Amplitude 49.83



Client:	Intel Corporation	Job Number:	J80398
Model:	Intel® Centrino® Advanced-N 6230	T-Log Number:	T80540
Contact:	Steve Hackett	Account Manager:	Christine Krebill
Standard:	FCC 15.247	Class:	N/A

RSS 210 and FCC 15.247 (DTS) Radiated Spurious Emissions (Band Edge)

Summary of Results

MAC Address: **00150079AD1A** DRTU Tool Version **1.2.12-0197** New tool from 9/14 Driver version **14.0.0.39**

Run #	Mode	Channel	Target Power	Measured Power	Test Performed	Limit	Result / Margin
Run # 1	n40 Chain A+B	#3 2422MHz	A: 13.5 B: 13.5	A: 7.3 B: 6.9	Restricted Band Edge at 2400 MHz	15.209	52.3dBµV/m @ 2389.9MHz (-1.7dB)
		#9 2452MHz	A: 13.5 B: 13.5	A: 6.8 B: 6.4	Restricted Band Edge at 2483.5 MHz	15.209	52.8dBµV/m @ 2484.2MHz (-1.2dB)
Run # 2	n40 Chain A+B	#4 2427MHz	A: 13.5 B: 13.5	A: 8.2 B: 8.4	Restricted Band Edge at 2400 MHz	15.209	51.0dBµV/m @ 2389.8MHz (-3.0dB)
		#8 2447MHz	A: 13.5 B: 13.5	A: 8.2 B: 8.5	Restricted Band Edge at 2483.5 MHz	15.209	53.0dBµV/m @ 2484.4MHz (-1.0dB)
Run # 3	n40 Chain A+B	#5 2432MHz	A: 13.5 B: 13.5	A: 10.5 B: 10.6	Restricted Band Edge at 2400 MHz	15.209	52.6dBµV/m @ 2390.0MHz (-1.4dB)
		#7 2442MHz	A: 13.5 B: 13.5	A: 10.5 B: 10.7	Restricted Band Edge at 2483.5 MHz	15.209	52.9dBµV/m @ 2483.5MHz (-1.1dB)
Run # 4	n40 Chain A+B	#6 2437MHz	A: 13.5 B: 13.5	A: 12.3 B: 12.4	Restricted Band Edge at 2400 MHz	15.209	51.8dBµV/m @ 2389.8MHz (-2.2dB)
					Restricted Band Edge at 2483.5 MHz	15.209	52.8dBµV/m @ 2483.5MHz (-1.2dB)
Run # 5	n20 Chain A+B	#1 2412MHz	A: 13.5 B: 13.5	A: 11.4 B: 11.6	Restricted Band Edge at 2400 MHz	15.209	51.9dBµV/m @ 2390.0MHz (-2.1dB)
		#11 2462MHz	A: 13.5 B: 13.5	A: 11.1 B: 10.7	Restricted Band Edge at 2483.5 MHz	15.209	53.0dBµV/m @ 2483.5MHz (-1.0dB)
Run # 6	n20 Chain A+B	#2 2417MHz	A: 13.5 B: 13.5	A: 13.5 B: 13.7	Restricted Band Edge at 2400 MHz	15.209	49.3dBµV/m @ 2389.9MHz (-4.7dB)
		#10 2457MHz	A: 13.5 B: 13.5	A: 13.6 B: 14.0	Restricted Band Edge at 2483.5 MHz	15.209	50.6dBµV/m @ 2483.5MHz (-3.4dB)

Note - the target and measured power are average powers (measured with average power sensor) and are used for reference purposes only. Power is set using " **GAIN CONTROL**" mode in the DRTU tool.

Client:	Intel Corporation	Job Number:	J80398
Model:	Intel® Centrino® Advanced-N 6230	T-Log Number:	T80540
		Account Manager:	Christine Krebill
Contact:	Steve Hackett		
Standard:	FCC 15.247	Class:	N/A

Test Specific Details

Objective: The objective of this test session is to perform engineering evaluation testing of the EUT with respect to the specification listed above.

General Test Configuration

The EUT was installed into a test fixture such that the EUT was exposed (i.e. outside of a host PC).
 For radiated emissions testing the measurement antenna was located 3 meters from the EUT.

Ambient Conditions:

Rel. Humidity: 15 - 55 %
 Temperature: 18 - 25 °C

Modifications Made During Testing

No modifications were made to the EUT during testing

Deviations From The Standard

No deviations were made from the requirements of the standard.

Client:	Intel Corporation	Job Number:	J80398
Model:	Intel® Centrino® Advanced-N 6230	T-Log Number:	T80540
Contact:	Steve Hackett	Account Manager:	Christine Krebill
Standard:	FCC 15.247	Class:	N/A

Run # 1, Band Edge Field Strength - n40, Chain A+B

Date of Test: 9/21/2010

Test Location: FT7

Test Engineer: Mehran

Config Change: none

Run # 1a, EUT on Channel #3 2422MHz - n40, Chain A+B

Chain	Target (dBm)				Power Settings Measured (dBm)				Software Setting
	A	B	C	Total	A	B	C	Total	
	13.5	13.5		16.5	7.3	6.9		10.1	21.5, 22.5

Fundamental Signal Field Strength

Frequency	Level	Pol	15.209 / 15.247		Detector	Azimuth	Height	Comments
MHz	dBμV/m	v/h	Limit	Margin	Pk/QP/Avg	degrees	meters	
2434.870	93.3	V	-	-	AVG	335	1.0	
2434.670	104.1	V	-	-	PK	335	1.0	
2409.730	92.9	H	-	-	AVG	11	1.3	
2415.470	103.4	H	-	-	PK	11	1.3	

Direct measurement of bandedge

Frequency	Level	Pol	15.209 / 15.247		Detector	Azimuth	Height	Comments
MHz	dBμV/m	v/h	Limit	Margin	Pk/QP/Avg	degrees	meters	
2389.870	52.3	H	54.0	-1.7	AVG	11	1.3	
2389.730	49.3	V	54.0	-4.7	AVG	335	1.0	
2389.270	65.2	H	74.0	-8.8	PK	11	1.3	
2383.870	60.6	V	74.0	-13.4	PK	335	1.0	

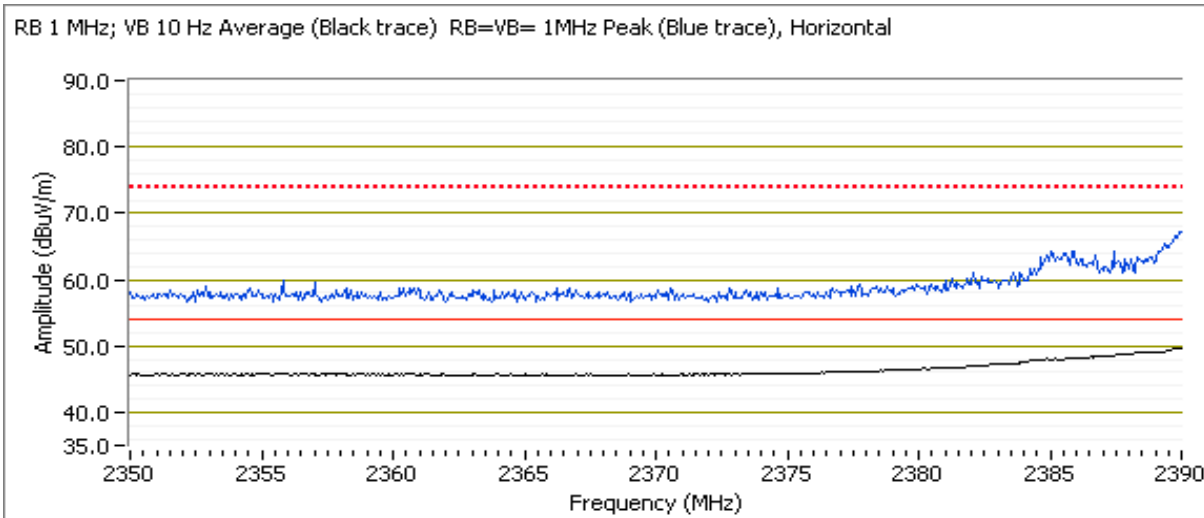

Client:	Intel Corporation	Job Number:	J80398
Model:	Intel® Centrino® Advanced-N 6230	T-Log Number:	T80540
Contact:	Steve Hackett	Account Manager:	Christine Krebill
Standard:	FCC 15.247	Class:	N/A

Run # 1b, EUT on Channel #9, 2452MHz - n40, Chain A+B

Chain	Power Settings								Software Setting
	Target (dBm)				Measured (dBm)				
	A	B	C	Total	A	B	C	Total	
	13.5	13.5		16.5	6.8	6.4		9.6	21.0, 22.0

Fundamental Signal Field Strength

Frequency	Level	Pol	15.209 / 15.247		Detector	Azimuth	Height	Comments
MHz	dBμV/m	v/h	Limit	Margin	Pk/QP/Avg	degrees	meters	
2464.870	92.6	H	-	-	AVG	16	1.0	
2463.470	102.7	H	-	-	PK	16	1.0	
2439.400	91.0	V	-	-	AVG	205	1.0	
2444.470	100.6	V	-	-	PK	205	1.0	

Direct measurement of bandedge

Frequency	Level	Pol	15.209 / 15.247		Detector	Azimuth	Height	Comments
MHz	dBμV/m	v/h	Limit	Margin	Pk/QP/Avg	degrees	meters	
2484.240	52.8	H	54.0	-1.2	AVG	16	1.0	
2484.460	50.8	V	54.0	-3.2	AVG	205	1.0	
2484.520	68.3	H	74.0	-5.7	PK	16	1.0	
2484.350	63.3	V	74.0	-10.7	PK	205	1.0	

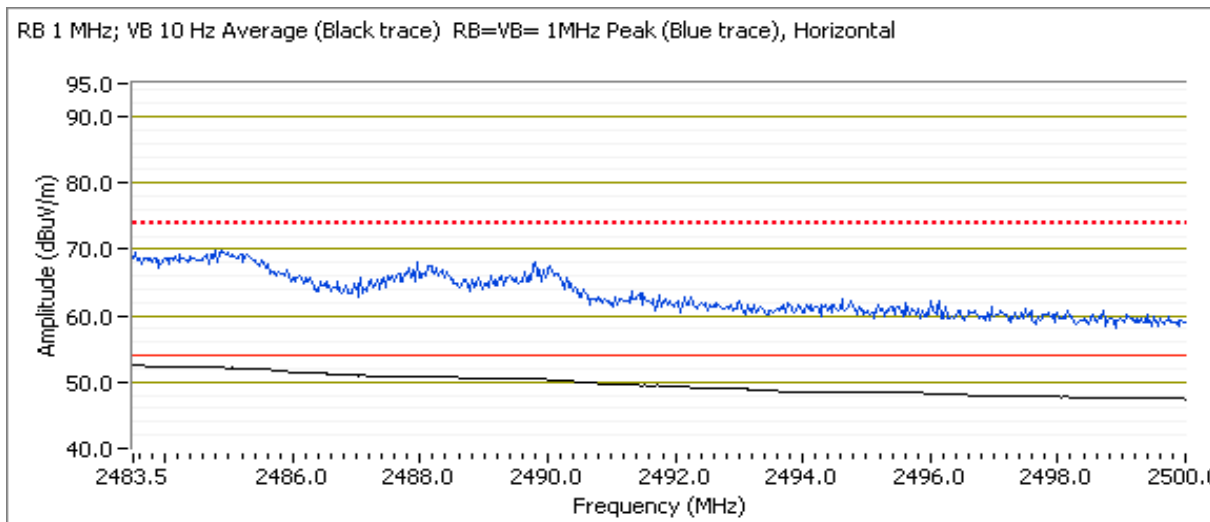

Client:	Intel Corporation	Job Number:	J80398
Model:	Intel® Centrino® Advanced-N 6230	T-Log Number:	T80540
Contact:	Steve Hackett	Account Manager:	Christine Krebill
Standard:	FCC 15.247	Class:	N/A

Run # 2, Band Edge Field Strength - n40, Chain A+B

Date of Test: 9/21/2010

Test Location: FT7

Test Engineer: Mehran

Config Change: none

Run # 2a, EUT on Channel #4, 2427MHz - n40, Chain A+B

Chain	Target (dBm)				Power Settings Measured (dBm)				Software Setting
	A	B	C	Total	A	B	C	Total	
	13.5	13.5		16.5	8.2	8.4		11.3	22.5, 23.5

Fundamental Signal Field Strength

Frequency	Level	Pol	15.209 / 15.247		Detector	Azimuth	Height	Comments
MHz	dBμV/m	v/h	Limit	Margin	Pk/QP/Avg	degrees	meters	
2430.000	92.2	V	-	-	AVG	205	1.0	
2438.330	102.4	V	-	-	PK	205	1.0	
2434.870	94.3	H	-	-	AVG	336	1.0	
2432.330	104.7	H	-	-	PK	336	1.0	

Direct measurement of bandedge

Frequency	Level	Pol	15.209 / 15.247		Detector	Azimuth	Height	Comments
MHz	dBμV/m	v/h	Limit	Margin	Pk/QP/Avg	degrees	meters	
2389.800	51.0	H	54.0	-3.0	AVG	336	1.0	
2389.730	51.0	V	54.0	-3.0	AVG	205	1.0	
2387.670	64.5	V	74.0	-9.5	PK	205	1.0	
2389.730	63.4	H	74.0	-10.6	PK	336	1.0	

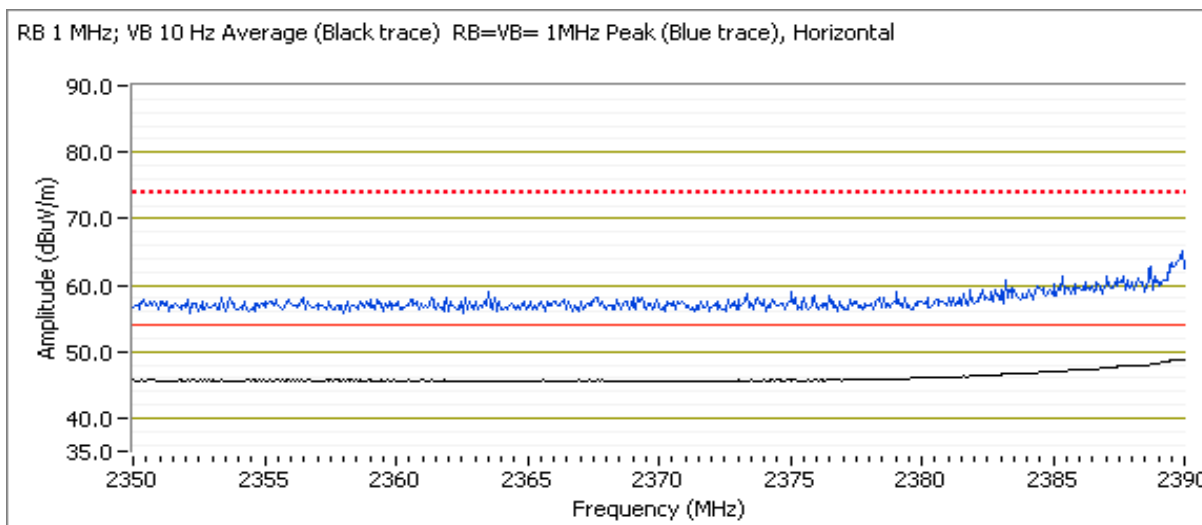

Client:	Intel Corporation	Job Number:	J80398
Model:	Intel® Centrino® Advanced-N 6230	T-Log Number:	T80540
Contact:	Steve Hackett	Account Manager:	Christine Krebill
Standard:	FCC 15.247	Class:	N/A

Run # 2b, EUT on Channel #8 2447MHz - n40, Chain A+B

Chain	Power Settings								Software Setting
	Target (dBm)				Measured (dBm)				
	A	B	C	Total	A	B	C	Total	
	13.5	13.5		16.5	8.2	8.5		11.4	22.5, 23.5

Fundamental Signal Field Strength

Frequency	Level	Pol	15.209 / 15.247		Detector	Azimuth	Height	Comments
MHz	dBμV/m	v/h	Limit	Margin	Pk/QP/Avg	degrees	meters	
2434.730	94.1	H	-	-	AVG	337	1.0	
2439.670	103.8	H	-	-	PK	337	1.0	
2434.600	92.9	V	-	-	AVG	205	1.0	
2442.270	103.2	V	-	-	PK	205	1.0	

Direct measurement of bandedge

Frequency	Level	Pol	15.209 / 15.247		Detector	Azimuth	Height	Comments
MHz	dBμV/m	v/h	Limit	Margin	Pk/QP/Avg	degrees	meters	
2484.410	53.0	H	54.0	-1.0	AVG	337	1.0	
2484.650	51.4	V	54.0	-2.6	AVG	205	1.0	
2484.820	67.8	H	74.0	-6.2	PK	337	1.0	
2484.980	64.2	V	74.0	-9.8	PK	205	1.0	

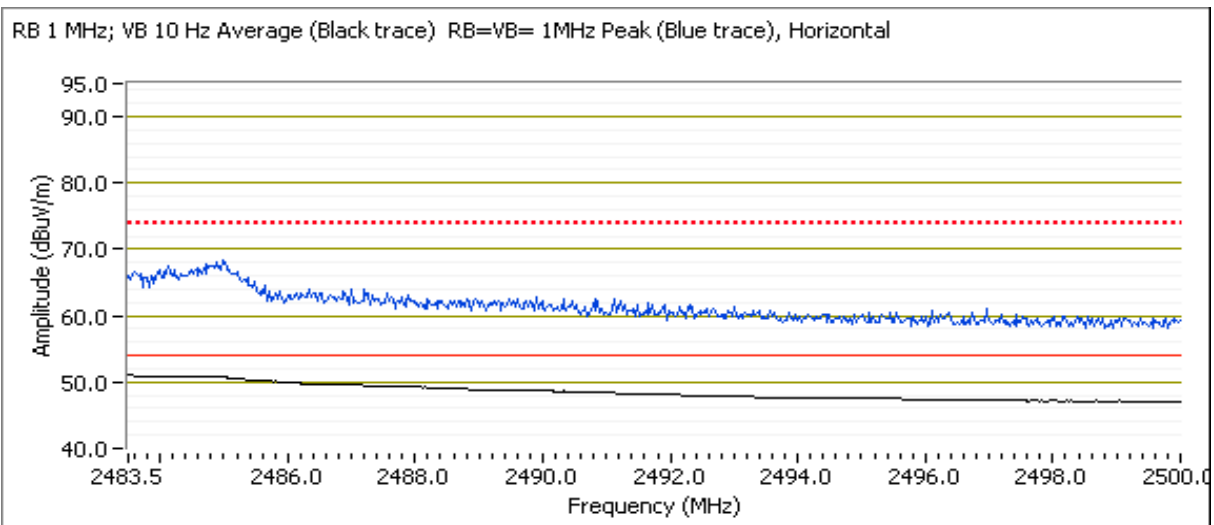

Client:	Intel Corporation	Job Number:	J80398
Model:	Intel® Centrino® Advanced-N 6230	T-Log Number:	T80540
Contact:	Steve Hackett	Account Manager:	Christine Krebill
Standard:	FCC 15.247	Class:	N/A

Run # 3, Band Edge Field Strength - n40, Chain A+B

Date of Test: 9/17/2010

Test Location: FT Chamber #7

Test Engineer: Rafael Varelas

Config Change: none

Run # 3a, EUT on Channel #5 2432MHz - n40, Chain A+B

Chain	Target (dBm)				Power Settings Measured (dBm)				Software Setting
	A	B	C	Total	A	B	C	Total	
	13.5	13.5		16.5	10.5	10.6		13.6	24.5/26.0

Fundamental Signal Field Strength

Frequency	Level	Pol	15.209 / 15.247		Detector	Azimuth	Height	Comments
MHz	dBµV/m	v/h	Limit	Margin	Pk/QP/Avg	degrees	meters	
2434.800	96.7	H	120.0	-23.3	AVG	9	1.0	RB 1 MHz;VB 10 Hz;Pk
2427.000	106.4	H	120.0	-13.6	PK	9	1.0	RB 1 MHz;VB 3 MHz;Pk
2429.330	92.6	V	120.0	-27.4	AVG	219	1.0	RB 1 MHz;VB 10 Hz;Pk
2427.330	103.1	V	120.0	-16.9	PK	219	1.0	RB 1 MHz;VB 3 MHz;Pk

Direct measurement of bandedge

Frequency	Level	Pol	15.209 / 15.247		Detector	Azimuth	Height	Comments
MHz	dBµV/m	v/h	Limit	Margin	Pk/QP/Avg	degrees	meters	
2389.950	52.6	H	54.0	-1.4	AVG	0	1.0	RB 1 MHz;VB 10 Hz;Pk
2390.000	66.9	H	74.0	-7.1	PK	0	1.0	RB 1 MHz;VB 3 MHz;Pk
2389.980	50.4	V	54.0	-3.6	AVG	220	1.0	RB 1 MHz;VB 10 Hz;Pk
2389.930	63.5	V	74.0	-10.5	PK	220	1.0	RB 1 MHz;VB 3 MHz;Pk

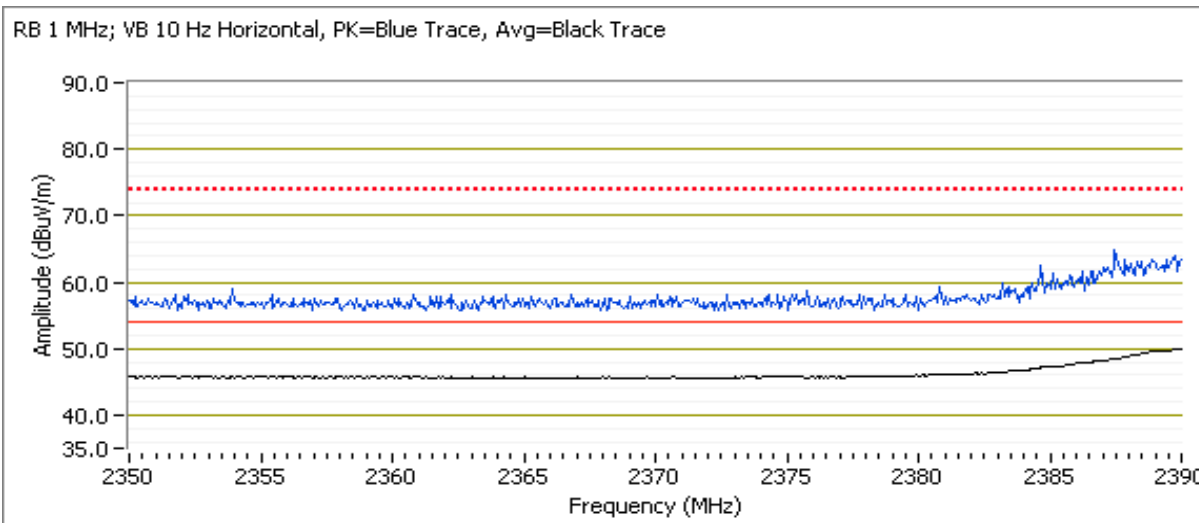

Client:	Intel Corporation	Job Number:	J80398
Model:	Intel® Centrino® Advanced-N 6230	T-Log Number:	T80540
Contact:	Steve Hackett	Account Manager:	Christine Krebill
Standard:	FCC 15.247	Class:	N/A

Run # 3b, EUT on Channel #7 2442MHz - n40, Chain A+B

Chain	Target (dBm)				Power Settings Measured (dBm)				Software Setting
	A	B	C	Total	A	B	C	Total	
	13.5	13.5		16.5	10.5	10.7		13.6	24.5/26.0

Fundamental Signal Field Strength

Frequency	Level	Pol	15.209 / 15.247		Detector	Azimuth	Height	Comments
MHz	dBμV/m	v/h	Limit	Margin	Pk/QP/Avg	degrees	meters	
2429.400	93.4	V	120.0	-26.6	AVG	215	1.0	RB 1 MHz;VB 10 Hz;Pk
2430.270	103.1	V	120.0	-16.9	PK	215	1.0	RB 1 MHz;VB 3 MHz;Pk
2433.530	96.3	H	120.0	-23.7	AVG	9	1.0	RB 1 MHz;VB 10 Hz;Pk
2436.200	106.9	H	120.0	-13.1	PK	9	1.0	RB 1 MHz;VB 3 MHz;Pk

Direct measurement of bandedge

Frequency	Level	Pol	15.209 / 15.247		Detector	Azimuth	Height	Comments
MHz	dBμV/m	v/h	Limit	Margin	Pk/QP/Avg	degrees	meters	
2483.540	52.9	H	54.0	-1.1	AVG	10	1.0	RB 1 MHz;VB 10 Hz;Pk
2483.580	65.8	H	74.0	-8.2	PK	10	1.0	RB 1 MHz;VB 3 MHz;Pk
2483.520	50.7	V	54.0	-3.3	AVG	343	1.0	RB 1 MHz;VB 10 Hz;Pk
2483.860	63.3	V	74.0	-10.7	PK	343	1.0	RB 1 MHz;VB 3 MHz;Pk

RB 1 MHz; VB 10 Hz Horizontal, PK=Blue Trace, Avg=Black Trace

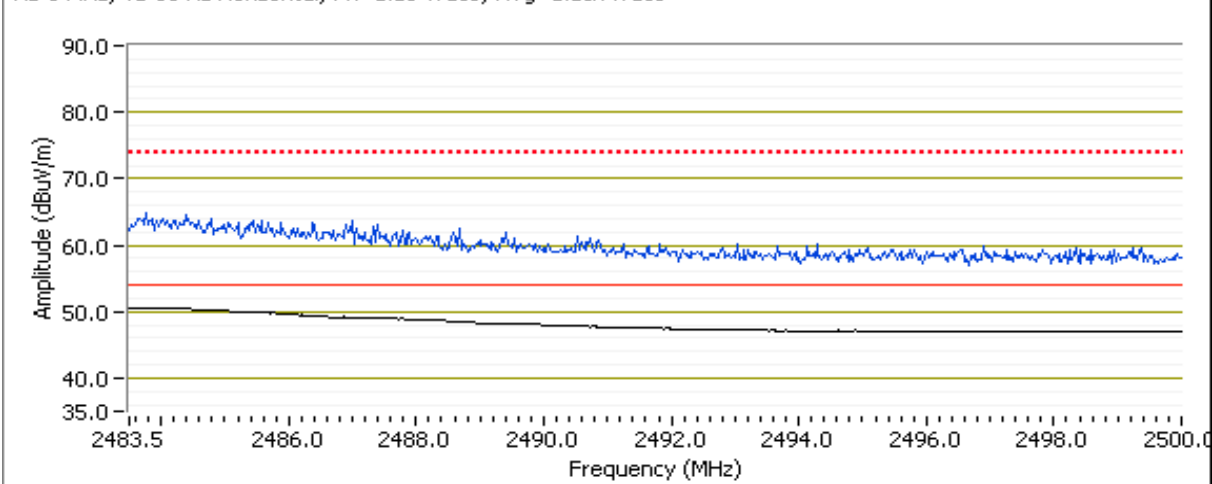

Client:	Intel Corporation	Job Number:	J80398
Model:	Intel® Centrino® Advanced-N 6230	T-Log Number:	T80540
Contact:	Steve Hackett	Account Manager:	Christine Krebill
Standard:	FCC 15.247	Class:	N/A

Run # 4, Band Edge Field Strength - n40, Chain A+B

Date of Test: 9/17/2010 Test Location: FT Chamber #7
 Test Engineer: Rafael Varelas Config Change: none

EUT on Channel #6 2437MHz - n40, Chain A+B

Chain	Target (dBm)				Power Settings Measured (dBm)				Software Setting
	A	B	C	Total	A	B	C	Total	
	13.5	13.5		16.5	12.3	12.4		15.4	26.5/28.0

Fundamental Signal Field Strength

Frequency	Level	Pol	15.209 / 15.247		Detector	Azimuth	Height	Comments
MHz	dBμV/m	v/h	Limit	Margin	Pk/QP/Avg	degrees	meters	
2425.600	94.3	V	120.0	-25.7	AVG	215	1.0	RB 1 MHz;VB 10 Hz;Pk
2432.130	104.3	V	120.0	-15.7	PK	215	1.0	RB 1 MHz;VB 3 MHz;Pk
2434.400	98.4	H	120.0	-21.6	AVG	10	1.0	RB 1 MHz;VB 10 Hz;Pk
2432.670	108.8	H	120.0	-11.2	PK	10	1.0	RB 1 MHz;VB 3 MHz;Pk

2390 MHz Band Edge

Direct measurement of bandedge

Frequency	Level	Pol	15.209 / 15.247		Detector	Azimuth	Height	Comments
MHz	dBμV/m	v/h	Limit	Margin	Pk/QP/Avg	degrees	meters	
2389.790	51.8	H	54.0	-2.2	AVG	360	1.0	RB 1 MHz;VB 10 Hz;Pk
2389.580	65.4	H	74.0	-8.6	PK	360	1.0	RB 1 MHz;VB 3 MHz;Pk
2389.810	50.6	V	54.0	-3.4	AVG	215	1.0	RB 1 MHz;VB 10 Hz;Pk
2389.220	63.5	V	74.0	-10.5	PK	215	1.0	RB 1 MHz;VB 3 MHz;Pk

RB 1 MHz; VB 10 Hz Horizontal, PK=Blue Trace, Avg=Black Trace

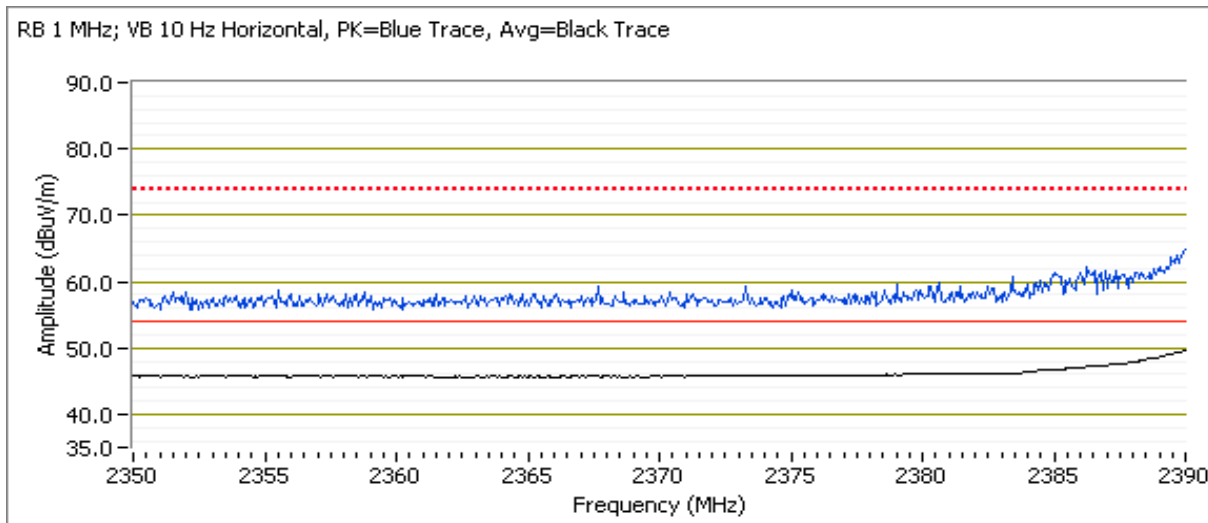

Client: Intel Corporation	Job Number: J80398
Model: Intel® Centrino® Advanced-N 6230	T-Log Number: T80540
	Account Manager: Christine Krebill
Contact: Steve Hackett	
Standard: FCC 15.247	Class: N/A

2483.5 MHz Band Edge

Direct measurement of bandedge

Frequency MHz	Level dBµV/m	Pol v/h	15.209 / 15.247		Detector Pk/QP/Avg	Azimuth degrees	Height meters	Comments
			Limit	Margin				
2483.500	52.8	H	54.0	-1.2	AVG	8	1.0	RB 1 MHz;VB 10 Hz;Pk
2484.700	65.3	H	74.0	-8.7	PK	8	1.0	RB 1 MHz;VB 3 MHz;Pk
2483.500	50.4	V	54.0	-3.6	AVG	342	1.0	RB 1 MHz;VB 10 Hz;Pk
2485.220	63.3	V	74.0	-10.7	PK	342	1.0	RB 1 MHz;VB 3 MHz;Pk

RB 1 MHz; VB 10 Hz Horizontal, PK=Blue Trace, Avg=Black Trace

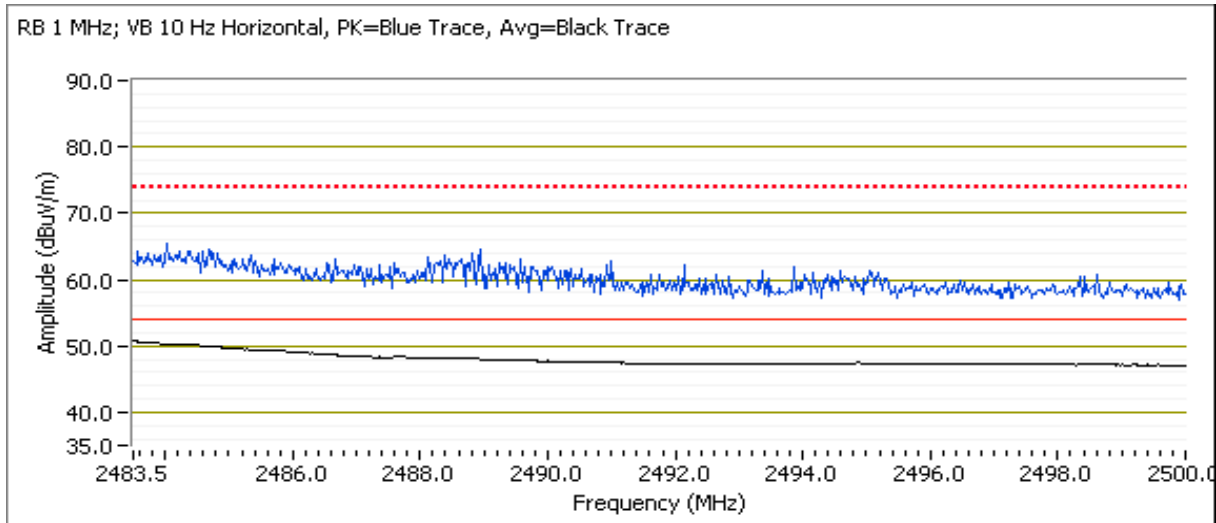

Client: Intel Corporation	Job Number: J80398
Model: Intel® Centrino® Advanced-N 6230	T-Log Number: T80540
	Account Manager: Christine Krebill
Contact: Steve Hackett	
Standard: FCC 15.247	Class: N/A

Run # 5, Band Edge Field Strength - n20, Chain A+B

Date of Test: 9/21/2010

Test Location: FT7

Test Engineer: Mehran

Config Change: none

Run # 5a, EUT on Channel #1 2412MHz - n20, Chain A+B

Chain	Target (dBm)				Power Settings Measured (dBm)				Software Setting
	A	B	C	Total	A	B	C	Total	
	13.5	13.5		16.5	11.4	11.6		14.5	26.0, 27.5

Fundamental Signal Field Strength

Frequency	Level	Pol	15.209 / 15.247		Detector	Azimuth	Height	Comments
MHz	dBμV/m	v/h	Limit	Margin	Pk/QP/Avg	degrees	meters	
2413.800	98.2	V	120.0	-21.8	AVG	189	1.0	
2414.270	108.3	V	120.0	-11.7	PK	189	1.0	
2416.170	100.6	H	120.0	-19.4	AVG	17	1.0	
2416.770	111.2	H	120.0	-8.8	PK	17	1.0	

Direct measurement of bandedge

Frequency	Level	Pol	15.209 / 15.247		Detector	Azimuth	Height	Comments
MHz	dBμV/m	v/h	Limit	Margin	Pk/QP/Avg	degrees	meters	
2390.000	51.9	H	54.0	-2.1	AVG	17	1.0	
2390.000	51.6	V	54.0	-2.4	AVG	189	1.0	
2389.870	63.8	V	74.0	-10.2	PK	189	1.0	
2389.730	63.4	H	74.0	-10.6	PK	17	1.0	

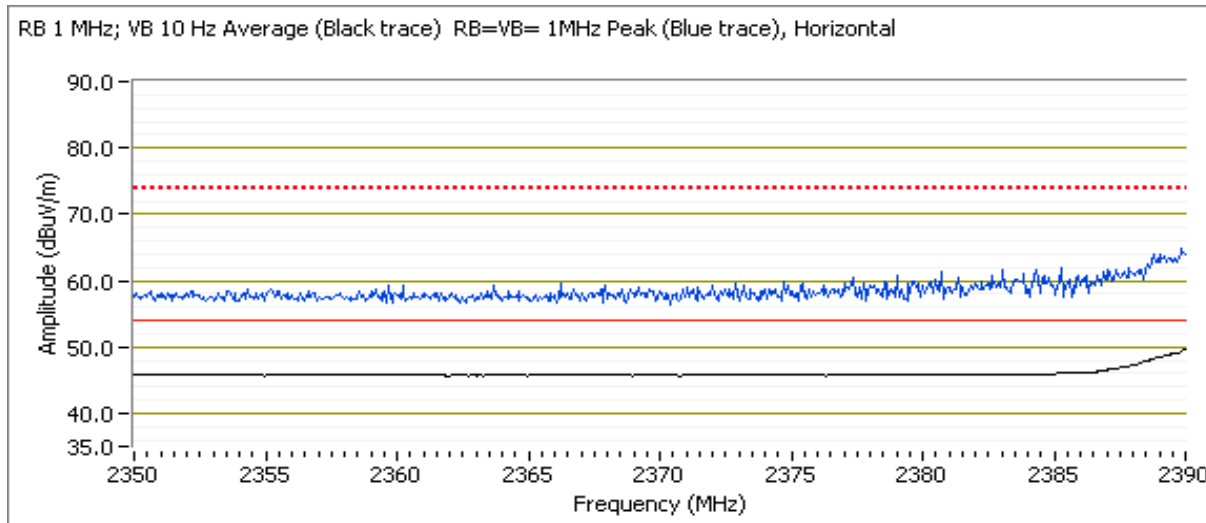

Client:	Intel Corporation	Job Number:	J80398
Model:	Intel® Centrino® Advanced-N 6230	T-Log Number:	T80540
Contact:	Steve Hackett	Account Manager:	Christine Krebill
Standard:	FCC 15.247	Class:	N/A

Run # 5b, EUT on Channel #11 2462MHz - n20, Chain A+B

Chain	Power Settings								Software Setting
	Target (dBm)				Measured (dBm)				
	A	B	C	Total	A	B	C	Total	
	13.5	13.5		16.5	11.1	10.7		13.9	25.5, 26.0

Fundamental Signal Field Strength

Frequency	Level	Pol	15.209 / 15.247		Detector	Azimuth	Height	Comments
MHz	dBμV/m	v/h	Limit	Margin	Pk/QP/Avg	degrees	meters	
2466.600	100.6	H	-	-	AVG	15	1.0	
2463.470	110.7	H	-	-	PK	15	1.0	
2463.670	96.7	V	-	-	AVG	187	0.9	
2466.600	107.1	V	-	-	PK	187	0.9	

Direct measurement of bandedge

Frequency	Level	Pol	15.209 / 15.247		Detector	Azimuth	Height	Comments
MHz	dBμV/m	v/h	Limit	Margin	Pk/QP/Avg	degrees	meters	
2483.500	53.0	H	54.0	-1.0	AVG	15	1.0	
2483.500	51.3	V	54.0	-2.7	AVG	187	0.9	
2484.320	66.2	H	74.0	-7.8	PK	15	1.0	
2483.500	63.5	V	74.0	-10.5	PK	187	0.9	

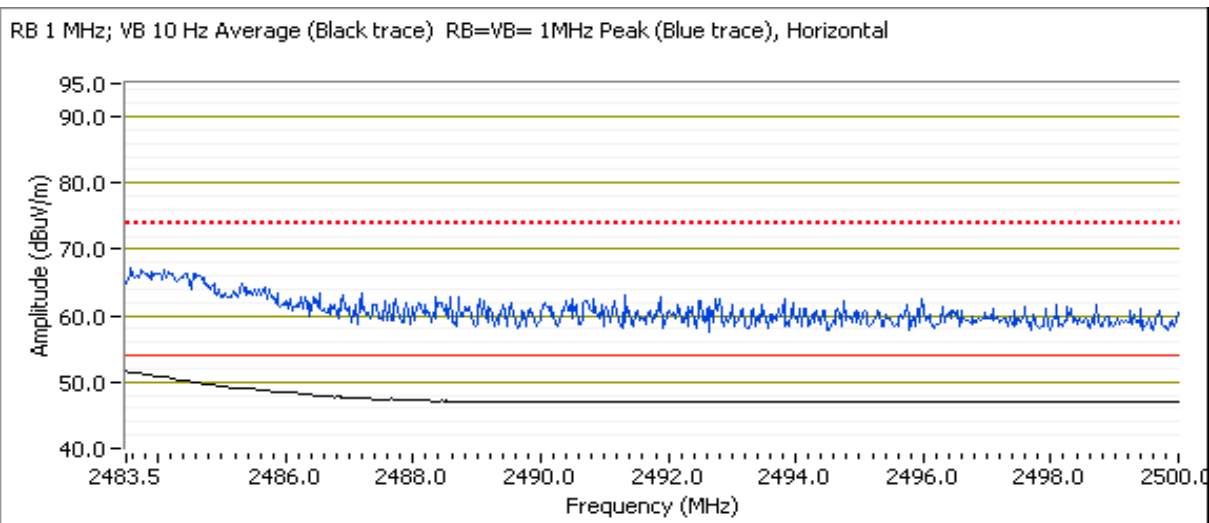

Client:	Intel Corporation	Job Number:	J80398
Model:	Intel® Centrino® Advanced-N 6230	T-Log Number:	T80540
Contact:	Steve Hackett	Account Manager:	Christine Krebill
Standard:	FCC 15.247	Class:	N/A

Run # 6, Band Edge Field Strength - n20, Chain A+B

Date of Test: 9/21/2010 Test Location: Chamber #4
 Test Engineer: Mehran Birgani Config Change: None

Run # 6a, EUT on Channel #2 2417MHz - n20, Chain A+B

Chain	Target (dBm)				Power Settings Measured (dBm)				Software Setting
	A	B	C	Total	A	B	C	Total	
	13.5	13.5		16.5	13.5	13.7		16.6	28.5, 29.5

Fundamental Signal Field Strength

Frequency	Level	Pol	15.209 / 15.247		Detector	Azimuth	Height	Comments
MHz	dBμV/m	v/h	Limit	Margin	Pk/QP/Avg	degrees	meters	
2412.800	103.0	H	-	-	AVG	10	1.3	
2415.570	113.1	H	-	-	PK	10	1.3	
2421.130	100.4	V	-	-	AVG	189	1.0	
2414.200	110.8	V	-	-	PK	189	1.0	

Direct measurement of bandedge

Frequency	Level	Pol	15.209 / 15.247		Detector	Azimuth	Height	Comments
MHz	dBμV/m	v/h	Limit	Margin	Pk/QP/Avg	degrees	meters	
2389.930	49.3	H	54.0	-4.7	AVG	10	1.3	
2389.600	49.0	V	54.0	-5.0	AVG	189	1.0	
2385.270	64.2	H	74.0	-9.8	PK	10	1.3	
2387.800	63.6	V	74.0	-10.4	PK	189	1.0	

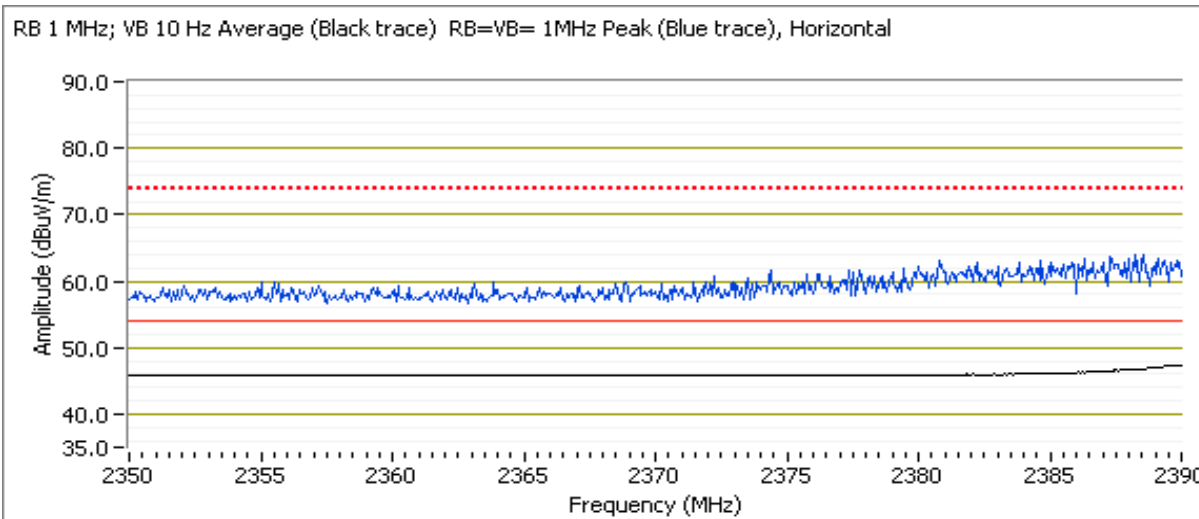

Client:	Intel Corporation	Job Number:	J80398
Model:	Intel® Centrino® Advanced-N 6230	T-Log Number:	T80540
Contact:	Steve Hackett	Account Manager:	Christine Krebill
Standard:	FCC 15.247	Class:	N/A

Run # 6b, EUT on Channel #10 2457MHz - n20, Chain A+B

Chain	Target (dBm)				Power Settings Measured (dBm)				Software Setting
	A	B	C	Total	A	B	C	Total	
	13.5	13.5		16.5	13.6	14.0		16.8	

Fundamental Signal Field Strength

Frequency	Level	Pol	15.209 / 15.247		Detector	Azimuth	Height	Comments
MHz	dB μ V/m	v/h	Limit	Margin	PK/QP/Avg	degrees	meters	
2460.870	102.9	H	120.0	-17.1	AVG	15	1.0	
2459.670	113.0	H	120.0	-7.0	PK	15	1.0	
2461.170	98.9	V	120.0	-21.1	AVG	197	1.0	
2461.630	109.1	V	120.0	-10.9	PK	197	1.0	

Direct measurement of bandedge

Frequency	Level	Pol	15.209 / 15.247		Detector	Azimuth	Height	Comments
MHz	dB μ V/m	v/h	Limit	Margin	PK/QP/Avg	degrees	meters	
2483.500	50.6	H	54.0	-3.4	AVG	15	1.0	
2483.660	49.5	V	54.0	-4.5	AVG	197	1.0	
2483.770	64.9	H	74.0	-9.1	PK	15	1.0	
2487.680	62.7	V	74.0	-11.3	PK	197	1.0	

RB 1 MHz; VB 10 Hz Average (Black trace) RB=VB= 1MHz Peak (Blue trace), Horizontal

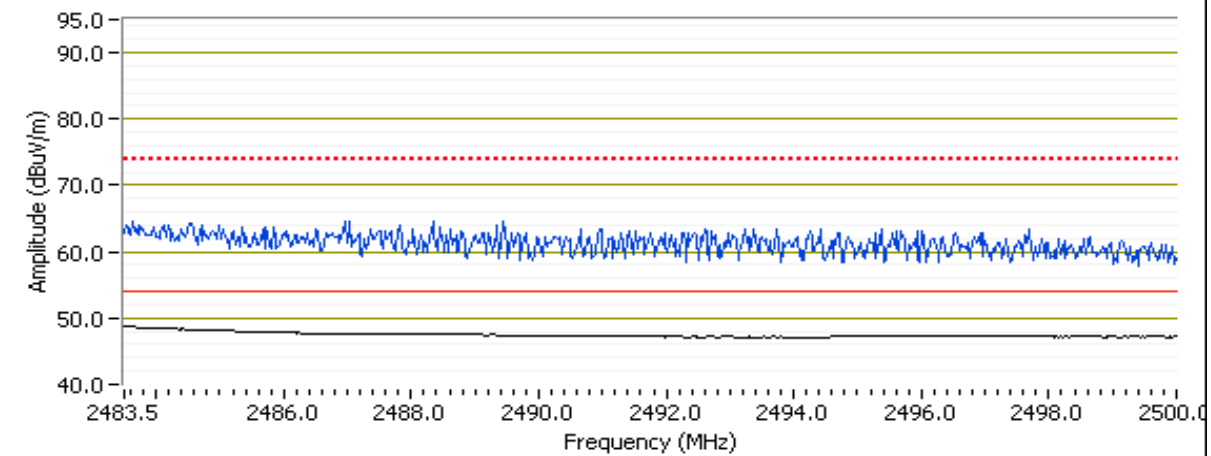

Client:	Intel Corporation	Job Number:	J80398
Model:	Intel® Centrino® Advanced-N 6230	T-Log Number:	T80540
Contact:	Steve Hackett	Account Manager:	Christine Krebill
Standard:	FCC 15.247	Class:	N/A

RSS 210 and FCC 15.247 (DTS) Radiated Spurious Emissions (1-26GHz)

Summary of Results

MAC Address: 00150079AD1A DRTU Tool Version 1.2.12-0197 New tool from 9/14 Driver version 14.0.0.39

Run #	Mode	Channel	Target Power	Measured Power	Test Performed	Limit	Result / Margin
Run #1	802.11b Chain A	#1 2412MHz	16.5	16.8	Radiated Emissions, 1 - 26 GHz	FCC 15.209 / 15.247	51.4dBµV/m @ 4824.0MHz (-2.6dB)
		#6 2437MHz	16.5	16.4			49.1dBµV/m @ 4874.0MHz (-4.9dB)
		#11 2462MHz	16.5	16.8			50.4dBµV/m @ 4924.0MHz (-3.6dB)
	802.11b Chain B	#1 2412MHz	16.5	16.8	Radiated Emissions, 1 - 26 GHz	FCC 15.209 / 15.247	50.0dBµV/m @ 4824.0MHz (-4.0dB)
		#6 2437MHz	16.5	15.0			50.7dBµV/m @ 4874.0MHz (-3.3dB)
		#11 2462MHz	16.5	15.9			50.8dBµV/m @ 4924.0MHz (-3.2dB)

Scans on center channel in all three OFDM modes to determine the worst case mode. Note that for n20 and n40 mode the output power was set to 16.5dBm per chain. The maximum power per chain in MIMO mode would be 13.5dBm, however as the single chain power could be 16.5dBm the scans were run at the higher single-chain power level with both chains active.

Run # 2	802.11g Chain A	#6 2437MHz	16.5	16.4	Radiated Emissions, 1 - 26 GHz	FCC 15.209 / 15.247	40.8dBµV/m @ 4874.2MHz (-13.2dB)
	802.11g Chain B	#6 2437MHz	16.5	16.7			44.3dBµV/m @ 4874.4MHz (-9.7dB)
	802.11n20 Chain A+B	#6 2437MHz	A:16.5 B:16.5	A:16.6 B:16.5			45.0dBµV/m @ 4873.2MHz (-9.0dB)
	802.11n40 Chain A+B	#6 2437MHz	A:16.5 B:16.5	A:16.6 B:16.5			39.5dBµV/m @ 4873.9MHz (-14.5dB)

Top and bottom channels in worst case OFDM mode:

Run # 3	Worst case OFDM 802.11n 20MHz Chain A+B	#1 2412MHz	16.5	A:16.5 B:16.6	Radiated Emissions, 1 - 26 GHz	FCC 15.209 / 15.247	36.5dBµV/m @ 4827.0MHz (-17.5dB)
		#11 2462MHz	16.5	A:16.7 B:16.7			43.3dBµV/m @ 4923.1MHz (-10.7dB)

Note - the target and measured power are average powers (measured with average power sensor) and are used for reference purposes only. Power is set using " **GAIN CONTROL**" mode in the DRTU tool.

Client:	Intel Corporation	Job Number:	J80398
Model:	Intel® Centrino® Advanced-N 6230	T-Log Number:	T80540
Contact:	Steve Hackett	Account Manager:	Christine Krebill
Standard:	FCC 15.247	Class:	N/A

Receiver Spurious Emissions							
Run #	Mode	Channel	Target Power	Measured Power	Test Performed	Limit	Result / Margin
Run # 4	Receive Chain A,B, A+B	#6, Chain A	-	-	Radiated Emissions, 1 - 7.5 GHz	RSS 210	40.7dBµV/m @ 1200.0MHz (-13.3dB)
		#6, Chain B	-	-			39.7dBµV/m @ 2986.7MHz (-14.3dB)
		#6, Chain A+B	-	-			39.2dBµV/m @ 1200.1MHz (-14.8dB)

Test Specific Details

Objective: The objective of this test session is to perform engineering evaluation testing of the EUT with respect to the specification listed above.

General Test Configuration

The EUT was installed into a test fixture such that the EUT was exposed (i.e. outside of a host PC). For radiated emissions testing the measurement antenna was located 3 meters from the EUT.

Ambient Conditions:

Rel. Humidity: 15 - 55 %
Temperature: 18 - 25 °C

Modifications Made During Testing

No modifications were made to the EUT during testing

Deviations From The Standard

No deviations were made from the requirements of the standard.

Client: Intel Corporation	Job Number: J80398
Model: Intel® Centrino® Advanced-N 6230	T-Log Number: T80540
	Account Manager: Christine Krebill
Contact: Steve Hackett	
Standard: FCC 15.247	Class: N/A

Run #1, Radiated Spurious Emissions, 1-26GHz, 802.11b, Chain A

Date of Test: 9/17/2010

Test Location: FT Chamber #7

Test Engineer: Rafael Varelas

Config Change: none

Run #1a, EUT on Channel #1 2412MHz - 802.11b, Chain A

	Power Settings		
	Target (dBm)	Measured (dBm)	Software Setting
Chain A	16.5	16.8	23.5

Spurious Radiated Emissions:

Frequency MHz	Level dB μ V/m	Pol v/h	15.209/15.247		Detector Pk/QP/Avg	Azimuth degrees	Height meters	Comments
			Limit	Margin				
4824.020	51.4	V	54.0	-2.6	AVG	2	1.0	RB 1 MHz;VB 10 Hz;Pk
4824.030	54.7	V	74.0	-19.3	PK	2	1.0	RB 1 MHz;VB 3 MHz;Pk

Note 1:

For emissions in restricted bands, the limit of 15.209 was used. For all other emissions, the limit is -30dBc for peak measurements in a measurement bandwidth of 100kHz.

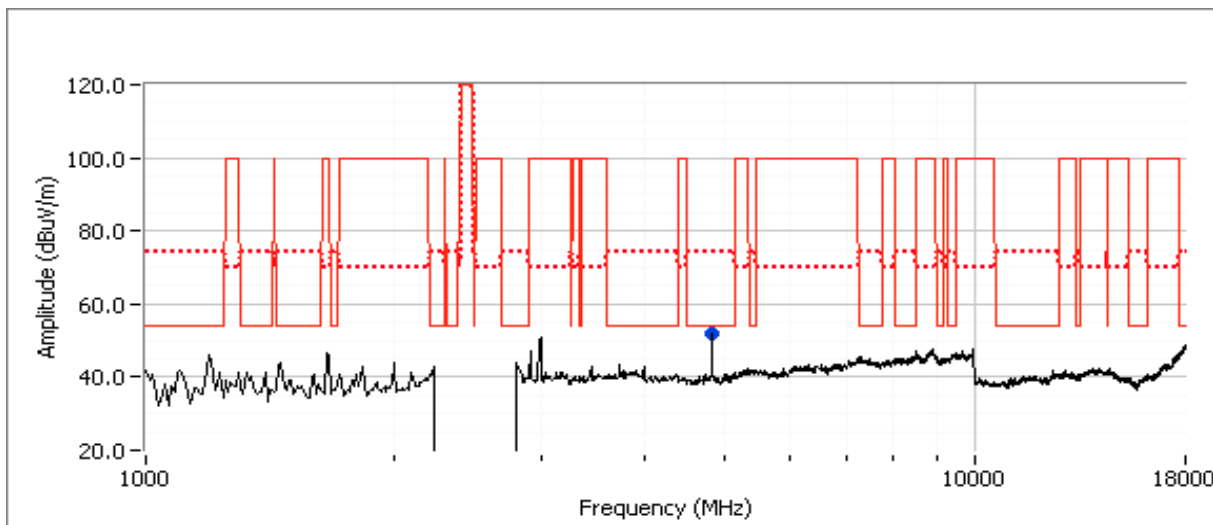

Client: Intel Corporation	Job Number: J80398
Model: Intel® Centrino® Advanced-N 6230	T-Log Number: T80540
Contact: Steve Hackett	Account Manager: Christine Krebill
Standard: FCC 15.247	Class: N/A

Run #1b: , EUT on Channel #6 2437MHz - 802.11b, Chain A

	Target (dBm)	Power Settings Measured (dBm)	Software Setting
Chain A	16.5	16.4	23.0

Spurious Radiated Emissions:

Frequency	Level	Pol	15.209/15.247	Detector	Azimuth	Height	Comments
MHz	dB μ V/m	v/h	Limit	Margin	PK/QP/Avg	degrees	meters
4873.980	49.1	V	54.0	-4.9	AVG	70	1.0
4873.980	52.2	V	74.0	-21.8	PK	70	1.0

- Note 1: For emissions in restricted bands, the limit of 15.209 was used. For all other emissions, the limit is -30dBc for peak measurements in a measurement bandwidth of 100kHz.
- Note 2: Scans made between 18 - 26GHz with the measurement antenna moved around the card and its antennas 20-50cm from the device indicated there were no significant emissions in this frequency range

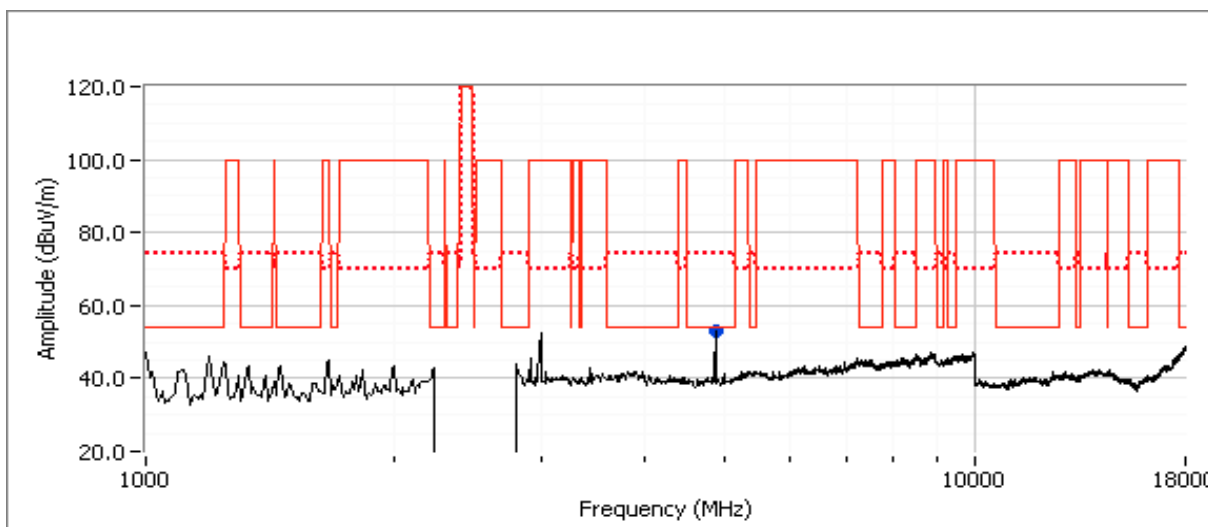

Client:	Intel Corporation	Job Number:	J80398
Model:	Intel® Centrino® Advanced-N 6230	T-Log Number:	T80540
Contact:	Steve Hackett	Account Manager:	Christine Krebill
Standard:	FCC 15.247	Class:	N/A

Run #1c: , EUT on Channel #11 2462MHz - 802.11b, Chain A

	Target (dBm)	Power Settings Measured (dBm)	Software Setting
Chain A	16.5	16.8	23.5

Spurious Radiated Emissions:

Frequency MHz	Level dBμV/m	Pol v/h	15.209/15.247		Detector Pk/QP/Avg	Azimuth degrees	Height meters	Comments
			Limit	Margin				
4924.030	50.4	V	54.0	-3.6	AVG	155	1.0	
4923.950	52.9	V	74.0	-21.1	PK	155	1.0	
1192.680	44.9	H	54.0	-9.1	AVG	120	1.7	
1192.680	46.9	H	74.0	-27.1	PK	120	1.7	
1220.250	33.8	V	54.0	-20.2	AVG	183	1.0	
1220.720	41.1	V	74.0	-32.9	PK	183	1.0	
2993.170	39.9	V	100.0	-60.1	AVG	152	1.0	
2999.570	57.6	V	70.0	-12.4	PK	152	1.0	

- Note 1: For emissions in restricted bands, the limit of 15.209 was used. For all other emissions, the limit is -30dBc for peak measurements in a measurement bandwidth of 100kHz.
- Note 2: Scans made between 18 - 26GHz with the measurement antenna moved around the card and its antennas 20-50cm from the device indicated there were no significant emissions in this frequency range

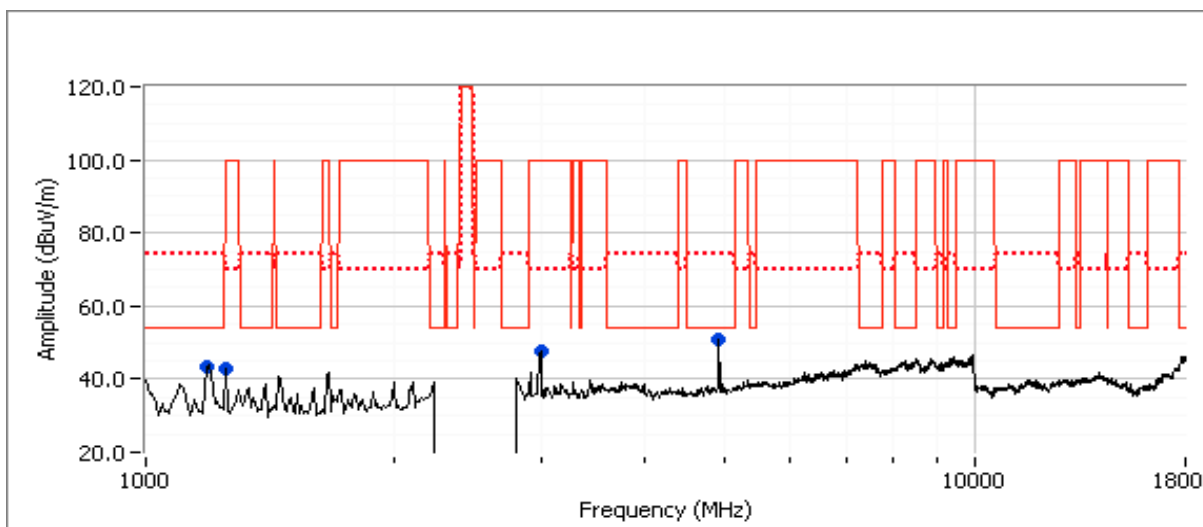

Client:	Intel Corporation	Job Number:	J80398
Model:	Intel® Centrino® Advanced-N 6230	T-Log Number:	T80540
Contact:	Steve Hackett	Account Manager:	Christine Krebill
Standard:	FCC 15.247	Class:	N/A

Run #1d, EUT on Channel #1 2412MHz - 802.11b, Chain B

	Target (dBm)	Power Settings Measured (dBm)	Software Setting
Chain B	16.5	16.8	25.0

Spurious Radiated Emissions:

Frequency MHz	Level dBμV/m	Pol v/h	15.209/15.247		Detector Pk/QP/Avg	Azimuth degrees	Height meters	Comments
			Limit	Margin				
4824.020	50.0	V	54.0	-4.0	AVG	191	1.0	
1192.550	43.6	V	54.0	-10.4	AVG	210	1.1	
4824.080	52.7	V	74.0	-21.3	PK	191	1.0	
1192.700	46.5	V	74.0	-27.5	PK	210	1.1	

- Note 1: For emissions in restricted bands, the limit of 15.209 was used. For all other emissions, the limit is -30dBc for peak measurements in a measurement bandwidth of 100kHz.
- Note 2: Scans made between 18 - 26GHz with the measurement antenna moved around the card and its antennas 20-50cm from the device indicated there were no significant emissions in this frequency range

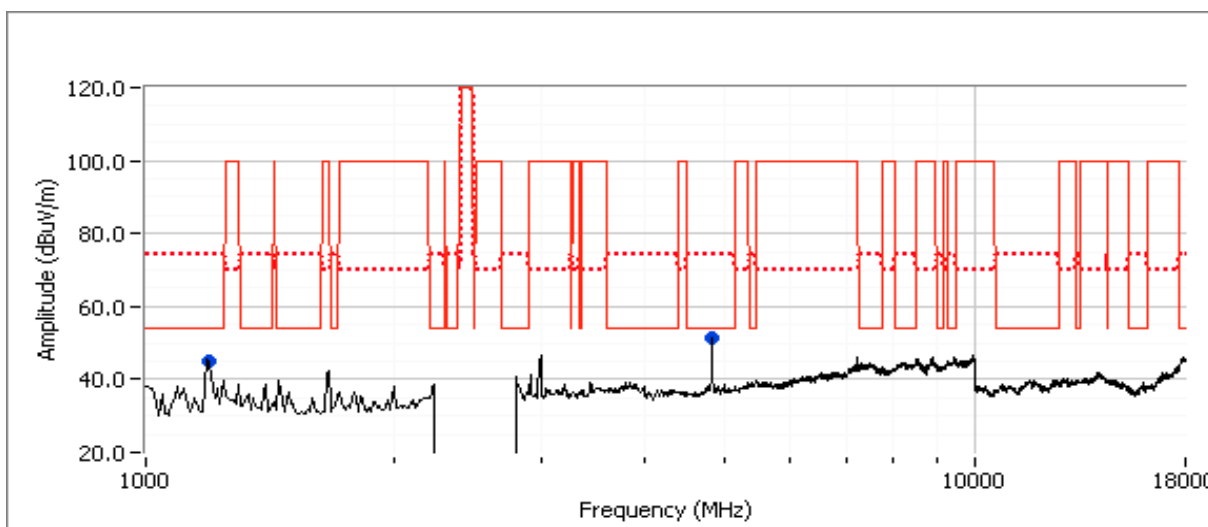

Client:	Intel Corporation	Job Number:	J80398
Model:	Intel® Centrino® Advanced-N 6230	T-Log Number:	T80540
Contact:	Steve Hackett	Account Manager:	Christine Krebill
Standard:	FCC 15.247	Class:	N/A

Run #1e: , EUT on Channel #6 2437MHz - 802.11b, Chain B

	Target (dBm)	Power Settings Measured (dBm)	Software Setting
Chain B	16.5	15.0	23.0

Spurious Radiated Emissions:

Frequency	Level	Pol	15.209/15.247	Detector	Azimuth	Height	Comments
MHz	dB μ V/m	v/h	Limit	Margin	PK/QP/Avg	degrees	meters
4873.990	50.7	V	54.0	-3.3	AVG	172	1.0
4873.990	53.2	V	74.0	-20.8	PK	172	1.0

- Note 1: For emissions in restricted bands, the limit of 15.209 was used. For all other emissions, the limit is -30dBc for peak measurements in a measurement bandwidth of 100kHz.
- Note 2: Scans made between 18 - 26GHz with the measurement antenna moved around the card and its antennas 20-50cm from the device indicated there were no significant emissions in this frequency range

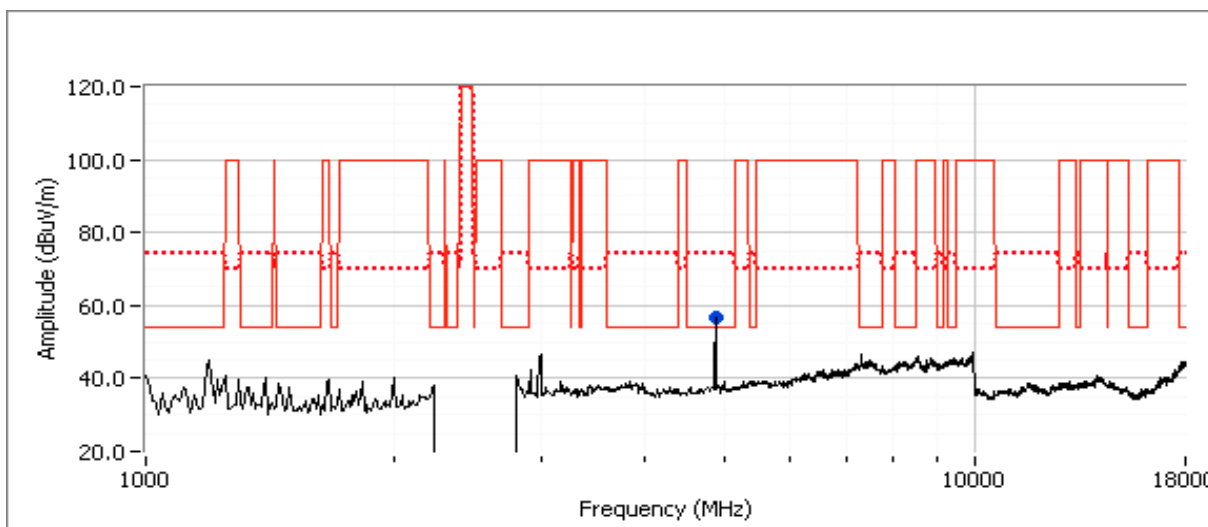

Client: Intel Corporation	Job Number: J80398
Model: Intel® Centrino® Advanced-N 6230	T-Log Number: T80540
	Account Manager: Christine Krebill
Contact: Steve Hackett	
Standard: FCC 15.247	Class: N/A

Run #1f: , EUT on Channel #11 2462MHz - 802.11b, Chain B

	Target (dBm)	Power Settings Measured (dBm)	Software Setting
Chain B	16.5	15.9	23.5

Spurious Radiated Emissions:

Frequency MHz	Level dBμV/m	Pol v/h	15.209/15.247		Detector Pk/QP/Avg	Azimuth degrees	Height meters	Comments
			Limit	Margin				
4923.980	50.8	V	54.0	-3.2	AVG	305	1.0	23.5
4923.920	53.2	V	74.0	-20.8	PK	305	1.0	23.5

Note 1: For emissions in restricted bands, the limit of 15.209 was used. For all other emissions, the limit is -30dBc for peak measurements in a measurement bandwidth of 100kHz.

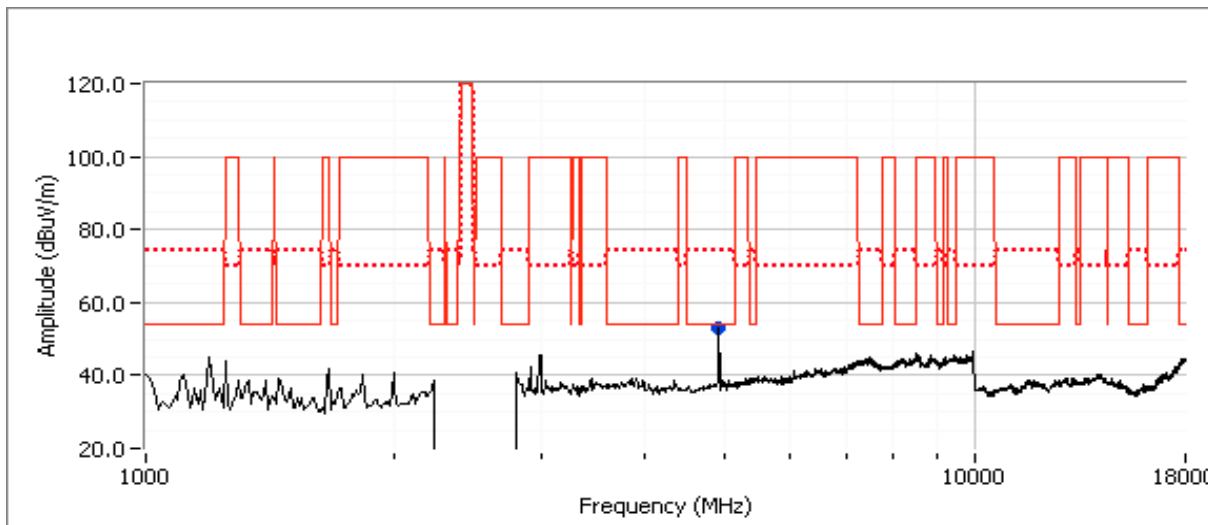

Client: Intel Corporation	Job Number: J80398
Model: Intel® Centrino® Advanced-N 6230	T-Log Number: T80540
	Account Manager: Christine Krebill
Contact: Steve Hackett	
Standard: FCC 15.247	Class: N/A

Run # 2, Radiated Spurious Emissions, 1-26GHz, 802.11g, n20 and n40, Chain A
 Date of Test: 9/20/2010 Test Location: Chamber #7
 Test Engineer: Mehran Birgani Config Change: None

Run # 2a, EUT on Channel #6 2437MHz - 802.11g Chain A

	Target (dBm)	Power Settings Measured (dBm)	Software Setting
Chain A	16.5	29.0	16.4

Spurious Radiated Emissions:

Frequency MHz	Level dBμV/m	Pol v/h	15.209/15.247		Detector Pk/QP/Avg	Azimuth degrees	Height meters	Comments
			Limit	Margin				
4874.230	40.8	V	54.0	-13.2	AVG	13	1.0	
4875.150	52.4	V	74.0	-21.6	PK	13	1.0	

- Note 1: For emissions in restricted bands, the limit of 15.209 was used. For all other emissions, the limit is -30dBc for peak measurements in a measurement bandwidth of 100kHz.
- Note 2: Scans made between 18 - 26GHz with the measurement antenna moved around the card and its antennas 20-50cm from the device indicated there were no significant emissions in this frequency range

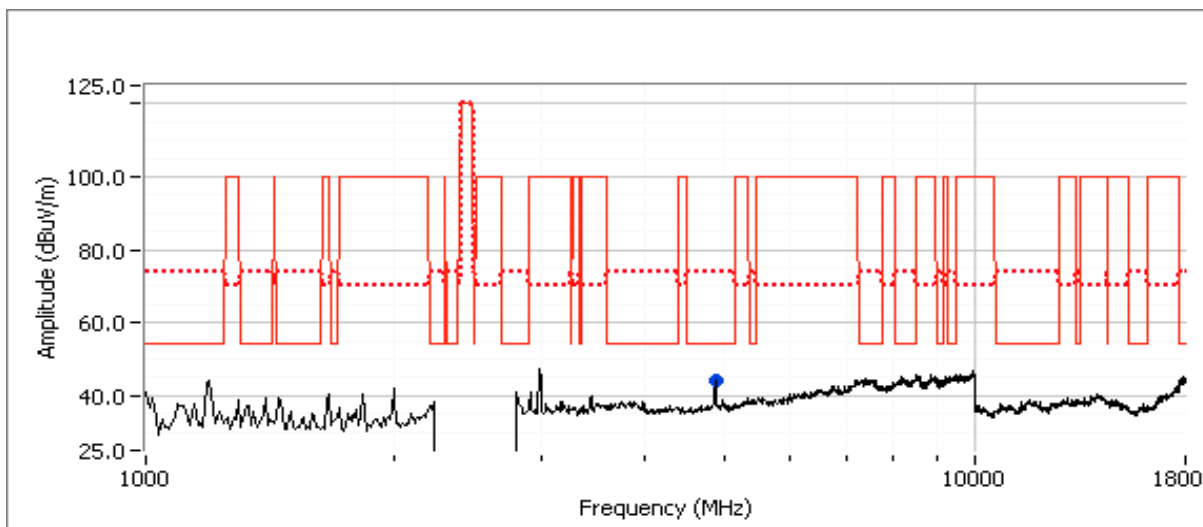

Client: Intel Corporation	Job Number: J80398
Model: Intel® Centrino® Advanced-N 6230	T-Log Number: T80540
	Account Manager: Christine Krebill
Contact: Steve Hackett	
Standard: FCC 15.247	Class: N/A

Run # 2a, EUT on Channel #6 2437MHz - 802.11g Chain B

	Target (dBm)	Power Settings Measured (dBm)	Software Setting
Chain B	16.5	30.5	16.7

Spurious Radiated Emissions:

Frequency MHz	Level dBμV/m	Pol v/h	15.209/15.247		Detector Pk/QP/Avg	Azimuth degrees	Height meters	Comments
			Limit	Margin				
4874.350	44.3	V	54.0	-9.7	AVG	181	1.0	
4876.520	55.7	V	74.0	-18.3	PK	181	1.0	

- Note 1: For emissions in restricted bands, the limit of 15.209 was used. For all other emissions, the limit is -30dBc for peak measurements in a measurement bandwidth of 100kHz.
- Note 2: Scans made between 18 - 26GHz with the measurement antenna moved around the card and its antennas 20-50cm from the device indicated there were no significant emissions in this frequency range

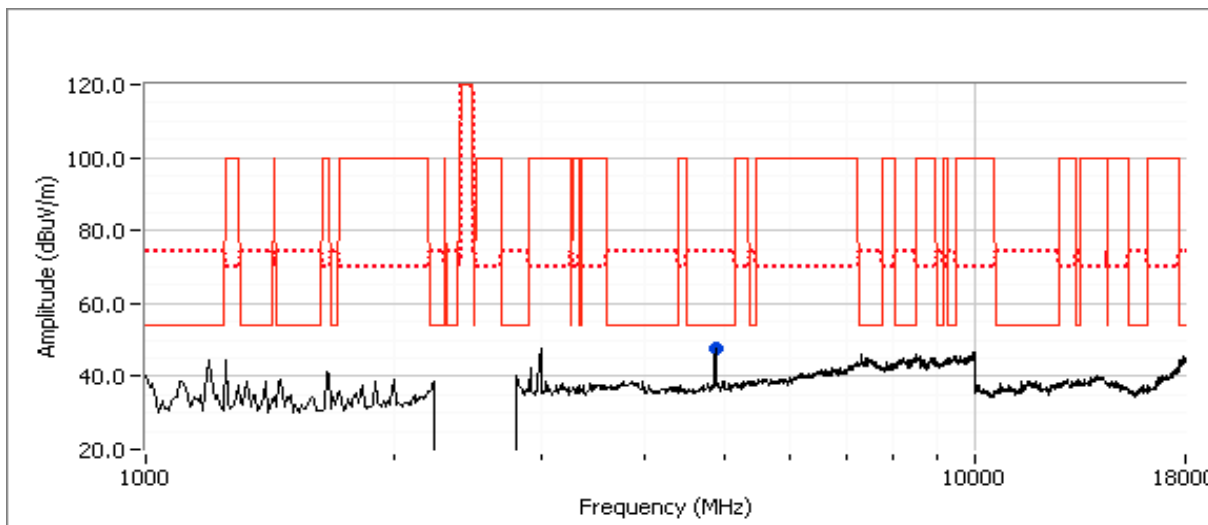

Client:	Intel Corporation	Job Number:	J80398
Model:	Intel® Centrino® Advanced-N 6230	T-Log Number:	T80540
Contact:	Steve Hackett	Account Manager:	Christine Krebill
Standard:	FCC 15.247	Class:	N/A

Run # 2c: , EUT on Channel #6 2437MHz - 802.11n20, Chain A+B

Chain	Target (dBm)				Power Settings Measured (dBm)				Software Setting
	A	B	C	Total	A	B	C	Total	
	16.5	16.5		19.5	16.6	16.5		19.6	

Spurious Radiated Emissions:

Frequency	Level	Pol	15.209/15.247		Detector	Azimuth	Height	Comments
MHz	dB μ V/m	v/h	Limit	Margin	PK/QP/Avg	degrees	meters	
4873.170	45.0	V	54.0	-9.0	AVG	180	1.1	
4874.040	59.8	V	74.0	-14.2	PK	180	1.1	

Note 1: For emissions in restricted bands, the limit of 15.209 was used. For all other emissions, the limit is -30dBc for peak measurements in a measurement bandwidth of 100kHz.

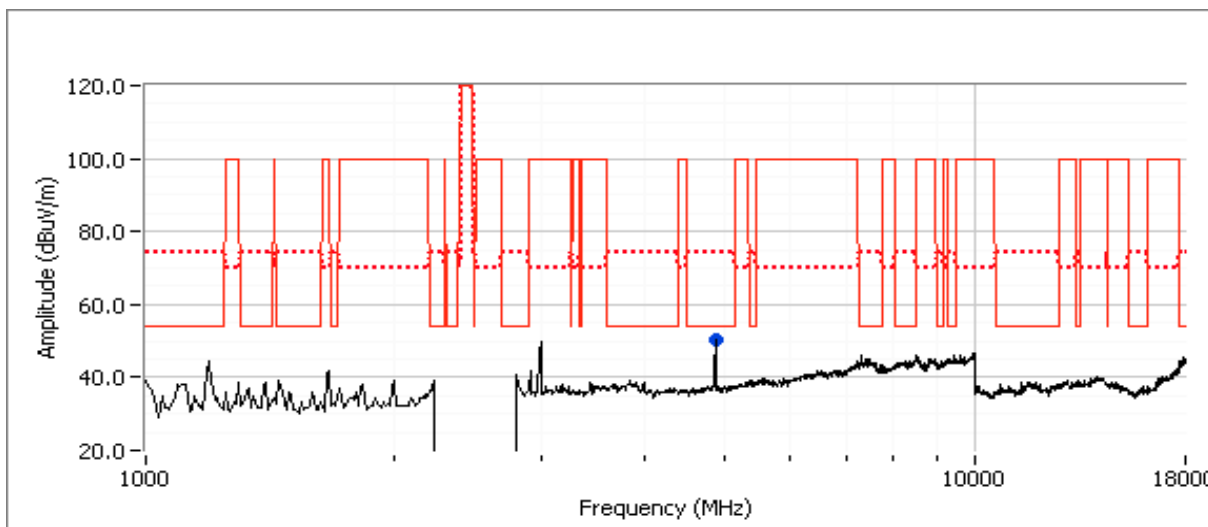

Client:	Intel Corporation	Job Number:	J80398
Model:	Intel® Centrino® Advanced-N 6230	T-Log Number:	T80540
Contact:	Steve Hackett	Account Manager:	Christine Krebill
Standard:	FCC 15.247	Class:	N/A

Run # 2d : EUT on Channel #6 2437MHz - 802.11n40, Chain A+B

Chain	Target (dBm)				Power Settings Measured (dBm)				Software Setting
	A	B	C	Total	A	B	C	Total	
	16.5	16.5		19.5	16.6	16.5		19.6	

Spurious Radiated Emissions:

Frequency	Level	Pol	15.209/15.247		Detector	Azimuth	Height	Comments
MHz	dB μ V/m	v/h	Limit	Margin	Pk/QP/Avg	degrees	meters	
4873.870	39.5	H	54.0	-14.5	AVG	120	1.1	
4874.030	54.7	H	74.0	-19.3	PK	120	1.1	

Note 1: For emissions in restricted bands, the limit of 15.209 was used. For all other emissions, the limit is -30dBc for peak measurements in a measurement bandwidth of 100kHz.

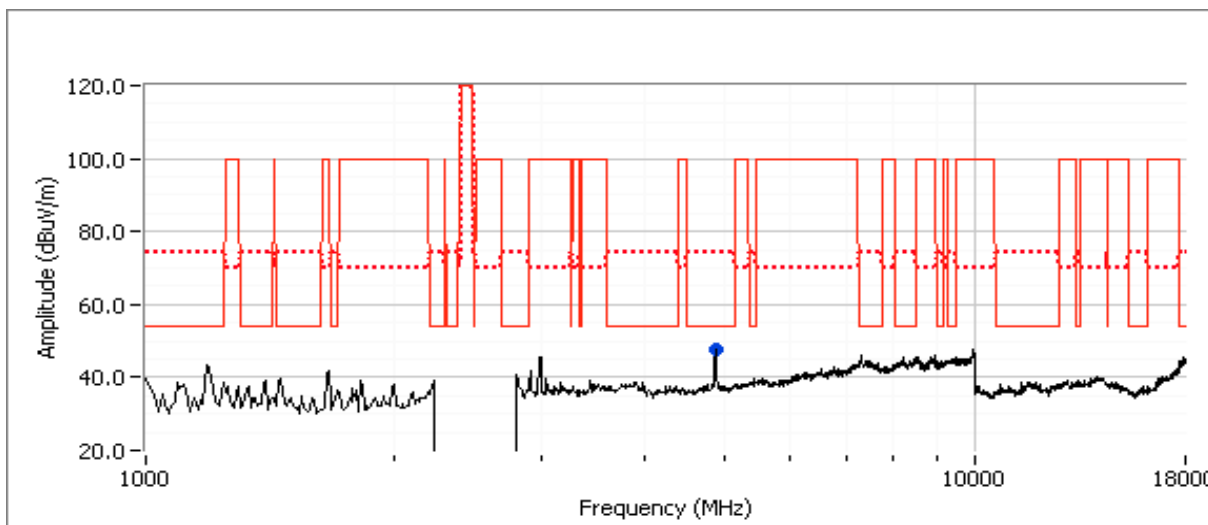

Client: Intel Corporation	Job Number: J80398
Model: Intel® Centrino® Advanced-N 6230	T-Log Number: T80540
Contact: Steve Hackett	Account Manager: Christine Krebill
Standard: FCC 15.247	Class: N/A

Run # 3, Radiated Spurious Emissions, 1-26GHz, Worst case OFDM 802.11n 20MHz, Chain A+B

Date of Test: 9/20/2010 Test Location: Chamber #7
 Test Engineer: Rafael Varelas Config Change: None

Run # 3a, EUT on Channel #1 2412MHz - 802.11n 20MHz, Chain A+B

Chain	Target (dBm)				Power Settings Measured (dBm)				Software Setting
	A	B	C	Total	A	B	C	Total	
	16.5	16.5		19.5	16.5	16.6		19.6	32.5, 34.0

Spurious Radiated Emissions:

Frequency MHz	Level dBµV/m	Pol v/h	15.209/15.247		Detector Pk/QP/Avg	Azimuth degrees	Height meters	Comments
			Limit	Margin				
4826.970	36.5	V	54.0	-17.5	AVG	137	1.1	RB 1 MHz;VB 10 Hz;Pk
4824.030	50.0	V	74.0	-24.0	PK	137	1.1	RB 1 MHz;VB 3 MHz;Pk
7236.050	48.4	V	70.0	-21.6	Peak	167	1.0	

Note 1: For emissions in restricted bands, the limit of 15.209 was used. For all other emissions, the limit is -30dBc for peak measurements in a measurement bandwidth of 100kHz.

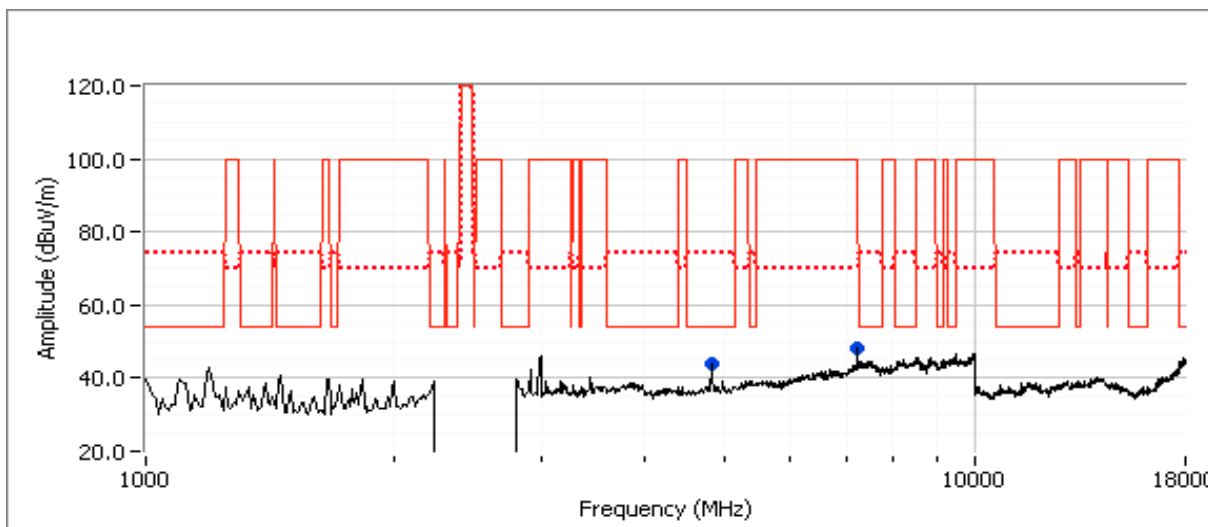

Client: Intel Corporation	Job Number: J80398
Model: Intel® Centrino® Advanced-N 6230	T-Log Number: T80540
	Account Manager: Christine Krebill
Contact: Steve Hackett	
Standard: FCC 15.247	Class: N/A

Run # 3b: , EUT on Channel #11 2462MHz - 802.11n 20MHz, Chain A+B
 Date of Test: 9/20/2010 Test Location: Chamber #7
 Test Engineer: Mehran Birgani Config Change: None

Chain	Target (dBm)				Measured (dBm)				Software Setting
	A	B	C	Total	A	B	C	Total	
	16.5	16.5		19.5	16.7	16.7		19.7	32.5, 34.0

Spurious Radiated Emissions:

Frequency MHz	Level dBμV/m	Pol v/h	15.209/15.247		Detector Pk/QP/Avg	Azimuth degrees	Height meters	Comments
			Limit	Margin				
4923.130	43.3	V	54.0	-10.7	AVG	318	1.0	
4924.130	58.1	V	74.0	-15.9	PK	318	1.0	

Note 1: For emissions in restricted bands, the limit of 15.209 was used. For all other emissions, the limit is -30dBc for peak measurements in a measurement bandwidth of 100kHz.

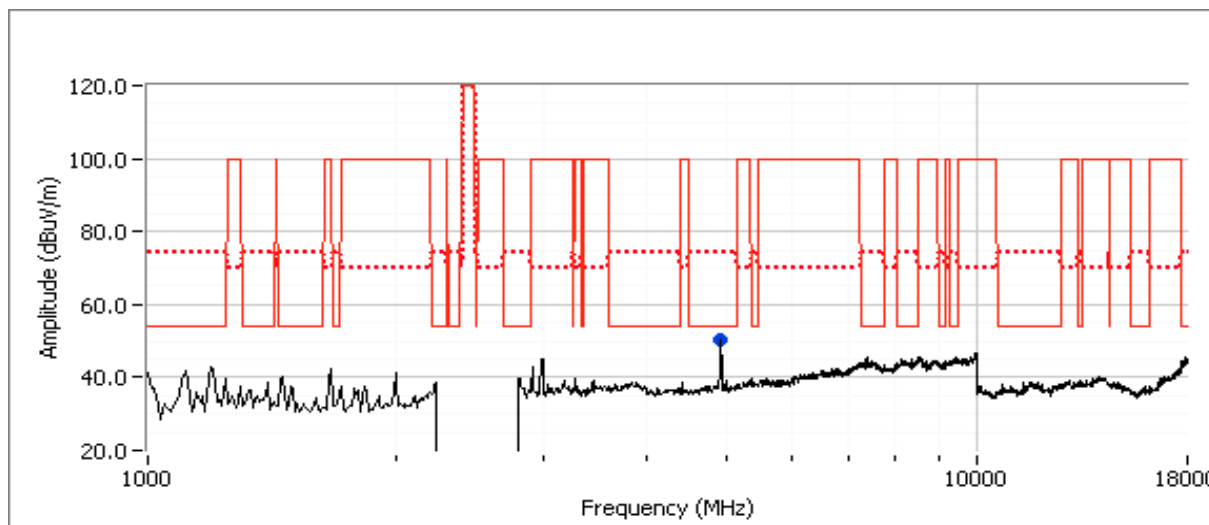

Client:	Intel Corporation	Job Number:	J80398
Model:	Intel® Centrino® Advanced-N 6230	T-Log Number:	T80540
Contact:	Steve Hackett	Account Manager:	Christine Krebill
Standard:	FCC 15.247	Class:	N/A

Run # 4, Radiated Spurious Emissions, 1-26GHz, Receive, Chain A,B, A+B

Date of Test: 9/20/2010

Test Location: Chamber #7

Test Engineer: Rafael Varelas

Config Change: none

Run # 4a, EUT on Channel #6 2437MHz - Receive, Chain A

Frequency MHz	Level dB μ V/m	Pol v/h	RSS 210		Detector Pk/QP/Avg	Azimuth degrees	Height meters	Comments
			Limit	Margin				
1200.040	40.7	H	54.0	-13.3	AVG	126	1.8	RB 1 MHz;VB 10 Hz;Pk
1200.060	46.3	H	74.0	-27.7	PK	126	1.8	RB 1 MHz;VB 3 MHz;Pk
2987.470	38.0	V	54.0	-16.0	AVG	170	1.0	RB 1 MHz;VB 10 Hz;Pk
3000.000	55.0	V	74.0	-19.0	PK	170	1.0	RB 1 MHz;VB 3 MHz;Pk
2330.940	36.5	V	54.0	-17.5	AVG	258	1.0	RB 1 MHz;VB 10 Hz;Pk
2331.440	53.7	V	74.0	-20.3	PK	258	1.0	RB 1 MHz;VB 3 MHz;Pk

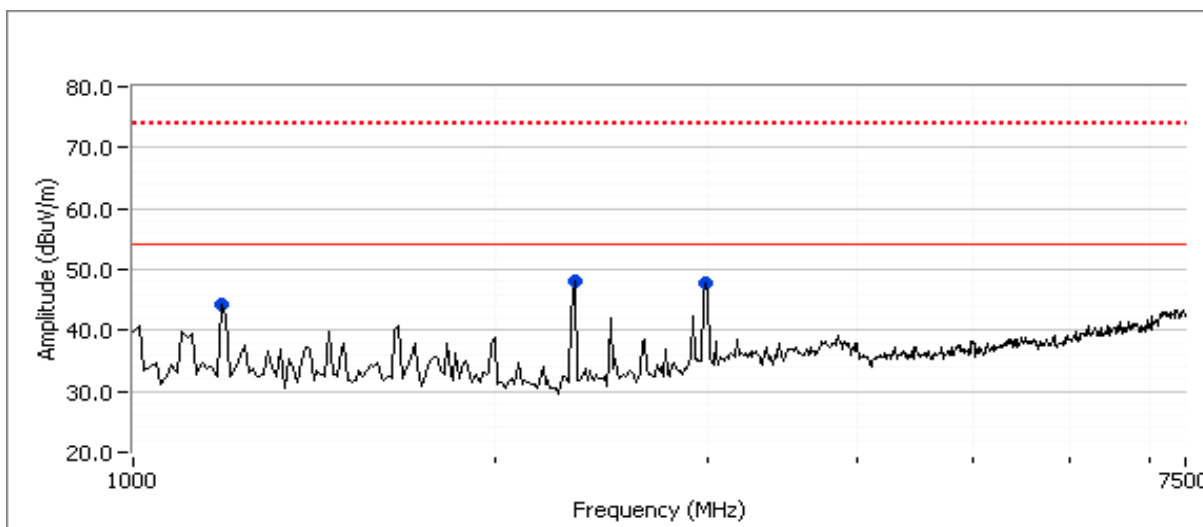

Client: Intel Corporation	Job Number: J80398
Model: Intel® Centrino® Advanced-N 6230	T-Log Number: T80540
	Account Manager: Christine Krebill
Contact: Steve Hackett	
Standard: FCC 15.247	Class: N/A

Run # 4b: EUT on Channel #6 2437MHz - Receive, Chain B

Frequency MHz	Level dB μ V/m	Pol v/h	RSS 210		Detector Pk/QP/Avg	Azimuth degrees	Height meters	Comments
			Limit	Margin				
2986.720	39.7	V	54.0	-14.3	AVG	161	1.0	RB 1 MHz;VB 10 Hz;Pk
2987.450	56.9	V	74.0	-17.1	PK	161	1.0	RB 1 MHz;VB 3 MHz;Pk
2324.000	37.6	V	54.0	-16.4	AVG	186	1.3	RB 1 MHz;VB 10 Hz;Pk
2324.460	55.7	V	74.0	-18.3	PK	186	1.3	RB 1 MHz;VB 3 MHz;Pk
1200.070	38.9	H	54.0	-15.1	AVG	120	1.7	RB 1 MHz;VB 10 Hz;Pk
1199.980	44.9	H	74.0	-29.1	PK	120	1.7	RB 1 MHz;VB 3 MHz;Pk

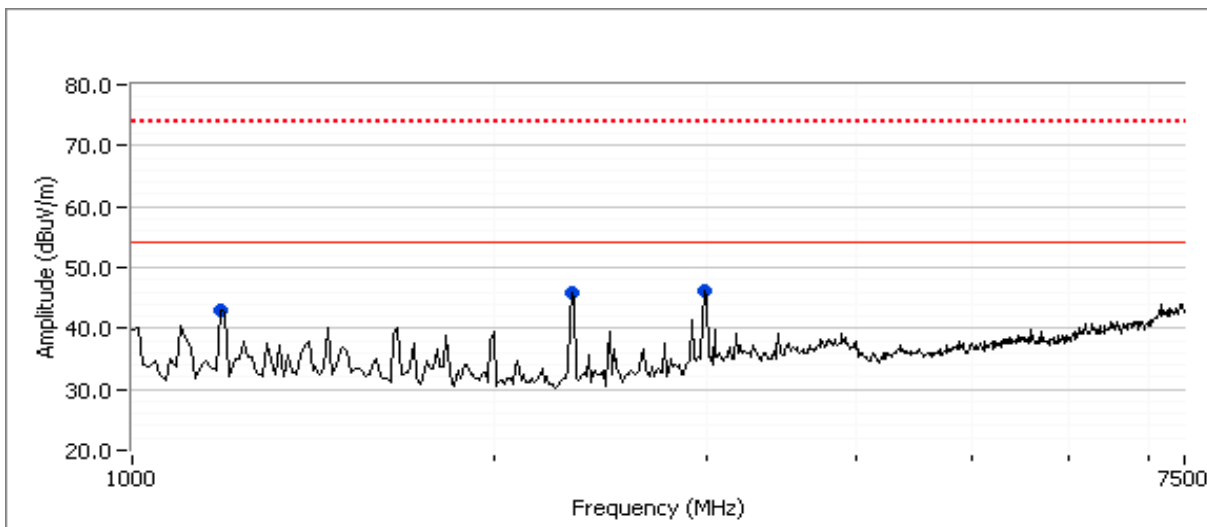

Client: Intel Corporation	Job Number: J80398
Model: Intel® Centrino® Advanced-N 6230	T-Log Number: T80540
	Account Manager: Christine Krebill
Contact: Steve Hackett	
Standard: FCC 15.247	Class: N/A

Run # 4c: EUT on Channel #6 2437MHz - Receive, Chain A+B

Frequency MHz	Level dB μ V/m	Pol v/h	RSS 210		Detector Pk/QP/Avg	Azimuth degrees	Height meters	Comments
			Limit	Margin				
1200.050	39.2	V	54.0	-14.8	AVG	104	1.8	RB 1 MHz;VB 10 Hz;Pk
1199.910	45.4	V	74.0	-28.6	PK	104	1.8	RB 1 MHz;VB 3 MHz;Pk
2987.130	38.9	V	54.0	-15.1	AVG	154	1.0	RB 1 MHz;VB 10 Hz;Pk
2985.230	56.5	V	74.0	-17.5	PK	154	1.0	RB 1 MHz;VB 3 MHz;Pk
2323.250	36.1	V	54.0	-17.9	AVG	360	1.0	RB 1 MHz;VB 10 Hz;Pk
2321.940	53.6	V	74.0	-20.4	PK	360	1.0	RB 1 MHz;VB 3 MHz;Pk

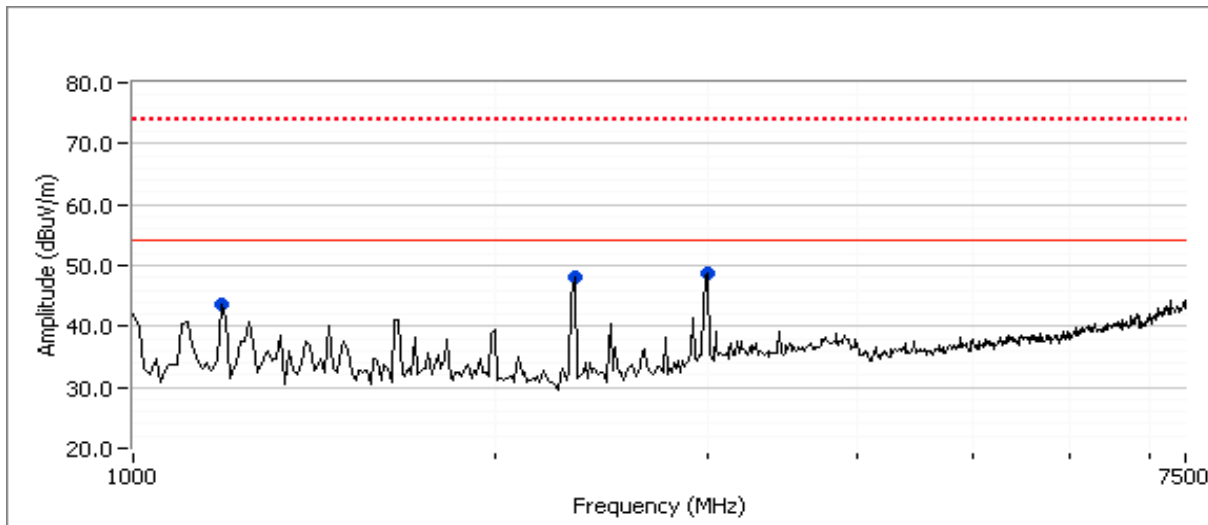

Client:	Intel Corporation	Job Number:	J80398
Model:	Intel® Centrino® Advanced-N 6230	T-Log Number:	T80540
Contact:	Steve Hackett	Account Manager:	Christine Krebill
Standard:	FCC 15.247	Class:	N/A

RSS 210 and FCC 15.247 (DTS) Radiated Spurious Emissions (1-26GHz)

Summary of Results

MAC Address: 00150079AD1A DRTU Tool Version 1.2.12-0197 New tool from 9/14 Driver version 14.0.0.39

Run #	Mode	Channel	Target Power	Measured Power	Test Performed	Limit	Result / Margin
-------	------	---------	--------------	----------------	----------------	-------	-----------------

Scans on center channel in all three OFDM modes to determine the worst case. Note that for n20 and n40 mode the output power was set to 16.5dBm per chain, the maximum power per chain in MIMO mode would be 13.5dBm, however as the single chain power could be 16.5dBm the scans were run at the higher single-chain power level but with both chains active to cover both MIMO and MISO modes.

Run # 1	802.11a Chain A	#157 5785MHz	16.5	16.7	Radiated Emissions, 1 - 40 GHz	FCC 15.209 / 15.247	44.8dBµV/m @ 11570.3MHz (-9.2dB)
	802.11a Chain B	#157 5785MHz	16.5	16.8			45.1dBµV/m @ 11570.2MHz (-8.9dB)
Run # 2	n20/n40 Chain A+B	#157 5785MHz	16.5	A=16.6 B=16.7	Radiated Emissions, 1 - 40 GHz	FCC 15.209 / 15.247	47.6dBµV/m @ 11570.8MHz (-6.4dB)
		#159 5795MHz	16.5	A=16.6 B=16.7			46.3dBµV/m @ 11590.1MHz (-7.7dB)

Top and bottom channels in worst case OFDM mode (n20, Chain A+B):

Run # 3	Mode: n20 Chain A+B	#149 5745MHz	16.5	A=16.7 B=16.8	Radiated Emissions, 1 - 40 GHz	FCC 15.209 / 15.247	46.4dBµV/m @ 11490.0MHz (-7.6dB)
		#165 5825MHz	16.5	A=16.6 B=16.7			49.4dBµV/m @ 11650.5MHz (-4.6dB)

Receiver Spurious Emissions

Run # 4	Receive Chain A,B, A+B	#157, Chain A	-	-	Radiated Emissions, 1 - 7.5 GHz	RSS 210	38.8dBµV/m @ 2998.7MHz (-15.2dB)
		#157, Chain B	-	-			38.7dBµV/m @ 2995.4MHz (-15.3dB)
		#157, Chain A+B	-	-			38.8dBµV/m @ 2328.2MHz (-15.2dB)

Note - the target and measured power are average powers (measured with average power sensor) and are used for reference purposes only. Power is set using " **GAIN CONTROL**" mode in the DRTU tool.

Test Specific Details

Objective: The objective of this test session is to perform engineering evaluation testing of the EUT with respect to the specification listed above.

General Test Configuration

The EUT was installed into a test fixture such that the EUT was exposed (i.e. outside of a host PC). For radiated emissions testing the measurement antenna was located 3 meters from the EUT.

Client: Intel Corporation	Job Number: J80398
Model: Intel® Centrino® Advanced-N 6230	T-Log Number: T80540
	Account Manager: Christine Krebill
Contact: Steve Hackett	
Standard: FCC 15.247	Class: N/A

Ambient Conditions:

Rel. Humidity: 15 - 55 %
 Temperature: 18 - 25 °C

Modifications Made During Testing

No modifications were made to the EUT during testing

Deviations From The Standard

No deviations were made from the requirements of the standard.

Run # 1, Radiated Spurious Emissions, 1-40GHz, 802.11a

Date of Test: 9/21/2010

Test Location: FT chamber #4

Test Engineer: Rafael Varelas

Config Change: none

Run # 1a, EUT on Channel #157 5785MHz - 802.11a, Chain A

	Target (dBm)	Power Settings Measured (dBm)	Software Setting
Chain A	16.5	16.7	29.5

Spurious Radiated Emissions:

Frequency MHz	Level dBμV/m	Pol v/h	15.209/15.247		Detector Pk/QP/Avg	Azimuth degrees	Height meters	Comments
			Limit	Margin				
11570.250	44.8	V	54.0	-9.2	AVG	162	1.1	RB 1 MHz;VB 10 Hz;Pk
11571.650	55.7	V	74.0	-18.3	PK	162	1.1	RB 1 MHz;VB 3 MHz;Pk
2331.360	35.9	V	54.0	-18.1	AVG	339	1.0	RB 1 MHz;VB 10 Hz;Pk
2325.530	53.0	V	74.0	-21.0	PK	339	1.0	RB 1 MHz;VB 3 MHz;Pk

- Note 1: For emissions in restricted bands, the limit of 15.209 was used. For all other emissions, the limit is -30dBc for peak measurements in a measurement bandwidth of 100kHz.
- Note 2: Scans made between 18 - 26GHz with the measurement antenna moved around the card and its antennas 20-50cm from the device indicated there were no significant emissions in this frequency range

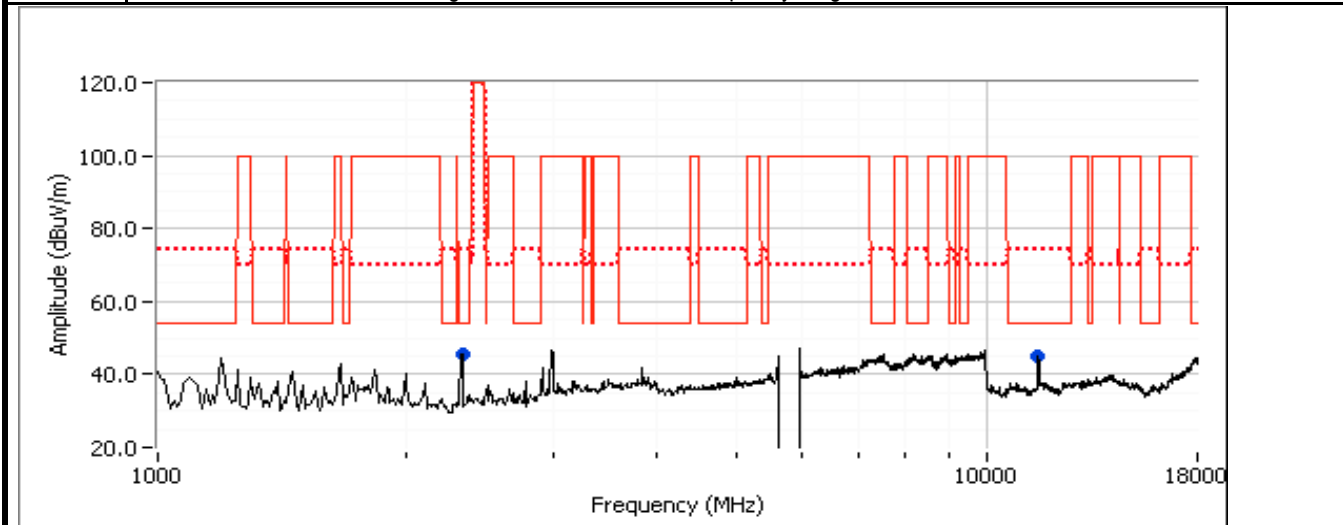

Client:	Intel Corporation	Job Number:	J80398
Model:	Intel® Centrino® Advanced-N 6230	T-Log Number:	T80540
Contact:	Steve Hackett	Account Manager:	Christine Krebill
Standard:	FCC 15.247	Class:	N/A

Run # 1b: , EUT on Channel #157 5785MHz - 802.11a, Chain B

	Target (dBm)	Power Settings Measured (dBm)	Software Setting
Chain A	16.5	16.8	29.0

Spurious Radiated Emissions:

Frequency MHz	Level dBuV/m	Pol v/h	15.209/15.247		Detector Pk/QP/Avg	Azimuth degrees	Height meters	Comments
			Limit	Margin				
11570.230	45.1	V	54.0	-8.9	AVG	285	1.0	RB 1 MHz;VB 10 Hz;Pk
11564.300	56.9	V	74.0	-17.1	PK	285	1.0	RB 1 MHz;VB 3 MHz;Pk
2323.600	38.2	V	54.0	-15.8	AVG	347	0.9	RB 1 MHz;VB 10 Hz;Pk
2321.900	56.9	V	74.0	-17.1	PK	347	0.9	RB 1 MHz;VB 3 MHz;Pk
3856.700	44.2	V	54.0	-9.8	AVG	219	1.0	RB 1 MHz;VB 10 Hz;Pk
3856.780	49.7	V	74.0	-24.3	PK	219	1.0	RB 1 MHz;VB 3 MHz;Pk

- Note 1: For emissions in restricted bands, the limit of 15.209 was used. For all other emissions, the limit is -30dBc for peak measurements in a measurement bandwidth of 100kHz.
- Note 2: Scans made between 18 - 40GHz with the measurement antenna moved around the card and its antennas 20-50cm from the device indicated there were no significant emissions in this frequency range

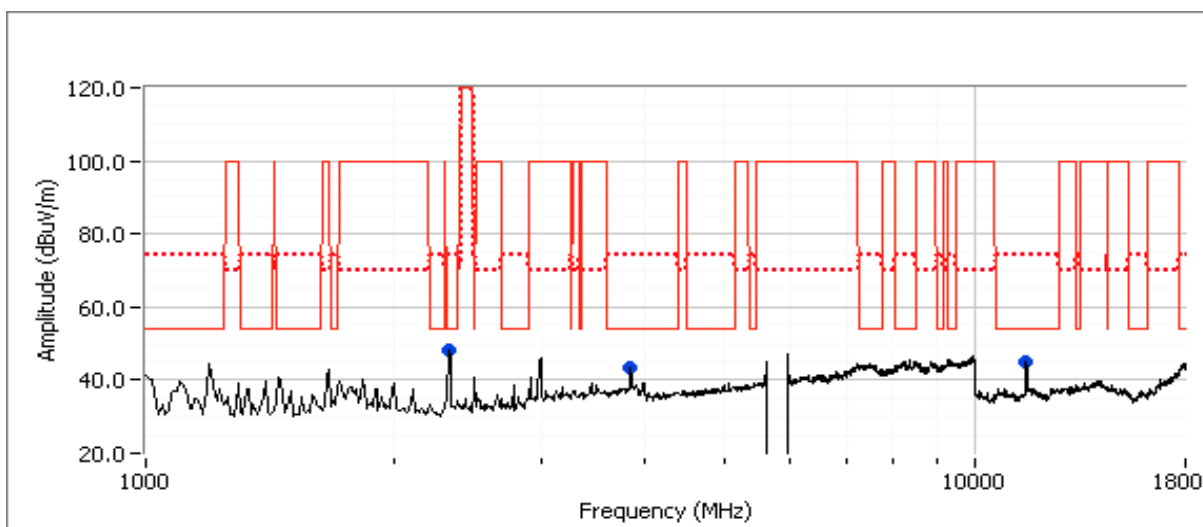

Client:	Intel Corporation	Job Number:	J80398
Model:	Intel® Centrino® Advanced-N 6230	T-Log Number:	T80540
Contact:	Steve Hackett	Account Manager:	Christine Krebill
Standard:	FCC 15.247	Class:	N/A

Run # 2, Radiated Spurious Emissions, 1-40GHz, 802.11n modes, Chain A+B
 Date of Test: 9/21/2010 Test Location: FT chamber #4
 Test Engineer: Rafael Varelas Config Change: none

Run # 2a, EUT on Channel #157 5785MHz - n20/n40, Chain A+B

Chain	Target (dBm)				Power Settings Measured (dBm)				Software Setting
	A	B	C	Total	A	B	C	Total	
	16.5	16.5		19.5	16.6	16.7		19.7	35.5/35.0

Spurious Radiated Emissions:

Frequency MHz	Level dBμV/m	Pol v/h	15.209/15.247 Limit	Margin	Detector Pk/QP/Avg	Azimuth degrees	Height meters	Comments
11570.800	47.6	V	54.0	-6.4	AVG	161	1.1	RB 1 MHz;VB 10 Hz;Pk
11570.000	60.7	V	74.0	-13.3	PK	161	1.1	RB 1 MHz;VB 3 MHz;Pk
3856.660	43.2	V	54.0	-10.8	AVG	269	1.0	RB 1 MHz;VB 10 Hz;Pk
3856.860	48.5	V	74.0	-25.5	PK	269	1.0	RB 1 MHz;VB 3 MHz;Pk
2331.460	38.4	V	54.0	-15.6	AVG	180	1.4	RB 1 MHz;VB 10 Hz;Pk
2331.830	57.5	V	74.0	-16.5	PK	180	1.4	RB 1 MHz;VB 3 MHz;Pk

Note 1: For emissions in restricted bands, the limit of 15.209 was used. For all other emissions, the limit is -30dBc for peak measurements in a measurement bandwidth of 100kHz.

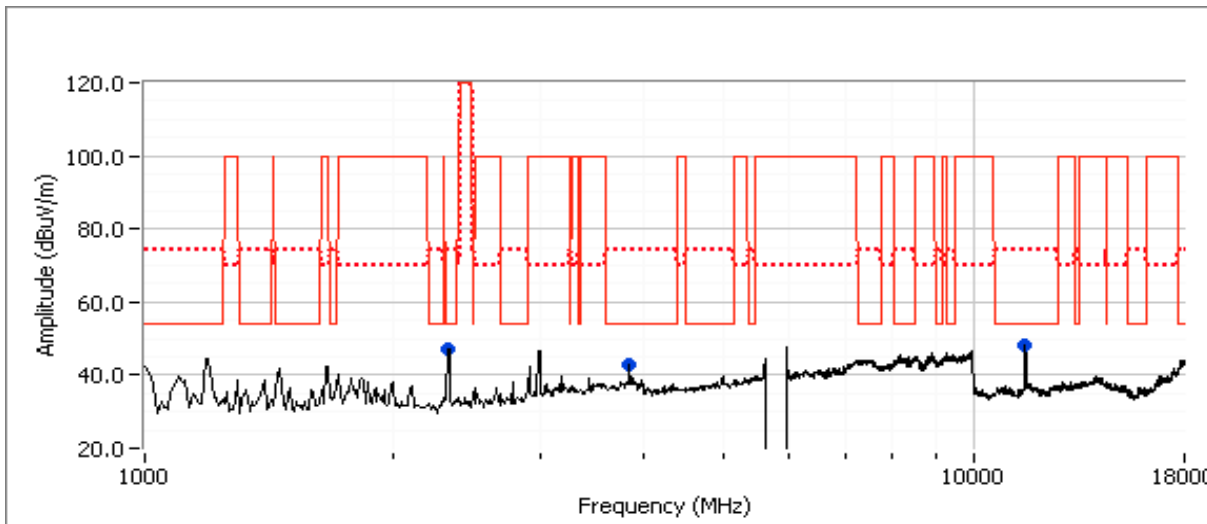

Client:	Intel Corporation	Job Number:	J80398
Model:	Intel® Centrino® Advanced-N 6230	T-Log Number:	T80540
Contact:	Steve Hackett	Account Manager:	Christine Krebill
Standard:	FCC 15.247	Class:	N/A

Run # 2b : EUT on Channel #159 5795MHz - n20/n40, Chain A+B

Chain	Target (dBm)				Power Settings Measured (dBm)				Software Setting
	A	B	C	Total	A	B	C	Total	
	16.5	16.5		19.5	16.6	16.7		19.7	

Spurious Radiated Emissions:

Frequency MHz	Level dBμV/m	Pol v/h	15.209/15.247		Detector Pk/QP/Avg	Azimuth degrees	Height meters	Comments
			Limit	Margin				
11590.100	46.3	V	54.0	-7.7	AVG	253	1.3	RB 1 MHz;VB 10 Hz;Pk
11590.200	60.7	V	74.0	-13.3	PK	253	1.3	RB 1 MHz;VB 3 MHz;Pk
2323.240	37.9	V	54.0	-16.1	AVG	160	1.4	RB 1 MHz;VB 10 Hz;Pk
2325.640	55.5	V	74.0	-18.5	PK	160	1.4	RB 1 MHz;VB 3 MHz;Pk
3863.370	42.6	V	54.0	-11.4	AVG	132	1.0	RB 1 MHz;VB 10 Hz;Pk
3863.360	47.6	V	74.0	-26.4	PK	132	1.0	RB 1 MHz;VB 3 MHz;Pk

Note 1: For emissions in restricted bands, the limit of 15.209 was used. For all other emissions, the limit is -30dBc for peak measurements in a measurement bandwidth of 100kHz.

Note 2: Scans made between 18 - 40GHz with the measurement antenna moved around the card and its antennas 20-50cm from the device indicated there were no significant emissions in this frequency range

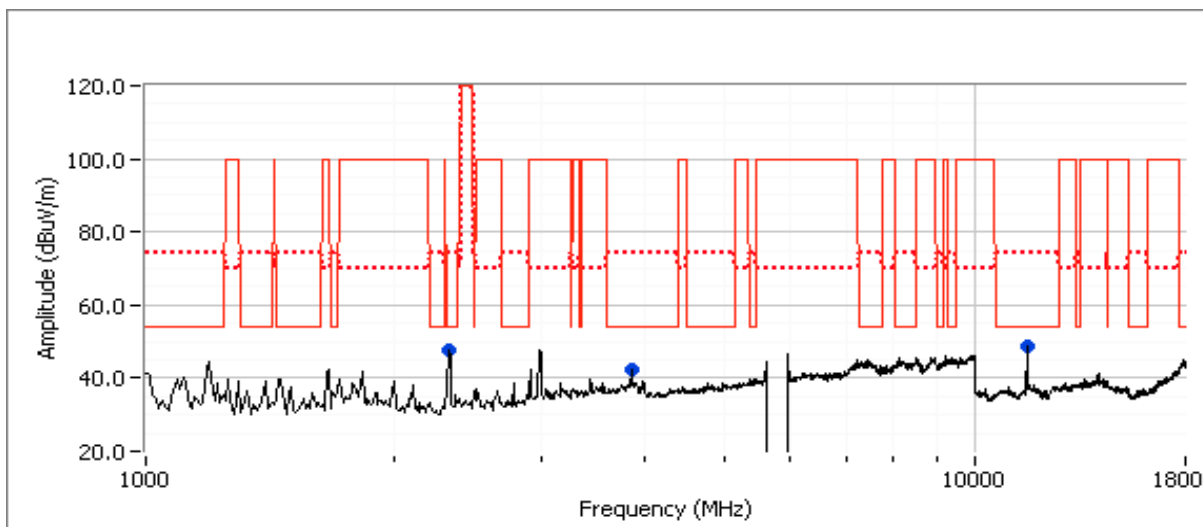

Client: Intel Corporation	Job Number: J80398
Model: Intel® Centrino® Advanced-N 6230	T-Log Number: T80540
	Account Manager: Christine Krebill
Contact: Steve Hackett	
Standard: FCC 15.247	Class: N/A

Run # 3, Radiated Spurious Emissions, 1-40GHz, 802.11n Mode, Chain A+B
 Date of Test: 9/21/2010 Test Location: FT chamber #4
 Test Engineer: Rafael Varelas Config Change: none

Run # 3a, EUT on Channel #149 5745MHz - 802.11n 20MHz Chain A+B

Chain	Target (dBm)				Power Settings Measured (dBm)				Software Setting
	A	B	C	Total	A	B	C	Total	
	16.5	16.5		19.5	16.7	16.8		19.8	35.5/35.0

Spurious Radiated Emissions:

Frequency MHz	Level dBμV/m	Pol v/h	15.209/15.247		Detector	Azimuth degrees	Height meters	Comments
			Limit	Margin	Pk/QP/Avg			
11490.000	46.4	V	54.0	-7.6	AVG	159	1.0	RB 1 MHz;VB 10 Hz;Pk
11490.230	61.2	V	74.0	-12.8	PK	159	1.0	RB 1 MHz;VB 3 MHz;Pk
2332.460	37.2	V	54.0	-16.8	AVG	167	1.1	RB 1 MHz;VB 10 Hz;Pk
2331.730	55.8	V	74.0	-18.2	PK	167	1.1	RB 1 MHz;VB 3 MHz;Pk
3830.000	40.4	V	54.0	-13.6	AVG	219	1.0	RB 1 MHz;VB 10 Hz;Pk
3829.910	47.5	V	74.0	-26.5	PK	219	1.0	RB 1 MHz;VB 3 MHz;Pk

Note 1: For emissions in restricted bands, the limit of 15.209 was used. For all other emissions, the limit is -30dBc for peak measurements in a measurement bandwidth of 100kHz.

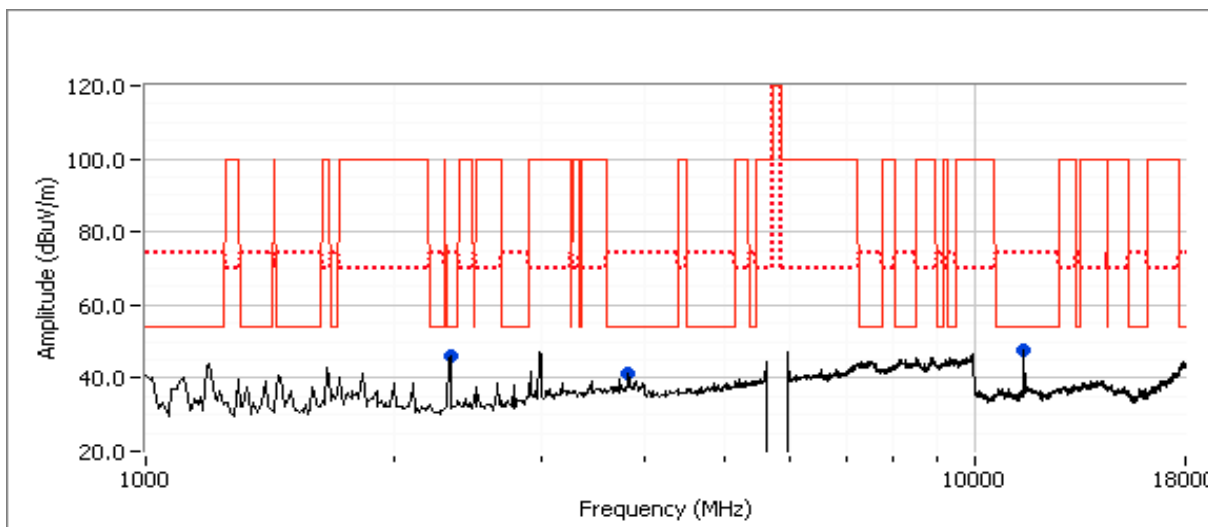

Client:	Intel Corporation	Job Number:	J80398
Model:	Intel® Centrino® Advanced-N 6230	T-Log Number:	T80540
Contact:	Steve Hackett	Account Manager:	Christine Krebill
Standard:	FCC 15.247	Class:	N/A

Run # 3b, EUT on Channel #165 5825MHz - 802.11n 20MHz Chain A+B

Chain	Target (dBm)				Power Settings Measured (dBm)				Software Setting
	A	B	C	Total	A	B	C	Total	
	16.5	16.5		19.5	16.6	16.7		19.7	

Spurious Radiated Emissions:

Frequency MHz	Level dBμV/m	Pol v/h	15.209/15.247		Detector	Azimuth degrees	Height meters	Comments
			Limit	Margin	Pk/QP/Avg			
11650.470	49.4	V	54.0	-4.6	AVG	159	1.1	RB 1 MHz;VB 10 Hz;Pk
11650.170	61.6	V	74.0	-12.4	PK	159	1.1	RB 1 MHz;VB 3 MHz;Pk
2323.040	37.3	V	54.0	-16.7	AVG	54	1.1	RB 1 MHz;VB 10 Hz;Pk
2321.740	54.7	V	74.0	-19.3	PK	54	1.1	RB 1 MHz;VB 3 MHz;Pk
3883.330	43.7	V	54.0	-10.3	AVG	50	1.0	RB 1 MHz;VB 10 Hz;Pk
3883.280	49.1	V	74.0	-24.9	PK	50	1.0	RB 1 MHz;VB 3 MHz;Pk

Note 1: For emissions in restricted bands, the limit of 15.209 was used. For all other emissions, the limit is -30dBc for peak measurements in a measurement bandwidth of 100kHz.

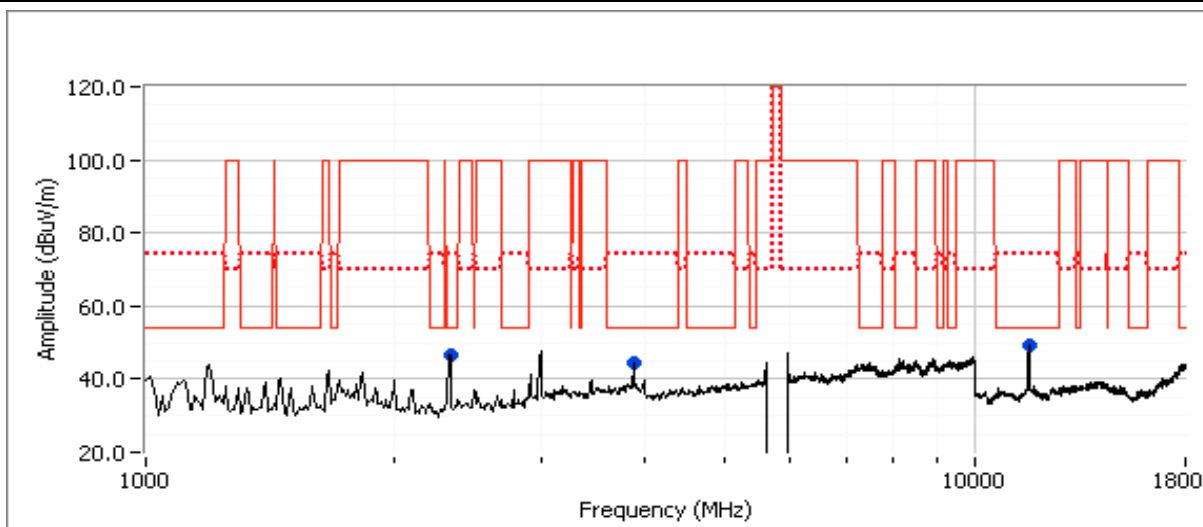

Client: Intel Corporation	Job Number: J80398
Model: Intel® Centrino® Advanced-N 6230	T-Log Number: T80540
	Account Manager: Christine Krebill
Contact: Steve Hackett	
Standard: FCC 15.247	Class: N/A

Run # 4, Radiated Spurious Emissions, 1-26GHz, Receive, Chain A,B, A+B

Date of Test: 9/21/2010

Test Location: FT chamber #4

Test Engineer: Rafael Varelas

Config Change: none

Run # 4a, EUT on Channel #157 5785MHz - Receive, Chain A

Frequency MHz	Level dB μ V/m	Pol v/h	RSS 210		Detector Pk/QP/Avg	Azimuth degrees	Height meters	Comments
			Limit	Margin				
2998.720	38.8	V	54.0	-15.2	AVG	122	1.0	RB 1 MHz;VB 10 Hz;Pk
2990.290	56.1	V	74.0	-17.9	PK	122	1.0	RB 1 MHz;VB 3 MHz;Pk
1244.620	26.8	V	54.0	-27.2	AVG	227	1.2	RB 1 MHz;VB 10 Hz;Pk
1242.850	37.4	V	74.0	-36.6	PK	227	1.2	RB 1 MHz;VB 3 MHz;Pk
2323.220	36.6	V	54.0	-17.4	AVG	111	1.3	RB 1 MHz;VB 10 Hz;Pk
2321.920	53.9	V	74.0	-20.1	PK	111	1.3	RB 1 MHz;VB 3 MHz;Pk

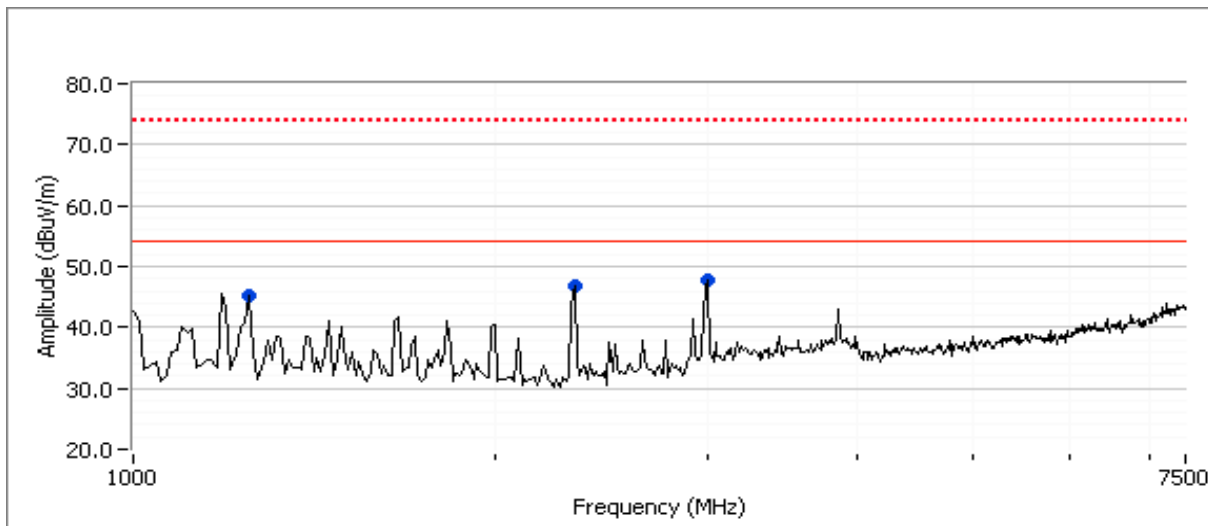

Client: Intel Corporation	Job Number: J80398
Model: Intel® Centrino® Advanced-N 6230	T-Log Number: T80540
	Account Manager: Christine Krebill
Contact: Steve Hackett	
Standard: FCC 15.247	Class: N/A

Run # 4b: EUT on Channel #157 5785MHz - Receive, Chain B

Frequency MHz	Level dB μ V/m	Pol v/h	RSS 210		Detector Pk/QP/Avg	Azimuth degrees	Height meters	Comments
			Limit	Margin				
2995.410	38.7	V	54.0	-15.3	AVG	113	1.0	RB 1 MHz;VB 10 Hz;Pk
2999.210	56.0	V	74.0	-18.0	PK	113	1.0	RB 1 MHz;VB 3 MHz;Pk
2323.010	36.6	V	54.0	-17.4	AVG	55	1.0	RB 1 MHz;VB 10 Hz;Pk
2323.070	54.1	V	74.0	-19.9	PK	55	1.0	RB 1 MHz;VB 3 MHz;Pk
1251.340	26.0	V	54.0	-28.0	AVG	18	1.0	RB 1 MHz;VB 10 Hz;Pk
1251.020	37.8	V	74.0	-36.2	PK	18	1.0	RB 1 MHz;VB 3 MHz;Pk

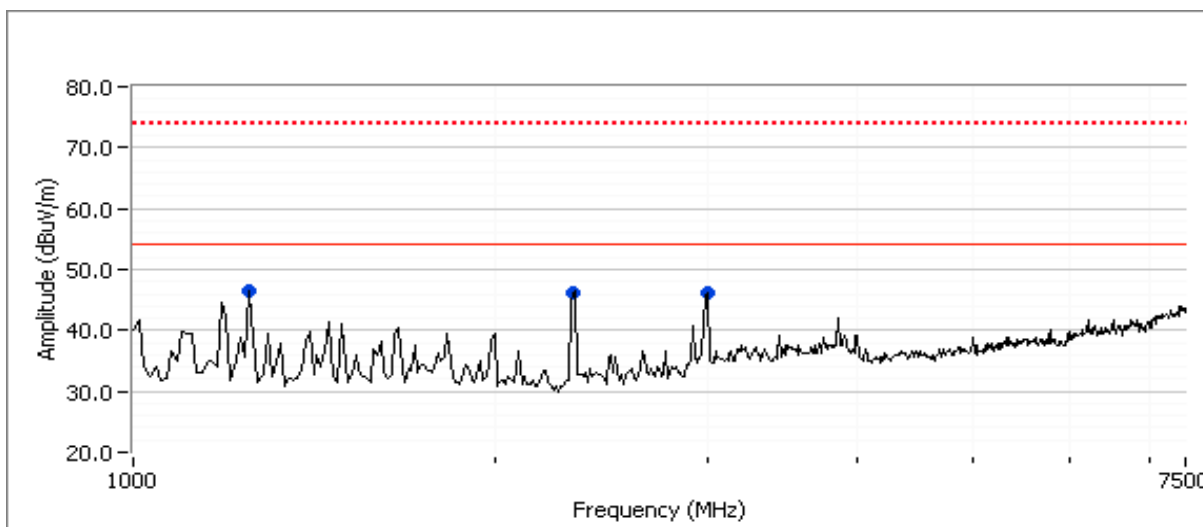

Client: Intel Corporation	Job Number: J80398
Model: Intel® Centrino® Advanced-N 6230	T-Log Number: T80540
	Account Manager: Christine Krebill
Contact: Steve Hackett	
Standard: FCC 15.247	Class: N/A

Run # 4c: EUT on Channel #157 5785MHz - Receive, Chain A+B

Frequency MHz	Level dB μ V/m	Pol v/h	RSS 210		Detector Pk/QP/Avg	Azimuth degrees	Height meters	Comments
			Limit	Margin				
2328.210	38.8	V	54.0	-15.2	AVG	353	1.0	RB 1 MHz;VB 10 Hz;Pk
2329.210	56.6	V	74.0	-17.4	PK	353	1.0	RB 1 MHz;VB 3 MHz;Pk
2992.320	39.1	V	54.0	-14.9	AVG	130	1.0	RB 1 MHz;VB 10 Hz;Pk
2990.920	55.9	V	74.0	-18.1	PK	130	1.0	RB 1 MHz;VB 3 MHz;Pk
1239.940	26.9	V	54.0	-27.1	AVG	9	1.0	RB 1 MHz;VB 10 Hz;Pk
1239.900	39.1	V	74.0	-34.9	PK	9	1.0	RB 1 MHz;VB 3 MHz;Pk

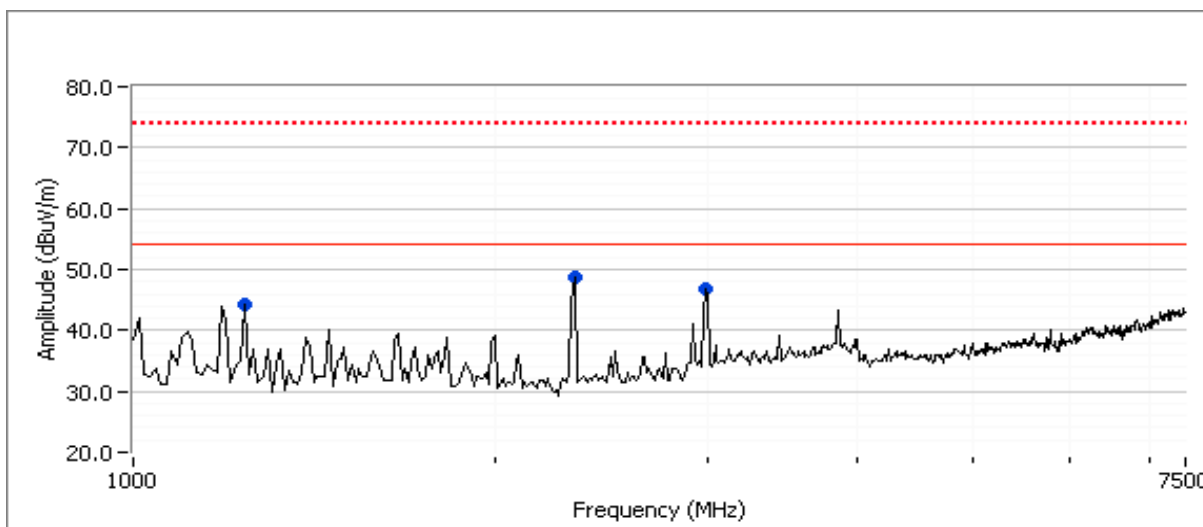

Client:	Intel Corporation	Job Number:	J80398
Model:	Intel® Centrino® Advanced-N 6230	T-Log Number:	T80759
		Account Manager:	Christine Krebill
Contact:	Steve Hackett		-
Emissions Standard(s):	FCC 15.247	Class:	B
Immunity Standard(s):	-	Environment:	-

EMC Test Data

For The

Intel Corporation

Model

Intel® Centrino® Advanced-N 6230

Date of Last Test:

Client:	Intel Corporation	Job Number:	J80398
Model:	Intel® Centrino® Advanced-N 6230	T-Log Number:	T80759
Contact:	Steve Hackett	Account Manager:	Christine Krebill
Standard:	FCC 15.247	Class:	N/A

**RSS 210 and FCC 15.247 (DTS) Antenna Port Measurements
Power, PSD, Bandwidth and Spurious Emissions**

Test Specific Details

Objective: The objective of this test session is to perform final qualification testing of the EUT with respect to the specification listed above.

Date of Test: 10/1/2010
 Test Engineer: Rafael Varelas
 Test Location: FT Chamber #7

Config. Used: 1
 Config Change: none
 Host Unit Voltage 120V/60Hz

General Test Configuration

The EUT was connected to the spectrum analyzer or power meter via a suitable attenuator. All measurements were made on a single chain.

All measurements have been corrected to allow for the external attenuators used.

Ambient Conditions:

Temperature: 21.9 °C
 Rel. Humidity: 42 %

Summary of Results

MAC Address: **00150079AD1A** DRTU Tool Version **1.2.12-0197** Driver version **14.0.0.39**

Run #	Pwr setting	Avg Pwr	Test Performed	Limit	Pass / Fail	Result / Margin
1			Output Power	15.247(b)	Pass	802.11b: 49 mW 802.11g: 38 mW n20: 35.5 mW n40: 17 mW
2			Power spectral Density (PSD)	15.247(d)	Pass	-7.4 dBm/3kHz
3			Minimum 6dB Bandwidth	15.247(a)	Pass	10.2 MHz
3			99% Bandwidth	RSS GEN	-	802.11b: 13.6 MHz 802.11g: 17.1 MHz n20: 18.3 MHz n40: 36.6 MHz
4			Spurious emissions	15.247(b)	Pass	All emissions below the limit

Modifications Made During Testing

No modifications were made to the EUT during testing

Client:	Intel Corporation	Job Number:	J80398
Model:	Intel® Centrino® Advanced-N 6230	T-Log Number:	T80759
Contact:	Steve Hackett	Account Manager:	Christine Krebill
Standard:	FCC 15.247	Class:	N/A

Deviations From The Standard

No deviations were made from the requirements of the standard.

Run #1: Output Power

802.11b Mode

Power Setting ²	Frequency (MHz)	Output Power		Antenna Gain (dBi)	Result	EIRP ^{Note 2}		Output Power	
		(dBm) ¹	mW			dBm	W	(dBm) ³	mW
23.5	2412	16.7	46.8	3.2	Pass	19.9	0.098	16.8	47.9
23.5	2437	16.9	49.0	3.2	Pass	20.1	0.102	16.8	47.9
23.5	2462	16.8	47.9	3.2	Pass	20.0	0.100	16.8	47.9

- Note 1: Output power measured using a spectrum analyzer (see plots below) with RBW=1MHz, VB=3 MHz, sample detector, power averaging on (transmitted signal was continuous) and power integration over **50 MHz** (option #2, method 1 in KDB 558074, equivalent to method 1 of DA-02-2138A1 for U-NII devices). Spurious limit becomes **-30dBc**.
- Note 1: Output power measured using a spectrum analyzer (see plots below) with RBW=1MHz, VB=3 MHz, sample detector, power averaging on (transmitted signal was continuous) and power integration over **50 MHz** (option #2, method 1 in KDB 558074, equivalent to method 1 of DA-02-2138A1 for U-NII devices). Spurious limit becomes **-30dBc**.
- Note 2: Power setting - the software power setting used during testing, included for reference only.
- Note 3: Power measured using average power meter and is included for reference only.

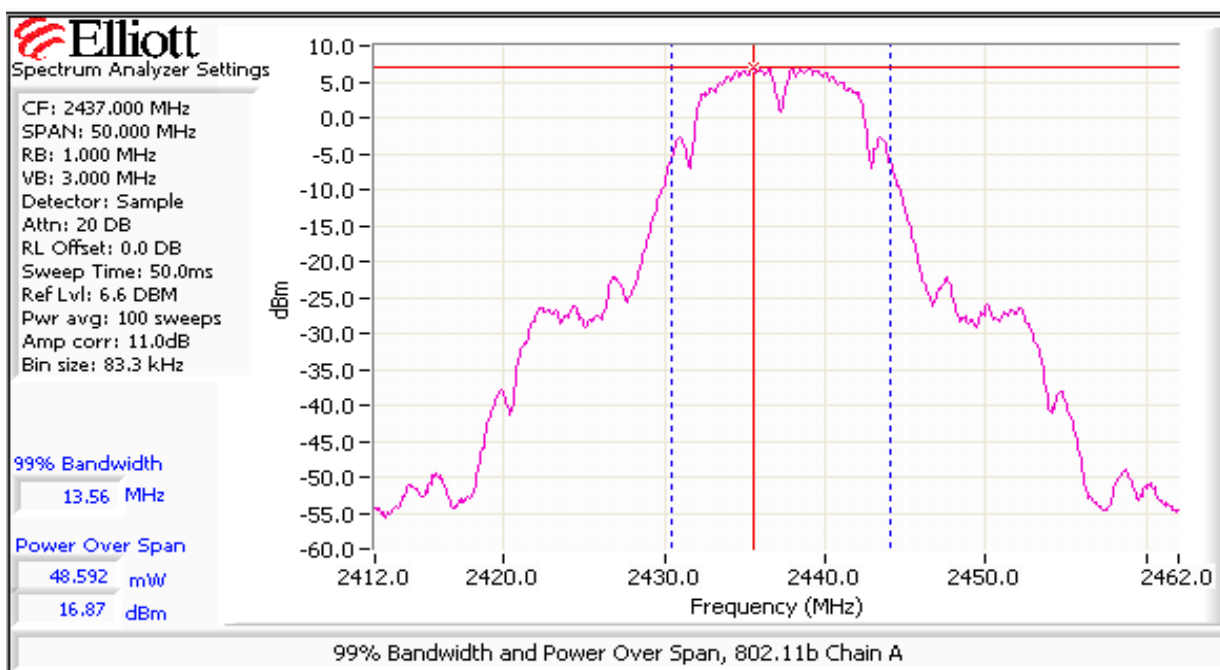

Client:	Intel Corporation	Job Number:	J80398
Model:	Intel® Centrino® Advanced-N 6230	T-Log Number:	T80759
Contact:	Steve Hackett	Account Manager:	Christine Krebill
Standard:	FCC 15.247	Class:	N/A

802.11g Mode

Power Setting ²	Frequency (MHz)	Output Power		Antenna Gain (dBi)	Result	EIRP ^{Note 2}		Output Power	
		(dBm) ¹	mW			dBm	W	(dBm) ³	mW
25.5	2412	12.9	19.5	3.2	Pass	16.1	0.041	14.1	25.7
29	2437	15.8	38.0	3.2	Pass	19.0	0.079	16.6	45.7
25.5	2462	13.1	20.4	3.2	Pass	16.3	0.043	14.0	25.1

- Note 1: Output power measured using a spectrum analyzer (see plots below) with RBW=1MHz, VB=3 MHz, sample detector, power averaging on (transmitted signal was continuous) and power integration over **50 MHz** (option #2, method 1 in KDB 558074, equivalent to method 1 of DA-02-2138A1 for U-NII devices). Spurious limit becomes **-30dBc**.
- Note 2: Power setting - the software power setting used during testing, included for reference only.
- Note 3: Power measured using average power meter and is included for reference only.

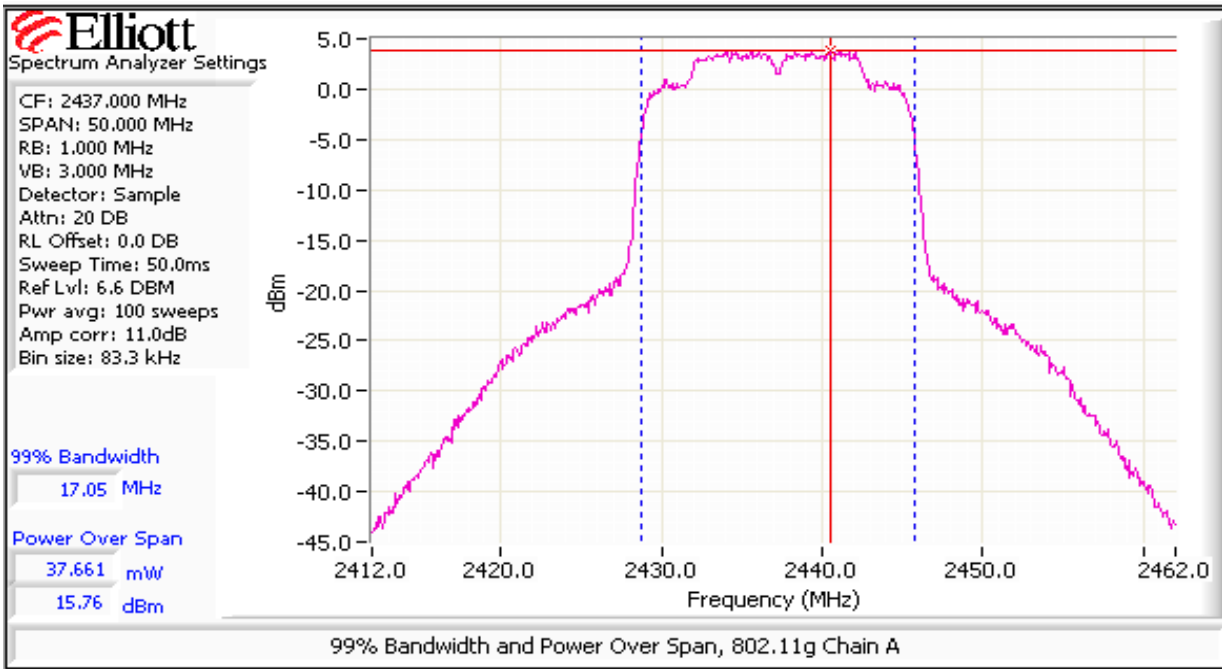

Client:	Intel Corporation	Job Number:	J80398
Model:	Intel® Centrino® Advanced-N 6230	T-Log Number:	T80759
Contact:	Steve Hackett	Account Manager:	Christine Krebill
Standard:	FCC 15.247	Class:	N/A

802.11n 20MHz Mode

Power Setting ²	Frequency (MHz)	Output Power		Antenna Gain (dBi)	Result	EIRP ^{Note 2}		Output Power	
		(dBm) ¹	mW			dBm	W	(dBm) ³	mW
24.5	2412	12.0	15.8	3.2	Pass	15.2	0.033	13.1	20.4
29	2437	15.5	35.5	3.2	Pass	18.7	0.074	16.5	44.7
24	2462	11.6	14.5	3.2	Pass	14.8	0.030	12.5	17.8

- Note 1: Output power measured using a spectrum analyzer (see plots below) with RBW=1MHz, VB=3 MHz, sample detector, power averaging on (transmitted signal was continuous) and power integration over **50 MHz** (option #2, method 1 in KDB 558074, equivalent to method 1 of DA-02-2138A1 for U-NII devices). Spurious limit becomes **-30dBc**.
- Note 2: Power setting - the software power setting used during testing, included for reference only.
- Note 3: Power measured using average power meter and is included for reference only.

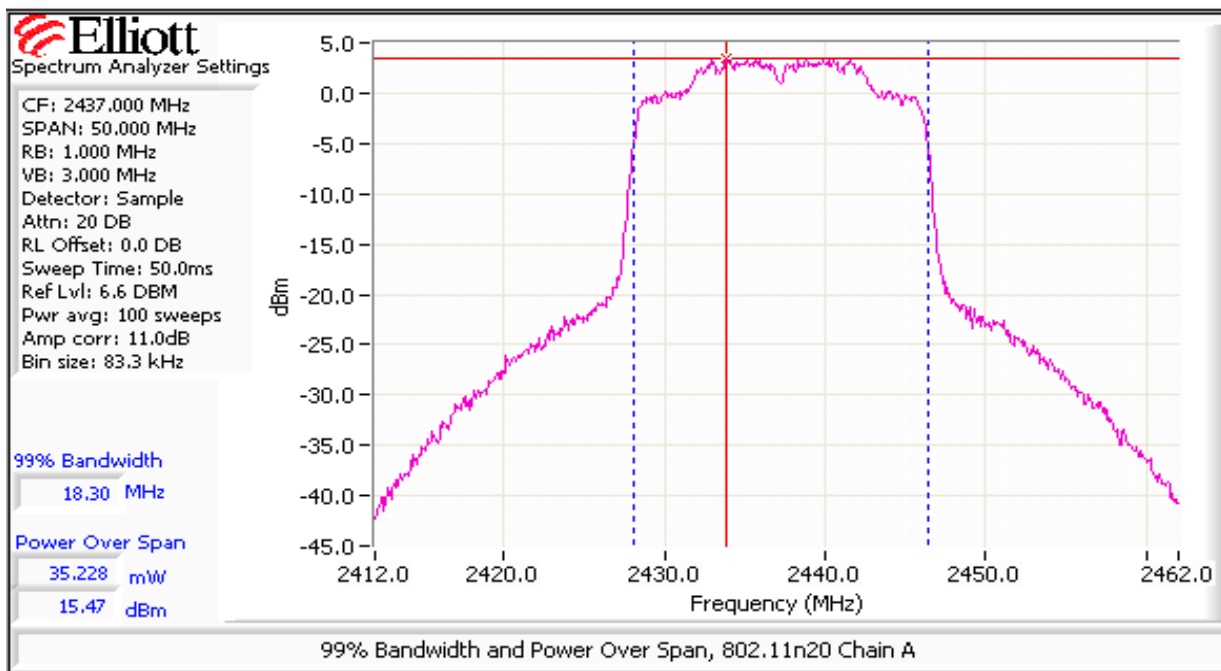

Client:	Intel Corporation	Job Number:	J80398
Model:	Intel® Centrino® Advanced-N 6230	T-Log Number:	T80759
Contact:	Steve Hackett	Account Manager:	Christine Krebill
Standard:	FCC 15.247	Class:	N/A

802.11n 40MHz Mode

Power Setting ²	Frequency (MHz)	Output Power		Antenna Gain (dBi)	Result	EIRP ^{Note 2}		Output Power	
		(dBm) ¹	mW			dBm	W	(dBm) ³	mW
22	2422	9.3	8.5	3.2	Pass	12.5	0.018	10.6	11.5
25	2437	12.3	17.0	3.2	Pass	15.5	0.035	13.6	22.9
21.5	2452	8.7	7.4	3.2	Pass	11.9	0.015	10.1	10.2

- Note 1: Output power measured using a spectrum analyzer (see plots below) with RBW=1MHz, VB=3 MHz, sample detector, power averaging on (transmitted signal was continuous) and power integration over **80 MHz** (option #2, method 1 in KDB 558074, equivalent to method 1 of DA-02-2138A1 for U-NII devices). Spurious limit becomes **-30dBc**.
- Note 2: Power setting - the software power setting used during testing, included for reference only.
- Note 3: Power measured using average power meter and is included for reference only.

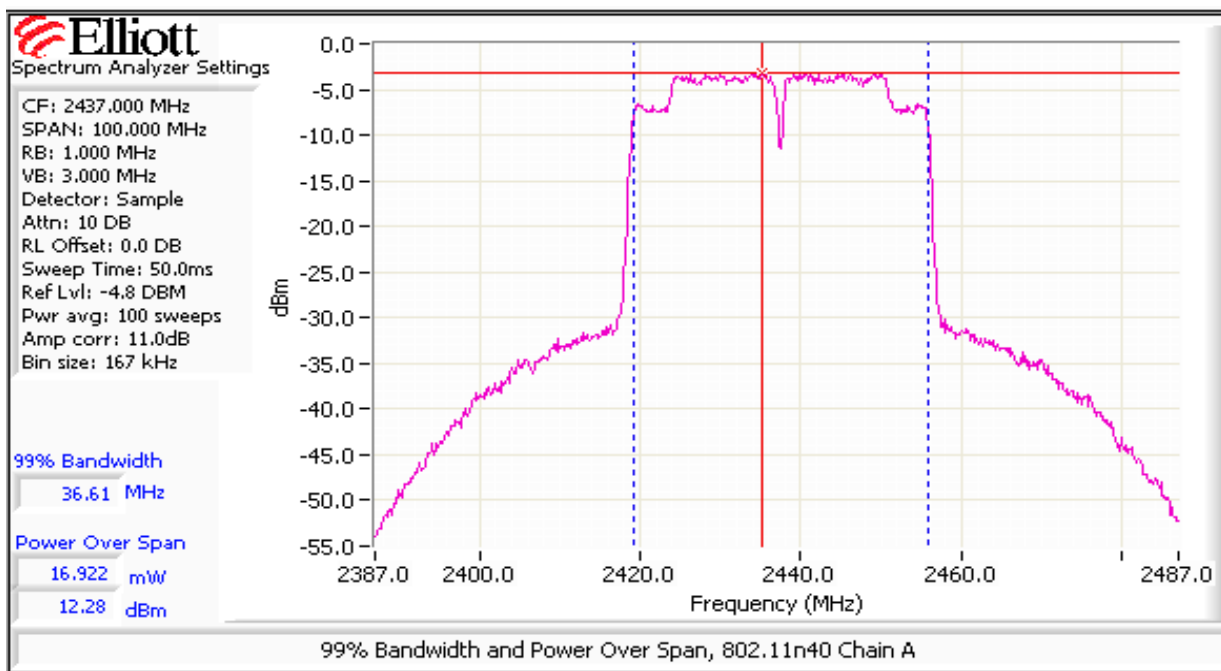

Client: Intel Corporation	Job Number: J80398
Model: Intel® Centrino® Advanced-N 6230	T-Log Number: T80759
	Account Manager: Christine Krebill
Contact: Steve Hackett	
Standard: FCC 15.247	Class: N/A

Run #2: Power spectral Density

Mode	Power Setting	Frequency (MHz)	PSD (dBm/3kHz) ^{Note 1}	Limit dBm/3kHz	Result
802.11b	23.5	2412	-8.2	8.0	Pass
	23.5	2437	-8.2	8.0	Pass
	23.5	2462	-7.4	8.0	Pass
802.11g	25.5	2412	-10.4	8.0	Pass
	29	2437	-8.2	8.0	Pass
	25.5	2462	-10.7	8.0	Pass
802.11n 20MHz	24.5	2412	-13.1	8.0	Pass
	29	2437	-8.9	8.0	Pass
	24	2462	-10.9	8.0	Pass
802.11n 40MHz	22	2422	-16.7	8.0	Pass
	25	2437	-13.4	8.0	Pass
	21.5	2452	-16.7	8.0	Pass

Note 1: Power spectral density measured using RB=3 kHz, VB=10kHz, analyzer with peak detector and with a sweep time set to ensure a dwell time of at least 1 second per 3kHz. The measurement is made at the frequency of PPSD determined from preliminary scans using RB=3kHz using multiple sweeps at a faster rate over the 6dB bandwidth of the signal.

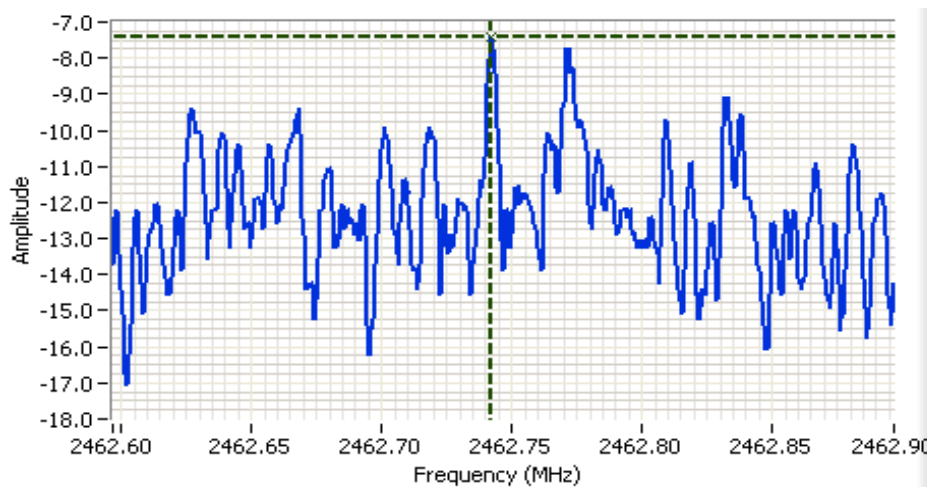

Analyzer Settings
 HP8564E,EMICF: 2462.747 MHz
 SPAN: 300 kHz
 RB: 3.00 kHz
 VB: 10.0 kHz
 Detector: Normal
 Attn: 10 DB
 RL Offset: 11.0 DB
 Sweep Time: 100.0s
 Ref Lvl: 4.1 DBM

Comments
 PSD @ 2462 MHz
 802.11b
 Chain A

Cursor 1	2462.7422	-7.40	
	0.0000	0.00	

Client:	Intel Corporation	Job Number:	J80398
Model:	Intel® Centrino® Advanced-N 6230	T-Log Number:	T80759
Contact:	Steve Hackett	Account Manager:	Christine Krebill
Standard:	FCC 15.247	Class:	N/A

Run #3: Signal Bandwidth

Mode	Power Setting	Frequency (MHz)	Resolution Bandwidth	Bandwidth (MHz)	
				6dB	99%
802.11b	23.5	2412	100kHz	10.2	13.6
	23.5	2437	100kHz	10.2	13.6
	23.5	2462	100kHz	10.2	13.6
802.11g	25.5	2412	100kHz	15.4	16.9
	29	2437	100kHz	15.2	17.1
	25.5	2462	100kHz	15.3	16.9
802.11n 20MHz	24.5	2412	100kHz	15.2	18.1
	29	2437	100kHz	15.3	18.3
	24	2462	100kHz	15.2	18.1
802.11n 40MHz	22	2422	100kHz	35.3	36.6
	25	2437	100kHz	35.3	36.6
	21.5	2452	100kHz	35.5	36.6

Note 1: 99% bandwidth measured in accordance with RSS GEN, with RB > 1% of the span and VB > 3xRB

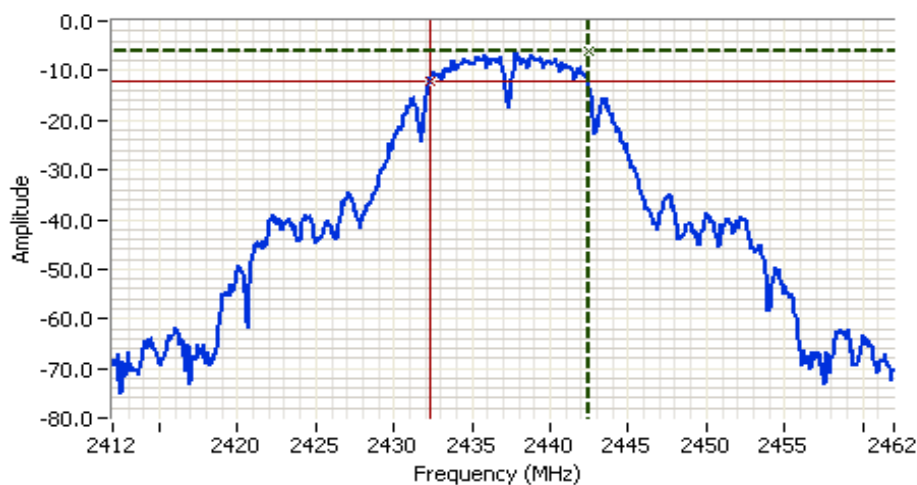

Analyzer Settings
 HP8564E,EMICF: 2437.000 MHz
 SPAN: 50.000 MHz
 RB: 100 kHz
 VB: 100 kHz
 Detector: Normal
 Attn: 10 DB
 RL Offset: 0.0 DB
 Sweep Time: 50.0ms
 Ref Lvl: -6.9 DBM

Comments

6dB BW: 10.167 MHz
 802.11b
 Chain A

Cursor 1	2442.4167	-6.23	
Cursor 2	2432.2500	-12.23	

Delta Freq. 10.167
 Delta Amplitude 6.00



Client:	Intel Corporation	Job Number:	J80398
Model:	Intel® Centrino® Advanced-N 6230	T-Log Number:	T80759
Contact:	Steve Hackett	Account Manager:	Christine Krebill
Standard:	FCC 15.247	Class:	N/A

Run #4: Out of Band Spurious Emissions
802.11b Mode

Frequency (MHz)	Limit	Result
2412	-30dBc	Pass
2437	-30dBc	Pass
2462	-30dBc	Pass

Plots for low channel, power setting(s) = 23.5

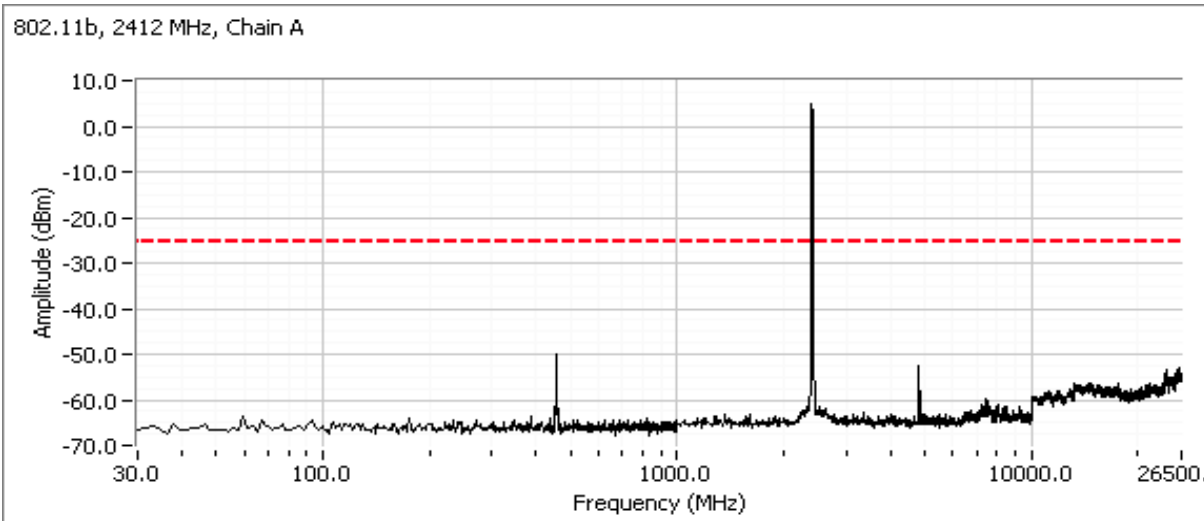

Additional plot showing compliance with **-30dBc** limit from 2390 MHz to 2400 MHz. Radiated measurements used to show compliance with the limits in the restricted band below 2390 MHz.

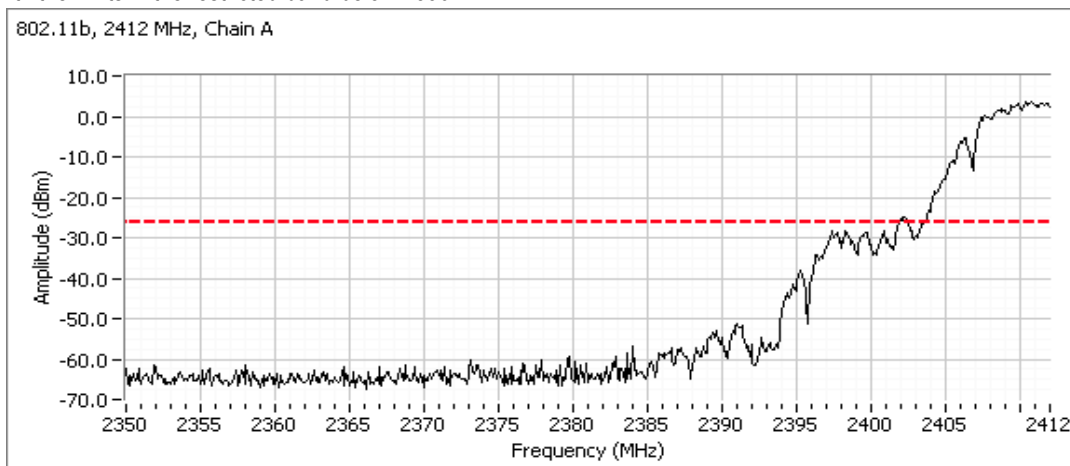

Client:	Intel Corporation	Job Number:	J80398
Model:	Intel® Centrino® Advanced-N 6230	T-Log Number:	T80759
Contact:	Steve Hackett	Account Manager:	Christine Krebill
Standard:	FCC 15.247	Class:	N/A

Plots for center channel, power setting(s) = 23.5

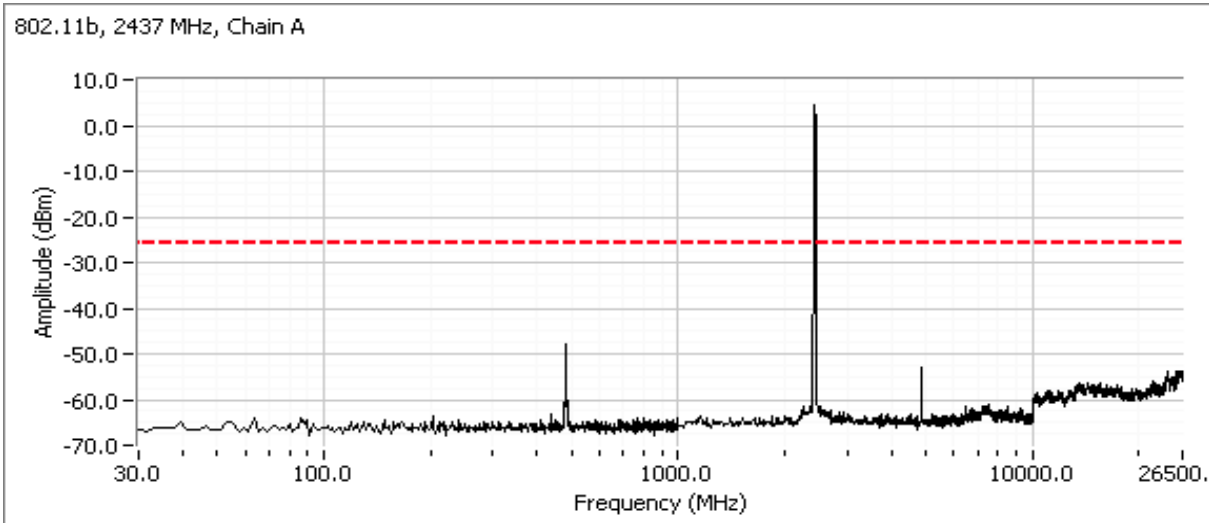

Plots for high channel, power setting(s) = 23.5

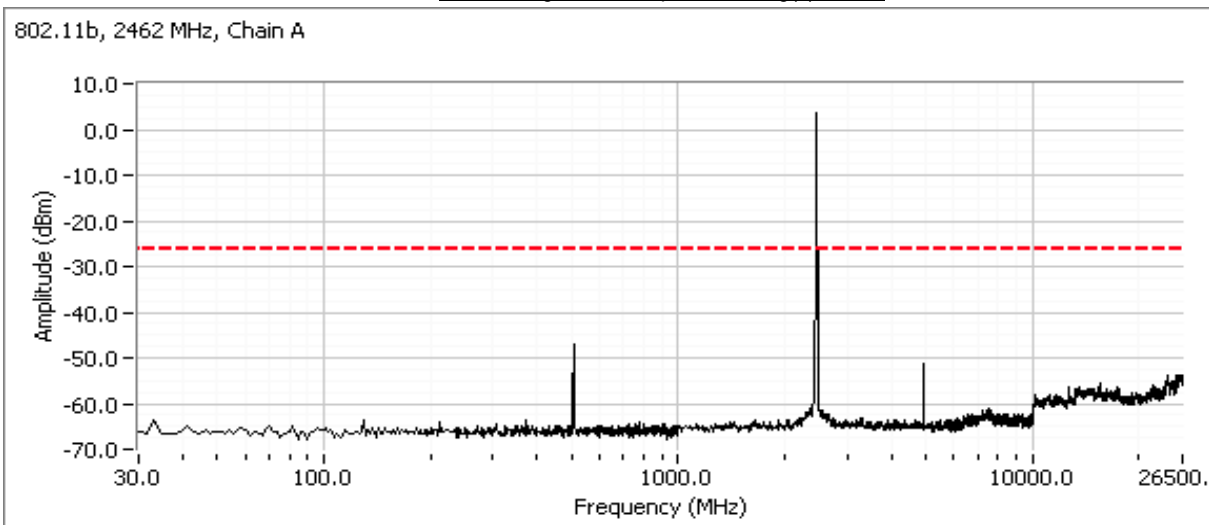

Client:	Intel Corporation	Job Number:	J80398
Model:	Intel® Centrino® Advanced-N 6230	T-Log Number:	T80759
Contact:	Steve Hackett	Account Manager:	Christine Krebill
Standard:	FCC 15.247	Class:	N/A

802.11g Mode

Frequency (MHz)	Limit	Result
2412	-30dBc	Pass
2437	-30dBc	Pass
2462	-30dBc	Pass

Plots for low channel, power setting(s) = 25.5

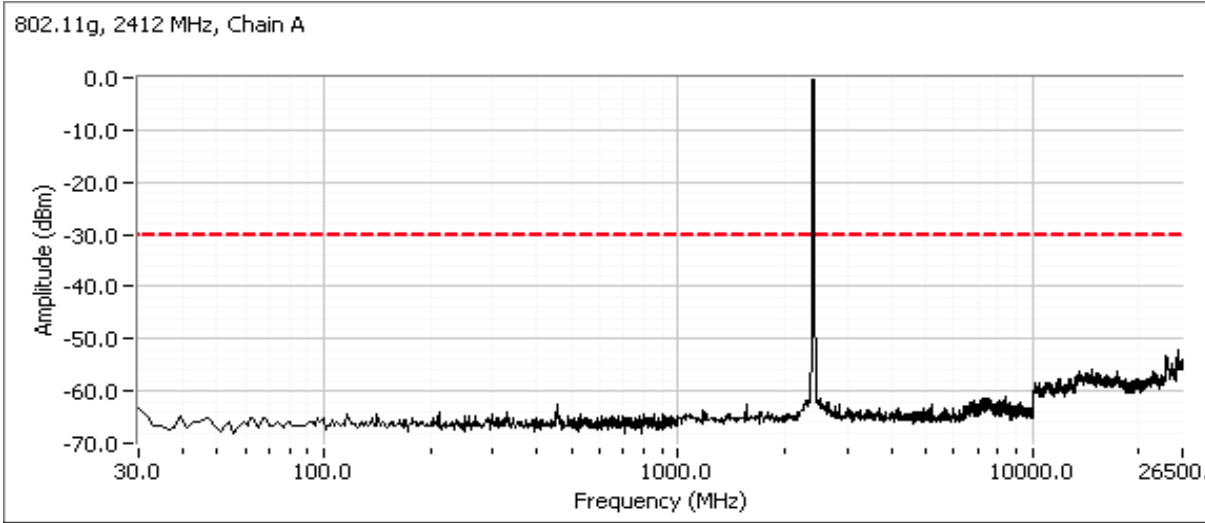

Additional plot showing compliance with **-30dBc** limit from 2390 MHz to 2400 MHz. Radiated measurements used to show compliance with the limits in the restricted band below 2390 MHz.

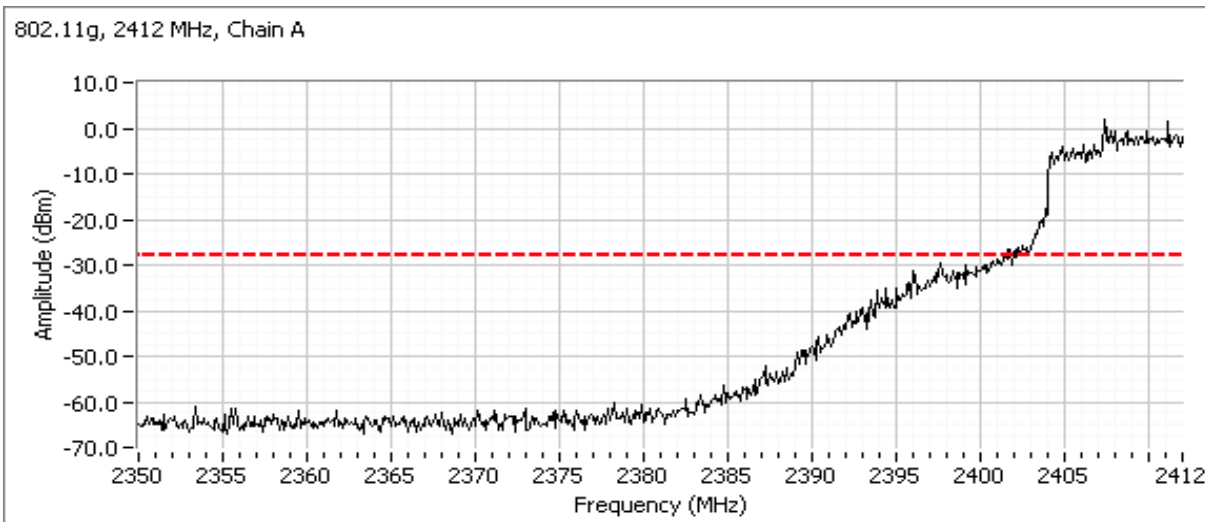

Client:	Intel Corporation	Job Number:	J80398
Model:	Intel® Centrino® Advanced-N 6230	T-Log Number:	T80759
Contact:	Steve Hackett	Account Manager:	Christine Krebill
Standard:	FCC 15.247	Class:	N/A

Plots for center channel, power setting(s) = 29

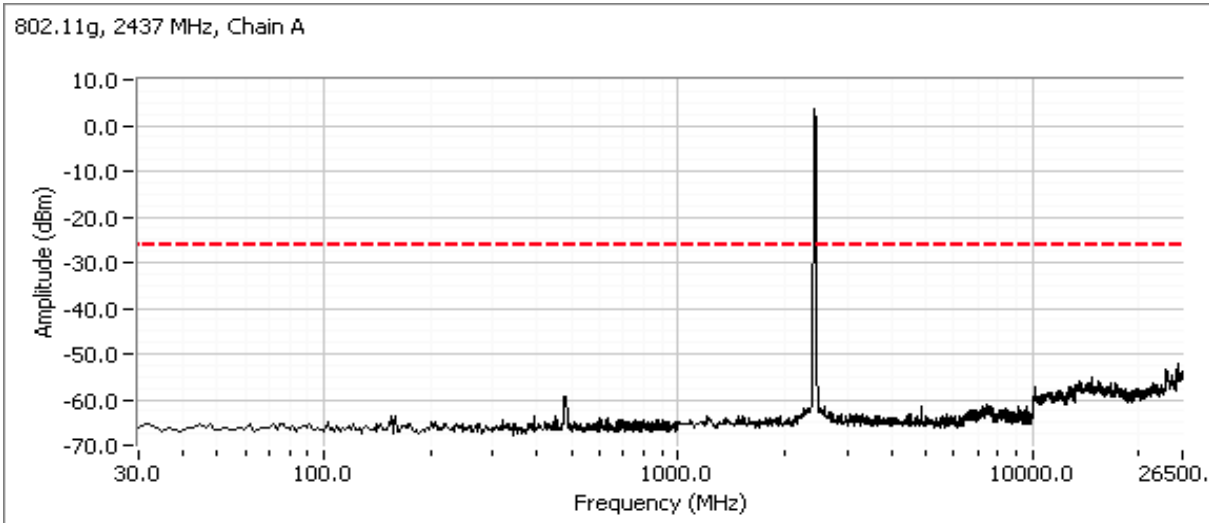

Plots for high channel, power setting(s) = 25.5

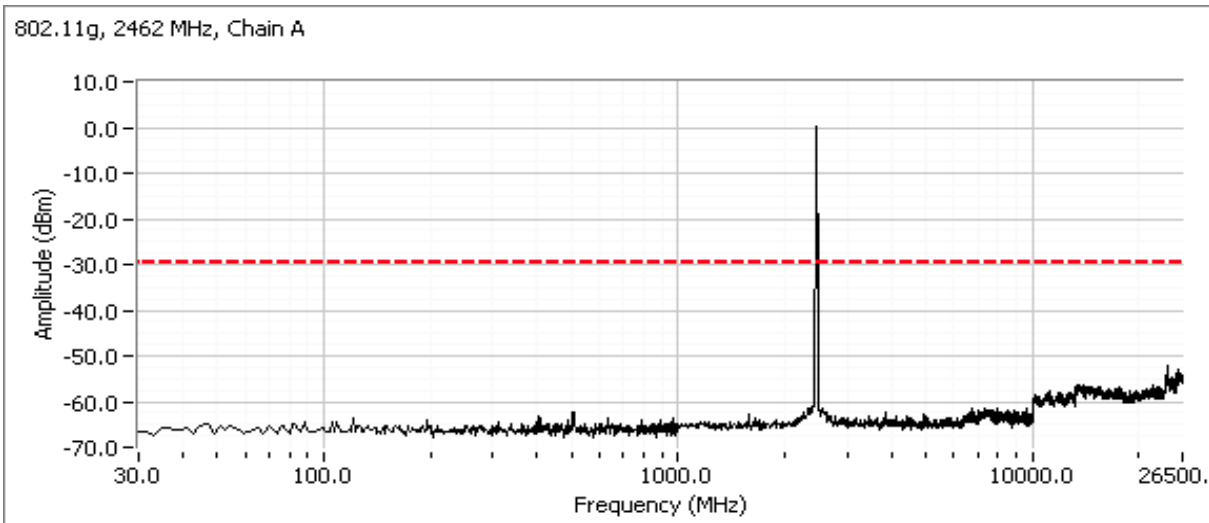

Client:	Intel Corporation	Job Number:	J80398
Model:	Intel® Centrino® Advanced-N 6230	T-Log Number:	T80759
Contact:	Steve Hackett	Account Manager:	Christine Krebill
Standard:	FCC 15.247	Class:	N/A

802.11n 20MHz Mode

Frequency (MHz)	Limit	Result
2412	-30dBc	Pass
2437	-30dBc	Pass
2462	-30dBc	Pass

Plots for low channel, power setting(s) = 24.5

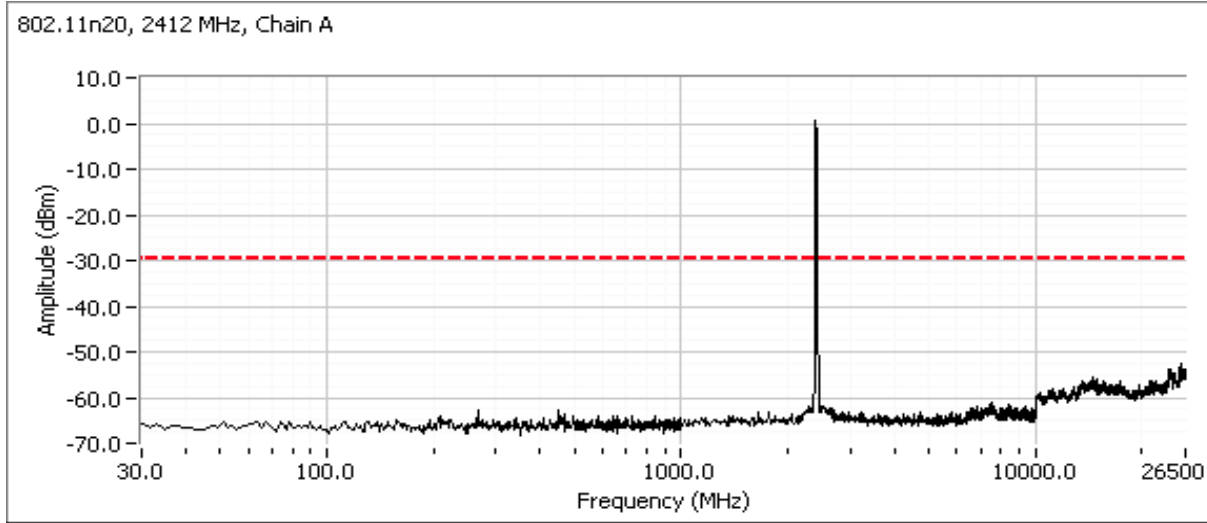

Additional plot showing compliance with **-30dBc** limit from 2390 MHz to 2400 MHz. Radiated measurements used to show compliance with the limits in the restricted band below 2390 MHz.

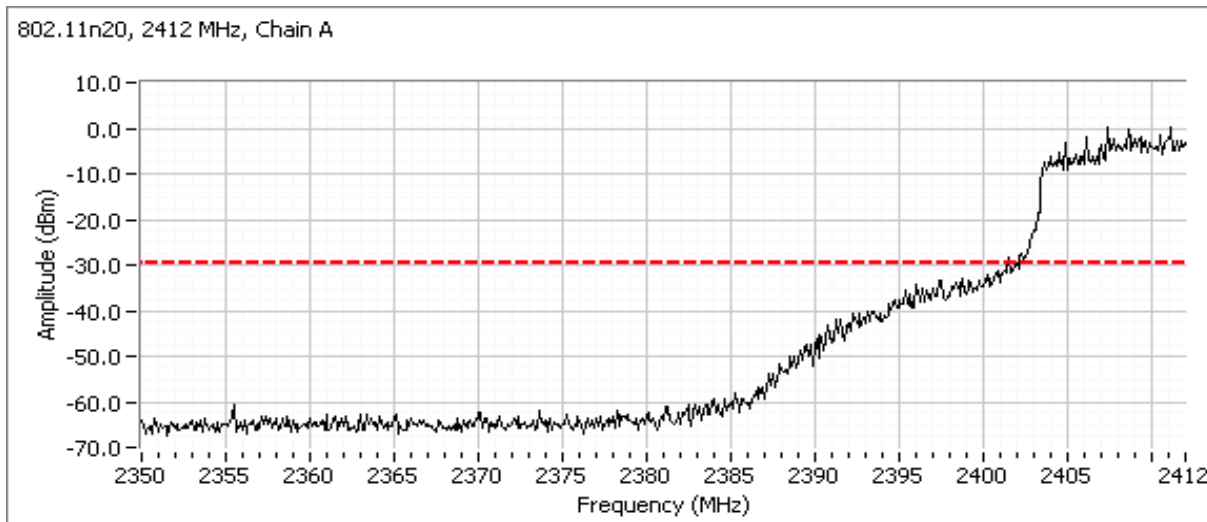

Client:	Intel Corporation	Job Number:	J80398
Model:	Intel® Centrino® Advanced-N 6230	T-Log Number:	T80759
Contact:	Steve Hackett	Account Manager:	Christine Krebill
Standard:	FCC 15.247	Class:	N/A

Plots for center channel, power setting(s) = 29

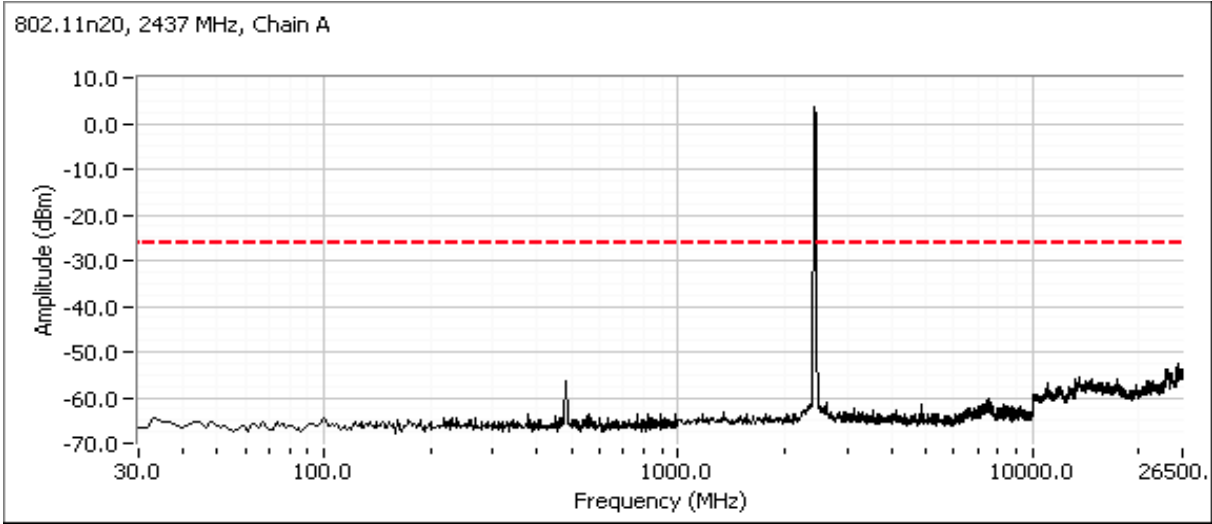

Plots for high channel, power setting(s) = 24

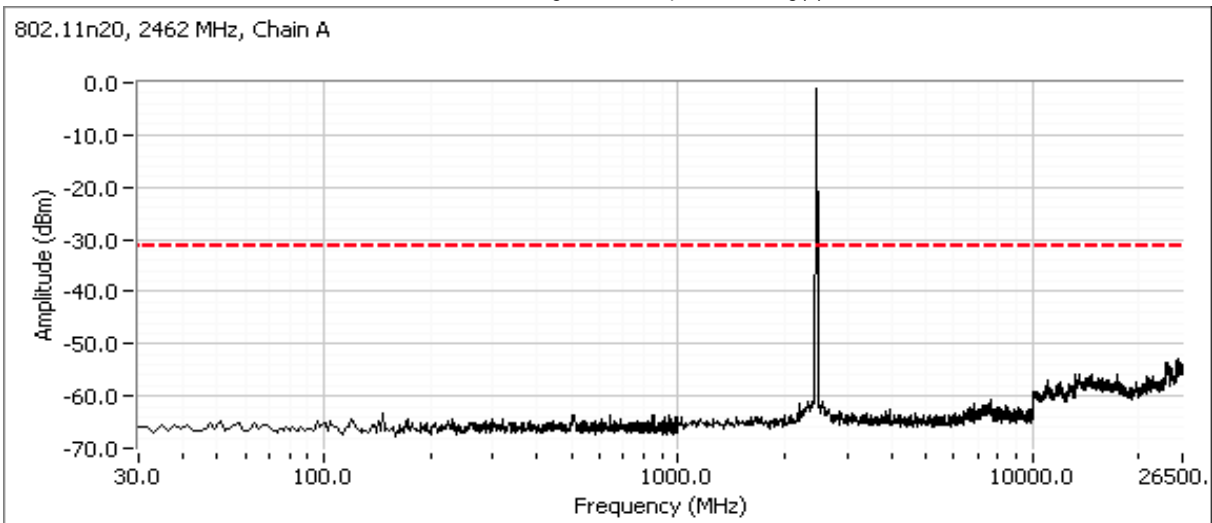

Client:	Intel Corporation	Job Number:	J80398
Model:	Intel® Centrino® Advanced-N 6230	T-Log Number:	T80759
Contact:	Steve Hackett	Account Manager:	Christine Krebill
Standard:	FCC 15.247	Class:	N/A

802.11n 40MHz Mode

Frequency (MHz)	Limit	Result
2422	-30dBc	Pass
2437	-30dBc	Pass
2452	-30dBc	Pass

Plots for low channel, power setting(s) = 22

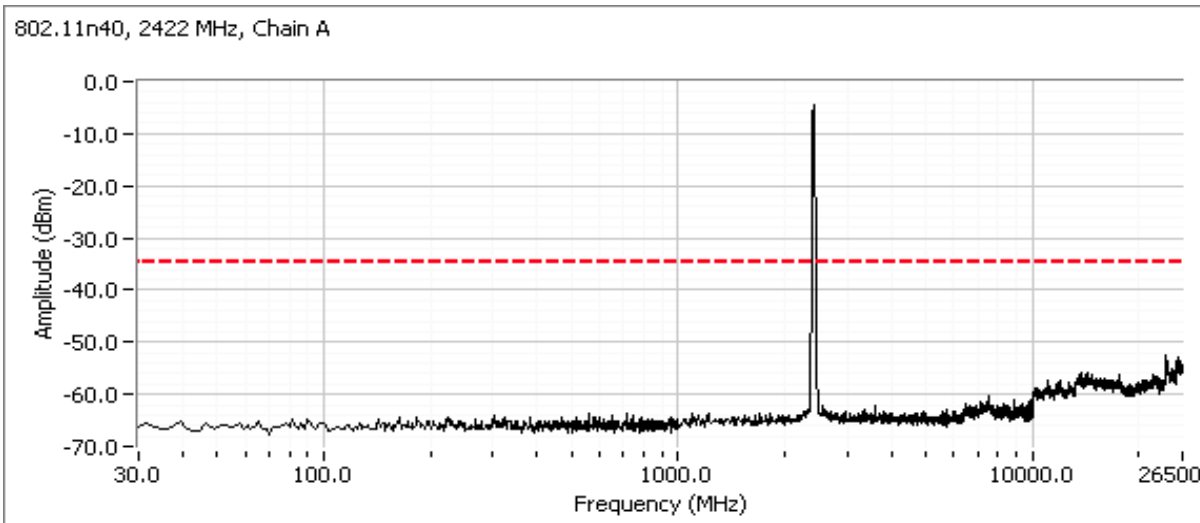

Additional plot showing compliance with **-30dBc** limit from 2390 MHz to 2400 MHz. Radiated measurements used to show compliance with the limits in the restricted band below 2390 MHz.

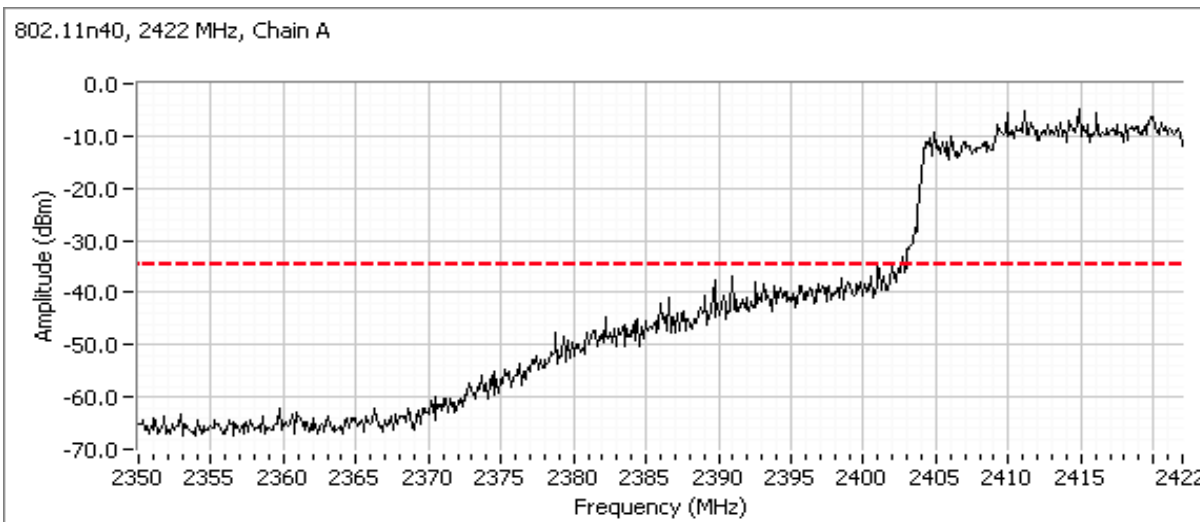

Client: Intel Corporation	Job Number: J80398
Model: Intel® Centrino® Advanced-N 6230	T-Log Number: T80759
	Account Manager: Christine Krebill
Contact: Steve Hackett	
Standard: FCC 15.247	Class: N/A

Plots for center channel, power setting(s) = 25

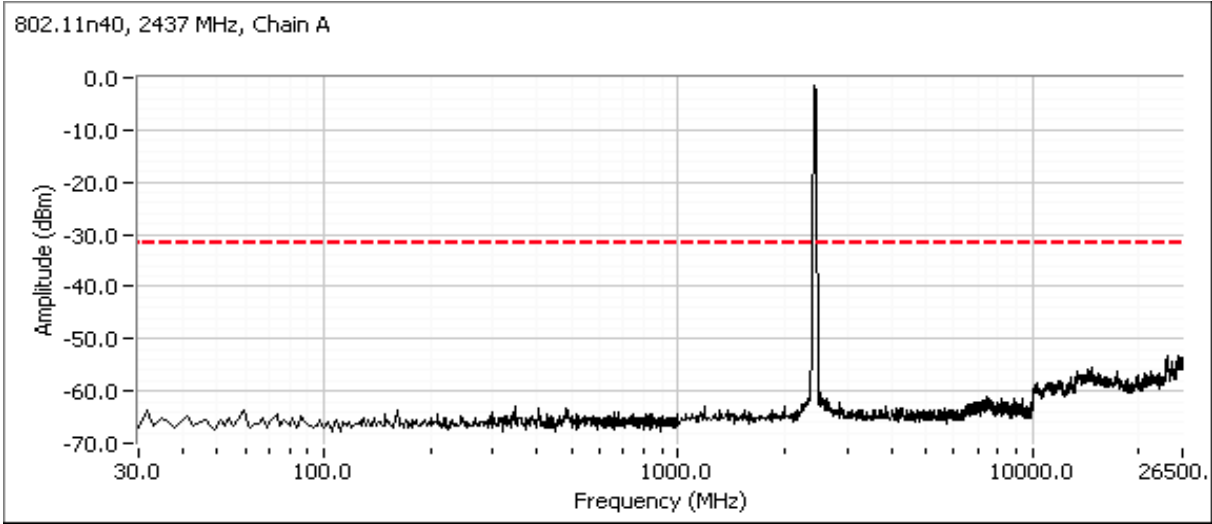

Plots for high channel, power setting(s) = 21.5

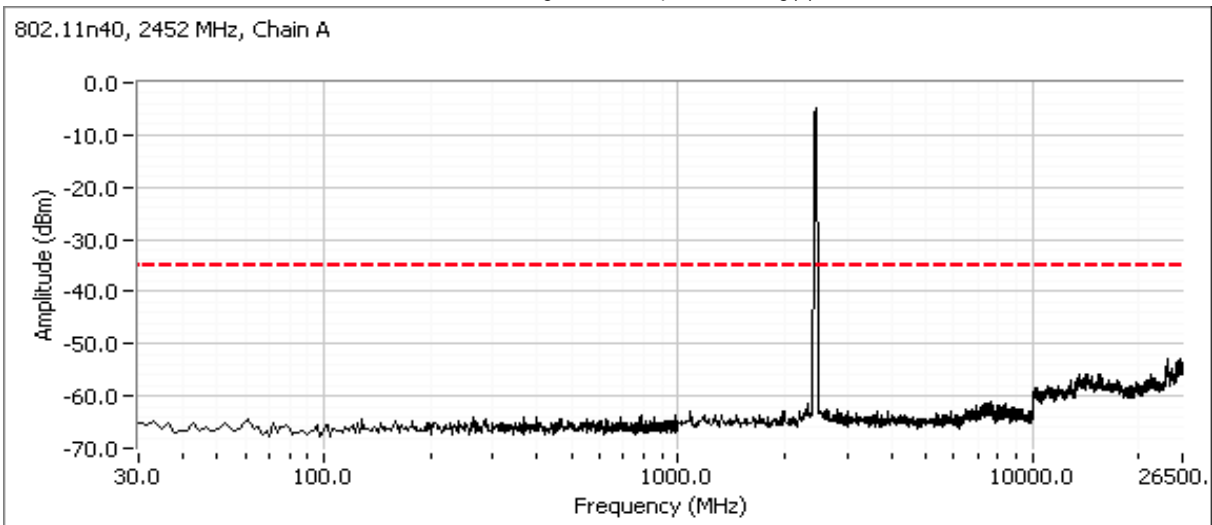

Client:	Intel Corporation	Job Number:	J80398
Model:	Intel® Centrino® Advanced-N 6230	T-Log Number:	T80759
Contact:	Steve Hackett	Account Manager:	Christine Krebill
Standard:	FCC 15.247	Class:	N/A

RSS 210 and FCC 15.247 (DTS) Antenna Port Measurements Power, PSD, Bandwidth and Spurious Emissions

Test Specific Details

Objective: The objective of this test session is to perform final qualification testing of the EUT with respect to the specification listed above.

Date of Test: 10/1/2010
 Test Engineer: Rafael Varelas
 Test Location: FT Chamber #7

Config. Used: 1
 Config Change: none
 Host Unit Voltage 120V/60Hz

General Test Configuration

The EUT was connected to the spectrum analyzer or power meter via a suitable attenuator. All measurements were made on a single chain.

All measurements have been corrected to allow for the external attenuators used.

Ambient Conditions:

Temperature: 20-25 °C
 Rel. Humidity: 40-50 %

Summary of Results

MAC Address: **00150079AD1A** DRTU Tool Version **1.2.12-0197** Driver version **14.0.0.39**

Run #	Pwr setting	Avg Pwr	Test Performed	Limit	Pass / Fail	Result / Margin
1			Output Power	15.247(b)	Pass	802.11b: 38 mW 802.11g: 34 mW n20: 33.1 mW n40: 14.1 mW
2			Power spectral Density (PSD)	15.247(d)	Pass	-6.9 dBm/3kHz
3			Minimum 6dB Bandwidth	15.247(a)	Pass	10.0 MHz
3			99% Bandwidth	RSS GEN	-	802.11b: 13.7 MHz 802.11g: 17.2 MHz n20: 18.5 MHz n40: 36.6 MHz
4			Spurious emissions	15.247(b)	Pass	All emissions below the limit

Modifications Made During Testing

No modifications were made to the EUT during testing

Deviations From The Standard

No deviations were made from the requirements of the standard.

Client:	Intel Corporation	Job Number:	J80398
Model:	Intel® Centrino® Advanced-N 6230	T-Log Number:	T80759
Contact:	Steve Hackett	Account Manager:	Christine Krebill
Standard:	FCC 15.247	Class:	N/A

Run #1: Output Power
802.11b Mode

Power Setting ²	Frequency (MHz)	Output Power		Antenna Gain (dBi)	Result	EIRP ^{Note 2}		Output Power	
		(dBm) ¹	mW			dBm	W	(dBm) ³	mW
25	2412	15.8	38.0	3.2	Pass	19.0	0.079	16.6	45.7
23	2437	14.2	26.3	3.2	Pass	17.4	0.055	15.0	31.6
24	2462	15.3	33.9	3.2	Pass	18.5	0.071	16.0	39.8

- Note 1: Output power measured using a spectrum analyzer (see plots below) with RBW=1MHz, VB=3 MHz, sample detector, power averaging on (transmitted signal was continuous) and power integration over **50 MHz** (option #2, method 1 in KDB 558074, equivalent to method 1 of DA-02-2138A1 for U-NII devices). Spurious limit becomes **-30dBc**.
- Note 2: Power setting - the software power setting used during testing, included for reference only.
- Note 3: Power measured using average power meter and is included for reference only.

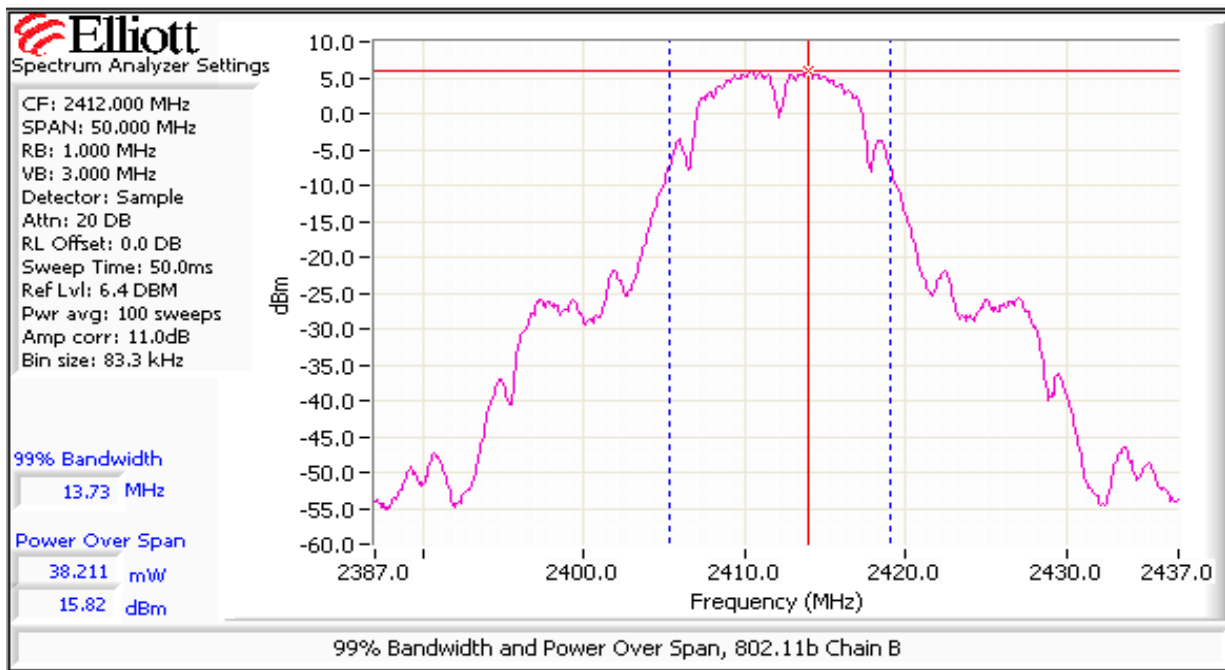

Client:	Intel Corporation	Job Number:	J80398
Model:	Intel® Centrino® Advanced-N 6230	T-Log Number:	T80759
Contact:	Steve Hackett	Account Manager:	Christine Krebill
Standard:	FCC 15.247	Class:	N/A

802.11g Mode

Power Setting ²	Frequency (MHz)	Output Power		Antenna Gain (dBi)	Result	EIRP ^{Note 2}		Output Power	
		(dBm) ¹	mW			dBm	W	(dBm) ³	mW
27	2412	12.1	16.2	3.2	Pass	15.3	0.034	13.9	24.5
30.5	2437	15.3	33.9	3.2	Pass	18.5	0.071	16.7	46.8
26.5	2462	12.0	15.8	3.2	Pass	15.2	0.033	13.5	22.4

- Note 1: Output power measured using a spectrum analyzer (see plots below) with RBW=1MHz, VB=3 MHz, sample detector, power averaging on (transmitted signal was continuous) and power integration over **50 MHz** (option #2, method 1 in KDB 558074, equivalent to method 1 of DA-02-2138A1 for U-NII devices). Spurious limit becomes **-30dBc**.
- Note 2: Power setting - the software power setting used during testing, included for reference only.
- Note 3: Power measured using average power meter and is included for reference only.

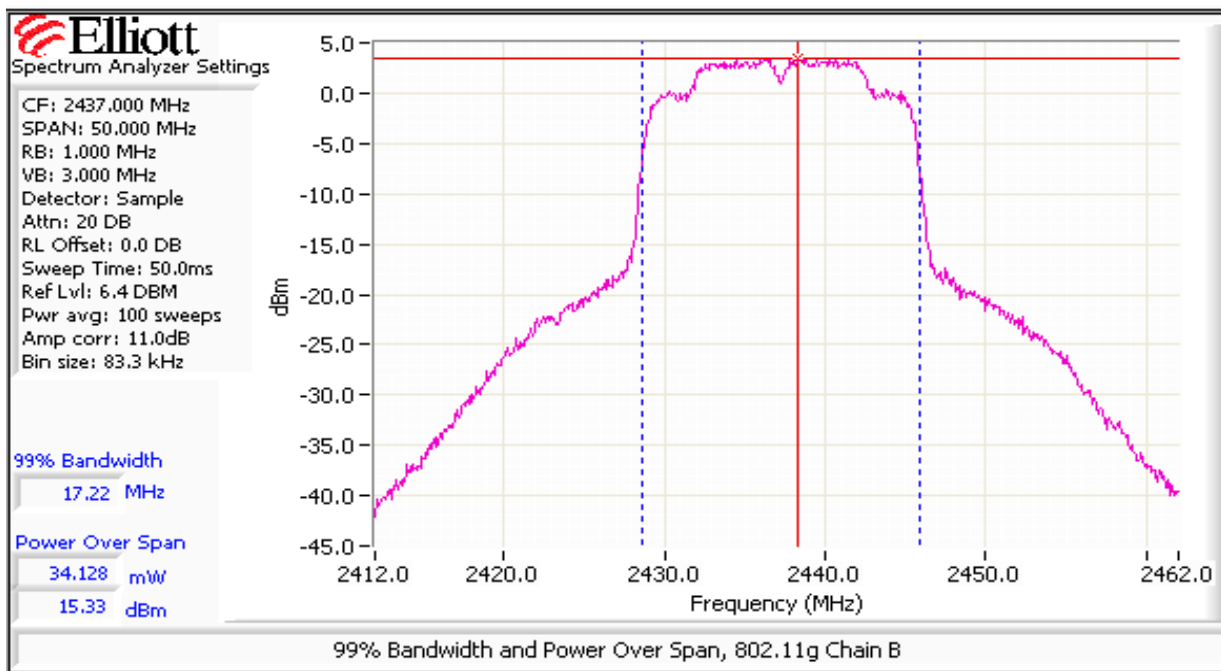

Client:	Intel Corporation	Job Number:	J80398
Model:	Intel® Centrino® Advanced-N 6230	T-Log Number:	T80759
Contact:	Steve Hackett	Account Manager:	Christine Krebill
Standard:	FCC 15.247	Class:	N/A

802.11n 20MHz Mode

Power Setting ²	Frequency (MHz)	Output Power		Antenna Gain (dBi)	Result	EIRP ^{Note 2}		Output Power	
		(dBm) ¹	mW			dBm	W	(dBm) ³	mW
25.5	2412	10.7	11.7	3.2	Pass	13.9	0.025	12.5	17.8
30.5	2437	15.2	33.1	3.2	Pass	18.4	0.069	16.6	45.7
25.5	2462	10.8	12.0	3.2	Pass	14.0	0.025	12.4	17.4

- Note 1: Output power measured using a spectrum analyzer (see plots below) with RBW=1MHz, VB=3 MHz, sample detector, power averaging on (transmitted signal was continuous) and power integration over **50 MHz** (option #2, method 1 in KDB 558074, equivalent to method 1 of DA-02-2138A1 for U-NII devices). Spurious limit becomes **-30dBc**.
- Note 2: Power setting - the software power setting used during testing, included for reference only.
- Note 3: Power measured using average power meter and is included for reference only.

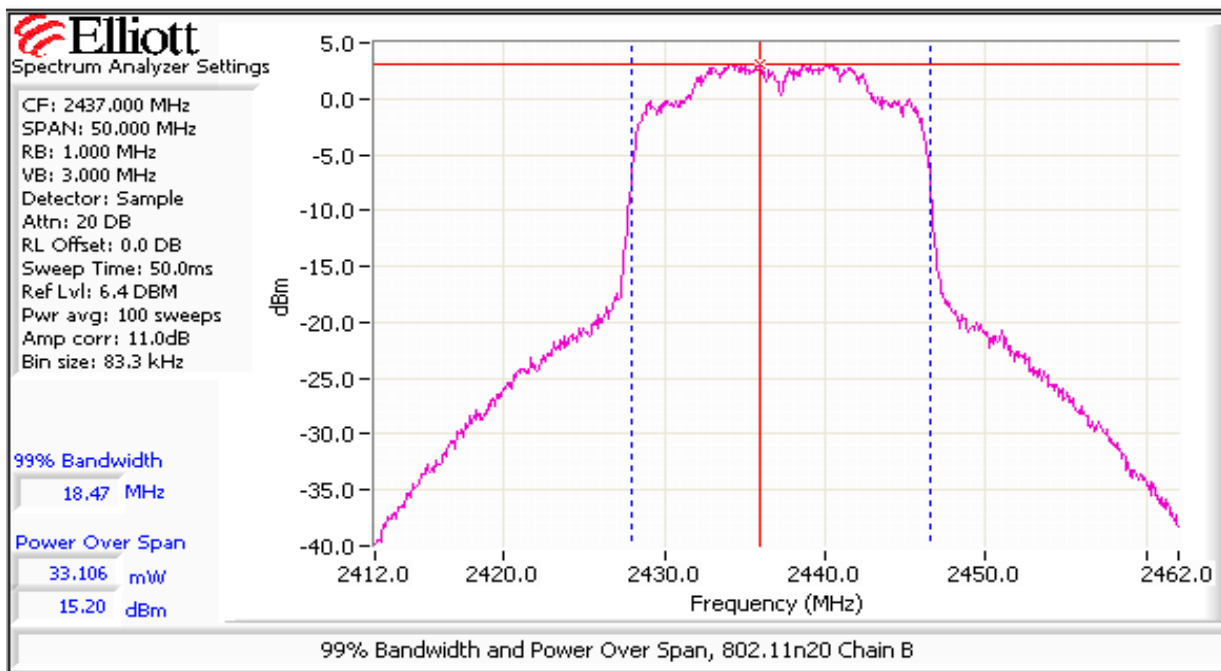

Client:	Intel Corporation	Job Number:	J80398
Model:	Intel® Centrino® Advanced-N 6230	T-Log Number:	T80759
Contact:	Steve Hackett	Account Manager:	Christine Krebill
Standard:	FCC 15.247	Class:	N/A

802.11n 40MHz Mode

Power Setting ²	Frequency (MHz)	Output Power		Antenna Gain (dBi)	Result	EIRP ^{Note 2}		Output Power	
		(dBm) ¹	mW			dBm	W	(dBm) ³	mW
22.0	2422	8.0	6.3	3.2	Pass	11.2	0.013	9.2	8.3
25.5	2437	11.5	14.1	3.2	Pass	14.7	0.030	12.7	18.6
23.0	2452	8.8	7.6	3.2	Pass	12.0	0.016	10.1	10.2

- Note 1: Output power measured using a spectrum analyzer (see plots below) with RBW=1MHz, VB=3 MHz, sample detector, power averaging on (transmitted signal was continuous) and power integration over **80 MHz** (option #2, method 1 in KDB 558074, equivalent to method 1 of DA-02-2138A1 for U-NII devices). Spurious limit becomes **-30dBc**.
- Note 2: Power setting - the software power setting used during testing, included for reference only.
- Note 3: Power measured using average power meter and is included for reference only.

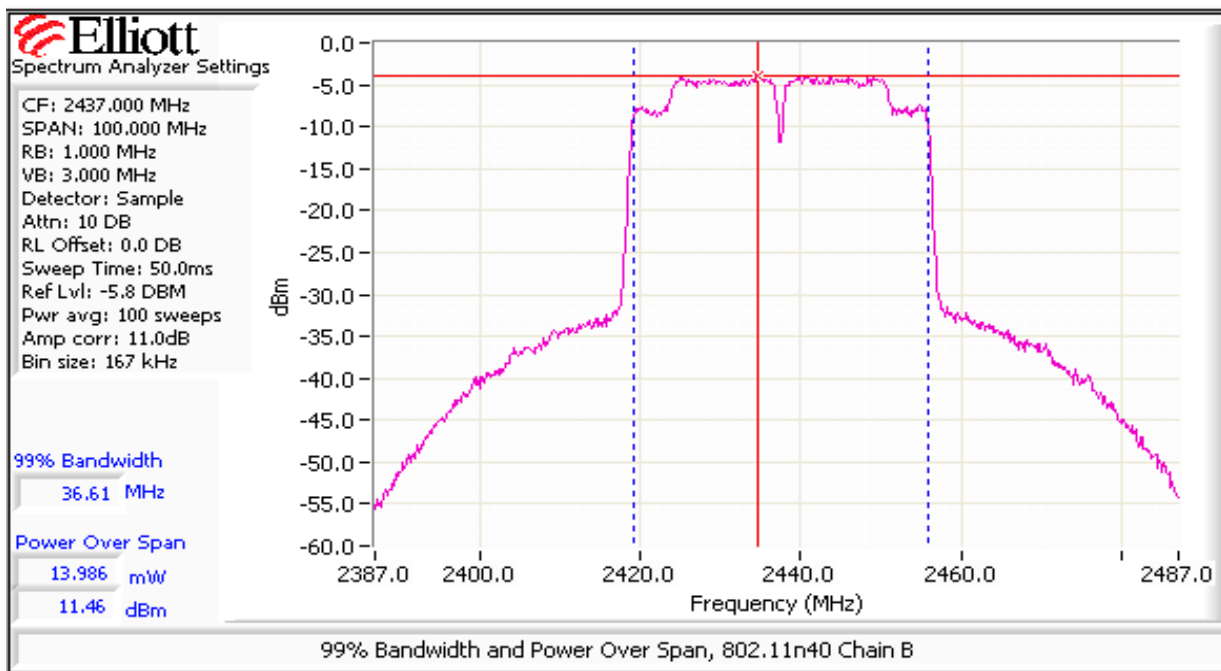

Client:	Intel Corporation	Job Number:	J80398
Model:	Intel® Centrino® Advanced-N 6230	T-Log Number:	T80759
Contact:	Steve Hackett	Account Manager:	Christine Krebill
Standard:	FCC 15.247	Class:	N/A

Run #2: Power spectral Density

Mode	Power Setting	Frequency (MHz)	PSD (dBm/3kHz) ^{Note 1}	Limit dBm/3kHz	Result
802.11b	25.0	2412	-8.4	8.0	Pass
	23.0	2437	-9.8	8.0	Pass
	24.0	2462	-8.7	8.0	Pass
802.11g	27.0	2412	-9.1	8.0	Pass
	30.5	2437	-7.8	8.0	Pass
	26.5	2462	-12.4	8.0	Pass
802.11n 20MHz	25.5	2412	-11.5	8.0	Pass
	30.5	2437	-6.9	8.0	Pass
	25.5	2462	-11.9	8.0	Pass
802.11n 40MHz	22.0	2422	-17.0	8.0	Pass
	25.5	2437	-13.3	8.0	Pass
	21.0	2452	-17.3	8.0	Pass

Note 1: Power spectral density measured using RB=3 kHz, VB=10kHz, analyzer with peak detector and with a sweep time set to ensure a dwell time of at least 1 second per 3kHz. The measurement is made at the frequency of PPSD determined from preliminary scans using RB=3kHz using multiple sweeps at a faster rate over the 6dB bandwidth of the signal.

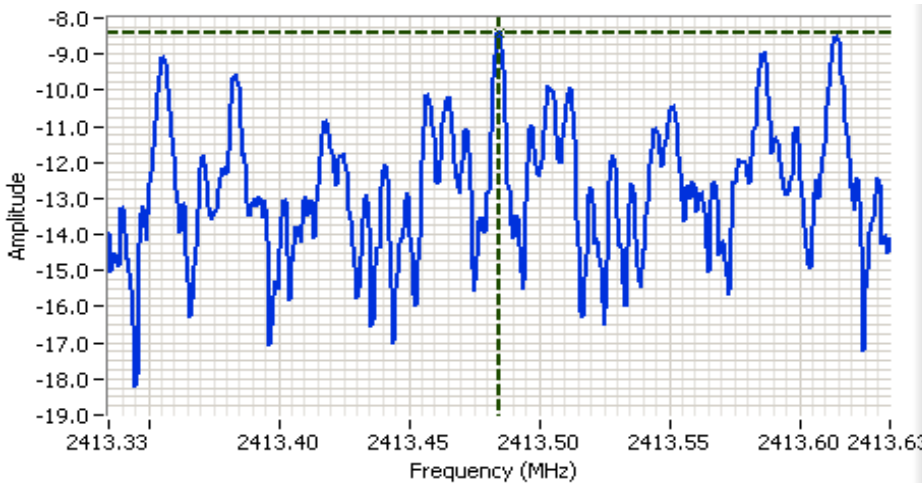

Analyzer Settings
 Agilent Technologies, E4446A
 CF: 2413.485 MHz
 SPAN: 300 kHz
 RB: 3.00 kHz
 VB: 10.0 kHz
 Detector: POS
 Attn: 20 DB
 RL Offset: 11.0 DB
 Sweep Time: 100.0s
 Ref Lvl: 21.0 DBM

Comments
 802.11b Chain B CH1

Cursor 1	2413.4846	-8.40	+	*	🔒
	0.0000	0.00	+	*	🔒

Client: Intel Corporation	Job Number: J80398
Model: Intel® Centrino® Advanced-N 6230	T-Log Number: T80759
Contact: Steve Hackett	Account Manager: Christine Krebill
Standard: FCC 15.247	Class: N/A

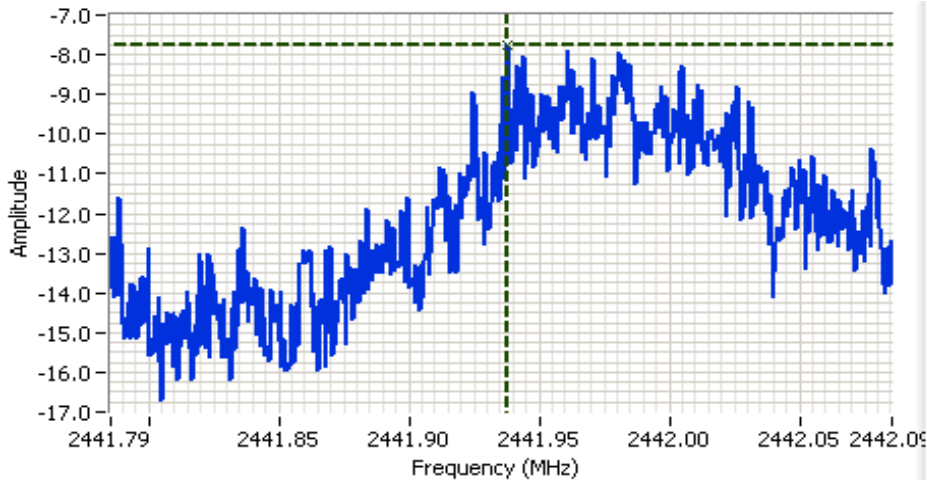

Analyzer Settings
 Agilent Technologies, E4446A
 CF: 2441.935 MHz
 SPAN: 300 kHz
 RB: 3.00 kHz
 VB: 10.0 kHz
 Detector: POS
 Attn: 20 DB
 RL Offset: 11.0 DB
 Sweep Time: 100.0s
 Ref Lvl: 21.0 DBM

Comments
 802.11g Chain B

Cursor 1 2441.9380 -7.77
 0.0000 0.00

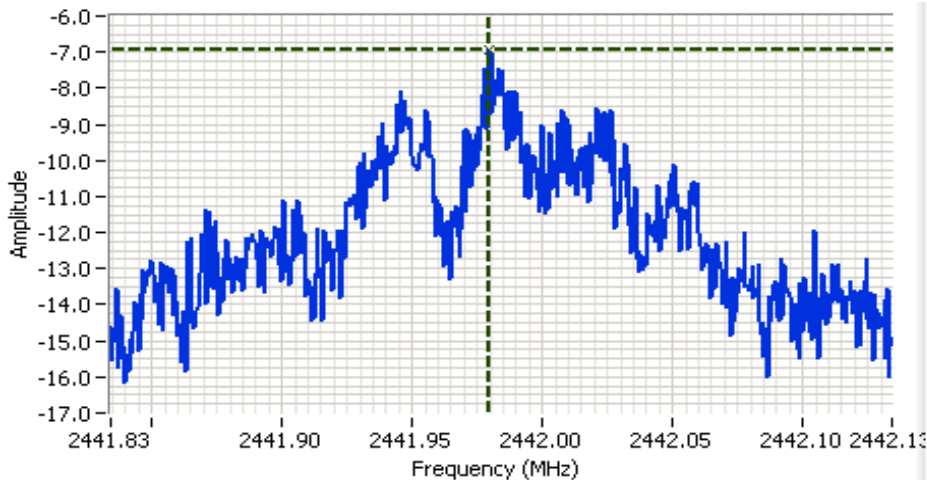

Analyzer Settings
 Agilent Technologies, E4446A
 CF: 2441.984 MHz
 SPAN: 300 kHz
 RB: 3.00 kHz
 VB: 10.0 kHz
 Detector: POS
 Attn: 20 DB
 RL Offset: 11.0 DB
 Sweep Time: 100.0s
 Ref Lvl: 21.0 DBM

Comments
 802.11n20 Chain B

Cursor 1 2441.9797 -6.92
 0.0000 0.00



Client:	Intel Corporation	Job Number:	J80398
Model:	Intel® Centrino® Advanced-N 6230	T-Log Number:	T80759
Contact:	Steve Hackett	Account Manager:	Christine Krebill
Standard:	FCC 15.247	Class:	N/A

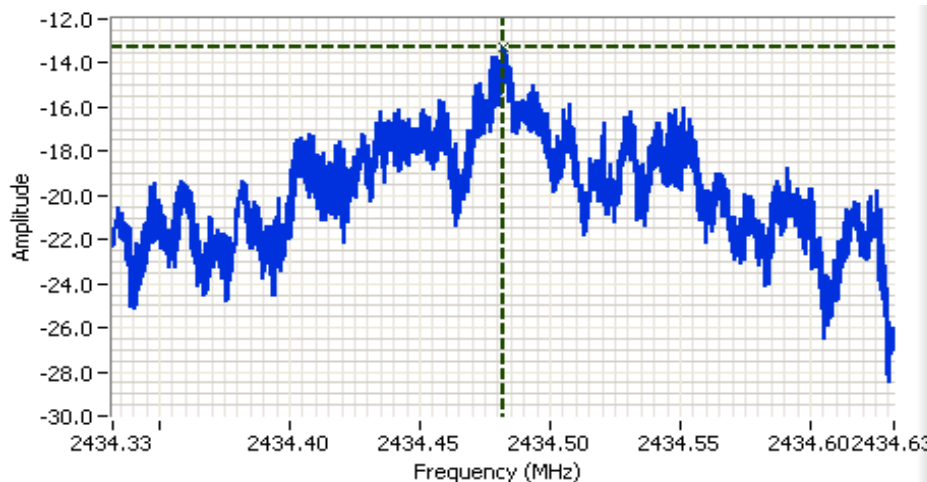

Analyzer Settings

Agilent Technologies, E4446A
 CF: 2434.482 MHz
 SPAN: 300 kHz
 RB: 3.00 kHz
 VB: 10.0 kHz
 Detector: POS
 Attn: 10 DB
 RL Offset: 11.0 DB
 Sweep Time: 100.0s
 Ref Lvl: -9.0 DBM

Comments

802.11n 40MHz
 CH 6
 PSD: -13.3 dBm/3kHz

Cursor 1 2434.4824 -13.29 [Move] [Star] [Lock]

 0.0000 0.00 [Move] [Lock]



Client: Intel Corporation	Job Number: J80398
Model: Intel® Centrino® Advanced-N 6230	T-Log Number: T80759
	Account Manager: Christine Krebill
Contact: Steve Hackett	
Standard: FCC 15.247	Class: N/A

Run #3: Signal Bandwidth

Mode	Power Setting	Frequency (MHz)	Resolution Bandwidth	Bandwidth (MHz)	
				6dB	99%
802.11b	25.0	2412	100kHz	10.0	13.7
	23.0	2437	100kHz	10.0	13.3
	24.0	2462	100kHz	10.0	13.6
802.11g	27.0	2412	100kHz	15.0	16.9
	30.5	2437	100kHz	15.0	17.2
	26.5	2462	100kHz	13.8	16.9
802.11n 20MHz	25.5	2412	100kHz	15.0	18.1
	30.5	2437	100kHz	15.0	18.5
	25.5	2462	100kHz	15.0	18.1
802.11n 40MHz	22.0	2422	100kHz	35.0	36.6
	25.5	2437	100kHz	35.0	36.6
	21.0	2452	100kHz	35.0	36.6

Note 1: 99% bandwidth measured in accordance with RSS GEN, with RB > 1% of the span and VB > 3xRB

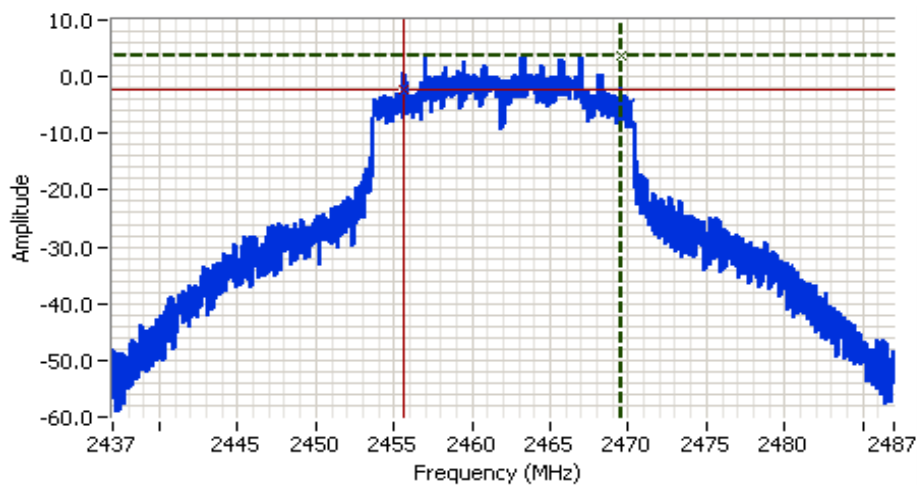

Analyzer Settings
 Agilent Technologies, E4446A
 CF: 2462.000 MHz
 SPAN: 50.000 MHz
 RB: 100 kHz
 VB: 100 kHz
 Detector: Normal
 Attn: 10 DB
 RL Offset: 11.0 DB
 Sweep Time: 6.0ms
 Ref Lvl: 11.0 DBM

Comments
 6dB BW: 13.833 MHz

Cursor 1	2469.5000	3.77	+	+	+	Delta Freq.	13.833
Cursor 2	2455.6667	-2.23	+	-	+	Delta Amplitude	6.00



Client:	Intel Corporation	Job Number:	J80398
Model:	Intel® Centrino® Advanced-N 6230	T-Log Number:	T80759
Contact:	Steve Hackett	Account Manager:	Christine Krebill
Standard:	FCC 15.247	Class:	N/A

Run #4: Out of Band Spurious Emissions
802.11b Mode

Frequency (MHz)	Limit	Result
2412	-30dBc	Pass
2437	-30dBc	Pass
2462	-30dBc	Pass

Plots for low channel, power setting(s) = 25

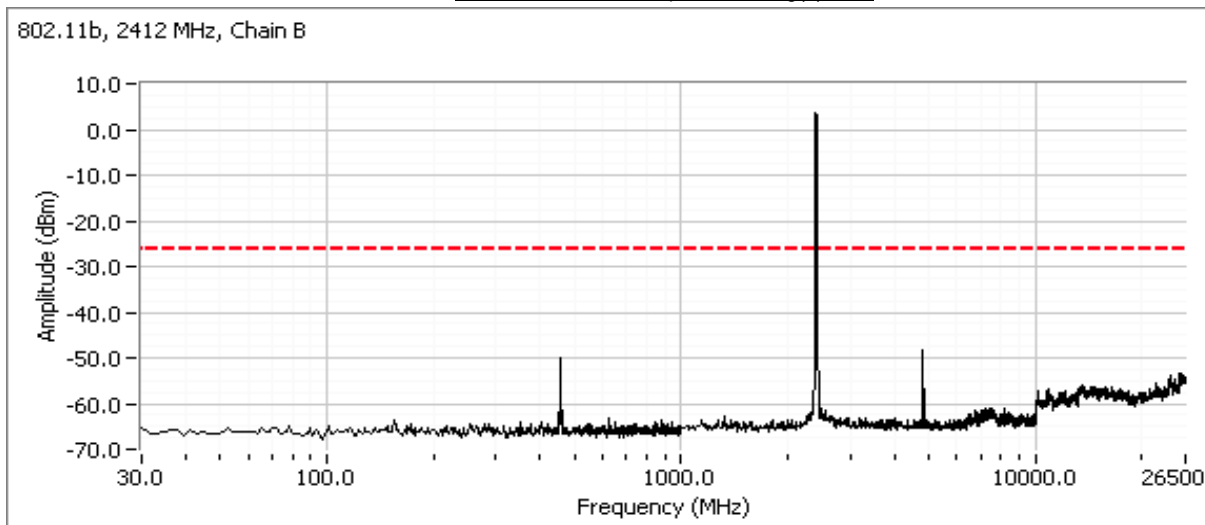

Additional plot showing compliance with **-30dBc** limit from 2390 MHz to 2400 MHz. Radiated measurements used to show compliance with the limits in the restricted band below 2390 MHz.

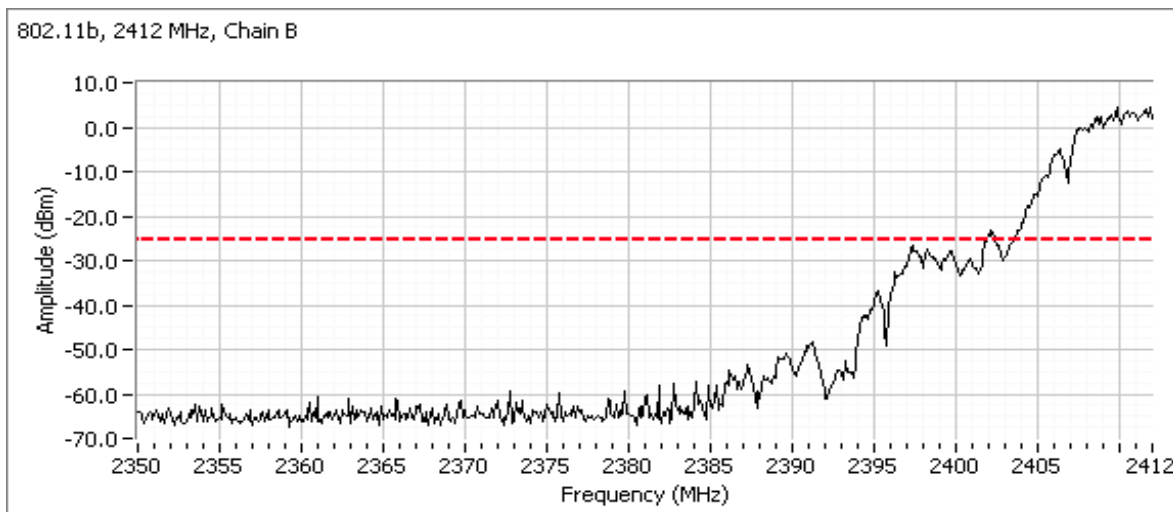

Client:	Intel Corporation	Job Number:	J80398
Model:	Intel® Centrino® Advanced-N 6230	T-Log Number:	T80759
Contact:	Steve Hackett	Account Manager:	Christine Krebill
Standard:	FCC 15.247	Class:	N/A

Plots for center channel, power setting(s) = 23

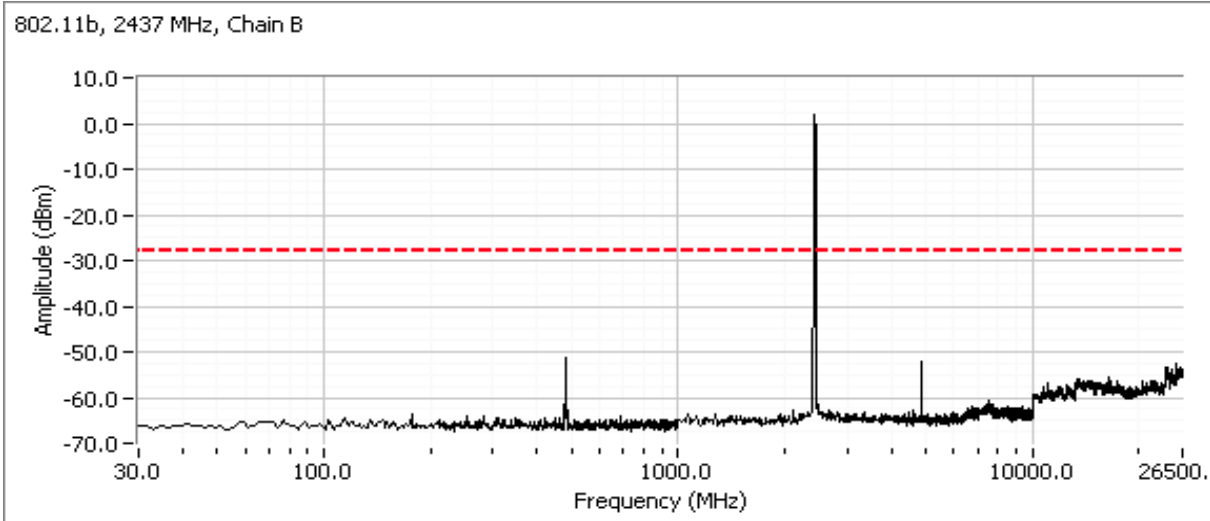

Plots for high channel, power setting(s) = 24

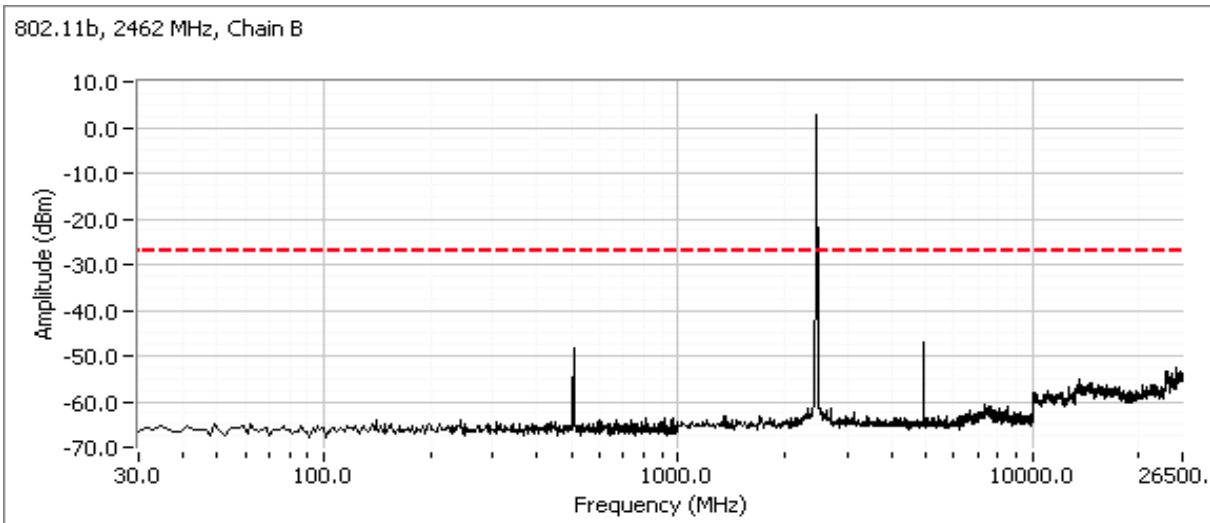

Client:	Intel Corporation	Job Number:	J80398
Model:	Intel® Centrino® Advanced-N 6230	T-Log Number:	T80759
Contact:	Steve Hackett	Account Manager:	Christine Krebill
Standard:	FCC 15.247	Class:	N/A

802.11g Mode

Frequency (MHz)	Limit	Result
2412	-30dBc	Pass
2437	-30dBc	Pass
2462	-30dBc	Pass

Plots for low channel, power setting(s) = 27

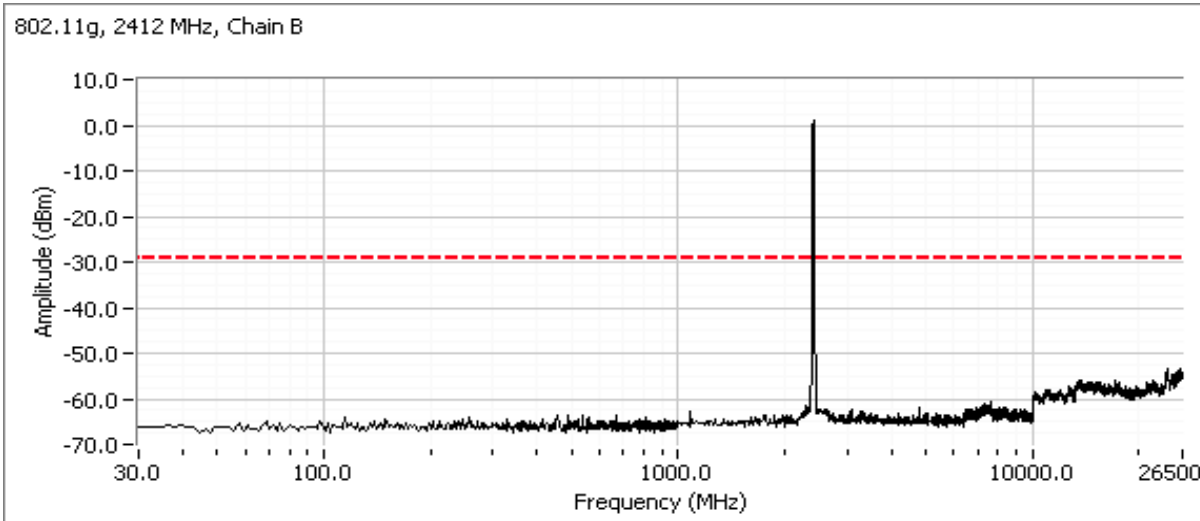

Additional plot showing compliance with **-30dBc** limit from 2390 MHz to 2400 MHz. Radiated measurements used to show compliance with the limits in the restricted band below 2390 MHz.

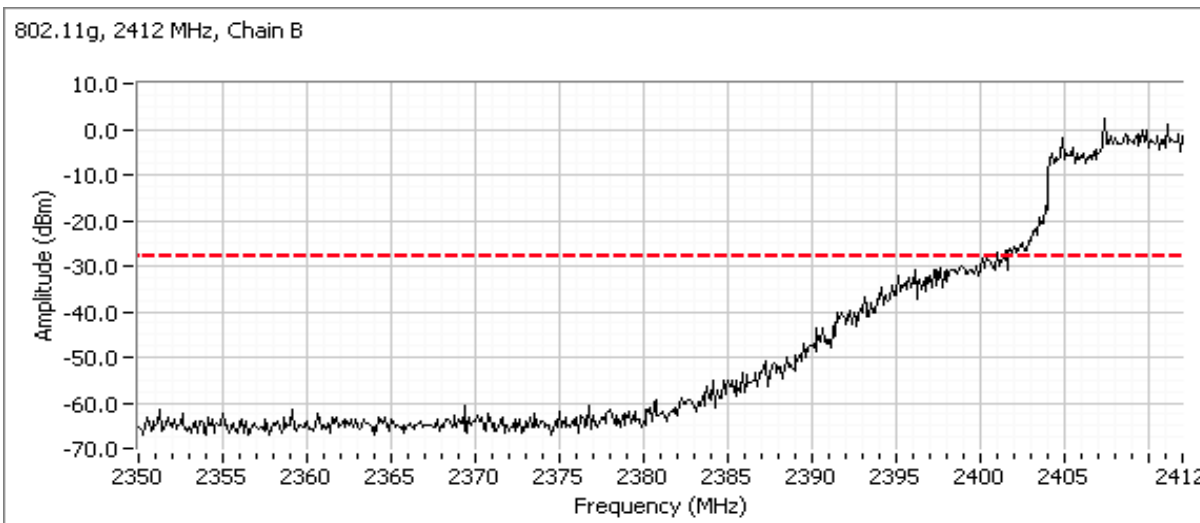

Client: Intel Corporation	Job Number: J80398
Model: Intel® Centrino® Advanced-N 6230	T-Log Number: T80759
Contact: Steve Hackett	Account Manager: Christine Krebill
Standard: FCC 15.247	Class: N/A

Plots for center channel, power setting(s) = 30.5

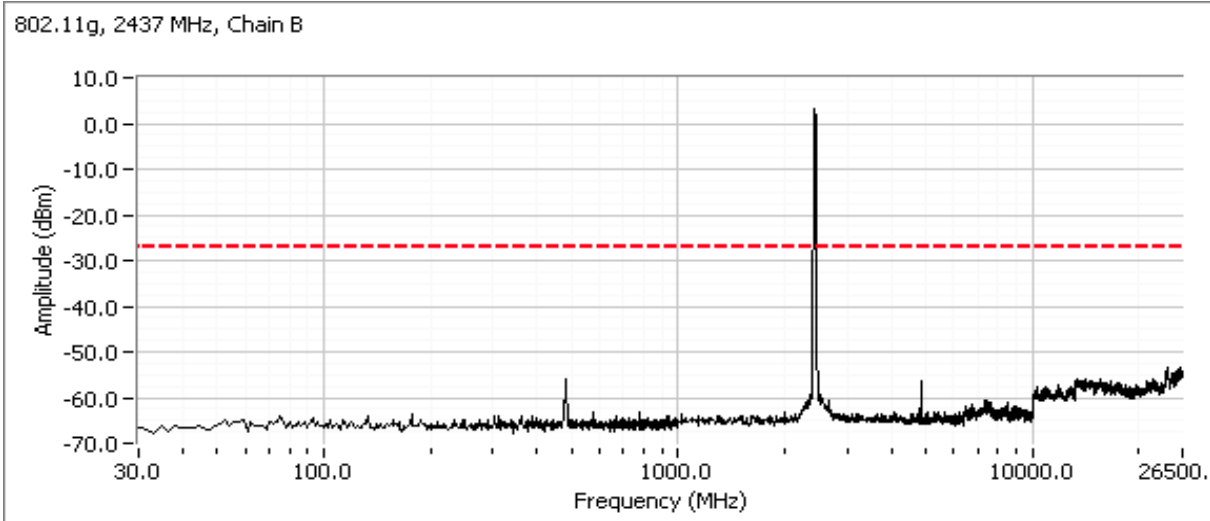

Plots for high channel, power setting(s) = 26.5

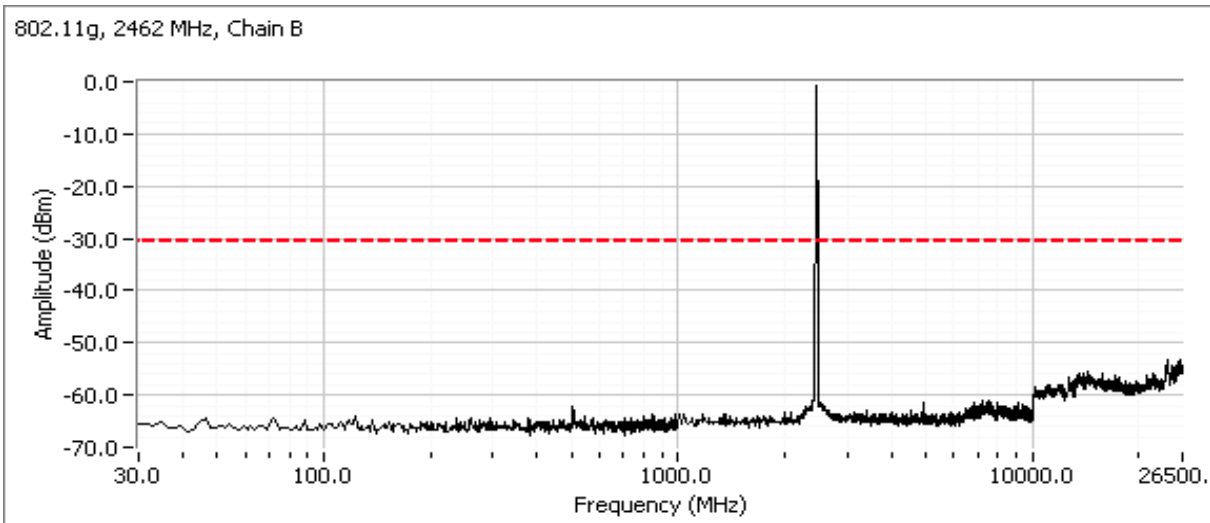

Client:	Intel Corporation	Job Number:	J80398
Model:	Intel® Centrino® Advanced-N 6230	T-Log Number:	T80759
Contact:	Steve Hackett	Account Manager:	Christine Krebill
Standard:	FCC 15.247	Class:	N/A

802.11n 20MHz Mode

Frequency (MHz)	Limit	Result
2412	-30dBc	Pass
2437	-30dBc	Pass
2462	-30dBc	Pass

Plots for low channel, power setting(s) = 25.5

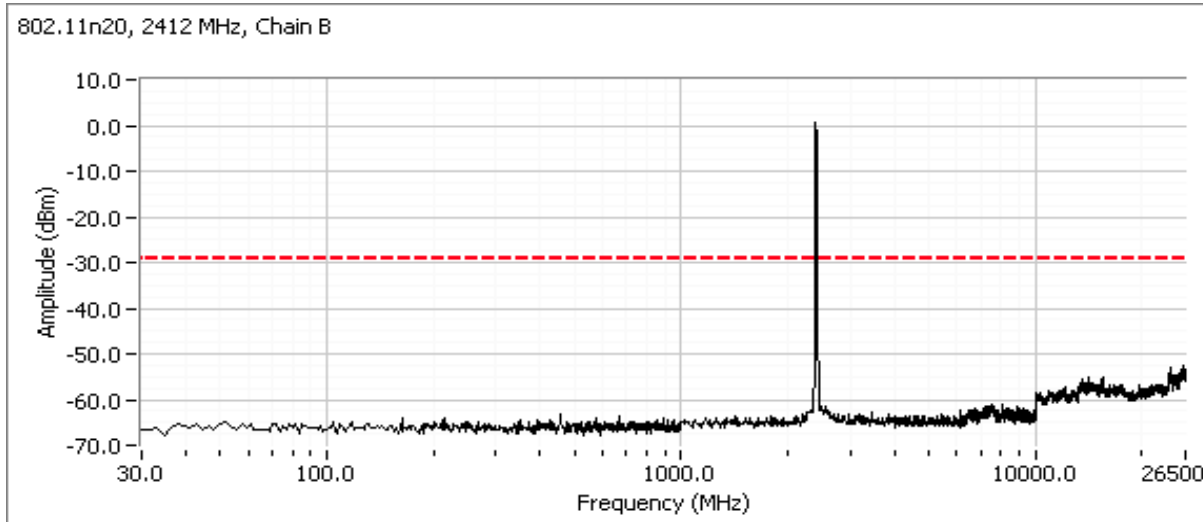

Additional plot showing compliance with **-30dBc** limit from 2390 MHz to 2400 MHz. Radiated measurements used to show compliance with the limits in the restricted band below 2390 MHz.

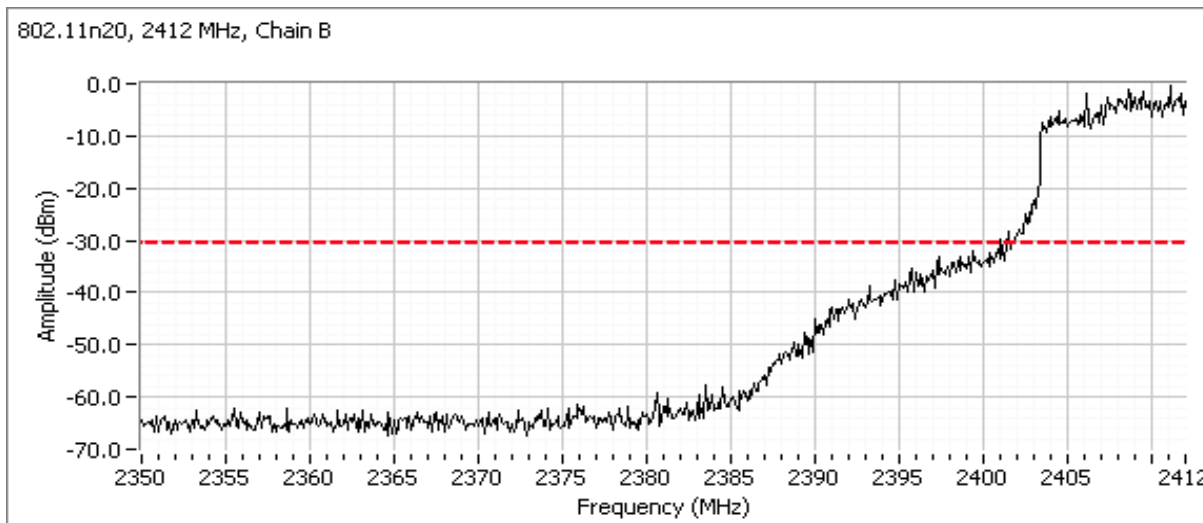

Client:	Intel Corporation	Job Number:	J80398
Model:	Intel® Centrino® Advanced-N 6230	T-Log Number:	T80759
Contact:	Steve Hackett	Account Manager:	Christine Krebill
Standard:	FCC 15.247	Class:	N/A

Plots for center channel, power setting(s) = 30.5

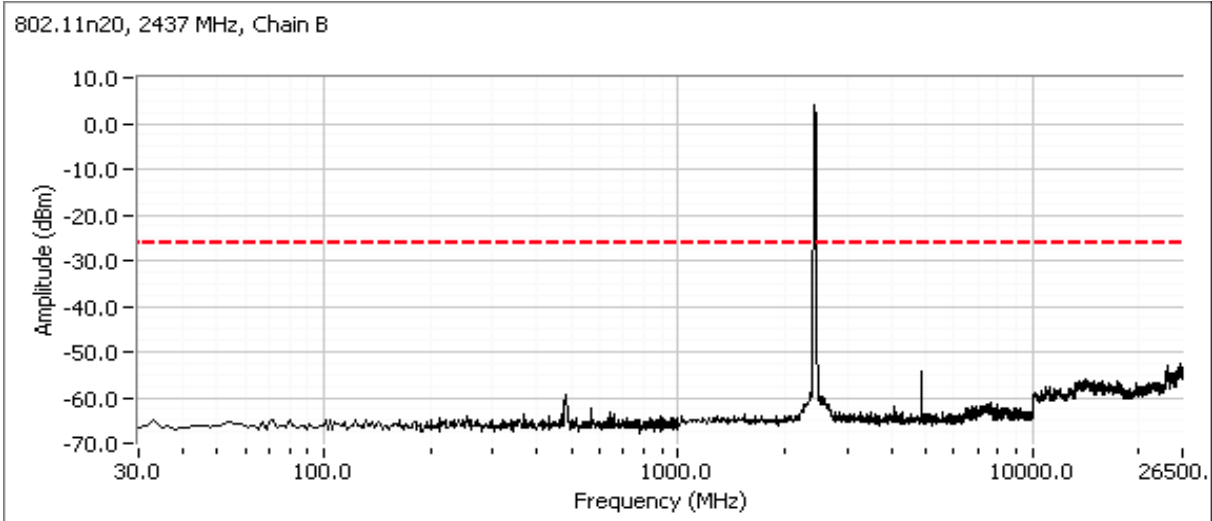

Plots for high channel, power setting(s) = 25.5

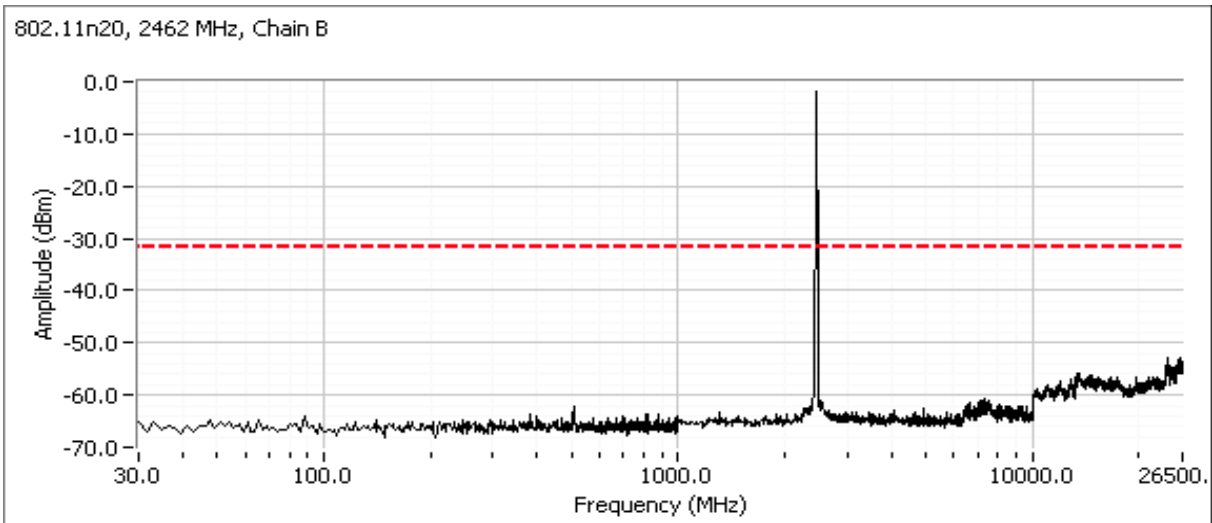

Client:	Intel Corporation	Job Number:	J80398
Model:	Intel® Centrino® Advanced-N 6230	T-Log Number:	T80759
Contact:	Steve Hackett	Account Manager:	Christine Krebill
Standard:	FCC 15.247	Class:	N/A

802.11n 40MHz Mode

Frequency (MHz)	Limit	Result
2422	-30dBc	Pass
2437	-30dBc	Pass
2452	-30dBc	Pass

Plots for low channel, power setting(s) = 22

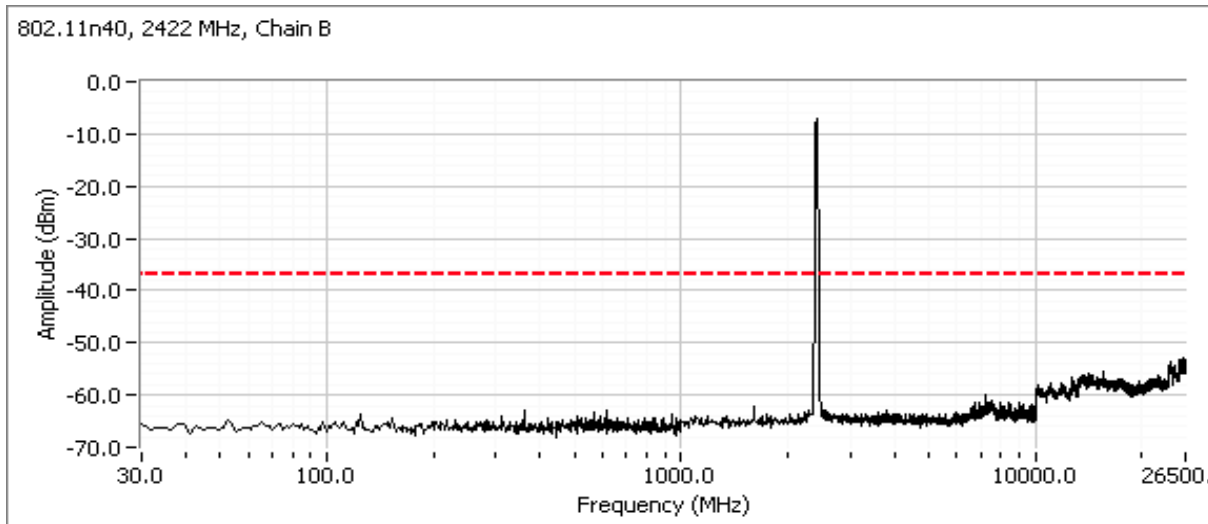

Additional plot showing compliance with **-30dBc** limit from 2390 MHz to 2400 MHz. Radiated measurements used to show compliance with the limits in the restricted band below 2390 MHz.

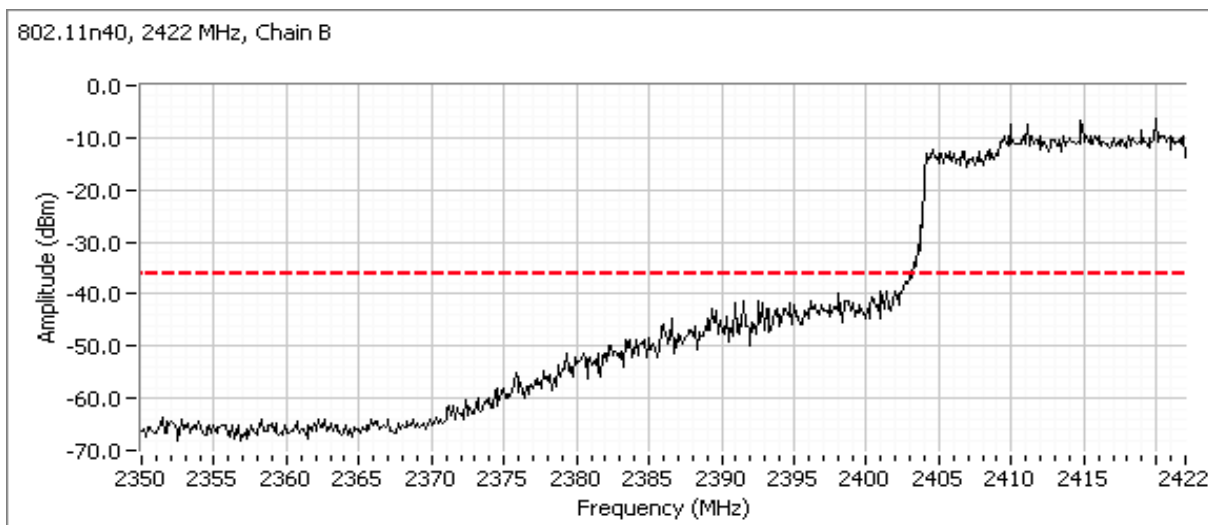

Client:	Intel Corporation	Job Number:	J80398
Model:	Intel® Centrino® Advanced-N 6230	T-Log Number:	T80759
Contact:	Steve Hackett	Account Manager:	Christine Krebill
Standard:	FCC 15.247	Class:	N/A

Plots for center channel, power setting(s) = 25.5

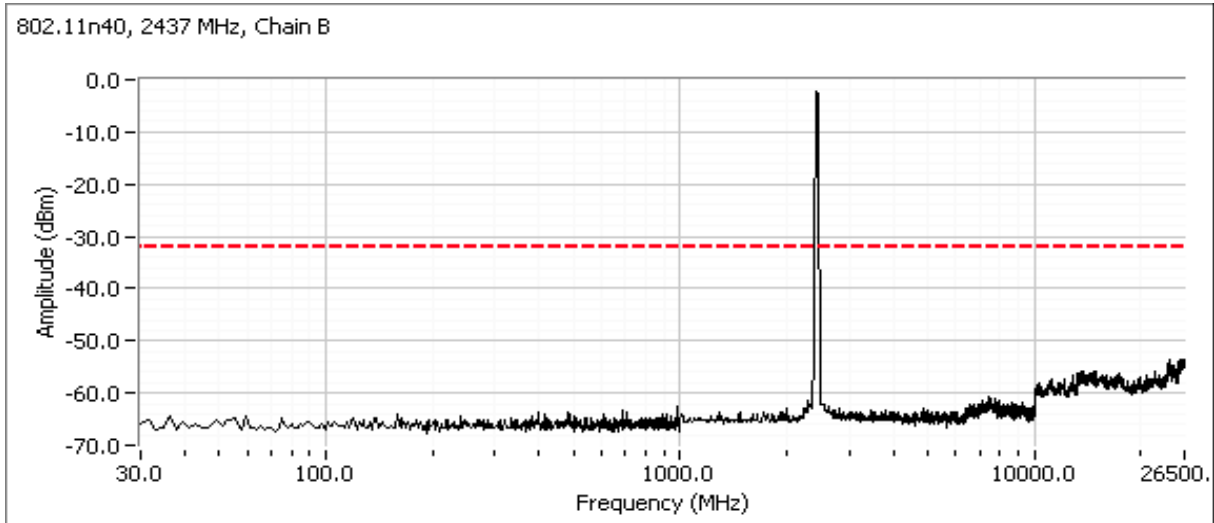

Plots for high channel, power setting(s) = 21

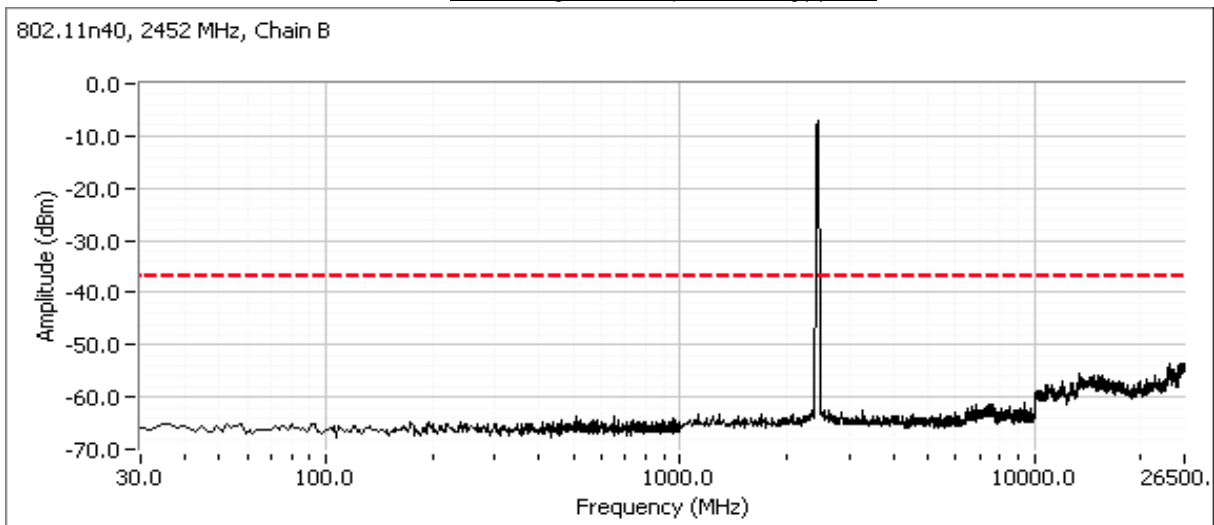

Client:	Intel Corporation	Job Number:	J80398
Model:	Intel® Centrino® Advanced-N 6230	T-Log Number:	T80759
		Account Manager:	Christine Krebill
Contact:	Steve Hackett		
Standard:	FCC 15.247	Class:	N/A

**RSS 210 and FCC 15.247 (DTS) Antenna Port Measurements
MIMO and Smart Antenna Systems
Power, PSD, Bandwidth and Spurious Emissions**

Test Specific Details

Objective: The objective of this test session is to perform final qualification testing of the EUT with respect to the specification listed above.

Date of Test: 10/4/2010
Test Engineer: M. Birgani/R. Varelas
Test Location: FT Lab #4

Config. Used: 1
Config Change: none
Host Unit Voltage 120V/60Hz

General Test Configuration

The EUT was connected to the spectrum analyzer or power meter via a suitable attenuator. All measurements were made on a single chain.

All measurements have been corrected to allow for the external attenuators used.

Ambient Conditions:

Temperature: 22.4 °C
Rel. Humidity: 39 %

Summary of Results

Run #	Pwr setting	Avg Pwr	Test Performed	Limit	Pass / Fail	Result / Margin
1			Output Power	15.247(b)	Pass	n20: 41 mW n40: 34 mW
2			Power spectral Density (PSD)	15.247(d)	Pass	-8.6 dBm/3kHz
3			Minimum 6dB Bandwidth	15.247(a)		These measurements are covered by the single chain data
3			99% Bandwidth	RSS GEN		
4			Spurious emissions	15.247(b)		

Modifications Made During Testing

No modifications were made to the EUT during testing

Deviations From The Standard

No deviations were made from the requirements of the standard.

Client:	Intel Corporation	Job Number:	J80398
Model:	Intel® Centrino® Advanced-N 6230	T-Log Number:	T80759
Contact:	Steve Hackett	Account Manager:	Christine Krebill
Standard:	FCC 15.247	Class:	N/A

Run #1: Output Power - Chain A + B

Use the same method for power measurement for each mode as was used for single chain measurements.

Operating Mode:

Transmitted signal on chain is coherent ? No

802.11 n 20MHz 2412 MHz	Chain 1	Chain 2	Chain 3	Chain 4	Total Across All Chains		Limit	
Power Setting ^{Note 3}	26.0	27.5						
Average Power ^{Note 3}					3.0 dBm	0.002 W		
Output Power (dBm) ^{Note 1}	11.6	11.6			14.6 dBm	0.029 W	30.0 dBm	1.000 W
Antenna Gain (dBi) ^{Note 2}	3.2	3.2				3.2 dBi	Pass	
eirp (dBm) ^{Note 2}	14.8	14.8			17.8 dBm	0.060 W		

802.11 n 20MHz 2437 MHz	Chain 1	Chain 2	Chain 3	Chain 4	Total Across All Chains		Limit	
Power Setting ^{Note 3}	28.0	29.0						
Average Power ^{Note 3}					3.0 dBm	0.002 W		
Output Power (dBm) ^{Note 1}	13.3	13.0			16.2 dBm	0.041 W	30.0 dBm	1.000 W
Antenna Gain (dBi) ^{Note 2}	3.2	3.2				3.2 dBi	Pass	
eirp (dBm) ^{Note 2}	16.5	16.2			19.4 dBm	0.086 W		

802.11 n 20MHz 2462 MHz	Chain 1	Chain 2	Chain 3	Chain 4	Total Across All Chains		Limit	
Power Setting ^{Note 3}	25.5	26.0						
Average Power ^{Note 3}					3.0 dBm	0.002 W		
Output Power (dBm) ^{Note 1}	11.1	10.4			13.8 dBm	0.024 W	30.0 dBm	1.000 W
Antenna Gain (dBi) ^{Note 2}	3.2	3.2				3.2 dBi	Pass	
eirp (dBm) ^{Note 2}	14.3	13.6			17.0 dBm	0.050 W		

Note 1:	Output power measured using a spectrum analyzer (see plots below) with RBW=1MHz, VB=3 MHz, sample detector, power averaging on (transmitted signal was continuous) and power integration over 50 MHz (option #2, method 1 in KDB 558074, equivalent to method 1 of DA-02-2138A1 for U-NII devices). Spurious limit becomes -30dBc .
Note 2:	As there is no coherency between chains the total EIRP is the sum of the individual EIRPs and effective antenna gain equals the eirp divide by the sum of the power on each chain.
Note 3:	Power setting and average power are for reference only. Average power measured using average power sensor.

Client:	Intel Corporation	Job Number:	J80398
Model:	Intel® Centrino® Advanced-N 6230	T-Log Number:	T80759
Contact:	Steve Hackett	Account Manager:	Christine Krebill
Standard:	FCC 15.247	Class:	N/A

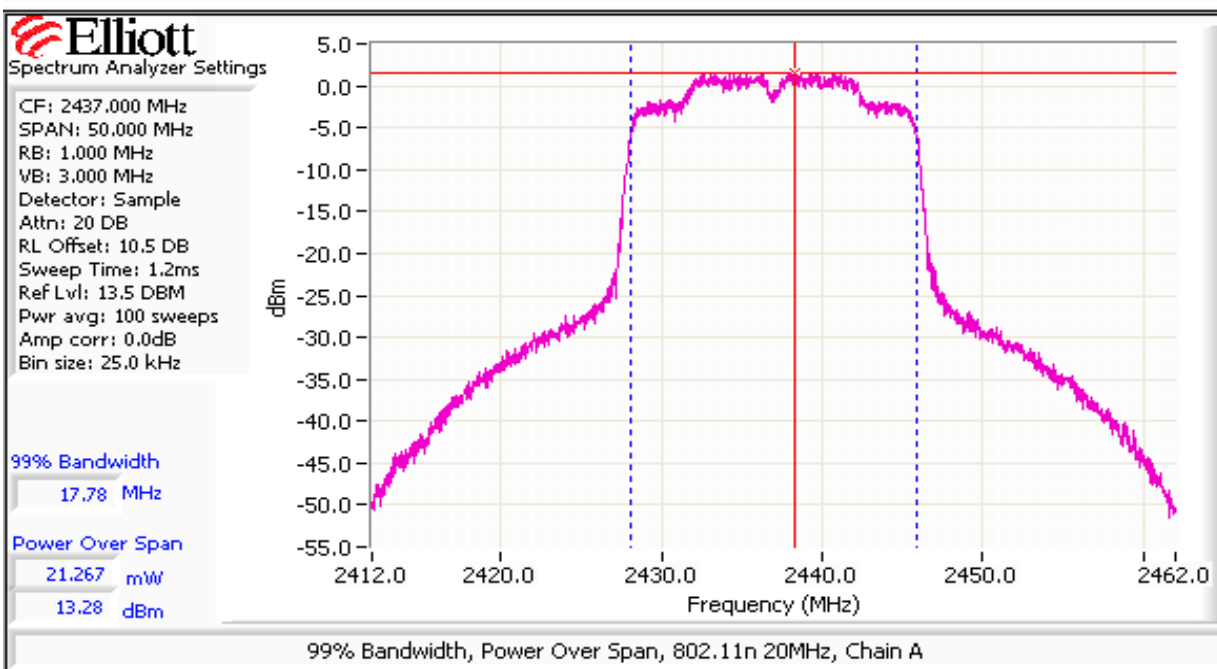
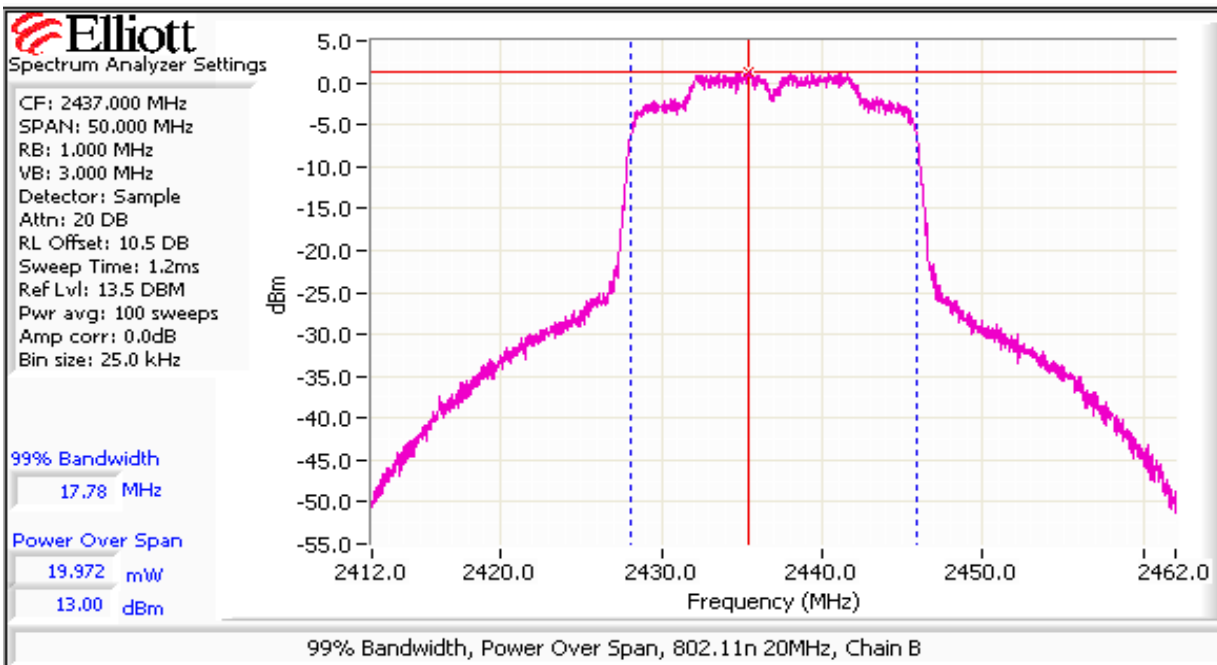

Client:	Intel Corporation	Job Number:	J80398
Model:	Intel® Centrino® Advanced-N 6230	T-Log Number:	T80759
Contact:	Steve Hackett	Account Manager:	Christine Krebill
Standard:	FCC 15.247	Class:	N/A

802.11 n 40MHz 2422 MHz	Chain 1	Chain 2	Chain 3	Chain 4	Total Across All Chains		Limit	
Power Setting ^{Note 3}	21.5	22.5						
Average Power ^{Note 3}					3.0 dBm	0.002 W		
Output Power (dBm) ^{Note 1}	7.3	7.0			10.2 dBm	0.010 W	30.0 dBm	1.000 W
Antenna Gain (dBi) ^{Note 2}	3.2	3.2				3.2 dBi	Pass	
eirp (dBm) ^{Note 2}	10.5	10.2			13.4 dBm	0.022 W		

802.11 n 40MHz 2437 MHz	Chain 1	Chain 2	Chain 3	Chain 4	Total Across All Chains		Limit	
Power Setting ^{Note 3}	26.5	28.0						
Average Power ^{Note 3}					3.0 dBm	0.002 W		
Output Power (dBm) ^{Note 1}	12.3	12.3			15.3 dBm	0.034 W	30.0 dBm	1.000 W
Antenna Gain (dBi) ^{Note 2}	3.2	3.2				3.2 dBi	Pass	
eirp (dBm) ^{Note 2}	15.5	15.5			18.5 dBm	0.071 W		

802.11 n 40MHz 2452 MHz	Chain 1	Chain 2	Chain 3	Chain 4	Total Across All Chains		Limit	
Power Setting ^{Note 3}	20.5	22.0						
Average Power ^{Note 3}					3.0 dBm	0.002 W		
Output Power (dBm) ^{Note 1}	6.5	6.7			9.6 dBm	0.009 W	30.0 dBm	1.000 W
Antenna Gain (dBi) ^{Note 2}	3.2	3.2				3.2 dBi	Pass	
eirp (dBm) ^{Note 2}	9.7	9.9			12.8 dBm	0.019 W		

- Note 1: Output power measured using a spectrum analyzer (see plots below) with RBW=1MHz, VB=3 MHz, sample detector, power averaging on (transmitted signal was continuous) and power integration over 100 MHz (option #2, method 1 in KDB 558074, equivalent to method 1 of DA-02-2138A1 for U-NII devices). Spurious limit becomes **-30dBc**.
- Note 2: As there is no coherency between chains the total EIRP is the sum of the individual EIRPs and effective antenna gain equals the eirp divide by the sum of the power on each chain.
- Note 3: Power setting and average power are for reference only. Average power measured using average power sensor.

Client:	Intel Corporation	Job Number:	J80398
Model:	Intel® Centrino® Advanced-N 6230	T-Log Number:	T80759
Contact:	Steve Hackett	Account Manager:	Christine Krebill
Standard:	FCC 15.247	Class:	N/A

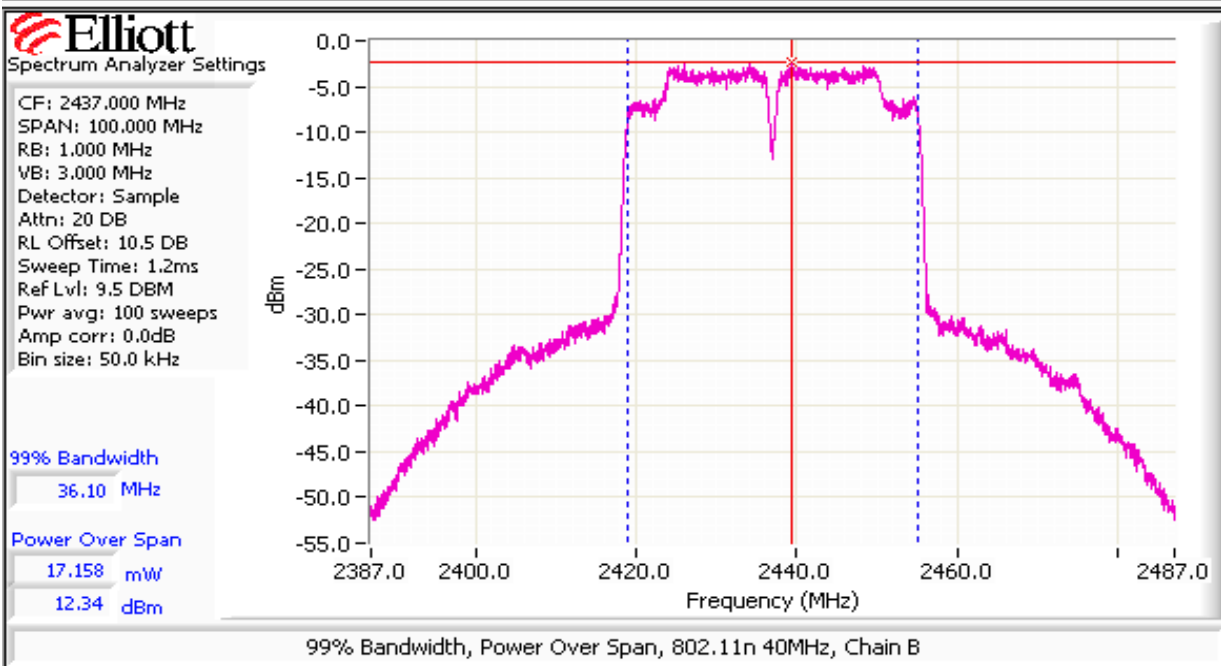
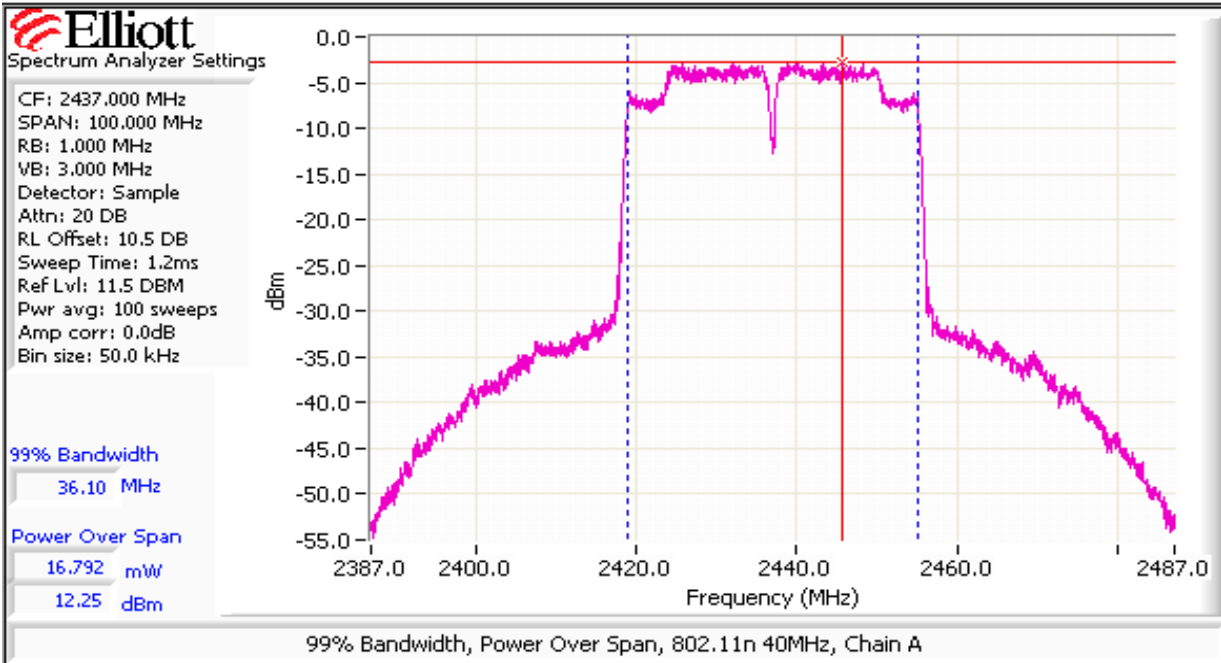

Client:	Intel Corporation	Job Number:	J80398
Model:	Intel® Centrino® Advanced-N 6230	T-Log Number:	T80759
Contact:	Steve Hackett	Account Manager:	Christine Krebill
Standard:	FCC 15.247	Class:	N/A

Run #2: Power spectral Density

Power Setting	Frequency (MHz)	PSD (dBm/3kHz) ^{Note 1}				Total	Limit dBm/3kHz	Result
		Chain 1	Chain 2	Chain 3	Chain 4			
802.11n 20MHz								
26.0/27.5	2412	-12.6	-11.5			-9.0	8.0	Pass
28.0/ 29.0	2437	-12.7	-10.8			-8.6	8.0	Pass
25.5/ 26.0	2467	-14.0	-13.2			-10.6	8.0	Pass
802.11n 40MHz								
21.5/ 22.5	2422	-18.6	-19.3			-15.9	8.0	Pass
26.5/ 28.0	2437	-13.7	-13.9			-10.8	8.0	Pass
20.5/ 22.0	2452	-19.5	-19.5			-16.5	8.0	Pass

Note 1: Power spectral density measured using RB=3 kHz, VB=10kHz, analyzer with peak detector and with a sweep time set to ensure a dwell time of at least 1 second per 3kHz. The measurement is made at the frequency of PPSD determined from preliminary scans using RB=3kHz using multiple sweeps at a faster rate over the 6dB bandwidth of the signal.

Client: Intel Corporation	Job Number: J80398
Model: Intel® Centrino® Advanced-N 6230	T-Log Number: T80759
	Account Manager: Christine Krebill
Contact: Steve Hackett	
Standard: FCC 15.247	Class: N/A

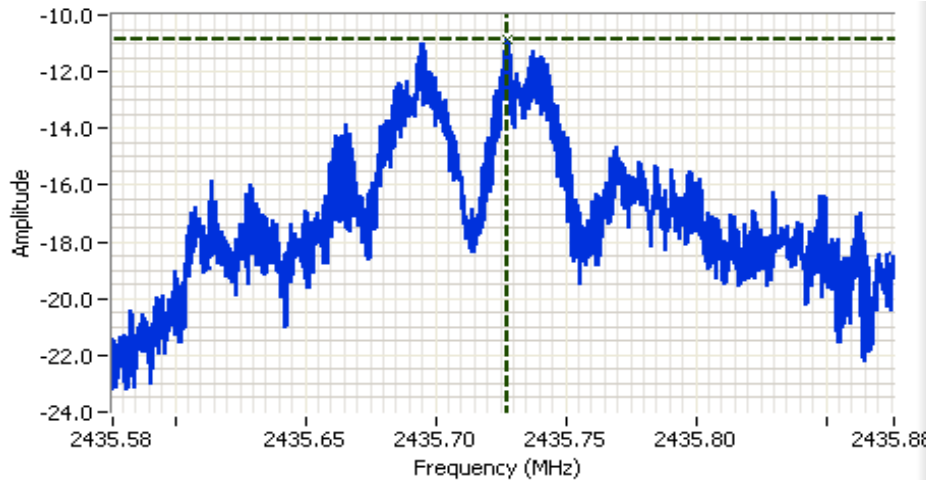

Analyzer Settings

Agilent Technologies, E4446A
 CF: 2435.726 MHz
 SPAN: 300 kHz
 RB: 3.00 kHz
 VB: 10.0 kHz
 Detector: POS
 Attn: 10 DB
 RL Offset: 10.5 DB
 Sweep Time: 100.0s
 Ref Lvl: -6.5 DBM

Comments

802.11n 20MHz, Chain B
 CH 6
 PSD: -10.8 dBm/3kHz

Cursor 1 2435.7280 -10.84

0.0000 0.00

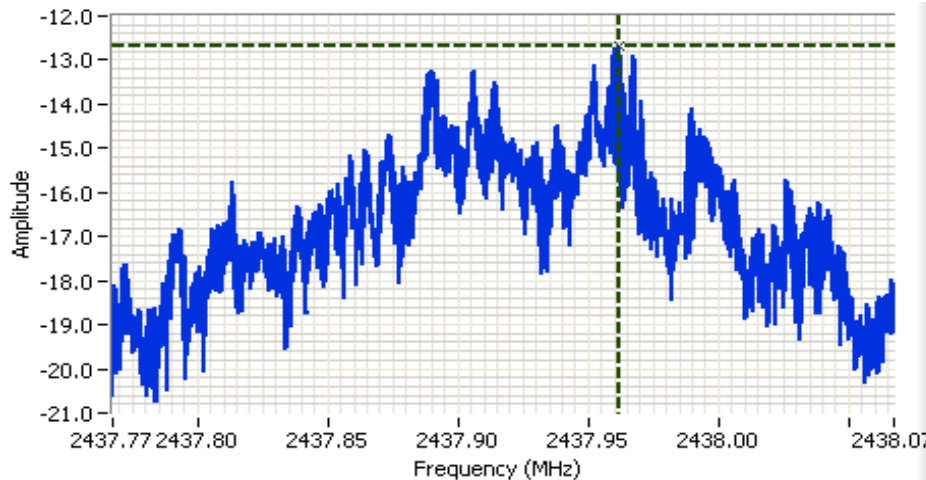

Analyzer Settings

Agilent Technologies, E4446A
 CF: 2437.917 MHz
 SPAN: 300 kHz
 RB: 3.00 kHz
 VB: 10.0 kHz
 Detector: POS
 Attn: 10 DB
 RL Offset: 10.5 DB
 Sweep Time: 100.0s
 Ref Lvl: -4.5 DBM

Comments

802.11n 20MHz
 Chain A, CH 6
 PSD: -12.7 dBm/3kHz

Cursor 1 2437.9616 -12.67

0.0000 0.00



Client:	Intel Corporation	Job Number:	J80398
Model:	Intel® Centrino® Advanced-N 6230	T-Log Number:	T80759
Contact:	Steve Hackett	Account Manager:	Christine Krebill
Standard:	FCC 15.247	Class:	N/A

**RSS 210 and FCC 15.247 (DTS) Antenna Port Measurements
Power, PSD, Bandwidth and Spurious Emissions - Chain A**

Test Specific Details

Objective: The objective of this test session is to perform final qualification testing of the EUT with respect to the specification listed above.

Date of Test: 9/29/2010
 Test Engineer: John Caizzi/R. Varelas
 Test Location: FT Chamber #7

Config. Used: Modular
 Config Change: none
 Host Unit Voltage 120V/60Hz

General Test Configuration

The EUT was connected to the spectrum analyzer or power meter via a suitable attenuator. All measurements were made on a single chain.

All measurements have been corrected to allow for the external attenuators used.

Ambient Conditions:

Temperature: 22.4 °C
 Rel. Humidity: 42 %

Summary of Results

MAC Address: 00150079AD1A DRTU Tool Version 1.2.12-0197 Driver version 14.0.0.39

Run #	Pwr setting	Avg Pwr	Test Performed	Limit	Pass / Fail	Result / Margin
1	30	16.5	Output Power	15.247(b)	Pass	802.11a: 27.3 mW n20: 29.4 mW n40: 95.5 mW
2	29	16.5	Power spectral Density (PSD)	15.247(d)	Pass	802.11a: -8.1dBm/3kHz n20: -7.9 dBm/3kHz n40: -10.3 dBm/3kHz
3	28.5	16.5	Minimum 6dB Bandwidth	15.247(a)	Pass	16.4 MHz
3	30.5	16.5	99% Bandwidth	RSS GEN	-	802.11a: 17.22 MHz n20: 18.39 MHz n40: 38.8 MHz
4	-	16.5	Spurious emissions	15.247(b)	Pass	All Emissions below the limit

Modifications Made During Testing

No modifications were made to the EUT during testing

Deviations From The Standard

No deviations were made from the requirements of the standard.

Client:	Intel Corporation	Job Number:	J80398
Model:	Intel® Centrino® Advanced-N 6230	T-Log Number:	T80759
Contact:	Steve Hackett	Account Manager:	Christine Krebill
Standard:	FCC 15.247	Class:	N/A

Run #1: Output Power

802.11a Mode

Power Setting ²	Frequency (MHz)	Output Power		Antenna Gain (dBi)	Result	EIRP ^{Note 2}		Output Power	
		(dBm) ¹	mW			dBm	W	(dBm) ³	mW
28.5	5745	14.4	27.3	5.0	Pass	19.4	0.086	16.5	44.7
28.5	5785	14.2	26.4	5.0	Pass	19.2	0.084	16.5	44.7
29.0	5825	14.2	26.1	5.0	Pass	19.2	0.083	16.5	44.7

- Note 1: Output power measured using a spectrum analyzer (see plots below) with RBW=1MHz, VB=3 MHz, sample detector, power averaging on (transmitted signal was continuous) and power integration over 50 MHz (option #2, method 1 in KDB 558074, equivalent to method 1 of DA-02-2138A1 for U-NII devices). Spurious limit becomes **-30dBc**.
- Note 2: Power setting - the software power setting used during testing, included for reference only.
- Note 3: Power measured using average power meter and is included for reference only.

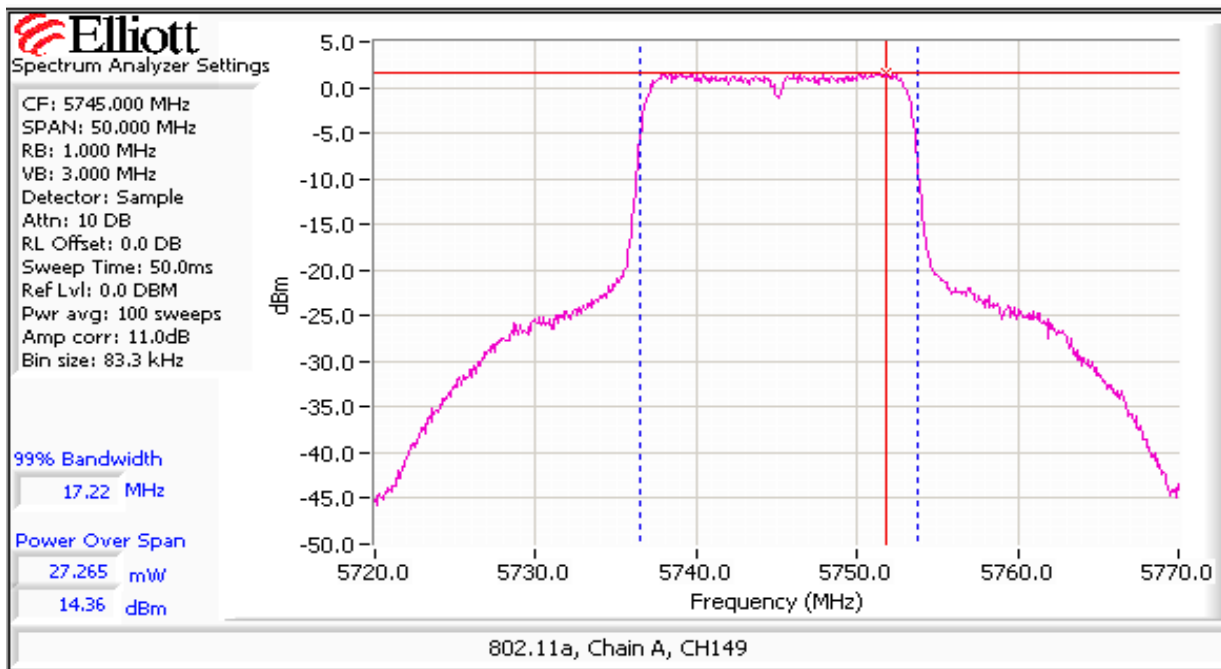

Client:	Intel Corporation	Job Number:	J80398
Model:	Intel® Centrino® Advanced-N 6230	T-Log Number:	T80759
Contact:	Steve Hackett	Account Manager:	Christine Krebill
Standard:	FCC 15.247	Class:	N/A

Spectrum Analyzer Settings

CF: 5785.000 MHz
 SPAN: 50.000 MHz
 RB: 1.000 MHz
 VB: 3.000 MHz
 Detector: Sample
 Attn: 10 DB
 RL Offset: 0.0 DB
 Sweep Time: 50.0ms
 Ref Lvl: 0.0 DBM
 Pwr avg: 100 sweeps
 Amp corr: 11.0dB
 Bin size: 83.3 kHz

99% Bandwidth
 17.22 MHz

Power Over Span
 26.428 mW
 14.22 dBm

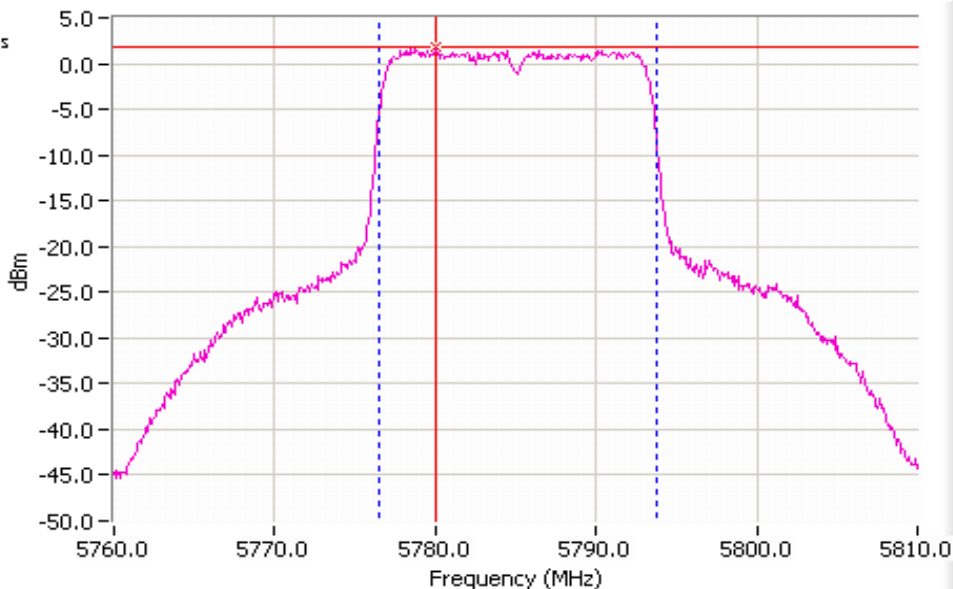

802.11a, Chain A, CH 157

Spectrum Analyzer Settings

CF: 5825.000 MHz
 SPAN: 50.000 MHz
 RB: 1.000 MHz
 VB: 3.000 MHz
 Detector: Sample
 Attn: 10 DB
 RL Offset: 0.0 DB
 Sweep Time: 50.0ms
 Ref Lvl: 0.0 DBM
 Pwr avg: 100 sweeps
 Amp corr: 11.0dB
 Bin size: 83.3 kHz

99% Bandwidth
 17.30 MHz

Power Over Span
 26.124 mW
 14.17 dBm

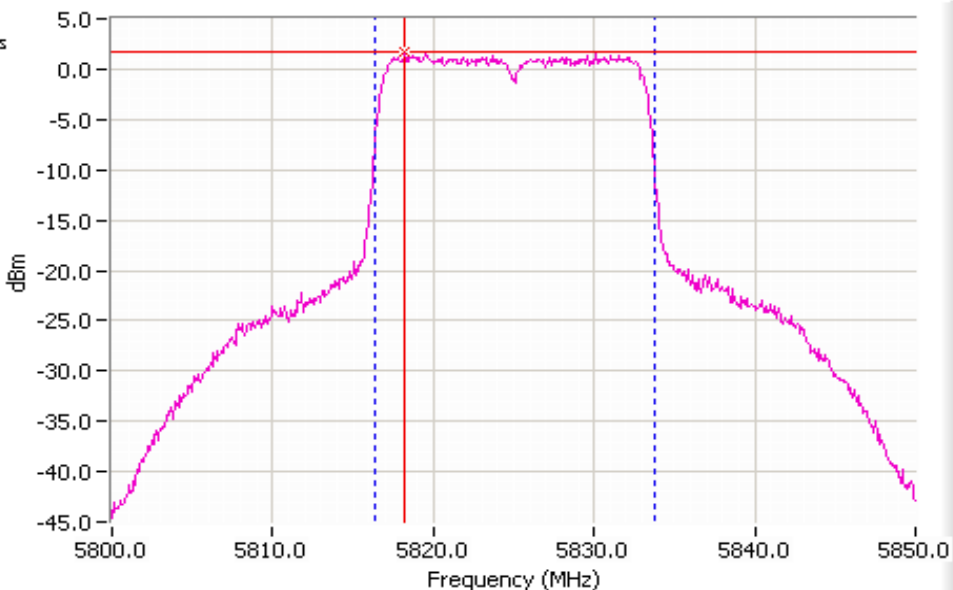

802.11a, Chain A, CH 165

Client:	Intel Corporation	Job Number:	J80398
Model:	Intel® Centrino® Advanced-N 6230	T-Log Number:	T80759
Contact:	Steve Hackett	Account Manager:	Christine Krebill
Standard:	FCC 15.247	Class:	N/A

802.11n 20MHz Mode

Power Setting ²	Frequency (MHz)	Output Power		Antenna Gain (dBi)	Result	EIRP ^{Note 2}		Output Power	
		(dBm) ¹	mW			dBm	W	(dBm) ³	mW
29.0	5745	14.7	29.4	5.0	Pass	19.7	0.093	16.6	45.7
29.0	5785	14.4	27.4	5.0	Pass	19.4	0.087	16.5	44.7
29.5	5825	14.4	27.4	5.0	Pass	19.4	0.086	16.5	44.7

- Note 1: Output power measured using a spectrum analyzer (see plots below) with RBW=1MHz, VB=3 MHz, sample detector, power averaging on (transmitted signal was continuous) and power integration over 50 MHz (option #2, method 1 in KDB 558074, equivalent to method 1 of DA-02-2138A1 for U-NII devices). Spurious limit becomes **-30dBc**.
- Note 2: Power setting - the software power setting used during testing, included for reference only.
- Note 3: Power measured using average power meter and is included for reference only.

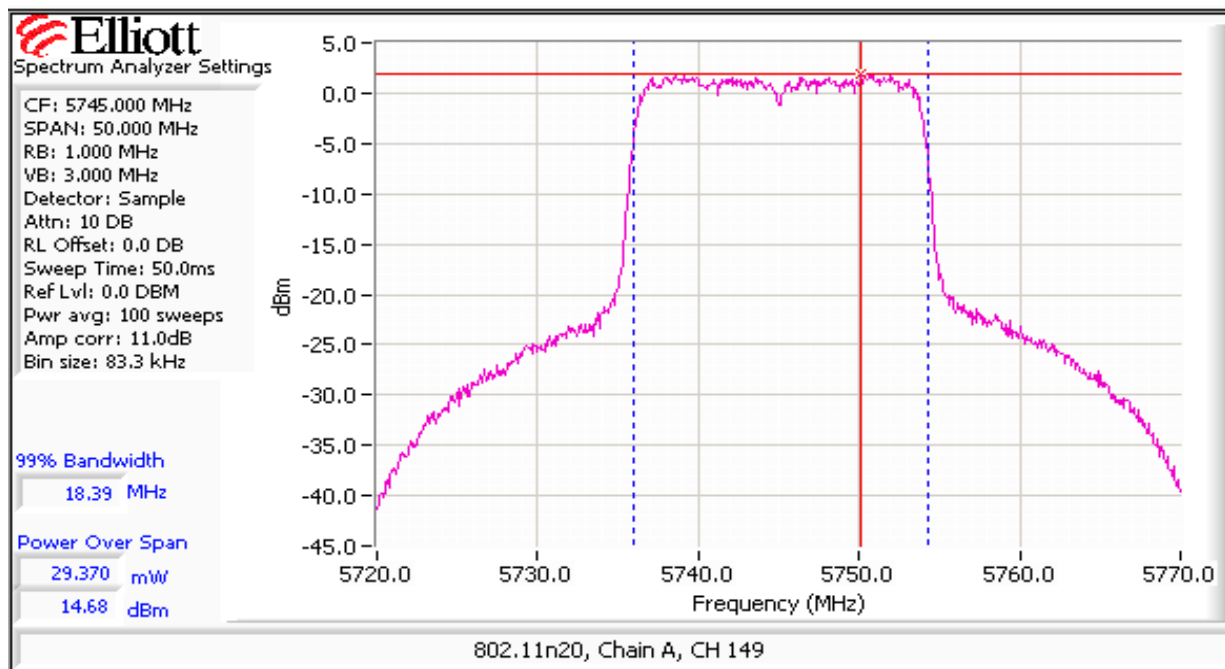

Client:	Intel Corporation	Job Number:	J80398
Model:	Intel® Centrino® Advanced-N 6230	T-Log Number:	T80759
Contact:	Steve Hackett	Account Manager:	Christine Krebill
Standard:	FCC 15.247	Class:	N/A

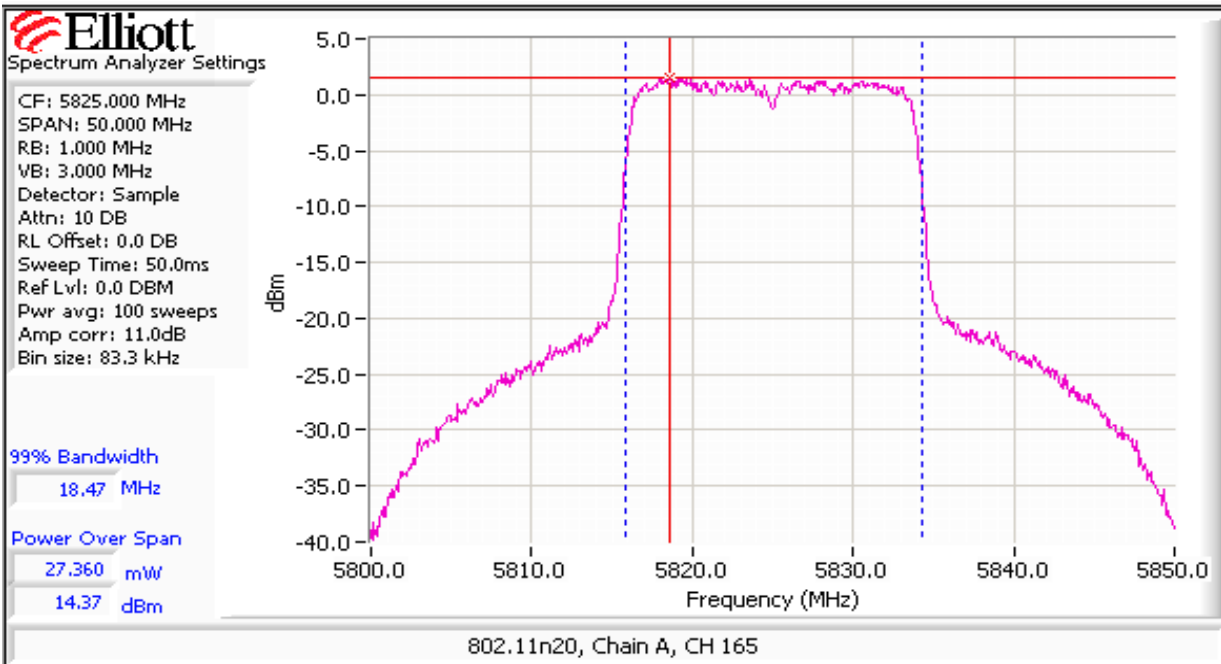
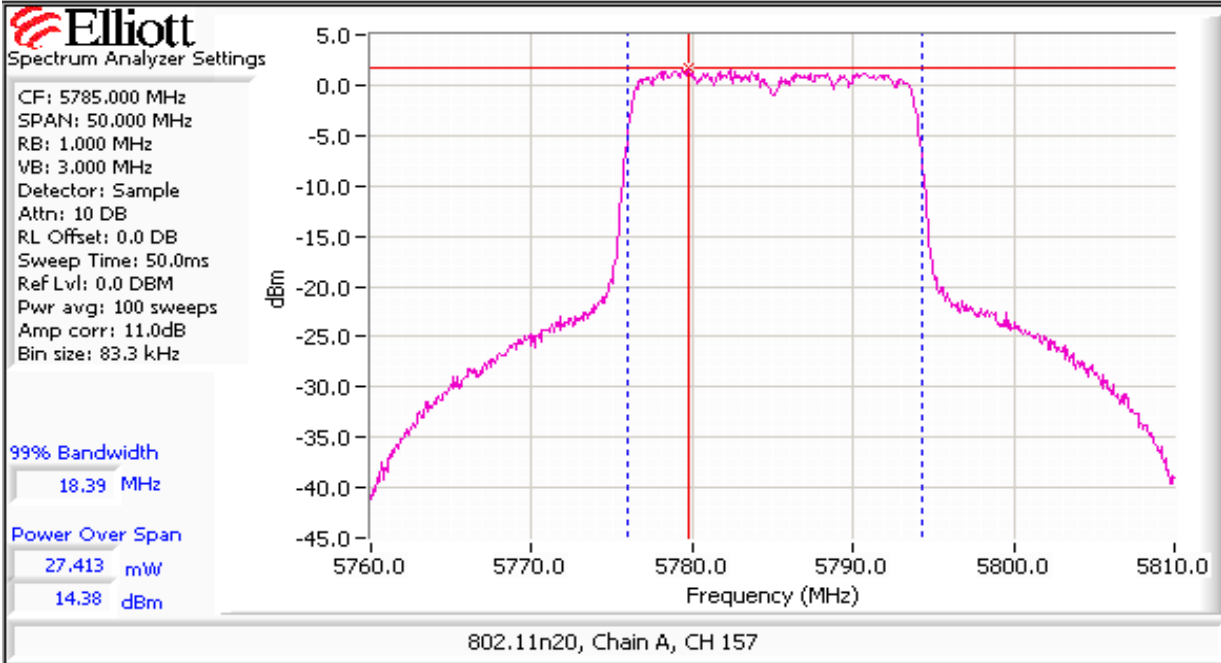

Client:	Intel Corporation	Job Number:	J80398
Model:	Intel® Centrino® Advanced-N 6230	T-Log Number:	T80759
Contact:	Steve Hackett	Account Manager:	Christine Krebill
Standard:	FCC 15.247	Class:	N/A

802.11n 40MHz Mode

Power Setting ²	Frequency (MHz)	Output Power		Antenna Gain (dBi)	Result	EIRP ^{Note 2}		Output Power	
		(dBm) ¹	mW			dBm	W	(dBm) ³	mW
30.0	5755	19.8	95.5	5.0	Pass	24.8	0.302	16.5	44.7
30.5	5795	19.6	91.2	5.0	Pass	24.6	0.288	16.5	44.7

- Note 1: Output power measured using a peak power meter, spurious limit is **-20dBc**.
- Note 2: Power setting - the software power setting used during testing, included for reference only.
- Note 3: Power measured using average power meter and is included for reference only.

Client: Intel Corporation	Job Number: J80398
Model: Intel® Centrino® Advanced-N 6230	T-Log Number: T80759
	Account Manager: Christine Krebill
Contact: Steve Hackett	
Standard: FCC 15.247	Class: N/A

Run #2: Power spectral Density

Mode	Power Setting	Frequency (MHz)	PSD (dBm/3kHz) ^{Note 1}	Limit dBm/3kHz	Result
802.11a	28.5	5745	-9.3	8.0	Pass
	28.5	5785	-8.9	8.0	Pass
	29	5825	-8.1	8.0	Pass
802.11n 20MHz	29	5745	-10.6	8.0	Pass
	29	5785	-7.9	8.0	Pass
	29.5	5825	-8.6	8.0	Pass
802.11n 40MHz	30	5755	-10.3	8.0	Pass
	30.5	5795	-13.6	8.0	Pass

Note 1: Power spectral density measured using RB=3 kHz, VB=10kHz, analyzer with peak detector and with a sweep time set to ensure a dwell time of at least 1 second per 3kHz. The measurement is made at the frequency of PPSD determined from preliminary scans using RB=3kHz using multiple sweeps at a faster rate over the 6dB bandwidth of the signal.

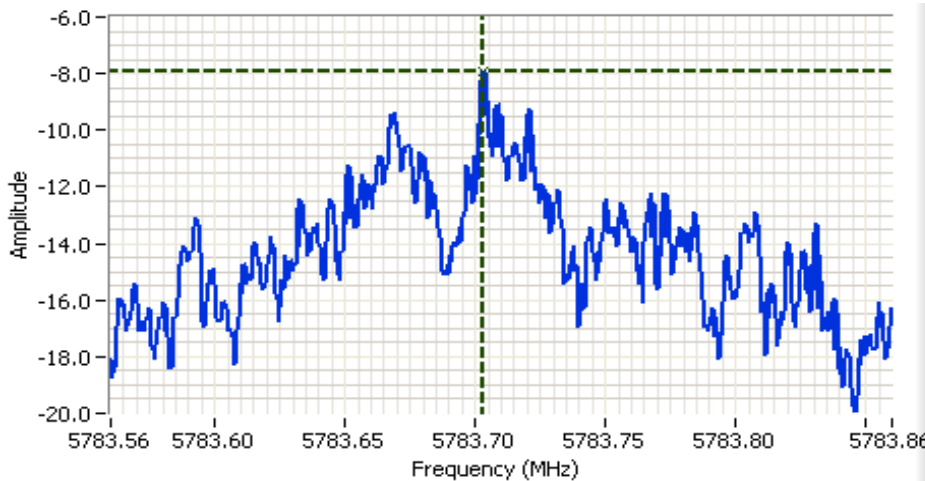

Analyzer Settings

HP8564E
CF: 5783.710 MHz
SPAN: 300 kHz
RB: 3.00 kHz
VB: 10.0 kHz
Detector: Normal
Attn: 10 DB
RL Offset: 11.0 DB
Sweep Time: 100.0s
Ref Lvl: 5.9 DBM

Comments

PSD @ 5785 MHz
802.11n20
Chain A

Cursor 1	5783.7030	-7.93	
	0.0000	0.00	

Client:	Intel Corporation	Job Number:	J80398
Model:	Intel® Centrino® Advanced-N 6230	T-Log Number:	T80759
Contact:	Steve Hackett	Account Manager:	Christine Krebill
Standard:	FCC 15.247	Class:	N/A

Run #3: Signal Bandwidth

Mode	Power Setting	Frequency (MHz)	Resolution Bandwidth	Bandwidth (MHz)	
				6dB	99%
802.11a	28.5	5745	100kHz	16.4	17.2
	28.5	5785	100kHz	16.4	17.2
	29.0	5825	100kHz	16.5	17.3
802.11n 20MHz	29.0	5745	100kHz	17.7	18.4
	29.0	5785	100kHz	17.8	18.4
	29.5	5825	100kHz	17.3	18.5
802.11n 40MHz	30.0	5755	100kHz	35.7	37.3
	30.5	5795	100kHz	36.2	38.8

Note 1: 99% bandwidth measured in accordance with RSS GEN, with RB > 1% of the span and VB > 3xRB

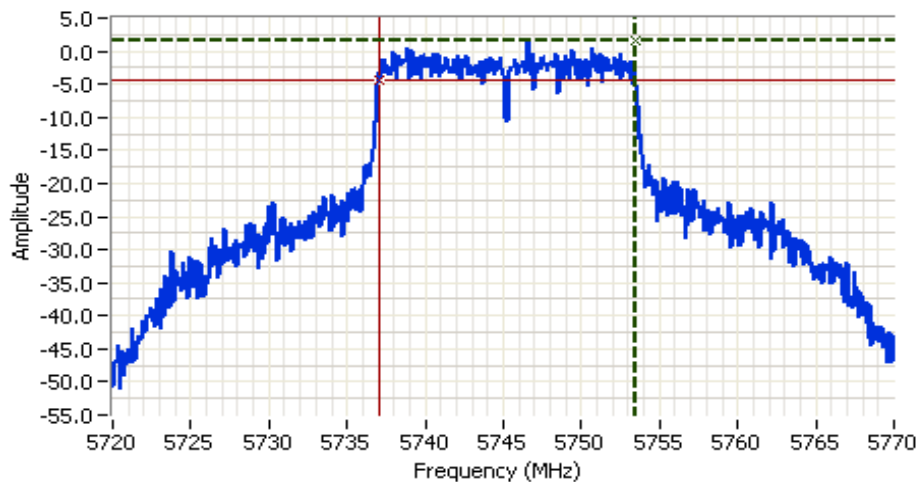

Analyzer Settings
 HP8564E
 CF: 5745.000 MHz
 SPAN: 50.000 MHz
 RB: 100 kHz
 VB: 100 kHz
 Detector: POS
 Attn: 10 DB
 RL Offset: 11.0 DB
 Sweep Time: 50.0ms
 Ref Lvl: 10.5 DBM

Comments
 802.11a
 6dB BW: 16.4 MHz

Cursor 1: 5753.4167 1.50
 Cursor 2: 5737.0000 -4.50
 Delta Freq: 16.417
 Delta Amplitude: 6.00



Client:	Intel Corporation	Job Number:	J80398
Model:	Intel® Centrino® Advanced-N 6230	T-Log Number:	T80759
Contact:	Steve Hackett	Account Manager:	Christine Krebill
Standard:	FCC 15.247	Class:	N/A

Run #4: Out of Band Spurious Emissions
802.11a Mode

Frequency (MHz)	Limit	Result
5745	-30dBc	Pass
5785	-30dBc	Pass
5825	-30dBc	Pass

Plots for low channel, power setting = 16.5 dBm

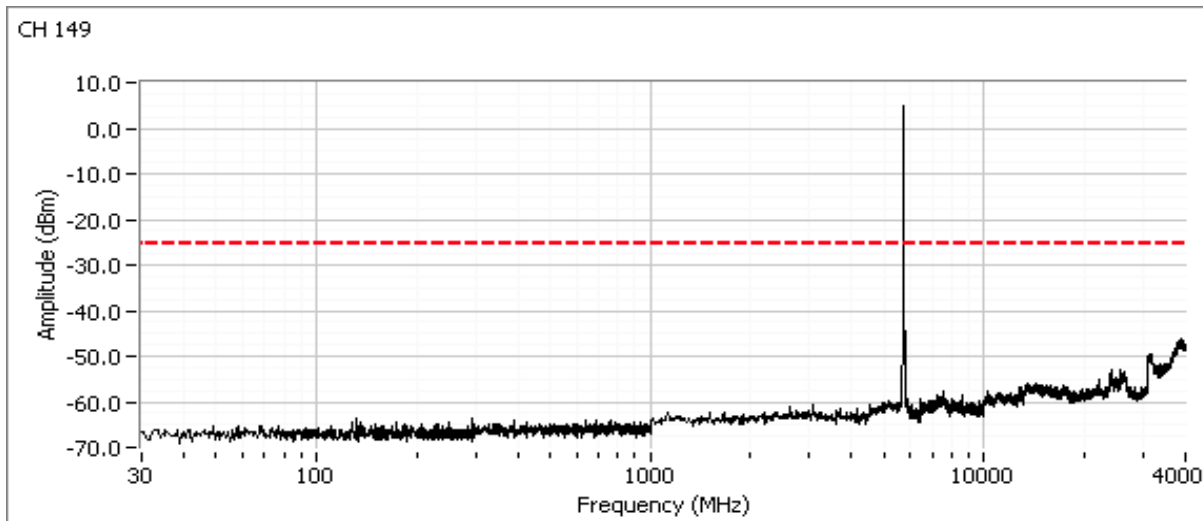

Additional plot from 5715 - 5755 MHz showing compliance with -30dBc at the band edge.

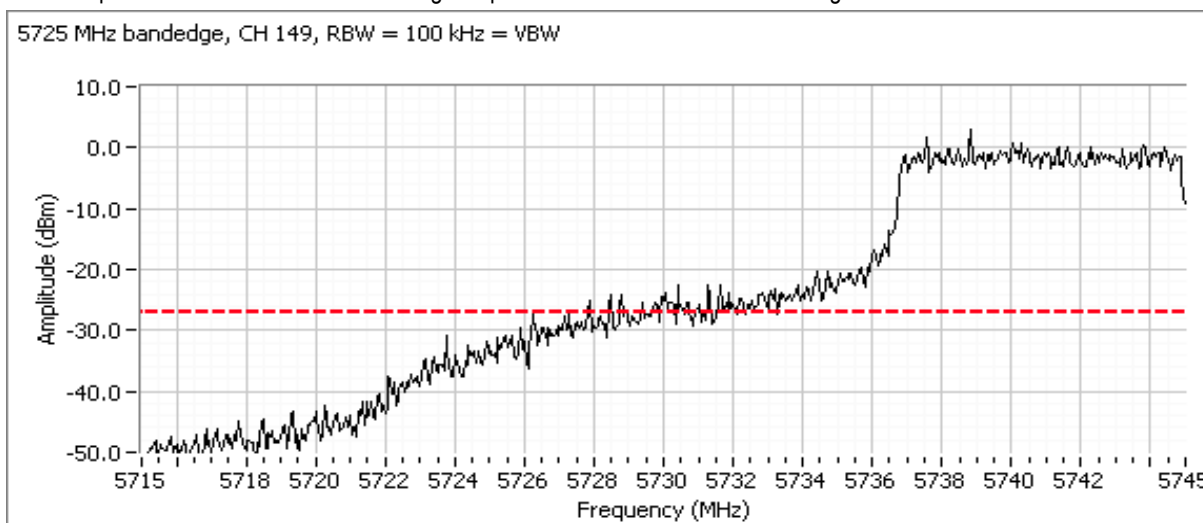

Client:	Intel Corporation	Job Number:	J80398
Model:	Intel® Centrino® Advanced-N 6230	T-Log Number:	T80759
Contact:	Steve Hackett	Account Manager:	Christine Krebill
Standard:	FCC 15.247	Class:	N/A

Plots for center channel, power setting = 16.5 dBm

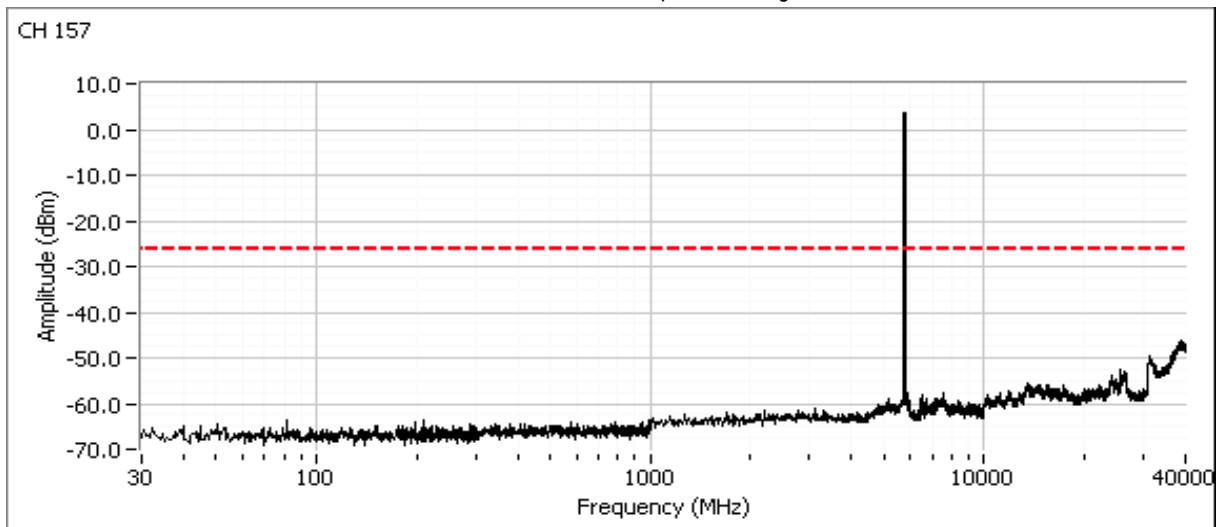

Plots for high channel, power setting = 16.5 dBm

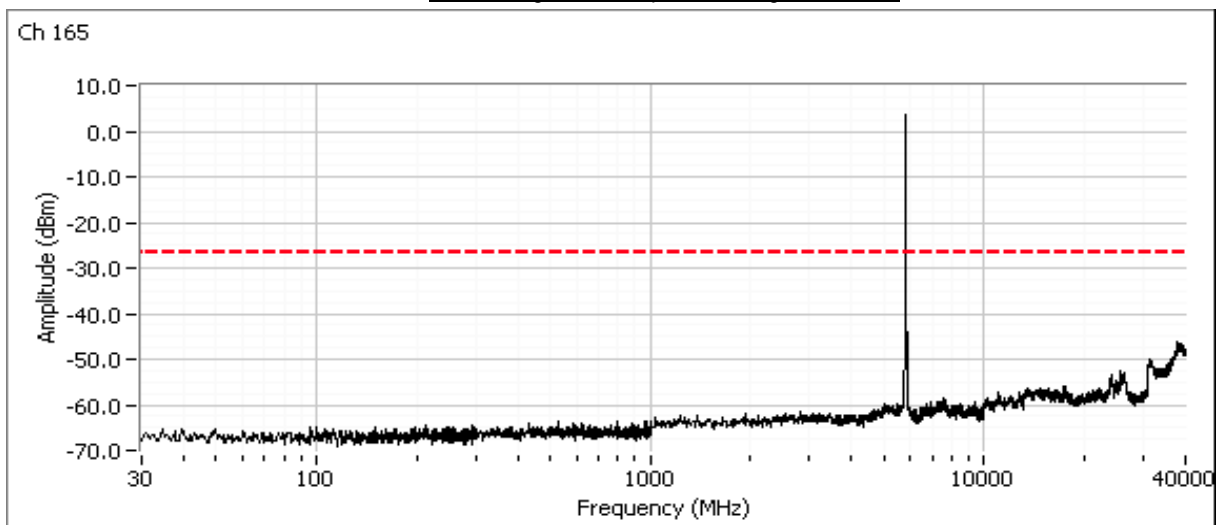

Client:	Intel Corporation	Job Number:	J80398
Model:	Intel® Centrino® Advanced-N 6230	T-Log Number:	T80759
Contact:	Steve Hackett	Account Manager:	Christine Krebill
Standard:	FCC 15.247	Class:	N/A

Additional plot from 5820 - 5860 MHz showing compliance with **-30dBc** at the band edge.

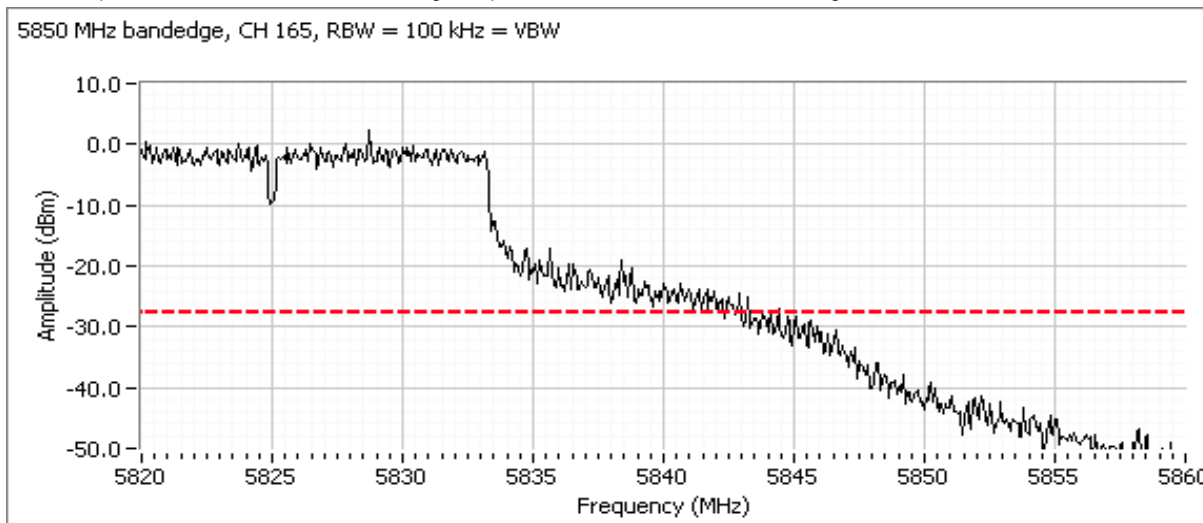

Client:	Intel Corporation	Job Number:	J80398
Model:	Intel® Centrino® Advanced-N 6230	T-Log Number:	T80759
Contact:	Steve Hackett	Account Manager:	Christine Krebill
Standard:	FCC 15.247	Class:	N/A

802.11n 20MHz Mode

Frequency (MHz)	Limit	Result
5745	-30dBc	Pass
5785	-30dBc	Pass
5825	-30dBc	Pass

Plots for low channel, power setting = 16.6 dBm

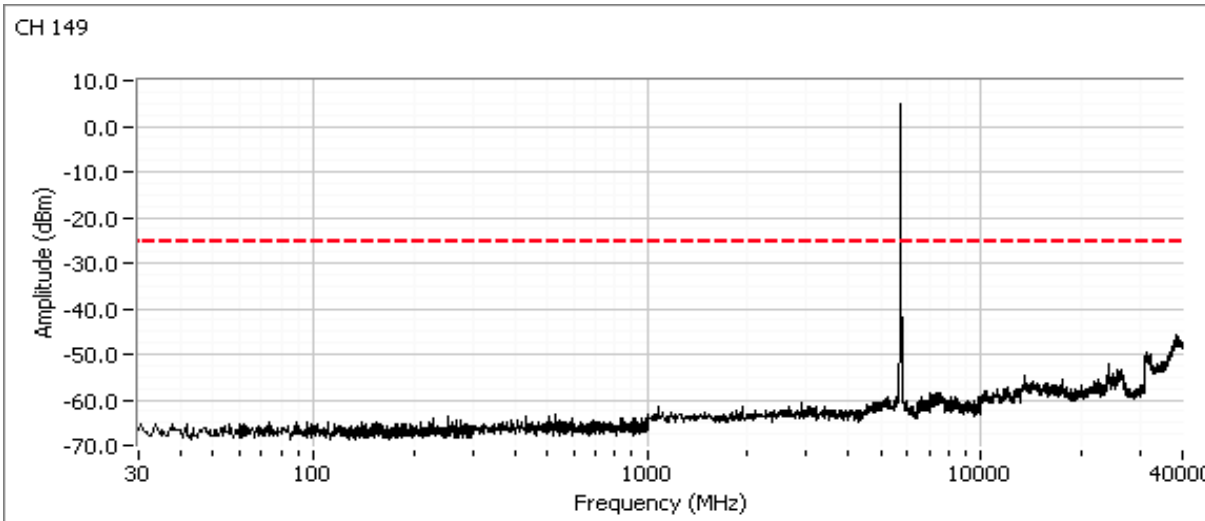

Additional plot from 5715 - 5755 MHz showing compliance with -30dBc at the band edge.

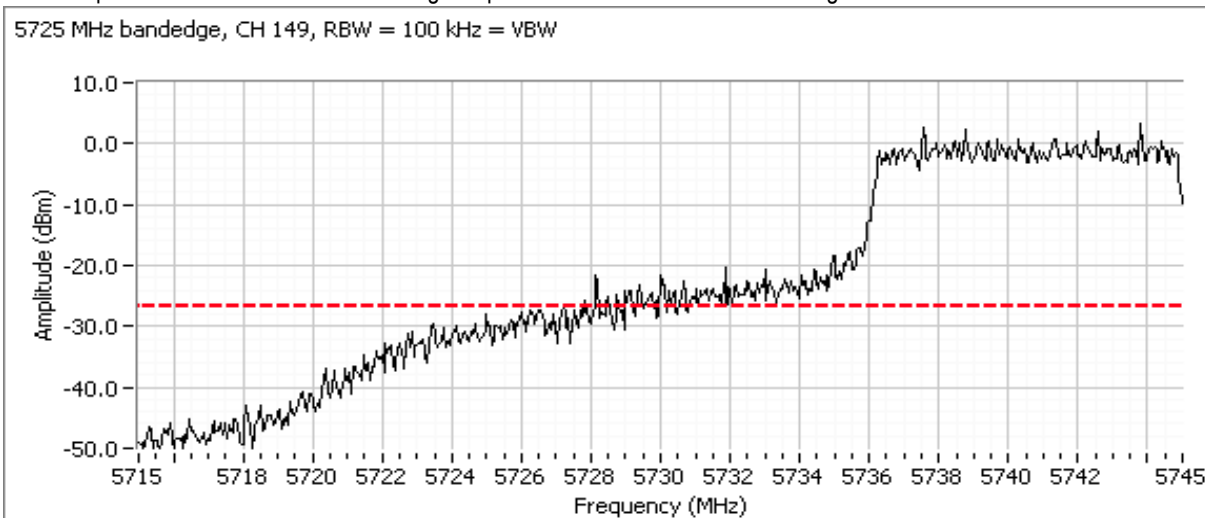

Client:	Intel Corporation	Job Number:	J80398
Model:	Intel® Centrino® Advanced-N 6230	T-Log Number:	T80759
Contact:	Steve Hackett	Account Manager:	Christine Krebill
Standard:	FCC 15.247	Class:	N/A

Plots for center channel, power setting = 16.5 dBm

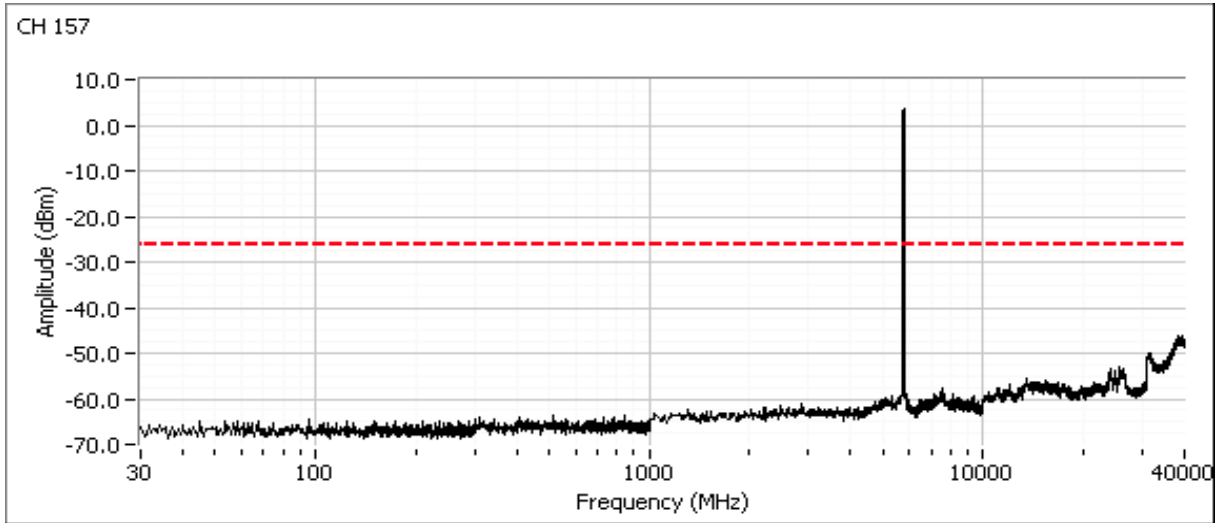

Plots for high channel, power setting = 16.5 dBm

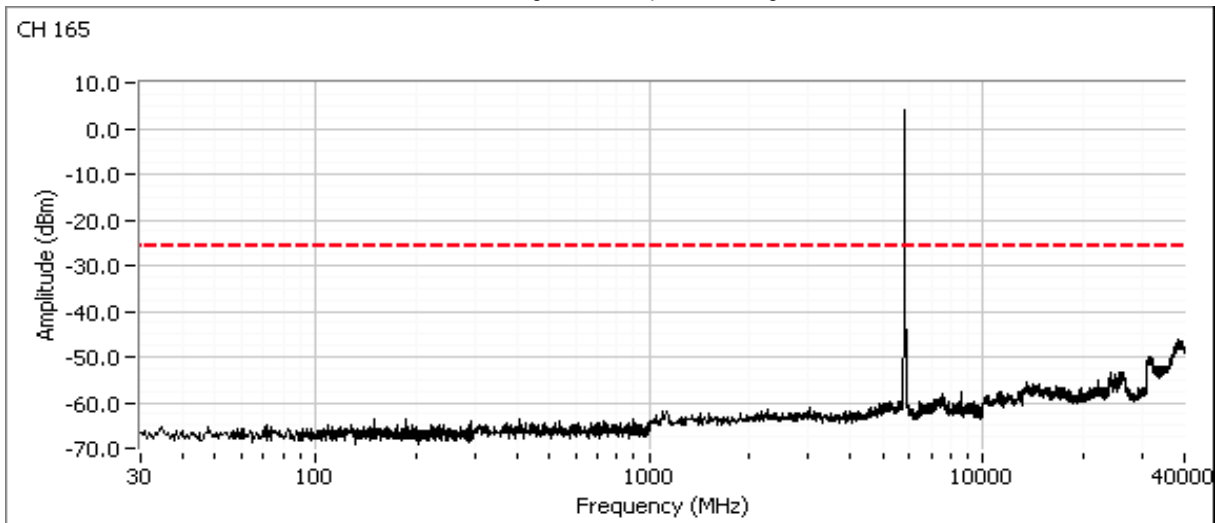

Client:	Intel Corporation	Job Number:	J80398
Model:	Intel® Centrino® Advanced-N 6230	T-Log Number:	T80759
Contact:	Steve Hackett	Account Manager:	Christine Krebill
Standard:	FCC 15.247	Class:	N/A

Additional plot from 5820 - 5860 MHz showing compliance with **-30dBc** at the band edge.

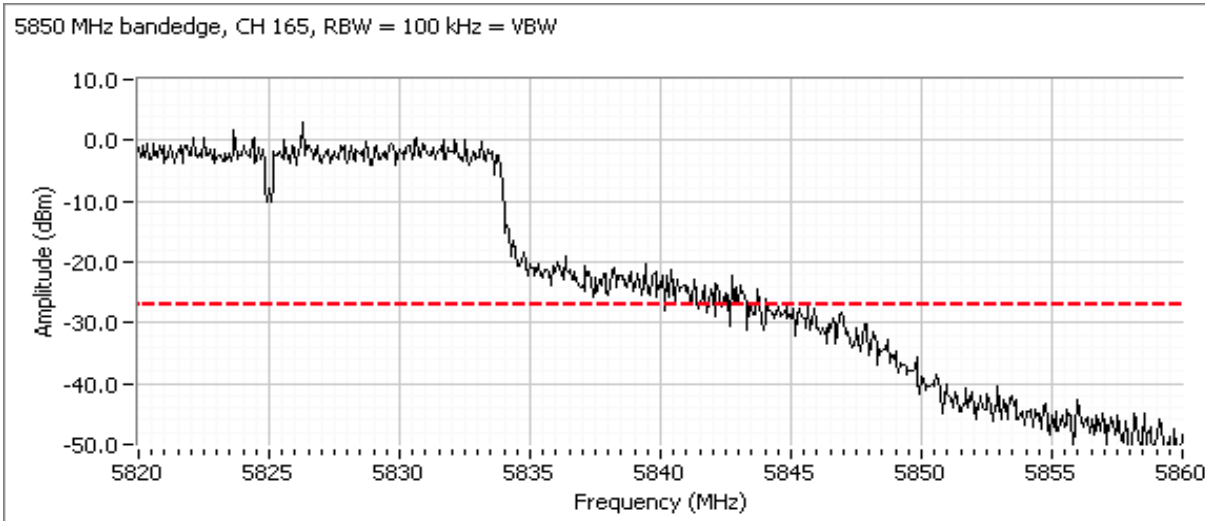

Client:	Intel Corporation	Job Number:	J80398
Model:	Intel® Centrino® Advanced-N 6230	T-Log Number:	T80759
Contact:	Steve Hackett	Account Manager:	Christine Krebill
Standard:	FCC 15.247	Class:	N/A

802.11n 40MHz Mode

Frequency (MHz)	Limit	Result
5795	-20dBc	Pass
5755	-20dBc	Pass

Plots for low channel, power setting = 16.5 dBm

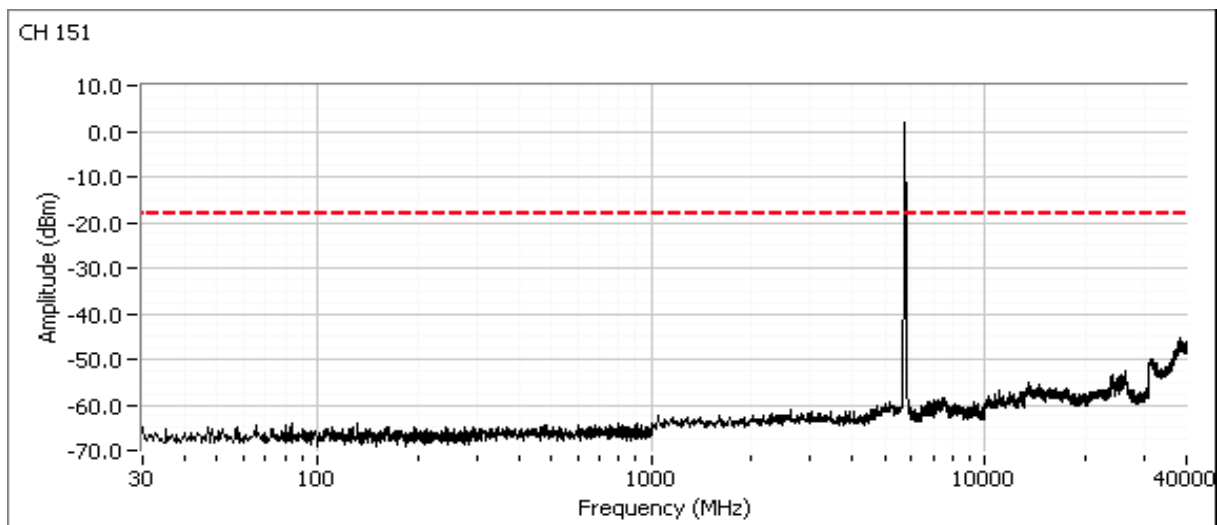

Client:	Intel Corporation	Job Number:	J80398
Model:	Intel® Centrino® Advanced-N 6230	T-Log Number:	T80759
Contact:	Steve Hackett	Account Manager:	Christine Krebill
Standard:	FCC 15.247	Class:	N/A

Additional plot from 5715 - 5775 MHz showing compliance with **-20dBc** at the band edge.

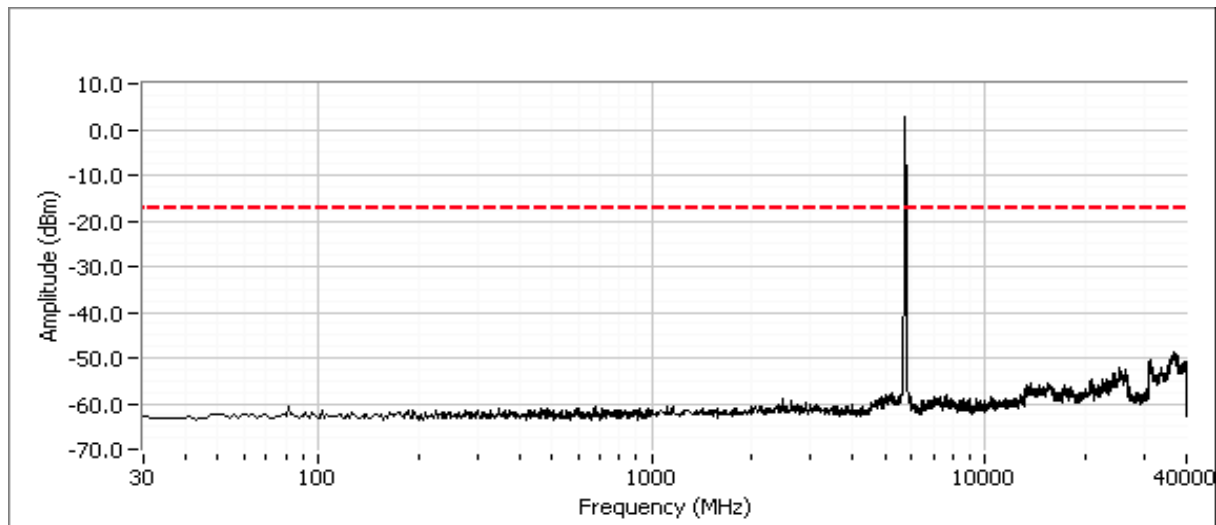
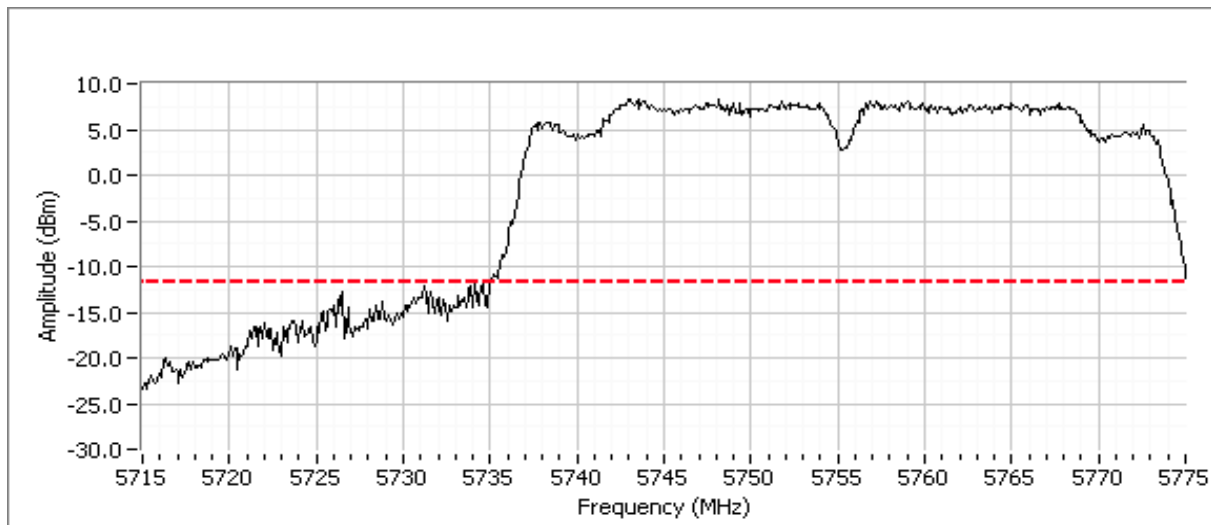

Client:	Intel Corporation	Job Number:	J80398
Model:	Intel® Centrino® Advanced-N 6230	T-Log Number:	T80759
Contact:	Steve Hackett	Account Manager:	Christine Krebill
Standard:	FCC 15.247	Class:	N/A

Plots for high channel, power setting = 16.5

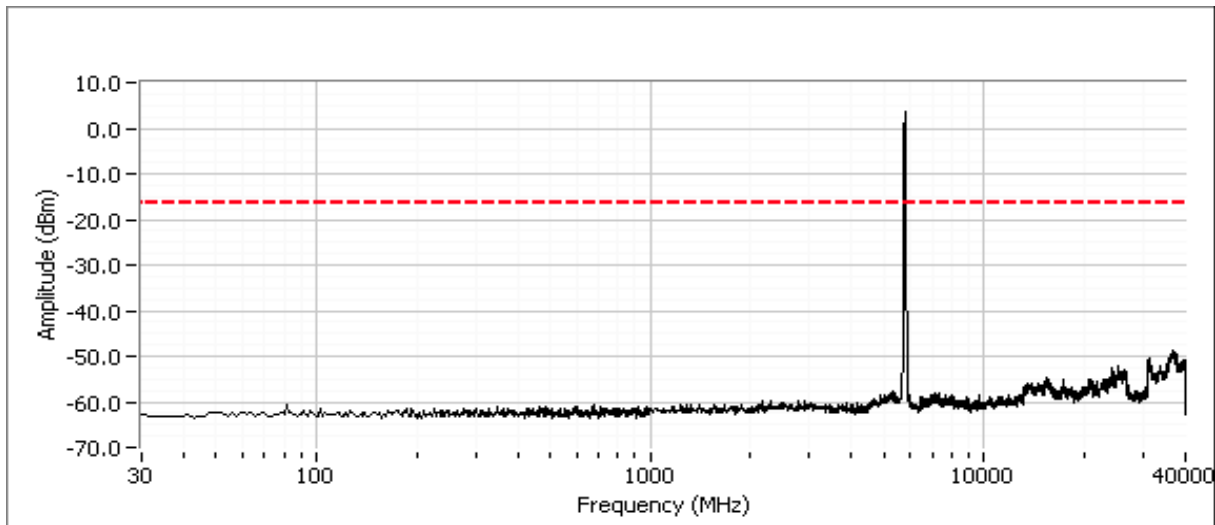

Additional plot from 5785 - 5860 MHz showing compliance with **-20dBc** at the band edge.

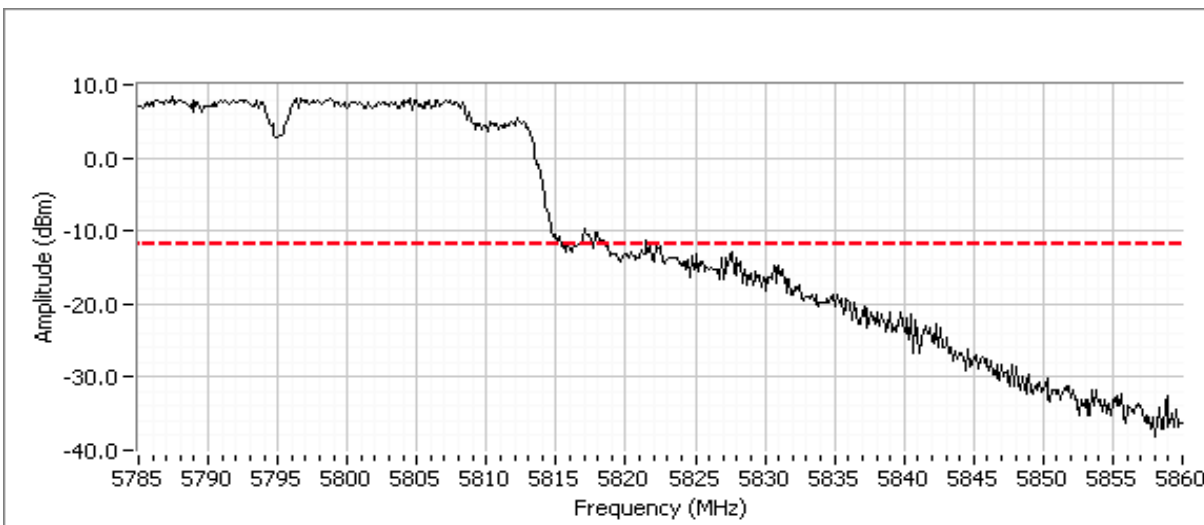

Client:	Intel Corporation	Job Number:	J80398
Model:	Intel® Centrino® Advanced-N 6230	T-Log Number:	T80759
		Account Manager:	Christine Krebill
Contact:	Steve Hackett		
Standard:	FCC 15.247	Class:	N/A

**RSS 210 and FCC 15.247 (DTS) Antenna Port Measurements
Power, PSD, Bandwidth and Spurious Emissions - Chain B**

Test Specific Details

Objective: The objective of this test session is to perform final qualification testing of the EUT with respect to the specification listed above.

Date of Test: 9/29/2010
 Test Engineer: Rafael Varelas
 Test Location: FT Chamber #5

Config. Used: 1
 Config Change: none
 Host Unit Voltage 120V/60Hz

General Test Configuration

The EUT was connected to the spectrum analyzer or power meter via a suitable attenuator. All measurements were made on a single chain.

All measurements have been corrected to allow for the external attenuators used.

Ambient Conditions:

Temperature: 22.4 °C
 Rel. Humidity: 42 %

Summary of Results

MAC Address: 00150079AD1A DRTU Tool Version 1.2.12-0197 Driver version 14.0.0.39

Run #	Pwr setting	Avg Pwr	Test Performed	Limit	Pass / Fail	Result / Margin
1	30	16.6	Output Power	15.247(b)	Pass	802.11a: 39.8 mW n20: 39.8 mW n40: 102 mW
2	29	16.7	Power spectral Density (PSD)	15.247(d)	Pass	802.11a:-7.7dBm/3kHz n20: -7.7dBm/3kHz n40: -8.2dBm/3kHz
3	29	16.6	Minimum 6dB Bandwidth	15.247(a)	Pass	16.3 MHz
3	30	16.6	99% Bandwidth	RSS GEN	-	802.11a: 17.6 MHz n20: 18.7 MHz n40: 37.8 MHz
4	-	-	Spurious emissions	15.247(b)	Pass	All emissions below the limit

Modifications Made During Testing

No modifications were made to the EUT during testing

Client: Intel Corporation	Job Number: J80398
Model: Intel® Centrino® Advanced-N 6230	T-Log Number: T80759
	Account Manager: Christine Krebill
Contact: Steve Hackett	
Standard: FCC 15.247	Class: N/A

Deviations From The Standard

No deviations were made from the requirements of the standard.

Run #1: Output Power

802.11a Mode

Power Setting ²	Frequency (MHz)	Output Power		Antenna Gain (dBi)	Result	EIRP ^{Note 2}		Output Power	
		(dBm) ¹	mW			dBm	W	(dBm) ³	mW
29	5745	16.0	39.8	5.0	Pass	21.0	0.126	16.7	46.8
29	5785	15.9	38.9	5.0	Pass	20.9	0.123	16.7	46.8
29	5825	15.9	38.9	5.0	Pass	20.9	0.123	16.6	45.7

- Note 1: Output power measured using a spectrum analyzer (see plots below) with RBW=1MHz, VB=3 MHz, sample detector, power averaging on (transmitted signal was continuous) and power integration over **50 MHz** (option #2, method 1 in KDB 558074, equivalent to method 1 of DA-02-2138A1 for U-NII devices). Spurious limit becomes **-30dBc**.
- Note 2: Power setting - the software power setting used during testing, included for reference only.
- Note 3: Power measured using average power meter and is included for reference only.

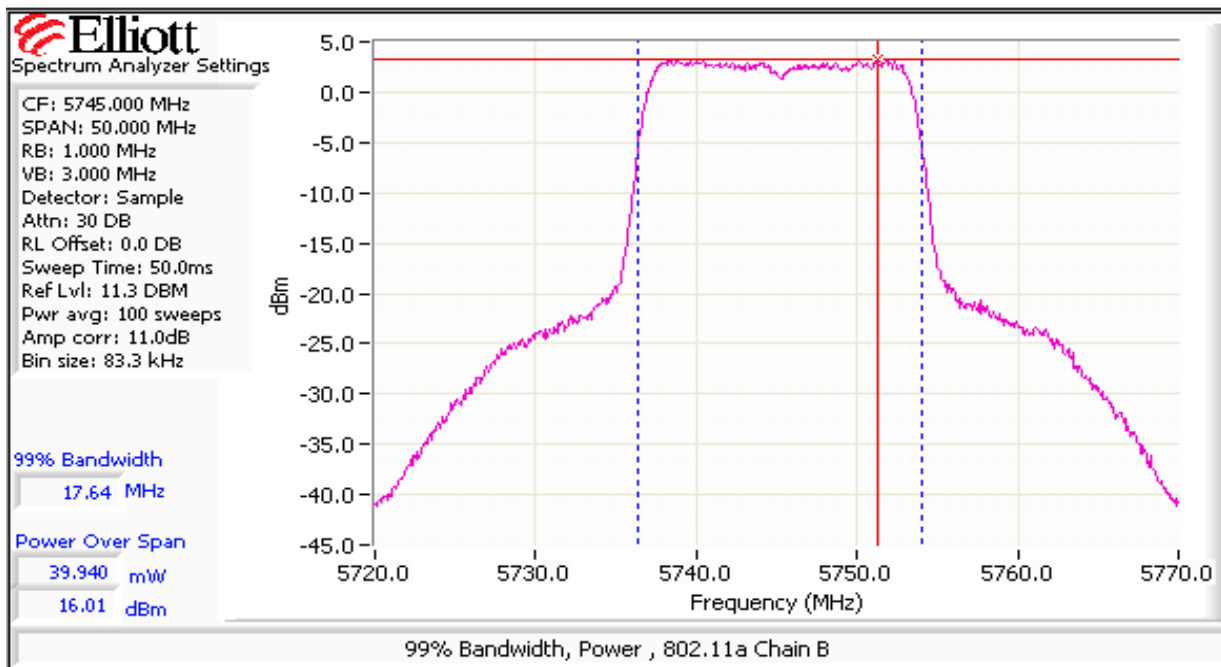

Client:	Intel Corporation	Job Number:	J80398
Model:	Intel® Centrino® Advanced-N 6230	T-Log Number:	T80759
Contact:	Steve Hackett	Account Manager:	Christine Krebill
Standard:	FCC 15.247	Class:	N/A

802.11n 20MHz Mode

Power Setting ²	Frequency (MHz)	Output Power		Antenna Gain (dBi)	Result	EIRP ^{Note 2}		Output Power	
		(dBm) ¹	mW			dBm	W	(dBm) ³	mW
29	5745	16.0	39.8	5.0	Pass	21.0	0.126	16.7	46.8
29	5785	15.9	38.9	5.0	Pass	20.9	0.123	16.6	45.7
29	5825	15.9	38.9	5.0	Pass	20.9	0.123	16.6	45.7

- Note 1: Output power measured using a spectrum analyzer (see plots below) with RBW=1MHz, VB=3 MHz, sample detector, power averaging on (transmitted signal was continuous) and power integration over **50 MHz** (option #2, method 1 in KDB 558074, equivalent to method 1 of DA-02-2138A1 for U-NII devices). Spurious limit becomes **-30dBc**.
- Note 2: Power setting - the software power setting used during testing, included for reference only.
- Note 3: Power measured using average power meter and is included for reference only.

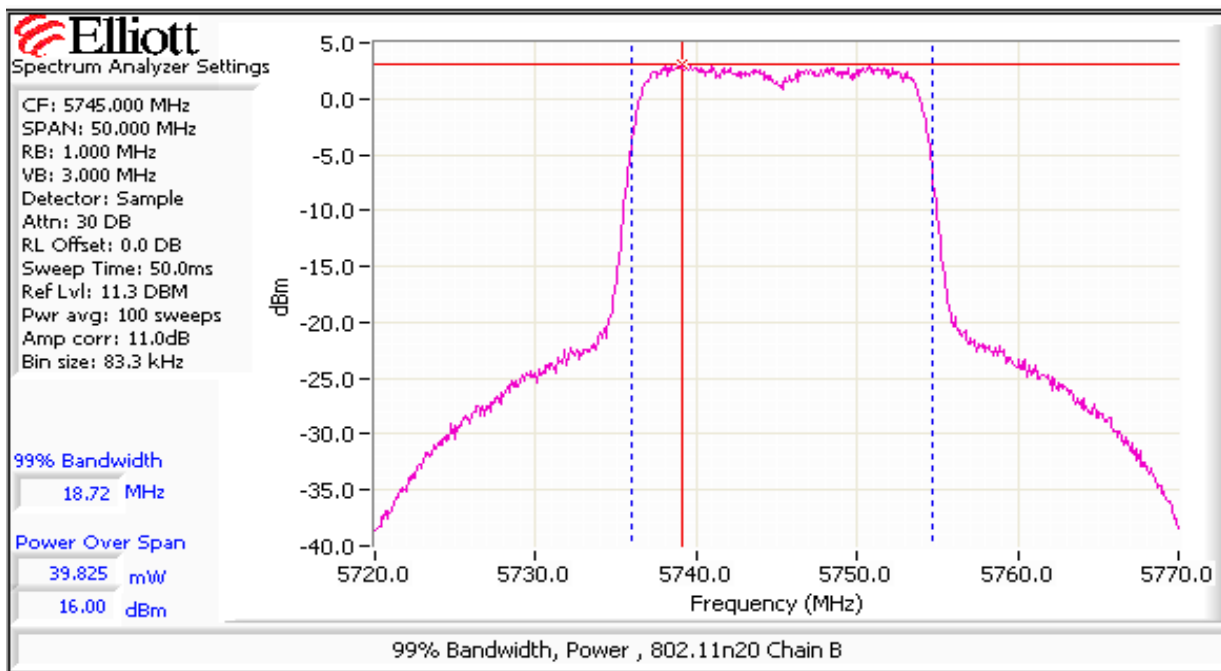

Client:	Intel Corporation	Job Number:	J80398
Model:	Intel® Centrino® Advanced-N 6230	T-Log Number:	T80759
Contact:	Steve Hackett	Account Manager:	Christine Krebill
Standard:	FCC 15.247	Class:	N/A

802.11n 40MHz Mode

Power Setting ²	Frequency (MHz)	Output Power		Antenna Gain (dBi)	Result	EIRP ^{Note 2}		Output Power	
		(dBm) ¹	mW			dBm	W	(dBm) ³	mW
30	5755	20.1	102.3	5.0	Pass	25.1	0.324	16.6	45.7
30	5795	20.1	102.3	5.0	Pass	25.1	0.324	16.6	45.7

Note 1:	Output power measured using a peak power meter, spurious limit is -20dBc .
Note 2:	Power setting - the software power setting used during testing, included for reference only.
Note 3:	Power measured using average power meter and is included for reference only.

Client: Intel Corporation	Job Number: J80398
Model: Intel® Centrino® Advanced-N 6230	T-Log Number: T80759
	Account Manager: Christine Krebill
Contact: Steve Hackett	
Standard: FCC 15.247	Class: N/A

Run #2: Power spectral Density

Mode	Power Setting	Frequency (MHz)	PSD (dBm/3kHz) ^{Note 1}	Limit dBm/3kHz	Result
802.11a	29	5745	-9.2	8.0	Pass
	29	5785	-9.5	8.0	Pass
	29	5825	-7.7	8.0	Pass
802.11n 20MHz	29	5745	-10.7	8.0	Pass
	29	5785	-7.8	8.0	Pass
	29	5825	-7.7	8.0	Pass
802.11n 40MHz	30	5755	-8.2	8.0	Pass
	30	5795	-8.5	8.0	Pass

Note 1: Power spectral density measured using RB=3 kHz, VB=10kHz, analyzer with peak detector and with a sweep time set to ensure a dwell time of at least 1 second per 3kHz. The measurement is made at the frequency of PPSD determined from preliminary scans using RB=3kHz using multiple sweeps at a faster rate over the 6dB bandwidth of the signal.

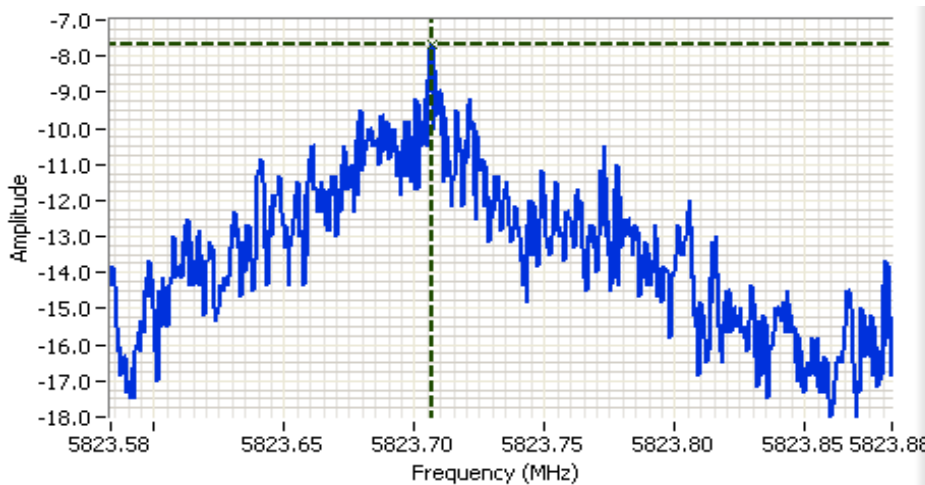

Analyzer Settings

HP8564E
CF: 5823.733 MHz
SPAN: 300 kHz
RB: 3.00 kHz
VB: 10.0 kHz
Detector: Normal
Attn: 10 DB
RL Offset: 11.0 DB
Sweep Time: 100.0s
Ref Lvl: 1.0 DBM

Comments

PSD @ 5825 MHz
802.11a
Chain B

Cursor 1	5823.7068	-7.67	
	0.0000	0.00	

Client:	Intel Corporation	Job Number:	J80398
Model:	Intel® Centrino® Advanced-N 6230	T-Log Number:	T80759
Contact:	Steve Hackett	Account Manager:	Christine Krebill
Standard:	FCC 15.247	Class:	N/A

Run #3: Signal Bandwidth

Mode	Power Setting	Frequency (MHz)	Resolution Bandwidth	Bandwidth (MHz)	
				6dB	99%
802.11a	29	5745	100kHz	16.5	17.6
	29	5785	100kHz	16.4	17.6
	29	5825	100kHz	16.3	17.6
802.11n 20MHz	29	5745	100kHz	17.1	18.7
	29	5785	100kHz	17.4	18.7
	29	5825	100kHz	17	18.6
802.11n 40MHz	30	5755	100kHz	34	37.8
	30	5795	100kHz	35.2	37.4

Note 1: 99% bandwidth measured in accordance with RSS GEN, with RB > 1% of the span and VB > 3xRB

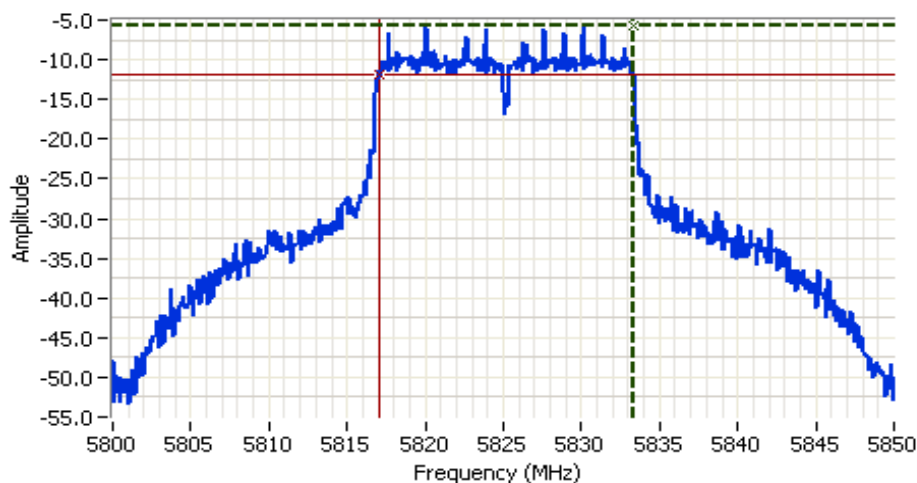

Analyzer Settings

HP8564E
CF: 5825.000 MHz
SPAN: 50.000 MHz
RB: 100 kHz
VB: 100 kHz
Detector: POS
Attn: 20 DB
RL Offset: 0.0 DB
Sweep Time: 50.0ms
Ref Lvl: 4.7 DBM

Comments

6dB BW: 16.333 MHz
802.11a
Chain B

Cursor 1	5833.3333	-5.80	
Cursor 2	5817.0000	-11.80	

Delta Freq. 16.333

Delta Amplitude 6.00



Client:	Intel Corporation	Job Number:	J80398
Model:	Intel® Centrino® Advanced-N 6230	T-Log Number:	T80759
Contact:	Steve Hackett	Account Manager:	Christine Krebill
Standard:	FCC 15.247	Class:	N/A

Run #4: Out of Band Spurious Emissions

802.11a Mode

Frequency (MHz)	Limit	Result
5745	-30dBc	Pass
5785	-30dBc	Pass
5825	-30dBc	Pass

Plots for low channel, power setting(s) = 29.0

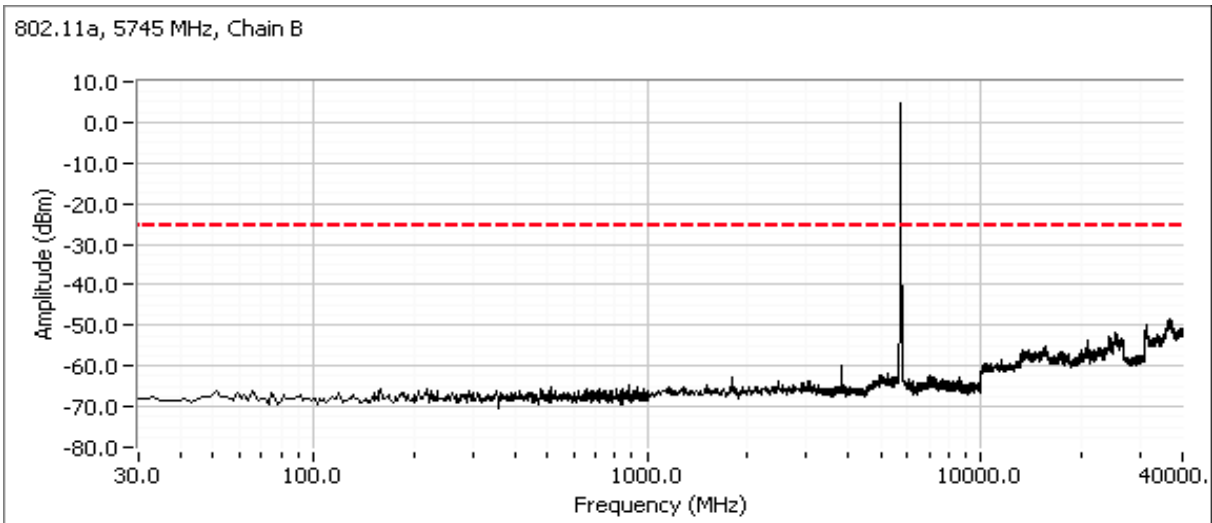

Client:	Intel Corporation	Job Number:	J80398
Model:	Intel® Centrino® Advanced-N 6230	T-Log Number:	T80759
Contact:	Steve Hackett	Account Manager:	Christine Krebill
Standard:	FCC 15.247	Class:	N/A

Additional plot from 5715 - 5755 MHz showing compliance with **-30dBc** at the band edge.

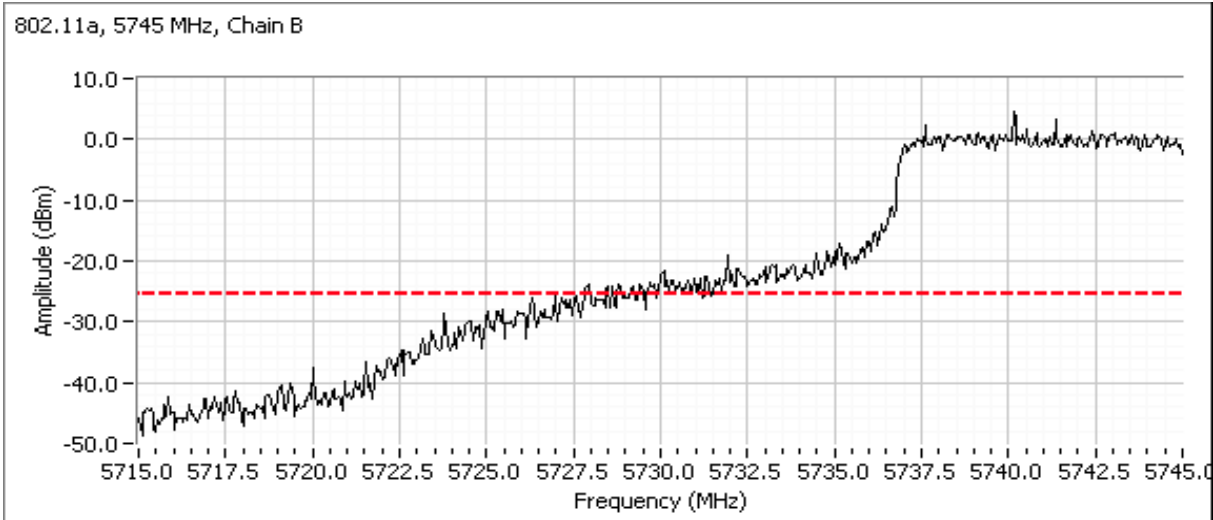

Plots for center channel, power setting(s) = 29.0

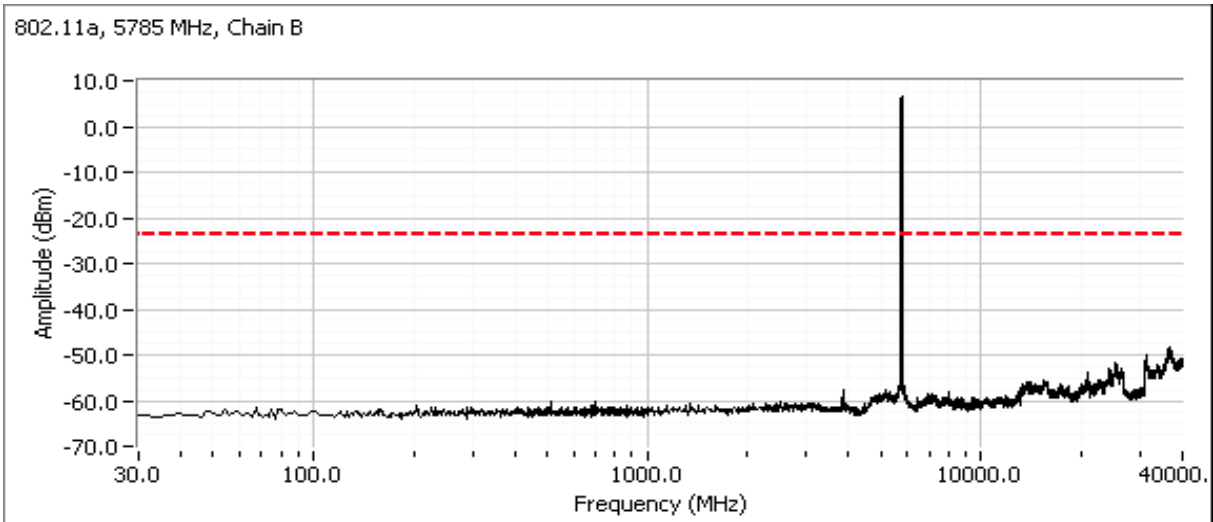

Client:	Intel Corporation	Job Number:	J80398
Model:	Intel® Centrino® Advanced-N 6230	T-Log Number:	T80759
Contact:	Steve Hackett	Account Manager:	Christine Krebill
Standard:	FCC 15.247	Class:	N/A

Plots for high channel, power setting(s) = 29.0

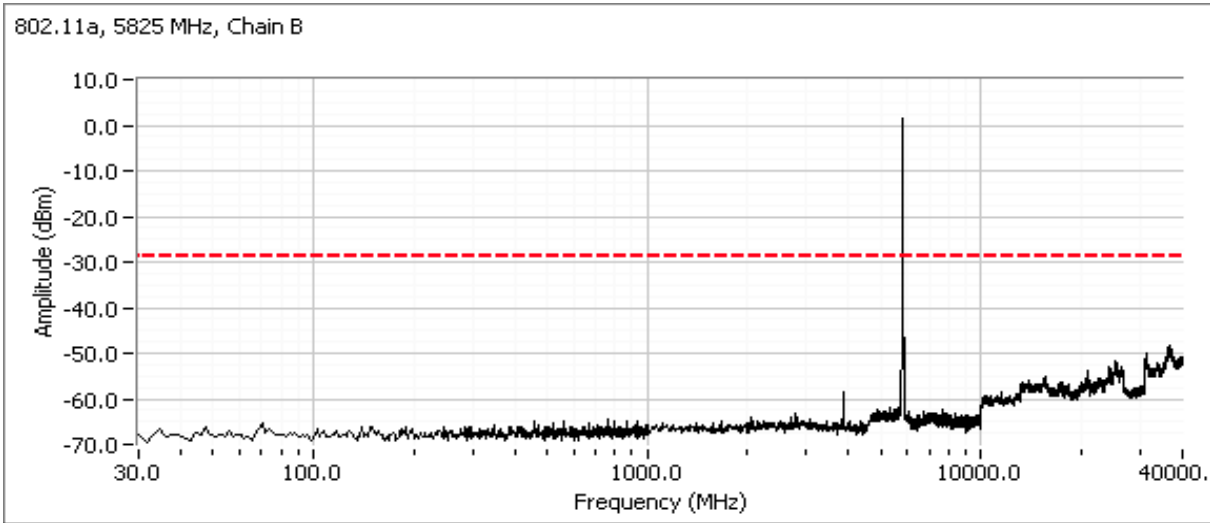

Additional plot from 5820 - 5860 MHz showing compliance with **-30dBc** at the band edge.

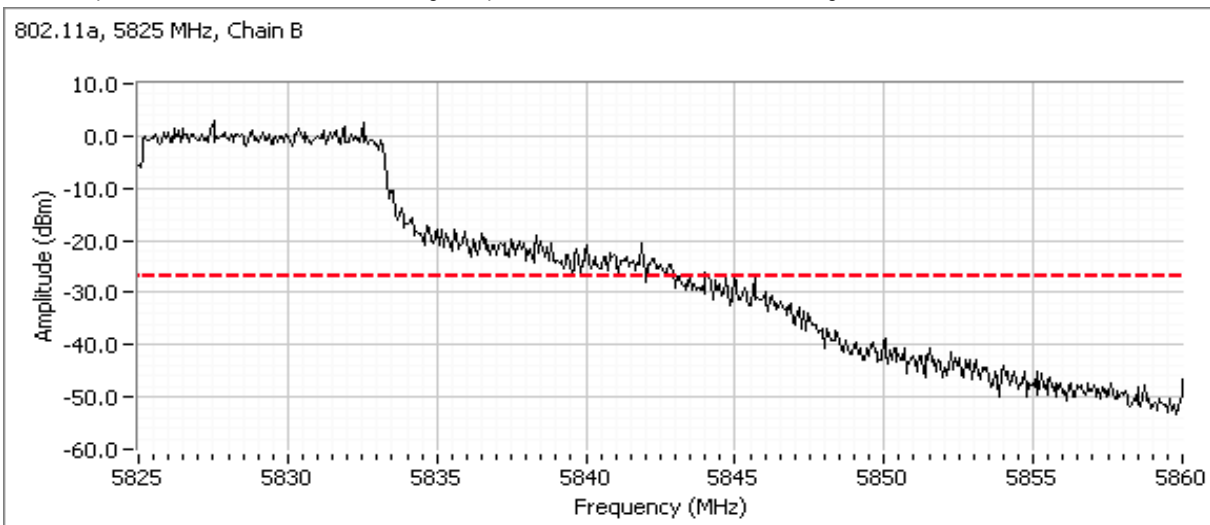

Client:	Intel Corporation	Job Number:	J80398
Model:	Intel® Centrino® Advanced-N 6230	T-Log Number:	T80759
Contact:	Steve Hackett	Account Manager:	Christine Krebill
Standard:	FCC 15.247	Class:	N/A

802.11n 20MHz Mode

Frequency (MHz)	Limit	Result
5745	-30dBc	Pass
5785	-30dBc	Pass
5825	-30dBc	Pass

Plots for low channel, power setting(s) = 29.0

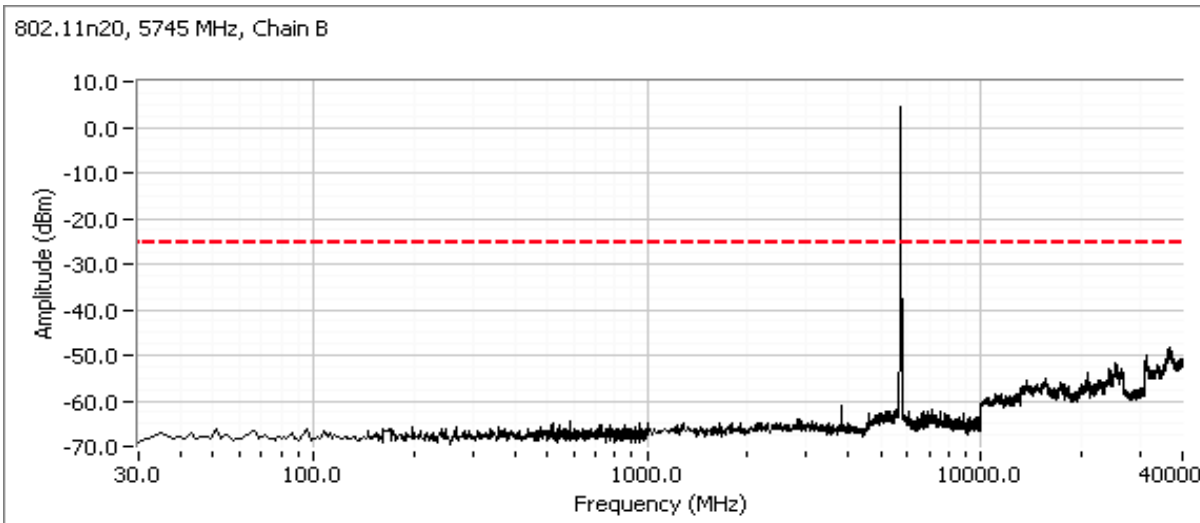

Additional plot from 5715 - 5755 MHz showing compliance with -30dBc at the band edge.

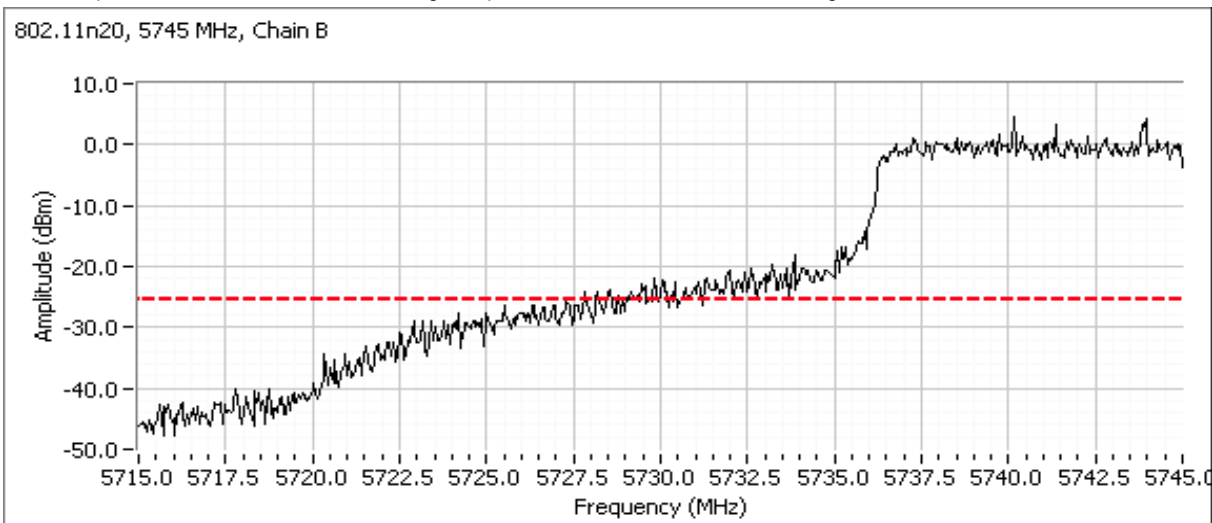

Client:	Intel Corporation	Job Number:	J80398
Model:	Intel® Centrino® Advanced-N 6230	T-Log Number:	T80759
Contact:	Steve Hackett	Account Manager:	Christine Krebill
Standard:	FCC 15.247	Class:	N/A

Plots for center channel, power setting(s) = 29.0

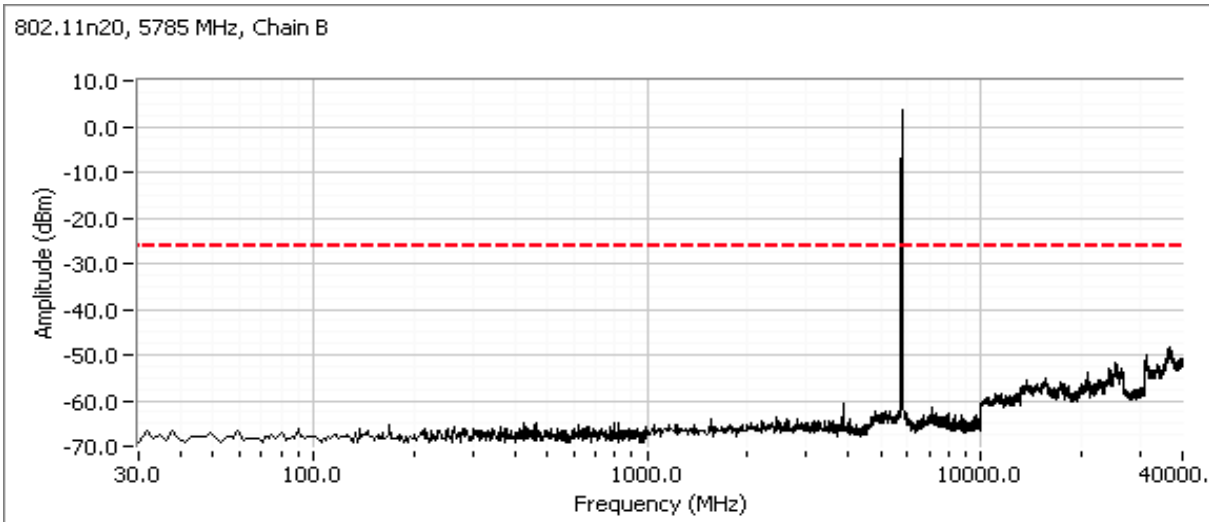

Plots for high channel, power setting(s) = 29.0

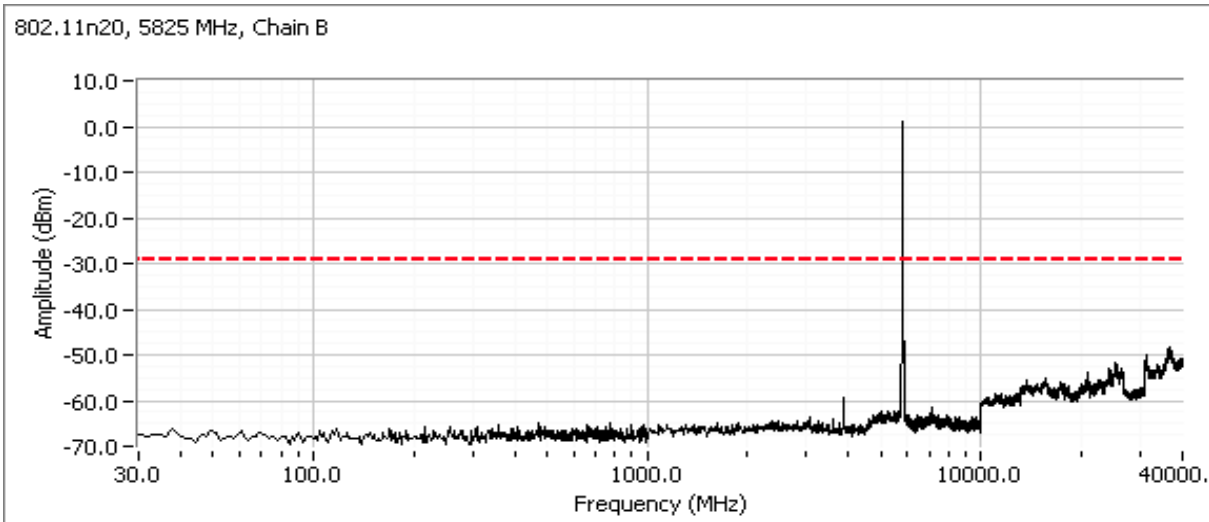

Client:	Intel Corporation	Job Number:	J80398
Model:	Intel® Centrino® Advanced-N 6230	T-Log Number:	T80759
Contact:	Steve Hackett	Account Manager:	Christine Krebill
Standard:	FCC 15.247	Class:	N/A

Additional plot from 5820 - 5860 MHz showing compliance with **-30dBc** at the band edge.

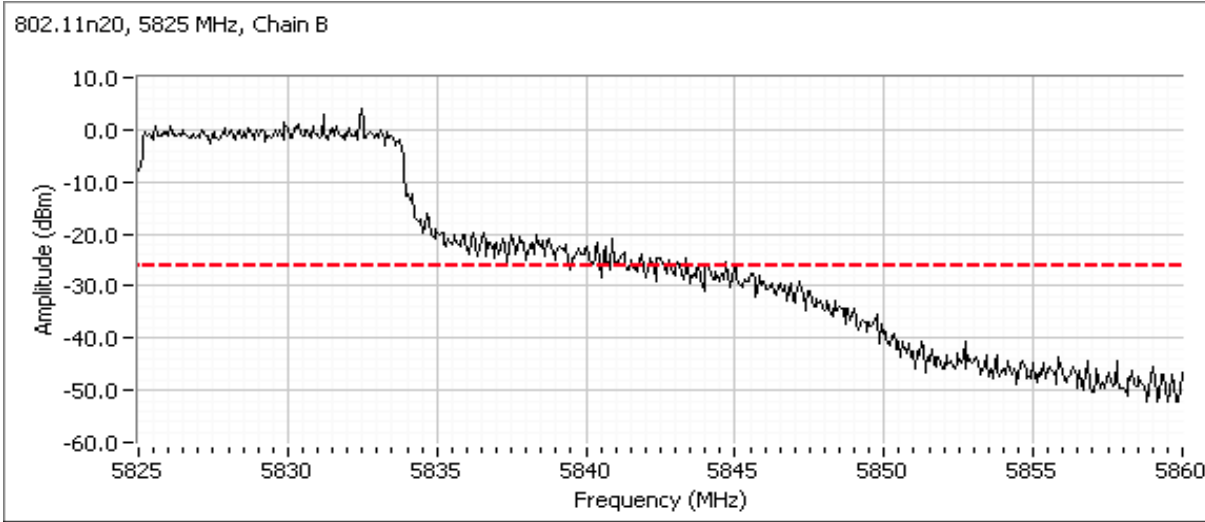

802.11n 40MHz Mode

Frequency (MHz)	Limit	Result
5755	-20dBc	Pass
5795	-20dBc	Pass

Plots for low channel, power setting(s) = 30.0

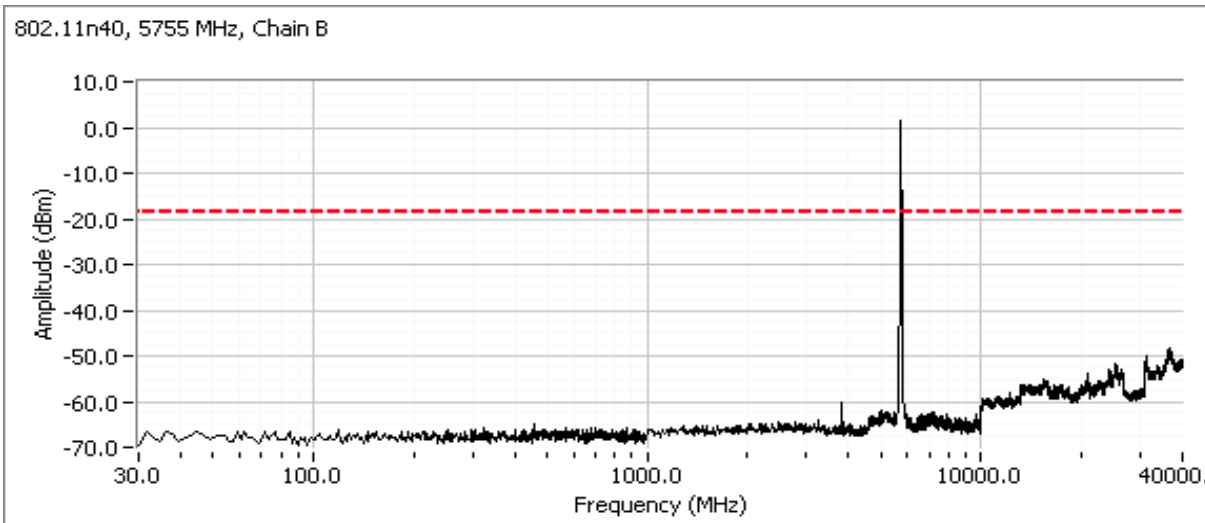

Client:	Intel Corporation	Job Number:	J80398
Model:	Intel® Centrino® Advanced-N 6230	T-Log Number:	T80759
Contact:	Steve Hackett	Account Manager:	Christine Krebill
Standard:	FCC 15.247	Class:	N/A

Additional plot from 5715 - 5755 MHz showing compliance with **-20dBc** at the band edge.

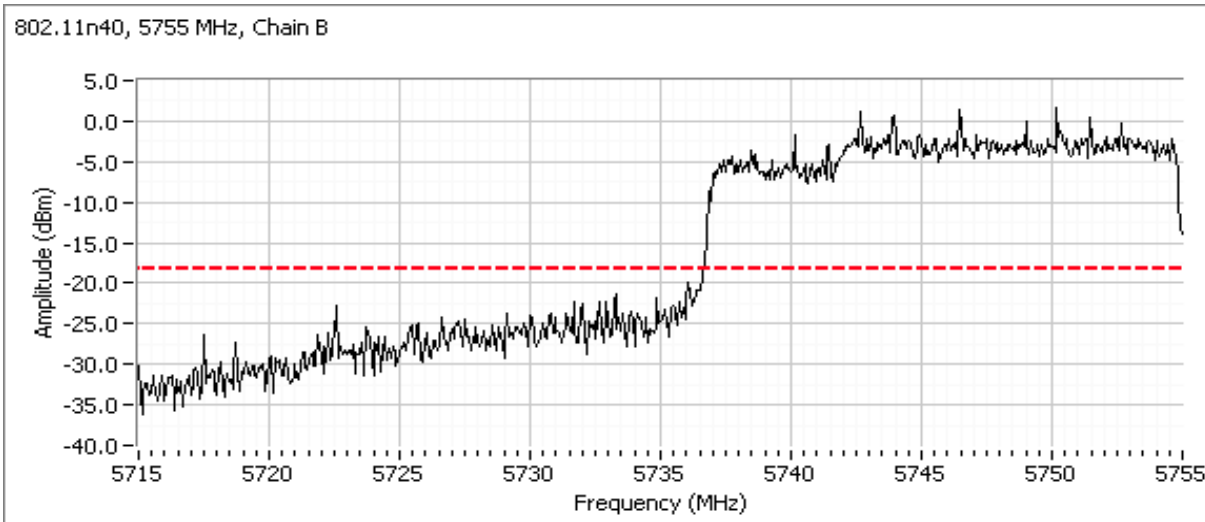

Plots for high channel, power setting(s) = 30.0

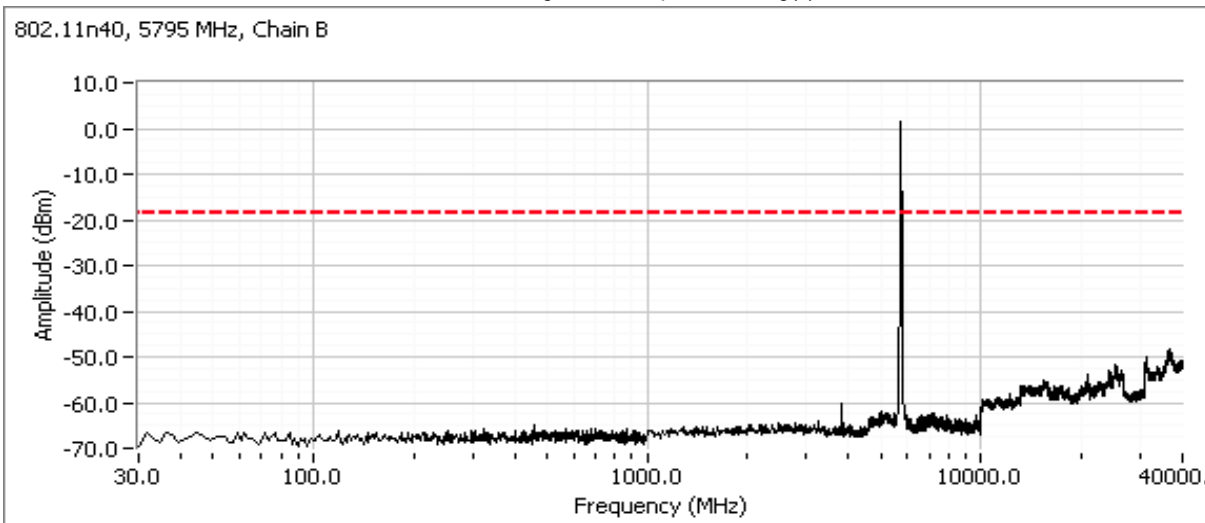

Client:	Intel Corporation	Job Number:	J80398
Model:	Intel® Centrino® Advanced-N 6230	T-Log Number:	T80759
Contact:	Steve Hackett	Account Manager:	Christine Krebill
Standard:	FCC 15.247	Class:	N/A

Additional plot from 5785 - 5860 MHz showing compliance with **-20dBc** at the band edge.

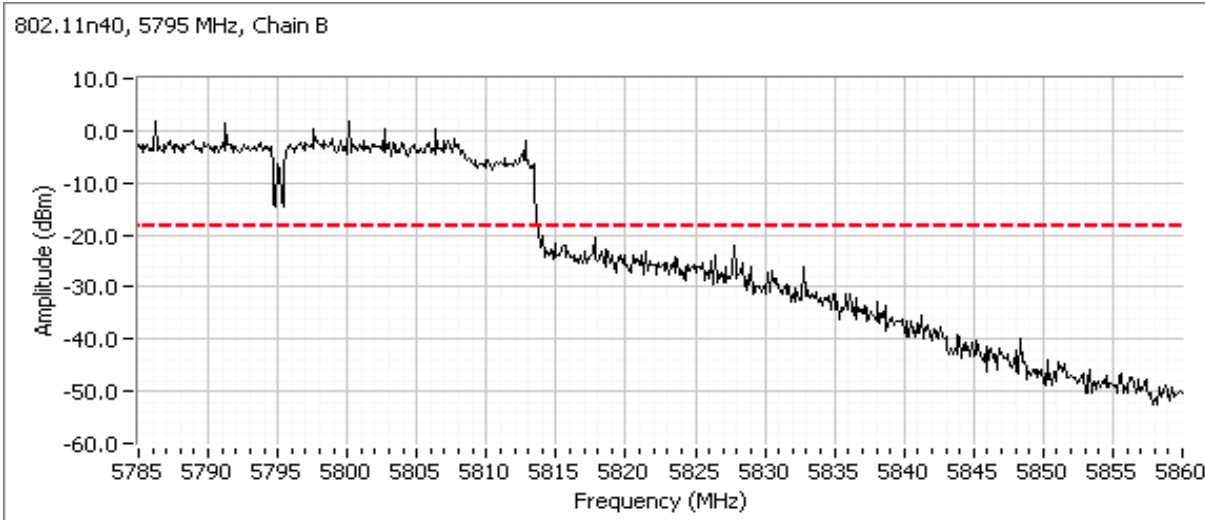

Client:	Intel Corporation	Job Number:	J80398
Model:	Intel® Centrino® Advanced-N 6230	T-Log Number:	T80759
Contact:	Steve Hackett	Account Manager:	Christine Krebill
Standard:	FCC 15.247	Class:	N/A

**RSS 210 and FCC 15.247 (DTS) Antenna Port Measurements
MIMO Antenna Systems - Chain A+B
Power, PSD, Bandwidth and Spurious Emissions**

Test Specific Details

Objective: The objective of this test session is to perform final qualification testing of the EUT with respect to the specification listed above.

Date of Test: 10/1/2010
Test Engineer: David Bare
Test Location: Chamber 7

Config. Used: 1
Config Change: None
Host Unit Voltage 120V/60Hz

General Test Configuration

The EUT was connected to the spectrum analyzer or power meter via a suitable attenuator. All measurements were made on a single chain.

All measurements have been corrected to allow for the external attenuators used.

Ambient Conditions:

Temperature: 22 °C
Rel. Humidity: 41 %

Summary of Results

MAC Address: 00150079AD1A DRTU Tool Version 1.2.12-0197 Driver version 14.0.0.39

Run #	Pwr setting	Avg Pwr	Test Performed	Limit	Pass / Fail	Result / Margin
Chain A + B						
1	See Below	See Below	Output Power, Average for n20, Peak for n40	15.247(b)	Pass	n20: 21 mW n40: 246 mW
2	See Below	See Below	Power spectral Density (PSD)	15.247(d)	Pass	n20: -10.3 dBm/3kHz n40: -12.2. dBm/3kHz
3			Minimum 6dB Bandwidth	15.247(a)		covered by
3			99% Bandwidth	RSS GEN		single chain
4			Spurious emissions	15.247(b)		Measurements

Modifications Made During Testing

No modifications were made to the EUT during testing

Deviations From The Standard

No deviations were made from the requirements of the standard.



EMC Test Data

Client:	Intel Corporation	Job Number:	J80398
Model:	Intel® Centrino® Advanced-N 6230	T-Log Number:	T80759
Contact:	Steve Hackett	Account Manager:	Christine Krebill
Standard:	FCC 15.247	Class:	N/A

Run #1: Output Power - Chain A + B
 Operating Mode: MIMO
 Transmitted signal on chain is coherent ? no

802.11n 20MHz 5745 MHz	Chain 1	Chain 2	Chain 3	Chain 4	Total Across All Chains		Limit	
Power Setting ^{Note 3}	31.0	28.0						
Average power ^{Note 3}	13.6	13.5						
Output Power (dBm) ^{Note 1}	10.4	10.2			13.3 dBm	0.021 W	30.0 dBm	1.000 W
Antenna Gain (dBi) ^{Note 2}	5	5				5.0 dBi	Pass	
eirp (dBm) ^{Note 2}	15.4	15.2			18.3 dBm	0.068 W		

802.11n 20MHz 5785 MHz	Chain 1	Chain 2	Chain 3	Chain 4	Total Across All Chains		Limit	
Power Setting ^{Note 3}	31.0	28.0						
Average power ^{Note 3}	13.5	13.4						
Output Power (dBm) ^{Note 1}	10.3	10.2			13.3 dBm	0.021 W	30.0 dBm	1.000 W
Antenna Gain (dBi) ^{Note 2}	5	5				5.0 dBi	Pass	
eirp (dBm) ^{Note 2}	15.3	15.2			18.3 dBm	0.067 W		

802.11n 20MHz 5825 MHz	Chain 1	Chain 2	Chain 3	Chain 4	Total Across All Chains		Limit	
Power Setting ^{Note 3}	31.0	28.5						
Average power ^{Note 3}	13.3	13.7						
Output Power (dBm) ^{Note 1}	10.2	10.4			13.3 dBm	0.021 W	30.0 dBm	1.000 W
Antenna Gain (dBi) ^{Note 2}	5	5				5.0 dBi	Pass	
eirp (dBm) ^{Note 2}	15.2	15.4			18.3 dBm	0.068 W		

- Note 1: Output power measured using a spectrum analyzer (see plots below) with RBW=1MHz, VB=3 MHz, sample detector, power averaging on (transmitted signal was continuous) and power integration over **50 MHz** (option #2, method 1 in KDB 558074, equivalent to method 1 of DA-02-2138A1 for U-NII devices). Spurious limit becomes **-30dBc**.
- Note 2: As there is no coherency between chains the total EIRP is the sum of the individual EIRPs and effective antenna gain equals the eirp divide by the sum of the power on each chain.
- Note 3: Power setting and average power are for reference only. Average power is the power measured using an average power sensor. Power setting is the power setting used in the test utility.

Client:	Intel Corporation	Job Number:	J80398
Model:	Intel® Centrino® Advanced-N 6230	T-Log Number:	T80759
Contact:	Steve Hackett	Account Manager:	Christine Krebill
Standard:	FCC 15.247	Class:	N/A

802.11n 40MHz 5755 MHz	Chain 1	Chain 2	Chain 3	Chain 4	Total Across All Chains		Limit	
Power Setting ^{Note 3}	31.0	29.0						
Average power ^{Note 3}	13.5	13.5						
Output Power (dBm) ^{Note 1}	21	20.8			23.9 dBm	0.246 W	30.0 dBm	1.000 W
Antenna Gain (dBi) ^{Note 2}	5	5				5.0 dBi	Pass	
eirp (dBm) ^{Note 2}	26	25.8			28.9 dBm	0.778 W		

802.11n 40MHz 5795 MHz	Chain 1	Chain 2	Chain 3	Chain 4	Total Across All Chains		Limit	
Power Setting ^{Note 3}	31.0	29.0						
Average power ^{Note 3}	13.3	13.4						
Output Power (dBm) ^{Note 1}	20.6	20.7			23.7 dBm	0.232 W	30.0 dBm	1.000 W
Antenna Gain (dBi) ^{Note 2}	5	5				5.0 dBi	Pass	
eirp (dBm) ^{Note 2}	25.6	25.7			28.7 dBm	0.735 W		

- Note 1: Output power measured using a peak power meter, spurious limit is **-20dBc**.
- Note 2: As there is no coherency between chains the total EIRP is the sum of the individual EIRPs and effective antenna gain equals the eirp divide by the sum of the power on each chain.
- Note 3: Power setting and average power are for reference only. Average power is the power measured using an average power sensor. Power setting is the power setting used in the test utility.

Run #2: Power spectral Density

Power Setting	Frequency (MHz)	PSD (dBm/3kHz) ^{Note 1}				Total	Limit dBm/3kHz	Result
		Chain 1	Chain 2	Chain 3	Chain 4			
802.11n 20MHz mode								
31 / 28	5745	-14.8	-15.2			-12.0	8.0	Pass
31 / 28	5785	-12.7	-14.0			-10.3	8.0	Pass
31 / 28.5	5825	-14.5	-14.8			-11.6	8.0	Pass
802.11n 40MHz mode								
31 / 29	5755	-15.5	-16.7			-13.0	8.0	Pass
31 / 29	5795	-14.8	-15.7			-12.2	8.0	Pass

Note 1: Power spectral density measured using RB=3 kHz, VB=10kHz, analyzer with peak detector and with a sweep time set to ensure a dwell time of at least 1 second per 3kHz. The measurement is made at the frequency of PPSD determined from preliminary scans using RB=3kHz using multiple sweeps at a faster rate over the 6dB bandwidth of the signal.



EMC Test Data

Client:	Intel Corporation	Job Number:	J80398
Model:	Intel® Centrino® Advanced-N 6230	T-Log Number:	T80540
		Account Manager:	Christine Krebill
Contact:	Steve Hackett		-
Emissions Standard(s):	FCC 15.247	Class:	B
Immunity Standard(s):	-	Environment:	-

EMC Test Data

For The

Intel Corporation

Model

Intel® Centrino® Advanced-N 6230

Date of Last Test: 10/6/2010

Client:	Intel Corporation	Job Number:	J80398
Model:	Intel® Centrino® Advanced-N 6230	T-Log Number:	T80540
Contact:	Steve Hackett	Account Manager:	Christine Krebill
Standard:	FCC 15.247	Class:	N/A

RSS 210 and FCC 15.247 (DSS) Radiated Spurious Emissions 802.11bgn and Bluetooth - Transmitter Mode

Test Specific Details

Objective: The objective of this test session is to perform engineering evaluation testing of the EUT with respect to the specification listed above.

General Test Configuration

The EUT was installed into a test fixture such that the EUT was exposed (i.e. outside of a host PC).
For conducted emissions testing the measurement antenna port.

Summary of Results

For Bluetooth: Tx is chain B, Rx is chain B. For WiFi, only Chain A is used for transmit in the 2.4GHz band, both chains used in 5GHz bands.

MAC Address: 00150079AD1A DRTU Tool Version 1.2.12-0197 New tool from 9/14 Driver version 14.0.0.39

Run #	Mode	Channel	Target Power	Measured Power	Test Performed	Limit	Result / Margin
1	BT 1Mb/s 802.11b	2402MHz 2412MHz	7dBm 16.5dBm	4.4 16.5	Radiated Emissions 1- 10 GHz	FCC 15.247	48.0dBµV/m @ 4824.0MHz (-6.0dB)
2	BT 1Mb/s 802.11b	2480MHz 2462MHz	7dBm 16.5dBm	5.3 16.6		FCC 15.247	48.4dBµV/m @ 2360.0MHz (-5.6dB)
3	BT 1Mb/s 802.11g	2402MHz 2412MHz	7dBm 16.5dBm	4.4 16.3		FCC 15.247	46.0dBµV/m @ 2281.9MHz (-8.0dB)
4	BT 1Mb/s 802.11g	2480MHz 2462MHz	7dBm 16.5dBm	5.3 16.9		FCC 15.247	46.6dBµV/m @ 2360.0MHz (-7.4dB)
WiFi mode for the following runs based on worst case mode from runs 1 through 4							
5	BT 1Mb/s 802.11b	2402MHz 2437MHz	7dBm 16.5dBm	4.3 16.6	Radiated Emissions 1- 10 GHz	FCC 15.247	46.8dBµV/m @ 2282.0MHz (-7.2dB)
6	BT 1Mb/s 802.11b	2440MHz 2412MHz	7dBm 16.5dBm	5.4 16.5		FCC 15.247	49.3dBµV/m @ 2320.0MHz (-4.7dB)
7	BT 1Mb/s 802.11b	2440MHz 2462MHz	7dBm 16.5dBm	5.4 16.6	Radiated Emissions 1- 10 GHz	FCC 15.247	47.8dBµV/m @ 2320.0MHz (-6.2dB)
8	BT 1Mb/s 802.11b	2480MHz 2437MHz	7dBm 16.5dBm	5.1 16.6		FCC 15.247	48.9dBµV/m @ 2360.0MHz (-5.1dB)
WiFi mode and channel and Bluetooth channel based on the worst case mode from runs 1 through 8							
9	BT 3Mb/s 802.11b	2440 MHz 2412 MHz	7dBm 16.5dBm	1.4 16.5	Radiated Emissions 1- 10 GHz	FCC 15.247	46.4dBµV/m @ 2383.9MHz (-7.6dB)

Client:	Intel Corporation	Job Number:	J80398
Model:	Intel® Centrino® Advanced-N 6230	T-Log Number:	T80540
Contact:	Steve Hackett	Account Manager:	Christine Krebill
Standard:	FCC 15.247	Class:	N/A

WiFi mode - 802.11n 20MHz with both chains active at 16.5dBm per chain, center channel in each 5GHz band. Bluetooth on center channel, 1Mb/s mode

Run #	Mode	Channel	Target Power	Measured Power	Test Performed	Limit	Result / Margin
10	BT 1Mb/s 802.11n20	2440MHz 5200MHz	7dBm 16.5/16.5	5.4 16.6/16.7	Radiated Emissions 1- 15 GHz	FCC 15.247	41.9dBµV/m @ 2280.0MHz (-12.1dB)
11	BT 1Mb/s 802.11n20	2440MHz 5300MHz	7dBm 16.5/16.5	5.4 16.7/16.5		FCC 15.247	37.2dBµV/m @ 10600.0MHz (-16.8dB)
12	BT 1Mb/s 802.11n20	2440MHz 5600MHz	7dBm 16.5/16.5	5.4 16.5/16.5		FCC 15.247	45.1dBµV/m @ 11199.8MHz (-8.9dB)
13	BT 1Mb/s 802.11n20	2440MHz 5785MHz	7dBm 16.5/16.5	5.4 16.5/16.7		FCC 15.247	44.7dBµV/m @ 11570.7MHz (-9.3dB)

Modifications Made During Testing

No modifications were made to the EUT during testing

Deviations From The Standard

No deviations were made from the requirements of the standard.

Notes:

Bluetooth uses a frequency hopping algorithm that means that the device, during normal operation, is only on a specific channel for a short period of time. The average correction factor is calculated as follows:

A maximum length packet has a duration of 5 time slots.

The hopping rate is 1600 hops/second so the maximum dwell time is 5/1600 seconds, or 3.125ms.

With a minimum of 20 hopping channels a channel will not be used more than 4 times in any 100ms period.

The maximum dwell time in a 100ms period is $4 \times 3.125\text{ms} = 12.5\text{ms}$.

The average correction factor is, therefore, $20\log(12.5/100) = -18\text{dB}$

As this is a hopping radio the correction factor can be applied to the average value of the signal provided the average value was measured with the device continuously transmitting. DA 00-0705 permits the use of the average correction on the **measured average** value for frequency hopping radios.

All measurements in this data sheet do not include the average correction factor.

Client:	Intel Corporation	Job Number:	J80398
Model:	Intel® Centrino® Advanced-N 6230	T-Log Number:	T80540
Contact:	Steve Hackett	Account Manager:	Christine Krebill
Standard:	FCC 15.247	Class:	N/A

Run # 1, Rainbow Peak 2x2: 1-10GHz, 802.11b @ 2412 MHz Chain A, BT Basic Rate @ 2402 MHz Chain B

	Target (dBm)	Power Settings Measured (dBm)	Software Setting
Chain A	16.5	16.5	24.5
Chain B	7.0	4.4	8.0

Spurious Radiated Emissions, 1 - 10GHz excluding the allocated band:

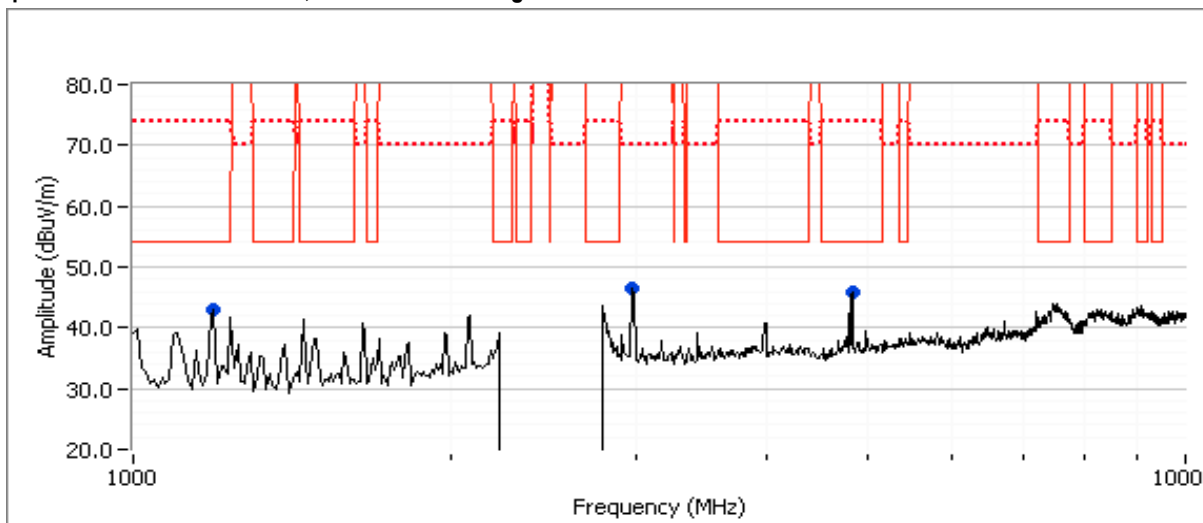

Preliminary Measurements (Peak versus average limit)

Frequency	Level	Pol	15.209/15.247		Detector	Azimuth	Height	Comments
MHz	dBuV/m	v/h	Limit	Margin	Pk/QP/Avg	degrees	meters	
4822.500	46.0	V	54.0	-8.0	Peak	154	1.0	
1192.500	42.9	V	54.0	-11.1	Peak	82	1.5	
2980.000	46.4	V	70.0	-23.6	Peak	154	1.0	

Final measurements at 3m

Frequency	Level	Pol	15.209/15.247		Detector	Azimuth	Height	Comments
MHz	dBuV/m	v/h	Limit	Margin	Pk/QP/Avg	degrees	meters	
4824.000	48.0	V	54.0	-6.0	AVG	153	1.16	
4823.900	50.8	V	74.0	-23.2	PK	153	1.16	
1192.530	42.9	V	54.0	-11.1	AVG	92	1.64	
1192.550	45.6	V	74.0	-28.4	PK	92	1.64	

Client:	Intel Corporation	Job Number:	J80398
Model:	Intel® Centrino® Advanced-N 6230	T-Log Number:	T80540
Contact:	Steve Hackett	Account Manager:	Christine Krebill
Standard:	FCC 15.247	Class:	N/A

Spurious Radiated Emissions, 2 - 3GHz

Preliminary Scan at ~ 20cm from the product to identify potential signals (Peak versus average limit)

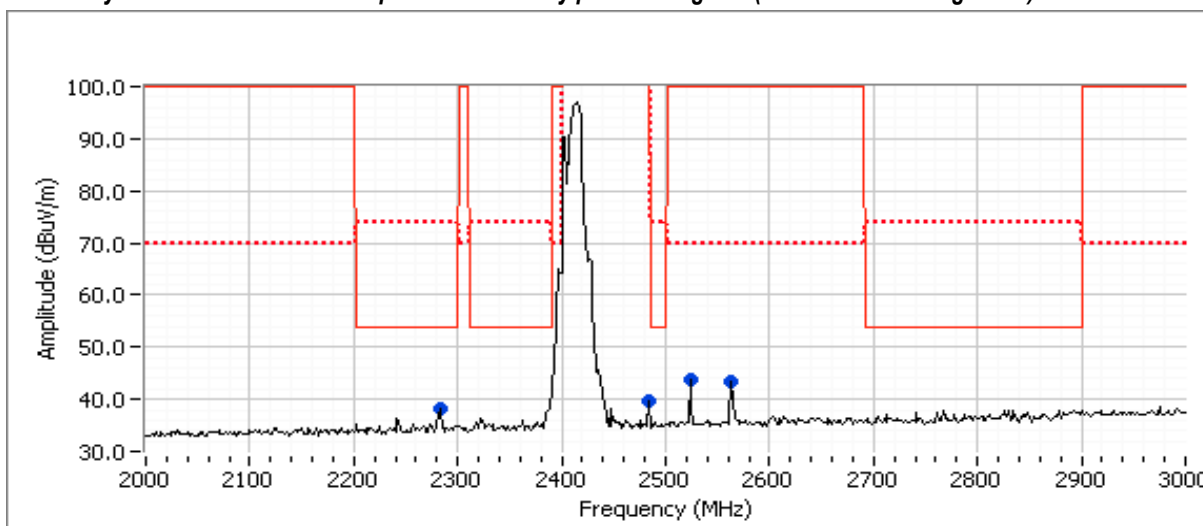

Preliminary measurements at ~ 20cm, RB=1MHz, VB=100kHz

Frequency	Level	Pol	15.209/15.247		Detector	Azimuth	Height	Comments
MHz	dBuV/m	v/h	Limit	Margin	Pk/QP/Avg	degrees	meters	
2283.330	38.3	H	54.0	-15.7	Peak	321	1.0	
2483.330	39.8	H	120.0	-80.2	Peak	4	1.0	In band
2523.330	43.6	H	70.0	-26.4	Peak	0	1.0	Non-restricted band
2563.330	43.4	H	70.0	-26.6	Peak	212	1.0	Non-restricted band

Final measurements at 3m

Frequency	Level	Pol	15.209/15.247		Detector	Azimuth	Height	Comments
MHz	dBuV/m	v/h	Limit	Margin	Pk/QP/Avg	degrees	meters	
2281.900	46.0	H	54.0	-8.0	AVG	69	2.18	Note 2
2282.130	55.6	H	74.0	-18.4	PK	69	2.18	Note 2

Note 1: For emissions in restricted bands, the limit of 15.209 was used. For all other emissions, the limit is -30dBc for peak measurements in a measurement bandwidth of 100kHz.

Note 2: Signal is only present when Bluetooth is enabled, average correction for hopping occupancy could be applied

Client:	Intel Corporation	Job Number:	J80398
Model:	Intel® Centrino® Advanced-N 6230	T-Log Number:	T80540
Contact:	Steve Hackett	Account Manager:	Christine Krebill
Standard:	FCC 15.247	Class:	N/A

Run # 2, Rainbow Peak 2x2: 1-10GHz, 802.11b @ 2462 MHz Chain A, BT Basic Rate @ 2480 MHz Chain B

	Target (dBm)	Power Settings	
		Measured (dBm)	Software Setting
Chain A	16.5	16.6	23.5
Chain B	7.0	5.3	8.0

Spurious Radiated Emissions, 1 - 10GHz excluding the allocated band:

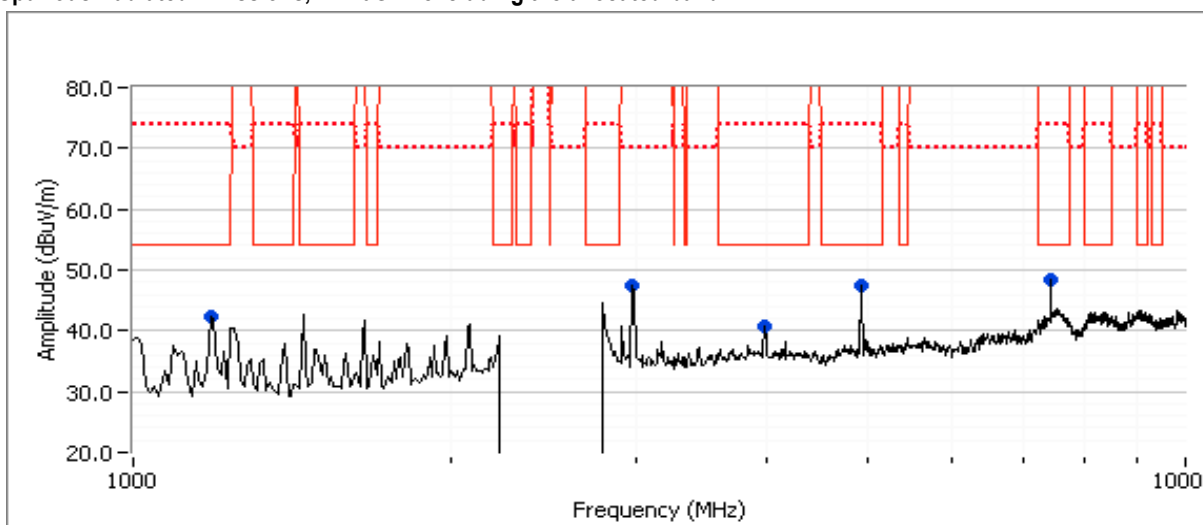

Preliminary Measurements (Peak versus average limit)

Frequency	Level	Pol	15.209/15.247		Detector	Azimuth	Height	Comments
MHz	dBuV/m	v/h	Limit	Margin	Pk/QP/Avg	degrees	meters	
7439.170	48.3	V	54.0	-5.7	Peak	167	2.0	
4914.170	47.5	V	54.0	-6.5	Peak	209	2.5	
1183.330	42.3	V	54.0	-11.7	Peak	97	2.0	
3979.170	40.8	V	54.0	-13.2	Peak	146	1.0	
2980.000	47.4	V	70.0	-22.6	Peak	153	1.0	

Final measurements at 3m

Frequency	Level	Pol	15.209/15.247		Detector	Azimuth	Height	Comments
MHz	dBuV/m	v/h	Limit	Margin	Pk/QP/Avg	degrees	meters	
4924.000	46.8	V	54.0	-7.2	AVG	212	2.48	
7439.940	46.5	V	54.0	-7.5	AVG	166	2.00	
4923.890	50.0	V	74.0	-24.0	PK	212	2.48	
7440.500	53.1	V	74.0	-20.9	PK	166	2.00	

Client:	Intel Corporation	Job Number:	J80398
Model:	Intel® Centrino® Advanced-N 6230	T-Log Number:	T80540
Contact:	Steve Hackett	Account Manager:	Christine Krebill
Standard:	FCC 15.247	Class:	N/A

Spurious Radiated Emissions, 2 - 3GHz

Preliminary Scan at ~ 20cm from the product to identify potential signals (Peak versus average limit)

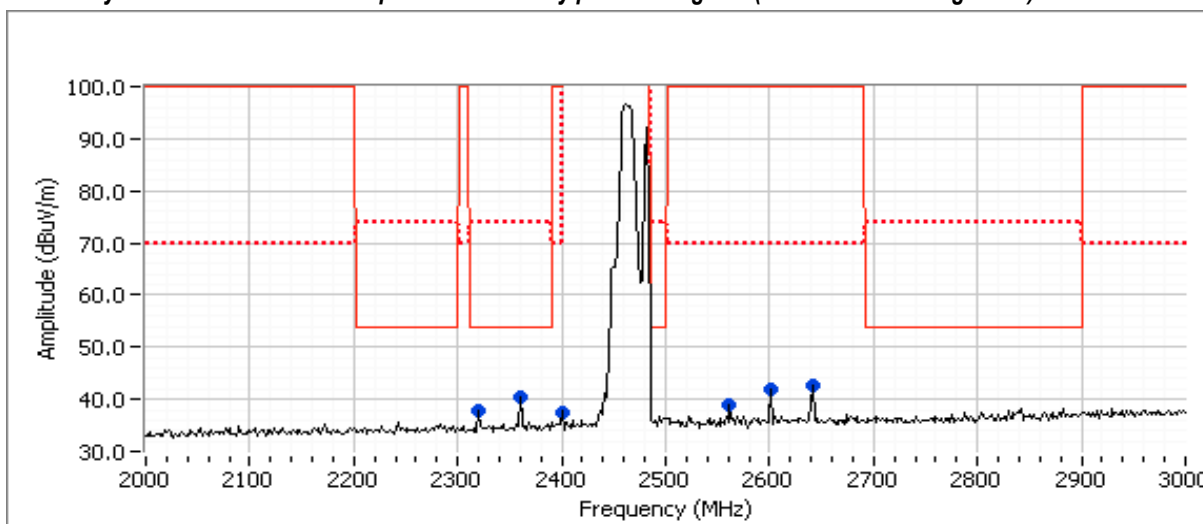

Preliminary measurements at ~ 20cm, RB=1MHz, VB=100kHz

Frequency	Level	Pol	15.209/15.247		Detector	Azimuth	Height	Comments
MHz	dBuV/m	v/h	Limit	Margin	Pk/QP/Avg	degrees	meters	
2320.000	37.9	H	54.0	-16.1	Peak	185	1.0	
2360.000	40.3	H	54.0	-13.7	Peak	338	1.0	
2400.000	37.4	H	70.0	-32.6	Peak	352	1.0	Non-restricted band
2561.670	39.1	H	70.0	-30.9	Peak	75	1.0	Non-restricted band
2601.670	42.1	H	70.0	-27.9	Peak	144	1.0	Non-restricted band
2641.670	42.5	H	70.0	-27.5	Peak	147	1.0	Non-restricted band

Final measurements at 3m

Frequency	Level	Pol	15.209/15.247		Detector	Azimuth	Height	Comments
MHz	dBuV/m	v/h	Limit	Margin	Pk/QP/Avg	degrees	meters	
2320.070	46.3	H	54.0	-7.7	AVG	345	1.25	Note 2
2319.830	56.6	H	74.0	-17.4	PK	345	1.25	Note 2
2360.020	48.4	H	54.0	-5.6	AVG	70	1.27	Note 2
2360.000	57.2	H	74.0	-16.8	PK	70	1.27	Note 2

Note 1: For emissions in restricted bands, the limit of 15.209 was used. For all other emissions, the limit is -30dBc for peak measurements in a measurement bandwidth of 100kHz.

Note 2: Signal is only present when Bluetooth is enabled, average correction for hopping occupancy could be applied

Client:	Intel Corporation	Job Number:	J80398
Model:	Intel® Centrino® Advanced-N 6230	T-Log Number:	T80540
Contact:	Steve Hackett	Account Manager:	Christine Krebill
Standard:	FCC 15.247	Class:	N/A

**Run # 3, Rainbow Peak 2x2: 1-10GHz, 802.11g @ 2412 MHz Chain A, BT Basic Rate @ 2402 MHz Chain B
Spurious Radiated Emissions, 1 - 10GHz excluding the allocated band:**

	Target (dBm)	Power Settings Measured (dBm)	Software Setting
Chain A	16.5	16.3	31.0
Chain B	7.0	4.4	8.0

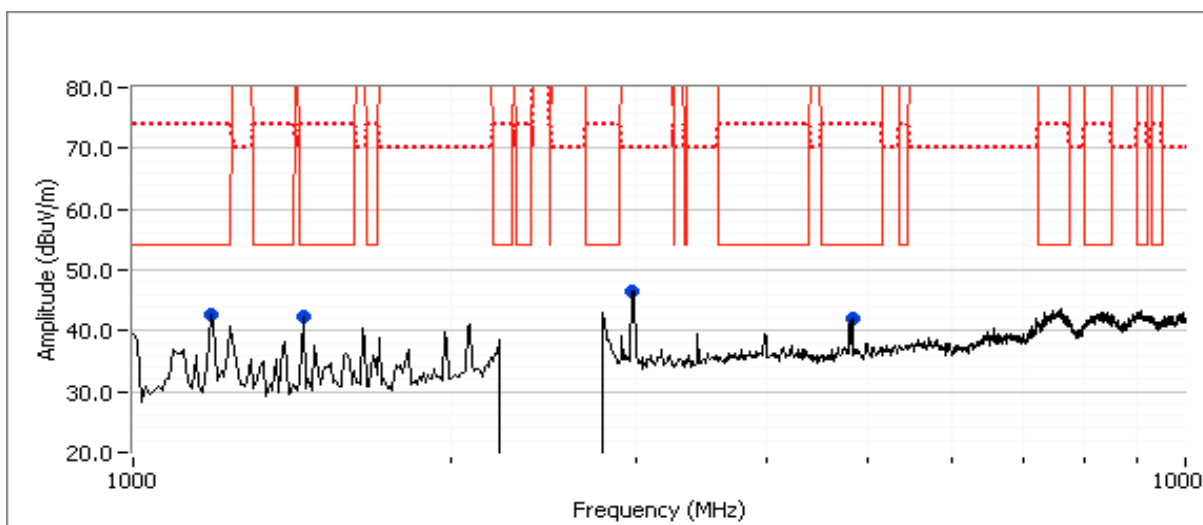

Preliminary Measurements (Peak versus average limit)

Frequency	Level	Pol	15.209/15.247		Detector	Azimuth	Height	Comments
MHz	dBuV/m	v/h	Limit	Margin	Pk/QP/Avg	degrees	meters	
1183.330	42.8	V	54.0	-11.2	Peak	102	2.0	
1449.170	42.5	H	54.0	-11.5	Peak	138	1.5	
4822.500	42.1	V	54.0	-11.9	Peak	283	2.0	
2980.000	46.4	V	70.0	-23.6	Peak	153	1.0	

Final measurements at 3m

Frequency	Level	Pol	15.209/15.247		Detector	Azimuth	Height	Comments
MHz	dBuV/m	v/h	Limit	Margin	Pk/QP/Avg	degrees	meters	
1457.590	43.2	H	54.0	-10.8	AVG	132	1.33	
1457.600	45.4	H	74.0	-28.6	PK	132	1.33	
1192.560	42.5	V	54.0	-11.5	AVG	89	1.99	
1192.600	44.8	V	74.0	-29.2	PK	89	1.99	
4823.900	40.7	V	54.0	-13.3	AVG	153	1.18	
4826.970	52.1	V	74.0	-21.9	PK	153	1.18	

Client:	Intel Corporation	Job Number:	J80398
Model:	Intel® Centrino® Advanced-N 6230	T-Log Number:	T80540
Contact:	Steve Hackett	Account Manager:	Christine Krebill
Standard:	FCC 15.247	Class:	N/A

Spurious Radiated Emissions, 2 - 3GHz

Preliminary Scan at ~ 20cm from the product to identify potential signals (Peak versus average limit)

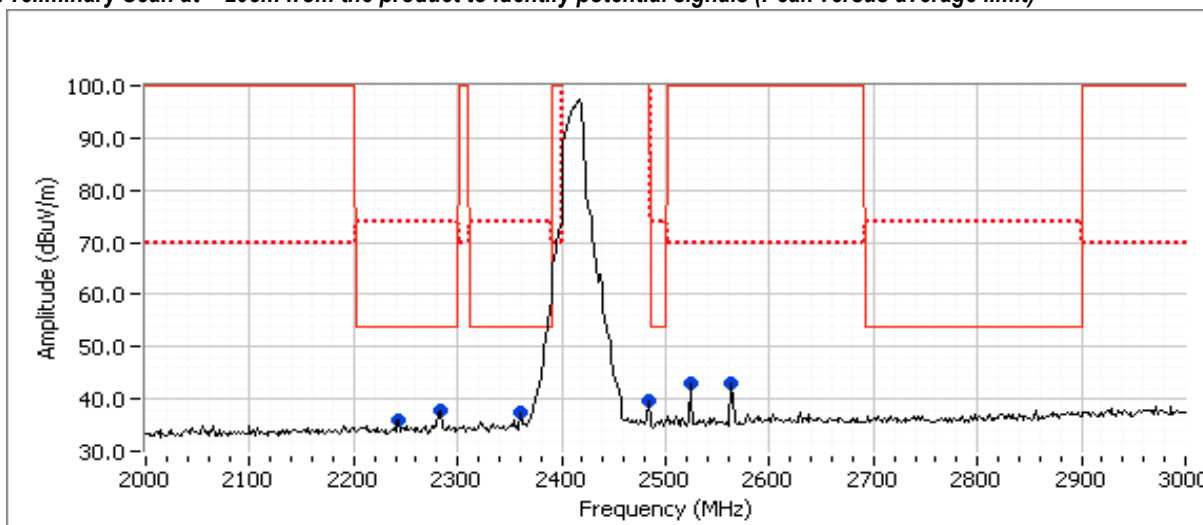

Preliminary measurements at ~ 20cm, RB=1MHz, VB=100kHz

Frequency	Level	Pol	15.209/15.247		Detector	Azimuth	Height	Comments
MHz	dBuV/m	v/h	Limit	Margin	Pk/QP/Avg	degrees	meters	
2243.330	36.1	V	54.0	-17.9	Peak	42	1.0	
2283.330	37.7	H	54.0	-16.3	Peak	306	1.0	
2360.000	37.3	H	54.0	-16.7	Peak	358	1.0	
2483.330	39.6	H	120.0	-80.4	Peak	10	1.0	In-band
2523.330	43.2	H	70.0	-26.8	Peak	31	1.0	Non-restricted band
2563.330	43.1	H	70.0	-26.9	Peak	20	1.0	Non-restricted band

Final measurements at 3m

Frequency	Level	Pol	15.209/15.247		Detector	Azimuth	Height	Comments
MHz	dBuV/m	v/h	Limit	Margin	Pk/QP/Avg	degrees	meters	
2241.910	45.2	V	54.0	-8.8	AVG	163	1.42	Note 2
2241.860	55.3	V	74.0	-18.7	PK	163	1.42	Note 2
2281.910	46.0	H	54.0	-8.0	AVG	70	2.27	Note 2
2281.960	55.5	H	74.0	-18.5	PK	70	2.27	Note 2
2362.170	44.9	H	54.0	-9.1	AVG	66	1.19	Note 2
2361.080	55.1	H	74.0	-18.9	PK	66	1.19	Note 2

Note 1: For emissions in restricted bands, the limit of 15.209 was used. For all other emissions, the limit is -30dBc for peak measurements in a measurement bandwidth of 100kHz.

Note 2: Signal is only present when Bluetooth is enabled, average correction for hopping occupancy could be applied

Client:	Intel Corporation	Job Number:	J80398
Model:	Intel® Centrino® Advanced-N 6230	T-Log Number:	T80540
Contact:	Steve Hackett	Account Manager:	Christine Krebill
Standard:	FCC 15.247	Class:	N/A

Run # 4, Rainbow Peak 2x2: 1-10GHz, 802.11g @ 2462 MHz Chain A, BT Basic Rate @ 2480 MHz Chain B

	Target (dBm)	Power Settings Measured (dBm)	Software Setting
Chain A	16.5	16.9	29.5
Chain B	7.0	5.3	8.0

Spurious Radiated Emissions, 1 - 10GHz excluding the allocated band:

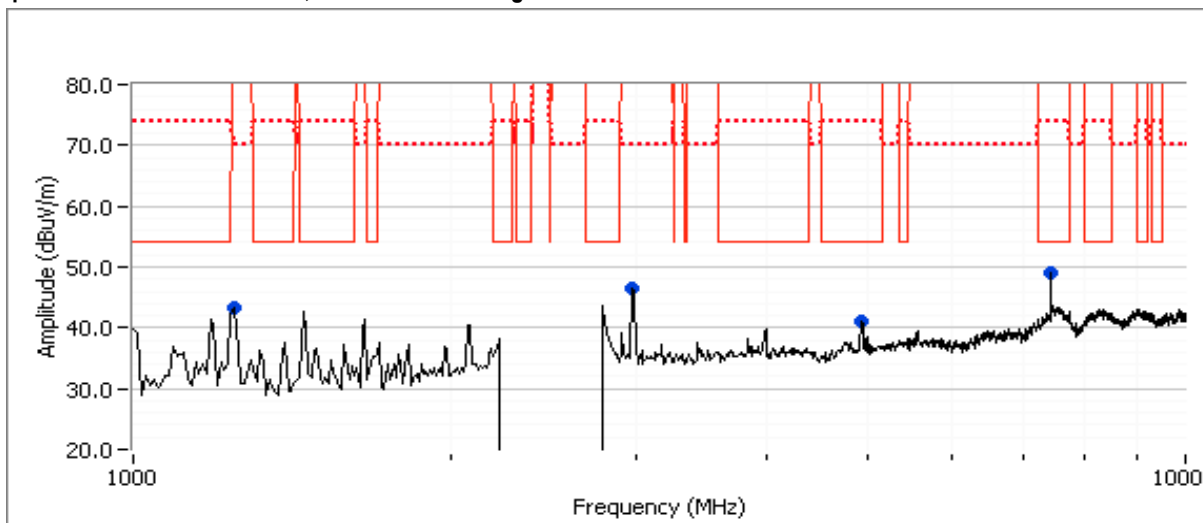

Preliminary Measurements (Peak versus average limit)

Frequency	Level	Pol	15.209/15.247		Detector	Azimuth	Height	Comments
MHz	dBuV/m	v/h	Limit	Margin	Pk/QP/Avg	degrees	meters	
7439.170	49.2	V	54.0	-4.8	Peak	174	1.5	
4923.330	41.1	V	54.0	-12.9	Peak	181	2.5	
2980.000	46.6	V	70.0	-23.4	Peak	160	1.0	
1247.500	43.4	H	70.0	-26.6	Peak	152	1.5	

Final measurements at 3m

Frequency	Level	Pol	15.209/15.247		Detector	Azimuth	Height	Comments
MHz	dBuV/m	v/h	Limit	Margin	Pk/QP/Avg	degrees	meters	
7440.020	45.8	V	54.0	-8.2	AVG	178	1.52	
7439.570	52.7	V	74.0	-21.3	PK	178	1.52	

Note: 7440MHz is directly related to the Bluetooth signal and was observed during the Bluetooth only spurious measurements.

Client:	Intel Corporation	Job Number:	J80398
Model:	Intel® Centrino® Advanced-N 6230	T-Log Number:	T80540
Contact:	Steve Hackett	Account Manager:	Christine Krebill
Standard:	FCC 15.247	Class:	N/A

Spurious Radiated Emissions, 2 - 3GHz

Preliminary Scan at ~ 20cm from the product to identify potential signals (Peak versus average limit)

No preamplifier used for these scans

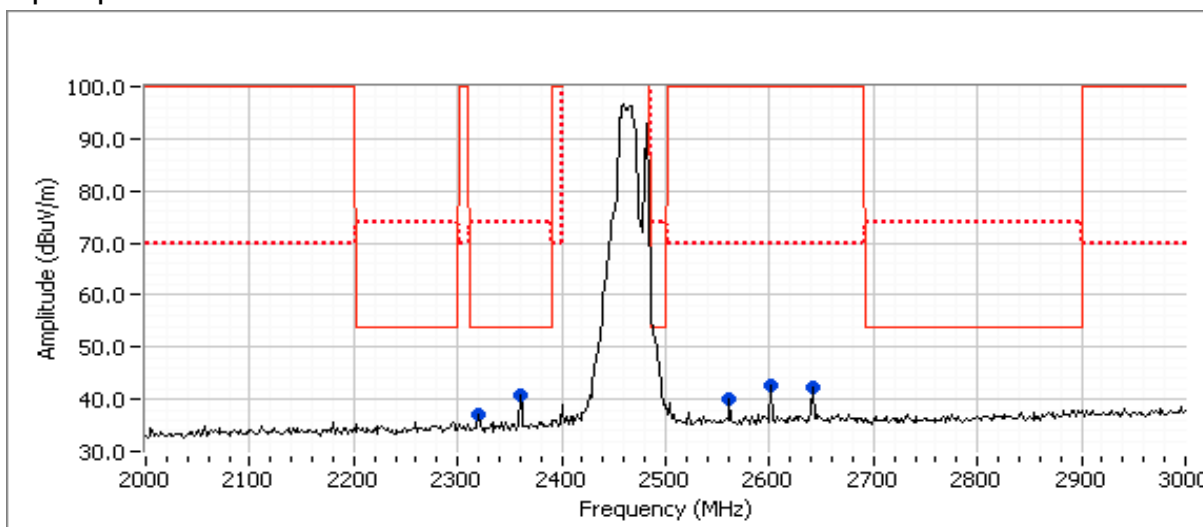

Preliminary measurements at ~ 20cm, RB=1MHz, VB=100kHz

Frequency	Level	Pol	15.209/15.247		Detector	Azimuth	Height	Comments
MHz	dBµV/m	v/h	Limit	Margin	Pk/QP/Avg	degrees	meters	
2320.000	37.2	H	54.0	-16.8	Peak	317	1.0	
2360.000	40.7	H	54.0	-13.3	Peak	347	1.0	
2561.670	39.9	H	70.0	-30.1	Peak	205	1.0	Non-restricted band
2601.670	42.6	H	70.0	-27.4	Peak	144	1.0	Non-restricted band
2641.670	42.4	H	70.0	-27.6	Peak	173	1.0	Non-restricted band

Final measurements at 3m

Frequency	Level	Pol	15.209/15.247		Detector	Azimuth	Height	Comments
MHz	dBµV/m	v/h	Limit	Margin	Pk/QP/Avg	degrees	meters	
2324.470	44.5	H	54.0	-9.5	AVG	236	1.0	
2360.040	46.6	H	54.0	-7.4	AVG	326	1.0	
2323.600	57.6	H	74.0	-16.4	PK	236	1.0	
2359.450	56.2	H	74.0	-17.8	PK	326	1.0	

Note 1: For emissions in restricted bands, the limit of 15.209 was used. For all other emissions, the limit is -30dBc for peak measurements in a measurement bandwidth of 100kHz.

Note 2: Signal is only present when Bluetooth is enabled, average correction for hopping occupancy could be applied

Note 3: Signal is present when Bluetooth is disabled (powered off)

Client:	Intel Corporation	Job Number:	J80398
Model:	Intel® Centrino® Advanced-N 6230	T-Log Number:	T80540
Contact:	Steve Hackett	Account Manager:	Christine Krebill
Standard:	FCC 15.247	Class:	N/A

Run # 5, Rainbow Peak 2x2: 1-10GHz, 802.11b @ 2437 MHz Chain A, BT Basic Rate @ 2402 MHz Chain B

	Target (dBm)	Power Settings Measured (dBm)	Software Setting
Chain A	16.5	16.6	23.5
Chain B	7.0	4.3	8.0

Spurious Radiated Emissions, 1 - 10GHz excluding the allocated band:
Preamplifier and notch filter used for these scans

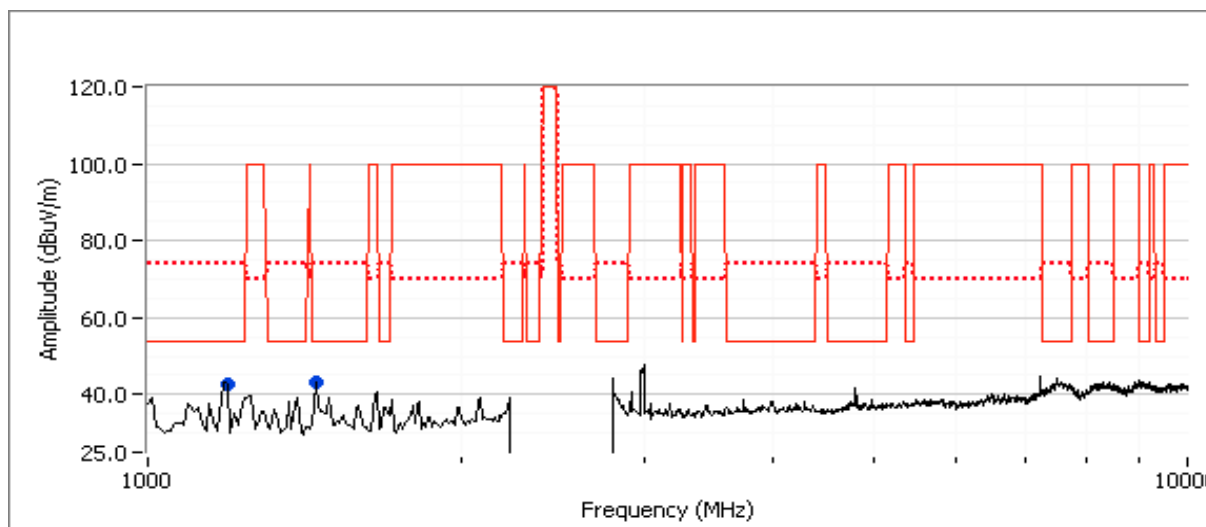

Preliminary Measurements (Peak versus average limit)

Frequency	Level	Pol	15.209/15.247		Detector	Azimuth	Height	Comments
MHz	dBuV/m	v/h	Limit	Margin	Pk/QP/Avg	degrees	meters	
1457.620	43.2	H	54.0	-10.8	Peak	130	1.5	
1199.820	42.6	V	54.0	-11.4	Peak	96	2.0	

Final measurements at 3m

Frequency	Level	Pol	15.209/15.247		Detector	Azimuth	Height	Comments
MHz	dBuV/m	v/h	Limit	Margin	Pk/QP/Avg	degrees	meters	
1200.140	40.1	V	54.0	-13.9	AVG	100	2.0	
1457.570	43.0	H	54.0	-11.0	AVG	127	1.4	
1199.950	44.7	V	74.0	-29.3	PK	100	2.0	
1457.490	45.1	H	74.0	-28.9	PK	127	1.4	

Note: 4804MHz is directly related to the Bluetooth signal and was observed during the Bluetooth only spurious measurements.

Client:	Intel Corporation	Job Number:	J80398
Model:	Intel® Centrino® Advanced-N 6230	T-Log Number:	T80540
Contact:	Steve Hackett	Account Manager:	Christine Krebill
Standard:	FCC 15.247	Class:	N/A

Spurious Radiated Emissions, 2 - 3GHz

Preliminary Scan at ~ 20cm from the product to identify potential signals (Peak versus average limit)

No preamplifier used for these scans

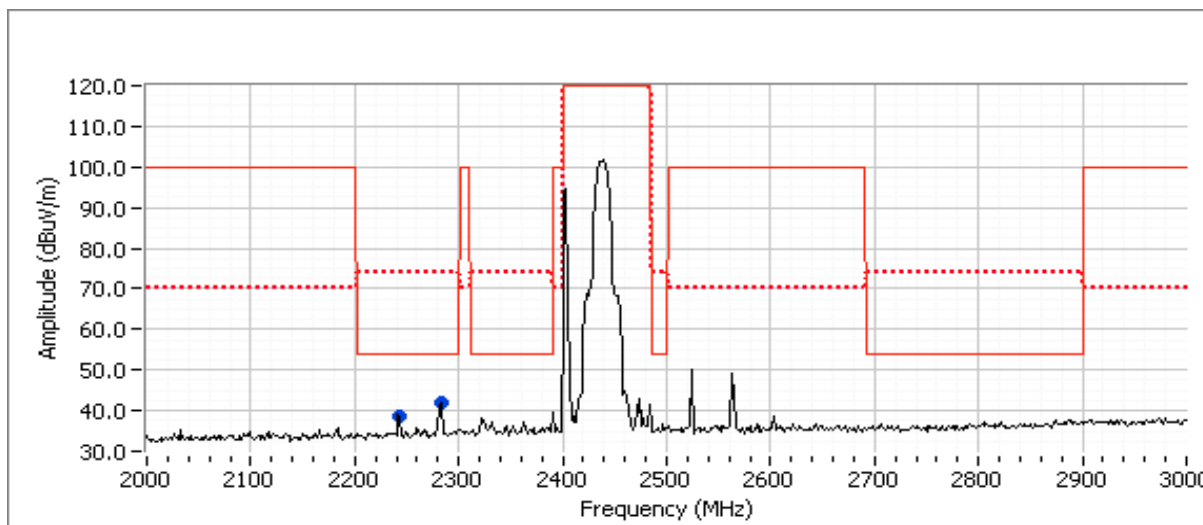

Preliminary measurements at ~ 20cm, RB=1MHz, VB=100kHz

Frequency	Level	Pol	15.209/15.247		Detector	Azimuth	Height	Comments
MHz	dBuV/m	v/h	Limit	Margin	Pk/QP/Avg	degrees	meters	
2283.330	41.8	V	54.0	-12.2	Peak	180	1.0	5
2243.330	38.7	V	54.0	-15.3	Peak	180	1.0	5

Final measurements at 3m

Frequency	Level	Pol	15.209/15.247		Detector	Azimuth	Height	Comments
MHz	dBuV/m	v/h	Limit	Margin	Pk/QP/Avg	degrees	meters	
2281.990	46.8	H	54.0	-7.2	AVG	70	1.0	RB 1 MHz;VB 10 Hz;Pk
2282.150	56.7	H	74.0	-17.3	PK	70	1.0	RB 1 MHz;VB 3 MHz;Pk
2242.060	46.7	H	54.0	-7.3	AVG	68	1.0	RB 1 MHz;VB 10 Hz;Pk
2241.580	56.3	H	74.0	-17.7	PK	68	1.0	RB 1 MHz;VB 3 MHz;Pk
2282.000	45.9	V	54.0	-8.1	AVG	105	1.2	RB 1 MHz;VB 10 Hz;Pk
2282.210	56.1	V	74.0	-17.9	PK	105	1.2	RB 1 MHz;VB 3 MHz;Pk

Note 1: For emissions in restricted bands, the limit of 15.209 was used. For all other emissions, the limit is -30dBc for peak measurements in a measurement bandwidth of 100kHz.

Note 2: Signal is only present when Bluetooth is enabled, average correction for hopping occupancy could be applied

Note 3: Signal is present when Bluetooth is disabled (powered off)

Client:	Intel Corporation	Job Number:	J80398
Model:	Intel® Centrino® Advanced-N 6230	T-Log Number:	T80540
Contact:	Steve Hackett	Account Manager:	Christine Krebill
Standard:	FCC 15.247	Class:	N/A

Run # 6, Rainbow Peak 2x2: 1-10GHz, 802.11b @ 2412 MHz Chain A, BT Basic Rate @ 2440 MHz Chain B

	Target (dBm)	Power Settings Measured (dBm)	Software Setting
Chain A	16.5	16.5	23.5
Chain B	7.0	5.4	8.0

**Spurious Radiated Emissions, 1 - 10GHz excluding the allocated band:
Preamplifier and notch filter used for these scans**

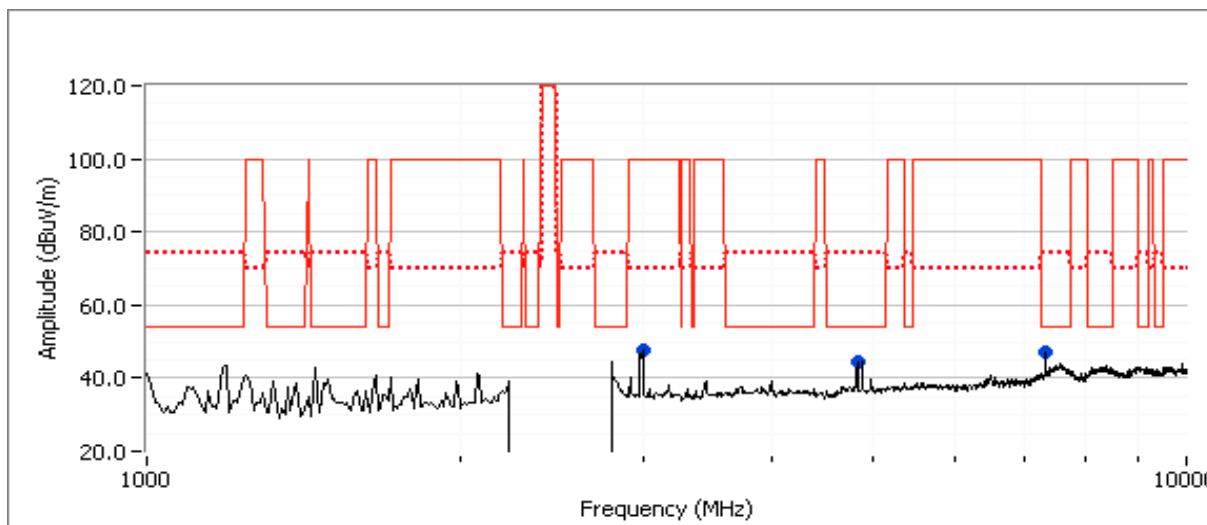

Preliminary Measurements (Peak versus average limit)

Frequency	Level	Pol	15.209/15.247		Detector	Azimuth	Height	Comments
MHz	dBuV/m	v/h	Limit	Margin	Pk/QP/Avg	degrees	meters	
2998.330	47.9	V	70.0	-22.1	Peak	141	1.0	
4823.990	44.6	V	54.0	-9.4	Peak	149	1.0	
7316.670	47.1	V	54.0	-6.9	Peak	165	1.9	

Final measurements at 3m

Frequency	Level	Pol	15.209/15.247		Detector	Azimuth	Height	Comments
MHz	dBuV/m	v/h	Limit	Margin	Pk/QP/Avg	degrees	meters	
4823.980	44.9	V	54.0	-9.1	AVG	149	1.3	RB 1 MHz;VB 10 Hz;Pk
4823.900	48.4	V	74.0	-25.6	PK	149	1.3	RB 1 MHz;VB 3 MHz;Pk
7319.940	43.6	V	54.0	-10.4	AVG	170	2.0	RB 1 MHz;VB 10 Hz;Pk
7319.350	51.4	V	74.0	-22.6	PK	170	2.0	RB 1 MHz;VB 3 MHz;Pk

Note: 7320 MHz is directly related to the Bluetooth signal and was observed during the Bluetooth only spurio us measurements.

Client:	Intel Corporation	Job Number:	J80398
Model:	Intel® Centrino® Advanced-N 6230	T-Log Number:	T80540
Contact:	Steve Hackett	Account Manager:	Christine Krebill
Standard:	FCC 15.247	Class:	N/A

Spurious Radiated Emissions, 2 - 3GHz

Preliminary Scan at ~ 20cm from the product to identify potential signals (Peak versus average limit)

No preamplifier used for these scans

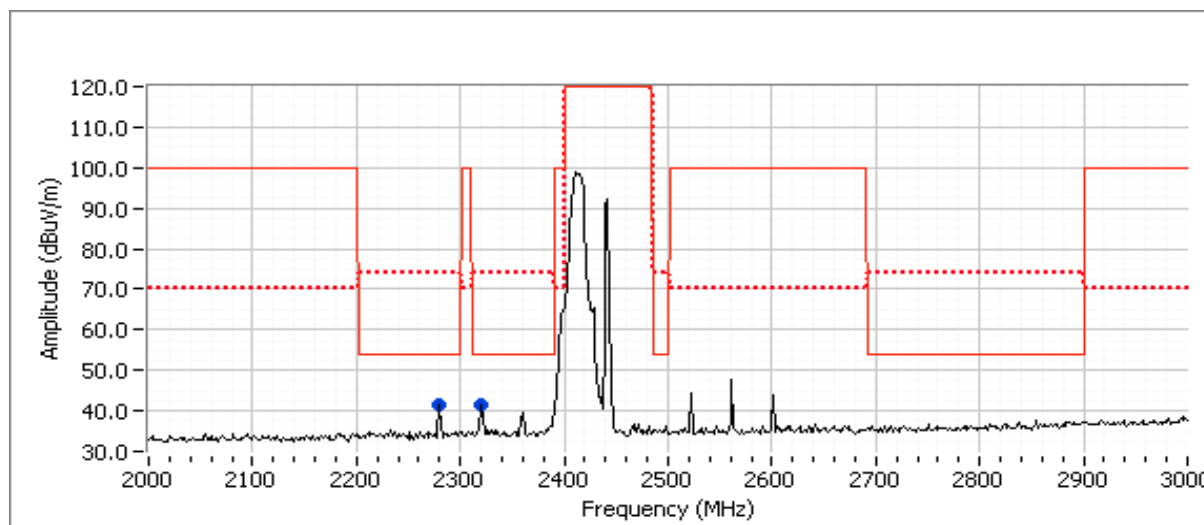

Preliminary measurements at ~ 20cm, RB=1MHz, VB=100kHz

Frequency	Level	Pol	15.209/15.247		Detector	Azimuth	Height	Comments
MHz	dBuV/m	v/h	Limit	Margin	Pk/QP/Avg	degrees	meters	
2320.000	40.1	-	54.0	-13.9	Peak	180	1.0	
2280.000	39.0	-	54.0	-15.0	Peak	180	1.0	

Final measurements at 3m

Frequency	Level	Pol	15.209/15.247		Detector	Azimuth	Height	Comments
MHz	dBuV/m	v/h	Limit	Margin	Pk/QP/Avg	degrees	meters	
2319.970	49.3	H	54.0	-4.7	AVG	70	1.2	RB 1 MHz;VB 10 Hz;Pk
2319.990	57.3	H	74.0	-16.7	PK	70	1.2	RB 1 MHz;VB 3 MHz;Pk
2279.960	46.8	H	54.0	-7.2	AVG	70	1.9	RB 1 MHz;VB 10 Hz;Pk
2279.780	55.9	H	74.0	-18.1	PK	70	1.9	RB 1 MHz;VB 3 MHz;Pk
2319.980	46.7	V	54.0	-7.3	AVG	104	1.0	RB 1 MHz;VB 10 Hz;Pk
2319.800	56.2	V	74.0	-17.8	PK	104	1.0	RB 1 MHz;VB 3 MHz;Pk

Note 1: For emissions in restricted bands, the limit of 15.209 was used. For all other emissions, the limit is -30dBc for peak measurements in a measurement bandwidth of 100kHz.

Note 2: Signal is only present when Bluetooth is enabled, average correction for hopping occupancy could be applied

Note 3: Signal is present when Bluetooth is disabled (powered off)

Client:	Intel Corporation	Job Number:	J80398
Model:	Intel® Centrino® Advanced-N 6230	T-Log Number:	T80540
Contact:	Steve Hackett	Account Manager:	Christine Krebill
Standard:	FCC 15.247	Class:	N/A

Run # 7, Rainbow Peak 2x2: 1-10GHz, 802.11b @ 2462 MHz Chain A, BT Basic Rate @ 2440 MHz Chain B

	Target (dBm)	Power Settings Measured (dBm)	Software Setting
Chain A	16.5	16.6	23.5
Chain B	7.0	5.4	8.0

**Spurious Radiated Emissions, 1 - 10GHz excluding the allocated band:
Pre-amplifier and notch filter used for these scans**

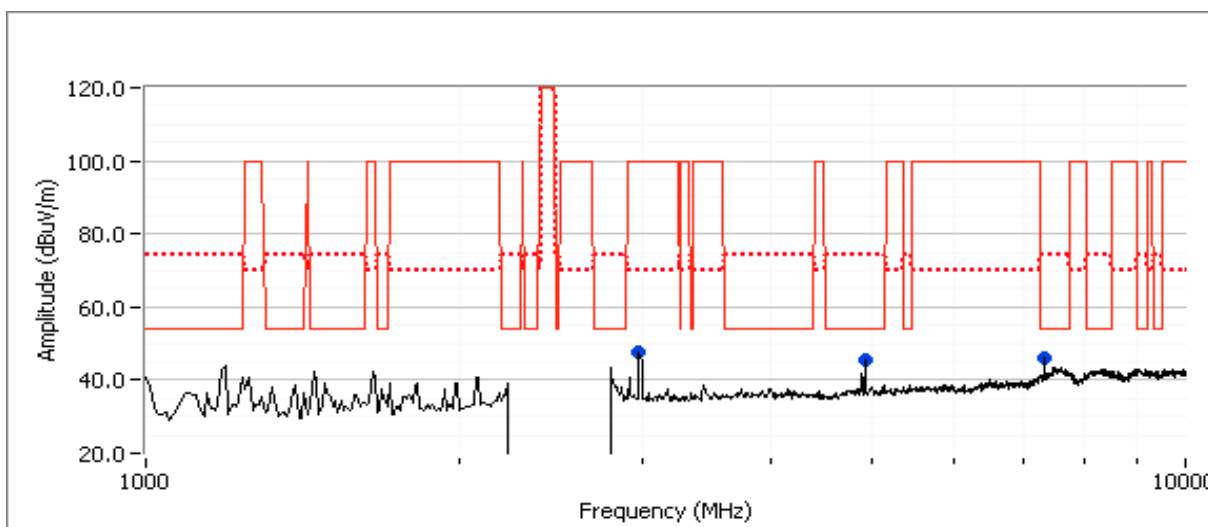

Preliminary Measurements (Peak versus average limit)

Frequency	Level	Pol	15.209/15.247		Detector	Azimuth	Height	Comments
MHz	dBuV/m	v/h	Limit	Margin	Pk/QP/Avg	degrees	meters	
2980.000	47.7	V	70.0	-22.3	Peak	141	1.0	
4923.860	45.3	V	54.0	-8.7	Peak	166	1.6	
7322.500	46.3	V	54.0	-7.7	Peak	182	1.6	

Final measurements at 3m

Frequency	Level	Pol	15.209/15.247		Detector	Azimuth	Height	Comments
MHz	dBuV/m	v/h	Limit	Margin	Pk/QP/Avg	degrees	meters	
4923.980	47.6	V	54.0	-6.4	AVG	166	1.7	RB 1 MHz;VB 10 Hz;Pk
4923.940	50.3	V	74.0	-23.7	PK	166	1.7	RB 1 MHz;VB 3 MHz;Pk
7320.050	41.2	V	54.0	-12.8	AVG	201	2.0	RB 1 MHz;VB 10 Hz;Pk
7320.180	49.5	V	74.0	-24.5	PK	201	2.0	RB 1 MHz;VB 3 MHz;Pk

Note: 7320 MHz is directly related to the Bluetooth signal and was observed during the Bluetooth only spurio us measurements.

Client:	Intel Corporation	Job Number:	J80398
Model:	Intel® Centrino® Advanced-N 6230	T-Log Number:	T80540
Contact:	Steve Hackett	Account Manager:	Christine Krebill
Standard:	FCC 15.247	Class:	N/A

Spurious Radiated Emissions, 2 - 3GHz

Preliminary Scan at ~ 20cm from the product to identify potential signals (Peak versus average limit)

No preamplifier used for these scans

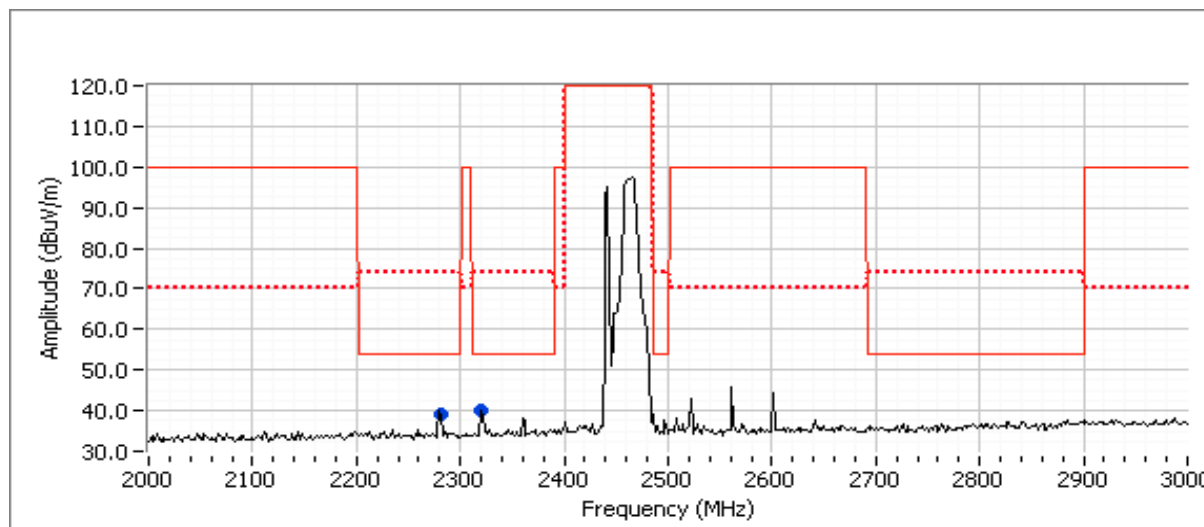

Preliminary measurements at ~ 20cm, RB=1MHz, VB=100kHz

Frequency MHz	Level dBuV/m	Pol v/h	15.209/15.247		Detector Pk/QP/Avg	Azimuth degrees	Height meters	Comments
			Limit	Margin				
2320.000	40.1	H	54.0	-13.9	Peak	180	1.0	
2288.500	39.0	H	54.0	-15.0	Peak	180	1.0	

Final measurements at 3m

Frequency MHz	Level dBuV/m	Pol v/h	15.209/15.247		Detector Pk/QP/Avg	Azimuth degrees	Height meters	Comments
			Limit	Margin				
2319.980	47.8	H	54.0	-6.2	AVG	72	1.2	
2279.930	46.7	H	54.0	-7.3	AVG	69	1.0	
2320.040	45.8	V	54.0	-8.2	AVG	100	1.0	
2279.930	45.2	V	54.0	-8.8	AVG	101	1.0	
2320.230	57.3	H	74.0	-16.7	PK	72	1.2	
2284.230	56.0	H	74.0	-18.0	PK	69	1.0	
2324.580	55.8	V	74.0	-18.2	PK	100	1.0	
2280.470	55.3	V	74.0	-18.7	PK	101	1.0	

Note 1: For emissions in restricted bands, the limit of 15.209 was used. For all other emissions, the limit is -30dBc for peak measurements in a measurement bandwidth of 100kHz.

Note 2: Signal is only present when Bluetooth is enabled, average correction for hopping occupancy could be applied

Note 3: Signal is present when Bluetooth is disabled (powered off)

Client:	Intel Corporation	Job Number:	J80398
Model:	Intel® Centrino® Advanced-N 6230	T-Log Number:	T80540
Contact:	Steve Hackett	Account Manager:	Christine Krebill
Standard:	FCC 15.247	Class:	N/A

Run # 8, Rainbow Peak 2x2: 1-10GHz, 802.11b @ 2437 MHz Chain A, BT Basic Rate @ 2480 MHz Chain B

	Target (dBm)	Power Settings Measured (dBm)	Software Setting
Chain A	16.5	16.6	23.5
Chain B	7.0	5.1	8.0

Spurious Radiated Emissions, 1 - 10GHz excluding the allocated band:
Preamplifier and notch filter used for these scans

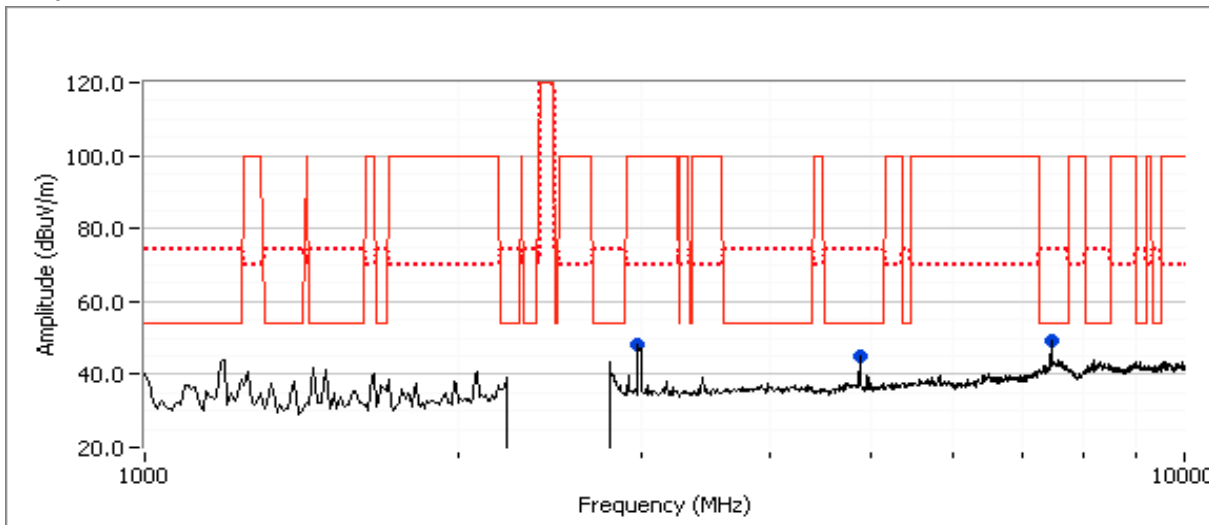

Preliminary Measurements (Peak versus average limit)

Frequency	Level	Pol	15.209/15.247		Detector	Azimuth	Height	Comments
MHz	dBuV/m	v/h	Limit	Margin	Pk/QP/Avg	degrees	meters	
2980.000	48.4	V	70.0	-21.6	Peak	148	1.0	
4873.880	45.0	V	54.0	-9.0	Peak	148	1.3	
7439.170	49.5	V	54.0	-4.5	Peak	166	2.2	

Final measurements at 3m

Frequency	Level	Pol	15.209/15.247		Detector	Azimuth	Height	Comments
MHz	dBuV/m	v/h	Limit	Margin	Pk/QP/Avg	degrees	meters	
4874.020	45.2	V	54.0	-8.8	AVG	146	1.2	RB 1 MHz;VB 10 Hz;Pk
4874.030	49.0	V	74.0	-25.0	PK	146	1.2	RB 1 MHz;VB 3 MHz;Pk
7440.000	44.9	V	54.0	-9.1	AVG	167	1.5	RB 1 MHz;VB 10 Hz;Pk
7440.270	52.2	V	74.0	-21.8	PK	167	1.5	RB 1 MHz;VB 3 MHz;Pk

Note: 7320 MHz is directly related to the Bluetooth signal and was observed during the Bluetooth only spurio us measurements.

Client:	Intel Corporation	Job Number:	J80398
Model:	Intel® Centrino® Advanced-N 6230	T-Log Number:	T80540
Contact:	Steve Hackett	Account Manager:	Christine Krebill
Standard:	FCC 15.247	Class:	N/A

Spurious Radiated Emissions, 2 - 3GHz

Preliminary Scan at ~ 20cm from the product to identify potential signals (Peak versus average limit)

No preamplifier used for these scans

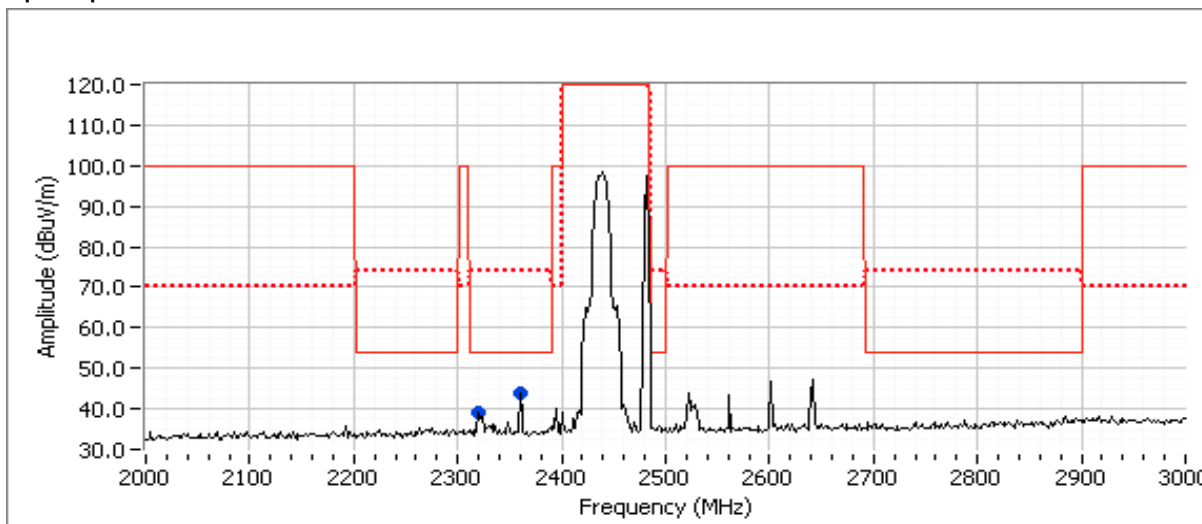

Preliminary measurements at ~ 20cm, RB=1MHz, VB=100kHz

Frequency MHz	Level dBuV/m	Pol v/h	15.209/15.247		Detector Pk/QP/Avg	Azimuth degrees	Height meters	Comments
			Limit	Margin				
2360.000	43.8	-	54.0	-10.2	Peak	180	1.0	
2320.000	39.2	-	54.0	-14.8	Peak	180	1.0	

Final measurements at 3m

Frequency MHz	Level dBuV/m	Pol v/h	15.209/15.247		Detector Pk/QP/Avg	Azimuth degrees	Height meters	Comments
			Limit	Margin				
2360.020	48.9	H	54.0	-5.1	AVG	328	1.0	
2319.980	47.9	H	54.0	-6.1	AVG	69	1.3	
2359.980	46.7	V	54.0	-7.3	AVG	107	1.0	
2320.040	45.7	V	54.0	-8.3	AVG	104	1.0	
2320.230	57.3	H	74.0	-16.7	PK	69	1.3	
2360.430	56.7	V	74.0	-17.3	PK	107	1.0	
2360.100	56.6	H	74.0	-17.4	PK	328	1.0	
2324.580	55.6	V	74.0	-18.4	PK	104	1.0	

Note 1: For emissions in restricted bands, the limit of 15.209 was used. For all other emissions, the limit is -30dBc for peak measurements in a measurement bandwidth of 100kHz.

Note 2: Signal is only present when Bluetooth is enabled, average correction for hopping occupancy could be applied

Note 3: Signal is present when Bluetooth is disabled (powered off)

Client:	Intel Corporation	Job Number:	J80398
Model:	Intel® Centrino® Advanced-N 6230	T-Log Number:	T80540
Contact:	Steve Hackett	Account Manager:	Christine Krebill
Standard:	FCC 15.247	Class:	N/A

Run # 9, Rainbow Peak 2x2: 1-10GHz, 802.11b @ 2412 MHz Chain A, BT EDR @ 2440 MHz Chain B

	Target (dBm)	Power Settings Measured (dBm)	Software Setting
Chain A	16.5	16.5	23.5
Chain B	7.0	1.4	8.0

Spurious Radiated Emissions, 1 - 10GHz excluding the allocated band:
Preamplifier and notch filter used for these scans

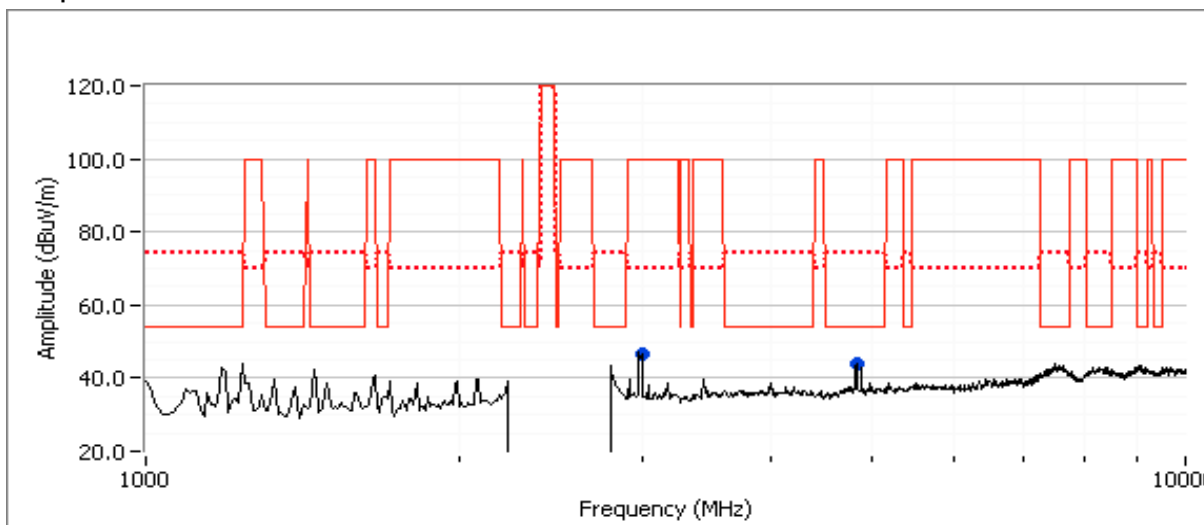

Preliminary Measurements (Peak versus average limit)

Frequency	Level	Pol	15.209/15.247		Detector	Azimuth	Height	Comments
MHz	dBuV/m	v/h	Limit	Margin	Pk/QP/Avg	degrees	meters	
2998.330	46.7	V	70.0	-23.3	Peak	130	1.0	
4823.990	44.0	V	54.0	-10.0	Peak	134	1.6	

Final measurements at 3m

Frequency	Level	Pol	15.209/15.247		Detector	Azimuth	Height	Comments
MHz	dBuV/m	v/h	Limit	Margin	Pk/QP/Avg	degrees	meters	
4824.030	43.1	V	54.0	-10.9	AVG	131	1.0	RB 1 MHz;VB 10 Hz;Pk
4823.990	47.7	V	74.0	-26.3	PK	131	1.0	RB 1 MHz;VB 3 MHz;Pk

Note: 4924 MHz is directly related to the WiFi (802.11b) signal and was observed during the 802.11b mode spurious measurements.

Client:	Intel Corporation	Job Number:	J80398
Model:	Intel® Centrino® Advanced-N 6230	T-Log Number:	T80540
Contact:	Steve Hackett	Account Manager:	Christine Krebill
Standard:	FCC 15.247	Class:	N/A

Spurious Radiated Emissions, 2 - 3GHz

Preliminary Scan at ~ 20cm from the product to identify potential signals (Peak versus average limit)

No preamplifier used for these scans

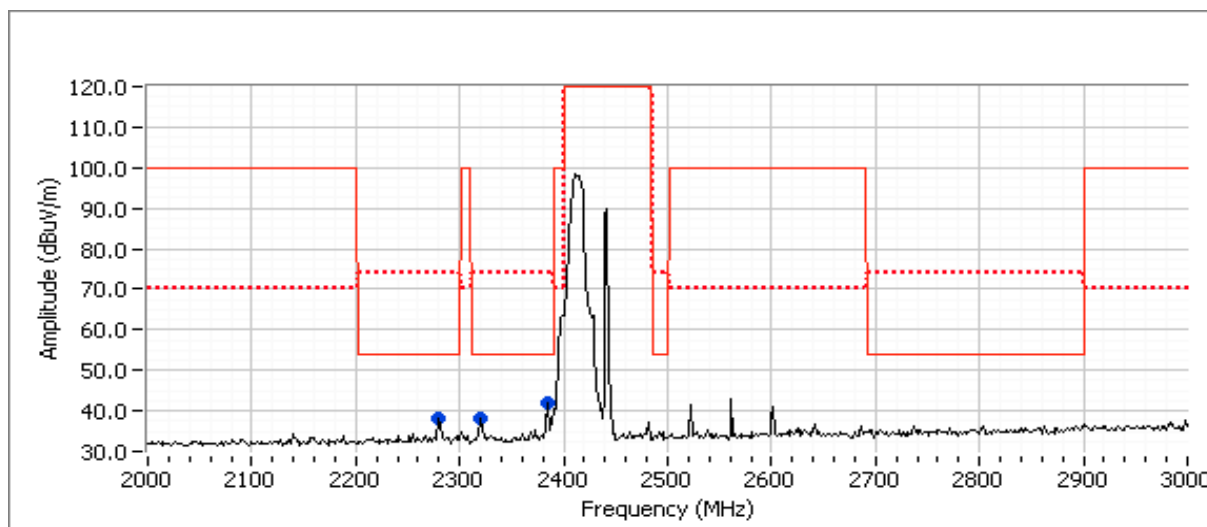

Preliminary measurements at ~ 20cm, RB=1MHz, VB=100kHz

Frequency	Level	Pol	15.209/15.247		Detector	Azimuth	Height	Comments
MHz	dBuV/m	v/h	Limit	Margin	Pk/QP/Avg	degrees	meters	
2385.000	42.2	V	54.0	-11.8	Peak	192	1.0	
2320.000	38.2	V	54.0	-15.8	Peak	192	1.0	
2280.000	38.2	V	54.0	-15.8	Peak	192	1.0	

Final measurements at 3m

Frequency	Level	Pol	15.209/15.247		Detector	Azimuth	Height	Comments
MHz	dBuV/m	v/h	Limit	Margin	Pk/QP/Avg	degrees	meters	
2383.860	46.4	H	54.0	-7.6	AVG	350	1.0	RB 1 MHz;VB 10 Hz;Pk
2384.460	59.4	H	74.0	-14.6	PK	350	1.0	RB 1 MHz;VB 3 MHz;Pk
2319.970	46.4	H	54.0	-7.6	AVG	3	1.1	RB 1 MHz;VB 10 Hz;Pk
2320.330	56.0	H	74.0	-18.0	PK	3	1.1	RB 1 MHz;VB 3 MHz;Pk
2279.900	44.6	H	54.0	-9.4	AVG	68	1.0	RB 1 MHz;VB 10 Hz;Pk
2279.060	55.4	H	74.0	-18.6	PK	68	1.0	RB 1 MHz;VB 3 MHz;Pk
2384.170	45.9	V	54.0	-8.1	AVG	205	1.5	RB 1 MHz;VB 10 Hz;Pk
2386.600	59.7	V	74.0	-14.3	PK	205	1.5	RB 1 MHz;VB 3 MHz;Pk

Note 1:	For emissions in restricted bands, the limit of 15.209 was used. For all other emissions, the limit is -30dBc for peak measurements in a measurement bandwidth of 100kHz.
Note 2:	Signal is only present when Bluetooth is enabled, average correction for hopping occupancy could be applied
Note 3:	Signal is present when Bluetooth is disabled (powered off)

Client:	Intel Corporation	Job Number:	J80398
Model:	Intel® Centrino® Advanced-N 6230	T-Log Number:	T80540
Contact:	Steve Hackett	Account Manager:	Christine Krebill
Standard:	FCC 15.247	Class:	N/A

Run # 10, Rainbow Peak 2x2: 1-15GHz, 802.11n20 @ 5200 MHz Chain A and B, BT Basic Rate @ 2440 MHz Chain B

	Target (dBm)	Power Settings Measured (dBm)	Software Setting
WiFi A	16.5	16.6	31.5
WiFi B	16.5	16.7	30.5
Bluetooth	7.0	5.4	8.0

Spurious Radiated Emissions, 7 - 15GHz:
 Preamplifier and high pass filter used for these scans

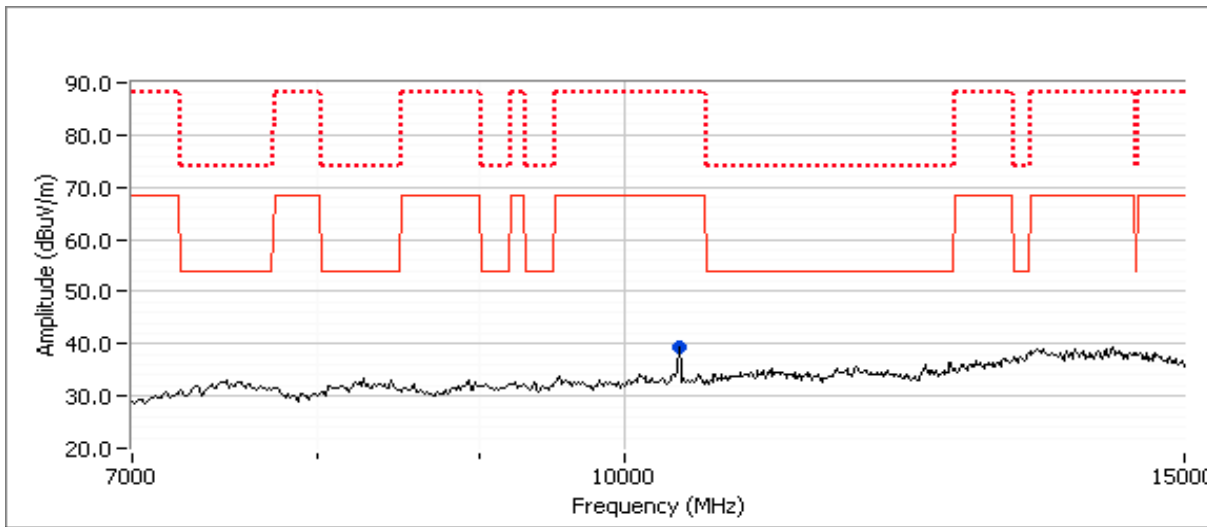

Preliminary Measurements (Peak versus average limit)

Frequency	Level	Pol	15.209/15.247/15E		Detector	Azimuth	Height	Comments
MHz	dBμV/m	v/h	Limit	Margin	Pk/QP/Avg	degrees	meters	
10400.000	39.4	V	68.3	-28.9	Peak	198	1.3	

Client:	Intel Corporation	Job Number:	J80398
Model:	Intel® Centrino® Advanced-N 6230	T-Log Number:	T80540
Contact:	Steve Hackett	Account Manager:	Christine Krebill
Standard:	FCC 15.247	Class:	N/A

Spurious Radiated Emissions, 1 - 7GHz (Scans from 1 - 3.5GHz and 3.5 - 7GHz)

Preliminary Scan at ~ 20cm from the product (card and antenna) to identify potential signals (Peak versus average limit)

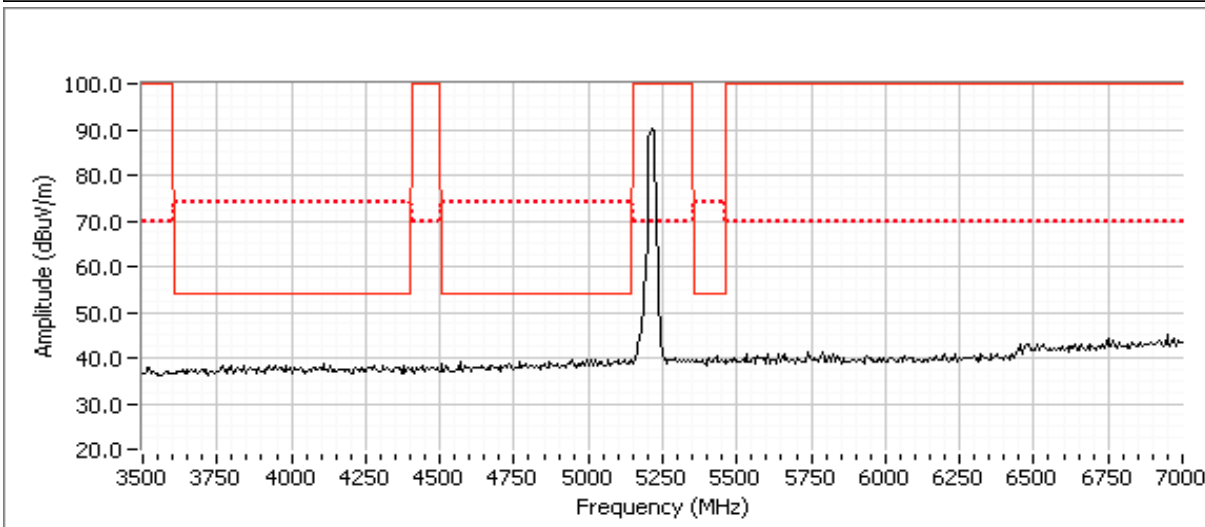
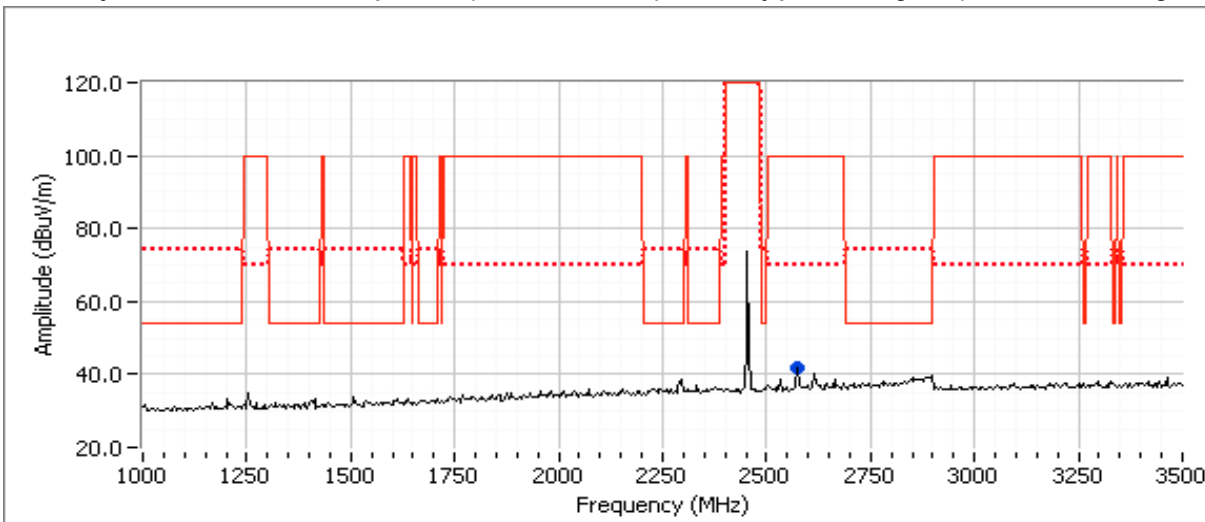

Client:	Intel Corporation	Job Number:	J80398
Model:	Intel® Centrino® Advanced-N 6230	T-Log Number:	T80540
Contact:	Steve Hackett	Account Manager:	Christine Krebill
Standard:	FCC 15.247	Class:	N/A

Spurious Radiated Emissions, 1 - 7GHz (Scans from 1 - 3.5GHz and 3.5 - 7GHz)

Preliminary measurements at ~ 20cm, RB=1MHz, VB=100kHz

Frequency	Level	Pol	15.209/15.247		Detector	Azimuth	Height	Comments
MHz	dBμV/m	v/h	Limit	Margin	Pk/QP/Avg	degrees	meters	
2560.000	40.1	V	100.0	-59.9	Peak	360	1.0	

Final measurements at 3m

Frequency	Level	Pol	15.209/15.247		Detector	Azimuth	Height	Comments
MHz	dBμV/m	v/h	Limit	Margin	Pk/QP/Avg	degrees	meters	
2280.000	41.9	H	54.0	-12.1	AVG	0	1.2	RB 1 MHz;VB 10 Hz;Pk Note 2
2320.000	41.7	V	54.0	-12.3	AVG	77	1.3	RB 1 MHz;VB 10 Hz;Pk Note 2
2360.000	39.6	V	54.0	-14.4	AVG	77	1.2	RB 1 MHz;VB 10 Hz;Pk Note 2
2320.000	39.4	H	54.0	-14.6	AVG	206	1.3	RB 1 MHz;VB 10 Hz;Pk Note 2
2360.000	38.1	H	54.0	-15.9	AVG	39	1.2	RB 1 MHz;VB 10 Hz;Pk Note 2
2280.000	37.8	V	54.0	-16.2	AVG	140	1.0	RB 1 MHz;VB 10 Hz;Pk Note 2
2320.000	55.0	V	74.0	-19.0	PK	77	1.3	RB 1 MHz;VB 3 MHz;Pk Note 2
2560.000	50.6	H	70.0	-19.4	PK	168	1.4	RB 1 MHz;VB 3 MHz;Pk Note 2
2560.000	46.9	V	70.0	-23.1	PK	216	1.9	RB 1 MHz;VB 3 MHz;Pk Note 2
2280.000	46.8	H	74.0	-27.2	PK	0	1.2	RB 1 MHz;VB 3 MHz;Pk Note 2
2320.000	46.2	H	74.0	-27.8	PK	206	1.3	RB 1 MHz;VB 3 MHz;Pk Note 2
2360.000	45.4	V	74.0	-28.6	PK	77	1.2	RB 1 MHz;VB 3 MHz;Pk Note 2
2360.000	44.3	H	74.0	-29.7	PK	39	1.2	RB 1 MHz;VB 3 MHz;Pk Note 2
2280.000	44.0	V	74.0	-30.0	PK	140	1.0	RB 1 MHz;VB 3 MHz;Pk Note 2
2560.000	46.3	H	100.0	-53.7	AVG	168	1.4	RB 1 MHz;VB 10 Hz;Pk Note 2
2560.000	40.5	V	100.0	-59.5	AVG	216	1.9	RB 1 MHz;VB 10 Hz;Pk Note 2

Note 1: For emissions in restricted bands, the limit of 15.209 was used. For all other emissions, the limit is -30dBc for peak measurements in a measurement bandwidth of 100kHz.

Note 2: Signal is only present when Bluetooth is enabled, average correction for hopping occupancy could be applied

Client:	Intel Corporation	Job Number:	J80398
Model:	Intel® Centrino® Advanced-N 6230	T-Log Number:	T80540
Contact:	Steve Hackett	Account Manager:	Christine Krebill
Standard:	FCC 15.247	Class:	N/A

Run # 11, Rainbow Peak 2x2: 1-15GHz, 802.11n20 @ 5300 MHz Chain A and B, BT Basic Rate @ 2440 MHz Chain B

	Target (dBm)	Power Settings Measured (dBm)	Software Setting
WiFi A	16.5	16.7	32.0
WiFi B	16.5	16.5	31.0
Bluetooth	7.0	5.4	8.0

Spurious Radiated Emissions, 7 - 15GHz:
Preamplifier and high pass filter used for these scans

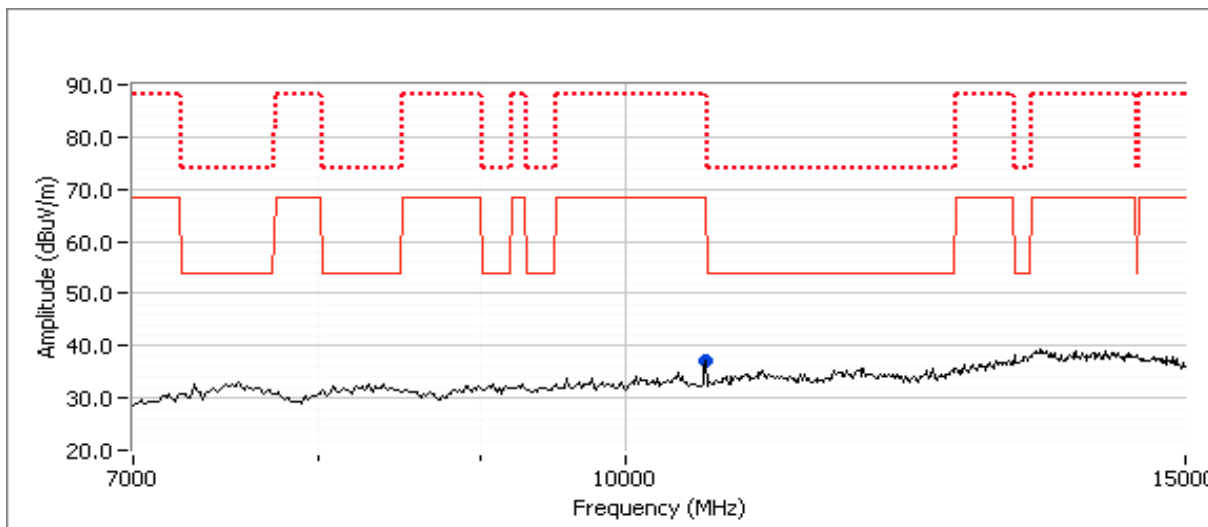

Preliminary Measurements (Peak versus average limit)

Frequency	Level	Pol	15.209/15.247/15E		Detector	Azimuth	Height	Comments
MHz	dBμV/m	v/h	Limit	Margin	Pk/QP/Avg	degrees	meters	
10600.000	37.2	V	54.0	-16.8	Peak	182	1.0	

Client: Intel Corporation	Job Number: J80398
Model: Intel® Centrino® Advanced-N 6230	T-Log Number: T80540
Contact: Steve Hackett	Account Manager: Christine Krebill
Standard: FCC 15.247	Class: N/A

Spurious Radiated Emissions, 1 - 7GHz (Scans from 1 - 3.5GHz and 3.5 - 7GHz)

Preliminary Scan at ~ 20cm from the product (card and antenna) to identify potential signals (Peak versus average limit)

No preamplifier used for these scans

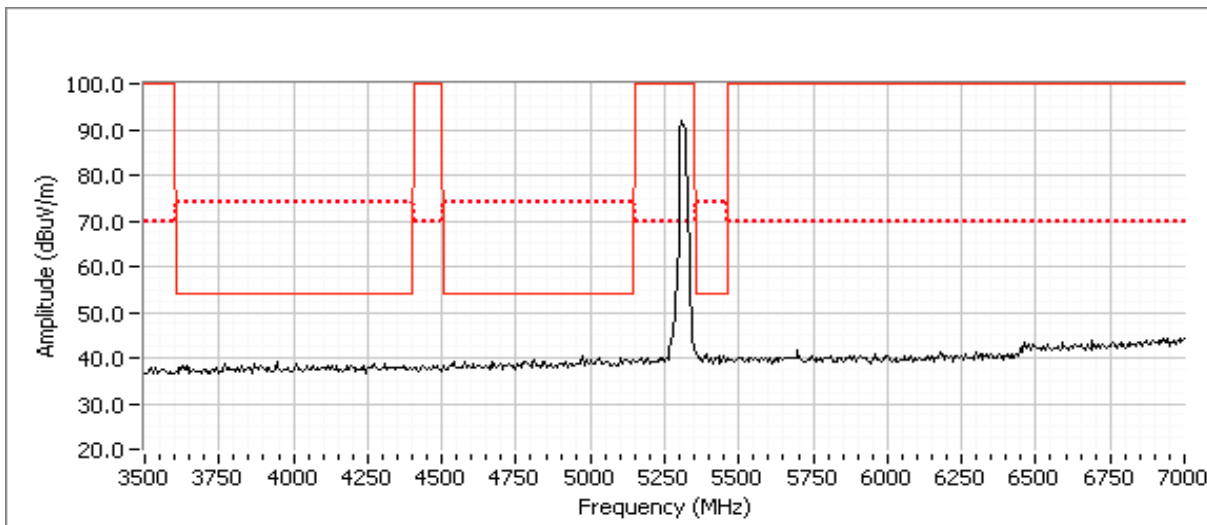
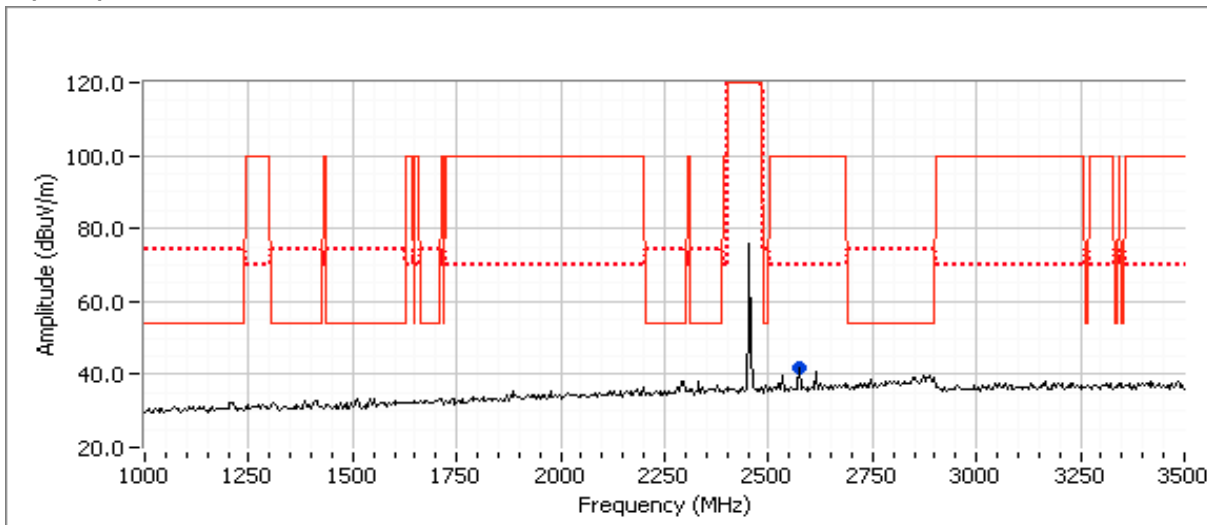

Note 1: The emissions observed above the noise floor are the same as those observed with the Wi-Fi radio at 5200 MHz (Run 10) and are unaffected when the Wi-Fi radio is disabled (powered off). Additional measurements were therefore not necessary.

Client:	Intel Corporation	Job Number:	J80398
Model:	Intel® Centrino® Advanced-N 6230	T-Log Number:	T80540
Contact:	Steve Hackett	Account Manager:	Christine Krebill
Standard:	FCC 15.247	Class:	N/A

Run # 12, Rainbow Peak 2x2: 1-15GHz, 802.11n20 @ 5600 MHz Chain A and B, BT Basic Rate @ 2440 MHz Chain B

	Target (dBm)	Power Settings Measured (dBm)	Software Setting
WiFi A	16.5	16.5	34.0
WiFi B	16.5	16.5	34.0
Bluetooth	7.0	5.4	8.0

Spurious Radiated Emissions, 7 - 15GHz:
 Preamplifier and high pass filter used for these scans

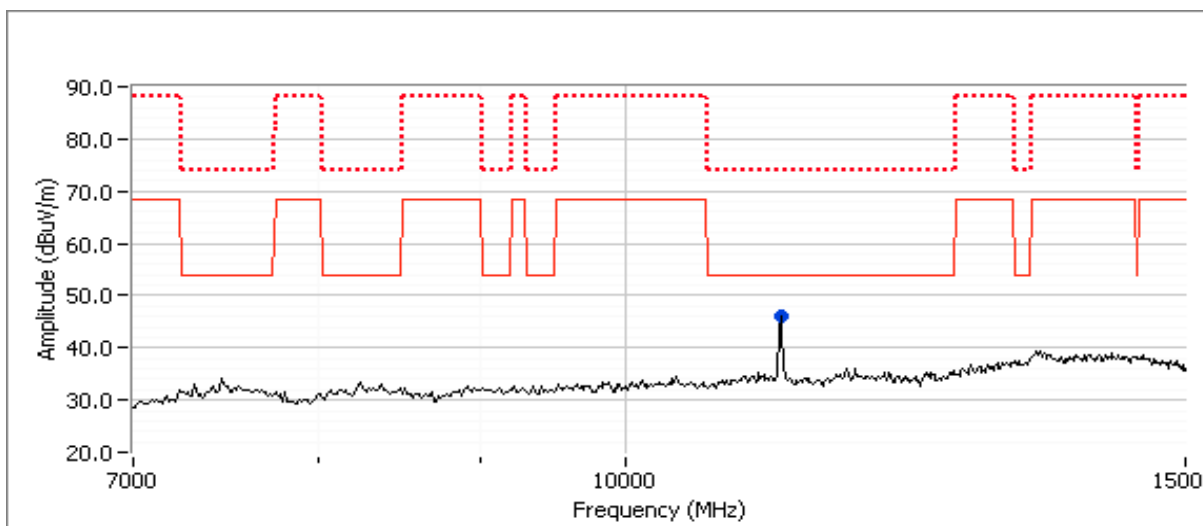

Preliminary Measurements (Peak versus average limit)

Frequency	Level	Pol	15.209/15.247/15E		Detector	Azimuth	Height	Comments
MHz	dBuV/m	v/h	Limit	Margin	Pk/QP/Avg	degrees	meters	
11200.340	46.0	V	54.0	-8.0	Peak	188	1.0	

Final measurements at 3m

Frequency	Level	Pol	15.209/15.247/15E		Detector	Azimuth	Height	Comments
MHz	dBuV/m	v/h	Limit	Margin	Pk/QP/Avg	degrees	meters	
11199.810	45.1	V	54.0	-8.9	AVG	157	1.9	RB 1 MHz;VB 10 Hz;Pk
11200.110	61.2	V	74.0	-12.8	PK	157	1.9	RB 1 MHz;VB 3 MHz;Pk

Client:	Intel Corporation	Job Number:	J80398
Model:	Intel® Centrino® Advanced-N 6230	T-Log Number:	T80540
Contact:	Steve Hackett	Account Manager:	Christine Krebill
Standard:	FCC 15.247	Class:	N/A

Spurious Radiated Emissions, 1 - 7GHz (Scans from 1 - 3.5GHz and 3.5 - 7GHz)

Preliminary Scan at ~ 20cm from the product (card and antenna) to identify potential signals (Peak versus average limit)

No preamplifier used for these scans

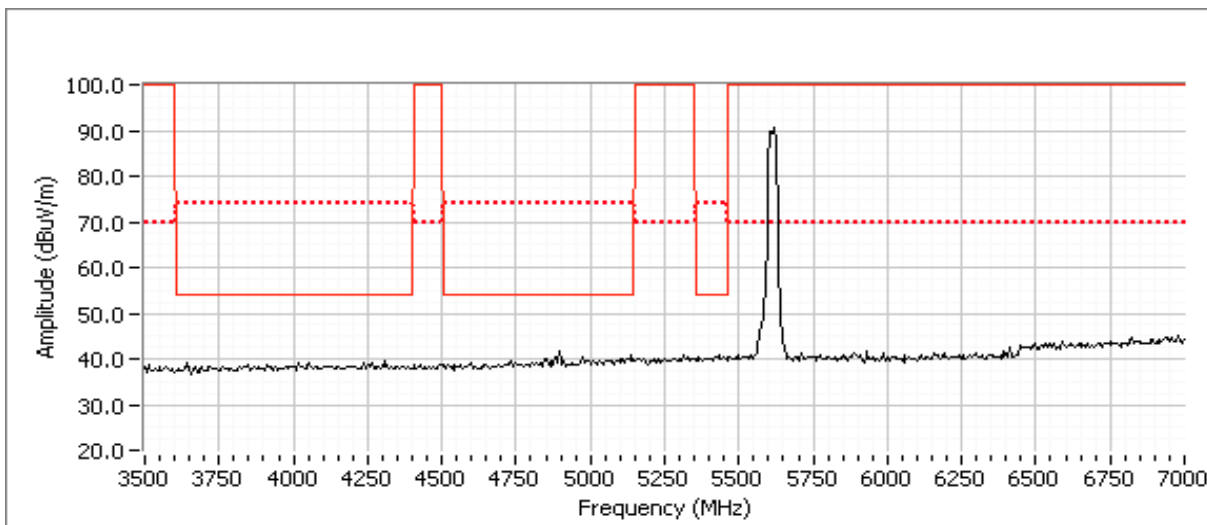
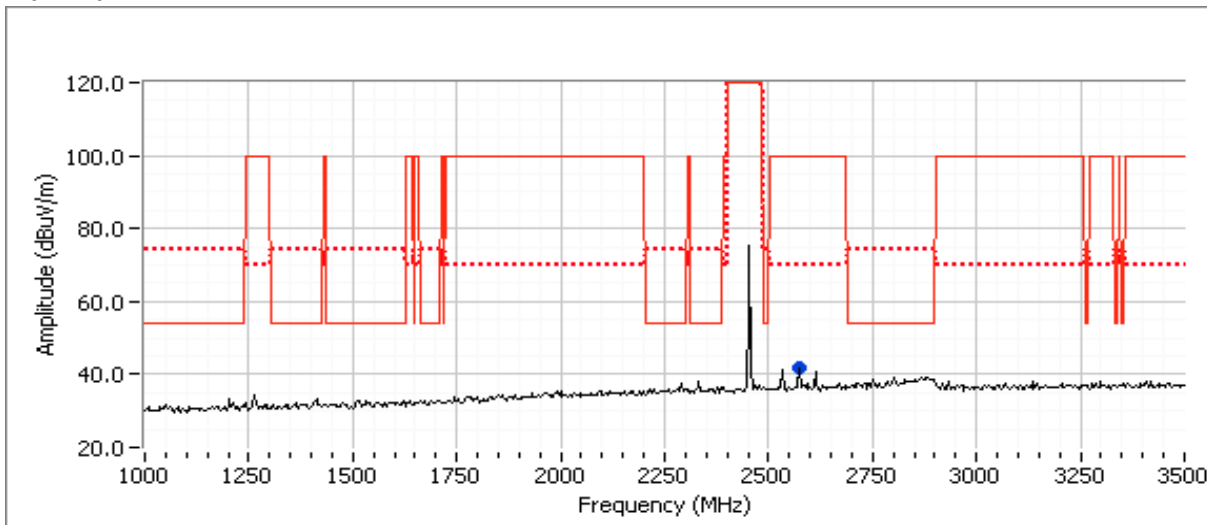

Note 1: The emissions observed above the noise floor are the same as those observed with the Wi-Fi radio at 5200 MHz (Run 10) and are unaffected when the Wi-Fi radio is disabled (powered off). Additional measurements were therefore not necessary.

Client:	Intel Corporation	Job Number:	J80398
Model:	Intel® Centrino® Advanced-N 6230	T-Log Number:	T80540
Contact:	Steve Hackett	Account Manager:	Christine Krebill
Standard:	FCC 15.247	Class:	N/A

Run # 13, Rainbow Peak 2x2: 1-15GHz, 802.11n20 @ 5785 MHz Chain A and B, BT Basic Rate @ 2440 MHz Chain B

	Target (dBm)	Power Settings Measured (dBm)	Software Setting
WiFi A	16.5	16.5	35.0
WiFi B	16.5	16.7	34.5
Bluetooth	7.0	5.4	8.0

Spurious Radiated Emissions, 7 - 15GHz:
 Preamplifier and high pass filter used for these scans

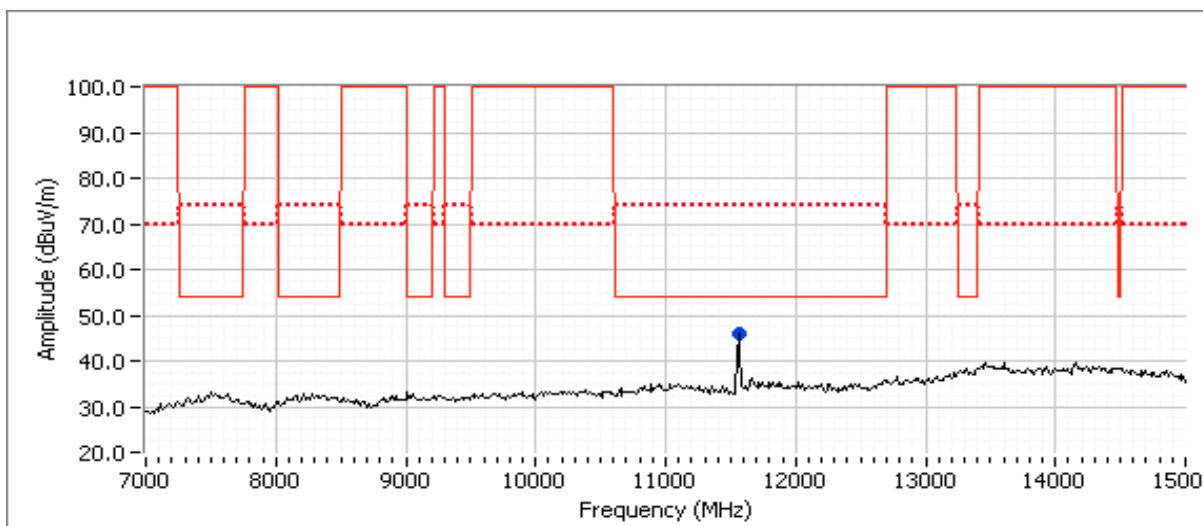

Preliminary Measurements (Peak versus average limit)

Frequency	Level	Pol	15.209/15.247/15E		Detector	Azimuth	Height	Comments
MHz	dBμV/m	v/h	Limit	Margin	Pk/QP/Avg	degrees	meters	
11570.410	45.9	V	54.0	-8.1	Peak	187	1.0	

Final measurements at 3m

Frequency	Level	Pol	15.209/15.247/15E		Detector	Azimuth	Height	Comments
MHz	dBμV/m	v/h	Limit	Margin	Pk/QP/Avg	degrees	meters	
11570.680	44.7	V	54.0	-9.3	AVG	192	1.4	RB 1 MHz;VB 10 Hz;Pk
11570.280	57.8	V	74.0	-16.2	PK	192	1.4	RB 1 MHz;VB 3 MHz;Pk

Client:	Intel Corporation	Job Number:	J80398
Model:	Intel® Centrino® Advanced-N 6230	T-Log Number:	T80540
Contact:	Steve Hackett	Account Manager:	Christine Krebill
Standard:	FCC 15.247	Class:	N/A

Spurious Radiated Emissions, 1 - 7GHz (Scans from 1 - 3.5GHz and 3.5 - 7GHz)

Preliminary Scan at ~ 20cm from the product (card and antenna) to identify potential signals (Peak versus average limit)

No preamplifier used for these scans

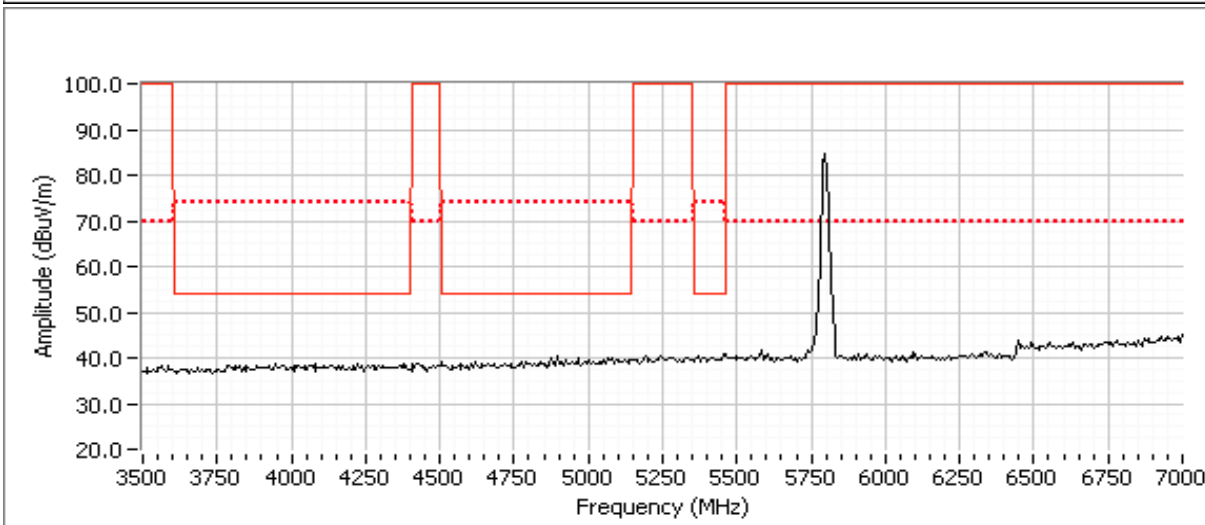
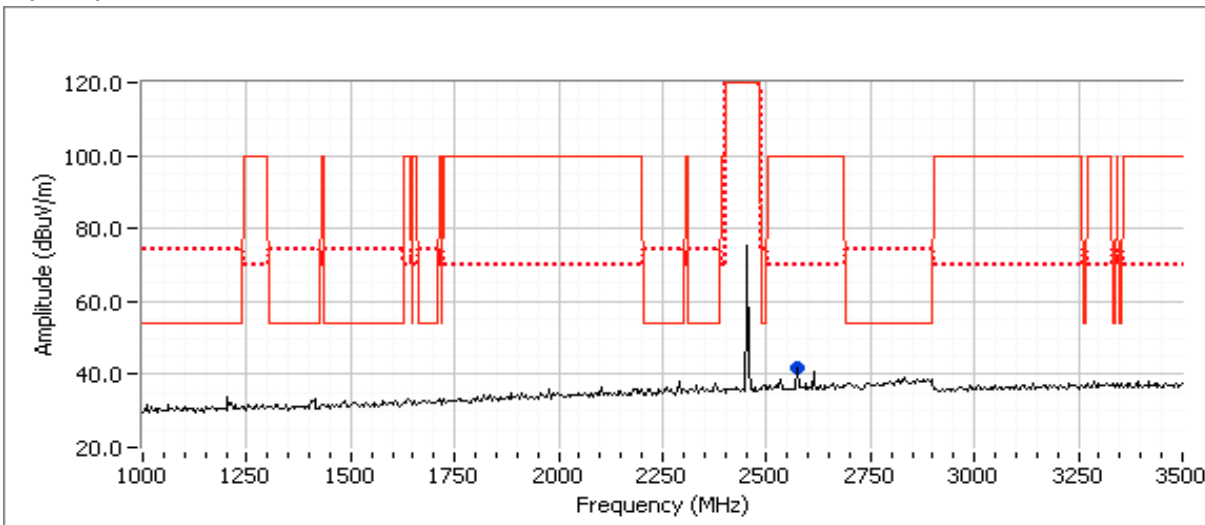

Note 1: The emissions observed above the noise floor are the same as those observed with the Wi-Fi radio at 5200 MHz (Run 10) and are unaffected when the Wi-Fi radio is disabled (powered off). Additional measurements were therefore not necessary.