



Modular Approval
Test Report
And Application for Grant of Equipment Authorization

TEST REPORT PERTAINING TO:

Equipment Under Test	Model Number(s)
Intel WiFi/WiMax Link 5350	533ANXMMW

CONFIGURATION
IEEE 802.16e with a set of Shanghai Universe Communication Electron Co., Ltd Antennas

MEASUREMENTS PERFORMED IN ACCORDANCE WITH THE FOLLOWING STANDARD (S)

Regulatory Standard(s)
47 CFR - FCC Part 27
Test Method: ANSI C63.4: 2003 American National Standard for Methods of Measurement of Radio-Noise Emissions from Low-Voltage Electrical and Electronic Equipment in the Range of 9 kHz to 40 GHz



Certificate Number: 1111.01

PREPARED FOR:

Intel Corporation
2111 NE 25th Avenue
Hillsboro, Oregon 97124
Contact(s): Ms. Marissa Faustino

PREPARED BY:

Aegis Labs, Inc.
8 Rancho Circle
Lake Forest, CA 92630
Agent(s): Mr. Rick Candelas
Mr. Johnny Candelas



Test Report #: INTEL-080116F

Test Report Revision: NONE

	REPORT BODY	APPENDICES		TOTAL PAGES
		A	B	
PAGES	12	53	1	66

The contents of this report shall not be reproduced except in full, without the written approval of Aegis Labs, Inc.
The Intel logo is used for identification purposes only and is a registered trademark of Intel Corporation



TABLE OF CONTENTS

SECTION	TITLE	PAGE
	COVER SHEET.....	01
	TABLE OF CONTENTS.....	02
1.0	REGULATORY COMPLIANCE GUIDELINES.....	03
1.1	Guidelines For Testing To Emissions Standards.....	03
2.0	SUMMARY OF REGULATORY LIMITS.....	04
3.0	ADMINISTRATIVE DATA AND TEST DESCRIPTION.....	06
4.0	DESCRIPTION OF EUT CONFIGURATION.....	07
4.1	EUT Description	07
4.2	EUT Configuration.....	08
4.3	List of EUT Sub-Assemblies and Host Equipment.....	08
4.4	I/O Cabling Diagram and Description	09
4.5	EMC Test Hardware and Software Measurement Equipment.....	10
5.0	CONDITIONS DURING EMISSIONS MEASUREMENTS.....	11
5.1	General.....	11
5.2	Conducted Emissions Test Setup.....	11
5.3	Radiated Emissions Test Setup.....	12

APPENDICES

A	Test Data
B	Modifications And Recommendations



1.0 REGULATORY COMPLIANCE GUIDELINES

Aegis Labs, Inc. operates as both a Nevada and California Corporation with no organizational or financial relationship with any company, institution, or private individual. Testing and engineering functions provided by Aegis Labs were furnished by RF technicians and engineers with accredited qualifications and training credentials to carry out their duties.

The object of this report was to publish verifiable test results of an EUT subjected to the tests outlined in the standard listed on the cover page of this report.

1.1 Guidelines For Testing To Emissions Standards

This standard for EMC emission requirements apply to electrical equipment for Information Technology Equipment (ITE). Compliance to these standards and in combination with the other standards listed in this test report can be used to demonstrate presumption of compliance with the protection requirements of the appropriate agency standard.

The purpose of this standard is to specify minimum requirements for emissions regarding electromagnetic compatibility (EMC) and protect the radio frequency spectrum 9 kHz. – 400 GHz. from unwanted interference generated from electrical/digital systems that intentionally or unintentionally generated RF energy. The emissions standards, normative documents and/or publications were used to conduct all tests performed on the equipment herein referred to as “Equipment Under Test”.



2.0 SUMMARY OF TEST RESULTS

802.16e Mode (2495-2690 MHz) 10MHz Wide Channels

EMISSIONS STANDARD			
FCC Part 27 & Part 2	Description	Results	Comments
27.50 2.1046	RF Power Output (Conducted) - The maximum peak output power of the intentional radiator shall not exceed 2 watts. The maximum conducted output power occurred in QPSK mode*	PASSED	2501 MHz = 23.25 dBm = 0.2114 W 2593 MHz = 22.60 dBm = 0.1820 W 2685 MHz = 22.44 dBm = 0.1754 W
27.50 2.1046	RF Power Output (E.I.R.P) - The maximum peak output power of the intentional radiator shall not exceed 2 watts. The maximum E.I.R.P measurement occurred in QPSK mode*	PASSED	2501 MHz = 23.83 dBm = 0.2416 W 2593 MHz = 22.89 dBm = 0.1945 W 2685 MHz = 22.61 dBm = 0.1824 W
27.54 2.1055	Frequency Stability	PASSED	See Data Sheets
27.53 2.1049	Occupied Emissions Bandwidth	PASSED	See Data Sheets
27.53 2.1051	Band Edge Measurements	PASSED	See Data Sheets
27.53 2.1051	Conducted Spurious Emissions	PASSED	See Data Sheets
27.53 2.1053	Radiated Spurious Emissions	PASSED	See Data Sheets
15.207	AC Conducted Emissions	PASSED	See FCC 15.247 report (INTEL-080114F)
15.209	Radiated Emissions (30-1000 MHz)	PASSED	

*See data sheets for all modes output power



2.0 Summary Of Test Results (Continued)

802.16e Mode (2495-2690 MHz) 5MHz Wide Channels

EMISSIONS STANDARD			
FCC Part 27 & Part 2	Description	Results	Comments
27.50 2.1046	RF Power Output (Conducted) - The maximum peak output power of the intentional radiator shall not exceed 2 watts. The maximum conducted output power occurred in 16QAM mode*	PASSED	2501 MHz = 23.07 dBm = 0.2028 W 2593 MHz = 23.14 dBm = 0.2061 W 2685 MHz = 22.51 dBm = 0.1782 W
27.50 2.1046	RF Power Output (E.I.R.P) - The maximum peak output power of the intentional radiator shall not exceed 2 watts. The maximum E.I.R.P measurement occurred in 16QAM mode*	PASSED	2501 MHz = 23.34 dBm = 0.2158 W 2593 MHz = 23.51 dBm = 0.2244 W 2685 MHz = 22.93 dBm = 0.1963 W
27.54 2.1055	Frequency Stability	PASSED	See Data Sheets
27.53 2.1049	Occupied Emissions Bandwidth	PASSED	See Data Sheets
27.53 2.1051	Band Edge Measurements	PASSED	See Data Sheets
27.53 2.1051	Conducted Spurious Emissions	PASSED	See Data Sheets
27.50 2.1053	Radiated Spurious Emissions	PASSED	See Data Sheets
15.207	AC Conducted Emissions	PASSED	See FCC 15.247 report (INTEL-080114F)
15.209	Radiated Emissions (30-1000 MHz)	PASSED	

*See data sheets for all modes output power

ANALYSIS AND CONCLUSIONS

Based upon the measurement results we find that this equipment is within the limits of the global standards listed on the cover page of this test report. All results are based on a test of one sample. If any significant changes are made to the unit, the changes shall be evaluated and a retest may be required.

Approval Signatories

Test and Report Completed By:

Johnny Candelas **04/03/08**
Date:
Test Technician
Aegis Labs, Inc.

Report Approved By:

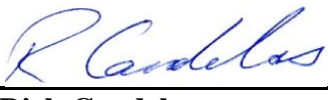
Rick Candelas **04/08/08**
Date:
Quality Assurance & EMC Lab Manager
Aegis Labs, Inc.



3.0 ADMINISTRATIVE DATA AND TEST DESCRIPTION

DEVICE TESTED:	ITE Type: Intel WiFi/WiMax Link 5350 Model Number(s): 533ANXMMW Serial Number: 0016EB01A3A8 FCC ID: PD9533ANXM
DATE EUT RECEIVED:	January 16 th , 2008
TEST DATE(S):	January 16 th – March 31 st , 2008
ORIGIN OF TEST SAMPLE(S):	Production
EQUIPMENT CLASS:	EUT tested as CLASS B device
RESPONSIBLE PARTY:	Intel Corporation 2111 NE 25 th Avenue Hillsboro, Oregon 97124
CLIENT CONTACT:	Ms. Marissa Faustino
MANUFACTURER:	Intel Corporation
TEST LOCATION:	Aegis Labs, Inc. 32231 Trabuco Creek Road Trabuco Canyon, CA 92678 Open Area Test Site #1 & #2
ACCREDITATION CERTIFICATE(S):	A2LA Certificate Number: 1111.01, Valid through April 30, 2008
PURPOSE OF TEST:	To demonstrate compliance with the standards as described in Sections 1.0 & 2.0 of this report.
UNCERTAINTY BUDGET:	Proficiency Testing and Uncertainty Calculations for all tests indicated in this report have been conducted in accordance with ISO 17025: 2005 requirements Section 5.4.6, and 5.9. Uncertainty Budgets and Proficiency Test results available upon request.
STATEMENT OF CALIBRATION:	All accredited equipment calibrations were performed by Liberty Labs, Inc. and World Cal. with typical calibration uncertainty estimates derived from ISO Guide to the determination of uncertainties with a Coverage Factor of k=2 for 95% level of confidence.

4.0 DESCRIPTION OF EUT CONFIGURATION

4.1 EUT Description

Equipment Under Test (EUT)	
Trade Name:	Intel WiFi/WiMax Link 5350
Model Number:	533ANXMMW
Frequency Range:	802.16e = 2.496-2.690 GHz
Modulation Type	16QAM & QPSK
Transfer Rate:	4Mbps UL / 10Mbps DL
Channel Bandwidth	10MHz & 5MHz
Enclosure:	The EUT contains it's own shield made of aluminum approximately 2.5cm wide by 2cm deep by 2mm high.
Antenna Type:	<u>Shanghai Universe Communication Electron Co., Ltd Antennas:</u> PIFA
Antenna Gain (See Note 2):	3.47dBi @ 2.5-2.6 GHz
Transmit Output Power:	Please see Appendix A (Data Sheets) for actual output power.
Power Supply:	3.3VDC from external source
Number of External Test Ports Exercised:	1 Antenna Port

The Intel WiFi/WiMax Link 5350 is an embedded IEEE 802.16e and 802.11a/b/g/n wireless network adapter that operate in the 2.4 GHz and 5.0 GHz spectra for WiFi and 2.5 GHz for WiMax. The adapter is capable of delivering up to 450 Mbps Tx/Rx over WiFi and up to 4 Mbps UL/10 Mbps DL over WiMax.

NOTE 1: For a more detailed description, please refer to the manufacture's specifications or User's Manual.

NOTE 2: The EUT was tested with a set of Shanghai Universe Communication Electron Co., Ltd Antennas. (Refer to the antenna specifications exhibits).

4.2 EUT Configuration

The EUT was tested installed in the Mini PCI-E slot of an extender board which is then connected to the host computer. The EUT was then connected to a set of antennas via its Chain A, B, & C antenna ports. Only Chain A is able to transmit, the other chains are used to connect to a remotely located ESG Vector Signal Generator. Data for a set of Shanghai Universe Communication Electron Co., Ltd Antennas can be found in Appendix A (Data Sheets)

The low, middle, and high channels were tested in 802.16e mode. Also, the EUT was tested transmitting with 16QAM and QPSK modulations out of Chain A antenna port only. The EUT was placed in continuous transmit mode by a program provided by the manufacturer (*VaTU software*).

4.3 List of EUT, Sub-Assemblies and Host Equipment

Equipment Under Test			
Manufacturer	Equipment Name	Model or Part Number	Serial Number
Intel Corporation	Intel WiFi/WiMax Link 5350	533ANXMMW	0016EB01A3A8

EUT Sub Assemblies			
Manufacturer	Equipment Name	Model or Part Number	Serial Number
Shanghai Universe Communication Electron Co., Ltd	Chain A Antenna	SUC ANT S11	N/A
	Chain B Antenna	SUC ANT S11	N/A

HOST EQUIPMENT LIST			
Manufacturer	Equipment Name	Model or Part Number	Serial Number
Generic	Host Laptop	ENG001	None
Protek	DC Power Source	3006B	AC2018
Logitech	Keyboard	Y-BF37	MCT25200581
Logitech	Mouse	M-BJ58	LNA22802012

NOTE: All the power cords of the above support equipment are standard and non-shielded.

4.4 I/O Cabling Diagram and Description

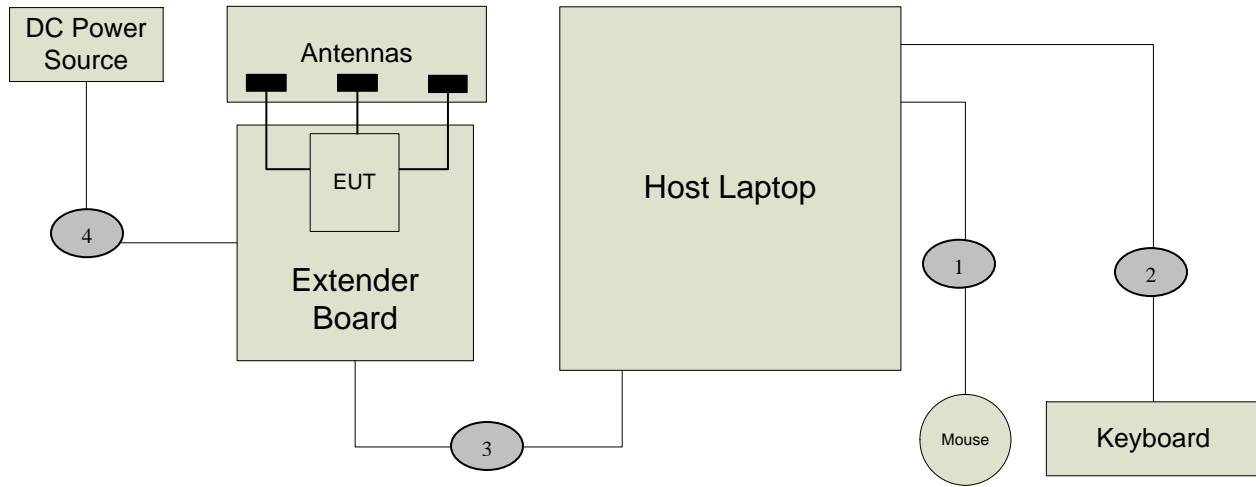

Remotely Located from EUT setup

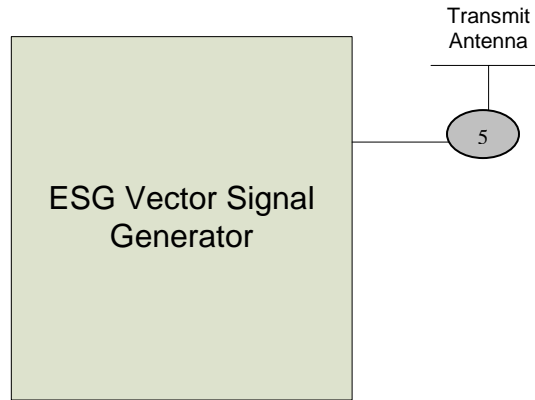

Signal Line Cable Description

Cable	Length	Construction	Source Connector	Destination Connector	Bundled Length	Ferrite Attached	Note
1	1.5m	Round, Braid & Foil Shielded	Host Computer: USB Port	Keyboard: Hardwired	N/A	N/A	N/A
2	1.5m	Round, Braid & Foil Shielded	Host Computer: USB Port	Mouse: Hardwired	N/A	N/A	N/A
3	0.5m	USB Cable, round, braid & foil shielded	Extender Board: USB Port	Host Laptop: USB Port	N/A	N/A	N/A
4	0.5m	Round Un-shielded	Extender Board: Power Input	DC Power Source: Power Output	N/A	N/A	N/A
5	0.5m	Round, Braid & Foil Shielded	Sig Gen: RF Out: SMA	Horn Antenna: SMA	N/A	N/A	N/A



4.5 EMC Test Hardware and Software Measurement Equipment

TEST EQUIPMENT LIST - Emissions					
Equipment Name	Manufacturer	Model Number	Serial Number	Calibration Due Date	Maintenance Calibration Cycle
Spectrum Analyzer	Agilent	8565EC	3946A00245	07/24/08	1 Year
PSA Spectrum Analyzer	Agilent	E4440A	MY44303400	10/24/08	1 Year
ESG Vector Signal Generator	Agilent	E4438C	MY45092227	01/16/10	2 Years
20GHz Signal Generator	Agilent	E8257D	MY46520341	09/25/09	2 Years
Antenna – Horn (Receive)	EMCO	3115	2230	05/15/08	1 Year
Antenna – Horn (Transmit)	ETS	3117	00057423	03/28/08	1 Year
Preamp	Miteq	JS42-01001800-25-10P	815980	09/21/08	1 Year
28 Foot Coax	Semflex	S1L29BFS1348	608	07/26/08	1 Year
30 Foot Coax	Semflex	S130SFBS10360	0619	07/26/08	1 Year
3 GHz High Pass Filter	Microwave Circuits, Inc	H3G020G2	0301DC0132	NCR	NCR
3 GHz Notch Filter	Microwave Circuits, Inc	L0022161	236054DC0734	NCR	NCR
Antenna - 18-26.5 GHz Pre-amplified Horn	Aegis Labs, Inc.	H042	SLK-35-3W	02/08/09	1 Year
Antenna - 26.5-40 GHz Pre-amplified Horn	Aegis Labs, Inc.	H028	GM1260-10	02/08/09	1 Year
EMI Receiver - RF Section	Hewlett Packard	8546A	3325A00137	04/26/08	1 Year
EMI Receiver - RF Filter Section	Hewlett Packard	85460A	3330A00138	04/26/08	1 Year
10 dB Attenuator	Pasternack	PE7014-10	N/A	09/05/08	1 Year
LISN (EUT)	Fisher Custom Communications	FCC-LISN-50-25-2	9931	03/30/09	1 Year
LISN (Access)	EMCO	3825/2	9108-1848	03/30/09	1 Year
Antenna - Biconical	EMCO	3110B	3383	03/20/09	1 Year
Antenna - Log Periodic	EMCO	3148	47943	03/20/09	1 Year
Power Meter	Anritsu	ML2487A	6K00001785	05/29/08	1 Year
Wide Bandwidth Sensor	Anritsu	MA2491A	31193	05/29/08	1 Year
12dB Attenuator	Narda	4779-12	203	06/09/08	1 Year
Temperature/Humidity Monitor	Dickson	TH550	7255185	04/13/08	1 Year

NCR – No Calibration Required.

5.0 CONDITIONS DURING EMISSIONS MEASUREMENTS

5.1 General

All measurements were made according to the procedures defined in or referred to by the standard listed on the cover page of this report. The measurements were made in the operating mode producing the largest emissions consistent with normal operation and connected to the minimum configuration of auxiliary devices.

5.2 Conducted Emissions Test Setup

The following was the test configuration.

EUT signal cables that hung closer than 40 cm to the horizontal metal ground plane were folded back and forth forming a bundle 30 cm to 40 cm long. The power cord of the EUT was also bundled in the center and plugged into one of the artificial mains network (AMN). All peripheral equipment was powered from a second AMN via a multiple outlet strip placed at a distance on 10cm from each other. The AMN and ISN were positioned 80cm from the EUT. Signal cables that were not connected to an AE were terminated using the correct termination. If applicable, the current probe was placed at 0.1 m from the ISN.

Peak, quasi-peak and/or average detectors were used for testing performed between 150 kHz and 30 MHz. A swept frequency scan was performed for both Line 1 and Line 2. The six highest readings were compared against the limit and recorded in the data sheet along with a snapshot image of the sweep scan. The graphical scans in Appendix A only reflect peak readings while the tabulated data sheets reflect peak, average, and/or quasi-peak measurements.

Climatic Conditions:

The EUT was tested within its intended operating and climatic conditions.

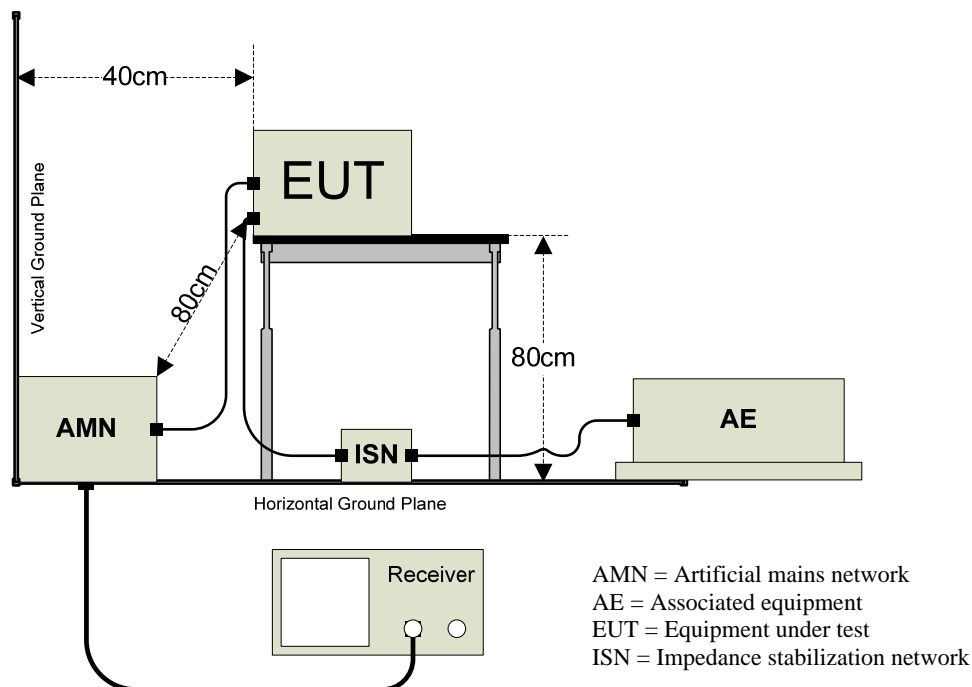

5.3 Radiated Emissions Test Setup

The Open Area Test Site (OATS) was used for radiated emission testing. The receiving (Rx) antenna(s) was placed 10m from the nearest side of the EUT facing the Rx antenna. The EUT (if floor-standing) was placed directly on the flush-mounted 360 degree rotating turntable. The EUT (if table-top) was placed directly on an 80cm high non-metallic table, and the table was placed on the rotating turntable. During the initial EMI scan, all the suspect frequencies, i.e.; harmonics, broadband signals were checked with the Rx broadband antennas in both vertical and horizontal polarities. The biconical Rx, log periodic Rx, and horn Rx antennas were used from 30MHz – 299.99MHz, 300MHz – 1000MHz, and 1GHz – 18GHz respectively.

Upon completion of all harmonic and broadband measurements, the balance of any remaining frequencies was checked between 30MHz – 18GHz. Any signals appearing within 20 dB of the classification limit was measured. Each signal was maximized by first rotating the turntable at least 360 degrees and recording the azimuth in the data sheet. Lastly, the Rx antenna was raised and/or lowered to maximize the signal elevation. If the measured signal was obtained using the peak detector and that signal appeared within 3 dB of the regulatory limit line, then the same signal was re-measured using the quasi-peak detector on the EMI receiver. Both meter readings if necessary were recorded on the data sheet.

Climatic Conditions:

The EUT was tested within its intended operating and climatic conditions.

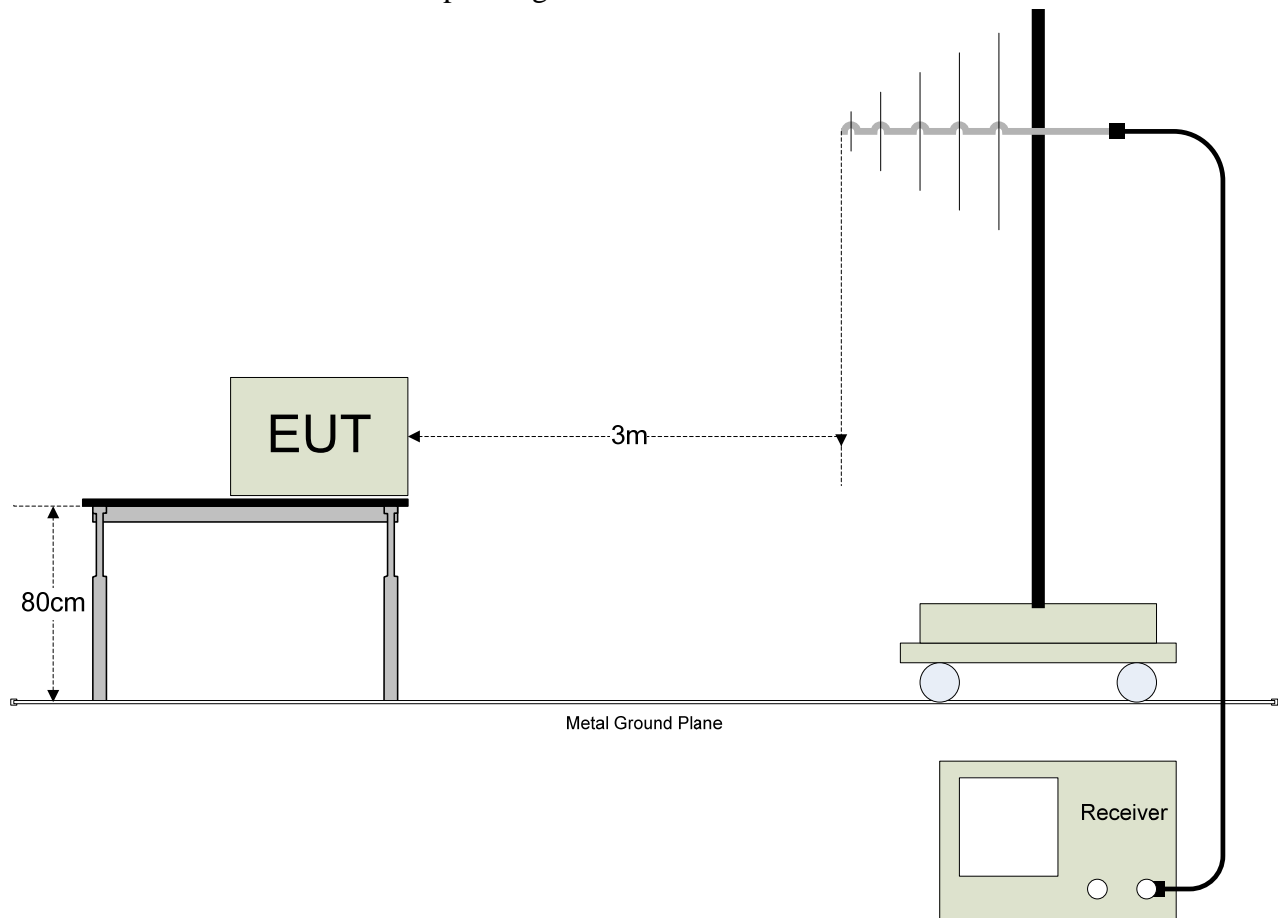



APPENDIX A

TEST DATA

**RF OUTPUT POWER – CONDUCTED & E.I.R.P**

CLIENT:	Intel Corporation	DATE:	03/24/08
EUT:	Intel WiFi/WiMax Link 5350	PROJECT NUMBER:	INTEL-080114
MODEL NUMBER:	533ANXMMW	TEST ENGINEER:	JC
SERIAL NUMBER:	0016EB01A3A8	SITE #:	2
CONFIGURATION:	Tested installed in an extender board connected to the host laptop's USB port in 802.16e (2496-2690 MHz) mode.	TEMPERATURE:	18 deg. C
		HUMIDITY:	22% RH
		TIME:	9:30 AM

Description:	The maximum peak output power of the intentional radiator shall not exceed 2 watts.
Results:	Passed (See Data Sheet)
Note:	Conducted Emissions Measurements were performed on the EUT with power supply set at the following voltage and frequency. <ul style="list-style-type: none">• 120VAC / 60 Hz.

Peak Transmit Power Limits	
Frequency (MHz)	Output Power (W)
2496-2690	2



RF Output Power – Conducted & E.I.R.P (Continued)

Conducted Power					
Channel	Frequency (MHz)	Modulation	Channel Band-width	Power (dBm)	Power (mW)
Low	2501	16QAM	10	23.22	209.89
Mid	2593	16QAM	10	22.53	179.06
High	2685	16QAM	10	22.23	167.11
Low	2501	QPSK	10	23.25	211.35
Mid	2593	QPSK	10	22.60	181.97
High	2685	QPSK	10	22.44	175.39
Low	2501	16QAM	5	23.07	202.77
Mid	2593	16QAM	5	23.14	206.06
High	2687.5	16QAM	5	22.51	178.24
Low	2501	QPSK	5	23.04	201.37
Mid	2593	QPSK	5	23.16	207.01
High	2687.5	QPSK	5	22.47	176.60

The RF output of the transmitter was connected to the input of the PSA spectrum analyzer through sufficient attenuation.

E.I.R.P Power								
Channel	Frequency (MHz)	Modulation	Channel Band-width	Sig Gen Level (dBm)	Pre-Amp Gain (dB)	Cable Loss (dB)	Antenna Gain (dBi)	Power (dBm)
Low	2501	16QAM	10	-17.99	36.62	3.25	8.40	23.77
Mid	2593	16QAM	10	-18.84	36.65	3.34	8.40	22.87
High	2685	16QAM	10	-19.87	36.68	3.39	8.90	22.32
Low	2501	QPSK	10	-18.43	36.62	3.25	8.90	23.83
Mid	2593	QPSK	10	-19.32	36.65	3.34	8.90	22.89
High	2685	QPSK	10	-19.58	36.68	3.39	8.90	22.61
Low	2501	16QAM	5	-18.42	36.62	3.25	8.40	23.34
Mid	2593	16QAM	5	-18.20	36.65	3.34	8.40	23.51
High	2687.5	16QAM	5	-18.86	36.68	3.39	8.50	22.93
Low	2501	QPSK	5	-19.00	36.62	3.25	8.90	23.26
Mid	2593	QPSK	5	-18.54	36.65	3.34	8.90	23.67
High	2687.5	QPSK	5	-19.24	36.68	3.39	8.50	22.55

**FREQUENCY STABILITY TEST RESULTS**

CLIENT:	Intel Corporation	DATE:	03/21/08
EUT:	Intel WiFi/WiMax Link 5350	PROJECT NUMBER:	INTEL-080114
MODEL NUMBER:	533ANXMMW	TEST ENGINEER:	JC
SERIAL NUMBER:	0016EB01A3A8	SITE #:	2
CONFIGURATION:	Tested installed in an extender board connected to the host laptop's USB port in 802.16e (2496-2690 MHz) mode.	TEMPERATURE:	20 deg. C
		HUMIDITY:	42% RH
		TIME:	11:00 AM

Description:	The frequency stability shall be sufficient to ensure that the fundamental emissions stay within the authorized bands of operation.
Results:	Passed (See Data Sheet)
Note:	<p><u>Frequency Stability vs. Temperature:</u> The equipment under test was connected to an external DC power supply and the RF output was connected to a PSA Spectrum Analyzer via feed-through attenuators. The EUT was placed inside the temperature chamber. The AC leads and RF output cable exited the chamber through an opening made for the purpose. After the temperature stabilized for the required period of time, the frequency output was recorded from the PSA.</p> <p><u>Frequency Stability vs. Voltage:</u> An external variable DC power supply source. The voltage was set to 115% of the nominal value and was then decreased to 85% of the nominal value. The output frequency was recorded for each voltage.</p>



Frequency Stability Test Results (Continued)

Temperature Varying						
Modulation	Channel Band-width	Temp (Celsius)	Voltage (VAC)	Reference Freq (MHz)	Measured Freq (MHz)	Difference (MHz)
10MHz Channel						
16QAM	10	-30	115 (Norm)	2680.32	2680.33	-0.01
16QAM	10	-20	115 (Norm)	2680.32	2680.31	0.01
16QAM	10	-10	115 (Norm)	2680.32	2680.33	-0.01
16QAM	10	0	115 (Norm)	2680.32	2680.30	0.02
16QAM	10	10	115 (Norm)	2680.32	2680.28	0.04
16QAM	10	20(Norm)	115 (Norm)	2680.32	2680.32	0.00
16QAM	10	30	115 (Norm)	2680.32	2680.35	-0.03
16QAM	10	40	115 (Norm)	2680.32	2680.35	-0.03
16QAM	10	50	115 (Norm)	2680.32	2680.33	-0.01
5MHz Channel						
QPSK	5	-30	115 (Norm)	2685.16	2684.78	0.38
QPSK	5	-20	115 (Norm)	2685.16	2684.89	0.27
QPSK	5	-10	115 (Norm)	2685.16	2684.93	0.23
QPSK	5	0	115 (Norm)	2685.16	2684.97	0.19
QPSK	5	10	115 (Norm)	2685.16	2685.02	0.14
QPSK	5	20(Norm)	115 (Norm)	2685.16	2685.16	0.00
QPSK	5	30	115 (Norm)	2685.16	2684.87	0.29
QPSK	5	40	115 (Norm)	2685.16	2684.77	0.39
QPSK	5	50	115 (Norm)	2685.16	2684.83	0.33

Voltage Varying						
Modulation	Channel Band-width	Temp (Celsius)	Voltage (VAC)	Reference Freq (MHz)	Measured Freq (MHz)	Difference (MHz)
10MHz Channel						
16QAM	10	20(Norm)	97.75 (85%)	2680.32	2680.28	0.04
16QAM	10	20(Norm)	115 (Norm)	2680.32	2680.32	0.00
16QAM	10	20(Norm)	132.25 (115%)	2680.32	2680.30	0.02
5MHz Channel						
QPSK	5	20(Norm)	97.75 (85%)	2685.16	2685.17	-0.01
QPSK	5	20(Norm)	115 (Norm)	2685.16	2685.16	0.00
QPSK	5	20(Norm)	132.25 (115%)	2685.16	2685.17	-0.01

**OCCUPIED EMISSIONS BANDWIDTH**

CLIENT:	Intel Corporation	DATE:	03/14/08
EUT:	Intel WiFi/WiMax Link 5350	PROJECT NUMBER:	INTEL-080114
MODEL NUMBER:	533ANXMMW	TEST ENGINEER:	JC
SERIAL NUMBER:	0016EB01A3A8	SITE #:	2
CONFIGURATION:	Tested installed in an extender board connected to the host laptop's USB port in 802.16e (2496-2690 MHz) mode.	TEMPERATURE:	20 deg. C
		HUMIDITY:	35% RH
		TIME:	9:00 AM

Description:	Emission bandwidth is defined as the width of the signal between two points, one below the carrier center frequency and one above the carrier center frequency, outside of which all emissions are attenuated at least 26dB below the transmitter power.
Results:	See Data Sheet
Note:	The resolution bandwidth of the spectrum analyzer was set at 100 kHz, 99% Power BW and -26dB BW were recorded.

Occupied Emissions Bandwidth (Continued)

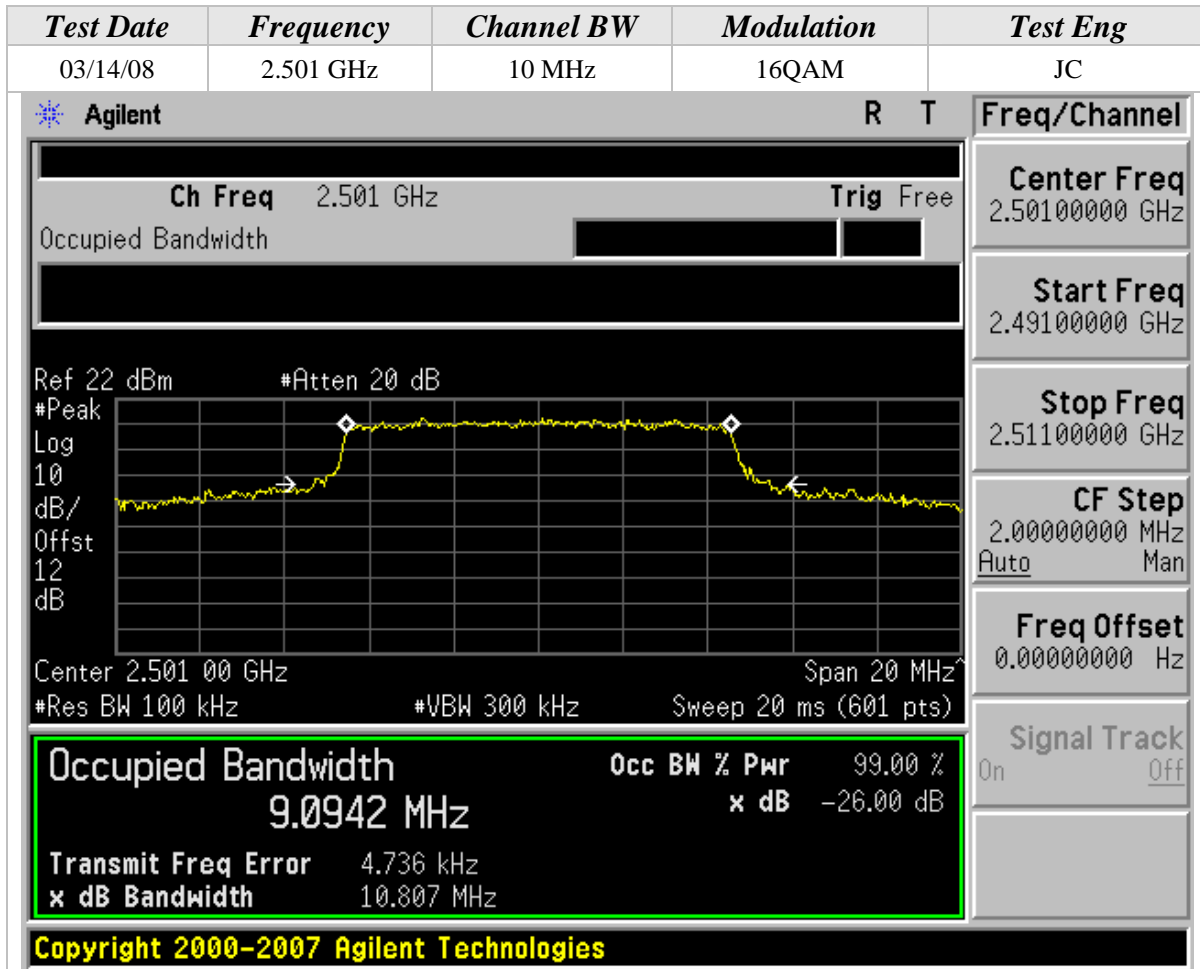

The RF output of the transmitter was connected to the input of the PSA spectrum analyzer through sufficient attenuation.



Occupied Emissions Bandwidth (Continued)

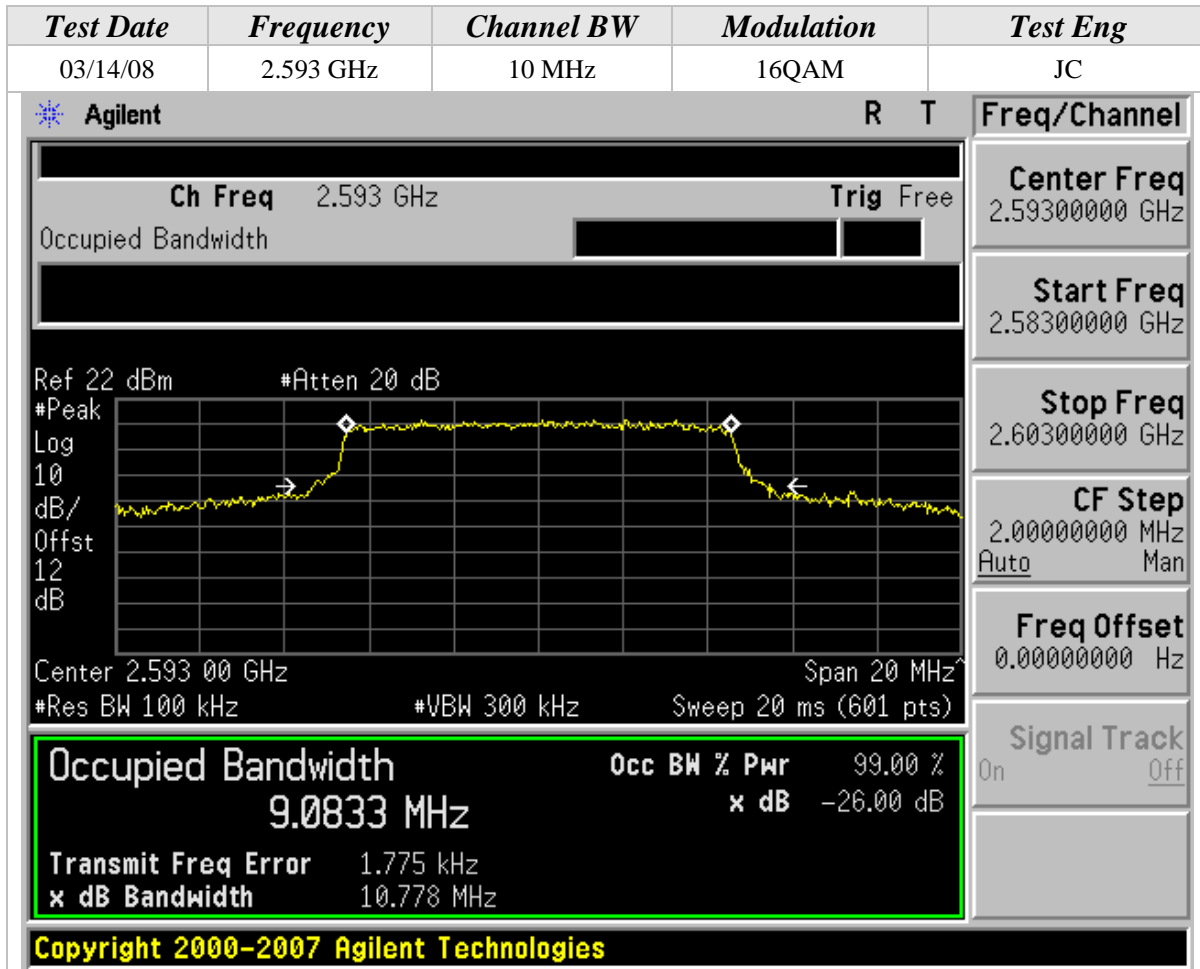



Occupied Emissions Bandwidth (Continued)

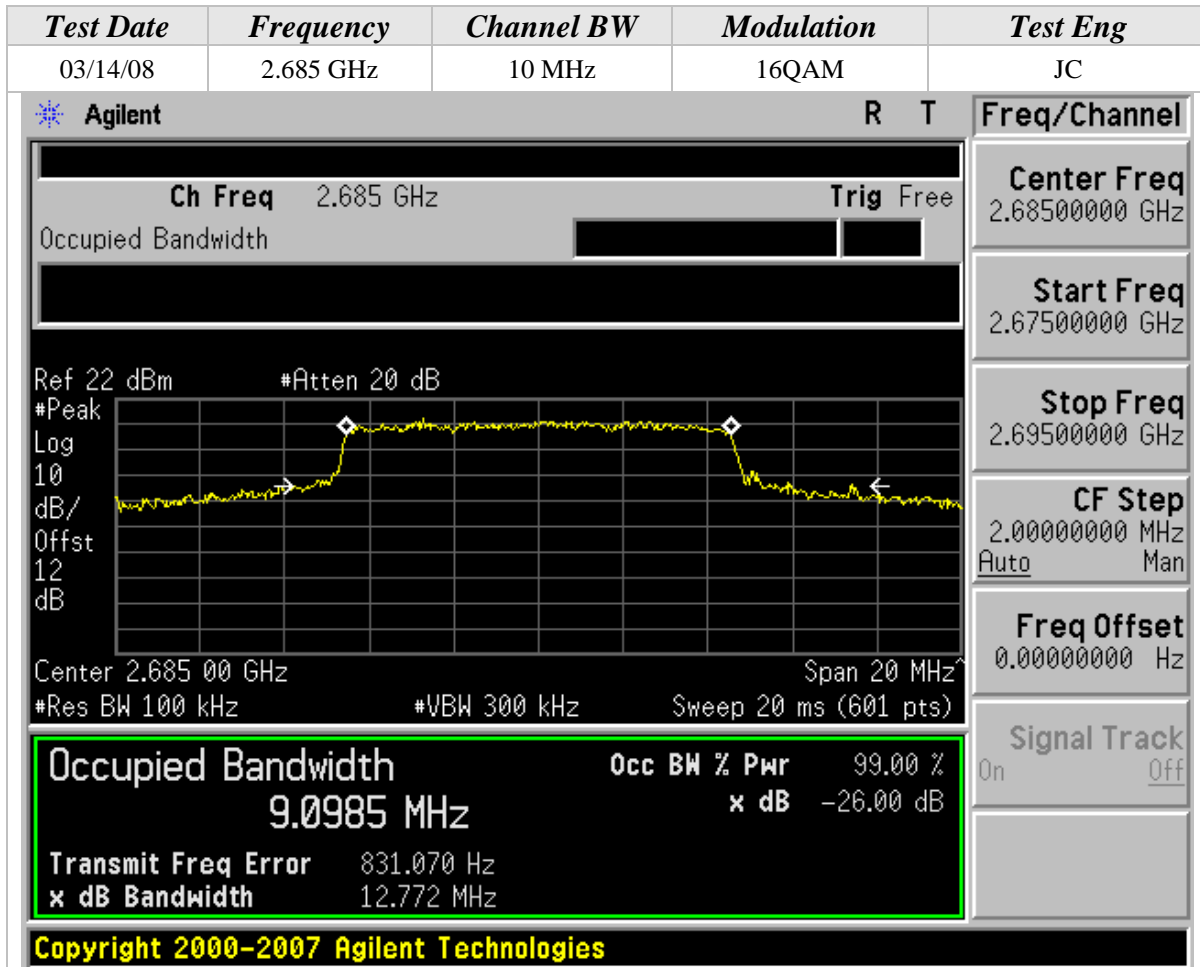



Occupied Emissions Bandwidth (Continued)

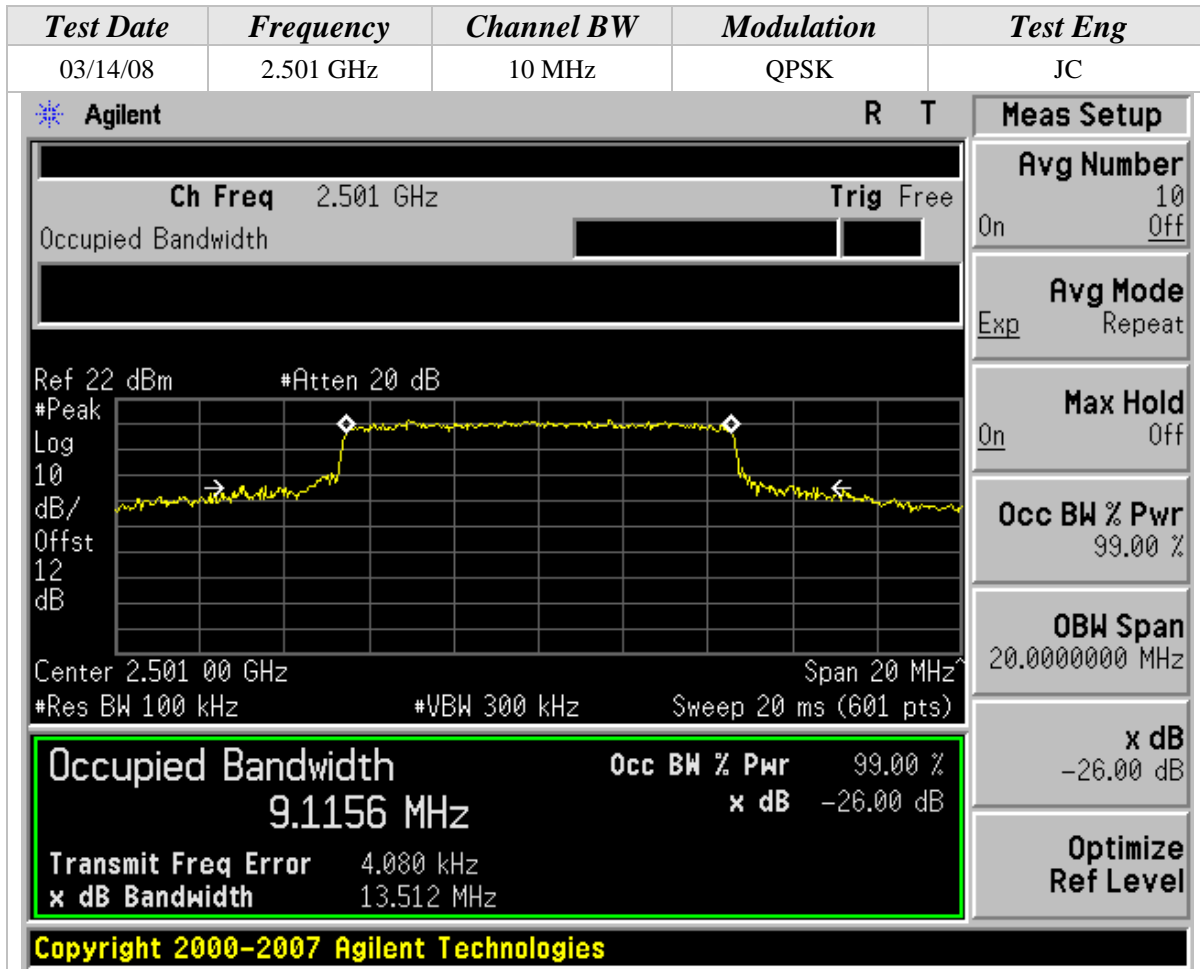



Occupied Emissions Bandwidth (Continued)

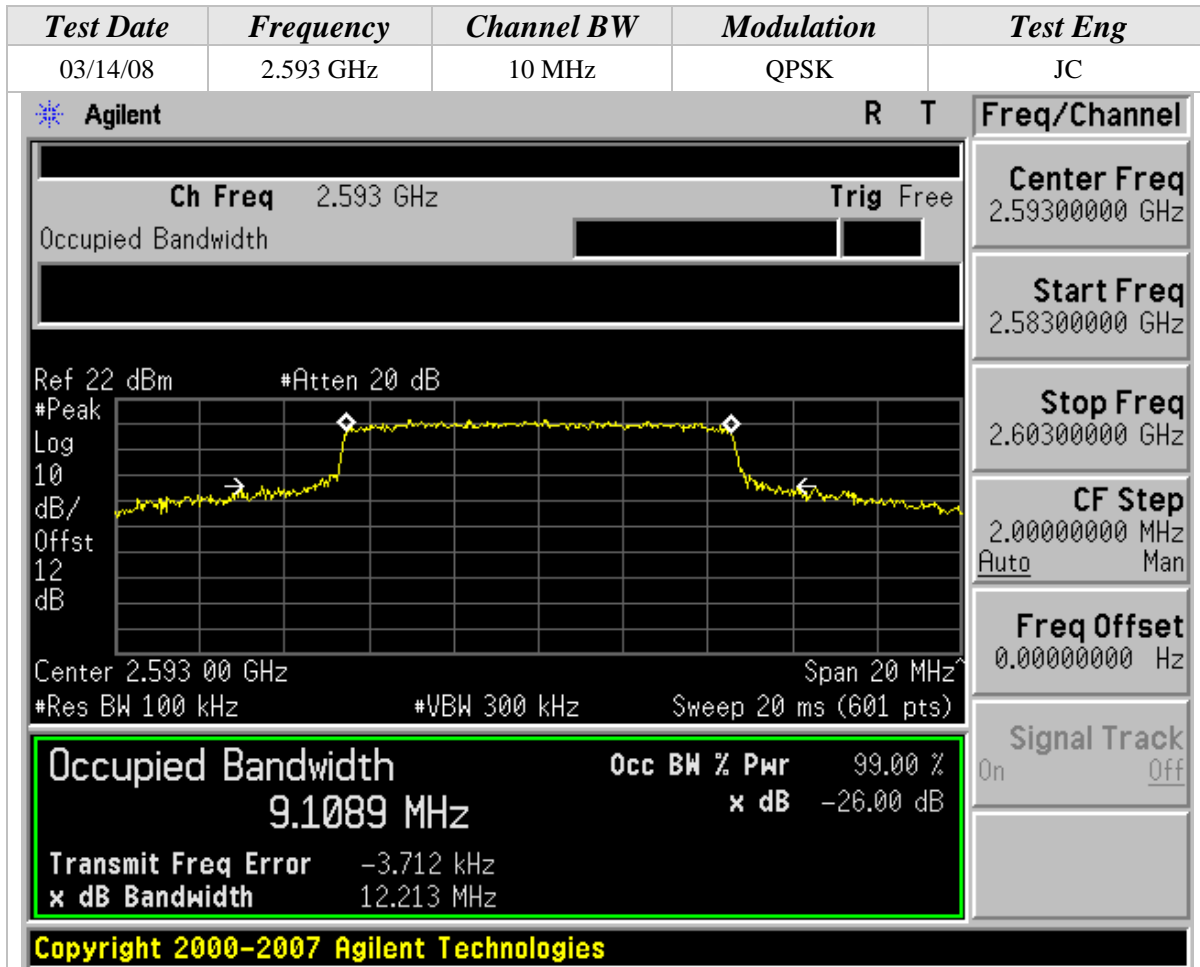



Occupied Emissions Bandwidth (Continued)

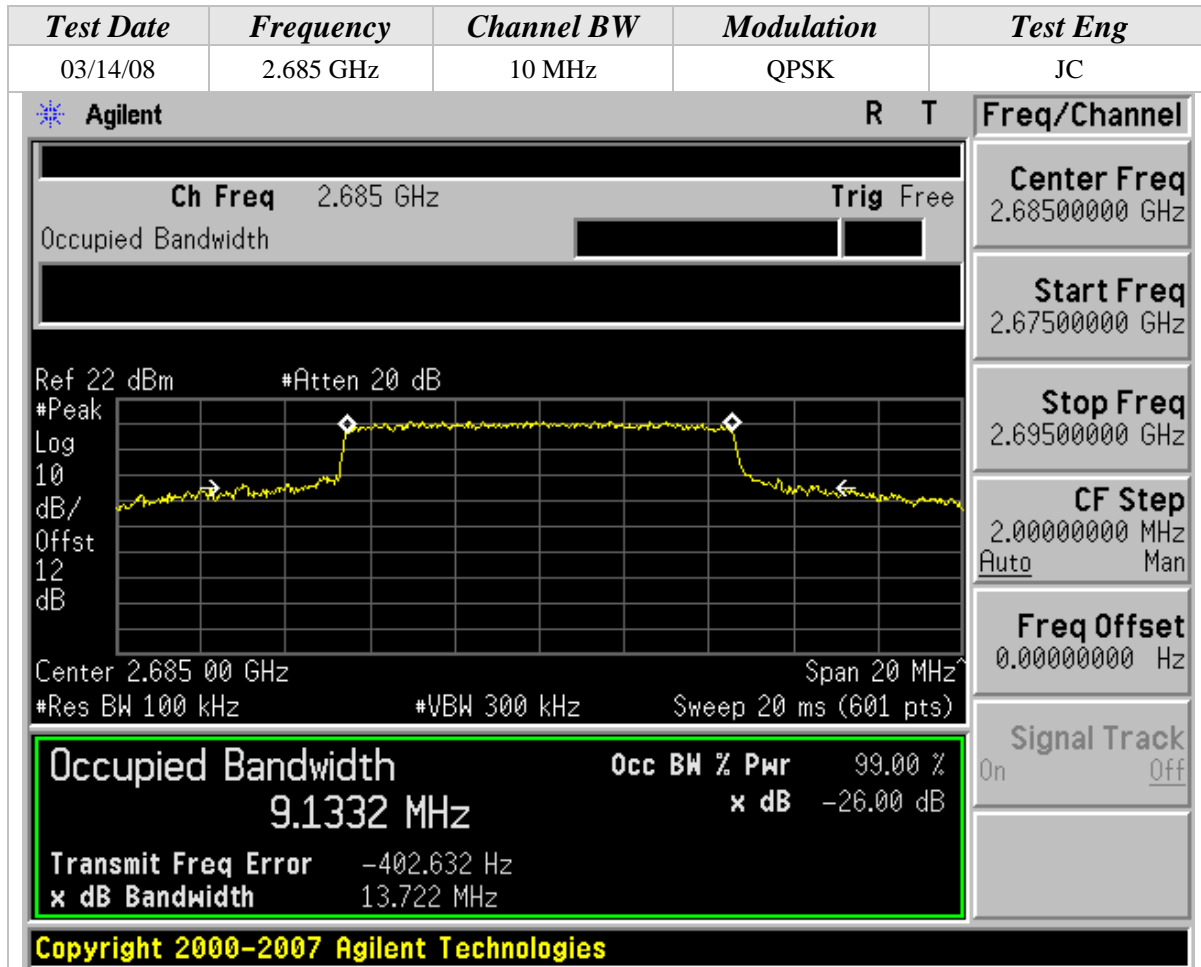



Occupied Emissions Bandwidth (Continued)

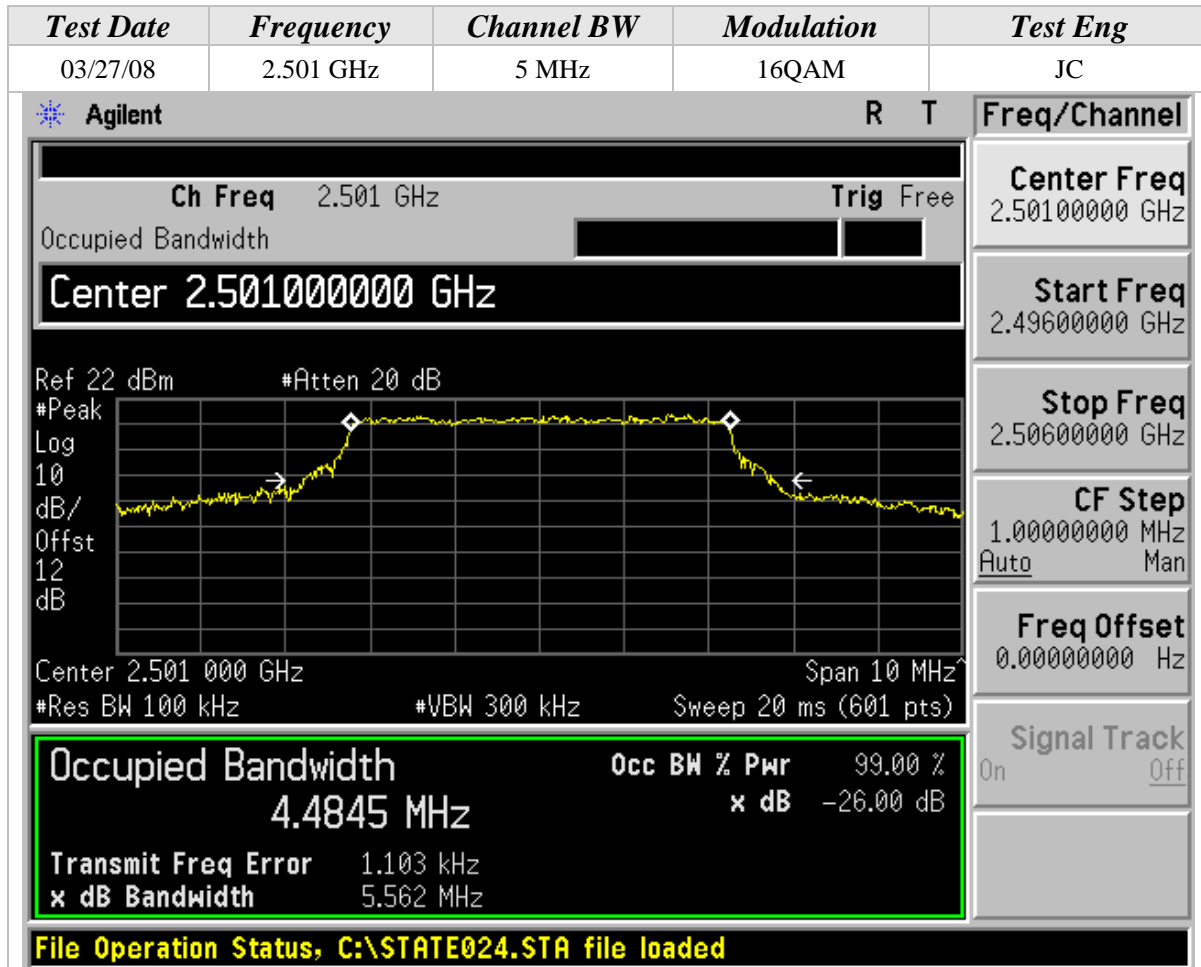



Occupied Emissions Bandwidth (Continued)

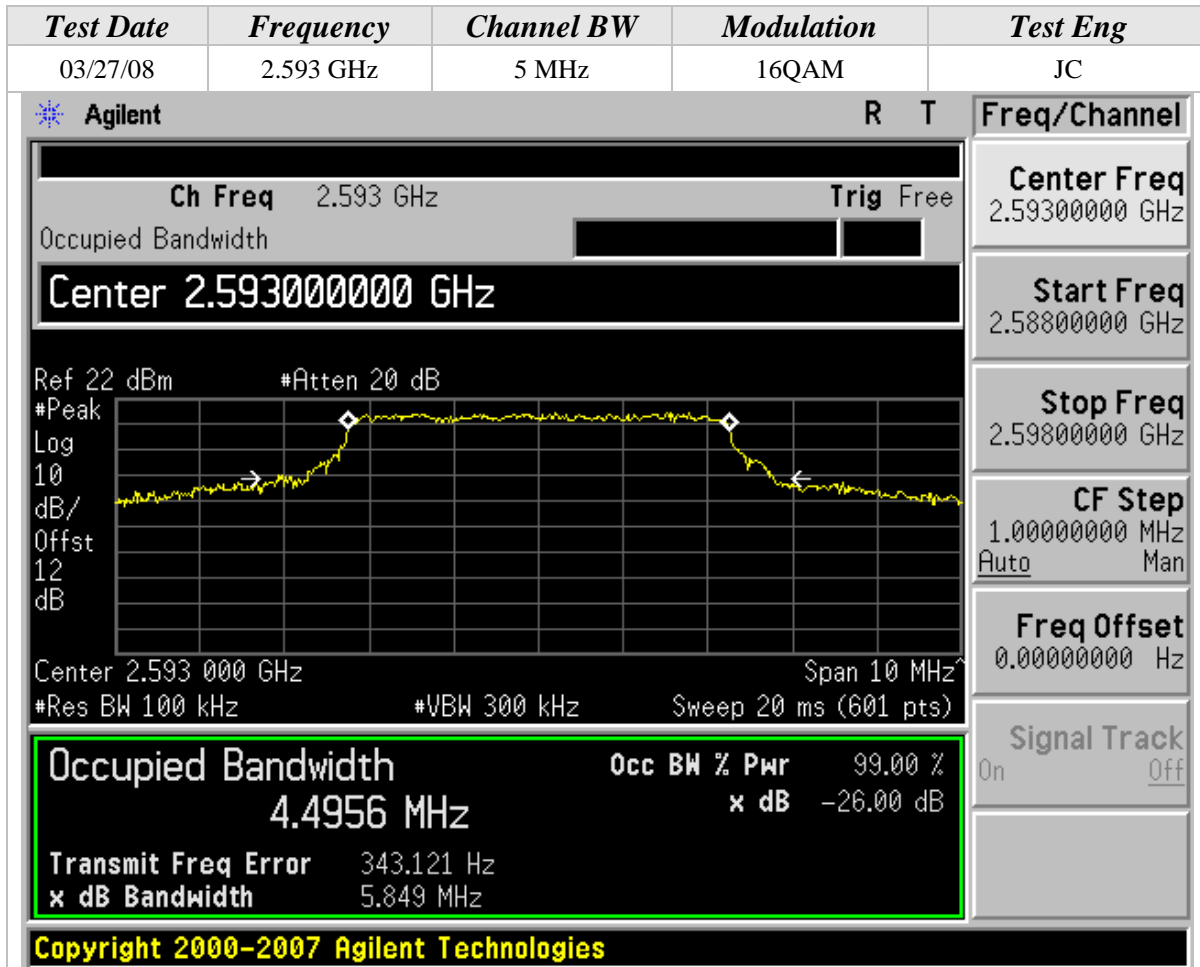



Occupied Emissions Bandwidth (Continued)

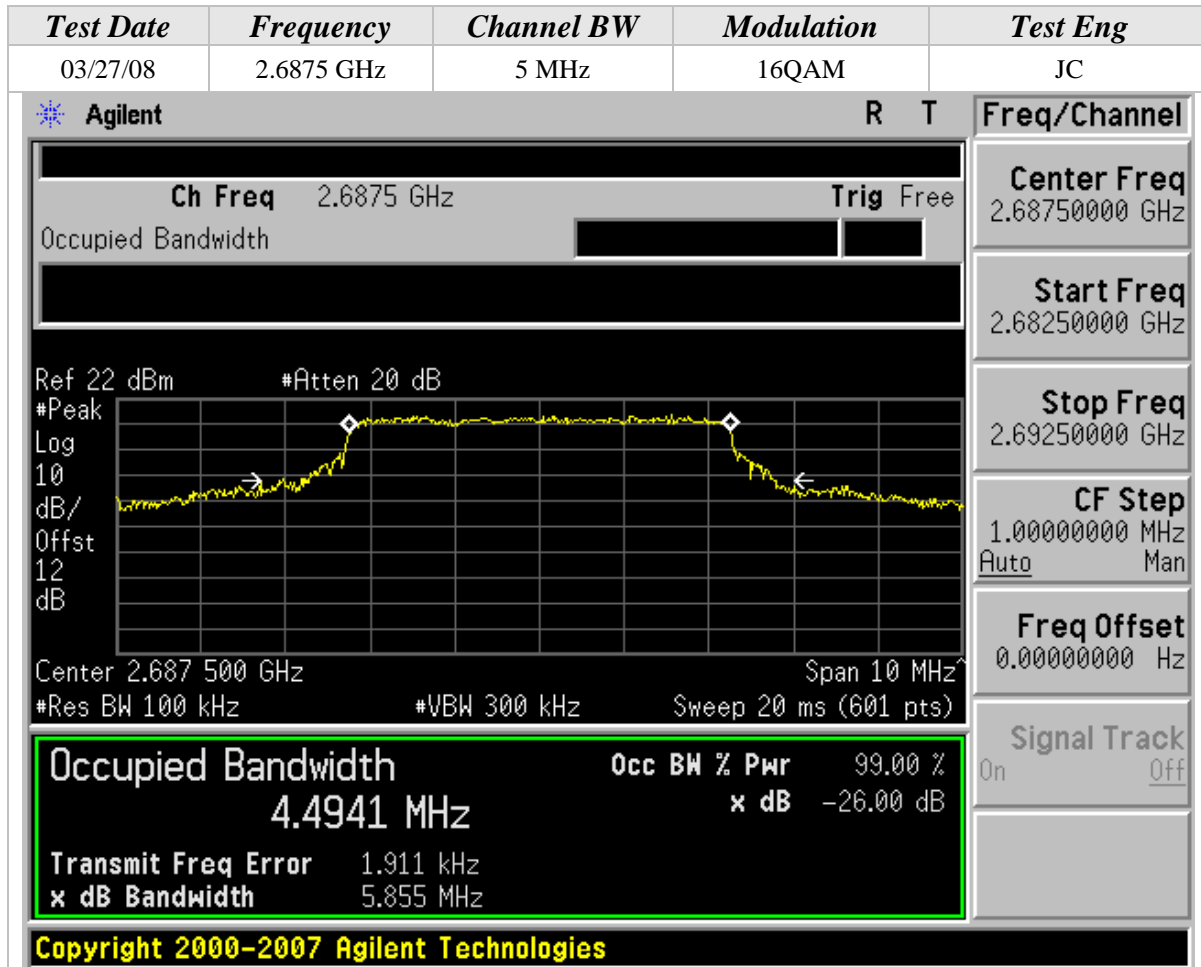



Occupied Emissions Bandwidth (Continued)

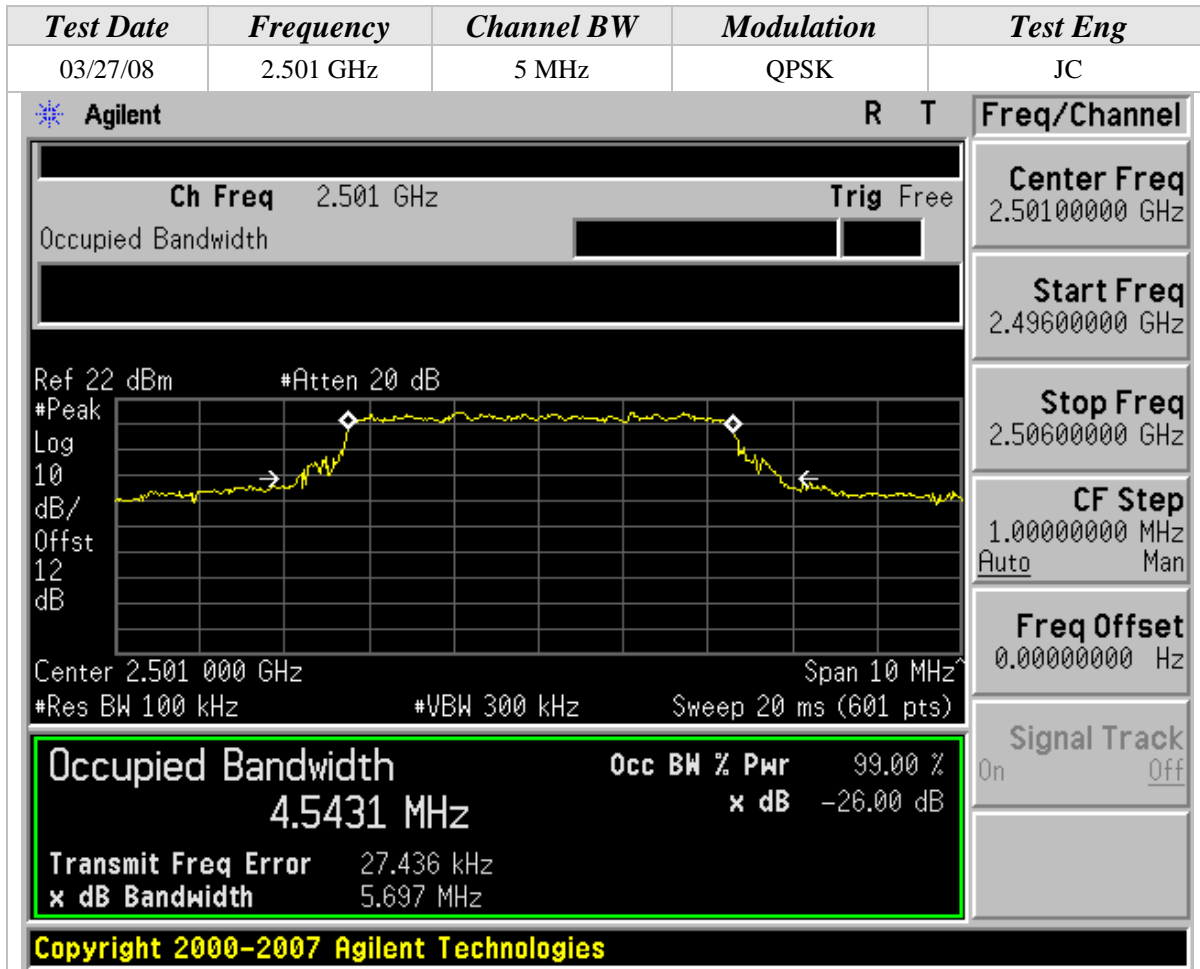



Occupied Emissions Bandwidth (Continued)

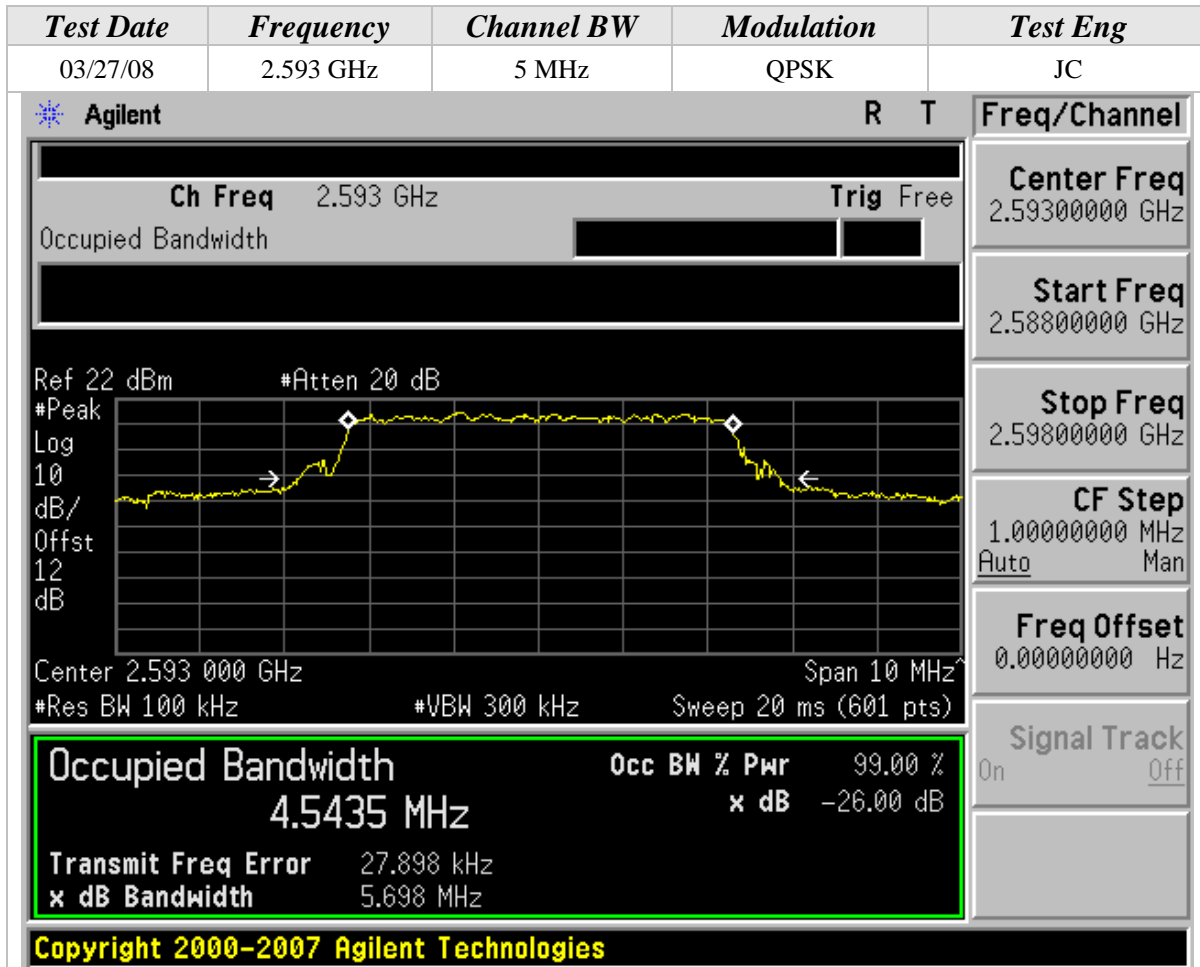



Occupied Emissions Bandwidth (Continued)

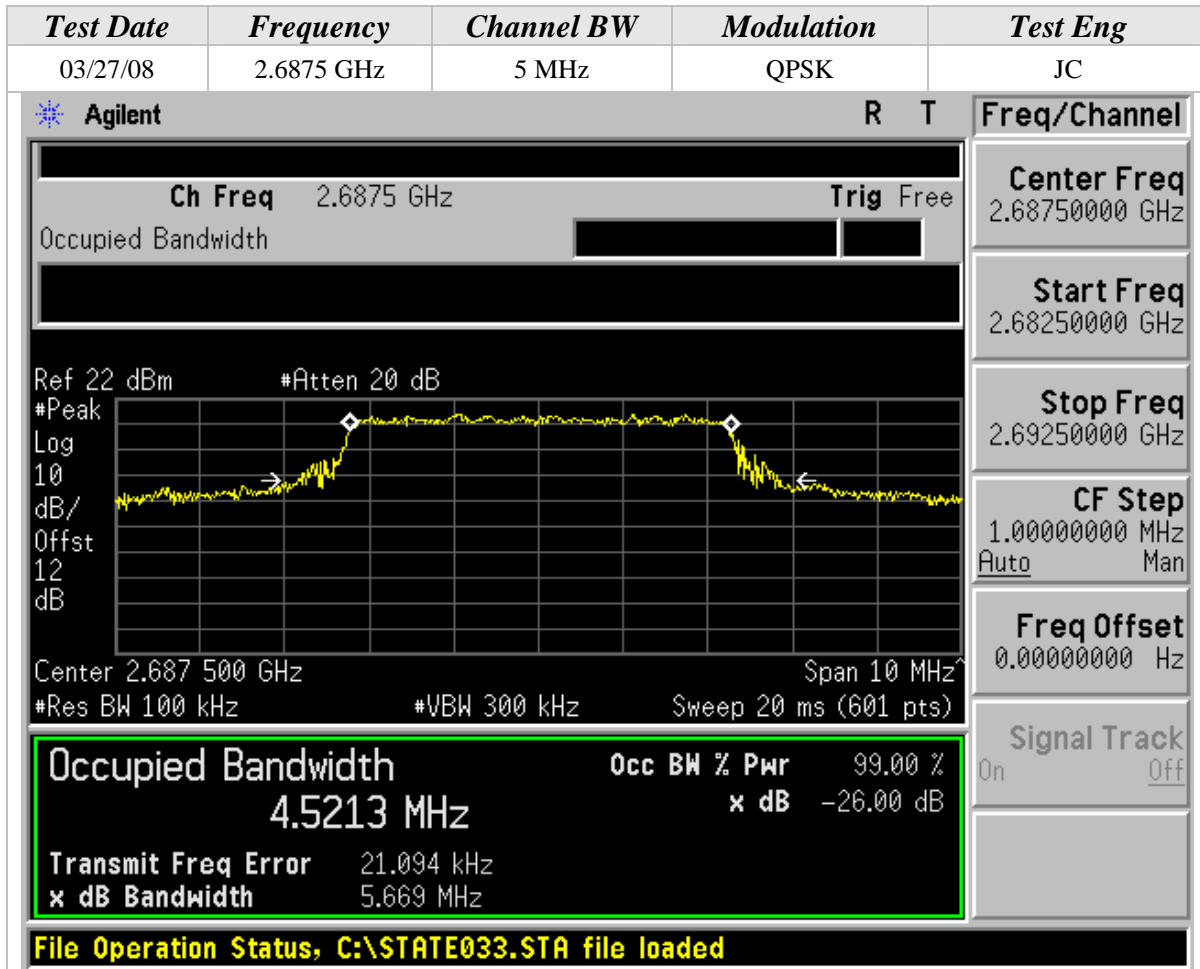

**BAND EDGE MEASUREMENT TEST RESULTS**

CLIENT:	Intel Corporation	DATE:	03/01/08
EUT:	Intel WiFi/WiMax Link 5350	PROJECT NUMBER:	INTEL-080114
MODEL NUMBER:	533ANXMMW	TEST ENGINEER:	JC
SERIAL NUMBER:	0016EB01A3A8	SITE #:	2
CONFIGURATION:	Tested installed in an extender board connected to the host laptop's USB port in 802.16e (2496-2690 MHz) mode.	TEMPERATURE:	17 deg. C
		HUMIDITY:	29% RH
		TIME:	8:30 AM

Description:	Power of any emission outside of the channel edge must be attenuated below the transmitting power (P) by a factor of at least $43 + 10 \log(P)$ dB. The limit of emission equal to -13 dBm. In the 1 MHz bands immediately outside and adjacent to the frequency block a resolution bandwidth of at least one percent of the emission bandwidth of the fundamental emission of the transmitter may be employed.
Results:	Passed (See Data Sheet)
Note:	Conducted Band Edge Emissions Measurements were performed on the EUT with power supply set at the following voltage and frequency. <ul style="list-style-type: none">• 120VAC / 60 Hz.

Band Edge Measurement Test Result (Continued)

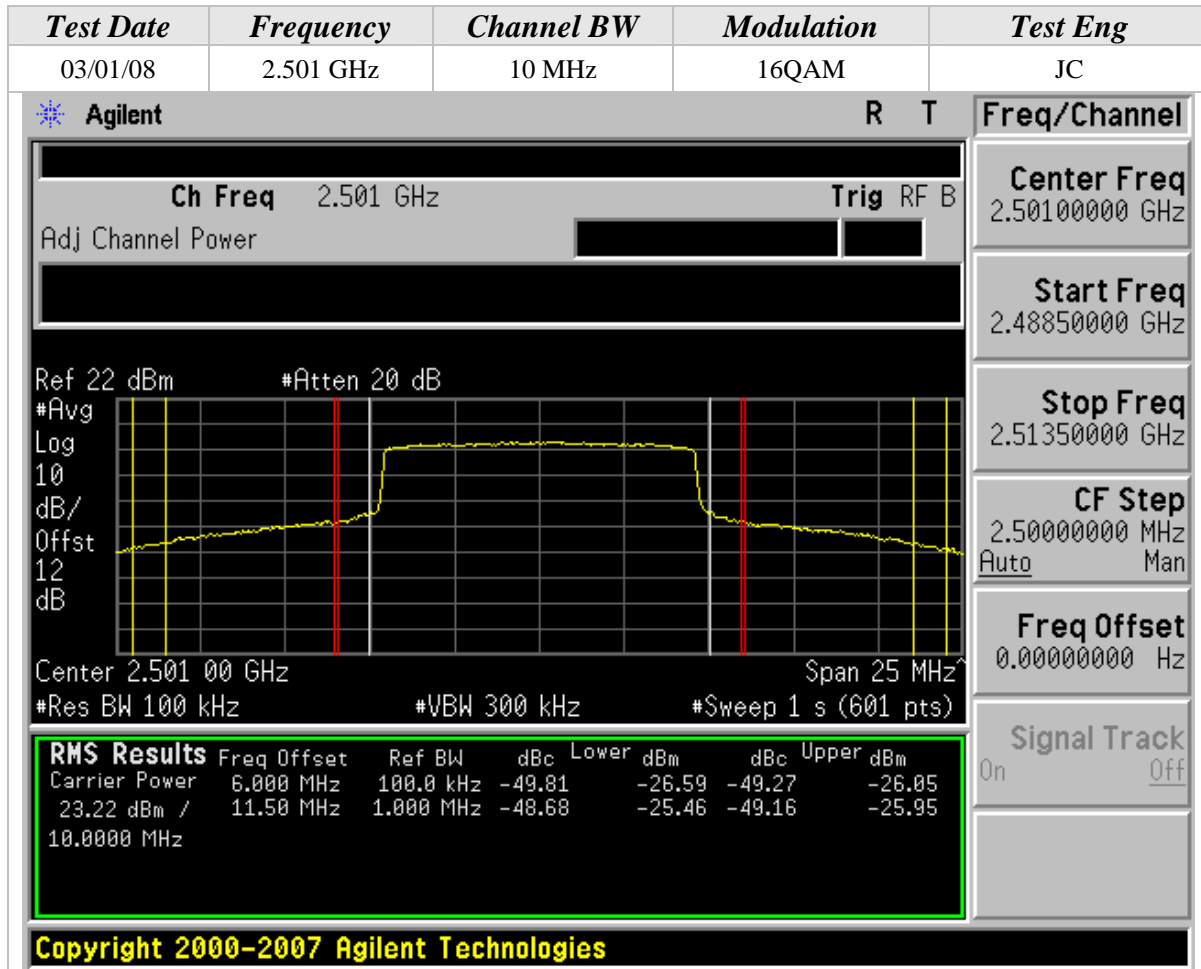

The RF output of the transmitter was connected to the input of the PSA spectrum analyzer through sufficient attenuation.



Band Edge Measurement Test Result (Continued)

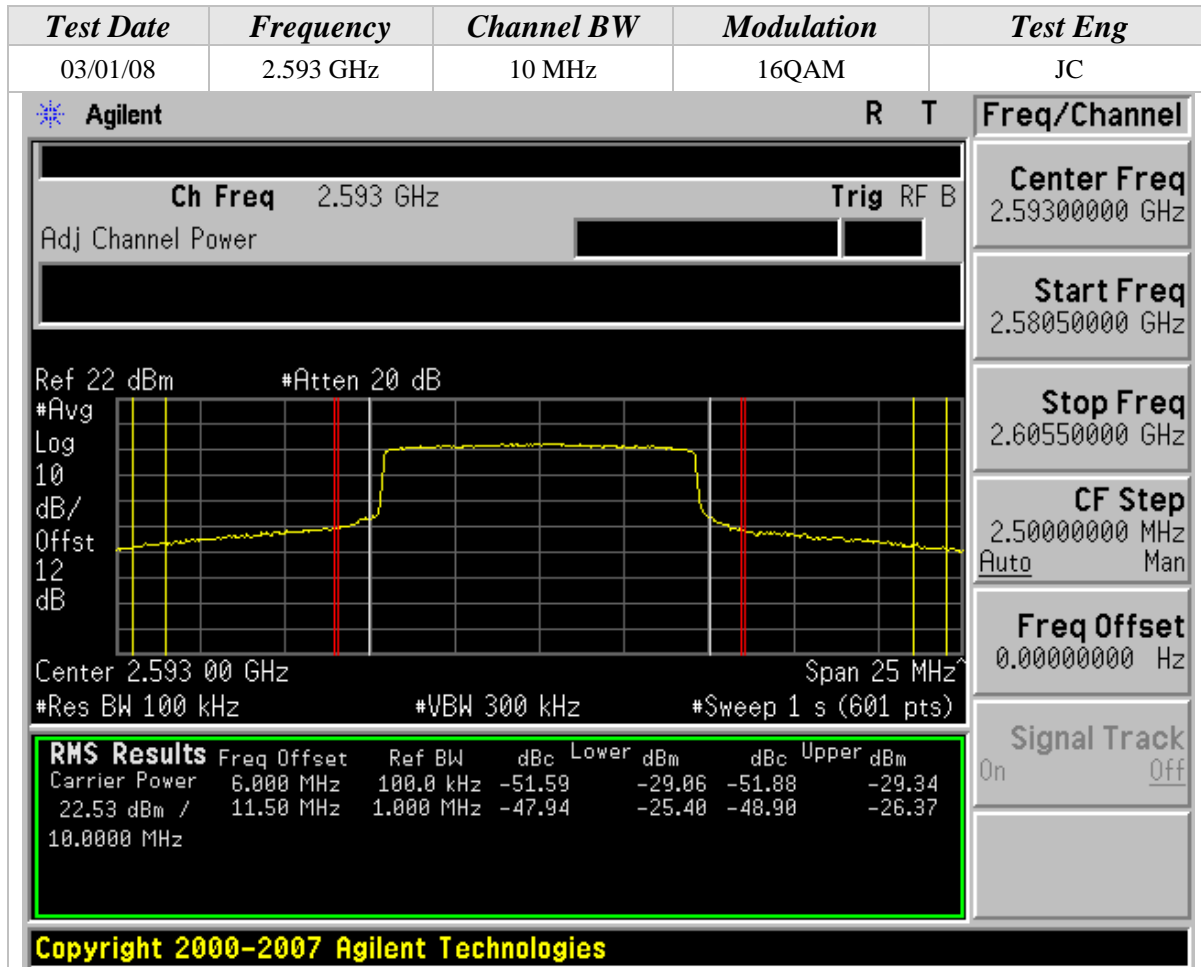



Band Edge Measurement Test Result (Continued)

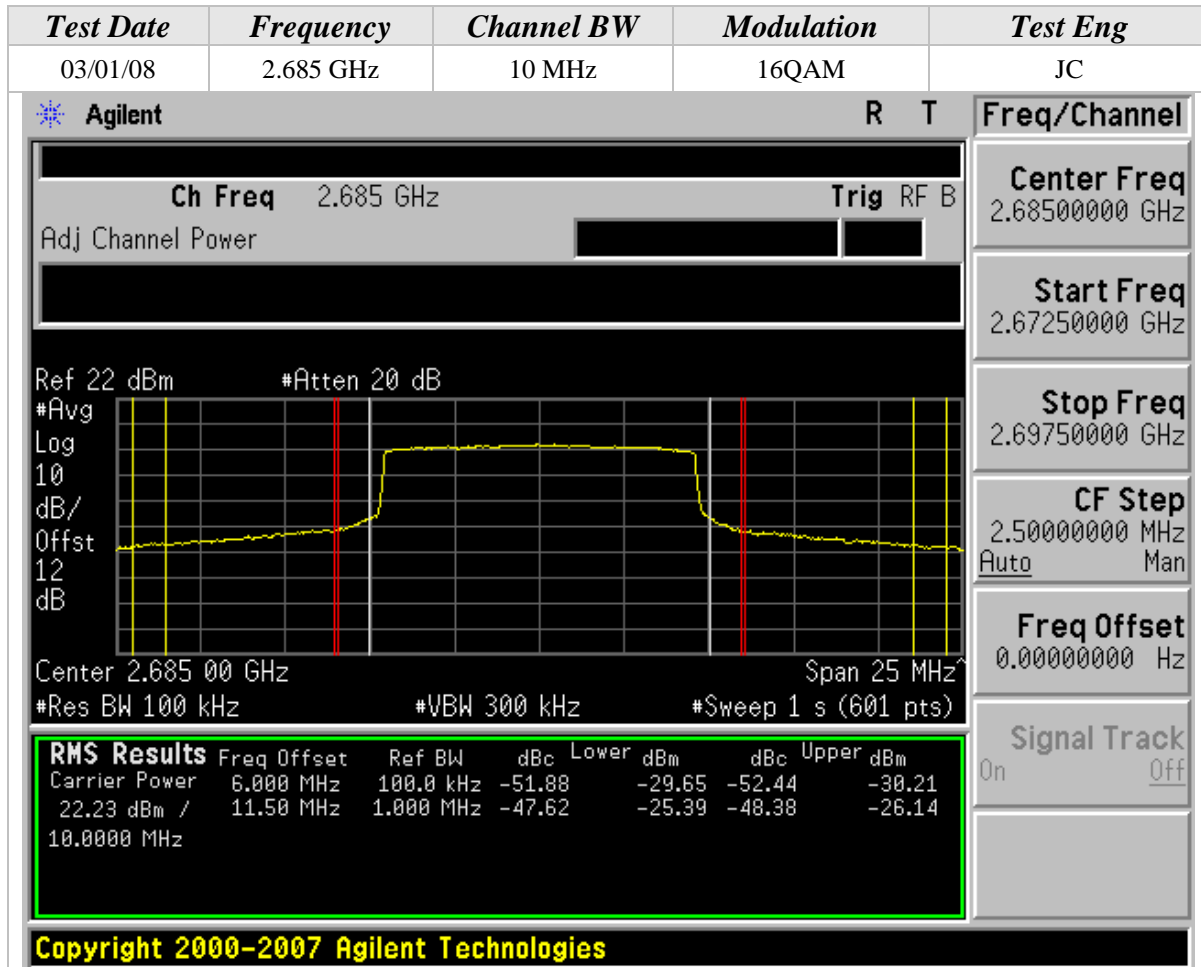



Band Edge Measurement Test Result (Continued)

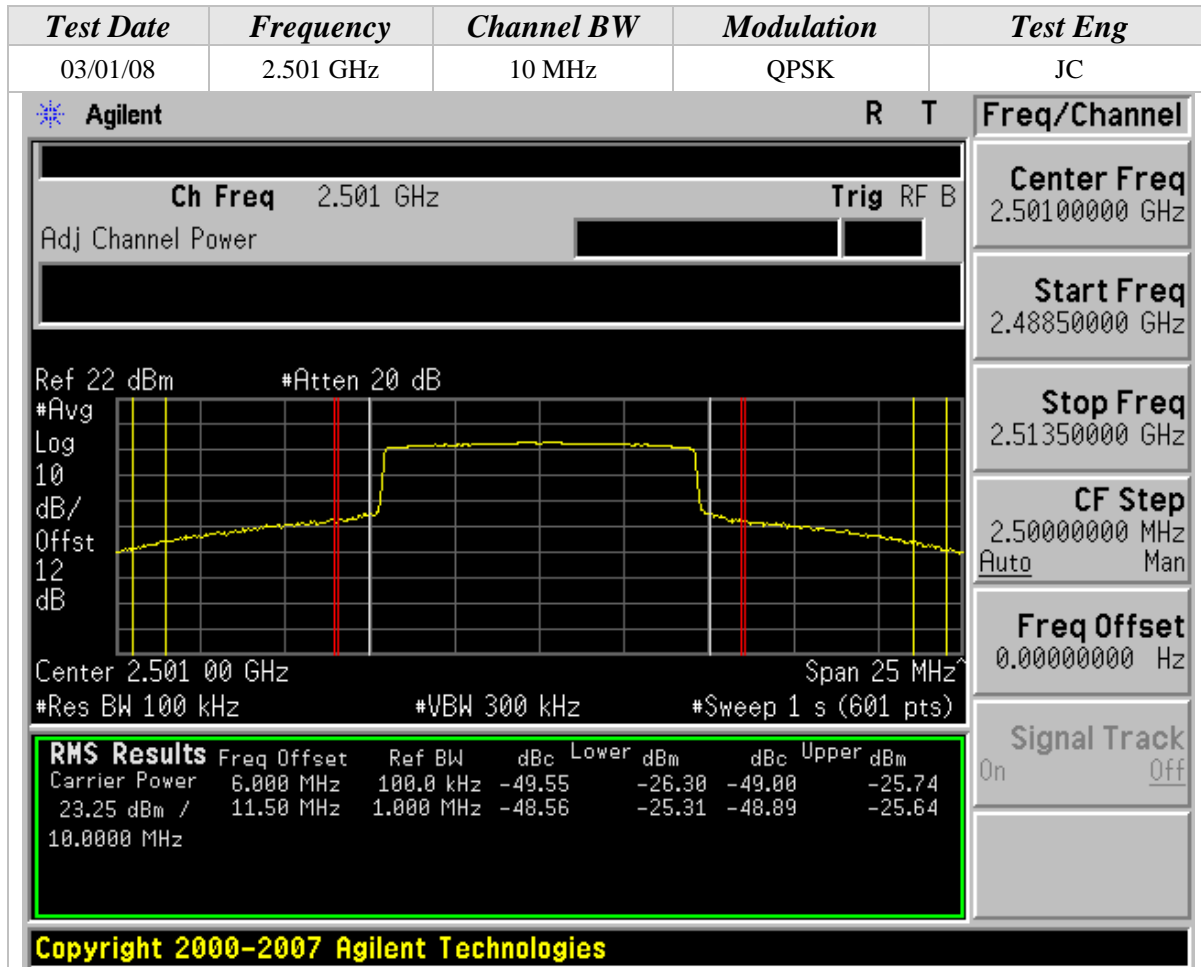



Band Edge Measurement Test Result (Continued)

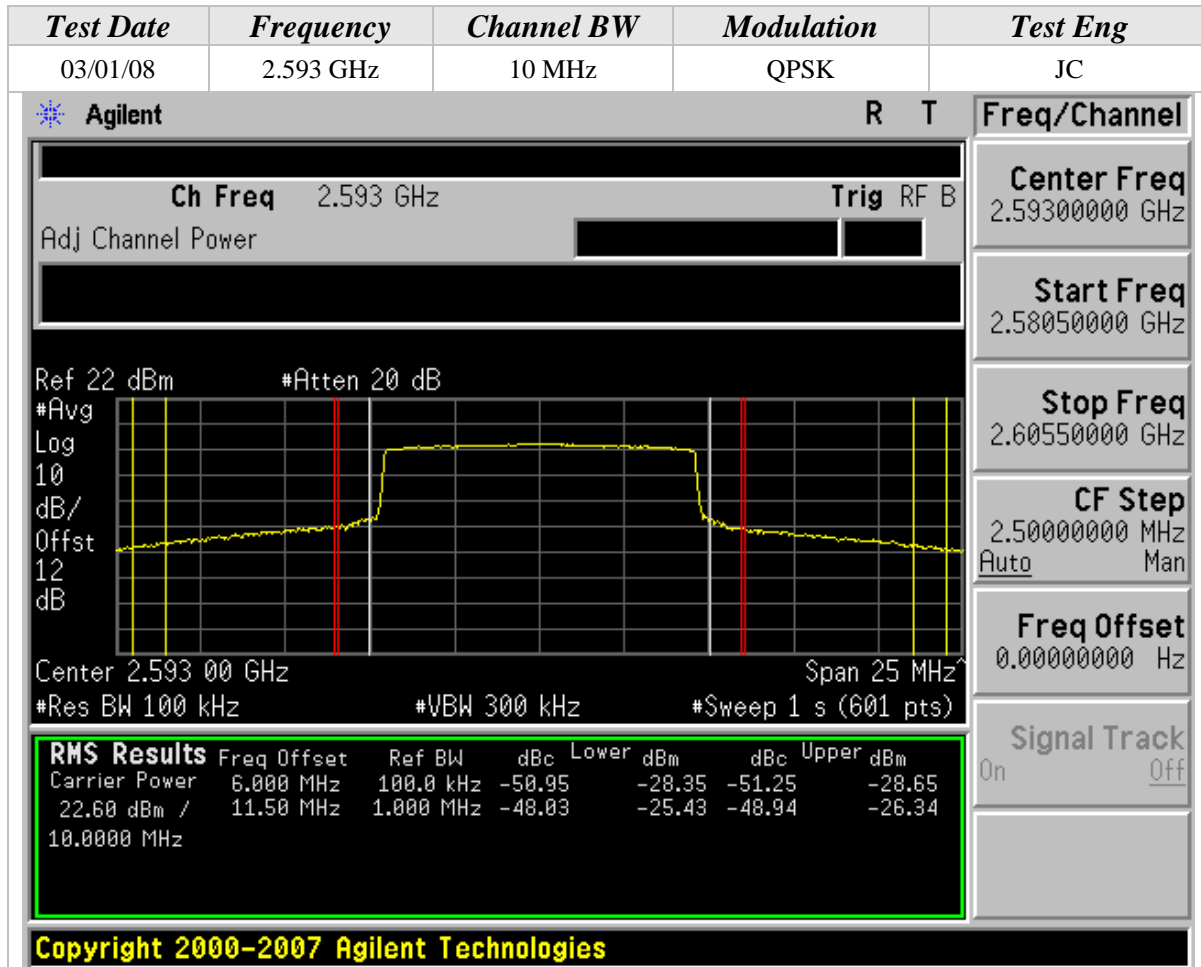



Band Edge Measurement Test Result (Continued)

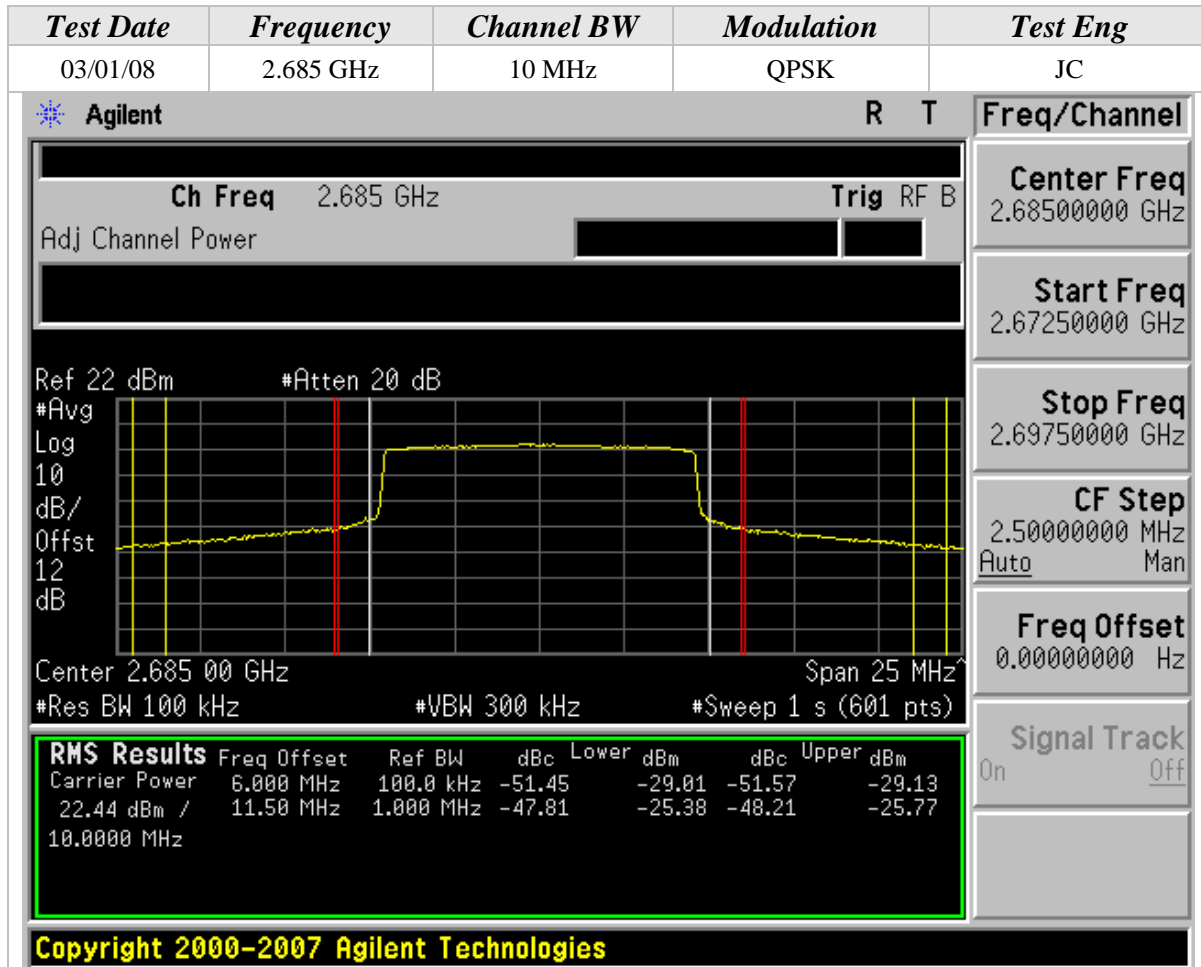



Band Edge Measurement Test Result (Continued)

Test Date	Frequency	Channel BW	Modulation	Test Eng
03/27/08	2.501 GHz	5 MHz	16QAM	JC

Agilent R T

Ch Freq 2.501 GHz **Trig** RF B

Adj Channel Power [] []

Ref 22 dBm #Atten 20 dB

#Avg Log 10 dB/Offst 12 dB

Center 2.501 000 GHz Span 17 MHz

#Res BW 100 kHz #VBW 300 kHz #Sweep 1 s (601 pts)

RMS Results						
	Freq Offset	Ref BW	dBc	Lower dBm	dBc	Upper dBm
Carrier Power	2.500 MHz	50.00 kHz	-44.00	-20.92	-44.24	-21.16
23.07 dBm /	3.500 MHz	1.000 MHz	-36.27	-13.19	-36.25	-13.17
5.00000 MHz	8.000 MHz	1.000 MHz	-55.18	-32.11	-55.09	-32.02

Signal Track
On Off

Copyright 2000-2007 Agilent Technologies



Band Edge Measurement Test Result (Continued)

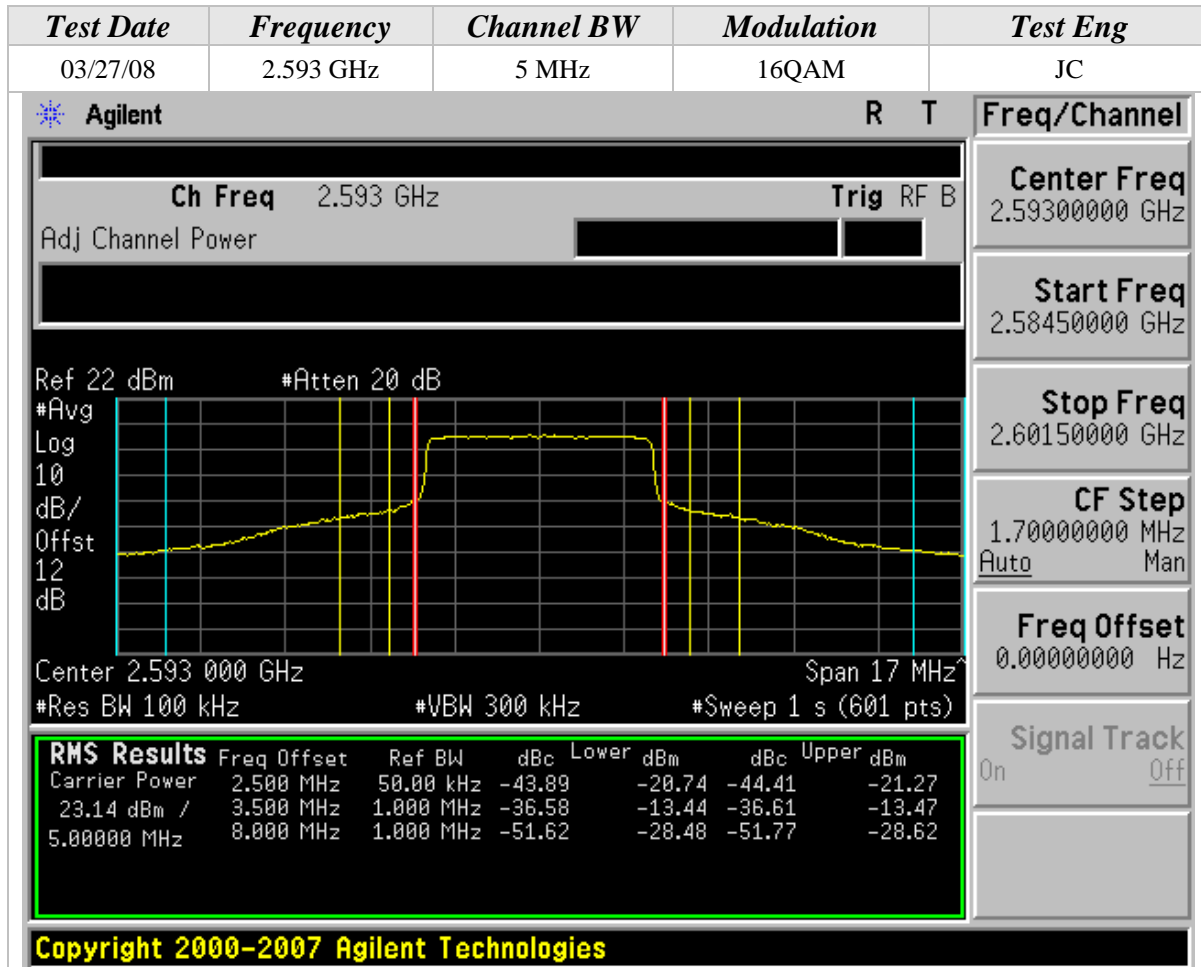



Band Edge Measurement Test Result (Continued)

Test Date	Frequency	Channel BW	Modulation	Test Eng
03/27/08	2.6875 GHz	5 MHz	16QAM	JC

Agilent R T

Ch Freq 2.6875 GHz **Trig** RF B

Adj Channel Power [] []

Ref 22 dBm #Atten 20 dB

#Avg Log 10 dB/Offst 12 dB

Center 2.687 500 GHz Span 17 MHz

#Res BW 100 kHz #VBW 300 kHz #Sweep 1 s (601 pts)

RMS Results						
	Freq Offset	Ref BW	dBc	Lower dBm	dBc	Upper dBm
Carrier Power	2.500 MHz	50.00 kHz	-43.87	-21.36	-44.17	-21.66
22.51 dBm /	3.500 MHz	1.000 MHz	-35.88	-13.37	-35.66	-13.15
5.00000 MHz	8.000 MHz	1.000 MHz	-49.88	-27.37	-49.85	-27.34

Signal Track
On Off

Copyright 2000-2007 Agilent Technologies



Band Edge Measurement Test Result (Continued)

Test Date	Frequency	Channel BW	Modulation	Test Eng
03/27/08	2.501 GHz	5 MHz	QPSK	JC

Agilent R T

Ch Freq 2.501 GHz **Trig** RF B

Adj Channel Power [] []

Ref 22 dBm #Atten 20 dB

#Avg Log 10 dB/Offst 12 dB

Center 2.501 000 GHz Span 17 MHz

#Res BW 100 kHz #VBW 300 kHz #Sweep 1 s (601 pts)

RMS Results						
	Freq Offset	Ref BW	dBc	Lower dBm	dBc	Upper dBm
Carrier Power	2.500 MHz	50.00 kHz	-44.15	-21.11	-42.95	-19.90
23.04 dBm /	3.500 MHz	1.000 MHz	-36.23	-13.19	-36.21	-13.17
5.00000 MHz	8.000 MHz	1.000 MHz	-54.96	-31.92	-55.15	-32.11

Signal Track
On Off

Copyright 2000-2007 Agilent Technologies



Band Edge Measurement Test Result (Continued)

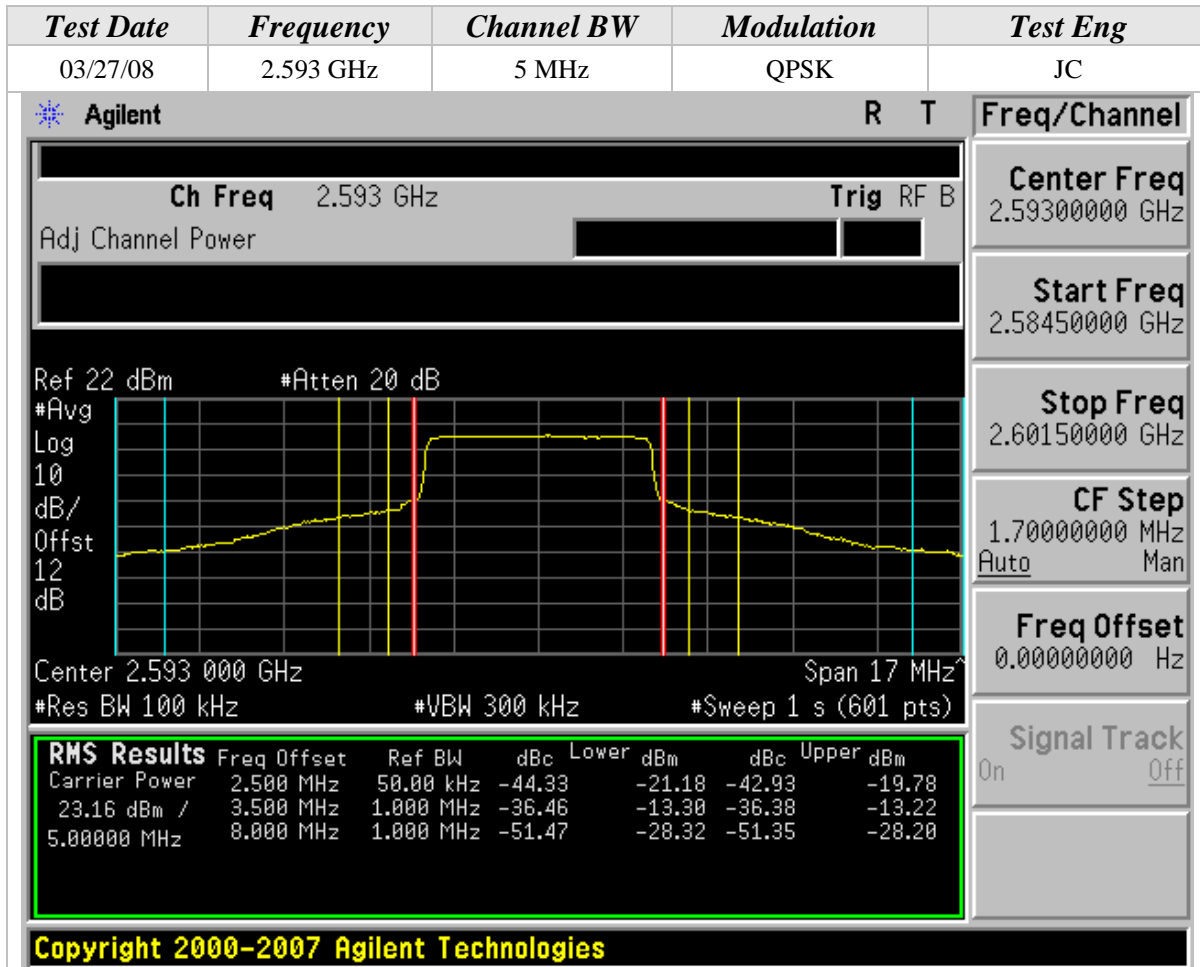

Band Edge Measurement Test Result (Continued)

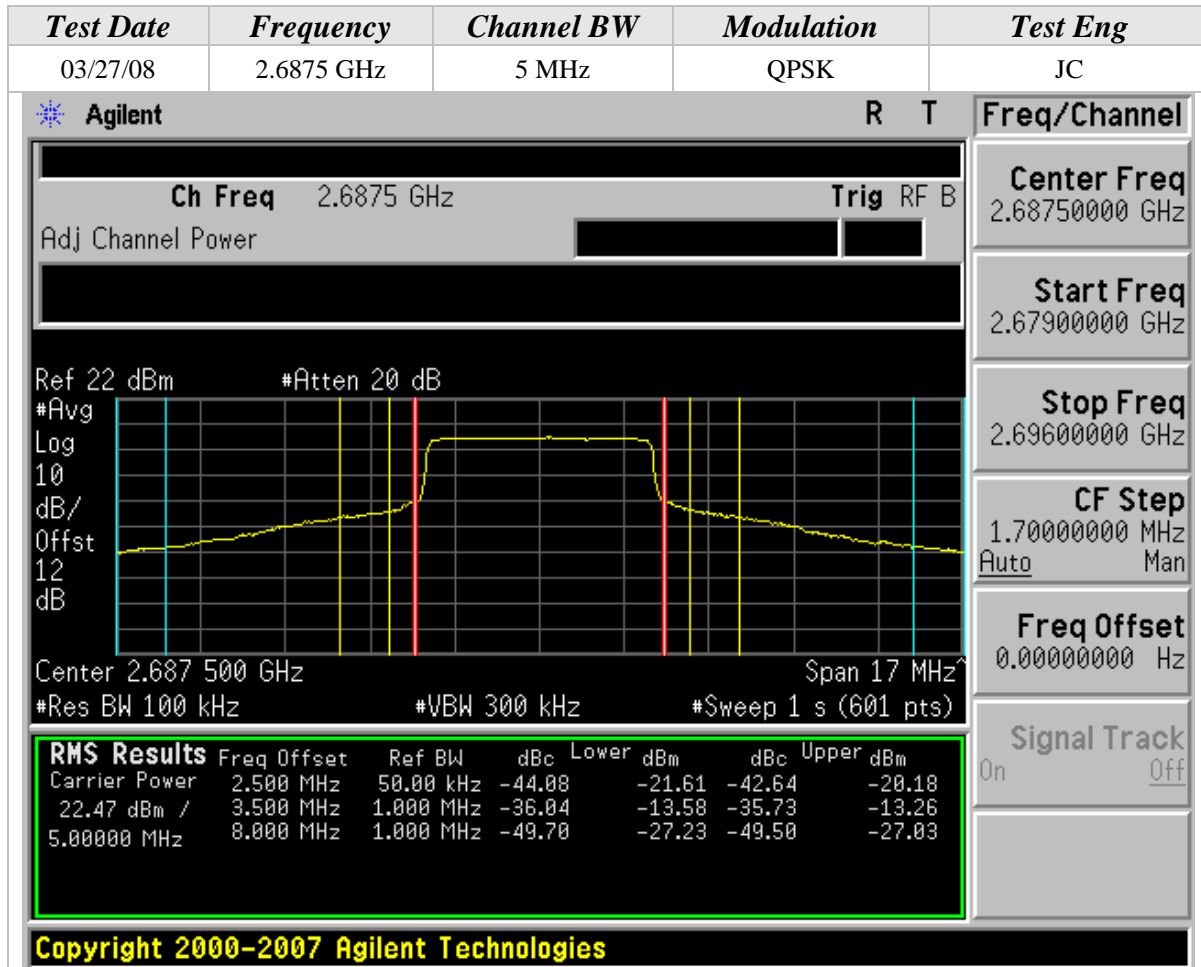

**CONDUCTED SPURIOUS EMISSIONS TEST RESULTS**

CLIENT:	Intel Corporation	DATE:	03/17/08
EUT:	Intel WiFi/WiMax Link 5350	PROJECT NUMBER:	INTEL-080114
MODEL NUMBER:	533ANXMMW	TEST ENGINEER:	JC
SERIAL NUMBER:	0016EB01A3A8	SITE #:	2
CONFIGURATION:	Tested installed in an extender board connected to the host laptop's USB port in 802.16e (2496-2690 MHz) mode.	TEMPERATURE:	22 deg. C
		HUMIDITY:	35% RH
		TIME:	1:30 PM

Description:	On any frequency outside a licensee's frequency block, the power of any emission shall be attenuated below the transmitter power (P) by at least $43 + 10 \log (P)$ dB. The specified minimum attenuation becomes 43dB and the limit of emission equal to -13 dBm.
Results:	PASSED Limits
Note:	Only the low channel data was inserted in the report for the reason that those channels used the highest output powers for all modes and were considered worst case. Conducted Emissions Measurements were performed on the EUT with power supply set at the following voltage and frequency. <ul style="list-style-type: none">• 120VAC / 60 Hz.



Conducted Spurious Emissions Test Results (Continued)

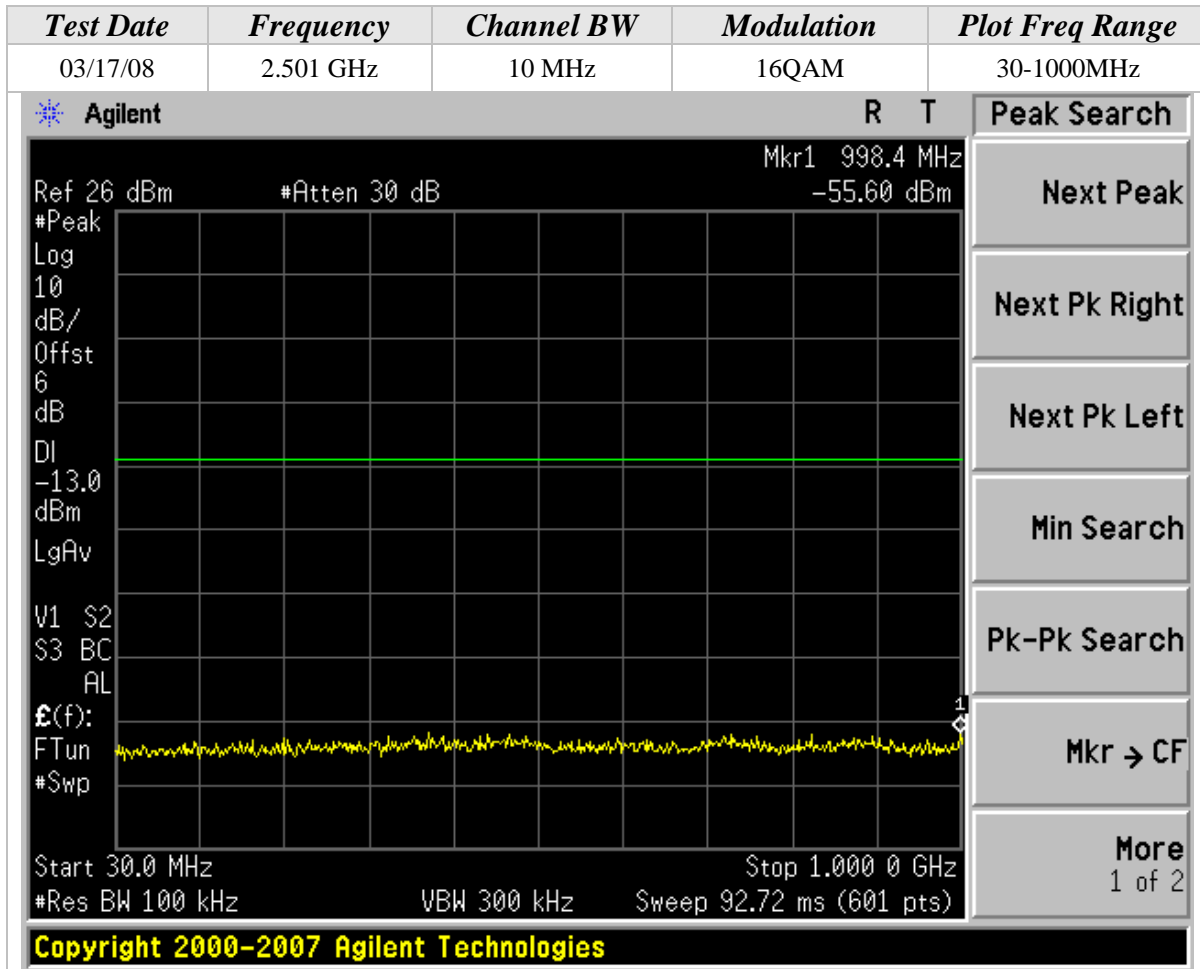

Conducted Spurious Emissions Test Results (Continued)

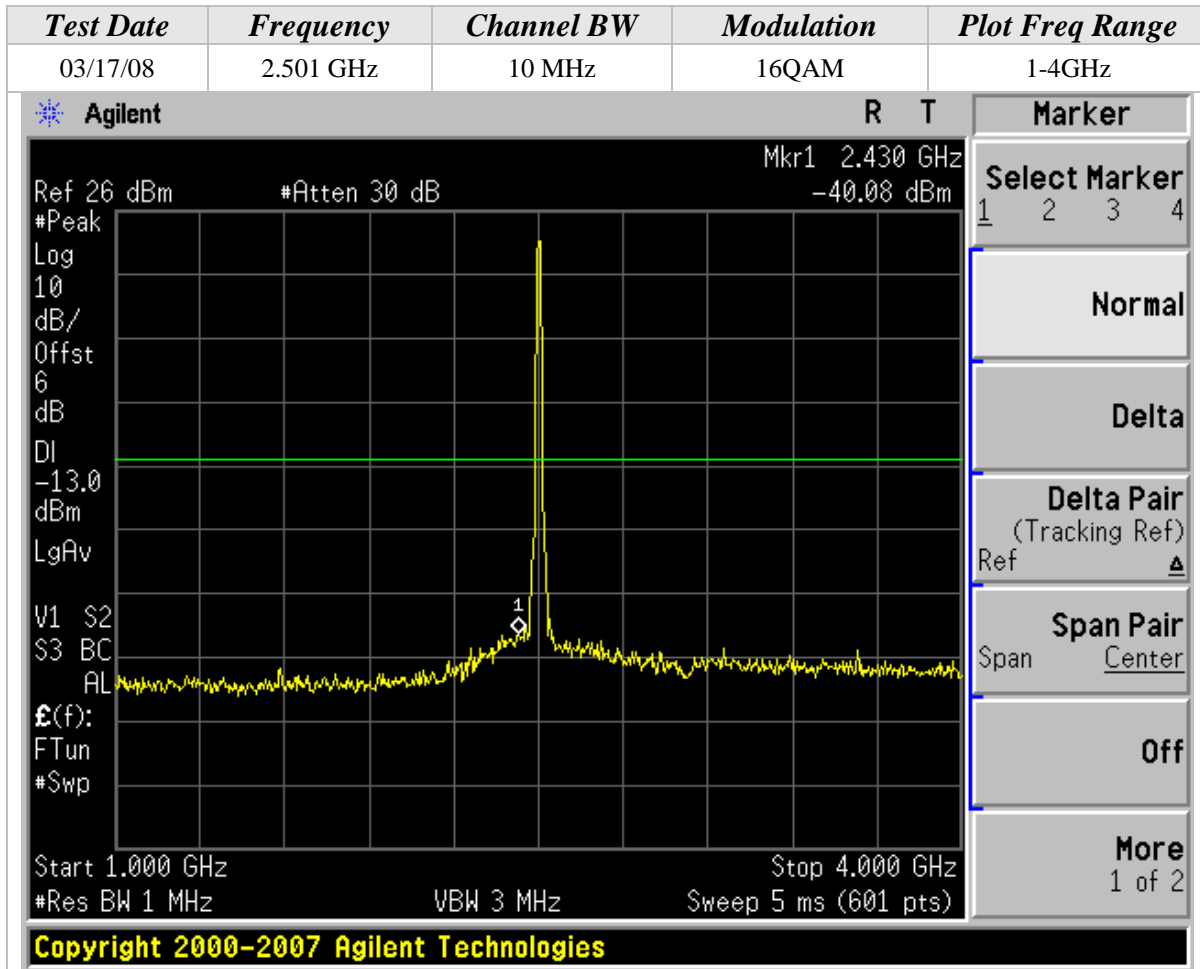

Conducted Spurious Emissions Test Results (Continued)

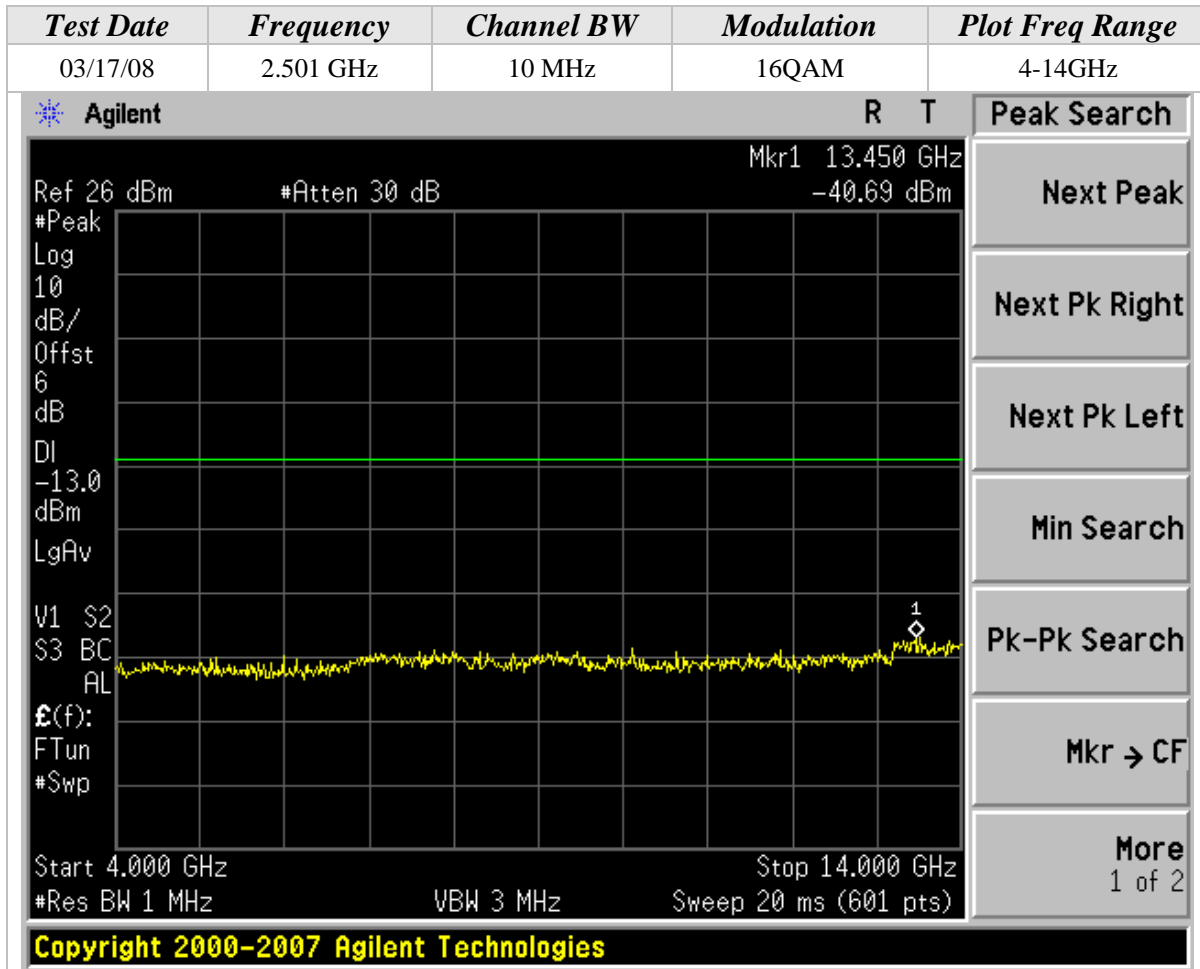

Conducted Spurious Emissions Test Results (Continued)

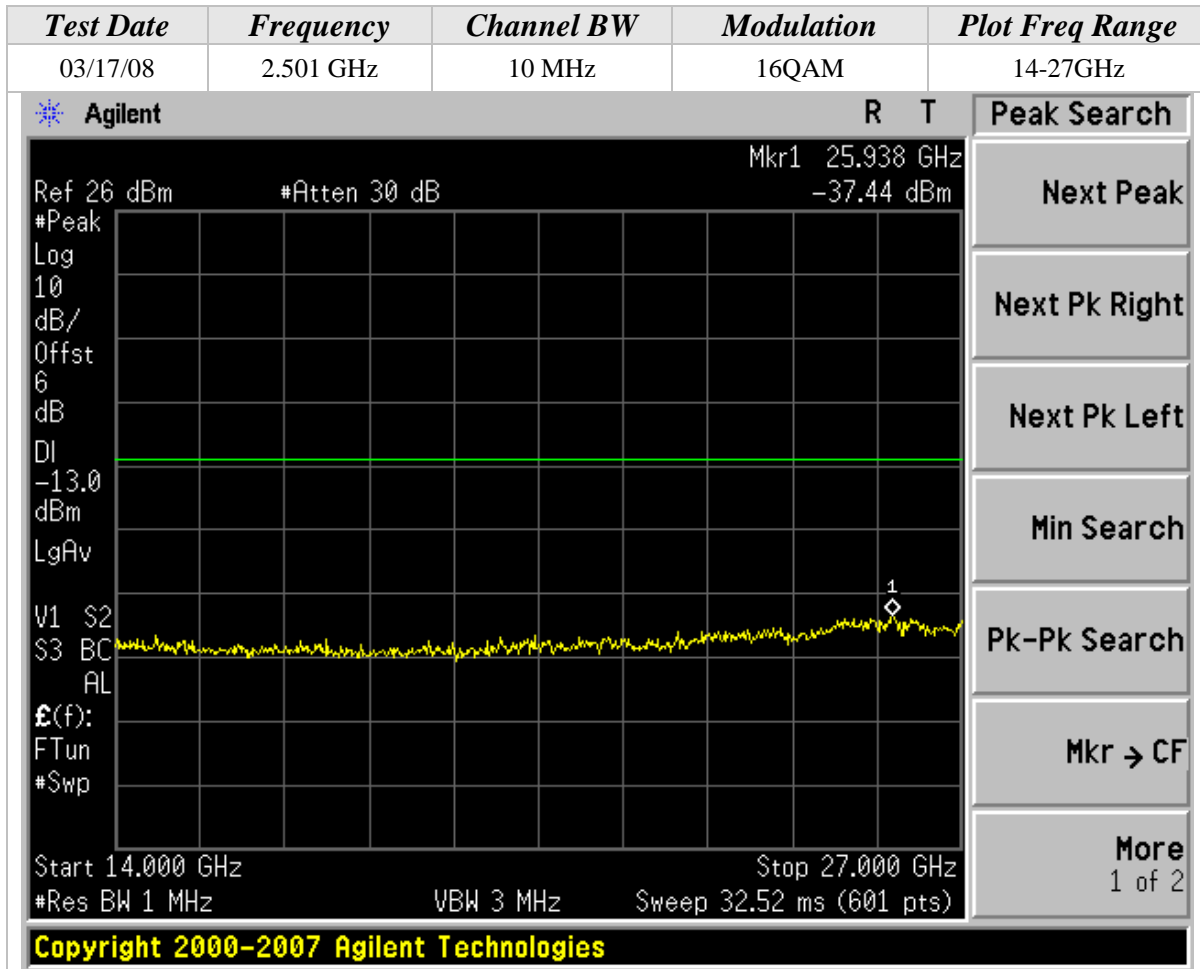



Conducted Spurious Emissions Test Results (Continued)

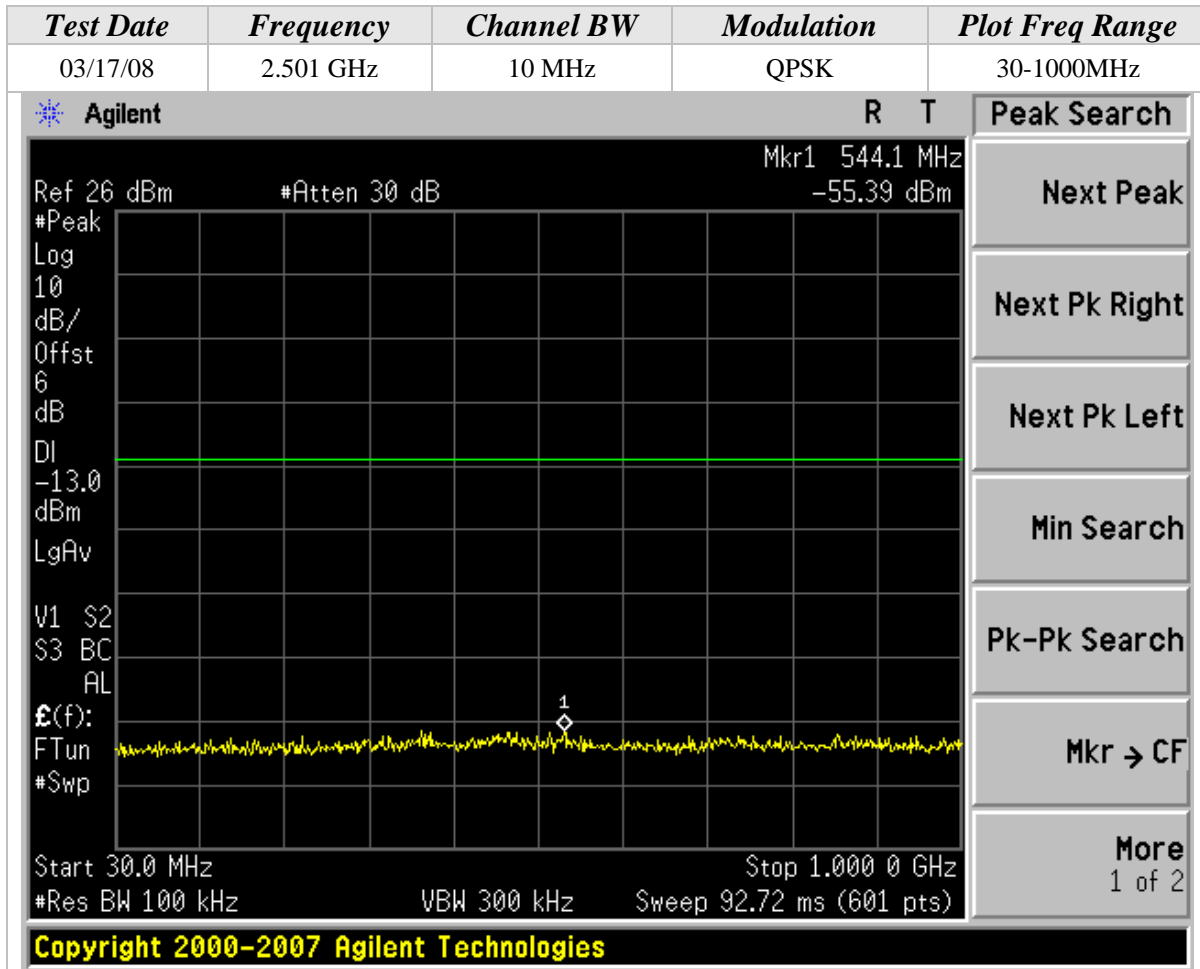

Conducted Spurious Emissions Test Results (Continued)

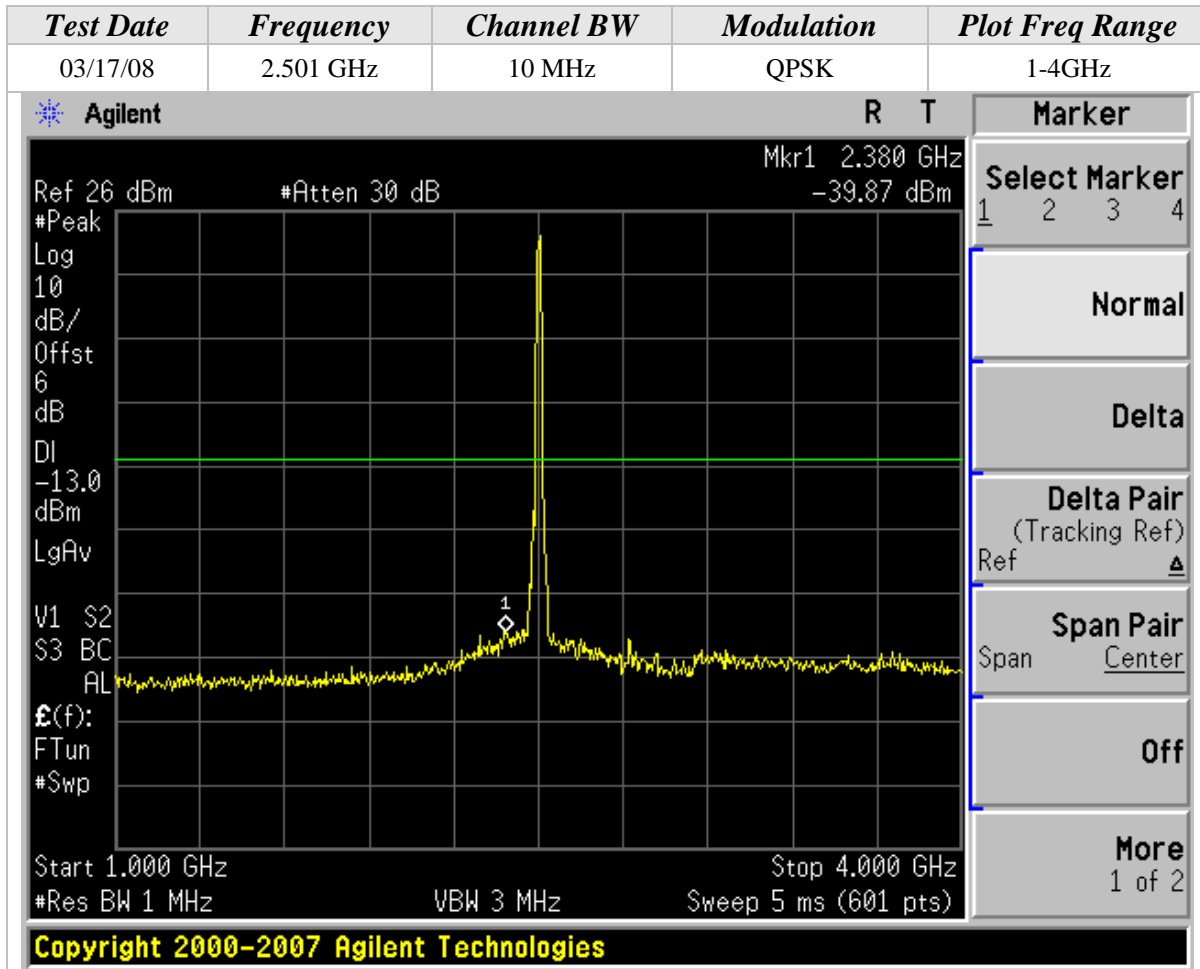

Conducted Spurious Emissions Test Results (Continued)

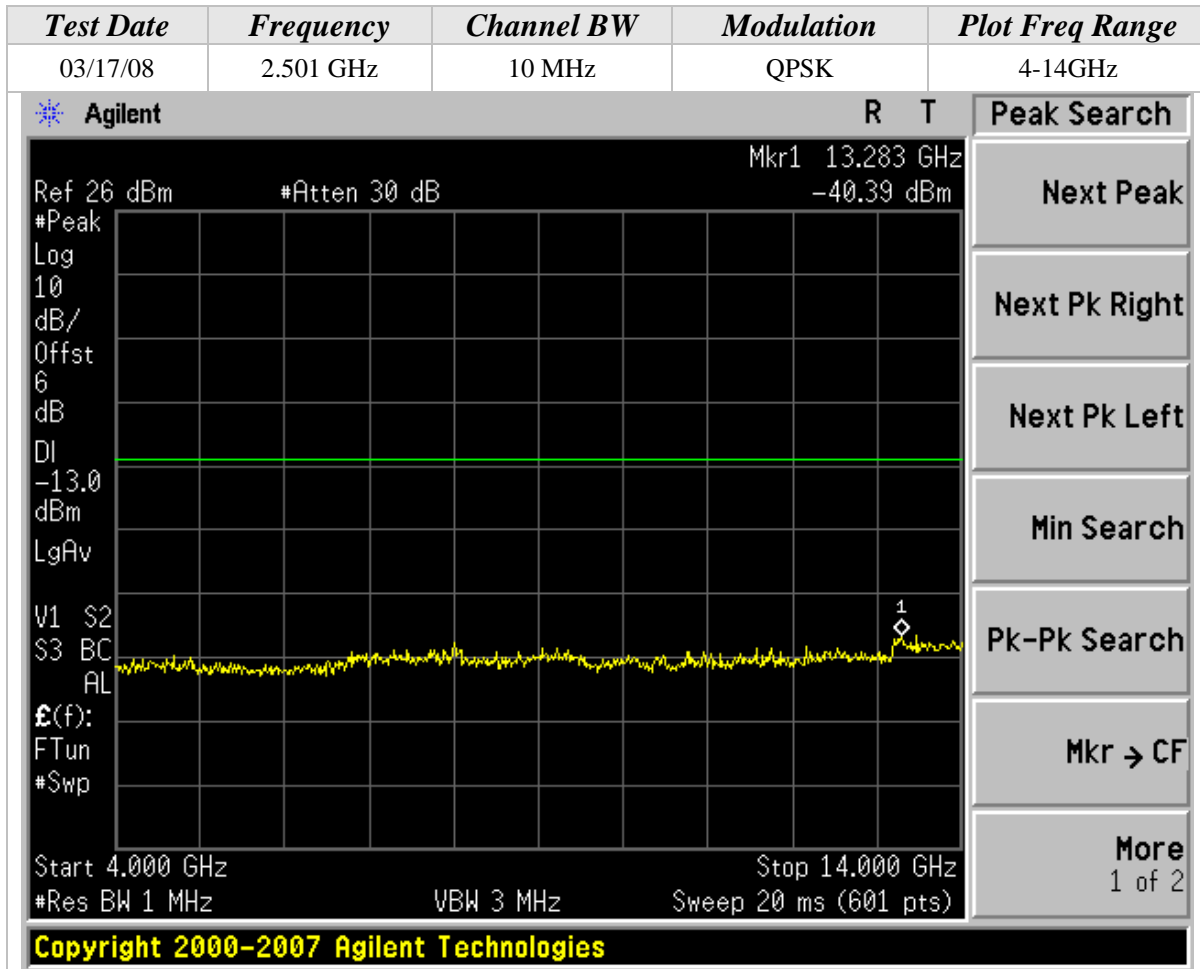

Conducted Spurious Emissions Test Results (Continued)

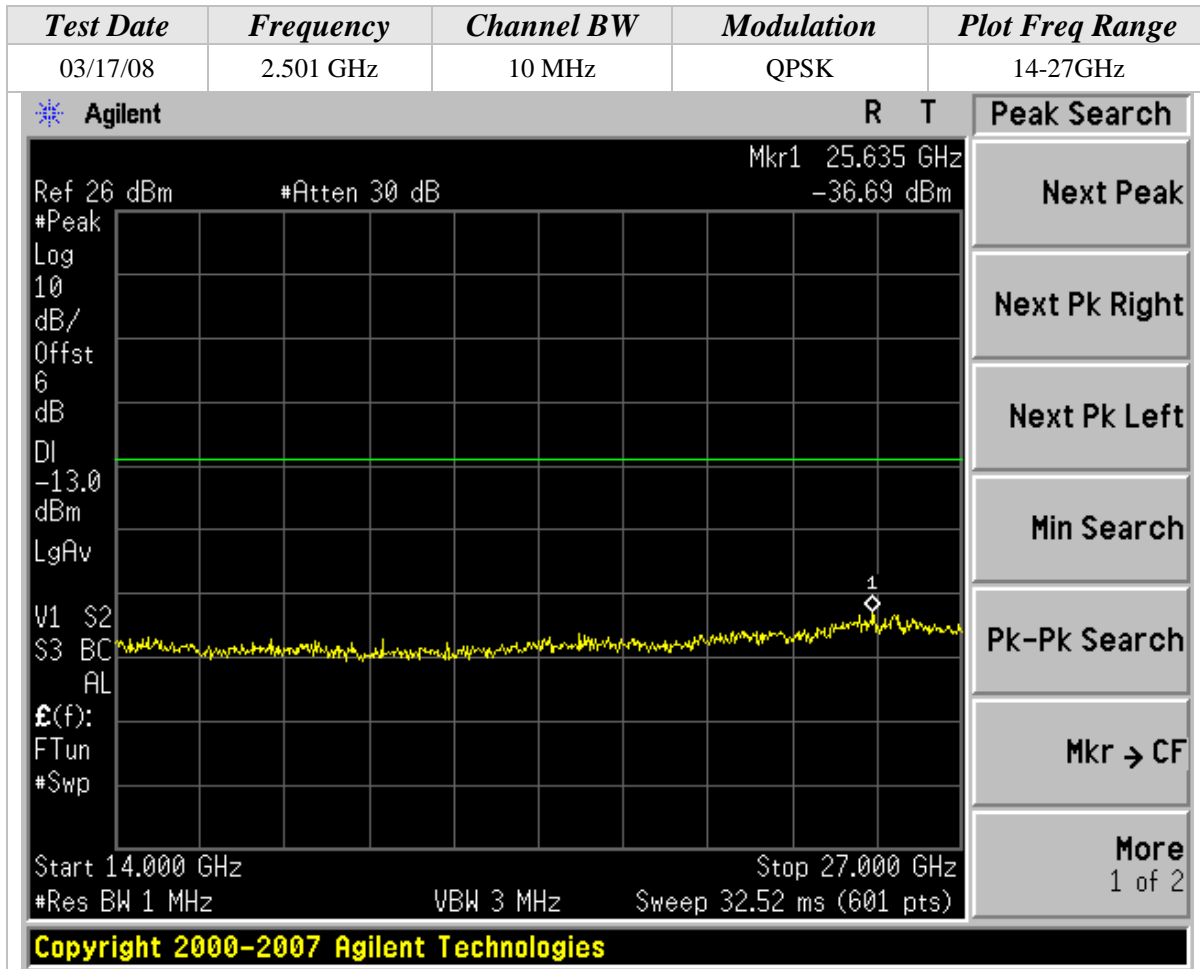



Conducted Spurious Emissions Test Results (Continued)

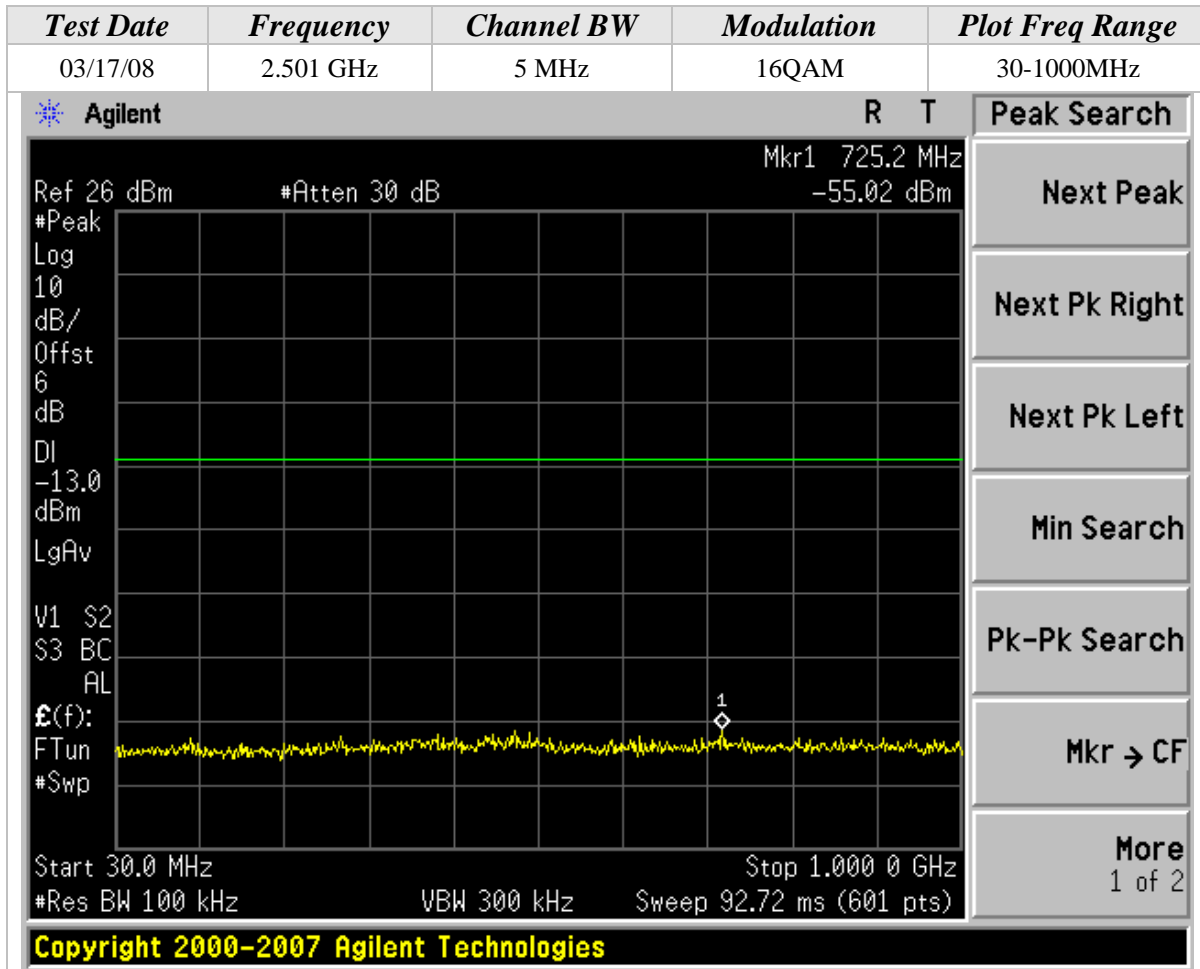

Conducted Spurious Emissions Test Results (Continued)

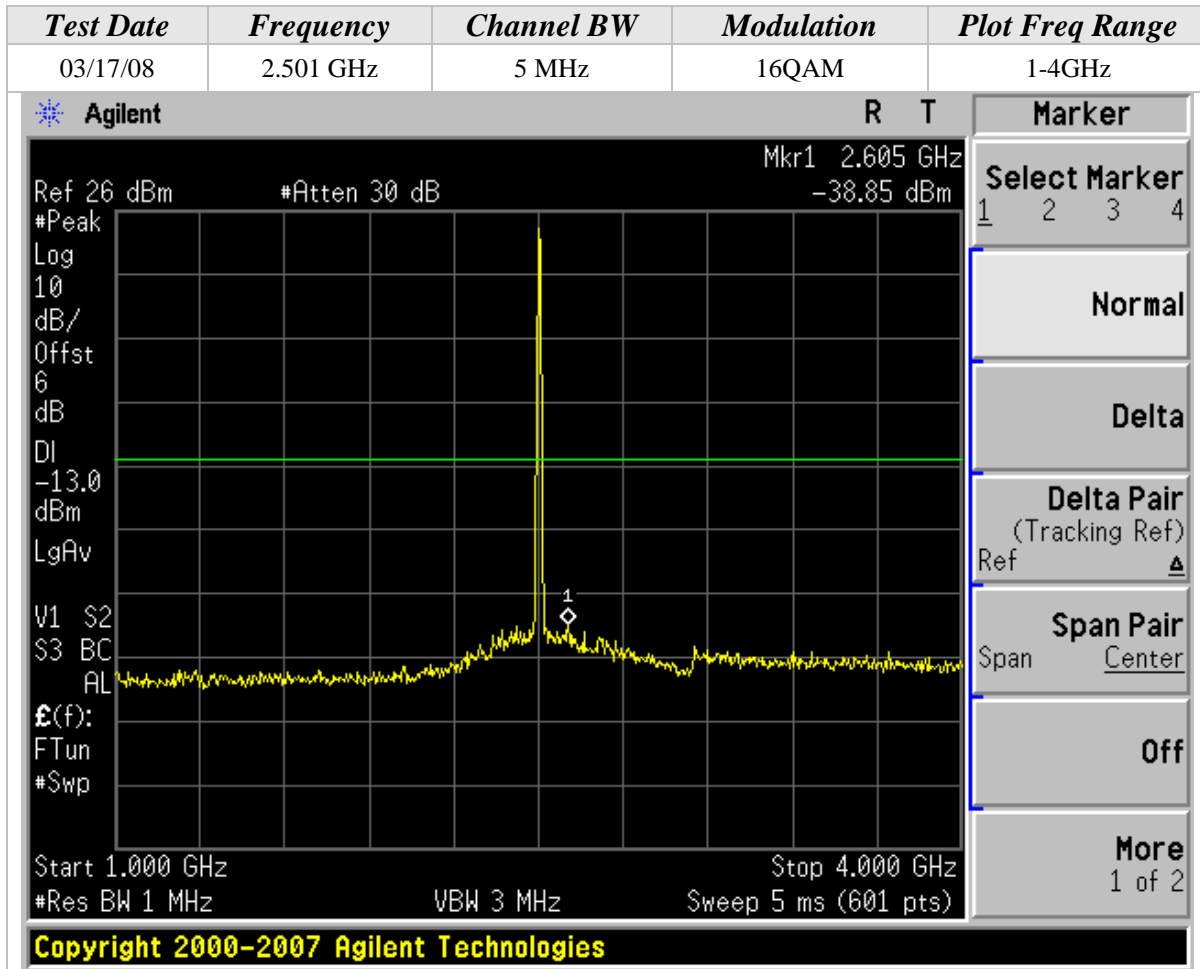



Conducted Spurious Emissions Test Results (Continued)

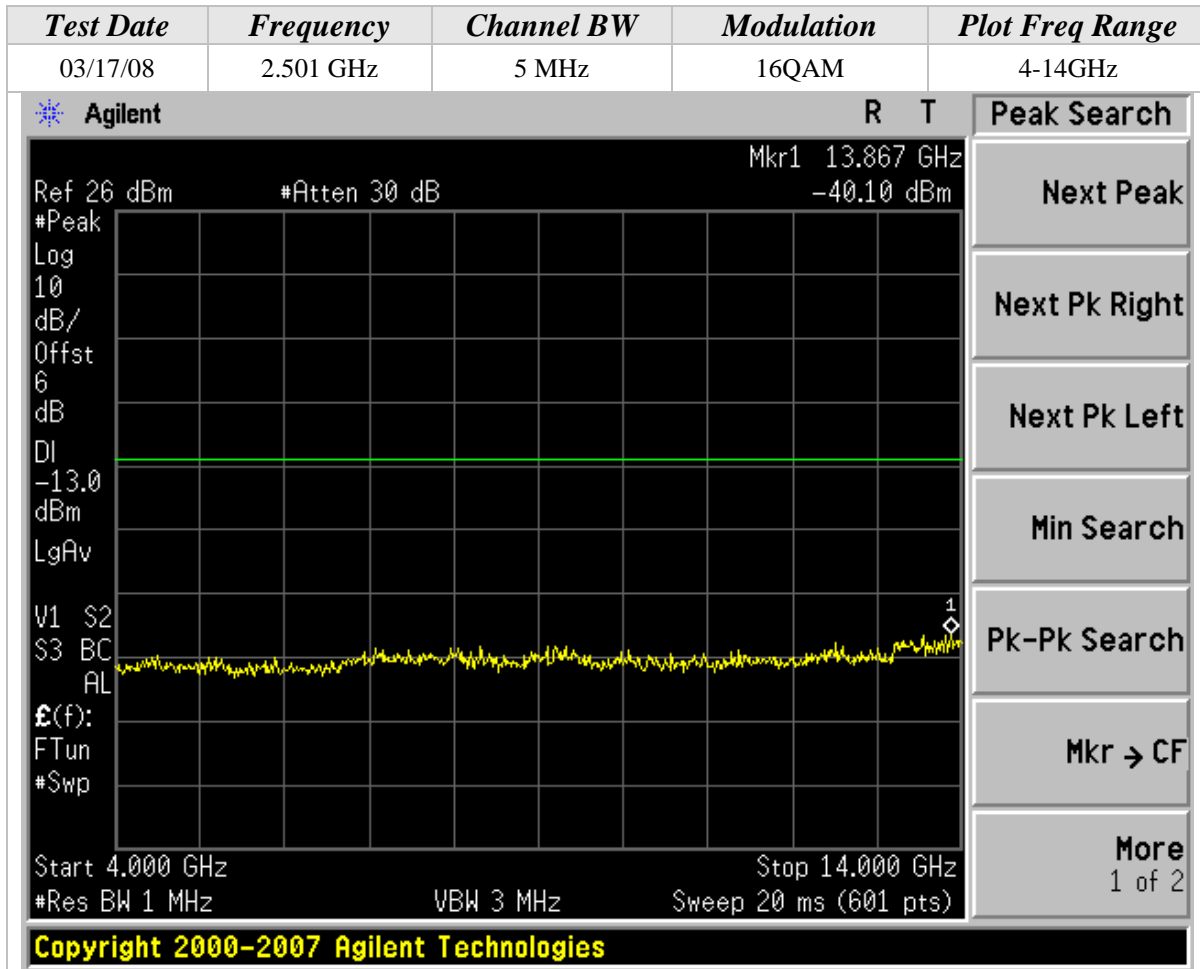



Conducted Spurious Emissions Test Results (Continued)

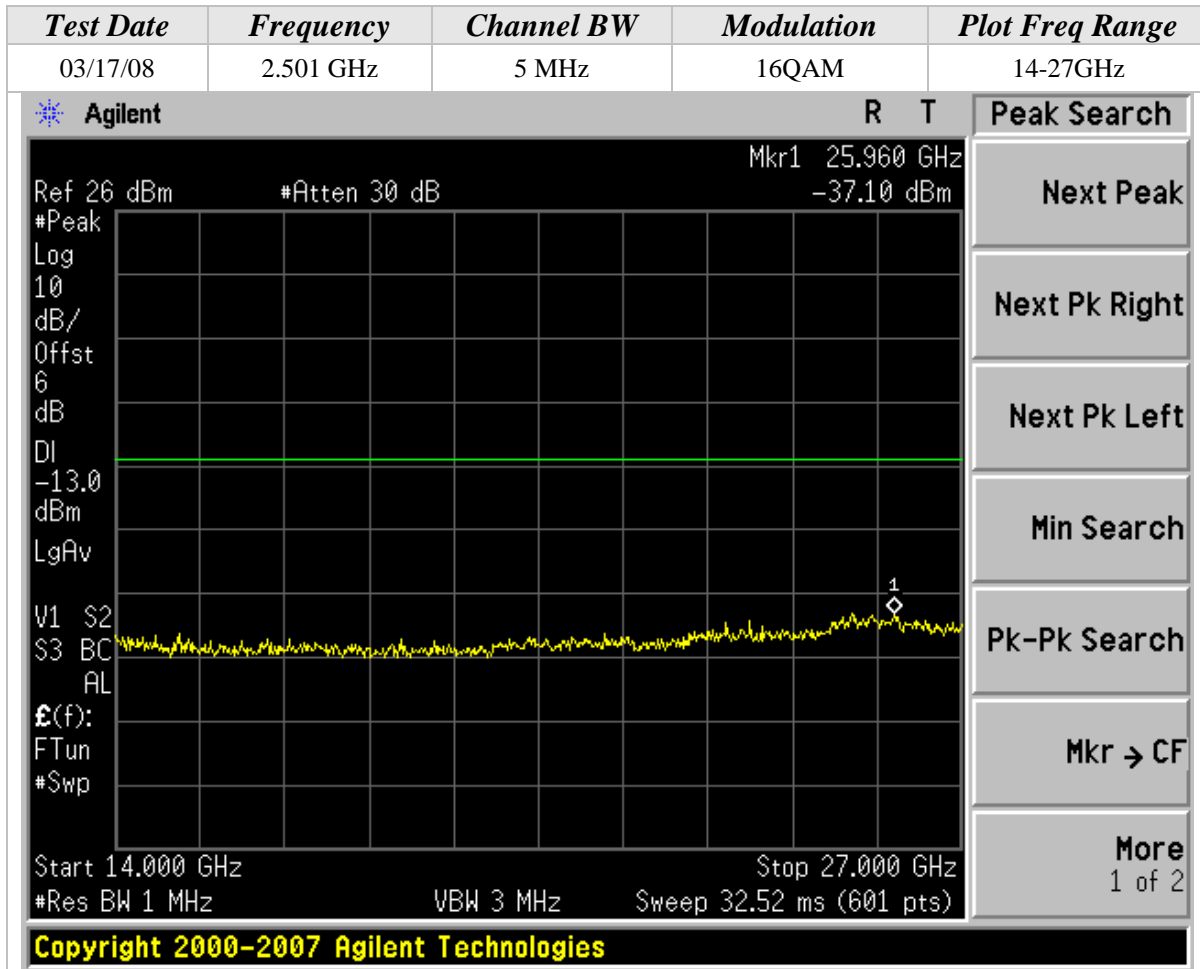



Conducted Spurious Emissions Test Results (Continued)

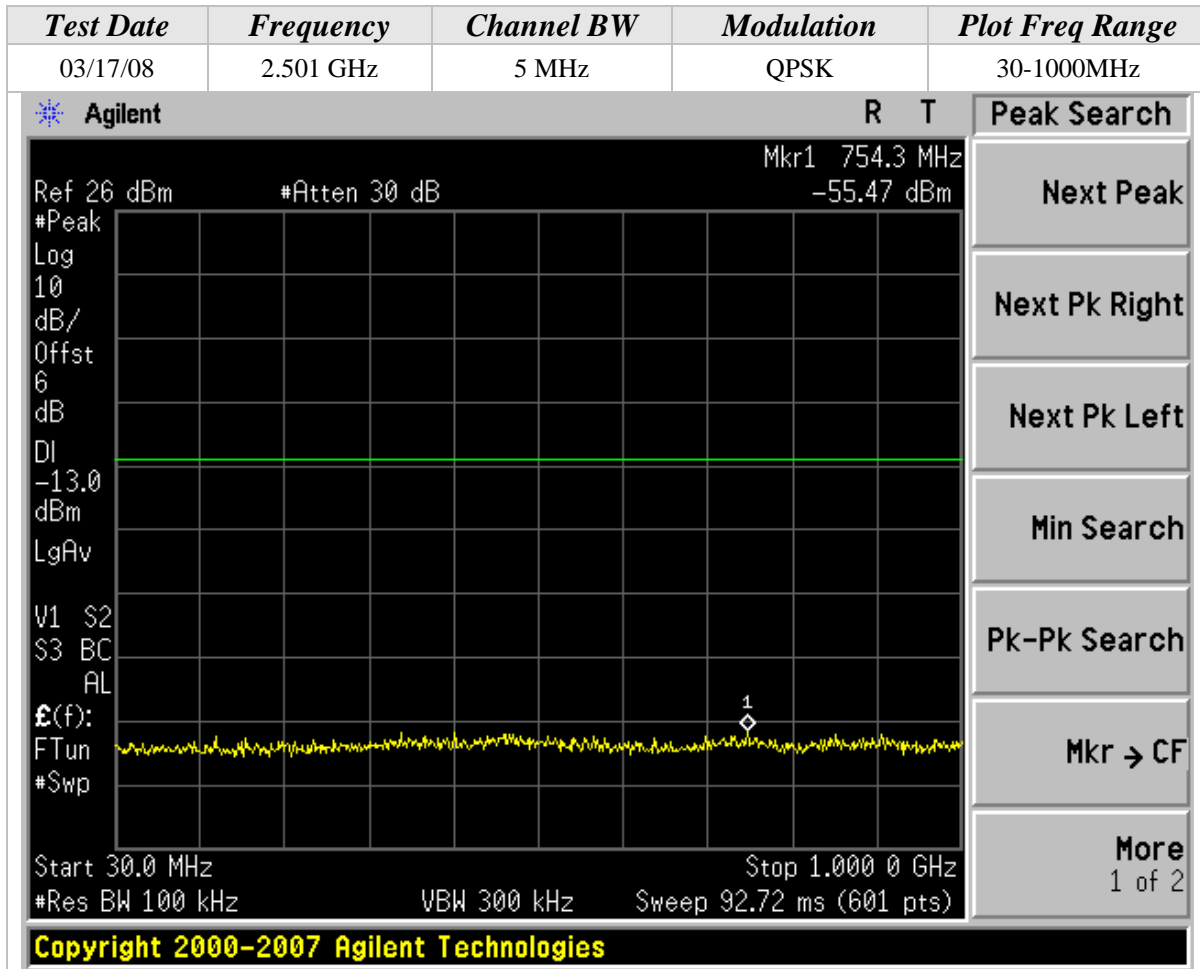

Conducted Spurious Emissions Test Results (Continued)

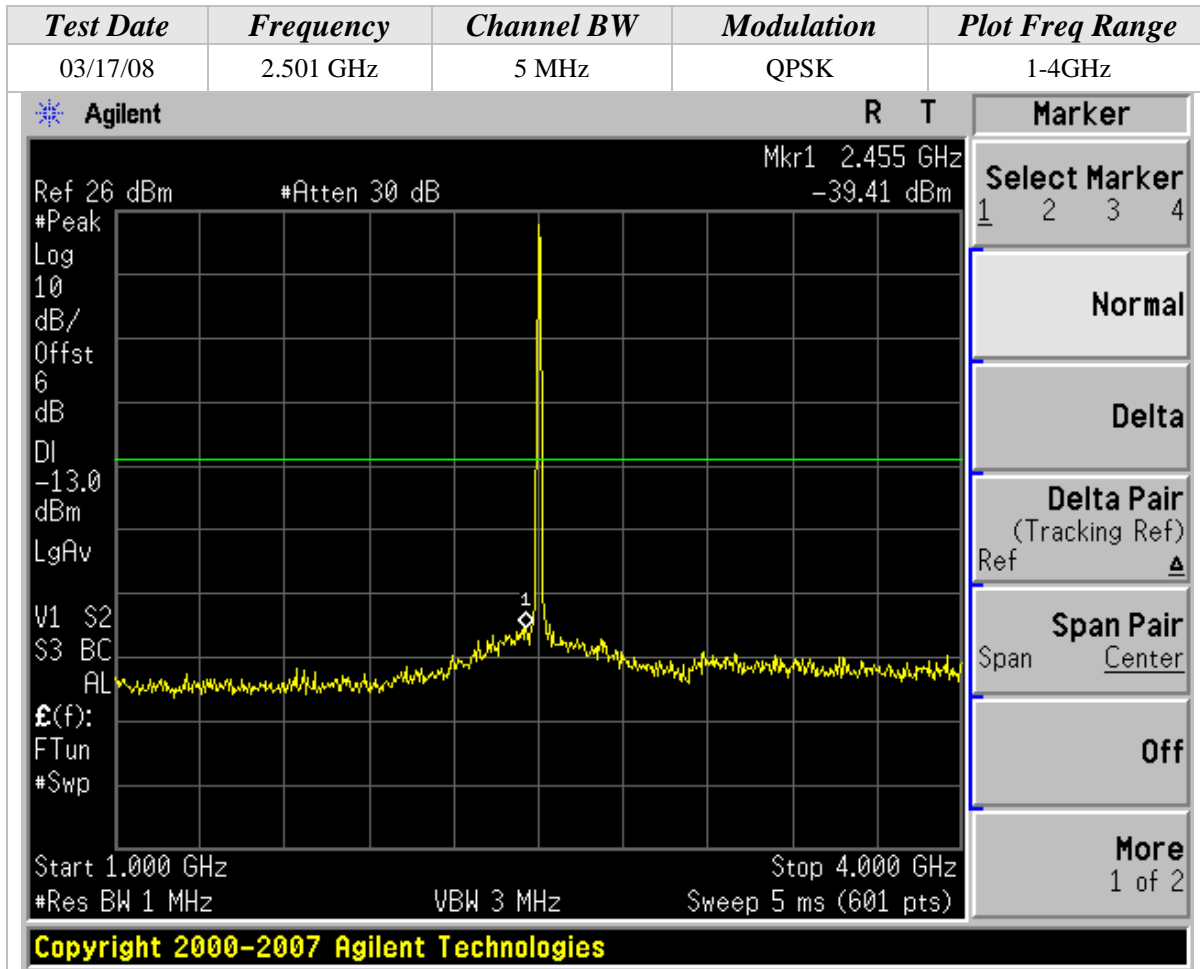

Conducted Spurious Emissions Test Results (Continued)

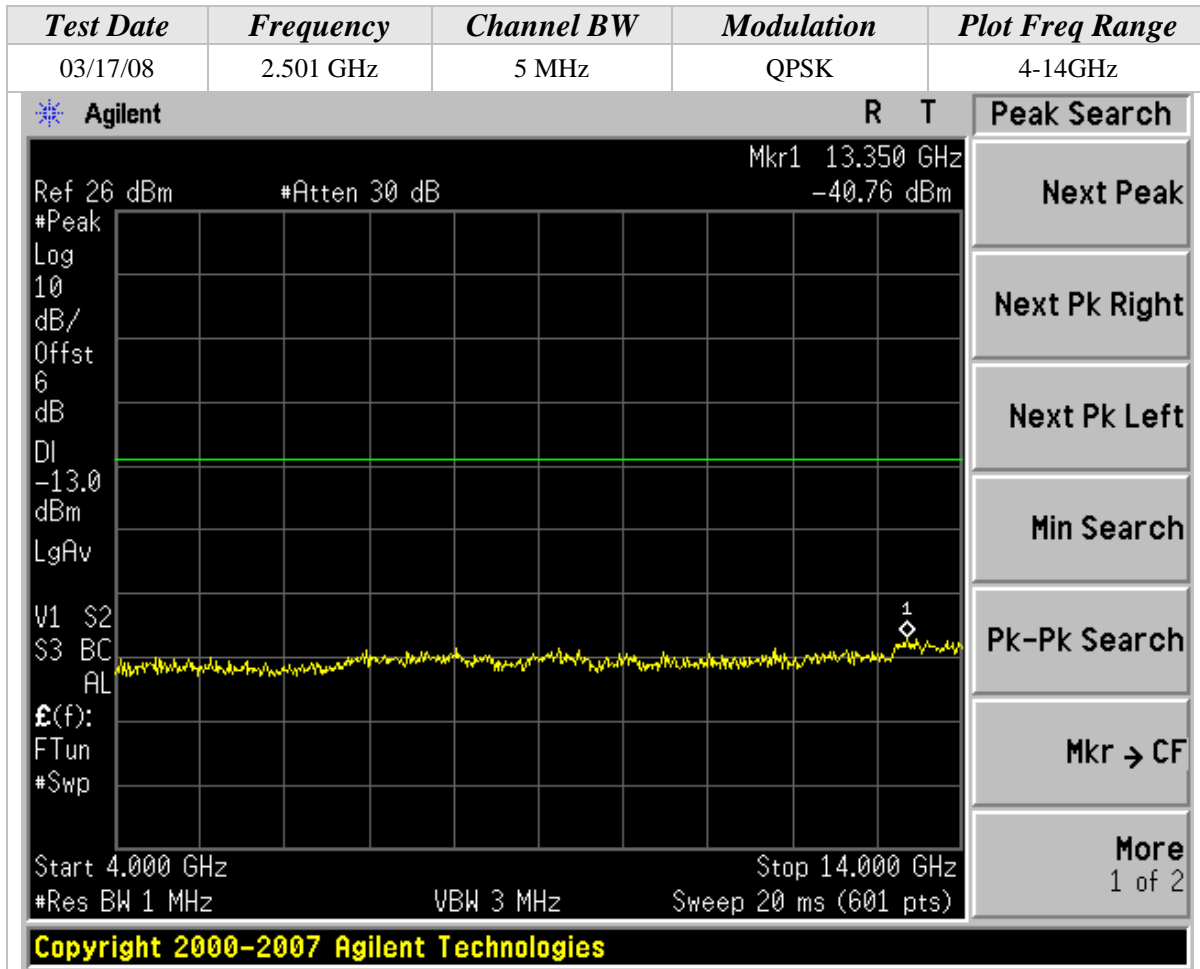



Conducted Spurious Emissions Test Results (Continued)

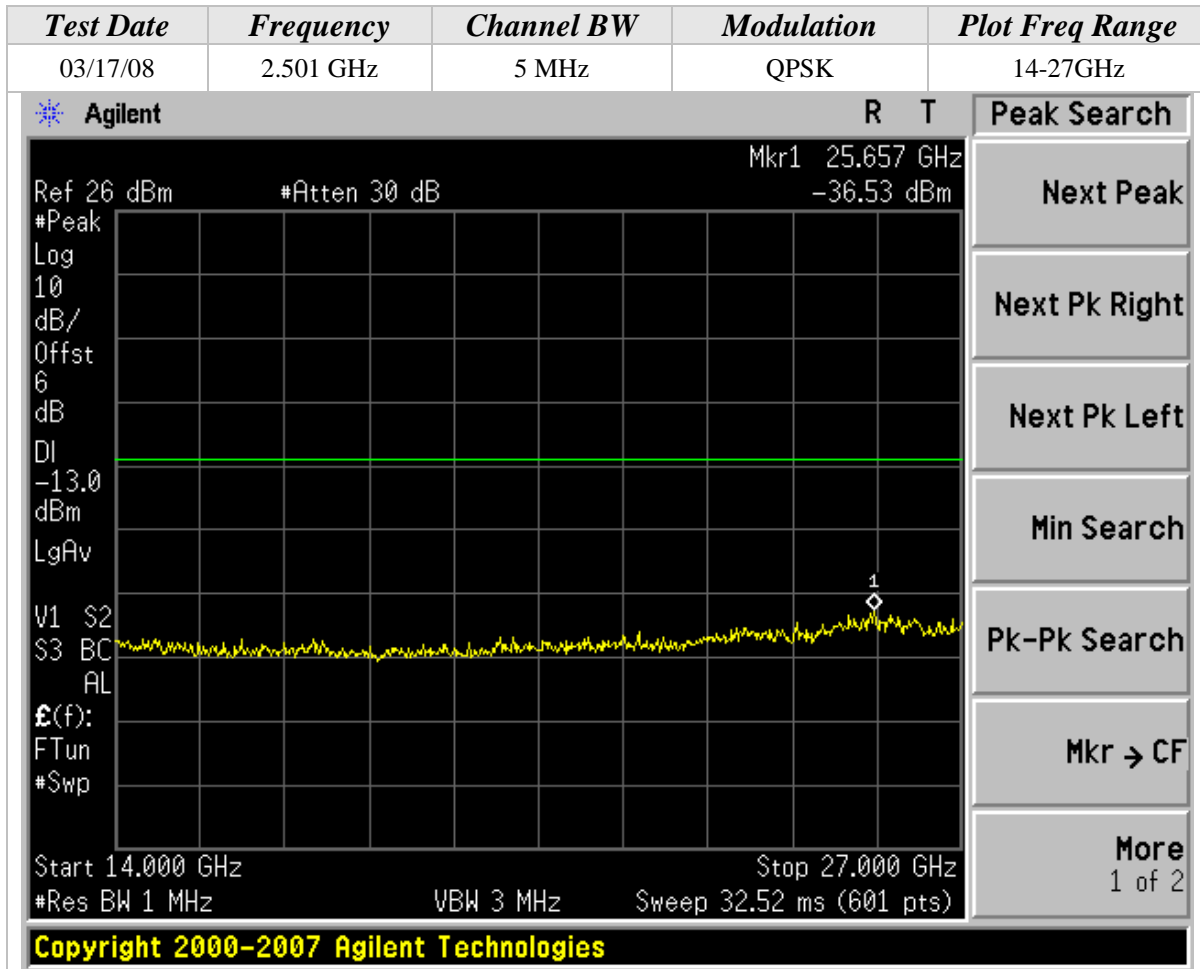

**RADIATED SPURIOUS EMISSIONS TEST RESULTS**

CLIENT:	Intel Corporation	DATE:	03/24/08
EUT:	Intel WiFi/WiMax Link 5350	PROJECT NUMBER:	INTEL-080114
MODEL NUMBER:	533ANXMMW	TEST ENGINEER:	JC
SERIAL NUMBER:	0016EB01A3A8	SITE #:	2
CONFIGURATION:	Tested installed in an extender board connected to the host laptop's USB port in 802.16e (2496-2690 MHz) mode.	TEMPERATURE:	18 deg. C
		HUMIDITY:	22% RH
		TIME:	9:30 AM

Description:	Radiated Spurious Emissions (1 GHz – 18 GHz)
Results:	PASSED Horizontal and Vertical Antenna Polarizations
Note:	On any frequency outside a licensee's frequency block, the power of any emission shall be attenuated below the transmitter power (P) by at least $43 + 10 \log (P)$ dB. The specified minimum attenuation becomes 43dB and the limit of emission equal to -13 dBm.



Radiated Spurious Emissions Test Results (Continued)

Radiated Spurious Measurements in 802.16e mode (2496-2690 MHz)
Channels Low-2501, Mid-2593, & High-2685
10MHz Channel BW in 16QAM modulation
Continuous TX at Chain A Antenna port
Aegis Labs, Inc. File #: INTEL-080114-18

RADIATED EMISSIONS - Horizontal Antenna Polarization									
<i>Freq. (MHz)</i>	<i>Meter Reading (dBuV)</i>	<i>Sig Gen Reading (dBm)</i>	<i>Antenna Height (cm)</i>	<i>Cable Loss (dB)</i>	<i>Ant. Gain (dBi)</i>	<i>Corrected Reading (dBuV)</i>	<i>Limits (dBuV)</i>	<i>Diff (dB) +/-FAIL</i>	<i>Channel Tested</i>
1068.32	40.63	-65.32	125	1.58	5.80	-61.10	-13.00	-48.10	Low
1606.70	45.85	-59.46	125	2.03	7.90	-53.59	-13.00	-40.59	
1070.78	38.54	-66.00	125	1.58	5.80	-61.78	-13.00	-48.78	Mid
1606.38	44.20	-61.34	125	2.03	7.90	-55.47	-13.00	-42.47	
1071.18	39.98	-65.85	125	1.58	5.80	-61.63	-13.00	-48.63	High
1606.06	44.27	-61.11	125	2.03	7.90	-55.24	-13.00	-42.24	

RADIATED EMISSIONS - Vertical Antenna Polarization									
<i>Freq. (MHz)</i>	<i>Meter Reading (dBuV)</i>	<i>Sig Gen Reading (dBm)</i>	<i>Antenna Height (cm)</i>	<i>Cable Loss (dB)</i>	<i>Ant. Gain (dBi)</i>	<i>Corrected Reading (dBuV)</i>	<i>Limits (dBuV)</i>	<i>Diff (dB) +/-FAIL</i>	<i>Channel Tested</i>
1067.15	40.81	-63.32	100	1.58	5.60	-59.30	-13.00	-46.30	Low
1607.01	48.10	-55.34	100	2.03	8.00	-49.37	-13.00	-36.37	
1070.78	40.64	-63.30	100	1.58	5.60	-59.28	-13.00	-46.28	Mid
1606.38	46.61	-57.51	100	2.03	8.00	-51.54	-13.00	-38.54	
1071.10	41.60	-60.88	100	1.58	5.60	-56.86	-13.00	-43.86	High
1606.67	50.07	-52.79	100	2.03	8.00	-46.82	-13.00	-33.82	



Radiated Spurious Emissions Test Results (Continued)

*Radiated Spurious Measurements in 802.16e mode (2496-2690 MHz)
Channels Low-2501, Mid-2593, & High-2685
10MHz Channel BW in QPSK modulation
Continuous TX at Chain A Antenna port
Aegis Labs, Inc. File #: INTEL-080114-18*

RADIATED EMISSIONS - Horizontal Antenna Polarization									
<i>Freq. (MHz)</i>	<i>Meter Reading (dBuV)</i>	<i>Sig Gen Reading (dBm)</i>	<i>Antenna Height (cm)</i>	<i>Cable Loss (dB)</i>	<i>Ant. Gain (dBi)</i>	<i>Corrected Reading (dBuV)</i>	<i>Limits (dBuV)</i>	<i>Diff (dB) +/-FAIL</i>	<i>Channel Tested</i>
1068.32	41.93	-63.74	125	1.58	5.80	-59.52	-13.00	-46.52	Low
1606.70	45.70	-59.59	125	2.03	7.90	-53.72	-13.00	-40.72	
1070.78	39.65	-64.33	125	1.58	5.80	-60.11	-13.00	-47.11	Mid
1606.38	45.34	-59.94	125	2.03	7.90	-54.07	-13.00	-41.07	
1071.18	39.55	-66.06	125	1.58	5.80	-61.84	-13.00	-48.84	High
1606.06	46.26	-58.35	125	2.03	7.90	-52.48	-13.00	-39.48	

RADIATED EMISSIONS - Vertical Antenna Polarization									
<i>Freq. (MHz)</i>	<i>Meter Reading (dBuV)</i>	<i>Sig Gen Reading (dBm)</i>	<i>Antenna Height (cm)</i>	<i>Cable Loss (dB)</i>	<i>Ant. Gain (dBi)</i>	<i>Corrected Reading (dBuV)</i>	<i>Limits (dBuV)</i>	<i>Diff (dB) +/-FAIL</i>	<i>Channel Tested</i>
1068.32	42.98	-61.34	100	1.58	5.60	-57.32	-13.00	-44.32	Low
1607.01	46.10	-58.28	100	2.03	8.00	-52.31	-13.00	-39.31	
1063.18	40.89	-66.35	100	1.58	5.60	-62.33	-13.00	-49.33	Mid
1606.38	47.63	-55.00	100	2.03	8.00	-49.03	-13.00	-36.03	
1062.77	42.52	-60.34	100	1.58	5.60	-56.32	-13.00	-43.32	High
1606.67	47.31	-55.60	100	2.03	8.00	-49.63	-13.00	-36.63	



Radiated Spurious Emissions Test Results (Continued)

*Radiated Spurious Measurements in 802.16e mode (2496-2690 MHz)
Channels Low-2501, Mid-2593, & High-2687.5
5MHz Channel BW in 16QAM modulation
Continuous TX at Chain A Antenna port
Aegis Labs, Inc. File #: INTEL-080114-18*

RADIATED EMISSIONS - Horizontal Antenna Polarization									
<i>Freq. (MHz)</i>	<i>Meter Reading (dBuV)</i>	<i>Sig Gen Reading (dBm)</i>	<i>Antenna Height (cm)</i>	<i>Cable Loss (dB)</i>	<i>Ant. Gain (dBi)</i>	<i>Corrected Reading (dBuV)</i>	<i>Limits (dBuV)</i>	<i>Diff (dB) +/-FAIL</i>	<i>Channel Tested</i>
1070.30	40.64	-62.89	125	2.12	5.80	-59.21	-13.00	-46.21	Low
1606.70	45.05	-57.55	125	2.58	7.90	-52.23	-13.00	-39.23	
1632.49	41.39	-60.86	125	2.60	8.00	-55.46	-13.00	-42.46	
1071.23	41.16	-61.36	125	2.12	5.80	-57.68	-13.00	-44.68	Mid
1606.53	45.44	-57.22	125	2.58	7.90	-51.90	-13.00	-38.90	
1071.20	42.72	-58.32	125	2.12	5.80	-54.64	-13.00	-41.64	High
1606.67	48.58	-54.08	125	2.58	7.90	-48.76	-13.00	-35.76	

RADIATED EMISSIONS - Vertical Antenna Polarization									
<i>Freq. (MHz)</i>	<i>Meter Reading (dBuV)</i>	<i>Sig Gen Reading (dBm)</i>	<i>Antenna Height (cm)</i>	<i>Cable Loss (dB)</i>	<i>Ant. Gain (dBi)</i>	<i>Corrected Reading (dBuV)</i>	<i>Limits (dBuV)</i>	<i>Diff (dB) +/-FAIL</i>	<i>Channel Tested</i>
1070.57	41.82	-57.90	100	2.12	5.60	-54.42	-13.00	-41.42	Low
1607.01	46.59	-55.06	100	2.58	8.00	-49.64	-13.00	-36.64	
1632.68	52.03	-48.18	100	2.60	8.10	-42.68	-13.00	-29.68	
1071.23	40.61	-60.14	100	2.12	5.60	-56.66	-13.00	-43.66	Mid
1606.53	46.39	-55.50	100	2.58	8.00	-50.08	-13.00	-37.08	
1071.20	41.80	-59.74	100	2.12	5.60	-56.26	-13.00	-43.26	High
1606.67	51.01	-49.62	100	2.58	8.00	-44.20	-13.00	-31.20	



Radiated Spurious Emissions Test Results (Continued)

Radiated Spurious Measurements in 802.16e mode (2496-2690 MHz)
Channels Low-2501, Mid-2593, & High-2687.5
5MHz Channel BW in QPSK modulation
Continuous TX at Chain A Antenna port
Aegis Labs, Inc. File #: INTEL-080114-18

RADIATED EMISSIONS - Horizontal Antenna Polarization									
<i>Freq. (MHz)</i>	<i>Meter Reading (dBuV)</i>	<i>Sig Gen Reading (dBm)</i>	<i>Antenna Height (cm)</i>	<i>Cable Loss (dB)</i>	<i>Ant. Gain (dBi)</i>	<i>Corrected Reading (dBuV)</i>	<i>Limits (dBuV)</i>	<i>Diff (dB) +/-FAIL</i>	<i>Channel Tested</i>
1070.30	40.64	-62.89	125	2.12	5.80	-59.21	-13.00	-46.21	Low
1606.70	45.05	-57.55	125	2.58	7.90	-52.23	-13.00	-39.23	
1632.49	41.39	-60.86	125	2.60	8.00	-55.46	-13.00	-42.46	
1071.23	41.16	-61.36	125	2.12	5.80	-57.68	-13.00	-44.68	Mid
1606.53	45.44	-57.22	125	2.58	7.90	-51.90	-13.00	-38.90	
1071.20	42.72	-58.32	125	2.12	5.80	-54.64	-13.00	-41.64	High
1606.67	48.58	-54.08	125	2.58	7.90	-48.76	-13.00	-35.76	

RADIATED EMISSIONS - Vertical Antenna Polarization									
<i>Freq. (MHz)</i>	<i>Meter Reading (dBuV)</i>	<i>Sig Gen Reading (dBm)</i>	<i>Antenna Height (cm)</i>	<i>Cable Loss (dB)</i>	<i>Ant. Gain (dBi)</i>	<i>Corrected Reading (dBuV)</i>	<i>Limits (dBuV)</i>	<i>Diff (dB) +/-FAIL</i>	<i>Channel Tested</i>
1070.57	41.82	-57.90	100	2.12	5.60	-54.42	-13.00	-41.42	Low
1607.01	46.59	-55.06	100	2.58	8.00	-49.64	-13.00	-36.64	
1632.68	52.03	-48.18	100	2.60	8.10	-42.68	-13.00	-29.68	
1071.23	40.61	-60.14	100	2.12	5.60	-56.66	-13.00	-43.66	Mid
1606.53	46.39	-55.50	100	2.58	8.00	-50.08	-13.00	-37.08	
1071.20	41.80	-59.74	100	2.12	5.60	-56.26	-13.00	-43.26	High
1606.67	51.01	-49.62	100	2.58	8.00	-44.20	-13.00	-31.20	



APPENDIX B

MODIFICATIONS AND RECOMMENDATIONS

1.0	NONE