



Modular Approval
Test Report
And Application for Grant of Equipment Authorization

TEST REPORT PERTAINING TO:

Equipment Under Test	Model Number(s)
Intel WiFi/WiMax Link 5350	533ANXMMW

CONFIGURATION
IEEE 802.11a / 802.11b / 802.11g / 802.11n with a set of Shanghai Universe Communication Electron Co., Ltd Antennas

MEASUREMENTS PERFORMED IN ACCORDANCE WITH THE FOLLOWING STANDARD (S)

Regulatory Standard(s)
47 CFR Part 15, Subpart E Section 15.407 (UNII Devices)
Test Method: ANSI C63.4: 2003 American National Standard for Methods of Measurement of Radio-Noise Emissions from Low-Voltage Electrical and Electronic Equipment in the Range of 9 kHz to 40 GHz



Certificate Number: 1111.01

PREPARED FOR:

Intel Corporation
2111 NE 25th Avenue
Hillsboro, Oregon 97124
Contact(s): Ms. Marissa Faustino

PREPARED BY:

Aegis Labs, Inc.
8 Rancho Circle
Lake Forest, CA 92630
Agent(s): Mr. Rick Candelas
Mr. Johnny Candelas



Test Report #: INTEL-080115F

Test Report Revision: NONE

	REPORT BODY	APPENDICES		TOTAL PAGES
		A	B	
PAGES	28	292	1	321

The contents of this report shall not be reproduced except in full, without the written approval of Aegis Labs, Inc.
The Intel logo is used for identification purposes only and is a registered trademark of Intel Corporation



TABLE OF CONTENTS

SECTION	TITLE	PAGE
	COVER SHEET.....	01
	TABLE OF CONTENTS.....	02
1.0	REGULATORY COMPLIANCE GUIDELINES.....	03
1.1	Guidelines For Testing To Emissions Standards.....	03
2.0	SUMMARY OF REGULATORY LIMITS.....	04
3.0	ADMINISTRATIVE DATA AND TEST DESCRIPTION.....	22
4.0	DESCRIPTION OF EUT CONFIGURATION.....	23
4.1	EUT Description	23
4.2	EUT Configuration.....	24
4.3	List of EUT Sub-Assemblies and Host Equipment.....	24
4.4	I/O Cabling Diagram and Description	25
4.5	EMC Test Hardware and Software Measurement Equipment.....	26
5.0	CONDITIONS DURING EMISSIONS MEASUREMENTS.....	27
5.1	General.....	27
5.2	Conducted Emissions Test Setup.....	27
5.3	Radiated Emissions Test Setup.....	28

APPENDICES

A	Test Data
B	Modifications And Recommendations



1.0 REGULATORY COMPLIANCE GUIDELINES

Aegis Labs, Inc. operates as both a Nevada and California Corporation with no organizational or financial relationship with any company, institution, or private individual. Testing and engineering functions provided by Aegis Labs were furnished by RF technicians and engineers with accredited qualifications and training credentials to carry out their duties.

The object of this report was to publish verifiable test results of an EUT subjected to the tests outlined in the standard listed on the cover page of this report.

1.1 Guidelines For Testing To Emissions Standards

This standard for EMC emission requirements apply to electrical equipment for Information Technology Equipment (ITE). Compliance to these standards and in combination with the other standards listed in this test report can be used to demonstrate presumption of compliance with the protection requirements of the appropriate agency standard.

The purpose of this standard is to specify minimum requirements for emissions regarding electromagnetic compatibility (EMC) and protect the radio frequency spectrum 9 kHz. – 400 GHz. from unwanted interference generated from electrical/digital systems that intentionally or unintentionally generated RF energy. The emissions standards, normative documents and/or publications were used to conduct all tests performed on the equipment herein referred to as “Equipment Under Test”.



2.0 SUMMARY OF TEST RESULTS

802.11a Mode (5150-5350 MHz) Chain A

EMISSIONS STANDARD			
FCC Part 15 Section	Description	Results	Comments
Operation in the 5.15-5.25 GHz Band			
15.407(d)	Any UNII device shall use a transmitting antenna that is an integral part of the device.	PASSED	The antenna will be integral when installed in a notebook computer
15.407(e)	UNII devices will be restricted to indoor operations.	PASSED	Refer to "User's Manual" Exhibit
15.407(a)(1)	26dB emissions bandwidth in MHz.	N/A	5.18 GHz = 23.08 MHz 5.20 GHz = 23.83 MHz 5.24 GHz = 23.58 MHz
15.407(a)(1)	Peak transmit power shall not exceed the lesser of 50mW or 4dBm+10logB (where B = 26dB emissions bandwidth).	PASSED	5.18 GHz = 16.47dBm (44.40mW) 5.20 GHz = 16.66dBm (46.38mW) 5.24 GHz = 16.76dBm (47.46mW)
15.407(a)(1)	The peak power spectral density shall not exceed 4dBm in any 1MHz band.	PASSED	5.18 GHz = -7.248dBm 5.20 GHz = -7.095dBm 5.24 GHz = -6.824dBm
15.407(a)(1)	Peak transmit power and the peak power spectral density shall be reduced by the amount in dB that the transmitting antenna exceeds 6dBi.	N/A	All antennas tested have less than 6dBi antenna gain (Please see the antenna data sheets)
15.407(b)(6) 15.209	Unwanted emissions below 1 GHz must comply with the general field strength limits set forth in Section 15.209.	PASSED	See FCC 15.247 report (INTEL-080114F)
15.407(b)(1)	All emissions outside of the 5.15-5.35 GHz band shall not exceed an EIRP of -27dBm/MHz.	PASSED	See Data Sheets
Operation in the 5.25-5.35 GHz Band			
15.407(a)(2)	26dB emissions bandwidth in MHz.	N/A	5.26 GHz = 23.25 MHz 5.28 GHz = 28.17 MHz 5.32 GHz = 23.08 MHz
15.407(a)(2)	Peak transmit power shall not exceed the lesser of 250mW or 11dBm+10logB (where B = 26dB emissions bandwidth).	PASSED	5.26 GHz = 16.52dBm (44.91mW) 5.28 GHz = 16.69dBm (46.71mW) 5.32 GHz = 16.34dBm (43.09mW)
15.407(a)(2)	The peak power spectral density shall not exceed 11dBm in any 1MHz band.	PASSED	5.26 GHz = -7.776dBm 5.28 GHz = -7.113dBm 5.32 GHz = -8.163dBm
15.407(a)(2)	Peak transmit power and the peak power spectral density shall be reduced by the amount in dB that the transmitting antenna exceeds 6dBi.	N/A	All antennas tested have less than 6dBi antenna gain (Please see the antenna data sheets)
15.407(b)(6) 15.209	Unwanted emissions below 1 GHz must comply with the general field strength limits set forth in Section 15.209.	PASSED	See FCC 15.247 report (INTEL-080114F)
15.407(b)(2)	All emissions outside of the 5.15-5.35 GHz band shall not exceed an EIRP of -27dBm/MHz. Must meet all applicable technical requirements for operating in the 5.15-5.25 GHz band.	PASSED	See Data Sheets
General Requirements For All Bands			
15.407(a)(6)	The ratio of the peak excursion of the modulation envelope to the peak transmit power shall not exceed 13dB across any 1 MHz bandwidth or the emissions bandwidth whichever is less.	PASSED	5.18 GHz = 5.13 dB 5.20 GHz = 5.02 dB 5.24 GHz = 5.99 dB 5.26 GHz = 5.14 dB 5.28 GHz = 5.29 dB 5.32 GHz = 2.77 dB
15.407(f)	Radio frequency radiation exposure requirement.	PASSED	Refer to MPE Calculations
15.407(b)(6) 15.207	UNII devices using AC power line are required to comply with the conducted limits set forth in Section 15.207.	PASSED	See FCC 15.247 report (INTEL-080114F)



2.0 Summary Of Test Results (Continued)

802.11a Mode (5150-5350 MHz) Chain B

EMISSIONS STANDARD			
FCC Part 15 Section	Description	Results	Comments
Operation in the 5.15-5.25 GHz Band			
15.407(d)	Any UNII device shall use a transmitting antenna that is an integral part of the device.	PASSED	The antenna will be integral when installed in a notebook computer
15.407(e)	UNII devices will be restricted to indoor operations.	PASSED	Refer to "User's Manual" Exhibit
15.407(a)(1)	26dB emissions bandwidth in MHz.	N/A	5.18 GHz = 23.25 MHz 5.20 GHz = 22.83 MHz 5.24 GHz = 23.08 MHz
15.407(a)(1)	Peak transmit power shall not exceed the lesser of 50mW or 4dBm+10logB (where B = 26dB emissions bandwidth).	PASSED	5.18 GHz = 16.58dBm (45.54mW) 5.20 GHz = 16.66dBm (46.38mW) 5.24 GHz = 16.47dBm (44.40mW)
15.407(a)(1)	The peak power spectral density shall not exceed 4dBm in any 1MHz band.	PASSED	5.18 GHz = -7.49dBm 5.20 GHz = -7.57dBm 5.24 GHz = -8.33dBm
15.407(a)(1)	Peak transmit power and the peak power spectral density shall be reduced by the amount in dB that the transmitting antenna exceeds 6dBi.	N/A	All antennas tested have less than 6dBi antenna gain (Please see the antenna data sheets)
15.407(b)(6) 15.209	Unwanted emissions below 1 GHz must comply with the general field strength limits set forth in Section 15.209.	PASSED	See FCC 15.247 report (INTEL-080114F)
15.407(b)(1)	All emissions outside of the 5.15-5.35 GHz band shall not exceed an EIRP of -27dBm/MHz.	PASSED	See Data Sheets
Operation in the 5.25-5.35 GHz Band			
15.407(a)(2)	26dB emissions bandwidth in MHz.	N/A	5.26 GHz = 22.75 MHz 5.28 GHz = 23.08 MHz 5.32 GHz = 23.17 MHz
15.407(a)(2)	Peak transmit power shall not exceed the lesser of 250mW or 11dBm+10logB (where B = 26dB emissions bandwidth).	PASSED	5.26 GHz = 16.61dBm (45.85mW) 5.28 GHz = 16.72dBm (47.03mW) 5.32 GHz = 16.42dBm (43.89mW)
15.407(a)(2)	The peak power spectral density shall not exceed 11dBm in any 1MHz band.	PASSED	5.26 GHz = -8.02dBm 5.28 GHz = -8.09dBm 5.32 GHz = -6.99dBm
15.407(a)(2)	Peak transmit power and the peak power spectral density shall be reduced by the amount in dB that the transmitting antenna exceeds 6dBi.	N/A	All antennas tested have less than 6dBi antenna gain (Please see the antenna data sheets)
15.407(b)(6) 15.209	Unwanted emissions below 1 GHz must comply with the general field strength limits set forth in Section 15.209.	PASSED	See FCC 15.247 report (INTEL-080114F)
15.407(b)(2)	All emissions outside of the 5.15-5.35 GHz band shall not exceed an EIRP of -27dBm/MHz. Must meet all applicable technical requirements for operating in the 5.15-5.25 GHz band.	PASSED	See Data Sheets
General Requirements For All Bands			
15.407(a)(6)	The ratio of the peak excursion of the modulation envelope to the peak transmit power shall not exceed 13dB across any 1 MHz bandwidth or the emissions bandwidth whichever is less.	PASSED	5.18 GHz = 4.95 dB 5.20 GHz = 4.81 dB 5.24 GHz = 4.77 dB 5.26 GHz = 4.70 dB 5.28 GHz = 4.73 dB 5.32 GHz = 4.90 dB
15.407(f)	Radio frequency radiation exposure requirement.	PASSED	Refer to MPE Calculations
15.407(b)(6) 15.207	UNII devices using AC power line are required to comply with the conducted limits set forth in Section 15.207.	PASSED	See FCC 15.247 report (INTEL-080114F)



2.0 Summary Of Test Results (Continued)

802.11a Mode (5150-5350 MHz) Chain C

EMISSIONS STANDARD			
FCC Part 15 Section	Description	Results	Comments
Operation in the 5.15-5.25 GHz Band			
15.407(d)	Any UNII device shall use a transmitting antenna that is an integral part of the device.	PASSED	The antenna will be integral when installed in a notebook computer
15.407(e)	UNII devices will be restricted to indoor operations.	PASSED	Refer to "User's Manual" Exhibit
15.407(a)(1)	26dB emissions bandwidth in MHz.	N/A	5.18 GHz = 22.33 MHz 5.20 GHz = 22.33 MHz 5.24 GHz = 21.58 MHz
15.407(a)(1)	Peak transmit power shall not exceed the lesser of 50mW or 4dBm+10logB (where B = 26dB emissions bandwidth).	PASSED	5.18 GHz = 16.33dBm (42.99mW) 5.20 GHz = 16.75dBm (47.35mW) 5.24 GHz = 16.69dBm (46.71mW)
15.407(a)(1)	The peak power spectral density shall not exceed 4dBm in any 1MHz band.	PASSED	5.18 GHz = -7.095dBm 5.20 GHz = -6.194dBm 5.24 GHz = -6.804dBm
15.407(a)(1)	Peak transmit power and the peak power spectral density shall be reduced by the amount in dB that the transmitting antenna exceeds 6dBi.	N/A	All antennas tested have less than 6dBi antenna gain (Please see the antenna data sheets)
15.407(b)(6) 15.209	Unwanted emissions below 1 GHz must comply with the general field strength limits set forth in Section 15.209.	PASSED	See FCC 15.247 report (INTEL-080114F)
15.407(b)(1)	All emissions outside of the 5.15-5.35 GHz band shall not exceed an EIRP of -27dBm/MHz.	PASSED	See Data Sheets
Operation in the 5.25-5.35 GHz Band			
15.407(a)(2)	26dB emissions bandwidth in MHz.	N/A	5.26 GHz = 21.67 MHz 5.28 GHz = 22.50 MHz 5.32 GHz = 22.08 MHz
15.407(a)(2)	Peak transmit power shall not exceed the lesser of 250mW or 11dBm+10logB (where B = 26dB emissions bandwidth).	PASSED	5.26 GHz = 16.42dBm (43.89mW) 5.28 GHz = 16.71dBm (46.92mW) 5.32 GHz = 16.73dBm (47.14mW)
15.407(a)(2)	The peak power spectral density shall not exceed 11dBm in any 1MHz band.	PASSED	5.26 GHz = -7.613dBm 5.28 GHz = -6.992dBm 5.32 GHz = -6.768dBm
15.407(a)(2)	Peak transmit power and the peak power spectral density shall be reduced by the amount in dB that the transmitting antenna exceeds 6dBi.	N/A	All antennas tested have less than 6dBi antenna gain (Please see the antenna data sheets)
15.407(b)(6) 15.209	Unwanted emissions below 1 GHz must comply with the general field strength limits set forth in Section 15.209.	PASSED	See FCC 15.247 report (INTEL-080114F)
15.407(b)(2)	All emissions outside of the 5.15-5.35 GHz band shall not exceed an EIRP of -27dBm/MHz. Must meet all applicable technical requirements for operating in the 5.15-5.25 GHz band.	PASSED	See Data Sheets
General Requirements For All Bands			
15.407(a)(6)	The ratio of the peak excursion of the modulation envelope to the peak transmit power shall not exceed 13dB across any 1 MHz bandwidth or the emissions bandwidth whichever is less.	PASSED	5.18 GHz = 4.79 dB 5.20 GHz = 4.71 dB 5.24 GHz = 4.44 dB 5.26 GHz = 4.43 dB 5.28 GHz = 4.51 dB 5.32 GHz = 4.65 dB
15.407(f)	Radio frequency radiation exposure requirement.	PASSED	Refer to MPE Calculations
15.407(b)(6) 15.207	UNII devices using AC power line are required to comply with the conducted limits set forth in Section 15.207.	PASSED	See FCC 15.247 report (INTEL-080114F)



2.0 Summary Of Test Results (Continued)

802.11n Mode 20MHz Wide (5150-5350 MHz) Chain A

EMISSIONS STANDARD			
FCC Part 15 Section	Description	Results	Comments
Operation in the 5.15-5.25 GHz Band			
15.407(d)	Any UNII device shall use a transmitting antenna that is an integral part of the device.	PASSED	The antenna will be integral when installed in a notebook computer
15.407(e)	UNII devices will be restricted to indoor operations.	PASSED	Refer to "User's Manual" Exhibit
15.407(a)(1)	26dB emissions bandwidth in MHz.	N/A	5.18 GHz = 22.33 MHz 5.20 GHz = 23.33 MHz 5.24 GHz = 23.33 MHz
15.407(a)(1)	Peak transmit power shall not exceed the lesser of 50mW or 4dBm+10logB (where B = 26dB emissions bandwidth).	PASSED	5.18 GHz = 16.62dBm (45.96mW) 5.20 GHz = 16.54dBm (45.12mW) 5.24 GHz = 16.69dBm (46.71mW)
15.407(a)(1)	The peak power spectral density shall not exceed 4dBm in any 1MHz band.	PASSED	5.18 GHz = -7.220dBm 5.20 GHz = -7.951dBm 5.24 GHz = -7.750dBm
15.407(a)(1)	Peak transmit power and the peak power spectral density shall be reduced by the amount in dB that the transmitting antenna exceeds 6dBi.	N/A	All antennas tested have less than 6dBi antenna gain (Please see the antenna data sheets)
15.407(b)(6) 15.209	Unwanted emissions below 1 GHz must comply with the general field strength limits set forth in Section 15.209.	PASSED	See FCC 15.247 report (INTEL-080114F)
15.407(b)(1)	All emissions outside of the 5.15-5.35 GHz band shall not exceed an EIRP of -27dBm/MHz.	PASSED	See Data Sheets
Operation in the 5.25-5.35 GHz Band			
15.407(a)(2)	26dB emissions bandwidth in MHz.	N/A	5.26 GHz = 22.33 MHz 5.28 GHz = 24.33 MHz 5.32 GHz = 22.83 MHz
15.407(a)(2)	Peak transmit power shall not exceed the lesser of 250mW or 11dBm+10logB (where B = 26dB emissions bandwidth).	PASSED	5.26 GHz = 16.43dBm (43.99mW) 5.28 GHz = 16.57dBm (45.43mW) 5.32 GHz = 16.81dBm (48.01mW)
15.407(a)(2)	The peak power spectral density shall not exceed 11dBm in any 1MHz band.	PASSED	5.26 GHz = -8.238dBm 5.28 GHz = -8.063dBm 5.32 GHz = -7.936dBm
15.407(a)(2)	Peak transmit power and the peak power spectral density shall be reduced by the amount in dB that the transmitting antenna exceeds 6dBi.	N/A	All antennas tested have less than 6dBi antenna gain (Please see the antenna data sheets)
15.407(b)(6) 15.209	Unwanted emissions below 1 GHz must comply with the general field strength limits set forth in Section 15.209.	PASSED	See FCC 15.247 report (INTEL-080114F)
15.407(b)(2)	All emissions outside of the 5.15-5.35 GHz band shall not exceed an EIRP of -27dBm/MHz. Must meet all applicable technical requirements for operating in the 5.15-5.25 GHz band.	PASSED	See Data Sheets
General Requirements For All Bands			
15.407(a)(6)	The ratio of the peak excursion of the modulation envelope to the peak transmit power shall not exceed 13dB across any 1 MHz bandwidth or the emissions bandwidth whichever is less.	PASSED	5.18 GHz = 5.04 dB 5.20 GHz = 4.84 dB 5.24 GHz = 4.77 dB 5.26 GHz = 4.76 dB 5.28 GHz = 4.67 dB 5.32 GHz = 4.94 dB
15.407(f)	Radio frequency radiation exposure requirement.	PASSED	Refer to MPE Calculations
15.407(b)(6) 15.207	UNII devices using AC power line are required to comply with the conducted limits set forth in Section 15.207.	PASSED	See FCC 15.247 report (INTEL-080114F)



2.0 Summary Of Test Results (Continued)

802.11n Mode 20MHz Wide (5150-5350 MHz) Chain B

EMISSIONS STANDARD			
FCC Part 15 Section	Description	Results	Comments
Operation in the 5.15-5.25 GHz Band			
15.407(d)	Any UNII device shall use a transmitting antenna that is an integral part of the device.	PASSED	The antenna will be integral when installed in a notebook computer
15.407(e)	UNII devices will be restricted to indoor operations.	PASSED	Refer to "User's Manual" Exhibit
15.407(a)(1)	26dB emissions bandwidth in MHz.	N/A	5.18 GHz = 23.33 MHz 5.20 GHz = 22.17 MHz 5.24 GHz = 24.92 MHz
15.407(a)(1)	Peak transmit power shall not exceed the lesser of 50mW or 4dBm+10logB (where B = 26dB emissions bandwidth).	PASSED	5.18 GHz = 16.52dBm (44.91mW) 5.20 GHz = 16.60dBm (45.75mW) 5.24 GHz = 16.79dBm (47.79mW)
15.407(a)(1)	The peak power spectral density shall not exceed 4dBm in any 1MHz band.	PASSED	5.18 GHz = -6.946dBm 5.20 GHz = -6.755dBm 5.24 GHz = -7.260dBm
15.407(a)(1)	Peak transmit power and the peak power spectral density shall be reduced by the amount in dB that the transmitting antenna exceeds 6dBi.	N/A	All antennas tested have less than 6dBi antenna gain (Please see the antenna data sheets)
15.407(b)(6) 15.209	Unwanted emissions below 1 GHz must comply with the general field strength limits set forth in Section 15.209.	PASSED	See FCC 15.247 report (INTEL-080114F)
15.407(b)(1)	All emissions outside of the 5.15-5.35 GHz band shall not exceed an EIRP of -27dBm/MHz.	PASSED	See Data Sheets
Operation in the 5.25-5.35 GHz Band			
15.407(a)(2)	26dB emissions bandwidth in MHz.	N/A	5.26 GHz = 23.67 MHz 5.28 GHz = 23.17 MHz 5.32 GHz = 24.25 MHz
15.407(a)(2)	Peak transmit power shall not exceed the lesser of 250mW or 11dBm+10logB (where B = 26dB emissions bandwidth).	PASSED	5.26 GHz = 16.48dBm (44.50mW) 5.28 GHz = 16.64dBm (46.17mW) 5.32 GHz = 16.36dBm (43.29mW)
15.407(a)(2)	The peak power spectral density shall not exceed 11dBm in any 1MHz band.	PASSED	5.26 GHz = -7.298dBm 5.28 GHz = -7.192dBm 5.32 GHz = -7.914dBm
15.407(a)(2)	Peak transmit power and the peak power spectral density shall be reduced by the amount in dB that the transmitting antenna exceeds 6dBi.	N/A	All antennas tested have less than 6dBi antenna gain (Please see the antenna data sheets)
15.407(b)(6) 15.209	Unwanted emissions below 1 GHz must comply with the general field strength limits set forth in Section 15.209.	PASSED	See FCC 15.247 report (INTEL-080114F)
15.407(b)(2)	All emissions outside of the 5.15-5.35 GHz band shall not exceed an EIRP of -27dBm/MHz. Must meet all applicable technical requirements for operating in the 5.15-5.25 GHz band.	PASSED	See Data Sheets
General Requirements For All Bands			
15.407(a)(6)	The ratio of the peak excursion of the modulation envelope to the peak transmit power shall not exceed 13dB across any 1 MHz bandwidth or the emissions bandwidth whichever is less.	PASSED	5.18 GHz = 4.71 dB 5.20 GHz = 4.70 dB 5.24 GHz = 4.55 dB 5.26 GHz = 4.71 dB 5.28 GHz = 4.81 dB 5.32 GHz = 6.04 dB
15.407(f)	Radio frequency radiation exposure requirement.	PASSED	Refer to MPE Calculations
15.407(b)(6) 15.207	UNII devices using AC power line are required to comply with the conducted limits set forth in Section 15.207.	PASSED	See FCC 15.247 report (INTEL-080114F)



2.0 Summary Of Test Results (Continued)

802.11n Mode 20MHz Wide (5150-5350 MHz) Chain C

EMISSIONS STANDARD			
FCC Part 15 Section	Description	Results	Comments
Operation in the 5.15-5.25 GHz Band			
15.407(d)	Any UNII device shall use a transmitting antenna that is an integral part of the device.	PASSED	The antenna will be integral when installed in a notebook computer
15.407(e)	UNII devices will be restricted to indoor operations.	PASSED	Refer to "User's Manual" Exhibit
15.407(a)(1)	26dB emissions bandwidth in MHz.	N/A	5.18 GHz = 21.83 MHz 5.20 GHz = 22.00 MHz 5.24 GHz = 22.08 MHz
15.407(a)(1)	Peak transmit power shall not exceed the lesser of 50mW or 4dBm+10logB (where B = 26dB emissions bandwidth).	PASSED	5.18 GHz = 16.74dBm (47.25mW) 5.20 GHz = 16.74dBm (47.25mW) 5.24 GHz = 16.62dBm (45.96mW)
15.407(a)(1)	The peak power spectral density shall not exceed 4dBm in any 1MHz band.	PASSED	5.18 GHz = -6.406dBm 5.20 GHz = -6.943dBm 5.24 GHz = -7.355dBm
15.407(a)(1)	Peak transmit power and the peak power spectral density shall be reduced by the amount in dB that the transmitting antenna exceeds 6dBi.	N/A	All antennas tested have less than 6dBi antenna gain (Please see the antenna data sheets)
15.407(b)(6) 15.209	Unwanted emissions below 1 GHz must comply with the general field strength limits set forth in Section 15.209.	PASSED	See FCC 15.247 report (INTEL-080114F)
15.407(b)(1)	All emissions outside of the 5.15-5.35 GHz band shall not exceed an EIRP of -27dBm/MHz.	PASSED	See Data Sheets
Operation in the 5.25-5.35 GHz Band			
15.407(a)(2)	26dB emissions bandwidth in MHz.	N/A	5.26 GHz = 21.75 MHz 5.28 GHz = 22.25 MHz 5.32 GHz = 21.67 MHz
15.407(a)(2)	Peak transmit power shall not exceed the lesser of 250mW or 11dBm+10logB (where B = 26dB emissions bandwidth).	PASSED	5.26 GHz = 16.34dBm (43.09mW) 5.28 GHz = 16.63dBm (46.06mW) 5.32 GHz = 16.64dBm (46.17mW)
15.407(a)(2)	The peak power spectral density shall not exceed 11dBm in any 1MHz band.	PASSED	5.26 GHz = -7.742dBm 5.28 GHz = -7.045dBm 5.32 GHz = -7.069dBm
15.407(a)(2)	Peak transmit power and the peak power spectral density shall be reduced by the amount in dB that the transmitting antenna exceeds 6dBi.	N/A	All antennas tested have less than 6dBi antenna gain (Please see the antenna data sheets)
15.407(b)(6) 15.209	Unwanted emissions below 1 GHz must comply with the general field strength limits set forth in Section 15.209.	PASSED	See FCC 15.247 report (INTEL-080114F)
15.407(b)(2)	All emissions outside of the 5.15-5.35 GHz band shall not exceed an EIRP of -27dBm/MHz. Must meet all applicable technical requirements for operating in the 5.15-5.25 GHz band.	PASSED	See Data Sheets
General Requirements For All Bands			
15.407(a)(6)	The ratio of the peak excursion of the modulation envelope to the peak transmit power shall not exceed 13dB across any 1 MHz bandwidth or the emissions bandwidth whichever is less.	PASSED	5.18 GHz = 4.48 dB 5.20 GHz = 4.96 dB 5.24 GHz = 4.84 dB 5.26 GHz = 4.92 dB 5.28 GHz = 4.99 dB 5.32 GHz = 4.74 dB
15.407(f)	Radio frequency radiation exposure requirement.	PASSED	Refer to MPE Calculations
15.407(b)(6) 15.207	UNII devices using AC power line are required to comply with the conducted limits set forth in Section 15.207.	PASSED	See FCC 15.247 report (INTEL-080114F)



2.0 Summary Of Test Results (Continued)

802.11n Mode 40MHz Wide (5150-5350 MHz) Chain A

EMISSIONS STANDARD			
FCC Part 15 Section	Description	Results	Comments
Operation in the 5.15-5.25 GHz Band			
15.407(d)	Any UNII device shall use a transmitting antenna that is an integral part of the device.	PASSED	The antenna will be integral when installed in a notebook computer
15.407(e)	UNII devices will be restricted to indoor operations.	PASSED	Refer to "User's Manual" Exhibit
15.407(a)(1)	26dB emissions bandwidth in MHz.	N/A	5.19 GHz = 40.67 MHz 5.23 GHz = 40.08 MHz
15.407(a)(1)	Peak transmit power shall not exceed the lesser of 50mW or 4dBm+10logB (where B = 26dB emissions bandwidth).	PASSED	5.19 GHz = 16.19dBm (41.57mW) 5.23 GHz = 16.29dBm (42.54mW)
15.407(a)(1)	The peak power spectral density shall not exceed 4dBm in any 1MHz band.	PASSED	5.19 GHz = -10.224dBm 5.23 GHz = -11.075dBm
15.407(a)(1)	Peak transmit power and the peak power spectral density shall be reduced by the amount in dB that the transmitting antenna exceeds 6dBi.	N/A	All antennas tested have less than 6dBi antenna gain (Please see the antenna data sheets)
15.407(b)(6) 15.209	Unwanted emissions below 1 GHz must comply with the general field strength limits set forth in Section 15.209.	PASSED	See FCC 15.247 report (INTEL-080114F)
15.407(b)(1)	All emissions outside of the 5.15-5.35 GHz band shall not exceed an EIRP of -27dBm/MHz.	PASSED	See Data Sheets
Operation in the 5.25-5.35 GHz Band			
15.407(a)(2)	26dB emissions bandwidth in MHz.	N/A	5.27 GHz = 39.92 MHz 5.31 GHz = 42.67 MHz
15.407(a)(2)	Peak transmit power shall not exceed the lesser of 250mW or 11dBm+10logB (where B = 26dB emissions bandwidth).	PASSED	5.27 GHz = 16.39dBm (43.53mW) 5.31 GHz = 16.29dBm (42.54mW)
15.407(a)(2)	The peak power spectral density shall not exceed 11dBm in any 1MHz band.	PASSED	5.27 GHz = -12.056dBm 5.31 GHz = -10.857dBm
15.407(a)(2)	Peak transmit power and the peak power spectral density shall be reduced by the amount in dB that the transmitting antenna exceeds 6dBi.	N/A	All antennas tested have less than 6dBi antenna gain (Please see the antenna data sheets)
15.407(b)(6) 15.209	Unwanted emissions below 1 GHz must comply with the general field strength limits set forth in Section 15.209.	PASSED	See FCC 15.247 report (INTEL-080114F)
15.407(b)(2)	All emissions outside of the 5.15-5.35 GHz band shall not exceed an EIRP of -27dBm/MHz. Must meet all applicable technical requirements for operating in the 5.15-5.25 GHz band.	PASSED	See Data Sheets
General Requirements For All Bands			
15.407(a)(6)	The ratio of the peak excursion of the modulation envelope to the peak transmit power shall not exceed 13dB across any 1 MHz bandwidth or the emissions bandwidth whichever is less.	PASSED	5.19 GHz = 4.81 dB 5.23 GHz = 4.80 dB 5.27 GHz = 4.64 dB 5.31 GHz = 4.75 dB
15.407(f)	Radio frequency radiation exposure requirement.	PASSED	Refer to MPE Calculations
15.407(b)(6) 15.207	UNII devices using AC power line are required to comply with the conducted limits set forth in Section 15.207.	PASSED	See FCC 15.247 report (INTEL-080114F)



2.0 Summary Of Test Results (Continued)

802.11n Mode 40MHz Wide (5150-5350 MHz) Chain B

EMISSIONS STANDARD			
FCC Part 15 Section	Description	Results	Comments
Operation in the 5.15-5.25 GHz Band			
15.407(d)	Any UNII device shall use a transmitting antenna that is an integral part of the device.	PASSED	The antenna will be integral when installed in a notebook computer
15.407(e)	UNII devices will be restricted to indoor operations.	PASSED	Refer to "User's Manual" Exhibit
15.407(a)(1)	26dB emissions bandwidth in MHz.	N/A	5.19 GHz = 41.08 MHz 5.23 GHz = 40.08 MHz
15.407(a)(1)	Peak transmit power shall not exceed the lesser of 50mW or 4dBm+10logB (where B = 26dB emissions bandwidth).	PASSED	5.19 GHz = 16.19dBm (41.57mW) 5.23 GHz = 15.99dBm (39.70mW)
15.407(a)(1)	The peak power spectral density shall not exceed 4dBm in any 1MHz band.	PASSED	5.19 GHz = -8.740dBm 5.23 GHz = -9.666dBm
15.407(a)(1)	Peak transmit power and the peak power spectral density shall be reduced by the amount in dB that the transmitting antenna exceeds 6dBi.	N/A	All antennas tested have less than 6dBi antenna gain (Please see the antenna data sheets)
15.407(b)(6) 15.209	Unwanted emissions below 1 GHz must comply with the general field strength limits set forth in Section 15.209.	PASSED	See FCC 15.247 report (INTEL-080114F)
15.407(b)(1)	All emissions outside of the 5.15-5.35 GHz band shall not exceed an EIRP of -27dBm/MHz.	PASSED	See Data Sheets
Operation in the 5.25-5.35 GHz Band			
15.407(a)(2)	26dB emissions bandwidth in MHz.	N/A	5.27 GHz = 39.75 MHz 5.31 GHz = 40.08 MHz
15.407(a)(2)	Peak transmit power shall not exceed the lesser of 250mW or 11dBm+10logB (where B = 26dB emissions bandwidth).	PASSED	5.27 GHz = 15.99dBm (39.70mW) 5.31 GHz = 16.19dBm (41.57mW)
15.407(a)(2)	The peak power spectral density shall not exceed 11dBm in any 1MHz band.	PASSED	5.27 GHz = -10.617dBm 5.31 GHz = -9.493dBm
15.407(a)(2)	Peak transmit power and the peak power spectral density shall be reduced by the amount in dB that the transmitting antenna exceeds 6dBi.	N/A	All antennas tested have less than 6dBi antenna gain (Please see the antenna data sheets)
15.407(b)(6) 15.209	Unwanted emissions below 1 GHz must comply with the general field strength limits set forth in Section 15.209.	PASSED	See FCC 15.247 report (INTEL-080114F)
15.407(b)(2)	All emissions outside of the 5.15-5.35 GHz band shall not exceed an EIRP of -27dBm/MHz. Must meet all applicable technical requirements for operating in the 5.15-5.25 GHz band.	PASSED	See Data Sheets
General Requirements For All Bands			
15.407(a)(6)	The ratio of the peak excursion of the modulation envelope to the peak transmit power shall not exceed 13dB across any 1 MHz bandwidth or the emissions bandwidth whichever is less.	PASSED	5.19 GHz = 4.37 dB 5.23 GHz = 4.37 dB 5.27 GHz = 4.89 dB 5.31 GHz = 4.94 dB
15.407(f)	Radio frequency radiation exposure requirement.	PASSED	Refer to MPE Calculations
15.407(b)(6) 15.207	UNII devices using AC power line are required to comply with the conducted limits set forth in Section 15.207.	PASSED	See FCC 15.247 report (INTEL-080114F)



2.0 Summary Of Test Results (Continued)

802.11n Mode 40MHz Wide (5150-5350 MHz) Chain C

EMISSIONS STANDARD			
FCC Part 15 Section	Description	Results	Comments
Operation in the 5.15-5.25 GHz Band			
15.407(d)	Any UNII device shall use a transmitting antenna that is an integral part of the device.	PASSED	The antenna will be integral when installed in a notebook computer
15.407(e)	UNII devices will be restricted to indoor operations.	PASSED	Refer to "User's Manual" Exhibit
15.407(a)(1)	26dB emissions bandwidth in MHz.	N/A	5.19 GHz = 39.83 MHz 5.23 GHz = 40.25 MHz
15.407(a)(1)	Peak transmit power shall not exceed the lesser of 50mW or 4dBm+10logB (where B = 26dB emissions bandwidth).	PASSED	5.19 GHz = 16.09dBm (40.62mW) 5.23 GHz = 16.29dBm (42.54mW)
15.407(a)(1)	The peak power spectral density shall not exceed 4dBm in any 1MHz band.	PASSED	5.19 GHz = -8.916dBm 5.23 GHz = -9.610dBm
15.407(a)(1)	Peak transmit power and the peak power spectral density shall be reduced by the amount in dB that the transmitting antenna exceeds 6dBi.	N/A	All antennas tested have less than 6dBi antenna gain (Please see the antenna data sheets)
15.407(b)(6) 15.209	Unwanted emissions below 1 GHz must comply with the general field strength limits set forth in Section 15.209.	PASSED	See FCC 15.247 report (INTEL-080114F)
15.407(b)(1)	All emissions outside of the 5.15-5.35 GHz band shall not exceed an EIRP of -27dBm/MHz.	PASSED	See Data Sheets
Operation in the 5.25-5.35 GHz Band			
15.407(a)(2)	26dB emissions bandwidth in MHz.	N/A	5.27 GHz = 39.67 MHz 5.31 GHz = 39.50 MHz
15.407(a)(2)	Peak transmit power shall not exceed the lesser of 250mW or 11dBm+10logB (where B = 26dB emissions bandwidth).	PASSED	5.27 GHz = 16.19dBm (41.57mW) 5.31 GHz = 16.09dBm (40.62mW)
15.407(a)(2)	The peak power spectral density shall not exceed 11dBm in any 1MHz band.	PASSED	5.27 GHz = -10.175dBm 5.31 GHz = -10.585dBm
15.407(a)(2)	Peak transmit power and the peak power spectral density shall be reduced by the amount in dB that the transmitting antenna exceeds 6dBi.	N/A	All antennas tested have less than 6dBi antenna gain (Please see the antenna data sheets)
15.407(b)(6) 15.209	Unwanted emissions below 1 GHz must comply with the general field strength limits set forth in Section 15.209.	PASSED	See FCC 15.247 report (INTEL-080114F)
15.407(b)(2)	All emissions outside of the 5.15-5.35 GHz band shall not exceed an EIRP of -27dBm/MHz. Must meet all applicable technical requirements for operating in the 5.15-5.25 GHz band.	PASSED	See Data Sheets
General Requirements For All Bands			
15.407(a)(6)	The ratio of the peak excursion of the modulation envelope to the peak transmit power shall not exceed 13dB across any 1 MHz bandwidth or the emissions bandwidth whichever is less.	PASSED	5.19 GHz = 4.83 dB 5.23 GHz = 4.72 dB 5.27 GHz = 4.89 dB 5.31 GHz = 4.48 dB
15.407(f)	Radio frequency radiation exposure requirement.	PASSED	Refer to MPE Calculations
15.407(b)(6) 15.207	UNII devices using AC power line are required to comply with the conducted limits set forth in Section 15.207.	PASSED	See FCC 15.247 report (INTEL-080114F)



2.0 Summary Of Test Results (Continued)

802.11a Mode (5470-5725 MHz) Chain A

EMISSIONS STANDARD			
FCC Part 15 Section	Description	Results	Comments
15.407(a)(2)	26dB emissions bandwidth in MHz.	N/A	5.50 GHz = 23.75 MHz 5.60 GHz = 22.25 MHz 5.70 GHz = 22.33 MHz
15.407(a)(2)	Peak transmit power shall not exceed the lesser of 250mW or 11dBm+10logB (where B = 26dB emissions bandwidth).	PASSED	5.50 GHz = 16.39dBm (43.59mW) 5.60 GHz = 16.64dBm (46.17mW) 5.70 GHz = 16.37dBm (43.39mW)
15.407(a)(2)	The peak power spectral density shall not exceed 11dBm in any 1MHz band.	PASSED	5.50 GHz = -7.985dBm 5.60 GHz = -6.873dBm 5.70 GHz = -6.134dBm
15.407(a)(2)	Peak transmit power and the peak power spectral density shall be reduced by the amount in dB that the transmitting antenna exceeds 6dBi.	N/A	All antennas tested have less than 6dBi antenna gain (Please see the antenna data sheets)
15.407(b)(6) 15.209	Unwanted emissions below 1 GHz must comply with the general field strength limits set forth in Section 15.209.	PASSED	See FCC 15.247 report (INTEL-080114F)
15.407(b)(3)	For transmitters operating in the 5.47-5.725 GHz band: all emissions outside of the 5.47-5.725 GHz band shall not exceed an EIRP of -27dBm/MHz.	PASSED	See Data Sheets
General Requirements For All Bands			
15.407(a)(6)	The ratio of the peak excursion of the modulation envelope to the peak transmit power shall not exceed 13dB across any 1 MHz bandwidth or the emissions bandwidth whichever is less.	PASSED	5.50 GHz = 5.48 dB 5.60 GHz = 4.89 dB 5.70 GHz = 4.40 dB
15.407(f)	Radio frequency radiation exposure requirement.	PASSED	Refer to MPE Calculations
15.407(b)(6) 15.207	UNII devices using AC power line are required to comply with the conducted limits set forth in Section 15.207.	PASSED	See FCC 15.247 report (INTEL-080114F)



2.0 Summary Of Test Results (Continued)

802.11a Mode (5470-5725 MHz) Chain B

EMISSIONS STANDARD			
FCC Part 15 Section	Description	Results	Comments
15.407(a)(2)	26dB emissions bandwidth in MHz.	N/A	5.50 GHz = 22.58 MHz 5.60 GHz = 24.08 MHz 5.70 GHz = 24.08 MHz
15.407(a)(2)	Peak transmit power shall not exceed the lesser of 250mW or 11dBm+10logB (where B = 26dB emissions bandwidth).	PASSED	5.50 GHz = 16.77dBm (47.57mW) 5.60 GHz = 16.52dBm (44.91mW) 5.70 GHz = 16.52dBm (44.91mW)
15.407(a)(2)	The peak power spectral density shall not exceed 11dBm in any 1MHz band.	PASSED	5.50 GHz = -5.819dBm 5.60 GHz = -5.043dBm 5.70 GHz = -4.034dBm
15.407(a)(2)	Peak transmit power and the peak power spectral density shall be reduced by the amount in dB that the transmitting antenna exceeds 6dBi.	N/A	All antennas tested have less than 6dBi antenna gain (Please see the antenna data sheets)
15.407(b)(6) 15.209	Unwanted emissions below 1 GHz must comply with the general field strength limits set forth in Section 15.209.	PASSED	See FCC 15.247 report (INTEL-080114F)
15.407(b)(3)	For transmitters operating in the 5.47-5.725 GHz band: all emissions outside of the 5.47-5.725 GHz band shall not exceed an EIRP of -27dBm/MHz.	PASSED	See Data Sheets
General Requirements For All Bands			
15.407(a)(6)	The ratio of the peak excursion of the modulation envelope to the peak transmit power shall not exceed 13dB across any 1 MHz bandwidth or the emissions bandwidth whichever is less.	PASSED	5.50 GHz = 4.93 dB 5.60 GHz = 4.64 dB 5.70 GHz = 4.85 dB
15.407(f)	Radio frequency radiation exposure requirement.	PASSED	Refer to MPE Calculations
15.407(b)(6) 15.207	UNII devices using AC power line are required to comply with the conducted limits set forth in Section 15.207.	PASSED	See FCC 15.247 report (INTEL-080114F)



2.0 Summary Of Test Results (Continued)

802.11a Mode (5470-5725 MHz) Chain C

EMISSIONS STANDARD			
FCC Part 15 Section	Description	Results	Comments
15.407(a)(2)	26dB emissions bandwidth in MHz.	N/A	5.50 GHz = 21.33 MHz 5.60 GHz = 21.00 MHz 5.70 GHz = 21.58 MHz
15.407(a)(2)	Peak transmit power shall not exceed the lesser of 250mW or 11dBm+10logB (where B = 26dB emissions bandwidth).	PASSED	5.50 GHz = 16.78dBm (47.68mW) 5.60 GHz = 16.74dBm (47.25mW) 5.70 GHz = 16.83dBm (48.24mW)
15.407(a)(2)	The peak power spectral density shall not exceed 11dBm in any 1MHz band.	PASSED	5.50 GHz = -6.271dBm 5.60 GHz = -5.796dBm 5.70 GHz = -4.444dBm
15.407(a)(2)	Peak transmit power and the peak power spectral density shall be reduced by the amount in dB that the transmitting antenna exceeds 6dBi.	N/A	All antennas tested have less than 6dBi antenna gain (Please see the antenna data sheets)
15.407(b)(6) 15.209	Unwanted emissions below 1 GHz must comply with the general field strength limits set forth in Section 15.209.	PASSED	See FCC 15.247 report (INTEL-080114F)
15.407(b)(3)	For transmitters operating in the 5.47-5.725 GHz band: all emissions outside of the 5.47-5.725 GHz band shall not exceed an EIRP of -27dBm/MHz.	PASSED	See Data Sheets
General Requirements For All Bands			
15.407(a)(6)	The ratio of the peak excursion of the modulation envelope to the peak transmit power shall not exceed 13dB across any 1 MHz bandwidth or the emissions bandwidth whichever is less.	PASSED	5.50 GHz = 4.72 dB 5.60 GHz = 4.74 dB 5.70 GHz = 4.75 dB
15.407(f)	Radio frequency radiation exposure requirement.	PASSED	Refer to MPE Calculations
15.407(b)(6) 15.207	UNII devices using AC power line are required to comply with the conducted limits set forth in Section 15.207.	PASSED	See FCC 15.247 report (INTEL-080114F)



2.0 Summary Of Test Results (Continued)

802.11n Mode 20MHz Wide (5470-5725 MHz) Chain A

EMISSIONS STANDARD			
FCC Part 15 Section	Description	Results	Comments
15.407(a)(2)	26dB emissions bandwidth in MHz.	N/A	5.50 GHz = 22.25 MHz 5.60 GHz = 22.33 MHz 5.70 GHz = 22.17 MHz
15.407(a)(2)	Peak transmit power shall not exceed the lesser of 250mW or 11dBm+10logB (where B = 26dB emissions bandwidth).	PASSED	5.50 GHz = 16.74dBm (47.25mW) 5.60 GHz = 16.52dBm (44.91mW) 5.70 GHz = 16.61dBm (45.85mW)
15.407(a)(2)	The peak power spectral density shall not exceed 11dBm in any 1MHz band.	PASSED	5.50 GHz = -8.216dBm 5.60 GHz = -6.750dBm 5.70 GHz = -5.587dBm
15.407(a)(2)	Peak transmit power and the peak power spectral density shall be reduced by the amount in dB that the transmitting antenna exceeds 6dBi.	N/A	All antennas tested have less than 6dBi antenna gain (Please see the antenna data sheets)
15.407(b)(6) 15.209	Unwanted emissions below 1 GHz must comply with the general field strength limits set forth in Section 15.209.	PASSED	See FCC 15.247 report (INTEL-080114F)
15.407(b)(3)	For transmitters operating in the 5.47-5.725 GHz band: all emissions outside of the 5.47-5.725 GHz band shall not exceed an EIRP of -27dBm/MHz.	PASSED	See Data Sheets
General Requirements For All Bands			
15.407(a)(6)	The ratio of the peak excursion of the modulation envelope to the peak transmit power shall not exceed 13dB across any 1 MHz bandwidth or the emissions bandwidth whichever is less.	PASSED	5.50 GHz = 4.87 dB 5.60 GHz = 5.10 dB 5.70 GHz = 4.55 dB
15.407(f)	Radio frequency radiation exposure requirement.	PASSED	Refer to MPE Calculations
15.407(b)(6) 15.207	UNII devices using AC power line are required to comply with the conducted limits set forth in Section 15.207.	PASSED	See FCC 15.247 report (INTEL-080114F)



2.0 Summary Of Test Results (Continued)

802.11n Mode 20MHz Wide (5470-5725 MHz) Chain B

EMISSIONS STANDARD			
FCC Part 15 Section	Description	Results	Comments
15.407(a)(2)	26dB emissions bandwidth in MHz.	N/A	5.50 GHz = 22.75 MHz 5.60 GHz = 22.17 MHz 5.70 GHz = 24.17 MHz
15.407(a)(2)	Peak transmit power shall not exceed the lesser of 250mW or 11dBm+10logB (where B = 26dB emissions bandwidth).	PASSED	5.50 GHz = 16.73dBm (47.14mW) 5.60 GHz = 16.44dBm (44.09mW) 5.70 GHz = 16.44dBm (44.09mW)
15.407(a)(2)	The peak power spectral density shall not exceed 11dBm in any 1MHz band.	PASSED	5.50 GHz = -8.036dBm 5.60 GHz = -6.199dBm 5.70 GHz = -5.764dBm
15.407(a)(2)	Peak transmit power and the peak power spectral density shall be reduced by the amount in dB that the transmitting antenna exceeds 6dBi.	N/A	All antennas tested have less than 6dBi antenna gain (Please see the antenna data sheets)
15.407(b)(6) 15.209	Unwanted emissions below 1 GHz must comply with the general field strength limits set forth in Section 15.209.	PASSED	See FCC 15.247 report (INTEL-080114F)
15.407(b)(3)	For transmitters operating in the 5.47-5.725 GHz band: all emissions outside of the 5.47-5.725 GHz band shall not exceed an EIRP of -27dBm/MHz.	PASSED	See Data Sheets
General Requirements For All Bands			
15.407(a)(6)	The ratio of the peak excursion of the modulation envelope to the peak transmit power shall not exceed 13dB across any 1 MHz bandwidth or the emissions bandwidth whichever is less.	PASSED	5.50 GHz = 4.75 dB 5.60 GHz = 4.91 dB 5.70 GHz = 5.40 dB
15.407(f)	Radio frequency radiation exposure requirement.	PASSED	Refer to MPE Calculations
15.407(b)(6) 15.207	UNII devices using AC power line are required to comply with the conducted limits set forth in Section 15.207.	PASSED	See FCC 15.247 report (INTEL-080114F)



2.0 Summary Of Test Results (Continued)

802.11n Mode 20MHz Wide (5470-5725 MHz) Chain C

EMISSIONS STANDARD			
FCC Part 15 Section	Description	Results	Comments
15.407(a)(2)	26dB emissions bandwidth in MHz.	N/A	5.50 GHz = 22.00 MHz 5.60 GHz = 21.83 MHz 5.70 GHz = 21.42 MHz
15.407(a)(2)	Peak transmit power shall not exceed the lesser of 250mW or 11dBm+10logB (where B = 26dB emissions bandwidth).	PASSED	5.50 GHz = 16.73dBm (47.14mW) 5.60 GHz = 16.79dBm (47.79mW) 5.70 GHz = 16.74dBm (47.25mW)
15.407(a)(2)	The peak power spectral density shall not exceed 11dBm in any 1MHz band.	PASSED	5.50 GHz = -6.645dBm 5.60 GHz = -5.327dBm 5.70 GHz = -4.882dBm
15.407(a)(2)	Peak transmit power and the peak power spectral density shall be reduced by the amount in dB that the transmitting antenna exceeds 6dBi.	N/A	All antennas tested have less than 6dBi antenna gain (Please see the antenna data sheets)
15.407(b)(6) 15.209	Unwanted emissions below 1 GHz must comply with the general field strength limits set forth in Section 15.209.	PASSED	See FCC 15.247 report (INTEL-080114F)
15.407(b)(3)	For transmitters operating in the 5.47-5.725 GHz band: all emissions outside of the 5.47-5.725 GHz band shall not exceed an EIRP of -27dBm/MHz.	PASSED	See Data Sheets
General Requirements For All Bands			
15.407(a)(6)	The ratio of the peak excursion of the modulation envelope to the peak transmit power shall not exceed 13dB across any 1 MHz bandwidth or the emissions bandwidth whichever is less.	PASSED	5.50 GHz = 6.63 dB 5.60 GHz = 5.44 dB 5.70 GHz = 4.59 dB
15.407(f)	Radio frequency radiation exposure requirement.	PASSED	Refer to MPE Calculations
15.407(b)(6) 15.207	UNII devices using AC power line are required to comply with the conducted limits set forth in Section 15.207.	PASSED	See FCC 15.247 report (INTEL-080114F)



2.0 Summary Of Test Results (Continued)

802.11n Mode 40MHz Wide (5470-5725 MHz) Chain A

EMISSIONS STANDARD			
FCC Part 15 Section	Description	Results	Comments
15.407(a)(2)	26dB emissions bandwidth in MHz.	N/A	5.51 GHz = 40.17 MHz 5.59 GHz = 40.00 MHz 5.67 GHz = 40.00 MHz
15.407(a)(2)	Peak transmit power shall not exceed the lesser of 250mW or 11dBm+10logB (where B = 26dB emissions bandwidth).	PASSED	5.51 GHz = 16.19dBm (41.57mW) 5.59 GHz = 16.29dBm (42.54mW) 5.67 GHz = 16.09dBm (40.62mW)
15.407(a)(2)	The peak power spectral density shall not exceed 11dBm in any 1MHz band.	PASSED	5.51 GHz = -11.343dBm 5.59 GHz = -10.007dBm 5.67 GHz = -12.100dBm
15.407(a)(2)	Peak transmit power and the peak power spectral density shall be reduced by the amount in dB that the transmitting antenna exceeds 6dBi.	N/A	All antennas tested have less than 6dBi antenna gain (Please see the antenna data sheets)
15.407(b)(6) 15.209	Unwanted emissions below 1 GHz must comply with the general field strength limits set forth in Section 15.209.	PASSED	See FCC 15.247 report (INTEL-080114F)
15.407(b)(3)	For transmitters operating in the 5.47-5.725 GHz band: all emissions outside of the 5.47-5.725 GHz band shall not exceed an EIRP of -27dBm/MHz.	PASSED	See Data Sheets
General Requirements For All Bands			
15.407(a)(6)	The ratio of the peak excursion of the modulation envelope to the peak transmit power shall not exceed 13dB across any 1 MHz bandwidth or the emissions bandwidth whichever is less.	PASSED	5.51 GHz = 5.03 dB 5.59 GHz = 5.06 dB 5.67 GHz = 5.15 dB
15.407(f)	Radio frequency radiation exposure requirement.	PASSED	Refer to MPE Calculations
15.407(b)(6) 15.207	UNII devices using AC power line are required to comply with the conducted limits set forth in Section 15.207.	PASSED	See FCC 15.247 report (INTEL-080114F)



2.0 Summary Of Test Results (Continued)

802.11n Mode 40MHz Wide (5470-5725 MHz) Chain B

EMISSIONS STANDARD			
FCC Part 15 Section	Description	Results	Comments
15.407(a)(2)	26dB emissions bandwidth in MHz.	N/A	5.51 GHz = 40.08 MHz 5.59 GHz = 40.25 MHz 5.67 GHz = 40.00 MHz
15.407(a)(2)	Peak transmit power shall not exceed the lesser of 250mW or 11dBm+10logB (where B = 26dB emissions bandwidth).	PASSED	5.51 GHz = 16.39dBm (43.53mW) 5.59 GHz = 16.19dBm (41.57mW) 5.67 GHz = 15.89dBm (38.79mW)
15.407(a)(2)	The peak power spectral density shall not exceed 11dBm in any 1MHz band.	PASSED	5.51 GHz = -10.071dBm 5.59 GHz = -9.043dBm 5.67 GHz = -11.890dBm
15.407(a)(2)	Peak transmit power and the peak power spectral density shall be reduced by the amount in dB that the transmitting antenna exceeds 6dBi.	N/A	All antennas tested have less than 6dBi antenna gain (Please see the antenna data sheets)
15.407(b)(6) 15.209	Unwanted emissions below 1 GHz must comply with the general field strength limits set forth in Section 15.209.	PASSED	See FCC 15.247 report (INTEL-080114F)
15.407(b)(3)	For transmitters operating in the 5.47-5.725 GHz band: all emissions outside of the 5.47-5.725 GHz band shall not exceed an EIRP of -27dBm/MHz.	PASSED	See Data Sheets
General Requirements For All Bands			
15.407(a)(6)	The ratio of the peak excursion of the modulation envelope to the peak transmit power shall not exceed 13dB across any 1 MHz bandwidth or the emissions bandwidth whichever is less.	PASSED	5.51 GHz = 4.64 dB 5.59 GHz = 4.67 dB 5.67 GHz = 4.93 dB
15.407(f)	Radio frequency radiation exposure requirement.	PASSED	Refer to MPE Calculations
15.407(b)(6) 15.207	UNII devices using AC power line are required to comply with the conducted limits set forth in Section 15.207.	PASSED	See FCC 15.247 report (INTEL-080114F)



2.0 Summary Of Test Results (Continued)

802.11n Mode 40MHz Wide (5470-5725 MHz) Chain C

EMISSIONS STANDARD			
FCC Part 15 Section	Description	Results	Comments
15.407(a)(2)	26dB emissions bandwidth in MHz.	N/A	5.51 GHz = 39.67 MHz 5.59 GHz = 39.25 MHz 5.67 GHz = 39.58 MHz
15.407(a)(2)	Peak transmit power shall not exceed the lesser of 250mW or 11dBm+10logB (where B = 26dB emissions bandwidth).	PASSED	5.51 GHz = 15.89dBm (38.79mW) 5.59 GHz = 16.19dBm (41.57mW) 5.67 GHz = 16.09dBm (40.62mW)
15.407(a)(2)	The peak power spectral density shall not exceed 11dBm in any 1MHz band.	PASSED	5.51 GHz = -9.957dBm 5.59 GHz = -8.211dBm 5.67 GHz = -12.30dBm
15.407(a)(2)	Peak transmit power and the peak power spectral density shall be reduced by the amount in dB that the transmitting antenna exceeds 6dBi.	N/A	All antennas tested have less than 6dBi antenna gain (Please see the antenna data sheets)
15.407(b)(6) 15.209	Unwanted emissions below 1 GHz must comply with the general field strength limits set forth in Section 15.209.	PASSED	See FCC 15.247 report (INTEL-080114F)
15.407(b)(3)	For transmitters operating in the 5.47-5.725 GHz band: all emissions outside of the 5.47-5.725 GHz band shall not exceed an EIRP of -27dBm/MHz.	PASSED	See Data Sheets
General Requirements For All Bands			
15.407(a)(6)	The ratio of the peak excursion of the modulation envelope to the peak transmit power shall not exceed 13dB across any 1 MHz bandwidth or the emissions bandwidth whichever is less.	PASSED	5.51 GHz = 4.93 dB 5.59 GHz = 5.14 dB 5.67 GHz = 4.97 dB
15.407(f)	Radio frequency radiation exposure requirement.	PASSED	Refer to MPE Calculations
15.407(b)(6) 15.207	UNII devices using AC power line are required to comply with the conducted limits set forth in Section 15.207.	PASSED	See FCC 15.247 report (INTEL-080114F)

ANALYSIS AND CONCLUSIONS

Based upon the measurement results we find that this equipment is within the limits of the global standards listed on the cover page of this test report. All results are based on a test of one sample. If any significant changes are made to the unit, the changes shall be evaluated and a retest may be required.

Approval Signatories

Test and Report Completed By:

Johnny Candelas **04/07/08**
 Date:
 Test Technician
 Aegis Labs, Inc.

Report Approved By:

Rick Candelas **04/09/08**
 Date:
 Quality Assurance & EMC Lab Manager
 Aegis Labs, Inc.



3.0 ADMINISTRATIVE DATA AND TEST DESCRIPTION

DEVICE TESTED:	ITE Type: Intel WiFi/WiMax Link 5350 Model Number(s): 533ANXMMW Serial Number: 0016EB01A3A8 FCC ID: PD9533ANXM
DATE EUT RECEIVED:	January 16 th , 2008
TEST DATE(S):	January 16 th – April 2 nd , 2008
ORIGIN OF TEST SAMPLE(S):	Production
EQUIPMENT CLASS:	EUT tested as CLASS B device
RESPONSIBLE PARTY:	Intel Corporation 2111 NE 25 th Avenue Hillsboro, Oregon 97124
CLIENT CONTACT:	Ms. Marissa Faustino
MANUFACTURER:	Intel Corporation
TEST LOCATION:	Aegis Labs, Inc. 32231 Trabuco Creek Road Trabuco Canyon, CA 92678 Open Area Test Site #1 & #2
ACCREDITATION CERTIFICATE(S):	A2LA Certificate Number: 1111.01, Valid through April 30, 2008
PURPOSE OF TEST:	To demonstrate compliance with the standards as described in Sections 1.0 & 2.0 of this report.
UNCERTAINTY BUDGET:	Proficiency Testing and Uncertainty Calculations for all tests indicated in this report have been conducted in accordance with ISO 17025: 2005 requirements Section 5.4.6, and 5.9. Uncertainty Budgets and Proficiency Test results available upon request.
STATEMENT OF CALIBRATION:	All accredited equipment calibrations were performed by Liberty Labs, Inc. and World Cal. with typical calibration uncertainty estimates derived from ISO Guide to the determination of uncertainties with a Coverage Factor of k=2 for 95% level of confidence.

4.0 DESCRIPTION OF EUT CONFIGURATION

4.1 EUT Description

Equipment Under Test (EUT)	
Trade Name:	Intel WiFi/WiMax Link 5350
Model Number:	533ANXMMW
Frequency Range:	802.11a = 5.15-5.35 GHz 802.11n = 5.15-5.35 GHz
Enclosure:	The EUT contains its own shield made of aluminum approximately 2.5cm wide by 2cm deep by 2mm high.
Transfer Rate:	6/36/54 Mbps for 802.11a mode Up to 450 Mbps for 802.11n mode
Antenna Type:	<u>Shanghai Universe Communication Electron Co., Ltd Antennas:</u> PIFA
Antenna Gain (See Note 2):	3.73dBi @ 5 GHz
Transmit Output Power:	Please see Appendix A (Data Sheets) for actual output power.
Power Supply:	3.3VDC from external source
Number of External Test Ports Exercised:	3 Antenna Ports (Chain A, B, & C)

The Intel WiFi/WiMax Link 5350 is an embedded IEEE 802.16e and 802.11a/b/g/n wireless network adapter that operate in the 2.4 GHz and 5.0 GHz spectra for WiFi and 2.5 GHz for WiMax. The adapter is capable of delivering up to 450 Mbps Tx/Rx over WiFi and up to 4 Mbps UL/10 Mbps DL over WiMax.

NOTE 1: For a more detailed description, please refer to the manufacture’s specifications or User’s Manual.

NOTE 2: The EUT was tested with a set of Shanghai Universe Communication Antennas. (Refer to the antenna information exhibits).

4.2 EUT Configuration

The EUT was tested installed in the Mini PCI-E slot of an extender board which is then connected to the host computer. The EUT was then connected to a set of antennas via its Chain A, B, & C antenna ports. Data for a set of Shanghai Universe Communication Electron Co., Ltd Antennas can be found in Appendix A (Data Sheets)

The low, middle, and high channels were tested in 802.11a, b, g, & n modes. Also, the EUT was tested once transmitting from each chain individually (Chain A, B, then C) and then tested with all chains transmitting simultaneously (Chain ABC). The EUT was placed in continuous transmit mode by a program provided by the manufacturer (*CRTU Version 5.0.51.0000*).

4.3 List of EUT, Sub-Assemblies and Host Equipment

Equipment Under Test			
Manufacturer	Equipment Name	Model or Part Number	Serial Number
Intel Corporation	Intel WiFi/WiMax Link 5350	533ANXMMW	0016EB01A3A8

EUT Sub Assemblies			
Manufacturer	Equipment Name	Model or Part Number	Serial Number
Shanghai Universe Communication Electron Co., Ltd	Chain A Antenna	SUC ANT S11	N/A
	Chain B Antenna	SUC ANT S11	N/A
	Chain C Antenna	SUC ANT S11	N/A

HOST EQUIPMENT LIST			
Manufacturer	Equipment Name	Model or Part Number	Serial Number
Generic	Host Laptop	ENG001	None
Protek	DC Power Source	3006B	AC2018
Logitech	Keyboard	Y-BF37	MCT25200581
Logitech	Mouse	M-BJ58	LNA22802012

NOTE: All the power cords of the above support equipment are standard and non-shielded.

4.4 I/O Cabling Diagram and Description

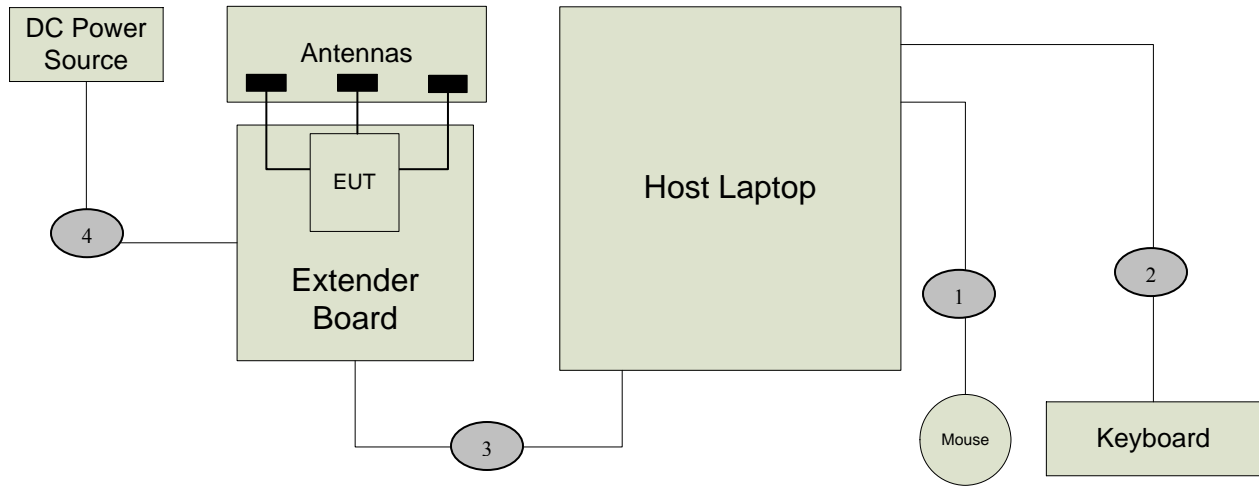

Signal Line Cable Description

Cable	Length	Construction	Source Connector	Destination Connector	Bundled Length	Ferrite Attached	Note
1	1.5m	Round, Braid & Foil Shielded	Host Computer: USB Port	Keyboard: Hardwired	N/A	N/A	N/A
2	1.5m	Round, Braid & Foil Shielded	Host Computer: USB Port	Mouse: Hardwired	N/A	N/A	N/A
3	0.5m	Flat, Braid & Foil Shielded	Extender Board: Mini PCIe slot	Host Laptop: Mini PCIe slot	N/A	N/A	N/A
4	0.5m	Round Un-shielded	Extender Board: Power Input	DC Power Source: Power Output	N/A	N/A	N/A



4.5 EMC Test Hardware and Software Measurement Equipment

TEST EQUIPMENT LIST - Emissions					
Equipment Name	Manufacturer	Model Number	Serial Number	Calibration Due Date	Maintenance Calibration Cycle
Spectrum Analyzer	Agilent	8565EC	3946A00245	07/24/08	1 Year
PSA Spectrum Analyzer	Agilent	E4440A	MY44303400	10/24/08	1 Year
Antenna – Horn	EMCO	3115	2230	05/15/08	1 Year
Preamp	Miteq	JS42-01001800-25-10P	815980	09/21/08	1 Year
28 Foot Coax	Semflex	S1L29BFS1348	608	07/26/08	1 Year
5.15-5.35 GHz Notch Filter	Microwave Circuits	N0452502	3173-01	NCR	NCR
Antenna - 18-26.5 GHz Pre-amplified Horn	Aegis Labs, Inc.	H042	SLK-35-3W	02/08/09	1 Year
Antenna - 26.5-40 GHz Pre-amplified Horn	Aegis Labs, Inc.	H028	GM1260-10	02/08/09	1 Year
EMI Receiver - RF Section	Hewlett Packard	8546A	3325A00137	04/26/08	1 Year
EMI Receiver - RF Filter Section	Hewlett Packard	85460A	3330A00138	04/26/08	1 Year
10 dB Attenuator	Pasternack	PE7014-10	N/A	09/05/08	1 Year
LISN (EUT)	Fisher Custom Communications	FCC-LISN-50-25-2	9931	03/30/09	1 Year
LISN (Access)	EMCO	3825/2	9108-1848	03/30/09	1 Year
Antenna - Biconical	EMCO	3110B	3383	03/20/09	1 Year
Antenna - Log Periodic	EMCO	3148	47943	03/20/09	1 Year
Power Meter	Anritsu	ML2487A	6K00001785	05/29/08	1 Year
Wide Bandwidth Sensor	Anritsu	MA2491A	31193	05/29/08	1 Year
12dB Attenuator	Narda	4779-12	203	06/09/08	1 Year
Temperature/Humidity Monitor	Dickson	TH550	7255185	04/13/08	1 Year

NCR – No Calibration Required.

5.0 CONDITIONS DURING EMISSIONS MEASUREMENTS

5.1 General

All measurements were made according to the procedures defined in or referred to by the standard listed on the cover page of this report. The measurements were made in the operating mode producing the largest emissions consistent with normal operation and connected to the minimum configuration of auxiliary devices.

5.2 Conducted Emissions Test Setup

The following was the test configuration.

EUT signal cables that hung closer than 40 cm to the horizontal metal ground plane were folded back and forth forming a bundle 30 cm to 40 cm long. The power cord of the EUT was also bundled in the center and plugged into one of the artificial mains network (AMN). All peripheral equipment was powered from a second AMN via a multiple outlet strip placed at a distance on 10cm from each other. The AMN and ISN were positioned 80cm from the EUT. Signal cables that were not connected to an AE were terminated using the correct termination. If applicable, the current probe was placed at 0.1 m from the ISN.

Peak, quasi-peak and/or average detectors were used for testing performed between 150 kHz and 30 MHz. A swept frequency scan was performed for both Line 1 and Line 2. The six highest readings were compared against the limit and recorded in the data sheet along with a snapshot image of the sweep scan. The graphical scans in Appendix A only reflect peak readings while the tabulated data sheets reflect peak, average, and/or quasi-peak measurements.

Climatic Conditions:

The EUT was tested within its intended operating and climatic conditions.

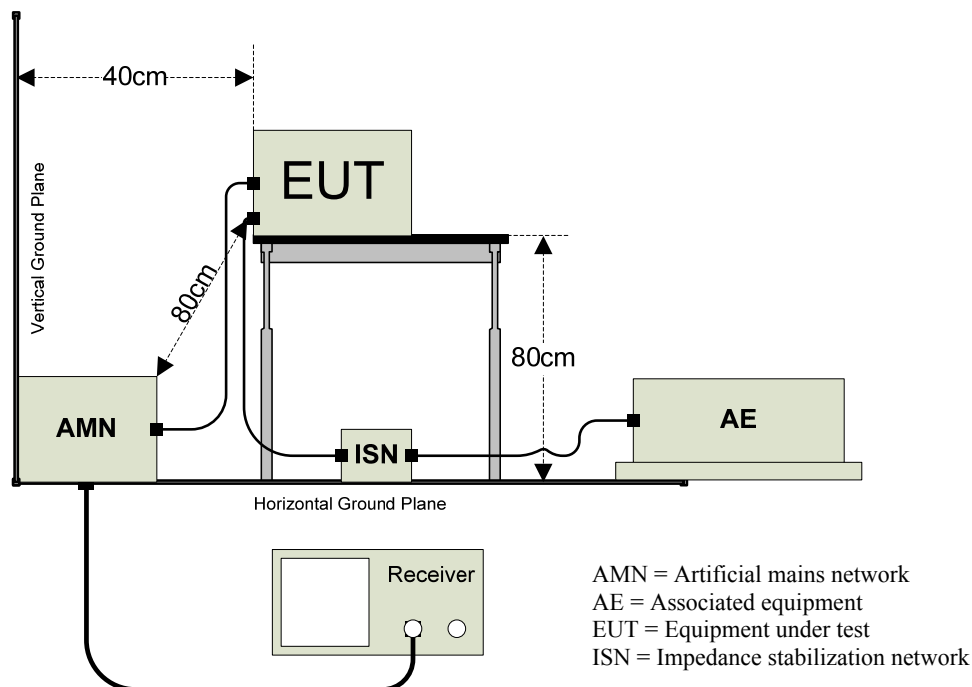

5.3 Radiated Emissions Test Setup

The Open Area Test Site (OATS) was used for radiated emission testing. The receiving (Rx) antenna(s) was placed 10m from the nearest side of the EUT facing the Rx antenna. The EUT (if floor-standing) was placed directly on the flush-mounted 360 degree rotating turntable. The EUT (if table-top) was placed directly on an 80cm high non-metallic table, and the table was placed on the rotating turntable. During the initial EMI scan, all the suspect frequencies, i.e.; harmonics, broadband signals were checked with the Rx broadband antennas in both vertical and horizontal polarities. The biconical Rx, log periodic Rx, and horn Rx antennas were used from 30MHz – 299.99MHz, 300MHz – 1000MHz, and 1GHz – 18GHz respectively.

Upon completion of all harmonic and broadband measurements, the balance of any remaining frequencies was checked between 30MHz – 18GHz. Any signals appearing within 20 dB of the classification limit was measured. Each signal was maximized by first rotating the turntable at least 360 degrees and recording the azimuth in the data sheet. Lastly, the Rx antenna was raised and/or lowered to maximize the signal elevation. If the measured signal was obtained using the peak detector and that signal appeared within 3 dB of the regulatory limit line, then the same signal was re-measured using the quasi-peak detector on the EMI receiver. Both meter readings if necessary were recorded on the data sheet.

Climatic Conditions:

The EUT was tested within its intended operating and climatic conditions.

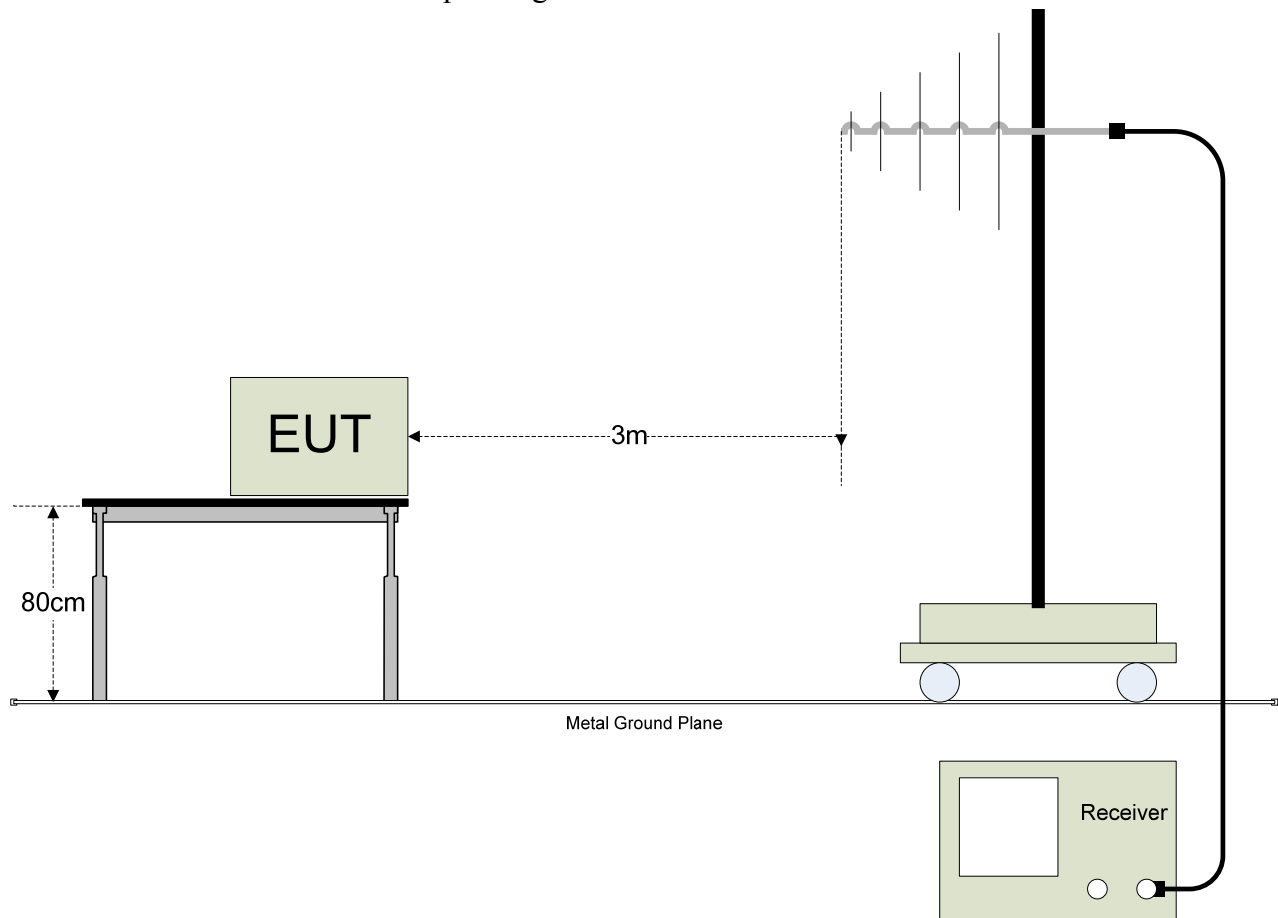



APPENDIX A

TEST DATA

**RADIATED EMISSIONS TEST RESULTS**

CLIENT:	Intel Corporation	DATE:	02/25/08
EUT:	Intel WiFi/WiMax Link 5350	PROJECT NUMBER:	INTEL-080114
MODEL NUMBER:	533ANXMMW	TEST ENGINEER:	JC/KN
SERIAL NUMBER:	0016EB01A3A8	SITE #:	2
CONFIGURATION:	Tested installed in an extender board connected to the host laptop's mini PCI slot in 802.11a (5150-5350 MHz) mode.	TEMPERATURE:	17 deg. C
		HUMIDITY:	52% RH
		TIME:	1:30 PM

Description:	Radiated RF Emissions (1 GHz – 18 GHz)
Results:	PASSED Horizontal and Vertical Antenna Polarizations Class B Limits
Note:	Radiated Emissions Measurements were performed on the EUT with power supply set at the following voltage and frequency. <ul style="list-style-type: none"> • 120VAC / 60 Hz.

Unwanted Spurious Emissions Limits			
Frequency (MHz)	Field Strength (uV/m)	Field Strength (dBuV/m) (Emissions in the restricted bands)	Field Strength (dBm/MHz) (Emissions outside the restricted bands)
Above 960	500	54.00 (Average) 74.00 (Peak)	< -20 dBc

Radiated Emissions Sample Calculations

$$\text{Corrected Meter Reading} = \text{Meter Reading} + F + C - D$$

Where, F = Antenna Factor

C = Cable Factor

G = Amplifier Gain

D = Distance Factor (if applicable)

Therefore, the equation for determining the Corrected Meter Reading Limit (CML) is:

$$\text{CML} = \text{Specification Limit} - F - C + D$$



Radiated Emissions Test Results (Continued)

*Fundamental Measurements in 802.11a mode (5150-5350 MHz)
Channels 36, 40, 48, 52, & 64
Continuous TX at Chain A Antenna port
Aegis Labs, Inc. File #: INTEL-080114-57*

RADIATED EMISSIONS - Horizontal Antenna Polarization											
Freq. (MHz)	Meter Reading (dBuV)	Antenna Height (cm)	Azimuth (degrees)	Quasi pk or AVG (dBuV)		Cable Factor (dB)	Ant. Factor (dB)	Corrected Reading (dBuV)	Limits (dBuV)	Diff (dB) +=FAIL	Comments
5180.00	70.17	100	45			2.98	34.62	107.77			Ch. 36
5180.00				60.00	A	2.98	34.62	97.60			
5200.00	70.00	100	45			2.98	34.66	107.64			Ch. 40
5200.00				59.00	A	2.98	34.66	96.64			
5240.00	69.33	100	45			3.00	34.73	107.06			Ch. 48
5240.00				59.00	A	3.00	34.73	96.73			
5260.00	68.67	100	45			3.00	34.77	106.44			Ch. 52
5260.00				58.33	A	3.00	34.77	96.10			
5320.00	69.67	100	135			3.02	34.88	107.57			Ch. 64
5320.00				58.00	A	3.02	34.88	95.90			

RADIATED EMISSIONS - Vertical Antenna Polarization											
Freq. (MHz)	Meter Reading (dBuV)	Antenna Height (cm)	Azimuth (degrees)	Quasi pk or AVG (dBuV)		Cable Factor (dB)	Ant. Factor (dB)	Corrected Reading (dBuV)	Limits (dBuV)	Diff (dB) +=FAIL	Comments
5180.00	67.33	100	315			2.98	34.39	104.70			Ch. 36
5180.00				57.50	A	2.98	34.39	94.87			
5200.00	68.83	100	315			2.98	34.42	106.23			Ch. 40
5200.00				57.67	A	2.98	34.42	95.07			
5240.00	66.83	100	270			3.00	34.48	104.31			Ch. 48
5240.00				56.50	A	3.00	34.48	93.98			
5260.00	66.17	100	315			3.00	34.52	103.69			Ch. 52
5260.00				55.50	A	3.00	34.52	93.02			
5320.00	67.17	100	315			3.02	34.61	104.80			Ch. 64
5320.00				56.83	A	3.02	34.61	94.46			

NOTE: Fundamental signals measured to calculate the band edge field strengths using the “Marker Delta Method”.



Radiated Emissions Test Results (Continued)

*Band Edge Field Strength Measurements in 802.11a mode (5150-5350 MHz)
Channels 36 & 64
Continuous TX at Chain A Antenna port
Aegis Labs, Inc. File #: INTEL-080114-57*

RADIATED EMISSIONS - Horizontal Antenna Polarization										
Freq. (MHz)	Meter Reading (dBuV)	Antenna Height (cm)	Azimuth (degrees)	Quasi pk or AVG (dBuV)	Cable Factor (dB)	Ant. Factor (dB)	Corrected Reading (dBuV)	Limits (dBuV)	Diff (dB) +=FAIL	Comments
5150.00							64.11	74.00	-9.89	Ch. 36
5150.00				A			44.93	54.00	-9.07	
5350.00							67.07	74.00	-6.93	Ch. 64
5350.00				A			42.57	54.00	-11.43	

RADIATED EMISSIONS - Vertical Antenna Polarization										
Freq. (MHz)	Meter Reading (dBuV)	Antenna Height (cm)	Azimuth (degrees)	Quasi pk or AVG (dBuV)	Cable Factor (dB)	Ant. Factor (dB)	Corrected Reading (dBuV)	Limits (dBuV)	Diff (dB) +=FAIL	Comments
5150.00							61.04	74.00	-12.96	Ch. 36
5150.00				A			42.20	54.00	-11.80	
5350.00							64.30	74.00	-9.70	Ch. 64
5350.00				A			41.13	54.00	-12.87	

NOTE: The “Band Edge Field Strength” was calculated using the “Fundamental” and “Conducted Band Edge” measurements per the “Marker-Delta Method” with the following formula:

$$BE = F_m - \Delta_m$$

Where

BE = Band Edge Field Strength

F_m = Measured Fundamental (Peak or Average)

Δ_m = Measured Conducted Band Edge Delta (Peak or Average)

Radiated Emissions Test Results (Continued)

Plots Showing Out-Of-Band Emissions (Peak RBW=VBW=1MHz; Average RBW = 1MHz, VBW = 10Hz)

<i>Test Date</i>	<i>Data</i>	<i>Test Eng.</i>
03/31/08	5.18 GHz band edge PEAK (INTEL-080114)	RC
*ATTEN 20dB ΔMKR 43.66dB RL 10.0dBm 10dB/ 34.5MHz		
CENTER 5.1500GHz SPAN 100.0MHz *RBW 1.0MHz *VBW 1.0MHz SWP 50.0ms		
<i>Test Date</i>	<i>Data</i>	<i>Test Eng.</i>
03/31/08	5.18 GHz band edge AVERAGE (INTEL-080114)	RC
*ATTEN 20dB ΔMKR 52.67dB RL 10.0dBm 10dB/ 34.0MHz		
CENTER 5.1500GHz SPAN 100.0MHz *RBW 1.0MHz *VBW 10Hz SWP 37.0sec		

Radiated Emissions Test Results (Continued)

Plots Showing Out-Of-Band Emissions (Peak RBW=VBW=1MHz; Average RBW = 1MHz, VBW = 10Hz)

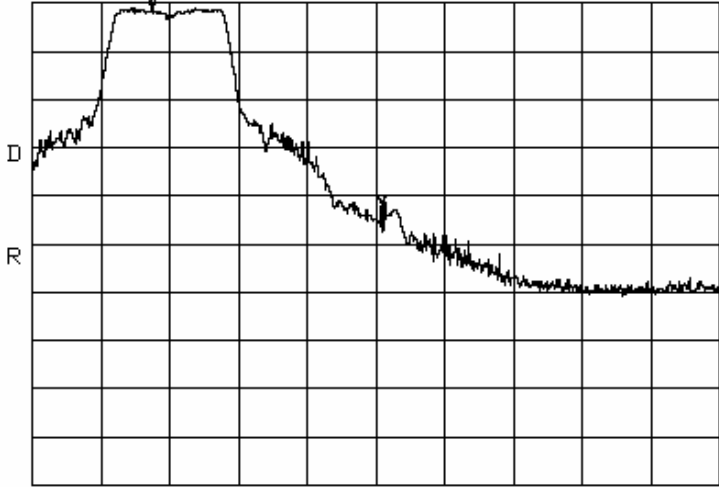
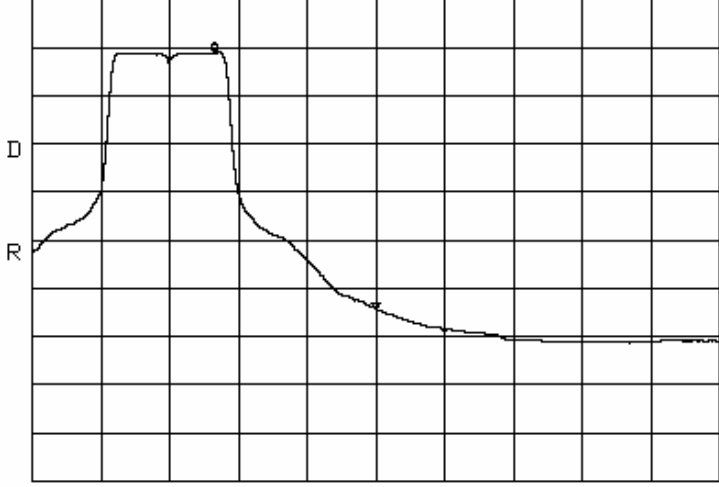
<i>Test Date</i>	<i>Data</i>	<i>Test Eng.</i>
03/31/08	5.32 GHz band edge PEAK (INTEL-080114)	RC
<p>*ATTEN 20dB ΔMKR 40.50dB RL 10.0dBm 10dB/ -33.3MHz</p>  <p>CENTER 5.3500GHz SPAN 100.0MHz *RBW 1.0MHz *VBW 1.0MHz SWP 50.0ms</p>		
<i>Test Date</i>	<i>Data</i>	<i>Test Eng.</i>
03/31/08	5.32 GHz band edge AVERAGE (INTEL-080114)	RC
<p>*ATTEN 20dB ΔMKR 53.33dB RL 10.0dBm 10dB/ -23.5MHz</p>  <p>CENTER 5.3500GHz SPAN 100.0MHz *RBW 1.0MHz *VBW 10Hz SWP 37.0sec</p>		



Radiated Emissions Test Results (Continued)

Fundamental Measurements in 802.11a mode (5150-5350 MHz)
Channels 36, 40, 48, 52, & 64
Continuous TX at Chain B Antenna port
Aegis Labs, Inc. File #: INTEL-080114-58

RADIATED EMISSIONS - Horizontal Antenna Polarization											
<i>Freq. (MHz)</i>	<i>Meter Reading (dBuV)</i>	<i>Antenna Height (cm)</i>	<i>Azimuth (degrees)</i>	<i>Quasi pk or AVG (dBuV)</i>		<i>Cable Factor (dB)</i>	<i>Ant. Factor (dB)</i>	<i>Corrected Reading (dBuV)</i>	<i>Limits (dBuV)</i>	<i>Diff (dB) +=FAIL</i>	<i>Comments</i>
5180.00	71.83	100	270			2.98	34.62	109.43			Ch. 36
5180.00				62.17	A	2.98	34.62	99.77			
5200.00	72.83	100	270			2.98	34.66	110.47			Ch. 40
5200.00				63.00	A	2.98	34.66	100.64			
5240.00	73.83	100	270			3.00	34.73	111.56			Ch. 48
5240.00				63.50	A	3.00	34.73	101.23			
5260.00	73.00	100	270			3.00	34.77	110.77			Ch. 52
5260.00				62.83	A	3.00	34.77	100.60			
5320.00	72.50	100	270			3.02	34.88	110.40			Ch. 64
5320.00				61.83	A	3.02	34.88	99.73			

RADIATED EMISSIONS - Vertical Antenna Polarization											
<i>Freq. (MHz)</i>	<i>Meter Reading (dBuV)</i>	<i>Antenna Height (cm)</i>	<i>Azimuth (degrees)</i>	<i>Quasi pk or AVG (dBuV)</i>		<i>Cable Factor (dB)</i>	<i>Ant. Factor (dB)</i>	<i>Corrected Reading (dBuV)</i>	<i>Limits (dBuV)</i>	<i>Diff (dB) +=FAIL</i>	<i>Comments</i>
5180.00	64.00	100	225			2.98	34.39	101.37			Ch. 36
5180.00				54.00	A	2.98	34.39	91.37			
5200.00	64.83	100	180			2.98	34.42	102.23			Ch. 40
5200.00				54.83	A	2.98	34.42	92.23			
5240.00	65.00	100	180			3.00	34.48	102.48			Ch. 48
5240.00				54.83	A	3.00	34.48	92.31			
5260.00	63.67	100	225			3.00	34.52	101.19			Ch. 52
5260.00				53.67	A	3.00	34.52	91.19			
5320.00	62.83	100	135			3.02	34.61	100.46			Ch. 64
5320.00				53.17	A	3.02	34.61	90.80			

NOTE: Fundamental signals measured to calculate the band edge field strengths using the "Marker Delta Method".

Radiated Emissions Test Results (Continued)

*Band Edge Field Strength Measurements in 802.11a mode (5150-5350 MHz)
Channels 36 & 64
Continuous TX at Chain B Antenna port
Aegis Labs, Inc. File #: INTEL-080114-58*

RADIATED EMISSIONS - Horizontal Antenna Polarization										
<i>Freq. (MHz)</i>	<i>Meter Reading (dBuV)</i>	<i>Antenna Height (cm)</i>	<i>Azimuth (degrees)</i>	<i>Quasi pk or AVG (dBuV)</i>	<i>Cable Factor (dB)</i>	<i>Ant. Factor (dB)</i>	<i>Corrected Reading (dBuV)</i>	<i>Limits (dBuV)</i>	<i>Diff (dB) +=FAIL</i>	<i>Comments</i>
5150.00							67.26	74.00	-6.74	Ch. 36
5150.00					A		48.60	54.00	-5.40	
5350.00							69.57	74.00	-4.43	Ch. 64
5350.00					A		47.73	54.00	-6.27	

RADIATED EMISSIONS - Vertical Antenna Polarization										
<i>Freq. (MHz)</i>	<i>Meter Reading (dBuV)</i>	<i>Antenna Height (cm)</i>	<i>Azimuth (degrees)</i>	<i>Quasi pk or AVG (dBuV)</i>	<i>Cable Factor (dB)</i>	<i>Ant. Factor (dB)</i>	<i>Corrected Reading (dBuV)</i>	<i>Limits (dBuV)</i>	<i>Diff (dB) +=FAIL</i>	<i>Comments</i>
5150.00							59.20	74.00	-14.80	Ch. 36
5150.00					A		40.20	54.00	-13.80	
5350.00							59.63	74.00	-14.37	Ch. 64
5350.00					A		38.80	54.00	-15.20	

NOTE: The “Band Edge Field Strength” was calculated using the “Fundamental” and “Conducted Band Edge” measurements per the “Marker-Delta Method” with the following formula:

$$BE = F_m - \Delta m$$

Where

BE = Band Edge Field Strength

F_m = Measured Fundamental (Peak or Average)

Δ_m = Measured Conducted Band Edge Delta (Peak or Average)

Radiated Emissions Test Results (Continued)

Plots Showing Out-Of-Band Emissions (Peak RBW=VBW=1MHz; Average RBW = 1MHz, VBW = 10Hz)

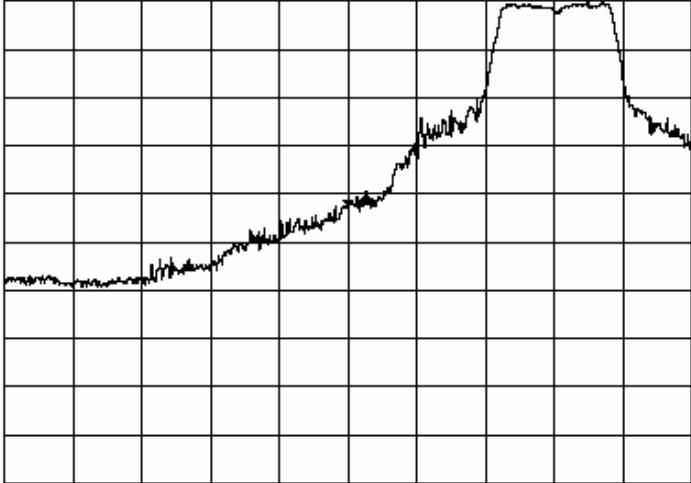
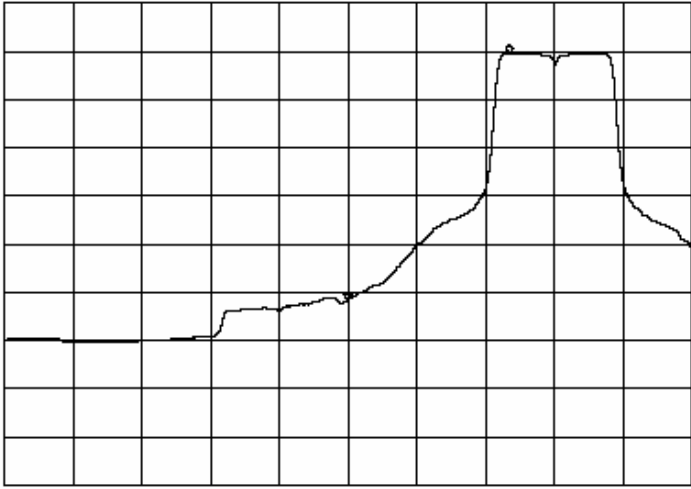
<i>Test Date</i>	<i>Data</i>	<i>Test Eng.</i>
03/31/08	5.18 GHz band edge PEAK (INTEL-080114)	RC
<p data-bbox="326 422 1039 474">*ATTEN 20dB ΔMKR 42.17dB RL 10.0dBm 10dB/ 35.0MHz</p>  <p data-bbox="326 963 1024 1016">CENTER 5.1500GHz SPAN 100.0MHz *RBW 1.0MHz *VBW 1.0MHz SWP 50.0ms</p>		
<i>Test Date</i>	<i>Data</i>	<i>Test Eng.</i>
03/31/08	5.18 GHz band edge AVERAGE (INTEL-080114)	RC
<p data-bbox="326 1129 1039 1182">*ATTEN 20dB ΔMKR 51.17dB RL 10.0dBm 10dB/ 23.5MHz</p>  <p data-bbox="326 1677 1024 1730">CENTER 5.1500GHz SPAN 100.0MHz *RBW 1.0MHz *VBW 10Hz SWP 37.0sec</p>		



Radiated Emissions Test Results (Continued)

Plots Showing Out-Of-Band Emissions (Peak RBW=VBW=1MHz; Average RBW = 1MHz, VBW = 10Hz)

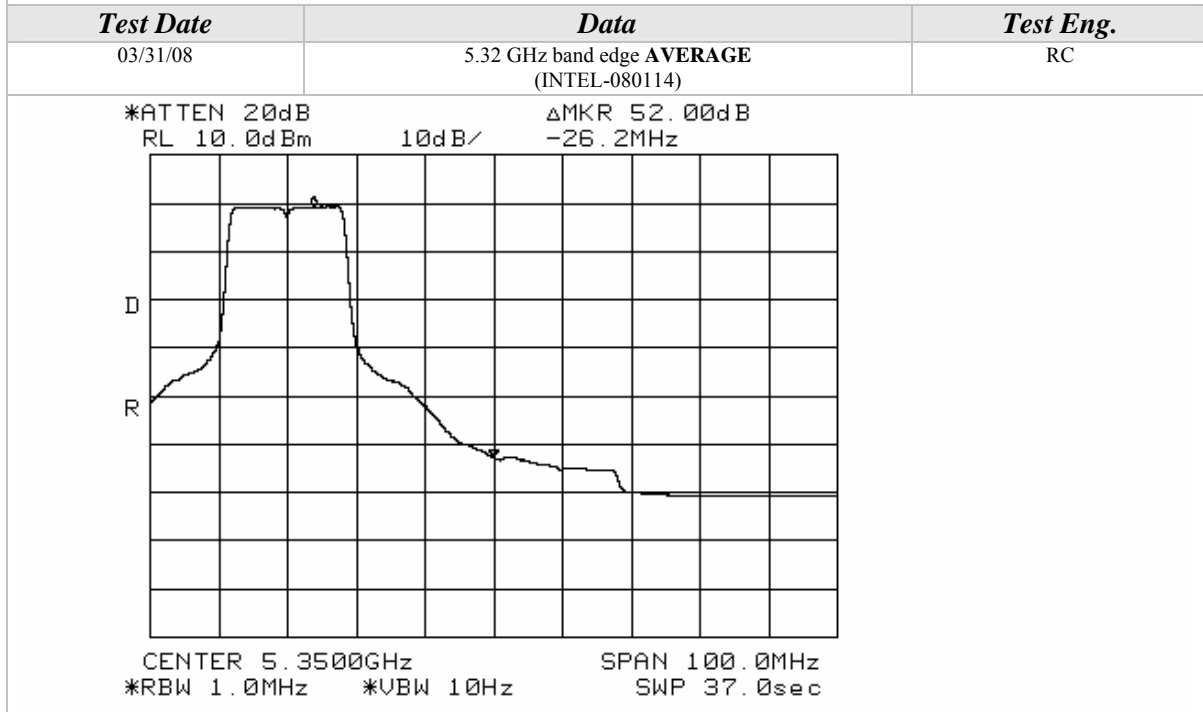
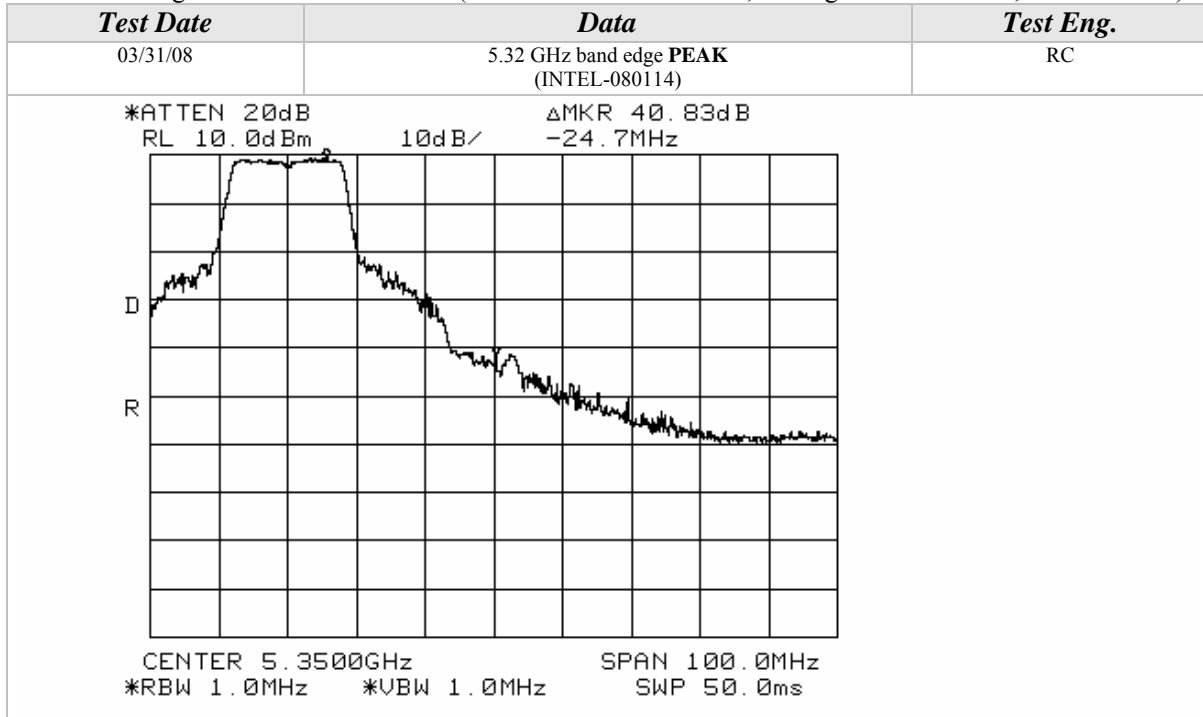



Radiated Emissions Test Results (Continued)

*Fundamental Measurements in 802.11a mode (5150-5350 MHz)
 Channels 36, 40, 48, 52, & 64
 Continuous TX at Chain C Antenna port
 Aegis Labs, Inc. File #: INTEL-080114-59*

RADIATED EMISSIONS - Horizontal Antenna Polarization											
<i>Freq. (MHz)</i>	<i>Meter Reading (dBuV)</i>	<i>Antenna Height (cm)</i>	<i>Azimuth (degrees)</i>	<i>Quasi pk or AVG (dBuV)</i>		<i>Cable Factor (dB)</i>	<i>Ant. Factor (dB)</i>	<i>Corrected Reading (dBuV)</i>	<i>Limits (dBuV)</i>	<i>Diff (dB) +=FAIL</i>	<i>Comments</i>
5180.00	68.50	100	315			2.98	34.62	106.10			Ch. 36
5180.00				58.33	A	2.98	34.62	95.93			
5200.00	68.67	100	315			2.98	34.66	106.31			Ch. 40
5200.00				59.33	A	2.98	34.66	96.97			
5240.00	64.00	100	315			3.00	34.73	101.73			Ch. 48
5240.00				55.00	A	3.00	34.73	92.73			
5260.00	66.50	100	315			3.00	34.77	104.27			Ch. 52
5260.00				56.67	A	3.00	34.77	94.44			
5320.00	68.00	100	315			3.02	34.88	105.90			Ch. 64
5320.00				58.00	A	3.02	34.88	95.90			

RADIATED EMISSIONS - Vertical Antenna Polarization											
<i>Freq. (MHz)</i>	<i>Meter Reading (dBuV)</i>	<i>Antenna Height (cm)</i>	<i>Azimuth (degrees)</i>	<i>Quasi pk or AVG (dBuV)</i>		<i>Cable Factor (dB)</i>	<i>Ant. Factor (dB)</i>	<i>Corrected Reading (dBuV)</i>	<i>Limits (dBuV)</i>	<i>Diff (dB) +=FAIL</i>	<i>Comments</i>
5180.00	65.83	100	90			2.98	34.39	103.20			Ch. 36
5180.00				56.33	A	2.98	34.39	93.70			
5200.00	66.83	100	90			2.98	34.42	104.23			Ch. 40
5200.00				56.67	A	2.98	34.42	94.07			
5240.00	67.33	100	90			3.00	34.48	104.81			Ch. 48
5240.00				57.50	A	3.00	34.48	94.98			
5260.00	67.67	100	90			3.00	34.52	105.19			Ch. 52
5260.00				57.50	A	3.00	34.52	95.02			
5320.00	66.50	100	90			3.02	34.61	104.13			Ch. 64
5320.00				56.83	A	3.02	34.61	94.46			

NOTE: Fundamental signals measured to calculate the band edge field strengths using the “Marker Delta Method”.



Radiated Emissions Test Results (Continued)

*Band Edge Field Strength Measurements in 802.11a mode (5150-5350 MHz)
Channels 36 & 64
Continuous TX at Chain C Antenna port
Aegis Labs, Inc. File #: INTEL-080114-59*

RADIATED EMISSIONS - Horizontal Antenna Polarization

Freq. (MHz)	Meter Reading (dBuV)	Antenna Height (cm)	Azimuth (degrees)	Quasi pk or AVG (dBuV)	Cable Factor (dB)	Ant. Factor (dB)	Corrected Reading (dBuV)	Limits (dBuV)	Diff (dB) +=FAIL	Comments
5150.00							63.60	74.00	-10.40	Ch. 36
5150.00				A			41.60	54.00	-12.40	
5350.00							62.90	74.00	-11.10	Ch. 64
5350.00				A			41.73	54.00	-12.27	

RADIATED EMISSIONS - Vertical Antenna Polarization

Freq. (MHz)	Meter Reading (dBuV)	Antenna Height (cm)	Azimuth (degrees)	Quasi pk or AVG (dBuV)	Cable Factor (dB)	Ant. Factor (dB)	Corrected Reading (dBuV)	Limits (dBuV)	Diff (dB) +=FAIL	Comments
5150.00							60.70	74.00	-13.30	Ch. 36
5150.00				A			39.37	54.00	-14.63	
5350.00							61.13	74.00	-12.87	Ch. 64
5350.00				A			40.29	54.00	-13.71	

NOTE: The "Band Edge Field Strength" was calculated using the "Fundamental" and "Conducted Band Edge" measurements per the "Marker-Delta Method" with the following formula:

$$BE = F_m - \Delta_m$$

Where

BE = Band Edge Field Strength

F_m = Measured Fundamental (Peak or Average)

Δ_m = Measured Conducted Band Edge Delta (Peak or Average)

Radiated Emissions Test Results (Continued)

Plots Showing Out-Of-Band Emissions (Peak RBW=VBW=1MHz; Average RBW = 1MHz, VBW = 10Hz)

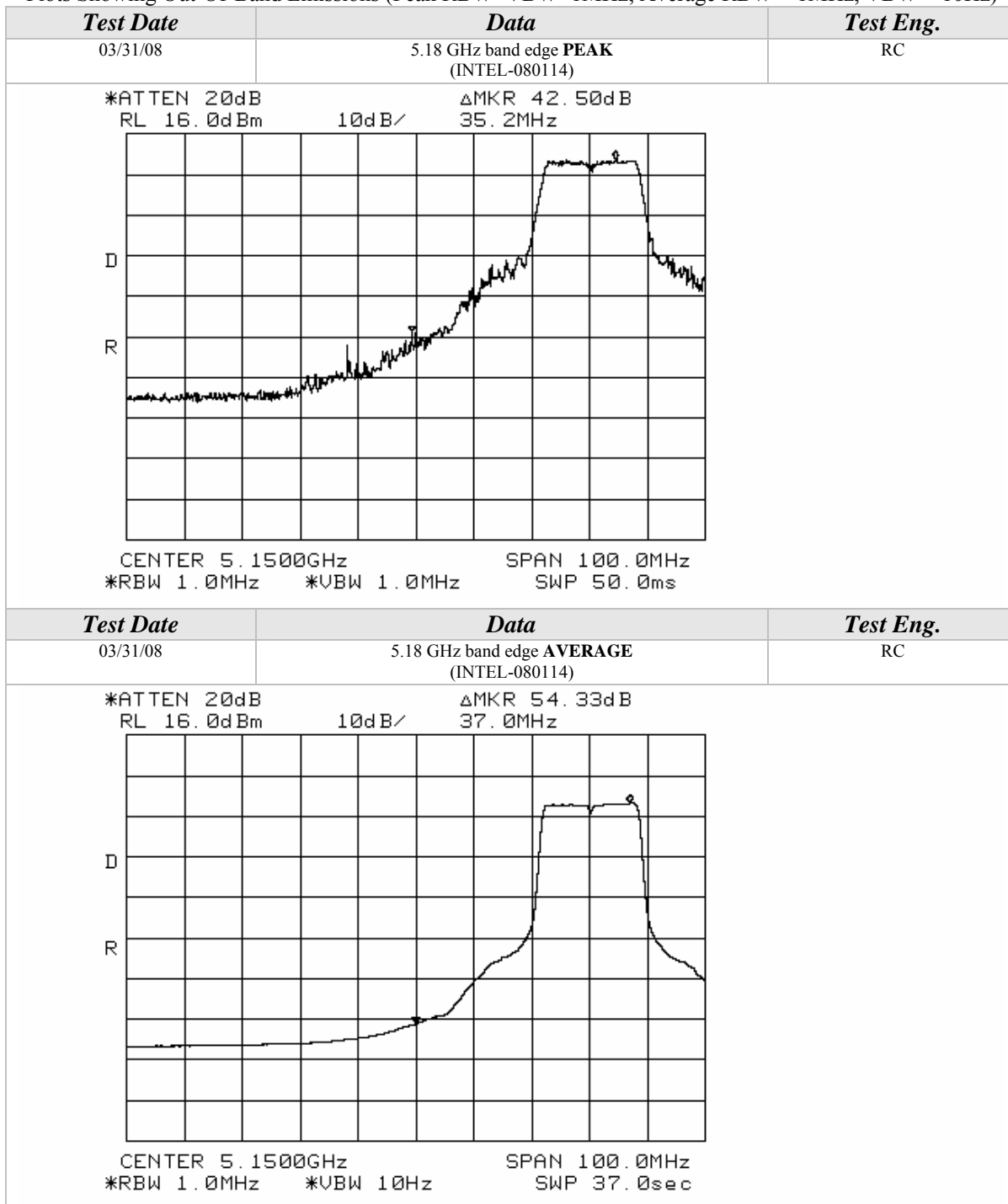

Radiated Emissions Test Results (Continued)

Plots Showing Out-Of-Band Emissions (Peak RBW=VBW=1MHz; Average RBW = 1MHz, VBW = 10Hz)

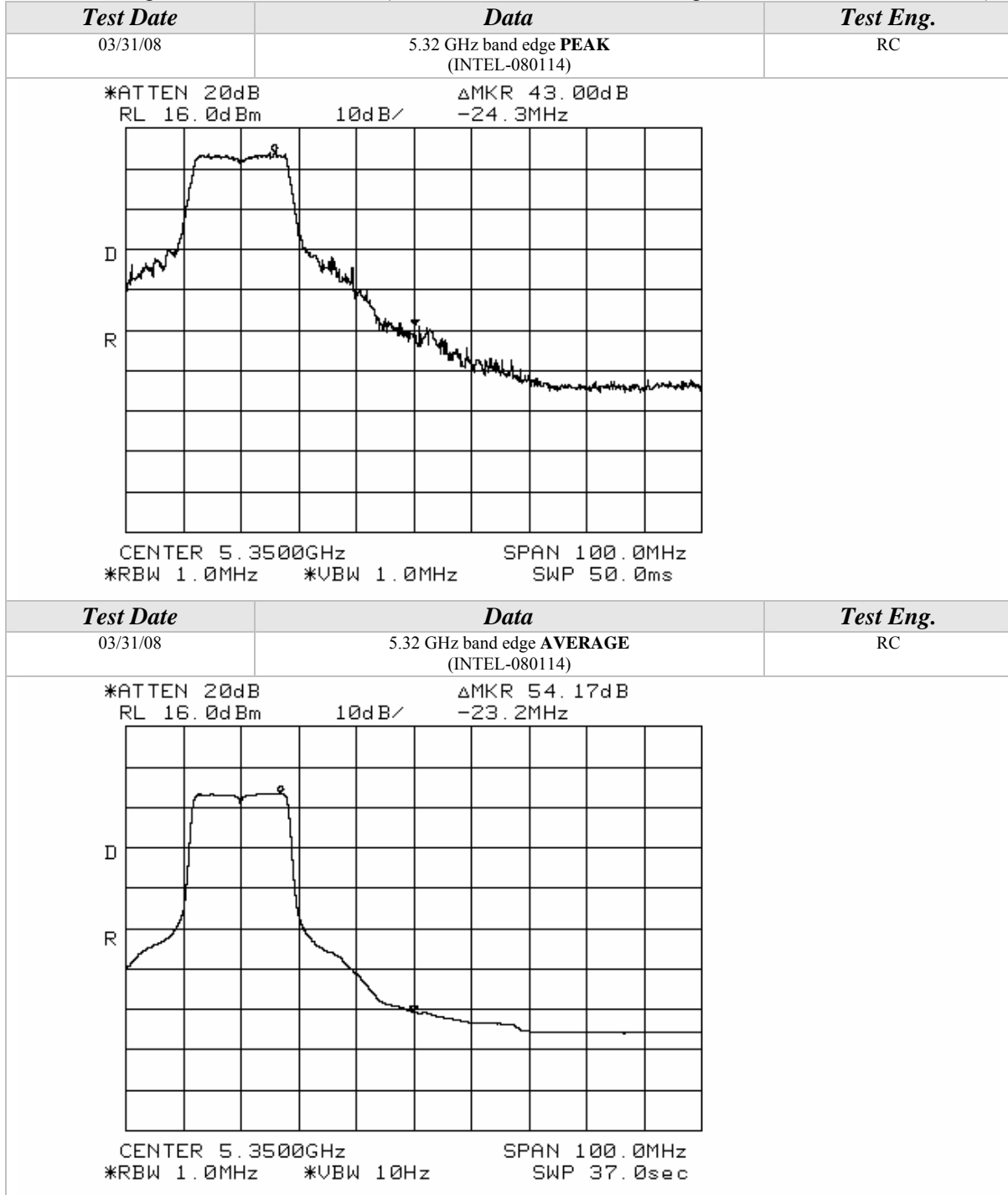



Radiated Emissions Test Results (Continued)

*Spurious Emissions Measurements in 802.11a mode (5150-5350 MHz)
Channels 36, 40, & 48
Continuous TX at Chain A, B, & C Antenna ports
Aegis Labs, Inc. File #: INTEL-080114-04*

RADIATED EMISSIONS - Horizontal Antenna Polarization

Freq. (MHz)	Meter Reading (dBuV)	Antenna Height (cm)	Azimuth (degrees)	Quasi pk or AVG (dBuV)	Preamp Factor (dB)	Cable Factor (dB)	Ant. Factor (dB)	Corrected Reading (dBuV)	Limits (dBuV)	Diff (dB) +/-FAIL	Channel/ Chain Tested
3466.66	53.67	100	225		46.60	2.42	32.32	41.81	68.00	-26.19	Ch. 40/
6933.33	59.33	100	180		45.15	3.48	35.93	53.59	68.00	-14.41	A
10400.00	51.17	100	180		44.48	4.40	38.64	49.74	68.00	-18.26	
3466.66	53.83	100	225		46.60	2.42	32.32	41.97	68.00	-26.03	Ch. 40/
6933.33	53.83	100	225		45.15	3.48	35.93	48.09	68.00	-19.91	B
10400.00	51.83	100	135		44.48	4.40	38.64	50.40	68.00	-17.60	
3466.66	53.33	100	225		46.60	2.42	32.32	41.47	68.00	-26.53	Ch. 40/
6933.33	56.67	100	225		45.15	3.48	35.93	50.93	68.00	-17.07	C
10400.00	51.17	100	135		44.48	4.40	38.64	49.74	68.00	-18.26	
3453.33	53.33	100	225		46.60	2.41	32.29	41.43	68.00	-26.57	Ch. 36/
6906.66	59.83	100	180		45.19	3.47	35.91	54.02	68.00	-13.98	A
10359.99	50.67	100	225		44.47	4.39	38.62	49.20	68.00	-18.80	
3493.33	53.00	100	45		46.60	2.43	32.38	41.21	68.00	-26.79	Ch. 48/
6986.66	55.50	100	180		45.07	3.50	35.99	49.92	68.00	-18.08	A
10480.00	51.67	100	45		44.49	4.43	38.69	50.30	68.00	-17.70	

RADIATED EMISSIONS - Vertical Antenna Polarization

Freq. (MHz)	Meter Reading (dBuV)	Antenna Height (cm)	Azimuth (degrees)	Quasi pk or AVG (dBuV)	Preamp Factor (dB)	Cable Factor (dB)	Ant. Factor (dB)	Corrected Reading (dBuV)	Limits (dBuV)	Diff (dB) +/-FAIL	Comments
3466.66	62.50	100	180		46.60	2.42	31.83	50.14	68.00	-17.86	Ch. 40/
6933.33	57.00	100	135		45.15	3.48	35.85	51.18	68.00	-16.82	A
10400.00	53.83	100	135		44.48	4.40	38.62	52.38	68.00	-15.62	
3466.66	52.33	250	315		46.60	2.42	31.83	39.97	68.00	-28.03	Ch. 40/
6933.33	57.17	100	180		45.15	3.48	35.85	51.35	68.00	-16.65	B
10400.00	51.00	100	225		44.48	4.40	38.62	49.55	68.00	-18.45	
3466.66	54.00	100	135		46.60	2.42	31.83	41.64	68.00	-26.36	Ch. 40/
6933.33	55.00	100	180		45.15	3.48	35.85	49.18	68.00	-18.82	C
10400.00	51.83	100	135		44.48	4.40	38.62	50.38	68.00	-17.62	
3453.33	52.67	100	225		46.60	2.41	31.80	40.28	68.00	-27.72	Ch. 36/
6906.66	56.50	100	180		45.19	3.47	35.83	50.60	68.00	-17.40	A
10359.99	50.83	100	180		44.47	4.39	38.59	49.34	68.00	-18.66	
3493.33	53.83	100	225		46.60	2.43	31.89	41.54	68.00	-26.46	Ch. 48/
6986.66	55.83	100	90		45.07	3.50	35.89	50.15	68.00	-17.85	A
10480.00	51.17	100	315		44.49	4.43	38.68	49.80	68.00	-18.20	



Radiated Emissions Test Results (Continued)

*Spurious Emissions Measurements in 802.11a mode (5150-5350 MHz)
Channels 52, 56, & 64
Continuous TX at Chain A, B, & C Antenna ports
Aegis Labs, Inc. File #: INTEL-080114-04*

RADIATED EMISSIONS - Horizontal Antenna Polarization

Freq. (MHz)	Meter Reading (dBuV)	Antenna Height (cm)	Azimuth (degrees)	Quasi pk or AVG (dBuV)		Preamp Factor (dB)	Cable Factor (dB)	Ant. Factor (dB)	Corrected Reading (dBuV)	Limits (dBuV)	Diff (dB) +/-FAIL	Channel/ Chain Tested
3520.00	54.33	100	225			46.59	2.44	32.44	42.62	68.00	-25.38	Ch. 56/
7040.00	57.00	100	135			45.03	3.51	36.10	51.59	68.00	-16.41	A
10560.00	51.50	100	180			44.57	4.45	38.72	50.10	68.00	-17.90	
3520.00	53.83	100	225			46.59	2.44	32.44	42.12	68.00	-25.88	Ch. 56/
7040.00	52.33	100	225			45.03	3.51	36.10	46.92	68.00	-21.08	B
10560.00	53.17	100	225			44.57	4.45	38.72	51.77	68.00	-16.23	
3520.00	54.00	100	225			46.59	2.44	32.44	42.29	68.00	-25.71	Ch. 56/
7040.00	53.67	100	135			45.03	3.51	36.10	48.26	68.00	-19.74	C
10560.00	51.00	100	225			44.57	4.45	38.72	49.60	68.00	-18.40	
3506.66	54.17	100	225			46.60	2.43	32.41	42.42	68.00	-25.58	Ch. 52/
7013.32	53.83	100	225			45.04	3.51	36.03	48.33	68.00	-19.67	A
10519.98	51.33	100	180			44.52	4.44	38.71	49.96	68.00	-18.04	
3546.66	54.67	100	225			46.59	2.45	32.50	43.03	68.00	-24.97	Ch. 64/
7093.32	52.83	100	225			45.01	3.53	36.24	47.59	68.00	-20.41	A
10639.98	50.50	100	180			44.67	4.46	38.76	49.04	74.00	-24.96	
10639.98				40.01	A	44.67	4.46	38.76	38.55	54.00	-15.45	

RADIATED EMISSIONS - Vertical Antenna Polarization

Freq. (MHz)	Meter Reading (dBuV)	Antenna Height (cm)	Azimuth (degrees)	Quasi pk or AVG (dBuV)		Preamp Factor (dB)	Cable Factor (dB)	Ant. Factor (dB)	Corrected Reading (dBuV)	Limits (dBuV)	Diff (dB) +/-FAIL	Comments
3520.00	54.33	100	225			46.59	2.44	31.95	42.13	68.00	-25.87	Ch. 56/
7040.00	55.83	100	135			45.03	3.51	36.00	50.32	68.00	-17.68	A
10560.00	52.00	100	180			44.57	4.45	38.71	50.59	68.00	-17.41	
3520.00	53.67	100	225			46.59	2.44	31.95	41.47	68.00	-26.53	Ch. 56/
7040.00	57.00	100	180			45.03	3.51	36.00	51.49	68.00	-16.51	B
10560.00	50.50	100	135			44.57	4.45	38.71	49.09	68.00	-18.91	
3520.00	55.00	100	225			46.59	2.44	31.95	42.80	68.00	-25.20	Ch. 56/
7040.00	53.50	100	180			45.03	3.51	36.00	47.99	68.00	-20.01	C
10560.00	52.33	100	135			44.57	4.45	38.71	50.92	68.00	-17.08	
3506.66	54.00	100	180			46.60	2.43	31.92	41.75	68.00	-26.25	Ch. 52/
7013.32	58.00	100	180			45.04	3.51	35.93	52.40	68.00	-15.60	A
10520.00	51.83	100	135			44.52	4.44	38.70	50.46	68.00	-17.54	
3546.66	54.33	100	225			46.59	2.45	32.02	42.21	68.00	-25.79	Ch. 64/
7093.32	55.33	100	180			45.01	3.53	36.14	49.99	68.00	-18.01	A
10640.00	50.67	100	135			44.67	4.46	38.73	49.18	74.00	-24.82	
10640.00				40.36	A	44.67	4.46	38.73	38.87	54.00	-15.13	

**RADIATED EMISSIONS TEST RESULTS**

CLIENT:	Intel Corporation	DATE:	02/28/08
EUT:	Intel WiFi/WiMax Link 5350	PROJECT NUMBER:	INTEL-080114
MODEL NUMBER:	533ANXMMW	TEST ENGINEER:	JC/KN
SERIAL NUMBER:	0016EB01A3A8	SITE #:	2
CONFIGURATION:	Tested installed in an extender board connected to the host laptop's mini PCI slot in 802.11n (5150-5350 MHz) mode 20MHz Wide.	TEMPERATURE:	19 deg. C
		HUMIDITY:	45% RH
		TIME:	8:00 AM

Description:	Radiated RF Emissions (1 GHz – 18 GHz)
Results:	PASSED Horizontal and Vertical Antenna Polarizations Class B Limits
Note:	Radiated Emissions Measurements were performed on the EUT with power supply set at the following voltage and frequency. <ul style="list-style-type: none"> • 120VAC / 60 Hz.

Unwanted Spurious Emissions Limits			
Frequency (MHz)	Field Strength (uV/m)	Field Strength (dBuV/m) (Emissions in the restricted bands)	Field Strength (dBm/MHz) (Emissions outside the restricted bands)
Above 960	500	54.00 (Average) 74.00 (Peak)	< -20 dBc

Radiated Emissions Sample Calculations

$$\text{Corrected Meter Reading} = \text{Meter Reading} + F + C - D$$

Where, F = Antenna Factor

C = Cable Factor

G = Amplifier Gain

D = Distance Factor (if applicable)

Therefore, the equation for determining the Corrected Meter Reading Limit (CML) is:

$$\text{CML} = \text{Specification Limit} - F - C + D$$



Radiated Emissions Test Results (Continued)

*Fundamental Measurements in 802.11n mode 20MHz Wide (5150-5350 MHz)
 Channels 36, 40, 48, 52, & 64
 Continuous TX at Chain A Antenna port
 Aegis Labs, Inc. File #: INTEL-080114-57*

RADIATED EMISSIONS - Horizontal Antenna Polarization											
<i>Freq. (MHz)</i>	<i>Meter Reading (dBuV)</i>	<i>Antenna Height (cm)</i>	<i>Azimuth (degrees)</i>	<i>Quasi pk or AVG (dBuV)</i>		<i>Cable Factor (dB)</i>	<i>Ant. Factor (dB)</i>	<i>Corrected Reading (dBuV)</i>	<i>Limits (dBuV)</i>	<i>Diff (dB) +=FAIL</i>	<i>Comments</i>
5180.00	69.17	100	45			2.98	34.62	106.77			Ch. 36
5180.00				58.33	A	2.98	34.62	95.93			
5200.00	68.83	100	45			2.98	34.66	106.47			Ch. 40
5200.00				58.83	A	2.98	34.66	96.47			
5240.00	67.83	100	135			3.00	34.73	105.56			Ch. 48
5240.00				58.00	A	3.00	34.73	95.73			
5260.00	67.17	100	45			3.00	34.77	104.94			Ch. 52
5260.00				57.67	A	3.00	34.77	95.44			
5320.00	68.67	100	135			3.02	34.88	106.57			Ch. 64
5320.00				58.33	A	3.02	34.88	96.23			

RADIATED EMISSIONS - Vertical Antenna Polarization											
<i>Freq. (MHz)</i>	<i>Meter Reading (dBuV)</i>	<i>Antenna Height (cm)</i>	<i>Azimuth (degrees)</i>	<i>Quasi pk or AVG (dBuV)</i>		<i>Cable Factor (dB)</i>	<i>Ant. Factor (dB)</i>	<i>Corrected Reading (dBuV)</i>	<i>Limits (dBuV)</i>	<i>Diff (dB) +=FAIL</i>	<i>Comments</i>
5180.00	69.00	100	315			2.98	34.39	106.37			Ch. 36
5180.00				58.67	A	2.98	34.39	96.04			
5200.00	67.33	100	315			2.98	34.42	104.73			Ch. 40
5200.00				57.17	A	2.98	34.42	94.57			
5240.00	67.33	100	315			3.00	34.48	104.81			Ch. 48
5240.00				56.83	A	3.00	34.48	94.31			
5260.00	66.83	100	315			3.00	34.52	104.35			Ch. 52
5260.00				57.17	A	3.00	34.52	94.69			
5320.00	66.00	100	315			3.02	34.61	103.63			Ch. 64
5320.00				56.17	A	3.02	34.61	93.80			

NOTE: Fundamental signals measured to calculate the band edge field strengths using the “Marker Delta Method”.



Radiated Emissions Test Results (Continued)

*Band Edge Field Strength Measurements in 802.11n mode 20MHz Wide (5150-5350 MHz)
Channels 36 & 64
Continuous TX at Chain A Antenna port
Aegis Labs, Inc. File #: INTEL-080114-57*

RADIATED EMISSIONS - Horizontal Antenna Polarization										
<i>Freq. (MHz)</i>	<i>Meter Reading (dBuV)</i>	<i>Antenna Height (cm)</i>	<i>Azimuth (degrees)</i>	<i>Quasi pk or AVG (dBuV)</i>	<i>Cable Factor (dB)</i>	<i>Ant. Factor (dB)</i>	<i>Corrected Reading (dBuV)</i>	<i>Limits (dBuV)</i>	<i>Diff (dB) +=FAIL</i>	<i>Comments</i>
5150.00							66.27	74.00	-7.73	Ch. 36
5150.00					A		45.10	54.00	-8.90	
5350.00							65.57	74.00	-8.43	Ch. 64
5350.00					A		46.06	54.00	-7.94	

RADIATED EMISSIONS - Vertical Antenna Polarization										
<i>Freq. (MHz)</i>	<i>Meter Reading (dBuV)</i>	<i>Antenna Height (cm)</i>	<i>Azimuth (degrees)</i>	<i>Quasi pk or AVG (dBuV)</i>	<i>Cable Factor (dB)</i>	<i>Ant. Factor (dB)</i>	<i>Corrected Reading (dBuV)</i>	<i>Limits (dBuV)</i>	<i>Diff (dB) +=FAIL</i>	<i>Comments</i>
5150.00							65.87	74.00	-8.13	Ch. 36
5150.00					A		45.21	54.00	-8.79	
5350.00							62.63	74.00	-11.37	Ch. 64
5350.00					A		43.63	54.00	-10.37	

NOTE: The “Band Edge Field Strength” was calculated using the “Fundamental” and “Conducted Band Edge” measurements per the “Marker-Delta Method” with the following formula:

$$BE = Fm - \Delta m$$

Where

BE = Band Edge Field Strength

Fm = Measured Fundamental (Peak or Average)

Δm = Measured Conducted Band Edge Delta (Peak or Average)

Radiated Emissions Test Results (Continued)

Plots Showing Out-Of-Band Emissions (Peak RBW=VBW=1MHz; Average RBW = 1MHz, VBW = 10Hz)

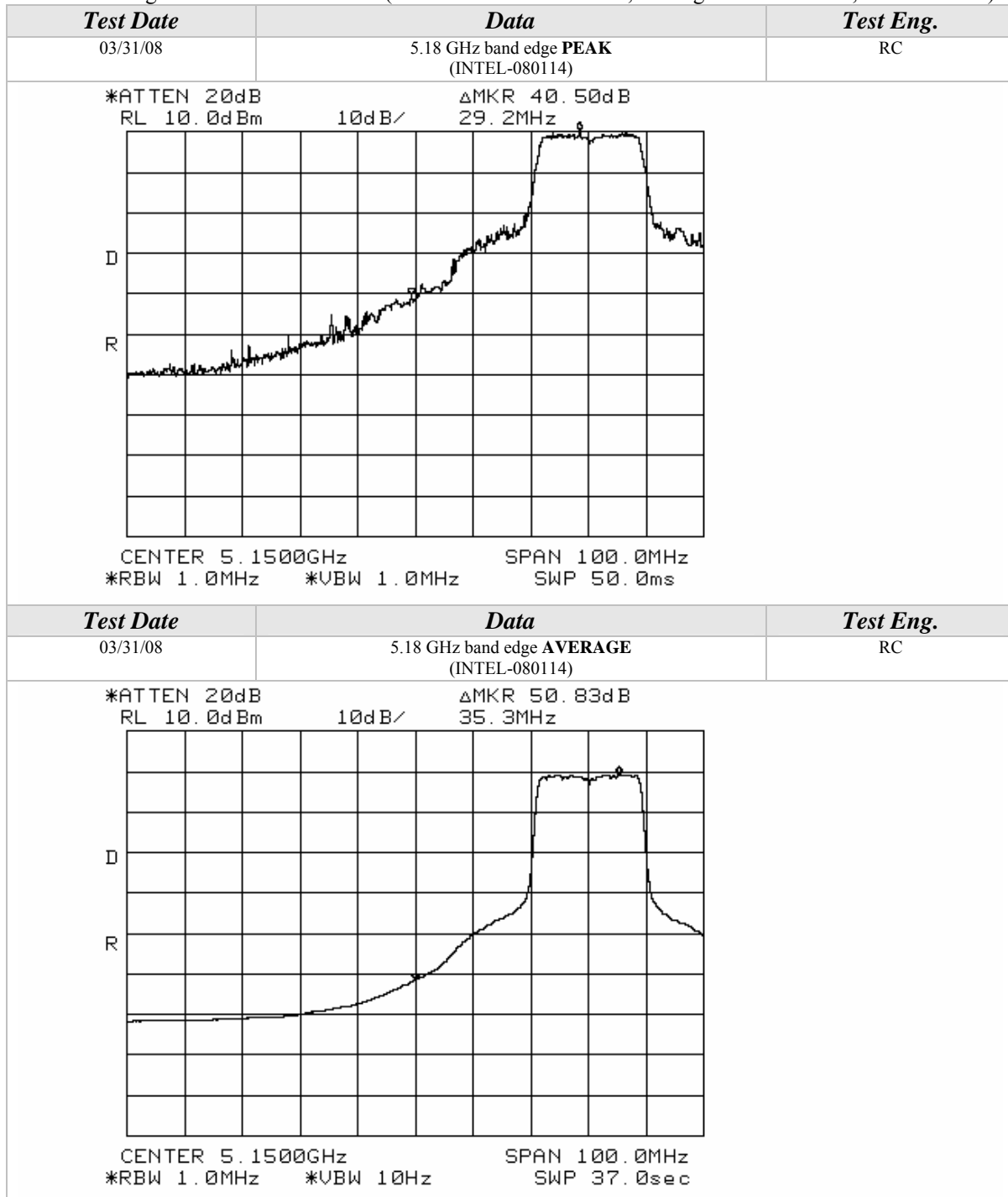

Radiated Emissions Test Results (Continued)

Plots Showing Out-Of-Band Emissions (Peak RBW=VBW=1MHz; Average RBW = 1MHz, VBW = 10Hz)

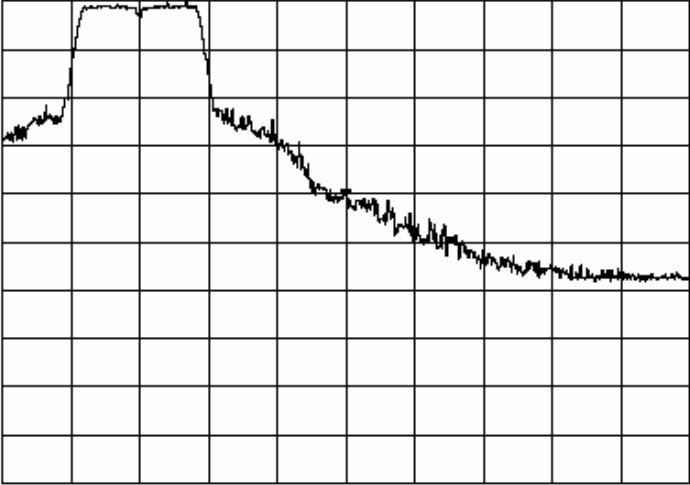
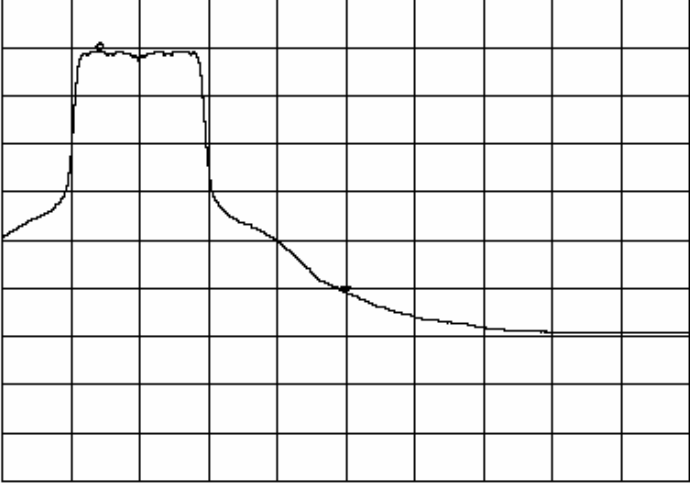
Test Date	Data	Test Eng.
03/31/08	5.32 GHz band edge PEAK (INTEL-080114)	RC
<div style="display: flex; justify-content: space-between;"> <div data-bbox="329 422 516 474"> <p>*ATTEN 20dB RL 10.0dBm</p> </div> <div data-bbox="743 422 954 474"> <p>ΔMKR 41.00dB -23.2MHz</p> </div> </div>  <div style="display: flex; justify-content: space-between; margin-top: 10px;"> <div data-bbox="329 961 751 1014"> <p>CENTER 5.3500GHz *RBW 1.0MHz *VBW 1.0MHz</p> </div> <div data-bbox="802 961 1023 1014"> <p>SPAN 100.0MHz SWP 50.0ms</p> </div> </div>		
Test Date	Data	Test Eng.
03/31/08	5.32 GHz band edge AVERAGE (INTEL-080114)	RC
<div style="display: flex; justify-content: space-between;"> <div data-bbox="329 1134 516 1186"> <p>*ATTEN 20dB RL 10.0dBm</p> </div> <div data-bbox="743 1134 954 1186"> <p>ΔMKR 50.17dB -35.8MHz</p> </div> </div>  <div style="display: flex; justify-content: space-between; margin-top: 10px;"> <div data-bbox="329 1673 719 1726"> <p>CENTER 5.3500GHz *RBW 1.0MHz *VBW 10Hz</p> </div> <div data-bbox="802 1673 1023 1726"> <p>SPAN 100.0MHz SWP 37.0sec</p> </div> </div>		



Radiated Emissions Test Results (Continued)

*Fundamental Measurements in 802.11n mode 20MHz Wide (5150-5350 MHz)
 Channels 36, 40, 48, 52, & 64
 Continuous TX at Chain B Antenna port
 Aegis Labs, Inc. File #: INTEL-080114-58*

RADIATED EMISSIONS - Horizontal Antenna Polarization											
Freq. (MHz)	Meter Reading (dBuV)	Antenna Height (cm)	Azimuth (degrees)	Quasi pk or AVG (dBuV)		Cable Factor (dB)	Ant. Factor (dB)	Corrected Reading (dBuV)	Limits (dBuV)	Diff (dB) +=FAIL	Comments
5180.00	72.50	100	225			2.98	34.62	110.10			Ch. 36
5180.00				62.17	A	2.98	34.62	99.77			
5200.00	72.50	100	270			2.98	34.66	110.14			Ch. 40
5200.00				62.67	A	2.98	34.66	100.31			
5240.00	73.17	100	270			3.00	34.73	110.90			Ch. 48
5240.00				62.83	A	3.00	34.73	100.56			
5260.00	72.83	100	270			3.00	34.77	110.60			Ch. 52
5260.00				62.17	A	3.00	34.77	99.94			
5320.00	72.33	100	270			3.02	34.88	110.23			Ch. 64
5320.00				61.67	A	3.02	34.88	99.57			

RADIATED EMISSIONS - Vertical Antenna Polarization											
Freq. (MHz)	Meter Reading (dBuV)	Antenna Height (cm)	Azimuth (degrees)	Quasi pk or AVG (dBuV)		Cable Factor (dB)	Ant. Factor (dB)	Corrected Reading (dBuV)	Limits (dBuV)	Diff (dB) +=FAIL	Comments
5180.00	63.33	100	225			2.98	34.39	100.70			Ch. 36
5180.00				53.33	A	2.98	34.39	90.70			
5200.00	64.17	100	180			2.98	34.42	101.57			Ch. 40
5200.00				54.33	A	2.98	34.42	91.73			
5240.00	65.00	100	225			3.00	34.48	102.48			Ch. 48
5240.00				55.00	A	3.00	34.48	92.48			
5260.00	65.17	100	225			3.00	34.52	102.69			Ch. 52
5260.00				54.83	A	3.00	34.52	92.35			
5320.00	62.83	100	135			3.02	34.61	100.46			Ch. 64
5320.00				53.33	A	3.02	34.61	90.96			

NOTE: Fundamental signals measured to calculate the band edge field strengths using the “Marker Delta Method”.



Radiated Emissions Test Results (Continued)

*Band Edge Field Strength Measurements in 802.11n mode 20MHz Wide (5150-5350 MHz)
Channels 36 & 64
Continuous TX at Chain B Antenna port
Aegis Labs, Inc. File #: INTEL-080114-58*

RADIATED EMISSIONS - Horizontal Antenna Polarization										
<i>Freq. (MHz)</i>	<i>Meter Reading (dBuV)</i>	<i>Antenna Height (cm)</i>	<i>Azimuth (degrees)</i>	<i>Quasi pk or AVG (dBuV)</i>	<i>Cable Factor (dB)</i>	<i>Ant. Factor (dB)</i>	<i>Corrected Reading (dBuV)</i>	<i>Limits (dBuV)</i>	<i>Diff (dB) +=FAIL</i>	<i>Comments</i>
5150.00							69.77	74.00	-4.23	Ch. 36
5150.00					A		49.27	54.00	-4.73	
5350.00							71.06	74.00	-2.94	Ch. 64
5350.00					A		47.90	54.00	-6.10	

RADIATED EMISSIONS - Vertical Antenna Polarization										
<i>Freq. (MHz)</i>	<i>Meter Reading (dBuV)</i>	<i>Antenna Height (cm)</i>	<i>Azimuth (degrees)</i>	<i>Quasi pk or AVG (dBuV)</i>	<i>Cable Factor (dB)</i>	<i>Ant. Factor (dB)</i>	<i>Corrected Reading (dBuV)</i>	<i>Limits (dBuV)</i>	<i>Diff (dB) +=FAIL</i>	<i>Comments</i>
5150.00							60.37	74.00	-13.63	Ch. 36
5150.00					A		40.20	54.00	-13.80	
5350.00							61.29	74.00	-12.71	Ch. 64
5350.00					A		39.29	54.00	-14.71	

NOTE: The “Band Edge Field Strength” was calculated using the “Fundamental” and “Conducted Band Edge” measurements per the “Marker-Delta Method” with the following formula:

$$BE = Fm - \Delta m$$

Where

BE = Band Edge Field Strength

Fm = Measured Fundamental (Peak or Average)

Δm = Measured Conducted Band Edge Delta (Peak or Average)



Radiated Emissions Test Results (Continued)

Plots Showing Out-Of-Band Emissions (Peak RBW=VBW=1MHz; Average RBW = 1MHz, VBW = 10Hz)

<i>Test Date</i>	<i>Data</i>	<i>Test Eng.</i>
03/31/08	5.18 GHz band edge PEAK (INTEL-080114)	RC
<p>*ATTEN 20dB ΔMKR 40.33dB RL 10.0dBm 10dB/ 36.0MHz</p> <p>CENTER 5.1500GHz SPAN 100.0MHz *RBW 1.0MHz *VBW 1.0MHz SWP 50.0ms</p>		
<i>Test Date</i>	<i>Data</i>	<i>Test Eng.</i>
03/31/08	5.18 GHz band edge AVERAGE (INTEL-080114)	RC
<p>*ATTEN 20dB ΔMKR 50.50dB RL 10.0dBm 10dB/ 33.3MHz</p> <p>CENTER 5.1500GHz SPAN 100.0MHz *RBW 1.0MHz *VBW 10Hz SWP 37.0sec</p>		

Radiated Emissions Test Results (Continued)

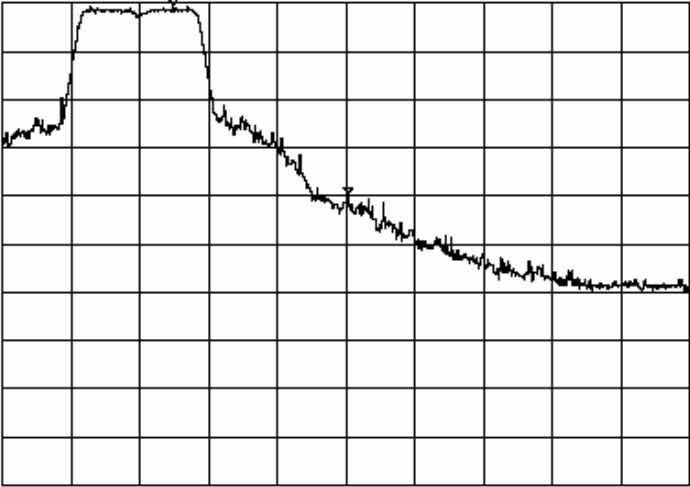
Plots Showing Out-Of-Band Emissions (Peak RBW=VBW=1MHz; Average RBW = 1MHz, VBW = 10Hz)

Test Date	Data	Test Eng.
03/31/08	5.32 GHz band edge PEAK (INTEL-080114)	RC
<div style="display: flex; justify-content: space-between;"> *ATTEN 20dB ΔMKR 39.17dB </div> <div style="display: flex; justify-content: space-between;"> RL 10.0dBm 10dB/ -25.5MHz </div>  <div style="display: flex; justify-content: space-between; margin-top: 10px;"> CENTER 5.350GHz SPAN 100.0MHz </div> <div style="display: flex; justify-content: space-between;"> *RBW 1.0MHz *VBW 1.0MHz SWP 50.0ms </div>		
Test Date	Data	Test Eng.
03/31/08	5.32 GHz band edge AVERAGE (INTEL-080114)	RC
<div style="display: flex; justify-content: space-between;"> *ATTEN 20dB ΔMKR 51.67dB </div> <div style="display: flex; justify-content: space-between;"> RL 10.0dBm 10dB/ -25.0MHz </div>  <div style="display: flex; justify-content: space-between; margin-top: 10px;"> CENTER 5.350GHz SPAN 100.0MHz </div> <div style="display: flex; justify-content: space-between;"> *RBW 1.0MHz *VBW 10Hz SWP 37.0sec </div>		



Radiated Emissions Test Results (Continued)

*Fundamental Measurements in 802.11n mode 20MHz Wide (5150-5350 MHz)
 Channels 36, 40, 48, 52, & 64
 Continuous TX at Chain C Antenna port
 Aegis Labs, Inc. File #: INTEL-080114-59*

RADIATED EMISSIONS - Horizontal Antenna Polarization											
<i>Freq. (MHz)</i>	<i>Meter Reading (dBuV)</i>	<i>Antenna Height (cm)</i>	<i>Azimuth (degrees)</i>	<i>Quasi pk or AVG (dBuV)</i>		<i>Cable Factor (dB)</i>	<i>Ant. Factor (dB)</i>	<i>Corrected Reading (dBuV)</i>	<i>Limits (dBuV)</i>	<i>Diff (dB) +=FAIL</i>	<i>Comments</i>
5180.00	68.67	100	135			2.98	34.62	106.27			Ch. 36
5180.00				58.83	A	2.98	34.62	96.43			
5200.00	69.17	100	135			2.98	34.66	106.81			Ch. 40
5200.00				59.33	A	2.98	34.66	96.97			
5240.00	68.33	100	135			3.00	34.73	106.06			Ch. 48
5240.00				58.33	A	3.00	34.73	96.06			
5260.00	67.33	100	135			3.00	34.77	105.10			Ch. 52
5260.00				57.00	A	3.00	34.77	94.77			
5320.00	68.67	100	135			3.02	34.88	106.57			Ch. 64
5320.00				58.50	A	3.02	34.88	96.40			

RADIATED EMISSIONS - Vertical Antenna Polarization											
<i>Freq. (MHz)</i>	<i>Meter Reading (dBuV)</i>	<i>Antenna Height (cm)</i>	<i>Azimuth (degrees)</i>	<i>Quasi pk or AVG (dBuV)</i>		<i>Cable Factor (dB)</i>	<i>Ant. Factor (dB)</i>	<i>Corrected Reading (dBuV)</i>	<i>Limits (dBuV)</i>	<i>Diff (dB) +=FAIL</i>	<i>Comments</i>
5180.00	67.67	100	135			2.98	34.39	105.04			Ch. 36
5180.00				57.33	A	2.98	34.39	94.70			
5200.00	67.17	100	90			2.98	34.42	104.57			Ch. 40
5200.00				57.50	A	2.98	34.42	94.90			
5240.00	67.83	100	90			3.00	34.48	105.31			Ch. 48
5240.00				57.50	A	3.00	34.48	94.98			
5260.00	66.83	100	90			3.00	34.52	104.35			Ch. 52
5260.00				56.33	A	3.00	34.52	93.85			
5320.00	67.00	100	90			3.02	34.61	104.63			Ch. 64
5320.00				57.00	A	3.02	34.61	94.63			

NOTE: Fundamental signals measured to calculate the band edge field strengths using the “Marker Delta Method”.



Radiated Emissions Test Results (Continued)

*Band Edge Field Strength Measurements in 802.11n mode 20MHz Wide (5150-5350 MHz)
Channels 36 & 64
Continuous TX at Chain C Antenna port
Aegis Labs, Inc. File #: INTEL-080114-59*

RADIATED EMISSIONS - Horizontal Antenna Polarization										
<i>Freq. (MHz)</i>	<i>Meter Reading (dBuV)</i>	<i>Antenna Height (cm)</i>	<i>Azimuth (degrees)</i>	<i>Quasi pk or AVG (dBuV)</i>	<i>Cable Factor (dB)</i>	<i>Ant. Factor (dB)</i>	<i>Corrected Reading (dBuV)</i>	<i>Limits (dBuV)</i>	<i>Diff (dB) +=FAIL</i>	<i>Comments</i>
5150.00							63.43	74.00	-10.57	Ch. 36
5150.00					A		43.26	54.00	-10.74	
5350.00							63.23	74.00	-10.77	Ch. 64
5350.00					A		42.57	54.00	-11.43	

RADIATED EMISSIONS - Vertical Antenna Polarization										
<i>Freq. (MHz)</i>	<i>Meter Reading (dBuV)</i>	<i>Antenna Height (cm)</i>	<i>Azimuth (degrees)</i>	<i>Quasi pk or AVG (dBuV)</i>	<i>Cable Factor (dB)</i>	<i>Ant. Factor (dB)</i>	<i>Corrected Reading (dBuV)</i>	<i>Limits (dBuV)</i>	<i>Diff (dB) +=FAIL</i>	<i>Comments</i>
5150.00							62.20	74.00	-11.80	Ch. 36
5150.00					A		41.53	54.00	-12.47	
5350.00							61.29	74.00	-12.71	Ch. 64
5350.00					A		40.80	54.00	-13.20	

NOTE: The “Band Edge Field Strength” was calculated using the “Fundamental” and “Conducted Band Edge” measurements per the “Marker-Delta Method” with the following formula:

$$BE = Fm - \Delta m$$

Where

BE = Band Edge Field Strength

Fm = Measured Fundamental (Peak or Average)

Δm = Measured Conducted Band Edge Delta (Peak or Average)



Radiated Emissions Test Results (Continued)

Plots Showing Out-Of-Band Emissions (Peak RBW=VBW=1MHz; Average RBW = 1MHz, VBW = 10Hz)

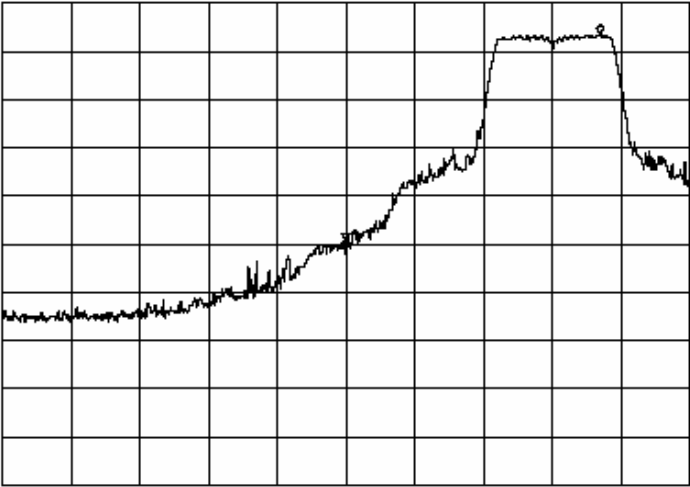
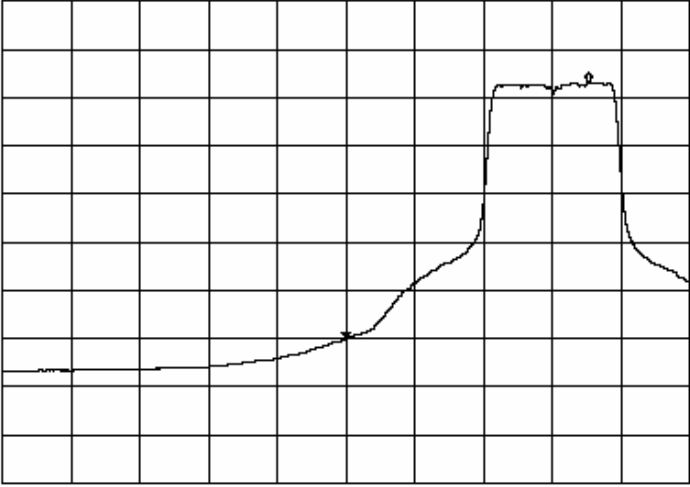
Test Date	Data	Test Eng.
03/31/08	5.18 GHz band edge PEAK (INTEL-080114)	RC
<p>*ATTEN 20dB ΔMKR 42.84dB RL 16.0dBm 10dB/ 37.0MHz</p>  <p>CENTER 5.1500GHz SPAN 100.0MHz *RBW 1.0MHz *VBW 1.0MHz SWP 50.0ms</p>		
Test Date	Data	Test Eng.
03/31/08	5.18 GHz band edge AVERAGE (INTEL-080114)	RC
<p>*ATTEN 20dB ΔMKR 53.17dB RL 16.0dBm 10dB/ 35.3MHz</p>  <p>CENTER 5.1500GHz SPAN 100.0MHz *RBW 1.0MHz *VBW 10Hz SWP 37.0sec</p>		

Radiated Emissions Test Results (Continued)

Plots Showing Out-Of-Band Emissions (Peak RBW=VBW=1MHz; Average RBW = 1MHz, VBW = 10Hz)

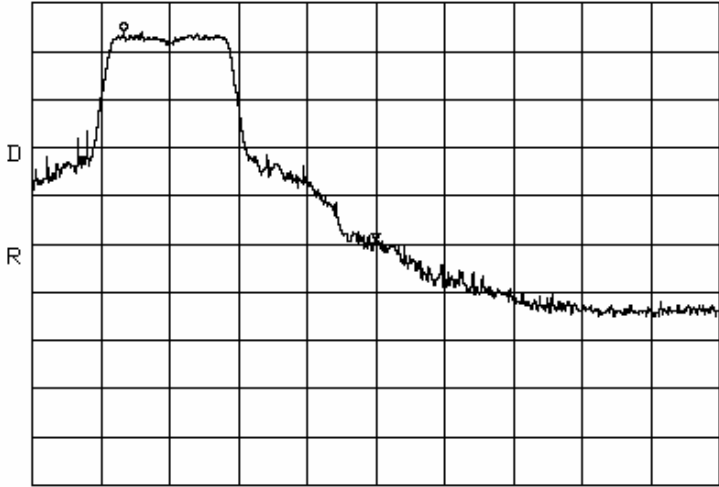
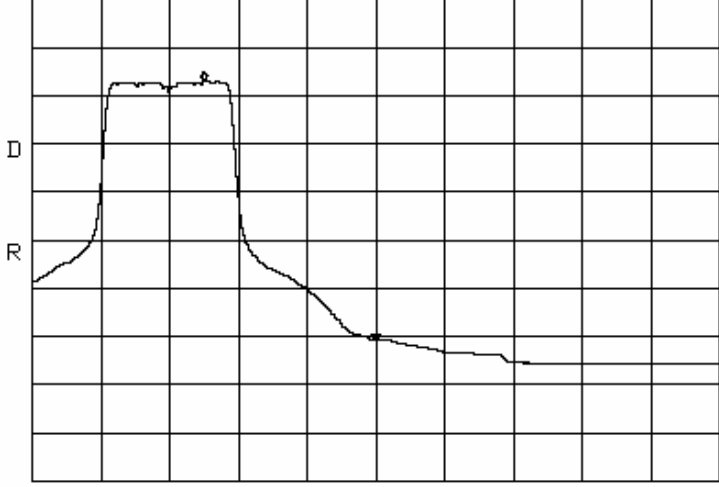
<i>Test Date</i>	<i>Data</i>	<i>Test Eng.</i>
03/31/08	5.32 GHz band edge PEAK (INTEL-080114)	RC
*ATTEN 20dB RL 16.0dBm 10dB/ ΔMKR 43.34dB -36.7MHz 		
CENTER 5.3500GHz SPAN 100.0MHz *RBW 1.0MHz *VBW 1.0MHz SWP 50.0ms		
<i>Test Date</i>	<i>Data</i>	<i>Test Eng.</i>
03/31/08	5.32 GHz band edge AVERAGE (INTEL-080114)	RC
*ATTEN 20dB RL 16.0dBm 10dB/ ΔMKR 53.83dB -25.0MHz 		
CENTER 5.3500GHz SPAN 100.0MHz *RBW 1.0MHz *VBW 10Hz SWP 37.0sec		



Radiated Emissions Test Results (Continued)

*Spurious Emissions Measurements in 802.11n mode 20MHz Wide (5150-5350 MHz)
Channels 36, 40, & 48
Continuous TX at Chain A, B, & C Antenna ports
Aegis Labs, Inc. File #: INTEL-080114-05*

RADIATED EMISSIONS - Horizontal Antenna Polarization

Freq. (MHz)	Meter Reading (dBuV)	Antenna Height (cm)	Azimuth (degrees)	Quasi pk or AVG (dBuV)	Preamp Factor (dB)	Cable Factor (dB)	Ant. Factor (dB)	Corrected Reading (dBuV)	Limits (dBuV)	Diff (dB) +/-FAIL	Channel/ Chain Tested
3466.66	53.83	100	225		46.60	2.42	32.32	41.97	68.00	-26.03	Ch. 40/
6933.33	57.17	100	180		45.15	3.48	35.93	51.43	68.00	-16.57	A
3466.66	53.17	100	135		46.60	2.42	32.32	41.31	68.00	-26.69	Ch. 40/
6933.33	54.33	100	135		45.15	3.48	35.93	48.59	68.00	-19.41	B
10400.00	50.67	100	180		44.48	4.40	38.64	49.24	68.00	-18.76	
3466.66	53.33	100	225		46.60	2.42	32.32	41.47	68.00	-26.53	Ch. 40/
6933.33	55.17	100	90		45.15	3.48	35.93	49.43	68.00	-18.57	C
3453.33	53.33	100	225		46.60	2.41	32.29	41.43	68.00	-26.57	Ch. 36/
6906.66	58.00	100	180		45.19	3.47	35.91	52.19	68.00	-15.81	A
10359.99	58.33	100	180		44.47	4.39	38.62	56.86	68.00	-11.14	
3493.33	55.17	100	225		46.60	2.43	32.38	43.38	68.00	-24.62	Ch. 48/
6986.66	57.83	100	180		45.07	3.50	35.99	52.25	68.00	-15.75	A
10480.00	50.50	100	180		44.49	4.43	38.69	49.13	68.00	-18.87	

RADIATED EMISSIONS - Vertical Antenna Polarization

Freq. (MHz)	Meter Reading (dBuV)	Antenna Height (cm)	Azimuth (degrees)	Quasi pk or AVG (dBuV)	Preamp Factor (dB)	Cable Factor (dB)	Ant. Factor (dB)	Corrected Reading (dBuV)	Limits (dBuV)	Diff (dB) +/-FAIL	Comments
3466.66	53.83	100	135		46.60	2.42	31.83	41.47	68.00	-26.53	Ch. 40/
6933.33	54.17	100	135		45.15	3.48	35.85	48.35	68.00	-19.65	A
3466.66	54.00	250	135		46.60	2.42	31.83	41.64	68.00	-26.36	Ch. 40/
6933.33	54.67	100	180		45.15	3.48	35.85	48.85	68.00	-19.15	B
10400.00	50.33	100	135		44.48	4.40	38.62	48.88	68.00	-19.12	
3466.66	53.83	100	135		46.60	2.42	31.83	41.47	68.00	-26.53	Ch. 40/
6933.33	55.33	100	180		45.15	3.48	35.85	49.51	68.00	-18.49	C
3453.33	53.67	100	135		46.60	2.41	31.80	41.28	68.00	-26.72	Ch. 36/
6906.66	56.67	100	225		45.19	3.47	35.83	50.77	68.00	-17.23	A
3493.33	55.17	100	135		46.60	2.43	31.89	42.88	68.00	-25.12	Ch. 48/
6986.66	53.50	100	180		45.07	3.50	35.89	47.82	68.00	-20.18	A



Radiated Emissions Test Results (Continued)

*Spurious Emissions Measurements in 802.11n mode 20MHz Wide (5150-5350 MHz)
 Channels 52, 56, & 64
 Continuous TX at Chain A, B, & C Antenna ports
 Aegis Labs, Inc. File #: INTEL-080114-05*

RADIATED EMISSIONS - Horizontal Antenna Polarization											
Freq. (MHz)	Meter Reading (dBuV)	Antenna Height (cm)	Azimuth (degrees)	Quasi pk or AVG (dBuV)	Preamp Factor (dB)	Cable Factor (dB)	Ant. Factor (dB)	Corrected Reading (dBuV)	Limits (dBuV)	Diff (dB) +/-FAIL	Channel/ Chain Tested
3520.00	55.50	100	270		46.59	2.44	32.44	43.79	68.00	-24.21	Ch. 56/
7040.00	56.33	100	135		45.03	3.51	36.10	50.92	68.00	-17.08	A
3520.00	54.17	100	315		46.59	2.44	32.44	42.46	68.00	-25.54	Ch. 56/
7040.00	53.67	100	135		45.03	3.51	36.10	48.26	68.00	-19.74	B
3520.00	55.83	100	270		46.59	2.44	32.44	44.12	68.00	-23.88	Ch. 56/
7040.00	53.67	100	90		45.03	3.51	36.10	48.26	68.00	-19.74	C
3506.66	53.17	100	315		46.60	2.43	32.41	41.42	68.00	-26.58	Ch. 52/
7013.32	57.83	100	135		45.04	3.51	36.03	52.33	68.00	-15.67	A
3546.66	54.33	100	270		46.59	2.45	32.50	42.69	68.00	-25.31	Ch. 64/
7093.32	54.17	100	135		45.01	3.53	36.24	48.93	68.00	-19.07	A

RADIATED EMISSIONS - Vertical Antenna Polarization											
Freq. (MHz)	Meter Reading (dBuV)	Antenna Height (cm)	Azimuth (degrees)	Quasi pk or AVG (dBuV)	Preamp Factor (dB)	Cable Factor (dB)	Ant. Factor (dB)	Corrected Reading (dBuV)	Limits (dBuV)	Diff (dB) +/-FAIL	Comments
3520.00	55.17	100	135		46.59	2.44	31.95	42.97	68.00	-25.03	Ch. 56/
7040.00	52.83	100	180		45.03	3.51	36.00	47.32	68.00	-20.68	A
3520.00	54.67	100	135		46.59	2.44	31.95	42.47	68.00	-25.53	Ch. 56/
7040.00	54.67	100	135		45.03	3.51	36.00	49.16	68.00	-18.84	B
3520.00	54.17	100	180		46.59	2.44	31.95	41.97	68.00	-26.03	Ch. 56/
7040.00	51.83	100	180		45.03	3.51	36.00	46.32	68.00	-21.68	C
3506.66	54.17	100	135		46.60	2.43	31.92	41.92	68.00	-26.08	Ch. 52/
7013.32	54.50	100	135		45.04	3.51	35.93	48.90	68.00	-19.10	A
10520.00	51.33	100	135		44.52	4.44	38.70	49.96	68.00	-18.04	
3546.66	53.83	100	135		46.59	2.45	32.02	41.71	68.00	-26.29	Ch. 64/
7093.32	53.33	100	135		45.01	3.53	36.14	47.99	68.00	-20.01	A



Radiated Emissions Test Results (Continued)

*Spurious Emissions Measurements in 802.11n mode 20MHz Wide (5150-5350 MHz)
Channels 36, 40, & 48
Continuous TX at Triple Chain ABC Antenna ports
Aegis Labs, Inc. File #: INTEL-080114-06*

RADIATED EMISSIONS - Horizontal Antenna Polarization

Freq. (MHz)	Meter Reading (dBuV)	Antenna Height (cm)	Azimuth (degrees)	Quasi pk or AVG (dBuV)	Preamp Factor (dB)	Cable Factor (dB)	Ant. Factor (dB)	Corrected Reading (dBuV)	Limits (dBuV)	Diff (dB) +=FAIL	Channel/ Chain Tested
3453.33	53.33	100	135		46.60	2.41	32.29	41.43	68.00	-26.57	Ch. 36/
6906.66	53.83	100	135		45.19	3.47	35.91	48.02	68.00	-19.98	ABC
10359.99	51.00	100	180		44.47	4.39	38.62	49.53	68.00	-18.47	
3466.66	53.83	100	135		46.60	2.42	32.32	41.97	68.00	-26.03	Ch. 40/
6933.33	59.83	100	225		45.15	3.48	35.93	54.09	68.00	-13.91	ABC
10399.98	50.83	100	180		44.48	4.40	38.64	49.40	68.00	-18.60	
3493.33	52.67	100	135		46.60	2.43	32.38	40.88	68.00	-27.12	Ch. 48/
6986.66	59.00	100	135		45.07	3.50	35.99	53.42	68.00	-14.58	ABC

RADIATED EMISSIONS - Vertical Antenna Polarization

Freq. (MHz)	Meter Reading (dBuV)	Antenna Height (cm)	Azimuth (degrees)	Quasi pk or AVG (dBuV)	Preamp Factor (dB)	Cable Factor (dB)	Ant. Factor (dB)	Corrected Reading (dBuV)	Limits (dBuV)	Diff (dB) +=FAIL	Comments
3453.33	53.50	100	315		46.60	2.41	31.80	41.11	68.00	-26.89	Ch. 36/
6906.66	60.17	100	225		45.19	3.47	35.83	54.27	68.00	-13.73	ABC
10359.99	50.50	100	180		44.47	4.39	38.59	49.01	68.00	-18.99	
3466.66	55.17	100	135		46.60	2.42	31.83	42.81	68.00	-25.19	Ch. 40/
6933.33	59.00	100	135		45.15	3.48	35.85	53.18	68.00	-14.82	ABC
10399.99	51.50	100	180		44.48	4.40	38.62	50.05	68.00	-17.95	
3493.33	54.67	100	135		46.60	2.43	31.89	42.38	68.00	-25.62	Ch. 48/
6986.66	58.17	100	225		45.07	3.50	35.89	52.49	68.00	-15.51	ABC
10479.91	52.50	100	180		44.49	4.43	38.68	51.13	68.00	-16.87	



Radiated Emissions Test Results (Continued)

Spurious Emissions Measurements in 802.11n mode 20MHz Wide (5150-5350 MHz)
Channels 52, 56, & 64
Continuous TX at Chain A, B, & C Antenna ports
Aegis Labs, Inc. File #: INTEL-080114-06

RADIATED EMISSIONS - Horizontal Antenna Polarization

Freq. (MHz)	Meter Reading (dBuV)	Antenna Height (cm)	Azimuth (degrees)	Quasi pk or AVG (dBuV)	Preamp Factor (dB)	Cable Factor (dB)	Ant. Factor (dB)	Corrected Reading (dBuV)	Limits (dBuV)	Diff (dB) +=FAIL	Channel/ Chain Tested
3506.66	53.33	100	135		46.60	2.43	32.41	41.58	68.00	-26.42	Ch. 52/
7013.32	59.67	100	135		45.04	3.51	36.03	54.17	68.00	-13.83	ABC
3520.00	53.00	100	135		46.59	2.44	32.44	41.29	68.00	-26.71	Ch. 56/
7040.00	54.00	100	225		45.03	3.51	36.10	48.59	68.00	-19.41	ABC
3546.66	54.67	100	135		46.59	2.45	32.50	43.03	68.00	-24.97	Ch. 64/
7093.32	55.83	100	135		45.01	3.53	36.24	50.59	68.00	-17.41	ABC

RADIATED EMISSIONS - Vertical Antenna Polarization

Freq. (MHz)	Meter Reading (dBuV)	Antenna Height (cm)	Azimuth (degrees)	Quasi pk or AVG (dBuV)	Preamp Factor (dB)	Cable Factor (dB)	Ant. Factor (dB)	Corrected Reading (dBuV)	Limits (dBuV)	Diff (dB) +=FAIL	Comments
3506.66	54.67	100	135		46.60	2.43	31.92	42.42	68.00	-25.58	Ch. 52/
7013.32	58.33	100	225		45.04	3.51	35.93	52.73	68.00	-15.27	ABC
10520.00	51.83	100	180		44.52	4.44	38.70	50.46	68.00	-17.54	
3520.00	56.33	100	135		46.59	2.44	31.95	44.13	68.00	-23.87	Ch. 56/
7040.00	57.00	100	225		45.03	3.51	36.00	51.49	68.00	-16.51	ABC
1056.00	52.00	100	225		46.35	1.32	24.75	31.72	68.00	-36.28	
3546.66	54.33	100	135		46.59	2.45	32.02	42.21	68.00	-25.79	Ch. 64/
7093.32	55.17	100	225		45.01	3.53	36.14	49.83	68.00	-18.17	ABC
10639.98	50.50	100	225		44.67	4.46	38.73	49.01	68.00	-18.99	

**RADIATED EMISSIONS TEST RESULTS**

CLIENT:	Intel Corporation	DATE:	02/25/08
EUT:	Intel WiFi/WiMax Link 5350	PROJECT NUMBER:	INTEL-080114
MODEL NUMBER:	533ANXMMW	TEST ENGINEER:	JC/KN
SERIAL NUMBER:	0016EB01A3A8	SITE #:	2
CONFIGURATION:	Tested installed in an extender board connected to the host laptop's mini PCI slot in 802.11n (5150-5350 MHz) mode 40MHz Wide.	TEMPERATURE:	17 deg. C
		HUMIDITY:	52% RH
		TIME:	1:30 PM

Description:	Radiated RF Emissions (1 GHz – 18 GHz)
Results:	PASSED Horizontal and Vertical Antenna Polarizations Class B Limits
Note:	Radiated Emissions Measurements were performed on the EUT with power supply set at the following voltage and frequency. <ul style="list-style-type: none"> • 120VAC / 60 Hz.

Unwanted Spurious Emissions Limits			
Frequency (MHz)	Field Strength (uV/m)	Field Strength (dBuV/m) (Emissions in the restricted bands)	Field Strength (dBm/MHz) (Emissions outside the restricted bands)
Above 960	500	54.00 (Average) 74.00 (Peak)	< -20 dBc

Radiated Emissions Sample Calculations

$$\text{Corrected Meter Reading} = \text{Meter Reading} + F + C - D$$

Where, F = Antenna Factor

C = Cable Factor

G = Amplifier Gain

D = Distance Factor (if applicable)

Therefore, the equation for determining the Corrected Meter Reading Limit (CML) is:

$$\text{CML} = \text{Specification Limit} - F - C + D$$



Radiated Emissions Test Results (Continued)

*Fundamental Measurements in 802.11n mode 40MHz Wide (5150-5350 MHz)
 Channels 38, 46, 54, & 62
 Continuous TX at Chain A Antenna port
 Aegis Labs, Inc. File #: INTEL-080114-57*

RADIATED EMISSIONS - Horizontal Antenna Polarization											
<i>Freq. (MHz)</i>	<i>Meter Reading (dBuV)</i>	<i>Antenna Height (cm)</i>	<i>Azimuth (degrees)</i>	<i>Quasi pk or AVG (dBuV)</i>		<i>Cable Factor (dB)</i>	<i>Ant. Factor (dB)</i>	<i>Corrected Reading (dBuV)</i>	<i>Limits (dBuV)</i>	<i>Diff (dB) +=FAIL</i>	<i>Comments</i>
5190.00	64.67	100	45			2.98	34.64	102.29			Ch. 38
5190.00				53.47	A	2.98	34.64	91.09			
5230.00	64.33	100	45			2.99	34.71	102.04			Ch. 46
5230.00				53.67	A	2.99	34.71	91.38			
5270.00	65.17	100	45			3.01	34.79	102.96			Ch. 54
5270.00				54.17	A	3.01	34.79	91.96			
5310.00	64.17	100	135			3.02	34.86	102.05			Ch. 62
5310.00				53.67	A	3.02	34.86	91.55			

RADIATED EMISSIONS - Vertical Antenna Polarization											
<i>Freq. (MHz)</i>	<i>Meter Reading (dBuV)</i>	<i>Antenna Height (cm)</i>	<i>Azimuth (degrees)</i>	<i>Quasi pk or AVG (dBuV)</i>		<i>Cable Factor (dB)</i>	<i>Ant. Factor (dB)</i>	<i>Corrected Reading (dBuV)</i>	<i>Limits (dBuV)</i>	<i>Diff (dB) +=FAIL</i>	<i>Comments</i>
5190.00	63.50	100	315			2.98	34.40	100.89			Ch. 38
5190.00				52.67	A	2.98	34.40	90.06			
5230.00	62.83	100	315			2.99	34.47	100.29			Ch. 46
5230.00				52.67	A	2.99	34.47	90.13			
5270.00	63.00	100	315			3.01	34.53	100.54			Ch. 54
5270.00				52.83	A	3.01	34.53	90.37			
5310.00	62.17	100	315			3.02	34.60	99.78			Ch. 62
5310.00				52.17	A	3.02	34.60	89.78			

NOTE: Fundamental signals measured to calculate the band edge field strengths using the “Marker Delta Method”.



Radiated Emissions Test Results (Continued)

*Band Edge Field Strength Measurements in 802.11n mode 40MHz Wide (5150-5350 MHz)
Channels 38 & 62
Continuous TX at Chain A Antenna port
Aegis Labs, Inc. File #: INTEL-080114-57*

RADIATED EMISSIONS - Horizontal Antenna Polarization										
Freq. (MHz)	Meter Reading (dBuV)	Antenna Height (cm)	Azimuth (degrees)	Quasi pk or AVG (dBuV)	Cable Factor (dB)	Ant. Factor (dB)	Corrected Reading (dBuV)	Limits (dBuV)	Diff (dB) +=FAIL	Comments
5150.00							70.79	74.00	-3.21	Ch. 38
5150.00					A		53.75	54.00	-0.25	
5350.00							73.55	74.00	-0.45	Ch. 62
5350.00					A		53.38	54.00	-0.62	

RADIATED EMISSIONS - Vertical Antenna Polarization										
Freq. (MHz)	Meter Reading (dBuV)	Antenna Height (cm)	Azimuth (degrees)	Quasi pk or AVG (dBuV)	Cable Factor (dB)	Ant. Factor (dB)	Corrected Reading (dBuV)	Limits (dBuV)	Diff (dB) +=FAIL	Comments
5150.00							69.39	74.00	-4.61	Ch. 38
5150.00					A		52.72	54.00	-1.28	
5350.00							71.28	74.00	-2.72	Ch. 62
5350.00					A		51.61	54.00	-2.39	

NOTE: The “Band Edge Field Strength” was calculated using the “Fundamental” and “Conducted Band Edge” measurements per the “Marker-Delta Method” with the following formula:

$$BE = Fm - \Delta m$$

Where



BE = Band Edge Field Strength

Fm = Measured Fundamental (Peak or Average)

Δm = Measured Conducted Band Edge Delta (Peak or Average)

Radiated Emissions Test Results (Continued)

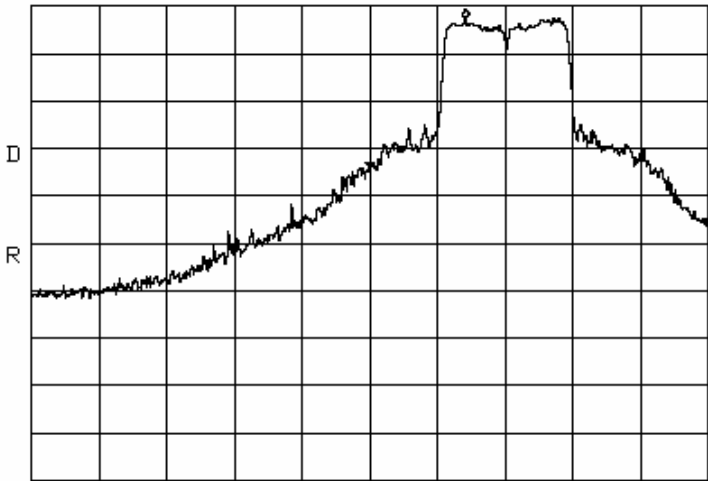
Plots Showing Out-Of-Band Emissions (Peak RBW=VBW=1MHz; Average RBW = 1MHz, VBW = 10Hz)

<i>Test Date</i>	<i>Data</i>	<i>Test Eng.</i>
03/31/08	5.19 GHz band edge PEAK (INTEL-080114)	RC
<p>*ATTEN 20dB ΔMKR 31.50dB RL 10.0dBm 10dB/ 28.3MHz</p>  <p>CENTER 5.1500GHz SPAN 200.0MHz *RBW 1.0MHz *VBW 1.0MHz SWP 50.0ms</p>		
<i>Test Date</i>	<i>Data</i>	<i>Test Eng.</i>
03/31/08	5.19 GHz band edge AVERAGE (INTEL-080114)	RC
<p>*ATTEN 20dB ΔMKR 37.34dB RL 10.0dBm 10dB/ 55.7MHz</p>  <p>CENTER 5.1500GHz SPAN 200.0MHz *RBW 1.0MHz *VBW 10Hz SWP 74.0sec</p>		

Radiated Emissions Test Results (Continued)

Plots Showing Out-Of-Band Emissions (Peak RBW=VBW=1MHz; Average RBW = 1MHz, VBW = 10Hz)

<i>Test Date</i>	<i>Data</i>	<i>Test Eng.</i>
03/31/08	5.31 GHz band edge PEAK (INTEL-080114)	RC
<p>*ATTEN 20dB ΔMKR 28.50dB RL 10.0dBm 10dB/ -55.7MHz</p> <p>CENTER 5.3500GHz SPAN 200.0MHz *RBW 1.0MHz *VBW 1.0MHz SWP 50.0ms</p>		
<i>Test Date</i>	<i>Data</i>	<i>Test Eng.</i>
03/31/08	5.31 GHz band edge AVERAGE (INTEL-080114)	RC
<p>*ATTEN 20dB ΔMKR 38.17dB RL 10.0dBm 10dB/ -29.0MHz</p> <p>CENTER 5.3500GHz SPAN 200.0MHz *RBW 1.0MHz *VBW 10Hz SWP 74.0sec</p>		



Radiated Emissions Test Results (Continued)

*Fundamental Measurements in 802.11n mode 40MHz Wide (5150-5350 MHz)
Channels 38, 46, 54, & 62
Continuous TX at Chain B Antenna port
Aegis Labs, Inc. File #: INTEL-080114-58*

RADIATED EMISSIONS - Horizontal Antenna Polarization											
<i>Freq. (MHz)</i>	<i>Meter Reading (dBuV)</i>	<i>Antenna Height (cm)</i>	<i>Azimuth (degrees)</i>	<i>Quasi pk or AVG (dBuV)</i>		<i>Cable Factor (dB)</i>	<i>Ant. Factor (dB)</i>	<i>Corrected Reading (dBuV)</i>	<i>Limits (dBuV)</i>	<i>Diff (dB) +=FAIL</i>	<i>Comments</i>
5190.00	62.67	100	270			2.98	34.64	100.29			Ch. 38
5190.00				52.00	A	2.98	34.64	89.62			
5230.00	62.50	100	270			2.99	34.71	100.21			Ch. 46
5230.00				52.83	A	2.99	34.71	90.54			
5270.00	62.17	100	270			3.01	34.79	99.96			Ch. 54
5270.00				52.17	A	3.01	34.79	89.96			
5310.00	62.50	100	270			3.02	34.86	100.38			Ch. 62
5310.00				52.00	A	3.02	34.86	89.88			

RADIATED EMISSIONS - Vertical Antenna Polarization											
<i>Freq. (MHz)</i>	<i>Meter Reading (dBuV)</i>	<i>Antenna Height (cm)</i>	<i>Azimuth (degrees)</i>	<i>Quasi pk or AVG (dBuV)</i>		<i>Cable Factor (dB)</i>	<i>Ant. Factor (dB)</i>	<i>Corrected Reading (dBuV)</i>	<i>Limits (dBuV)</i>	<i>Diff (dB) +=FAIL</i>	<i>Comments</i>
5190.00	59.50	100	180			2.98	34.40	96.89			Ch. 38
5190.00				48.83	A	2.98	34.40	86.22			
5230.00	61.50	100	225			2.99	34.47	98.96			Ch. 46
5230.00				50.00	A	2.99	34.47	87.46			
5270.00	58.33	100	225			3.01	34.53	95.87			Ch. 54
5270.00				48.67	A	3.01	34.53	86.21			
5310.00	57.83	100	135			3.02	34.60	95.44			Ch. 62
5310.00				47.50	A	3.02	34.60	85.11			

NOTE: Fundamental signals measured to calculate the band edge field strengths using the “Marker Delta Method”.



Radiated Emissions Test Results (Continued)

*Band Edge Field Strength Measurements in 802.11n mode 40MHz Wide (5150-5350 MHz)
Channels 38 & 62
Continuous TX at Chain B Antenna port
Aegis Labs, Inc. File #: INTEL-080114-58*

RADIATED EMISSIONS - Horizontal Antenna Polarization										
Freq. (MHz)	Meter Reading (dBuV)	Antenna Height (cm)	Azimuth (degrees)	Quasi pk or AVG (dBuV)	Cable Factor (dB)	Ant. Factor (dB)	Corrected Reading (dBuV)	Limits (dBuV)	Diff (dB) +=FAIL	Comments
5150.00							72.40	74.00	-1.60	Ch. 38
5150.00					A		53.79	54.00	-0.21	
5350.00							73.54	74.00	-0.46	Ch. 62
5350.00					A		52.88	54.00	-1.12	

RADIATED EMISSIONS - Vertical Antenna Polarization										
Freq. (MHz)	Meter Reading (dBuV)	Antenna Height (cm)	Azimuth (degrees)	Quasi pk or AVG (dBuV)	Cable Factor (dB)	Ant. Factor (dB)	Corrected Reading (dBuV)	Limits (dBuV)	Diff (dB) +=FAIL	Comments
5150.00							69.00	74.00	-5.00	Ch. 38
5150.00					A		50.39	54.00	-3.61	
5350.00							68.60	74.00	-5.40	Ch. 62
5350.00					A		48.11	54.00	-5.89	

NOTE: The “Band Edge Field Strength” was calculated using the “Fundamental” and “Conducted Band Edge” measurements per the “Marker-Delta Method” with the following formula:

$$BE = F_m - \Delta m$$

Where

BE = Band Edge Field Strength

F_m = Measured Fundamental (Peak or Average)

Δ_m = Measured Conducted Band Edge Delta (Peak or Average)

Radiated Emissions Test Results (Continued)

Plots Showing Out-Of-Band Emissions (Peak RBW=VBW=1MHz; Average RBW = 1MHz, VBW = 10Hz)

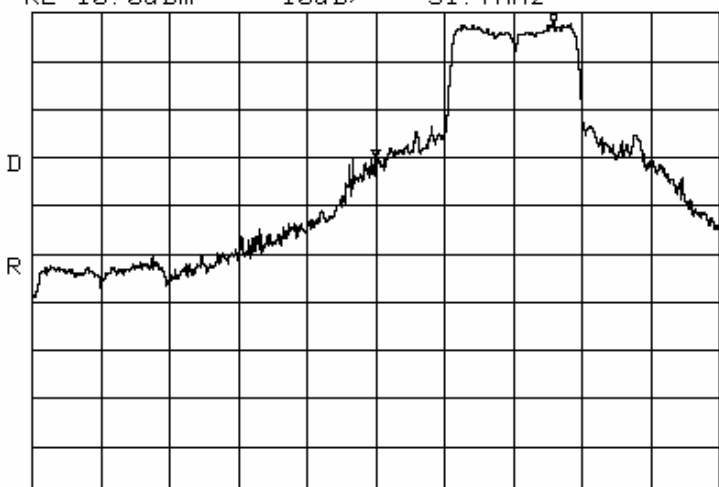
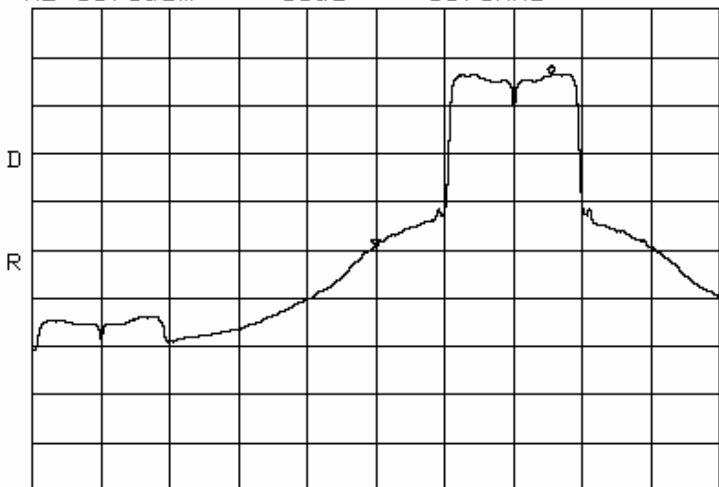
<i>Test Date</i>	<i>Data</i>	<i>Test Eng.</i>
03/31/08	5.19 GHz band edge PEAK (INTEL-080114)	RC
*ATTEN 20dB ΔMKR 27.84dB RL 10.0dBm 10dB/ 51.7MHz  <p style="text-align: center;"> CENTER 5.1500GHz SPAN 200.0MHz *RBW 1.0MHz *VBW 1.0MHz SWP 50.0ms </p>		
<i>Test Date</i>	<i>Data</i>	<i>Test Eng.</i>
03/31/08	5.19 GHz band edge AVERAGE (INTEL-080114)	RC
*ATTEN 20dB ΔMKR 35.83dB RL 10.0dBm 10dB/ 51.0MHz  <p style="text-align: center;"> CENTER 5.1500GHz SPAN 200.0MHz *RBW 1.0MHz *VBW 10Hz SWP 74.0sec </p>		

Radiated Emissions Test Results (Continued)

Plots Showing Out-Of-Band Emissions (Peak RBW=VBW=1MHz; Average RBW = 1MHz, VBW = 10Hz)

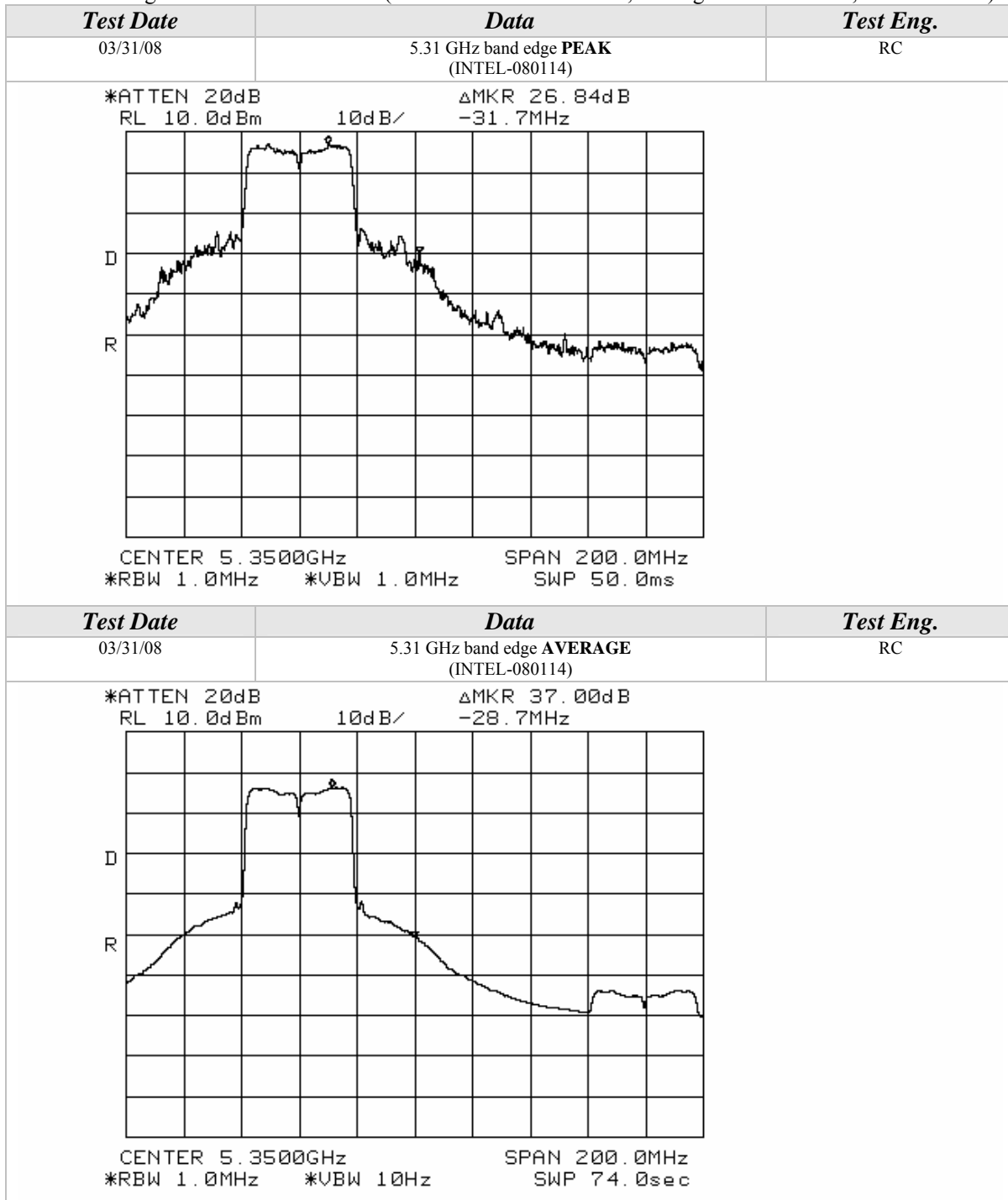



Radiated Emissions Test Results (Continued)

*Fundamental Measurements in 802.11n mode 40MHz Wide (5150-5350 MHz)
Channels 38, 46, 54, & 62
Continuous TX at Chain C Antenna port
Aegis Labs, Inc. File #: INTEL-080114-59*

RADIATED EMISSIONS - Horizontal Antenna Polarization											
<i>Freq. (MHz)</i>	<i>Meter Reading (dBuV)</i>	<i>Antenna Height (cm)</i>	<i>Azimuth (degrees)</i>	<i>Quasi pk or AVG (dBuV)</i>		<i>Cable Factor (dB)</i>	<i>Ant. Factor (dB)</i>	<i>Corrected Reading (dBuV)</i>	<i>Limits (dBuV)</i>	<i>Diff (dB) +=FAIL</i>	<i>Comments</i>
5190.00	64.00	100	135			2.98	34.64	101.62			Ch. 38
5190.00				53.83	A	2.98	34.64	91.45			
5230.00	63.17	100	135			2.99	34.71	100.88			Ch. 46
5230.00				53.17	A	2.99	34.71	90.88			
5270.00	62.17	100	135			3.01	34.79	99.96			Ch. 54
5270.00				52.17	A	3.01	34.79	89.96			
5310.00	62.33	100	135			3.02	34.86	100.21			Ch. 62
5310.00				52.17	A	3.02	34.86	90.05			

RADIATED EMISSIONS - Vertical Antenna Polarization											
<i>Freq. (MHz)</i>	<i>Meter Reading (dBuV)</i>	<i>Antenna Height (cm)</i>	<i>Azimuth (degrees)</i>	<i>Quasi pk or AVG (dBuV)</i>		<i>Cable Factor (dB)</i>	<i>Ant. Factor (dB)</i>	<i>Corrected Reading (dBuV)</i>	<i>Limits (dBuV)</i>	<i>Diff (dB) +=FAIL</i>	<i>Comments</i>
5190.00	62.33	100	135			2.98	34.40	99.72			Ch. 38
5190.00				52.33	A	2.98	34.40	89.72			
5230.00	64.00	100	90			2.99	34.47	101.46			Ch. 46
5230.00				53.67	A	2.99	34.47	91.13			
5270.00	63.17	100	90			3.01	34.53	100.71			Ch. 54
5270.00				52.67	A	3.01	34.53	90.21			
5310.00	62.00	100	90			3.02	34.60	99.61			Ch. 62
5310.00				51.50	A	3.02	34.60	89.11			

NOTE: Fundamental signals measured to calculate the band edge field strengths using the “Marker Delta Method”.



Radiated Emissions Test Results (Continued)

*Band Edge Field Strength Measurements in 802.11n mode 40MHz Wide (5150-5350 MHz)
Channels 38 & 62
Continuous TX at Chain C Antenna port
Aegis Labs, Inc. File #: INTEL-080114-59*

RADIATED EMISSIONS - Horizontal Antenna Polarization										
Freq. (MHz)	Meter Reading (dBuV)	Antenna Height (cm)	Azimuth (degrees)	Quasi pk or AVG (dBuV)	Cable Factor (dB)	Ant. Factor (dB)	Corrected Reading (dBuV)	Limits (dBuV)	Diff (dB) +=FAIL	Comments
5150.00							70.12	74.00	-3.88	Ch. 38
5150.00				A			52.28	54.00	-1.72	
5350.00							68.88	74.00	-5.12	Ch. 62
5350.00				A			48.55	54.00	-5.45	

RADIATED EMISSIONS - Vertical Antenna Polarization										
Freq. (MHz)	Meter Reading (dBuV)	Antenna Height (cm)	Azimuth (degrees)	Quasi pk or AVG (dBuV)	Cable Factor (dB)	Ant. Factor (dB)	Corrected Reading (dBuV)	Limits (dBuV)	Diff (dB) +=FAIL	Comments
5150.00							68.22	74.00	-5.78	Ch. 38
5150.00				A			50.55	54.00	-3.45	
5350.00							68.28	74.00	-5.72	Ch. 62
5350.00				A			47.61	54.00	-6.39	

NOTE: The “Band Edge Field Strength” was calculated using the “Fundamental” and “Conducted Band Edge” measurements per the “Marker-Delta Method” with the following formula:

$$BE = Fm - \Delta m$$

Where

BE = Band Edge Field Strength

Fm = Measured Fundamental (Peak or Average)

Δm = Measured Conducted Band Edge Delta (Peak or Average)



Radiated Emissions Test Results (Continued)

*Spurious Emissions Measurements in 802.11n mode 40MHz Wide (5150-5350 MHz)
Channels 36, 40, & 48
Continuous TX at Chain A, B, & C Antenna ports
Aegis Labs, Inc. File #: INTEL-080114-05*

RADIATED EMISSIONS - Horizontal Antenna Polarization

Freq. (MHz)	Meter Reading (dBuV)	Antenna Height (cm)	Azimuth (degrees)	Quasi pk or AVG (dBuV)	Preamp Factor (dB)	Cable Factor (dB)	Ant. Factor (dB)	Corrected Reading (dBuV)	Limits (dBuV)	Diff (dB) +/-FAIL	Channel/ Chain Tested
3466.66	53.83	100	225		46.60	2.42	32.32	41.97	68.00	-26.03	Ch. 40/
6933.33	57.17	100	180		45.15	3.48	35.93	51.43	68.00	-16.57	A
3466.66	53.17	100	135		46.60	2.42	32.32	41.31	68.00	-26.69	Ch. 40/
6933.33	54.33	100	135		45.15	3.48	35.93	48.59	68.00	-19.41	B
10400.00	50.67	100	180		44.48	4.40	38.64	49.24	68.00	-18.76	
3466.66	53.33	100	225		46.60	2.42	32.32	41.47	68.00	-26.53	Ch. 40/
6933.33	55.17	100	90		45.15	3.48	35.93	49.43	68.00	-18.57	C
3453.33	53.33	100	225		46.60	2.41	32.29	41.43	68.00	-26.57	Ch. 36/
6906.66	58.00	100	180		45.19	3.47	35.91	52.19	68.00	-15.81	A
10359.99	58.33	100	180		44.47	4.39	38.62	56.86	68.00	-11.14	
3493.33	55.17	100	225		46.60	2.43	32.38	43.38	68.00	-24.62	Ch. 48/
6986.66	57.83	100	180		45.07	3.50	35.99	52.25	68.00	-15.75	A
10480.00	50.50	100	180		44.49	4.43	38.69	49.13	68.00	-18.87	

RADIATED EMISSIONS - Vertical Antenna Polarization

Freq. (MHz)	Meter Reading (dBuV)	Antenna Height (cm)	Azimuth (degrees)	Quasi pk or AVG (dBuV)	Preamp Factor (dB)	Cable Factor (dB)	Ant. Factor (dB)	Corrected Reading (dBuV)	Limits (dBuV)	Diff (dB) +/-FAIL	Comments
3466.66	53.83	100	135		46.60	2.42	31.83	41.47	68.00	-26.53	Ch. 40/
6933.33	54.17	100	135		45.15	3.48	35.85	48.35	68.00	-19.65	A
3466.66	54.00	250	135		46.60	2.42	31.83	41.64	68.00	-26.36	Ch. 40/
6933.33	54.67	100	180		45.15	3.48	35.85	48.85	68.00	-19.15	B
10400.00	50.33	100	135		44.48	4.40	38.62	48.88	68.00	-19.12	
3466.66	53.83	100	135		46.60	2.42	31.83	41.47	68.00	-26.53	Ch. 40/
6933.33	55.33	100	180		45.15	3.48	35.85	49.51	68.00	-18.49	C
3453.33	53.67	100	135		46.60	2.41	31.80	41.28	68.00	-26.72	Ch. 36/
6906.66	56.67	100	225		45.19	3.47	35.83	50.77	68.00	-17.23	A
3493.33	55.17	100	135		46.60	2.43	31.89	42.88	68.00	-25.12	Ch. 48/
6986.66	53.50	100	180		45.07	3.50	35.89	47.82	68.00	-20.18	A



Radiated Emissions Test Results (Continued)

*Spurious Emissions Measurements in 802.11n mode 40MHz Wide (5150-5350 MHz)
Channels 52, 56, & 64
Continuous TX at Chain A, B, & C Antenna ports
Aegis Labs, Inc. File #: INTEL-080114-05*

RADIATED EMISSIONS - Horizontal Antenna Polarization											
Freq. (MHz)	Meter Reading (dBuV)	Antenna Height (cm)	Azimuth (degrees)	Quasi pk or AVG (dBuV)	Preamp Factor (dB)	Cable Factor (dB)	Ant. Factor (dB)	Corrected Reading (dBuV)	Limits (dBuV)	Diff (dB) +/-FAIL	Channel/ Chain Tested
3520.00	55.50	100	270		46.59	2.44	32.44	43.79	68.00	-24.21	Ch. 56/
7040.00	56.33	100	135		45.03	3.51	36.10	50.92	68.00	-17.08	A
3520.00	54.17	100	315		46.59	2.44	32.44	42.46	68.00	-25.54	Ch. 56/
7040.00	53.67	100	135		45.03	3.51	36.10	48.26	68.00	-19.74	B
3520.00	55.83	100	270		46.59	2.44	32.44	44.12	68.00	-23.88	Ch. 56/
7040.00	53.67	100	90		45.03	3.51	36.10	48.26	68.00	-19.74	C
3506.66	53.17	100	315		46.60	2.43	32.41	41.42	68.00	-26.58	Ch. 52/
7013.32	57.83	100	135		45.04	3.51	36.03	52.33	68.00	-15.67	A
3546.66	54.33	100	270		46.59	2.45	32.50	42.69	68.00	-25.31	Ch. 64/
7093.32	54.17	100	135		45.01	3.53	36.24	48.93	68.00	-19.07	A

RADIATED EMISSIONS - Vertical Antenna Polarization											
Freq. (MHz)	Meter Reading (dBuV)	Antenna Height (cm)	Azimuth (degrees)	Quasi pk or AVG (dBuV)	Preamp Factor (dB)	Cable Factor (dB)	Ant. Factor (dB)	Corrected Reading (dBuV)	Limits (dBuV)	Diff (dB) +/-FAIL	Comments
3520.00	55.17	100	135		46.59	2.44	31.95	42.97	68.00	-25.03	Ch. 56/
7040.00	52.83	100	180		45.03	3.51	36.00	47.32	68.00	-20.68	A
3520.00	54.67	100	135		46.59	2.44	31.95	42.47	68.00	-25.53	Ch. 56/
7040.00	54.67	100	135		45.03	3.51	36.00	49.16	68.00	-18.84	B
3520.00	54.17	100	180		46.59	2.44	31.95	41.97	68.00	-26.03	Ch. 56/
7040.00	51.83	100	180		45.03	3.51	36.00	46.32	68.00	-21.68	C
3506.66	54.17	100	135		46.60	2.43	31.92	41.92	68.00	-26.08	Ch. 52/
7013.32	54.50	100	135		45.04	3.51	35.93	48.90	68.00	-19.10	A
10520.00	51.33	100	135		44.52	4.44	38.70	49.96	68.00	-18.04	
3546.66	53.83	100	135		46.59	2.45	32.02	41.71	68.00	-26.29	Ch. 64/
7093.32	53.33	100	135		45.01	3.53	36.14	47.99	68.00	-20.01	A

**RADIATED EMISSIONS TEST RESULTS**

CLIENT:	Intel Corporation	DATE:	02/25/08
EUT:	Intel WiFi/WiMax Link 5350	PROJECT NUMBER:	INTEL-080114
MODEL NUMBER:	533ANXMMW	TEST ENGINEER:	JC/KN
SERIAL NUMBER:	0016EB01A3A8	SITE #:	2
CONFIGURATION:	Tested installed in an extender board connected to the host laptop's mini PCI slot in 802.11a (5470-5725 MHz) mode.	TEMPERATURE:	17 deg. C
		HUMIDITY:	52% RH
		TIME:	1:30 PM

Description:	Radiated RF Emissions (1 GHz – 18 GHz)
Results:	PASSED Horizontal and Vertical Antenna Polarizations Class B Limits
Note:	Radiated Emissions Measurements were performed on the EUT with power supply set at the following voltage and frequency. <ul style="list-style-type: none"> • 120VAC / 60 Hz.

Unwanted Spurious Emissions Limits			
Frequency (MHz)	Field Strength (uV/m)	Field Strength (dBuV/m) (Emissions in the restricted bands)	Field Strength (dBm/MHz) (Emissions outside the restricted bands)
Above 960	500	54.00 (Average) 74.00 (Peak)	< -20 dBc

Radiated Emissions Sample Calculations

$$\text{Corrected Meter Reading} = \text{Meter Reading} + F + C - D$$

Where, F = Antenna Factor

C = Cable Factor

G = Amplifier Gain

D = Distance Factor (if applicable)

Therefore, the equation for determining the Corrected Meter Reading Limit (CML) is:

$$\text{CML} = \text{Specification Limit} - F - C + D$$



Radiated Emissions Test Results (Continued)

*Fundamental Measurements in 802.11a mode (5470-5725 MHz)
Channels 100, 120, & 140
Continuous TX at Chain A Antenna port
Aegis Labs, Inc. File #: INTEL-080114-57*

RADIATED EMISSIONS - Horizontal Antenna Polarization											
Freq. (MHz)	Meter Reading (dBuV)	Antenna Height (cm)	Azimuth (degrees)	Quasi pk or AVG (dBuV)		Cable Factor (dB)	Ant. Factor (dB)	Corrected Reading (dBuV)	Limits (dBuV)	Diff (dB) +=FAIL	Comments
5500.00	69.00	100	135			3.08	35.20	107.28			Ch. 100
5500.00				58.50	A	3.08	35.20	96.78			
5600.00	69.83	100	45			3.11	35.22	108.16			Ch. 120
5600.00				59.00	A	3.11	35.22	97.33			
5700.00	66.83	100	45			3.14	35.24	105.21			Ch. 140
5700.00				56.67	A	3.14	35.24	95.05			

RADIATED EMISSIONS - Vertical Antenna Polarization											
Freq. (MHz)	Meter Reading (dBuV)	Antenna Height (cm)	Azimuth (degrees)	Quasi pk or AVG (dBuV)		Cable Factor (dB)	Ant. Factor (dB)	Corrected Reading (dBuV)	Limits (dBuV)	Diff (dB) +=FAIL	Comments
5500.00	66.33	100	45			3.08	34.90	104.31			Ch. 100
5500.00				55.33	A	3.08	34.90	93.31			
5600.00	66.00	100	90			3.11	34.96	104.07			Ch. 120
5600.00				55.17	A	3.11	34.96	93.24			
5700.00	62.50	100	90			3.14	35.02	100.66			Ch. 140
5700.00				50.67	A	3.14	35.02	88.83			

NOTE: Fundamental signals measured to calculate the band edge field strengths using the “Marker Delta Method”.



Radiated Emissions Test Results (Continued)

*Band Edge Field Strength Measurements in 802.11a mode (5470-5725 MHz)
Channels 100 & 140
Continuous TX at Chain A Antenna port
Aegis Labs, Inc. File #: INTEL-080114-57*

RADIATED EMISSIONS - Horizontal Antenna Polarization										
<i>Freq. (MHz)</i>	<i>Meter Reading (dBuV)</i>	<i>Antenna Height (cm)</i>	<i>Azimuth (degrees)</i>	<i>Quasi pk or AVG (dBuV)</i>	<i>Cable Factor (dB)</i>	<i>Ant. Factor (dB)</i>	<i>Corrected Reading (dBuV)</i>	<i>Limits (dBuV)</i>	<i>Diff (dB) +=FAIL</i>	<i>Comments</i>
5460.00							59.61	74.00	-14.39	Ch. 100
5460.00					A		39.62	54.00	-14.38	
5725.00	32.17	100	45			3.15 35.25	70.56	85.21	-14.65	Ch. 140

RADIATED EMISSIONS - Vertical Antenna Polarization										
<i>Freq. (MHz)</i>	<i>Meter Reading (dBuV)</i>	<i>Antenna Height (cm)</i>	<i>Azimuth (degrees)</i>	<i>Quasi pk or AVG (dBuV)</i>	<i>Cable Factor (dB)</i>	<i>Ant. Factor (dB)</i>	<i>Corrected Reading (dBuV)</i>	<i>Limits (dBuV)</i>	<i>Diff (dB) +=FAIL</i>	<i>Comments</i>
5460.00							56.64	74.00	-17.36	Ch. 100
5460.00					A		36.15	54.00	-17.85	
5725.00	28.60	100	90			3.15 35.04	66.78	80.66	-13.88	Ch. 140

NOTE: The “Band Edge Field Strength” was calculated using the “Fundamental” and “Conducted Band Edge” measurements per the “Marker-Delta Method” with the following formula:

$$BE = Fm - \Delta m$$

Where

BE = Band Edge Field Strength

Fm = Measured Fundamental (Peak or Average)

Δm = Measured Conducted Band Edge Delta (Peak or Average)



Radiated Emissions Test Results (Continued)

*Fundamental Measurements in 802.11a mode (5470-5725 MHz)
Channels 100, 120, & 140
Continuous TX at Chain B Antenna port
Aegis Labs, Inc. File #: INTEL-080114-58*

RADIATED EMISSIONS - Horizontal Antenna Polarization											
Freq. (MHz)	Meter Reading (dBuV)	Antenna Height (cm)	Azimuth (degrees)	Quasi pk or AVG (dBuV)		Cable Factor (dB)	Ant. Factor (dB)	Corrected Reading (dBuV)	Limits (dBuV)	Diff (dB) +/-FAIL	Comments
5500.00	75.83	100	270			3.08	35.20	114.11			Ch. 100
5500.00				65.83	A	3.08	35.20	104.11			
5600.00	72.83	100	270			3.11	35.22	111.16			Ch. 120
5600.00				62.83	A	3.11	35.22	101.16			
5700.00	72.17	100	270			3.14	35.24	110.55			Ch. 140
5700.00				62.17	A	3.14	35.24	100.55			

RADIATED EMISSIONS - Vertical Antenna Polarization											
Freq. (MHz)	Meter Reading (dBuV)	Antenna Height (cm)	Azimuth (degrees)	Quasi pk or AVG (dBuV)		Cable Factor (dB)	Ant. Factor (dB)	Corrected Reading (dBuV)	Limits (dBuV)	Diff (dB) +/-FAIL	Comments
5500.00	68.00	100	180			3.08	34.90	105.98			Ch. 100
5500.00				58.00	A	3.08	34.90	95.98			
5600.00	65.83	100	180			3.11	34.96	103.90			Ch. 120
5600.00				55.00	A	3.11	34.96	93.07			
5700.00	64.33	100	180			3.14	35.02	102.49			Ch. 140
5700.00				54.17	A	3.14	35.02	92.33			

NOTE: Fundamental signals measured to calculate the band edge field strengths using the “Marker Delta Method”.

Radiated Emissions Test Results (Continued)

*Band Edge Field Strength Measurements in 802.11a mode (5470-5725 MHz)
Channels 100 & 140
Continuous TX at Chain B Antenna port
Aegis Labs, Inc. File #: INTEL-080114-58*

RADIATED EMISSIONS - Horizontal Antenna Polarization											
<i>Freq. (MHz)</i>	<i>Meter Reading (dBuV)</i>	<i>Antenna Height (cm)</i>	<i>Azimuth (degrees)</i>	<i>Quasi pk or AVG (dBuV)</i>	<i>Cable Factor (dB)</i>	<i>Ant. Factor (dB)</i>	<i>Corrected Reading (dBuV)</i>	<i>Limits (dBuV)</i>	<i>Diff (dB) +=FAIL</i>	<i>Comments</i>	
5460.00							66.95	74.00	-7.05	Ch. 100	
5460.00					A		49.44	54.00	-4.56		
5725.00	37.50	100	270			3.15	35.25	75.89	90.55	-14.66	Ch. 140

RADIATED EMISSIONS - Vertical Antenna Polarization											
<i>Freq. (MHz)</i>	<i>Meter Reading (dBuV)</i>	<i>Antenna Height (cm)</i>	<i>Azimuth (degrees)</i>	<i>Quasi pk or AVG (dBuV)</i>	<i>Cable Factor (dB)</i>	<i>Ant. Factor (dB)</i>	<i>Corrected Reading (dBuV)</i>	<i>Limits (dBuV)</i>	<i>Diff (dB) +=FAIL</i>	<i>Comments</i>	
5460.00							58.82	74.00	-15.18	Ch. 100	
5460.00					A		41.31	54.00	-12.69		
5725.00	30.17	100	180			3.15	35.04	68.35	82.49	-14.14	Ch. 140

NOTE: The “Band Edge Field Strength” was calculated using the “Fundamental” and “Conducted Band Edge” measurements per the “Marker-Delta Method” with the following formula:

$$BE = F_m - \Delta_m$$

Where

BE = Band Edge Field Strength

F_m = Measured Fundamental (Peak or Average)

Δ_m = Measured Conducted Band Edge Delta (Peak or Average)



Radiated Emissions Test Results (Continued)

Plots Showing Out-Of-Band Emissions (Peak RBW=VBW=1MHz; Average RBW = 1MHz, VBW = 10Hz)

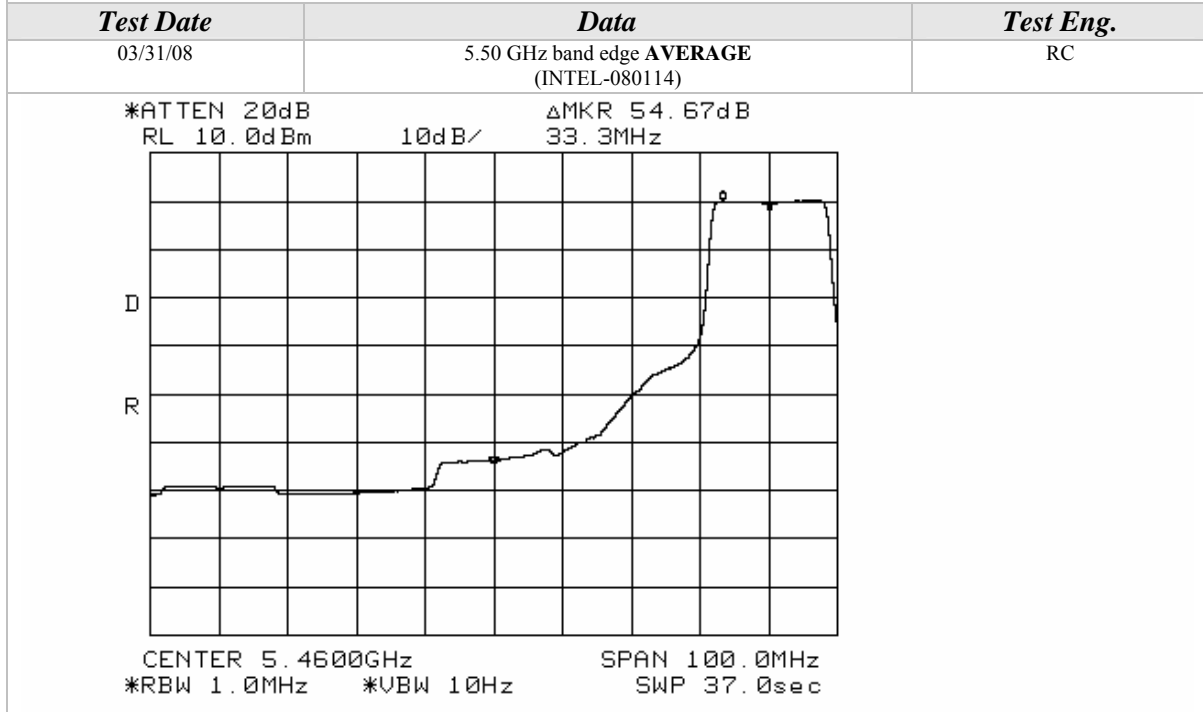
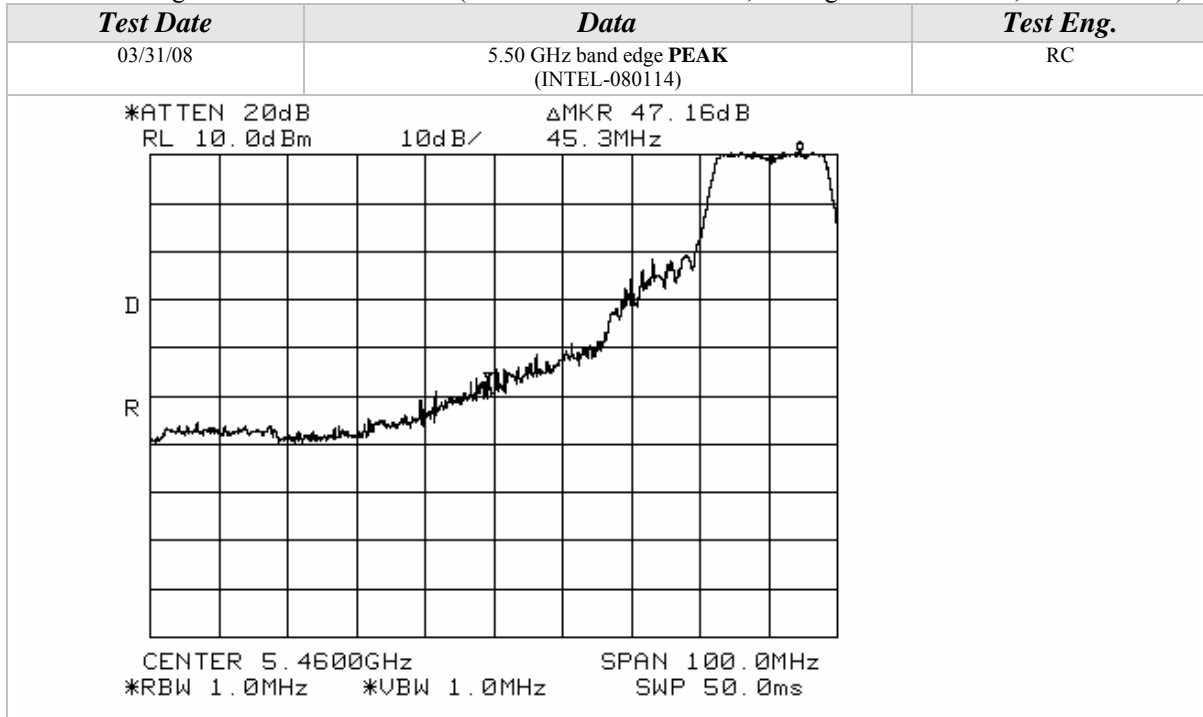



Radiated Emissions Test Results (Continued)

*Fundamental Measurements in 802.11a mode (5470-5725 MHz)
Channels 100, 120, & 140
Continuous TX at Chain C Antenna port
Aegis Labs, Inc. File #: INTEL-080114-59*

RADIATED EMISSIONS - Horizontal Antenna Polarization											
Freq. (MHz)	Meter Reading (dBuV)	Antenna Height (cm)	Azimuth (degrees)	Quasi pk or AVG (dBuV)		Cable Factor (dB)	Ant. Factor (dB)	Corrected Reading (dBuV)	Limits (dBuV)	Diff (dB) +/-FAIL	Comments
5500.00	69.50	100	135			3.08	35.20	107.78			Ch. 100
5500.00				59.00	A	3.08	35.20	97.28			
5600.00	69.50	100	135			3.11	35.22	107.83			Ch. 120
5600.00				59.50	A	3.11	35.22	97.83			
5700.00	67.17	100	135			3.14	35.24	105.55			Ch. 140
5700.00				56.00	A	3.14	35.24	94.38			

RADIATED EMISSIONS - Vertical Antenna Polarization											
Freq. (MHz)	Meter Reading (dBuV)	Antenna Height (cm)	Azimuth (degrees)	Quasi pk or AVG (dBuV)		Cable Factor (dB)	Ant. Factor (dB)	Corrected Reading (dBuV)	Limits (dBuV)	Diff (dB) +/-FAIL	Comments
5500.00	66.17	100	90			3.08	34.90	104.15			Ch. 100
5500.00				56.00	A	3.08	34.90	93.98			
5600.00	65.83	100	45			3.11	34.96	103.90			Ch. 120
5600.00				56.00	A	3.11	34.96	94.07			
5700.00	63.17	100	0			3.14	35.02	101.33			Ch. 140
5700.00				53.50	A	3.14	35.02	91.66			

NOTE: Fundamental signals measured to calculate the band edge field strengths using the “Marker Delta Method”.



Radiated Emissions Test Results (Continued)

*Band Edge Field Strength Measurements in 802.11a mode (5470-5725 MHz)
Channels 100 & 140
Continuous TX at Chain C Antenna port
Aegis Labs, Inc. File #: INTEL-080114-59*

RADIATED EMISSIONS - Horizontal Antenna Polarization											
<i>Freq. (MHz)</i>	<i>Meter Reading (dBuV)</i>	<i>Antenna Height (cm)</i>	<i>Azimuth (degrees)</i>	<i>Quasi pk or AVG (dBuV)</i>	<i>Cable Factor (dB)</i>	<i>Ant. Factor (dB)</i>	<i>Corrected Reading (dBuV)</i>	<i>Limits (dBuV)</i>	<i>Diff (dB) +=FAIL</i>	<i>Comments</i>	
5460.00							56.11	74.00	-17.89	Ch. 100	
5460.00					A		38.94	54.00	-15.06		
5725.00	32.67	100	135			3.15	35.25	71.06	85.55	-14.49	Ch. 140

RADIATED EMISSIONS - Vertical Antenna Polarization											
<i>Freq. (MHz)</i>	<i>Meter Reading (dBuV)</i>	<i>Antenna Height (cm)</i>	<i>Azimuth (degrees)</i>	<i>Quasi pk or AVG (dBuV)</i>	<i>Cable Factor (dB)</i>	<i>Ant. Factor (dB)</i>	<i>Corrected Reading (dBuV)</i>	<i>Limits (dBuV)</i>	<i>Diff (dB) +=FAIL</i>	<i>Comments</i>	
5460.00							52.48	74.00	-21.52	Ch. 100	
5460.00					A		35.64	54.00	-18.36		
5725.00	32.00	100	0			3.15	35.04	70.18	81.33	-11.15	Ch. 140

NOTE: The “Band Edge Field Strength” was calculated using the “Fundamental” and “Conducted Band Edge” measurements per the “Marker-Delta Method” with the following formula:

$$BE = Fm - \Delta m$$

Where

BE = Band Edge Field Strength

Fm = Measured Fundamental (Peak or Average)

Δm = Measured Conducted Band Edge Delta (Peak or Average)



Radiated Emissions Test Results (Continued)

Plots Showing Out-Of-Band Emissions (Peak RBW=VBW=1MHz; Average RBW = 1MHz, VBW = 10Hz)

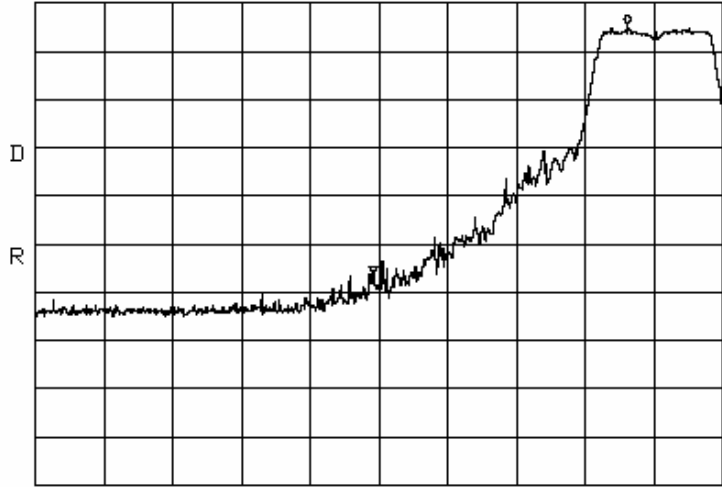
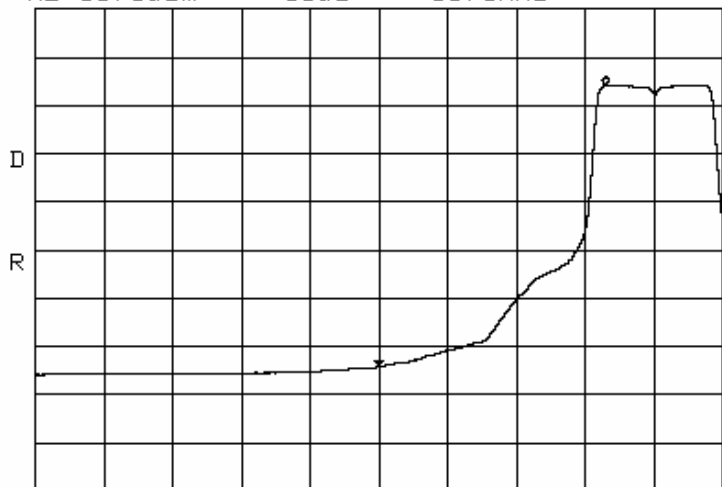
Test Date	Data	Test Eng.
03/31/08	5.50 GHz band edge PEAK (INTEL-080114)	RC
*ATTEN 20dB RL 16.0dBm 10dB/ ΔMKR 51.67dB 37.0MHz  CENTER 5.4600GHz SPAN 100.0MHz *RBW 1.0MHz *VBW 1.0MHz SWP 50.0ms		
Test Date	Data	Test Eng.
03/31/08	5.50 GHz band edge AVERAGE (INTEL-080114)	RC
*ATTEN 20dB RL 16.0dBm 10dB/ ΔMKR 58.34dB 33.0MHz  CENTER 5.4600GHz SPAN 100.0MHz *RBW 1.0MHz *VBW 10Hz SWP 37.0sec		



Radiated Emissions Test Results (Continued)

Spurious Emissions Measurements in 802.11a mode (5470-5725 MHz)
Channels 100, 120, & 140
Continuous TX at Chain A, B, & C Antenna ports
Aegis Labs, Inc. File #: INTEL-080114-04

RADIATED EMISSIONS - Horizontal Antenna Polarization												
Freq. (MHz)	Meter Reading (dBuV)	Antenna Height (cm)	Azimuth (degrees)	Quasi pk or AVG (dBuV)		Preamp Factor (dB)	Cable Factor (dB)	Ant. Factor (dB)	Corrected Reading (dBuV)	Limits (dBuV)	Diff (dB) +/-FAIL	Channel/Chain Tested
3733.33	57.00	100	180			46.55	2.53	32.91	45.89	74.00	-28.11	Ch. 120/
3733.33				50.28	A	46.55	2.53	32.91	39.17	54.00	-14.83	A
7466.66	52.33	100	135			44.88	3.63	37.21	48.30	74.00	-25.70	
7466.66				42.19	A	44.88	3.63	37.21	38.16	54.00	-15.84	
11200.00	50.83	100	180			45.09	4.55	39.02	49.32	74.00	-24.68	
11200.00				38.32	A	45.09	4.55	39.02	36.81	54.00	-17.19	
3733.33	56.17	100	180			46.55	2.53	32.91	45.06	74.00	-28.94	Ch. 120/
3733.33				49.93	A	46.55	2.53	32.91	38.82	54.00	-15.18	B
7466.66	56.83	100	180			44.88	3.63	37.21	52.80	74.00	-21.20	
7466.66				49.46	A	44.88	3.63	37.21	45.43	54.00	-8.57	
11200.00	56.33	100	180			45.09	4.55	39.02	54.82	74.00	-19.18	
11200.00				39.39	A	45.09	4.55	39.02	37.88	54.00	-16.12	
3733.33	53.33	100	225			46.55	2.53	32.91	42.22	74.00	-31.78	Ch. 120/
3733.33				42.09	A	46.55	2.53	32.91	30.98	54.00	-23.02	C
7466.66	52.50	100	135			44.88	3.63	37.21	48.47	74.00	-25.53	
7466.66				41.51	A	44.88	3.63	37.21	37.48	54.00	-16.52	
11200.00	51.67	100	225			45.09	4.55	39.02	50.16	74.00	-23.84	
11200.00				39.22	A	45.09	4.55	39.02	37.71	54.00	-16.29	
3666.66	52.17	100	225			46.56	2.50	32.77	40.87	74.00	-33.13	Ch. 100/
3666.66				42.37	A	46.56	2.50	32.77	31.07	54.00	-22.93	B
7333.33	52.17	100	135			44.92	3.60	36.87	47.71	74.00	-26.29	
7333.33				40.03	A	44.92	3.60	36.87	35.57	54.00	-18.43	
11000.00	50.50	100	225			45.13	4.50	38.90	48.77	74.00	-25.23	
11000.00				39.22	A	45.13	4.50	38.90	37.49	54.00	-16.51	
3800.00	45.17	100	135			46.54	2.55	33.06	34.25	74.00	-39.75	Ch. 140/
3800.00				53.33	A	46.54	2.55	33.06	42.41	54.00	-11.59	B
7600.00	52.17	100	135			44.86	3.67	37.36	48.34	74.00	-25.66	
7600.00				41.32	A	44.86	3.67	37.36	37.49	54.00	-16.51	
11400.00	51.00	100	225			45.04	4.61	39.14	49.71	74.00	-24.29	
11400.00				39.15	A	45.04	4.61	39.14	37.86	54.00	-16.14	



Radiated Emissions Test Results (Continued)

RADIATED EMISSIONS - Vertical Antenna Polarization												
Freq. (MHz)	Meter Reading (dBuV)	Antenna Height (cm)	Azimuth (degrees)	Quasi pk or AVG (dBuV)		Preamp Factor (dB)	Cable Factor (dB)	Ant. Factor (dB)	Corrected Reading (dBuV)	Limits (dBuV)	Diff (dB) +/-FAIL	Comments
3733.33	55.67	100	135			46.55	2.53	32.51	44.15	74.00	-29.85	Ch. 120/
3733.33				48.04	A	46.55	2.53	32.51	36.52	54.00	-17.48	A
7466.66	54.00	100	180			44.88	3.63	37.11	49.87	74.00	-24.13	
7466.66				46.54	A	44.88	3.63	37.11	42.41	54.00	-11.59	
11200.00	50.33	100	135			45.09	4.55	38.96	48.76	74.00	-25.24	
11200.00				39.44	A	45.09	4.55	38.96	37.87	54.00	-16.13	
3733.33	55.00	100	180			46.55	2.53	32.51	43.48	74.00	-30.52	Ch. 120/
3733.33				47.51	A	46.55	2.53	32.51	35.99	54.00	-18.01	B
7466.66	54.67	100	180			44.88	3.63	37.11	50.54	74.00	-23.46	
7466.66				46.98	A	44.88	3.63	37.11	42.85	54.00	-11.15	
11200.00	50.83	100	135			45.09	4.55	38.96	49.26	74.00	-24.74	
11200.00				40.76	A	45.09	4.55	38.96	39.19	54.00	-14.81	
3733.33	53.00	100	135			46.55	2.53	32.51	41.48	74.00	-32.52	Ch. 120/
3733.33				43.82	A	46.55	2.53	32.51	32.30	54.00	-21.70	C
7466.66	53.33	100	135			44.88	3.63	37.11	49.20	74.00	-24.80	
7466.66				42.61	A	44.88	3.63	37.11	38.48	54.00	-15.52	
11200.00	50.33	100	135			45.09	4.55	38.96	48.76	74.00	-25.24	
11200.00				38.17	A	45.09	4.55	38.96	36.60	54.00	-17.40	
3666.66	56.17	100	135			46.56	2.50	32.33	44.44	74.00	-29.56	Ch. 100/
3666.66				43.82	A	46.56	2.50	32.33	32.09	54.00	-21.91	B
7333.33	51.67	100	180			44.92	3.60	36.77	47.11	74.00	-26.89	
7333.33				42.54	A	44.92	3.60	36.77	37.98	54.00	-16.02	
11000.00	51.17	100	180			45.13	4.50	38.80	49.34	74.00	-24.66	
11000.00				39.08	A	45.13	4.50	38.80	37.25	54.00	-16.75	
3800.00	53.83	100	135			46.54	2.55	32.68	42.53	74.00	-31.47	Ch. 140/
3800.00				44.91	A	46.54	2.55	32.68	33.61	54.00	-20.39	B
7600.00	55.00	100	180			44.86	3.67	37.24	51.05	74.00	-22.95	
7600.00				48.56	A	44.86	3.67	37.24	44.61	54.00	-9.39	
11400.00		100	225	53.67		45.04	4.61	39.12	52.36	74.00	-21.64	
11400.00				41.35	A	45.04	4.61	39.12	40.04	54.00	-13.96	

**RADIATED EMISSIONS TEST RESULTS**

CLIENT:	Intel Corporation	DATE:	02/25/08
EUT:	Intel WiFi/WiMax Link 5350	PROJECT NUMBER:	INTEL-080114
MODEL NUMBER:	533ANXMMW	TEST ENGINEER:	JC/KN
SERIAL NUMBER:	0016EB01A3A8	SITE #:	2
CONFIGURATION:	Tested installed in an extender board connected to the host laptop's mini PCI slot in 802.11n (5740-5745 MHz) mode 20MHz Wide.	TEMPERATURE:	17 deg. C
		HUMIDITY:	52% RH
		TIME:	1:30 PM

Description:	Radiated RF Emissions (1 GHz – 18 GHz)
Results:	PASSED Horizontal and Vertical Antenna Polarizations Class B Limits
Note:	Radiated Emissions Measurements were performed on the EUT with power supply set at the following voltage and frequency. <ul style="list-style-type: none"> • 120VAC / 60 Hz.

Unwanted Spurious Emissions Limits			
Frequency (MHz)	Field Strength (uV/m)	Field Strength (dBuV/m) (Emissions in the restricted bands)	Field Strength (dBm/MHz) (Emissions outside the restricted bands)
Above 960	500	54.00 (Average) 74.00 (Peak)	< -20 dBc

Radiated Emissions Sample Calculations

$$\text{Corrected Meter Reading} = \text{Meter Reading} + F + C - D$$

Where, F = Antenna Factor

C = Cable Factor

G = Amplifier Gain

D = Distance Factor (if applicable)

Therefore, the equation for determining the Corrected Meter Reading Limit (CML) is:

$$\text{CML} = \text{Specification Limit} - F - C + D$$



Radiated Emissions Test Results (Continued)

*Fundamental Measurements in 802.11n mode 20MHz Wide (5470-5725 MHz)
Channels 100, 120, & 140
Continuous TX at Chain A Antenna port
Aegis Labs, Inc. File #: INTEL-080114-57*

RADIATED EMISSIONS - Horizontal Antenna Polarization											
Freq. (MHz)	Meter Reading (dBuV)	Antenna Height (cm)	Azimuth (degrees)	Quasi pk or AVG (dBuV)		Cable Factor (dB)	Ant. Factor (dB)	Corrected Reading (dBuV)	Limits (dBuV)	Diff (dB) +=FAIL	Comments
5500.00	67.83	100	135			3.08	35.20	106.11			Ch. 100
5500.00				57.83	A	3.08	35.20	96.11			
5600.00	68.17	100	45			3.11	35.22	106.50			Ch. 120
5600.00				58.00	A	3.11	35.22	96.33			
5700.00	66.67	100	45			3.14	35.24	105.05			Ch. 140
5700.00				56.00	A	3.14	35.24	94.38			

RADIATED EMISSIONS - Vertical Antenna Polarization											
Freq. (MHz)	Meter Reading (dBuV)	Antenna Height (cm)	Azimuth (degrees)	Quasi pk or AVG (dBuV)		Cable Factor (dB)	Ant. Factor (dB)	Corrected Reading (dBuV)	Limits (dBuV)	Diff (dB) +=FAIL	Comments
5500.00	67.17	100	90			3.08	34.90	105.15			Ch. 100
5500.00				57.67	A	3.08	34.90	95.65			
5600.00	67.83	100	90			3.11	34.96	105.90			Ch. 120
5600.00				57.17	A	3.11	34.96	95.24			
5700.00	64.33	100	90			3.14	35.02	102.49			Ch. 140
5700.00				54.00	A	3.14	35.02	92.16			

NOTE: Fundamental signals measured to calculate the band edge field strengths using the “Marker Delta Method”.



Radiated Emissions Test Results (Continued)

*Band Edge Field Strength Measurements in 802.11n mode 20MHz Wide (5470-5725 MHz)
Channels 100 & 140
Continuous TX at Chain A Antenna port
Aegis Labs, Inc. File #: INTEL-080114-57*

RADIATED EMISSIONS - Horizontal Antenna Polarization										
<i>Freq. (MHz)</i>	<i>Meter Reading (dBuV)</i>	<i>Antenna Height (cm)</i>	<i>Azimuth (degrees)</i>	<i>Quasi pk or AVG (dBuV)</i>	<i>Cable Factor (dB)</i>	<i>Ant. Factor (dB)</i>	<i>Corrected Reading (dBuV)</i>	<i>Limits (dBuV)</i>	<i>Diff (dB) +=FAIL</i>	<i>Comments</i>
5460.00							59.78	74.00	-14.22	Ch. 100
5460.00					A		39.61	54.00	-14.39	
5725.00	34.00	100	45			3.15 35.25	72.39	85.05	-12.66	Ch. 140

RADIATED EMISSIONS - Vertical Antenna Polarization										
<i>Freq. (MHz)</i>	<i>Meter Reading (dBuV)</i>	<i>Antenna Height (cm)</i>	<i>Azimuth (degrees)</i>	<i>Quasi pk or AVG (dBuV)</i>	<i>Cable Factor (dB)</i>	<i>Ant. Factor (dB)</i>	<i>Corrected Reading (dBuV)</i>	<i>Limits (dBuV)</i>	<i>Diff (dB) +=FAIL</i>	<i>Comments</i>
5460.00							58.82	74.00	-15.18	Ch. 100
5460.00					A		39.15	54.00	-14.85	
5725.00	32.67	100	90			3.15 35.04	70.85	82.49	-11.64	Ch. 140

NOTE: The “Band Edge Field Strength” was calculated using the “Fundamental” and “Conducted Band Edge” measurements per the “Marker-Delta Method” with the following formula:

$$BE = Fm - \Delta m$$

Where

BE = Band Edge Field Strength

Fm = Measured Fundamental (Peak or Average)

Δm = Measured Conducted Band Edge Delta (Peak or Average)



Radiated Emissions Test Results (Continued)

Plots Showing Out-Of-Band Emissions (Peak RBW=VBW=1MHz; Average RBW = 1MHz, VBW = 10Hz)

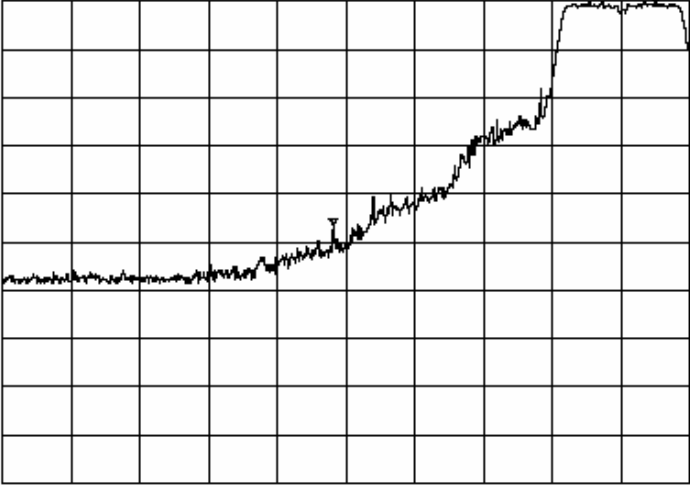
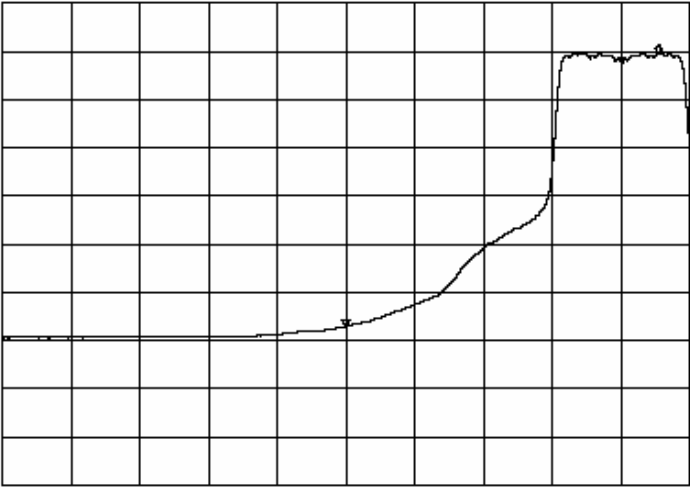
Test Date	Data	Test Eng.
03/31/08	5.50 GHz band edge PEAK (INTEL-080114)	RC
<p data-bbox="328 422 951 472">*ATTEN 20dB ΔMKR 46.33dB RL 10.0dBm 10dB/ 46.8MHz</p>  <p data-bbox="328 963 1024 1014">CENTER 5.4600GHz SPAN 100.0MHz *RBW 1.0MHz *VBW 1.0MHz SWP 50.0ms</p>		
Test Date	Data	Test Eng.
03/31/08	5.50 GHz band edge AVERAGE (INTEL-080114)	RC
<p data-bbox="328 1129 951 1180">*ATTEN 20dB ΔMKR 56.50dB RL 10.0dBm 10dB/ 45.5MHz</p>  <p data-bbox="328 1671 1024 1722">CENTER 5.4600GHz SPAN 100.0MHz *RBW 1.0MHz *VBW 10Hz SWP 37.0sec</p>		



Radiated Emissions Test Results (Continued)

*Fundamental Measurements in 802.11n mode 20MHz Wide (5470-5725 MHz)
Channels 100, 120, & 140
Continuous TX at Chain B Antenna port
Aegis Labs, Inc. File #: INTEL-080114-58*

RADIATED EMISSIONS - Horizontal Antenna Polarization											
Freq. (MHz)	Meter Reading (dBuV)	Antenna Height (cm)	Azimuth (degrees)	Quasi pk or AVG (dBuV)		Cable Factor (dB)	Ant. Factor (dB)	Corrected Reading (dBuV)	Limits (dBuV)	Diff (dB) +=FAIL	Comments
5500.00	75.00	100	270			3.08	35.20	113.28			Ch. 100
5500.00				65.00	A	3.08	35.20	103.28			
5600.00	72.33	100	270			3.11	35.22	110.66			Ch. 120
5600.00				62.50	A	3.11	35.22	100.83			
5700.00	72.33	100	270			3.14	35.24	110.71			Ch. 140
5700.00				61.83	A	3.14	35.24	100.21			

RADIATED EMISSIONS - Vertical Antenna Polarization											
Freq. (MHz)	Meter Reading (dBuV)	Antenna Height (cm)	Azimuth (degrees)	Quasi pk or AVG (dBuV)		Cable Factor (dB)	Ant. Factor (dB)	Corrected Reading (dBuV)	Limits (dBuV)	Diff (dB) +=FAIL	Comments
5500.00	68.50	100	180			3.08	34.90	106.48			Ch. 100
5500.00				58.17	A	3.08	34.90	96.15			
5600.00	64.00	100	180			3.11	34.96	102.07			Ch. 120
5600.00				54.17	A	3.11	34.96	92.24			
5700.00	64.17	100	180			3.14	35.02	102.33			Ch. 140
5700.00				54.17	A	3.14	35.02	92.33			

NOTE: Fundamental signals measured to calculate the band edge field strengths using the “Marker Delta Method”.



Radiated Emissions Test Results (Continued)

*Band Edge Field Strength Measurements in 802.11n mode 20MHz Wide (5470-5725 MHz)
Channels 100 & 140
Continuous TX at Chain B Antenna port
Aegis Labs, Inc. File #: INTEL-080114-58*

RADIATED EMISSIONS - Horizontal Antenna Polarization											
<i>Freq. (MHz)</i>	<i>Meter Reading (dBuV)</i>	<i>Antenna Height (cm)</i>	<i>Azimuth (degrees)</i>	<i>Quasi pk or AVG (dBuV)</i>	<i>Cable Factor (dB)</i>	<i>Ant. Factor (dB)</i>	<i>Corrected Reading (dBuV)</i>	<i>Limits (dBuV)</i>	<i>Diff (dB) +=FAIL</i>	<i>Comments</i>	
5460.00							65.94	74.00	-8.06	Ch. 100	
5460.00					A		48.95	54.00	-5.05		
5725.00	41.75	100	270			3.15	35.25	80.14	90.71	-10.57	Ch. 140

RADIATED EMISSIONS - Vertical Antenna Polarization											
<i>Freq. (MHz)</i>	<i>Meter Reading (dBuV)</i>	<i>Antenna Height (cm)</i>	<i>Azimuth (degrees)</i>	<i>Quasi pk or AVG (dBuV)</i>	<i>Cable Factor (dB)</i>	<i>Ant. Factor (dB)</i>	<i>Corrected Reading (dBuV)</i>	<i>Limits (dBuV)</i>	<i>Diff (dB) +=FAIL</i>	<i>Comments</i>	
5460.00							59.14	74.00	-14.86	Ch. 100	
5460.00					A		41.82	54.00	-12.18		
5725.00	32.67	100	180			3.15	35.04	70.85	82.33	-11.48	Ch. 140

NOTE: The “Band Edge Field Strength” was calculated using the “Fundamental” and “Conducted Band Edge” measurements per the “Marker-Delta Method” with the following formula:

$$BE = F_m - \Delta_m$$

Where

BE = Band Edge Field Strength

F_m = Measured Fundamental (Peak or Average)

Δ_m = Measured Conducted Band Edge Delta (Peak or Average)



Radiated Emissions Test Results (Continued)

Plots Showing Out-Of-Band Emissions (Peak RBW=VBW=1MHz; Average RBW = 1MHz, VBW = 10Hz)

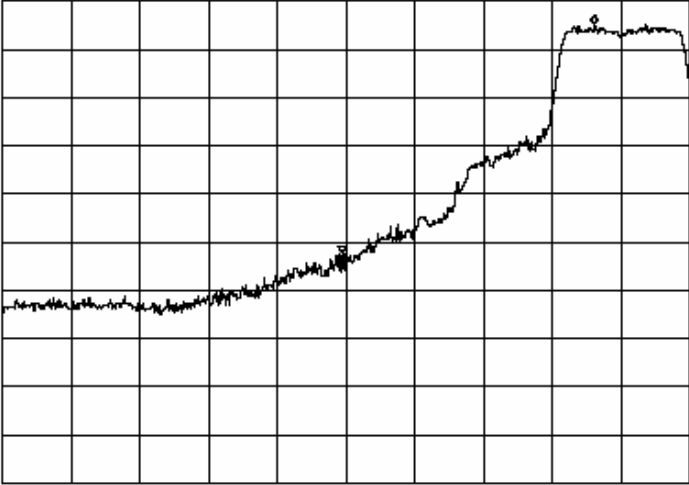
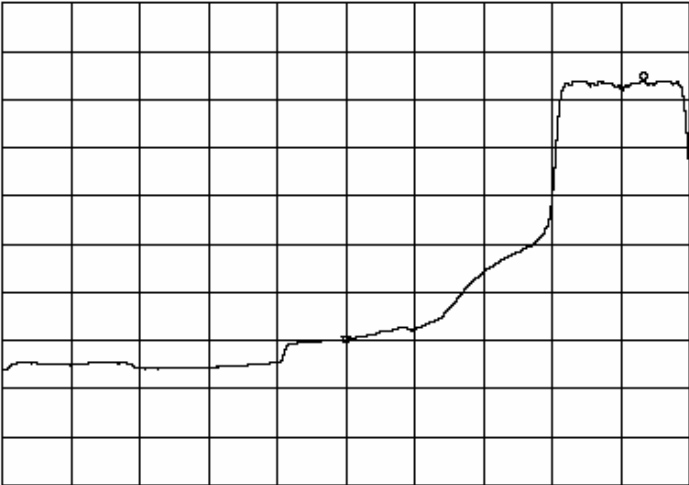
<i>Test Date</i>	<i>Data</i>	<i>Test Eng.</i>
03/31/08	5.50 GHz band edge PEAK (INTEL-080114)	RC
<p>*ATTEN 20dB ΔMKR 47.34dB RL 16.0dBm 10dB/ 36.7MHz</p>  <p>CENTER 5.4600GHz SPAN 100.0MHz *RBW 1.0MHz *VBW 1.0MHz SWP 50.0ms</p>		
<i>Test Date</i>	<i>Data</i>	<i>Test Eng.</i>
03/31/08	5.50 GHz band edge AVERAGE (INTEL-080114)	RC
<p>*ATTEN 20dB ΔMKR 54.33dB RL 16.0dBm 10dB/ 43.3MHz</p>  <p>CENTER 5.4600GHz SPAN 100.0MHz *RBW 1.0MHz *VBW 10Hz SWP 37.0sec</p>		



Radiated Emissions Test Results (Continued)

*Fundamental Measurements in 802.11n mode 20MHz Wide (5470-5725 MHz)
Channels 100, 120, & 140
Continuous TX at Chain C Antenna port
Aegis Labs, Inc. File #: INTEL-080114-59*

RADIATED EMISSIONS - Horizontal Antenna Polarization											
Freq. (MHz)	Meter Reading (dBuV)	Antenna Height (cm)	Azimuth (degrees)	Quasi pk or AVG (dBuV)		Cable Factor (dB)	Ant. Factor (dB)	Corrected Reading (dBuV)	Limits (dBuV)	Diff (dB) +=FAIL	Comments
5500.00	69.00	100	135			3.08	35.20	107.28			Ch. 100
5500.00				58.67	A	3.08	35.20	96.95			
5600.00	68.17	100	135			3.11	35.22	106.50			Ch. 120
5600.00				58.50	A	3.11	35.22	96.83			
5700.00	66.17	100	135			3.14	35.24	104.55			Ch. 140
5700.00				56.50	A	3.14	35.24	94.88			

RADIATED EMISSIONS - Vertical Antenna Polarization											
Freq. (MHz)	Meter Reading (dBuV)	Antenna Height (cm)	Azimuth (degrees)	Quasi pk or AVG (dBuV)		Cable Factor (dB)	Ant. Factor (dB)	Corrected Reading (dBuV)	Limits (dBuV)	Diff (dB) +=FAIL	Comments
5500.00	66.17	100	90			3.08	34.90	104.15			Ch. 100
5500.00				55.83	A	3.08	34.90	93.81			
5600.00	66.17	100	135			3.11	34.96	104.24			Ch. 120
5600.00				56.00	A	3.11	34.96	94.07			
5700.00	63.33	100	0			3.14	35.02	101.49			Ch. 140
5700.00				53.17	A	3.14	35.02	91.33			

NOTE: Fundamental signals measured to calculate the band edge field strengths using the “Marker Delta Method”.



Radiated Emissions Test Results (Continued)

*Band Edge Field Strength Measurements in 802.11n mode 20MHz Wide (5470-5725 MHz)
Channels 100 & 140
Continuous TX at Chain C Antenna port
Aegis Labs, Inc. File #: INTEL-080114-59*

RADIATED EMISSIONS - Horizontal Antenna Polarization										
<i>Freq. (MHz)</i>	<i>Meter Reading (dBuV)</i>	<i>Antenna Height (cm)</i>	<i>Azimuth (degrees)</i>	<i>Quasi pk or AVG (dBuV)</i>	<i>Cable Factor (dB)</i>	<i>Ant. Factor (dB)</i>	<i>Corrected Reading (dBuV)</i>	<i>Limits (dBuV)</i>	<i>Diff (dB) +=FAIL</i>	<i>Comments</i>
5460.00							55.78	74.00	-18.22	Ch. 100
5460.00					A		39.12	54.00	-14.88	
5725.00	32.50	100	135			3.15 35.25	70.89	84.55	-13.66	Ch. 140

RADIATED EMISSIONS - Vertical Antenna Polarization										
<i>Freq. (MHz)</i>	<i>Meter Reading (dBuV)</i>	<i>Antenna Height (cm)</i>	<i>Azimuth (degrees)</i>	<i>Quasi pk or AVG (dBuV)</i>	<i>Cable Factor (dB)</i>	<i>Ant. Factor (dB)</i>	<i>Corrected Reading (dBuV)</i>	<i>Limits (dBuV)</i>	<i>Diff (dB) +=FAIL</i>	<i>Comments</i>
5350.00					A		40.80	54.00	-13.20	Ch. 100
5460.00							52.65	74.00	-21.35	
5460.00					A		35.98	54.00	-18.02	Ch. 140

NOTE: The “Band Edge Field Strength” was calculated using the “Fundamental” and “Conducted Band Edge” measurements per the “Marker-Delta Method” with the following formula:

$$BE = F_m - \Delta_m$$

Where

BE = Band Edge Field Strength

F_m = Measured Fundamental (Peak or Average)

Δ_m = Measured Conducted Band Edge Delta (Peak or Average)



Radiated Emissions Test Results (Continued)

*Spurious Emissions Measurements in 802.11n mode 20MHz Wide (5470-5725 MHz)
Channels 100, 120, & 140
Continuous TX at Chain A, B, & C Antenna ports
Aegis Labs, Inc. File #: INTEL-080114-05*

RADIATED EMISSIONS - Horizontal Antenna Polarization												
Freq. (MHz)	Meter Reading (dBuV)	Antenna Height (cm)	Azimuth (degrees)	Quasi pk or AVG (dBuV)		Preamp Factor (dB)	Cable Factor (dB)	Ant. Factor (dB)	Corrected Reading (dBuV)	Limits (dBuV)	Diff (dB) +/-FAIL	Channel/Chain Tested
3733.33	52.83	100	225			46.55	2.53	32.91	41.72	74.00	-32.28	Ch. 120/
3733.33				42.17	A	46.55	2.53	32.91	31.06	54.00	-22.94	A
7466.66	52.83	100	225			44.88	3.63	37.21	48.80	74.00	-25.20	
7466.66				42.82	A	44.88	3.63	37.21	38.79	54.00	-15.21	
3733.33	54.83	100	180			46.55	2.53	32.91	43.72	74.00	-30.28	Ch. 120/
3733.33				46.87	A	46.55	2.53	32.91	35.76	54.00	-18.24	B
7466.66	54.67	100	225			44.88	3.63	37.21	50.64	74.00	-23.36	
7466.66				42.46	A	44.88	3.63	37.21	38.43	54.00	-15.57	
3733.33	52.83	100	225			46.55	2.53	32.91	41.72	74.00	-32.28	Ch. 120/
3733.33				41.26	A	46.55	2.53	32.91	30.15	54.00	-23.85	C
7466.66	53.00	100	225			44.88	3.63	37.21	48.97	74.00	-25.03	
7466.66				42.54	A	44.88	3.63	37.21	38.51	54.00	-15.49	
3666.66	54.83	100	225			46.56	2.50	32.77	43.53	74.00	-30.47	Ch. 100/
3666.66				42.24	A	46.56	2.50	32.77	30.94	54.00	-23.06	A
7333.33	53.00	100	225			44.92	3.60	36.87	48.54	74.00	-25.46	
7333.33				42.19	A	44.92	3.60	36.87	37.73	54.00	-16.27	
3800.00	54.00	100	225			46.54	2.55	33.06	43.08	74.00	-30.92	Ch. 140/
3800.00				43.55	A	46.54	2.55	33.06	32.63	54.00	-21.37	A
7600.00	52.00	100	225			44.86	3.67	37.36	48.17	74.00	-25.83	
7600.00				40.89	A	44.86	3.67	37.36	37.06	54.00	-16.94	



Radiated Emissions Test Results (Continued)

RADIATED EMISSIONS - Vertical Antenna Polarization												
Freq. (MHz)	Meter Reading (dBuV)	Antenna Height (cm)	Azimuth (degrees)	Quasi pk or AVG (dBuV)		Preamp Factor (dB)	Cable Factor (dB)	Ant. Factor (dB)	Corrected Reading (dBuV)	Limits (dBuV)	Diff (dB) +/-FAIL	Comments
3733.33	53.83	100	270			46.55	2.53	32.51	42.31	74.00	-31.69	Ch. 120/
3733.33				42.63	A	46.55	2.53	32.51	31.11	54.00	-22.89	A
7466.66	52.50	100	225			44.88	3.63	37.11	48.37	74.00	-25.63	
7466.66				41.32	A	44.88	3.63	37.11	37.19	54.00	-16.81	
3733.33	56.33	100	225			46.55	2.53	32.51	44.81	74.00	-29.19	Ch. 120/
3733.33				49.15	A	46.55	2.53	32.51	37.63	54.00	-16.37	B
7466.66	55.00	100	180			44.88	3.63	37.11	50.87	74.00	-23.13	
7466.66				48.44	A	44.88	3.63	37.11	44.31	54.00	-9.69	
11200.00	49.17	100	135			45.09	4.55	38.96	47.60	74.00	-26.40	
11200.00				39.08	A	45.09	4.55	38.96	37.51	54.00	-16.49	
3733.33	54.17	100	180			46.55	2.53	32.51	42.65	74.00	-31.35	Ch. 120/
3733.33				44.46	A	46.55	2.53	32.51	32.94	54.00	-21.06	C
7466.66	53.00	100	180			44.88	3.63	37.11	48.87	74.00	-25.13	
7466.66				46.73	A	44.88	3.63	37.11	42.60	54.00	-11.40	
3666.66	57.33	100	180			46.56	2.50	32.33	45.60	74.00	-28.40	Ch. 100/
3666.66				48.75	A	46.56	2.50	32.33	37.02	54.00	-16.98	B
7333.33	51.50	100	225			44.92	3.60	36.77	46.94	74.00	-27.06	
7333.33				42.78	A	44.92	3.60	36.77	38.22	54.00	-15.78	
3800.00	54.50	100	180			46.54	2.55	32.68	43.20	74.00	-30.80	Ch. 140/
3800.00				46.59	A	46.54	2.55	32.68	35.29	54.00	-18.71	B
7600.00	55.00	100	180			44.86	3.67	37.24	51.05	74.00	-22.95	
7600.00				48.17	A	44.86	3.67	37.24	44.22	54.00	-9.78	
11400.00	50.83	100	135	53.67		45.04	4.61	39.12	52.36	74.00	-21.64	
11400.00				40.10	A	45.04	4.61	39.12	38.79	54.00	-15.21	



Radiated Emissions Test Results (Continued)

*Spurious Emissions Measurements in 802.11n mode 20MHz Wide (5470-5725 MHz)
Channels 100, 120, & 140
Continuous TX at Triple Chain ABC Antenna ports
Aegis Labs, Inc. File #: INTEL-080114-06*

RADIATED EMISSIONS - Horizontal Antenna Polarization

Freq. (MHz)	Meter Reading (dBuV)	Antenna Height (cm)	Azimuth (degrees)	Quasi pk or AVG (dBuV)		Preamp Factor (dB)	Cable Factor (dB)	Ant. Factor (dB)	Corrected Reading (dBuV)	Limits (dBuV)	Diff (dB) +/-FAIL	Channel/Chain Tested
3666.66	54.17	100	180			46.56	2.50	32.77	42.87	74.00	-31.13	Ch. 100/
3666.66				46.35	A	46.56	2.50	32.77	35.05	54.00	-18.95	ABC
7333.33	50.67	100	225			44.92	3.60	36.87	46.21	74.00	-27.79	
7333.33				41.75	A	44.92	3.60	36.87	37.29	54.00	-16.71	
3733.33	56.67	100	180			46.55	2.53	32.91	45.56	74.00	-28.44	Ch. 120/
3733.33				50.62	A	46.55	2.53	32.91	39.51	54.00	-14.49	ABC
7466.66	43.00	100	135			44.88	3.63	37.21	38.97	74.00	-35.03	
7466.66				31.91	A	44.88	3.63	37.21	27.88	54.00	-26.12	
3800.00	53.17	100	225			46.54	2.55	33.06	42.25	74.00	-31.75	Ch. 140/
3800.00				43.01	A	46.54	2.55	33.06	32.09	54.00	-21.91	ABC
7600.00	52.33	100	135			44.86	3.67	37.36	48.50	74.00	-25.50	
7600.00				42.37	A	44.86	3.67	37.36	38.54	54.00	-15.46	
11400.00	50.33	100	225			45.04	4.61	39.14	49.04	74.00	-24.96	
11400.00				39.53	A	45.04	4.61	39.14	38.24	54.00	-15.76	

RADIATED EMISSIONS - Vertical Antenna Polarization

Freq. (MHz)	Meter Reading (dBuV)	Antenna Height (cm)	Azimuth (degrees)	Quasi pk or AVG (dBuV)		Preamp Factor (dB)	Cable Factor (dB)	Ant. Factor (dB)	Corrected Reading (dBuV)	Limits (dBuV)	Diff (dB) +/-FAIL	Comments
3666.66	55.50	100	225			46.56	2.50	32.33	43.77	74.00	-30.23	Ch. 100/
3666.66				47.76	A	46.56	2.50	32.33	36.03	54.00	-17.97	ABC
7333.33	50.83	100	135			44.92	3.60	36.77	46.27	74.00	-27.73	
7333.33				41.78	A	44.92	3.60	36.77	37.22	54.00	-16.78	
3733.33	54.17	100	180			46.55	2.53	32.51	42.65	74.00	-31.35	Ch. 120/
3733.33				45.94	A	46.55	2.53	32.51	34.42	54.00	-19.58	ABC
7466.66	51.00	100	225			44.88	3.63	37.11	46.87	74.00	-27.13	
7466.66				41.57	A	44.88	3.63	37.11	37.44	54.00	-16.56	
3800.00	53.83	100	180			46.54	2.55	32.68	42.53	74.00	-31.47	Ch. 140/
3800.00				45.38	A	46.54	2.55	32.68	34.08	54.00	-19.92	ABC
7600.00	53.17	100	135			44.86	3.67	37.24	49.22	74.00	-24.78	
7600.00				43.58	A	44.86	3.67	37.24	39.63	54.00	-14.37	
11400.00	51.93	100	225	53.67		45.04	4.61	39.12	52.36	74.00	-21.64	
11400.00				41.21	A	45.04	4.61	39.12	39.90	54.00	-14.10	

**RADIATED EMISSIONS TEST RESULTS**

CLIENT:	Intel Corporation	DATE:	02/25/08
EUT:	Intel WiFi/WiMax Link 5350	PROJECT NUMBER:	INTEL-080114
MODEL NUMBER:	533ANXMMW	TEST ENGINEER:	JC/KN
SERIAL NUMBER:	0016EB01A3A8	SITE #:	2
CONFIGURATION:	Tested installed in an extender board connected to the host laptop's mini PCI slot in 802.11n (5740-5745 MHz) mode 40MHz Wide.	TEMPERATURE:	17 deg. C
		HUMIDITY:	52% RH
		TIME:	1:30 PM

Description:	Radiated RF Emissions (1 GHz – 18 GHz)
Results:	PASSED Horizontal and Vertical Antenna Polarizations Class B Limits
Note:	Radiated Emissions Measurements were performed on the EUT with power supply set at the following voltage and frequency. <ul style="list-style-type: none"> • 120VAC / 60 Hz.

Unwanted Spurious Emissions Limits			
Frequency (MHz)	Field Strength (uV/m)	Field Strength (dBuV/m) (Emissions in the restricted bands)	Field Strength (dBm/MHz) (Emissions outside the restricted bands)
Above 960	500	54.00 (Average) 74.00 (Peak)	< -20 dBc

Radiated Emissions Sample Calculations

$$\text{Corrected Meter Reading} = \text{Meter Reading} + F + C - D$$

Where, F = Antenna Factor

C = Cable Factor

G = Amplifier Gain

D = Distance Factor (if applicable)

Therefore, the equation for determining the Corrected Meter Reading Limit (CML) is:

$$\text{CML} = \text{Specification Limit} - F - C + D$$



Radiated Emissions Test Results (Continued)

*Fundamental Measurements in 802.11n mode 40MHz Wide (5470-5725 MHz)
Channels 102, 118, & 134
Continuous TX at Chain A Antenna port
Aegis Labs, Inc. File #: INTEL-080114-57*

RADIATED EMISSIONS - Horizontal Antenna Polarization											
Freq. (MHz)	Meter Reading (dBuV)	Antenna Height (cm)	Azimuth (degrees)	Quasi pk or AVG (dBuV)		Cable Factor (dB)	Ant. Factor (dB)	Corrected Reading (dBuV)	Limits (dBuV)	Diff (dB) +=FAIL	Comments
5510.00	64.17	100	90			3.08	35.20	102.45			Ch. 102
5510.00				53.83	A	3.08	35.20	92.11			
5590.00	63.17	100	90			3.10	35.22	101.49			Ch. 118
5590.00				52.33	A	3.10	35.22	90.65			
5670.00	64.50	100	45			3.13	35.23	102.86			Ch. 134
5670.00				53.67	A	3.13	35.23	92.03			

RADIATED EMISSIONS - Vertical Antenna Polarization											
Freq. (MHz)	Meter Reading (dBuV)	Antenna Height (cm)	Azimuth (degrees)	Quasi pk or AVG (dBuV)		Cable Factor (dB)	Ant. Factor (dB)	Corrected Reading (dBuV)	Limits (dBuV)	Diff (dB) +=FAIL	Comments
5510.00	62.00	100	90			3.08	34.91	99.99			Ch. 102
5510.00				51.50	A	3.08	34.91	89.49			
5590.00	61.33	100	90			3.10	34.95	99.39			Ch. 118
5590.00				49.33	A	3.10	34.95	87.39			
5670.00	60.67	100	90			3.13	35.00	98.80			Ch. 134
5670.00				50.00	A	3.13	35.00	88.13			

NOTE: Fundamental signals measured to calculate the band edge field strengths using the “Marker Delta Method”.



Radiated Emissions Test Results (Continued)

Band Edge Field Strength Measurements in 802.11n mode 40MHz Wide (5470-5725 MHz)
Channels 102 & 134
Continuous TX at Chain A Antenna port
Aegis Labs, Inc. File #: INTEL-080114-57

RADIATED EMISSIONS - Horizontal Antenna Polarization

<i>Freq. (MHz)</i>	<i>Meter Reading (dBuV)</i>	<i>Antenna Height (cm)</i>	<i>Azimuth (degrees)</i>	<i>Quasi pk or AVG (dBuV)</i>	<i>Cable Factor (dB)</i>	<i>Ant. Factor (dB)</i>	<i>Corrected Reading (dBuV)</i>	<i>Limits (dBuV)</i>	<i>Diff (dB) +=FAIL</i>	<i>Comments</i>
5460.00							66.29	74.00	-7.71	Ch. 102
5460.00				A			47.77	54.00	-6.23	
5725.00	29.67	100	45		3.15	35.25	68.06	82.86	-14.80	Ch. 134

RADIATED EMISSIONS - Vertical Antenna Polarization

<i>Freq. (MHz)</i>	<i>Meter Reading (dBuV)</i>	<i>Antenna Height (cm)</i>	<i>Azimuth (degrees)</i>	<i>Quasi pk or AVG (dBuV)</i>	<i>Cable Factor (dB)</i>	<i>Ant. Factor (dB)</i>	<i>Corrected Reading (dBuV)</i>	<i>Limits (dBuV)</i>	<i>Diff (dB) +=FAIL</i>	<i>Comments</i>
5460.00							63.83	74.00	-10.17	Ch. 102
5460.00				A			45.15	54.00	-8.85	
5725.00	29.33	100	90		3.15	35.04	67.51	78.80	-11.29	Ch. 134

NOTE: The “Band Edge Field Strength” was calculated using the “Fundamental” and “Conducted Band Edge” measurements per the “Marker-Delta Method” with the following formula:

$$BE = F_m - \Delta_m$$

Where

BE = Band Edge Field Strength

F_m = Measured Fundamental (Peak or Average)

Δ_m = Measured Conducted Band Edge Delta (Peak or Average)

Radiated Emissions Test Results (Continued)

Plots Showing Out-Of-Band Emissions (Peak RBW=VBW=1MHz; Average RBW = 1MHz, VBW = 10Hz)

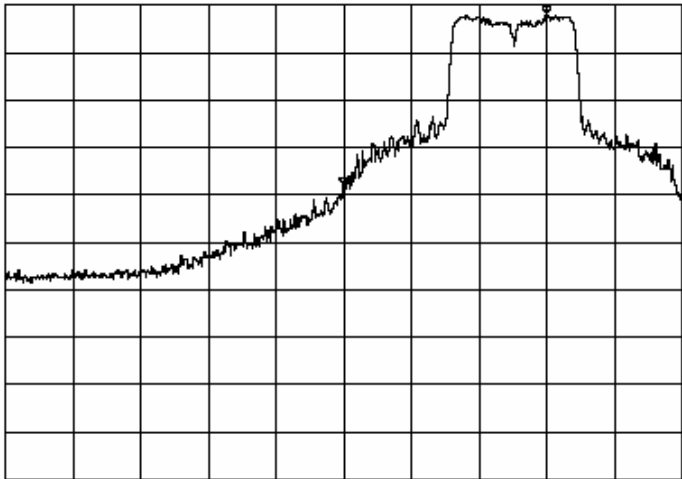
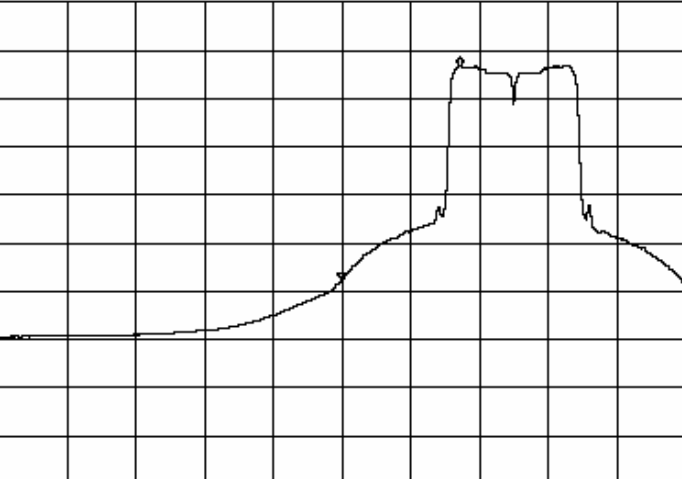
Test Date	Data	Test Eng.
03/31/08	5.50 GHz band edge PEAK (INTEL-080114)	RC
<p>*ATTEN 20dB ΔMKR 36.16dB RL 10.0dBm 10dB/ 60.0MHz</p>  <p>CENTER 5.4600GHz SPAN 200.0MHz *RBW 1.0MHz *VBW 1.0MHz SWP 50.0ms</p>		
Test Date	Data	Test Eng.
03/31/08	5.50 GHz band edge AVERAGE (INTEL-080114)	RC
<p>*ATTEN 20dB ΔMKR 44.34dB RL 10.0dBm 10dB/ 34.3MHz</p>  <p>CENTER 5.4600GHz SPAN 200.0MHz *RBW 1.0MHz *VBW 10Hz SWP 74.0sec</p>		



Radiated Emissions Test Results (Continued)

*Fundamental Measurements in 802.11n mode 40MHz Wide (5470-5725 MHz)
Channels 102, 118, & 134
Continuous TX at Chain B Antenna port
Aegis Labs, Inc. File #: INTEL-080114-58*

RADIATED EMISSIONS - Horizontal Antenna Polarization											
Freq. (MHz)	Meter Reading (dBuV)	Antenna Height (cm)	Azimuth (degrees)	Quasi pk or AVG (dBuV)		Cable Factor (dB)	Ant. Factor (dB)	Corrected Reading (dBuV)	Limits (dBuV)	Diff (dB) +=FAIL	Comments
5510.00	70.00	100	270			3.08	35.20	108.28			Ch. 102
5510.00				58.33	A	3.08	35.20	96.61			
5590.00	66.00	100	270			3.10	35.22	104.32			Ch. 118
5590.00				55.67	A	3.10	35.22	93.99			
5670.00	66.33	100	270			3.13	35.23	104.69			Ch. 134
5670.00				56.00	A	3.13	35.23	94.36			

RADIATED EMISSIONS - Vertical Antenna Polarization											
Freq. (MHz)	Meter Reading (dBuV)	Antenna Height (cm)	Azimuth (degrees)	Quasi pk or AVG (dBuV)		Cable Factor (dB)	Ant. Factor (dB)	Corrected Reading (dBuV)	Limits (dBuV)	Diff (dB) +=FAIL	Comments
5510.00	61.33	100	180			3.08	34.91	99.32			Ch. 100
5510.00				51.67	A	3.08	34.91	89.66			
5590.00	59.33	100	180			3.10	34.95	97.39			Ch. 120
5590.00				49.17	A	3.10	34.95	87.23			
5670.00	59.00	100	180			3.13	35.00	97.13			Ch. 140
5670.00				49.17	A	3.13	35.00	87.30			

NOTE: Fundamental signals measured to calculate the band edge field strengths using the “Marker Delta Method”.



Radiated Emissions Test Results (Continued)

*Band Edge Field Strength Measurements in 802.11n mode 40MHz Wide (5470-5725 MHz)
Channels 102 & 134
Continuous TX at Chain B Antenna port
Aegis Labs, Inc. File #: INTEL-080114-58*

RADIATED EMISSIONS - Horizontal Antenna Polarization										
<i>Freq. (MHz)</i>	<i>Meter Reading (dBuV)</i>	<i>Antenna Height (cm)</i>	<i>Azimuth (degrees)</i>	<i>Quasi pk or AVG (dBuV)</i>	<i>Cable Factor (dB)</i>	<i>Ant. Factor (dB)</i>	<i>Corrected Reading (dBuV)</i>	<i>Limits (dBuV)</i>	<i>Diff (dB) +=FAIL</i>	<i>Comments</i>
5460.00							72.78	74.00	-1.22	Ch. 102
5460.00					A		52.44	54.00	-1.56	
5725.00	29.33	100	270			3.15 35.25	67.72	84.69	-16.97	Ch. 134

RADIATED EMISSIONS - Vertical Antenna Polarization										
<i>Freq. (MHz)</i>	<i>Meter Reading (dBuV)</i>	<i>Antenna Height (cm)</i>	<i>Azimuth (degrees)</i>	<i>Quasi pk or AVG (dBuV)</i>	<i>Cable Factor (dB)</i>	<i>Ant. Factor (dB)</i>	<i>Corrected Reading (dBuV)</i>	<i>Limits (dBuV)</i>	<i>Diff (dB) +=FAIL</i>	<i>Comments</i>
5460.00							63.82	74.00	-10.18	Ch. 102
5460.00					A		45.49	54.00	-8.51	
5725.00	30.50	100	180			3.15 35.04	68.68	77.13	-8.45	Ch. 134

NOTE: The “Band Edge Field Strength” was calculated using the “Fundamental” and “Conducted Band Edge” measurements per the “Marker-Delta Method” with the following formula:

$$BE = Fm - \Delta m$$

Where

BE = Band Edge Field Strength

Fm = Measured Fundamental (Peak or Average)

Δm = Measured Conducted Band Edge Delta (Peak or Average)



Radiated Emissions Test Results (Continued)

Plots Showing Out-Of-Band Emissions (Peak RBW=VBW=1MHz; Average RBW = 1MHz, VBW = 10Hz)

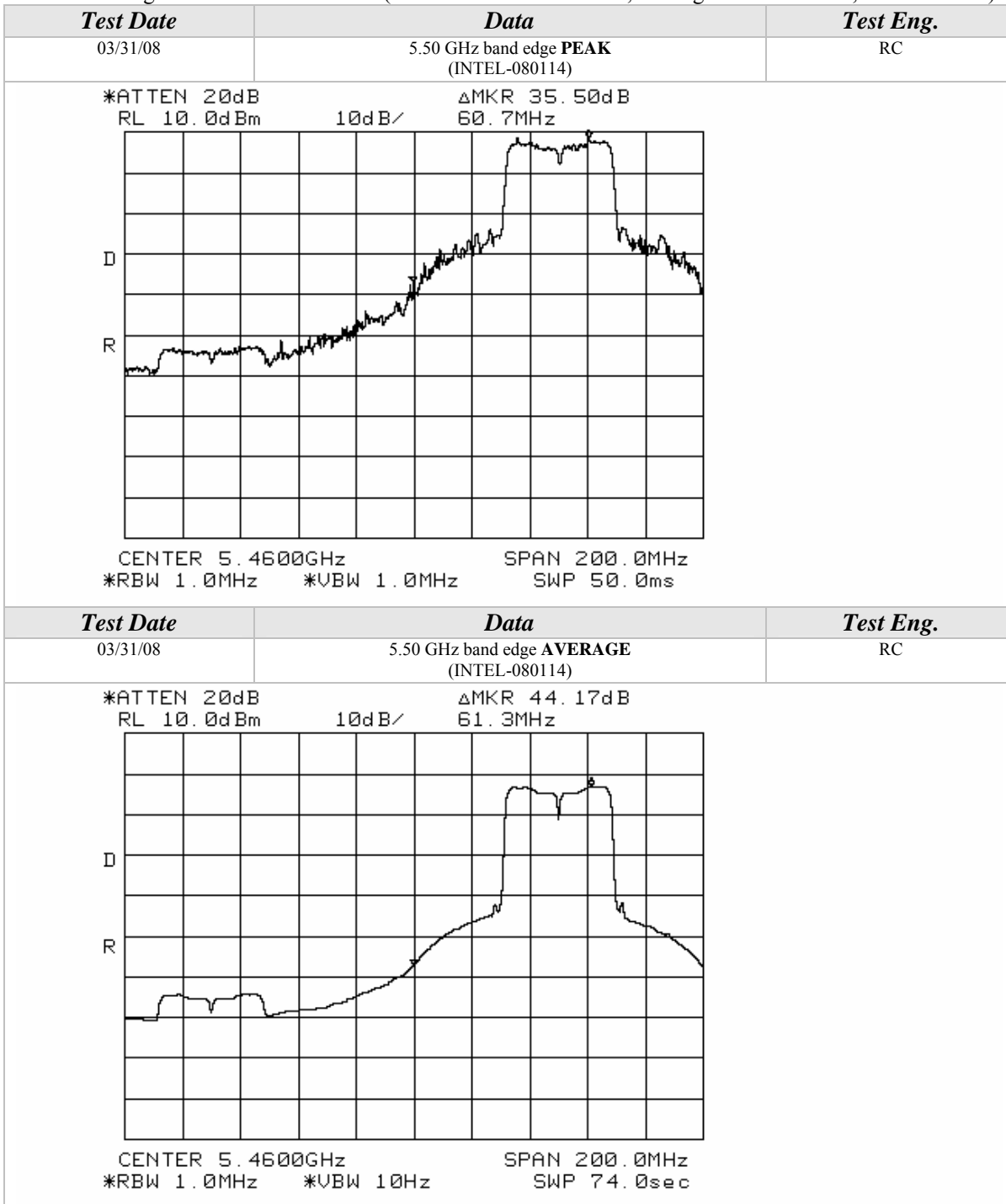



Radiated Emissions Test Results (Continued)

*Fundamental Measurements in 802.11n mode 40MHz Wide (5470-5725 MHz)
Channels 102, 118, & 134
Continuous TX at Chain C Antenna port
Aegis Labs, Inc. File #: INTEL-080114-59*

RADIATED EMISSIONS - Horizontal Antenna Polarization											
Freq. (MHz)	Meter Reading (dBuV)	Antenna Height (cm)	Azimuth (degrees)	Quasi pk or AVG (dBuV)		Cable Factor (dB)	Ant. Factor (dB)	Corrected Reading (dBuV)	Limits (dBuV)	Diff (dB) +=FAIL	Comments
5510.00	62.67	100	135			3.08	35.20	100.95			Ch. 102
5510.00				52.33	A	3.08	35.20	90.61			
5590.00	63.17	100	135			3.10	35.22	101.49			Ch. 118
5590.00				52.50	A	3.10	35.22	90.82			
5670.00	61.67	100	135			3.13	35.23	100.03			Ch. 134
5670.00				51.50	A	3.13	35.23	89.86			

RADIATED EMISSIONS - Vertical Antenna Polarization											
Freq. (MHz)	Meter Reading (dBuV)	Antenna Height (cm)	Azimuth (degrees)	Quasi pk or AVG (dBuV)		Cable Factor (dB)	Ant. Factor (dB)	Corrected Reading (dBuV)	Limits (dBuV)	Diff (dB) +=FAIL	Comments
5510.00	60.33	100	90			3.08	34.91	98.32			Ch. 102
5510.00				49.67	A	3.08	34.91	87.66			
5590.00	60.17	100	135			3.10	34.95	98.23			Ch. 118
5590.00				50.00	A	3.10	34.95	88.06			
5670.00	57.50	100	45			3.13	35.00	95.63			Ch. 134
5670.00				47.83	A	3.13	35.00	85.96			

NOTE: Fundamental signals measured to calculate the band edge field strengths using the “Marker Delta Method”.



Radiated Emissions Test Results (Continued)

*Band Edge Field Strength Measurements in 802.11n mode 40MHz Wide (5470-5725 MHz)
Channels 102 & 134
Continuous TX at Chain C Antenna port
Aegis Labs, Inc. File #: INTEL-080114-59*

RADIATED EMISSIONS - Horizontal Antenna Polarization										
<i>Freq. (MHz)</i>	<i>Meter Reading (dBuV)</i>	<i>Antenna Height (cm)</i>	<i>Azimuth (degrees)</i>	<i>Quasi pk or AVG (dBuV)</i>	<i>Cable Factor (dB)</i>	<i>Ant. Factor (dB)</i>	<i>Corrected Reading (dBuV)</i>	<i>Limits (dBuV)</i>	<i>Diff (dB) +=FAIL</i>	<i>Comments</i>
5460.00							58.28	74.00	-15.72	Ch. 102
5460.00					A		42.28	54.00	-11.72	
5725.00	27.50	100	135			3.15 35.25	65.89	80.03	-14.14	Ch. 134

RADIATED EMISSIONS - Vertical Antenna Polarization										
<i>Freq. (MHz)</i>	<i>Meter Reading (dBuV)</i>	<i>Antenna Height (cm)</i>	<i>Azimuth (degrees)</i>	<i>Quasi pk or AVG (dBuV)</i>	<i>Cable Factor (dB)</i>	<i>Ant. Factor (dB)</i>	<i>Corrected Reading (dBuV)</i>	<i>Limits (dBuV)</i>	<i>Diff (dB) +=FAIL</i>	<i>Comments</i>
5460.00							55.65	74.00	-18.35	Ch. 102
5460.00					A		39.33	54.00	-14.67	
5725.00	31.50	100	45			3.15 35.04	69.68	75.63	-5.95	Ch. 134

NOTE: The “Band Edge Field Strength” was calculated using the “Fundamental” and “Conducted Band Edge” measurements per the “Marker-Delta Method” with the following formula:

$$BE = Fm - \Delta m$$

Where

BE = Band Edge Field Strength

Fm = Measured Fundamental (Peak or Average)

Δm = Measured Conducted Band Edge Delta (Peak or Average)



Radiated Emissions Test Results (Continued)

Plots Showing Out-Of-Band Emissions (Peak RBW=VBW=1MHz; Average RBW = 1MHz, VBW = 10Hz)

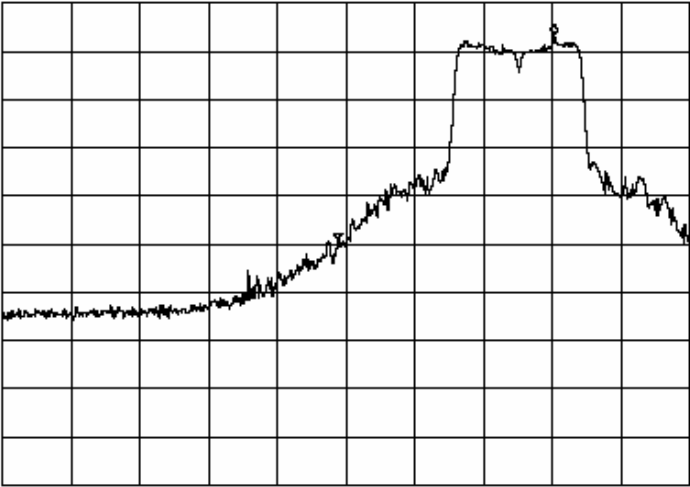
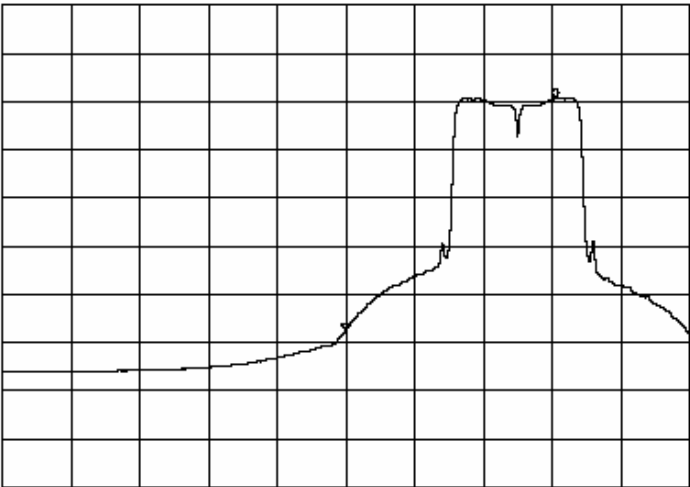
Test Date	Data	Test Eng.
03/31/08	5.50 GHz band edge PEAK (INTEL-080114)	RC
<p>*ATTEN 20dB ΔMKR 42.67dB RL 16.0dBm 10dB/ 63.0MHz</p>  <p>CENTER 5.4600GHz SPAN 200.0MHz *RBW 1.0MHz *VBW 1.0MHz SWP 50.0ms</p>		
Test Date	Data	Test Eng.
03/31/08	5.50 GHz band edge AVERAGE (INTEL-080114)	RC
<p>*ATTEN 20dB ΔMKR 48.33dB RL 16.0dBm 10dB/ 61.0MHz</p>  <p>CENTER 5.4600GHz SPAN 200.0MHz *RBW 1.0MHz *VBW 10Hz SWP 74.0sec</p>		



Radiated Emissions Test Results (Continued)

*Spurious Emissions Measurements in 802.11n mode 40MHz Wide (5470-5725 MHz)
 Channels 102, 118, & 134
 Continuous TX at Chain A, B, & C Antenna ports
 Aegis Labs, Inc. File #: INTEL-080114-05*

RADIATED EMISSIONS - Horizontal Antenna Polarization												
Freq. (MHz)	Meter Reading (dBuV)	Antenna Height (cm)	Azimuth (degrees)	Quasi pk or AVG (dBuV)		Preamp Factor (dB)	Cable Factor (dB)	Ant. Factor (dB)	Corrected Reading (dBuV)	Limits (dBuV)	Diff (dB) +/-FAIL	Channel/Chain Tested
3733.33	52.83	100	225			46.55	2.53	32.91	41.72	74.00	-32.28	Ch. 118/
3733.33				42.17	A	46.55	2.53	32.91	31.06	54.00	-22.94	A
7466.66	52.83	100	225			44.88	3.63	37.21	48.80	74.00	-25.20	
7466.66				42.82	A	44.88	3.63	37.21	38.79	54.00	-15.21	
3733.33	54.83	100	180			46.55	2.53	32.91	43.72	74.00	-30.28	Ch. 118/
3733.33				46.87	A	46.55	2.53	32.91	35.76	54.00	-18.24	B
7466.66	54.67	100	225			44.88	3.63	37.21	50.64	74.00	-23.36	
7466.66				42.46	A	44.88	3.63	37.21	38.43	54.00	-15.57	
3733.33	52.83	100	225			46.55	2.53	32.91	41.72	74.00	-32.28	Ch. 118/
3733.33				41.26	A	46.55	2.53	32.91	30.15	54.00	-23.85	C
7466.66	53.00	100	225			44.88	3.63	37.21	48.97	74.00	-25.03	
7466.66				42.54	A	44.88	3.63	37.21	38.51	54.00	-15.49	
3666.66	54.83	100	225			46.56	2.50	32.77	43.53	74.00	-30.47	Ch. 102/
3666.66				42.24	A	46.56	2.50	32.77	30.94	54.00	-23.06	A
7333.33	53.00	100	225			44.92	3.60	36.87	48.54	74.00	-25.46	
7333.33				42.19	A	44.92	3.60	36.87	37.73	54.00	-16.27	
3800.00	54.00	100	225			46.54	2.55	33.06	43.08	74.00	-30.92	Ch. 134/
3800.00				43.55	A	46.54	2.55	33.06	32.63	54.00	-21.37	A
7600.00	52.00	100	225			44.86	3.67	37.36	48.17	74.00	-25.83	
7600.00				40.89	A	44.86	3.67	37.36	37.06	54.00	-16.94	



Radiated Emissions Test Results (Continued)

RADIATED EMISSIONS - Vertical Antenna Polarization												
Freq. (MHz)	Meter Reading (dBuV)	Antenna Height (cm)	Azimuth (degrees)	Quasi pk or AVG (dBuV)		Preamp Factor (dB)	Cable Factor (dB)	Ant. Factor (dB)	Corrected Reading (dBuV)	Limits (dBuV)	Diff (dB) +/-FAIL	Comments
3733.33	53.83	100	270			46.55	2.53	32.51	42.31	74.00	-31.69	Ch. 118/
3733.33				42.63	A	46.55	2.53	32.51	31.11	54.00	-22.89	A
7466.66	52.50	100	225			44.88	3.63	37.11	48.37	74.00	-25.63	
7466.66				41.32	A	44.88	3.63	37.11	37.19	54.00	-16.81	
3733.33	56.33	100	225			46.55	2.53	32.51	44.81	74.00	-29.19	Ch. 118/
3733.33				49.15	A	46.55	2.53	32.51	37.63	54.00	-16.37	B
7466.66	55.00	100	180			44.88	3.63	37.11	50.87	74.00	-23.13	
7466.66				48.44	A	44.88	3.63	37.11	44.31	54.00	-9.69	
11200.00	49.17	100	135			45.09	4.55	38.96	47.60	74.00	-26.40	
11200.00				39.08	A	45.09	4.55	38.96	37.51	54.00	-16.49	
3733.33	54.17	100	180			46.55	2.53	32.51	42.65	74.00	-31.35	Ch. 118/
3733.33				44.46	A	46.55	2.53	32.51	32.94	54.00	-21.06	C
7466.66	53.00	100	180			44.88	3.63	37.11	48.87	74.00	-25.13	
7466.66				46.73	A	44.88	3.63	37.11	42.60	54.00	-11.40	
3666.66	57.33	100	180			46.56	2.50	32.33	45.60	74.00	-28.40	Ch. 102/
3666.66				48.75	A	46.56	2.50	32.33	37.02	54.00	-16.98	B
7333.33	51.50	100	225			44.92	3.60	36.77	46.94	74.00	-27.06	
7333.33				42.78	A	44.92	3.60	36.77	38.22	54.00	-15.78	
3800.00	54.50	100	180			46.54	2.55	32.68	43.20	74.00	-30.80	Ch. 134/
3800.00				46.59	A	46.54	2.55	32.68	35.29	54.00	-18.71	B
7600.00	55.00	100	180			44.86	3.67	37.24	51.05	74.00	-22.95	
7600.00				48.17	A	44.86	3.67	37.24	44.22	54.00	-9.78	
11400.00	50.83	100	135	53.67		45.04	4.61	39.12	52.36	74.00	-21.64	
11400.00				40.10	A	45.04	4.61	39.12	38.79	54.00	-15.21	



Radiated Emissions Test Results (Continued)

*Spurious Emissions Measurements in 802.11n mode 40MHz Wide (5470-5725 MHz)
Channels 102, 118, & 134
Continuous TX at Triple Chain ABC Antenna ports
Aegis Labs, Inc. File #: INTEL-080114-06*

RADIATED EMISSIONS - Horizontal Antenna Polarization

Freq. (MHz)	Meter Reading (dBuV)	Antenna Height (cm)	Azimuth (degrees)	Quasi pk or AVG (dBuV)		Preamp Factor (dB)	Cable Factor (dB)	Ant. Factor (dB)	Corrected Reading (dBuV)	Limits (dBuV)	Diff (dB) +/-FAIL	Channel/ Chain Tested
3666.66	54.17	100	180			46.56	2.50	32.77	42.87	74.00	-31.13	Ch. 102/
3666.66				46.35	A	46.56	2.50	32.77	35.05	54.00	-18.95	ABC
7333.33	50.67	100	225			44.92	3.60	36.87	46.21	74.00	-27.79	
7333.33				41.75	A	44.92	3.60	36.87	37.29	54.00	-16.71	
3733.33	56.67	100	180			46.55	2.53	32.91	45.56	74.00	-28.44	Ch. 118/
3733.33				50.62	A	46.55	2.53	32.91	39.51	54.00	-14.49	ABC
7466.66	43.00	100	135			44.88	3.63	37.21	38.97	74.00	-35.03	
7466.66				31.91	A	44.88	3.63	37.21	27.88	54.00	-26.12	
3800.00	53.17	100	225			46.54	2.55	33.06	42.25	74.00	-31.75	Ch. 134/
3800.00				43.01	A	46.54	2.55	33.06	32.09	54.00	-21.91	ABC
7600.00	52.33	100	135			44.86	3.67	37.36	48.50	74.00	-25.50	
7600.00				42.37	A	44.86	3.67	37.36	38.54	54.00	-15.46	
11400.00	50.33	100	225			45.04	4.61	39.14	49.04	74.00	-24.96	
11400.00				39.53	A	45.04	4.61	39.14	38.24	54.00	-15.76	

RADIATED EMISSIONS - Vertical Antenna Polarization

Freq. (MHz)	Meter Reading (dBuV)	Antenna Height (cm)	Azimuth (degrees)	Quasi pk or AVG (dBuV)		Preamp Factor (dB)	Cable Factor (dB)	Ant. Factor (dB)	Corrected Reading (dBuV)	Limits (dBuV)	Diff (dB) +/-FAIL	Comments
3666.66	55.50	100	225			46.56	2.50	32.33	43.77	74.00	-30.23	Ch. 102/
3666.66				47.76	A	46.56	2.50	32.33	36.03	54.00	-17.97	ABC
7333.33	50.83	100	135			44.92	3.60	36.77	46.27	74.00	-27.73	
7333.33				41.78	A	44.92	3.60	36.77	37.22	54.00	-16.78	
3733.33	54.17	100	180			46.55	2.53	32.51	42.65	74.00	-31.35	Ch. 118/
3733.33				45.94	A	46.55	2.53	32.51	34.42	54.00	-19.58	ABC
7466.66	51.00	100	225			44.88	3.63	37.11	46.87	74.00	-27.13	
7466.66				41.57	A	44.88	3.63	37.11	37.44	54.00	-16.56	
3800.00	53.83	100	180			46.54	2.55	32.68	42.53	74.00	-31.47	Ch. 134/
3800.00				45.38	A	46.54	2.55	32.68	34.08	54.00	-19.92	ABC
7600.00	53.17	100	135			44.86	3.67	37.24	49.22	74.00	-24.78	
7600.00				43.58	A	44.86	3.67	37.24	39.63	54.00	-14.37	
11400.00	51.93	100	225	53.67		45.04	4.61	39.12	52.36	74.00	-21.64	
11400.00				41.21	A	45.04	4.61	39.12	39.90	54.00	-14.10	

**PEAK TRANSMIT POWER**

CLIENT:	Intel Corporation	DATE:	04/03/08
EUT:	Intel WiFi/WiMax Link 5350	PROJECT NUMBER:	INTEL-080114
MODEL NUMBER:	533ANXMMW	TEST ENGINEER:	RC/KN
SERIAL NUMBER:	0016EB01A3A8	SITE #:	2
CONFIGURATION:	Tested installed in an extender board connected to the host laptop's mini PCI slot	TEMPERATURE:	23 deg. C
		HUMIDITY:	46% RH
		TIME:	11:00 AM

Description:	<p>For the band 5.15-5.25 GHz, the peak transmit power over the frequency band of operation shall not exceed the lesser of 50 mW or $4 \text{ dBm} + 10\log B$, where B is the 26-dB emission bandwidth in MHz.</p> <p>For the band 5.25-5.35 GHz, the peak transmit power over the frequency band of operation shall not exceed the lesser of 250 mW or $11 \text{ dBm} + 10\log B$, where B is the 26-dB emission bandwidth in MHz.</p>
Results:	Passed (See Data Sheet)
Note:	<p>Conducted Emissions Measurements were performed on the EUT with power supply set at the following voltage and frequency.</p> <ul style="list-style-type: none">• 120VAC / 60 Hz.



Peak Transmit Power (Continued)

Mode	Channel	Frequency (MHz)	Chain	Data Rate (Mbps)	Total Power (dBm)	Total Power (mW)
802.11a	36	5180	A	6	16.47	44.40
802.11a	40	5200	A	6	16.66	46.38
802.11a	48	5240	A	6	16.76	47.46
802.11a	52	5260	A	6	16.52	44.91
802.11a	56	5280	A	6	16.69	46.71
802.11a	64	5320	A	6	16.34	43.09
802.11a	36	5180	B	6	16.58	45.54
802.11a	40	5200	B	6	16.66	46.38
802.11a	48	5240	B	6	16.47	44.40
802.11a	52	5260	B	6	16.61	45.85
802.11a	56	5280	B	6	16.72	47.03
802.11a	64	5320	B	6	16.42	43.89
802.11a	36	5180	C	6	16.33	42.99
802.11a	40	5200	C	6	16.75	47.35
802.11a	48	5240	C	6	16.69	46.71
802.11a	52	5260	C	6	16.42	43.89
802.11a	56	5280	C	6	16.71	46.92
802.11a	64	5320	C	6	16.73	47.14
802.11n	36	5180	A	HT0	16.62	45.96
802.11n	40	5200	A	HT0	16.54	45.12
802.11n	48	5240	A	HT0	16.69	46.71
802.11n	52	5260	A	HT0	16.43	43.99
802.11n	56	5280	A	HT0	16.57	45.43
802.11n	64	5320	A	HT0	16.81	48.01
802.11n	36	5180	B	HT0	16.52	44.91
802.11n	40	5200	B	HT0	16.60	45.75
802.11n	48	5240	B	HT0	16.79	47.79
802.11n	52	5260	B	HT0	16.48	44.50
802.11n	56	5280	B	HT0	16.64	46.17
802.11n	64	5320	B	HT0	16.36	43.29
802.11n	36	5180	C	HT0	16.74	47.25
802.11n	40	5200	C	HT0	16.74	47.25
802.11n	48	5240	C	HT0	16.62	45.96
802.11n	52	5260	C	HT0	16.34	43.09
802.11n	56	5280	C	HT0	16.63	46.06
802.11n	64	5320	C	HT0	16.64	46.17

NOTE: The output power measurement is conducted.



Peak Transmit Power (Continued)

Mode	Channel	Frequency (MHz)	Chain	Data Rate (Mbps)	Total Power (dBm)	Total Power (mW)
802.11a	100	5500	A	6	16.39	43.59
802.11a	120	5600	A	6	16.64	46.17
802.11a	140	5700	A	6	16.37	43.39
802.11a	100	5500	B	6	16.77	47.57
802.11a	120	5600	B	6	16.52	44.91
802.11a	140	5700	B	6	16.52	44.91
802.11a	100	5500	C	6	16.78	47.68
802.11a	120	5600	C	6	16.74	47.25
802.11a	140	5700	C	6	16.83	48.24
802.11n	100	5500	A	HT0	16.74	47.25
802.11n	120	5600	A	HT0	16.52	44.91
802.11n	140	5700	A	HT0	16.61	45.85
802.11n	100	5500	B	HT0	16.73	47.14
802.11n	120	5600	B	HT0	16.44	44.09
802.11n	140	5700	B	HT0	16.44	44.09
802.11n	100	5500	C	HT0	16.73	47.14
802.11n	120	5600	C	HT0	16.79	47.79
802.11n	140	5700	C	HT0	16.74	47.25
802.11n (40MHz)	38(F)	5190	A	HT0	16.19	41.57
802.11n (40MHz)	46(F)	5230	A	HT0	16.29	42.54
802.11n (40MHz)	54(F)	5270	A	HT0	16.39	43.53
802.11n (40MHz)	62(F)	5310	A	HT0	16.29	42.54
802.11n (40MHz)	38(F)	5190	B	HT0	16.19	41.57
802.11n (40MHz)	46(F)	5230	B	HT0	15.99	39.70
802.11n (40MHz)	54(F)	5270	B	HT0	15.99	39.70
802.11n (40MHz)	62(F)	5310	B	HT0	16.19	41.57
802.11n (40MHz)	38(F)	5190	C	HT0	16.09	40.62
802.11n (40MHz)	46(F)	5230	C	HT0	16.29	42.54
802.11n (40MHz)	54(F)	5270	C	HT0	16.19	41.57
802.11n (40MHz)	62(F)	5310	C	HT0	16.09	40.62
802.11n (40MHz)	102(F)	5510	A	HT0	16.19	41.57
802.11n (40MHz)	118(F)	5590	A	HT0	16.29	42.54
802.11n (40MHz)	134(F)	5670	A	HT0	16.09	40.62
802.11n (40MHz)	102(F)	5510	B	HT0	16.39	43.53
802.11n (40MHz)	118(F)	5590	B	HT0	16.19	41.57
802.11n (40MHz)	134(F)	5670	B	HT0	15.89	38.79
802.11n (40MHz)	102(F)	5510	C	HT0	15.89	38.79
802.11n (40MHz)	118(F)	5590	C	HT0	16.19	41.57
802.11n (40MHz)	134(F)	5670	C	HT0	16.09	40.62

NOTE: The output power measurement is conducted.



Peak Transmit Power (Continued)

Triple Chain ABC Aggregate Power

Mode	Channel	Frequency (MHz)	Chain	Data Rate (Mbps)	Total Output Power (dBm)	Total Output Power (mW)
802.11n (20MHz)	36	5180	ABC	HT16	16.45	44.17
802.11n (20MHz)	40	5200	ABC	HT16	16.40	43.64
802.11n (20MHz)	48	5240	ABC	HT16	16.46	44.29
802.11n (20MHz)	52	5260	ABC	HT16	16.46	44.28
802.11n (20MHz)	56	5280	ABC	HT16	16.63	46.01
802.11n (20MHz)	64	5320	ABC	HT16	16.55	45.20
802.11n (40MHz)	38(F)	5190	ABC	HT16	16.50	44.67
802.11n (40MHz)	46(F)	5230	ABC	HT16	16.60	45.71
802.11n (40MHz)	54(F)	5270	ABC	HT16	16.43	43.95
802.11n (40MHz)	62(F)	5310	ABC	HT16	16.54	45.10
802.11n (20MHz)	100	5500	ABC	HT16	16.44	44.04
802.11n (20MHz)	120	5600	ABC	HT16	16.23	42.01
802.11n (20MHz)	140	5700	ABC	HT16	16.39	43.51
802.11n (40MHz)	102(F)	5510	ABC	HT16	16.39	43.59
802.11n (40MHz)	118(F)	5590	ABC	HT16	16.41	43.79
802.11n (40MHz)	134(F)	5670	ABC	HT16	16.57	45.41

(F) = Fat Channel

**CONDCUTED BAND EDGE EMISSIONS TEST RESULTS**

CLIENT:	Intel Corporation	DATE:	04/10/08
EUT:	Intel WiFi/WiMax Link 5350	PROJECT NUMBER:	INTEL-080114
MODEL NUMBER:	533ANXMMW	TEST ENGINEER:	RC
SERIAL NUMBER:	0016EB01A3A8	SITE #:	1
CONFIGURATION:	Tested installed in an extender board connected to the host laptop's mini PCI slot	TEMPERATURE:	25° C
		HUMIDITY:	35% RH
		TIME:	4:00 PM

Description:	For transmitters operating in the 5.25-5.35 GHz band: all emissions outside of the 5.15-5.35 GHz band shall not exceed an EIRP of -27 dBm/MHz. Devices operating in the 5.25-5.35 GHz band that generate emissions in the 5.15-5.25 GHz band must meet all applicable technical requirements for operation in the 5.15-5.25 GHz band (including indoor use) or alternatively meet an out-of-band emission EIRP limit of -27 dBm/MHz in the 5.15-5.25 GHz band.
Results:	See Data Sheet
Note:	Conducted Emissions Measurements were performed on the EUT with power supply set at the following voltage and frequency. <ul style="list-style-type: none"> • 120VAC / 60 Hz.

Unwanted Spurious Emissions Limits	
Frequency (MHz)	Field Strength (dBm/Hz) (Emissions outside the restricted bands)
5250-5350	EIRP < -27dBm/Hz (68.3dBuV/m)



Conducted Band Edge Emissions Test Results (Continued)

CONDCUTED BAND EDGE EMISSIONS TEST RESULTS							
Freq.(MHz)	TX Chain	Power Spec Den. Reading (dBm/MHz)	Antenna Gain (dBi)	Corrected Reading (dBm/MHz)	Limits (dBm/MHz)	Diff (dB) +=FAIL	Comments
802.11a							
5250.00	A	-31.32	2.57	-28.75	-27.00	-1.75	Tx @ 5240 MHz
5250.00	A	-30.97	2.57	-28.40	-27.00	-1.40	Tx @ 5260 MHz
5250.00	B	-31.12	2.57	-28.55	-27.00	-1.55	Tx @ 5240 MHz
5250.00	B	-30.46	2.57	-27.89	-27.00	-0.89	Tx @ 5260 MHz
5250.00	C	-31.38	2.57	-28.81	-27.00	-1.81	Tx @ 5240 MHz
5250.00	C	-31.41	2.57	-28.84	-27.00	-1.84	Tx @ 5260 MHz
802.11n (20MHz Wide)							
5250.00	A	-29.77	2.57	-27.20	-27.00	-0.20	Tx @ 5240 MHz
5250.00	A	-30.34	2.57	-27.77	-27.00	-0.77	Tx @ 5260 MHz
5250.00	B	-30.20	2.57	-27.63	-27.00	-0.63	Tx @ 5240 MHz
5250.00	B	-29.96	2.57	-27.39	-27.00	-0.39	Tx @ 5260 MHz
5250.00	C	-30.42	2.57	-27.85	-27.00	-0.85	Tx @ 5240 MHz
5250.00	C	-29.68	2.57	-27.11	-27.00	-0.11	Tx @ 5260 MHz
802.11n (40MHz Wide)							
5250.00	A	-36.78	2.57	-34.21	-27.00	-7.21	Tx @ 5240 MHz
5250.00	A	-36.78	2.57	-34.21	-27.00	-7.21	Tx @ 5260 MHz
5250.00	B	-35.85	2.57	-33.28	-27.00	-6.28	Tx @ 5240 MHz
5250.00	B	-36.22	2.57	-33.65	-27.00	-6.65	Tx @ 5260 MHz
5250.00	C	-36.78	2.57	-34.21	-27.00	-7.21	Tx @ 5240 MHz
5250.00	C	-37.48	2.57	-34.91	-27.00	-7.91	Tx @ 5260 MHz



Conducted Band Edge Emissions Test Results (Continued)

802.11a Mode – Chain A

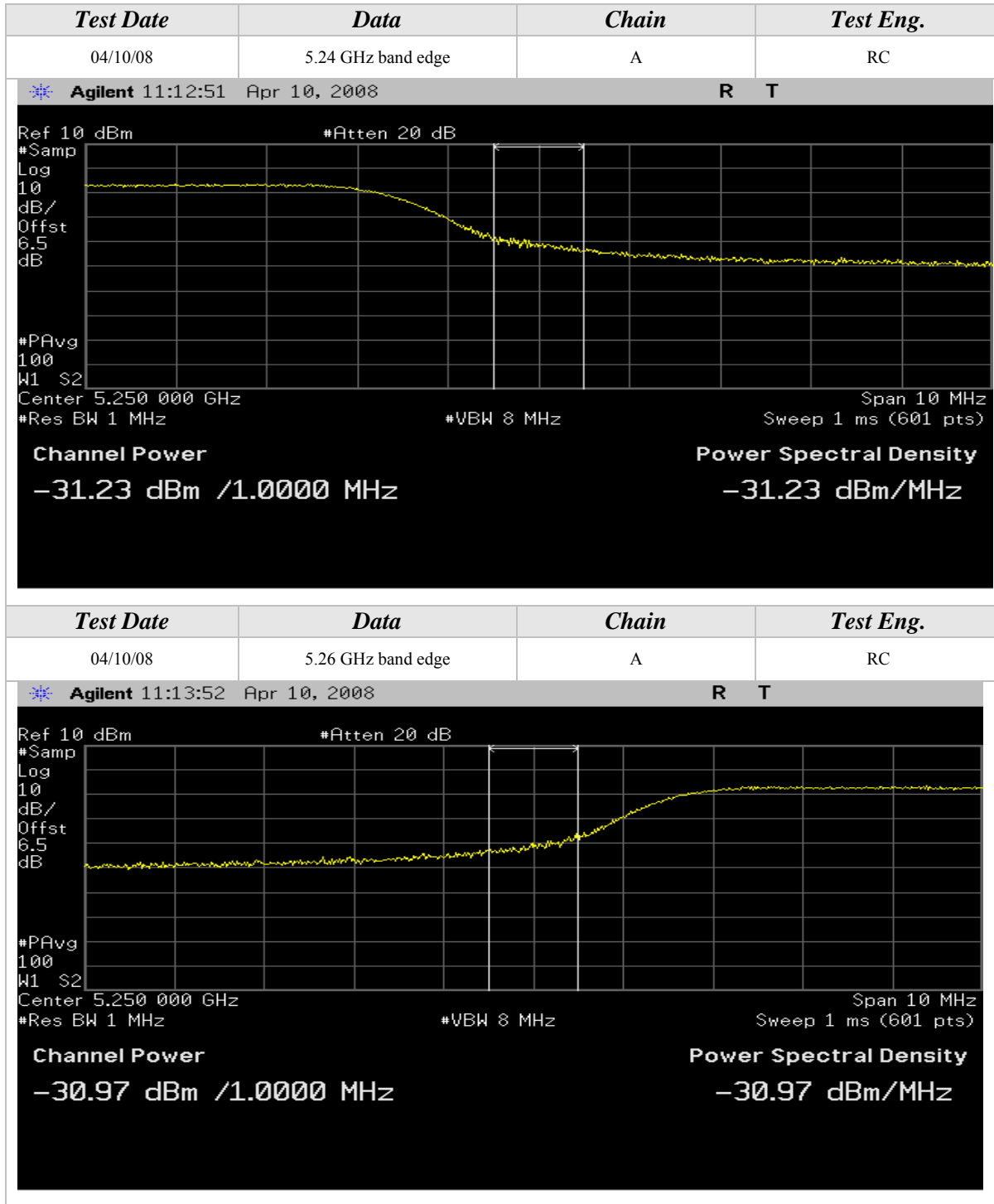



Conducted Band Edge Emissions Test Results (Continued)

802.11a Mode – Chain B

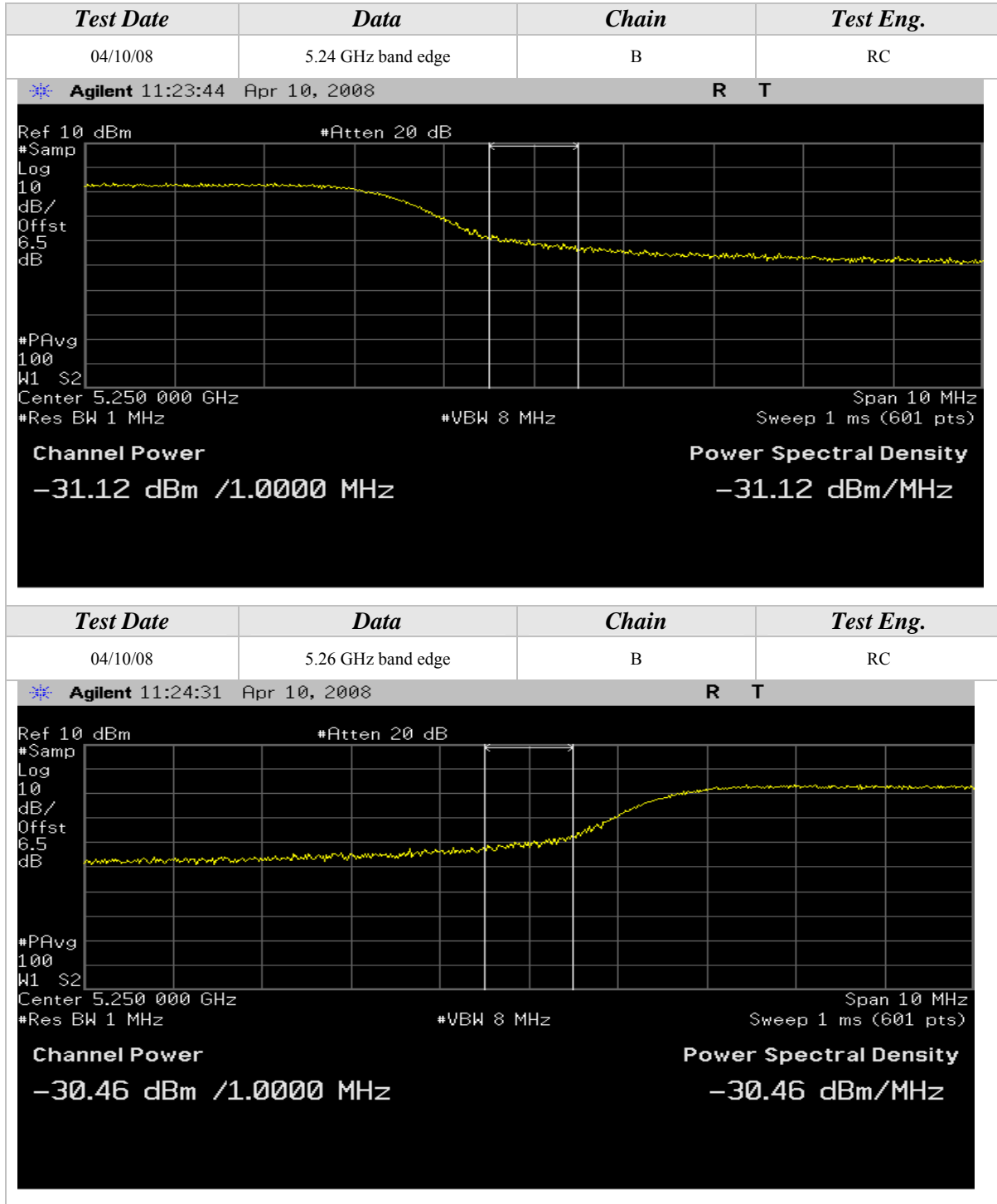



Conducted Band Edge Emissions Test Results (Continued)

802.11a Mode – Chain C

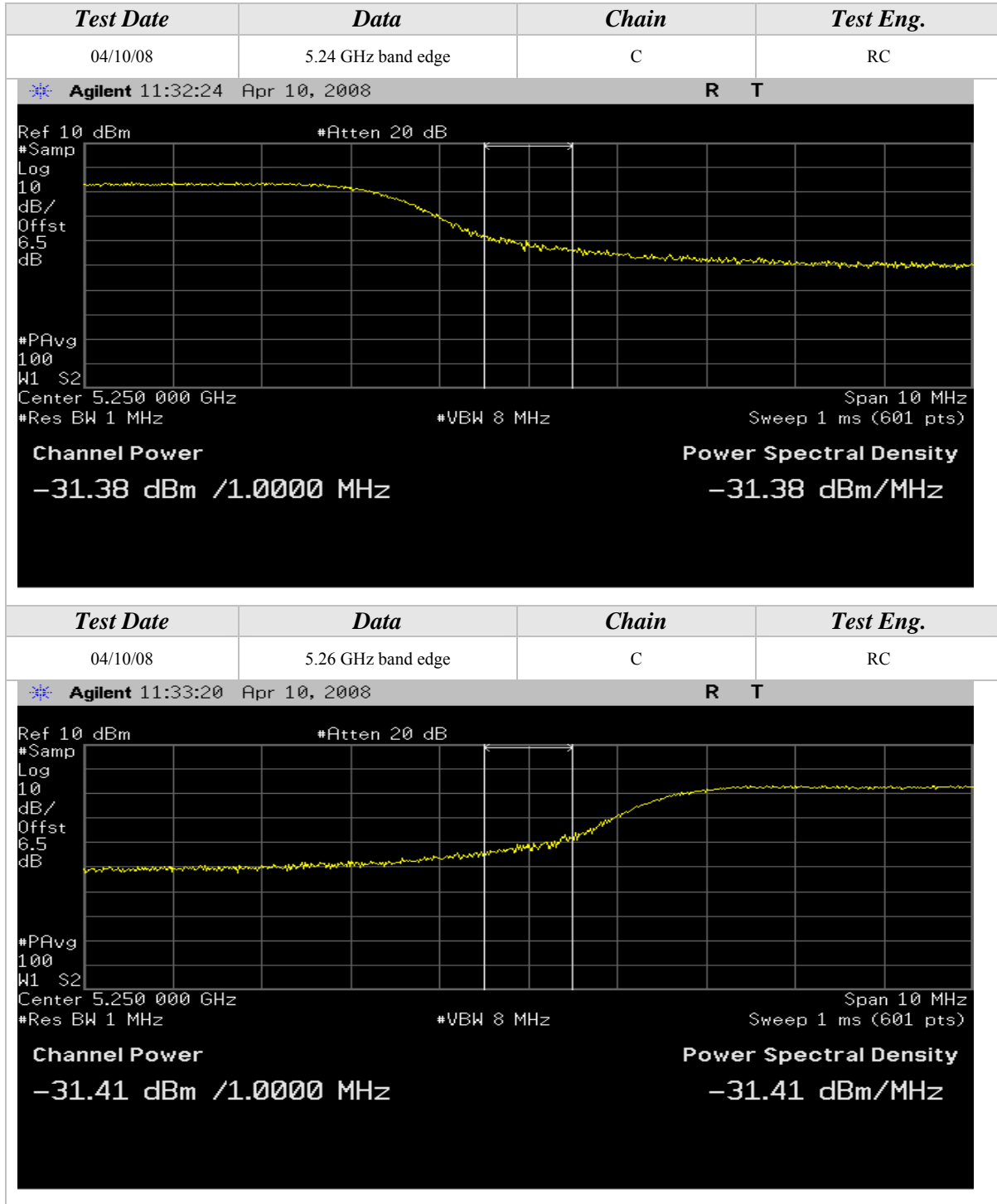

Conducted Band Edge Emissions Test Results (Continued)

802.11n Mode (20 MHz Wide)

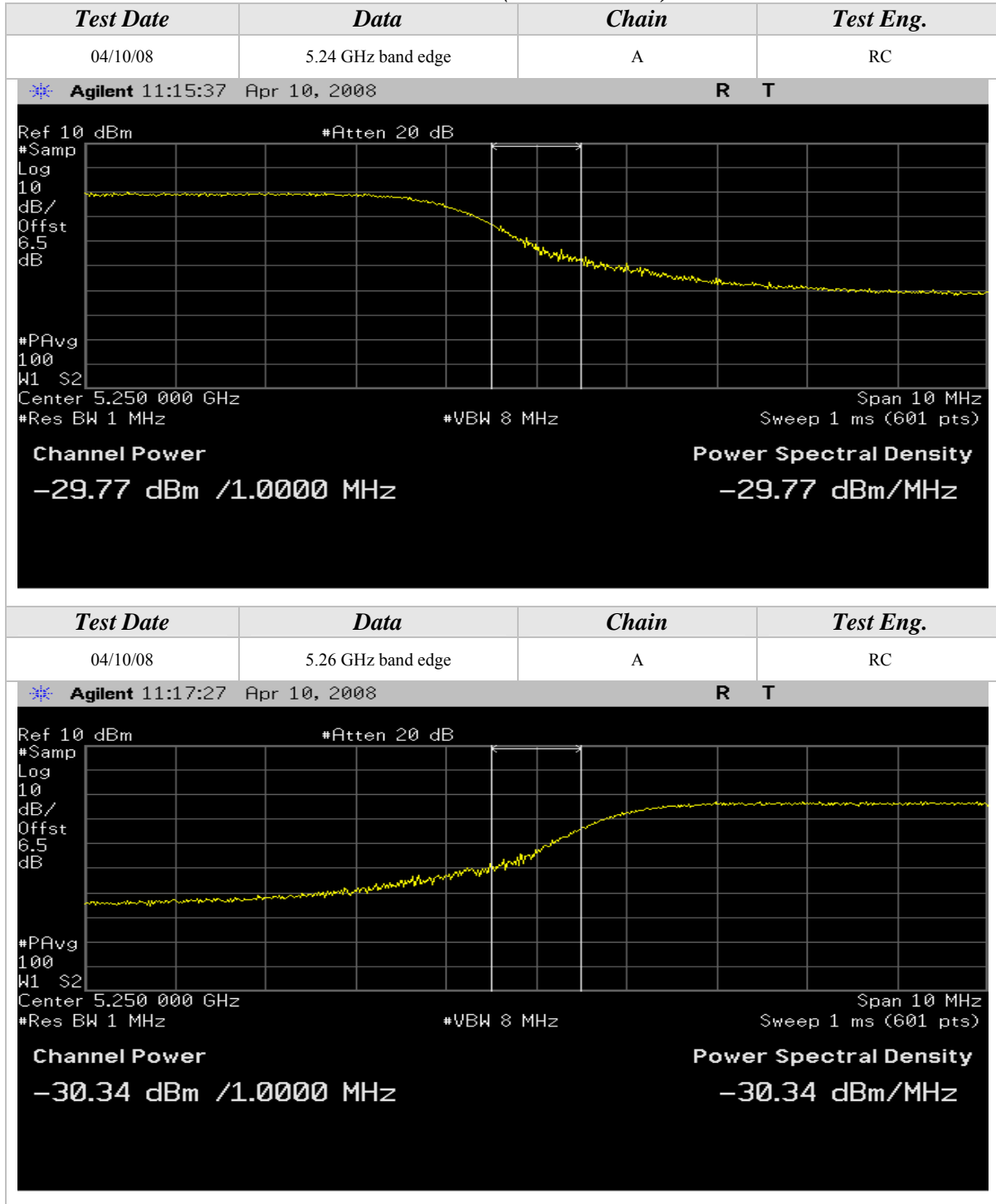

Conducted Band Edge Emissions Test Results (Continued)

802.11n Mode (20 MHz Wide)

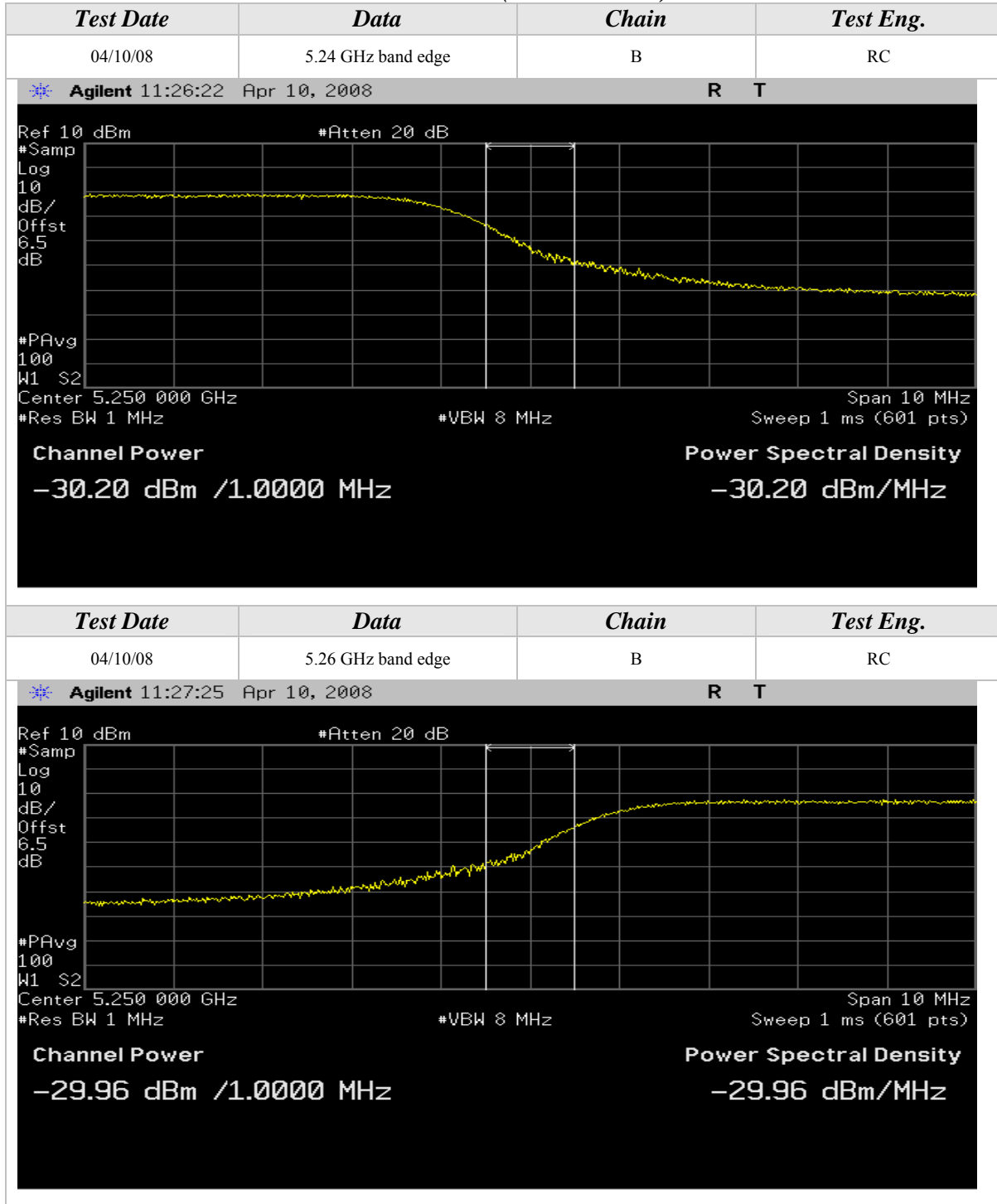



Conducted Band Edge Emissions Test Results (Continued)

802.11n Mode (20 MHz Wide)

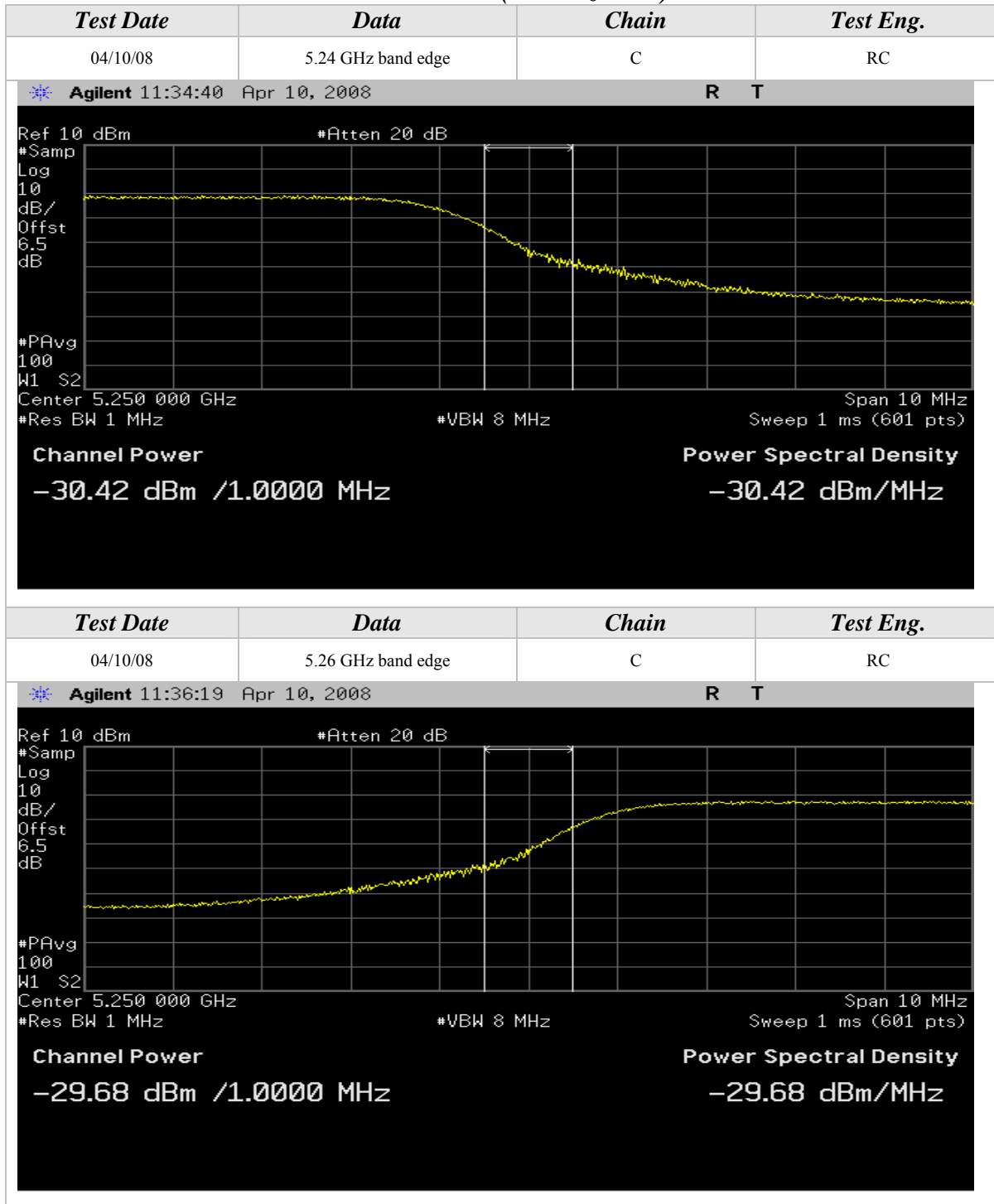



Conducted Band Edge Emissions Test Results (Continued)

802.11n Mode (40 MHz Wide)

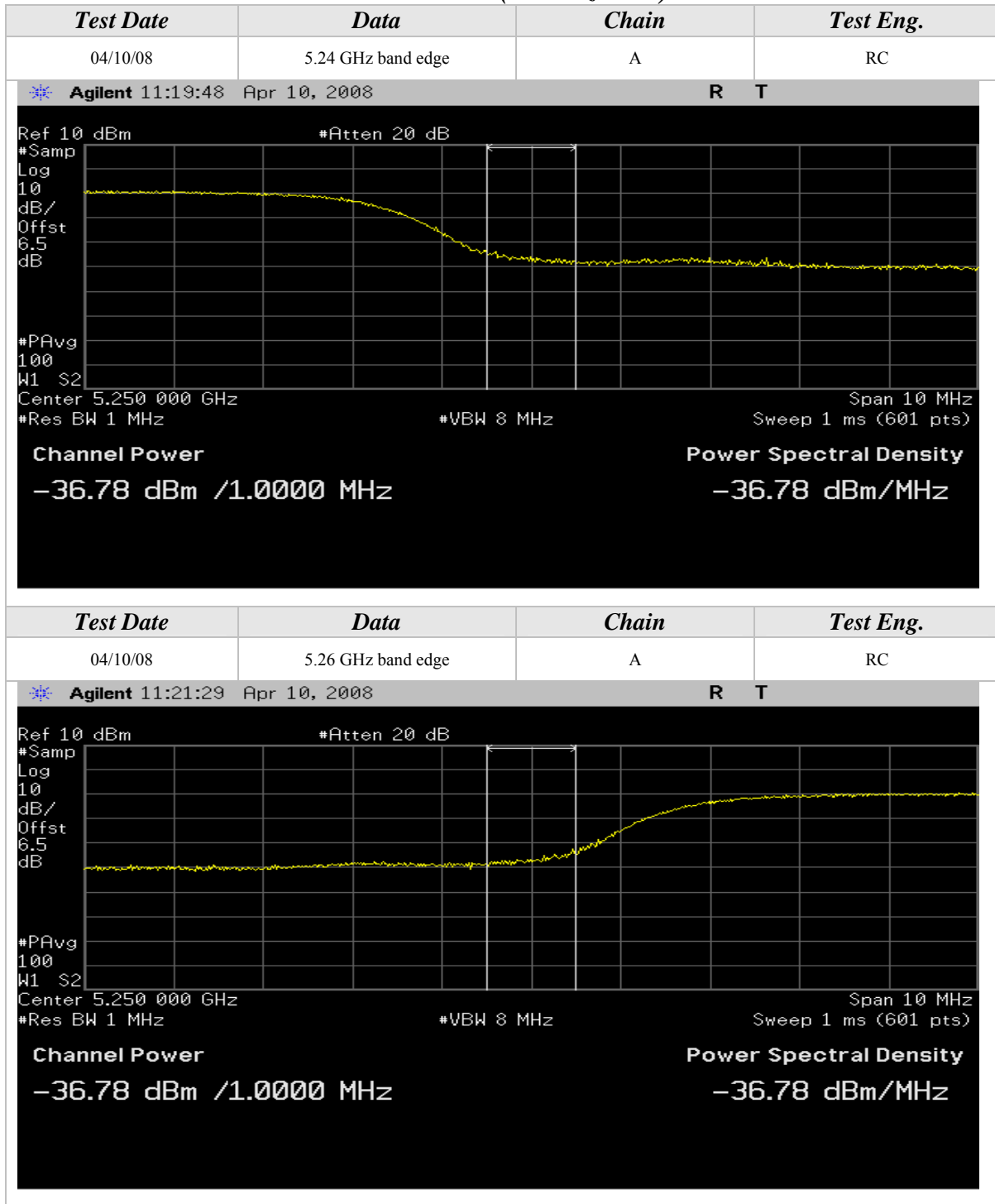

Conducted Band Edge Emissions Test Results (Continued)

802.11n Mode (40 MHz Wide)

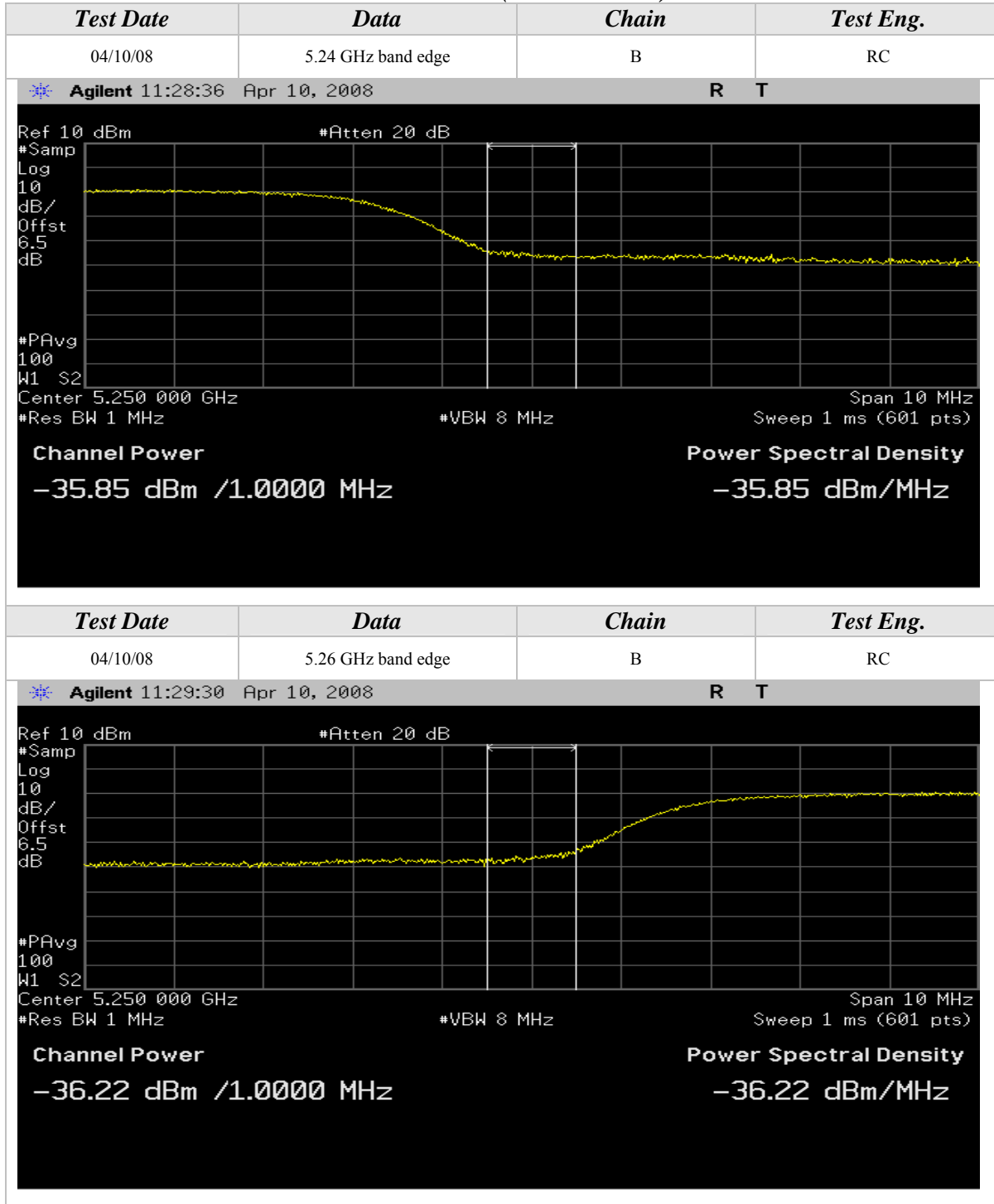



Conducted Band Edge Emissions Test Results (Continued)

802.11n Mode (40 MHz Wide)

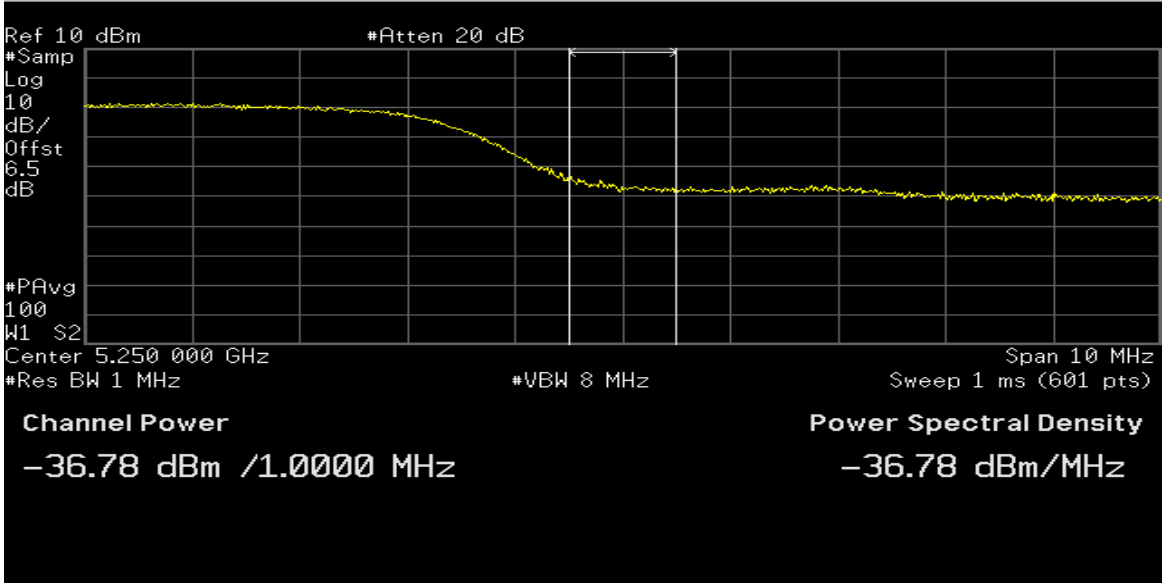
Test Date	Data	Chain	Test Eng.
04/10/08	5.24 GHz band edge	C	RC
* Agilent 11:37:31 Apr 10, 2008 R T			
			
Test Date	Data	Chain	Test Eng.
04/10/08	5.26 GHz band edge	C	RC
* Agilent 11:38:30 Apr 10, 2008 R T			
