



Modular Approval
Test Report
And Application for Grant of Equipment Authorization

TEST REPORT PERTAINING TO:

| Equipment Under Test | Model Number(s) |
|----------------------|-----------------|
| Intel WiFi Link 5300 | 533AN_HMW |

| CONFIGURATION |
|---------------------------------------------------------------------------------------------------------|
| IEEE 802.11a / 802.11b / 802.11g / 802.11n with a set of Ethertronics & Wistron Neweb Corp. Antennas |

MEASUREMENTS PERFORMED IN ACCORDANCE WITH THE FOLLOWING STANDARD (S)

| Regulatory Standard(s) |
|------------------------------------------------------------------------------------------------------------------------------------------------------------------------------------------------------|
| 47 CFR Part 15, Subpart E Section 15.407 (UNII Devices) |
| Test Method: ANSI C63.4: 2003 American National Standard for Methods of Measurement of Radio-Noise Emissions from Low-Voltage Electrical and Electronic Equipment in the Range of 9 kHz to 40 GHz |



Certificate Number: 1111.01

PREPARED FOR:

Intel Corporation
2111 NE 25th Avenue
Hillsboro, Oregon 97124
Contact(s): Mr. Robert Paxman

PREPARED BY:

Aegis Labs, Inc.
8 Rancho Circle
Lake Forest, CA 92630
Agent(s): Mr. Rick Candelas
Mr. Johnny Candelas



Test Report #: INTEL-081126F

Test Report Revision: NONE

| | REPORT BODY | APPENDICES | | TOTAL PAGES |
|-------|-------------|------------|---|-------------|
| | | A | B | |
| PAGES | 28 | 313 | 1 | 342 |

The contents of this report shall not be reproduced except in full, without the written approval of Aegis Labs, Inc.
The Intel logo is used for identification purposes only and is a registered trademark of Intel Corporation



TABLE OF CONTENTS

| SECTION | TITLE | PAGE |
|------------|-----------------------------------------------------------|-----------|
| | COVER SHEET..... | 01 |
| | TABLE OF CONTENTS..... | 02 |
| 1.0 | REGULATORY COMPLIANCE GUIDELINES..... | 03 |
| 1.1 | Guidelines For Testing To Emissions Standards..... | 03 |
| 2.0 | SUMMARY OF REGULATORY LIMITS..... | 04 |
| 3.0 | ADMINISTRATIVE DATA AND TEST DESCRIPTION..... | 22 |
| 4.0 | DESCRIPTION OF EUT CONFIGURATION..... | 23 |
| 4.1 | EUT Description | 23 |
| 4.2 | EUT Configuration..... | 24 |
| 4.3 | List of EUT Sub-Assemblies and Host Equipment..... | 24 |
| 4.4 | I/O Cabling Diagram and Description | 25 |
| 4.5 | EMC Test Hardware and Software Measurement Equipment..... | 26 |
| 5.0 | CONDITIONS DURING EMISSIONS MEASUREMENTS..... | 27 |
| 5.1 | General..... | 27 |
| 5.2 | Conducted Emissions Test Setup..... | 27 |
| 5.3 | Radiated Emissions Test Setup..... | 28 |

APPENDICES

| | |
|----------|-----------------------------------|
| A | Test Data |
| B | Modifications And Recommendations |



1.0 REGULATORY COMPLIANCE GUIDELINES

Aegis Labs, Inc. operates as both a Nevada and California Corporation with no organizational or financial relationship with any company, institution, or private individual. Testing and engineering functions provided by Aegis Labs were furnished by RF technicians and engineers with accredited qualifications and training credentials to carry out their duties.

The object of this report was to publish verifiable test results of an EUT subjected to the tests outlined in the standard listed on the cover page of this report.

1.1 Guidelines For Testing To Emissions Standards

This standard for EMC emission requirements apply to electrical equipment for Information Technology Equipment (ITE). Compliance to these standards and in combination with the other standards listed in this test report can be used to demonstrate presumption of compliance with the protection requirements of the appropriate agency standard.

The purpose of this standard is to specify minimum requirements for emissions regarding electromagnetic compatibility (EMC) and protect the radio frequency spectrum 9 kHz. – 400 GHz. from unwanted interference generated from electrical/digital systems that intentionally or unintentionally generated RF energy. The emissions standards, normative documents and/or publications were used to conduct all tests performed on the equipment herein referred to as “Equipment Under Test”.



2.0 SUMMARY OF TEST RESULTS

802.11a Mode (5150-5350 MHz) Chain A

| EMISSIONS STANDARD | | | |
|--------------------------------------------|--------------------------------------------------------------------------------------------------------------------------------------------------------------------------------------|----------------|----------------------------------------------------------------------------------------------------------------------------------|
| FCC Part 15 Section | Description | Results | Comments |
| Operation in the 5.15-5.25 GHz Band | | | |
| 15.407(d) | Any UNII device shall use a transmitting antenna that is an integral part of the device. | PASSED | The antenna will be integral when installed in a notebook computer |
| 15.407(e) | UNII devices will be restricted to indoor operations. | PASSED | Refer to "User's Manual" Exhibit |
| 15.407(a)(1) | 26dB emissions bandwidth in MHz. | N/A | 5.18 GHz = 21.58 MHz 5.20 GHz = 22.33 MHz 5.24 GHz = 21.67 MHz |
| 15.407(a)(1) | Peak transmit power shall not exceed the lesser of 50mW or 4dBm+10logB (where B = 26dB emissions bandwidth). | PASSED | 5.18 GHz = 16.04dBm (40.21mW) 5.20 GHz = 16.29dBm (42.60mW) 5.24 GHz = 16.24dBm (42.11mW) |
| 15.407(a)(1) | The peak power spectral density shall not exceed 4dBm in any 1MHz band. | PASSED | 5.18 GHz = 1.64dBm 5.20 GHz = 1.34dBm 5.24 GHz = 1.47dBm |
| 15.407(a)(1) | Peak transmit power and the peak power spectral density shall be reduced by the amount in dB that the transmitting antenna exceeds 6dBi. | N/A | All antennas tested have less than 6dBi antenna gain (Please see the antenna data sheets) |
| 15.407(b)(6) 15.209 | Unwanted emissions below 1 GHz must comply with the general field strength limits set forth in Section 15.209. | PASSED | See FCC 15.247 report (INTEL-081125F) |
| 15.407(b)(1) | All emissions outside of the 5.15-5.35 GHz band shall not exceed an EIRP of -27dBm/MHz. | PASSED | See Data Sheets |
| Operation in the 5.25-5.35 GHz Band | | | |
| 15.407(a)(2) | 26dB emissions bandwidth in MHz. | N/A | 5.26 GHz = 22.42 MHz 5.28 GHz = 22.50 MHz 5.32 GHz = 21.58 MHz |
| 15.407(a)(2) | Peak transmit power shall not exceed the lesser of 250mW or 11dBm+10logB (where B = 26dB emissions bandwidth). | PASSED | 5.26 GHz = 16.34dBm (43.09mW) 5.28 GHz = 16.34dBm (43.09mW) 5.32 GHz = 16.44dBm (44.09mW) |
| 15.407(a)(2) | The peak power spectral density shall not exceed 11dBm in any 1MHz band. | PASSED | 5.26 GHz = 2.38dBm 5.28 GHz = 2.06dBm 5.32 GHz = 1.89dBm |
| 15.407(a)(2) | Peak transmit power and the peak power spectral density shall be reduced by the amount in dB that the transmitting antenna exceeds 6dBi. | N/A | All antennas tested have less than 6dBi antenna gain (Please see the antenna data sheets) |
| 15.407(b)(6) 15.209 | Unwanted emissions below 1 GHz must comply with the general field strength limits set forth in Section 15.209. | PASSED | See FCC 15.247 report (INTEL-081125F) |
| 15.407(b)(2) | All emissions outside of the 5.15-5.35 GHz band shall not exceed an EIRP of -27dBm/MHz. Must meet all applicable technical requirements for operating in the 5.15-5.25 GHz band. | PASSED | See Data Sheets |
| General Requirements For All Bands | | | |
| 15.407(a)(6) | The ratio of the peak excursion of the modulation envelope to the peak transmit power shall not exceed 13dB across any 1 MHz bandwidth or the emissions bandwidth whichever is less. | PASSED | 5.18 GHz = 5.84 dB 5.20 GHz = 5.50 dB 5.24 GHz = 6.00 dB 5.26 GHz = 6.50 dB 5.28 GHz = 6.00 dB 5.32 GHz = 5.67 dB |
| 15.407(f) | Radio frequency radiation exposure requirement. | PASSED | Refer to MPE Calculations |
| 15.407(b)(6) 15.207 | UNII devices using AC power line are required to comply with the conducted limits set forth in Section 15.207. | PASSED | See FCC 15.247 report (INTEL-081125F) |



2.0 Summary Of Test Results (Continued)

802.11a Mode (5150-5350 MHz) Chain B

| EMISSIONS STANDARD | | | |
|--------------------------------------------|--------------------------------------------------------------------------------------------------------------------------------------------------------------------------------------|----------------|----------------------------------------------------------------------------------------------------------------------------------|
| FCC Part 15 Section | Description | Results | Comments |
| Operation in the 5.15-5.25 GHz Band | | | |
| 15.407(d) | Any UNII device shall use a transmitting antenna that is an integral part of the device. | PASSED | The antenna will be integral when installed in a notebook computer |
| 15.407(e) | UNII devices will be restricted to indoor operations. | PASSED | Refer to "User's Manual" Exhibit |
| 15.407(a)(1) | 26dB emissions bandwidth in MHz. | N/A | 5.18 GHz = 22.17 MHz 5.20 GHz = 21.50 MHz 5.24 GHz = 20.67 MHz |
| 15.407(a)(1) | Peak transmit power shall not exceed the lesser of 50mW or 4dBm+10logB (where B = 26dB emissions bandwidth). | PASSED | 5.18 GHz = 16.34dBm (43.09mW) 5.20 GHz = 16.19dBm (41.63mW) 5.24 GHz = 16.44dBm (44.09mW) |
| 15.407(a)(1) | The peak power spectral density shall not exceed 4dBm in any 1MHz band. | PASSED | 5.18 GHz = -4.57dBm 5.20 GHz = 1.20dBm 5.24 GHz = 1.50dBm |
| 15.407(a)(1) | Peak transmit power and the peak power spectral density shall be reduced by the amount in dB that the transmitting antenna exceeds 6dBi. | N/A | All antennas tested have less than 6dBi antenna gain (Please see the antenna data sheets) |
| 15.407(b)(6) 15.209 | Unwanted emissions below 1 GHz must comply with the general field strength limits set forth in Section 15.209. | PASSED | See FCC 15.247 report (INTEL-081125F) |
| 15.407(b)(1) | All emissions outside of the 5.15-5.35 GHz band shall not exceed an EIRP of -27dBm/MHz. | PASSED | See Data Sheets |
| Operation in the 5.25-5.35 GHz Band | | | |
| 15.407(a)(2) | 26dB emissions bandwidth in MHz. | N/A | 5.26 GHz = 21.25 MHz 5.28 GHz = 21.08 MHz 5.32 GHz = 21.25 MHz |
| 15.407(a)(2) | Peak transmit power shall not exceed the lesser of 250mW or 11dBm+10logB (where B = 26dB emissions bandwidth). | PASSED | 5.26 GHz = 16.29dBm (42.60mW) 5.28 GHz = 16.24dBm (42.11mW) 5.32 GHz = 16.54dBm (45.12mW) |
| 15.407(a)(2) | The peak power spectral density shall not exceed 11dBm in any 1MHz band. | PASSED | 5.26 GHz = 1.75dBm 5.28 GHz = 1.58dBm 5.32 GHz = 1.99dBm |
| 15.407(a)(2) | Peak transmit power and the peak power spectral density shall be reduced by the amount in dB that the transmitting antenna exceeds 6dBi. | N/A | All antennas tested have less than 6dBi antenna gain (Please see the antenna data sheets) |
| 15.407(b)(6) 15.209 | Unwanted emissions below 1 GHz must comply with the general field strength limits set forth in Section 15.209. | PASSED | See FCC 15.247 report (INTEL-081125F) |
| 15.407(b)(2) | All emissions outside of the 5.15-5.35 GHz band shall not exceed an EIRP of -27dBm/MHz. Must meet all applicable technical requirements for operating in the 5.15-5.25 GHz band. | PASSED | See Data Sheets |
| General Requirements For All Bands | | | |
| 15.407(a)(6) | The ratio of the peak excursion of the modulation envelope to the peak transmit power shall not exceed 13dB across any 1 MHz bandwidth or the emissions bandwidth whichever is less. | PASSED | 5.18 GHz = 5.66 dB 5.20 GHz = 5.67 dB 5.24 GHz = 6.17 dB 5.26 GHz = 6.50 dB 5.28 GHz = 5.16 dB 5.32 GHz = 5.83 dB |
| 15.407(f) | Radio frequency radiation exposure requirement. | PASSED | Refer to MPE Calculations |
| 15.407(b)(6) 15.207 | UNII devices using AC power line are required to comply with the conducted limits set forth in Section 15.207. | PASSED | See FCC 15.247 report (INTEL-081125F) |



2.0 Summary Of Test Results (Continued)

802.11a Mode (5150-5350 MHz) Chain C

| EMISSIONS STANDARD | | | |
|--------------------------------------------|--------------------------------------------------------------------------------------------------------------------------------------------------------------------------------------|----------------|----------------------------------------------------------------------------------------------------------------------------------|
| FCC Part 15 Section | Description | Results | Comments |
| Operation in the 5.15-5.25 GHz Band | | | |
| 15.407(d) | Any UNII device shall use a transmitting antenna that is an integral part of the device. | PASSED | The antenna will be integral when installed in a notebook computer |
| 15.407(e) | UNII devices will be restricted to indoor operations. | PASSED | Refer to "User's Manual" Exhibit |
| 15.407(a)(1) | 26dB emissions bandwidth in MHz. | N/A | 5.18 GHz = 22.33 MHz 5.20 GHz = 22.25 MHz 5.24 GHz = 22.17 MHz |
| 15.407(a)(1) | Peak transmit power shall not exceed the lesser of 50mW or 4dBm+10logB (where B = 26dB emissions bandwidth). | PASSED | 5.18 GHz = 16.54dBm (45.12mW) 5.20 GHz = 16.49dBm (44.60mW) 5.24 GHz = 16.64dBm (46.17mW) |
| 15.407(a)(1) | The peak power spectral density shall not exceed 4dBm in any 1MHz band. | PASSED | 5.18 GHz = 0.61dBm 5.20 GHz = 2.48dBm 5.24 GHz = 2.63dBm |
| 15.407(a)(1) | Peak transmit power and the peak power spectral density shall be reduced by the amount in dB that the transmitting antenna exceeds 6dBi. | N/A | All antennas tested have less than 6dBi antenna gain (Please see the antenna data sheets) |
| 15.407(b)(6) 15.209 | Unwanted emissions below 1 GHz must comply with the general field strength limits set forth in Section 15.209. | PASSED | See FCC 15.247 report (INTEL-081125F) |
| 15.407(b)(1) | All emissions outside of the 5.15-5.35 GHz band shall not exceed an EIRP of -27dBm/MHz. | PASSED | See Data Sheets |
| Operation in the 5.25-5.35 GHz Band | | | |
| 15.407(a)(2) | 26dB emissions bandwidth in MHz. | N/A | 5.26 GHz = 21.92 MHz 5.28 GHz = 21.58 MHz 5.32 GHz = 21.75 MHz |
| 15.407(a)(2) | Peak transmit power shall not exceed the lesser of 250mW or 11dBm+10logB (where B = 26dB emissions bandwidth). | PASSED | 5.26 GHz = 16.64dBm (46.17mW) 5.28 GHz = 16.64dBm (46.17mW) 5.32 GHz = 16.54dBm (45.12mW) |
| 15.407(a)(2) | The peak power spectral density shall not exceed 11dBm in any 1MHz band. | PASSED | 5.26 GHz = 2.23dBm 5.28 GHz = 2.20dBm 5.32 GHz = 2.13dBm |
| 15.407(a)(2) | Peak transmit power and the peak power spectral density shall be reduced by the amount in dB that the transmitting antenna exceeds 6dBi. | N/A | All antennas tested have less than 6dBi antenna gain (Please see the antenna data sheets) |
| 15.407(b)(6) 15.209 | Unwanted emissions below 1 GHz must comply with the general field strength limits set forth in Section 15.209. | PASSED | See FCC 15.247 report (INTEL-081125F) |
| 15.407(b)(2) | All emissions outside of the 5.15-5.35 GHz band shall not exceed an EIRP of -27dBm/MHz. Must meet all applicable technical requirements for operating in the 5.15-5.25 GHz band. | PASSED | See Data Sheets |
| General Requirements For All Bands | | | |
| 15.407(a)(6) | The ratio of the peak excursion of the modulation envelope to the peak transmit power shall not exceed 13dB across any 1 MHz bandwidth or the emissions bandwidth whichever is less. | PASSED | 5.18 GHz = 5.50 dB 5.20 GHz = 6.17 dB 5.24 GHz = 5.50 dB 5.26 GHz = 5.84 dB 5.28 GHz = 5.67 dB 5.32 GHz = 6.17 dB |
| 15.407(f) | Radio frequency radiation exposure requirement. | PASSED | Refer to MPE Calculations |
| 15.407(b)(6) 15.207 | UNII devices using AC power line are required to comply with the conducted limits set forth in Section 15.207. | PASSED | See FCC 15.247 report (INTEL-081125F) |



2.0 Summary Of Test Results (Continued)

802.11n Mode 20MHz Wide (5150-5350 MHz) Chain A

| EMISSIONS STANDARD | | | |
|--------------------------------------------|--------------------------------------------------------------------------------------------------------------------------------------------------------------------------------------|----------------|----------------------------------------------------------------------------------------------------------------------------------|
| FCC Part 15 Section | Description | Results | Comments |
| Operation in the 5.15-5.25 GHz Band | | | |
| 15.407(d) | Any UNII device shall use a transmitting antenna that is an integral part of the device. | PASSED | The antenna will be integral when installed in a notebook computer |
| 15.407(e) | UNII devices will be restricted to indoor operations. | PASSED | Refer to "User's Manual" Exhibit |
| 15.407(a)(1) | 26dB emissions bandwidth in MHz. | N/A | 5.18 GHz = 22.08 MHz 5.20 GHz = 21.92 MHz 5.24 GHz = 22.08 MHz |
| 15.407(a)(1) | Peak transmit power shall not exceed the lesser of 50mW or 4dBm+10logB (where B = 26dB emissions bandwidth). | PASSED | 5.18 GHz = 16.04dBm (40.21mW) 5.20 GHz = 16.24dBm (42.11mW) 5.24 GHz = 16.19dBm (41.63mW) |
| 15.407(a)(1) | The peak power spectral density shall not exceed 4dBm in any 1MHz band. | PASSED | 5.18 GHz = 0.98dBm 5.20 GHz = 1.27dBm 5.24 GHz = 1.30dBm |
| 15.407(a)(1) | Peak transmit power and the peak power spectral density shall be reduced by the amount in dB that the transmitting antenna exceeds 6dBi. | N/A | All antennas tested have less than 6dBi antenna gain (Please see the antenna data sheets) |
| 15.407(b)(6) 15.209 | Unwanted emissions below 1 GHz must comply with the general field strength limits set forth in Section 15.209. | PASSED | See FCC 15.247 report (INTEL-081125F) |
| 15.407(b)(1) | All emissions outside of the 5.15-5.35 GHz band shall not exceed an EIRP of -27dBm/MHz. | PASSED | See Data Sheets |
| Operation in the 5.25-5.35 GHz Band | | | |
| 15.407(a)(2) | 26dB emissions bandwidth in MHz. | N/A | 5.26 GHz = 22.17 MHz 5.28 GHz = 22.50 MHz 5.32 GHz = 21.83 MHz |
| 15.407(a)(2) | Peak transmit power shall not exceed the lesser of 250mW or 11dBm+10logB (where B = 26dB emissions bandwidth). | PASSED | 5.26 GHz = 16.29dBm (42.60mW) 5.28 GHz = 16.24dBm (42.11mW) 5.32 GHz = 16.04dBm (40.21mW) |
| 15.407(a)(2) | The peak power spectral density shall not exceed 11dBm in any 1MHz band. | PASSED | 5.26 GHz = 2.01dBm 5.28 GHz = 2.00dBm 5.32 GHz = 1.31dBm |
| 15.407(a)(2) | Peak transmit power and the peak power spectral density shall be reduced by the amount in dB that the transmitting antenna exceeds 6dBi. | N/A | All antennas tested have less than 6dBi antenna gain (Please see the antenna data sheets) |
| 15.407(b)(6) 15.209 | Unwanted emissions below 1 GHz must comply with the general field strength limits set forth in Section 15.209. | PASSED | See FCC 15.247 report (INTEL-081125F) |
| 15.407(b)(2) | All emissions outside of the 5.15-5.35 GHz band shall not exceed an EIRP of -27dBm/MHz. Must meet all applicable technical requirements for operating in the 5.15-5.25 GHz band. | PASSED | See Data Sheets |
| General Requirements For All Bands | | | |
| 15.407(a)(6) | The ratio of the peak excursion of the modulation envelope to the peak transmit power shall not exceed 13dB across any 1 MHz bandwidth or the emissions bandwidth whichever is less. | PASSED | 5.18 GHz = 5.33 dB 5.20 GHz = 6.67 dB 5.24 GHz = 5.83 dB 5.26 GHz = 5.83 dB 5.28 GHz = 5.67 dB 5.32 GHz = 6.00 dB |
| 15.407(f) | Radio frequency radiation exposure requirement. | PASSED | Refer to MPE Calculations |
| 15.407(b)(6) 15.207 | UNII devices using AC power line are required to comply with the conducted limits set forth in Section 15.207. | PASSED | See FCC 15.247 report (INTEL-081125F) |



2.0 Summary Of Test Results (Continued)

802.11n Mode 20MHz Wide (5150-5350 MHz) Chain B

| EMISSIONS STANDARD | | | |
|--------------------------------------------|--------------------------------------------------------------------------------------------------------------------------------------------------------------------------------------|----------------|----------------------------------------------------------------------------------------------------------------------------------|
| FCC Part 15 Section | Description | Results | Comments |
| Operation in the 5.15-5.25 GHz Band | | | |
| 15.407(d) | Any UNII device shall use a transmitting antenna that is an integral part of the device. | PASSED | The antenna will be integral when installed in a notebook computer |
| 15.407(e) | UNII devices will be restricted to indoor operations. | PASSED | Refer to "User's Manual" Exhibit |
| 15.407(a)(1) | 26dB emissions bandwidth in MHz. | N/A | 5.18 GHz = 22.25 MHz 5.20 GHz = 22.25 MHz 5.24 GHz = 22.00 MHz |
| 15.407(a)(1) | Peak transmit power shall not exceed the lesser of 50mW or 4dBm+10logB (where B = 26dB emissions bandwidth). | PASSED | 5.18 GHz = 16.04dBm (40.21mW) 5.20 GHz = 16.44dBm (44.09mW) 5.24 GHz = 16.14dBm (41.15mW) |
| 15.407(a)(1) | The peak power spectral density shall not exceed 4dBm in any 1MHz band. | PASSED | 5.18 GHz = 0.98dBm 5.20 GHz = 2.04dBm 5.24 GHz = 1.12dBm |
| 15.407(a)(1) | Peak transmit power and the peak power spectral density shall be reduced by the amount in dB that the transmitting antenna exceeds 6dBi. | N/A | All antennas tested have less than 6dBi antenna gain (Please see the antenna data sheets) |
| 15.407(b)(6) 15.209 | Unwanted emissions below 1 GHz must comply with the general field strength limits set forth in Section 15.209. | PASSED | See FCC 15.247 report (INTEL-081125F) |
| 15.407(b)(1) | All emissions outside of the 5.15-5.35 GHz band shall not exceed an EIRP of -27dBm/MHz. | PASSED | See Data Sheets |
| Operation in the 5.25-5.35 GHz Band | | | |
| 15.407(a)(2) | 26dB emissions bandwidth in MHz. | N/A | 5.26 GHz = 21.75 MHz 5.28 GHz = 22.08 MHz 5.32 GHz = 21.75 MHz |
| 15.407(a)(2) | Peak transmit power shall not exceed the lesser of 250mW or 11dBm+10logB (where B = 26dB emissions bandwidth). | PASSED | 5.26 GHz = 16.54dBm (45.12mW) 5.28 GHz = 16.44dBm (44.09mW) 5.32 GHz = 16.34dBm (43.09mW) |
| 15.407(a)(2) | The peak power spectral density shall not exceed 11dBm in any 1MHz band. | PASSED | 5.26 GHz = 2.54dBm 5.28 GHz = 1.93dBm 5.32 GHz = 1.53dBm |
| 15.407(a)(2) | Peak transmit power and the peak power spectral density shall be reduced by the amount in dB that the transmitting antenna exceeds 6dBi. | N/A | All antennas tested have less than 6dBi antenna gain (Please see the antenna data sheets) |
| 15.407(b)(6) 15.209 | Unwanted emissions below 1 GHz must comply with the general field strength limits set forth in Section 15.209. | PASSED | See FCC 15.247 report (INTEL-081125F) |
| 15.407(b)(2) | All emissions outside of the 5.15-5.35 GHz band shall not exceed an EIRP of -27dBm/MHz. Must meet all applicable technical requirements for operating in the 5.15-5.25 GHz band. | PASSED | See Data Sheets |
| General Requirements For All Bands | | | |
| 15.407(a)(6) | The ratio of the peak excursion of the modulation envelope to the peak transmit power shall not exceed 13dB across any 1 MHz bandwidth or the emissions bandwidth whichever is less. | PASSED | 5.18 GHz = 5.84 dB 5.20 GHz = 5.67 dB 5.24 GHz = 5.83 dB 5.26 GHz = 5.83 dB 5.28 GHz = 6.00 dB 5.32 GHz = 6.00 dB |
| 15.407(f) | Radio frequency radiation exposure requirement. | PASSED | Refer to MPE Calculations |
| 15.407(b)(6) 15.207 | UNII devices using AC power line are required to comply with the conducted limits set forth in Section 15.207. | PASSED | See FCC 15.247 report (INTEL-081125F) |



2.0 Summary Of Test Results (Continued)

802.11n Mode 20MHz Wide (5150-5350 MHz) Chain C

| EMISSIONS STANDARD | | | |
|--------------------------------------------|--------------------------------------------------------------------------------------------------------------------------------------------------------------------------------------|----------------|----------------------------------------------------------------------------------------------------------------------------------|
| FCC Part 15 Section | Description | Results | Comments |
| Operation in the 5.15-5.25 GHz Band | | | |
| 15.407(d) | Any UNII device shall use a transmitting antenna that is an integral part of the device. | PASSED | The antenna will be integral when installed in a notebook computer |
| 15.407(e) | UNII devices will be restricted to indoor operations. | PASSED | Refer to "User's Manual" Exhibit |
| 15.407(a)(1) | 26dB emissions bandwidth in MHz. | N/A | 5.18 GHz = 22.58 MHz 5.20 GHz = 21.83 MHz 5.24 GHz = 21.83 MHz |
| 15.407(a)(1) | Peak transmit power shall not exceed the lesser of 50mW or 4dBm+10logB (where B = 26dB emissions bandwidth). | PASSED | 5.18 GHz = 16.44dBm (44.09mW) 5.20 GHz = 16.34dBm (43.09mW) 5.24 GHz = 16.54dBm (45.12mW) |
| 15.407(a)(1) | The peak power spectral density shall not exceed 4dBm in any 1MHz band. | PASSED | 5.18 GHz = 2.02dBm 5.20 GHz = 1.65dBm 5.24 GHz = 2.19dBm |
| 15.407(a)(1) | Peak transmit power and the peak power spectral density shall be reduced by the amount in dB that the transmitting antenna exceeds 6dBi. | N/A | All antennas tested have less than 6dBi antenna gain (Please see the antenna data sheets) |
| 15.407(b)(6) 15.209 | Unwanted emissions below 1 GHz must comply with the general field strength limits set forth in Section 15.209. | PASSED | See FCC 15.247 report (INTEL-081125F) |
| 15.407(b)(1) | All emissions outside of the 5.15-5.35 GHz band shall not exceed an EIRP of -27dBm/MHz. | PASSED | See Data Sheets |
| Operation in the 5.25-5.35 GHz Band | | | |
| 15.407(a)(2) | 26dB emissions bandwidth in MHz. | N/A | 5.26 GHz = 22.00 MHz 5.28 GHz = 22.58 MHz 5.32 GHz = 21.67 MHz |
| 15.407(a)(2) | Peak transmit power shall not exceed the lesser of 250mW or 11dBm+10logB (where B = 26dB emissions bandwidth). | PASSED | 5.26 GHz = 16.54dBm (45.12mW) 5.28 GHz = 16.54dBm (45.12mW) 5.32 GHz = 16.44dBm (44.09mW) |
| 15.407(a)(2) | The peak power spectral density shall not exceed 11dBm in any 1MHz band. | PASSED | 5.26 GHz = 2.13dBm 5.28 GHz = 2.21dBm 5.32 GHz = 1.75dBm |
| 15.407(a)(2) | Peak transmit power and the peak power spectral density shall be reduced by the amount in dB that the transmitting antenna exceeds 6dBi. | N/A | All antennas tested have less than 6dBi antenna gain (Please see the antenna data sheets) |
| 15.407(b)(6) 15.209 | Unwanted emissions below 1 GHz must comply with the general field strength limits set forth in Section 15.209. | PASSED | See FCC 15.247 report (INTEL-081125F) |
| 15.407(b)(2) | All emissions outside of the 5.15-5.35 GHz band shall not exceed an EIRP of -27dBm/MHz. Must meet all applicable technical requirements for operating in the 5.15-5.25 GHz band. | PASSED | See Data Sheets |
| General Requirements For All Bands | | | |
| 15.407(a)(6) | The ratio of the peak excursion of the modulation envelope to the peak transmit power shall not exceed 13dB across any 1 MHz bandwidth or the emissions bandwidth whichever is less. | PASSED | 5.18 GHz = 6.00 dB 5.20 GHz = 6.00 dB 5.24 GHz = 5.83 dB 5.26 GHz = 5.66 dB 5.28 GHz = 5.66 dB 5.32 GHz = 5.84 dB |
| 15.407(f) | Radio frequency radiation exposure requirement. | PASSED | Refer to MPE Calculations |
| 15.407(b)(6) 15.207 | UNII devices using AC power line are required to comply with the conducted limits set forth in Section 15.207. | PASSED | See FCC 15.247 report (INTEL-081125F) |



2.0 Summary Of Test Results (Continued)

802.11n Mode 40MHz Wide (5150-5350 MHz) Chain A

| EMISSIONS STANDARD | | | |
|--------------------------------------------|--------------------------------------------------------------------------------------------------------------------------------------------------------------------------------------|----------------|-------------------------------------------------------------------------------------------|
| FCC Part 15 Section | Description | Results | Comments |
| Operation in the 5.15-5.25 GHz Band | | | |
| 15.407(d) | Any UNII device shall use a transmitting antenna that is an integral part of the device. | PASSED | The antenna will be integral when installed in a notebook computer |
| 15.407(e) | UNII devices will be restricted to indoor operations. | PASSED | Refer to "User's Manual" Exhibit |
| 15.407(a)(1) | 26dB emissions bandwidth in MHz. | N/A | 5.19 GHz = 39.92 MHz 5.23 GHz = 39.50 MHz |
| 15.407(a)(1) | Peak transmit power shall not exceed the lesser of 50mW or 4dBm+10logB (where B = 26dB emissions bandwidth). | PASSED | 5.19 GHz = 16.60dBm (45.69mW) 5.23 GHz = 16.64dBm (46.11mW) |
| 15.407(a)(1) | The peak power spectral density shall not exceed 4dBm in any 1MHz band. | PASSED | 5.19 GHz = -2.81dBm 5.23 GHz = -2.43dBm |
| 15.407(a)(1) | Peak transmit power and the peak power spectral density shall be reduced by the amount in dB that the transmitting antenna exceeds 6dBi. | N/A | All antennas tested have less than 6dBi antenna gain (Please see the antenna data sheets) |
| 15.407(b)(6) 15.209 | Unwanted emissions below 1 GHz must comply with the general field strength limits set forth in Section 15.209. | PASSED | See FCC 15.247 report (INTEL-081125F) |
| 15.407(b)(1) | All emissions outside of the 5.15-5.35 GHz band shall not exceed an EIRP of -27dBm/MHz. | PASSED | See Data Sheets |
| Operation in the 5.25-5.35 GHz Band | | | |
| 15.407(a)(2) | 26dB emissions bandwidth in MHz. | N/A | 5.27 GHz = 39.50 MHz 5.31 GHz = 39.67 MHz |
| 15.407(a)(2) | Peak transmit power shall not exceed the lesser of 250mW or 11dBm+10logB (where B = 26dB emissions bandwidth). | PASSED | 5.27 GHz = 16.65dBm (46.21mW) 5.31 GHz = 16.38dBm (43.43mW) |
| 15.407(a)(2) | The peak power spectral density shall not exceed 11dBm in any 1MHz band. | PASSED | 5.27 GHz = -2.05dBm 5.31 GHz = -2.43dBm |
| 15.407(a)(2) | Peak transmit power and the peak power spectral density shall be reduced by the amount in dB that the transmitting antenna exceeds 6dBi. | N/A | All antennas tested have less than 6dBi antenna gain (Please see the antenna data sheets) |
| 15.407(b)(6) 15.209 | Unwanted emissions below 1 GHz must comply with the general field strength limits set forth in Section 15.209. | PASSED | See FCC 15.247 report (INTEL-081125F) |
| 15.407(b)(2) | All emissions outside of the 5.15-5.35 GHz band shall not exceed an EIRP of -27dBm/MHz. Must meet all applicable technical requirements for operating in the 5.15-5.25 GHz band. | PASSED | See Data Sheets |
| General Requirements For All Bands | | | |
| 15.407(a)(6) | The ratio of the peak excursion of the modulation envelope to the peak transmit power shall not exceed 13dB across any 1 MHz bandwidth or the emissions bandwidth whichever is less. | PASSED | 5.19 GHz = 5.83 dB 5.23 GHz = 6.50 dB 5.27 GHz = 6.33 dB 5.31 GHz = 6.34 dB |
| 15.407(f) | Radio frequency radiation exposure requirement. | PASSED | Refer to MPE Calculations |
| 15.407(b)(6) 15.207 | UNII devices using AC power line are required to comply with the conducted limits set forth in Section 15.207. | PASSED | See FCC 15.247 report (INTEL-081125F) |



2.0 Summary Of Test Results (Continued)

802.11n Mode 40MHz Wide (5150-5350 MHz) Chain B

| EMISSIONS STANDARD | | | |
|--------------------------------------------|--------------------------------------------------------------------------------------------------------------------------------------------------------------------------------------|----------------|-------------------------------------------------------------------------------------------|
| FCC Part 15 Section | Description | Results | Comments |
| Operation in the 5.15-5.25 GHz Band | | | |
| 15.407(d) | Any UNII device shall use a transmitting antenna that is an integral part of the device. | PASSED | The antenna will be integral when installed in a notebook computer |
| 15.407(e) | UNII devices will be restricted to indoor operations. | PASSED | Refer to "User's Manual" Exhibit |
| 15.407(a)(1) | 26dB emissions bandwidth in MHz. | N/A | 5.19 GHz = 39.67 MHz 5.23 GHz = 39.75 MHz |
| 15.407(a)(1) | Peak transmit power shall not exceed the lesser of 50mW or 4dBm+10logB (where B = 26dB emissions bandwidth). | PASSED | 5.19 GHz = 16.64dBm (46.11mW) 5.23 GHz = 16.47dBm (44.34mW) |
| 15.407(a)(1) | The peak power spectral density shall not exceed 4dBm in any 1MHz band. | PASSED | 5.19 GHz = -1.75dBm 5.23 GHz = -1.75dBm |
| 15.407(a)(1) | Peak transmit power and the peak power spectral density shall be reduced by the amount in dB that the transmitting antenna exceeds 6dBi. | N/A | All antennas tested have less than 6dBi antenna gain (Please see the antenna data sheets) |
| 15.407(b)(6) 15.209 | Unwanted emissions below 1 GHz must comply with the general field strength limits set forth in Section 15.209. | PASSED | See FCC 15.247 report (INTEL-081125F) |
| 15.407(b)(1) | All emissions outside of the 5.15-5.35 GHz band shall not exceed an EIRP of -27dBm/MHz. | PASSED | See Data Sheets |
| Operation in the 5.25-5.35 GHz Band | | | |
| 15.407(a)(2) | 26dB emissions bandwidth in MHz. | N/A | 5.27 GHz = 39.75 MHz 5.31 GHz = 39.75 MHz |
| 15.407(a)(2) | Peak transmit power shall not exceed the lesser of 250mW or 11dBm+10logB (where B = 26dB emissions bandwidth). | PASSED | 5.27 GHz = 16.32dBm (42.83mW) 5.31 GHz = 16.62dBm (45.90mW) |
| 15.407(a)(2) | The peak power spectral density shall not exceed 11dBm in any 1MHz band. | PASSED | 5.27 GHz = -2.64dBm 5.31 GHz = -1.70dBm |
| 15.407(a)(2) | Peak transmit power and the peak power spectral density shall be reduced by the amount in dB that the transmitting antenna exceeds 6dBi. | N/A | All antennas tested have less than 6dBi antenna gain (Please see the antenna data sheets) |
| 15.407(b)(6) 15.209 | Unwanted emissions below 1 GHz must comply with the general field strength limits set forth in Section 15.209. | PASSED | See FCC 15.247 report (INTEL-081125F) |
| 15.407(b)(2) | All emissions outside of the 5.15-5.35 GHz band shall not exceed an EIRP of -27dBm/MHz. Must meet all applicable technical requirements for operating in the 5.15-5.25 GHz band. | PASSED | See Data Sheets |
| General Requirements For All Bands | | | |
| 15.407(a)(6) | The ratio of the peak excursion of the modulation envelope to the peak transmit power shall not exceed 13dB across any 1 MHz bandwidth or the emissions bandwidth whichever is less. | PASSED | 5.19 GHz = 5.84 dB 5.23 GHz = 6.16 dB 5.27 GHz = 5.67 dB 5.31 GHz = 6.66 dB |
| 15.407(f) | Radio frequency radiation exposure requirement. | PASSED | Refer to MPE Calculations |
| 15.407(b)(6) 15.207 | UNII devices using AC power line are required to comply with the conducted limits set forth in Section 15.207. | PASSED | See FCC 15.247 report (INTEL-081125F) |



2.0 Summary Of Test Results (Continued)

802.11n Mode 40MHz Wide (5150-5350 MHz) Chain C

| EMISSIONS STANDARD | | | |
|--------------------------------------------|--------------------------------------------------------------------------------------------------------------------------------------------------------------------------------------|----------------|-------------------------------------------------------------------------------------------|
| FCC Part 15 Section | Description | Results | Comments |
| Operation in the 5.15-5.25 GHz Band | | | |
| 15.407(d) | Any UNII device shall use a transmitting antenna that is an integral part of the device. | PASSED | The antenna will be integral when installed in a notebook computer |
| 15.407(e) | UNII devices will be restricted to indoor operations. | PASSED | Refer to "User's Manual" Exhibit |
| 15.407(a)(1) | 26dB emissions bandwidth in MHz. | N/A | 5.19 GHz = 39.50 MHz 5.23 GHz = 39.58 MHz |
| 15.407(a)(1) | Peak transmit power shall not exceed the lesser of 50mW or 4dBm+10logB (where B = 26dB emissions bandwidth). | PASSED | 5.19 GHz = 16.42dBm (43.83mW) 5.23 GHz = 16.54dBm (45.06mW) |
| 15.407(a)(1) | The peak power spectral density shall not exceed 4dBm in any 1MHz band. | PASSED | 5.19 GHz = -1.56dBm 5.23 GHz = -1.62dBm |
| 15.407(a)(1) | Peak transmit power and the peak power spectral density shall be reduced by the amount in dB that the transmitting antenna exceeds 6dBi. | N/A | All antennas tested have less than 6dBi antenna gain (Please see the antenna data sheets) |
| 15.407(b)(6) 15.209 | Unwanted emissions below 1 GHz must comply with the general field strength limits set forth in Section 15.209. | PASSED | See FCC 15.247 report (INTEL-081125F) |
| 15.407(b)(1) | All emissions outside of the 5.15-5.35 GHz band shall not exceed an EIRP of -27dBm/MHz. | PASSED | See Data Sheets |
| Operation in the 5.25-5.35 GHz Band | | | |
| 15.407(a)(2) | 26dB emissions bandwidth in MHz. | N/A | 5.27 GHz = 39.67 MHz 5.31 GHz = 39.67 MHz |
| 15.407(a)(2) | Peak transmit power shall not exceed the lesser of 250mW or 11dBm+10logB (where B = 26dB emissions bandwidth). | PASSED | 5.27 GHz = 16.41dBm (43.73mW) 5.31 GHz = 16.33dBm (42.93mW) |
| 15.407(a)(2) | The peak power spectral density shall not exceed 11dBm in any 1MHz band. | PASSED | 5.27 GHz = -1.95dBm 5.31 GHz = -2.74dBm |
| 15.407(a)(2) | Peak transmit power and the peak power spectral density shall be reduced by the amount in dB that the transmitting antenna exceeds 6dBi. | N/A | All antennas tested have less than 6dBi antenna gain (Please see the antenna data sheets) |
| 15.407(b)(6) 15.209 | Unwanted emissions below 1 GHz must comply with the general field strength limits set forth in Section 15.209. | PASSED | See FCC 15.247 report (INTEL-081125F) |
| 15.407(b)(2) | All emissions outside of the 5.15-5.35 GHz band shall not exceed an EIRP of -27dBm/MHz. Must meet all applicable technical requirements for operating in the 5.15-5.25 GHz band. | PASSED | See Data Sheets |
| General Requirements For All Bands | | | |
| 15.407(a)(6) | The ratio of the peak excursion of the modulation envelope to the peak transmit power shall not exceed 13dB across any 1 MHz bandwidth or the emissions bandwidth whichever is less. | PASSED | 5.19 GHz = 6.00 dB 5.23 GHz = 6.16 dB 5.27 GHz = 5.66 dB 5.31 GHz = 6.17 dB |
| 15.407(f) | Radio frequency radiation exposure requirement. | PASSED | Refer to MPE Calculations |
| 15.407(b)(6) 15.207 | UNII devices using AC power line are required to comply with the conducted limits set forth in Section 15.207. | PASSED | See FCC 15.247 report (INTEL-081125F) |



2.0 Summary Of Test Results (Continued)

802.11a Mode (5470-5725 MHz) Chain A

| EMISSIONS STANDARD | | | |
|-------------------------------------------|--------------------------------------------------------------------------------------------------------------------------------------------------------------------------------------|----------------|-------------------------------------------------------------------------------------------------|
| FCC Part 15 Section | Description | Results | Comments |
| 15.407(a)(2) | 26dB emissions bandwidth in MHz. | N/A | 5.50 GHz = 21.50 MHz 5.60 GHz = 21.67 MHz 5.70 GHz = 21.67 MHz |
| 15.407(a)(2) | Peak transmit power shall not exceed the lesser of 250mW or 11dBm+10logB (where B = 26dB emissions bandwidth). | PASSED | 5.50 GHz = 16.04dBm (40.21mW) 5.60 GHz = 16.34dBm (43.09mW) 5.70 GHz = 16.04dBm (40.21mW) |
| 15.407(a)(2) | The peak power spectral density shall not exceed 11dBm in any 1MHz band. | PASSED | 5.50 GHz = 2.12dBm 5.60 GHz = 2.16dBm 5.70 GHz = 2.50dBm |
| 15.407(a)(2) | Peak transmit power and the peak power spectral density shall be reduced by the amount in dB that the transmitting antenna exceeds 6dBi. | N/A | All antennas tested have less than 6dBi antenna gain (Please see the antenna data sheets) |
| 15.407(b)(6) 15.209 | Unwanted emissions below 1 GHz must comply with the general field strength limits set forth in Section 15.209. | PASSED | See FCC 15.247 report (INTEL-081125F) |
| 15.407(b)(3) | For transmitters operating in the 5.47-5.725 GHz band: all emissions outside of the 5.47-5.725 GHz band shall not exceed an EIRP of -27dBm/MHz. | PASSED | See Data Sheets |
| General Requirements For All Bands | | | |
| 15.407(a)(6) | The ratio of the peak excursion of the modulation envelope to the peak transmit power shall not exceed 13dB across any 1 MHz bandwidth or the emissions bandwidth whichever is less. | PASSED | 5.50 GHz = 5.50 dB 5.60 GHz = 5.50 dB 5.70 GHz = 6.16 dB |
| 15.407(f) | Radio frequency radiation exposure requirement. | PASSED | Refer to MPE Calculations |
| 15.407(b)(6) 15.207 | UNII devices using AC power line are required to comply with the conducted limits set forth in Section 15.207. | PASSED | See FCC 15.247 report (INTEL-081125F) |



2.0 Summary Of Test Results (Continued)

802.11a Mode (5470-5725 MHz) Chain B

| EMISSIONS STANDARD | | | |
|-------------------------------------------|--------------------------------------------------------------------------------------------------------------------------------------------------------------------------------------|----------------|-------------------------------------------------------------------------------------------------|
| FCC Part 15 Section | Description | Results | Comments |
| 15.407(a)(2) | 26dB emissions bandwidth in MHz. | N/A | 5.50 GHz = 21.17 MHz 5.60 GHz = 21.17 MHz 5.70 GHz = 20.92 MHz |
| 15.407(a)(2) | Peak transmit power shall not exceed the lesser of 250mW or 11dBm+10logB (where B = 26dB emissions bandwidth). | PASSED | 5.50 GHz = 16.34dBm (43.09mW) 5.60 GHz = 16.44dBm (44.09mW) 5.70 GHz = 16.34dBm (43.09mW) |
| 15.407(a)(2) | The peak power spectral density shall not exceed 11dBm in any 1MHz band. | PASSED | 5.50 GHz = 1.55dBm 5.60 GHz = 1.78dBm 5.70 GHz = 2.36dBm |
| 15.407(a)(2) | Peak transmit power and the peak power spectral density shall be reduced by the amount in dB that the transmitting antenna exceeds 6dBi. | N/A | All antennas tested have less than 6dBi antenna gain (Please see the antenna data sheets) |
| 15.407(b)(6) 15.209 | Unwanted emissions below 1 GHz must comply with the general field strength limits set forth in Section 15.209. | PASSED | See FCC 15.247 report (INTEL-081125F) |
| 15.407(b)(3) | For transmitters operating in the 5.47-5.725 GHz band: all emissions outside of the 5.47-5.725 GHz band shall not exceed an EIRP of -27dBm/MHz. | PASSED | See Data Sheets |
| General Requirements For All Bands | | | |
| 15.407(a)(6) | The ratio of the peak excursion of the modulation envelope to the peak transmit power shall not exceed 13dB across any 1 MHz bandwidth or the emissions bandwidth whichever is less. | PASSED | 5.50 GHz = 5.67 dB 5.60 GHz = 5.66 dB 5.70 GHz = 5.66 dB |
| 15.407(f) | Radio frequency radiation exposure requirement. | PASSED | Refer to MPE Calculations |
| 15.407(b)(6) 15.207 | UNII devices using AC power line are required to comply with the conducted limits set forth in Section 15.207. | PASSED | See FCC 15.247 report (INTEL-081125F) |



2.0 Summary Of Test Results (Continued)

802.11a Mode (5470-5725 MHz) Chain C

| EMISSIONS STANDARD | | | |
|-------------------------------------------|--------------------------------------------------------------------------------------------------------------------------------------------------------------------------------------|----------------|-------------------------------------------------------------------------------------------------|
| FCC Part 15 Section | Description | Results | Comments |
| 15.407(a)(2) | 26dB emissions bandwidth in MHz. | N/A | 5.50 GHz = 21.17 MHz 5.60 GHz = 21.33 MHz 5.70 GHz = 21.25 MHz |
| 15.407(a)(2) | Peak transmit power shall not exceed the lesser of 250mW or 11dBm+10logB (where B = 26dB emissions bandwidth). | PASSED | 5.50 GHz = 16.14dBm (41.15mW) 5.60 GHz = 16.64dBm (46.17mW) 5.70 GHz = 16.14dBm (41.15mW) |
| 15.407(a)(2) | The peak power spectral density shall not exceed 11dBm in any 1MHz band. | PASSED | 5.50 GHz = 2.00dBm 5.60 GHz = 2.53dBm 5.70 GHz = 2.70dBm |
| 15.407(a)(2) | Peak transmit power and the peak power spectral density shall be reduced by the amount in dB that the transmitting antenna exceeds 6dBi. | N/A | All antennas tested have less than 6dBi antenna gain (Please see the antenna data sheets) |
| 15.407(b)(6) 15.209 | Unwanted emissions below 1 GHz must comply with the general field strength limits set forth in Section 15.209. | PASSED | See FCC 15.247 report (INTEL-081125F) |
| 15.407(b)(3) | For transmitters operating in the 5.47-5.725 GHz band: all emissions outside of the 5.47-5.725 GHz band shall not exceed an EIRP of -27dBm/MHz. | PASSED | See Data Sheets |
| General Requirements For All Bands | | | |
| 15.407(a)(6) | The ratio of the peak excursion of the modulation envelope to the peak transmit power shall not exceed 13dB across any 1 MHz bandwidth or the emissions bandwidth whichever is less. | PASSED | 5.50 GHz = 5.83 dB 5.60 GHz = 5.83 dB 5.70 GHz = 5.84 dB |
| 15.407(f) | Radio frequency radiation exposure requirement. | PASSED | Refer to MPE Calculations |
| 15.407(b)(6) 15.207 | UNII devices using AC power line are required to comply with the conducted limits set forth in Section 15.207. | PASSED | See FCC 15.247 report (INTEL-081125F) |



2.0 Summary Of Test Results (Continued)

802.11n Mode 20MHz Wide (5470-5725 MHz) Chain A

| EMISSIONS STANDARD | | | |
|-------------------------------------------|--------------------------------------------------------------------------------------------------------------------------------------------------------------------------------------|----------------|-------------------------------------------------------------------------------------------------|
| FCC Part 15 Section | Description | Results | Comments |
| 15.407(a)(2) | 26dB emissions bandwidth in MHz. | N/A | 5.50 GHz = 21.67 MHz 5.60 GHz = 21.75 MHz 5.70 GHz = 21.92 MHz |
| 15.407(a)(2) | Peak transmit power shall not exceed the lesser of 250mW or 11dBm+10logB (where B = 26dB emissions bandwidth). | PASSED | 5.50 GHz = 16.04dBm (40.21mW) 5.60 GHz = 16.19dBm (41.63mW) 5.70 GHz = 16.39dBm (43.59mW) |
| 15.407(a)(2) | The peak power spectral density shall not exceed 11dBm in any 1MHz band. | PASSED | 5.50 GHz = 1.03dBm 5.60 GHz = 2.20dBm 5.70 GHz = 3.03dBm |
| 15.407(a)(2) | Peak transmit power and the peak power spectral density shall be reduced by the amount in dB that the transmitting antenna exceeds 6dBi. | N/A | All antennas tested have less than 6dBi antenna gain (Please see the antenna data sheets) |
| 15.407(b)(6) 15.209 | Unwanted emissions below 1 GHz must comply with the general field strength limits set forth in Section 15.209. | PASSED | See FCC 15.247 report (INTEL-081125F) |
| 15.407(b)(3) | For transmitters operating in the 5.47-5.725 GHz band: all emissions outside of the 5.47-5.725 GHz band shall not exceed an EIRP of -27dBm/MHz. | PASSED | See Data Sheets |
| General Requirements For All Bands | | | |
| 15.407(a)(6) | The ratio of the peak excursion of the modulation envelope to the peak transmit power shall not exceed 13dB across any 1 MHz bandwidth or the emissions bandwidth whichever is less. | PASSED | 5.50 GHz = 5.83 dB 5.60 GHz = 7.00 dB 5.70 GHz = 6.34 dB |
| 15.407(f) | Radio frequency radiation exposure requirement. | PASSED | Refer to MPE Calculations |
| 15.407(b)(6) 15.207 | UNII devices using AC power line are required to comply with the conducted limits set forth in Section 15.207. | PASSED | See FCC 15.247 report (INTEL-081125F) |



2.0 Summary Of Test Results (Continued)

802.11n Mode 20MHz Wide (5470-5725 MHz) Chain B

| EMISSIONS STANDARD | | | |
|-------------------------------------------|--------------------------------------------------------------------------------------------------------------------------------------------------------------------------------------|----------------|-------------------------------------------------------------------------------------------------|
| FCC Part 15 Section | Description | Results | Comments |
| 15.407(a)(2) | 26dB emissions bandwidth in MHz. | N/A | 5.50 GHz = 21.67 MHz 5.60 GHz = 21.67 MHz 5.70 GHz = 21.92 MHz |
| 15.407(a)(2) | Peak transmit power shall not exceed the lesser of 250mW or 11dBm+10logB (where B = 26dB emissions bandwidth). | PASSED | 5.50 GHz = 16.04dBm (40.21mW) 5.60 GHz = 16.24dBm (42.11mW) 5.70 GHz = 16.14dBm (41.15mW) |
| 15.407(a)(2) | The peak power spectral density shall not exceed 11dBm in any 1MHz band. | PASSED | 5.50 GHz = 1.45dBm 5.60 GHz = 2.09dBm 5.70 GHz = 1.63dBm |
| 15.407(a)(2) | Peak transmit power and the peak power spectral density shall be reduced by the amount in dB that the transmitting antenna exceeds 6dBi. | N/A | All antennas tested have less than 6dBi antenna gain (Please see the antenna data sheets) |
| 15.407(b)(6) 15.209 | Unwanted emissions below 1 GHz must comply with the general field strength limits set forth in Section 15.209. | PASSED | See FCC 15.247 report (INTEL-081125F) |
| 15.407(b)(3) | For transmitters operating in the 5.47-5.725 GHz band: all emissions outside of the 5.47-5.725 GHz band shall not exceed an EIRP of -27dBm/MHz. | PASSED | See Data Sheets |
| General Requirements For All Bands | | | |
| 15.407(a)(6) | The ratio of the peak excursion of the modulation envelope to the peak transmit power shall not exceed 13dB across any 1 MHz bandwidth or the emissions bandwidth whichever is less. | PASSED | 5.50 GHz = 5.67 dB 5.60 GHz = 6.00 dB 5.70 GHz = 5.83 dB |
| 15.407(f) | Radio frequency radiation exposure requirement. | PASSED | Refer to MPE Calculations |
| 15.407(b)(6) 15.207 | UNII devices using AC power line are required to comply with the conducted limits set forth in Section 15.207. | PASSED | See FCC 15.247 report (INTEL-081125F) |



2.0 Summary Of Test Results (Continued)

802.11n Mode 20MHz Wide (5470-5725 MHz) Chain C

| EMISSIONS STANDARD | | | |
|-------------------------------------------|--------------------------------------------------------------------------------------------------------------------------------------------------------------------------------------|----------------|-------------------------------------------------------------------------------------------------|
| FCC Part 15 Section | Description | Results | Comments |
| 15.407(a)(2) | 26dB emissions bandwidth in MHz. | N/A | 5.50 GHz = 22.58 MHz 5.60 GHz = 21.67 MHz 5.70 GHz = 21.58 MHz |
| 15.407(a)(2) | Peak transmit power shall not exceed the lesser of 250mW or 11dBm+10logB (where B = 26dB emissions bandwidth). | PASSED | 5.50 GHz = 16.54dBm (45.12mW) 5.60 GHz = 16.54dBm (45.12mW) 5.70 GHz = 16.44dBm (44.09mW) |
| 15.407(a)(2) | The peak power spectral density shall not exceed 11dBm in any 1MHz band. | PASSED | 5.50 GHz = 2.42dBm 5.60 GHz = 2.11dBm 5.70 GHz = 2.18dBm |
| 15.407(a)(2) | Peak transmit power and the peak power spectral density shall be reduced by the amount in dB that the transmitting antenna exceeds 6dBi. | N/A | All antennas tested have less than 6dBi antenna gain (Please see the antenna data sheets) |
| 15.407(b)(6) 15.209 | Unwanted emissions below 1 GHz must comply with the general field strength limits set forth in Section 15.209. | PASSED | See FCC 15.247 report (INTEL-081125F) |
| 15.407(b)(3) | For transmitters operating in the 5.47-5.725 GHz band: all emissions outside of the 5.47-5.725 GHz band shall not exceed an EIRP of -27dBm/MHz. | PASSED | See Data Sheets |
| General Requirements For All Bands | | | |
| 15.407(a)(6) | The ratio of the peak excursion of the modulation envelope to the peak transmit power shall not exceed 13dB across any 1 MHz bandwidth or the emissions bandwidth whichever is less. | PASSED | 5.50 GHz = 6.66 dB 5.60 GHz = 5.67 dB 5.70 GHz = 5.84 dB |
| 15.407(f) | Radio frequency radiation exposure requirement. | PASSED | Refer to MPE Calculations |
| 15.407(b)(6) 15.207 | UNII devices using AC power line are required to comply with the conducted limits set forth in Section 15.207. | PASSED | See FCC 15.247 report (INTEL-081125F) |



2.0 Summary Of Test Results (Continued)

802.11n Mode 40MHz Wide (5470-5725 MHz) Chain A

| EMISSIONS STANDARD | | | |
|-------------------------------------------|--------------------------------------------------------------------------------------------------------------------------------------------------------------------------------------|----------------|-------------------------------------------------------------------------------------------------|
| FCC Part 15 Section | Description | Results | Comments |
| 15.407(a)(2) | 26dB emissions bandwidth in MHz. | N/A | 5.51 GHz = 39.25 MHz 5.59 GHz = 39.42 MHz 5.67 GHz = 39.17 MHz |
| 15.407(a)(2) | Peak transmit power shall not exceed the lesser of 250mW or 11dBm+10logB (where B = 26dB emissions bandwidth). | PASSED | 5.51 GHz = 16.62dBm (45.90mW) 5.59 GHz = 16.57dBm (45.37mW) 5.67 GHz = 16.32dBm (42.83mW) |
| 15.407(a)(2) | The peak power spectral density shall not exceed 11dBm in any 1MHz band. | PASSED | 5.51 GHz = -2.16dBm 5.59 GHz = -2.25dBm 5.67 GHz = -2.62dBm |
| 15.407(a)(2) | Peak transmit power and the peak power spectral density shall be reduced by the amount in dB that the transmitting antenna exceeds 6dBi. | N/A | All antennas tested have less than 6dBi antenna gain (Please see the antenna data sheets) |
| 15.407(b)(6) 15.209 | Unwanted emissions below 1 GHz must comply with the general field strength limits set forth in Section 15.209. | PASSED | See FCC 15.247 report (INTEL-081125F) |
| 15.407(b)(3) | For transmitters operating in the 5.47-5.725 GHz band: all emissions outside of the 5.47-5.725 GHz band shall not exceed an EIRP of -27dBm/MHz. | PASSED | See Data Sheets |
| General Requirements For All Bands | | | |
| 15.407(a)(6) | The ratio of the peak excursion of the modulation envelope to the peak transmit power shall not exceed 13dB across any 1 MHz bandwidth or the emissions bandwidth whichever is less. | PASSED | 5.51 GHz = 5.84 dB 5.59 GHz = 7.66 dB 5.67 GHz = 5.67 dB |
| 15.407(f) | Radio frequency radiation exposure requirement. | PASSED | Refer to MPE Calculations |
| 15.407(b)(6) 15.207 | UNII devices using AC power line are required to comply with the conducted limits set forth in Section 15.207. | PASSED | See FCC 15.247 report (INTEL-081125F) |



2.0 Summary Of Test Results (Continued)

802.11n Mode 40MHz Wide (5470-5725 MHz) Chain B

| EMISSIONS STANDARD | | | |
|-------------------------------------------|--------------------------------------------------------------------------------------------------------------------------------------------------------------------------------------|----------------|-------------------------------------------------------------------------------------------------|
| FCC Part 15 Section | Description | Results | Comments |
| 15.407(a)(2) | 26dB emissions bandwidth in MHz. | N/A | 5.51 GHz = 39.58 MHz 5.59 GHz = 39.58 MHz 5.67 GHz = 39.25 MHz |
| 15.407(a)(2) | Peak transmit power shall not exceed the lesser of 250mW or 11dBm+10logB (where B = 26dB emissions bandwidth). | PASSED | 5.51 GHz = 16.29dBm (42.54mW) 5.59 GHz = 16.63dBm (46.00mW) 5.67 GHz = 16.50dBm (44.65mW) |
| 15.407(a)(2) | The peak power spectral density shall not exceed 11dBm in any 1MHz band. | PASSED | 5.51 GHz = -2.76dBm 5.59 GHz = -1.39dBm 5.67 GHz = -2.09dBm |
| 15.407(a)(2) | Peak transmit power and the peak power spectral density shall be reduced by the amount in dB that the transmitting antenna exceeds 6dBi. | N/A | All antennas tested have less than 6dBi antenna gain (Please see the antenna data sheets) |
| 15.407(b)(6) 15.209 | Unwanted emissions below 1 GHz must comply with the general field strength limits set forth in Section 15.209. | PASSED | See FCC 15.247 report (INTEL-081125F) |
| 15.407(b)(3) | For transmitters operating in the 5.47-5.725 GHz band: all emissions outside of the 5.47-5.725 GHz band shall not exceed an EIRP of -27dBm/MHz. | PASSED | See Data Sheets |
| General Requirements For All Bands | | | |
| 15.407(a)(6) | The ratio of the peak excursion of the modulation envelope to the peak transmit power shall not exceed 13dB across any 1 MHz bandwidth or the emissions bandwidth whichever is less. | PASSED | 5.51 GHz = 6.66 dB 5.59 GHz = 7.67 dB 5.67 GHz = 5.50 dB |
| 15.407(f) | Radio frequency radiation exposure requirement. | PASSED | Refer to MPE Calculations |
| 15.407(b)(6) 15.207 | UNII devices using AC power line are required to comply with the conducted limits set forth in Section 15.207. | PASSED | See FCC 15.247 report (INTEL-081125F) |



2.0 Summary Of Test Results (Continued)

802.11n Mode 40MHz Wide (5470-5725 MHz) Chain C

| EMISSIONS STANDARD | | | |
|-------------------------------------------|--------------------------------------------------------------------------------------------------------------------------------------------------------------------------------------|----------------|-------------------------------------------------------------------------------------------------|
| FCC Part 15 Section | Description | Results | Comments |
| 15.407(a)(2) | 26dB emissions bandwidth in MHz. | N/A | 5.51 GHz = 39.75 MHz 5.59 GHz = 39.92 MHz 5.67 GHz = 39.25 MHz |
| 15.407(a)(2) | Peak transmit power shall not exceed the lesser of 250mW or 11dBm+10logB (where B = 26dB emissions bandwidth). | PASSED | 5.51 GHz = 16.22dBm (41.86mW) 5.59 GHz = 16.51dBm (44.75mW) 5.67 GHz = 16.47dBm (44.34mW) |
| 15.407(a)(2) | The peak power spectral density shall not exceed 11dBm in any 1MHz band. | PASSED | 5.51 GHz = -2.55dBm 5.59 GHz = -2.77dBm 5.67 GHz = -1.66dBm |
| 15.407(a)(2) | Peak transmit power and the peak power spectral density shall be reduced by the amount in dB that the transmitting antenna exceeds 6dBi. | N/A | All antennas tested have less than 6dBi antenna gain (Please see the antenna data sheets) |
| 15.407(b)(6) 15.209 | Unwanted emissions below 1 GHz must comply with the general field strength limits set forth in Section 15.209. | PASSED | See FCC 15.247 report (INTEL-081125F) |
| 15.407(b)(3) | For transmitters operating in the 5.47-5.725 GHz band: all emissions outside of the 5.47-5.725 GHz band shall not exceed an EIRP of -27dBm/MHz. | PASSED | See Data Sheets |
| General Requirements For All Bands | | | |
| 15.407(a)(6) | The ratio of the peak excursion of the modulation envelope to the peak transmit power shall not exceed 13dB across any 1 MHz bandwidth or the emissions bandwidth whichever is less. | PASSED | 5.51 GHz = 6.33 dB 5.59 GHz = 5.67 dB 5.67 GHz = 5.83 dB |
| 15.407(f) | Radio frequency radiation exposure requirement. | PASSED | Refer to MPE Calculations |
| 15.407(b)(6) 15.207 | UNII devices using AC power line are required to comply with the conducted limits set forth in Section 15.207. | PASSED | See FCC 15.247 report (INTEL-081125F) |

ANALYSIS AND CONCLUSIONS

Based upon the measurement results we find that this equipment is within the limits of the global standards listed on the cover page of this test report. All results are based on a test of one sample. If any significant changes are made to the unit, the changes shall be evaluated and a retest may be required.

Approval Signatories

Test and Report Completed By:

Johnny Candelas **12/02/08**
 Date:
 Test Technician
 Aegis Labs, Inc.

Report Approved By:

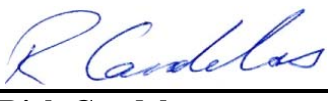
Rick Candelas **12/02/08**
 Date:
 Quality Assurance & EMC Lab Manager
 Aegis Labs, Inc.



3.0 ADMINISTRATIVE DATA AND TEST DESCRIPTION

| | |
|--------------------------------------|------------------------------------------------------------------------------------------------------------------------------------------------------------------------------------------------------------------------------------------------------------------|
| DEVICE TESTED: | ITE Type: Intel WiFi Link 5300 Model Number(s): 533AN_HMW Serial Number: 0016EA038A16 FCC ID: PD9533ANHU |
| DATE EUT RECEIVED: | March 17 th , 2008 |
| TEST DATE(S): | March 17 th – June 6 th , 2008 |
| ORIGIN OF TEST SAMPLE(S): | Production |
| EQUIPMENT CLASS: | EUT tested as CLASS B device |
| RESPONSIBLE PARTY: | Intel Corporation 2111 NE 25 th Avenue Hillsboro, Oregon 97124 |
| CLIENT CONTACT: | Mr. Robert Paxman |
| MANUFACTURER: | Intel Corporation |
| TEST LOCATION: | Aegis Labs, Inc. 32231 Trabuco Creek Road Trabuco Canyon, CA 92678 Open Area Test Site #1 & #2 |
| ACCREDITATION CERTIFICATE(S): | A2LA Certificate Number: 1111.01, Valid through February 28, 2010 |
| PURPOSE OF TEST: | To demonstrate compliance with the standards as described in Sections 1.0 & 2.0 of this report. |
| UNCERTAINTY BUDGET: | Proficiency Testing and Uncertainty Calculations for all tests indicated in this report have been conducted in accordance with ISO 17025: 2005 requirements Section 5.4.6, and 5.9. Uncertainty Budgets and Proficiency Test results available upon request. |
| STATEMENT OF CALIBRATION: | All accredited equipment calibrations were performed by Liberty Labs, Inc. and World Cal. with typical calibration uncertainty estimates derived from ISO Guide to the determination of uncertainties with a Coverage Factor of k=2 for 95% level of confidence. |

4.0 DESCRIPTION OF EUT CONFIGURATION

4.1 EUT Description

| Equipment Under Test (EUT) | | |
|-------------------------------------------------|----------------------------------------------------------------------------------------------------|---------------------------------------------|
| Trade Name: | Intel WiFi Link 5300 | |
| Model Number: | 533AN_HMW | |
| Frequency Range: | 802.11a = 5.15-5.35 GHz 802.11n = 5.15-5.35 GHz | |
| Enclosure: | The EUT contains its own shield made of aluminum approximately 2.5cm wide by 2cm deep by 2mm high. | |
| Transfer Rate: | 6/36/54 Mbps for 802.11a mode Up to 450 Mbps for 802.11n mode | |
| Antenna Type: | <u>Ethertronics Antennas:</u> Magnetic Dipole | <u>Wistron Neweb Corp Antennas:</u> PIFA |
| Antenna Gain (See Note 2): | 5.00dBi @ 5 GHz | 4.87dBi @ 5 GHz |
| Transmit Output Power: | Please see Appendix A (Data Sheets) for actual output power. | |
| Power Supply: | 3.3VDC from external source | |
| Number of External Test Ports Exercised: | 3 Antenna Ports (Chain A, B, & C) | |

The Intel WiFi Link 5300 is an embedded IEEE 802.11a/b/g/n wireless network adapter that operates in the 2.4 GHz and 5.0 GHz spectrum. The adapter is capable of delivering up to 450 Mbps Tx/Rx.

NOTE 1: For a more detailed description, please refer to the manufacture’s specifications or User’s Manual.

NOTE 2: The EUT was tested with a set of Ethertronics & Wistron NeWeb Corp. Antennas. (Refer to the antenna information exhibits).

4.2 EUT Configuration

The EUT was tested installed in the Mini PCI-E slot of an extender board which is then connected to the host computer. The EUT was then connected to a set of antennas via its Chain A, B, & C antenna ports. Data for a set of Ethertronics & Wistron NeWeb Corp. Antennas can be found in Appendix A (Data Sheets)

The low, middle, and high channels were tested in 802.11a, b, g, & n modes. Also, the EUT was tested once transmitting from each chain individually (Chain A, B, then C) and then tested with all chains transmitting simultaneously (Chain ABC). The EUT was placed in continuous transmit mode by a program provided by the manufacturer (*CRTU Version 5.0.51.0000*).

4.3 List of EUT, Sub-Assemblies and Host Equipment

| Equipment Under Test | | | |
|-----------------------------|-----------------------|-----------------------------|----------------------|
| Manufacturer | Equipment Name | Model or Part Number | Serial Number |
| Intel Corporation | Intel WiFi Link 5300 | 533AN_HMW | 0016EA038A16 |

| EUT Sub Assemblies | | | |
|---------------------------|-----------------------|-----------------------------|----------------------|
| Manufacturer | Equipment Name | Model or Part Number | Serial Number |
| Ethertronics | Chain A Antenna | MPCI01001 | N/A |
| | Chain B Antenna | MPCI01001 | N/A |
| | Chain C Antenna | MPCI01001 | N/A |
| Wistron Neweb Corp. | Chain A Antenna | 81.EBJ15.006 | N/A |
| | Chain B Antenna | 81.EBJ15.006 | N/A |
| | Chain C Antenna | 81.EBJ15.006 | N/A |

| HOST EQUIPMENT LIST | | | |
|----------------------------|-----------------------|-----------------------------|----------------------|
| Manufacturer | Equipment Name | Model or Part Number | Serial Number |
| Generic | Host Laptop | ENG001 | None |
| Protek | DC Power Source | 3006B | AC2018 |
| Logitech | Keyboard | Y-BF37 | MCT25200581 |
| Logitech | Mouse | M-BJ58 | LNA22802012 |

NOTE: All the power cords of the above support equipment are standard and non-shielded.

4.4 I/O Cabling Diagram and Description

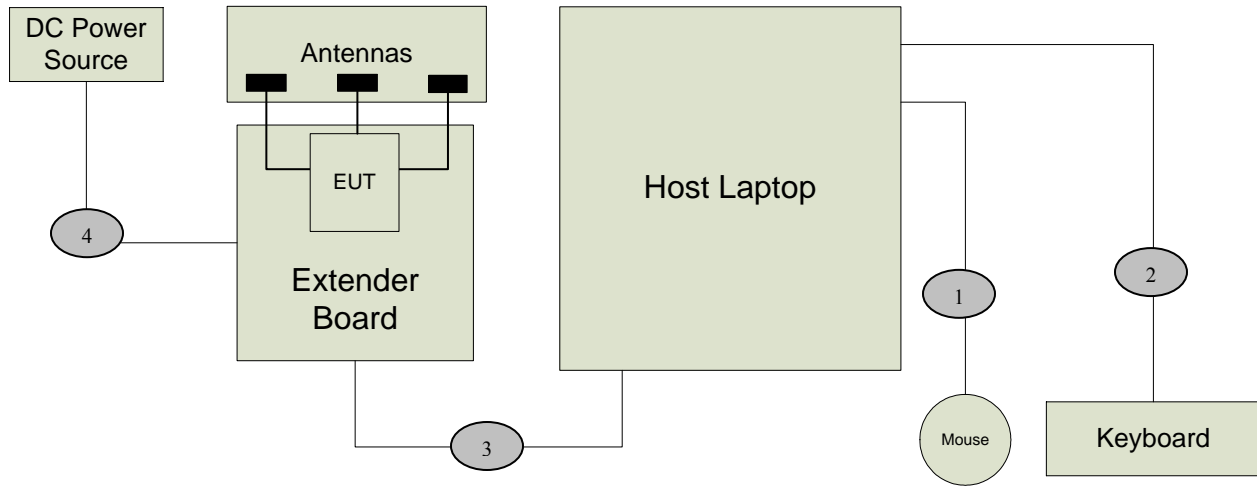

Signal Line Cable Description

| Cable | Length | Construction | Source Connector | Destination Connector | Bundled Length | Ferrite Attached | Note |
|-------|--------|------------------------------|--------------------------------|-------------------------------|----------------|------------------|------|
| 1 | 1.5m | Round, Braid & Foil Shielded | Host Computer: USB Port | Keyboard: Hardwired | N/A | N/A | N/A |
| 2 | 1.5m | Round, Braid & Foil Shielded | Host Computer: USB Port | Mouse: Hardwired | N/A | N/A | N/A |
| 3 | 0.5m | Flat, Braid & Foil Shielded | Extender Board: Mini PCIe slot | Host Laptop: Mini PCIe slot | N/A | N/A | N/A |
| 4 | 0.5m | Round Un-shielded | Extender Board: Power Input | DC Power Source: Power Output | N/A | N/A | N/A |



4.5 EMC Test Hardware and Software Measurement Equipment

| TEST EQUIPMENT LIST - Emissions | | | | | |
|------------------------------------------|------------------------------|----------------------|---------------|----------------------|-------------------------------|
| Equipment Name | Manufacturer | Model Number | Serial Number | Calibration Due Date | Maintenance Calibration Cycle |
| Spectrum Analyzer | Agilent | 8565EC | 3946A00245 | 07/24/08 | 1 Year |
| PSA Spectrum Analyzer | Agilent | E4440A | MY44303400 | 10/24/08 | 1 Year |
| Antenna – Horn | ETS | 3117 | 00057423 | 03/28/09 | 1 Year |
| Preamp | Miteq | JS42-01001800-25-10P | 815980 | 09/21/08 | 1 Year |
| 28 Foot Coax | Semflex | S1L29BFS1348 | 608 | 07/26/08 | 1 Year |
| 5.15-5.35 GHz Notch Filter | Microwave Circuits | N0452502 | 3173-01 | NCR | NCR |
| Antenna - 18-26.5 GHz Pre-amplified Horn | Aegis Labs, Inc. | H042 | SLK-35-3W | 02/08/09 | 1 Year |
| Antenna - 26.5-40 GHz Pre-amplified Horn | Aegis Labs, Inc. | H028 | GM1260-10 | 02/08/09 | 1 Year |
| EMI Receiver - RF Section | Hewlett Packard | 8546A | 3325A00137 | 04/26/09 | 1 Year |
| EMI Receiver - RF Filter Section | Hewlett Packard | 85460A | 3330A00138 | 04/26/09 | 1 Year |
| 10 dB Attenuator | Pasternack | PE7014-10 | N/A | 09/05/08 | 1 Year |
| LISN (EUT) | Fisher Custom Communications | FCC-LISN-50-25-2 | 9931 | 03/30/09 | 1 Year |
| LISN (Access) | EMCO | 3825/2 | 9108-1848 | 03/30/09 | 1 Year |
| Antenna - Biconical | EMCO | 3110B | 3383 | 03/20/09 | 1 Year |
| Antenna - Log Periodic | EMCO | 3148 | 47943 | 03/20/09 | 1 Year |
| Power Meter | Anritsu | ML2487A | 6K00001785 | 05/29/09 | 1 Year |
| Wide Bandwidth Sensor | Anritsu | MA2491A | 31193 | 05/29/09 | 1 Year |
| 12dB Attenuator | Narda | 4779-12 | 203 | 06/09/08 | 1 Year |
| Temperature/Humidity Monitor | Dickson | TH550 | 7255185 | 04/13/09 | 1 Year |

NCR – No Calibration Required.

5.0 CONDITIONS DURING EMISSIONS MEASUREMENTS

5.1 General

All measurements were made according to the procedures defined in or referred to by the standard listed on the cover page of this report. The measurements were made in the operating mode producing the largest emissions consistent with normal operation and connected to the minimum configuration of auxiliary devices.

5.2 Conducted Emissions Test Setup

The following was the test configuration.

EUT signal cables that hung closer than 40 cm to the horizontal metal ground plane were folded back and forth forming a bundle 30 cm to 40 cm long. The power cord of the EUT was also bundled in the center and plugged into one of the artificial mains network (AMN). All peripheral equipment was powered from a second AMN via a multiple outlet strip placed at a distance on 10cm from each other. The AMN and ISN were positioned 80cm from the EUT. Signal cables that were not connected to an AE were terminated using the correct termination. If applicable, the current probe was placed at 0.1 m from the ISN.

Peak, quasi-peak and/or average detectors were used for testing performed between 150 kHz and 30 MHz. A swept frequency scan was performed for both Line 1 and Line 2. The six highest readings were compared against the limit and recorded in the data sheet along with a snapshot image of the sweep scan. The graphical scans in Appendix A only reflect peak readings while the tabulated data sheets reflect peak, average, and/or quasi-peak measurements.

Climatic Conditions:

The EUT was tested within its intended operating and climatic conditions.

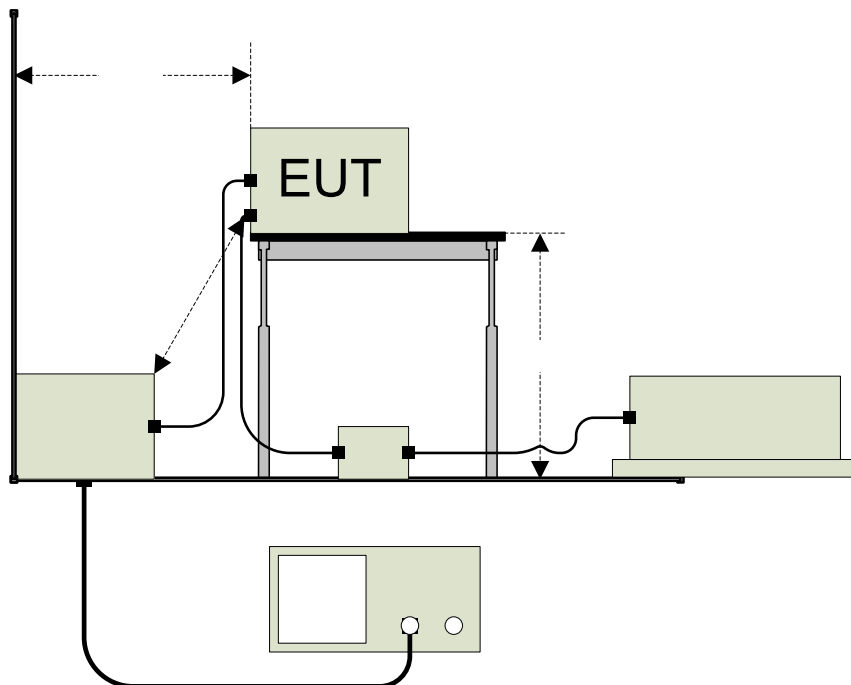

AMN = Artificial mains network
AE = Associated equipment
EUT = Equipment under test
ISN = Impedance stabilization network

5.3 Radiated Emissions Test Setup

The Open Area Test Site (OATS) was used for radiated emission testing. The receiving (Rx) antenna(s) was placed 10m from the nearest side of the EUT facing the Rx antenna. The EUT (if floor-standing) was placed directly on the flush-mounted 360 degree rotating turntable. The EUT (if table-top) was placed directly on an 80cm high non-metallic table, and the table was placed on the rotating turntable. During the initial EMI scan, all the suspect frequencies, i.e.; harmonics, broadband signals were checked with the Rx broadband antennas in both vertical and horizontal polarities. The biconical Rx, log periodic Rx, and horn Rx antennas were used from 30MHz – 299.99MHz, 300MHz – 1000MHz, and 1GHz – 18GHz respectively.

Upon completion of all harmonic and broadband measurements, the balance of any remaining frequencies was checked between 30MHz – 18GHz. Any signals appearing within 20 dB of the classification limit was measured. Each signal was maximized by first rotating the turntable at least 360 degrees and recording the azimuth in the data sheet. Lastly, the Rx antenna was raised and/or lowered to maximize the signal elevation. If the measured signal was obtained using the peak detector and that signal appeared within 3 dB of the regulatory limit line, then the same signal was re-measured using the quasi-peak detector on the EMI receiver. Both meter readings if necessary were recorded on the data sheet.

Climatic Conditions:

The EUT was tested within its intended operating and climatic conditions.

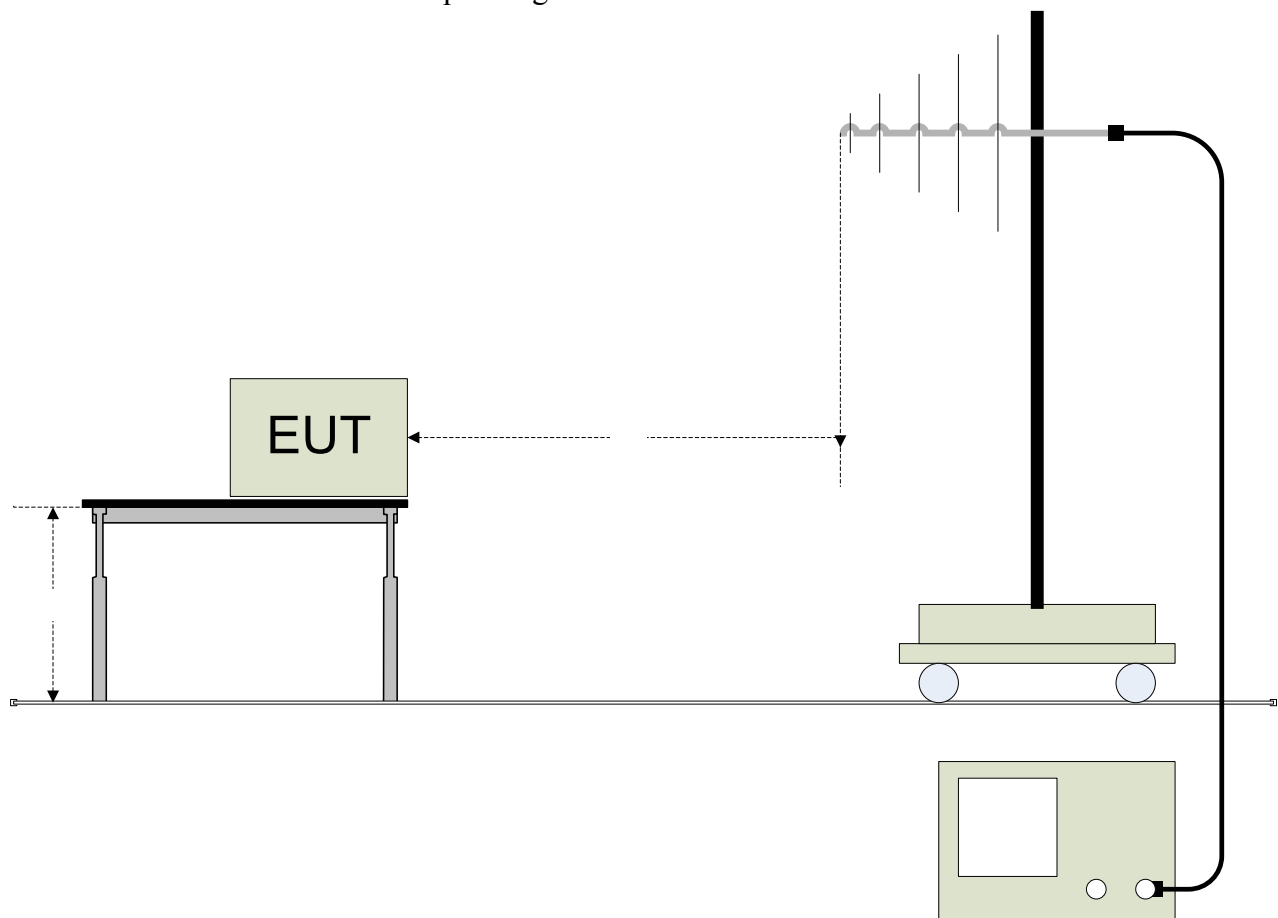



APPENDIX A

TEST DATA

**RADIATED EMISSIONS TEST RESULTS**

| | | | |
|-----------------------|----------------------------------------------------------------------------------------------------------------------------|------------------------|--------------|
| CLIENT: | Intel Corporation | DATE: | 04/08/08 |
| EUT: | Intel WiFi Link 5300 | PROJECT NUMBER: | INTEL-081125 |
| MODEL NUMBER: | 533AN_HMW | TEST ENGINEER: | KN/RC |
| SERIAL NUMBER: | 0016EA038A16 | SITE #: | 2 |
| CONFIGURATION: | Tested installed in an extender board connected to the host laptop's mini PCI slot in 802.11a (5150-5350 MHz) mode. | TEMPERATURE: | 22° C |
| | | HUMIDITY: | 39% RH |
| | | TIME: | 8:00 AM |

| | |
|---------------------|---------------------------------------------------------------------------------------------------------------------------------------------------------------------------------------------|
| Description: | Radiated RF Emissions (1 GHz – 18 GHz) |
| Results: | PASSED Horizontal and Vertical Antenna Polarizations Class B Limits |
| Note: | Radiated Emissions Measurements were performed on the EUT with power supply set at the following voltage and frequency. <ul style="list-style-type: none"> • 120VAC / 60 Hz. |

| Unwanted Spurious Emissions Limits | | | |
|-------------------------------------------|------------------------------|------------------------------------------------------------------------|------------------------------------------------------------------------------|
| Frequency (MHz) | Field Strength (uV/m) | Field Strength (dBuV/m) (Emissions in the restricted bands) | Field Strength (dBm/MHz) (Emissions outside the restricted bands) |
| Above 960 | 500 | 54.00 (Average) 74.00 (Peak) | < -20 dBc |

Radiated Emissions Sample Calculations

$$\text{Corrected Meter Reading} = \text{Meter Reading} + F + C - D$$

Where, F = Antenna Factor

C = Cable Factor

G = Amplifier Gain

D = Distance Factor (if applicable)

Therefore, the equation for determining the Corrected Meter Reading Limit (CML) is:

$$\text{CML} = \text{Specification Limit} - F - C + D$$



Radiated Emissions Test Results (Continued)

*Fundamental Measurements in 802.11a mode (5150-5350 MHz)
Channels 36, 40, 48, 52, & 64
Continuous TX at Chain A Antenna port with Ethertronics Antennas
Aegis Labs, Inc. File #: INTEL-081125-51*

| RADIATED EMISSIONS - Horizontal Antenna Polarization | | | | | | | | | | | |
|-------------------------------------------------------------|----------------------|---------------------|-------------------|------------------------|---|-------------------|------------------|--------------------------|---------------|------------------|---------------|
| Freq. (MHz) | Meter Reading (dBuV) | Antenna Height (cm) | Azimuth (degrees) | Quasi pk or AVG (dBuV) | | Cable Factor (dB) | Ant. Factor (dB) | Corrected Reading (dBuV) | Limits (dBuV) | Diff (dB) +=FAIL | Comments |
| 5180.00 | 65.67 | 100 | 135 | | | 3.77 | 34.32 | 103.76 | | | Ch. 36 |
| 5180.00 | | | | 55.00 | A | 3.77 | 34.32 | 93.09 | | | |
| 5200.00 | 66.17 | 100 | 135 | | | 3.78 | 34.34 | 104.29 | | | Ch. 40 |
| 5200.00 | | | | 55.83 | A | 3.78 | 34.34 | 93.95 | | | |
| 5240.00 | 65.83 | 100 | 135 | | | 3.80 | 34.39 | 104.01 | | | Ch. 48 |
| 5240.00 | | | | 55.83 | A | 3.80 | 34.39 | 94.01 | | | |
| 5260.00 | 66.00 | 100 | 135 | | | 3.80 | 34.41 | 104.22 | | | Ch. 52 |
| 5260.00 | | | | 55.67 | A | 3.80 | 34.41 | 93.89 | | | |
| 5320.00 | 66.33 | 100 | 135 | | | 3.83 | 34.48 | 104.64 | | | Ch. 64 |
| 5320.00 | | | | 55.50 | A | 3.83 | 34.48 | 93.81 | | | |

| RADIATED EMISSIONS - Vertical Antenna Polarization | | | | | | | | | | | |
|-----------------------------------------------------------|----------------------|---------------------|-------------------|------------------------|---|-------------------|------------------|--------------------------|---------------|------------------|---------------|
| Freq. (MHz) | Meter Reading (dBuV) | Antenna Height (cm) | Azimuth (degrees) | Quasi pk or AVG (dBuV) | | Cable Factor (dB) | Ant. Factor (dB) | Corrected Reading (dBuV) | Limits (dBuV) | Diff (dB) +=FAIL | Comments |
| 5180.00 | 60.33 | 100 | 225 | | | 3.77 | 34.31 | 98.41 | | | Ch. 36 |
| 5180.00 | | | | 51.17 | A | 3.77 | 34.31 | 89.25 | | | |
| 5200.00 | 62.33 | 100 | 225 | | | 3.78 | 34.32 | 100.43 | | | Ch. 40 |
| 5200.00 | | | | 52.50 | A | 3.78 | 34.32 | 90.60 | | | |
| 5240.00 | 64.00 | 100 | 225 | | | 3.80 | 34.34 | 102.14 | | | Ch. 48 |
| 5240.00 | | | | 54.00 | A | 3.80 | 34.34 | 92.14 | | | |
| 5260.00 | 66.67 | 100 | 225 | | | 3.80 | 34.36 | 104.83 | | | Ch. 52 |
| 5260.00 | | | | 56.33 | A | 3.80 | 34.36 | 94.49 | | | |
| 5320.00 | 65.83 | 100 | 225 | | | 3.83 | 34.39 | 104.05 | | | Ch. 64 |
| 5320.00 | | | | 55.67 | A | 3.83 | 34.39 | 93.89 | | | |

NOTE: Fundamental signals measured to calculate the band edge field strengths using the “Marker Delta Method”.



Radiated Emissions Test Results (Continued)

*Band Edge Field Strength Measurements in 802.11a mode (5150-5350 MHz)
Channels 36 & 64
Continuous TX at Chain A Antenna port with Ethertronics Antennas
Aegis Labs, Inc. File #: INTEL-081125-51*

| RADIATED EMISSIONS - Horizontal Antenna Polarization | | | | | | | | | | |
|-------------------------------------------------------------|----------------------|---------------------|-------------------|------------------------|-------------------|------------------|--------------------------|---------------|------------------|---------------|
| Freq. (MHz) | Meter Reading (dBuV) | Antenna Height (cm) | Azimuth (degrees) | Quasi pk or AVG (dBuV) | Cable Factor (dB) | Ant. Factor (dB) | Corrected Reading (dBuV) | Limits (dBuV) | Diff (dB) +=FAIL | Comments |
| 5150.00 | | | | | | | 59.26 | 74.00 | -14.74 | Ch. 36 |
| 5150.00 | | | | | A | | 40.09 | 54.00 | -13.91 | |
| 5350.00 | | | | | | | 59.47 | 74.00 | -14.53 | Ch. 64 |
| 5350.00 | | | | | A | | 41.65 | 54.00 | -12.35 | |

| RADIATED EMISSIONS - Vertical Antenna Polarization | | | | | | | | | | |
|-----------------------------------------------------------|----------------------|---------------------|-------------------|------------------------|-------------------|------------------|--------------------------|---------------|------------------|---------------|
| Freq. (MHz) | Meter Reading (dBuV) | Antenna Height (cm) | Azimuth (degrees) | Quasi pk or AVG (dBuV) | Cable Factor (dB) | Ant. Factor (dB) | Corrected Reading (dBuV) | Limits (dBuV) | Diff (dB) +=FAIL | Comments |
| 5150.00 | | | | | | | 53.91 | 74.00 | -20.09 | Ch. 36 |
| 5150.00 | | | | | A | | 36.25 | 54.00 | -17.75 | |
| 5350.00 | | | | | | | 58.88 | 74.00 | -15.12 | Ch. 64 |
| 5350.00 | | | | | A | | 41.73 | 54.00 | -12.27 | |

NOTE: The “Band Edge Field Strength” was calculated using the “Fundamental” and “Conducted Band Edge” measurements per the “Marker-Delta Method” with the following formula:

$$BE = Fm - \Delta m$$

Where

BE = Band Edge Field Strength

Fm = Measured Fundamental (Peak or Average)

Δm = Measured Conducted Band Edge Delta (Peak or Average)



Radiated Emissions Test Results (Continued)

Plots Showing Out-Of-Band Emissions (Peak RBW=VBW=1MHz; Average RBW = 1MHz, VBW = 10Hz)

| <i>Test Date</i> | <i>Data</i> | <i>Test Eng.</i> |
|-------------------------------------------------------------------------------------------------------------------------------------------------------------------------|-----------------------------------|------------------|
| 04/05/08 | 5.18 GHz band edge PEAK | RC |
| <p>*ATTEN 20dB ΔMKR 44.50dB RL 16.0dBm 10dB/ 36.3MHz</p> <p>CENTER 5.1500GHz SPAN 100.0MHz *RBW 1.0MHz *VBW 1.0MHz SWP 50.0ms</p> | | |
| <i>Test Date</i> | <i>Data</i> | <i>Test Eng.</i> |
| 04/05/08 | 5.18 GHz band edge AVERAGE | RC |
| <p>*ATTEN 20dB ΔMKR 53.00dB RL 16.0dBm 10dB/ 36.5MHz</p> <p>CENTER 5.1500GHz SPAN 100.0MHz *RBW 1.0MHz *VBW 10Hz SWP 37.0sec</p> | | |



Radiated Emissions Test Results (Continued)

Plots Showing Out-Of-Band Emissions (Peak RBW=VBW=1MHz; Average RBW = 1MHz, VBW = 10Hz)

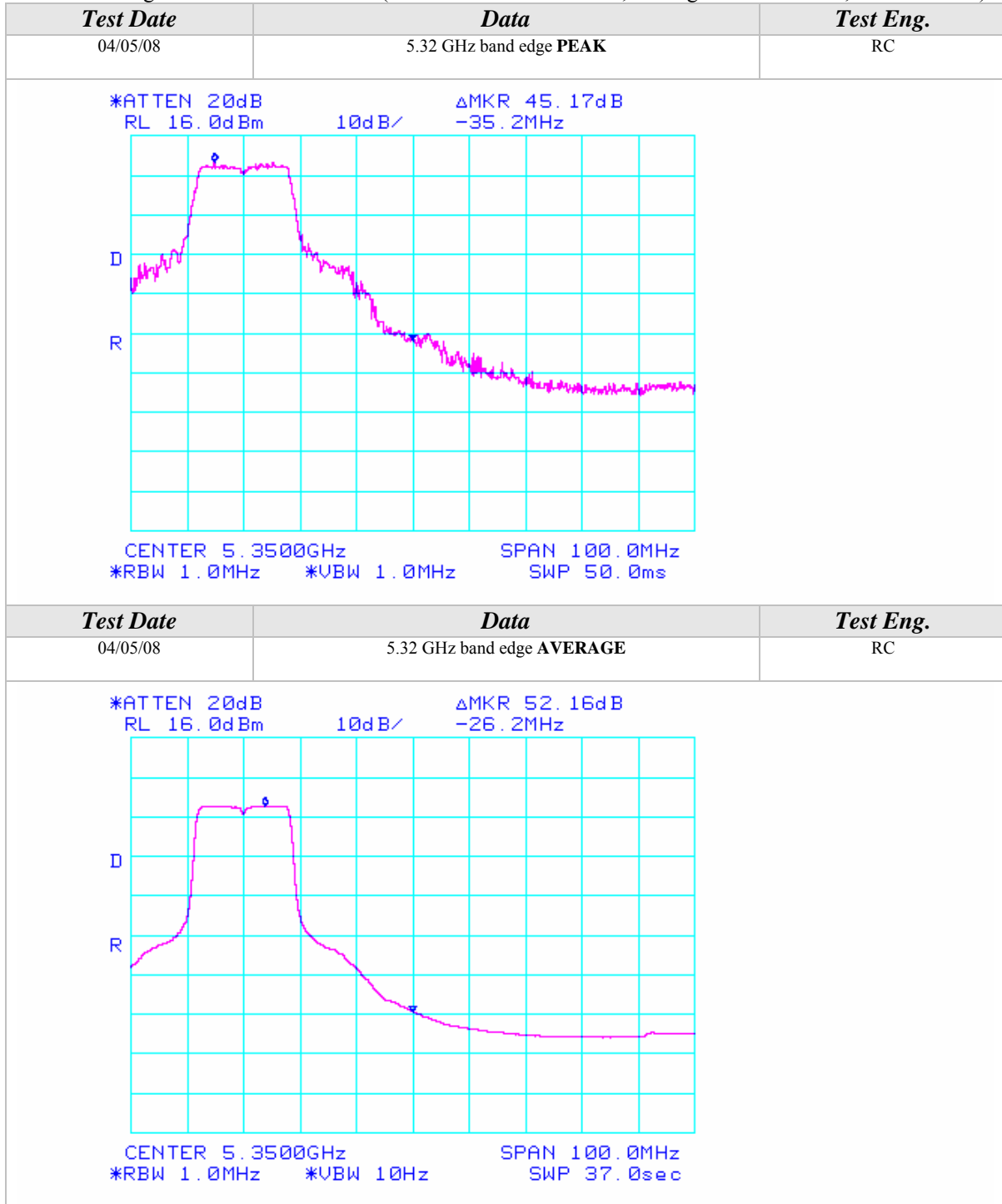



Radiated Emissions Test Results (Continued)

*Fundamental Measurements in 802.11a mode (5150-5350 MHz)
 Channels 36, 40, 48, 52, & 64
 Continuous TX at Chain B Antenna port with Ethertronics Antennas
 Aegis Labs, Inc. File #: INTEL-081125-52*

| RADIATED EMISSIONS - Horizontal Antenna Polarization | | | | | | | | | | | |
|-------------------------------------------------------------|----------------------|---------------------|-------------------|------------------------|---|-------------------|------------------|--------------------------|---------------|------------------|---------------|
| Freq. (MHz) | Meter Reading (dBuV) | Antenna Height (cm) | Azimuth (degrees) | Quasi pk or AVG (dBuV) | | Cable Factor (dB) | Ant. Factor (dB) | Corrected Reading (dBuV) | Limits (dBuV) | Diff (dB) +=FAIL | Comments |
| 5180.00 | 62.50 | 100 | 225 | | | 3.77 | 34.32 | 100.59 | | | Ch. 36 |
| 5180.00 | | | | 52.33 | A | 3.77 | 34.32 | 90.42 | | | |
| 5200.00 | 62.17 | 100 | 225 | | | 3.78 | 34.34 | 100.29 | | | Ch. 40 |
| 5200.00 | | | | 52.50 | A | 3.78 | 34.34 | 90.62 | | | |
| 5240.00 | 65.83 | 100 | 225 | | | 3.80 | 34.39 | 104.01 | | | Ch. 48 |
| 5240.00 | | | | 55.17 | A | 3.80 | 34.39 | 93.35 | | | |
| 5260.00 | 64.67 | 100 | 225 | | | 3.80 | 34.41 | 102.89 | | | Ch. 52 |
| 5260.00 | | | | 54.67 | A | 3.80 | 34.41 | 92.89 | | | |
| 5320.00 | 65.50 | 100 | 225 | | | 3.83 | 34.48 | 103.81 | | | Ch. 64 |
| 5320.00 | | | | 55.33 | A | 3.83 | 34.48 | 93.64 | | | |

| RADIATED EMISSIONS - Vertical Antenna Polarization | | | | | | | | | | | |
|-----------------------------------------------------------|----------------------|---------------------|-------------------|------------------------|---|-------------------|------------------|--------------------------|---------------|------------------|---------------|
| Freq. (MHz) | Meter Reading (dBuV) | Antenna Height (cm) | Azimuth (degrees) | Quasi pk or AVG (dBuV) | | Cable Factor (dB) | Ant. Factor (dB) | Corrected Reading (dBuV) | Limits (dBuV) | Diff (dB) +=FAIL | Comments |
| 5180.00 | 62.17 | 100 | 225 | | | 3.77 | 34.31 | 100.25 | | | Ch. 36 |
| 5180.00 | | | | 52.00 | A | 3.77 | 34.31 | 90.08 | | | |
| 5200.00 | 60.67 | 100 | 225 | | | 3.78 | 34.32 | 98.77 | | | Ch. 40 |
| 5200.00 | | | | 51.17 | A | 3.78 | 34.32 | 89.27 | | | |
| 5240.00 | 63.17 | 100 | 225 | | | 3.80 | 34.34 | 101.31 | | | Ch. 48 |
| 5240.00 | | | | 53.00 | A | 3.80 | 34.34 | 91.14 | | | |
| 5260.00 | 63.50 | 100 | 135 | | | 3.80 | 34.36 | 101.66 | | | Ch. 52 |
| 5260.00 | | | | 53.67 | A | 3.80 | 34.36 | 91.83 | | | |
| 5320.00 | 66.17 | 100 | 180 | | | 3.83 | 34.39 | 104.39 | | | Ch. 64 |
| 5320.00 | | | | 55.83 | A | 3.83 | 34.39 | 94.05 | | | |

NOTE: Fundamental signals measured to calculate the band edge field strengths using the “Marker Delta Method”.



Radiated Emissions Test Results (Continued)

*Band Edge Field Strength Measurements in 802.11a mode (5150-5350 MHz)
Channels 36 & 64
Continuous TX at Chain B Antenna port with Ethertronics Antennas
Aegis Labs, Inc. File #: INTEL-081125-52*

| RADIATED EMISSIONS - Horizontal Antenna Polarization | | | | | | | | | | |
|-------------------------------------------------------------|----------------------|---------------------|-------------------|------------------------|-------------------|------------------|--------------------------|---------------|------------------|---------------|
| Freq. (MHz) | Meter Reading (dBuV) | Antenna Height (cm) | Azimuth (degrees) | Quasi pk or AVG (dBuV) | Cable Factor (dB) | Ant. Factor (dB) | Corrected Reading (dBuV) | Limits (dBuV) | Diff (dB) +=FAIL | Comments |
| 5150.00 | | | | | | | 57.76 | 74.00 | -16.24 | Ch. 36 |
| 5150.00 | | | | | A | | 35.92 | 54.00 | -18.08 | |
| 5350.00 | | | | | | | 60.81 | 74.00 | -13.19 | Ch. 64 |
| 5350.00 | | | | | A | | 43.64 | 54.00 | -10.36 | |

| RADIATED EMISSIONS - Vertical Antenna Polarization | | | | | | | | | | |
|-----------------------------------------------------------|----------------------|---------------------|-------------------|------------------------|-------------------|------------------|--------------------------|---------------|------------------|---------------|
| Freq. (MHz) | Meter Reading (dBuV) | Antenna Height (cm) | Azimuth (degrees) | Quasi pk or AVG (dBuV) | Cable Factor (dB) | Ant. Factor (dB) | Corrected Reading (dBuV) | Limits (dBuV) | Diff (dB) +=FAIL | Comments |
| 5150.00 | | | | | | | 57.42 | 74.00 | -16.58 | Ch. 36 |
| 5150.00 | | | | | A | | 35.58 | 54.00 | -18.42 | |
| 5350.00 | | | | | | | 61.39 | 74.00 | -12.61 | Ch. 64 |
| 5350.00 | | | | | A | | 44.05 | 54.00 | -9.95 | |

NOTE: The “Band Edge Field Strength” was calculated using the “Fundamental” and “Conducted Band Edge” measurements per the “Marker-Delta Method” with the following formula:

$$BE = Fm - \Delta m$$

Where

BE = Band Edge Field Strength

Fm = Measured Fundamental (Peak or Average)

Δm = Measured Conducted Band Edge Delta (Peak or Average)



Radiated Emissions Test Results (Continued)

Plots Showing Out-Of-Band Emissions (Peak RBW=VBW=1MHz; Average RBW = 1MHz, VBW = 10Hz)

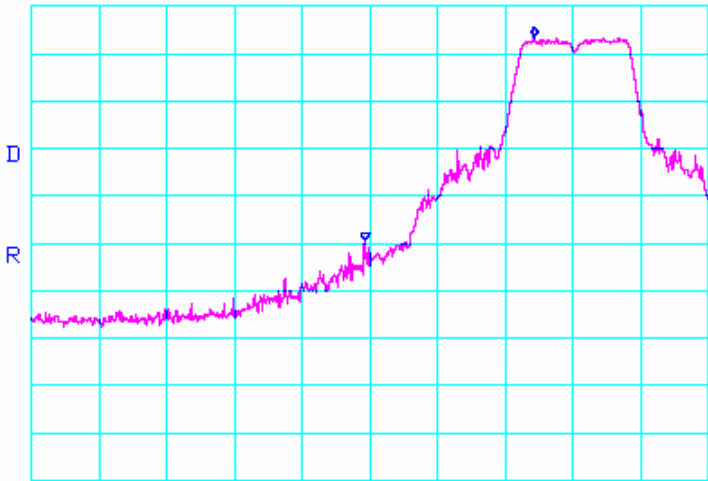
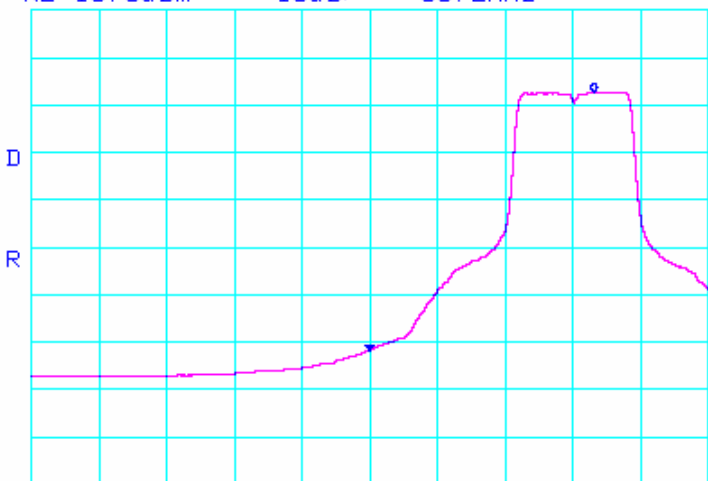
| <i>Test Date</i> | <i>Data</i> | <i>Test Eng.</i> |
|-----------------------------------------------------------------------------------------------------------------------------------------------------------------------------------------------------------------------------------------------------------------------------------------|-----------------------------------|------------------|
| 04/05/08 | 5.18 GHz band edge PEAK | RC |
| <div style="padding: 10px;">*ATTEN 20dB ΔMKR 42.83dB RL 16.0dBm 10dB/ 25.0MHz  CENTER 5.1500GHz SPAN 100.0MHz *RBW 1.0MHz *VBW 1.0MHz SWP 50.0ms</div> | | |
| <i>Test Date</i> | <i>Data</i> | <i>Test Eng.</i> |
| 04/05/08 | 5.18 GHz band edge AVERAGE | RC |
| <div style="padding: 10px;">*ATTEN 20dB ΔMKR 54.50dB RL 16.0dBm 10dB/ 33.2MHz  CENTER 5.1500GHz SPAN 100.0MHz *RBW 1.0MHz *VBW 10Hz SWP 37.0sec</div> | | |

Radiated Emissions Test Results (Continued)

Plots Showing Out-Of-Band Emissions (Peak RBW=VBW=1MHz; Average RBW = 1MHz, VBW = 10Hz)

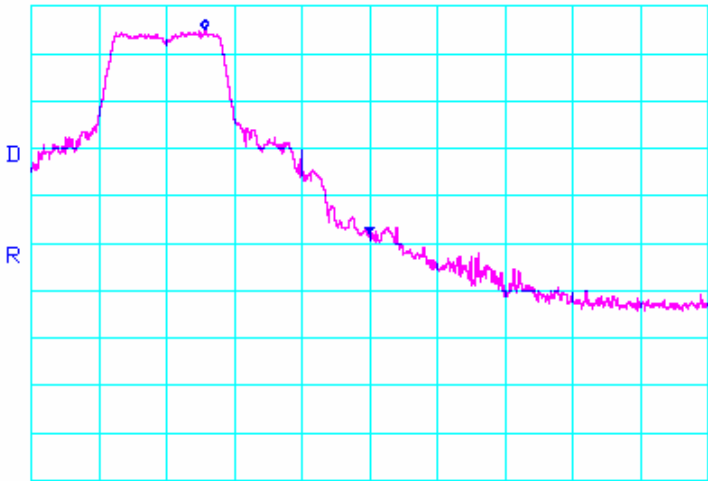
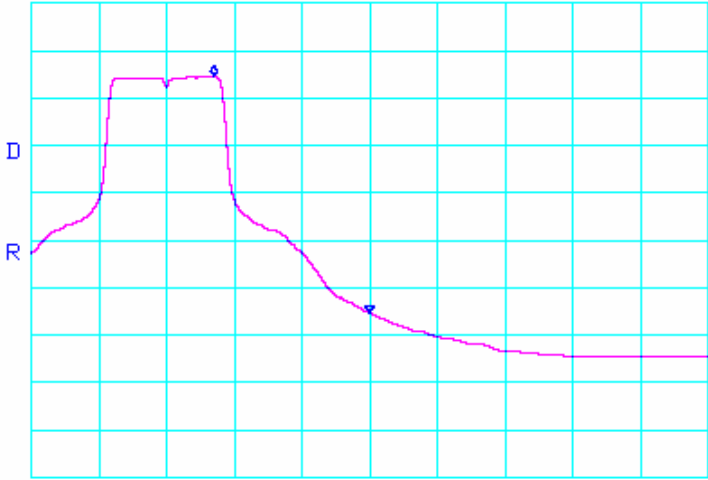
| <i>Test Date</i> | <i>Data</i> | <i>Test Eng.</i> |
|---------------------------------------------------------------------------------------------------------------------------------------------------------------------------------------------------------------------------------------------------------------------------------------------------------------------------------------------------------------------------------------------------------------------------------------------------------|-----------------------------------|------------------|
| 04/05/08 | 5.32 GHz band edge PEAK | RC |
| <div style="display: flex; justify-content: space-between;"> *ATTEN 20dB RL 16.0dBm 10dB/ ΔMKR 43.00dB -24.3MHz </div>  <div style="display: flex; justify-content: space-between; margin-top: 10px;"> CENTER 5.3500GHz *RBW 1.0MHz SPAN 100.0MHz *VBW 1.0MHz SWP 50.0ms </div> | | |
| <i>Test Date</i> | <i>Data</i> | <i>Test Eng.</i> |
| 04/05/08 | 5.32 GHz band edge AVERAGE | RC |
| <div style="display: flex; justify-content: space-between;"> *ATTEN 20dB RL 16.0dBm 10dB/ ΔMKR 50.00dB -23.0MHz </div>  <div style="display: flex; justify-content: space-between; margin-top: 10px;"> CENTER 5.3500GHz *RBW 1.0MHz SPAN 100.0MHz *VBW 10Hz SWP 37.0sec </div> | | |



Radiated Emissions Test Results (Continued)

*Fundamental Measurements in 802.11a mode (5150-5350 MHz)
Channels 36, 40, 48, 52, & 64
Continuous TX at Chain C Antenna port with Ethertronics Antennas
Aegis Labs, Inc. File #: INTEL-081125-53*

| RADIATED EMISSIONS - Horizontal Antenna Polarization | | | | | | | | | | | |
|-------------------------------------------------------------|----------------------|---------------------|-------------------|------------------------|---|-------------------|------------------|--------------------------|---------------|------------------|---------------|
| Freq. (MHz) | Meter Reading (dBuV) | Antenna Height (cm) | Azimuth (degrees) | Quasi pk or AVG (dBuV) | | Cable Factor (dB) | Ant. Factor (dB) | Corrected Reading (dBuV) | Limits (dBuV) | Diff (dB) +=FAIL | Comments |
| 5180.00 | 69.00 | 100 | 225 | | | 3.77 | 34.32 | 107.09 | | | Ch. 36 |
| 5180.00 | | | | 59.33 | A | 3.77 | 34.32 | 97.42 | | | |
| 5200.00 | 69.17 | 100 | 225 | | | 3.78 | 34.34 | 107.29 | | | Ch. 40 |
| 5200.00 | | | | 58.83 | A | 3.78 | 34.34 | 96.95 | | | |
| 5240.00 | 68.83 | 100 | 225 | | | 3.80 | 34.39 | 107.01 | | | Ch. 48 |
| 5240.00 | | | | 58.33 | A | 3.80 | 34.39 | 96.51 | | | |
| 5260.00 | 67.67 | 100 | 315 | | | 3.80 | 34.41 | 105.89 | | | Ch. 52 |
| 5260.00 | | | | 57.67 | A | 3.80 | 34.41 | 95.89 | | | |
| 5320.00 | 67.67 | 100 | 315 | | | 3.83 | 34.48 | 105.98 | | | Ch. 64 |
| 5320.00 | | | | 57.33 | A | 3.83 | 34.48 | 95.64 | | | |

| RADIATED EMISSIONS - Vertical Antenna Polarization | | | | | | | | | | | |
|-----------------------------------------------------------|----------------------|---------------------|-------------------|------------------------|---|-------------------|------------------|--------------------------|---------------|------------------|---------------|
| Freq. (MHz) | Meter Reading (dBuV) | Antenna Height (cm) | Azimuth (degrees) | Quasi pk or AVG (dBuV) | | Cable Factor (dB) | Ant. Factor (dB) | Corrected Reading (dBuV) | Limits (dBuV) | Diff (dB) +=FAIL | Comments |
| 5180.00 | 66.50 | 100 | 315 | | | 3.77 | 34.31 | 104.58 | | | Ch. 36 |
| 5180.00 | | | | 56.67 | A | 3.77 | 34.31 | 94.75 | | | |
| 5200.00 | 66.33 | 100 | 315 | | | 3.78 | 34.32 | 104.43 | | | Ch. 40 |
| 5200.00 | | | | 56.50 | A | 3.78 | 34.32 | 94.60 | | | |
| 5240.00 | 66.83 | 100 | 315 | | | 3.80 | 34.34 | 104.97 | | | Ch. 48 |
| 5240.00 | | | | 56.50 | A | 3.80 | 34.34 | 94.64 | | | |
| 5260.00 | 67.00 | 100 | 90 | | | 3.80 | 34.36 | 105.16 | | | Ch. 52 |
| 5260.00 | | | | 57.50 | A | 3.80 | 34.36 | 95.66 | | | |
| 5320.00 | 67.50 | 100 | 90 | | | 3.83 | 34.39 | 105.72 | | | Ch. 64 |
| 5320.00 | | | | 57.33 | A | 3.83 | 34.39 | 95.55 | | | |

NOTE: Fundamental signals measured to calculate the band edge field strengths using the “Marker Delta Method”.



Radiated Emissions Test Results (Continued)

*Band Edge Field Strength Measurements in 802.11a mode (5150-5350 MHz)
Channels 36 & 64
Continuous TX at Chain C Antenna port with Ethertronics Antennas
Aegis Labs, Inc. File #: INTEL-081125-53*

| RADIATED EMISSIONS - Horizontal Antenna Polarization | | | | | | | | | | |
|------------------------------------------------------|----------------------|---------------------|-------------------|------------------------|-------------------|------------------|--------------------------|---------------|------------------|---------------|
| Freq. (MHz) | Meter Reading (dBuV) | Antenna Height (cm) | Azimuth (degrees) | Quasi pk or AVG (dBuV) | Cable Factor (dB) | Ant. Factor (dB) | Corrected Reading (dBuV) | Limits (dBuV) | Diff (dB) +=FAIL | Comments |
| 5150.00 | | | | | | | 63.09 | 74.00 | -10.91 | Ch. 36 |
| 5150.00 | | | | A | | | 44.42 | 54.00 | -9.58 | |
| 5350.00 | | | | | | | 63.81 | 74.00 | -10.19 | Ch. 64 |
| 5350.00 | | | | A | | | 43.81 | 54.00 | -10.19 | |

| RADIATED EMISSIONS - Vertical Antenna Polarization | | | | | | | | | | |
|----------------------------------------------------|----------------------|---------------------|-------------------|------------------------|-------------------|------------------|--------------------------|---------------|------------------|---------------|
| Freq. (MHz) | Meter Reading (dBuV) | Antenna Height (cm) | Azimuth (degrees) | Quasi pk or AVG (dBuV) | Cable Factor (dB) | Ant. Factor (dB) | Corrected Reading (dBuV) | Limits (dBuV) | Diff (dB) +=FAIL | Comments |
| 5150.00 | | | | | | | 60.58 | 74.00 | -13.42 | Ch. 36 |
| 5150.00 | | | | A | | | 41.75 | 54.00 | -12.25 | |
| 5350.00 | | | | | | | 63.55 | 74.00 | -10.45 | Ch. 64 |
| 5350.00 | | | | A | | | 43.72 | 54.00 | -10.28 | |

NOTE: The “Band Edge Field Strength” was calculated using the “Fundamental” and “Conducted Band Edge” measurements per the “Marker-Delta Method” with the following formula:

$$BE = F_m - \Delta m$$

Where

BE = Band Edge Field Strength

F_m = Measured Fundamental (Peak or Average)

Δ_m = Measured Conducted Band Edge Delta (Peak or Average)

Radiated Emissions Test Results (Continued)

Plots Showing Out-Of-Band Emissions (Peak RBW=VBW=1MHz; Average RBW = 1MHz, VBW = 10Hz)

| <i>Test Date</i> | <i>Data</i> | <i>Test Eng.</i> |
|-----------------------------------------------------------------------------------------------------------------------------------------------------------------------------------------------------------------------------------------------------------------------------------------|-----------------------------------|------------------|
| 04/05/08 | 5.18 GHz band edge PEAK | RC |
| <p>*ATTEN 20dB ΔMKR 44.00dB RL 16.0dBm 10dB/ 34.5MHz</p> <p>CENTER 5.1500GHz SPAN 100.0MHz *RBW 1.0MHz *VBW 1.0MHz SWP 50.0ms</p> | | |
| <i>Test Date</i> | <i>Data</i> | <i>Test Eng.</i> |
| 04/05/08 | 5.18 GHz band edge AVERAGE | RC |
| <p>*ATTEN 20dB ΔMKR 53.00dB RL 16.0dBm 10dB/ 35.5MHz</p> <p>CENTER 5.1500GHz SPAN 100.0MHz *RBW 1.0MHz *VBW 10Hz SWP 37.0sec</p> | | |



Radiated Emissions Test Results (Continued)

Plots Showing Out-Of-Band Emissions (Peak RBW=VBW=1MHz; Average RBW = 1MHz, VBW = 10Hz)

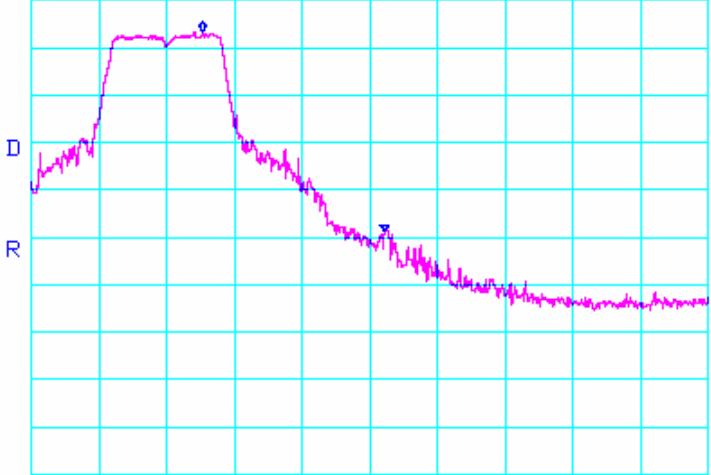
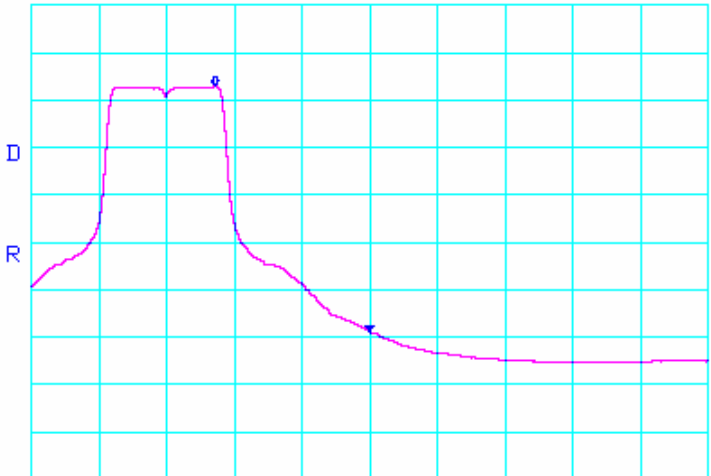
| <i>Test Date</i> | <i>Data</i> | <i>Test Eng.</i> |
|----------------------------------------------------------------------------------------------------------------------------------------------------------------------------------------------------------------------------|-----------------------------------|------------------|
| 04/05/08 | 5.32 GHz band edge PEAK | RC |
| <p>*ATTEN 20dB RL 16.0dBm 10dB/ ΔMKR 42.17dB -26.8MHz</p>  <p>CENTER 5.3500GHz SPAN 100.0MHz *RBW 1.0MHz *VBW 1.0MHz SWP 50.0ms</p> | | |
| <i>Test Date</i> | <i>Data</i> | <i>Test Eng.</i> |
| 04/05/08 | 5.32 GHz band edge AVERAGE | RC |
| <p>*ATTEN 20dB RL 16.0dBm 10dB/ ΔMKR 51.83dB -22.8MHz</p>  <p>CENTER 5.3500GHz SPAN 100.0MHz *RBW 1.0MHz *VBW 10Hz SWP 37.0sec</p> | | |



Radiated Emissions Test Results (Continued)

*Spurious Emissions Measurements in 802.11a mode (5150-5350 MHz)
Channels 36, 40, & 48
Continuous TX at Chain A, B, & C Antenna ports with Ethertronics Antennas
Aegis Labs, Inc. File #: INTEL-081125-45*

| RADIATED EMISSIONS - Horizontal Antenna Polarization | | | | | | | | | | | |
|-------------------------------------------------------------|----------------------|---------------------|-------------------|------------------------|--------------------|-------------------|------------------|--------------------------|---------------|-------------------|-----------------------|
| Freq. (MHz) | Meter Reading (dBuV) | Antenna Height (cm) | Azimuth (degrees) | Quasi pk or AVG (dBuV) | Preamp Factor (dB) | Cable Factor (dB) | Ant. Factor (dB) | Corrected Reading (dBuV) | Limits (dBuV) | Diff (dB) +/-FAIL | Channel/ Chain Tested |
| 3466.66 | 54.17 | 100 | 45 | | 46.62 | 3.06 | 32.79 | 43.40 | 68.00 | -24.60 | Ch. 40/ |
| 6933.33 | 53.67 | 100 | 135 | | 45.05 | 4.40 | 35.69 | 48.71 | 68.00 | -19.29 | A |
| 3466.66 | 54.00 | 100 | 225 | | 46.62 | 3.06 | 32.79 | 43.23 | 68.00 | -24.77 | Ch. 40/ |
| 6933.33 | 54.67 | 100 | 225 | | 45.05 | 4.40 | 35.69 | 49.71 | 68.00 | -18.29 | B |
| 10400.00 | 51.00 | 100 | 225 | | 45.71 | 5.53 | 37.44 | 48.26 | 68.00 | -19.74 | |
| 3466.66 | 53.83 | 100 | 225 | | 46.62 | 3.06 | 32.79 | 43.06 | 68.00 | -24.94 | Ch. 40/ |
| 6933.33 | 56.83 | 100 | 225 | | 45.05 | 4.40 | 35.69 | 51.87 | 68.00 | -16.13 | C |
| 10400.00 | 51.00 | 100 | 225 | | 45.71 | 5.53 | 37.44 | 48.26 | 68.00 | -19.74 | |
| 3453.33 | 53.33 | 100 | 225 | | 46.62 | 3.06 | 32.78 | 42.56 | 68.00 | -25.44 | Ch. 36/ |
| 6906.66 | 59.83 | 100 | 180 | | 45.01 | 4.39 | 35.68 | 54.89 | 68.00 | -13.11 | C |
| 10359.99 | 50.67 | 100 | 225 | | 45.70 | 5.52 | 37.42 | 47.91 | 68.00 | -20.09 | |
| 3493.33 | 53.00 | 100 | 45 | | 46.61 | 3.06 | 32.80 | 42.24 | 68.00 | -25.76 | Ch. 48/ |
| 6986.66 | 55.50 | 100 | 180 | | 45.12 | 4.42 | 35.70 | 50.51 | 68.00 | -17.49 | C |
| 10480.00 | 51.67 | 100 | 45 | | 45.73 | 5.55 | 37.49 | 48.98 | 68.00 | -19.02 | |

| RADIATED EMISSIONS - Vertical Antenna Polarization | | | | | | | | | | | |
|-----------------------------------------------------------|----------------------|---------------------|-------------------|------------------------|--------------------|-------------------|------------------|--------------------------|---------------|-------------------|----------|
| Freq. (MHz) | Meter Reading (dBuV) | Antenna Height (cm) | Azimuth (degrees) | Quasi pk or AVG (dBuV) | Preamp Factor (dB) | Cable Factor (dB) | Ant. Factor (dB) | Corrected Reading (dBuV) | Limits (dBuV) | Diff (dB) +/-FAIL | Comments |
| 3466.66 | 54.50 | 100 | 0 | | 46.62 | 3.06 | 32.88 | 43.82 | 68.00 | -24.18 | Ch. 40/ |
| 6933.33 | 56.00 | 100 | 225 | | 45.05 | 4.40 | 35.60 | 50.95 | 68.00 | -17.05 | A |
| 3466.66 | 54.50 | 100 | 0 | | 46.62 | 3.06 | 32.88 | 43.82 | 68.00 | -24.18 | Ch. 40/ |
| 6933.33 | 58.00 | 100 | 180 | | 45.05 | 4.40 | 35.60 | 52.95 | 68.00 | -15.05 | B |
| 10400.00 | 51.67 | 100 | 135 | | 45.71 | 5.53 | 37.44 | 48.93 | 68.00 | -19.07 | |
| 3466.66 | 54.83 | 100 | 45 | | 46.62 | 3.06 | 32.88 | 44.15 | 68.00 | -23.85 | Ch. 40/ |
| 6933.33 | 56.17 | 100 | 180 | | 45.05 | 4.40 | 35.60 | 51.12 | 68.00 | -16.88 | C |
| 10400.00 | 50.50 | 100 | 180 | | 45.71 | 5.53 | 37.44 | 47.76 | 68.00 | -20.24 | |
| 3453.33 | 52.67 | 100 | 225 | | 46.62 | 3.06 | 32.87 | 41.99 | 68.00 | -26.01 | Ch. 36/ |
| 6906.66 | 56.50 | 100 | 180 | | 45.01 | 4.39 | 35.60 | 51.48 | 68.00 | -16.52 | B |
| 10359.99 | 50.83 | 100 | 180 | | 45.70 | 5.52 | 37.42 | 48.07 | 68.00 | -19.93 | |
| 3493.33 | 53.83 | 100 | 225 | | 46.61 | 3.06 | 32.90 | 43.17 | 68.00 | -24.83 | Ch. 48/ |
| 6986.66 | 55.83 | 100 | 90 | | 45.12 | 4.42 | 35.60 | 50.74 | 68.00 | -17.26 | B |
| 10480.00 | 51.17 | 100 | 315 | | 45.73 | 5.55 | 37.49 | 48.48 | 68.00 | -19.52 | |



Radiated Emissions Test Results (Continued)

*Spurious Emissions Measurements in 802.11a mode (5150-5350 MHz)
Channels 36, 40, & 48
Continuous TX at Chain A, B, & C Antenna ports with Wistron Neweb Corp. Antennas
Aegis Labs, Inc. File #: INTEL-081125-74*

RADIATED EMISSIONS - Horizontal Antenna Polarization

| Freq. (MHz) | Meter Reading (dBuV) | Antenna Height (cm) | Azimuth (degrees) | Quasi pk or AVG (dBuV) | Preamp Factor (dB) | Cable Factor (dB) | Ant. Factor (dB) | Corrected Reading (dBuV) | Limits (dBuV) | Diff (dB) +/-FAIL | Channel/Chain Tested |
|-------------|----------------------|---------------------|-------------------|------------------------|--------------------|-------------------|------------------|--------------------------|---------------|-------------------|----------------------|
| 3466.66 | 59.33 | 100 | 0 | | 46.60 | 2.42 | 32.01 | 47.16 | 68.00 | -20.84 | Ch. 40/ |
| 6933.33 | 60.33 | 100 | 225 | | 45.15 | 3.48 | 34.89 | 53.55 | 68.00 | -14.45 | A |
| 3466.66 | 59.50 | 100 | 0 | | 46.60 | 2.42 | 32.01 | 47.33 | 68.00 | -20.67 | Ch. 40/ |
| 6933.33 | 59.83 | 100 | 0 | | 45.15 | 3.48 | 34.89 | 53.05 | 68.00 | -14.95 | B |
| 10400.00 | 56.17 | 100 | 315 | | 44.48 | 4.40 | 36.44 | 52.54 | 68.00 | -15.46 | |
| 3466.66 | 60.33 | 100 | 45 | | 46.60 | 2.42 | 32.01 | 48.16 | 68.00 | -19.84 | Ch. 40/ |
| 6933.33 | 63.00 | 100 | 270 | | 45.15 | 3.48 | 34.89 | 56.22 | 68.00 | -11.78 | C |
| 10400.00 | 57.17 | 100 | 315 | | 44.48 | 4.40 | 36.44 | 53.54 | 68.00 | -14.46 | |
| 3453.33 | 58.83 | 100 | 0 | | 46.60 | 2.41 | 32.02 | 46.66 | 68.00 | -21.34 | Ch. 36/ |
| 6906.66 | 64.33 | 100 | 225 | | 45.19 | 3.47 | 34.88 | 57.49 | 68.00 | -10.51 | C |
| 10359.99 | 56.17 | 100 | 0 | | 44.47 | 4.39 | 36.42 | 52.50 | 68.00 | -15.50 | |
| 3493.33 | 59.67 | 100 | 90 | | 46.60 | 2.43 | 32.00 | 47.50 | 68.00 | -20.50 | Ch. 48/ |
| 6986.66 | 60.00 | 100 | 225 | | 45.07 | 3.50 | 34.90 | 53.33 | 68.00 | -14.67 | C |

RADIATED EMISSIONS - Vertical Antenna Polarization

| Freq. (MHz) | Meter Reading (dBuV) | Antenna Height (cm) | Azimuth (degrees) | Quasi pk or AVG (dBuV) | Preamp Factor (dB) | Cable Factor (dB) | Ant. Factor (dB) | Corrected Reading (dBuV) | Limits (dBuV) | Diff (dB) +/-FAIL | Comments |
|-------------|----------------------|---------------------|-------------------|------------------------|--------------------|-------------------|------------------|--------------------------|---------------|-------------------|----------|
| 3466.66 | 62.00 | 100 | 45 | | 46.60 | 2.42 | 30.72 | 48.54 | 68.00 | -19.46 | Ch. 40/ |
| 6933.33 | 61.83 | 100 | 90 | | 45.15 | 3.48 | 33.97 | 54.13 | 68.00 | -13.87 | A |
| 10400.00 | 58.33 | 100 | 0 | | 44.48 | 4.40 | 35.82 | 54.08 | 68.00 | -13.92 | |
| 3466.66 | 62.17 | 100 | 0 | | 46.60 | 2.42 | 30.72 | 48.71 | 68.00 | -19.29 | Ch. 40/ |
| 6933.33 | 61.17 | 100 | 135 | | 45.15 | 3.48 | 33.97 | 53.47 | 68.00 | -14.53 | B |
| 10400.00 | 57.17 | 100 | 0 | | 44.48 | 4.40 | 35.82 | 52.92 | 68.00 | -15.08 | |
| 3466.66 | 61.50 | 100 | 0 | | 46.60 | 2.42 | 30.72 | 48.04 | 68.00 | -19.96 | Ch. 40/ |
| 6933.33 | 64.00 | 100 | 0 | | 45.15 | 3.48 | 33.97 | 56.30 | 68.00 | -11.70 | C |
| 10400.00 | 60.50 | 100 | 315 | | 44.48 | 4.40 | 35.82 | 56.25 | 68.00 | -11.75 | |
| 3453.33 | 60.67 | 100 | 0 | | 46.60 | 2.41 | 30.73 | 47.21 | 68.00 | -20.79 | Ch. 36/ |
| 6906.66 | 65.33 | 100 | 180 | | 45.19 | 3.47 | 33.96 | 57.57 | 68.00 | -10.43 | C |
| 10359.99 | 59.00 | 100 | 315 | | 44.47 | 4.39 | 35.79 | 54.71 | 68.00 | -13.29 | |
| 3493.33 | 60.83 | 100 | 315 | | 46.60 | 2.43 | 30.70 | 47.36 | 68.00 | -20.64 | Ch. 48/ |
| 6986.66 | 61.33 | 100 | 180 | | 45.07 | 3.50 | 33.99 | 53.76 | 68.00 | -14.24 | C |
| 10480.00 | 58.50 | 100 | 315 | | 44.49 | 4.43 | 35.88 | 54.33 | 68.00 | -13.67 | |



Radiated Emissions Test Results (Continued)

*Spurious Emissions Measurements in 802.11a mode (5150-5350 MHz)
Channels 52, 56, & 64
Continuous TX at Chain A, B, & C Antenna ports with Ethertronics Antennas
Aegis Labs, Inc. File #: INTEL-081125-45*

| RADIATED EMISSIONS - Horizontal Antenna Polarization | | | | | | | | | | | | |
|-------------------------------------------------------------|----------------------|---------------------|-------------------|------------------------|---|--------------------|-------------------|------------------|--------------------------|---------------|-------------------|-----------------------|
| Freq. (MHz) | Meter Reading (dBuV) | Antenna Height (cm) | Azimuth (degrees) | Quasi pk or AVG (dBuV) | | Preamp Factor (dB) | Cable Factor (dB) | Ant. Factor (dB) | Corrected Reading (dBuV) | Limits (dBuV) | Diff (dB) +/-FAIL | Channel/ Chain Tested |
| 3520.00 | 54.00 | 100 | 45 | | | 46.61 | 3.08 | 32.82 | 43.30 | 68.00 | -24.70 | Ch. 56/ |
| 7040.00 | 52.83 | 100 | 270 | | | 45.12 | 4.44 | 35.72 | 47.87 | 68.00 | -20.13 | A |
| 10560.00 | 50.17 | 100 | 270 | | | 45.67 | 5.57 | 37.55 | 47.62 | 68.00 | -20.38 | |
| 3520.00 | 54.17 | 100 | 225 | | | 46.61 | 3.08 | 32.82 | 43.47 | 68.00 | -24.53 | Ch. 56/ |
| 7040.00 | 53.50 | 100 | 225 | | | 45.12 | 4.44 | 35.72 | 48.54 | 68.00 | -19.46 | B |
| 10560.00 | 52.17 | 100 | 180 | | | 45.67 | 5.57 | 37.55 | 49.62 | 68.00 | -18.38 | |
| 3520.00 | 54.00 | 100 | 225 | | | 46.61 | 3.08 | 32.82 | 43.30 | 68.00 | -24.70 | Ch. 56/ |
| 7040.00 | 53.50 | 100 | 225 | | | 45.12 | 4.44 | 35.72 | 48.54 | 68.00 | -19.46 | C |
| 10560.00 | 51.83 | 100 | 225 | | | 45.67 | 5.57 | 37.55 | 49.28 | 68.00 | -18.72 | |
| 3506.66 | 54.17 | 100 | 225 | | | 46.61 | 3.07 | 32.81 | 43.43 | 68.00 | -24.57 | Ch. 52/ |
| 7013.32 | 53.83 | 100 | 225 | | | 45.13 | 4.43 | 35.71 | 48.84 | 68.00 | -19.16 | B |
| 10519.98 | 51.33 | 100 | 180 | | | 45.71 | 5.56 | 37.52 | 48.70 | 68.00 | -19.30 | |
| 3546.66 | 54.67 | 100 | 225 | | | 46.61 | 3.12 | 32.86 | 44.04 | 68.00 | -23.96 | Ch. 64/ |
| 7093.32 | 52.83 | 100 | 225 | | | 45.11 | 4.46 | 35.76 | 47.94 | 68.00 | -20.06 | B |
| 10639.98 | 50.50 | 100 | 180 | | | 45.58 | 5.59 | 37.61 | 48.11 | 74.00 | -25.89 | |
| 10639.98 | | | | 40.01 | A | 45.58 | 5.59 | 37.61 | 37.62 | 54.00 | -16.38 | |

| RADIATED EMISSIONS - Vertical Antenna Polarization | | | | | | | | | | | | |
|-----------------------------------------------------------|----------------------|---------------------|-------------------|------------------------|---|--------------------|-------------------|------------------|--------------------------|---------------|-------------------|----------|
| Freq. (MHz) | Meter Reading (dBuV) | Antenna Height (cm) | Azimuth (degrees) | Quasi pk or AVG (dBuV) | | Preamp Factor (dB) | Cable Factor (dB) | Ant. Factor (dB) | Corrected Reading (dBuV) | Limits (dBuV) | Diff (dB) +/-FAIL | Comments |
| 3520.00 | 54.33 | 100 | 0 | | | 46.61 | 3.08 | 32.92 | 43.72 | 68.00 | -24.28 | Ch. 56/ |
| 7040.00 | 55.83 | 100 | 135 | | | 45.12 | 4.44 | 35.64 | 50.79 | 68.00 | -17.21 | A |
| 10560.00 | 51.67 | 100 | 180 | | | 45.67 | 5.57 | 37.55 | 49.12 | 68.00 | -18.88 | |
| 3520.00 | 55.33 | 100 | 45 | | | 46.61 | 3.08 | 32.92 | 44.72 | 68.00 | -23.28 | Ch. 56/ |
| 7040.00 | 55.50 | 100 | 180 | | | 45.12 | 4.44 | 35.64 | 50.46 | 68.00 | -17.54 | B |
| 10560.00 | 51.83 | 100 | 135 | | | 45.67 | 5.57 | 37.55 | 49.28 | 68.00 | -18.72 | |
| 3520.00 | 53.67 | 100 | 0 | | | 46.61 | 3.08 | 32.92 | 43.06 | 68.00 | -24.94 | Ch. 56/ |
| 7040.00 | 53.50 | 100 | 135 | | | 45.12 | 4.44 | 35.64 | 48.46 | 68.00 | -19.54 | C |
| 10560.00 | 51.17 | 100 | 135 | | | 45.67 | 5.57 | 37.55 | 48.62 | 68.00 | -19.38 | |
| 3506.66 | 54.00 | 100 | 180 | | | 46.61 | 3.07 | 32.91 | 43.36 | 68.00 | -24.64 | Ch. 52/ |
| 7013.32 | 58.00 | 100 | 180 | | | 45.13 | 4.43 | 35.61 | 52.92 | 68.00 | -15.08 | A |
| 10520.00 | 51.83 | 100 | 135 | | | 45.71 | 5.56 | 37.52 | 49.20 | 68.00 | -18.80 | |
| 3546.66 | 54.33 | 100 | 225 | | | 46.61 | 3.12 | 32.95 | 43.79 | 68.00 | -24.21 | Ch. 64/ |
| 7093.32 | 55.33 | 100 | 180 | | | 45.11 | 4.46 | 35.69 | 50.37 | 68.00 | -17.63 | A |
| 10640.00 | 50.67 | 100 | 135 | | | 45.58 | 5.59 | 37.61 | 48.28 | 74.00 | -25.72 | |
| 10640.00 | | | | 40.36 | A | 45.58 | 5.59 | 37.61 | 37.97 | 54.00 | -16.03 | |



Radiated Emissions Test Results (Continued)

Spurious Emissions Measurements in 802.11a mode (5150-5350 MHz)
Channels 52, 56, & 64
Continuous TX at Chain A, B, & C Antenna ports with Wistron Neweb Corp. Antennas
Aegis Labs, Inc. File #: INTEL-081125-74

RADIATED EMISSIONS - Horizontal Antenna Polarization

| Freq. (MHz) | Meter Reading (dBuV) | Antenna Height (cm) | Azimuth (degrees) | Quasi pk or AVG (dBuV) | Preamp Factor (dB) | Cable Factor (dB) | Ant. Factor (dB) | Corrected Reading (dBuV) | Limits (dBuV) | Diff (dB) +=FAIL | Channel/ Chain Tested |
|-------------|----------------------|---------------------|-------------------|------------------------|--------------------|-------------------|------------------|--------------------------|---------------|------------------|-----------------------|
| 3520.00 | 60.50 | 100 | 270 | | 46.59 | 2.44 | 32.04 | 48.38 | 68.00 | -19.62 | Ch. 56/ |
| 7040.00 | 59.67 | 100 | 315 | | 45.03 | 3.51 | 34.91 | 53.06 | 68.00 | -14.94 | A |
| 10560.00 | 56.33 | 100 | 0 | | 44.57 | 4.45 | 36.49 | 52.69 | 68.00 | -15.31 | |
| 3520.00 | 61.33 | 100 | 0 | | 46.59 | 2.44 | 32.04 | 49.21 | 68.00 | -18.79 | Ch. 56/ |
| 7040.00 | 59.00 | 100 | 315 | | 45.03 | 3.51 | 34.91 | 52.39 | 68.00 | -15.61 | B |
| 10560.00 | 56.33 | 100 | 0 | | 44.57 | 4.45 | 36.49 | 52.69 | 68.00 | -15.31 | |
| 3520.00 | 61.17 | 100 | 315 | | 46.59 | 2.44 | 32.04 | 49.05 | 68.00 | -18.95 | Ch. 56/ |
| 7040.00 | 59.00 | 100 | 0 | | 45.03 | 3.51 | 34.91 | 52.39 | 68.00 | -15.61 | C |
| 10560.00 | 56.50 | 100 | 270 | | 44.57 | 4.45 | 36.49 | 52.86 | 68.00 | -15.14 | |
| 3506.66 | 60.83 | 100 | 90 | | 46.60 | 2.43 | 32.01 | 48.68 | 68.00 | -19.32 | Ch. 52/ |
| 7013.32 | 60.00 | 100 | 0 | | 45.04 | 3.51 | 34.90 | 53.37 | 68.00 | -14.63 | B |
| 3546.66 | 60.17 | 100 | 270 | | 46.59 | 2.45 | 32.09 | 48.12 | 68.00 | -19.88 | Ch. 64/ |
| 7093.32 | 58.33 | 100 | 315 | | 45.01 | 3.53 | 34.92 | 51.77 | 68.00 | -16.23 | B |

RADIATED EMISSIONS - Vertical Antenna Polarization

| Freq. (MHz) | Meter Reading (dBuV) | Antenna Height (cm) | Azimuth (degrees) | Quasi pk or AVG (dBuV) | Preamp Factor (dB) | Cable Factor (dB) | Ant. Factor (dB) | Corrected Reading (dBuV) | Limits (dBuV) | Diff (dB) +=FAIL | Comments |
|-------------|----------------------|---------------------|-------------------|------------------------|--------------------|-------------------|------------------|--------------------------|---------------|------------------|----------|
| 3520.00 | 61.33 | 100 | 0 | | 46.59 | 2.44 | 30.74 | 47.92 | 68.00 | -20.08 | Ch. 56/ |
| 7040.00 | 61.50 | 100 | 90 | | 45.03 | 3.51 | 34.01 | 53.99 | 68.00 | -14.01 | A |
| 10560.00 | 56.83 | 100 | 0 | | 44.57 | 4.45 | 35.91 | 52.62 | 68.00 | -15.38 | |
| 3520.00 | 62.50 | 100 | 45 | | 46.59 | 2.44 | 30.74 | 49.09 | 68.00 | -18.91 | Ch. 56/ |
| 7040.00 | 61.00 | 100 | 270 | | 45.03 | 3.51 | 34.01 | 53.49 | 68.00 | -14.51 | B |
| 10560.00 | 56.50 | 100 | 0 | | 44.57 | 4.45 | 35.91 | 52.29 | 68.00 | -15.71 | |
| 3520.00 | 61.33 | 100 | 270 | | 46.59 | 2.44 | 30.74 | 47.92 | 68.00 | -20.08 | Ch. 56/ |
| 7040.00 | 60.00 | 100 | 90 | | 45.03 | 3.51 | 34.01 | 52.49 | 68.00 | -15.51 | C |
| 10560.00 | 56.67 | 100 | 0 | | 44.57 | 4.45 | 35.91 | 52.46 | 68.00 | -15.54 | |
| 3506.66 | 60.67 | 100 | 45 | | 46.60 | 2.43 | 30.71 | 47.22 | 68.00 | -20.78 | Ch. 52/ |
| 7013.32 | 61.50 | 100 | 90 | | 45.04 | 3.51 | 34.00 | 53.97 | 68.00 | -14.03 | A |
| 10520.00 | 57.33 | 100 | 0 | | 44.52 | 4.44 | 35.90 | 53.16 | 68.00 | -14.84 | |
| 3546.66 | 61.83 | 100 | 270 | | 46.59 | 2.45 | 30.80 | 48.49 | 68.00 | -19.51 | Ch. 64/ |
| 7093.32 | 62.50 | 100 | 315 | | 45.01 | 3.53 | 34.02 | 55.04 | 68.00 | -12.96 | A |

**RADIATED EMISSIONS TEST RESULTS**

| | | | |
|-----------------------|---------------------------------------------------------------------------------------------------------------------------------------|------------------------|--------------|
| CLIENT: | Intel Corporation | DATE: | 04/08/08 |
| EUT: | Intel WiFi Link 5300 | PROJECT NUMBER: | INTEL-081125 |
| MODEL NUMBER: | 533AN_HMW | TEST ENGINEER: | KN/RC |
| SERIAL NUMBER: | 0016EA038A16 | SITE #: | 2 |
| CONFIGURATION: | Tested installed in an extender board connected to the host laptop's mini PCI slot in 802.11n (5150-5350 MHz) mode 20MHz Wide. | TEMPERATURE: | 22° C |
| | | HUMIDITY: | 39% RH |
| | | TIME: | 8:00 AM |

| | |
|---------------------|---------------------------------------------------------------------------------------------------------------------------------------------------------------------------------------------|
| Description: | Radiated RF Emissions (1 GHz – 18 GHz) |
| Results: | PASSED Horizontal and Vertical Antenna Polarizations Class B Limits |
| Note: | Radiated Emissions Measurements were performed on the EUT with power supply set at the following voltage and frequency. <ul style="list-style-type: none"> • 120VAC / 60 Hz. |

| Unwanted Spurious Emissions Limits | | | |
|-------------------------------------------|------------------------------|------------------------------------------------------------------------|------------------------------------------------------------------------------|
| Frequency (MHz) | Field Strength (uV/m) | Field Strength (dBuV/m) (Emissions in the restricted bands) | Field Strength (dBm/MHz) (Emissions outside the restricted bands) |
| Above 960 | 500 | 54.00 (Average) 74.00 (Peak) | < -20 dBc |

Radiated Emissions Sample Calculations

$$\text{Corrected Meter Reading} = \text{Meter Reading} + F + C - D$$

Where, F = Antenna Factor

C = Cable Factor

G = Amplifier Gain

D = Distance Factor (if applicable)

Therefore, the equation for determining the Corrected Meter Reading Limit (CML) is:

$$\text{CML} = \text{Specification Limit} - F - C + D$$



Radiated Emissions Test Results (Continued)

*Fundamental Measurements in 802.11n mode 20MHz Wide (5150-5350 MHz)
 Channels 36, 40, 48, 52, & 64
 Continuous TX at Chain A Antenna port with Ethertronics Antennas
 Aegis Labs, Inc. File #: INTEL-081125-51*

| RADIATED EMISSIONS - Horizontal Antenna Polarization | | | | | | | | | | | |
|-------------------------------------------------------------|----------------------|---------------------|-------------------|------------------------|---|-------------------|------------------|--------------------------|---------------|------------------|---------------|
| Freq. (MHz) | Meter Reading (dBuV) | Antenna Height (cm) | Azimuth (degrees) | Quasi pk or AVG (dBuV) | | Cable Factor (dB) | Ant. Factor (dB) | Corrected Reading (dBuV) | Limits (dBuV) | Diff (dB) +=FAIL | Comments |
| 5180.00 | 63.83 | 100 | 135 | | | 3.77 | 34.32 | 101.92 | | | Ch. 36 |
| 5180.00 | | | | 53.83 | A | 3.77 | 34.32 | 91.92 | | | |
| 5200.00 | 63.33 | 100 | 135 | | | 3.78 | 34.34 | 101.45 | | | Ch. 40 |
| 5200.00 | | | | 53.33 | A | 3.78 | 34.34 | 91.45 | | | |
| 5240.00 | 64.17 | 100 | 135 | | | 3.80 | 34.39 | 102.35 | | | Ch. 48 |
| 5240.00 | | | | 54.17 | A | 3.80 | 34.39 | 92.35 | | | |
| 5260.00 | 64.50 | 100 | 135 | | | 3.80 | 34.41 | 102.72 | | | Ch. 52 |
| 5260.00 | | | | 54.17 | A | 3.80 | 34.41 | 92.39 | | | |
| 5320.00 | 64.33 | 100 | 135 | | | 3.83 | 34.48 | 102.64 | | | Ch. 64 |
| 5320.00 | | | | 53.83 | A | 3.83 | 34.48 | 92.14 | | | |

| RADIATED EMISSIONS - Vertical Antenna Polarization | | | | | | | | | | | |
|-----------------------------------------------------------|----------------------|---------------------|-------------------|------------------------|---|-------------------|------------------|--------------------------|---------------|------------------|---------------|
| Freq. (MHz) | Meter Reading (dBuV) | Antenna Height (cm) | Azimuth (degrees) | Quasi pk or AVG (dBuV) | | Cable Factor (dB) | Ant. Factor (dB) | Corrected Reading (dBuV) | Limits (dBuV) | Diff (dB) +=FAIL | Comments |
| 5180.00 | 63.17 | 100 | 225 | | | 3.77 | 34.31 | 101.25 | | | Ch. 36 |
| 5180.00 | | | | 52.67 | A | 3.77 | 34.31 | 90.75 | | | |
| 5200.00 | 63.00 | 100 | 225 | | | 3.78 | 34.32 | 101.10 | | | Ch. 40 |
| 5200.00 | | | | 53.17 | A | 3.78 | 34.32 | 91.27 | | | |
| 5240.00 | 64.00 | 100 | 225 | | | 3.80 | 34.34 | 102.14 | | | Ch. 48 |
| 5240.00 | | | | 53.83 | A | 3.80 | 34.34 | 91.97 | | | |
| 5260.00 | 65.00 | 100 | 225 | | | 3.80 | 34.36 | 103.16 | | | Ch. 52 |
| 5260.00 | | | | 54.50 | A | 3.80 | 34.36 | 92.66 | | | |
| 5320.00 | 65.17 | 100 | 135 | | | 3.83 | 34.39 | 103.39 | | | Ch. 64 |
| 5320.00 | | | | 55.00 | A | 3.83 | 34.39 | 93.22 | | | |

NOTE: Fundamental signals measured to calculate the band edge field strengths using the “Marker Delta Method”.



Radiated Emissions Test Results (Continued)

*Band Edge Field Strength Measurements in 802.11n mode 20MHz Wide (5150-5350 MHz)
Channels 36 & 64
Continuous TX at Chain A Antenna port with Ethertronics Antennas
Aegis Labs, Inc. File #: INTEL-081125-51*

| RADIATED EMISSIONS - Horizontal Antenna Polarization | | | | | | | | | | |
|-------------------------------------------------------------|----------------------|---------------------|-------------------|------------------------|-------------------|------------------|--------------------------|---------------|------------------|---------------|
| Freq. (MHz) | Meter Reading (dBuV) | Antenna Height (cm) | Azimuth (degrees) | Quasi pk or AVG (dBuV) | Cable Factor (dB) | Ant. Factor (dB) | Corrected Reading (dBuV) | Limits (dBuV) | Diff (dB) +=FAIL | Comments |
| 5150.00 | | | | | | | 57.25 | 74.00 | -16.75 | Ch. 36 |
| 5150.00 | | | | A | | | 39.42 | 54.00 | -14.58 | |
| 5350.00 | | | | | | | 58.80 | 74.00 | -15.20 | Ch. 64 |
| 5350.00 | | | | A | | | 39.48 | 54.00 | -14.52 | |

| RADIATED EMISSIONS - Vertical Antenna Polarization | | | | | | | | | | |
|-----------------------------------------------------------|----------------------|---------------------|-------------------|------------------------|-------------------|------------------|--------------------------|---------------|------------------|---------------|
| Freq. (MHz) | Meter Reading (dBuV) | Antenna Height (cm) | Azimuth (degrees) | Quasi pk or AVG (dBuV) | Cable Factor (dB) | Ant. Factor (dB) | Corrected Reading (dBuV) | Limits (dBuV) | Diff (dB) +=FAIL | Comments |
| 5150.00 | | | | | | | 56.58 | 74.00 | -17.42 | Ch. 36 |
| 5150.00 | | | | A | | | 38.25 | 54.00 | -15.75 | |
| 5350.00 | | | | | | | 59.55 | 74.00 | -14.45 | Ch. 64 |
| 5350.00 | | | | A | | | 40.56 | 54.00 | -13.44 | |

NOTE: The “Band Edge Field Strength” was calculated using the “Fundamental” and “Conducted Band Edge” measurements per the “Marker-Delta Method” with the following formula:

$$BE = Fm - \Delta m$$

Where

BE = Band Edge Field Strength

Fm = Measured Fundamental (Peak or Average)

Δm = Measured Conducted Band Edge Delta (Peak or Average)



Radiated Emissions Test Results (Continued)

Plots Showing Out-Of-Band Emissions (Peak RBW=VBW=1MHz; Average RBW = 1MHz, VBW = 10Hz)

| <i>Test Date</i> | <i>Data</i> | <i>Test Eng.</i> |
|------------------|--------------------------------|------------------|
| 04/05/08 | 5.18 GHz band edge PEAK | RC |

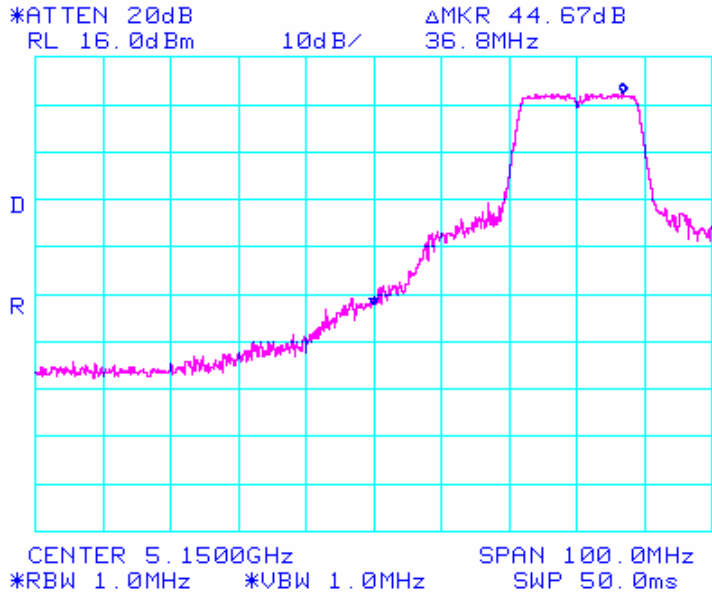

| <i>Test Date</i> | <i>Data</i> | <i>Test Eng.</i> |
|------------------|-----------------------------------|------------------|
| 04/05/08 | 5.18 GHz band edge AVERAGE | RC |

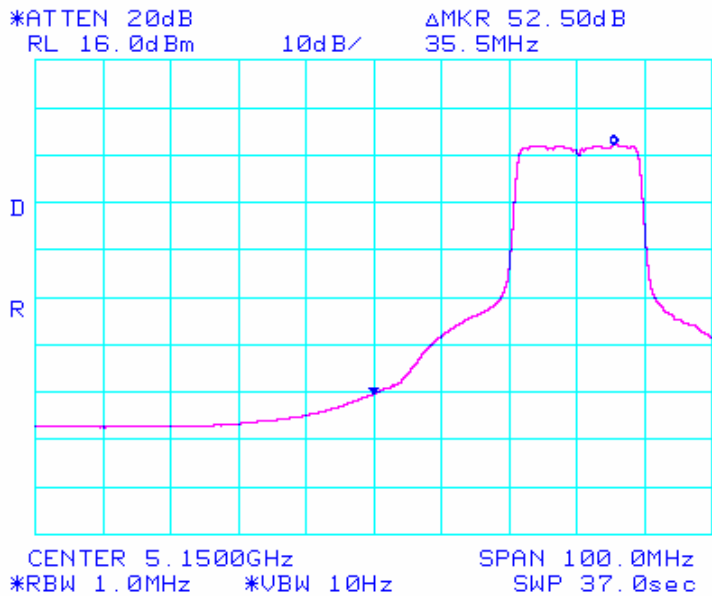



Radiated Emissions Test Results (Continued)

Plots Showing Out-Of-Band Emissions (Peak RBW=VBW=1MHz; Average RBW = 1MHz, VBW = 10Hz)

| <i>Test Date</i> | <i>Data</i> | <i>Test Eng.</i> |
|----------------------------------------------------------------------------------------------------------------------------------------------------------------------------|-----------------------------------|------------------|
| 04/05/08 | 5.32 GHz band edge PEAK | RC |
| <p>*ATTEN 20dB ΔMKR 43.84dB RL 16.0dBm 10dB/ -24.7MHz</p> <p>CENTER 5.3500GHz SPAN 100.0MHz *RBW 1.0MHz *VBW 1.0MHz SWP 50.0ms</p> | | |
| <i>Test Date</i> | <i>Data</i> | <i>Test Eng.</i> |
| 04/05/08 | 5.32 GHz band edge AVERAGE | RC |
| <p>*ATTEN 20dB ΔMKR 52.66dB RL 16.0dBm 10dB/ -27.0MHz</p> <p>CENTER 5.3500GHz SPAN 100.0MHz *RBW 1.0MHz *VBW 10Hz SWP 37.0sec</p> | | |



Radiated Emissions Test Results (Continued)

*Fundamental Measurements in 802.11n mode 20MHz Wide (5150-5350 MHz)
 Channels 36, 40, 48, 52, & 64
 Continuous TX at Chain B Antenna port with Ethertronics Antennas
 Aegis Labs, Inc. File #: INTEL-081125-52*

| RADIATED EMISSIONS - Horizontal Antenna Polarization | | | | | | | | | | | |
|-------------------------------------------------------------|----------------------|---------------------|-------------------|------------------------|---|-------------------|------------------|--------------------------|---------------|------------------|---------------|
| Freq. (MHz) | Meter Reading (dBuV) | Antenna Height (cm) | Azimuth (degrees) | Quasi pk or AVG (dBuV) | | Cable Factor (dB) | Ant. Factor (dB) | Corrected Reading (dBuV) | Limits (dBuV) | Diff (dB) +=FAIL | Comments |
| 5180.00 | 64.17 | 100 | 225 | | | 3.77 | 34.32 | 102.26 | | | Ch. 36 |
| 5180.00 | | | | 53.50 | A | 3.77 | 34.32 | 91.59 | | | |
| 5200.00 | 64.67 | 100 | 225 | | | 3.78 | 34.34 | 102.79 | | | Ch. 40 |
| 5200.00 | | | | 55.33 | A | 3.78 | 34.34 | 93.45 | | | |
| 5240.00 | 65.17 | 100 | 225 | | | 3.80 | 34.39 | 103.35 | | | Ch. 48 |
| 5240.00 | | | | 55.17 | A | 3.80 | 34.39 | 93.35 | | | |
| 5260.00 | 64.83 | 100 | 225 | | | 3.80 | 34.41 | 103.05 | | | Ch. 52 |
| 5260.00 | | | | 54.83 | A | 3.80 | 34.41 | 93.05 | | | |
| 5320.00 | 66.00 | 100 | 225 | | | 3.83 | 34.48 | 104.31 | | | Ch. 64 |
| 5320.00 | | | | 55.50 | A | 3.83 | 34.48 | 93.81 | | | |

| RADIATED EMISSIONS - Vertical Antenna Polarization | | | | | | | | | | | |
|-----------------------------------------------------------|----------------------|---------------------|-------------------|------------------------|---|-------------------|------------------|--------------------------|---------------|------------------|---------------|
| Freq. (MHz) | Meter Reading (dBuV) | Antenna Height (cm) | Azimuth (degrees) | Quasi pk or AVG (dBuV) | | Cable Factor (dB) | Ant. Factor (dB) | Corrected Reading (dBuV) | Limits (dBuV) | Diff (dB) +=FAIL | Comments |
| 5180.00 | 62.17 | 100 | 225 | | | 3.77 | 34.31 | 100.25 | | | Ch. 36 |
| 5180.00 | | | | 52.33 | A | 3.77 | 34.31 | 90.41 | | | |
| 5200.00 | 63.83 | 100 | 225 | | | 3.78 | 34.32 | 101.93 | | | Ch. 40 |
| 5200.00 | | | | 53.00 | A | 3.78 | 34.32 | 91.10 | | | |
| 5240.00 | 63.83 | 100 | 135 | | | 3.80 | 34.34 | 101.97 | | | Ch. 48 |
| 5240.00 | | | | 53.17 | A | 3.80 | 34.34 | 91.31 | | | |
| 5260.00 | 64.67 | 100 | 135 | | | 3.80 | 34.36 | 102.83 | | | Ch. 52 |
| 5260.00 | | | | 54.50 | A | 3.80 | 34.36 | 92.66 | | | |
| 5320.00 | 65.50 | 100 | 135 | | | 3.83 | 34.39 | 103.72 | | | Ch. 64 |
| 5320.00 | | | | 55.67 | A | 3.83 | 34.39 | 93.89 | | | |

NOTE: Fundamental signals measured to calculate the band edge field strengths using the “Marker Delta Method”.



Radiated Emissions Test Results (Continued)

*Band Edge Field Strength Measurements in 802.11n mode 20MHz Wide (5150-5350 MHz)
Channels 36 & 64
Continuous TX at Chain B Antenna port with Ethertronics Antennas
Aegis Labs, Inc. File #: INTEL-081125-52*

| RADIATED EMISSIONS - Horizontal Antenna Polarization | | | | | | | | | | |
|------------------------------------------------------|----------------------|---------------------|-------------------|------------------------|-------------------|------------------|--------------------------|---------------|------------------|---------------|
| Freq. (MHz) | Meter Reading (dBuV) | Antenna Height (cm) | Azimuth (degrees) | Quasi pk or AVG (dBuV) | Cable Factor (dB) | Ant. Factor (dB) | Corrected Reading (dBuV) | Limits (dBuV) | Diff (dB) +=FAIL | Comments |
| 5150.00 | | | | | | | 57.43 | 74.00 | -16.57 | Ch. 36 |
| 5150.00 | | | | | A | | 39.09 | 54.00 | -14.91 | |
| 5350.00 | | | | | | | 61.97 | 74.00 | -12.03 | Ch. 64 |
| 5350.00 | | | | | A | | 40.81 | 54.00 | -13.19 | |

| RADIATED EMISSIONS - Vertical Antenna Polarization | | | | | | | | | | |
|----------------------------------------------------|----------------------|---------------------|-------------------|------------------------|-------------------|------------------|--------------------------|---------------|------------------|---------------|
| Freq. (MHz) | Meter Reading (dBuV) | Antenna Height (cm) | Azimuth (degrees) | Quasi pk or AVG (dBuV) | Cable Factor (dB) | Ant. Factor (dB) | Corrected Reading (dBuV) | Limits (dBuV) | Diff (dB) +=FAIL | Comments |
| 5150.00 | | | | | | | 55.42 | 74.00 | -18.58 | Ch. 36 |
| 5150.00 | | | | | A | | 37.91 | 54.00 | -16.09 | |
| 5350.00 | | | | | | | 61.38 | 74.00 | -12.62 | Ch. 64 |
| 5350.00 | | | | | A | | 40.89 | 54.00 | -13.11 | |

NOTE: The “Band Edge Field Strength” was calculated using the “Fundamental” and “Conducted Band Edge” measurements per the “Marker-Delta Method” with the following formula:

$$BE = F_m - \Delta m$$

Where

BE = Band Edge Field Strength

F_m = Measured Fundamental (Peak or Average)

Δ_m = Measured Conducted Band Edge Delta (Peak or Average)

Radiated Emissions Test Results (Continued)

Plots Showing Out-Of-Band Emissions (Peak RBW=VBW=1MHz; Average RBW = 1MHz, VBW = 10Hz)

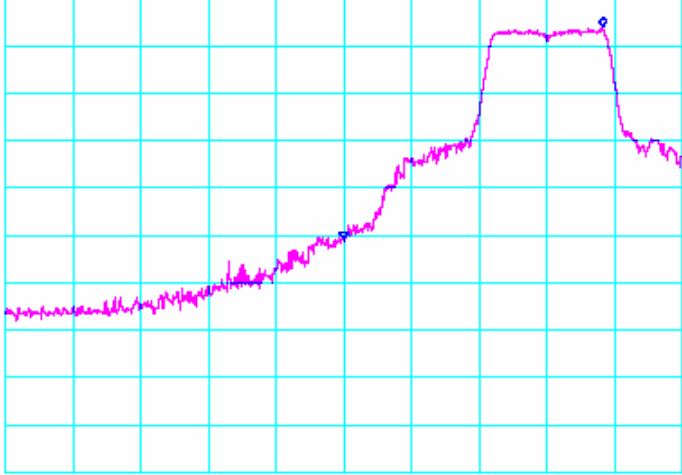
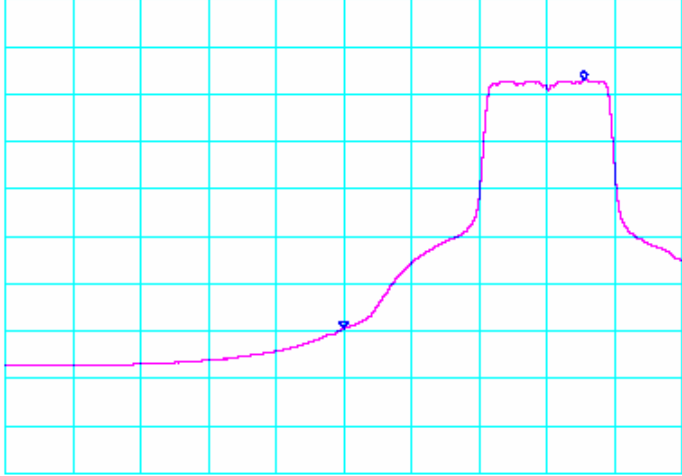
| Test Date | Data | Test Eng. |
|--------------------------------------------------------------------------------------------------------------------------------------------------------------------------------------------------------------------------------------------------------------------------------------------------------------------------------------------------------------------------------------------------------------------------------------------------------------------------------------------------------------------------------------------------------------------------------------------------------------------------------------------------|-----------------------------------|-----------|
| 04/05/08 | 5.18 GHz band edge PEAK | RC |
| <div style="display: flex; justify-content: space-between;"> <div data-bbox="337 432 522 485"> <p>*ATTEN 20dB RL 16.0dBm</p> </div> <div data-bbox="607 453 688 485"> <p>10dB/</p> </div> <div data-bbox="745 432 951 485"> <p>ΔMKR 44.83dB 38.3MHz</p> </div> </div>  <div style="display: flex; justify-content: space-between; margin-top: 10px;"> <div data-bbox="337 968 620 1020"> <p>CENTER 5.1500GHz *RBW 1.0MHz</p> </div> <div data-bbox="802 968 1019 1020"> <p>SPAN 100.0MHz *VBW 1.0MHz SWP 50.0ms</p> </div> </div> | | |
| Test Date | Data | Test Eng. |
| 04/05/08 | 5.18 GHz band edge AVERAGE | RC |
| <div style="display: flex; justify-content: space-between;"> <div data-bbox="337 1150 522 1203"> <p>*ATTEN 20dB RL 16.0dBm</p> </div> <div data-bbox="607 1171 688 1203"> <p>10dB/</p> </div> <div data-bbox="745 1150 951 1203"> <p>ΔMKR 52.50dB 35.5MHz</p> </div> </div>  <div style="display: flex; justify-content: space-between; margin-top: 10px;"> <div data-bbox="337 1686 620 1738"> <p>CENTER 5.1500GHz *RBW 1.0MHz</p> </div> <div data-bbox="802 1686 1019 1738"> <p>SPAN 100.0MHz *VBW 10Hz SWP 37.0sec</p> </div> </div> | | |

Radiated Emissions Test Results (Continued)

Plots Showing Out-Of-Band Emissions (Peak RBW=VBW=1MHz; Average RBW = 1MHz, VBW = 10Hz)

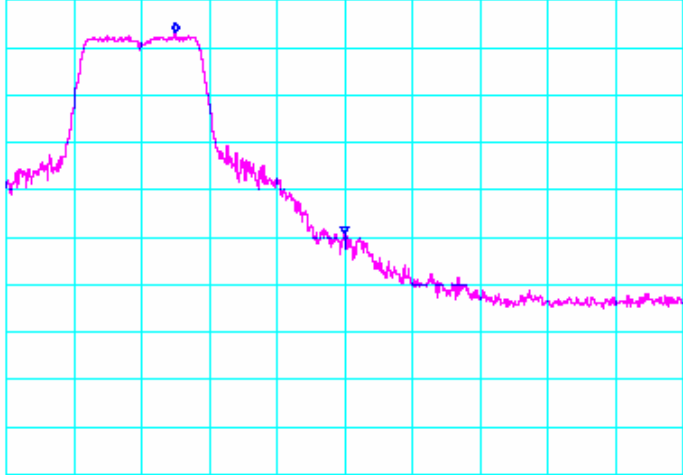
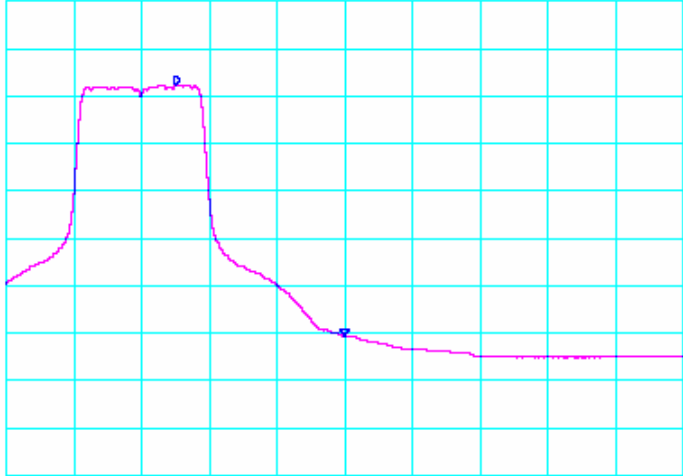
| Test Date | Data | Test Eng. |
|-------------------------------------------------------------------------------------------------------------------------------------------------------------------------------------------------------------------------------------------------------------------------------------------------------------------------------------------------------------------------------------------------------------------------------------------------------------------------------------------------------------------------------------------------------------------------------------------------|-----------------------------------|-----------|
| 04/05/08 | 5.32 GHz band edge PEAK | RC |
| <div style="display: flex; justify-content: space-between;"> <div data-bbox="337 430 527 483">*ATTEN 20dB RL 16.0dBm</div> <div data-bbox="609 451 706 483">10dB/</div> <div data-bbox="755 430 950 483">ΔMKR 42.34dB -25.0MHz</div> </div>  <div style="display: flex; justify-content: space-around; margin-top: 10px;"> <div data-bbox="337 961 755 1014">CENTER 5.3500GHz *RBW 1.0MHz *VBW 1.0MHz</div> <div data-bbox="803 961 1023 1014">SPAN 100.0MHz SWP 50.0ms</div> </div> | | |
| Test Date | Data | Test Eng. |
| 04/05/08 | 5.32 GHz band edge AVERAGE | RC |
| <div style="display: flex; justify-content: space-between;"> <div data-bbox="337 1148 527 1201">*ATTEN 20dB RL 16.0dBm</div> <div data-bbox="609 1169 706 1201">10dB/</div> <div data-bbox="755 1148 950 1201">ΔMKR 53.00dB -24.8MHz</div> </div>  <div style="display: flex; justify-content: space-around; margin-top: 10px;"> <div data-bbox="337 1680 755 1732">CENTER 5.3500GHz *RBW 1.0MHz *VBW 10Hz</div> <div data-bbox="803 1680 1023 1732">SPAN 100.0MHz SWP 37.0sec</div> </div> | | |



Radiated Emissions Test Results (Continued)

*Fundamental Measurements in 802.11n mode 20MHz Wide (5150-5350 MHz)
Channels 36, 40, 48, 52, & 64
Continuous TX at Chain C Antenna port with Ethertronics Antennas
Aegis Labs, Inc. File #: INTEL-081125-53*

| RADIATED EMISSIONS - Horizontal Antenna Polarization | | | | | | | | | | | |
|-------------------------------------------------------------|-----------------------------|----------------------------|--------------------------|-------------------------------|---|--------------------------|-------------------------|---------------------------------|----------------------|-------------------------|-----------------|
| <i>Freq. (MHz)</i> | <i>Meter Reading (dBuV)</i> | <i>Antenna Height (cm)</i> | <i>Azimuth (degrees)</i> | <i>Quasi pk or AVG (dBuV)</i> | | <i>Cable Factor (dB)</i> | <i>Ant. Factor (dB)</i> | <i>Corrected Reading (dBuV)</i> | <i>Limits (dBuV)</i> | <i>Diff (dB) +=FAIL</i> | <i>Comments</i> |
| 5180.00 | 69.67 | 100 | 225 | | | 3.77 | 34.32 | 107.76 | | | Ch. 36 |
| 5180.00 | | | | 60.00 | A | 3.77 | 34.32 | 98.09 | | | |
| 5200.00 | 69.00 | 100 | 225 | | | 3.78 | 34.34 | 107.12 | | | Ch. 40 |
| 5200.00 | | | | 59.00 | A | 3.78 | 34.34 | 97.12 | | | |
| 5240.00 | 68.83 | 100 | 225 | | | 3.80 | 34.39 | 107.01 | | | Ch. 48 |
| 5240.00 | | | | 57.83 | A | 3.80 | 34.39 | 96.01 | | | |
| 5260.00 | 66.50 | 100 | 315 | | | 3.80 | 34.41 | 104.72 | | | Ch. 52 |
| 5260.00 | | | | 57.00 | A | 3.80 | 34.41 | 95.22 | | | |
| 5320.00 | 68.50 | 100 | 315 | | | 3.83 | 34.48 | 106.81 | | | Ch. 64 |
| 5320.00 | | | | 58.17 | A | 3.83 | 34.48 | 96.48 | | | |

| RADIATED EMISSIONS - Vertical Antenna Polarization | | | | | | | | | | | |
|-----------------------------------------------------------|-----------------------------|----------------------------|--------------------------|-------------------------------|---|--------------------------|-------------------------|---------------------------------|----------------------|-------------------------|-----------------|
| <i>Freq. (MHz)</i> | <i>Meter Reading (dBuV)</i> | <i>Antenna Height (cm)</i> | <i>Azimuth (degrees)</i> | <i>Quasi pk or AVG (dBuV)</i> | | <i>Cable Factor (dB)</i> | <i>Ant. Factor (dB)</i> | <i>Corrected Reading (dBuV)</i> | <i>Limits (dBuV)</i> | <i>Diff (dB) +=FAIL</i> | <i>Comments</i> |
| 5180.00 | 65.67 | 100 | 315 | | | 3.77 | 34.31 | 103.75 | | | Ch. 36 |
| 5180.00 | | | | 55.83 | A | 3.77 | 34.31 | 93.91 | | | |
| 5200.00 | 65.50 | 100 | 315 | | | 3.78 | 34.32 | 103.60 | | | Ch. 40 |
| 5200.00 | | | | 55.33 | A | 3.78 | 34.32 | 93.43 | | | |
| 5240.00 | 67.67 | 100 | 315 | | | 3.80 | 34.34 | 105.81 | | | Ch. 48 |
| 5240.00 | | | | 57.67 | A | 3.80 | 34.34 | 95.81 | | | |
| 5260.00 | 68.00 | 100 | 315 | | | 3.80 | 34.36 | 106.16 | | | Ch. 52 |
| 5260.00 | | | | 57.67 | A | 3.80 | 34.36 | 95.83 | | | |
| 5320.00 | 68.33 | 100 | 315 | | | 3.83 | 34.39 | 106.55 | | | Ch. 64 |
| 5320.00 | | | | 57.83 | A | 3.83 | 34.39 | 96.05 | | | |

NOTE: Fundamental signals measured to calculate the band edge field strengths using the “Marker Delta Method”.



Radiated Emissions Test Results (Continued)

*Band Edge Field Strength Measurements in 802.11n mode 20MHz Wide (5150-5350 MHz)
Channels 36 & 64
Continuous TX at Chain C Antenna port with Ethertronics Antennas
Aegis Labs, Inc. File #: INTEL-081125-53*

| RADIATED EMISSIONS - Horizontal Antenna Polarization | | | | | | | | | | |
|-------------------------------------------------------------|-----------------------------|----------------------------|--------------------------|-------------------------------|--------------------------|-------------------------|---------------------------------|----------------------|-------------------------|-----------------|
| <i>Freq. (MHz)</i> | <i>Meter Reading (dBuV)</i> | <i>Antenna Height (cm)</i> | <i>Azimuth (degrees)</i> | <i>Quasi pk or AVG (dBuV)</i> | <i>Cable Factor (dB)</i> | <i>Ant. Factor (dB)</i> | <i>Corrected Reading (dBuV)</i> | <i>Limits (dBuV)</i> | <i>Diff (dB) +=FAIL</i> | <i>Comments</i> |
| 5150.00 | | | | | | | 68.43 | 74.00 | -5.57 | Ch. 36 |
| 5150.00 | | | | | A | | 46.92 | 54.00 | -7.08 | |
| 5350.00 | | | | | | | 65.48 | 74.00 | -8.52 | Ch. 64 |
| 5350.00 | | | | | A | | 45.32 | 54.00 | -8.68 | |

| RADIATED EMISSIONS - Vertical Antenna Polarization | | | | | | | | | | |
|-----------------------------------------------------------|-----------------------------|----------------------------|--------------------------|-------------------------------|--------------------------|-------------------------|---------------------------------|----------------------|-------------------------|-----------------|
| <i>Freq. (MHz)</i> | <i>Meter Reading (dBuV)</i> | <i>Antenna Height (cm)</i> | <i>Azimuth (degrees)</i> | <i>Quasi pk or AVG (dBuV)</i> | <i>Cable Factor (dB)</i> | <i>Ant. Factor (dB)</i> | <i>Corrected Reading (dBuV)</i> | <i>Limits (dBuV)</i> | <i>Diff (dB) +=FAIL</i> | <i>Comments</i> |
| 5150.00 | | | | | | | 64.42 | 74.00 | -9.58 | Ch. 36 |
| 5150.00 | | | | | A | | 42.74 | 54.00 | -11.26 | |
| 5350.00 | | | | | | | 65.22 | 74.00 | -8.78 | Ch. 64 |
| 5350.00 | | | | | A | | 44.89 | 54.00 | -9.11 | |

NOTE: The “Band Edge Field Strength” was calculated using the “Fundamental” and “Conducted Band Edge” measurements per the “Marker-Delta Method” with the following formula:

$$BE = Fm - \Delta m$$

Where

BE = Band Edge Field Strength

Fm = Measured Fundamental (Peak or Average)

Δm = Measured Conducted Band Edge Delta (Peak or Average)

Radiated Emissions Test Results (Continued)

Plots Showing Out-Of-Band Emissions (Peak RBW=VBW=1MHz; Average RBW = 1MHz, VBW = 10Hz)

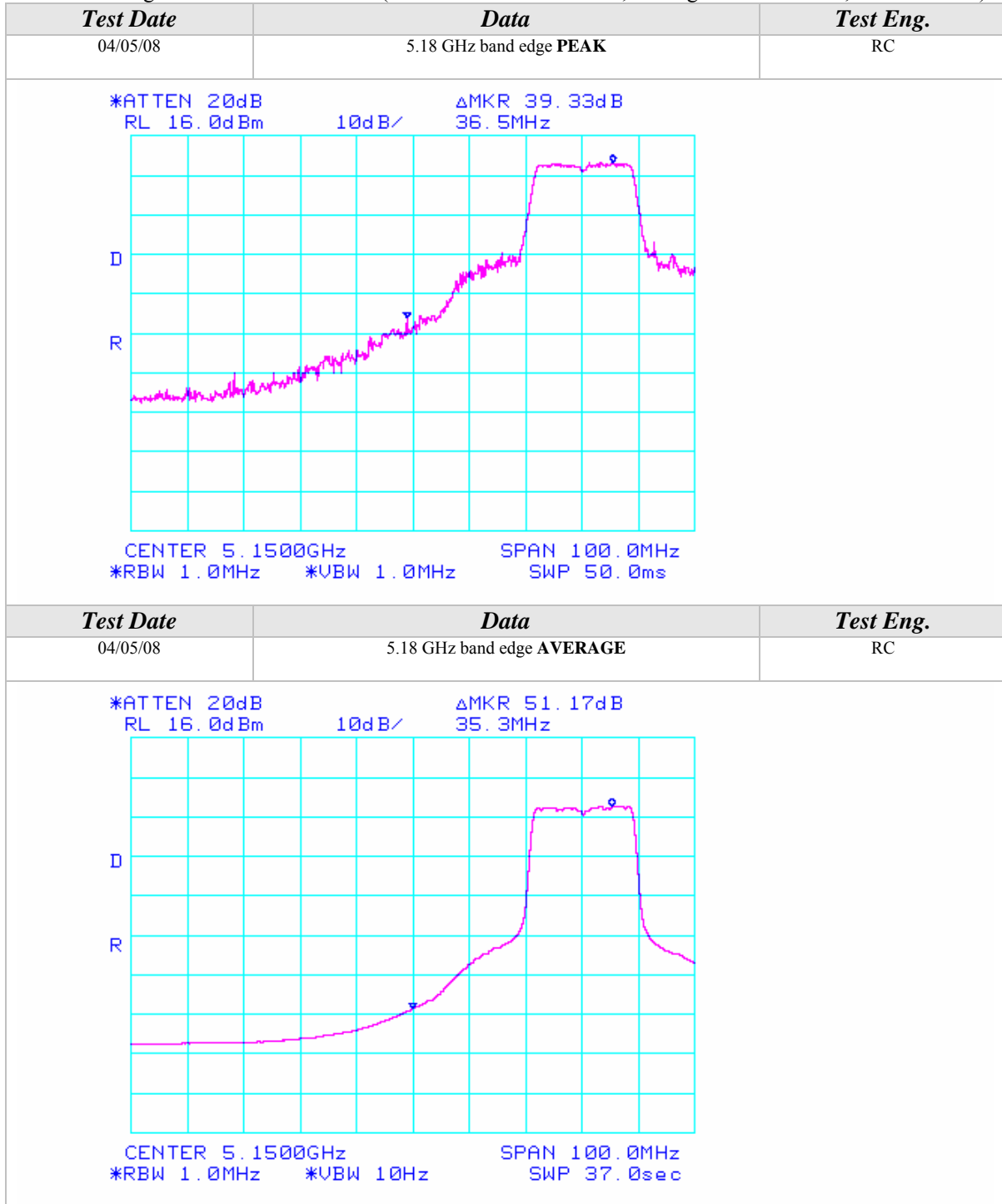



Radiated Emissions Test Results (Continued)

Plots Showing Out-Of-Band Emissions (Peak RBW=VBW=1MHz; Average RBW = 1MHz, VBW = 10Hz)

| Test Date | Data | Test Eng. |
|-----------|--------------------------------|-----------|
| 04/05/08 | 5.32 GHz band edge PEAK | RC |

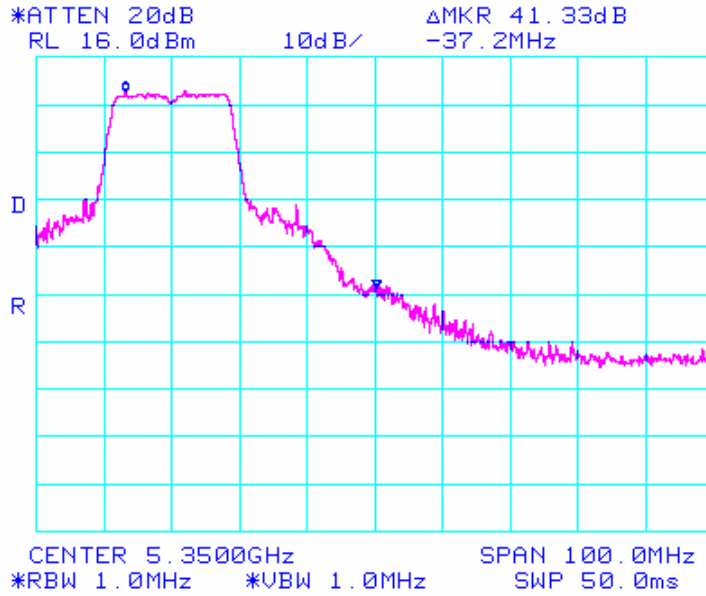

| Test Date | Data | Test Eng. |
|-----------|-----------------------------------|-----------|
| 04/05/08 | 5.32 GHz band edge AVERAGE | RC |

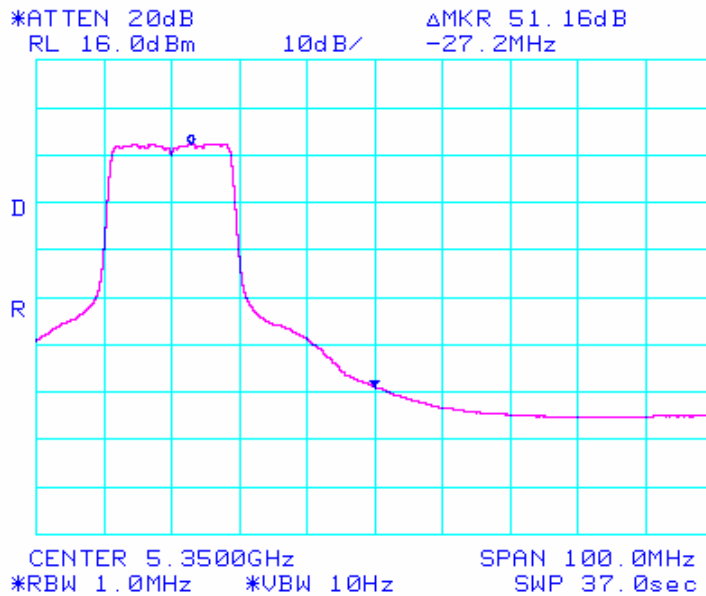



Radiated Emissions Test Results (Continued)

*Spurious Emissions Measurements in 802.11n mode 20MHz Wide (5150-5350 MHz)
Channels 36, 40, & 48
Continuous TX at Chain A, B, & C Antenna ports with Ethertronics Antennas
Aegis Labs, Inc. File #: INTEL-081125-46*

RADIATED EMISSIONS - Horizontal Antenna Polarization

| Freq. (MHz) | Meter Reading (dBuV) | Antenna Height (cm) | Azimuth (degrees) | Quasi pk or AVG (dBuV) | Preamp Factor (dB) | Cable Factor (dB) | Ant. Factor (dB) | Corrected Reading (dBuV) | Limits (dBuV) | Diff (dB) +=FAIL | Channel/ Chain Tested |
|-------------|----------------------|---------------------|-------------------|------------------------|--------------------|-------------------|------------------|--------------------------|---------------|------------------|-----------------------|
| 3466.66 | 54.67 | 100 | 90 | | 50.72 | 3.06 | 32.79 | 39.80 | 68.00 | -28.20 | Ch. 40/ |
| 6933.33 | 52.67 | 100 | 90 | | 50.48 | 4.40 | 35.69 | 42.28 | 68.00 | -25.72 | A |
| 3466.66 | 53.50 | 100 | 45 | | 50.72 | 3.06 | 32.79 | 38.63 | 68.00 | -29.37 | Ch. 40/ |
| 6933.33 | 53.33 | 100 | 135 | | 50.48 | 4.40 | 35.69 | 42.94 | 68.00 | -25.06 | B |
| 10400.00 | 50.17 | 100 | 135 | | 50.40 | 5.53 | 37.44 | 42.74 | 68.00 | -25.26 | |
| 3466.66 | 53.33 | 100 | 45 | | 50.72 | 3.06 | 32.79 | 38.46 | 68.00 | -29.54 | Ch. 40/ |
| 6933.33 | 55.50 | 100 | 135 | | 50.48 | 4.40 | 35.69 | 45.11 | 68.00 | -22.89 | C |
| 10400.00 | 49.50 | 100 | 135 | | 50.40 | 5.53 | 37.44 | 42.07 | 68.00 | -25.93 | |
| 3453.33 | 53.33 | 100 | 225 | | 50.71 | 3.06 | 32.78 | 38.47 | 68.00 | -29.53 | Ch. 36/ |
| 6906.66 | 58.00 | 100 | 180 | | 50.50 | 4.39 | 35.68 | 47.57 | 68.00 | -20.43 | C |
| 10359.99 | 58.33 | 100 | 180 | | 50.39 | 5.52 | 37.42 | 50.88 | 68.00 | -17.12 | |
| 3493.33 | 55.17 | 100 | 225 | | 50.75 | 3.06 | 32.80 | 40.28 | 68.00 | -27.72 | Ch. 48/ |
| 6986.66 | 57.83 | 100 | 180 | | 50.44 | 4.42 | 35.70 | 47.51 | 68.00 | -20.49 | C |
| 10480.00 | 50.50 | 100 | 180 | | 50.42 | 5.55 | 37.49 | 43.12 | 68.00 | -24.88 | |

RADIATED EMISSIONS - Vertical Antenna Polarization

| Freq. (MHz) | Meter Reading (dBuV) | Antenna Height (cm) | Azimuth (degrees) | Quasi pk or AVG (dBuV) | Preamp Factor (dB) | Cable Factor (dB) | Ant. Factor (dB) | Corrected Reading (dBuV) | Limits (dBuV) | Diff (dB) +=FAIL | Comments |
|-------------|----------------------|---------------------|-------------------|------------------------|--------------------|-------------------|------------------|--------------------------|---------------|------------------|----------|
| 3466.66 | 53.17 | 100 | 270 | | 50.72 | 3.06 | 32.88 | 38.39 | 68.00 | -29.61 | Ch. 40/ |
| 6933.33 | 54.50 | 100 | 45 | | 50.48 | 4.40 | 35.60 | 44.02 | 68.00 | -23.98 | A |
| 3466.66 | 54.00 | 100 | 225 | | 50.72 | 3.06 | 32.88 | 39.22 | 68.00 | -28.78 | Ch. 40/ |
| 6933.33 | 55.67 | 100 | 180 | | 50.48 | 4.40 | 35.60 | 45.19 | 68.00 | -22.81 | B |
| 10400.00 | 50.83 | 100 | 135 | | 50.40 | 5.53 | 37.44 | 43.40 | 68.00 | -24.60 | |
| 3466.66 | 55.17 | 100 | 0 | | 50.72 | 3.06 | 32.88 | 40.39 | 68.00 | -27.61 | Ch. 40/ |
| 6933.33 | 54.83 | 100 | 90 | | 50.48 | 4.40 | 35.60 | 44.35 | 68.00 | -23.65 | C |
| 10400.00 | 51.67 | 100 | 135 | | 50.40 | 5.53 | 37.44 | 44.24 | 68.00 | -23.76 | |
| 3453.33 | 53.67 | 100 | 135 | | 50.71 | 3.06 | 32.87 | 38.90 | 68.00 | -29.10 | Ch. 36/ |
| 6906.66 | 56.67 | 100 | 225 | | 50.50 | 4.39 | 35.60 | 46.16 | 68.00 | -21.84 | B |
| 3493.33 | 55.17 | 100 | 135 | | 50.75 | 3.06 | 32.90 | 40.37 | 68.00 | -27.63 | Ch. 48/ |
| 6986.66 | 53.50 | 100 | 180 | | 50.44 | 4.42 | 35.60 | 43.08 | 68.00 | -24.92 | B |



Radiated Emissions Test Results (Continued)

*Spurious Emissions Measurements in 802.11n mode 20MHz Wide (5150-5350 MHz)
Channels 36, 40, & 48
Continuous TX at Chain A, B, & C Antenna ports with Wistron Neweb Corp. Antennas
Aegis Labs, Inc. File #: INTEL-081125-75*

RADIATED EMISSIONS - Horizontal Antenna Polarization

| Freq. (MHz) | Meter Reading (dBuV) | Antenna Height (cm) | Azimuth (degrees) | Quasi pk or AVG (dBuV) | Preamp Factor (dB) | Cable Factor (dB) | Ant. Factor (dB) | Corrected Reading (dBuV) | Limits (dBuV) | Diff (dB) +=FAIL | Channel/ Chain Tested |
|-------------|----------------------|---------------------|-------------------|------------------------|--------------------|-------------------|------------------|--------------------------|---------------|------------------|-----------------------|
| 3466.66 | 58.83 | 100 | 135 | | 46.60 | 2.42 | 32.01 | 46.66 | 68.00 | -21.34 | Ch. 40/ |
| 6933.33 | 60.17 | 100 | 225 | | 45.15 | 3.48 | 34.89 | 53.39 | 68.00 | -14.61 | A |
| 3466.66 | 59.50 | 100 | 90 | | 46.60 | 2.42 | 32.01 | 47.33 | 68.00 | -20.67 | Ch. 40/ |
| 6933.33 | 64.00 | 100 | 225 | | 45.15 | 3.48 | 34.89 | 57.22 | 68.00 | -10.78 | B |
| 10400.00 | 55.50 | 100 | 180 | | 44.48 | 4.40 | 36.44 | 51.87 | 68.00 | -16.13 | |
| 3466.66 | 58.50 | 100 | 90 | | 46.60 | 2.42 | 32.01 | 46.33 | 68.00 | -21.67 | Ch. 40/ |
| 6933.33 | 60.67 | 100 | 180 | | 45.15 | 3.48 | 34.89 | 53.89 | 68.00 | -14.11 | C |
| 10400.00 | 55.83 | 100 | 180 | | 44.48 | 4.40 | 36.44 | 52.20 | 68.00 | -15.80 | |
| | | | | | | | | | | | |
| 3453.33 | 58.50 | 100 | 270 | | 46.60 | 2.41 | 32.02 | 46.33 | 68.00 | -21.67 | Ch. 36/ |
| 6906.66 | 64.50 | 100 | 180 | | 45.19 | 3.47 | 34.88 | 57.66 | 68.00 | -10.34 | B |
| 10359.99 | 55.67 | 100 | 225 | | 44.47 | 4.39 | 36.42 | 52.00 | 68.00 | -16.00 | |
| 3493.33 | 59.00 | 100 | 180 | | 46.60 | 2.43 | 32.00 | 46.83 | 68.00 | -21.17 | Ch. 48/ |
| 6986.66 | 60.50 | 100 | 180 | | 45.07 | 3.50 | 34.90 | 53.83 | 68.00 | -14.17 | B |
| 10480.00 | 55.67 | 100 | 90 | | 44.49 | 4.43 | 36.49 | 52.10 | 68.00 | -15.90 | |

RADIATED EMISSIONS - Vertical Antenna Polarization

| Freq. (MHz) | Meter Reading (dBuV) | Antenna Height (cm) | Azimuth (degrees) | Quasi pk or AVG (dBuV) | Preamp Factor (dB) | Cable Factor (dB) | Ant. Factor (dB) | Corrected Reading (dBuV) | Limits (dBuV) | Diff (dB) +=FAIL | Comments |
|-------------|----------------------|---------------------|-------------------|------------------------|--------------------|-------------------|------------------|--------------------------|---------------|------------------|----------|
| 3466.66 | 60.33 | 100 | 180 | | 46.60 | 2.42 | 30.72 | 46.87 | 68.00 | -21.13 | Ch. 40/ |
| 6933.33 | 62.83 | 100 | 90 | | 45.15 | 3.48 | 33.97 | 55.13 | 68.00 | -12.87 | A |
| 10400.00 | 56.17 | 100 | 90 | | 44.48 | 4.40 | 35.82 | 51.92 | 68.00 | -16.08 | |
| 3466.66 | 60.33 | 100 | 45 | | 46.60 | 2.42 | 30.72 | 46.87 | 68.00 | -21.13 | Ch. 40/ |
| 6933.33 | 65.17 | 100 | 0 | | 45.15 | 3.48 | 33.97 | 57.47 | 68.00 | -10.53 | B |
| 10400.00 | 56.67 | 100 | 45 | | 44.48 | 4.40 | 35.82 | 52.42 | 68.00 | -15.58 | |
| 3466.66 | 59.67 | 100 | 0 | | 46.60 | 2.42 | 30.72 | 46.21 | 68.00 | -21.79 | Ch. 40/ |
| 6933.33 | 63.17 | 100 | 270 | | 45.15 | 3.48 | 33.97 | 55.47 | 68.00 | -12.53 | C |
| 10400.00 | 56.83 | 100 | 45 | | 44.48 | 4.40 | 35.82 | 52.58 | 68.00 | -15.42 | |
| | | | | | | | | | | | |
| 3453.33 | 61.17 | 100 | 180 | | 46.60 | 2.41 | 30.73 | 47.71 | 68.00 | -20.29 | Ch. 36/ |
| 6906.66 | 65.50 | 100 | 180 | | 45.19 | 3.47 | 33.96 | 57.74 | 68.00 | -10.26 | B |
| 3493.33 | 60.17 | 100 | 180 | | 46.60 | 2.43 | 30.70 | 46.70 | 68.00 | -21.30 | Ch. 48/ |
| 6986.66 | 61.83 | 100 | 315 | | 45.07 | 3.50 | 33.99 | 54.26 | 68.00 | -13.74 | B |



Radiated Emissions Test Results (Continued)

*Spurious Emissions Measurements in 802.11n mode 20MHz Wide (5150-5350 MHz)
Channels 52, 56, & 64
Continuous TX at Chain A, B, & C Antenna ports with Ethertronics Antennas
Aegis Labs, Inc. File #: INTEL-081125-46*

| RADIATED EMISSIONS - Horizontal Antenna Polarization | | | | | | | | | | | |
|-------------------------------------------------------------|----------------------|---------------------|-------------------|------------------------|--------------------|-------------------|------------------|--------------------------|---------------|-------------------|-----------------------|
| Freq. (MHz) | Meter Reading (dBuV) | Antenna Height (cm) | Azimuth (degrees) | Quasi pk or AVG (dBuV) | Preamp Factor (dB) | Cable Factor (dB) | Ant. Factor (dB) | Corrected Reading (dBuV) | Limits (dBuV) | Diff (dB) +/-FAIL | Channel/ Chain Tested |
| 3520.00 | 53.17 | 100 | 135 | | 50.74 | 3.08 | 32.82 | 38.34 | 68.00 | -29.66 | Ch. 56/ |
| 7040.00 | 53.50 | 100 | 225 | | 50.41 | 4.44 | 35.72 | 43.26 | 68.00 | -24.74 | A |
| 3520.00 | 52.67 | 100 | 270 | | 50.74 | 3.08 | 32.82 | 37.84 | 68.00 | -30.16 | Ch. 56/ |
| 7040.00 | 52.00 | 100 | 135 | | 50.41 | 4.44 | 35.72 | 41.76 | 68.00 | -26.24 | B |
| 3520.00 | 52.17 | 100 | 135 | | 50.74 | 3.08 | 32.82 | 37.34 | 68.00 | -30.66 | Ch. 56/ |
| 7040.00 | 51.50 | 100 | 135 | | 50.41 | 4.44 | 35.72 | 41.26 | 68.00 | -26.74 | C |
| 3506.66 | 53.17 | 100 | 315 | | 50.75 | 3.07 | 32.81 | 38.29 | 68.00 | -29.71 | Ch. 52/ |
| 7013.32 | 57.83 | 100 | 135 | | 50.42 | 4.43 | 35.71 | 47.55 | 68.00 | -20.45 | A |
| 3546.66 | 54.33 | 100 | 270 | | 50.71 | 3.12 | 32.86 | 39.59 | 68.00 | -28.41 | Ch. 64/ |
| 7093.32 | 54.17 | 100 | 135 | | 50.38 | 4.46 | 35.76 | 44.01 | 68.00 | -23.99 | A |

| RADIATED EMISSIONS - Vertical Antenna Polarization | | | | | | | | | | | |
|-----------------------------------------------------------|----------------------|---------------------|-------------------|------------------------|--------------------|-------------------|------------------|--------------------------|---------------|-------------------|----------|
| Freq. (MHz) | Meter Reading (dBuV) | Antenna Height (cm) | Azimuth (degrees) | Quasi pk or AVG (dBuV) | Preamp Factor (dB) | Cable Factor (dB) | Ant. Factor (dB) | Corrected Reading (dBuV) | Limits (dBuV) | Diff (dB) +/-FAIL | Comments |
| 3520.00 | 52.50 | 100 | 0 | | 50.74 | 3.08 | 32.92 | 37.76 | 68.00 | -30.24 | Ch. 56/ |
| 7040.00 | 54.17 | 100 | 135 | | 50.41 | 4.44 | 35.64 | 43.84 | 68.00 | -24.16 | A |
| 3520.00 | 54.00 | 100 | 0 | | 50.74 | 3.08 | 32.92 | 39.26 | 68.00 | -28.74 | Ch. 56/ |
| 7040.00 | 53.83 | 100 | 135 | | 50.41 | 4.44 | 35.64 | 43.50 | 68.00 | -24.50 | B |
| 3520.00 | 53.17 | 100 | 180 | | 50.74 | 3.08 | 32.92 | 38.43 | 68.00 | -29.57 | Ch. 56/ |
| 7040.00 | 53.00 | 100 | 270 | | 50.41 | 4.44 | 35.64 | 42.67 | 68.00 | -25.33 | C |
| 10560.00 | 51.17 | 100 | 225 | | 50.43 | 5.57 | 37.55 | 43.86 | 68.00 | -24.14 | |
| 3506.66 | 54.17 | 100 | 135 | | 50.75 | 3.07 | 32.91 | 39.39 | 68.00 | -28.61 | Ch. 52/ |
| 7013.32 | 54.50 | 100 | 135 | | 50.42 | 4.43 | 35.61 | 44.12 | 68.00 | -23.88 | C |
| 10520.00 | 51.33 | 100 | 135 | | 50.43 | 5.56 | 37.52 | 43.98 | 68.00 | -24.02 | |
| 3546.66 | 53.83 | 100 | 135 | | 50.71 | 3.12 | 32.95 | 39.18 | 68.00 | -28.82 | Ch. 64/ |
| 7093.32 | 53.33 | 100 | 135 | | 50.38 | 4.46 | 35.69 | 43.10 | 68.00 | -24.90 | C |



Radiated Emissions Test Results (Continued)

*Spurious Emissions Measurements in 802.11n mode 20MHz Wide (5150-5350 MHz)
Channels 52, 56, & 64
Continuous TX at Chain A, B, & C Antenna ports with Wistron Neweb Corp. Antennas
Aegis Labs, Inc. File #: INTEL-081125-75*

RADIATED EMISSIONS - Horizontal Antenna Polarization

| Freq. (MHz) | Meter Reading (dBuV) | Antenna Height (cm) | Azimuth (degrees) | Quasi pk or AVG (dBuV) | Preamp Factor (dB) | Cable Factor (dB) | Ant. Factor (dB) | Corrected Reading (dBuV) | Limits (dBuV) | Diff (dB) +=FAIL | Channel/ Chain Tested |
|-------------|----------------------|---------------------|-------------------|------------------------|--------------------|-------------------|------------------|--------------------------|---------------|------------------|-----------------------|
| 3520.00 | 60.83 | 100 | 90 | | 46.59 | 2.44 | 32.04 | 48.71 | 68.00 | -19.29 | Ch. 56/ |
| 7040.00 | 59.83 | 100 | 0 | | 45.03 | 3.51 | 34.91 | 53.22 | 68.00 | -14.78 | A |
| 3520.00 | 61.33 | 100 | 90 | | 46.59 | 2.44 | 32.04 | 49.21 | 68.00 | -18.79 | Ch. 56/ |
| 7040.00 | 60.17 | 100 | 315 | | 45.03 | 3.51 | 34.91 | 53.56 | 68.00 | -14.44 | B |
| 3520.00 | 61.17 | 100 | 90 | | 46.59 | 2.44 | 32.04 | 49.05 | 68.00 | -18.95 | Ch. 56/ |
| 7040.00 | 58.50 | 100 | 90 | | 45.03 | 3.51 | 34.91 | 51.89 | 68.00 | -16.11 | C |
| 3506.66 | 60.00 | 100 | 90 | | 46.60 | 2.43 | 32.01 | 47.85 | 68.00 | -20.15 | Ch. 52/ |
| 7013.32 | 60.17 | 100 | 315 | | 45.04 | 3.51 | 34.90 | 53.54 | 68.00 | -14.46 | B |
| 3546.66 | 60.33 | 100 | 0 | | 46.59 | 2.45 | 32.09 | 48.28 | 68.00 | -19.72 | Ch. 64/ |
| 7093.32 | 60.17 | 100 | 270 | | 45.01 | 3.53 | 34.92 | 53.61 | 68.00 | -14.39 | B |

RADIATED EMISSIONS - Vertical Antenna Polarization

| Freq. (MHz) | Meter Reading (dBuV) | Antenna Height (cm) | Azimuth (degrees) | Quasi pk or AVG (dBuV) | Preamp Factor (dB) | Cable Factor (dB) | Ant. Factor (dB) | Corrected Reading (dBuV) | Limits (dBuV) | Diff (dB) +=FAIL | Comments |
|-------------|----------------------|---------------------|-------------------|------------------------|--------------------|-------------------|------------------|--------------------------|---------------|------------------|----------|
| 3520.00 | 62.00 | 100 | 0 | | 46.59 | 2.44 | 30.74 | 48.59 | 68.00 | -19.41 | Ch. 56/ |
| 7040.00 | 62.83 | 100 | 90 | | 45.03 | 3.51 | 34.01 | 55.32 | 68.00 | -12.68 | A |
| 3520.00 | 62.17 | 100 | 315 | | 46.59 | 2.44 | 30.74 | 48.76 | 68.00 | -19.24 | Ch. 56/ |
| 7040.00 | 61.33 | 100 | 315 | | 45.03 | 3.51 | 34.01 | 53.82 | 68.00 | -14.18 | B |
| 10560.00 | 56.67 | 100 | 45 | | 44.57 | 4.45 | 35.91 | 52.46 | 68.00 | -15.54 | |
| 3520.00 | 61.33 | 100 | 270 | | 46.59 | 2.44 | 30.74 | 47.92 | 68.00 | -20.08 | Ch. 56/ |
| 7040.00 | 61.17 | 100 | 45 | | 45.03 | 3.51 | 34.01 | 53.66 | 68.00 | -14.34 | C |
| 10560.00 | 55.50 | 100 | 270 | | 44.57 | 4.45 | 35.91 | 51.29 | 68.00 | -16.71 | |
| 3506.66 | 60.33 | 100 | 45 | | 46.60 | 2.43 | 30.71 | 46.88 | 68.00 | -21.12 | Ch. 52/ |
| 7013.32 | 61.67 | 100 | 315 | | 45.04 | 3.51 | 34.00 | 54.14 | 68.00 | -13.86 | C |
| 10520.00 | 56.17 | 100 | 180 | | 44.52 | 4.44 | 35.90 | 52.00 | 68.00 | -16.00 | |
| 3546.66 | 62.17 | 100 | 45 | | 46.59 | 2.45 | 30.80 | 48.83 | 68.00 | -19.17 | Ch. 64/ |
| 7093.32 | 62.83 | 100 | 180 | | 45.01 | 3.53 | 34.02 | 55.37 | 68.00 | -12.63 | C |



Radiated Emissions Test Results (Continued)

*Spurious Emissions Measurements in 802.11n mode 20MHz Wide (5150-5350 MHz)
Channels 36, 40, & 48
Continuous TX at Triple Chain ABC Antenna ports with Ethertronics Antennas
Aegis Labs, Inc. File #: INTEL-081125-46*

RADIATED EMISSIONS - Horizontal Antenna Polarization

| Freq. (MHz) | Meter Reading (dBuV) | Antenna Height (cm) | Azimuth (degrees) | Quasi pk or AVG (dBuV) | Preamp Factor (dB) | Cable Factor (dB) | Ant. Factor (dB) | Corrected Reading (dBuV) | Limits (dBuV) | Diff (dB) +=FAIL | Channel/Chain Tested | |
|-------------|----------------------|---------------------|-------------------|------------------------|--------------------|-------------------|------------------|--------------------------|---------------|------------------|----------------------|---------|
| 3453.33 | 53.33 | 100 | 225 | | | 50.71 | 3.06 | 32.78 | 38.47 | 68.00 | -29.53 | Ch. 36/ |
| 6906.66 | 58.00 | 100 | 180 | | | 50.50 | 4.39 | 35.68 | 47.57 | 68.00 | -20.43 | ABC |
| 10359.99 | 58.33 | 100 | 180 | | | 50.39 | 5.52 | 37.42 | 50.88 | 68.00 | -17.12 | |
| 3466.66 | 52.17 | 100 | 45 | | | 50.72 | 3.06 | 32.79 | 37.30 | 68.00 | -30.70 | Ch. 40/ |
| 6933.33 | 55.50 | 100 | 135 | | | 50.48 | 4.40 | 35.69 | 45.11 | 68.00 | -22.89 | ABC |
| 10399.98 | 52.67 | 100 | 135 | | | 50.40 | 5.53 | 37.44 | 45.24 | 68.00 | -22.76 | |
| 3493.33 | 55.17 | 100 | 225 | | | 50.75 | 3.06 | 32.80 | 40.28 | 68.00 | -27.72 | Ch. 48/ |
| 6986.66 | 57.83 | 100 | 180 | | | 50.44 | 4.42 | 35.70 | 47.51 | 68.00 | -20.49 | ABC |
| 10480.00 | 50.50 | 100 | 180 | | | 50.42 | 5.55 | 37.49 | 43.12 | 68.00 | -24.88 | |

RADIATED EMISSIONS - Vertical Antenna Polarization

| Freq. (MHz) | Meter Reading (dBuV) | Antenna Height (cm) | Azimuth (degrees) | Quasi pk or AVG (dBuV) | Preamp Factor (dB) | Cable Factor (dB) | Ant. Factor (dB) | Corrected Reading (dBuV) | Limits (dBuV) | Diff (dB) +=FAIL | Comments | |
|-------------|----------------------|---------------------|-------------------|------------------------|--------------------|-------------------|------------------|--------------------------|---------------|------------------|----------|---------|
| 3453.33 | 53.67 | 100 | 135 | | | 50.71 | 3.06 | 32.87 | 38.90 | 68.00 | -29.10 | Ch. 36/ |
| 6906.66 | 56.67 | 100 | 225 | | | 50.50 | 4.39 | 35.60 | 46.16 | 68.00 | -21.84 | ABC |
| 3466.66 | 53.83 | 100 | 0 | | | 50.72 | 3.06 | 32.88 | 39.05 | 68.00 | -28.95 | Ch. 40/ |
| 6933.33 | 54.67 | 100 | 180 | | | 50.48 | 4.40 | 35.60 | 44.19 | 68.00 | -23.81 | ABC |
| 10399.99 | 53.33 | 100 | 135 | | | 50.40 | 5.53 | 37.44 | 45.90 | 68.00 | -22.10 | |
| 3493.33 | 55.17 | 100 | 135 | | | 50.75 | 3.06 | 32.90 | 40.37 | 68.00 | -27.63 | Ch. 48/ |
| 6986.66 | 53.50 | 100 | 180 | | | 50.44 | 4.42 | 35.60 | 43.08 | 68.00 | -24.92 | ABC |



Radiated Emissions Test Results (Continued)

*Spurious Emissions Measurements in 802.11n mode 20MHz Wide (5150-5350 MHz)
Channels 36, 40, & 48
Continuous TX at Triple Chain ABC Antenna ports with Wistron Neweb Corp. Antennas
Aegis Labs, Inc. File #: INTEL-081125-75*

| RADIATED EMISSIONS - Horizontal Antenna Polarization | | | | | | | | | | | |
|-------------------------------------------------------------|----------------------|---------------------|-------------------|------------------------|--------------------|-------------------|------------------|--------------------------|---------------|------------------|----------------------|
| Freq. (MHz) | Meter Reading (dBuV) | Antenna Height (cm) | Azimuth (degrees) | Quasi pk or AVG (dBuV) | Preamp Factor (dB) | Cable Factor (dB) | Ant. Factor (dB) | Corrected Reading (dBuV) | Limits (dBuV) | Diff (dB) +=FAIL | Channel/Chain Tested |
| 3453.33 | 50.83 | 100 | 315 | | 36.68 | 2.41 | 32.02 | 48.58 | 68.00 | -19.42 | Ch. 36/ |
| 6906.66 | 56.83 | 100 | 225 | | 36.57 | 3.47 | 34.88 | 58.62 | 68.00 | -9.38 | ABC |
| 10360.00 | 51.00 | 100 | 0 | | 36.88 | 4.39 | 36.42 | 54.92 | 68.00 | -13.08 | |
| 3466.66 | 51.50 | 100 | 45 | | 36.68 | 2.42 | 32.01 | 49.25 | 68.00 | -18.75 | Ch. 40/ |
| 6933.33 | 55.00 | 100 | 225 | | 36.58 | 3.48 | 34.89 | 56.79 | 68.00 | -11.21 | ABC |
| 10400.00 | 51.83 | 100 | 0 | | 36.85 | 4.40 | 36.44 | 55.82 | 68.00 | -12.18 | |
| 3493.33 | 51.50 | 100 | 315 | | 36.67 | 2.43 | 32.00 | 49.26 | 68.00 | -18.74 | Ch. 48/ |
| 6986.66 | 53.17 | 100 | 180 | | 36.60 | 3.50 | 34.90 | 54.96 | 68.00 | -13.04 | ABC |
| 10480.00 | 52.00 | 100 | 0 | | 36.79 | 4.43 | 36.49 | 56.13 | 68.00 | -11.87 | |

| RADIATED EMISSIONS - Vertical Antenna Polarization | | | | | | | | | | | |
|-----------------------------------------------------------|----------------------|---------------------|-------------------|------------------------|--------------------|-------------------|------------------|--------------------------|---------------|------------------|----------------|
| Freq. (MHz) | Meter Reading (dBuV) | Antenna Height (cm) | Azimuth (degrees) | Quasi pk or AVG (dBuV) | Preamp Factor (dB) | Cable Factor (dB) | Ant. Factor (dB) | Corrected Reading (dBuV) | Limits (dBuV) | Diff (dB) +=FAIL | Comments |
| 3453.33 | 51.50 | 100 | 45 | | 36.68 | 2.41 | 30.73 | 47.96 | 68.00 | -20.04 | Ch. 36/ |
| 6906.66 | 57.50 | 100 | 180 | | 36.57 | 3.47 | 33.96 | 58.37 | 68.00 | -9.63 | ABC |
| 10360.00 | 51.83 | 100 | 45 | | 36.88 | 4.39 | 35.79 | 55.12 | 68.00 | -12.88 | |
| 3466.66 | 52.00 | 100 | 270 | | 36.68 | 2.42 | 30.72 | 48.46 | 68.00 | -19.54 | Ch. 40/ |
| 6933.33 | 56.50 | 100 | 180 | | 36.58 | 3.48 | 33.97 | 57.37 | 68.00 | -10.63 | ABC |
| 10400.00 | 52.33 | 100 | 0 | | 36.85 | 4.40 | 35.82 | 55.70 | 68.00 | -12.30 | |
| 3493.33 | 51.67 | 100 | 45 | | 36.67 | 2.43 | 30.70 | 48.13 | 68.00 | -19.87 | Ch. 48/ |
| 6986.66 | 55.33 | 100 | 45 | | 36.60 | 3.50 | 33.99 | 56.22 | 68.00 | -11.78 | ABC |
| 10480.00 | 52.50 | 100 | 90 | | 36.79 | 4.43 | 35.88 | 56.02 | 68.00 | -11.98 | |



Radiated Emissions Test Results (Continued)

*Spurious Emissions Measurements in 802.11n mode 20MHz Wide (5150-5350 MHz)
Channels 52, 56, & 64
Continuous TX at Triple Chain ABC Antenna ports with Ethertronics Antennas
Aegis Labs, Inc. File #: INTEL-081125-46*

RADIATED EMISSIONS - Horizontal Antenna Polarization

| Freq. (MHz) | Meter Reading (dBuV) | Antenna Height (cm) | Azimuth (degrees) | Quasi pk or AVG (dBuV) | Preamp Factor (dB) | Cable Factor (dB) | Ant. Factor (dB) | Corrected Reading (dBuV) | Limits (dBuV) | Diff (dB) +=FAIL | Channel/ Chain Tested |
|-------------|----------------------|---------------------|-------------------|------------------------|--------------------|-------------------|------------------|--------------------------|---------------|------------------|-----------------------|
| 3506.66 | 53.17 | 100 | 315 | | 50.75 | 3.07 | 32.81 | 38.29 | 68.00 | -29.71 | Ch. 52/ |
| 7013.32 | 57.83 | 100 | 135 | | 50.42 | 4.43 | 35.71 | 47.55 | 68.00 | -20.45 | ABC |
| 3520.00 | 52.50 | 100 | 270 | | 50.74 | 3.08 | 32.82 | 37.67 | 68.00 | -30.33 | Ch. 56/ |
| 7040.00 | 52.33 | 100 | 225 | | 50.41 | 4.44 | 35.72 | 42.09 | 68.00 | -25.91 | ABC |
| 3546.66 | 54.33 | 100 | 270 | | 50.71 | 3.12 | 32.86 | 39.59 | 68.00 | -28.41 | Ch. 64/ |
| 7093.32 | 54.17 | 100 | 135 | | 50.38 | 4.46 | 35.76 | 44.01 | 68.00 | -23.99 | ABC |

RADIATED EMISSIONS - Vertical Antenna Polarization

| Freq. (MHz) | Meter Reading (dBuV) | Antenna Height (cm) | Azimuth (degrees) | Quasi pk or AVG (dBuV) | Preamp Factor (dB) | Cable Factor (dB) | Ant. Factor (dB) | Corrected Reading (dBuV) | Limits (dBuV) | Diff (dB) +=FAIL | Comments |
|-------------|----------------------|---------------------|-------------------|------------------------|--------------------|-------------------|------------------|--------------------------|---------------|------------------|----------------|
| 3506.66 | 54.17 | 100 | 135 | | 50.75 | 3.07 | 32.91 | 39.39 | 68.00 | -28.61 | Ch. 52/ |
| 7013.32 | 54.50 | 100 | 135 | | 50.42 | 4.43 | 35.61 | 44.12 | 68.00 | -23.88 | ABC |
| 10520.00 | 51.33 | 100 | 135 | | 50.43 | 5.56 | 37.52 | 43.98 | 68.00 | -24.02 | |
| 3520.00 | 53.50 | 100 | 0 | | 50.74 | 3.08 | 32.92 | 38.76 | 68.00 | -29.24 | Ch. 56/ |
| 7040.00 | 54.33 | 100 | 135 | | 50.41 | 4.44 | 35.64 | 44.00 | 68.00 | -24.00 | ABC |
| 10560.00 | 53.67 | 100 | 135 | | 50.43 | 5.57 | 37.55 | 46.36 | 68.00 | -21.64 | |
| 3546.66 | 53.83 | 100 | 135 | | 50.71 | 3.12 | 32.95 | 39.18 | 68.00 | -28.82 | Ch. 64/ |
| 7093.32 | 53.33 | 100 | 135 | | 50.38 | 4.46 | 35.69 | 43.10 | 68.00 | -24.90 | ABC |



Radiated Emissions Test Results (Continued)

*Spurious Emissions Measurements in 802.11n mode 20MHz Wide (5150-5350 MHz)
Channels 52, 56, & 64
Continuous TX at Triple Chain ABC Antenna ports with Wistron Neweb Corp. Antennas
Aegis Labs, Inc. File #: INTEL-081125-75*

RADIATED EMISSIONS - Horizontal Antenna Polarization

| Freq. (MHz) | Meter Reading (dBuV) | Antenna Height (cm) | Azimuth (degrees) | Quasi pk or AVG (dBuV) | Preamp Factor (dB) | Cable Factor (dB) | Ant. Factor (dB) | Corrected Reading (dBuV) | Limits (dBuV) | Diff (dB) +=FAIL | Channel/ Chain Tested |
|-------------|----------------------|---------------------|-------------------|------------------------|--------------------|-------------------|------------------|--------------------------|---------------|------------------|-----------------------|
| 3506.66 | 51.67 | 100 | 45 | | 36.66 | 2.43 | 32.01 | 49.45 | 68.00 | -18.55 | Ch. 52/ |
| 7013.33 | 52.33 | 100 | 0 | | 36.61 | 3.51 | 34.90 | 54.13 | 68.00 | -13.87 | ABC |
| 10520.00 | 51.50 | 100 | 0 | | 36.76 | 4.44 | 36.50 | 55.67 | 68.00 | -12.33 | |
| 3520.00 | 51.67 | 100 | 45 | | 36.65 | 2.44 | 32.04 | 49.50 | 68.00 | -18.50 | Ch. 56/ |
| 7040.00 | 52.17 | 100 | 315 | | 36.61 | 3.51 | 34.91 | 53.98 | 68.00 | -14.02 | ABC |
| 10560.00 | 52.50 | 100 | 315 | | 36.73 | 4.45 | 36.49 | 56.70 | 68.00 | -11.30 | |
| 3546.66 | 52.33 | 100 | 225 | | 36.63 | 2.45 | 32.09 | 50.25 | 68.00 | -17.75 | Ch. 64/ |
| 7093.33 | 53.17 | 100 | 315 | | 36.61 | 3.53 | 34.92 | 55.01 | 68.00 | -12.99 | ABC |
| 10640.00 | 51.17 | 100 | 315 | | 36.67 | 4.46 | 36.47 | 55.43 | 68.00 | -12.57 | |

RADIATED EMISSIONS - Vertical Antenna Polarization

| Freq. (MHz) | Meter Reading (dBuV) | Antenna Height (cm) | Azimuth (degrees) | Quasi pk or AVG (dBuV) | Preamp Factor (dB) | Cable Factor (dB) | Ant. Factor (dB) | Corrected Reading (dBuV) | Limits (dBuV) | Diff (dB) +=FAIL | Comments |
|-------------|----------------------|---------------------|-------------------|------------------------|--------------------|-------------------|------------------|--------------------------|---------------|------------------|----------------|
| 3506.66 | 52.33 | 100 | 45 | | 36.66 | 2.43 | 30.71 | 48.81 | 68.00 | -19.19 | Ch. 52/ |
| 7013.33 | 55.33 | 100 | 45 | | 36.61 | 3.51 | 34.00 | 56.23 | 68.00 | -11.77 | ABC |
| 10520.00 | 51.67 | 100 | 45 | | 36.76 | 4.44 | 35.90 | 55.25 | 68.00 | -12.75 | |
| 3520.00 | 52.00 | 100 | 0 | | 36.65 | 2.44 | 30.74 | 48.53 | 68.00 | -19.47 | Ch. 56/ |
| 7040.00 | 55.17 | 100 | 45 | | 36.61 | 3.51 | 34.01 | 56.08 | 68.00 | -11.92 | ABC |
| 10560.00 | 52.33 | 100 | 315 | | 36.73 | 4.45 | 35.91 | 55.96 | 68.00 | -12.04 | |
| 3546.66 | 53.67 | 100 | 45 | | 36.63 | 2.45 | 30.80 | 50.30 | 68.00 | -17.70 | Ch. 64/ |
| 7093.33 | 56.33 | 100 | 45 | | 36.61 | 3.53 | 34.02 | 57.27 | 68.00 | -10.73 | ABC |
| 10640.00 | 52.83 | 100 | 45 | | 36.67 | 4.46 | 35.93 | 56.54 | 68.00 | -11.46 | |

**RADIATED EMISSIONS TEST RESULTS**

| | | | |
|-----------------------|---------------------------------------------------------------------------------------------------------------------------------------|------------------------|--------------|
| CLIENT: | Intel Corporation | DATE: | 04/08/08 |
| EUT: | Intel WiFi Link 5300 | PROJECT NUMBER: | INTEL-081125 |
| MODEL NUMBER: | 533AN_HMW | TEST ENGINEER: | KN/RC |
| SERIAL NUMBER: | 0016EA038A16 | SITE #: | 2 |
| CONFIGURATION: | Tested installed in an extender board connected to the host laptop's mini PCI slot in 802.11n (5150-5350 MHz) mode 40MHz Wide. | TEMPERATURE: | 22° C |
| | | HUMIDITY: | 39% RH |
| | | TIME: | 8:00 AM |

| | |
|---------------------|---------------------------------------------------------------------------------------------------------------------------------------------------------------------------------------------|
| Description: | Radiated RF Emissions (1 GHz – 18 GHz) |
| Results: | PASSED Horizontal and Vertical Antenna Polarizations Class B Limits |
| Note: | Radiated Emissions Measurements were performed on the EUT with power supply set at the following voltage and frequency. <ul style="list-style-type: none"> • 120VAC / 60 Hz. |

| Unwanted Spurious Emissions Limits | | | |
|-------------------------------------------|------------------------------|------------------------------------------------------------------------|------------------------------------------------------------------------------|
| Frequency (MHz) | Field Strength (uV/m) | Field Strength (dBuV/m) (Emissions in the restricted bands) | Field Strength (dBm/MHz) (Emissions outside the restricted bands) |
| Above 960 | 500 | 54.00 (Average) 74.00 (Peak) | < -20 dBc |

Radiated Emissions Sample Calculations

$$\text{Corrected Meter Reading} = \text{Meter Reading} + F + C - D$$

Where, F = Antenna Factor

C = Cable Factor

G = Amplifier Gain

D = Distance Factor (if applicable)

Therefore, the equation for determining the Corrected Meter Reading Limit (CML) is:

$$\text{CML} = \text{Specification Limit} - F - C + D$$



Radiated Emissions Test Results (Continued)

*Fundamental Measurements in 802.11n mode 40MHz Wide (5150-5350 MHz)
Channels 38, 46, 54, & 62
Continuous TX at Chain A Antenna port with Ethertronics Antennas
Aegis Labs, Inc. File #: INTEL-081125-51*

| RADIATED EMISSIONS - Horizontal Antenna Polarization | | | | | | | | | | | |
|-------------------------------------------------------------|-----------------------------|----------------------------|--------------------------|-------------------------------|---|--------------------------|-------------------------|---------------------------------|----------------------|-------------------------|-----------------|
| <i>Freq. (MHz)</i> | <i>Meter Reading (dBuV)</i> | <i>Antenna Height (cm)</i> | <i>Azimuth (degrees)</i> | <i>Quasi pk or AVG (dBuV)</i> | | <i>Cable Factor (dB)</i> | <i>Ant. Factor (dB)</i> | <i>Corrected Reading (dBuV)</i> | <i>Limits (dBuV)</i> | <i>Diff (dB) +=FAIL</i> | <i>Comments</i> |
| 5190.00 | 60.17 | 100 | 135 | | | 3.78 | 34.33 | 98.28 | | | Ch. 38 |
| 5190.00 | | | | 49.83 | A | 3.78 | 34.33 | 87.94 | | | |
| 5230.00 | 62.83 | 100 | 135 | | | 3.79 | 34.38 | 101.00 | | | Ch. 46 |
| 5230.00 | | | | 52.16 | A | 3.79 | 34.38 | 90.33 | | | |
| 5270.00 | 63.00 | 100 | 135 | | | 3.81 | 34.42 | 101.23 | | | Ch. 54 |
| 5270.00 | | | | 52.83 | A | 3.81 | 34.42 | 91.06 | | | |
| 5310.00 | 64.17 | 100 | 135 | | | 3.82 | 34.47 | 102.46 | | | Ch. 62 |
| 5310.00 | | | | 53.67 | A | 3.82 | 34.47 | 91.96 | | | |

| RADIATED EMISSIONS - Vertical Antenna Polarization | | | | | | | | | | | |
|-----------------------------------------------------------|-----------------------------|----------------------------|--------------------------|-------------------------------|---|--------------------------|-------------------------|---------------------------------|----------------------|-------------------------|-----------------|
| <i>Freq. (MHz)</i> | <i>Meter Reading (dBuV)</i> | <i>Antenna Height (cm)</i> | <i>Azimuth (degrees)</i> | <i>Quasi pk or AVG (dBuV)</i> | | <i>Cable Factor (dB)</i> | <i>Ant. Factor (dB)</i> | <i>Corrected Reading (dBuV)</i> | <i>Limits (dBuV)</i> | <i>Diff (dB) +=FAIL</i> | <i>Comments</i> |
| 5190.00 | 61.33 | 100 | 315 | | | 3.78 | 34.31 | 99.42 | | | Ch. 38 |
| 5190.00 | | | | 50.50 | A | 3.78 | 34.31 | 88.59 | | | |
| 5230.00 | 63.50 | 100 | 225 | | | 3.79 | 34.34 | 101.63 | | | Ch. 46 |
| 5230.00 | | | | 52.83 | A | 3.79 | 34.34 | 90.96 | | | |
| 5270.00 | 64.00 | 100 | 225 | | | 3.81 | 34.36 | 102.17 | | | Ch. 54 |
| 5270.00 | | | | 53.83 | A | 3.81 | 34.36 | 92.00 | | | |
| 5310.00 | 64.17 | 100 | 225 | | | 3.82 | 34.39 | 102.38 | | | Ch. 62 |
| 5310.00 | | | | 53.33 | A | 3.82 | 34.39 | 91.54 | | | |

NOTE: Fundamental signals measured to calculate the band edge field strengths using the “Marker Delta Method”.



Radiated Emissions Test Results (Continued)

*Band Edge Field Strength Measurements in 802.11n mode 40MHz Wide (5150-5350 MHz)
 Channels 38 & 62
 Continuous TX at Chain A Antenna port with Ethertronics Antennas
 Aegis Labs, Inc. File #: INTEL-081125-51*

| RADIATED EMISSIONS - Horizontal Antenna Polarization | | | | | | | | | | |
|-------------------------------------------------------------|-----------------------------|----------------------------|--------------------------|-------------------------------|--------------------------|-------------------------|---------------------------------|----------------------|-------------------------|-----------------|
| <i>Freq. (MHz)</i> | <i>Meter Reading (dBuV)</i> | <i>Antenna Height (cm)</i> | <i>Azimuth (degrees)</i> | <i>Quasi pk or AVG (dBuV)</i> | <i>Cable Factor (dB)</i> | <i>Ant. Factor (dB)</i> | <i>Corrected Reading (dBuV)</i> | <i>Limits (dBuV)</i> | <i>Diff (dB) +=FAIL</i> | <i>Comments</i> |
| 5150.00 | | | | | | | 67.28 | 74.00 | -6.72 | Ch. 38 |
| 5150.00 | | | | | A | | 49.77 | 54.00 | -4.23 | |
| 5350.00 | | | | | | | 71.96 | 74.00 | -2.04 | Ch. 62 |
| 5350.00 | | | | | A | | 50.96 | 54.00 | -3.04 | |

| RADIATED EMISSIONS - Vertical Antenna Polarization | | | | | | | | | | |
|-----------------------------------------------------------|-----------------------------|----------------------------|--------------------------|-------------------------------|--------------------------|-------------------------|---------------------------------|----------------------|-------------------------|-----------------|
| <i>Freq. (MHz)</i> | <i>Meter Reading (dBuV)</i> | <i>Antenna Height (cm)</i> | <i>Azimuth (degrees)</i> | <i>Quasi pk or AVG (dBuV)</i> | <i>Cable Factor (dB)</i> | <i>Ant. Factor (dB)</i> | <i>Corrected Reading (dBuV)</i> | <i>Limits (dBuV)</i> | <i>Diff (dB) +=FAIL</i> | <i>Comments</i> |
| 5150.00 | | | | | | | 68.42 | 74.00 | -5.58 | Ch. 38 |
| 5150.00 | | | | | A | | 50.42 | 54.00 | -3.58 | |
| 5350.00 | | | | | | | 71.88 | 74.00 | -2.12 | Ch. 62 |
| 5350.00 | | | | | A | | 50.54 | 54.00 | -3.46 | |

NOTE: The “Band Edge Field Strength” was calculated using the “Fundamental” and “Conducted Band Edge” measurements per the “Marker-Delta Method” with the following formula:

$$BE = F_m - \Delta m$$

Where

BE = Band Edge Field Strength

F_m = Measured Fundamental (Peak or Average)

Δ_m = Measured Conducted Band Edge Delta (Peak or Average)



Radiated Emissions Test Results (Continued)

*Fundamental Measurements in 802.11n mode 40MHz Wide (5150-5350 MHz)
Channels 38, 46, 54, & 62
Continuous TX at Chain A Antenna port with Wistron Neweb Corp. Antennas
Aegis Labs, Inc. File #: INTEL-081125-71*

| RADIATED EMISSIONS - Horizontal Antenna Polarization | | | | | | | | | | | |
|-------------------------------------------------------------|-----------------------------|----------------------------|--------------------------|-------------------------------|---|--------------------------|-------------------------|---------------------------------|----------------------|-------------------------|-----------------|
| <i>Freq. (MHz)</i> | <i>Meter Reading (dBuV)</i> | <i>Antenna Height (cm)</i> | <i>Azimuth (degrees)</i> | <i>Quasi pk or AVG (dBuV)</i> | | <i>Cable Factor (dB)</i> | <i>Ant. Factor (dB)</i> | <i>Corrected Reading (dBuV)</i> | <i>Limits (dBuV)</i> | <i>Diff (dB) +=FAIL</i> | <i>Comments</i> |
| 5190.00 | 64.17 | 100 | 225 | | | 3.78 | 34.33 | 102.28 | | | Ch. 38 |
| 5190.00 | | | | 53.83 | A | 3.78 | 34.33 | 91.94 | | | |
| 5230.00 | 64.33 | 100 | 180 | | | 3.79 | 34.38 | 102.50 | | | Ch. 46 |
| 5230.00 | | | | 53.33 | A | 3.79 | 34.38 | 91.50 | | | |
| 5270.00 | 63.67 | 100 | 180 | | | 3.81 | 34.42 | 101.90 | | | Ch. 54 |
| 5270.00 | | | | 53.00 | A | 3.81 | 34.42 | 91.23 | | | |
| 5310.00 | 63.50 | 100 | 180 | | | 3.82 | 34.47 | 101.79 | | | Ch. 62 |
| 5310.00 | | | | 51.50 | A | 3.82 | 34.47 | 89.79 | | | |

| RADIATED EMISSIONS - Vertical Antenna Polarization | | | | | | | | | | | |
|-----------------------------------------------------------|-----------------------------|----------------------------|--------------------------|-------------------------------|---|--------------------------|-------------------------|---------------------------------|----------------------|-------------------------|-----------------|
| <i>Freq. (MHz)</i> | <i>Meter Reading (dBuV)</i> | <i>Antenna Height (cm)</i> | <i>Azimuth (degrees)</i> | <i>Quasi pk or AVG (dBuV)</i> | | <i>Cable Factor (dB)</i> | <i>Ant. Factor (dB)</i> | <i>Corrected Reading (dBuV)</i> | <i>Limits (dBuV)</i> | <i>Diff (dB) +=FAIL</i> | <i>Comments</i> |
| 5190.00 | 65.00 | 100 | 315 | | | 3.78 | 34.31 | 103.09 | | | Ch. 38 |
| 5190.00 | | | | 53.67 | A | 3.78 | 34.31 | 91.76 | | | |
| 5230.00 | 67.50 | 100 | 270 | | | 3.79 | 34.34 | 105.63 | | | Ch. 46 |
| 5230.00 | | | | 56.17 | A | 3.79 | 34.34 | 94.30 | | | |
| 5270.00 | 66.00 | 100 | 270 | | | 3.81 | 34.36 | 104.17 | | | Ch. 54 |
| 5270.00 | | | | 55.33 | A | 3.81 | 34.36 | 93.50 | | | |
| 5310.00 | 65.67 | 100 | 270 | | | 3.82 | 34.39 | 103.88 | | | Ch. 62 |
| 5310.00 | | | | 55.33 | A | 3.82 | 34.39 | 93.54 | | | |

NOTE: Fundamental signals measured to calculate the band edge field strengths using the “Marker Delta Method”.



Radiated Emissions Test Results (Continued)

*Band Edge Field Strength Measurements in 802.11n mode 40MHz Wide (5150-5350 MHz)
Channels 38 & 62
Continuous TX at Chain A Antenna port with Wistron Neweb Corp. Antennas
Aegis Labs, Inc. File #: INTEL-081125-71*

| RADIATED EMISSIONS - Horizontal Antenna Polarization | | | | | | | | | | |
|-------------------------------------------------------------|-----------------------------|----------------------------|--------------------------|-------------------------------|--------------------------|-------------------------|---------------------------------|----------------------|-------------------------|-----------------|
| <i>Freq. (MHz)</i> | <i>Meter Reading (dBuV)</i> | <i>Antenna Height (cm)</i> | <i>Azimuth (degrees)</i> | <i>Quasi pk or AVG (dBuV)</i> | <i>Cable Factor (dB)</i> | <i>Ant. Factor (dB)</i> | <i>Corrected Reading (dBuV)</i> | <i>Limits (dBuV)</i> | <i>Diff (dB) +=FAIL</i> | <i>Comments</i> |
| 5150.00 | | | | | | | 71.28 | 74.00 | -2.72 | Ch. 38 |
| 5150.00 | | | | | A | | 53.77 | 54.00 | -0.23 | |
| 5350.00 | | | | | | | 71.29 | 74.00 | -2.71 | Ch. 62 |
| 5350.00 | | | | | A | | 48.79 | 54.00 | -5.21 | |

| RADIATED EMISSIONS - Vertical Antenna Polarization | | | | | | | | | | |
|-----------------------------------------------------------|-----------------------------|----------------------------|--------------------------|-------------------------------|--------------------------|-------------------------|---------------------------------|----------------------|-------------------------|-----------------|
| <i>Freq. (MHz)</i> | <i>Meter Reading (dBuV)</i> | <i>Antenna Height (cm)</i> | <i>Azimuth (degrees)</i> | <i>Quasi pk or AVG (dBuV)</i> | <i>Cable Factor (dB)</i> | <i>Ant. Factor (dB)</i> | <i>Corrected Reading (dBuV)</i> | <i>Limits (dBuV)</i> | <i>Diff (dB) +=FAIL</i> | <i>Comments</i> |
| 5150.00 | | | | | | | 72.09 | 74.00 | -1.91 | Ch. 38 |
| 5150.00 | | | | | A | | 53.59 | 54.00 | -0.41 | |
| 5350.00 | | | | | | | 73.38 | 74.00 | -0.62 | Ch. 62 |
| 5350.00 | | | | | A | | 52.54 | 54.00 | -1.46 | |

NOTE: The “Band Edge Field Strength” was calculated using the “Fundamental” and “Conducted Band Edge” measurements per the “Marker-Delta Method” with the following formula:

$$BE = Fm - \Delta m$$

Where

BE = Band Edge Field Strength

Fm = Measured Fundamental (Peak or Average)

Δm = Measured Conducted Band Edge Delta (Peak or Average)

Radiated Emissions Test Results (Continued)

Plots Showing Out-Of-Band Emissions (Peak RBW=VBW=1MHz; Average RBW = 1MHz, VBW = 10Hz)

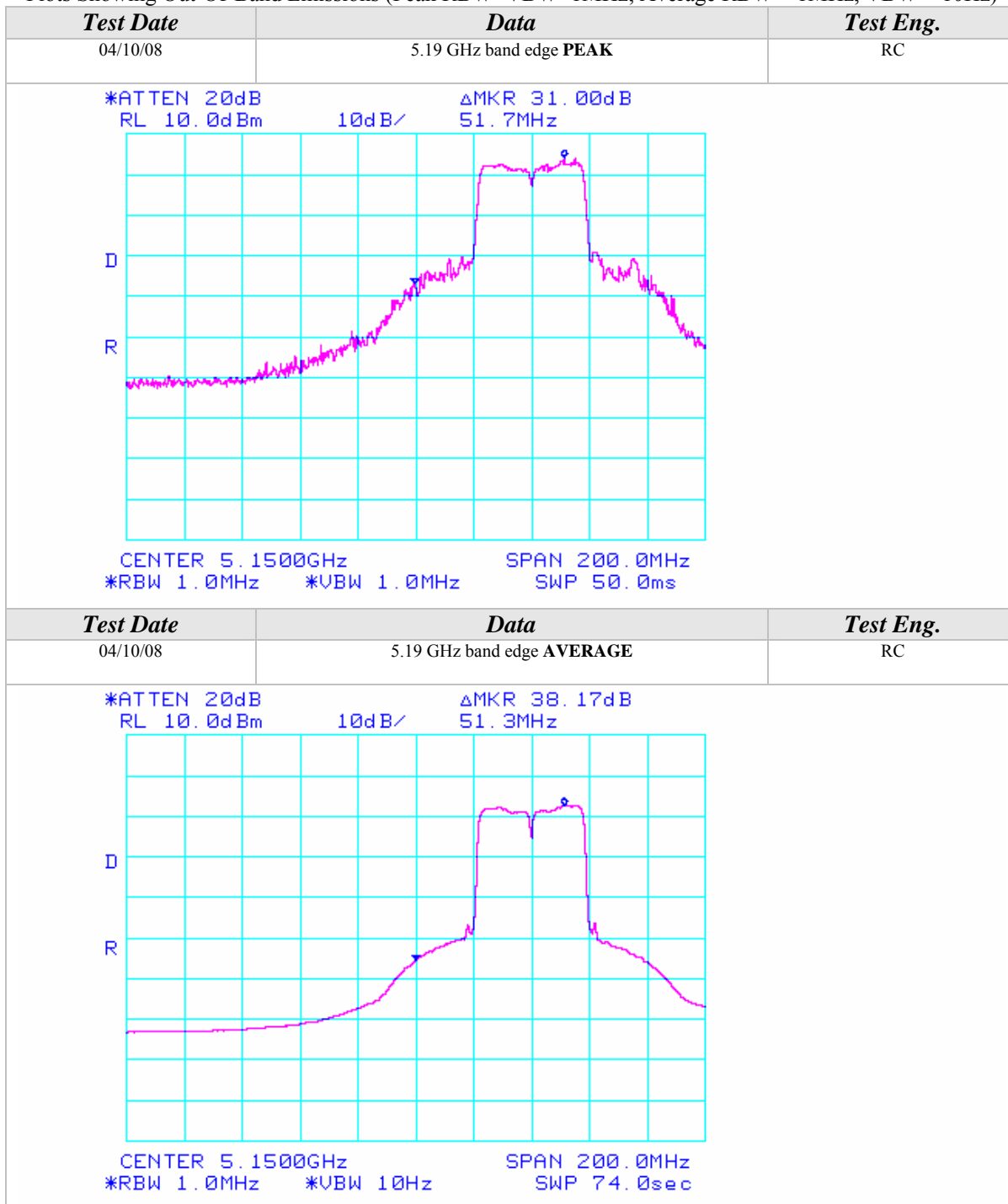

Radiated Emissions Test Results (Continued)

Plots Showing Out-Of-Band Emissions (Peak RBW=VBW=1MHz; Average RBW = 1MHz, VBW = 10Hz)

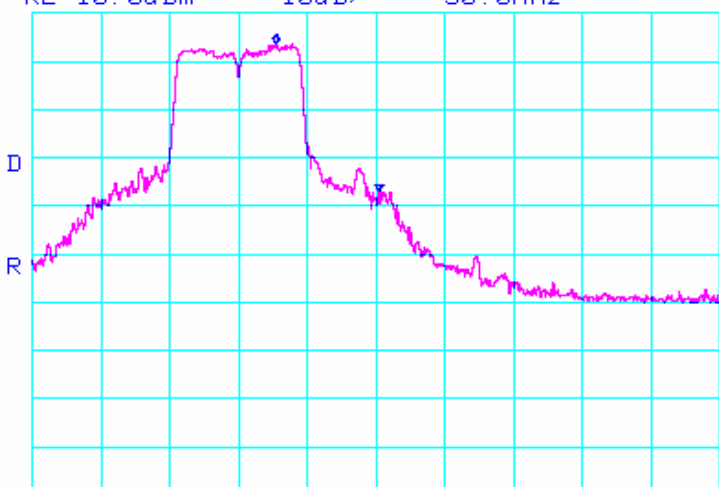
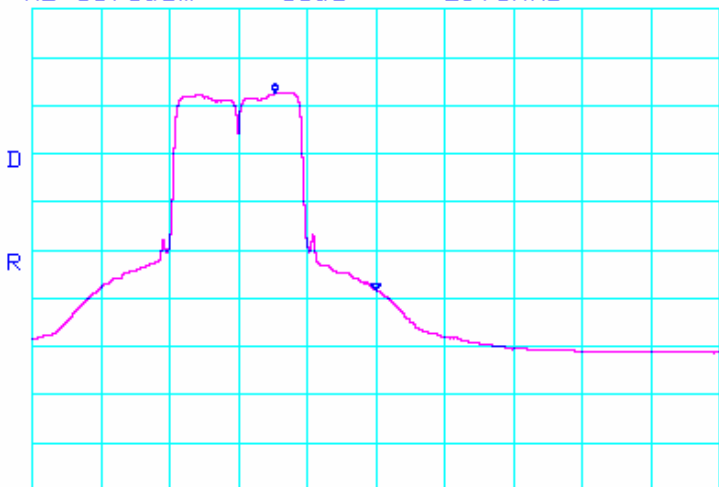
| <i>Test Date</i> | <i>Data</i> | <i>Test Eng.</i> |
|--------------------------------------------------------------------------------------------------------------------------------------------------------------------------------------------------------------------------------------------------------------|-----------------------------------|------------------|
| 04/10/08 | 5.31 GHz band edge PEAK | RC |
| <p>*ATTEN 20dB ΔMKR 30.50dB RL 10.0dBm 10dB/ -30.0MHz</p>  <p>CENTER 5.3500GHz SPAN 200.0MHz *RBW 1.0MHz *VBW 1.0MHz SWP 50.0ms</p> | | |
| <i>Test Date</i> | <i>Data</i> | <i>Test Eng.</i> |
| 04/10/08 | 5.31 GHz band edge AVERAGE | RC |
| <p>*ATTEN 20dB ΔMKR 41.00dB RL 10.0dBm 10dB/ -29.3MHz</p>  <p>CENTER 5.3500GHz SPAN 200.0MHz *RBW 1.0MHz *VBW 10Hz SWP 74.0sec</p> | | |



Radiated Emissions Test Results (Continued)

*Fundamental Measurements in 802.11n mode 40MHz Wide (5150-5350 MHz)
 Channels 38, 46, 54, & 62
 Continuous TX at Chain B Antenna port with Ethertronics Antennas
 Aegis Labs, Inc. File #: INTEL-081125-52*

| RADIATED EMISSIONS - Horizontal Antenna Polarization | | | | | | | | | | | |
|-------------------------------------------------------------|-----------------------------|----------------------------|--------------------------|-------------------------------|---|--------------------------|-------------------------|---------------------------------|----------------------|-------------------------|-----------------|
| <i>Freq. (MHz)</i> | <i>Meter Reading (dBuV)</i> | <i>Antenna Height (cm)</i> | <i>Azimuth (degrees)</i> | <i>Quasi pk or AVG (dBuV)</i> | | <i>Cable Factor (dB)</i> | <i>Ant. Factor (dB)</i> | <i>Corrected Reading (dBuV)</i> | <i>Limits (dBuV)</i> | <i>Diff (dB) +=FAIL</i> | <i>Comments</i> |
| 5190.00 | 60.83 | 100 | 315 | | | 3.78 | 34.33 | 98.94 | | | Ch. 38 |
| 5190.00 | | | | 51.80 | A | 3.78 | 34.33 | 89.91 | | | |
| 5230.00 | 61.67 | 100 | 315 | | | 3.79 | 34.38 | 99.84 | | | Ch. 46 |
| 5230.00 | | | | 52.67 | A | 3.79 | 34.38 | 90.84 | | | |
| 5270.00 | 60.50 | 100 | 315 | | | 3.81 | 34.42 | 98.73 | | | Ch. 54 |
| 5270.00 | | | | 50.33 | A | 3.81 | 34.42 | 88.56 | | | |
| 5310.00 | 59.83 | 100 | 270 | | | 3.82 | 34.47 | 98.12 | | | Ch. 62 |
| 5310.00 | | | | 50.16 | A | 3.82 | 34.47 | 88.45 | | | |

| RADIATED EMISSIONS - Vertical Antenna Polarization | | | | | | | | | | | |
|-----------------------------------------------------------|-----------------------------|----------------------------|--------------------------|-------------------------------|---|--------------------------|-------------------------|---------------------------------|----------------------|-------------------------|-----------------|
| <i>Freq. (MHz)</i> | <i>Meter Reading (dBuV)</i> | <i>Antenna Height (cm)</i> | <i>Azimuth (degrees)</i> | <i>Quasi pk or AVG (dBuV)</i> | | <i>Cable Factor (dB)</i> | <i>Ant. Factor (dB)</i> | <i>Corrected Reading (dBuV)</i> | <i>Limits (dBuV)</i> | <i>Diff (dB) +=FAIL</i> | <i>Comments</i> |
| 5190.00 | 59.50 | 100 | 225 | | | 3.78 | 34.31 | 97.59 | | | Ch. 38 |
| 5190.00 | | | | 50.47 | A | 3.78 | 34.31 | 88.56 | | | |
| 5230.00 | 58.67 | 100 | 225 | | | 3.79 | 34.34 | 96.80 | | | Ch. 46 |
| 5230.00 | | | | 49.67 | A | 3.79 | 34.34 | 87.80 | | | |
| 5270.00 | 61.17 | 100 | 135 | | | 3.81 | 34.36 | 99.34 | | | Ch. 54 |
| 5270.00 | | | | 51.00 | A | 3.81 | 34.36 | 89.17 | | | |
| 5310.00 | 62.67 | 100 | 135 | | | 3.82 | 34.39 | 100.88 | | | Ch. 62 |
| 5310.00 | | | | 53.00 | A | 3.82 | 34.39 | 91.21 | | | |

NOTE: Fundamental signals measured to calculate the band edge field strengths using the “Marker Delta Method”.



Radiated Emissions Test Results (Continued)

*Band Edge Field Strength Measurements in 802.11n mode 40MHz Wide (5150-5350 MHz)
Channels 38 & 62
Continuous TX at Chain B Antenna port with Ethertronics Antennas
Aegis Labs, Inc. File #: INTEL-081125-52*

RADIATED EMISSIONS - Horizontal Antenna Polarization

| Freq. (MHz) | Meter Reading (dBuV) | Antenna Height (cm) | Azimuth (degrees) | Quasi pk or AVG (dBuV) | Cable Factor (dB) | Ant. Factor (dB) | Corrected Reading (dBuV) | Limits (dBuV) | Diff (dB) +=FAIL | Comments |
|-------------|----------------------|---------------------|-------------------|------------------------|-------------------|------------------|--------------------------|---------------|------------------|---------------|
| 5150.00 | | | | | | | 67.61 | 74.00 | -6.39 | Ch. 38 |
| 5150.00 | | | | A | | | 51.08 | 54.00 | -2.92 | |
| 5350.00 | | | | | | | 66.95 | 74.00 | -7.05 | Ch. 62 |
| 5350.00 | | | | A | | | 46.95 | 54.00 | -7.05 | |

RADIATED EMISSIONS - Vertical Antenna Polarization

| Freq. (MHz) | Meter Reading (dBuV) | Antenna Height (cm) | Azimuth (degrees) | Quasi pk or AVG (dBuV) | Cable Factor (dB) | Ant. Factor (dB) | Corrected Reading (dBuV) | Limits (dBuV) | Diff (dB) +=FAIL | Comments |
|-------------|----------------------|---------------------|-------------------|------------------------|-------------------|------------------|--------------------------|---------------|------------------|---------------|
| 5150.00 | | | | | | | 66.26 | 74.00 | -7.74 | Ch. 38 |
| 5150.00 | | | | A | | | 49.73 | 54.00 | -4.27 | |
| 5350.00 | | | | | | | 69.71 | 74.00 | -4.29 | Ch. 62 |
| 5350.00 | | | | A | | | 49.71 | 54.00 | -4.29 | |

NOTE: The “Band Edge Field Strength” was calculated using the “Fundamental” and “Conducted Band Edge” measurements per the “Marker-Delta Method” with the following formula:

$$BE = Fm - \Delta m$$

Where

BE = Band Edge Field Strength

Fm = Measured Fundamental (Peak or Average)

Δm = Measured Conducted Band Edge Delta (Peak or Average)



Radiated Emissions Test Results (Continued)

*Fundamental Measurements in 802.11n mode 40MHz Wide (5150-5350 MHz)
Channels 38, 46, 54, & 62
Continuous TX at Chain B Antenna port with Wistron Neweb Corp. Antennas
Aegis Labs, Inc. File #: INTEL-081125-72*

| RADIATED EMISSIONS - Horizontal Antenna Polarization | | | | | | | | | | | |
|-------------------------------------------------------------|-----------------------------|----------------------------|--------------------------|-------------------------------|---|--------------------------|-------------------------|---------------------------------|----------------------|-------------------------|-----------------|
| <i>Freq. (MHz)</i> | <i>Meter Reading (dBuV)</i> | <i>Antenna Height (cm)</i> | <i>Azimuth (degrees)</i> | <i>Quasi pk or AVG (dBuV)</i> | | <i>Cable Factor (dB)</i> | <i>Ant. Factor (dB)</i> | <i>Corrected Reading (dBuV)</i> | <i>Limits (dBuV)</i> | <i>Diff (dB) +=FAIL</i> | <i>Comments</i> |
| 5190.00 | 65.33 | 100 | 90 | | | 3.78 | 34.33 | 103.44 | | | Ch. 38 |
| 5190.00 | | | | 54.17 | A | 3.78 | 34.33 | 92.28 | | | |
| 5230.00 | 66.50 | 100 | 90 | | | 3.79 | 34.38 | 104.67 | | | Ch. 46 |
| 5230.00 | | | | 56.17 | A | 3.79 | 34.38 | 94.34 | | | |
| 5270.00 | 66.33 | 100 | 90 | | | 3.81 | 34.42 | 104.56 | | | Ch. 54 |
| 5270.00 | | | | 56.17 | A | 3.81 | 34.42 | 94.40 | | | |
| 5310.00 | 66.17 | 100 | 90 | | | 3.82 | 34.47 | 104.46 | | | Ch. 62 |
| 5310.00 | | | | 56.17 | A | 3.82 | 34.47 | 94.46 | | | |

| RADIATED EMISSIONS - Vertical Antenna Polarization | | | | | | | | | | | |
|-----------------------------------------------------------|-----------------------------|----------------------------|--------------------------|-------------------------------|---|--------------------------|-------------------------|---------------------------------|----------------------|-------------------------|-----------------|
| <i>Freq. (MHz)</i> | <i>Meter Reading (dBuV)</i> | <i>Antenna Height (cm)</i> | <i>Azimuth (degrees)</i> | <i>Quasi pk or AVG (dBuV)</i> | | <i>Cable Factor (dB)</i> | <i>Ant. Factor (dB)</i> | <i>Corrected Reading (dBuV)</i> | <i>Limits (dBuV)</i> | <i>Diff (dB) +=FAIL</i> | <i>Comments</i> |
| 5190.00 | 59.50 | 100 | 225 | | | 3.78 | 34.31 | 97.59 | | | Ch. 38 |
| 5190.00 | | | | 50.47 | A | 3.78 | 34.31 | 88.56 | | | |
| 5230.00 | 58.67 | 100 | 225 | | | 3.79 | 34.34 | 96.80 | | | Ch. 46 |
| 5230.00 | | | | 49.67 | A | 3.79 | 34.34 | 87.80 | | | |
| 5270.00 | 61.17 | 100 | 135 | | | 3.81 | 34.36 | 99.34 | | | Ch. 54 |
| 5270.00 | | | | 51.00 | A | 3.81 | 34.36 | 89.17 | | | |
| 5310.00 | 62.67 | 100 | 135 | | | 3.82 | 34.39 | 100.88 | | | Ch. 62 |
| 5310.00 | | | | 50.89 | A | 3.82 | 34.39 | 89.10 | | | |

NOTE: Fundamental signals measured to calculate the band edge field strengths using the “Marker Delta Method”.



Radiated Emissions Test Results (Continued)

*Band Edge Field Strength Measurements in 802.11n mode 40MHz Wide (5150-5350 MHz)
Channels 38 & 62
Continuous TX at Chain B Antenna port with Wistron Neweb Corp. Antennas
Aegis Labs, Inc. File #: INTEL-081125-72*

| RADIATED EMISSIONS - Horizontal Antenna Polarization | | | | | | | | | | |
|-------------------------------------------------------------|-----------------------------|----------------------------|--------------------------|-------------------------------|--------------------------|-------------------------|---------------------------------|----------------------|-------------------------|-----------------|
| <i>Freq. (MHz)</i> | <i>Meter Reading (dBuV)</i> | <i>Antenna Height (cm)</i> | <i>Azimuth (degrees)</i> | <i>Quasi pk or AVG (dBuV)</i> | <i>Cable Factor (dB)</i> | <i>Ant. Factor (dB)</i> | <i>Corrected Reading (dBuV)</i> | <i>Limits (dBuV)</i> | <i>Diff (dB) +=FAIL</i> | <i>Comments</i> |
| 5150.00 | | | | | | | 72.11 | 74.00 | -1.89 | Ch. 38 |
| 5150.00 | | | | | A | | 53.45 | 54.00 | -0.55 | |
| 5350.00 | | | | | | | 73.29 | 74.00 | -0.71 | Ch. 62 |
| 5350.00 | | | | | A | | 52.96 | 54.00 | -1.04 | |

| RADIATED EMISSIONS - Vertical Antenna Polarization | | | | | | | | | | |
|-----------------------------------------------------------|-----------------------------|----------------------------|--------------------------|-------------------------------|--------------------------|-------------------------|---------------------------------|----------------------|-------------------------|-----------------|
| <i>Freq. (MHz)</i> | <i>Meter Reading (dBuV)</i> | <i>Antenna Height (cm)</i> | <i>Azimuth (degrees)</i> | <i>Quasi pk or AVG (dBuV)</i> | <i>Cable Factor (dB)</i> | <i>Ant. Factor (dB)</i> | <i>Corrected Reading (dBuV)</i> | <i>Limits (dBuV)</i> | <i>Diff (dB) +=FAIL</i> | <i>Comments</i> |
| 5150.00 | | | | | | | 66.26 | 74.00 | -7.74 | Ch. 38 |
| 5150.00 | | | | | A | | 49.73 | 54.00 | -4.27 | |
| 5350.00 | | | | | | | 69.71 | 74.00 | -4.29 | Ch. 62 |
| 5350.00 | | | | | A | | 47.60 | 54.00 | -6.40 | |

NOTE: The “Band Edge Field Strength” was calculated using the “Fundamental” and “Conducted Band Edge” measurements per the “Marker-Delta Method” with the following formula:

$$BE = Fm - \Delta m$$

Where

BE = Band Edge Field Strength

Fm = Measured Fundamental (Peak or Average)

Δm = Measured Conducted Band Edge Delta (Peak or Average)

Radiated Emissions Test Results (Continued)

Plots Showing Out-Of-Band Emissions (Peak RBW=VBW=1MHz; Average RBW = 1MHz, VBW = 10Hz)

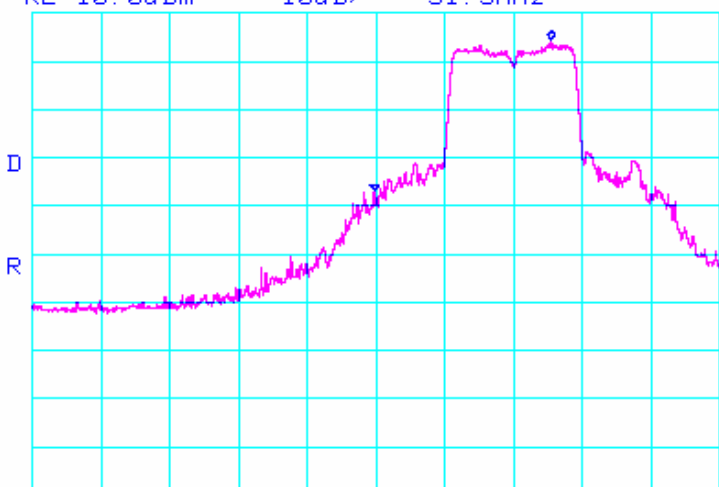
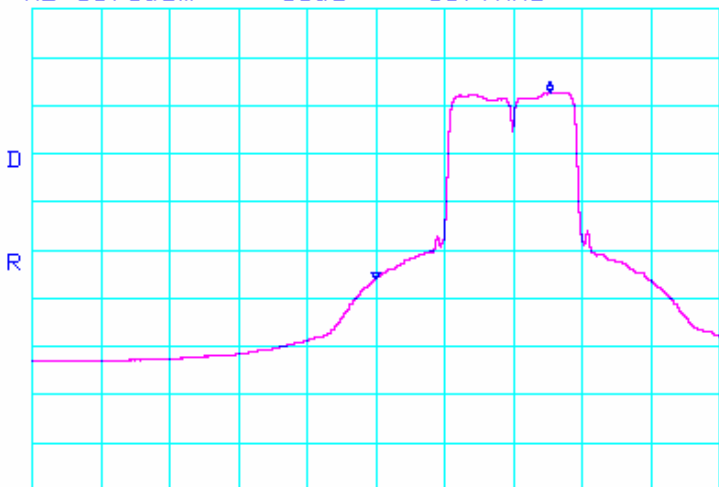
| Test Date | Data | Test Eng. |
|-------------------------------------------------------------------------------------------------------------------------------------------------------------------------------------------------------------------------------------------------------------------------------------------------------------------------------------------------------------------------------------------------------------------------------------------------------------------------------------------------------|-----------------------------------|------------------|
| 04/10/08 | 5.19 GHz band edge PEAK | RC |
| <p>*ATTEN 20dB ΔMKR 31.33dB RL 10.0dBm 10dB/ 51.3MHz</p>  <p>CENTER 5.1500GHz SPAN 200.0MHz *RBW 1.0MHz *VBW 1.0MHz SWP 50.0ms</p> | | |
| Test Date | Data | Test Eng. |
| 04/10/08 | 5.19 GHz band edge AVERAGE | RC |
| <p>*ATTEN 20dB ΔMKR 38.83dB RL 10.0dBm 10dB/ 50.7MHz</p>  <p>CENTER 5.1500GHz SPAN 200.0MHz *RBW 1.0MHz *VBW 10Hz SWP 74.0sec</p> | | |

Radiated Emissions Test Results (Continued)

Plots Showing Out-Of-Band Emissions (Peak RBW=VBW=1MHz; Average RBW = 1MHz, VBW = 10Hz)

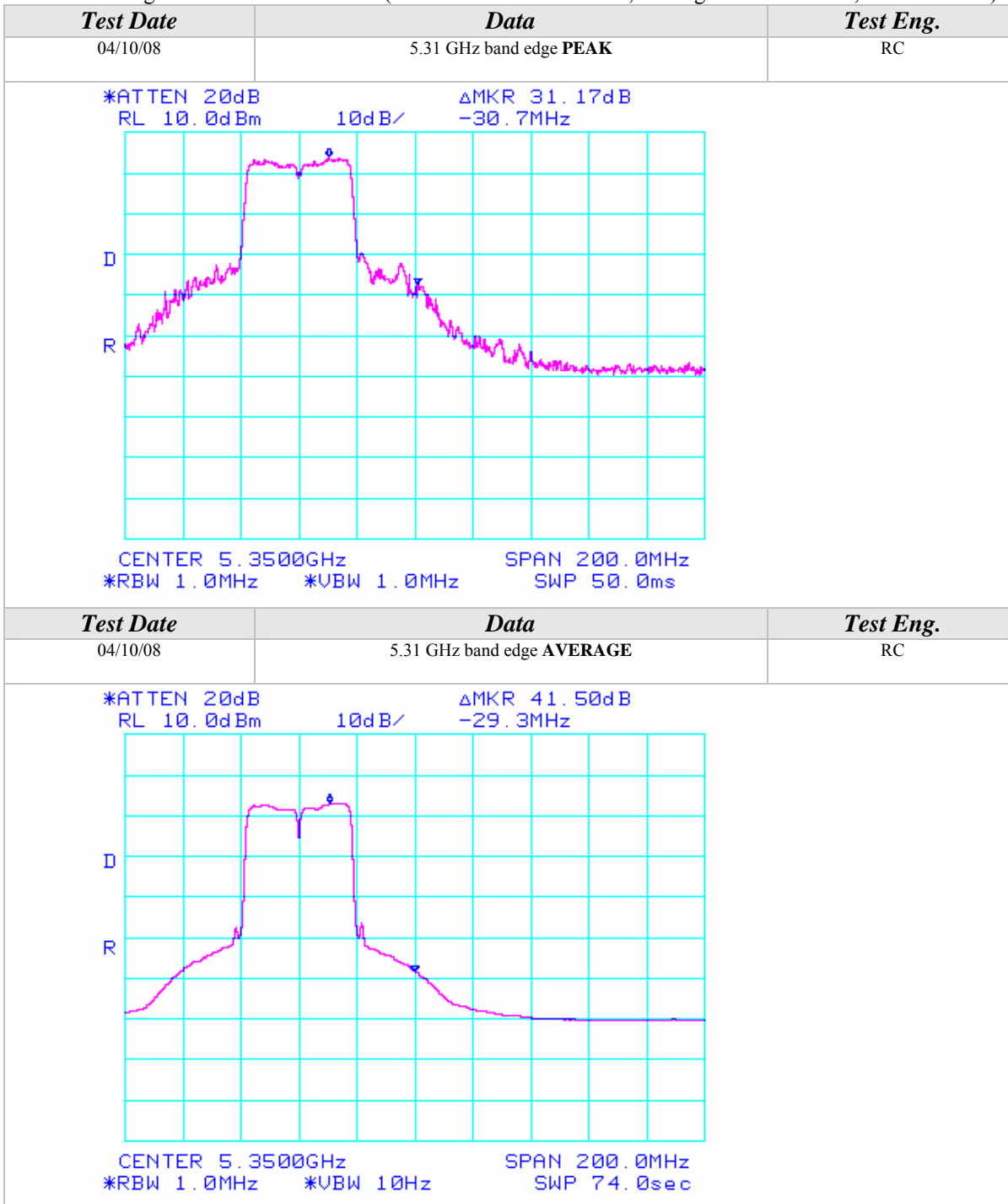

Radiated Emissions Test Results (Continued)

Fundamental Measurements in 802.11n mode 40MHz Wide (5150-5350 MHz)
Channels 38, 46, 54, & 62
Continuous TX at Chain C Antenna port with Ethertronics Antennas
Aegis Labs, Inc. File #: INTEL-081125-53

| RADIATED EMISSIONS - Horizontal Antenna Polarization | | | | | | | | | | | |
|-------------------------------------------------------------|-----------------------------|----------------------------|--------------------------|-------------------------------|---|--------------------------|-------------------------|---------------------------------|----------------------|-------------------------|-----------------|
| <i>Freq. (MHz)</i> | <i>Meter Reading (dBuV)</i> | <i>Antenna Height (cm)</i> | <i>Azimuth (degrees)</i> | <i>Quasi pk or AVG (dBuV)</i> | | <i>Cable Factor (dB)</i> | <i>Ant. Factor (dB)</i> | <i>Corrected Reading (dBuV)</i> | <i>Limits (dBuV)</i> | <i>Diff (dB) +=FAIL</i> | <i>Comments</i> |
| 5190.00 | 64.67 | 100 | 225 | | | 3.78 | 34.33 | 102.94 | | | Ch. 38 |
| 5190.00 | | | | 55.13 | A | 3.78 | 34.33 | 94.24 | | | |
| 5230.00 | 67.00 | 100 | 225 | | | 3.79 | 34.38 | 105.17 | | | Ch. 46 |
| 5230.00 | | | | 56.33 | A | 3.79 | 34.38 | 94.50 | | | |
| 5270.00 | 67.33 | 100 | 225 | | | 3.81 | 34.42 | 105.56 | | | Ch. 54 |
| 5270.00 | | | | 55.50 | A | 3.81 | 34.42 | 93.73 | | | |
| 5310.00 | 65.33 | 100 | 225 | | | 3.82 | 34.47 | 103.62 | | | Ch. 62 |
| 5310.00 | | | | 55.00 | A | 3.82 | 34.47 | 93.29 | | | |

| RADIATED EMISSIONS - Vertical Antenna Polarization | | | | | | | | | | | |
|-----------------------------------------------------------|-----------------------------|----------------------------|--------------------------|-------------------------------|---|--------------------------|-------------------------|---------------------------------|----------------------|-------------------------|-----------------|
| <i>Freq. (MHz)</i> | <i>Meter Reading (dBuV)</i> | <i>Antenna Height (cm)</i> | <i>Azimuth (degrees)</i> | <i>Quasi pk or AVG (dBuV)</i> | | <i>Cable Factor (dB)</i> | <i>Ant. Factor (dB)</i> | <i>Corrected Reading (dBuV)</i> | <i>Limits (dBuV)</i> | <i>Diff (dB) +=FAIL</i> | <i>Comments</i> |
| 5190.00 | 63.33 | 100 | 225 | | | 3.78 | 34.31 | 101.42 | | | Ch. 38 |
| 5190.00 | | | | 52.50 | A | 3.78 | 34.31 | 90.59 | | | |
| 5230.00 | 63.67 | 100 | 225 | | | 3.79 | 34.34 | 101.80 | | | Ch. 46 |
| 5230.00 | | | | 52.50 | A | 3.79 | 34.34 | 90.63 | | | |
| 5270.00 | 63.33 | 100 | 270 | | | 3.81 | 34.36 | 101.50 | | | Ch. 54 |
| 5270.00 | | | | 52.33 | A | 3.81 | 34.36 | 90.50 | | | |
| 5310.00 | 61.33 | 100 | 270 | | | 3.82 | 34.39 | 99.54 | | | Ch. 62 |
| 5310.00 | | | | 50.83 | A | 3.82 | 34.39 | 89.04 | | | |

NOTE: Fundamental signals measured to calculate the band edge field strengths using the "Marker Delta Method".



Radiated Emissions Test Results (Continued)

*Band Edge Field Strength Measurements in 802.11n mode 40MHz Wide (5150-5350 MHz)
Channels 38 & 62
Continuous TX at Chain C Antenna port with Ethertronics Antennas
Aegis Labs, Inc. File #: INTEL-081125-53*

| RADIATED EMISSIONS - Horizontal Antenna Polarization | | | | | | | | | | |
|-------------------------------------------------------------|-----------------------------|----------------------------|--------------------------|-------------------------------|--------------------------|-------------------------|---------------------------------|----------------------|-------------------------|-----------------|
| <i>Freq. (MHz)</i> | <i>Meter Reading (dBuV)</i> | <i>Antenna Height (cm)</i> | <i>Azimuth (degrees)</i> | <i>Quasi pk or AVG (dBuV)</i> | <i>Cable Factor (dB)</i> | <i>Ant. Factor (dB)</i> | <i>Corrected Reading (dBuV)</i> | <i>Limits (dBuV)</i> | <i>Diff (dB) +=FAIL</i> | <i>Comments</i> |
| 5150.00 | | | | | | | 72.95 | 74.00 | -1.05 | Ch. 38 |
| 5150.00 | | | | | A | | 52.91 | 54.00 | -1.09 | |
| 5350.00 | | | | | | | 71.79 | 74.00 | -2.21 | Ch. 62 |
| 5350.00 | | | | | A | | 49.79 | 54.00 | -4.21 | |

| RADIATED EMISSIONS - Vertical Antenna Polarization | | | | | | | | | | |
|-----------------------------------------------------------|-----------------------------|----------------------------|--------------------------|-------------------------------|--------------------------|-------------------------|---------------------------------|----------------------|-------------------------|-----------------|
| <i>Freq. (MHz)</i> | <i>Meter Reading (dBuV)</i> | <i>Antenna Height (cm)</i> | <i>Azimuth (degrees)</i> | <i>Quasi pk or AVG (dBuV)</i> | <i>Cable Factor (dB)</i> | <i>Ant. Factor (dB)</i> | <i>Corrected Reading (dBuV)</i> | <i>Limits (dBuV)</i> | <i>Diff (dB) +=FAIL</i> | <i>Comments</i> |
| 5150.00 | | | | | | | 71.59 | 74.00 | -2.41 | Ch. 38 |
| 5150.00 | | | | | A | | 50.26 | 54.00 | -3.74 | |
| 5350.00 | | | | | | | 67.71 | 74.00 | -6.29 | Ch. 62 |
| 5350.00 | | | | | A | | 45.54 | 54.00 | -8.46 | |

NOTE: The “Band Edge Field Strength” was calculated using the “Fundamental” and “Conducted Band Edge” measurements per the “Marker-Delta Method” with the following formula:

$$BE = Fm - \Delta m$$

Where

BE = Band Edge Field Strength

Fm = Measured Fundamental (Peak or Average)

Δm = Measured Conducted Band Edge Delta (Peak or Average)



Radiated Emissions Test Results (Continued)

*Fundamental Measurements in 802.11n mode 40MHz Wide (5150-5350 MHz)
Channels 38, 46, 54, & 62
Continuous TX at Chain C Antenna port with Wistron Neweb Corp. Antennas
Aegis Labs, Inc. File #: INTEL-081125-73*

| RADIATED EMISSIONS - Horizontal Antenna Polarization | | | | | | | | | | | |
|-------------------------------------------------------------|-----------------------------|----------------------------|--------------------------|-------------------------------|---|--------------------------|-------------------------|---------------------------------|----------------------|-------------------------|-----------------|
| <i>Freq. (MHz)</i> | <i>Meter Reading (dBuV)</i> | <i>Antenna Height (cm)</i> | <i>Azimuth (degrees)</i> | <i>Quasi pk or AVG (dBuV)</i> | | <i>Cable Factor (dB)</i> | <i>Ant. Factor (dB)</i> | <i>Corrected Reading (dBuV)</i> | <i>Limits (dBuV)</i> | <i>Diff (dB) +=FAIL</i> | <i>Comments</i> |
| 5190.00 | 64.17 | 100 | 135 | | | 3.78 | 34.33 | 102.28 | | | Ch. 38 |
| 5190.00 | | | | 54.33 | A | 3.78 | 34.33 | 92.44 | | | |
| 5230.00 | 64.33 | 100 | 180 | | | 3.79 | 34.38 | 102.50 | | | Ch. 46 |
| 5230.00 | | | | 53.67 | A | 3.79 | 34.38 | 91.84 | | | |
| 5270.00 | 63.00 | 100 | 180 | | | 3.81 | 34.42 | 101.23 | | | Ch. 54 |
| 5270.00 | | | | 52.83 | A | 3.81 | 34.42 | 91.06 | | | |
| 5310.00 | 64.67 | 100 | 180 | | | 3.82 | 34.47 | 102.96 | | | Ch. 62 |
| 5310.00 | | | | 53.67 | A | 3.82 | 34.47 | 91.96 | | | |

| RADIATED EMISSIONS - Vertical Antenna Polarization | | | | | | | | | | | |
|-----------------------------------------------------------|-----------------------------|----------------------------|--------------------------|-------------------------------|---|--------------------------|-------------------------|---------------------------------|----------------------|-------------------------|-----------------|
| <i>Freq. (MHz)</i> | <i>Meter Reading (dBuV)</i> | <i>Antenna Height (cm)</i> | <i>Azimuth (degrees)</i> | <i>Quasi pk or AVG (dBuV)</i> | | <i>Cable Factor (dB)</i> | <i>Ant. Factor (dB)</i> | <i>Corrected Reading (dBuV)</i> | <i>Limits (dBuV)</i> | <i>Diff (dB) +=FAIL</i> | <i>Comments</i> |
| 5190.00 | 63.50 | 100 | 315 | | | 3.78 | 34.31 | 101.59 | | | Ch. 38 |
| 5190.00 | | | | 53.33 | A | 3.78 | 34.31 | 91.42 | | | |
| 5230.00 | 65.50 | 100 | 315 | | | 3.79 | 34.34 | 103.63 | | | Ch. 46 |
| 5230.00 | | | | 55.17 | A | 3.79 | 34.34 | 93.30 | | | |
| 5270.00 | 64.17 | 100 | 315 | | | 3.81 | 34.36 | 102.34 | | | Ch. 54 |
| 5270.00 | | | | 53.67 | A | 3.81 | 34.36 | 91.84 | | | |
| 5310.00 | 62.83 | 100 | 0 | | | 3.82 | 34.39 | 101.04 | | | Ch. 62 |
| 5310.00 | | | | 51.67 | A | 3.82 | 34.39 | 89.88 | | | |

NOTE: Fundamental signals measured to calculate the band edge field strengths using the “Marker Delta Method”.



Radiated Emissions Test Results (Continued)

*Band Edge Field Strength Measurements in 802.11n mode 40MHz Wide (5150-5350 MHz)
Channels 38 & 62
Continuous TX at Chain C Antenna port with Wistron Neweb Corp. Antennas
Aegis Labs, Inc. File #: INTEL-081125-73*

| RADIATED EMISSIONS - Horizontal Antenna Polarization | | | | | | | | | | |
|-------------------------------------------------------------|----------------------|---------------------|-------------------|------------------------|-------------------|------------------|--------------------------|---------------|------------------|---------------|
| Freq. (MHz) | Meter Reading (dBuV) | Antenna Height (cm) | Azimuth (degrees) | Quasi pk or AVG (dBuV) | Cable Factor (dB) | Ant. Factor (dB) | Corrected Reading (dBuV) | Limits (dBuV) | Diff (dB) +=FAIL | Comments |
| 5150.00 | | | | | | | 72.45 | 74.00 | -1.55 | Ch. 38 |
| 5150.00 | | | | A | | | 52.11 | 54.00 | -1.89 | |
| 5350.00 | | | | | | | 71.13 | 74.00 | -2.87 | Ch. 62 |
| 5350.00 | | | | A | | | 48.46 | 54.00 | -5.54 | |

| RADIATED EMISSIONS - Vertical Antenna Polarization | | | | | | | | | | |
|-----------------------------------------------------------|----------------------|---------------------|-------------------|------------------------|-------------------|------------------|--------------------------|---------------|------------------|---------------|
| Freq. (MHz) | Meter Reading (dBuV) | Antenna Height (cm) | Azimuth (degrees) | Quasi pk or AVG (dBuV) | Cable Factor (dB) | Ant. Factor (dB) | Corrected Reading (dBuV) | Limits (dBuV) | Diff (dB) +=FAIL | Comments |
| 5150.00 | | | | | | | 71.76 | 74.00 | -2.24 | Ch. 38 |
| 5150.00 | | | | A | | | 51.09 | 54.00 | -2.91 | |
| 5350.00 | | | | | | | 69.21 | 74.00 | -4.79 | Ch. 62 |
| 5350.00 | | | | A | | | 46.38 | 54.00 | -7.62 | |

NOTE: The “Band Edge Field Strength” was calculated using the “Fundamental” and “Conducted Band Edge” measurements per the “Marker-Delta Method” with the following formula:

$$BE = Fm - \Delta m$$

Where

BE = Band Edge Field Strength

Fm = Measured Fundamental (Peak or Average)

Δm = Measured Conducted Band Edge Delta (Peak or Average)

Radiated Emissions Test Results (Continued)

Plots Showing Out-Of-Band Emissions (Peak RBW=VBW=1MHz; Average RBW = 1MHz, VBW = 10Hz)

| Test Date | Data | Test Eng. |
|-------------------------------------------------------------------------------------------------------------------------------------------------------------------------------------------------------------------------------------------------------------------------------------------|-----------------------------------|------------------|
| 04/10/08 | 5.19 GHz band edge PEAK | RC |
| <p>*ATTEN 20dB ΔMKR 29.83dB RL 10.0dBm 10dB/ 55.0MHz</p> <p>CENTER 5.1500GHz SPAN 200.0MHz *RBW 1.0MHz *VBW 1.0MHz SWP 50.0ms</p> | | |
| Test Date | Data | Test Eng. |
| 04/10/08 | 5.19 GHz band edge AVERAGE | RC |
| <p>*ATTEN 20dB ΔMKR 40.33dB RL 10.0dBm 10dB/ 51.3MHz</p> <p>CENTER 5.1500GHz SPAN 200.0MHz *RBW 1.0MHz *VBW 10Hz SWP 74.0sec</p> | | |

Radiated Emissions Test Results (Continued)

Plots Showing Out-Of-Band Emissions (Peak RBW=VBW=1MHz; Average RBW = 1MHz, VBW = 10Hz)

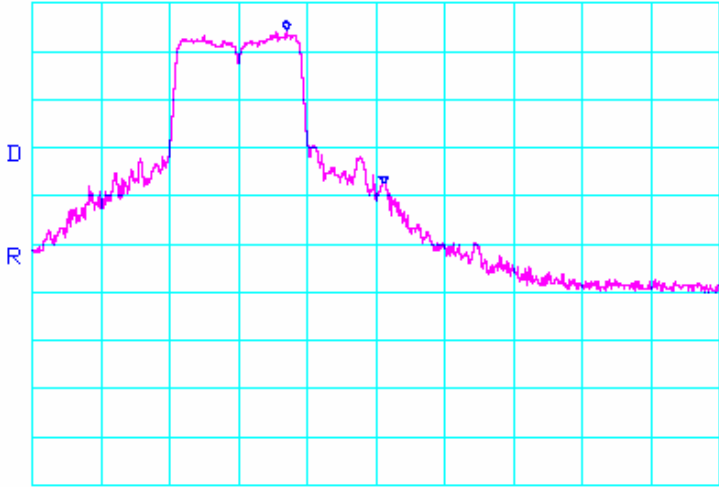
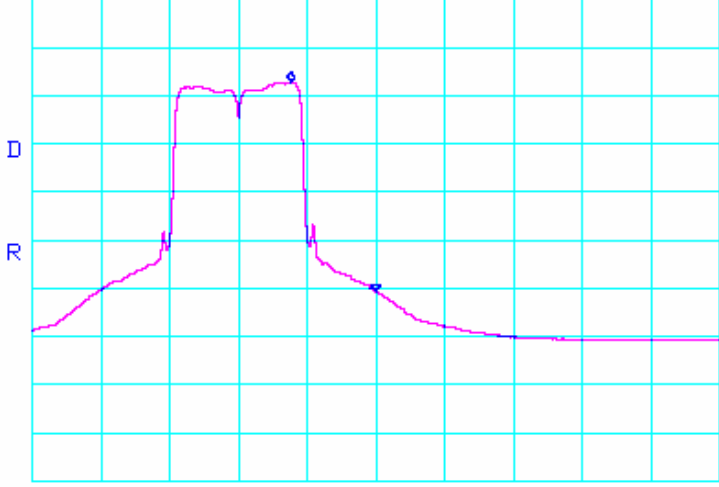
| Test Date | Data | Test Eng. |
|---------------------------------------------------------------------------------------------------------------------------------------------------------------------------------------------------------------------------------------------------------------------------------------------------------------------------------------------------------------------------------------------------------------------------------------------------------------------------------------------------------------------------------------------------------------------------------------------------------------------------|-----------------------------------|-----------|
| 04/10/08 | 5.31 GHz band edge PEAK | RC |
| <div style="display: flex; justify-content: space-between;"> *ATTEN 20dB ΔMKR 31.83dB </div> <div style="display: flex; justify-content: space-between;"> RL 10.0dBm 10dB/ -28.3MHz </div>  <div style="display: flex; justify-content: space-between;"> CENTER 5.350GHz SPAN 200.0MHz </div> <div style="display: flex; justify-content: space-between;"> *RBW 1.0MHz *VBW 1.0MHz SWP 50.0ms </div> | | |
| Test Date | Data | Test Eng. |
| 04/10/08 | 5.31 GHz band edge AVERAGE | RC |
| <div style="display: flex; justify-content: space-between;"> *ATTEN 20dB ΔMKR 43.50dB </div> <div style="display: flex; justify-content: space-between;"> RL 10.0dBm 10dB/ -24.7MHz </div>  <div style="display: flex; justify-content: space-between;"> CENTER 5.350GHz SPAN 200.0MHz </div> <div style="display: flex; justify-content: space-between;"> *RBW 1.0MHz *VBW 10Hz SWP 74.0sec </div> | | |



RADIATED EMISSIONS TEST RESULTS

| | | | |
|-----------------------|----------------------------------------------------------------------------------------------------------------------------|------------------------|--------------|
| CLIENT: | Intel Corporation | DATE: | 04/08/08 |
| EUT: | Intel WiFi Link 5300 | PROJECT NUMBER: | INTEL-081125 |
| MODEL NUMBER: | 533AN_HMW | TEST ENGINEER: | KN/RC |
| SERIAL NUMBER: | 0016EA038A16 | SITE #: | 2 |
| CONFIGURATION: | Tested installed in an extender board connected to the host laptop's mini PCI slot in 802.11a (5470-5725 MHz) mode. | TEMPERATURE: | 22° C |
| | | HUMIDITY: | 39% RH |
| | | TIME: | 8:00 AM |

| | |
|---------------------|---------------------------------------------------------------------------------------------------------------------------------------------------------------------------------------------|
| Description: | Radiated RF Emissions (1 GHz – 18 GHz) |
| Results: | PASSED Horizontal and Vertical Antenna Polarizations Class B Limits |
| Note: | Radiated Emissions Measurements were performed on the EUT with power supply set at the following voltage and frequency. <ul style="list-style-type: none"> • 120VAC / 60 Hz. |

| Unwanted Spurious Emissions Limits | | | |
|------------------------------------|-----------------------|----------------------------------------------------------------|----------------------------------------------------------------------|
| Frequency (MHz) | Field Strength (uV/m) | Field Strength (dBuV/m) (Emissions in the restricted bands) | Field Strength (dBm/MHz) (Emissions outside the restricted bands) |
| Above 960 | 500 | 54.00 (Average) 74.00 (Peak) | < -20 dBc |

Radiated Emissions Sample Calculations

$$\text{Corrected Meter Reading} = \text{Meter Reading} + F + C - D$$

Where, F = Antenna Factor

C = Cable Factor

G = Amplifier Gain

D = Distance Factor (if applicable)

Therefore, the equation for determining the Corrected Meter Reading Limit (CML) is:

$$\text{CML} = \text{Specification Limit} - F - C + D$$

Radiated Emissions Test Results (Continued)

*Fundamental Measurements in 802.11a mode (5470-5725 MHz)
Channels 100, 120, & 140
Continuous TX at Chain A Antenna port with Ethertronics Antennas
Aegis Labs, Inc. File #: INTEL-081125-51*

| RADIATED EMISSIONS - Horizontal Antenna Polarization | | | | | | | | | | | |
|-------------------------------------------------------------|----------------------|---------------------|-------------------|------------------------|---|-------------------|------------------|--------------------------|---------------|------------------|----------------|
| Freq. (MHz) | Meter Reading (dBuV) | Antenna Height (cm) | Azimuth (degrees) | Quasi pk or AVG (dBuV) | | Cable Factor (dB) | Ant. Factor (dB) | Corrected Reading (dBuV) | Limits (dBuV) | Diff (dB) +=FAIL | Comments |
| 5500.00 | 62.17 | 100 | 135 | | | 3.89 | 34.70 | 100.76 | | | Ch. 100 |
| 5500.00 | | | | 52.50 | A | 3.89 | 34.70 | 91.09 | | | |
| 5600.00 | 61.33 | 100 | 135 | | | 3.93 | 34.86 | 100.12 | | | Ch. 120 |
| 5600.00 | | | | 51.00 | A | 3.93 | 34.86 | 89.79 | | | |
| 5700.00 | 62.33 | 100 | 135 | | | 3.97 | 35.02 | 101.32 | | | Ch. 140 |
| 5700.00 | | | | 51.33 | A | 3.97 | 35.02 | 90.32 | | | |

| RADIATED EMISSIONS - Vertical Antenna Polarization | | | | | | | | | | | |
|-----------------------------------------------------------|----------------------|---------------------|-------------------|------------------------|---|-------------------|------------------|--------------------------|---------------|------------------|----------------|
| Freq. (MHz) | Meter Reading (dBuV) | Antenna Height (cm) | Azimuth (degrees) | Quasi pk or AVG (dBuV) | | Cable Factor (dB) | Ant. Factor (dB) | Corrected Reading (dBuV) | Limits (dBuV) | Diff (dB) +=FAIL | Comments |
| 5500.00 | 68.67 | 100 | 225 | | | 3.89 | 34.50 | 107.06 | | | Ch. 100 |
| 5500.00 | | | | 58.33 | A | 3.89 | 34.50 | 96.72 | | | |
| 5600.00 | 69.50 | 100 | 225 | | | 3.93 | 34.68 | 108.11 | | | Ch. 120 |
| 5600.00 | | | | 59.17 | A | 3.93 | 34.68 | 97.78 | | | |
| 5700.00 | 69.83 | 100 | 225 | | | 3.97 | 34.86 | 108.66 | | | Ch. 140 |
| 5700.00 | | | | 59.33 | A | 3.97 | 34.86 | 98.16 | | | |

NOTE: Fundamental signals measured to calculate the band edge field strengths using the “Marker Delta Method”.



Radiated Emissions Test Results (Continued)

*Band Edge Field Strength Measurements in 802.11a mode (5470-5725 MHz)
Channels 100 & 140
Continuous TX at Chain A Antenna port with Ethertronics Antennas
Aegis Labs, Inc. File #: INTEL-081125-51*

| RADIATED EMISSIONS - Horizontal Antenna Polarization | | | | | | | | | | | |
|-------------------------------------------------------------|-----------------------------|----------------------------|--------------------------|-------------------------------|--------------------------|-------------------------|---------------------------------|----------------------|-------------------------|-----------------|----------------|
| <i>Freq. (MHz)</i> | <i>Meter Reading (dBuV)</i> | <i>Antenna Height (cm)</i> | <i>Azimuth (degrees)</i> | <i>Quasi pk or AVG (dBuV)</i> | <i>Cable Factor (dB)</i> | <i>Ant. Factor (dB)</i> | <i>Corrected Reading (dBuV)</i> | <i>Limits (dBuV)</i> | <i>Diff (dB) +=FAIL</i> | <i>Comments</i> | |
| 5460.00 | | | | | | | 49.43 | 74.00 | -24.57 | Ch. 100 | |
| 5460.00 | | | | | A | | 32.92 | 54.00 | -21.08 | | |
| 5725.00 | 30.83 | 100 | 135 | | | 3.98 | 35.06 | 69.87 | 81.32 | -11.45 | Ch. 140 |

| RADIATED EMISSIONS - Vertical Antenna Polarization | | | | | | | | | | | |
|-----------------------------------------------------------|-----------------------------|----------------------------|--------------------------|-------------------------------|--------------------------|-------------------------|---------------------------------|----------------------|-------------------------|-----------------|----------------|
| <i>Freq. (MHz)</i> | <i>Meter Reading (dBuV)</i> | <i>Antenna Height (cm)</i> | <i>Azimuth (degrees)</i> | <i>Quasi pk or AVG (dBuV)</i> | <i>Cable Factor (dB)</i> | <i>Ant. Factor (dB)</i> | <i>Corrected Reading (dBuV)</i> | <i>Limits (dBuV)</i> | <i>Diff (dB) +=FAIL</i> | <i>Comments</i> | |
| 5460.00 | | | | | | | 55.73 | 74.00 | -18.27 | Ch. 100 | |
| 5460.00 | | | | | A | | 38.55 | 54.00 | -15.45 | | |
| 5725.00 | 31.33 | 100 | 225 | | | 3.98 | 34.91 | 70.21 | 88.66 | -18.45 | Ch. 140 |

NOTE: The “Band Edge Field Strength” was calculated using the “Fundamental” and “Conducted Band Edge” measurements per the “Marker-Delta Method” with the following formula:

$$BE = Fm - \Delta m$$

Where

BE = Band Edge Field Strength

Fm = Measured Fundamental (Peak or Average)

Δm = Measured Conducted Band Edge Delta (Peak or Average)



Radiated Emissions Test Results (Continued)

*Fundamental Measurements in 802.11a mode (5470-5725 MHz)
 Channels 100, 120, & 140
 Continuous TX at Chain B Antenna port with Ethertronics Antennas
 Aegis Labs, Inc. File #: INTEL-081125-52*

| RADIATED EMISSIONS - Horizontal Antenna Polarization | | | | | | | | | | | |
|-------------------------------------------------------------|----------------------|---------------------|-------------------|------------------------|---|-------------------|------------------|--------------------------|---------------|------------------|----------------|
| Freq. (MHz) | Meter Reading (dBuV) | Antenna Height (cm) | Azimuth (degrees) | Quasi pk or AVG (dBuV) | | Cable Factor (dB) | Ant. Factor (dB) | Corrected Reading (dBuV) | Limits (dBuV) | Diff (dB) +=FAIL | Comments |
| 5500.00 | 60.83 | 100 | 90 | | | 3.89 | 34.70 | 99.42 | | | Ch. 100 |
| 5500.00 | | | | 50.50 | A | 3.89 | 34.70 | 89.09 | | | |
| 5600.00 | 60.17 | 100 | 135 | | | 3.93 | 34.86 | 98.96 | | | Ch. 120 |
| 5600.00 | | | | 49.83 | A | 3.93 | 34.86 | 88.62 | | | |
| 5700.00 | 63.17 | 100 | 135 | | | 3.97 | 35.02 | 102.16 | | | Ch. 140 |
| 5700.00 | | | | 53.00 | A | 3.97 | 35.02 | 91.99 | | | |

| RADIATED EMISSIONS - Vertical Antenna Polarization | | | | | | | | | | | |
|-----------------------------------------------------------|----------------------|---------------------|-------------------|------------------------|---|-------------------|------------------|--------------------------|---------------|------------------|----------------|
| Freq. (MHz) | Meter Reading (dBuV) | Antenna Height (cm) | Azimuth (degrees) | Quasi pk or AVG (dBuV) | | Cable Factor (dB) | Ant. Factor (dB) | Corrected Reading (dBuV) | Limits (dBuV) | Diff (dB) +=FAIL | Comments |
| 5500.00 | 70.17 | 100 | 135 | | | 3.89 | 34.50 | 108.56 | | | Ch. 100 |
| 5500.00 | | | | 59.50 | A | 3.89 | 34.50 | 97.89 | | | |
| 5600.00 | 71.17 | 100 | 180 | | | 3.93 | 34.68 | 109.78 | | | Ch. 120 |
| 5600.00 | | | | 60.50 | A | 3.93 | 34.68 | 99.11 | | | |
| 5700.00 | 70.33 | 100 | 225 | | | 3.97 | 34.86 | 109.16 | | | Ch. 140 |
| 5700.00 | | | | 60.50 | A | 3.97 | 34.86 | 99.33 | | | |

NOTE: Fundamental signals measured to calculate the band edge field strengths using the “Marker Delta Method”.



Radiated Emissions Test Results (Continued)

*Band Edge Field Strength Measurements in 802.11a mode (5470-5725 MHz)
Channels 100 & 140
Continuous TX at Chain B Antenna port with Ethertronics Antennas
Aegis Labs, Inc. File #: INTEL-081125-52*

| RADIATED EMISSIONS - Horizontal Antenna Polarization | | | | | | | | | | |
|-------------------------------------------------------------|-----------------------------|----------------------------|--------------------------|-------------------------------|--------------------------|-------------------------|---------------------------------|----------------------|-------------------------|-----------------|
| <i>Freq. (MHz)</i> | <i>Meter Reading (dBuV)</i> | <i>Antenna Height (cm)</i> | <i>Azimuth (degrees)</i> | <i>Quasi pk or AVG (dBuV)</i> | <i>Cable Factor (dB)</i> | <i>Ant. Factor (dB)</i> | <i>Corrected Reading (dBuV)</i> | <i>Limits (dBuV)</i> | <i>Diff (dB) +=FAIL</i> | <i>Comments</i> |
| 5460.00 | | | | | | | 44.59 | 74.00 | -29.41 | Ch. 100 |
| 5460.00 | | | | | A | | 32.09 | 54.00 | -21.91 | |
| 5725.00 | 31.33 | 100 | 135 | | | 3.98 35.06 | 70.37 | 82.16 | -11.79 | Ch. 140 |

| RADIATED EMISSIONS - Vertical Antenna Polarization | | | | | | | | | | |
|-----------------------------------------------------------|-----------------------------|----------------------------|--------------------------|-------------------------------|--------------------------|-------------------------|---------------------------------|----------------------|-------------------------|-----------------|
| <i>Freq. (MHz)</i> | <i>Meter Reading (dBuV)</i> | <i>Antenna Height (cm)</i> | <i>Azimuth (degrees)</i> | <i>Quasi pk or AVG (dBuV)</i> | <i>Cable Factor (dB)</i> | <i>Ant. Factor (dB)</i> | <i>Corrected Reading (dBuV)</i> | <i>Limits (dBuV)</i> | <i>Diff (dB) +=FAIL</i> | <i>Comments</i> |
| 5460.00 | | | | | | | 53.73 | 74.00 | -20.27 | Ch. 100 |
| 5460.00 | | | | | A | | 40.89 | 54.00 | -13.11 | |
| 5725.00 | 31.00 | 100 | 225 | | | 3.98 34.91 | 69.88 | 89.16 | -19.28 | Ch. 140 |

NOTE: The “Band Edge Field Strength” was calculated using the “Fundamental” and “Conducted Band Edge” measurements per the “Marker-Delta Method” with the following formula:

$$BE = Fm - \Delta m$$

Where

BE = Band Edge Field Strength

Fm = Measured Fundamental (Peak or Average)

Δm = Measured Conducted Band Edge Delta (Peak or Average)



Radiated Emissions Test Results (Continued)

Plots Showing Out-Of-Band Emissions (Peak RBW=VBW=1MHz; Average RBW = 1MHz, VBW = 10Hz)

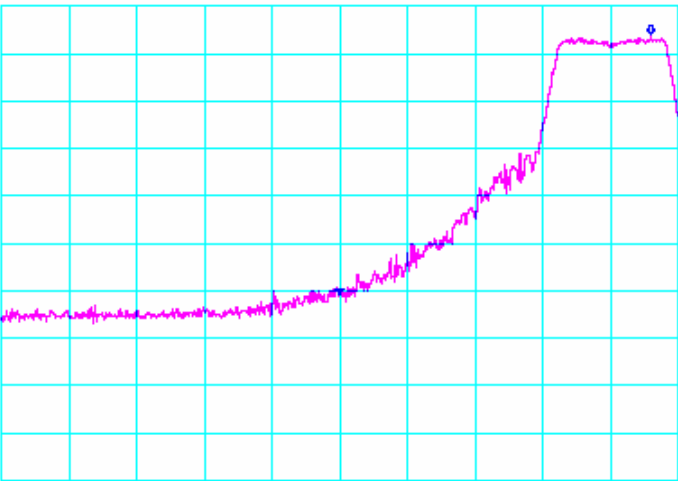
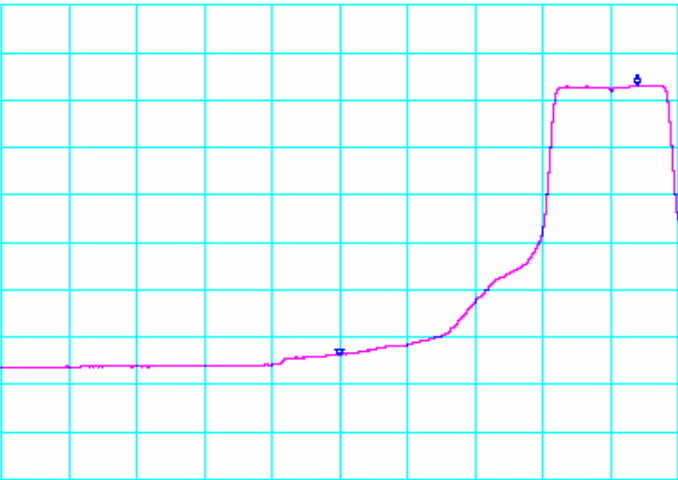
| Test Date | Data | Test Eng. |
|---------------------------------------------------------------------------------------------------------------------------------------------------------------------------------------------------------------------------------------------------------------------------------------------------------------------------------------------------------------------------------------------------------------------------------------------------------------------------------------------------------------------------------------------------------------------------------------------------------------------------------------------|-----------------------------------|-----------|
| 04/05/08 | 5.50 GHz band edge PEAK | RC |
| <div style="display: flex; justify-content: space-between;"> *ATTEN 20dB ΔMKR 54.83dB </div> <div style="display: flex; justify-content: space-between;"> RL 16.0dBm 10dB/ 46.0MHz </div>  <div style="display: flex; justify-content: space-between; margin-top: 10px;"> CENTER 5.4600GHz SPAN 100.0MHz </div> <div style="display: flex; justify-content: space-between;"> *RBW 1.0MHz *VBW 1.0MHz SWP 50.0ms </div> | | |
| Test Date | Data | Test Eng. |
| 04/05/08 | 5.50 GHz band edge AVERAGE | RC |
| <div style="display: flex; justify-content: space-between;"> *ATTEN 20dB ΔMKR 57.00dB </div> <div style="display: flex; justify-content: space-between;"> RL 16.0dBm 10dB/ 44.0MHz </div>  <div style="display: flex; justify-content: space-between; margin-top: 10px;"> CENTER 5.4600GHz SPAN 100.0MHz </div> <div style="display: flex; justify-content: space-between;"> *RBW 1.0MHz *VBW 10Hz SWP 37.0sec </div> | | |



Radiated Emissions Test Results (Continued)

*Fundamental Measurements in 802.11a mode (5470-5725 MHz)
Channels 100, 120, & 140
Continuous TX at Chain C Antenna port with Ethertronics Antennas
Aegis Labs, Inc. File #: INTEL-081125-53*

| RADIATED EMISSIONS - Horizontal Antenna Polarization | | | | | | | | | | | |
|-------------------------------------------------------------|----------------------|---------------------|-------------------|------------------------|---|-------------------|------------------|--------------------------|---------------|------------------|----------------|
| Freq. (MHz) | Meter Reading (dBuV) | Antenna Height (cm) | Azimuth (degrees) | Quasi pk or AVG (dBuV) | | Cable Factor (dB) | Ant. Factor (dB) | Corrected Reading (dBuV) | Limits (dBuV) | Diff (dB) +=FAIL | Comments |
| 5500.00 | 68.17 | 100 | 225 | | | 3.89 | 34.70 | 106.76 | | | Ch. 100 |
| 5500.00 | | | | 58.00 | A | 3.89 | 34.70 | 96.59 | | | |
| 5600.00 | 68.00 | 100 | 225 | | | 3.93 | 34.86 | 106.79 | | | Ch. 120 |
| 5600.00 | | | | 58.00 | A | 3.93 | 34.86 | 96.79 | | | |
| 5700.00 | 68.00 | 100 | 180 | | | 3.97 | 35.02 | 106.99 | | | Ch. 140 |
| 5700.00 | | | | 58.17 | A | 3.97 | 35.02 | 97.16 | | | |

| RADIATED EMISSIONS - Vertical Antenna Polarization | | | | | | | | | | | |
|-----------------------------------------------------------|----------------------|---------------------|-------------------|------------------------|---|-------------------|------------------|--------------------------|---------------|------------------|----------------|
| Freq. (MHz) | Meter Reading (dBuV) | Antenna Height (cm) | Azimuth (degrees) | Quasi pk or AVG (dBuV) | | Cable Factor (dB) | Ant. Factor (dB) | Corrected Reading (dBuV) | Limits (dBuV) | Diff (dB) +=FAIL | Comments |
| 5500.00 | 65.17 | 100 | 90 | | | 3.89 | 34.50 | 103.56 | | | Ch. 100 |
| 5500.00 | | | | 54.50 | A | 3.89 | 34.50 | 92.89 | | | |
| 5600.00 | 63.83 | 100 | 135 | | | 3.93 | 34.68 | 102.44 | | | Ch. 120 |
| 5600.00 | | | | 53.17 | A | 3.93 | 34.68 | 91.78 | | | |
| 5700.00 | 64.17 | 100 | 315 | | | 3.97 | 34.86 | 103.00 | | | Ch. 140 |
| 5700.00 | | | | 54.50 | A | 3.97 | 34.86 | 93.33 | | | |

NOTE: Fundamental signals measured to calculate the band edge field strengths using the “Marker Delta Method”.



Radiated Emissions Test Results (Continued)

*Band Edge Field Strength Measurements in 802.11a mode (5470-5725 MHz)
Channels 100 & 140
Continuous TX at Chain C Antenna port with Ethertronics Antennas
Aegis Labs, Inc. File #: INTEL-081125-53*

| RADIATED EMISSIONS - Horizontal Antenna Polarization | | | | | | | | | | | |
|-------------------------------------------------------------|-----------------------------|----------------------------|--------------------------|-------------------------------|--------------------------|-------------------------|---------------------------------|----------------------|-------------------------|-----------------|----------------|
| <i>Freq. (MHz)</i> | <i>Meter Reading (dBuV)</i> | <i>Antenna Height (cm)</i> | <i>Azimuth (degrees)</i> | <i>Quasi pk or AVG (dBuV)</i> | <i>Cable Factor (dB)</i> | <i>Ant. Factor (dB)</i> | <i>Corrected Reading (dBuV)</i> | <i>Limits (dBuV)</i> | <i>Diff (dB) +=FAIL</i> | <i>Comments</i> | |
| 5460.00 | | | | | | | 55.59 | 74.00 | -18.41 | Ch. 100 | |
| 5460.00 | | | | | A | | 38.76 | 54.00 | -15.24 | | |
| 5725.00 | 31.67 | 100 | 180 | | | 3.98 | 35.06 | 70.71 | 86.99 | -16.28 | Ch. 140 |

| RADIATED EMISSIONS - Vertical Antenna Polarization | | | | | | | | | | | |
|-----------------------------------------------------------|-----------------------------|----------------------------|--------------------------|-------------------------------|--------------------------|-------------------------|---------------------------------|----------------------|-------------------------|-----------------|----------------|
| <i>Freq. (MHz)</i> | <i>Meter Reading (dBuV)</i> | <i>Antenna Height (cm)</i> | <i>Azimuth (degrees)</i> | <i>Quasi pk or AVG (dBuV)</i> | <i>Cable Factor (dB)</i> | <i>Ant. Factor (dB)</i> | <i>Corrected Reading (dBuV)</i> | <i>Limits (dBuV)</i> | <i>Diff (dB) +=FAIL</i> | <i>Comments</i> | |
| 5460.00 | | | | | | | 52.39 | 74.00 | -21.61 | Ch. 100 | |
| 5460.00 | | | | | A | | 35.06 | 54.00 | -18.94 | | |
| 5725.00 | 31.50 | 100 | 315 | | | 3.98 | 34.91 | 70.38 | 83.00 | -12.62 | Ch. 140 |

NOTE: The “Band Edge Field Strength” was calculated using the “Fundamental” and “Conducted Band Edge” measurements per the “Marker-Delta Method” with the following formula:

$$BE = Fm - \Delta m$$

Where

BE = Band Edge Field Strength

Fm = Measured Fundamental (Peak or Average)

Δm = Measured Conducted Band Edge Delta (Peak or Average)

Radiated Emissions Test Results (Continued)

Plots Showing Out-Of-Band Emissions (Peak RBW=VBW=1MHz; Average RBW = 1MHz, VBW = 10Hz)

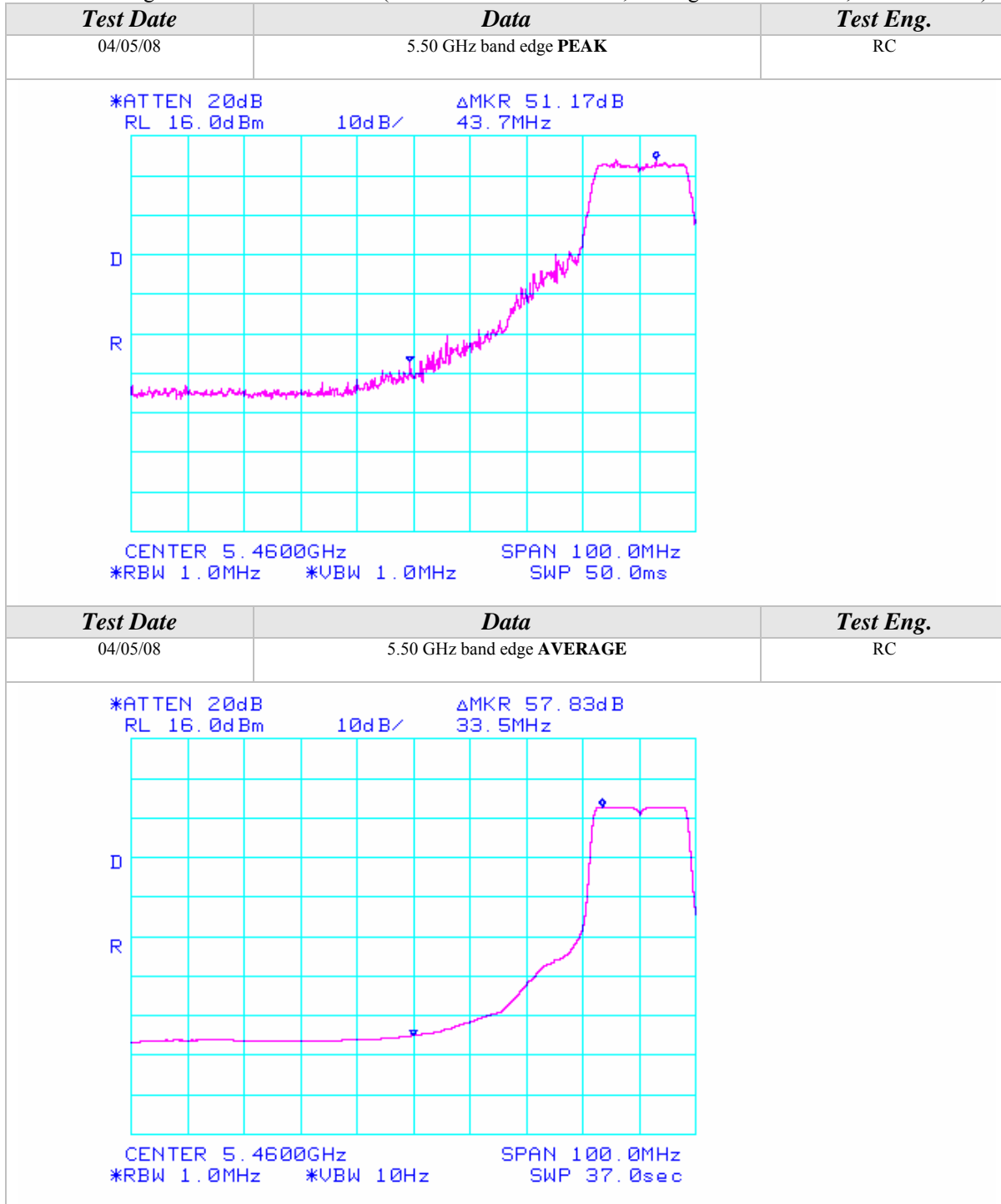



Radiated Emissions Test Results (Continued)

*Spurious Emissions Measurements in 802.11a mode (5470-5725 MHz)
Channels 100, 120, & 140
Continuous TX at Chain A, B, & C Antenna ports with Ethertronics Antennas
Aegis Labs, Inc. File #: INTEL-081125-45*

| RADIATED EMISSIONS - Horizontal Antenna Polarization | | | | | | | | | | | | |
|------------------------------------------------------|----------------------|---------------------|-------------------|------------------------|---|--------------------|-------------------|------------------|--------------------------|---------------|------------------|-----------------------|
| Freq. (MHz) | Meter Reading (dBuV) | Antenna Height (cm) | Azimuth (degrees) | Quasi pk or AVG (dBuV) | | Preamp Factor (dB) | Cable Factor (dB) | Ant. Factor (dB) | Corrected Reading (dBuV) | Limits (dBuV) | Diff (dB) +=FAIL | Channel/ Chain Tested |
| 3733.33 | 53.83 | 100 | 225 | | | 46.53 | 3.19 | 33.08 | 43.57 | 74.00 | -30.43 | Ch. 120/ |
| 3733.33 | | | | 44.19 | A | 46.53 | 3.19 | 33.08 | 33.93 | 54.00 | -20.07 | A |
| 7466.66 | 52.33 | 100 | 135 | | | 45.03 | 4.60 | 35.98 | 47.88 | 74.00 | -26.12 | |
| 7466.66 | | | | 44.32 | A | 45.03 | 4.60 | 35.98 | 39.87 | 54.00 | -14.13 | |
| 11200.00 | 58.00 | 100 | 135 | | | 44.96 | 5.75 | 38.22 | 57.02 | 74.00 | -16.98 | |
| 11200.00 | | | | 44.19 | A | 44.96 | 5.75 | 38.22 | 43.21 | 54.00 | -10.79 | |
| 3733.33 | 53.67 | 100 | 135 | | | 46.53 | 3.19 | 33.08 | 43.41 | 74.00 | -30.59 | Ch. 120/ |
| 3733.33 | | | | 42.92 | A | 46.53 | 3.19 | 33.08 | 32.66 | 54.00 | -21.34 | B |
| 7466.66 | 52.50 | 100 | 225 | | | 45.03 | 4.60 | 35.98 | 48.05 | 74.00 | -25.95 | |
| 7466.66 | | | | 43.41 | A | 45.03 | 4.60 | 35.98 | 38.96 | 54.00 | -15.04 | |
| 11200.00 | 52.50 | 100 | 225 | | | 44.96 | 5.75 | 38.22 | 51.52 | 74.00 | -22.48 | |
| 11200.00 | | | | 39.90 | A | 44.96 | 5.75 | 38.22 | 38.92 | 54.00 | -15.08 | |
| 3733.33 | 52.83 | 100 | 180 | | | 46.53 | 3.19 | 33.08 | 42.57 | 74.00 | -31.43 | Ch. 120/ |
| 3733.33 | | | | 42.24 | A | 46.53 | 3.19 | 33.08 | 31.98 | 54.00 | -22.02 | C |
| 7466.66 | 51.50 | 100 | 270 | | | 45.03 | 4.60 | 35.98 | 47.05 | 74.00 | -26.95 | |
| 7466.66 | | | | 41.35 | A | 45.03 | 4.60 | 35.98 | 36.90 | 54.00 | -17.10 | |
| 11200.00 | 52.17 | 100 | 270 | | | 44.96 | 5.75 | 38.22 | 51.19 | 74.00 | -22.81 | |
| 11200.00 | | | | 37.67 | A | 44.96 | 5.75 | 38.22 | 36.69 | 54.00 | -17.31 | |
| 3666.66 | 52.17 | 100 | 225 | | | 46.56 | 3.17 | 33.00 | 41.78 | 74.00 | -32.22 | Ch. 100/ |
| 3666.66 | | | | 42.37 | A | 46.56 | 3.17 | 33.00 | 31.98 | 54.00 | -22.02 | A |
| 7333.33 | 52.17 | 100 | 135 | | | 45.06 | 4.55 | 35.90 | 47.56 | 74.00 | -26.44 | |
| 7333.33 | | | | 40.03 | A | 45.06 | 4.55 | 35.90 | 35.42 | 54.00 | -18.58 | |
| 11000.00 | 50.50 | 100 | 225 | | | 45.20 | 5.65 | 37.90 | 48.86 | 74.00 | -25.15 | |
| 11000.00 | | | | 39.22 | A | 45.20 | 5.65 | 37.90 | 37.58 | 54.00 | -16.43 | |
| 3800.00 | 45.17 | 100 | 135 | | | 46.50 | 3.24 | 33.16 | 35.07 | 74.00 | -38.93 | Ch. 140/ |
| 3800.00 | | | | 53.33 | A | 46.50 | 3.24 | 33.16 | 43.23 | 54.00 | -10.77 | A |
| 7600.00 | 52.17 | 100 | 135 | | | 44.91 | 4.64 | 36.02 | 47.91 | 74.00 | -26.09 | |
| 7600.00 | | | | 41.32 | A | 44.91 | 4.64 | 36.02 | 37.06 | 54.00 | -16.94 | |
| 11400.00 | 51.00 | 100 | 225 | | | 44.72 | 5.86 | 38.54 | 50.68 | 74.00 | -23.32 | |
| 11400.00 | | | | 39.15 | A | 44.72 | 5.86 | 38.54 | 38.83 | 54.00 | -15.17 | |



Radiated Emissions Test Results (Continued)

| RADIATED EMISSIONS - Vertical Antenna Polarization | | | | | | | | | | | | |
|----------------------------------------------------|----------------------|---------------------|-------------------|------------------------|---|--------------------|-------------------|------------------|--------------------------|---------------|-------------------|-----------------|
| Freq. (MHz) | Meter Reading (dBuV) | Antenna Height (cm) | Azimuth (degrees) | Quasi pk or AVG (dBuV) | | Preamp Factor (dB) | Cable Factor (dB) | Ant. Factor (dB) | Corrected Reading (dBuV) | Limits (dBuV) | Diff (dB) +/-FAIL | Comments |
| 3733.33 | 54.00 | 100 | 90 | | | 46.53 | 3.19 | 33.13 | 43.80 | 74.00 | -30.20 | Ch. 120/ |
| 3733.33 | | | | 41.83 | A | 46.53 | 3.19 | 33.13 | 31.63 | 54.00 | -22.37 | A |
| 7466.66 | 52.50 | 100 | 45 | | | 45.03 | 4.60 | 36.07 | 48.14 | 74.00 | -25.86 | |
| 7466.66 | | | | 44.90 | A | 45.03 | 4.60 | 36.07 | 40.54 | 54.00 | -13.46 | |
| 11200.00 | 57.17 | 100 | 90 | | | 44.96 | 5.75 | 38.10 | 56.07 | 74.00 | -17.93 | |
| 11200.00 | | | | 43.84 | A | 44.96 | 5.75 | 38.10 | 42.74 | 54.00 | -11.26 | |
| 3733.33 | 53.00 | 100 | 90 | | | 46.53 | 3.19 | 33.13 | 42.80 | 74.00 | -31.20 | Ch. 120/ |
| 3733.33 | | | | 43.58 | A | 46.53 | 3.19 | 33.13 | 33.38 | 54.00 | -20.62 | B |
| 7466.66 | 52.50 | 100 | 315 | | | 45.03 | 4.60 | 36.07 | 48.14 | 74.00 | -25.86 | |
| 7466.66 | | | | 45.66 | A | 45.03 | 4.60 | 36.07 | 41.30 | 54.00 | -12.70 | |
| 11200.00 | 52.17 | 100 | 225 | | | 44.96 | 5.75 | 38.10 | 51.07 | 74.00 | -22.93 | |
| 11200.00 | | | | 39.57 | A | 44.96 | 5.75 | 38.10 | 38.47 | 54.00 | -15.53 | |
| 3733.33 | 52.33 | 100 | 0 | | | 46.53 | 3.19 | 33.13 | 42.13 | 74.00 | -31.87 | Ch. 120/ |
| 3733.33 | | | | 42.24 | A | 46.53 | 3.19 | 33.13 | 32.04 | 54.00 | -21.96 | C |
| 7466.66 | 52.33 | 100 | 270 | | | 45.03 | 4.60 | 36.07 | 47.97 | 74.00 | -26.03 | |
| 7466.66 | | | | 44.73 | A | 45.03 | 4.60 | 36.07 | 40.37 | 54.00 | -13.63 | |
| 11200.00 | 52.50 | 100 | 135 | | | 44.96 | 5.75 | 38.10 | 51.40 | 74.00 | -22.60 | |
| 11200.00 | | | | 39.93 | A | 44.96 | 5.75 | 38.10 | 38.83 | 54.00 | -15.17 | |
| | | | | | | | | | | | | |
| 3666.66 | 56.17 | 100 | 135 | | | 46.56 | 3.17 | 33.07 | 45.85 | 74.00 | -28.15 | Ch. 100/ |
| 3666.66 | | | | 43.82 | A | 46.56 | 3.17 | 33.07 | 33.50 | 54.00 | -20.50 | B |
| 7333.33 | 51.67 | 100 | 180 | | | 45.06 | 4.55 | 35.93 | 47.09 | 74.00 | -26.91 | |
| 7333.33 | | | | 42.54 | A | 45.06 | 4.55 | 35.93 | 37.96 | 54.00 | -16.04 | |
| 11000.00 | 51.17 | 100 | 180 | | | 45.20 | 5.65 | 37.90 | 49.53 | 74.00 | -24.48 | |
| 11000.00 | | | | 39.08 | A | 45.20 | 5.65 | 37.90 | 37.44 | 54.00 | -16.57 | |
| 3800.00 | 53.83 | 100 | 135 | | | 46.50 | 3.24 | 33.20 | 43.77 | 74.00 | -30.23 | Ch. 140/ |
| 3800.00 | | | | 44.91 | A | 46.50 | 3.24 | 33.20 | 34.85 | 54.00 | -19.15 | B |
| 7600.00 | 55.00 | 100 | 180 | | | 44.91 | 4.64 | 36.12 | 50.84 | 74.00 | -23.16 | |
| 7600.00 | | | | 48.56 | A | 44.91 | 4.64 | 36.12 | 44.40 | 54.00 | -9.60 | |
| 11400.00 | | 100 | 225 | 53.67 | | 44.72 | 5.86 | 38.30 | 53.11 | 74.00 | -20.89 | |
| 11400.00 | | | | 41.35 | A | 44.72 | 5.86 | 38.30 | 40.79 | 54.00 | -13.21 | |



Radiated Emissions Test Results (Continued)

*Spurious Emissions Measurements in 802.11a mode (5470-5725 MHz)
Channels 100, 120, & 140
Continuous TX at Chain A, B, & C Antenna ports with Wistron Neweb Corp. Antennas
Aegis Labs, Inc. File #: INTEL-081125-74*

| RADIATED EMISSIONS - Horizontal Antenna Polarization | | | | | | | | | | | | |
|------------------------------------------------------|----------------------|---------------------|-------------------|------------------------|---|--------------------|-------------------|------------------|--------------------------|---------------|-------------------|-----------------------|
| Freq. (MHz) | Meter Reading (dBuV) | Antenna Height (cm) | Azimuth (degrees) | Quasi pk or AVG (dBuV) | | Preamp Factor (dB) | Cable Factor (dB) | Ant. Factor (dB) | Corrected Reading (dBuV) | Limits (dBuV) | Diff (dB) +/-FAIL | Channel/ Chain Tested |
| 3733.33 | 60.50 | 100 | 135 | | | 46.55 | 2.53 | 32.47 | 48.94 | 74.00 | -25.06 | Ch. 120/ |
| 3733.33 | | | | 48.59 | A | 46.55 | 2.53 | 32.47 | 37.03 | 54.00 | -16.97 | A |
| 7466.66 | 60.17 | 100 | 0 | | | 44.88 | 3.63 | 34.99 | 53.92 | 74.00 | -20.08 | |
| 7466.66 | | | | 52.44 | A | 44.88 | 3.63 | 34.99 | 46.19 | 54.00 | -7.81 | |
| 11200.00 | 61.50 | 100 | 90 | | | 45.09 | 4.55 | 36.56 | 57.53 | 74.00 | -16.47 | |
| 11200.00 | | | | 48.29 | A | 45.09 | 4.55 | 36.56 | 44.32 | 54.00 | -9.68 | |
| 3733.33 | 59.33 | 100 | 315 | | | 46.55 | 2.53 | 32.47 | 47.77 | 74.00 | -26.23 | Ch. 120/ |
| 3733.33 | | | | 47.86 | A | 46.55 | 2.53 | 32.47 | 36.30 | 54.00 | -17.70 | B |
| 7466.66 | 60.00 | 100 | 315 | | | 44.88 | 3.63 | 34.99 | 53.75 | 74.00 | -20.25 | |
| 7466.66 | | | | 52.10 | A | 44.88 | 3.63 | 34.99 | 45.85 | 54.00 | -8.15 | |
| 11200.00 | 59.83 | 100 | 225 | | | 45.09 | 4.55 | 36.56 | 55.86 | 74.00 | -18.14 | |
| 11200.00 | | | | 47.23 | A | 45.09 | 4.55 | 36.56 | 43.26 | 54.00 | -10.74 | |
| 3733.33 | 59.50 | 100 | 0 | | | 46.55 | 2.53 | 32.47 | 47.94 | 74.00 | -26.06 | Ch. 120/ |
| 3733.33 | | | | 48.34 | A | 46.55 | 2.53 | 32.47 | 36.78 | 54.00 | -17.22 | C |
| 7466.66 | 59.17 | 100 | 225 | | | 44.88 | 3.63 | 34.99 | 52.92 | 74.00 | -21.08 | |
| 7466.66 | | | | 50.04 | A | 44.88 | 3.63 | 34.99 | 43.79 | 54.00 | -10.21 | |
| 11200.00 | 58.00 | 100 | 0 | | | 45.09 | 4.55 | 36.56 | 54.03 | 74.00 | -19.97 | |
| 11200.00 | | | | 44.89 | A | 45.09 | 4.55 | 36.56 | 40.92 | 54.00 | -13.08 | |
| 3666.66 | 61.00 | 100 | 270 | | | 46.56 | 2.50 | 32.33 | 49.27 | 74.00 | -24.73 | Ch. 100/ |
| 3666.66 | | | | 50.11 | A | 46.56 | 2.50 | 32.33 | 38.38 | 54.00 | -15.62 | A |
| 7333.33 | 58.83 | 100 | 0 | | | 44.92 | 3.60 | 34.97 | 52.47 | 74.00 | -21.53 | |
| 7333.33 | | | | 52.15 | A | 44.92 | 3.60 | 34.97 | 45.79 | 54.00 | -8.21 | |
| 11000.00 | 57.00 | 100 | 270 | | | 45.13 | 4.50 | 36.40 | 52.77 | 74.00 | -21.23 | |
| 11000.00 | | | | 44.44 | A | 45.13 | 4.50 | 36.40 | 40.21 | 54.00 | -13.79 | |
| 3800.00 | 59.83 | 100 | 135 | | | 46.54 | 2.55 | 32.60 | 48.45 | 74.00 | -25.55 | Ch. 140/ |
| 3800.00 | | | | 51.02 | A | 46.54 | 2.55 | 32.60 | 39.64 | 54.00 | -14.36 | A |
| 7600.00 | 56.33 | 100 | 0 | | | 44.86 | 3.67 | 34.98 | 50.12 | 74.00 | -23.88 | |
| 7600.00 | | | | 45.83 | A | 44.86 | 3.67 | 34.98 | 39.62 | 54.00 | -14.38 | |
| 11400.00 | 60.67 | 100 | 0 | | | 45.04 | 4.61 | 36.72 | 56.96 | 74.00 | -17.04 | |
| 11400.00 | | | | 47.09 | A | 45.04 | 4.61 | 36.72 | 43.38 | 54.00 | -10.62 | |



Radiated Emissions Test Results (Continued)

| RADIATED EMISSIONS - Vertical Antenna Polarization | | | | | | | | | | | | |
|----------------------------------------------------|----------------------|---------------------|-------------------|------------------------|---|--------------------|-------------------|------------------|--------------------------|---------------|------------------|-----------------|
| Freq. (MHz) | Meter Reading (dBuV) | Antenna Height (cm) | Azimuth (degrees) | Quasi pk or AVG (dBuV) | | Preamp Factor (dB) | Cable Factor (dB) | Ant. Factor (dB) | Corrected Reading (dBuV) | Limits (dBuV) | Diff (dB) +=FAIL | Comments |
| 3733.33 | 60.67 | 100 | 315 | | | 46.55 | 2.53 | 31.21 | 47.86 | 74.00 | -26.14 | Ch. 120/ |
| 3733.33 | | | | 52.20 | A | 46.55 | 2.53 | 31.21 | 39.39 | 54.00 | -14.61 | A |
| 7466.66 | 60.33 | 100 | 315 | | | 44.88 | 3.63 | 34.09 | 53.18 | 74.00 | -20.82 | |
| 7466.66 | | | | 51.19 | A | 44.88 | 3.63 | 34.09 | 44.04 | 54.00 | -9.96 | |
| 11200.00 | 64.17 | 100 | 270 | | | 45.09 | 4.55 | 36.12 | 59.76 | 74.00 | -14.24 | |
| 11200.00 | | | | 51.19 | A | 45.09 | 4.55 | 36.12 | 46.78 | 54.00 | -7.22 | |
| 3733.33 | 59.50 | 100 | 0 | | | 46.55 | 2.53 | 31.21 | 46.69 | 74.00 | -27.31 | Ch. 120/ |
| 3733.33 | | | | 50.23 | A | 46.55 | 2.53 | 31.21 | 37.42 | 54.00 | -16.58 | B |
| 7466.66 | 61.17 | 100 | 315 | | | 44.88 | 3.63 | 34.09 | 54.02 | 74.00 | -19.98 | |
| 7466.66 | | | | 54.32 | A | 44.88 | 3.63 | 34.09 | 47.17 | 54.00 | -6.83 | |
| 11200.00 | 62.83 | 100 | 0 | | | 45.09 | 4.55 | 36.12 | 58.42 | 74.00 | -15.58 | |
| 11200.00 | | | | 50.23 | A | 45.09 | 4.55 | 36.12 | 45.82 | 54.00 | -8.18 | |
| 3733.33 | 60.67 | 100 | 315 | | | 46.55 | 2.53 | 31.21 | 47.86 | 74.00 | -26.14 | Ch. 120/ |
| 3733.33 | | | | 51.79 | A | 46.55 | 2.53 | 31.21 | 38.98 | 54.00 | -15.02 | C |
| 7466.66 | 60.50 | 100 | 45 | | | 44.88 | 3.63 | 34.09 | 53.35 | 74.00 | -20.65 | |
| 7466.66 | | | | 54.40 | A | 44.88 | 3.63 | 34.09 | 47.25 | 54.00 | -6.75 | |
| 11200.00 | 60.00 | 100 | 0 | | | 45.09 | 4.55 | 36.12 | 55.59 | 74.00 | -18.41 | |
| 11200.00 | | | | 47.96 | A | 45.09 | 4.55 | 36.12 | 43.55 | 54.00 | -10.45 | |
| | | | | | | | | | | | | |
| 3666.66 | 64.83 | 100 | 0 | | | 46.56 | 2.50 | 31.07 | 51.83 | 74.00 | -22.17 | Ch. 100/ |
| 3666.66 | | | | 54.32 | A | 46.56 | 2.50 | 31.07 | 41.32 | 54.00 | -12.68 | A |
| 7333.33 | 61.00 | 100 | 270 | | | 44.92 | 3.60 | 34.07 | 53.74 | 74.00 | -20.26 | |
| 7333.33 | | | | 56.41 | A | 44.92 | 3.60 | 34.07 | 49.15 | 54.00 | -4.85 | |
| 3800.00 | 54.17 | 100 | 0 | | | 46.54 | 2.55 | 31.36 | 41.55 | 74.00 | -32.45 | Ch. 140/ |
| 3800.00 | | | | 46.49 | A | 46.54 | 2.55 | 31.36 | 33.87 | 54.00 | -20.13 | A |
| 7600.00 | 60.67 | 100 | 270 | | | 44.86 | 3.67 | 34.08 | 53.56 | 74.00 | -20.44 | |
| 7600.00 | | | | 54.71 | A | 44.86 | 3.67 | 34.08 | 47.60 | 54.00 | -6.40 | |
| 11400.00 | 61.17 | 100 | 0 | | | 45.04 | 4.61 | 36.24 | 56.98 | 74.00 | -17.02 | |
| 11400.00 | | | | 47.59 | A | 45.04 | 4.61 | 36.24 | 43.40 | 54.00 | -10.60 | |



RADIATED EMISSIONS TEST RESULTS

| | | | |
|-----------------------|---------------------------------------------------------------------------------------------------------------------------------------|------------------------|--------------|
| CLIENT: | Intel Corporation | DATE: | 04/08/08 |
| EUT: | Intel WiFi Link 5300 | PROJECT NUMBER: | INTEL-081125 |
| MODEL NUMBER: | 533AN_HMW | TEST ENGINEER: | KN/RC |
| SERIAL NUMBER: | 0016EA038A16 | SITE #: | 2 |
| CONFIGURATION: | Tested installed in an extender board connected to the host laptop's mini PCI slot in 802.11n (5740-5745 MHz) mode 20MHz Wide. | TEMPERATURE: | 22° C |
| | | HUMIDITY: | 39% RH |
| | | TIME: | 8:00 AM |

| | |
|---------------------|---------------------------------------------------------------------------------------------------------------------------------------------------------------------------------------------|
| Description: | Radiated RF Emissions (1 GHz – 18 GHz) |
| Results: | PASSED Horizontal and Vertical Antenna Polarizations Class B Limits |
| Note: | Radiated Emissions Measurements were performed on the EUT with power supply set at the following voltage and frequency. <ul style="list-style-type: none"> • 120VAC / 60 Hz. |

| Unwanted Spurious Emissions Limits | | | |
|------------------------------------|-----------------------|----------------------------------------------------------------|----------------------------------------------------------------------|
| Frequency (MHz) | Field Strength (uV/m) | Field Strength (dBuV/m) (Emissions in the restricted bands) | Field Strength (dBm/MHz) (Emissions outside the restricted bands) |
| Above 960 | 500 | 54.00 (Average) 74.00 (Peak) | < -20 dBc |

Radiated Emissions Sample Calculations

$$\text{Corrected Meter Reading} = \text{Meter Reading} + F + C - D$$

Where, F = Antenna Factor

C = Cable Factor

G = Amplifier Gain

D = Distance Factor (if applicable)

Therefore, the equation for determining the Corrected Meter Reading Limit (CML) is:

$$\text{CML} = \text{Specification Limit} - F - C + D$$



Radiated Emissions Test Results (Continued)

*Fundamental Measurements in 802.11n mode 20MHz Wide (5470-5725 MHz)
Channels 100, 120, & 140
Continuous TX at Chain A Antenna port with Ethertronics Antennas
Aegis Labs, Inc. File #: INTEL-081125-51*

| RADIATED EMISSIONS - Horizontal Antenna Polarization | | | | | | | | | | | |
|-------------------------------------------------------------|----------------------|---------------------|-------------------|------------------------|---|-------------------|------------------|--------------------------|---------------|-------------------|----------------|
| Freq. (MHz) | Meter Reading (dBuV) | Antenna Height (cm) | Azimuth (degrees) | Quasi pk or AVG (dBuV) | | Cable Factor (dB) | Ant. Factor (dB) | Corrected Reading (dBuV) | Limits (dBuV) | Diff (dB) +/-FAIL | Comments |
| 5500.00 | 60.83 | 100 | 135 | | | 3.89 | 34.70 | 99.42 | | | Ch. 100 |
| 5500.00 | | | | 50.83 | A | 3.89 | 34.70 | 89.42 | | | |
| 5600.00 | 60.83 | 100 | 135 | | | 3.93 | 34.86 | 99.62 | | | Ch. 120 |
| 5600.00 | | | | 50.00 | A | 3.93 | 34.86 | 88.79 | | | |
| 5700.00 | 61.83 | 100 | 135 | | | 3.97 | 35.02 | 100.82 | | | Ch. 140 |
| 5700.00 | | | | 50.83 | A | 3.97 | 35.02 | 89.82 | | | |

| RADIATED EMISSIONS - Vertical Antenna Polarization | | | | | | | | | | | |
|-----------------------------------------------------------|----------------------|---------------------|-------------------|------------------------|---|-------------------|------------------|--------------------------|---------------|-------------------|----------------|
| Freq. (MHz) | Meter Reading (dBuV) | Antenna Height (cm) | Azimuth (degrees) | Quasi pk or AVG (dBuV) | | Cable Factor (dB) | Ant. Factor (dB) | Corrected Reading (dBuV) | Limits (dBuV) | Diff (dB) +/-FAIL | Comments |
| 5500.00 | 68.33 | 100 | 225 | | | 3.89 | 34.50 | 106.72 | | | Ch. 100 |
| 5500.00 | | | | 58.17 | A | 3.89 | 34.50 | 96.56 | | | |
| 5600.00 | 69.67 | 100 | 225 | | | 3.93 | 34.68 | 108.28 | | | Ch. 120 |
| 5600.00 | | | | 58.67 | A | 3.93 | 34.68 | 97.28 | | | |
| 5700.00 | 68.50 | 100 | 225 | | | 3.97 | 34.86 | 107.33 | | | Ch. 140 |
| 5700.00 | | | | 57.50 | A | 3.97 | 34.86 | 96.33 | | | |

NOTE: Fundamental signals measured to calculate the band edge field strengths using the “Marker Delta Method”.



Radiated Emissions Test Results (Continued)

*Band Edge Field Strength Measurements in 802.11n mode 20MHz Wide (5470-5725 MHz)
Channels 100 & 140
Continuous TX at Chain A Antenna port with Ethertronics Antennas
Aegis Labs, Inc. File #: INTEL-081125-51*

| RADIATED EMISSIONS - Horizontal Antenna Polarization | | | | | | | | | | | |
|-------------------------------------------------------------|-----------------------------|----------------------------|--------------------------|-------------------------------|--------------------------|-------------------------|---------------------------------|----------------------|-------------------------|-----------------|----------------|
| <i>Freq. (MHz)</i> | <i>Meter Reading (dBuV)</i> | <i>Antenna Height (cm)</i> | <i>Azimuth (degrees)</i> | <i>Quasi pk or AVG (dBuV)</i> | <i>Cable Factor (dB)</i> | <i>Ant. Factor (dB)</i> | <i>Corrected Reading (dBuV)</i> | <i>Limits (dBuV)</i> | <i>Diff (dB) +=FAIL</i> | <i>Comments</i> | |
| 5460.00 | | | | | | | 47.76 | 74.00 | -26.24 | Ch. 100 | |
| 5460.00 | | | | | A | | 31.92 | 54.00 | -22.08 | | |
| 5725.00 | 32.17 | 100 | 135 | | | 3.98 | 35.06 | 71.21 | 80.82 | -9.61 | Ch. 140 |

| RADIATED EMISSIONS - Vertical Antenna Polarization | | | | | | | | | | | |
|-----------------------------------------------------------|-----------------------------|----------------------------|--------------------------|-------------------------------|--------------------------|-------------------------|---------------------------------|----------------------|-------------------------|-----------------|----------------|
| <i>Freq. (MHz)</i> | <i>Meter Reading (dBuV)</i> | <i>Antenna Height (cm)</i> | <i>Azimuth (degrees)</i> | <i>Quasi pk or AVG (dBuV)</i> | <i>Cable Factor (dB)</i> | <i>Ant. Factor (dB)</i> | <i>Corrected Reading (dBuV)</i> | <i>Limits (dBuV)</i> | <i>Diff (dB) +=FAIL</i> | <i>Comments</i> | |
| 5460.00 | | | | | | | 55.06 | 74.00 | -18.94 | Ch. 100 | |
| 5460.00 | | | | | A | | 39.06 | 54.00 | -14.94 | | |
| 5725.00 | 31.50 | 100 | 225 | | | 3.98 | 34.91 | 70.38 | 87.33 | -16.95 | Ch. 140 |

NOTE: The “Band Edge Field Strength” was calculated using the “Fundamental” and “Conducted Band Edge” measurements per the “Marker-Delta Method” with the following formula:

$$BE = F_m - \Delta_m$$

Where

BE = Band Edge Field Strength

F_m = Measured Fundamental (Peak or Average)

Δ_m = Measured Conducted Band Edge Delta (Peak or Average)

Radiated Emissions Test Results (Continued)

Plots Showing Out-Of-Band Emissions (Peak RBW=VBW=1MHz; Average RBW = 1MHz, VBW = 10Hz)

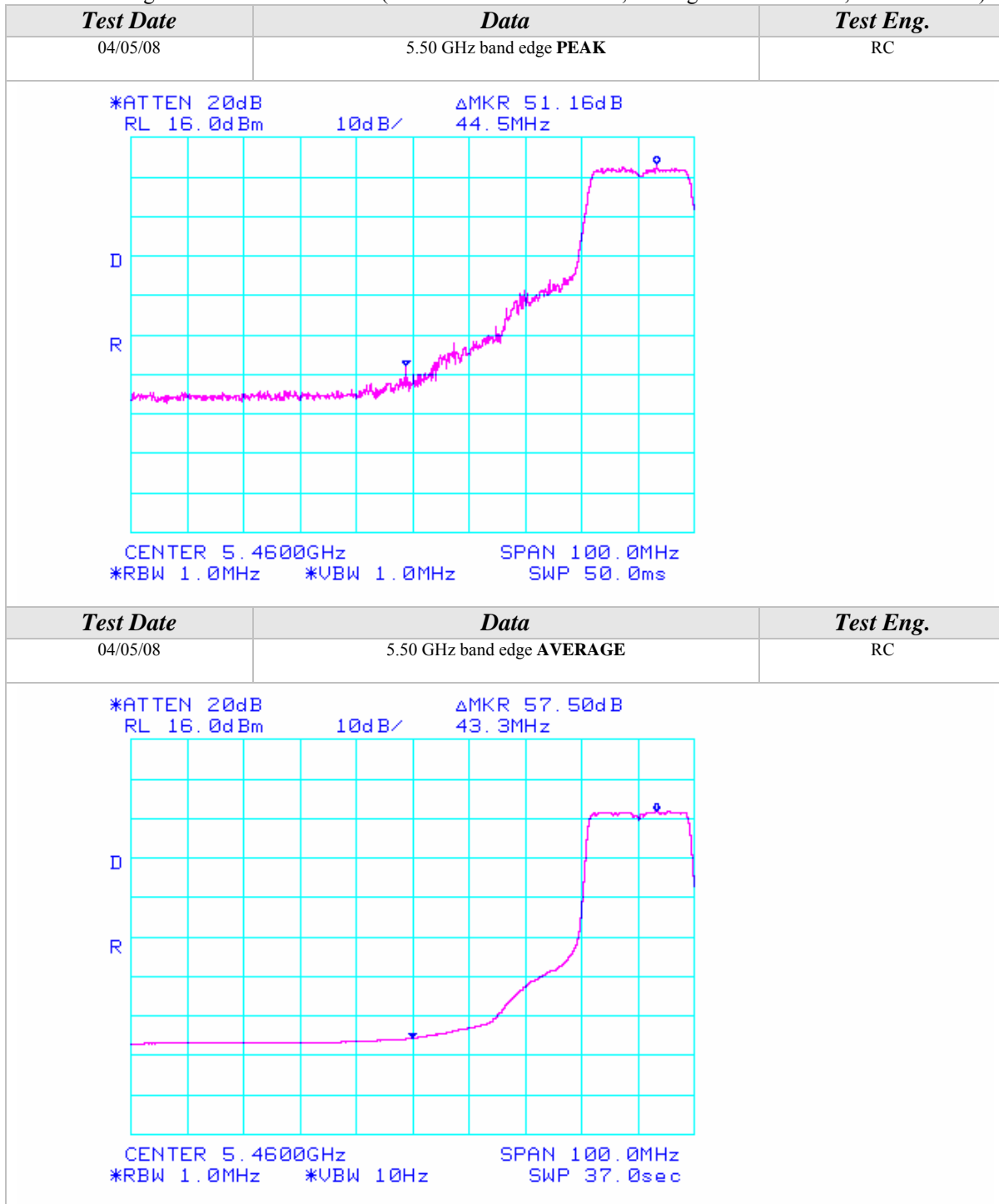



Radiated Emissions Test Results (Continued)

*Fundamental Measurements in 802.11n mode 20MHz Wide (5470-5725 MHz)
Channels 100, 120, & 140
Continuous TX at Chain B Antenna port with Ethertronics Antennas
Aegis Labs, Inc. File #: INTEL-081125-52*

| RADIATED EMISSIONS - Horizontal Antenna Polarization | | | | | | | | | | | |
|-------------------------------------------------------------|----------------------|---------------------|-------------------|------------------------|---|-------------------|------------------|--------------------------|---------------|------------------|----------------|
| Freq. (MHz) | Meter Reading (dBuV) | Antenna Height (cm) | Azimuth (degrees) | Quasi pk or AVG (dBuV) | | Cable Factor (dB) | Ant. Factor (dB) | Corrected Reading (dBuV) | Limits (dBuV) | Diff (dB) +=FAIL | Comments |
| 5500.00 | 59.67 | 100 | 180 | | | 3.89 | 34.70 | 98.26 | | | Ch. 100 |
| 5500.00 | | | | 49.00 | A | 3.89 | 34.70 | 87.59 | | | |
| 5600.00 | 60.00 | 100 | 135 | | | 3.93 | 34.86 | 98.79 | | | Ch. 120 |
| 5600.00 | | | | 49.67 | A | 3.93 | 34.86 | 88.46 | | | |
| 5700.00 | 62.17 | 100 | 135 | | | 3.97 | 35.02 | 101.16 | | | Ch. 140 |
| 5700.00 | | | | 51.67 | A | 3.97 | 35.02 | 90.66 | | | |

| RADIATED EMISSIONS - Vertical Antenna Polarization | | | | | | | | | | | |
|-----------------------------------------------------------|----------------------|---------------------|-------------------|------------------------|---|-------------------|------------------|--------------------------|---------------|------------------|----------------|
| Freq. (MHz) | Meter Reading (dBuV) | Antenna Height (cm) | Azimuth (degrees) | Quasi pk or AVG (dBuV) | | Cable Factor (dB) | Ant. Factor (dB) | Corrected Reading (dBuV) | Limits (dBuV) | Diff (dB) +=FAIL | Comments |
| 5500.00 | 70.00 | 100 | 135 | | | 3.89 | 34.50 | 108.39 | | | Ch. 100 |
| 5500.00 | | | | 59.17 | A | 3.89 | 34.50 | 97.56 | | | |
| 5600.00 | 69.33 | 100 | 180 | | | 3.93 | 34.68 | 107.94 | | | Ch. 120 |
| 5600.00 | | | | 59.33 | A | 3.93 | 34.68 | 97.94 | | | |
| 5700.00 | 69.67 | 100 | 225 | | | 3.97 | 34.86 | 108.50 | | | Ch. 140 |
| 5700.00 | | | | 59.83 | A | 3.97 | 34.86 | 98.66 | | | |

NOTE: Fundamental signals measured to calculate the band edge field strengths using the “Marker Delta Method”.



Radiated Emissions Test Results (Continued)

*Band Edge Field Strength Measurements in 802.11n mode 20MHz Wide (5470-5725 MHz)
Channels 100 & 140
Continuous TX at Chain B Antenna port with Ethertronics Antennas
Aegis Labs, Inc. File #: INTEL-081125-52*

| RADIATED EMISSIONS - Horizontal Antenna Polarization | | | | | | | | | | | |
|-------------------------------------------------------------|-----------------------------|----------------------------|--------------------------|-------------------------------|--------------------------|-------------------------|---------------------------------|----------------------|-------------------------|-----------------|----------------|
| <i>Freq. (MHz)</i> | <i>Meter Reading (dBuV)</i> | <i>Antenna Height (cm)</i> | <i>Azimuth (degrees)</i> | <i>Quasi pk or AVG (dBuV)</i> | <i>Cable Factor (dB)</i> | <i>Ant. Factor (dB)</i> | <i>Corrected Reading (dBuV)</i> | <i>Limits (dBuV)</i> | <i>Diff (dB) +=FAIL</i> | <i>Comments</i> | |
| 5460.00 | | | | | | | 46.60 | 74.00 | -27.40 | Ch. 100 | |
| 5460.00 | | | | | A | | 31.25 | 54.00 | -22.75 | | |
| 5725.00 | 31.17 | 100 | 135 | | | 3.98 | 35.06 | 70.21 | 81.16 | -10.95 | Ch. 140 |

| RADIATED EMISSIONS - Vertical Antenna Polarization | | | | | | | | | | | |
|-----------------------------------------------------------|-----------------------------|----------------------------|--------------------------|-------------------------------|--------------------------|-------------------------|---------------------------------|----------------------|-------------------------|-----------------|----------------|
| <i>Freq. (MHz)</i> | <i>Meter Reading (dBuV)</i> | <i>Antenna Height (cm)</i> | <i>Azimuth (degrees)</i> | <i>Quasi pk or AVG (dBuV)</i> | <i>Cable Factor (dB)</i> | <i>Ant. Factor (dB)</i> | <i>Corrected Reading (dBuV)</i> | <i>Limits (dBuV)</i> | <i>Diff (dB) +=FAIL</i> | <i>Comments</i> | |
| 5460.00 | | | | | | | 56.73 | 74.00 | -17.27 | Ch. 100 | |
| 5460.00 | | | | | A | | 41.22 | 54.00 | -12.78 | | |
| 5725.00 | 31.33 | 100 | 225 | | | 3.98 | 34.91 | 70.21 | 88.50 | -18.29 | Ch. 140 |

NOTE: The “Band Edge Field Strength” was calculated using the “Fundamental” and “Conducted Band Edge” measurements per the “Marker-Delta Method” with the following formula:

$$BE = F_m - \Delta_m$$

Where

BE = Band Edge Field Strength

F_m = Measured Fundamental (Peak or Average)

Δ_m = Measured Conducted Band Edge Delta (Peak or Average)

Radiated Emissions Test Results (Continued)

Plots Showing Out-Of-Band Emissions (Peak RBW=VBW=1MHz; Average RBW = 1MHz, VBW = 10Hz)

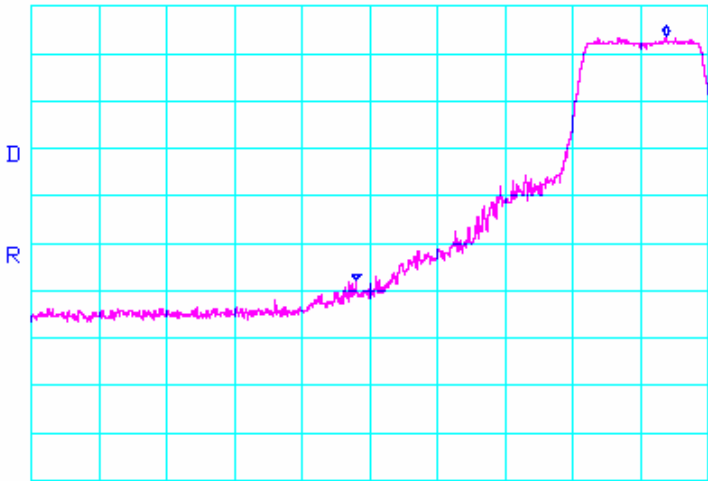
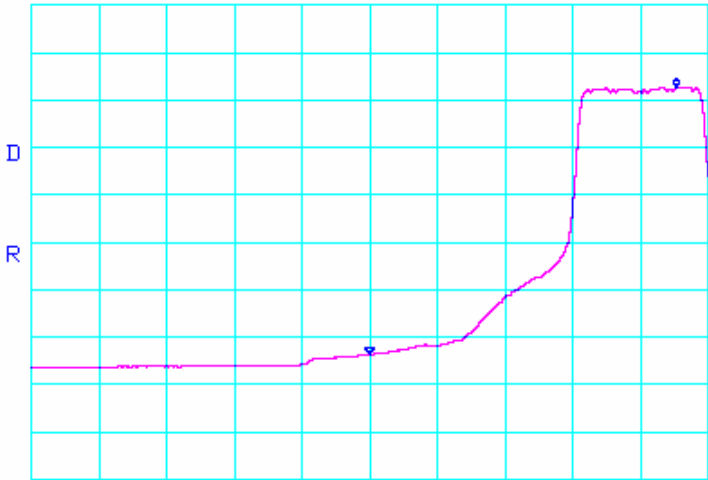
| <i>Test Date</i> | <i>Data</i> | <i>Test Eng.</i> |
|-----------------------------------------------------------------------------------------------------------------------------------------------------------------------------------------------------------------------------------------------------------------------------------------------------------------------------------------------------------------|-----------------------------------|------------------|
| 04/05/08 | 5.50 GHz band edge PEAK | RC |
| <p>*ATTEN 20dB ΔMKR 51.66dB RL 16.0dBm 10dB/ 45.8MHz</p>  <p>CENTER 5.4600GHz SPAN 100.0MHz *RBW 1.0MHz *VBW 1.0MHz SWP 50.0ms</p> | | |
| <i>Test Date</i> | <i>Data</i> | <i>Test Eng.</i> |
| 04/05/08 | 5.50 GHz band edge AVERAGE | RC |
| <p>*ATTEN 20dB ΔMKR 56.34dB RL 16.0dBm 10dB/ 45.3MHz</p>  <p>CENTER 5.4600GHz SPAN 100.0MHz *RBW 1.0MHz *VBW 10Hz SWP 37.0sec</p> | | |

Radiated Emissions Test Results (Continued)

*Fundamental Measurements in 802.11n mode 20MHz Wide (5470-5725 MHz)
Channels 100, 120, & 140
Continuous TX at Chain C Antenna port with Ethertronics Antennas
Aegis Labs, Inc. File #: INTEL-081125-53*

| RADIATED EMISSIONS - Horizontal Antenna Polarization | | | | | | | | | | | |
|-------------------------------------------------------------|----------------------|---------------------|-------------------|------------------------|---|-------------------|------------------|--------------------------|---------------|-------------------|----------------|
| Freq. (MHz) | Meter Reading (dBuV) | Antenna Height (cm) | Azimuth (degrees) | Quasi pk or AVG (dBuV) | | Cable Factor (dB) | Ant. Factor (dB) | Corrected Reading (dBuV) | Limits (dBuV) | Diff (dB) +/-FAIL | Comments |
| 5500.00 | 70.17 | 100 | 225 | | | 3.89 | 34.70 | 108.76 | | | Ch. 100 |
| 5500.00 | | | | 60.00 | A | 3.89 | 34.70 | 98.59 | | | |
| 5600.00 | 68.00 | 100 | 225 | | | 3.93 | 34.86 | 106.79 | | | Ch. 120 |
| 5600.00 | | | | 58.17 | A | 3.93 | 34.86 | 96.96 | | | |
| 5700.00 | 70.67 | 100 | 180 | | | 3.97 | 35.02 | 109.66 | | | Ch. 140 |
| 5700.00 | | | | 59.67 | A | 3.97 | 35.02 | 98.66 | | | |

| RADIATED EMISSIONS - Vertical Antenna Polarization | | | | | | | | | | | |
|-----------------------------------------------------------|----------------------|---------------------|-------------------|------------------------|---|-------------------|------------------|--------------------------|---------------|-------------------|----------------|
| Freq. (MHz) | Meter Reading (dBuV) | Antenna Height (cm) | Azimuth (degrees) | Quasi pk or AVG (dBuV) | | Cable Factor (dB) | Ant. Factor (dB) | Corrected Reading (dBuV) | Limits (dBuV) | Diff (dB) +/-FAIL | Comments |
| 5500.00 | 65.00 | 100 | 315 | | | 3.89 | 34.50 | 103.39 | | | Ch. 100 |
| 5500.00 | | | | 54.17 | A | 3.89 | 34.50 | 92.56 | | | |
| 5600.00 | 62.33 | 100 | 90 | | | 3.93 | 34.68 | 100.94 | | | Ch. 120 |
| 5600.00 | | | | 52.17 | A | 3.93 | 34.68 | 90.78 | | | |
| 5700.00 | 65.00 | 100 | 315 | | | 3.97 | 34.86 | 103.83 | | | Ch. 140 |
| 5700.00 | | | | 54.67 | A | 3.97 | 34.86 | 93.50 | | | |

NOTE: Fundamental signals measured to calculate the band edge field strengths using the “Marker Delta Method”.



Radiated Emissions Test Results (Continued)

*Band Edge Field Strength Measurements in 802.11n mode 20MHz Wide (5470-5725 MHz)
Channels 100 & 140
Continuous TX at Chain C Antenna port with Ethertronics Antennas
Aegis Labs, Inc. File #: INTEL-081125-53*

| RADIATED EMISSIONS - Horizontal Antenna Polarization | | | | | | | | | | |
|-------------------------------------------------------------|-----------------------------|----------------------------|--------------------------|-------------------------------|--------------------------|-------------------------|---------------------------------|----------------------|-------------------------|-----------------|
| <i>Freq. (MHz)</i> | <i>Meter Reading (dBuV)</i> | <i>Antenna Height (cm)</i> | <i>Azimuth (degrees)</i> | <i>Quasi pk or AVG (dBuV)</i> | <i>Cable Factor (dB)</i> | <i>Ant. Factor (dB)</i> | <i>Corrected Reading (dBuV)</i> | <i>Limits (dBuV)</i> | <i>Diff (dB) +=FAIL</i> | <i>Comments</i> |
| 5460.00 | | | | | | | 59.60 | 74.00 | -14.40 | Ch. 100 |
| 5460.00 | | | | | A | | 42.59 | 54.00 | -11.41 | |
| 5725.00 | 32.67 | 100 | 180 | | | 3.98 35.06 | 71.71 | 89.66 | -17.95 | Ch. 140 |

| RADIATED EMISSIONS - Vertical Antenna Polarization | | | | | | | | | | |
|-----------------------------------------------------------|-----------------------------|----------------------------|--------------------------|-------------------------------|--------------------------|-------------------------|---------------------------------|----------------------|-------------------------|-----------------|
| <i>Freq. (MHz)</i> | <i>Meter Reading (dBuV)</i> | <i>Antenna Height (cm)</i> | <i>Azimuth (degrees)</i> | <i>Quasi pk or AVG (dBuV)</i> | <i>Cable Factor (dB)</i> | <i>Ant. Factor (dB)</i> | <i>Corrected Reading (dBuV)</i> | <i>Limits (dBuV)</i> | <i>Diff (dB) +=FAIL</i> | <i>Comments</i> |
| 5460.00 | | | | | | | 54.23 | 74.00 | -19.77 | Ch. 100 |
| 5460.00 | | | | | A | | 36.56 | 54.00 | -17.44 | |
| 5725.00 | 31.50 | 100 | 315 | | | 3.98 34.91 | 70.38 | 83.83 | -13.45 | Ch. 140 |

NOTE: The “Band Edge Field Strength” was calculated using the “Fundamental” and “Conducted Band Edge” measurements per the “Marker-Delta Method” with the following formula:

$$BE = Fm - \Delta m$$

Where

BE = Band Edge Field Strength

Fm = Measured Fundamental (Peak or Average)

Δm = Measured Conducted Band Edge Delta (Peak or Average)



Radiated Emissions Test Results (Continued)

Plots Showing Out-Of-Band Emissions (Peak RBW=VBW=1MHz; Average RBW = 1MHz, VBW = 10Hz)

| <i>Test Date</i> | <i>Data</i> | <i>Test Eng.</i> |
|------------------|--------------------------------|------------------|
| 04/05/08 | 5.50 GHz band edge PEAK | RC |

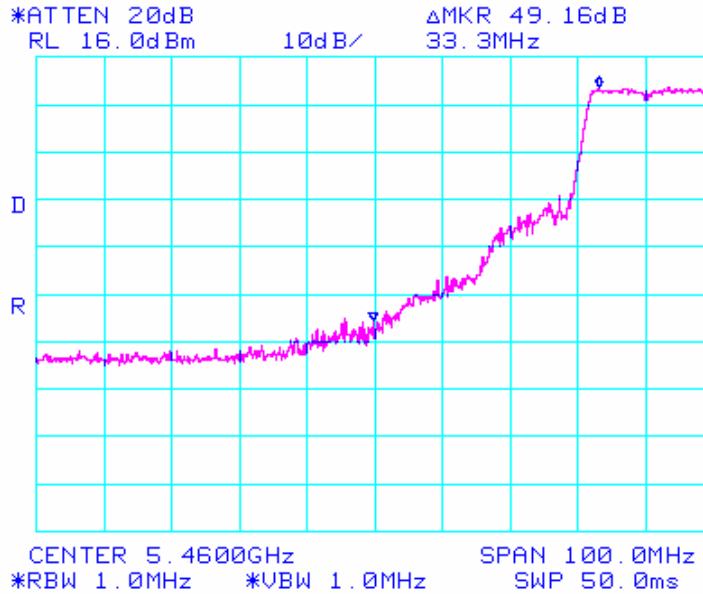

| <i>Test Date</i> | <i>Data</i> | <i>Test Eng.</i> |
|------------------|-----------------------------------|------------------|
| 04/05/08 | 5.50 GHz band edge AVERAGE | RC |

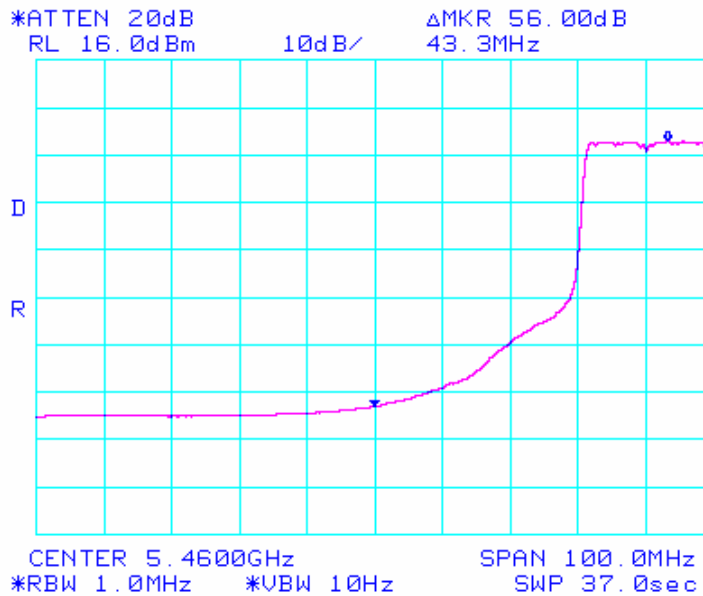



Radiated Emissions Test Results (Continued)

*Spurious Emissions Measurements in 802.11n mode 20MHz Wide (5470-5725 MHz)
 Channels 100, 120, & 140
 Continuous TX at Chain A, B, & C Antenna ports with Ethertronics Antennas
 Aegis Labs, Inc. File #: INTEL-081125-46*

| RADIATED EMISSIONS - Horizontal Antenna Polarization | | | | | | | | | | | | |
|-------------------------------------------------------------|----------------------|---------------------|-------------------|------------------------|---|--------------------|-------------------|------------------|--------------------------|---------------|------------------|----------------------|
| Freq. (MHz) | Meter Reading (dBuV) | Antenna Height (cm) | Azimuth (degrees) | Quasi pk or AVG (dBuV) | | Preamp Factor (dB) | Cable Factor (dB) | Ant. Factor (dB) | Corrected Reading (dBuV) | Limits (dBuV) | Diff (dB) +=FAIL | Channel/Chain Tested |
| 3733.33 | 51.83 | 100 | 315 | | | 50.76 | 3.19 | 33.08 | 37.34 | 74.00 | -36.66 | Ch. 120/ |
| 3733.33 | | | | 41.43 | A | 50.76 | 3.19 | 33.08 | 26.94 | 54.00 | -27.06 | A |
| 7466.66 | 51.17 | 100 | 270 | | | 50.20 | 4.60 | 35.98 | 41.55 | 74.00 | -32.45 | |
| 7466.66 | | | | 42.39 | A | 50.20 | 4.60 | 35.98 | 32.77 | 54.00 | -21.23 | |
| 3733.33 | 54.83 | 100 | 180 | | | 50.76 | 3.19 | 33.08 | 40.34 | 74.00 | -33.66 | Ch. 120/ |
| 3733.33 | | | | 46.87 | A | 50.76 | 3.19 | 33.08 | 32.38 | 54.00 | -21.62 | B |
| 7466.66 | 54.67 | 100 | 225 | | | 50.20 | 4.60 | 35.98 | 45.05 | 74.00 | -28.95 | |
| 7466.66 | | | | 42.46 | A | 50.20 | 4.60 | 35.98 | 32.84 | 54.00 | -21.16 | |
| 3733.33 | 52.83 | 100 | 225 | | | 50.76 | 3.19 | 33.08 | 38.34 | 74.00 | -35.66 | Ch. 120/ |
| 3733.33 | | | | 41.26 | A | 50.76 | 3.19 | 33.08 | 26.77 | 54.00 | -27.23 | C |
| 7466.66 | 53.00 | 100 | 225 | | | 50.20 | 4.60 | 35.98 | 43.38 | 74.00 | -30.62 | |
| 7466.66 | | | | 42.54 | A | 50.20 | 4.60 | 35.98 | 32.92 | 54.00 | -21.08 | |
| 11199.99 | 56.00 | 100 | 135 | | | 50.48 | 5.75 | 38.22 | 49.49 | 74.00 | -24.51 | |
| 11199.99 | | | | 42.94 | A | 50.48 | 5.75 | 38.22 | 36.43 | 54.00 | -17.57 | |
| 3666.66 | 54.83 | 100 | 225 | | | 50.75 | 3.17 | 33.00 | 40.25 | 74.00 | -33.75 | Ch. 100/ |
| 3666.66 | | | | 42.24 | A | 50.75 | 3.17 | 33.00 | 27.66 | 54.00 | -26.34 | A |
| 7333.33 | 53.00 | 100 | 225 | | | 50.26 | 4.55 | 35.90 | 43.19 | 74.00 | -30.81 | |
| 7333.33 | | | | 42.19 | A | 50.26 | 4.55 | 35.90 | 32.38 | 54.00 | -21.62 | |
| 3800.00 | 54.00 | 100 | 225 | | | 50.68 | 3.24 | 33.16 | 39.72 | 74.00 | -34.28 | Ch. 140/ |
| 3800.00 | | | | 43.55 | A | 50.68 | 3.24 | 33.16 | 29.27 | 54.00 | -24.73 | A |
| 7600.00 | 52.00 | 100 | 225 | | | 50.16 | 4.64 | 36.02 | 42.49 | 74.00 | -31.51 | |
| 7600.00 | | | | 40.89 | A | 50.16 | 4.64 | 36.02 | 31.38 | 54.00 | -22.62 | |



Radiated Emissions Test Results (Continued)

| RADIATED EMISSIONS - Vertical Antenna Polarization | | | | | | | | | | | | |
|----------------------------------------------------|----------------------|---------------------|-------------------|------------------------|---|--------------------|-------------------|------------------|--------------------------|---------------|-------------------|-----------------|
| Freq. (MHz) | Meter Reading (dBuV) | Antenna Height (cm) | Azimuth (degrees) | Quasi pk or AVG (dBuV) | | Preamp Factor (dB) | Cable Factor (dB) | Ant. Factor (dB) | Corrected Reading (dBuV) | Limits (dBuV) | Diff (dB) +/-FAIL | Comments |
| 3733.33 | 53.00 | 100 | 0 | | | 50.76 | 3.19 | 33.13 | 38.57 | 74.00 | -35.43 | Ch. 120/ |
| 3733.33 | | | | 43.23 | A | 50.76 | 3.19 | 33.13 | 28.80 | 54.00 | -25.20 | A |
| 7466.66 | 53.17 | 100 | 315 | | | 50.20 | 4.60 | 36.07 | 43.64 | 74.00 | -30.36 | |
| 7466.66 | | | | 45.87 | A | 50.20 | 4.60 | 36.07 | 36.34 | 54.00 | -17.66 | |
| 11200.00 | 55.17 | 100 | 225 | | | 50.48 | 5.75 | 38.10 | 48.54 | 74.00 | -25.46 | |
| 11200.00 | | | | 42.05 | A | 50.48 | 5.75 | 38.10 | 35.42 | 54.00 | -18.58 | |
| 3733.33 | 52.00 | 100 | 0 | | | 50.76 | 3.19 | 33.13 | 37.57 | 74.00 | -36.43 | Ch. 120/ |
| 3733.33 | | | | 43.43 | A | 50.76 | 3.19 | 33.13 | 29.00 | 54.00 | -25.00 | B |
| 7466.66 | 52.00 | 100 | 270 | | | 50.20 | 4.60 | 36.07 | 42.47 | 74.00 | -31.53 | |
| 7466.66 | | | | 44.40 | A | 50.20 | 4.60 | 36.07 | 34.87 | 54.00 | -19.13 | |
| 11200.00 | 53.00 | 100 | 135 | | | 50.48 | 5.75 | 38.10 | 46.37 | 74.00 | -27.63 | |
| 11200.00 | | | | 39.93 | A | 50.48 | 5.75 | 38.10 | 33.30 | 54.00 | -20.70 | |
| 3733.33 | 53.00 | 100 | 90 | | | 50.76 | 3.19 | 33.13 | 38.57 | 74.00 | -35.43 | Ch. 120/ |
| 3733.33 | | | | 43.12 | A | 50.76 | 3.19 | 33.13 | 28.69 | 54.00 | -25.31 | C |
| 7466.66 | 52.17 | 100 | 180 | | | 50.20 | 4.60 | 36.07 | 42.64 | 74.00 | -31.36 | |
| 7466.66 | | | | 44.50 | A | 50.20 | 4.60 | 36.07 | 34.97 | 54.00 | -19.03 | |
| 11200.00 | 41.67 | 100 | 135 | | | 50.48 | 5.75 | 38.10 | 35.04 | 74.00 | -38.96 | |
| 11200.00 | | | | 32.73 | A | 50.48 | 5.75 | 38.10 | 26.10 | 54.00 | -27.90 | |
| 3666.66 | 57.33 | 100 | 180 | | | 50.75 | 3.17 | 33.07 | 42.82 | 74.00 | -31.18 | Ch. 100/ |
| 3666.66 | | | | 48.75 | A | 50.75 | 3.17 | 33.07 | 34.24 | 54.00 | -19.76 | B |
| 7333.33 | 51.50 | 100 | 225 | | | 50.26 | 4.55 | 35.93 | 41.72 | 74.00 | -32.28 | |
| 7333.33 | | | | 42.78 | A | 50.26 | 4.55 | 35.93 | 33.00 | 54.00 | -21.00 | |
| 3800.00 | 54.50 | 100 | 180 | | | 50.68 | 3.24 | 33.20 | 40.26 | 74.00 | -33.74 | Ch. 140/ |
| 3800.00 | | | | 46.59 | A | 50.68 | 3.24 | 33.20 | 32.35 | 54.00 | -21.65 | B |
| 7600.00 | 55.00 | 100 | 180 | | | 50.16 | 4.64 | 36.12 | 45.59 | 74.00 | -28.41 | |
| 7600.00 | | | | 48.17 | A | 50.16 | 4.64 | 36.12 | 38.76 | 54.00 | -15.24 | |
| 11400.00 | 50.83 | 100 | 135 | 53.67 | | 50.51 | 5.86 | 38.30 | 47.31 | 74.00 | -26.69 | |
| 11400.00 | | | | 40.10 | A | 50.51 | 5.86 | 38.30 | 33.74 | 54.00 | -20.26 | |



Radiated Emissions Test Results (Continued)

*Spurious Emissions Measurements in 802.11n mode 20MHz Wide (5470-5725 MHz)
Channels 100, 120, & 140
Continuous TX at Chain A, B, & C Antenna ports with Wistron Neweb Corp. Antennas
Aegis Labs, Inc. File #: INTEL-081125-75*

| RADIATED EMISSIONS - Horizontal Antenna Polarization | | | | | | | | | | | | |
|-------------------------------------------------------------|----------------------|---------------------|-------------------|------------------------|---|--------------------|-------------------|------------------|--------------------------|---------------|------------------|----------------------|
| Freq. (MHz) | Meter Reading (dBuV) | Antenna Height (cm) | Azimuth (degrees) | Quasi pk or AVG (dBuV) | | Preamp Factor (dB) | Cable Factor (dB) | Ant. Factor (dB) | Corrected Reading (dBuV) | Limits (dBuV) | Diff (dB) +=FAIL | Channel/Chain Tested |
| 3733.33 | 59.67 | 100 | 90 | | | 46.55 | 2.53 | 32.47 | 48.11 | 74.00 | -25.89 | Ch. 120/ |
| 3733.33 | | | | 49.82 | A | 46.55 | 2.53 | 32.47 | 38.26 | 54.00 | -15.74 | A |
| 7466.66 | 59.50 | 100 | 135 | | | 44.88 | 3.63 | 34.99 | 53.25 | 74.00 | -20.75 | |
| 7466.66 | | | | 50.86 | A | 44.88 | 3.63 | 34.99 | 44.61 | 54.00 | -9.39 | |
| 3733.33 | 59.50 | 100 | 135 | | | 46.55 | 2.53 | 32.47 | 47.94 | 74.00 | -26.06 | Ch. 120/ |
| 3733.33 | | | | 50.08 | A | 46.55 | 2.53 | 32.47 | 38.52 | 54.00 | -15.48 | B |
| 7466.66 | 59.83 | 100 | 135 | | | 44.88 | 3.63 | 34.99 | 53.58 | 74.00 | -20.42 | |
| 7466.66 | | | | 51.94 | A | 44.88 | 3.63 | 34.99 | 45.69 | 54.00 | -8.31 | |
| 3733.33 | 59.33 | 100 | 135 | | | 46.55 | 2.53 | 32.47 | 47.77 | 74.00 | -26.23 | Ch. 120/ |
| 3733.33 | | | | 49.82 | A | 46.55 | 2.53 | 32.47 | 38.26 | 54.00 | -15.74 | C |
| 7466.66 | 60.17 | 100 | 135 | | | 44.88 | 3.63 | 34.99 | 53.92 | 74.00 | -20.08 | |
| 7466.66 | | | | 53.10 | A | 44.88 | 3.63 | 34.99 | 46.85 | 54.00 | -7.15 | |
| 11199.99 | 56.67 | 100 | 45 | | | 45.09 | 4.55 | 36.56 | 52.70 | 74.00 | -21.30 | |
| 11199.99 | | | | 43.96 | A | 45.09 | 4.55 | 36.56 | 39.99 | 54.00 | -14.01 | |
| 3666.66 | 59.83 | 100 | 90 | | | 46.56 | 2.50 | 32.33 | 48.10 | 74.00 | -25.90 | Ch. 100/ |
| 3666.66 | | | | 51.15 | A | 46.56 | 2.50 | 32.33 | 39.42 | 54.00 | -14.58 | C |
| 7333.33 | 58.50 | 100 | 0 | | | 44.92 | 3.60 | 34.97 | 52.14 | 74.00 | -21.86 | |
| 7333.33 | | | | 48.27 | A | 44.92 | 3.60 | 34.97 | 41.91 | 54.00 | -12.09 | |
| 3800.00 | 58.33 | 100 | 315 | | | 46.54 | 2.55 | 32.60 | 46.95 | 74.00 | -27.05 | Ch. 140/ |
| 3800.00 | | | | 47.23 | A | 46.54 | 2.55 | 32.60 | 35.85 | 54.00 | -18.15 | C |
| 7600.00 | 57.00 | 100 | 0 | | | 44.86 | 3.67 | 34.98 | 50.79 | 74.00 | -23.21 | |
| 7600.00 | | | | 45.77 | A | 44.86 | 3.67 | 34.98 | 39.56 | 54.00 | -14.44 | |



Radiated Emissions Test Results (Continued)

| RADIATED EMISSIONS - Vertical Antenna Polarization | | | | | | | | | | | | |
|----------------------------------------------------|----------------------|---------------------|-------------------|------------------------|---|--------------------|-------------------|------------------|--------------------------|---------------|-------------------|-----------------|
| Freq. (MHz) | Meter Reading (dBuV) | Antenna Height (cm) | Azimuth (degrees) | Quasi pk or AVG (dBuV) | | Preamp Factor (dB) | Cable Factor (dB) | Ant. Factor (dB) | Corrected Reading (dBuV) | Limits (dBuV) | Diff (dB) +/-FAIL | Comments |
| 3733.33 | 61.33 | 100 | 0 | | | 46.55 | 2.53 | 31.21 | 48.52 | 74.00 | -25.48 | Ch. 120/ |
| 3733.33 | | | | 55.04 | A | 46.55 | 2.53 | 31.21 | 42.23 | 54.00 | -11.77 | A |
| 7466.66 | 61.17 | 100 | 315 | | | 44.88 | 3.63 | 34.09 | 54.02 | 74.00 | -19.98 | |
| 7466.66 | | | | 55.11 | A | 44.88 | 3.63 | 34.09 | 47.96 | 54.00 | -6.04 | |
| 11200.00 | 56.83 | 100 | 270 | | | 45.09 | 4.55 | 36.12 | 52.42 | 74.00 | -21.58 | |
| 11200.00 | | | | 44.08 | A | 45.09 | 4.55 | 36.12 | 39.67 | 54.00 | -14.33 | |
| 3733.33 | 61.00 | 100 | 0 | | | 46.55 | 2.53 | 31.21 | 48.19 | 74.00 | -25.81 | Ch. 120/ |
| 3733.33 | | | | 54.00 | A | 46.55 | 2.53 | 31.21 | 41.19 | 54.00 | -12.81 | B |
| 7466.66 | 60.50 | 100 | 45 | | | 44.88 | 3.63 | 34.09 | 53.35 | 74.00 | -20.65 | |
| 7466.66 | | | | 53.67 | A | 44.88 | 3.63 | 34.09 | 46.52 | 54.00 | -7.48 | |
| 11200.00 | 55.83 | 100 | 45 | | | 45.09 | 4.55 | 36.12 | 51.42 | 74.00 | -22.58 | |
| 11200.00 | | | | 43.67 | A | 45.09 | 4.55 | 36.12 | 39.26 | 54.00 | -14.74 | |
| 3733.33 | 62.33 | 100 | 0 | | | 46.55 | 2.53 | 31.21 | 49.52 | 74.00 | -24.48 | Ch. 120/ |
| 3733.33 | | | | 55.83 | A | 46.55 | 2.53 | 31.21 | 43.02 | 54.00 | -10.98 | C |
| 7466.66 | 59.83 | 100 | 45 | | | 44.88 | 3.63 | 34.09 | 52.68 | 74.00 | -21.32 | |
| 7466.66 | | | | 52.15 | A | 44.88 | 3.63 | 34.09 | 45.00 | 54.00 | -9.00 | |
| 11200.00 | 58.83 | 100 | 45 | | | 45.09 | 4.55 | 36.12 | 54.42 | 74.00 | -19.58 | |
| 11200.00 | | | | 45.11 | A | 45.09 | 4.55 | 36.12 | 40.70 | 54.00 | -13.30 | |
| 3666.66 | 62.83 | 100 | 0 | | | 46.56 | 2.50 | 31.07 | 49.83 | 74.00 | -24.17 | Ch. 100/ |
| 3666.66 | | | | 53.54 | A | 46.56 | 2.50 | 31.07 | 40.54 | 54.00 | -13.46 | B |
| 7333.33 | 60.83 | 100 | 270 | | | 44.92 | 3.60 | 34.07 | 53.57 | 74.00 | -20.43 | |
| 7333.33 | | | | 54.52 | A | 44.92 | 3.60 | 34.07 | 47.26 | 54.00 | -6.74 | |
| 3800.00 | 59.67 | 100 | 315 | | | 46.54 | 2.55 | 31.36 | 47.05 | 74.00 | -26.95 | Ch. 140/ |
| 3800.00 | | | | 52.73 | A | 46.54 | 2.55 | 31.36 | 40.11 | 54.00 | -13.89 | B |
| 7600.00 | 58.83 | 100 | 270 | | | 44.86 | 3.67 | 34.08 | 51.72 | 74.00 | -22.28 | |
| 7600.00 | | | | 51.46 | A | 44.86 | 3.67 | 34.08 | 44.35 | 54.00 | -9.65 | |
| 11400.00 | 56.33 | 100 | 0 | | | 45.04 | 4.61 | 36.24 | 52.14 | 74.00 | -21.86 | |
| 11400.00 | | | | 45.39 | A | 45.04 | 4.61 | 36.24 | 41.20 | 54.00 | -12.80 | |



Radiated Emissions Test Results (Continued)

*Spurious Emissions Measurements in 802.11n mode 20MHz Wide (5470-5725 MHz)
Channels 100, 120, & 140
Continuous TX at Triple Chain ABC Antenna ports with Ethertronics Antennas
Aegis Labs, Inc. File #: INTEL-081125-46*

| RADIATED EMISSIONS - Horizontal Antenna Polarization | | | | | | | | | | | | |
|------------------------------------------------------|----------------------|---------------------|-------------------|------------------------|---|--------------------|-------------------|------------------|--------------------------|---------------|-------------------|----------------------|
| Freq. (MHz) | Meter Reading (dBuV) | Antenna Height (cm) | Azimuth (degrees) | Quasi pk or AVG (dBuV) | | Preamp Factor (dB) | Cable Factor (dB) | Ant. Factor (dB) | Corrected Reading (dBuV) | Limits (dBuV) | Diff (dB) +/-FAIL | Channel/Chain Tested |
| 3666.66 | 54.83 | 100 | 225 | | | 50.75 | 3.17 | 33.00 | 40.25 | 74.00 | -33.75 | Ch. 100/ |
| 3666.66 | | | | 42.24 | A | 50.75 | 3.17 | 33.00 | 27.66 | 54.00 | -26.34 | ABC |
| 7333.33 | 53.00 | 100 | 225 | | | 50.26 | 4.55 | 35.90 | 43.19 | 74.00 | -30.81 | |
| 7333.33 | | | | 42.19 | A | 50.26 | 4.55 | 35.90 | 32.38 | 54.00 | -21.62 | |
| 3733.33 | 51.00 | 100 | 135 | | | 50.76 | 3.19 | 33.08 | 36.51 | 74.00 | -37.49 | Ch. 120/ |
| 3733.33 | | | | 40.95 | A | 50.76 | 3.19 | 33.08 | 26.46 | 54.00 | -27.54 | ABC |
| 7466.66 | 52.17 | 100 | 225 | | | 50.20 | 4.60 | 35.98 | 42.55 | 74.00 | -31.45 | |
| 7466.66 | | | | 43.30 | A | 50.20 | 4.60 | 35.98 | 33.68 | 54.00 | -20.32 | |
| 11199.99 | 52.50 | 100 | 270 | | | 50.48 | 5.75 | 38.22 | 45.99 | 74.00 | -28.01 | |
| 11199.99 | | | | 40.00 | A | 50.48 | 5.75 | 38.22 | 33.49 | 54.00 | -20.51 | |
| 3800.00 | 54.00 | 100 | 225 | | | 50.68 | 3.24 | 33.16 | 39.72 | 74.00 | -34.28 | Ch. 140/ |
| 3800.00 | | | | 43.55 | A | 50.68 | 3.24 | 33.16 | 29.27 | 54.00 | -24.73 | ABC |
| 7600.00 | 52.00 | 100 | 225 | | | 50.16 | 4.64 | 36.02 | 42.49 | 74.00 | -31.51 | |
| 7600.00 | | | | 40.89 | A | 50.16 | 4.64 | 36.02 | 31.38 | 54.00 | -22.62 | |

| RADIATED EMISSIONS - Vertical Antenna Polarization | | | | | | | | | | | | |
|----------------------------------------------------|----------------------|---------------------|-------------------|------------------------|---|--------------------|-------------------|------------------|--------------------------|---------------|-------------------|-----------------|
| Freq. (MHz) | Meter Reading (dBuV) | Antenna Height (cm) | Azimuth (degrees) | Quasi pk or AVG (dBuV) | | Preamp Factor (dB) | Cable Factor (dB) | Ant. Factor (dB) | Corrected Reading (dBuV) | Limits (dBuV) | Diff (dB) +/-FAIL | Comments |
| 3666.66 | 57.33 | 100 | 180 | | | 50.75 | 3.17 | 33.07 | 42.82 | 74.00 | -31.18 | Ch. 100/ |
| 3666.66 | | | | 48.75 | A | 50.75 | 3.17 | 33.07 | 34.24 | 54.00 | -19.76 | ABC |
| 7333.33 | 51.50 | 100 | 225 | | | 50.26 | 4.55 | 35.93 | 41.72 | 74.00 | -32.28 | |
| 7333.33 | | | | 42.78 | A | 50.26 | 4.55 | 35.93 | 33.00 | 54.00 | -21.00 | |
| 3733.33 | 52.17 | 100 | 90 | | | 50.76 | 3.19 | 33.13 | 37.74 | 74.00 | -36.26 | Ch. 120/ |
| 3733.33 | | | | 43.26 | A | 50.76 | 3.19 | 33.13 | 28.83 | 54.00 | -25.17 | ABC |
| 7466.66 | 53.67 | 100 | 135 | | | 50.20 | 4.60 | 36.07 | 44.14 | 74.00 | -29.86 | |
| 7466.66 | | | | 46.61 | A | 50.20 | 4.60 | 36.07 | 37.08 | 54.00 | -16.92 | |
| 11200.00 | 53.33 | 100 | 225 | | | 50.48 | 5.75 | 38.10 | 46.70 | 74.00 | -27.30 | |
| 11200.00 | | | | 41.99 | A | 50.48 | 5.75 | 38.10 | 35.36 | 54.00 | -18.64 | |
| 3800.00 | 54.50 | 100 | 180 | | | 50.68 | 3.24 | 33.20 | 40.26 | 74.00 | -33.74 | Ch. 140/ |
| 3800.00 | | | | 46.59 | A | 50.68 | 3.24 | 33.20 | 32.35 | 54.00 | -21.65 | ABC |
| 7600.00 | 55.00 | 100 | 180 | | | 50.16 | 4.64 | 36.12 | 45.59 | 74.00 | -28.41 | |
| 7600.00 | | | | 48.17 | A | 50.16 | 4.64 | 36.12 | 38.76 | 54.00 | -15.24 | |
| 11400.00 | 50.83 | 100 | 135 | 53.67 | | 50.51 | 5.86 | 38.30 | 47.31 | 74.00 | -26.69 | |
| 11400.00 | | | | 40.10 | A | 50.51 | 5.86 | 38.30 | 33.74 | 54.00 | -20.26 | |



Radiated Emissions Test Results (Continued)

*Spurious Emissions Measurements in 802.11n mode 20MHz Wide (5470-5725 MHz)
Channels 100, 120, & 140
Continuous TX at Triple Chain ABC Antenna ports with Wistron Neweb Corp. Antennas
Aegis Labs, Inc. File #: INTEL-081125-75*

| RADIATED EMISSIONS - Horizontal Antenna Polarization | | | | | | | | | | | | |
|-------------------------------------------------------------|----------------------|---------------------|-------------------|------------------------|---|--------------------|-------------------|------------------|--------------------------|---------------|-------------------|-----------------------|
| Freq. (MHz) | Meter Reading (dBuV) | Antenna Height (cm) | Azimuth (degrees) | Quasi pk or AVG (dBuV) | | Preamp Factor (dB) | Cable Factor (dB) | Ant. Factor (dB) | Corrected Reading (dBuV) | Limits (dBuV) | Diff (dB) +/-FAIL | Channel/ Chain Tested |
| 3666.66 | 51.17 | 100 | 45 | | | 36.51 | 2.50 | 32.33 | 49.49 | 74.00 | -24.51 | Ch. 100/ |
| 3666.66 | | | | 40.88 | A | 36.51 | 2.50 | 32.33 | 39.20 | 54.00 | -14.80 | ABC |
| 7333.33 | 52.67 | 100 | 180 | | | 36.60 | 3.60 | 34.97 | 54.63 | 74.00 | -19.37 | |
| 7333.33 | | | | 44.93 | A | 36.60 | 3.60 | 34.97 | 46.89 | 54.00 | -7.11 | |
| 11000.00 | 50.33 | 100 | 225 | | | 36.40 | 4.50 | 36.40 | 54.83 | 74.00 | -19.17 | |
| 11000.00 | | | | 38.39 | A | 36.40 | 4.50 | 36.40 | 42.89 | 54.00 | -11.11 | |
| 3733.33 | 51.17 | 100 | 0 | | | 36.45 | 2.53 | 32.47 | 49.71 | 74.00 | -24.29 | Ch. 120/ |
| 3733.33 | | | | 40.34 | A | 36.45 | 2.53 | 32.47 | 38.88 | 54.00 | -15.12 | ABC |
| 7466.66 | 52.67 | 100 | 315 | | | 36.60 | 3.63 | 34.99 | 54.70 | 74.00 | -19.30 | |
| 7466.66 | | | | 43.28 | A | 36.60 | 3.63 | 34.99 | 45.31 | 54.00 | -8.69 | |
| 11200.00 | 50.17 | 100 | 0 | | | 36.45 | 4.55 | 36.56 | 54.84 | 74.00 | -19.16 | |
| 11200.00 | | | | 39.19 | A | 36.45 | 4.55 | 36.56 | 43.86 | 54.00 | -10.14 | |
| 3800.00 | 50.50 | 100 | 0 | | | 36.39 | 2.55 | 32.60 | 49.27 | 74.00 | -24.73 | Ch. 140/ |
| 3800.00 | | | | 39.92 | A | 36.39 | 2.55 | 32.60 | 38.69 | 54.00 | -15.31 | ABC |
| 7600.00 | 50.83 | 100 | 315 | | | 36.64 | 3.67 | 34.98 | 52.84 | 74.00 | -21.16 | |
| 7600.00 | | | | 40.56 | A | 36.64 | 3.67 | 34.98 | 42.57 | 54.00 | -11.43 | |
| 11400.00 | 50.50 | 100 | 0 | | | 36.50 | 4.61 | 36.72 | 55.33 | 74.00 | -18.67 | |
| 11400.00 | | | | 38.37 | A | 36.50 | 4.61 | 36.72 | 43.20 | 54.00 | -10.80 | |



Radiated Emissions Test Results (Continued)

| RADIATED EMISSIONS - Vertical Antenna Polarization | | | | | | | | | | | | |
|----------------------------------------------------|----------------------|---------------------|-------------------|------------------------|---|--------------------|-------------------|------------------|--------------------------|---------------|-------------------|-----------------|
| Freq. (MHz) | Meter Reading (dBuV) | Antenna Height (cm) | Azimuth (degrees) | Quasi pk or AVG (dBuV) | | Preamp Factor (dB) | Cable Factor (dB) | Ant. Factor (dB) | Corrected Reading (dBuV) | Limits (dBuV) | Diff (dB) +/-FAIL | Comments |
| 3666.66 | 52.83 | 100 | 0 | | | 36.51 | 2.50 | 31.07 | 49.88 | 74.00 | -24.12 | Ch. 100/ |
| 3666.66 | | | | 45.11 | A | 36.51 | 2.50 | 31.07 | 42.16 | 54.00 | -11.84 | ABC |
| 7333.33 | 55.50 | 100 | 315 | | | 36.60 | 3.60 | 34.07 | 56.56 | 74.00 | -17.44 | |
| 7333.33 | | | | 50.78 | A | 36.60 | 3.60 | 34.07 | 51.84 | 54.00 | -2.16 | |
| 11000.00 | 50.67 | 100 | 315 | | | 36.40 | 4.50 | 36.00 | 54.77 | 74.00 | -19.23 | |
| 11000.00 | | | | 38.34 | A | 36.40 | 4.50 | 36.00 | 42.44 | 54.00 | -11.56 | |
| 3733.33 | 54.17 | 100 | 0 | | | 36.45 | 2.53 | 31.21 | 51.46 | 74.00 | -22.54 | Ch. 120/ |
| 3733.33 | | | | 46.86 | A | 36.45 | 2.53 | 31.21 | 44.15 | 54.00 | -9.85 | ABC |
| 7466.66 | 55.17 | 100 | 315 | | | 36.60 | 3.63 | 34.09 | 56.30 | 74.00 | -17.70 | |
| 7466.66 | | | | 49.44 | A | 36.60 | 3.63 | 34.09 | 50.57 | 54.00 | -3.43 | |
| 11200.00 | 51.00 | 100 | 45 | | | 36.45 | 4.55 | 36.12 | 55.23 | 74.00 | -18.77 | |
| 11200.00 | | | | 38.85 | A | 36.45 | 4.55 | 36.12 | 43.08 | 54.00 | -10.92 | |
| 3800.00 | 52.17 | 100 | 0 | | | 36.39 | 2.55 | 31.36 | 49.70 | 74.00 | -24.30 | Ch. 140/ |
| 3800.00 | | | | 45.57 | A | 36.39 | 2.55 | 31.36 | 43.10 | 54.00 | -10.90 | ABC |
| 7600.00 | 53.17 | 100 | 315 | | | 36.64 | 3.67 | 34.08 | 54.28 | 74.00 | -19.72 | |
| 7600.00 | | | | 45.97 | A | 36.64 | 3.67 | 34.08 | 47.08 | 54.00 | -6.92 | |
| 11400.00 | 52.50 | 100 | 0 | | | 36.50 | 4.61 | 36.24 | 56.85 | 74.00 | -17.15 | |
| 11400.00 | | | | 40.04 | A | 36.50 | 4.61 | 36.24 | 44.39 | 54.00 | -9.61 | |



RADIATED EMISSIONS TEST RESULTS

| | | | |
|-----------------------|---------------------------------------------------------------------------------------------------------------------------------------|------------------------|--------------|
| CLIENT: | Intel Corporation | DATE: | 04/08/08 |
| EUT: | Intel WiFi Link 5300 | PROJECT NUMBER: | INTEL-081125 |
| MODEL NUMBER: | 533AN_HMW | TEST ENGINEER: | KN/RC |
| SERIAL NUMBER: | 0016EA038A16 | SITE #: | 2 |
| CONFIGURATION: | Tested installed in an extender board connected to the host laptop's mini PCI slot in 802.11n (5740-5745 MHz) mode 40MHz Wide. | TEMPERATURE: | 22° C |
| | | HUMIDITY: | 39% RH |
| | | TIME: | 8:00 AM |

| | |
|---------------------|---------------------------------------------------------------------------------------------------------------------------------------------------------------------------------------------|
| Description: | Radiated RF Emissions (1 GHz – 18 GHz) |
| Results: | PASSED Horizontal and Vertical Antenna Polarizations Class B Limits |
| Note: | Radiated Emissions Measurements were performed on the EUT with power supply set at the following voltage and frequency. <ul style="list-style-type: none"> • 120VAC / 60 Hz. |

| Unwanted Spurious Emissions Limits | | | |
|------------------------------------|-----------------------|----------------------------------------------------------------|----------------------------------------------------------------------|
| Frequency (MHz) | Field Strength (uV/m) | Field Strength (dBuV/m) (Emissions in the restricted bands) | Field Strength (dBm/MHz) (Emissions outside the restricted bands) |
| Above 960 | 500 | 54.00 (Average) 74.00 (Peak) | < -20 dBc |

Radiated Emissions Sample Calculations

$$\text{Corrected Meter Reading} = \text{Meter Reading} + F + C - D$$

Where, F = Antenna Factor

C = Cable Factor

G = Amplifier Gain

D = Distance Factor (if applicable)

Therefore, the equation for determining the Corrected Meter Reading Limit (CML) is:

$$\text{CML} = \text{Specification Limit} - F - C + D$$



Radiated Emissions Test Results (Continued)

*Fundamental Measurements in 802.11n mode 40MHz Wide (5470-5725 MHz)
Channels 102, 118, & 134
Continuous TX at Chain A Antenna port with Ethertronics Antennas
Aegis Labs, Inc. File #: INTEL-081125-51*

| RADIATED EMISSIONS - Horizontal Antenna Polarization | | | | | | | | | | | |
|-------------------------------------------------------------|----------------------|---------------------|-------------------|------------------------|---|-------------------|------------------|--------------------------|---------------|------------------|----------------|
| Freq. (MHz) | Meter Reading (dBuV) | Antenna Height (cm) | Azimuth (degrees) | Quasi pk or AVG (dBuV) | | Cable Factor (dB) | Ant. Factor (dB) | Corrected Reading (dBuV) | Limits (dBuV) | Diff (dB) +=FAIL | Comments |
| 5510.00 | 62.17 | 100 | 315 | | | 3.89 | 34.72 | 100.78 | | | Ch. 102 |
| 5510.00 | | | | 51.33 | A | 3.89 | 34.72 | 89.94 | | | |
| 5590.00 | 62.83 | 100 | 315 | | | 3.92 | 34.84 | 101.60 | | | Ch. 118 |
| 5590.00 | | | | 52.17 | A | 3.92 | 34.84 | 90.94 | | | |
| 5670.00 | 61.83 | 100 | 315 | | | 3.95 | 34.97 | 100.76 | | | Ch. 134 |
| 5670.00 | | | | 51.33 | A | 3.95 | 34.97 | 90.26 | | | |

| RADIATED EMISSIONS - Vertical Antenna Polarization | | | | | | | | | | | |
|-----------------------------------------------------------|----------------------|---------------------|-------------------|------------------------|---|-------------------|------------------|--------------------------|---------------|------------------|----------------|
| Freq. (MHz) | Meter Reading (dBuV) | Antenna Height (cm) | Azimuth (degrees) | Quasi pk or AVG (dBuV) | | Cable Factor (dB) | Ant. Factor (dB) | Corrected Reading (dBuV) | Limits (dBuV) | Diff (dB) +=FAIL | Comments |
| 5510.00 | 65.83 | 100 | 225 | | | 3.89 | 34.52 | 104.24 | | | Ch. 102 |
| 5510.00 | | | | 54.17 | A | 3.89 | 34.52 | 92.58 | | | |
| 5590.00 | 63.33 | 100 | 225 | | | 3.92 | 34.66 | 101.92 | | | Ch. 118 |
| 5590.00 | | | | 52.67 | A | 3.92 | 34.66 | 91.26 | | | |
| 5670.00 | 63.83 | 100 | 225 | | | 3.95 | 34.81 | 102.59 | | | Ch. 134 |
| 5670.00 | | | | 53.33 | A | 3.95 | 34.81 | 92.09 | | | |

NOTE: Fundamental signals measured to calculate the band edge field strengths using the “Marker Delta Method”.



Radiated Emissions Test Results (Continued)

*Band Edge Field Strength Measurements in 802.11n mode 40MHz Wide (5470-5725 MHz)
Channels 102 & 134
Continuous TX at Chain A Antenna port with Ethertronics Antennas
Aegis Labs, Inc. File #: INTEL-081125-51*

| RADIATED EMISSIONS - Horizontal Antenna Polarization | | | | | | | | | | | |
|-------------------------------------------------------------|-----------------------------|----------------------------|--------------------------|-------------------------------|--------------------------|-------------------------|---------------------------------|----------------------|-------------------------|-----------------|----------------|
| <i>Freq. (MHz)</i> | <i>Meter Reading (dBuV)</i> | <i>Antenna Height (cm)</i> | <i>Azimuth (degrees)</i> | <i>Quasi pk or AVG (dBuV)</i> | <i>Cable Factor (dB)</i> | <i>Ant. Factor (dB)</i> | <i>Corrected Reading (dBuV)</i> | <i>Limits (dBuV)</i> | <i>Diff (dB) +=FAIL</i> | <i>Comments</i> | |
| 5460.00 | | | | | | | 59.95 | 74.00 | -14.05 | Ch. 102 | |
| 5460.00 | | | | | A | | 41.78 | 54.00 | -12.22 | | |
| 5725.00 | 31.67 | 100 | 315 | | | 3.98 | 35.06 | 70.71 | 80.76 | -10.05 | Ch. 134 |

| RADIATED EMISSIONS - Vertical Antenna Polarization | | | | | | | | | | | |
|-----------------------------------------------------------|-----------------------------|----------------------------|--------------------------|-------------------------------|--------------------------|-------------------------|---------------------------------|----------------------|-------------------------|-----------------|----------------|
| <i>Freq. (MHz)</i> | <i>Meter Reading (dBuV)</i> | <i>Antenna Height (cm)</i> | <i>Azimuth (degrees)</i> | <i>Quasi pk or AVG (dBuV)</i> | <i>Cable Factor (dB)</i> | <i>Ant. Factor (dB)</i> | <i>Corrected Reading (dBuV)</i> | <i>Limits (dBuV)</i> | <i>Diff (dB) +=FAIL</i> | <i>Comments</i> | |
| 5460.00 | | | | | | | 63.41 | 74.00 | -10.59 | Ch. 102 | |
| 5460.00 | | | | | A | | 44.42 | 54.00 | -9.58 | | |
| 5725.00 | 30.83 | 100 | 225 | | | 3.98 | 34.91 | 69.71 | 82.59 | -12.88 | Ch. 134 |

NOTE: The “Band Edge Field Strength” was calculated using the “Fundamental” and “Conducted Band Edge” measurements per the “Marker-Delta Method” with the following formula:

$$BE = Fm - \Delta m$$

Where

BE = Band Edge Field Strength

Fm = Measured Fundamental (Peak or Average)

Δm = Measured Conducted Band Edge Delta (Peak or Average)



Radiated Emissions Test Results (Continued)

*Fundamental Measurements in 802.11n mode 40MHz Wide (5470-5725 MHz)
Channels 102, 118, & 134
Continuous TX at Chain B Antenna port with Ethertronics Antennas
Aegis Labs, Inc. File #: INTEL-081125-52*

| RADIATED EMISSIONS - Horizontal Antenna Polarization | | | | | | | | | | | |
|-------------------------------------------------------------|----------------------|---------------------|-------------------|------------------------|---|-------------------|------------------|--------------------------|---------------|------------------|----------------|
| Freq. (MHz) | Meter Reading (dBuV) | Antenna Height (cm) | Azimuth (degrees) | Quasi pk or AVG (dBuV) | | Cable Factor (dB) | Ant. Factor (dB) | Corrected Reading (dBuV) | Limits (dBuV) | Diff (dB) +=FAIL | Comments |
| 5510.00 | 59.33 | 100 | 225 | | | 3.89 | 34.72 | 97.94 | | | Ch. 102 |
| 5510.00 | | | | 48.33 | A | 3.89 | 34.72 | 86.94 | | | |
| 5590.00 | 59.83 | 100 | 315 | | | 3.92 | 34.84 | 98.60 | | | Ch. 118 |
| 5590.00 | | | | 48.92 | A | 3.92 | 34.84 | 87.69 | | | |
| 5670.00 | 60.00 | 100 | 315 | | | 3.95 | 34.97 | 98.93 | | | Ch. 134 |
| 5670.00 | | | | 49.33 | A | 3.95 | 34.97 | 88.26 | | | |

| RADIATED EMISSIONS - Vertical Antenna Polarization | | | | | | | | | | | |
|-----------------------------------------------------------|----------------------|---------------------|-------------------|------------------------|---|-------------------|------------------|--------------------------|---------------|------------------|----------------|
| Freq. (MHz) | Meter Reading (dBuV) | Antenna Height (cm) | Azimuth (degrees) | Quasi pk or AVG (dBuV) | | Cable Factor (dB) | Ant. Factor (dB) | Corrected Reading (dBuV) | Limits (dBuV) | Diff (dB) +=FAIL | Comments |
| 5510.00 | 66.67 | 100 | 180 | | | 3.89 | 34.52 | 105.08 | | | Ch. 102 |
| 5510.00 | | | | 55.67 | A | 3.89 | 34.52 | 94.08 | | | |
| 5590.00 | 67.67 | 100 | 135 | | | 3.92 | 34.66 | 106.26 | | | Ch. 118 |
| 5590.00 | | | | 56.76 | A | 3.92 | 34.66 | 95.35 | | | |
| 5670.00 | 66.50 | 100 | 135 | | | 3.95 | 34.81 | 105.26 | | | Ch. 134 |
| 5670.00 | | | | 55.83 | A | 3.95 | 34.81 | 94.59 | | | |

NOTE: Fundamental signals measured to calculate the band edge field strengths using the “Marker Delta Method”.



Radiated Emissions Test Results (Continued)

*Band Edge Field Strength Measurements in 802.11n mode 40MHz Wide (5470-5725 MHz)
Channels 102 & 134
Continuous TX at Chain B Antenna port with Ethertronics Antennas
Aegis Labs, Inc. File #: INTEL-081125-52*

| RADIATED EMISSIONS - Horizontal Antenna Polarization | | | | | | | | | | |
|-------------------------------------------------------------|-----------------------------|----------------------------|--------------------------|-------------------------------|--------------------------|-------------------------|---------------------------------|----------------------|-------------------------|-----------------|
| <i>Freq. (MHz)</i> | <i>Meter Reading (dBuV)</i> | <i>Antenna Height (cm)</i> | <i>Azimuth (degrees)</i> | <i>Quasi pk or AVG (dBuV)</i> | <i>Cable Factor (dB)</i> | <i>Ant. Factor (dB)</i> | <i>Corrected Reading (dBuV)</i> | <i>Limits (dBuV)</i> | <i>Diff (dB) +=FAIL</i> | <i>Comments</i> |
| 5460.00 | | | | | | | 56.28 | 74.00 | -17.72 | Ch. 102 |
| 5460.00 | | | | | A | | 37.27 | 54.00 | -16.73 | |
| 5725.00 | 30.50 | 100 | 315 | | | 3.98 35.06 | 69.54 | 78.93 | -9.39 | Ch. 134 |

| RADIATED EMISSIONS - Vertical Antenna Polarization | | | | | | | | | | |
|-----------------------------------------------------------|-----------------------------|----------------------------|--------------------------|-------------------------------|--------------------------|-------------------------|---------------------------------|----------------------|-------------------------|-----------------|
| <i>Freq. (MHz)</i> | <i>Meter Reading (dBuV)</i> | <i>Antenna Height (cm)</i> | <i>Azimuth (degrees)</i> | <i>Quasi pk or AVG (dBuV)</i> | <i>Cable Factor (dB)</i> | <i>Ant. Factor (dB)</i> | <i>Corrected Reading (dBuV)</i> | <i>Limits (dBuV)</i> | <i>Diff (dB) +=FAIL</i> | <i>Comments</i> |
| 5460.00 | | | | | | | 63.42 | 74.00 | -10.58 | Ch. 102 |
| 5460.00 | | | | | A | | 44.41 | 54.00 | -9.59 | |
| 5725.00 | 30.33 | 100 | 135 | | | 3.98 34.91 | 69.21 | 85.26 | -16.05 | Ch. 134 |

NOTE: The “Band Edge Field Strength” was calculated using the “Fundamental” and “Conducted Band Edge” measurements per the “Marker-Delta Method” with the following formula:

$$BE = F_m - \Delta_m$$

Where

BE = Band Edge Field Strength

F_m = Measured Fundamental (Peak or Average)

Δ_m = Measured Conducted Band Edge Delta (Peak or Average)

Radiated Emissions Test Results (Continued)

Plots Showing Out-Of-Band Emissions (Peak RBW=VBW=1MHz; Average RBW = 1MHz, VBW = 10Hz)

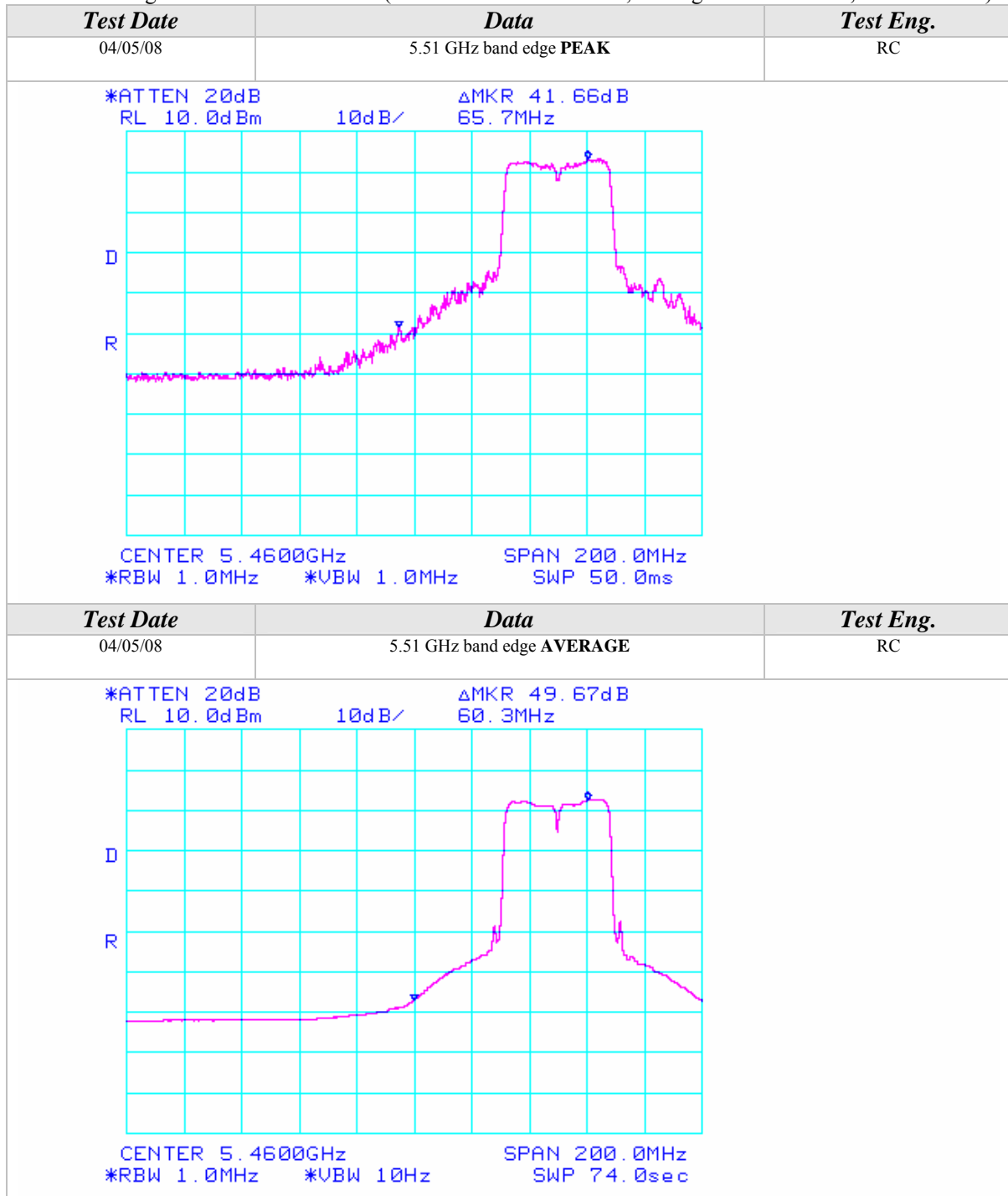



Radiated Emissions Test Results (Continued)

*Fundamental Measurements in 802.11n mode 40MHz Wide (5470-5725 MHz)
Channels 102, 118, & 134
Continuous TX at Chain C Antenna port with Ethertronics Antennas
Aegis Labs, Inc. File #: INTEL-081125-53*

| RADIATED EMISSIONS - Horizontal Antenna Polarization | | | | | | | | | | | |
|-------------------------------------------------------------|----------------------|---------------------|-------------------|------------------------|---|-------------------|------------------|--------------------------|---------------|------------------|----------------|
| Freq. (MHz) | Meter Reading (dBuV) | Antenna Height (cm) | Azimuth (degrees) | Quasi pk or AVG (dBuV) | | Cable Factor (dB) | Ant. Factor (dB) | Corrected Reading (dBuV) | Limits (dBuV) | Diff (dB) +=FAIL | Comments |
| 5510.00 | 66.67 | 100 | 180 | | | 3.89 | 34.72 | 105.28 | | | Ch. 102 |
| 5510.00 | | | | 56.00 | A | 3.89 | 34.72 | 94.61 | | | |
| 5590.00 | 66.50 | 100 | 180 | | | 3.92 | 34.84 | 105.27 | | | Ch. 118 |
| 5590.00 | | | | 56.00 | A | 3.92 | 34.84 | 94.77 | | | |
| 5670.00 | 64.00 | 100 | 180 | | | 3.95 | 34.97 | 102.93 | | | Ch. 134 |
| 5670.00 | | | | 54.00 | A | 3.95 | 34.97 | 92.93 | | | |

| RADIATED EMISSIONS - Vertical Antenna Polarization | | | | | | | | | | | |
|-----------------------------------------------------------|----------------------|---------------------|-------------------|------------------------|---|-------------------|------------------|--------------------------|---------------|------------------|----------------|
| Freq. (MHz) | Meter Reading (dBuV) | Antenna Height (cm) | Azimuth (degrees) | Quasi pk or AVG (dBuV) | | Cable Factor (dB) | Ant. Factor (dB) | Corrected Reading (dBuV) | Limits (dBuV) | Diff (dB) +=FAIL | Comments |
| 5510.00 | 58.50 | 100 | 90 | | | 3.89 | 34.52 | 96.91 | | | Ch. 102 |
| 5510.00 | | | | 49.00 | A | 3.89 | 34.52 | 87.41 | | | |
| 5590.00 | 59.50 | 100 | 90 | | | 3.92 | 34.66 | 98.09 | | | Ch. 118 |
| 5590.00 | | | | 49.17 | A | 3.92 | 34.66 | 87.76 | | | |
| 5670.00 | 61.33 | 100 | 225 | | | 3.95 | 34.81 | 100.09 | | | Ch. 134 |
| 5670.00 | | | | 50.00 | A | 3.95 | 34.81 | 88.76 | | | |

NOTE: Fundamental signals measured to calculate the band edge field strengths using the “Marker Delta Method”.



Radiated Emissions Test Results (Continued)

*Band Edge Field Strength Measurements in 802.11n mode 40MHz Wide (5470-5725 MHz)
Channels 102 & 134
Continuous TX at Chain C Antenna port with Ethertronics Antennas
Aegis Labs, Inc. File #: INTEL-081125-53*

RADIATED EMISSIONS - Horizontal Antenna Polarization

| Freq. (MHz) | Meter Reading (dBuV) | Antenna Height (cm) | Azimuth (degrees) | Quasi pk or AVG (dBuV) | Cable Factor (dB) | Ant. Factor (dB) | Corrected Reading (dBuV) | Limits (dBuV) | Diff (dB) +=FAIL | Comments |
|-------------|----------------------|---------------------|-------------------|------------------------|-------------------|------------------|--------------------------|---------------|------------------|----------------|
| 5460.00 | | | | | | | 64.61 | 74.00 | -9.39 | Ch. 102 |
| 5460.00 | | | | | A | | 45.61 | 54.00 | -8.39 | |
| 5725.00 | 31.17 | 100 | 180 | | | 3.98 | 70.21 | 82.93 | -12.72 | Ch. 134 |

RADIATED EMISSIONS - Vertical Antenna Polarization

| Freq. (MHz) | Meter Reading (dBuV) | Antenna Height (cm) | Azimuth (degrees) | Quasi pk or AVG (dBuV) | Cable Factor (dB) | Ant. Factor (dB) | Corrected Reading (dBuV) | Limits (dBuV) | Diff (dB) +=FAIL | Comments |
|-------------|----------------------|---------------------|-------------------|------------------------|-------------------|------------------|--------------------------|---------------|------------------|----------------|
| 5460.00 | | | | | | | 56.24 | 74.00 | -17.76 | Ch. 102 |
| 5460.00 | | | | | A | | 38.41 | 54.00 | -15.59 | |
| 5725.00 | 31.50 | 100 | 225 | | | 3.98 | 70.38 | 80.09 | -9.71 | Ch. 134 |

NOTE: The "Band Edge Field Strength" was calculated using the "Fundamental" and "Conducted Band Edge" measurements per the "Marker-Delta Method" with the following formula:

$$BE = F_m - \Delta_m$$

Where

BE = Band Edge Field Strength

F_m = Measured Fundamental (Peak or Average)

Δ_m = Measured Conducted Band Edge Delta (Peak or Average)

Radiated Emissions Test Results (Continued)

Plots Showing Out-Of-Band Emissions (Peak RBW=VBW=1MHz; Average RBW = 1MHz, VBW = 10Hz)

| <i>Test Date</i> | <i>Data</i> | <i>Test Eng.</i> |
|-------------------------------------------------------------------------------------------------------------------------------------------------------------------------------------------------------------------------------------------------------------------------|-----------------------------------|------------------|
| 04/05/08 | 5.50 GHz band edge PEAK | RC |
| <p>*ATTEN 20dB ΔMKR 40.67dB RL 10.0dBm 10dB/ 59.7MHz</p> <p>CENTER 5.4600GHz SPAN 200.0MHz *RBW 1.0MHz *VBW 1.0MHz SWP 50.0ms</p> | | |
| <i>Test Date</i> | <i>Data</i> | <i>Test Eng.</i> |
| 04/05/08 | 5.50 GHz band edge AVERAGE | RC |
| <p>*ATTEN 20dB ΔMKR 49.00dB RL 10.0dBm 10dB/ 60.7MHz</p> <p>CENTER 5.4600GHz SPAN 200.0MHz *RBW 1.0MHz *VBW 10Hz SWP 74.0sec</p> | | |



Radiated Emissions Test Results (Continued)

*Spurious Emissions Measurements in 802.11n mode 40MHz Wide (5470-5725 MHz)
Channels 102, 118, & 134
Continuous TX at Chain A, B, & C Antenna ports with Ethertronics Antennas
Aegis Labs, Inc. File #: INTEL-081125-46*

| RADIATED EMISSIONS - Horizontal Antenna Polarization | | | | | | | | | | | | |
|-------------------------------------------------------------|----------------------|---------------------|-------------------|------------------------|---|--------------------|-------------------|------------------|--------------------------|---------------|-------------------|----------------------|
| Freq. (MHz) | Meter Reading (dBuV) | Antenna Height (cm) | Azimuth (degrees) | Quasi pk or AVG (dBuV) | | Preamp Factor (dB) | Cable Factor (dB) | Ant. Factor (dB) | Corrected Reading (dBuV) | Limits (dBuV) | Diff (dB) +/-FAIL | Channel/Chain Tested |
| 3733.33 | 52.83 | 100 | 225 | | | 46.55 | 2.53 | 32.91 | 41.72 | 74.00 | -32.28 | Ch. 118/ |
| 3733.33 | | | | 42.17 | A | 46.55 | 2.53 | 32.91 | 31.06 | 54.00 | -22.94 | A |
| 7466.66 | 52.83 | 100 | 225 | | | 44.88 | 3.63 | 37.21 | 48.80 | 74.00 | -25.20 | |
| 7466.66 | | | | 42.82 | A | 44.88 | 3.63 | 37.21 | 38.79 | 54.00 | -15.21 | |
| 3733.33 | 54.83 | 100 | 180 | | | 46.55 | 2.53 | 32.91 | 43.72 | 74.00 | -30.28 | Ch. 118/ |
| 3733.33 | | | | 46.87 | A | 46.55 | 2.53 | 32.91 | 35.76 | 54.00 | -18.24 | B |
| 7466.66 | 54.67 | 100 | 225 | | | 44.88 | 3.63 | 37.21 | 50.64 | 74.00 | -23.36 | |
| 7466.66 | | | | 42.46 | A | 44.88 | 3.63 | 37.21 | 38.43 | 54.00 | -15.57 | |
| 3733.33 | 52.83 | 100 | 225 | | | 46.55 | 2.53 | 32.91 | 41.72 | 74.00 | -32.28 | Ch. 118/ |
| 3733.33 | | | | 41.26 | A | 46.55 | 2.53 | 32.91 | 30.15 | 54.00 | -23.85 | C |
| 7466.66 | 53.00 | 100 | 225 | | | 44.88 | 3.63 | 37.21 | 48.97 | 74.00 | -25.03 | |
| 7466.66 | | | | 42.54 | A | 44.88 | 3.63 | 37.21 | 38.51 | 54.00 | -15.49 | |
| 3666.66 | 54.83 | 100 | 225 | | | 46.56 | 2.50 | 32.77 | 43.53 | 74.00 | -30.47 | Ch. 102/ |
| 3666.66 | | | | 42.24 | A | 46.56 | 2.50 | 32.77 | 30.94 | 54.00 | -23.06 | A |
| 7333.33 | 53.00 | 100 | 225 | | | 44.92 | 3.60 | 36.87 | 48.54 | 74.00 | -25.46 | |
| 7333.33 | | | | 42.19 | A | 44.92 | 3.60 | 36.87 | 37.73 | 54.00 | -16.27 | |
| 3800.00 | 54.00 | 100 | 225 | | | 46.54 | 2.55 | 33.06 | 43.08 | 74.00 | -30.92 | Ch. 134/ |
| 3800.00 | | | | 43.55 | A | 46.54 | 2.55 | 33.06 | 32.63 | 54.00 | -21.37 | A |
| 7600.00 | 52.00 | 100 | 225 | | | 44.86 | 3.67 | 37.36 | 48.17 | 74.00 | -25.83 | |
| 7600.00 | | | | 40.89 | A | 44.86 | 3.67 | 37.36 | 37.06 | 54.00 | -16.94 | |



Radiated Emissions Test Results (Continued)

| RADIATED EMISSIONS - Vertical Antenna Polarization | | | | | | | | | | | | |
|----------------------------------------------------|----------------------|---------------------|-------------------|------------------------|---|--------------------|-------------------|------------------|--------------------------|---------------|-------------------|-----------------|
| Freq. (MHz) | Meter Reading (dBuV) | Antenna Height (cm) | Azimuth (degrees) | Quasi pk or AVG (dBuV) | | Preamp Factor (dB) | Cable Factor (dB) | Ant. Factor (dB) | Corrected Reading (dBuV) | Limits (dBuV) | Diff (dB) +/-FAIL | Comments |
| 3733.33 | 53.83 | 100 | 270 | | | 46.55 | 2.53 | 32.51 | 42.31 | 74.00 | -31.69 | Ch. 118/ |
| 3733.33 | | | | 42.63 | A | 46.55 | 2.53 | 32.51 | 31.11 | 54.00 | -22.89 | A |
| 7466.66 | 52.50 | 100 | 225 | | | 44.88 | 3.63 | 37.11 | 48.37 | 74.00 | -25.63 | |
| 7466.66 | | | | 41.32 | A | 44.88 | 3.63 | 37.11 | 37.19 | 54.00 | -16.81 | |
| 3733.33 | 56.33 | 100 | 225 | | | 46.55 | 2.53 | 32.51 | 44.81 | 74.00 | -29.19 | Ch. 118/ |
| 3733.33 | | | | 49.15 | A | 46.55 | 2.53 | 32.51 | 37.63 | 54.00 | -16.37 | B |
| 7466.66 | 55.00 | 100 | 180 | | | 44.88 | 3.63 | 37.11 | 50.87 | 74.00 | -23.13 | |
| 7466.66 | | | | 48.44 | A | 44.88 | 3.63 | 37.11 | 44.31 | 54.00 | -9.69 | |
| 11200.00 | 49.17 | 100 | 135 | | | 45.09 | 4.55 | 38.96 | 47.60 | 74.00 | -26.40 | |
| 11200.00 | | | | 39.08 | A | 45.09 | 4.55 | 38.96 | 37.51 | 54.00 | -16.49 | |
| 3733.33 | 54.17 | 100 | 180 | | | 46.55 | 2.53 | 32.51 | 42.65 | 74.00 | -31.35 | Ch. 118/ |
| 3733.33 | | | | 44.46 | A | 46.55 | 2.53 | 32.51 | 32.94 | 54.00 | -21.06 | C |
| 7466.66 | 53.00 | 100 | 180 | | | 44.88 | 3.63 | 37.11 | 48.87 | 74.00 | -25.13 | |
| 7466.66 | | | | 46.73 | A | 44.88 | 3.63 | 37.11 | 42.60 | 54.00 | -11.40 | |
| 3666.66 | 57.33 | 100 | 180 | | | 46.56 | 2.50 | 32.33 | 45.60 | 74.00 | -28.40 | Ch. 102/ |
| 3666.66 | | | | 48.75 | A | 46.56 | 2.50 | 32.33 | 37.02 | 54.00 | -16.98 | B |
| 7333.33 | 51.50 | 100 | 225 | | | 44.92 | 3.60 | 36.77 | 46.94 | 74.00 | -27.06 | |
| 7333.33 | | | | 42.78 | A | 44.92 | 3.60 | 36.77 | 38.22 | 54.00 | -15.78 | |
| 3800.00 | 54.50 | 100 | 180 | | | 46.54 | 2.55 | 32.68 | 43.20 | 74.00 | -30.80 | Ch. 134/ |
| 3800.00 | | | | 46.59 | A | 46.54 | 2.55 | 32.68 | 35.29 | 54.00 | -18.71 | B |
| 7600.00 | 55.00 | 100 | 180 | | | 44.86 | 3.67 | 37.24 | 51.05 | 74.00 | -22.95 | |
| 7600.00 | | | | 48.17 | A | 44.86 | 3.67 | 37.24 | 44.22 | 54.00 | -9.78 | |
| 11400.00 | 50.83 | 100 | 135 | 53.67 | | 45.04 | 4.61 | 39.12 | 52.36 | 74.00 | -21.64 | |
| 11400.00 | | | | 40.10 | A | 45.04 | 4.61 | 39.12 | 38.79 | 54.00 | -15.21 | |



Radiated Emissions Test Results (Continued)

*Spurious Emissions Measurements in 802.11n mode 40MHz Wide (5470-5725 MHz)
Channels 102, 118, & 134
Continuous TX at Triple Chain ABC Antenna ports with Ethertronics Antennas
Aegis Labs, Inc. File #: INTEL-081125-46*

| RADIATED EMISSIONS - Horizontal Antenna Polarization | | | | | | | | | | | | |
|-------------------------------------------------------------|----------------------|---------------------|-------------------|------------------------|---|--------------------|-------------------|------------------|--------------------------|---------------|-------------------|-----------------------|
| Freq. (MHz) | Meter Reading (dBuV) | Antenna Height (cm) | Azimuth (degrees) | Quasi pk or AVG (dBuV) | | Preamp Factor (dB) | Cable Factor (dB) | Ant. Factor (dB) | Corrected Reading (dBuV) | Limits (dBuV) | Diff (dB) +/-FAIL | Channel/ Chain Tested |
| 3666.66 | 54.17 | 100 | 180 | | | 46.56 | 2.50 | 32.77 | 42.87 | 74.00 | -31.13 | Ch. 102/ |
| 3666.66 | | | | 46.35 | A | 46.56 | 2.50 | 32.77 | 35.05 | 54.00 | -18.95 | ABC |
| 7333.33 | 50.67 | 100 | 225 | | | 44.92 | 3.60 | 36.87 | 46.21 | 74.00 | -27.79 | |
| 7333.33 | | | | 41.75 | A | 44.92 | 3.60 | 36.87 | 37.29 | 54.00 | -16.71 | |
| 3733.33 | 56.67 | 100 | 180 | | | 46.55 | 2.53 | 32.91 | 45.56 | 74.00 | -28.44 | Ch. 118/ |
| 3733.33 | | | | 50.62 | A | 46.55 | 2.53 | 32.91 | 39.51 | 54.00 | -14.49 | ABC |
| 7466.66 | 43.00 | 100 | 135 | | | 44.88 | 3.63 | 37.21 | 38.97 | 74.00 | -35.03 | |
| 7466.66 | | | | 31.91 | A | 44.88 | 3.63 | 37.21 | 27.88 | 54.00 | -26.12 | |
| 3800.00 | 53.17 | 100 | 225 | | | 46.54 | 2.55 | 33.06 | 42.25 | 74.00 | -31.75 | Ch. 134/ |
| 3800.00 | | | | 43.01 | A | 46.54 | 2.55 | 33.06 | 32.09 | 54.00 | -21.91 | ABC |
| 7600.00 | 52.33 | 100 | 135 | | | 44.86 | 3.67 | 37.36 | 48.50 | 74.00 | -25.50 | |
| 7600.00 | | | | 42.37 | A | 44.86 | 3.67 | 37.36 | 38.54 | 54.00 | -15.46 | |
| 11400.00 | 50.33 | 100 | 225 | | | 45.04 | 4.61 | 39.14 | 49.04 | 74.00 | -24.96 | |
| 11400.00 | | | | 39.53 | A | 45.04 | 4.61 | 39.14 | 38.24 | 54.00 | -15.76 | |

| RADIATED EMISSIONS - Vertical Antenna Polarization | | | | | | | | | | | | |
|-----------------------------------------------------------|----------------------|---------------------|-------------------|------------------------|---|--------------------|-------------------|------------------|--------------------------|---------------|-------------------|-----------------|
| Freq. (MHz) | Meter Reading (dBuV) | Antenna Height (cm) | Azimuth (degrees) | Quasi pk or AVG (dBuV) | | Preamp Factor (dB) | Cable Factor (dB) | Ant. Factor (dB) | Corrected Reading (dBuV) | Limits (dBuV) | Diff (dB) +/-FAIL | Comments |
| 3666.66 | 55.50 | 100 | 225 | | | 46.56 | 2.50 | 32.33 | 43.77 | 74.00 | -30.23 | Ch. 102/ |
| 3666.66 | | | | 47.76 | A | 46.56 | 2.50 | 32.33 | 36.03 | 54.00 | -17.97 | ABC |
| 7333.33 | 50.83 | 100 | 135 | | | 44.92 | 3.60 | 36.77 | 46.27 | 74.00 | -27.73 | |
| 7333.33 | | | | 41.78 | A | 44.92 | 3.60 | 36.77 | 37.22 | 54.00 | -16.78 | |
| 3733.33 | 54.17 | 100 | 180 | | | 46.55 | 2.53 | 32.51 | 42.65 | 74.00 | -31.35 | Ch. 118/ |
| 3733.33 | | | | 45.94 | A | 46.55 | 2.53 | 32.51 | 34.42 | 54.00 | -19.58 | ABC |
| 7466.66 | 51.00 | 100 | 225 | | | 44.88 | 3.63 | 37.11 | 46.87 | 74.00 | -27.13 | |
| 7466.66 | | | | 41.57 | A | 44.88 | 3.63 | 37.11 | 37.44 | 54.00 | -16.56 | |
| 3800.00 | 53.83 | 100 | 180 | | | 46.54 | 2.55 | 32.68 | 42.53 | 74.00 | -31.47 | Ch. 134/ |
| 3800.00 | | | | 45.38 | A | 46.54 | 2.55 | 32.68 | 34.08 | 54.00 | -19.92 | ABC |
| 7600.00 | 53.17 | 100 | 135 | | | 44.86 | 3.67 | 37.24 | 49.22 | 74.00 | -24.78 | |
| 7600.00 | | | | 43.58 | A | 44.86 | 3.67 | 37.24 | 39.63 | 54.00 | -14.37 | |
| 11400.00 | 51.93 | 100 | 225 | 53.67 | | 45.04 | 4.61 | 39.12 | 52.36 | 74.00 | -21.64 | |
| 11400.00 | | | | 41.21 | A | 45.04 | 4.61 | 39.12 | 39.90 | 54.00 | -14.10 | |

**PEAK TRANSMIT POWER**

| | | | |
|-----------------------|------------------------------------------------------------------------------------|------------------------|--------------|
| CLIENT: | Intel Corporation | DATE: | 04/07/08 |
| EUT: | Intel WiFi Link 5300 | PROJECT NUMBER: | INTEL-081125 |
| MODEL NUMBER: | 533AN_HMW | TEST ENGINEER: | RC/KN |
| SERIAL NUMBER: | 0016EA038A16 | SITE #: | 1 |
| CONFIGURATION: | Tested installed in an extender board connected to the host laptop's mini PCI slot | TEMPERATURE: | 25 deg. C |
| | | HUMIDITY: | 29% RH |
| | | TIME: | 9:00 AM |

| | |
|---------------------|-----------------------------------------------------------------------------------------------------------------------------------------------------------------------------------------------------------------------------------------------------------------------------------------------------------------------------------------------------------------------------------------------------------------------------------------------------------------|
| Description: | <p>For the band 5.15-5.25 GHz, the peak transmit power over the frequency band of operation shall not exceed the lesser of 50 mW or $4 \text{ dBm} + 10\log B$, where B is the 26-dB emission bandwidth in MHz.</p> <p>For the band 5.25-5.35 GHz, the peak transmit power over the frequency band of operation shall not exceed the lesser of 250 mW or $11 \text{ dBm} + 10\log B$, where B is the 26-dB emission bandwidth in MHz.</p> |
| Results: | Passed (See Data Sheet) |
| Note: | <p>Conducted Emissions Measurements were performed on the EUT with power supply set at the following voltage and frequency.</p> <ul style="list-style-type: none">• 120VAC / 60 Hz. |



Peak Transmit Power (Continued)

| Mode | Channel | Frequency (MHz) | Chain | Data Rate (Mbps) | Total Power (dBm) | Total Power (mW) |
|----------------|---------|-----------------|-------|------------------|-------------------|------------------|
| 802.11a | 36 | 5180 | A | 6 | 16.04 | 40.21 |
| 802.11a | 40 | 5200 | A | 6 | 16.29 | 42.60 |
| 802.11a | 48 | 5240 | A | 6 | 16.24 | 42.11 |
| 802.11a | 52 | 5260 | A | 6 | 16.34 | 43.09 |
| 802.11a | 56 | 5280 | A | 6 | 16.34 | 43.09 |
| 802.11a | 64 | 5320 | A | 6 | 16.44 | 44.09 |
| 802.11a | 36 | 5180 | B | 6 | 16.34 | 43.09 |
| 802.11a | 40 | 5200 | B | 6 | 16.19 | 41.63 |
| 802.11a | 48 | 5240 | B | 6 | 16.44 | 44.09 |
| 802.11a | 52 | 5260 | B | 6 | 16.29 | 42.60 |
| 802.11a | 56 | 5280 | B | 6 | 16.24 | 42.11 |
| 802.11a | 64 | 5320 | B | 6 | 16.54 | 45.12 |
| 802.11a | 36 | 5180 | C | 6 | 16.54 | 45.12 |
| 802.11a | 40 | 5200 | C | 6 | 16.49 | 44.60 |
| 802.11a | 48 | 5240 | C | 6 | 16.64 | 46.17 |
| 802.11a | 52 | 5260 | C | 6 | 16.64 | 46.17 |
| 802.11a | 56 | 5280 | C | 6 | 16.64 | 46.17 |
| 802.11a | 64 | 5320 | C | 6 | 16.54 | 45.12 |
| | | | | | | |
| 802.11n | 36 | 5180 | A | HT0 | 16.04 | 40.21 |
| 802.11n | 40 | 5200 | A | HT0 | 16.24 | 42.11 |
| 802.11n | 48 | 5240 | A | HT0 | 16.19 | 41.63 |
| 802.11n | 52 | 5260 | A | HT0 | 16.29 | 42.60 |
| 802.11n | 56 | 5280 | A | HT0 | 16.24 | 42.11 |
| 802.11n | 64 | 5320 | A | HT0 | 16.04 | 40.21 |
| 802.11n | 36 | 5180 | B | HT0 | 16.04 | 40.21 |
| 802.11n | 40 | 5200 | B | HT0 | 16.44 | 44.09 |
| 802.11n | 48 | 5240 | B | HT0 | 16.14 | 41.15 |
| 802.11n | 52 | 5260 | B | HT0 | 16.54 | 45.12 |
| 802.11n | 56 | 5280 | B | HT0 | 16.44 | 44.09 |
| 802.11n | 64 | 5320 | B | HT0 | 16.34 | 43.09 |
| 802.11n | 36 | 5180 | C | HT0 | 16.44 | 44.09 |
| 802.11n | 40 | 5200 | C | HT0 | 16.34 | 43.09 |
| 802.11n | 48 | 5240 | C | HT0 | 16.54 | 45.12 |
| 802.11n | 52 | 5260 | C | HT0 | 16.54 | 45.12 |
| 802.11n | 56 | 5280 | C | HT0 | 16.54 | 45.12 |
| 802.11n | 64 | 5320 | C | HT0 | 16.44 | 44.09 |

NOTE: The output power measurement is conducted.



Peak Transmit Power (Continued)

| Mode | Channel | Frequency (MHz) | Chain | Data Rate (Mbps) | Total Power (dBm) | Total Power (mW) |
|-----------------|---------|-----------------|-------|------------------|-------------------|------------------|
| 802.11a | 100 | 5500 | A | 6 | 16.04 | 40.21 |
| 802.11a | 120 | 5600 | A | 6 | 16.34 | 43.09 |
| 802.11a | 140 | 5700 | A | 6 | 16.04 | 40.21 |
| 802.11a | 100 | 5500 | B | 6 | 16.34 | 43.09 |
| 802.11a | 120 | 5600 | B | 6 | 16.44 | 44.09 |
| 802.11a | 140 | 5700 | B | 6 | 16.34 | 43.09 |
| 802.11a | 100 | 5500 | C | 6 | 16.14 | 41.15 |
| 802.11a | 120 | 5600 | C | 6 | 16.64 | 46.17 |
| 802.11a | 140 | 5700 | C | 6 | 16.14 | 41.15 |
| 802.11n | 100 | 5500 | A | HT0 | 16.04 | 40.21 |
| 802.11n | 120 | 5600 | A | HT0 | 16.19 | 41.63 |
| 802.11n | 140 | 5700 | A | HT0 | 16.39 | 43.59 |
| 802.11n | 100 | 5500 | B | HT0 | 16.04 | 40.21 |
| 802.11n | 120 | 5600 | B | HT0 | 16.24 | 42.11 |
| 802.11n | 140 | 5700 | B | HT0 | 16.14 | 41.15 |
| 802.11n | 100 | 5500 | C | HT0 | 16.54 | 45.12 |
| 802.11n | 120 | 5600 | C | HT0 | 16.54 | 45.12 |
| 802.11n | 140 | 5700 | C | HT0 | 16.44 | 44.09 |
| 802.11n (40MHz) | 38(F) | 5190 | A | HT0 | 16.60 | 45.69 |
| 802.11n (40MHz) | 46(F) | 5230 | A | HT0 | 16.64 | 46.11 |
| 802.11n (40MHz) | 54(F) | 5270 | A | HT0 | 16.65 | 46.21 |
| 802.11n (40MHz) | 62(F) | 5310 | A | HT0 | 16.38 | 43.43 |
| 802.11n (40MHz) | 38(F) | 5190 | B | HT0 | 16.64 | 46.11 |
| 802.11n (40MHz) | 46(F) | 5230 | B | HT0 | 16.47 | 44.34 |
| 802.11n (40MHz) | 54(F) | 5270 | B | HT0 | 16.32 | 42.83 |
| 802.11n (40MHz) | 62(F) | 5310 | B | HT0 | 16.62 | 45.90 |
| 802.11n (40MHz) | 38(F) | 5190 | C | HT0 | 16.42 | 43.83 |
| 802.11n (40MHz) | 46(F) | 5230 | C | HT0 | 16.54 | 45.06 |
| 802.11n (40MHz) | 54(F) | 5270 | C | HT0 | 16.41 | 43.73 |
| 802.11n (40MHz) | 62(F) | 5310 | C | HT0 | 16.33 | 42.93 |
| 802.11n (40MHz) | 102(F) | 5510 | A | HT0 | 16.62 | 45.90 |
| 802.11n (40MHz) | 118(F) | 5590 | A | HT0 | 16.57 | 45.37 |
| 802.11n (40MHz) | 134(F) | 5670 | A | HT0 | 16.32 | 42.83 |
| 802.11n (40MHz) | 102(F) | 5510 | B | HT0 | 16.29 | 42.54 |
| 802.11n (40MHz) | 118(F) | 5590 | B | HT0 | 16.63 | 46.00 |
| 802.11n (40MHz) | 134(F) | 5670 | B | HT0 | 16.50 | 44.65 |
| 802.11n (40MHz) | 102(F) | 5510 | C | HT0 | 16.22 | 41.86 |
| 802.11n (40MHz) | 118(F) | 5590 | C | HT0 | 16.51 | 44.75 |
| 802.11n (40MHz) | 134(F) | 5670 | C | HT0 | 16.47 | 44.34 |

NOTE: The output power measurement is conducted.



Peak Transmit Power (Continued)

Triple Chain ABC Aggregate Power

| Mode | Channel | Frequency (MHz) | Chain | Data Rate (Mbps) | Total Output Power (dBm) | Total Output Power (mW) |
|-----------------|---------|-----------------|-------|------------------|--------------------------|-------------------------|
| 802.11n (20MHz) | 36 | 5180 | ABC | HT16 | 16.44 | 44.01 |
| 802.11n (20MHz) | 40 | 5200 | ABC | HT16 | 16.46 | 44.29 |
| 802.11n (20MHz) | 48 | 5240 | ABC | HT16 | 16.45 | 44.16 |
| 802.11n (20MHz) | 52 | 5260 | ABC | HT16 | 16.53 | 44.94 |
| 802.11n (20MHz) | 56 | 5280 | ABC | HT16 | 16.33 | 42.90 |
| 802.11n (20MHz) | 64 | 5320 | ABC | HT16 | 16.54 | 45.03 |
| 802.11n (40MHz) | 38(F) | 5190 | ABC | HT16 | 16.52 | 44.86 |
| 802.11n (40MHz) | 46(F) | 5230 | ABC | HT16 | 16.44 | 44.09 |
| 802.11n (40MHz) | 54(F) | 5270 | ABC | HT16 | 16.57 | 45.35 |
| 802.11n (40MHz) | 62(F) | 5310 | ABC | HT16 | 16.52 | 44.83 |
| 802.11n (20MHz) | 100 | 5500 | ABC | HT16 | 16.45 | 44.13 |
| 802.11n (20MHz) | 120 | 5600 | ABC | HT16 | 16.38 | 43.40 |
| 802.11n (20MHz) | 140 | 5700 | ABC | HT16 | 16.50 | 44.62 |
| 802.11n (40MHz) | 102(F) | 5510 | ABC | HT16 | 16.57 | 45.36 |
| 802.11n (40MHz) | 118(F) | 5590 | ABC | HT16 | 16.47 | 44.40 |
| 802.11n (40MHz) | 134(F) | 5670 | ABC | HT16 | 16.44 | 44.01 |

(F) = Fat Channel

**CONDCUTED BAND EDGE EMISSIONS TEST RESULTS**

| | | | |
|-----------------------|------------------------------------------------------------------------------------|------------------------|--------------|
| CLIENT: | Intel Corporation | DATE: | 05/05/08 |
| EUT: | Intel WiFi Link 5300 | PROJECT NUMBER: | INTEL-081125 |
| MODEL NUMBER: | 533AN_HMW | TEST ENGINEER: | KN |
| SERIAL NUMBER: | 0016EA038A16 | SITE #: | 1 |
| CONFIGURATION: | Tested installed in an extender board connected to the host laptop's mini PCI slot | TEMPERATURE: | 18° C |
| | | HUMIDITY: | 43% RH |
| | | TIME: | 8:00 AM |

| | |
|---------------------|----------------------------------------------------------------------------------------------------------------------------------------------------------------------------------------------------------------------------------------------------------------------------------------------------------------------------------------------------------------------------------------------------------------------------------------------------------------|
| Description: | For transmitters operating in the 5.25-5.35 GHz band: all emissions outside of the 5.15-5.35 GHz band shall not exceed an EIRP of -27 dBm/MHz. Devices operating in the 5.25-5.35 GHz band that generate emissions in the 5.15-5.25 GHz band must meet all applicable technical requirements for operation in the 5.15-5.25 GHz band (including indoor use) or alternatively meet an out-of-band emission EIRP limit of -27 dBm/MHz in the 5.15-5.25 GHz band. |
| Results: | See Data Sheet |
| Note: | Conducted Emissions Measurements were performed on the EUT with power supply set at the following voltage and frequency. <ul style="list-style-type: none"> • 120VAC / 60 Hz. |

| Unwanted Spurious Emissions Limits | |
|-------------------------------------------|-----------------------------------------------------------------------------|
| Frequency (MHz) | Field Strength (dBm/Hz) (Emissions outside the restricted bands) |
| 5250-5350 | EIRP < -27dBm/Hz (68.3dBuV/m) |



Conducted Band Edge Emissions Test Results (Continued)

| CONDCUTED BAND EDGE EMISSIONS TEST RESULTS | | | | | | | |
|--------------------------------------------|-----------------|------------------------------------------|---------------------------|------------------------------------|-------------------------|-------------------------|-----------------|
| <i>Freq.(MHz)</i> | <i>TX Chain</i> | <i>Power Spec Den. Reading (dBm/MHz)</i> | <i>Antenna Gain (dBi)</i> | <i>Corrected Reading (dBm/MHz)</i> | <i>Limits (dBm/MHz)</i> | <i>Diff (dB) +=FAIL</i> | <i>Comments</i> |
| 802.11a | | | | | | | |
| 5250.00 | A | -34.72 | 5.00 | -29.72 | -27.00 | -2.72 | Tx @ 5240 MHz |
| 5250.00 | A | -33.73 | 5.00 | -28.73 | -27.00 | -1.73 | Tx @ 5260 MHz |
| 5250.00 | B | -33.06 | 5.00 | -28.06 | -27.00 | -1.06 | Tx @ 5240 MHz |
| 5250.00 | B | -35.17 | 5.00 | -30.17 | -27.00 | -3.17 | Tx @ 5260 MHz |
| 5250.00 | C | -33.17 | 5.00 | -28.17 | -27.00 | -1.17 | Tx @ 5240 MHz |
| 5250.00 | C | -34.29 | 5.00 | -29.29 | -27.00 | -2.29 | Tx @ 5260 MHz |
| 802.11n (20MHz Wide) | | | | | | | |
| 5250.00 | A | -32.51 | 5.00 | -27.51 | -27.00 | -0.51 | Tx @ 5240 MHz |
| 5250.00 | A | -33.67 | 5.00 | -28.67 | -27.00 | -1.67 | Tx @ 5260 MHz |
| 5250.00 | B | -33.73 | 5.00 | -28.73 | -27.00 | -1.73 | Tx @ 5240 MHz |
| 5250.00 | B | -33.25 | 5.00 | -28.25 | -27.00 | -1.25 | Tx @ 5260 MHz |
| 5250.00 | C | -32.52 | 5.00 | -27.52 | -27.00 | -0.52 | Tx @ 5240 MHz |
| 5250.00 | C | -32.46 | 5.00 | -27.46 | -27.00 | -0.46 | Tx @ 5260 MHz |
| 802.11n (40MHz Wide) | | | | | | | |
| 5250.00 | A | -42.99 | 5.00 | -37.99 | -27.00 | -10.99 | Tx @ 5240 MHz |
| 5250.00 | A | -41.29 | 5.00 | -36.29 | -27.00 | -9.29 | Tx @ 5260 MHz |
| 5250.00 | B | -41.99 | 5.00 | -36.99 | -27.00 | -9.99 | Tx @ 5240 MHz |
| 5250.00 | B | -42.75 | 5.00 | -37.75 | -27.00 | -10.75 | Tx @ 5260 MHz |
| 5250.00 | C | -43.85 | 5.00 | -38.85 | -27.00 | -11.85 | Tx @ 5240 MHz |
| 5250.00 | C | -42.39 | 5.00 | -37.39 | -27.00 | -10.39 | Tx @ 5260 MHz |



Conducted Band Edge Emissions Test Results (Continued)

802.11a Mode - Chain A

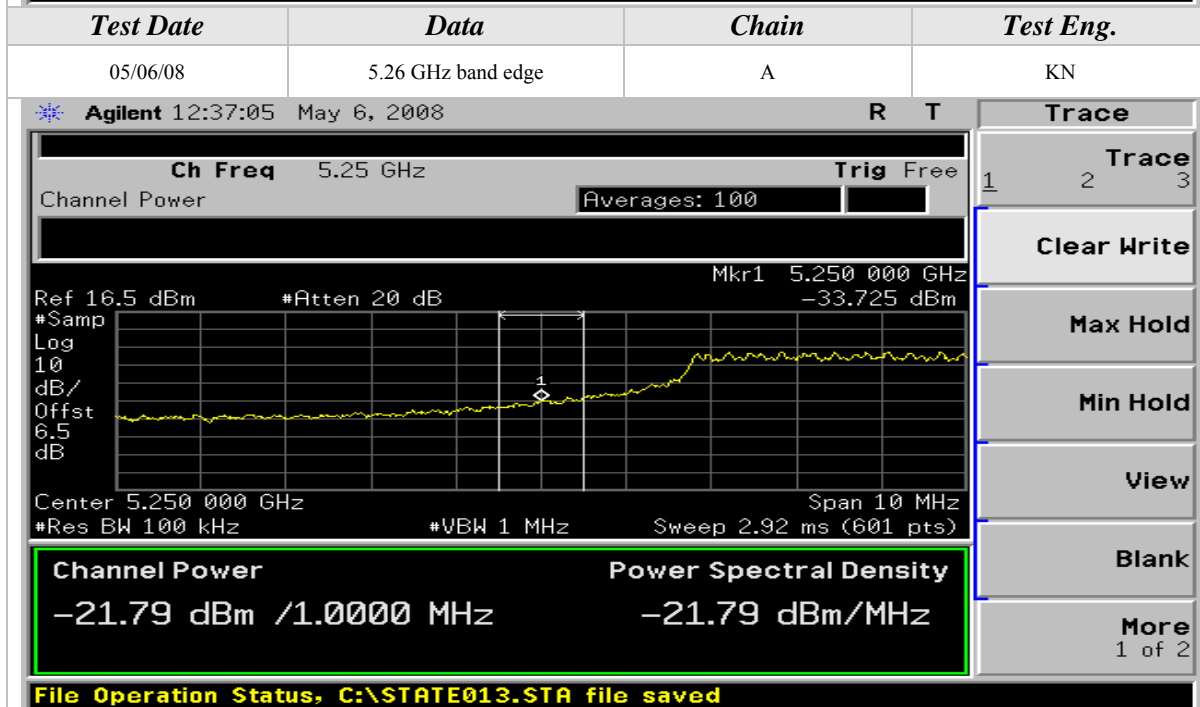
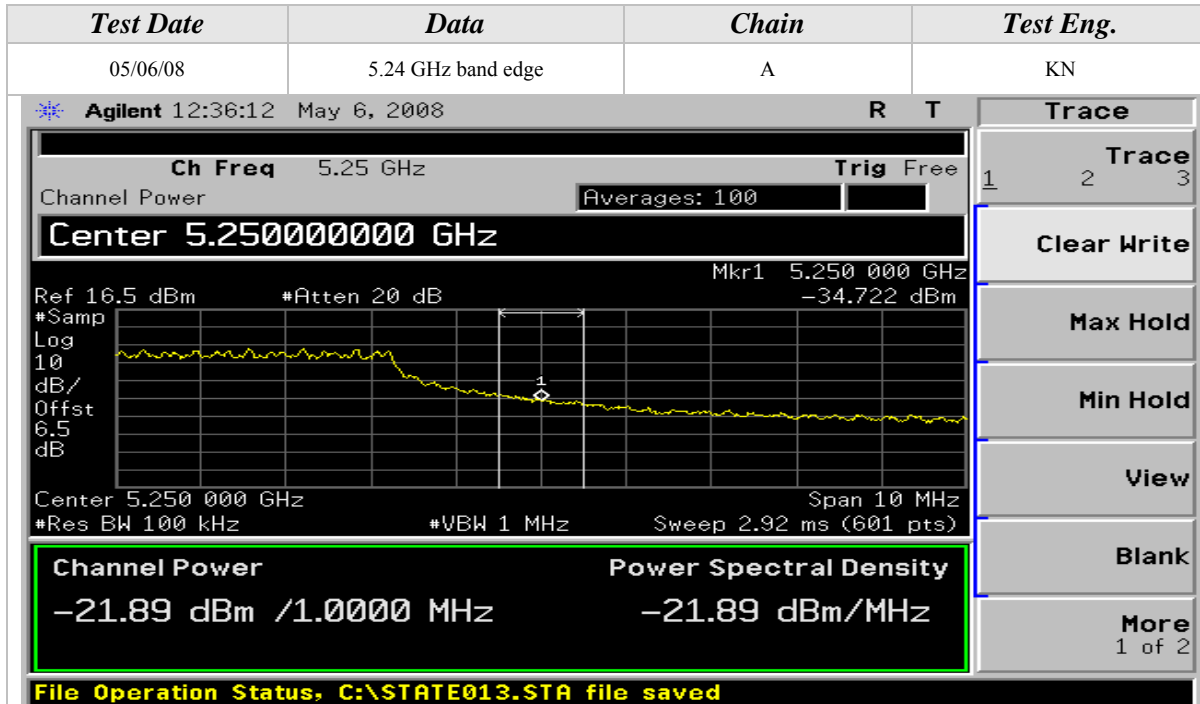



Conducted Band Edge Emissions Test Results (Continued)

802.11a Mode – Chain B





Conducted Band Edge Emissions Test Results (Continued)

802.11a Mode – Chain C





Conducted Band Edge Emissions Test Results (Continued)

802.11n Mode (20 MHz Wide)





Conducted Band Edge Emissions Test Results (Continued)

802.11n Mode (20 MHz Wide)





Conducted Band Edge Emissions Test Results (Continued)

802.11n Mode (20 MHz Wide)





Conducted Band Edge Emissions Test Results (Continued)

802.11n Mode (40 MHz Wide)





Conducted Band Edge Emissions Test Results (Continued)

802.11n Mode (40 MHz Wide)





Conducted Band Edge Emissions Test Results (Continued)

802.11n Mode (40 MHz Wide)

