



TEST REPORT PERTAINING TO:

Equipment Under Test	Model Number(s)
Intel WiMax/WiFi Link 5150	512ANXMMW

CONFIGURATION

IEEE 802.11a / 802.11b / 802.11g / 802.11n & 802.16e with a set of Shanghai Universe Communication Electron Co., Ltd Antennas

MEASUREMENTS PERFORMED IN ACCORDANCE WITH THE FOLLOWING STANDARD (S)

Regulatory Standard(s)

FCC CFR 47, PART 15 SUBPART B CLASS B



Certificate Number: 1111.01

PREPARED FOR:

Intel Corporation
2111 NE 25th Avenue
Hillsboro, Oregon 97124
Contact(s): Mr. Robert Paxman

PREPARED BY:

Aegis Labs, Inc.
8 Rancho Circle
Lake Forest, CA 92630
Agent(s): Mr. Rick Candelas
Mr. Johnny Candelas



Test Report #: INTEL-080312F

Test Report Revision: NONE

	REPORT BODY	APPENDICES				TOTAL PAGES
		A	B	C	D	
PAGES	12	6	5	1	6	30

The contents of this report shall not be reproduced except in full, without the written approval of Aegis Labs, Inc. The Intel Corporation logo is used for identification purposes only and is a registered trademark of Intel Corporation



TABLE OF CONTENTS

SECTION	TITLE	PAGE
	COVER SHEET.....	01
	TABLE OF CONTENTS.....	02
1.0	REGULATORY COMPLIANCE GUIDELINES.....	03
1.1	Guidelines For Testing To Emissions Standards.....	03
2.0	SUMMARY OF REGULATORY LIMITS.....	04
3.0	ADMINISTRATIVE DATA AND TEST DESCRIPTION.....	05
4.0	DESCRIPTION OF EUT CONFIGURATION.....	06
4.1	Arrangement and Location of EUT and Host Equipment.....	06
4.2	EUT Description and Configuration.....	07
4.2.1	Product Description.....	07
4.2.2	EUT Configuration.....	07
4.3	List of EUT Sub-Assemblies and Host Equipment.....	08
4.4	Signal Line Cable Description And Connection Location.....	09
4.5	EMC Test Hardware and Software Measurement Equipment.....	10
5.0	CONDITIONS DURING EMISSIONS MEASUREMENTS.....	11
5.1	General.....	11
5.2	Conducted Emissions Test Setup.....	11
5.3	Radiated Emissions Test Setup.....	12

APPENDICES

A	Test Data
B	Photographs – Test Setups
C	Modifications Required
D	Accreditation Certificate



1.0 REGULATORY COMPLIANCE GUIDELINES

Aegis Labs, Inc. operates as both a Nevada and California Corporation with no organizational or financial relationship with any company, institution, or private individual. Testing and engineering functions provided by Aegis Labs were furnished by RF technicians and engineers with accredited qualifications and training credentials to carry out their duties.

The object of this report was to publish verifiable test results of an EUT subjected to the tests outlined in the standard listed on the cover page of this report.

1.1 Guidelines For Testing To Emissions Standards

These global standards for EMC emission requirements apply to electrical equipment for Information Technology Equipment (ITE). Compliance to these standards and in combination with the other standards listed in this test report can be used to demonstrate presumption of compliance with the protection requirements of the appropriate agency standard.

The purpose of these standards is to specify minimum requirements for emissions regarding electromagnetic compatibility (EMC) and protect the radio frequency spectrum 9 kHz. – 400 GHz. from unwanted interference generated from electrical/digital systems that intentionally or unintentionally generated RF energy. The emissions standards, normative documents and/or publications were used to conduct all tests performed on the equipment herein referred to as “Equipment Under Test”.



2.0 SUMMARY OF TEST RESULTS

Emissions

Index	Standard	Test Limits / Levels			Results
1	FCC PART 15	A.C. Mains Port; Conducted Emissions; 0.150 MHz to 30 MHz			PASSED
		Frequency	Q-P Limit	AVG Limit	
		0.150 – 0.5 MHz	66 dBuV	56 dBuV	
		0.5 – 5	56 dBuV	46 dBuV	
		5 – 30	60 dBuV	50 dBuV	
1	FCC PART 15	R.F. Electromagnetic Fields, 30 to 1000 MHz			PASSED
		Frequency	Limit	Distance	
		30 – 230 MHz	30 dBuV/m	10m	
		230 – 1000 MHz	37 dBuV/m	10m	

ANALYSIS AND CONCLUSIONS

Based upon the measurement results we find that this equipment is within the limits of the global standards listed on the cover page of this test report. All results are based on a test of one sample. If any significant changes are made to the unit, the changes shall be evaluated and a retest may be required.

Approval Signatories

Test and Report Completed By:

Johnny Candelas **09/02/08**
Date:
 Test Technician
 Aegis Labs, Inc.

Report Approved By:

Rick Candelas **09/04/08**
Date:
 Quality Assurance & EMC Lab Manager
 Aegis Labs, Inc.



3.0 ADMINISTRATIVE DATA AND TEST DESCRIPTION

DEVICE TESTED:	ITE Type: Intel WiMax/WiFi Link 5150 Model Number(s): 512ANXMMW Serial Number: 0016EB0420CE
DATE EUT RECEIVED:	April 16 th , 2008
TEST DATE(S):	April 16 th – August 2 nd , 2008
ORIGIN OF TEST SAMPLE(S):	Production
EQUIPMENT CLASS:	EUT tested as CLASS B device
RESPONSIBLE PARTY:	Intel Corporation 2111 NE 25 th Avenue Hillsboro, Oregon 97124
CLIENT CONTACT:	Mr. Robert Paxman
MANUFACTURER:	Intel Corporation
TEST LOCATION:	Aegis Labs, Inc. 32231 Trabuco Creek Road Trabuco Canyon, CA 92678 Open Area Test Site #1 & #2
ACCREDITATION CERTIFICATE(S):	A2LA Certificate Number: 1111.01, Valid through February 28, 2010
PURPOSE OF TEST:	To demonstrate compliance with the standards as described in Sections 1.0 & 2.0 of this report.
UNCERTAINTY BUDGET:	Proficiency Testing and Uncertainty Calculations for all tests indicated in this report have been conducted in accordance with ISO 17025: 2005 requirements Section 5.4.6, and 5.9. Uncertainty Budgets and Proficiency Test results available upon request.
STATEMENT OF CALIBRATION:	All accredited equipment calibrations were performed by Liberty Labs, Inc. and World Cal. with typical calibration uncertainty estimates derived from ISO Guide to the determination of uncertainties with a Coverage Factor of k=2 for 95% level of confidence.

4.0 DESCRIPTION OF EUT CONFIGURATION

4.1 Arrangement and Location of EUT and Host Equipment

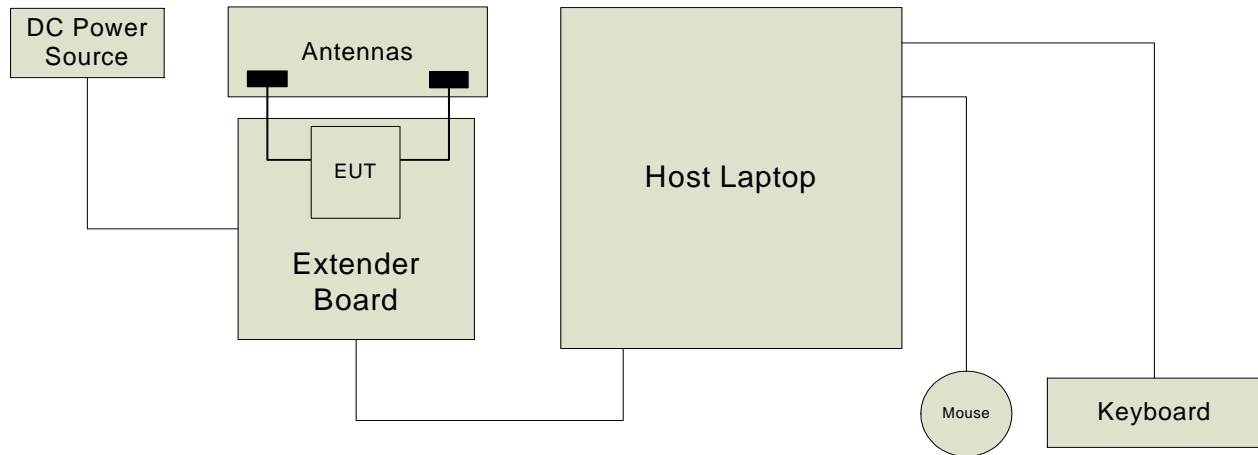

4.2 EUT Description and Configuration

Equipment Under Test (EUT): Intel WiMax/WiFi Link 5150	
Test Routine Software Programs used during testing of EUT and Peripherals:	Intel Corporation Software (CRTU Ver. 5.0.51.0000)
Number of External Test Ports Exercised:	2 Antenna Ports
Power Supply Voltage applied to EUT during qualification measurements:	Conducted: 120VAC / 60Hz Radiated: 120 VAC / 60 Hz
Clocks and/or Crystal Oscillator(s):	N/A

4.2.1 Product Description

The Intel WiMax/WiFi Link 5150 is an embedded IEEE 802.16e and 802.11a/b/g/n wireless network adapter that operates in the 2.4 GHz and 5.0 GHz spectra for WiFi and 2.5 GHz for WiMax. The adapter is capable of delivering up to 450 Mbps Tx/Rx over WiFi and up to 4 Mbps UL/10 Mbps DL over WiMax.

4.2.2 EUT Configuration

The EUT was tested installed in the Mini PCI-E slot of an extender board which is then connected to the host computer. The EUT was then connected to a set of antennas via its Chain A & B antenna ports. Data for a set of Shanghai Universe Communication Electron Co., Ltd Antennas can be found in Appendix A (Data Sheets)

The low, middle, and high channels were tested in 802.11a, b, g, & n modes. Also, the EUT was tested transmitting from Chain A. The EUT was placed in continuous transmit mode by a program provided by the manufacturer (*CRTU Version 5.0.51.0000*).

4.3 List of EUT, Sub-Assemblies and Host Equipment

Equipment Under Test			
Manufacturer	Equipment Name	Model or Part Number	Serial Number
Intel Corporation	Intel WiMax/WiFi Link 5150	512ANXMMW	0013E804612B

EUT Sub-Assemblies			
Manufacturer	Equipment Name	Model or Part Number	Serial Number
Shanghai Universe Communication Electron Co., Ltd	Chain A Antenna	SUC ANT S11	N/A
	Chain B Antenna	SUC ANT S11	N/A

Remotely Located Support Equipment			
Manufacturer	Equipment Name	Model or Part Number	Serial Number
Generic	Host Laptop	ENG001	None
Protek	DC Power Source	3006B	AC2018
Logitech	Keyboard	Y-BF37	MCT25200581
Logitech	Mouse	M-BJ58	LNA22802012

NOTE: All the power cords of the above support equipment are standard and non-shielded.

4.4 Signal Line Cable Description and Connection Location

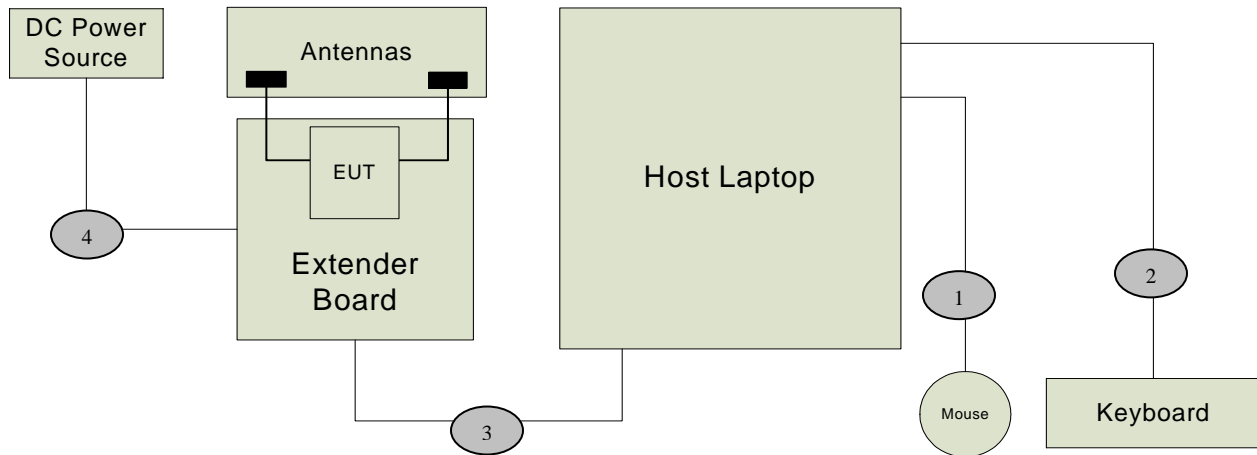

Signal Line Cable Description

Cable	Length	Construction	Source Connector	Destination Connector	Bundled Length	Ferrite Attached	Note
1	1.5m	Round, Braid & Foil Shielded	Host Computer: USB Port	Keyboard: Hardwired	N/A	N/A	N/A
2	1.5m	Round, Braid & Foil Shielded	Host Computer: USB Port	Mouse: Hardwired	N/A	N/A	N/A
3	0.5m	Flat, Braid & Foil Shielded	Extender Board: Mini PCIe slot	Host Laptop: Mini PCIe slot	N/A	N/A	N/A
4	0.5m	Round Un-shielded	Extender Board: Power Input	DC Power Source: Power Output	N/A	N/A	N/A



4.5 EMC Test Hardware and Software Measurement Equipment

TEST EQUIPMENT LIST					
Equipment Name	Manufacturer	Model Number	Serial Number	Calibration Due Date	Maintenance Calibration Cycle
EMI Receiver - RF Section	Hewlett Packard	8546A	3325A00137	04/26/09	1 Year
EMI Receiver - RF Filter Section	Hewlett Packard	85460A	3330A00138	04/26/09	1 Year
10 dB Attenuator	Pasternack	PE7014-10	N/A	09/05/08	1 Year
LISN (EUT)	Fisher Custom Communications	FCC-LISN-50-25-2	9931	03/30/09	1 Year
LISN (Access)	EMCO	3825/2	9108-1848	03/30/09	1 Year
Antenna - Biconical	EMCO	3110B	3383	03/20/09	1 Year
Antenna - Log Periodic	EMCO	3148	47943	03/20/09	1 Year

5.0 CONDITIONS DURING EMISSIONS MEASUREMENTS

5.1 General

All measurements were made according to the procedures defined in or referred to by the standard listed on the cover page of this report. The measurements were made in the operating mode producing the largest emissions consistent with normal operation and connected to the minimum configuration of auxiliary devices.

5.2 Conducted Emissions Test Setup

The following was the test configuration.

EUT signal cables that hung closer than 40 cm to the horizontal metal ground plane were folded back and forth forming a bundle 30 cm to 40 cm long. The power cord of the EUT was also bundled in the center and plugged into one of the artificial mains network (AMN). All peripheral equipment was powered from a second AMN via a multiple outlet strip placed at a distance on 10cm from each other. The AMN and ISN were positioned 80cm from the EUT. Signal cables that were not connected to an AE were terminated using the correct termination. If applicable, the current probe was placed at 0.1 m from the ISN.

Peak, quasi-peak and/or average detectors were used for testing performed between 150 kHz and 30 MHz. A swept frequency scan was performed for both Line 1 and Line 2. The six highest readings were compared against the limit and recorded in the data sheet along with a snapshot image of the sweep scan. The graphical scans in Appendix A only reflect peak readings while the tabulated data sheets reflect peak, average, and/or quasi-peak measurements.

Climatic Conditions:

The EUT was tested within its intended operating and climatic conditions.

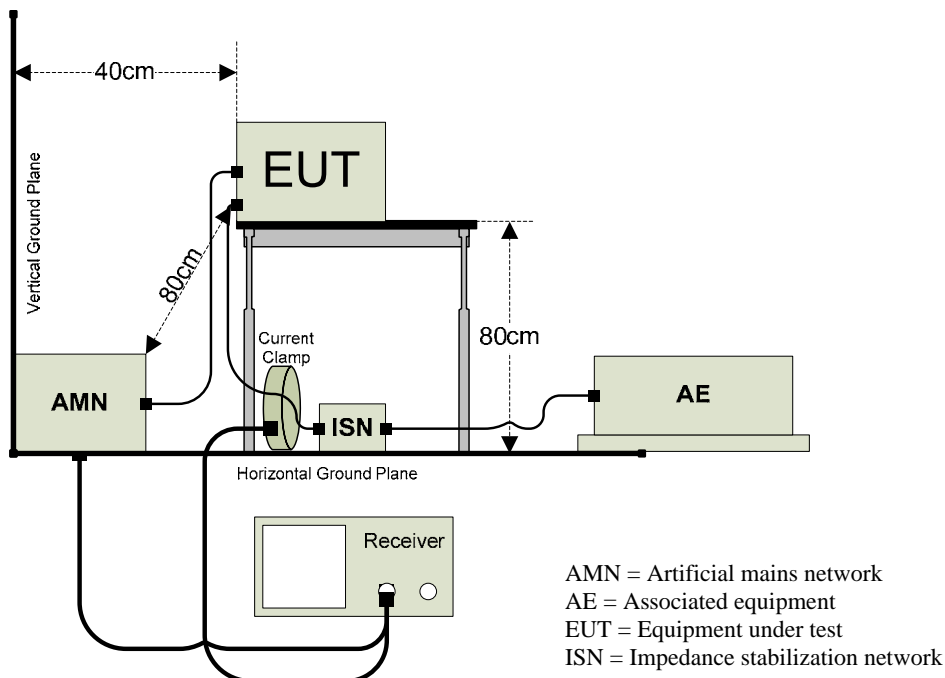

5.3 Radiated Emissions Test Setup

The Open Area Test Site (OATS) was used for radiated emission testing. The receiving (Rx) antenna(s) was placed 10m from the nearest side of the EUT facing the Rx antenna. The EUT (if floor-standing) was placed directly on the flush-mounted 360 degree rotating turntable. The EUT (if table-top) was placed directly on an 80cm high non-metallic table, and the table was placed on the rotating turntable. During the initial EMI scan, all the suspect frequencies, i.e.; harmonics, broadband signals were checked with the Rx broadband antennas in both vertical and horizontal polarities. The biconical Rx, log periodic Rx, and horn Rx antennas were used from 30MHz – 300MHz, 300MHz – 1000MHz, and 1GHz – 18GHz respectively.

Upon completion of all harmonic and broadband measurements, the balance of any remaining frequencies was checked between 30MHz – 18GHz. Any signals appearing within 20 dB of the classification limit was measured. Each signal was maximized by first rotating the turntable at least 360 degrees and recording the azimuth in the data sheet. Lastly, the Rx antenna was raised and/or lowered to maximize the signal elevation. If the measured signal was obtained using the peak detector and that signal appeared within 3 dB of the regulatory limit line, then the same signal was re-measured using the quasi-peak detector on the EMI receiver. Both meter readings if necessary were recorded on the data sheet.

Climatic Conditions:

The EUT was tested within its intended operating and climatic conditions.

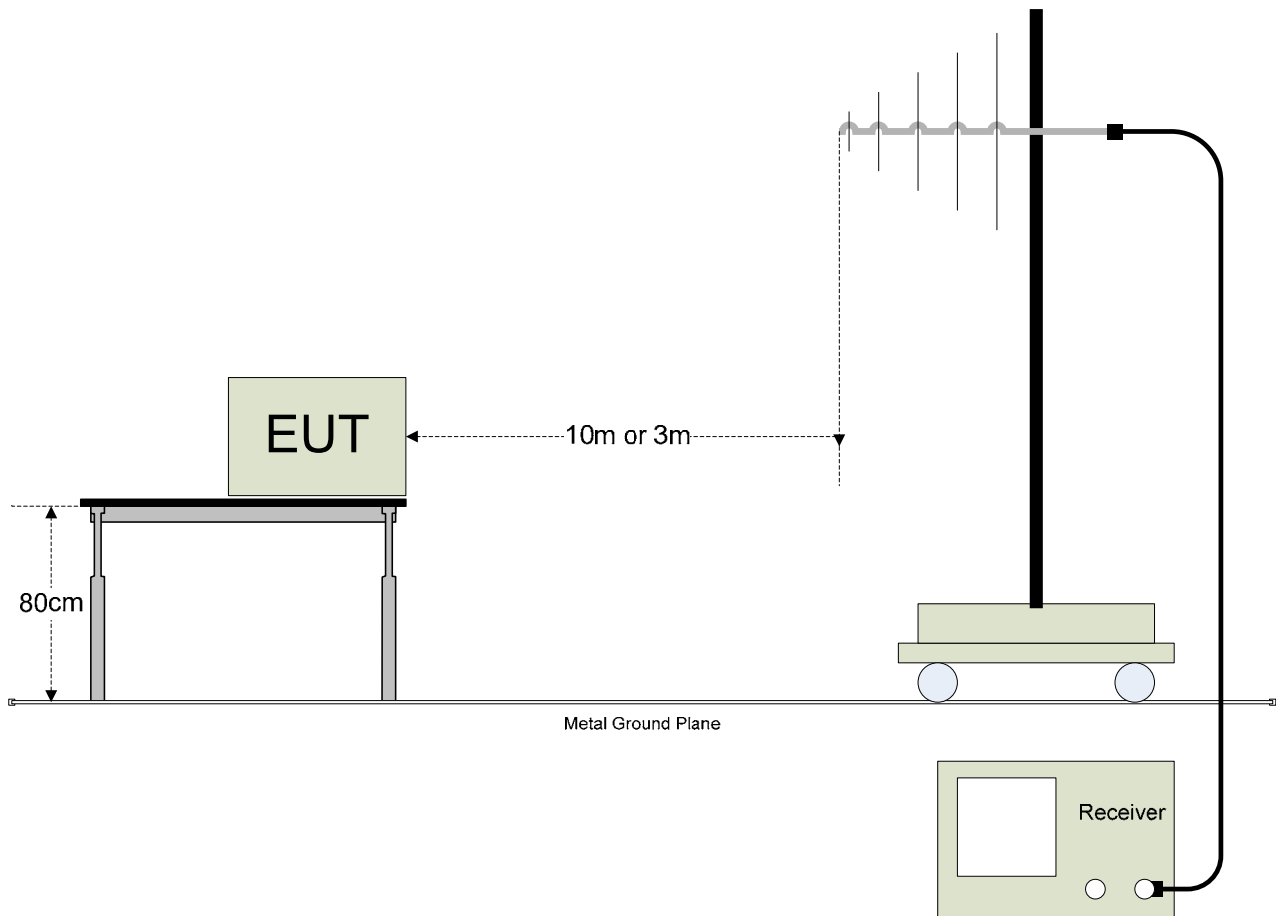



APPENDIX A

TEST DATA

**AC POWER PORT - CONDUCTED EMISSIONS TEST RESULTS**

CLIENT:	Intel Corporation	DATE:	06/02/08
EUT:	Intel WiMax/WiFi Link 5150	PROJECT NUMBER:	INTEL-080309
MODEL NUMBER:	512ANXMMW	TEST ENGINEER:	JC
SERIAL NUMBER:	0016EB0420CE	SITE #:	1
CONFIGURATION:	Tested installed in an extender board connected to the host laptop's mini PCI slot	TEMPERATURE:	22 deg. C
		HUMIDITY:	49%
		TIME:	12:15 PM

Description:	Conducted Power RF Emissions (150 kHz – 30 MHz)
Results:	PASSED LINE 1 and LINE 2 Limits
Note:	Conducted Emissions Measurements were performed on the EUT with the power supply set at the following voltage and frequency. <ul style="list-style-type: none">• 120VAC / 60 Hz

Conducted Limits		
Frequency (MHz)	Quasi-Peak Limit (dBuV)	Average Limit (dBuV)
0.15-0.5	66 to 56*	56 to 46*
0.5-5	56	46
5-30	60	50

*Decreases with the logarithm of the frequency.



AC Power Port – Conducted Emissions Test Results (Continued)

Continuously Transmitting @ 120VAC/60Hz (INTEL-080309-02)

FCC CLASS B CONDUCTED EMISSIONS – LINE 1

Freq. (MHz)	Meter Reading (dBuV)	Detector (PK/QP/AV)	Average Limit (dBuV)	Average Delta(dB)	Quasi-Peak Limit (dBuV)	Quasi-Peak Delta(dB)
3.9000	35.33	PK	46.00	-10.67	56.00	-20.67
4.1300	34.16	PK	46.00	-11.84	56.00	-21.84
4.9600	36.25	PK	46.00	-9.75	56.00	-19.75
8.1800	42.32	PK	50.00	-7.68	60.00	-17.68
13.0000	39.30	PK	50.00	-10.70	60.00	-20.70
16.6200	39.65	PK	50.00	-10.35	60.00	-20.35

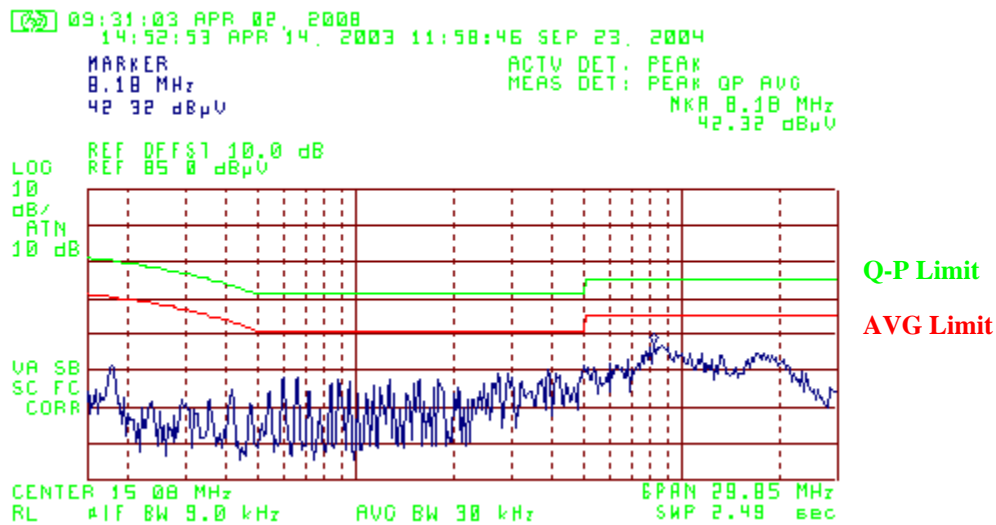



AC Power Port – Conducted Emissions Test Results (Continued)

Continuously Transmitting @ 120VAC/60Hz (INTEL-080309-02)

FCC CLASS B CONDUCTED EMISSIONS - LINE 2

Freq. (MHz)	Meter Reading (dBuV)	Detector (PK/QP/AV)	Average Limit (dBuV)	Average Delta(dB)	Quasi-Peak Limit (dBuV)	Quasi-Peak Delta(dB)
2.6600	30.92	PK	46.00	-15.08	56.00	-25.08
2.9700	31.51	PK	46.00	-14.49	56.00	-24.49
3.9000	31.39	PK	46.00	-14.61	56.00	-24.61
8.4300	42.36	PK	50.00	-7.64	60.00	-17.64
17.8300	40.07	PK	50.00	-9.93	60.00	-19.93
23.1500	34.23	PK	50.00	-15.77	60.00	-25.77

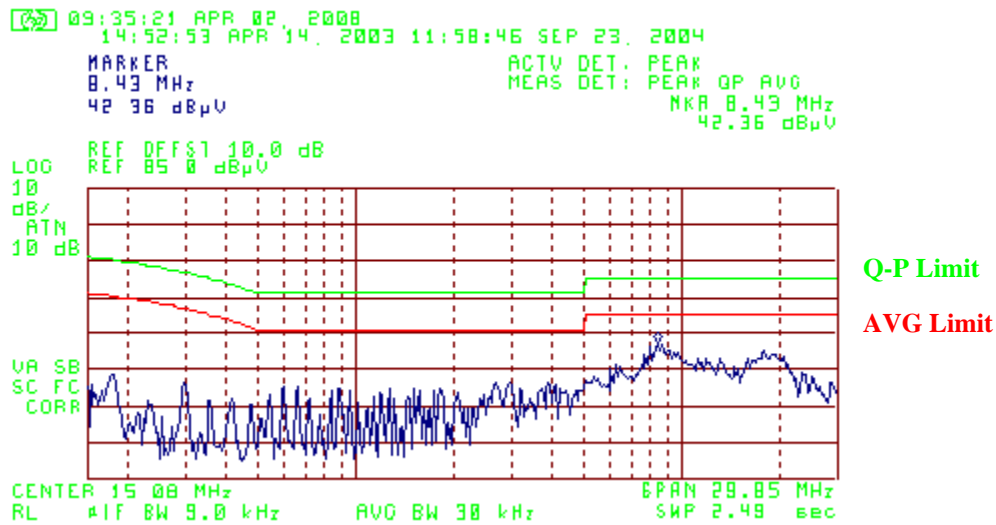



RADIATED EMISSIONS TEST RESULTS

CLIENT:	Intel Corporation	DATE:	06/02/08
EUT:	Intel WiMax/WiFi Link 5150	PROJECT NUMBER:	INTEL-080309
MODEL NUMBER:	512ANXMMW	TEST ENGINEER:	JC
SERIAL NUMBER:	0016EB0420CE	SITE #:	1
CONFIGURATION:	Tested installed in an extender board connected to the host laptop's mini PCI slot	TEMPERATURE:	22 deg. C
		HUMIDITY:	49%
		TIME:	12:15 PM

Description:	Radiated RF Emissions (30 MHz – 1000 MHz)
Results:	PASSED Horizontal and Vertical Antenna Polarizations Class B Limits
Note:	Radiated Emissions Measurements were performed on the EUT with the power supply set at the following voltage and frequency. <ul style="list-style-type: none">• 120VAC / 60 Hz.

Radiated Emissions Sample Calculations

$$\text{Corrected Meter Reading} = \text{Meter Reading} + F + C - D$$

Where, F = Antenna Factor

C = Cable Factor

G = Amplifier Gain

D = Distance Factor (if applicable)

Therefore, the equation for determining the Corrected Meter Reading Limit (CML) is:

$$\text{CML} = \text{Specification Limit} - F - C + D$$



Radiated Emissions Test Results (Continued)

Continuously Transmitting @ 120VAC/60Hz (INTEL-080309-05)

Horizontal Open Field Maximized Data											
<i>Freq. (MHz)</i>	<i>Meter Reading (dBuV)</i>	<i>Antenna Height (cm)</i>	<i>Azimuth (degrees)</i>	<i>Quasi pk or AVG (dBuV)</i>		<i>Cable Factor (dB)</i>	<i>Cable Factor (dB)</i>	<i>Antenna Factor (dB)</i>	<i>Corrected Reading (dBuV/m)</i>	<i>Limits (dBuV/m)</i>	<i>Diff (dB) +/-FAIL</i>
48.02	8.58	400	45			2.65	10.32	10.46	32.01	40.00	-7.99
120.00	14.23	400	90	11.03	Q	2.39	11.20	10.46	35.08	43.50	-8.42
250.01	10.96	350	90			2.91	17.40	10.46	41.73	46.00	-4.27
305.09	11.32	300	270			3.07	14.49	10.46	39.33	46.00	-6.67
375.00	10.53	250	45			3.35	15.10	10.46	39.44	46.00	-6.57
386.00	11.63	225	45			3.39	15.54	10.46	41.02	46.00	-4.98

Vertical Open Field Maximized Data											
<i>Freq. (MHz)</i>	<i>Meter Reading (dBuV)</i>	<i>Antenna Height (cm)</i>	<i>Azimuth (degrees)</i>	<i>Quasi pk or AVG (dBuV)</i>		<i>Cable Factor (dB)</i>	<i>Cable Factor (dB)</i>	<i>Antenna Factor (dB)</i>	<i>Corrected Reading (dBuV/m)</i>	<i>Limits (dBuV/m)</i>	<i>Diff (dB) +/-FAIL</i>
48.01	11.12	100	45			2.65	10.52	10.46	34.75	40.00	-5.25
119.98	18.40	100	90	14.65	Q	2.39	10.80	10.46	38.30	43.50	-5.20
250.03	8.51	100	45			2.91	18.30	10.46	40.18	46.00	-5.82
306.35	13.06	100	45			3.07	14.78	10.46	41.37	46.00	-4.63
358.01	7.94	100	0			3.27	15.44	10.46	37.11	46.00	-8.89
375.05	8.85	100	90			3.35	15.30	10.46	37.96	46.00	-8.04
386.01	15.71	100	180	13.62	Q	3.39	15.61	10.46	43.08	46.00	-2.92



APPENDIX B

PHOTOGRAPHS – (TEST SETUPS)



CONDUCTED EMISSIONS – FRONT VIEW

FOR

*EUT: Intel WiMax/WiFi Link 5150
MODEL NUMBER: 512ANXMMW*

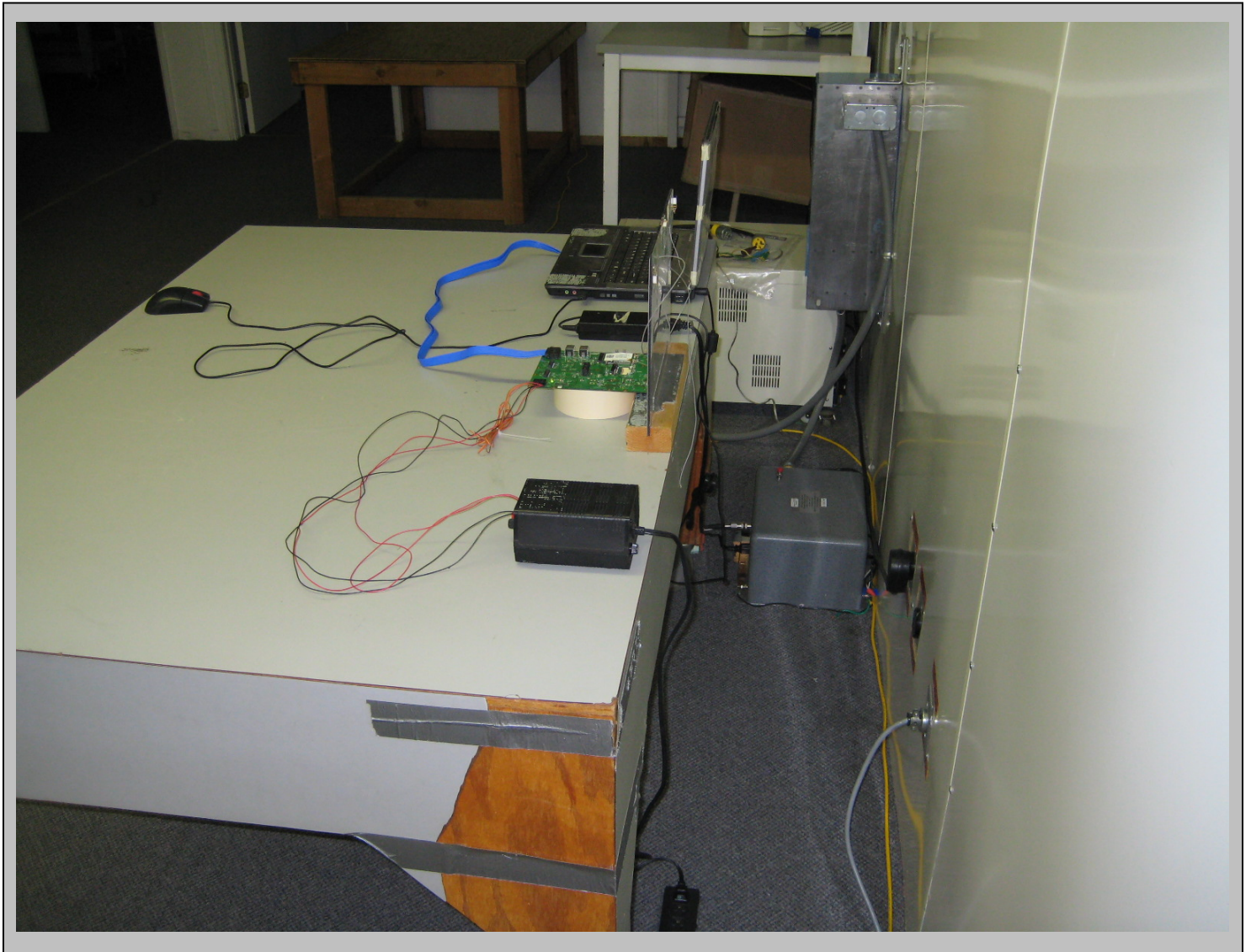

CONDUCTED EMISSIONS – SIDE VIEW

FOR

*EUT: Intel WiMax/WiFi Link 5150
MODEL NUMBER: 512ANXMMW*

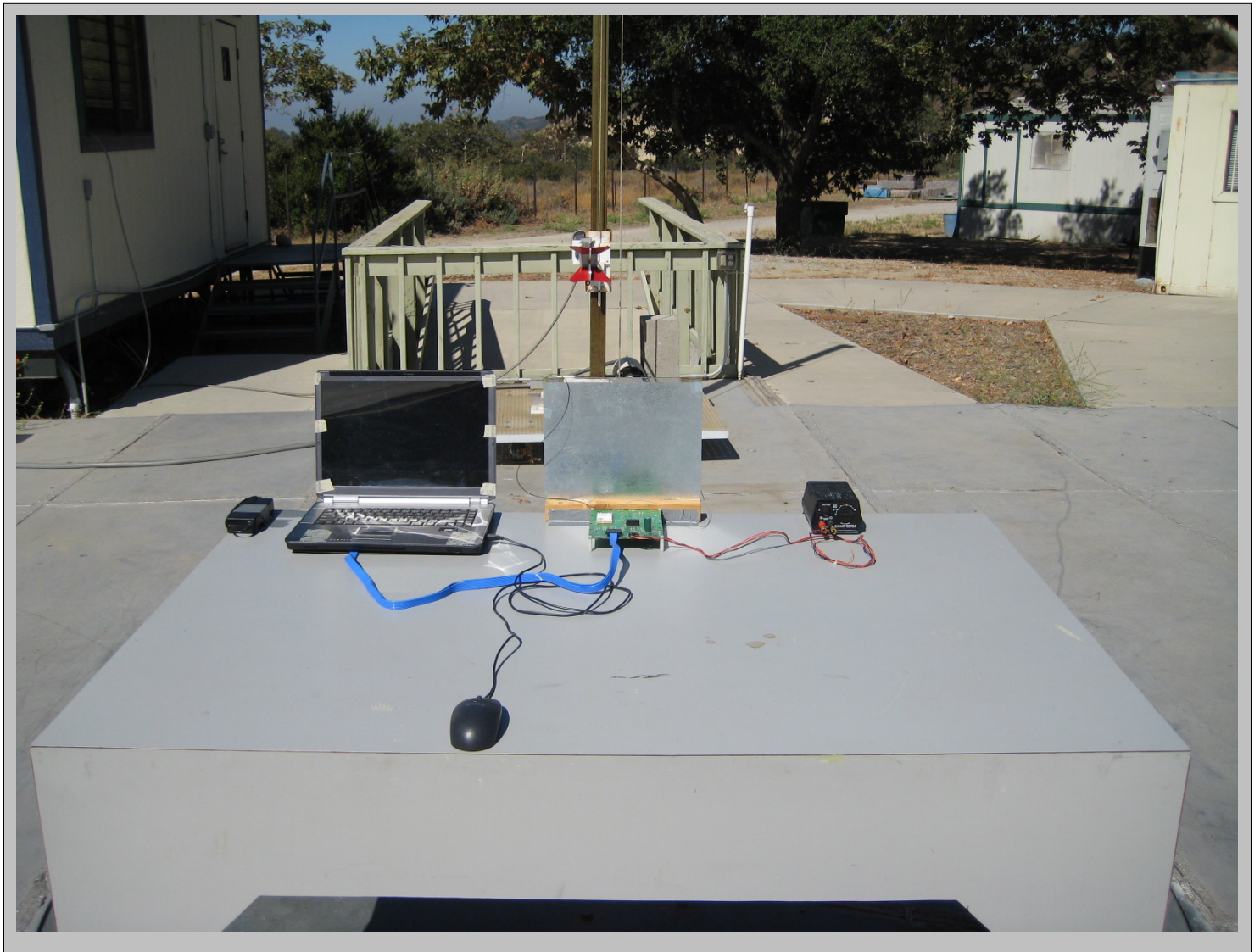

RADIATED EMISSIONS – FRONT VIEW

FOR

*EUT: Intel WiMax/WiFi Link 5150
MODEL NUMBER: 512ANXMMW*

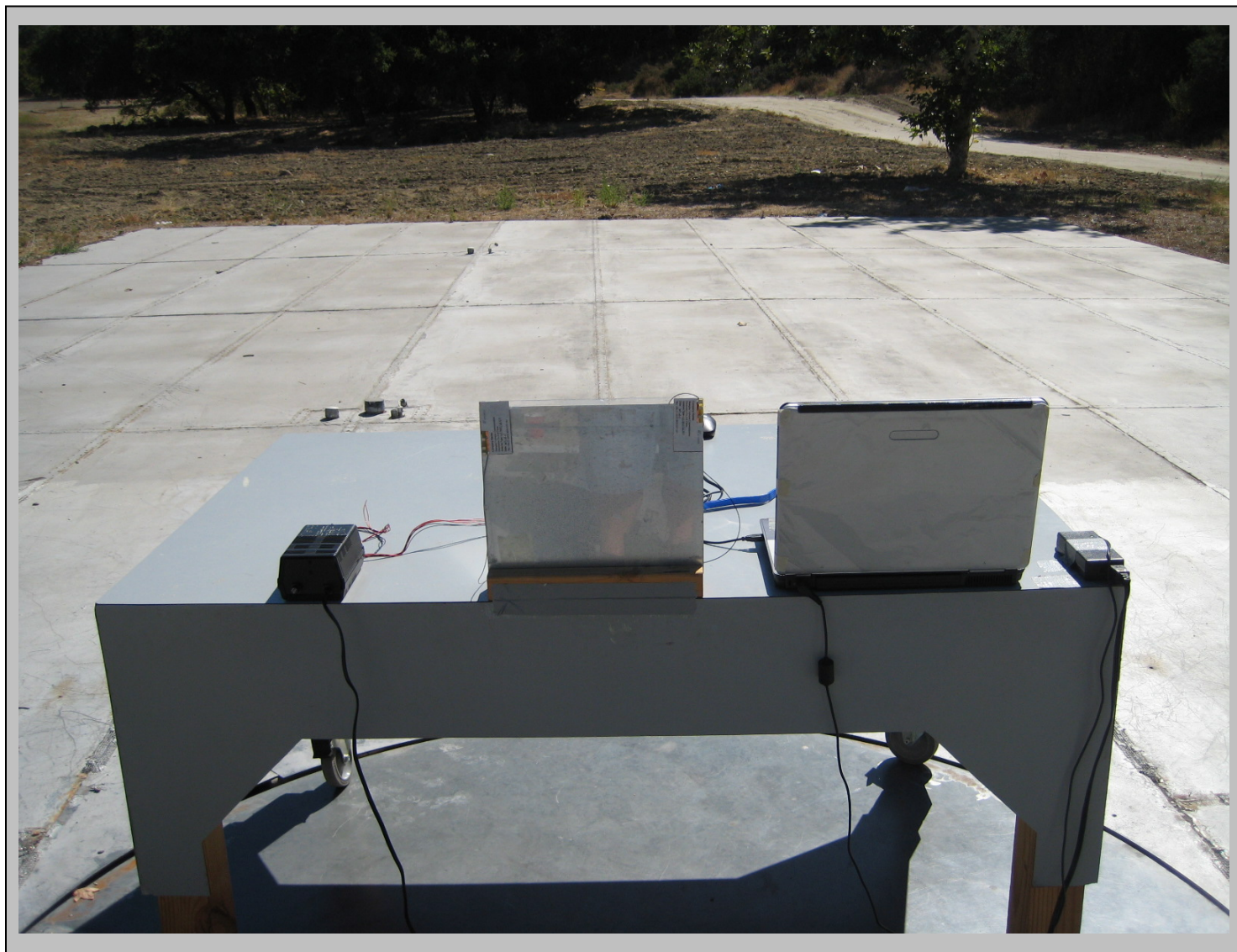

RADIATED EMISSIONS – REAR VIEW

FOR

*EUT: Intel WiMax/WiFi Link 5150
MODEL NUMBER: 512ANXMMW*



APPENDIX C

MODIFICATIONS REQUIRED

1.0	NONE



APPENDIX D

ACCREDITATION CERTIFICATE (S)



THE AMERICAN ASSOCIATION FOR
LABORATORY ACCREDITATION

ACCREDITED LABORATORY

A2LA has accredited

AEGIS LABS, INC.
Trabuco Canyon, CA

for technical competence in the field of

Electrical Testing

This laboratory is accredited in accordance with the recognized International Standard ISO/IEC 17025:2005 *General Requirements for the Competence of Testing and Calibration Laboratories*. This accreditation demonstrates technical competence for a defined scope and the operation of a laboratory quality management system (refer to joint ISO-ILAC-IAF Communiqué dated 18 June 2005).

Presented this 11th day of June 2008.

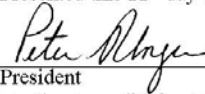

President

For the Accreditation Council

Certificate Number 1111.01

Valid to February 28, 2010



For the tests or types of tests to which this accreditation applies,
please refer to the laboratory's Electrical Scope of Accreditation.



SCOPE OF ACCREDITATION TO ISO/IEC 17025:2005

AEGIS LABS, INC.¹
 32231 Trabuco Creek Road
 Trabuco Canyon, CA 92678
 Rick Candelas Phone: 949-459-7886

ELECTRICAL (EMC)

Valid To: February 28, 2010

Certificate Number: 1111.01

In recognition of the successful completion of the A2LA evaluation process, accreditation is granted to this laboratory to perform the following electromagnetic compatibility tests:

<u>Technology</u>	<u>Test Method(s)</u>
<i>Emissions</i>	
<i>Radiated and Conducted</i>	
	CFR 47, FCC Part 15 (ANSI C63.4:2003)
	CFR 47, FCC Part 18 (ANSI C63.4:2003)
	ICES-001
	ICES-003
	ICES-005
	VCCI V-3
	CNS13438: 2006
	EN 55011: 1998 + A1: 1999 + A2: 2002
	EN 55011: 2007 + A2: 2007
	EN 55014-1: 2000 + A1: 2001 + A2: 2002
	EN 55014-1: 2006
	EN 55014-2: 1997 + A1: 2001
	EN 55022: 1998 + A1: 2000 + A2: 2003
	EN 55022: 2006
	CISPR 11: 1997 + A1: 1999 + A2: 2002
	CISPR 11: 2003 + A1: 2004 + A2: 2006
	CISPR 13: 2001 + A1: 2003 + A2: 2006
	CISPR 14-1: 2000 + A1: 2001 + A2: 2002
	CISPR 14-1: 2005
	CISPR 14-2: 1997 + A1: 2001
	CISPR 22: 1997 + A1: 2000 + A2: 2003
	CISPR 22: 2005
	AS/NZS CISPR 11: 2004
	AS/NZS CISPR 14.1: 2005
	AS/NZS CISPR 14.2: 2003
	AS/NZS CISPR 22: 2006

¹ This accreditation covers testing performed at the main laboratory listed above, and the satellite laboratory indicated.



Technology

Emissions (cont'd)

Radiated and Conducted

Test Method(s)

SABS CISPR 11

SABS CISPR 13

SANS 222: 2006/CISPR22: 2006 (SABS CISPR: 2006)

SII 961-6-1: 2002

KN11

KN13

KN14

KN22

RRL Notice No. 2008-4 (February 11, 2008)

RRL Notice No. 2008-5 (February 11, 2008)

SS IEC CISPR22:

IDA TS EMC

***Product Family and
Generic Standards***

EN 61000-6-1: 2001, 2007

EN 61000-6-2: 2001, 2005

EN 61000-6-3: 2001 + A1: 2004, 2007

EN 61000-6-4: 2001, 2007

EN 50130-4: 1995 + A1:998 + A2: 2003

EN 55103-1: 1996

EN 55103-2: 1996

EN 60601-1-2: 2001

EN 61326: 1997 + A1: 1998 + A2: 2001 + A3: 2003

EN 61326-1: 2006

EN 55020: 2002 +A1: 2003 + A2: 2005

EN 55020: 2007

IEC 61000-6-1: 1997, 2005

IEC 61000-6-2: 1999, 2005

IEC 61000-6-3: 1996, 2006

IEC 61000-6-4: 1997, 2006

IEC 60601-1-2: 2001

IEC 61326: 1997 + A1: 1998 + A2: 2000 + A3: 2002

IEC 61326-1: 2005

CISPR 20: 2002 +A1: 2002 + A2: 2005

CISPR 20: 2006

KN 20

AS/NZS 4251.1: 1999

AS/NZS 4251.2: 1999

AS/NZS 61000.6.1: 2006

AS/NZS 61000.6.2: 2006



<u>Technology</u>	<u>Test Method(s)</u>
<i>Radio Communications</i>	CFR 47, FCC Part 27 (ANSI C63.4:2003) AS/NZS 4771: 2000 + A1: 2003 AS/NZS 4268: 2003 + A1: 2005 + A2: 2006 RSS-GEN RSS-210 RSS-310 IDA TS SRD EN 300 220-1, EN 300 220-2, EN 300 220-3 EN 300 328-1, EN 300 328-2, EN 300 328 EN 300 386 EN 300 440-1, EN 300 440-2 EN 301 489-1 (Excluding Section 9.6) EN 301 489-3 EN 301 489-4 EN 301 489-17 EN 301 893 (Excluding DFS testing)
<i>Harmonics</i>	EN 61000-3-2: 2000 + A2: 2005 EN 61000-3-2: 2006 IEC 61000-3-2: 2000 + A1: 2001 + A2: 2004 AS/NZS 61000.3.2
<i>Flickers</i>	EN 61000-3-3: 1995 + A1: 2001 + A2: 2005 IEC 61000-3-3: 1994 + A1: 2001 + A2: 2005 AS/NZS 61000.3.3

AEGIS LABS, Inc.
8 Rancho Circle
Lake Forest, CA 92360
949 454 8295

<u>Technology</u>	<u>Test Method(s)</u>
<i>Immunity</i>	EN 55024: 1998 +A1: 2001 + A2: 2003 EN 61000-4-2 EN 61000-4-3 EN 61000-4-4 EN 61000-4-5, ITU-T K.20 EN 61000-4-6 EN 61000-4-8 EN 61000-4-11



Technology
Immunity (cont'd)

Test Method(s)

CISPR 24: 1997 + A1: 2001 + A2: 2002

IEC 61000-4-2

IEC 61000-4-3

IEC 61000-4-4

IEC 61000-4-5

IEC 61000-4-6

IEC 61000-4-8

IEC 61000-4-11

KN 24 with RRL Notice No. 2007-99 (2007.12.26) & RRL Notice No. 2007-101 (2007.12.26)

KN 61000-4-2

KN 61000-4-3

KN 61000-4-4

KN 61000-4-5

KN 61000-4-6

KN 61000-4-8

KN 61000-4-11

AS/NZS 61000.4.2

AS/NZS 61000.4.3

AS/NZS 61000.4.4

AS/NZS 61000.4.5

AS/NZS 61000.4.6

AS/NZS 61000.4.8

AS/NZS 61000.4.11

Avionics / Military

RTCA/DO-160 (Sections 15-22 & 25)

RTCA/DO-301 (Sections 2.3.13 – 2.3.19)

MIL-STD-461

MIL-STD-462

MIL-STD-704 (MIL-HDBK-704-1, MIL-HDBK-704-7, MIL-HDBK-704-8)

BOEING D6-16050-4

BOEING D6-16050-5

BOEING 787B3-0147 (Section 3)

AIRBUS ABD0100.1.8 (Section 1.2, 1.3, 2)