



SAR & HAC Instruments for Wireless • Consulting • Research • Standards • Compliance • Training

Applicant Name: Intel Corporation
Applicant Address: Intel Corporation
 2111 Ne 25th Avenue JF3-3-G14,
 Hillsboro, OR 97124
Project Number: ITLB-MINI-WiMAX-GAL-NRSB-5434
Test/Analysis Date: November December 08/March June 2009



DUT Type	Intel WiFi-Link 5150
Antenna Type	Galtronics
Project Name	Mini-Cooper
Received Status	Pre Production Model
DUT Serial Number	21022915000009
Experimental/Compliance	Compliance-FCC
Tx Frequency	2412MHz to 2462MHz 802.11bg(n) 2501MHz to 2685MHz WiMAX 5180MHz to 5320MHz 802.11a(n) 5500MHz to 5700MHz 802.11a(n) 5745MHz to 5825MHz 802.11a(n)
Max Tx Power	802.11bg = 16.64dBm 2450n = 16.5dBm WiMAX = 24.1dBm Average 802.11a = 16.45dBm 802.11an = 16.54dBm
Conservative Averaged SAR (RF Exposure)	802.11b 2462MHz = 0.021 802.11g 2437MHz = 0.029 802.11n 2437MHz = 0.019 802.11n* 2437MHz = 0.019 WiMAX 10MHz 2685MHz = 0.117 corrected = 0.150 WiMAX 5MHz 2685MHz = 0.040 corrected = 0.035 802.11a 5180MHz = 0.066 802.11n 5180MHz = 0.066 802.11n* 5190MHz = 0.063 802.11a 5500MHz = 0.043 802.11n 550MHz = 0.045 802.11n* 5510MHz = 0.028 802.11a 5745MHz = 0.025 802.11n 5745MHz = 0.026 802.11n* 5755MHz = 0.021 NOTE: 802.11n = 20MHz / 802.11n* = 40MHz

We the undersigned of APREL Laboratories, located at 17 Bentley Ave, Ottawa, Ontario, Canada, K2E 6T7, on the date indicated attest that the Device Under Test as detailed within this test report has been tested and found to be compliant with the Uncontrolled Environment RF exposure rules and regulations as defined by the methodologies, procedures, and standards as described in this document. Signed this day June 4th 2009.

APREL Laboratories are an ISO 17025 accredited facility registered under Standards Council Canada lab 48.

Art Brennan
 Document Control

 Stuart Nicol,
 Director Product Development

 Dr Jacek J. Wojcik,
 P. Engineer



Table of Contents

1.0 Introduction 3

2.0 Applicable Documents 14

3.0 ALSAS-10U System Description 15

3.1 Applications 16

3.2 Visualisation and reporting 16

3.3 Field scans 16

3.3.1 Area Scans 16

3.3.2 Zoom Scan (Cube Scan Averaging) 17

3.4 Operator settings 17

3.5 ALSAS-10U Interpolation and Extrapolation Uncertainty 17

4.0 ALSAS-10U Hardware 18

4.1 Isotropic E-Field Probe 18

4.2 Isotropic E-Field Probe Specification 19

4.3 Boundary Detection Unit and Probe Mounting Device 20

4.4 Daq-Paq (Analog to Digital Electronics) 20

4.5 Axis Articulated Robot 21

4.6 ALSAS Universal Workstation 21

4.7 Universal Device Positioner 22

4.8 Phantom Types 23

4.8.1 APREL SAM Phantoms 23

4.8.2 APREL Laboratories Universal Phantom 24

4.9 Validation Dipoles 25

5.0 Tissue Simulation Fluid 26

5.1 Tissue Calibration Procedure Using a Coaxial Probe 27

5.2 Tissue Calibration Results 27

6.0 System Validation 28

6.1 Experimental Results Summary 30

6.2 SAR Measurement Procedure 30

6.3 SAR Exposure Limits 30

6.4 Equipment List 31

6.5 SAR Measurement Results 32

- Appendix a SAR Plots
- Appendix b Calibration
- Appendix c PbA
- Appendix d Acquisition Methodology



1.0 Introduction

Tests were conducted at APREL Laboratories within the ISO 17025 accredited SAR facility to establish the conservative exposure value associated with the Device Under Test as detailed within this test report. Assessments were made in line with the guidelines contained in the reference documents. The method used for assessment was the ALSAS-10U (APREL Laboratories SAR Assessment System-10 Universal). All practices along with standards and scientific methodologies which have been utilized during the assessment of the Device Under Test (DUT) are detailed within this test report.

APREL Laboratories employees currently hold senior and executive positions in multiple international standards organizations, including IEC, IEEE, among others, and work closely with several national regulators, including the FCC and IC. APREL Laboratories currently hold the chair for the Canadian National committee to IEC to which we have a liaison with CENELEC, and informal links to other national and international standards organizations.

1.2 Device Description

The tests conducted on a Dell laptop computer which utilises a set of Galtronics antennas running the Intel Wireless link 5150 network card which runs on both WiFi and WiMAX systems. The card was connected to the antennas with the DUT set to transmit at the maximum power as defined by the manufacturer and analysis was ran on the antenna and position which showed the highest SAR. A predefined waveform which was provided by Intel was used to set the 5150 card to transmit and both average and peak power measurements were made to determine the maximum transmitting power. The card was operated utilizing proprietary software and each channel was measured using a broadband power meter to determine the maximum average power on the antenna port of the wireless card for WiFi assessments..



NOTE: The laptop was tested with 0mm separation or greater distance for all positions at 90 degrees.

1.3 RSB Testing

Additional tests were conducted on the system which had a RSB (Radio Sensing Board) in series between the TX port of the card and the antenna. The RSB is a peripheral which is included in some versions of the laptop tested and it was found that all tests conducted showed a lower SAR value when tested in the position which showed the maximum SAR without the RSB. Data supporting this finding is shown in the SAR test data.

1.4 Antenna Locations

The antennas on the Dell laptop with the Intel® WiFi-Link 5150 Series card installed are located within the chassis as identified in the image below. The antennas are located around the LCD where the conservative SAR was found to be in a position where the LCD is horizontally located near the phantom.

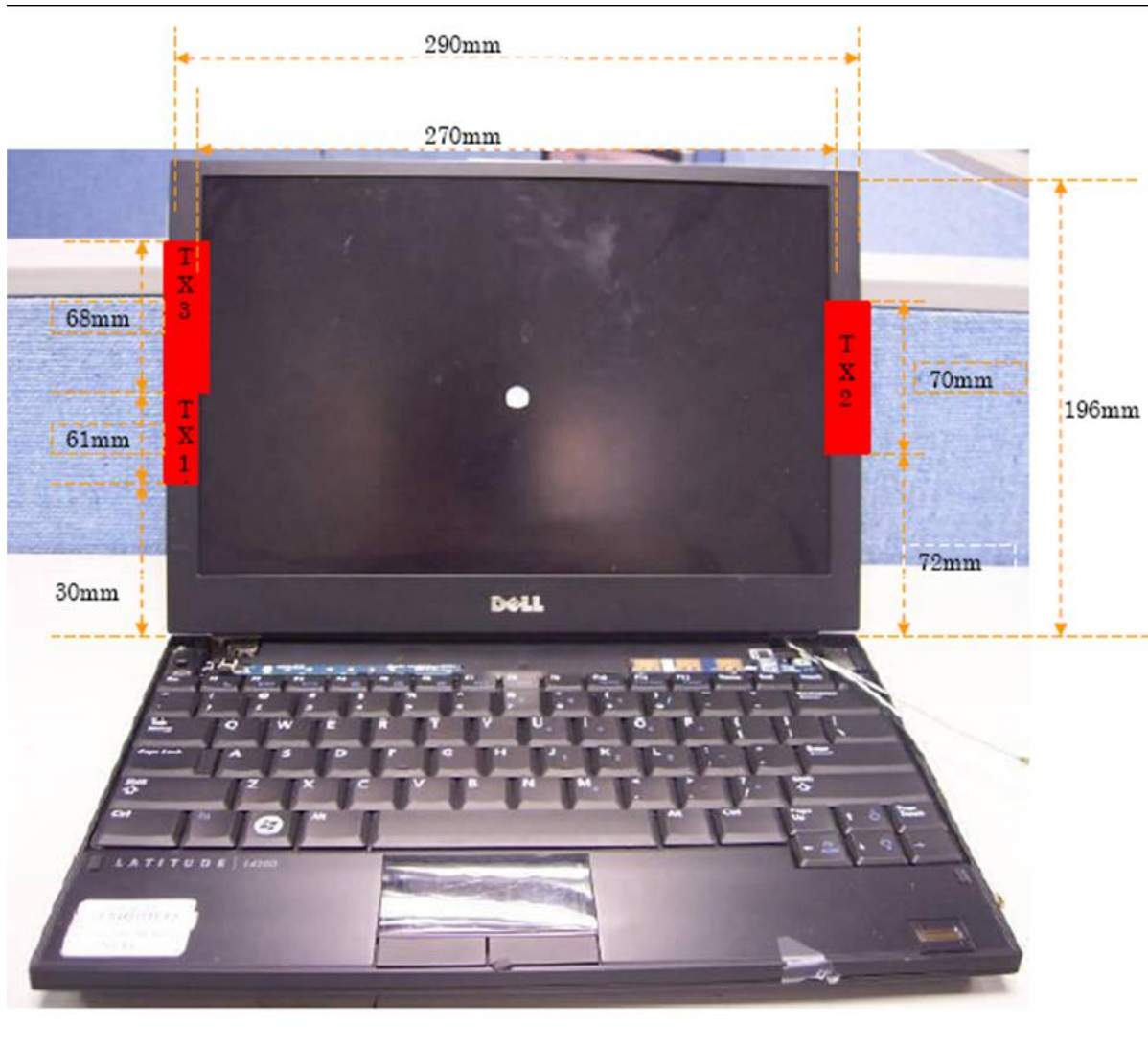

Antenna Locations WLAN (no RSB)



WLAN and WWAN Antenna Locations (RSB)



Location of the RSB (Radio Sensing Board)



Power Measurement Setup



UFL to SMA Setup

1.5 Test Vector Details

Test Vector File Name	BW	DL/UL Symbols	UL duty Cycle Measured	Actual Power(mW)- Lowest power is used among L/M/H	Duty Factor Compensation Factor As per FCC
DQ4_12_UQ16_12_10M	10MHz	35/12	23.3%	190.5	1.286
DQ64_UQ4_12_21s_10M	10 MHz	26/21	42%	182	1.390
DQ4_12_UQ16_34_5M	5 MHz	29/18	36.7%	234.4	1.562
DQ64_56_UQ4_12_5M	5 MHz	29/18	36.7%	234.4	1.562

The DQ4_12_UQ16_12_10M waveform was not available at the time of the PbA application. The Duty Factor plot and average power plots are presented below.

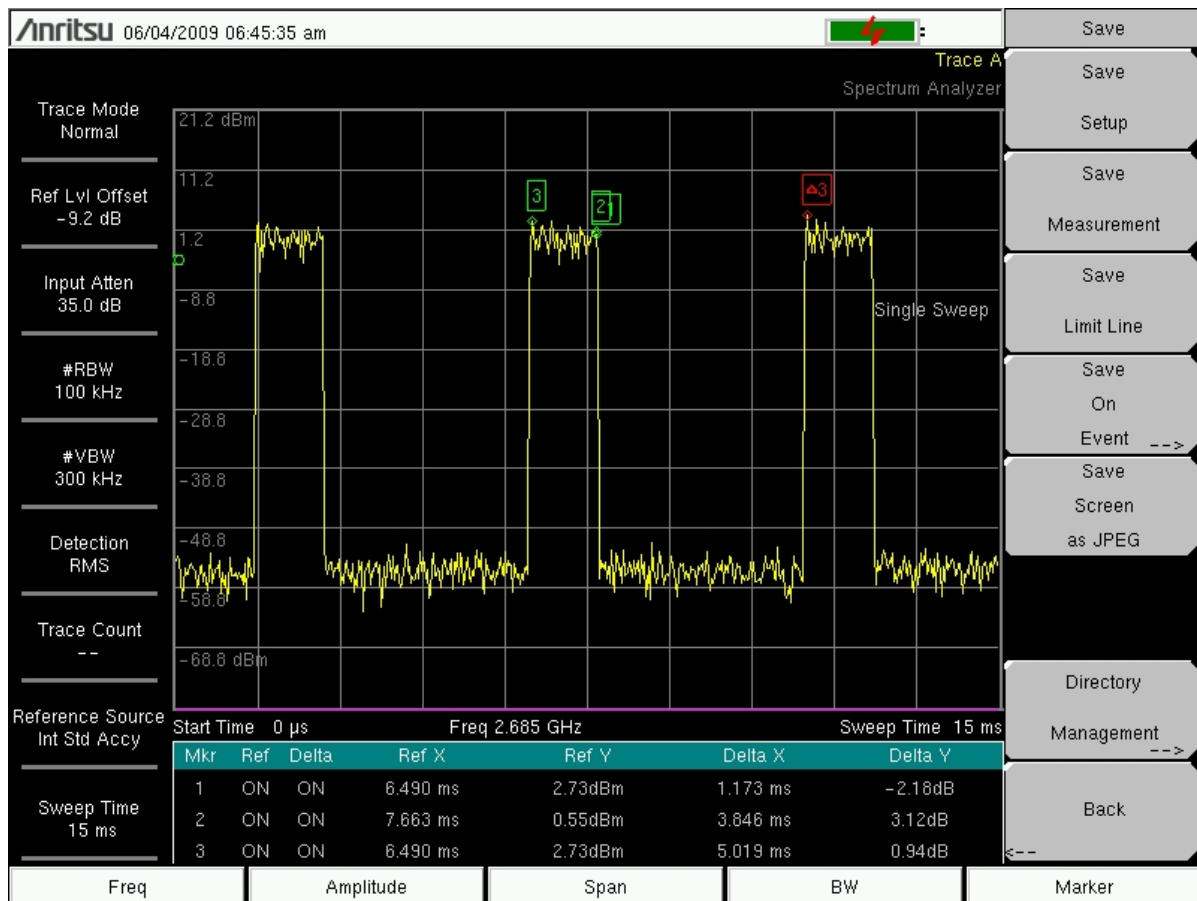

Duty Factor Measurement DQ4_12_UQ16_12_10M



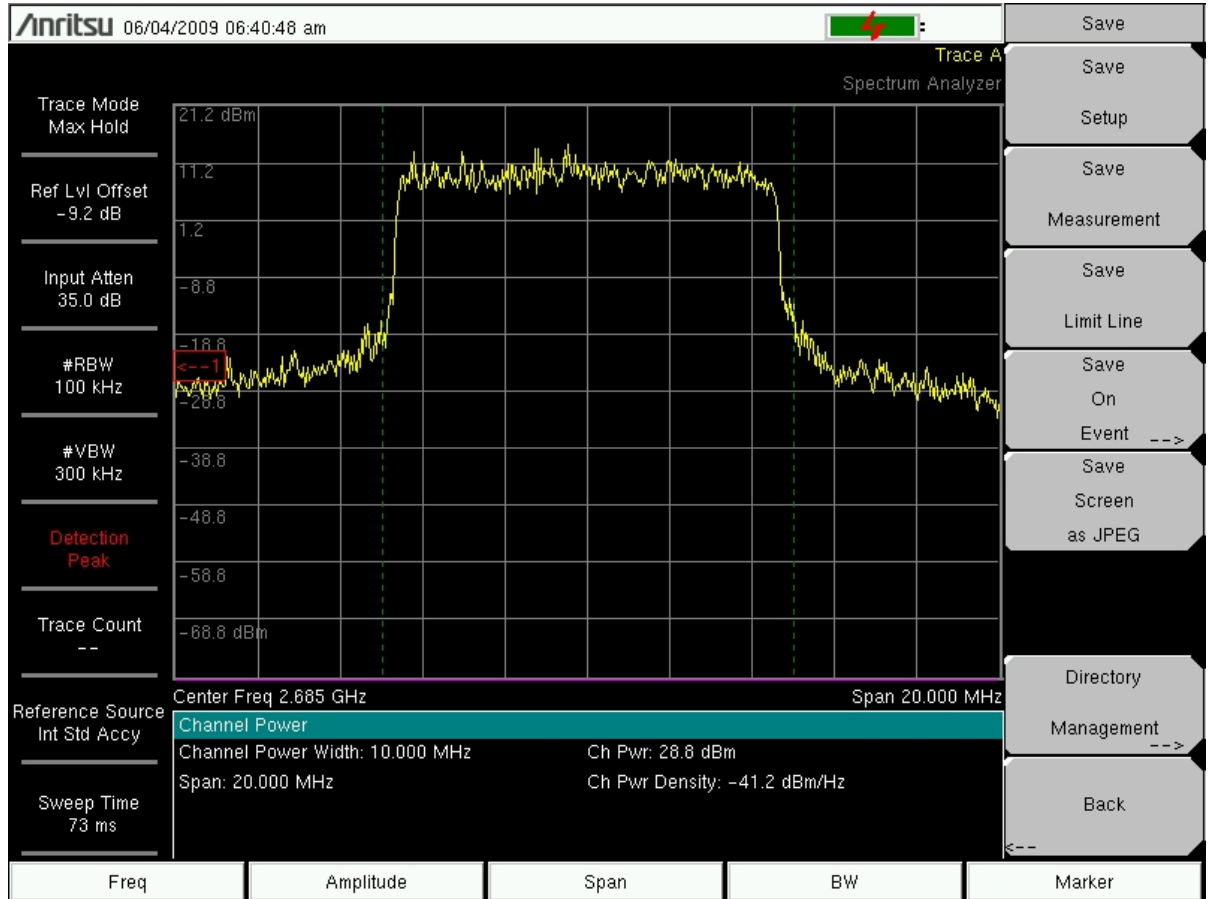

Peak Power Measurement DQ4_12_UQ16_12_10M



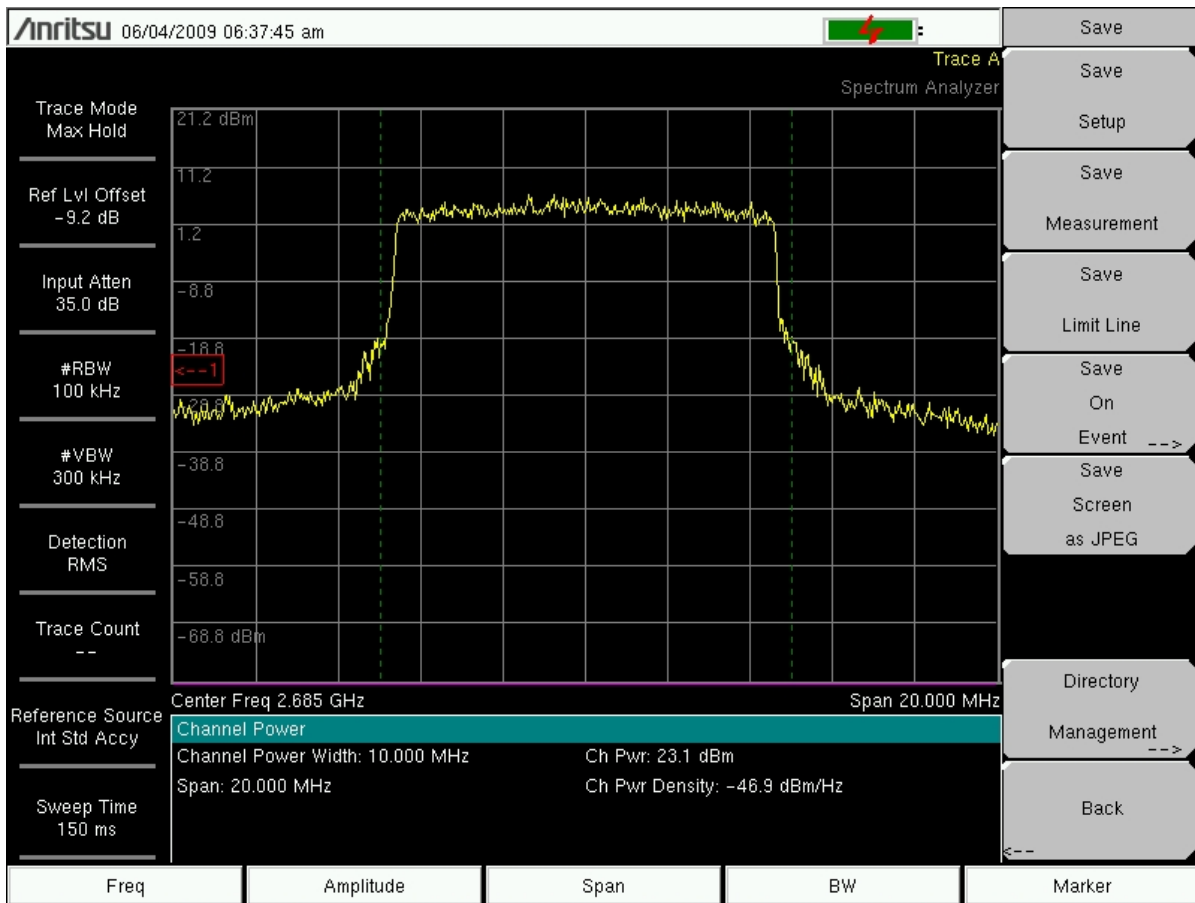

Average Power Measurement DQ4_12_UQ16_12_10M



1.6 WiMAX Power Measurements

Mode	Channel Band-Width (MHz)	Channel Number	R(MHz)	Conducted Power (dBm)		Peak to Average Ratio	Duty Cycle %	Target Ave Power
				Peak	Average			
16QAM	10	0	2501	28.2	22.8	5.4	24	22.80
		386	2593	28.4	23.0	5.4		22.95
		736	2685	28.1	23.1	5.0		23.10

Mode	Channel Band-Width (MHz)	Channel Number	R(MHz)	Conducted Power (dBm)		Peak to Average Ratio	Duty Cycle %	Target Ave Power
				Peak	Average			
QPSK (4QAM)	10	0	2501	28.6	22.6	6.0	42	22.58
		386	2593	28.9	22.7	6.2		22.69
		736	2685	28.7	23.0	5.7		22.94

Mode	Channel Band-Width (MHz)	Channel Number	R(MHz)	Conducted Power (dBm)		Peak to Average Ratio	Duty Cycle %	Target Ave Power
				Peak	Average			
16QAM	5	0	2498.5	29.6	23.7	5.9	34	23.71
		378	2593.0	29.8	24.1	5.7		24.05
		756	2687.5	29.8	24.0	5.8		24.02

Mode	Channel Band-Width (MHz)	Channel Number	R(MHz)	Conducted Power (dBm)		Peak to Average Ratio	Duty Cycle %	Target Ave Power
				Peak	Average			
QPSK (4QAM)	5	0	2498.5	29.1	23.7	5.4	36	23.68
		378	2593.0	29.3	24.1	5.2		24.05
		756	2687.5	29.7	23.9	5.8		23.94



1.7 Duty Factor Power Scaling

SAR evaluations were performed by using test vector waveform file loaded in the Vector Signal Generator.

For 10MHz bandwidth, test vector waveform file with 12 UL symbol and control symbols not allocated nor active, each burst contains 12 traffic symbols. For an in-network / end-user DL:UL symbol ratio of 29:18, the duty factor scaling formula is:

$$\{(ctrl_symb_power \times 3 + traffic_symb_max_power \times 15) / (actual_power \times 12)\}$$

The control channels may occupy up to 5 slots during normal operation. A slot is a sub-channel with the duration of 3 symbols. There are a total of 35 slots in the 10MHz channel configuration.

**

The actual highest measured output power is 23.0dBm/200mW for 10MHz BW/QPSK @ 2685MHz. Control Symbol power is calculated as: $200 \times 5/35 = 28.57\text{mW}$. 23.0dBm is the highest output power for 10MHz BW/QPSK modulation.

Since the control symbols are not allocated nor active, the measured burst power is equal to traffic symbol power = 200mW.
 $(28.57\text{mW} \times 3 + 200 \times 15) / (200\text{mW} \times 21) = 0.734$ (duty factor scaling factor for 10MHz BW/QPSK @ 2593MHz).

**

The actual highest measured power is 23.1dBm/204.2mW for 10MHz BW/16QAM @ 2685MHz
 The highest output power for 10MHz BW/16QAM is 23.1dBm/204.2mW which will be used as traffic symbol maximum power.
 Control Symbol power is calculated as: $204.2 \times 5/35 = 29.17\text{mW}$.

Since the control symbols are not allocated nor active, the measured burst power is equal to the maximum traffic symbol power = 204.2mW
 $(29.17\text{mW} \times 3 + 204.2\text{mW} \times 15) / (204.2\text{mW} \times 12) = 1.286$ (duty factor scaling factor for 10MHz BW/16QAM @ 2685MHz).

For 5MHz bandwidth, test vector waveform file with 18 UL symbol and control symbols not allocated nor active, each burst contains 18 traffic symbols. For an in-network / end-user DL:UL symbol ratio of 29:18, the duty factor scaling formula is:

$$\{(ctrl_symb_power \times 3 + traffic_symb_max_power \times 15) / (actual_power \times 18)\}$$

The control channels may occupy up to 5 slots during normal operation. A slot is a sub-channel with the duration of 3 symbols. There are a total of 17 slots in the 5MHz channel configuration.

**

The actual highest measured output power is 24.1dBm/257mW for 5MHz BW/QPSK @ 2593MHz.
 The maximum measured output power for 5MHz BW/QPSK is 24.1dBm/257mW which is used as traffic symbol maximum power.

Control Symbol power is calculated as: $257 \times 5/17 = 75.6\text{mW}$.

Since the control symbols are not allocated nor active, the measured burst power is equal to traffic symbol power = 257mW.

$$(75.6\text{mW} \times 3 + 257\text{mW} \times 15) / (257\text{mW} \times 18) = 0.88 \text{ (duty factor scaling factor for 5MHz BW/QPSK @ 2593MHz).}$$

**

The actual lowest measured output power is 24.1dBm/257mW for 5MHz BW/16QAM @ 2593MHz. The highest measured output power for 5MHz BW/16QAM is 24.1dBm/257mW which is used as traffic symbol maximum power.

Control Symbol power is calculated as: $257 \times 5/17 = 75.6\text{mW}$.

Since the control symbols are not allocated nor active, the measured burst power is equal to traffic symbol power = 257mW.

$$(75.6\text{mW} \times 3 + 257\text{mW} \times 15) / (257\text{mW} \times 18) = 0.88 \text{ (duty factor scaling factor for 5MHz BW/16QAM @ 2593MHz).}$$

**

The measured SAR must be scaled to the 29:18 in network / end-user DL:UL ratio.

**

Duty Factor and Crest Factor: Since control symbols are not allocated nor active in the SAR measurement. All UL symbols are counted. A duty factor = (number of uplink symbols x 102.857us)/5000us. Crest Factor = 1/(duty factor) for this periodic pulse signal device.

Test Vector File Name	BW	DL/UL Symbols	UL duty Cycle Measure d	Actual Power(mW)- Maximum power is used among L/M/H	Duty Cycle Compensation Factor
DQ4_12_UQ16_12_10 M	10MHz	35/12	23.3%	204.2	1.286
DQ64_UQ4_12_21s_10 M	10 MHz	26/21	42%	200 mW	0.734
DQ4_12_UQ16_34_5M	5 MHz	29/18	36.7%	257 mW	0.88
DQ64_56_UQ4_12_5M	5 MHz	29/18	36.7%	257 mW	0.88



2.0 Applicable Documents

ANSI/IEEE C95.1-1999, IEEE Standard for Safety Levels with Respect to Human Exposure to Radio Frequency Electromagnetic Fields, 3 kHz to 300 GHz.

ANSI/IEEE C95.3-1992, IEEE Recommended Practice for the Measurement of Potentially Hazardous Electromagnetic Fields – RF and Microwave.

OET Bulletin 65 (Edition 97-01) Supplement C (Edition 01-01), “Evaluating Compliance with FCC Guidelines for Human Exposure to Radio Frequency Electromagnetic Fields”.

OET Laboratory Division FCC (December 2007) SAR Evaluation Considerations for Laptop Computers with Antennas Built –in on Display Screens

OET Laboratory Division FCC (May 2007 Revised) SAR Measurement Procedures for 802.11abg Transmitters

OET Laboratory Division FCC (October 2006) SAR Measurement Procedures for 3-6GHz

IEEE 1528b “Recommended Practice for Determining the Peak Spatial Average Specific Absorption Rate (SAR) in the Human Body Due to Wireless Communication Devices: Experimental Techniques.”

ICNIRP Guidelines “GUIDELINES FOR LIMITING EXPOSURE TO TIME-VARYING ELECTRIC, MAGNETIC, AND ELECTROMAGNETIC FIELDS (UP TO 300 GHz)”

IEC-62209 “Human exposure to radio frequency fields from hand-held and body-mounted wireless communication devices – Human models, instrumentation, and procedures”
 Part 1: “Procedure to determine the Specific Absorption Rate (SAR) for hand-held devices used in close proximity of the ear (frequency range of 300 MHz to 3 GHz)”

IEC-62209 “Human exposure to radio frequency fields from hand-held and body-mounted wireless communication devices – Human models, instrumentation, and procedures”
 Part 2 *Draft*: “Procedure to determine the Specific Absorption Rate (SAR) for hand-held devices used in close proximity of the ear (frequency range of 30 MHz to 6 GHz)”

OET Laboratory Division FCC Mobile and Portable Device RF Exposure Equipment Authorization Procedures KDB -447498

OET Laboratory Division FCC Permit But Ask Procedure KDB-388624

3.0 ALSAS-10U System Description

APREL Laboratories ALSAS-10-U (APREL Laboratories SAR Assessment System) is fully optimized for the dosimetric evaluation of a broad range of wireless transceivers and antennas. It is an easy-to-use development and compliance tool, which provides excellent application flexibility. Developed in line with the latest methodologies it is fully compliant with the technical and scientific requirements of IEEE 1528, IEC 62212, CENELEC, ARIB, ACA, and the Federal Communications Commission. The system comprises of a six axes articulated robot which utilizes a dedicated controller.

ALSAS-10U has been developed with a strong engineering focus, and with custom modular software/hardware for the broadest range of applications, including dosimetry research and measurements in various Phantoms – SAM Phantom, UniPhantom™ Universal Phantom, Universal Flat Phantom and others.

Free space E-Field measurements of mobile devices and base station antennas can also be executed using ALSAS. With the current ALSAS configuration, several phantoms and setups can be arranged around the system – and since the phantoms are designed to be light and easy to move for interchanging between test frequencies.

ALSAS-10U has been developed using the latest methodologies and FDTD modeling to provide a platform which is repeatable with minimum uncertainty.

The ongoing commitment from APREL Laboratories to the field of Dosimetric research and development will ensure that the ALSAS-10-U measurement system can easily be upgraded to accommodate changes to wireless technologies, and scientific methodologies.



3.1 Applications

Predefined measurement procedures compliant with the guidelines of CENELEC, IEEE, IEC, FCC, etc are utilized during the assessment for the device. Automatic detection for all SAR maxima are embedded within the core architecture for the system, ensuring that peak locations used for centering the zoom scan are within a 1mm resolution and a 0.05mm repeatable position. A little less than 10 min per device position measurement completion time, (depending of DUT size) ensures minimum power drift during the assessment. No user interaction is required during the measurement processes: area scan, evaluation of cube maximal search, fine cube measurements and device power drift measurement. System operation range currently available up-to 6 GHz in simulated tissue.

ALSAS-10U can be used for all analog and digital devices, including wideband, spread spectrum and pulsed systems, etc.: handsets, handhelds, wireless data, electronic article surveillance, accessories, wireless access points, WLAN, cordless, radio, etc.

3.2 Visualization and reporting

2/3D isoline distribution, scatter graphics, polar graphics, and vector reproduction. Device representation and phantom visualization in 2/3D graphics with measurement data overlaid (in color plot format). Freely configurable output graphic formats with automatic title, data and legend generation which includes all relevant information relating to the measurement process. Uncertainty analysis and budget calculated and reported drawing on active device drift assessment, and tissue simulation values.

3.3 Field scans

ALSAS-10U can provide multiple scan types including Measurements along lines (X, Y, Z), multiple planes, curved surfaces (normalize probe to surface), volumes in free space or restricted volumes (phantoms). Cube measurements with surface extrapolation and spatial SAR evaluation for 1g and/or 10g. Time measurements (source power drift). Probe rotation measurements (isotropy) and many others in line with the requirements of any given standard or procedure.

3.3.1 Area Scans

Area scans are defined prior to the measurement process being executed with a user defined variable spacing between each measurement point (integral) allowing low uncertainty measurements to be conducted. Scans defined for FCC applications utilize a 10mm² step integral, with 1mm interpolation used to locate the peak SAR area used for zoom scan assessments.

A maximum area scan size is set at 280mm x 200mm which can be changed to a smaller size dependent on the filed distribution of the device under test. The area scan size is documented within the SAR report which is delivered by the SAR system software.

Where the system identifies multiple SAR peaks (which are within 2dB of each peak value) the system will provide the user with the option of assessing each peak location individually for zoom scan averaging.

3.3.2 Zoom Scan (Cube Scan Averaging)

The averaging zoom scan volume utilized in the ALSAS-10U software is in the shape of a cube and the side dimension of a 1 g or 10 g mass is dependent on the density of the liquid representing the simulated tissue. A density of 1 000 kg/m³ is used to represent the head and body tissue density and not the phantom liquid density, in order to be consistent with the definition of the liquid dielectric properties, i.e. the side length of the 1 g cube is 10mm, with the side length of the 10 g cube 21,5mm.

When the cube intersects with the surface of the phantom, it is oriented so that 3 vertices touch the surface of the shell or the centre of a face is tangent to the surface. The face of the cube closest to the surface is modified in order to conform to the tangent surface. The centre of the cube and the tangential angle associated defines each face of the cube so that all transitional points follow this tangential angle.

The zoom scan integer steps can be user defined so as to reduce uncertainty, but normal practice for typical test applications (including FCC) utilize a physical step of 5x5x9 (8mmx8mmx4mm Fx <3GHz) and 9x9x17 (4mmx4mmx2mm Fx >3GHz) providing a volume of 32mm in the X & Y axis, and 32mm in the Z axis. All points remain tangential to the surface by utilizing the normalize (probe tilt) feature so as to reduce measurement uncertainty.

3.4 Operator settings

Multiple access levels (password protected) for parametric modifications/test scenarios in line with selected standards, including the FCC. Any number of predefined settings (probes, phantoms, liquids, devices, measurement procedures, etc.) can be stored for future use and repeatable assessments.

3.5 ALSAS-10U Interpolation and Extrapolation Uncertainty

The overall uncertainty for the methodology and algorithms that are used during the SAR calculation was evaluated using the data from IEEE 1528 based on the example f3 algorithm:

$$f_3(x, y, z) = A \frac{a^2}{\frac{a^2}{4} + x'^2 + y'^2} \cdot \left(e^{-\frac{2z}{a}} + \frac{a^2}{2(a + 2z)^2} \right)$$

4.0 ALSAS-10U Hardware

The ALSAS-10U comprises of hardware designed exclusively by APREL Laboratories based on methodologies presented in IEEE 1528, IEC 62212, CENELEC and FCC supplement C OET bulletin 65.

4.1 Isotropic E-Field Probe

The isotropic E-Field probe used by APREL Laboratories, has been fully calibrated and assessed for isotropicity, and boundary effect within a controlled environment. Depending on the frequency for which the probe is calibrated the method utilized for calibration will change. APREL Laboratories utilize a number of methods for calibrating probes, and these are outlined in the table below.

Calibration Frequency (MHz)	Air Calibration	Tissue Calibration
300	TEM Cell	Temperature
450	TEM Cell	Temperature
835	TEM Cell	Temperature
900	TEM Cell	Temperature
1800	TEM Cell	Temperature
1900	TEM Cell	Temperature
2450	Waveguide	Waveguide
5200	Waveguide	Waveguide
5600	Waveguide	Waveguide
5800	Waveguide	Waveguide

The APREL Laboratories E-Field probe utilizes a triangular sensor arrangement as detailed in the diagram below.



SAR is assessed with a calibrated probe which moves at a default height of 1.4mm from the centre of the diode, which is mounted to the sensor, to the phantom surface (in the Z Axis). The 1.4mm offset height has been selected so as to minimize any resultant boundary effect due to the probe being in close proximity to the phantom surface.

The following algorithm is an example of the function used by the system for linearization of the output from the probe when measuring complex modulation schemes.

$$V_i = U_i + U_i^2 \cdot \frac{cf}{dcp_i}$$



4.2 Isotropic E-Field Probe Specification

Calibration in Air	Frequency Dependent Below 2GHz Calibration in air performed in a TEM Cell Above 2GHz Calibration in air performed in waveguide
Sensitivity	0.60 $\mu\text{V}/(\text{V}/\text{m})^2$ to 1.25 $\mu\text{V}/(\text{V}/\text{m})^2$
Dynamic Range	0.01 W/kg to 100 W/kg
Isotropic Response	Better than 0.2dB in air Better than 0.05dB in tissue
Diode Compression Point (DCP)	Calibrated for Specific Frequency typically 95mV +/- 10%
Probe Tip Radius	<2.9mm
Sensor Offset	1.06 (+/-0.02mm)
Probe Length	290mm
Video Bandwidth	@ 500 Hz: 1 dB @ 1.02 KHz: 3 dB
Boundary Effect	Less than 2% for distances greater than 1.4mm
Spatial Resolution	Better than 1mm
Probe Diameter	Less than 2.8mm

4.3 Probe Calibration

For the purpose of WiMAX testing a separate probe calibration routine is ran where the probe is calibration using a 20MHz signal modulated to 25/40%. The results from this calibration are then compared against predicted data with respect to multiple duty cycles and the uncertainty is calculated to be less than 9% throughout the band with the maximum 40% duty cycle. The figure bellows shows the expected SAR trend for the probe when calibrated following the advanced WiMAX routine.

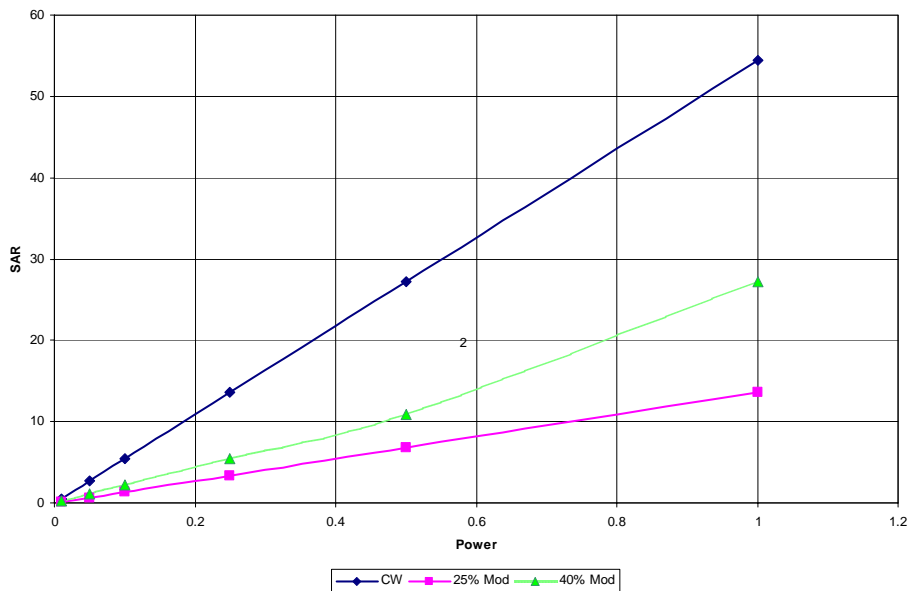

Calculated Probe Output



4.3 Boundary Detection Unit and Probe Mounting Device

ALSAS-10U incorporates a boundary detection unit with a sensitivity of 0.05mm for detecting all types of surfaces. The robust design allows for detection during probe tilt (probe normalize) exercises, and utilizes a second stage emergency stop. The signal electronics are fed directly into the robot controller for high accuracy surface detection in lateral and axial detection modes (X, Y, & Z).

The probe is mounted directly onto the Boundary Detection unit for accurate tooling and displacement calculations controlled by the robot kinematics. The probe is connect to an isolated probe interconnect where the output stage of the probe is fed directly into the amplifier stage of the Daq-Paq.

4.4 Daq-Paq (Analog to Digital Electronics)

ALSAS-10U incorporates a fully calibrated Daq-Paq (analog to digital conversion system) which has a 4 channel input stage, sent into an amplifier module. The input signal is amplified accordingly so as to offer a dynamic range from 5µV to 800mV. Integration of the fields measured is carried out at board level utilizing a Co-Processor which then sends the measured fields down into the main computational module in digitized form via an RS232 communications port. Probe linearization and duty cycle compensation is carried out within the main Daq-Paq module.

ADC	16 Bit
Amplifier Range	30 µV to +200 mV (16 bit resolution: 4µV, 400mV)
Field Integration	Local Co-Processor utilizing proprietary integration algorithms
Number of Input Channels	4 in total 3 dedicated and 1 spare
Communication	Packet data via RS232



4.5 Axis Articulated Robot



ALSAS-10U utilizes a six axis articulated robot, which is controlled using a Pentium based real-time movement controller. The movement kinematics engine utilizes proprietary (Thermo CRS) interpolation and extrapolation algorithms, which allow full freedom of movement for each of the six joints within the working envelope. Utilization of joint 6 allows for full probe rotation with a tolerance better than 0.05mm around the central axis.

Robot/Controller Manufacturer	Thermo CRS
Number of Axis	Six independently controlled axis
Positioning Repeatability	0.05mm
Controller Type	Single phase Pentium based C500C
Robot Reach	710mm
Communication	RS232 and LAN compatible

4.6 ALSAS Universal Workstation

ALSAS Universal workstation was developed with a strong engineering focus taking into consideration flexibility and engineering needs, and the necessity to have integrated system which will allow for repeatability and fast adaptability. ALSAS workstation technology is stable and robust in structure, but at the same time flexible so that users can do calibration, testing and measurements using different types of phantoms with one set up, which significantly speeds up the measurement process.

The workstation incorporates a modular structure which can be easily adapted to specific engineering requirements and needs. Phantoms which are self contained modular units are easily located, removable and swappable. Three fully configurable shelves allow for setting up of a test device in a way which can either utilize the APREL Laboratories device positioner, or custom designed units. When using the modular shelf for positioning of a device, additional loading characteristics have been avoided.

The workstation has been constructed entirely out of composite wood and Canadian maple, with all metallic fasteners kept at a compliant distance from the Device under test.



4.7 Universal Device Positioner



The APREL Laboratories universal device positioner has been developed so as to allow complete freedom of movement of the DUT. Developed to hold a DUT in a free-space scenario any additional loading attributable to the material used in the construction of the positioner has been eliminated. Repeatability has been enhanced through the linear scales which form the design used to indicate positioning for any given test scenario in all major axes. A 15° tilt indicator has been included for the of aid cheek to tilt movements for head SAR analysis. Overall uncertainty for measurements have been reduced due to the design of the Universal device positioner, which allows positioning of a device in as near to a free-space scenario as possible, and by providing the means for complete repeatability.



Length	201mm
Width	140mm
Height	222mm
Weight	1.95kg
Number of Axis	6 axis freedom of movement
Translation Along MB Line	+/- 76.2mm
Translation Along NF Line	+/- 38.1mm
Translation Along Z Axis	+/- 25.4mm (expandable to 500mm)
Rotation Around MB Line (yaw)	+/- 10°
Rotation Around NF Line (pitch)	+/- 30°
Rotation Around Z Axis (roll)	360° full circle
Minimum Grip Range	0mm
Maximum Grip	152mm
Maximum Distance from Device to Positioner Material	40mm
Tilt Movement	Full movement with predefined 15° guide

4.8 Phantom Types

The ALSAS-10U has been designed so as to allow the integration of multiple phantom types. This includes but is not limited to the APREL Laboratories SAM Phantoms fully compliant with IEEE 1528, Universal Phantom, and Universal Flat.

4.8.1 APREL SAM Phantoms

The APREL Laboratories SAM phantoms have been designed so as to aid repeatability and positioning for any DUT. Developed using the IEEE SAM CAD file they are fully compliant with the requirements for both IEEE 1528 and FCC Supplement C. Both the left and right SAM phantoms are interchangeable, transparent and include the IEEE 1528 grid with visible NF and MB lines.

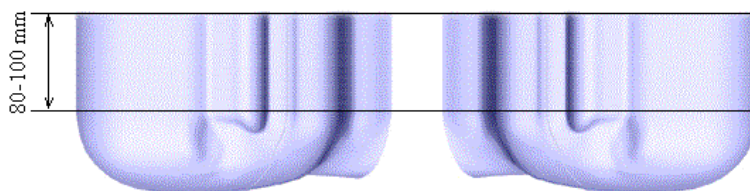

Compliant Standards	IEEE-1528, IEC 62212, CENELEC, and others
Manufacturing Process	Injection molded
Material	Composite urethane
Manufacturing Tolerance	+/- 0.2mm
Frame Material	Corian
Tissue Simulation Volume	7 ltr with 15cm tissue
Thickness	2mm nominally 6mm at NF/MB intersection
Loss Tangent	<0.05
Relative Permittivity	<5
Resistant to Solvents	Resistant to all solvents detailed in IEEE 1528
Load Deflection	<1mm with sugar water compositions

4.8.2 APREL Laboratories Universal Phantom



The APREL Laboratories Universal Phantom has been developed as an engineering tool for both compliance and development. It is also used on the ALSAS-10U as a system validation phantom. The unique design allows repeatable measurements for all devices, including handsets, PDA units, laptop computers, and validation dipoles. The APREL Laboratories Universal Phantom has been fully validated both experimentally from 800MHz to 6GHz and numerically using XFDTD numerical software. The shell thickness is 2mm overall, with a 4mm spacer located at the NF/MB intersection providing an overall thickness of 6mm in line with the requirements of IEEE-1528. The design allows for fast and accurate measurements, of handsets, by allowing the conservative SAR to be evaluated at on frequency for

both left and right head experiments in one measurement. The phantom is surrounded by a Corian frame, which adds additional support and load bearing characteristics.

Compliant Standards	IEEE-1528, IEC 62212, CENELEC, and others
Frequency Range	800MHz to 6GHz
Material	Vivac
Manufacturing Tolerance	+/- 0.2mm
Frame Material	Corian
Tissue Simulation Volume	8 ltr with 15cm tissue
Thickness	2mm nominally 6mm at NF/MB intersection
Loss Tangent	<0.05
Relative Permittivity	<5
Resistant to Solvents	Resistant to all solvents detailed in IEEE 1528
Load Deflection	<1% Length with sugar water compositions
Dimensions	Length 220mm x breadth 170mm

4.9 Validation Dipoles

APREL Laboratories utilize dipoles based on the IEEE-1528 standard, and have ensured that they comply with mechanical and electrical specifications in line with the requirements of both IEEE and FCC Supplement C. The table below provides details for the mechanical and electrical specifications for the dipoles used by APREL Laboratories.

Body validation target numbers have been derived using XFDTD numerical software, and validated experimentally.

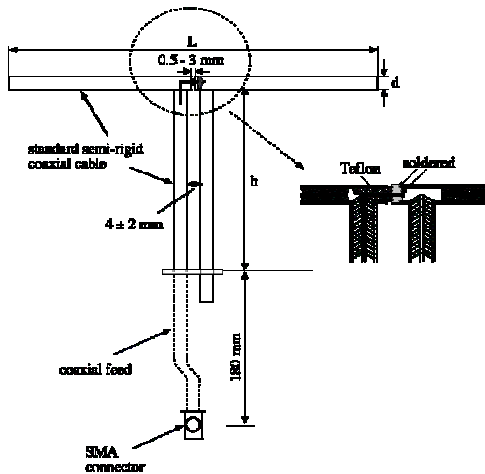

APREL Laboratories have developed high frequency dipoles based on current scientific research carried both experimentally and numerically here at the APREL Laboratories site. Mechanical and electrical parameters for the dipoles have been established using experimental and numerical techniques, and target SAR values have been established following IEC methodologies. The results of the experimental and numerical research have been published and released for peer review.

Frequency (MHz)	L (mm)	h (mm)	d (mm)
300	396.0	250.0	6.0
450	270.0	166.7	6.0
835	161.0	89.8	3.6
900	149.0	83.3	3.6
1450	89.1	51.7	3.6
1800	72.0	41.7	3.6
1900	68.0	39.5	3.6
2000	64.5	37.5	3.6
2450	51.5	30.4	3.6
2600	49.0	30	3.6
3000	41.5	25.0	3.6
5200	23.6	14	3.6
5800	21.6	13	3.6
5190-5900	23.1	20.7	3.6

5.0 Tissue Simulation Fluid

Tissue simulation fluids in the frequency range of 450MHz to 2450MHz are based on IEEE-1528 and FCC Supplement C guidelines. All fluids meet the dielectric specifications as outlined in the above standards (within allowable tolerances) and are calibrated on a regular basis, to maintain stability. The recipes used along with the dielectric target values are included in the table below.

Ingredients (% Weight)	450 MHz Head	835 MHz Head	915 MHz Head	1900 MHz Head	2450 MHz Head
Water	38.56	41.45	41.05	54.9	62.7
Salt	3.95	1.45	1.35	0.18	0.5
Sugar	56.32	56.0	56.5	x	x
HEC	0.98	1.0	1.0	x	x
Bactericide	0.19	0.1	0.1	0.1	X
Triton-X	X	X	X	X	36.8
DGBE	X	X	X	44.92	x
ϵ^r	43.42	42.54	42.0	39.9	39.8
δ	0.85	0.91	1.0	1.42	1.88

Ingredients (% Weight)	450 MHz Body	835 MHz Body	915 MHz Body	1900 MHz Body	2450 MHz Body
Water	51.16	52.4	56.0	40.4	73.2
Salt	1.49	1.4	0.76	0.5	0.04
Sugar	46.78	45.0	41.76	58.0	X
HEC	0.52	1.0	1.21	1.0	X
Bactericide	0.05	0.1	0.27	0.1	X
Triton-X	X	X	X	X	X
DGBE	X	X	X	X	26.7
ϵ^r	58.0	56.1	56.8	54.0	52.5
δ	0.83	0.95	1.07	1.45	1.95

NOTE. Recipes are based on those presented in FCC Supplement C Page 36.

For frequencies above 2450MHz recipes will be presented as and when requested by a designated body.

Ingredients (% Weight)	2600 MHz Body	5200 MHz Body	5600 MHz Body	5800 MHz Body
Water	69.6	x	x	x
Salt	0.03	x	x	x
Sugar	X	x	x	x
HEC	X	x	x	x
Bactericide	X	x	x	x
Triton-X	X	x	x	x
DGBE	30.37	x	x	x
ϵ^r	52.4	48.9	47.6	48.2
δ	2.15	5.35	5.8	6.00



5.1 Tissue Calibration Procedure Using a Coaxial Probe

The VNA (Vector Network Analyzer) is configured and calibrated for the frequency of the simulated tissue which has to be assessed. The Coaxial probe is then calibrated in line with the tissue frequency using an open, short, and De-Ionized water routine. The sample of simulated tissue is placed into a non-metallic container for use during the calibration. The temperature of the simulated tissue sample is measured. The probe head is then completely immersed in the simulated tissue sample (the probe is held in place using a non metallic probe holder). The simulated tissue sample is then measured to assess the permittivity and conductivity.

5.2 Tissue Calibration Results

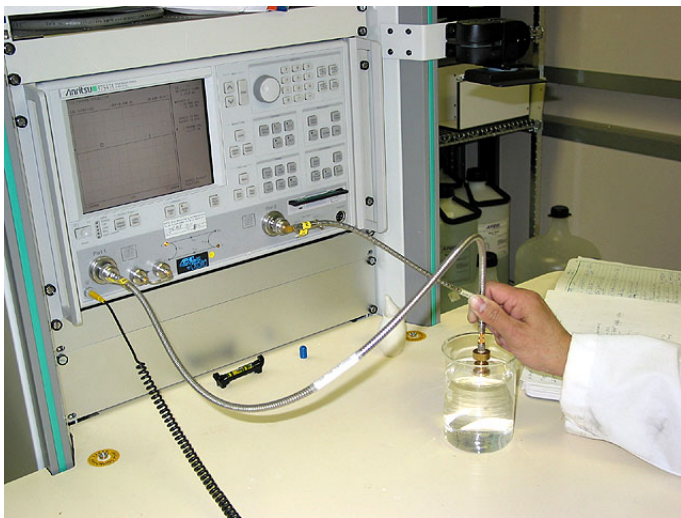

Tissue used during the SAR assessment is calibrated prior to use in the measurement process. APREL Laboratories use the co-axial probe method for all tissue calibration exercises. Tissue which is being used over a period of 24 hours is re-calibrated to ensure that no change to the dielectric properties will affect the SAR measurement process. The table below provides details of the results from the tissue equivalent dielectric calibration. This project was conducted over a period of 6 days and the tissues were calibrated daily to ensure that they met the values presented below.

Calibrated By	Calibration Date	Frequency MHz	Tissue Type	Epsilon (ϵ')	Sigma (δ)
Maryna. N	Daily	2450	Body	50.53	2.02
Maryna. N	Daily	2600	Body	51.41	2.23
Maryna. N	Daily	5200	Body	47.24	5.16
Maryna. N	Daily	5600	Body	46.58	5.66
Maryna. N	Daily	5800	Body	46.08	5.97

Variation of the tissue was maintained daily to be less than 2%.

6.0 System Validation

ALSAS-10U is fully validated prior to the SAR assessment of the DUT following methodologies presented in IEEE-1528 section 8. The system is validated using tissue which has been calibrated within a 24 hour period. When the measurement process exceeds a 24 hour period a secondary system validation is executed and the results presented within this test report. The graphic plots resulting from the system validation are included in Appendix A SAR plots.

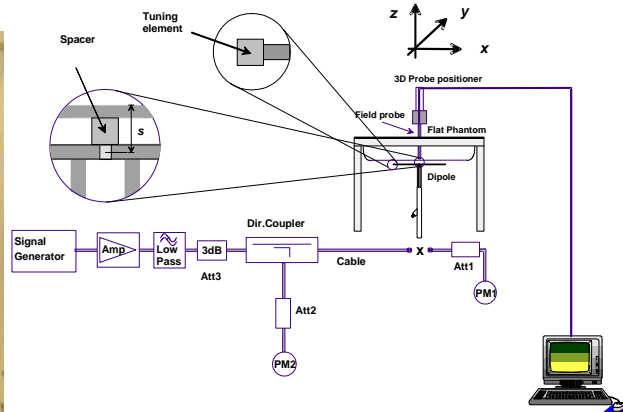

Date	Validation Frequency (MHZ)	Dipole Separation Distance mm	Power W	Dipole	SAR 1g W/kg	Target 1g W/kg
Daily	2450	10	1.0	AL-CD10	53.4	52.9
Daily	2600	10	1.0	ALS-WiMAX	56.2	54.4
Daily	5200	10	1.0	Broad-band	52.4	51.8
Daily	5600	10	1.0	Broad-band	51.3	52.1
Daily	5800	10	1.0	Broad-band	47.5	49.1

Currently no standards are in place for validating a system while using body tissue. System validation and values are based on current guidance coming from the FCC and utilize the APREL Laboratories dipoles for frequencies above 5GHz. This project was conducted over a period of 6 working days and when necessary system validations were repeated when the test completion was greater than a 24 hour period. Where the system validation was greater than 2% from those presented above the tissue was then reassessed and brought back to within 2% of initial dielectric values to show consistency throughout the measurement cycle.

6.1 WiMAX System Validation

Additional validation procedures were made to determine the linearity of the test setup and to ensure that the probe and electronics were functioning correctly.

The values presented below relate to the deviation from the standard CW validation target numbers along with deviations from predicted values when the signal is modulated with the appropriate square waveform.

Frequency	Separation	Power	Measured	Target
2600	10	1.0	56.2	54.4

All measurements were taken at 2600MHz

Measured with dipole and CW signal

100 mW	3.3%
200 mW	3.5%
500 mW	3.6%

Measured with dipole and 25% signal of 20MHz channel

100 mW	5.5%
200 mW	6%
500 mW	6.1%

Measured with dipole and 40% signal of 20MHz channel

100 mW	7.15%
200 mW	7.8%
500 mW	7.93%

Additional validation methods and linearity assessment are presented in the approved PbA.

6.1 Experimental Results Summary

The results for each experimental assessment are contained within this section. Where any deviation has been made from the given procedures contained within IEEE-1528 or FCC Supplement C this has been described accordingly.

6.2 SAR Measurement Procedure

The ALSAS-10U calculates SAR using the following equation,

$$SAR = \frac{\sigma |E|^2}{\rho}$$

σ : represents the simulated tissue conductivity
 ρ : represents the tissue density

The DUT is set to transmit at the required power in line with product specification, at each frequency relating to the LOW, MID, and HIGH channel settings.

Pre-scans are made on the device to establish the location for the transmitting antenna, using a large area scan in either air or tissue simulation fluid.

The DUT is placed against the Universal Phantom where the maximum area scan dimensions are larger than the physical size of the resonating antenna. When the scan size is not large enough to cover the peak SAR distribution, it is modified by either extending the area scan size in both the X and Y directions, or the device is shifted within the predefined area.

The area scan is then run to establish the peak SAR location (interpolated resolution set at 1mm²) which is then used to orient the center of the zoom scan. The zoom scan is then executed and the 1g and 10g averages are derived from the zoom scan volume (interpolated resolution set at 1mm³).

6.3 SAR Exposure Limits

SAR assessments have been made in line with the requirements of the documents listed in section 2 of this report.

Type of Exposure	Uncontrolled Environment Limit
Spatial Peak SAR (1g cube tissue for brain or body)	1.60 W/kg
Spatial Average SAR (whole body)	0.08 W/kg
Spatial Peak SAR (10g for hands, feet, ankles and wrist)	4.00 W/kg



6.4 Equipment List

APREL Laboratories utilize the following equipment.

Equipment Description	Asset/Serial Number	Calibration Date
ALSAS-10U	301571	Prior to Test and Every 24hrs
Boundary Detection Unit	301572	Calibrated Once
Daq-Paq	301573	January 2009
Pentium 4 Workstation	301574	Not Required
Signal Generator	301468	September 2008
Gigatronics Power Meter	301393	August 2008
Gigatronics Broad Band Power Sensor	301394	August 2008
HP-Directional Coupler	100251	October 2008
APREL Laboratories 800-4200MHz 12W Amplifier	301577	Prior to Test
APREL Laboratories 2450MHz Validation Dipole	301581	November 2008
APREL Laboratories E-030 E-Field Probe	226	May 2008
40MHz -20GHz VNA	301382	August 2008
TRL Calibration Kit	301582	January 2009
APREL Laboratories Coaxial Probe (Dielectric Probe Kit)	100757	Prior to Test
APREL Laboratories Universal Phantom	301511	Calibrated Once
APREL Laboratories SAM Phantom LHS	301500	Calibrated Once
APREL Laboratories SAM Phantom RHS	301501	Calibrated Once
APREL Laboratories 15mm Dipole Separation Kit	301546	Calibrated Once
APREL Laboratories 10mm Dipole Separation Kit	301547	Calibrated Once
APREL Laboratories 5-6GHz 2 W Amplifier	NYA	March 2008
APREL Laboratories MMW Directional Coupler	NYA	March 2008
APREL Laboratories 5240MHz Validation Dipole	301460	March 2008
APREL Laboratories 5800MHz Validation Dipole	PT-015-a	March 2008
ALSAS-10 Device Positioner ALS-H-E-SET-2	ALS-H-E-SET-2-LAB1	Not Required
APREL Laboratories 2600MHz Validation Dipole	ALS-WiMAX-2600	July 12 th 2008
Agilent ESG	100892	September 2008

6.5 SAR Measurement Results

Intel® WiFi-Link 5150 Series Network Connection with Galtronics Antennas **802.11b MODE**



Power	16.64dBm
DUT Position	Underside
Separation	0mm
Antenna Type	IFA
Antenna Manufacturer	Galtronics
Antenna Location	Left Hand Side
Power Mode	Battery
Tx Frequency	2412-2462MHz
Duty Cycle	100%
Epsilon	50.43
Sigma	2.02
Tissue Depth	15cm
Phantom Type	Universal
DUT Workstation Location	Centre
Device Positioner	Not Needed
Test Date	November 2008
Test Engineer	Maryna. N

Maximum Measured SAR NO RSB

Mode	Separation Distance (mm)	Channel	Frequency MHz	1g SAR W/kg
802.11b	0	1	2412	0.018
802.11b	0	6	2437	0.019
802.11b	0	11	2462	0.021

Maximum Measured SAR with RSB

802.11b	0	11	2462	0.014
---------	---	----	------	-------

SAR Limit	Conservative Measured SAR
1.6 W/kg 1 gram Average Maximum	0.021 W/kg 1gram Average

SAR Plot for Conservative SAR Included in Appendix A.

Intel® WiFi-Link 5150 Series Network Connection with Galtronics Antennas **802.11g MODE**



Power	16.5dBm
DUT Position	Underside
Separation	0mm
Antenna Type	IFA
Antenna Manufacturer	Galtronics
Antenna Location	Left Hand Side
Power Mode	Battery
Tx Frequency	2412-2462MHz
Duty Cycle	100%
Epsilon	50.43
Sigma	2.02
Tissue Depth	15cm
Phantom Type	Universal
DUT Workstation Location	Centre
Device Positioner	Not Needed
Test Date	November 2008
Test Engineer	Maryna. N

Maximum Measured SAR NO RSB

Mode	Separation Distance (mm)	Channel	Frequency MHz	1g SAR W/kg
802.11g	0	1	2412	0.013
802.11g	0	6	2437	0.029
802.11g	0	11	2462	0.017

Maximum Measured SAR with RSB

802.11g	0	6	2437	0.009
---------	---	---	------	-------

SAR Limit	Conservative Measured SAR
1.6 W/kg 1 gram Average Maximum	0.029 W/kg 1gram Average

SAR Plot for Conservative SAR Included in Appendix A.



Intel® WiFi-Link 5150 Series Network Connection with Galtronics Antennas **2450n MODE**



Power	16.5dBm
DUT Position	Underside
Separation	0mm
Antenna Type	IFA
Antenna Manufacturer	Galtronics
Antenna Location	Left Hand Side
Power Mode	Battery
Tx Frequency	2412-2462MHz
Duty Cycle	100%
Epsilon	50.43
Sigma	2.02
Tissue Depth	15cm
Phantom Type	Universal
DUT Workstation Location	Centre
Device Positioner	Not Needed
Test Date	November 2008
Test Engineer	Maryna. N

Maximum Measured SAR NO RSB

Mode	Separation Distance (mm)	Channel	Frequency MHz	1g SAR W/kg
802.11n	0	1	2412	0.012
802.11n	0	6	2437	0.019
802.11n	0	11	2462	0.015
802.11n 40MHz	0	6	2437	0.019

Maximum Measured SAR with RSB

802.11n	0	6	2437	0.008
802.11n 40MHz	0	6	2437	0.007

SAR Limit	Conservative Measured SAR
1.6 W/kg 1gram Average Maximum 20MHz	0.0192 W/kg 1gram Average
1.6 W/kg 1gram Average Maximum 40MHz	0.0196 W/kg 1gram Average

SAR Plot for Conservative SAR Included in Appendix A.



Intel® WiFi-Link 5150 Series Network Connection with Galtronics Antennas **WiMAX MODE**

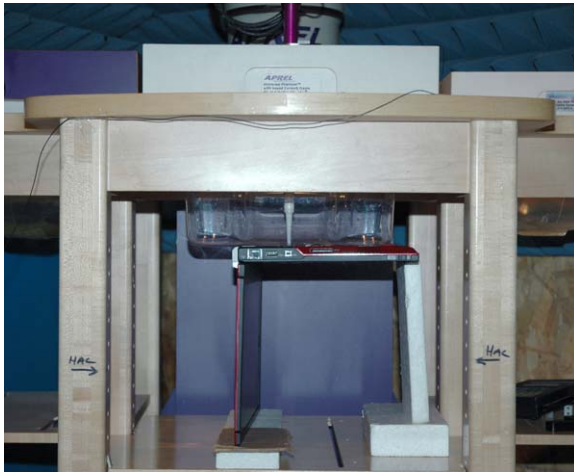

Power	22.6 - 241.1 dBm Average
DUT Position	Underside
Separation	0mm
Antenna Type	IFA
Antenna Manufacturer	Galtronics
Antenna Location	Left Hand Side
Power Mode	Battery
Tx Frequency	2501-22685MHz
Duty Cycle	See Below
Epsilon	51.41
Sigma	2.23
Tissue Depth	15cm
Phantom Type	Universal
DUT Workstation Location	Centre
Device Positioner	Not Needed
Test Date	March/June 2009
Test Engineer	Maryna. N

Mode	Separation Distance (mm)	Channel	Duty Factor %	Frequency MHz	Waveform	1g SAR W/kg	Corrected SAR
WiMAX	0	0	23.3	2501	DQ4_12_UQ16_12_10M	0.102	0.131
WiMAX	0	386	23.3	2593	DQ4_12_UQ16_12_10M	0.097	0.124
WiMAX	0	736	23.3	2685	DQ4_12_UQ16_12_10M	0.117	0.150

Mode	Separation Distance (mm)	Channel	Duty Factor %	Frequency MHz	Waveform	1g SAR W/kg	Corrected SAR
WiMAX	0	0	42	2501	DQ64_UQ4_12_21S_10M	0.017	0.0124
WiMAX	0	386	42	2593	DQ64_UQ4_12_21S_10M	0.014	0.0102
WiMAX	0	736	42	2685	DQ64_UQ4_12_21S_10M	0.021	0.0154

Mode	Separation Distance (mm)	Channel	Duty Factor %	Frequency MHz	Waveform	1g SAR W/kg	Corrected SAR
WiMAX	0	0	36.7	2501	DQ4_12_UQ16_34_5M	0.012	0.0105
WiMAX	0	386	36.7	2593	DQ4_12_UQ16_34_5M	0.017	0.0150
WiMAX	0	736	36.7	2685	DQ4_12_UQ16_34_5M	0.040	0.0352

Mode	Separation Distance (mm)	Channel	Duty Factor %	Frequency MHz	Waveform	1g SAR W/kg	Corrected SAR
WiMAX	0	0	36.7	2501	DQ64_56_UQ4_12_5M	0.018	0.016
WiMAX	0	386	36.7	2593	DQ64_56_UQ4_12_5M	0.017	0.015
WiMAX	0	736	36.7	2685	DQ64_56_UQ4_12_5M	0.031	0.027

SAR Limit	Conservative Measured SAR
1.6 W/kg 1gram Average Maximum 20MHz	0.117 W/kg 1gram Average

ALL Data Measured with NO RSB.

SAR Plot for Conservative SAR Included in Appendix A.



Intel® WiFi-Link 5150 Series Network Connection with Galtronics Antennas **WiMAX MODE with RSB**

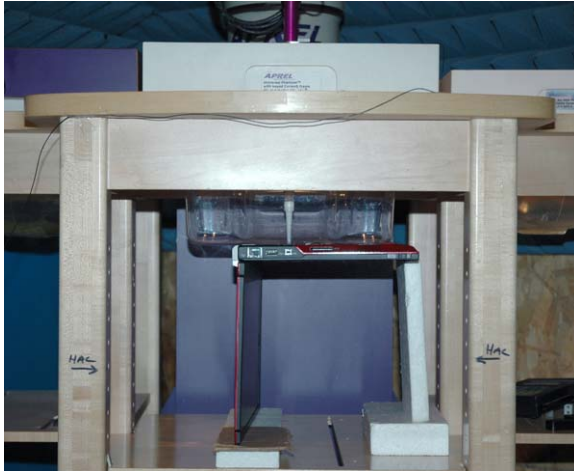

Power	22.6 - 241.1 dBm Average
DUT Position	Underside
Separation	0mm
Antenna Type	IFA
Antenna Manufacturer	Galtronics
Antenna Location	Left Hand Side
Power Mode	Battery
Tx Frequency	2501-22685MHz
Duty Cycle	See Below
Epsilon	51.41
Sigma	2.23
Tissue Depth	15cm
Phantom Type	Universal
DUT Workstation Location	Centre
Device Positioner	Not Needed
Test Date	March/June 2009
Test Engineer	Maryna. N

Mode	Separation Distance (mm)	Channel	Duty Factor %	Frequency MHz	Waveform	1g SAR W/kg	Corrected SAR
WiMAX	0	0	23.3	2501	DQ4_12_UQ16_12_10M	-	-
WiMAX	0	386	23.3	2593	DQ4_12_UQ16_12_10M	-	-
WiMAX	0	736	23.3	2685	DQ4_12_UQ16_12_10M	0.077	0.099

Mode	Separation Distance (mm)	Channel	Duty Factor %	Frequency MHz	Waveform	1g SAR W/kg	Corrected SAR
WiMAX	0	0	42	2501	DQ64_UQ4_12_21S_10M	-	-
WiMAX	0	386	42	2593	DQ64_UQ4_12_21S_10M	-	-
WiMAX	0	736	42	2685	DQ64_UQ4_12_21S_10M	0.020	0.015

Mode	Separation Distance (mm)	Channel	Duty Factor %	Frequency MHz	Waveform	1g SAR W/kg	Corrected SAR
WiMAX	0	0	36.7	2501	DQ4_12_UQ16_34_5M	-	-
WiMAX	0	386	36.7	2593	DQ4_12_UQ16_34_5M	-	-
WiMAX	0	736	36.7	2685	DQ4_12_UQ16_34_5M	0.032	0.028

Mode	Separation Distance (mm)	Channel	Duty Factor %	Frequency MHz	Waveform	1g SAR W/kg	Corrected SAR
WiMAX	0	0	36.7	2501	DQ64_56_UQ4_12_5M	-	-
WiMAX	0	386	36.7	2593	DQ64_56_UQ4_12_5M	-	-
WiMAX	0	736	36.7	2685	DQ64_56_UQ4_12_5M	0.026	0.023

SAR Limit	Conservative Measured SAR
1.6 W/kg 1gram Average Maximum 20MHz	0.077 W/kg 1gram Average

ALL Data Measured with RSB.

SAR Plot for Conservative SAR Included in Appendix A.



Intel® WiFi-Link 5150 Series Network Connection with Galtronics Antennas **802.11a Low Band MODE**

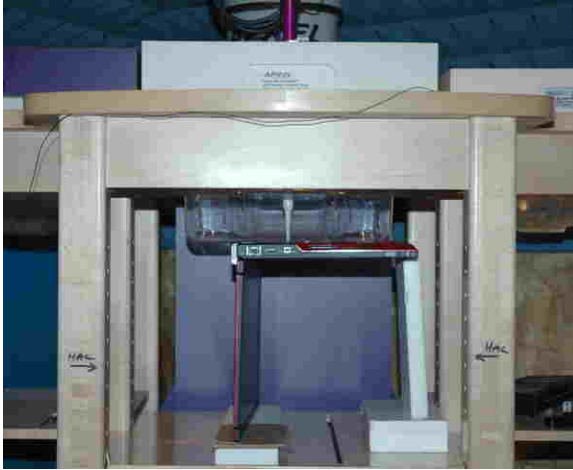

Power	16.45dBm
DUT Position	Underside
Separation	0mm
Antenna Type	IFA
Antenna Manufacturer	Galtronics
Antenna Location	Left Hand Side
Power Mode	Battery
Tx Frequency	5180-5320MHz
Duty Cycle	100%
Epsilon	47.24
Sigma	5.16
Tissue Depth	15cm
Phantom Type	Universal
DUT Workstation Location	Centre
Device Positioner	Not Needed
Test Date	December 2008
Test Engineer	Maryna. N

Maximum Measured SAR NO RSB

Mode	Separation Distance (mm)	Channel	Frequency MHz	1g SAR W/kg
802.11a	0	36	5180	0.066
802.11a	0	52	5260	0.055
802.11a	0	64	5320	0.053

Maximum Measured SAR with RSB

802.11a	0	36	5180	0.041
---------	---	----	------	-------

SAR Limit	Conservative Measured SAR
1.6 W/kg 1gram Average Maximum	0.066 W/kg 1gram Average

SAR Plot for Conservative SAR Included in Appendix A.



Intel® WiFi-Link 5150 Series Network Connection with Galtronics Antennas **802.11an Low Band MODE**



Power	16.54dBm
DUT Position	Back of LCD
Separation	0mm
Antenna Type	IFA
Antenna Manufacturer	Galtronics
Antenna Location	Left Hand Side
Power Mode	Battery
Tx Frequency	5180-5320MHz
Duty Cycle	100%
Epsilon	47.24
Sigma	5.16
Tissue Depth	15cm
Phantom Type	Universal
DUT Workstation Location	Centre
Device Positioner	Not Needed
Test Date	December 2008
Test Engineer	Maryna. N

Maximum Measured SAR NO RSB

Mode	Separation Distance (mm)	Channel	Frequency MHz	1g SAR W/kg
802.11n 20MHz	0	36	5180	0.066
802.11n 40MHz	0	38	5190	0.063

Maximum Measured SAR with RSB

802.11n 20MHz	0	36	5180	0.024
802.11n 40MHz	0	38	5190	0.029

SAR Limit	Conservative Measured SAR
1.6 W/kg 1gram Average Maximum	0.066 W/kg 1gram Average

SAR Plot for Conservative SAR Included in Appendix A.



Intel® WiFi-Link 5150 Series Network Connection with Galtronics Antennas **802.11a Mid Band MODE**



Power	16.45dBm
DUT Position	Underside
Separation	0mm
Antenna Type	IFA
Antenna Manufacturer	Galtronics
Antenna Location	Left Hand Side
Power Mode	Battery
Tx Frequency	5500-5700MHz
Duty Cycle	100%
Epsilon	46.58
Sigma	5.66
Tissue Depth	15cm
Phantom Type	Universal
DUT Workstation Location	Centre
Device Positioner	Not Needed
Test Date	December 2008
Test Engineer	Maryna. N

Maximum Measured SAR NO RSB

Mode	Separation Distance (mm)	Channel	Frequency MHz	1g SAR W/kg
802.11a	0	100	5500	0.043
802.11a	0	120	5600	0.037
802.11a	0	140	5700	0.031

Maximum Measured SAR with RSB

802.11a	0	100	5500	0.021
---------	---	-----	------	-------

SAR Limit	Conservative Measured SAR
1.6 W/kg 1gram Average Maximum	0.043 W/kg 1gram Average

SAR Plot for Conservative SAR Included in Appendix A.



Intel® WiFi-Link 5150 Series Network Connection with Galtronics Antennas **802.11n Mid Band MODE**



Power	16.54dBm
DUT Position	Underside
Separation	0mm
Antenna Type	IFA
Antenna Manufacturer	Galtronics
Antenna Location	Left Hand Side
Power Mode	Battery
Tx Frequency	5500-5700MHz
Duty Cycle	100%
Epsilon	46.75
Sigma	5.84
Tissue Depth	15cm
Phantom Type	Universal
DUT Workstation Location	Centre
Device Positioner	Not Needed
Test Date	October 2008
Test Engineer	Maryna. N

Maximum Measured SAR NO RSB

Mode	Separation Distance (mm)	Channel	Frequency MHz	1g SAR W/kg
802.11n 20MHz	0	100	5500	0.045
802.11n 40MHz	0	102	5510	0.028

Maximum Measured SAR with RSB

802.11n 20MHz	0	100	5500	0.020
802.11n 40MHz	0	102	5510	0.014

SAR Limit	Conservative Measured SAR
1.6 W/kg 1gram Average Maximum	0.045 W/kg 1gram Average

SAR Plot for Conservative SAR Included in Appendix A.



Intel® WiFi-Link 5150 Series Network Connection with Galtronics Antennas **802.11a High Band MODE**



Power	16.45dBm
DUT Position	Underside
Separation	0mm
Antenna Type	IFA
Antenna Manufacturer	Galtronics
Antenna Location	Left Hand Side
Power Mode	Battery
Tx Frequency	5745-5825MHz
Duty Cycle	100%
Epsilon	46.08
Sigma	5.97
Tissue Depth	15cm
Phantom Type	Universal
DUT Workstation Location	Centre
Device Positioner	Not Needed
Test Date	December 2008
Test Engineer	Maryna. N

Maximum Measured SAR NO RSB

Mode	Separation Distance (mm)	Channel	Frequency MHz	1g SAR W/kg
802.11a	0	149	5745	0.025
802.11a	0	157	5785	0.020
802.11a	0	165	5825	0.020

Maximum Measured SAR with RSB

802.11a	0	157	5785	0.016
---------	---	-----	------	-------

SAR Limit	Conservative Measured SAR
1.6 W/kg 1gram Average Maximum	0.025 W/kg 1gram Average

SAR Plot for Conservative SAR Included in Appendix A.



Intel® WiFi-Link 5150 Series Network Connection with Galtronics Antennas **802.11n Mid Band MODE**



Power	16.54dBm
DUT Position	Underside
Separation	0mm
Antenna Type	IFA
Antenna Manufacturer	Galtronics
Antenna Location	Left Hand Side
Power Mode	Battery
Tx Frequency	5500-5700MHz
Duty Cycle	100%
Epsilon	46.08
Sigma	5.97
Tissue Depth	15cm
Phantom Type	Universal
DUT Workstation Location	Centre
Device Positioner	Not Needed
Test Date	December 2008
Test Engineer	Maryna. N

Maximum Measured SAR NO RSB

Mode	Separation Distance (mm)	Channel	Frequency MHz	1g SAR W/kg
802.11n 20MHz	0	149	5745	0.026
802.11n 40MHz	0	151	5755	0.021

Maximum Measured SAR with RSB

802.11n 20MHz	0	149	5745	0.021
802.11n 40MHz	0	151	5755	0.017

SAR Limit	Conservative Measured SAR
1.6 W/kg 1gram Average Maximum	0.026 W/kg 1gram Average

SAR Plot for Conservative SAR Included in Appendix A.



6.6 Additional Information

The Intel® WiFi-Link 5150 Series Network Connection card located inside a Dell laptop computer was tested at other locations to ensure a conservative SAR was assessed.



APREL *Laboratories*

SAR & HAC Instruments for Wireless • Consulting • Research • Standards • Compliance • Training

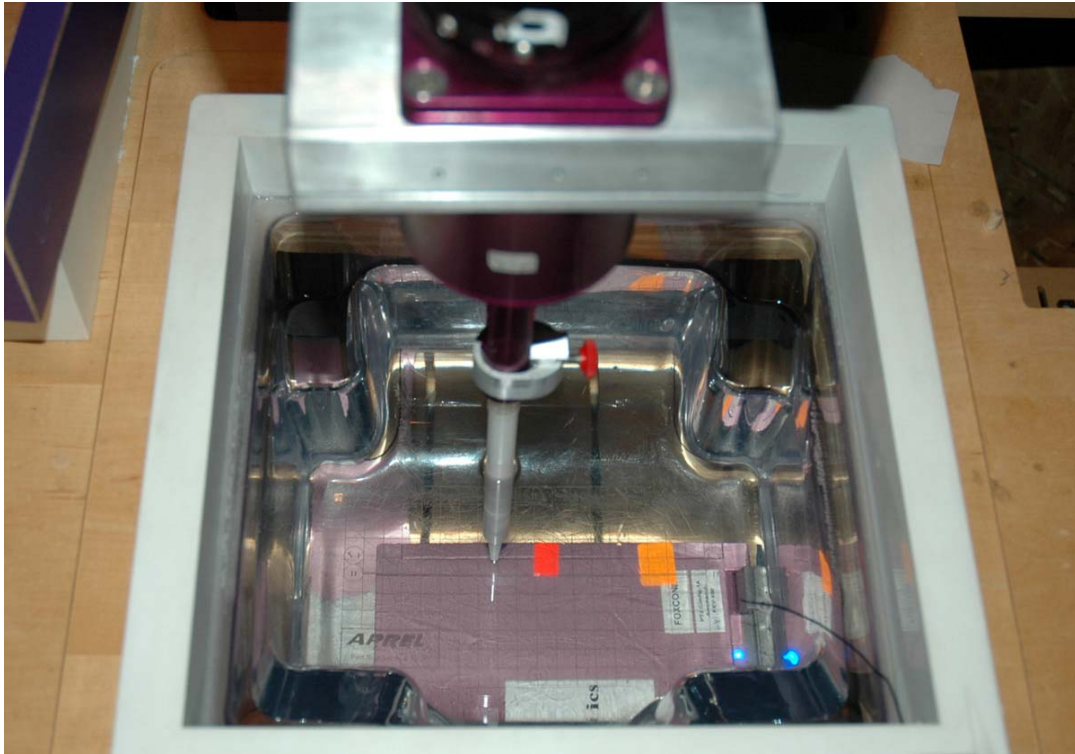

APREL *Laboratories*

SAR & HAC Instruments for Wireless • Consulting • Research • Standards • Compliance • Training



APREL *Laboratories*

SAR & HAC Instruments for Wireless • Consulting • Research • Standards • Compliance • Training

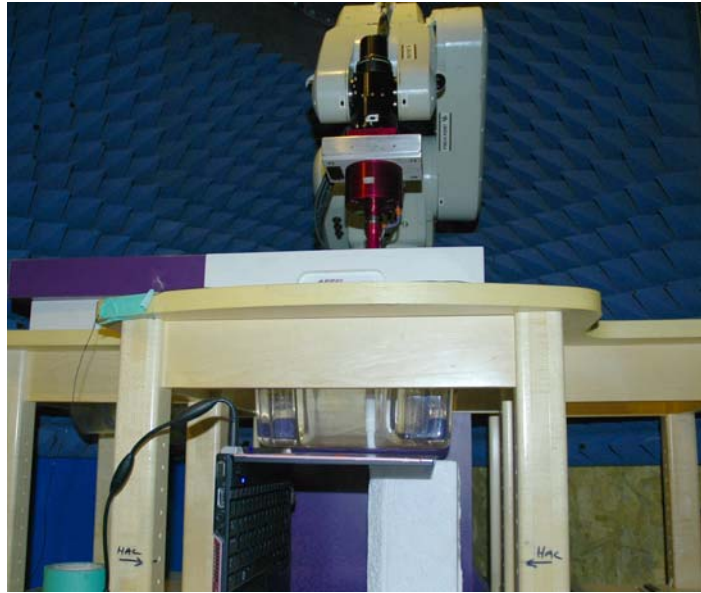

APREL *Laboratories*

SAR & HAC Instruments for Wireless • Consulting • Research • Standards • Compliance • Training

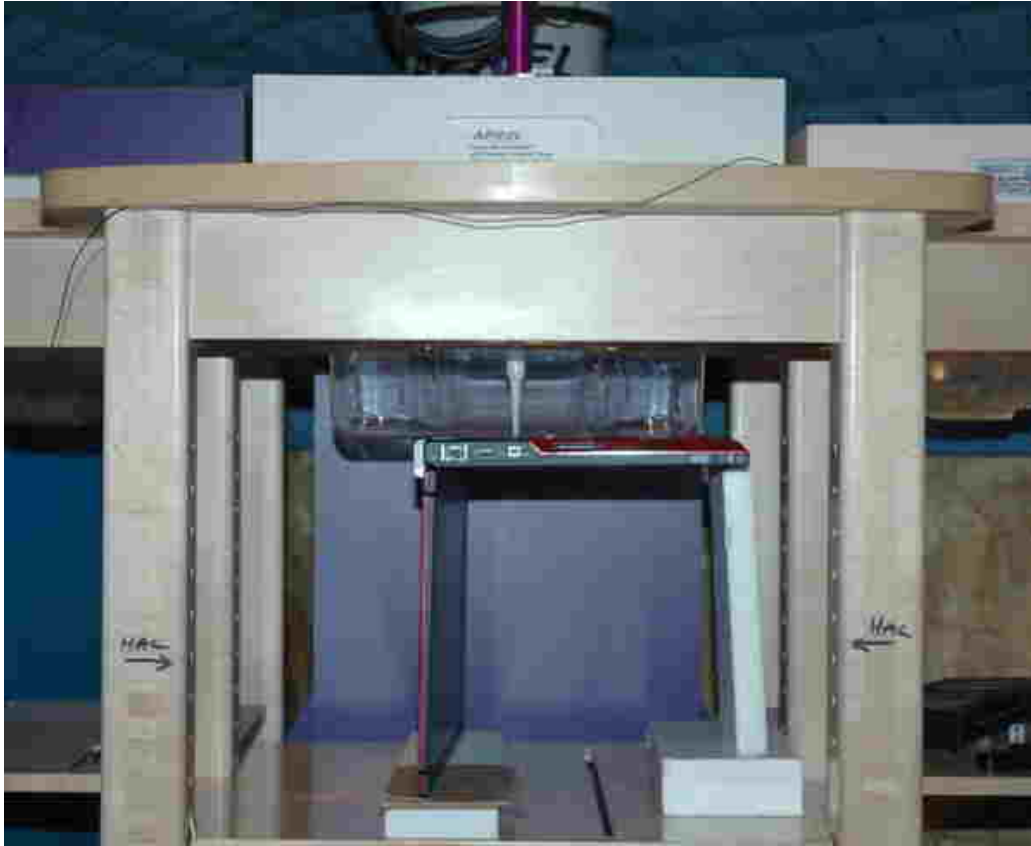



APREL *Laboratories*

SAR & HAC Instruments for Wireless • Consulting • Research • Standards • Compliance • Training







APREL *Laboratories*

SAR & HAC Instruments for Wireless • Consulting • Research • Standards • Compliance • Training

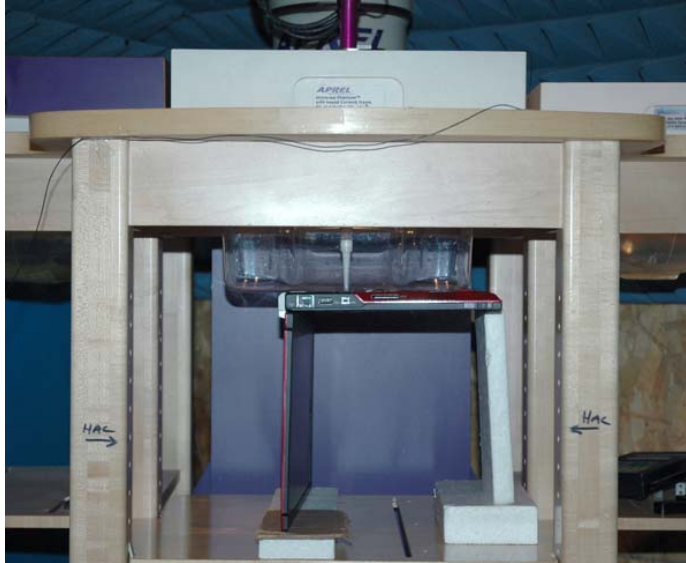

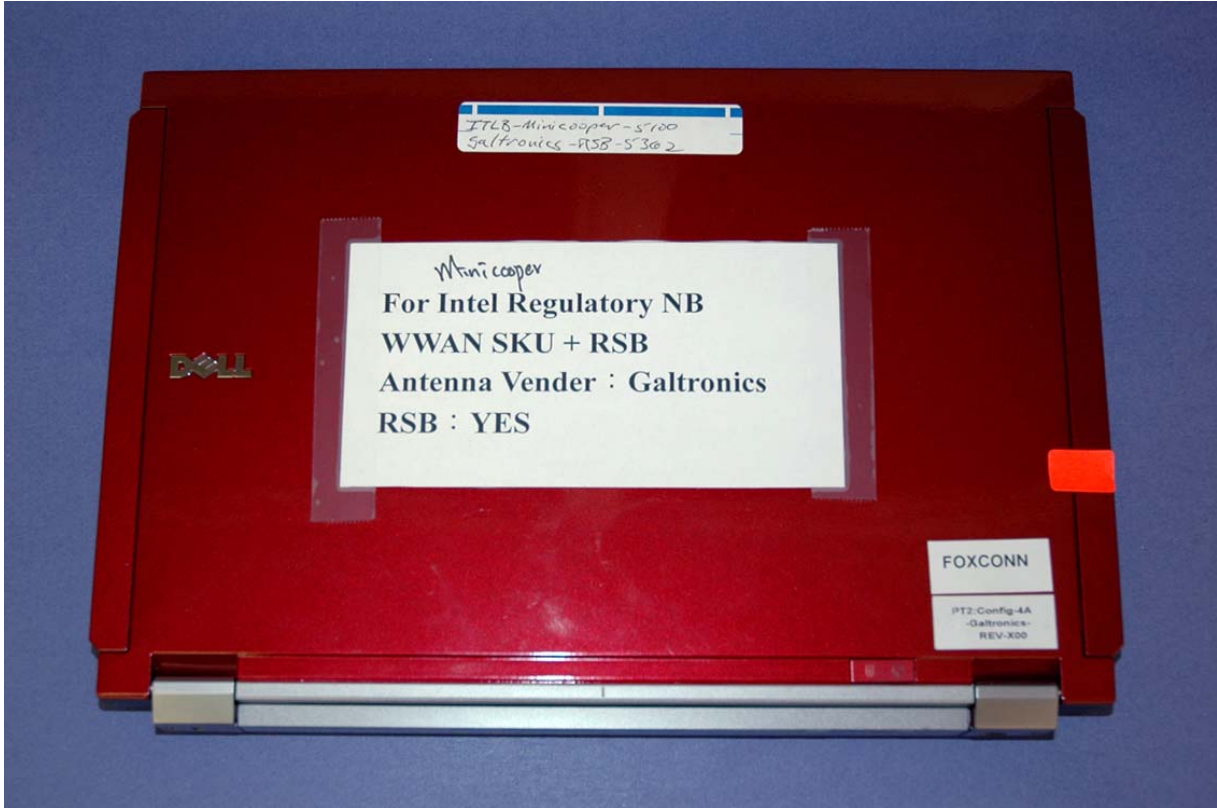



SAR & HAC Instruments for Wireless • Consulting • Research • Standards • Compliance • Training

Appendix A SAR Plots



SAR Test Report

Report Date : 21-Nov-2008
 By Operator : 123
 Measurement Date : 21-Nov-2009
 Starting Time : 21-Nov-2009 01:01:15 PM
 End Time : 21-Nov-2009 01:16:42 PM
 Scanning Time : 927 secs

Product Data
 Device Name : minicooper-bottom
 Serial No. :
 Type : Other
 Model : 5441
 Frequency : 2450.00 MHz
 Max. Transmit Pwr : 1 W
 Drift Time : 0 min(s)
 Length : 90 mm
 Width : 70 mm
 Depth : 20 mm
 Antenna Type : Internal
 Orientation : Touch
 Power Drift-Start : 0.041 W/kg
 Power Drift-Finish: 0.043 W/kg
 Power Drift (%) : 5.842
 Picture : C:\alsas\bitmap\Gucci-back.bmp

Phantom Data
 Name : APREL-Uni
 Type : Uni-Phantom
 Size (mm) : 280 x 280 x 200
 Serial No. : User Define
 Location : Center
 Description : U

Tissue Data
 Type : BODY
 Serial No. : 2450_B
 Frequency : 2450.00 MHz
 Last Calib. Date : 20-May-2008
 Temperature : 20.00 °C
 Ambient Temp. : 20.00 °C
 Humidity : 40.00 RH%
 Epsilon : 50.38 F/m
 Sigma : 1.92 S/m
 Density : 1000.00 kg/cu. m

Probe Data

Name : .E30
 Model : E30
 Type : E-Field Triangle
 Serial No. : 222
 Last Calib. Date : 16-Jan-2009
 Frequency : 2450.00 MHz
 Duty Cycle Factor: 1
 Conversion Factor: 4.75
 Probe Sensitivity: 1.20 1.20 1.20 $\mu\text{V}/(\text{V}/\text{m})^2$
 Compression Point: 95.00 mV
 Offset : 1.56 mm

Measurement Data

Crest Factor : 1
 Scan Type : Complete
 Tissue Temp. : 21.00 °C
 Ambient Temp. : 23.00 °C
 Set-up Date : 21-May-2009
 Set-up Time : 1:00:44 PM
 Area Scan : 9x7x1 : Measurement x=10mm, y=10mm, z=4mm
 Zoom Scan : 5x5x8 : Measurement x=8mm, y=8mm, z=4mm

Other Data

DUT Position : Touch
 Separation : 0
 Channel : Low



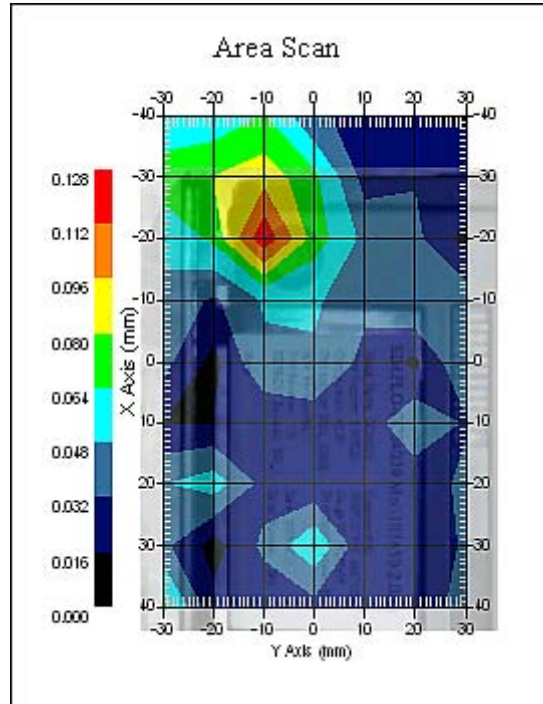

1 gram SAR value : 0.029 W/kg
Zoom Scan Peak SAR : 0.150 W/kg





SAR & HAC Instruments for Wireless • Consulting • Research • Standards • Compliance • Training

Exposure Assessment Measurement Uncertainty

Source of Uncertainty	Tolerance Value	Probability Distribution	Divisor	c_i^{-1} (1-g)	c_i^{-1} (10-g)	Standard Uncertainty (1-g) %	Standard Uncertainty (10-g) %
Measurement System							
Probe Calibration	3.5	normal	1	1	1	3.5	3.5
Axial Isotropy	3.7	rectangular	•3	$(1-cp)^{1/2}$	$(1-cp)^{1/2}$	1.5	1.5
Hemispherical Isotropy	10.9	rectangular	•3	•cp	•cp	4.4	4.4
Boundary Effect	1.0	rectangular	•3	1	1	0.6	0.6
Linearity	4.7	rectangular	•3	1	1	2.7	2.7
Detection Limit	1.0	rectangular	•3	1	1	0.6	0.6
Readout Electronics	1.0	normal	1	1	1	1.0	1.0
Response Time	0.8	rectangular	•3	1	1	0.5	0.5
Integration Time	1.7	rectangular	•3	1	1	1.0	1.0
RF Ambient Condition	3.0	rectangular	•3	1	1	1.7	1.7
Probe Positioner Mech.	0.4	rectangular	•3	1	1	0.2	0.2
Restriction							
Probe Positioning with respect to Phantom Shell	2.9	rectangular	•3	1	1	1.7	1.7
Extrapolation and Integration	3.7	rectangular	•3	1	1	2.1	2.1
Test Sample Positioning	4.0	normal	1	1	1	4.0	4.0
Device Holder Uncertainty	2.0	normal	1	1	1	2.0	2.0
Drift of Output Power	5.8	rectangular	•3	1	1	2.4	2.4
Phantom and Setup							
Phantom Uncertainty(shape & thickness tolerance)	3.4	rectangular	•3	1	1	2	2
Liquid Conductivity(target)	5.0	rectangular	•3	0.7	0.5	2	1.4
Liquid Conductivity(meas.)	1.5	normal	1	0.7	0.5	1.1	0.8
Liquid Permittivity(target)	5.0	rectangular	•3	0.6	0.5	1.7	1.4
Liquid Permittivity(meas.)	4.4	normal	1	0.6	0.5	2.6	2.2
Combined Uncertainty		RSS				11.8	10.2
Combined Uncertainty (coverage factor=2)		Normal (k=2)				23.6	20.4



SAR-Z Axis at Hotspot x:-25.87 y:-10.09

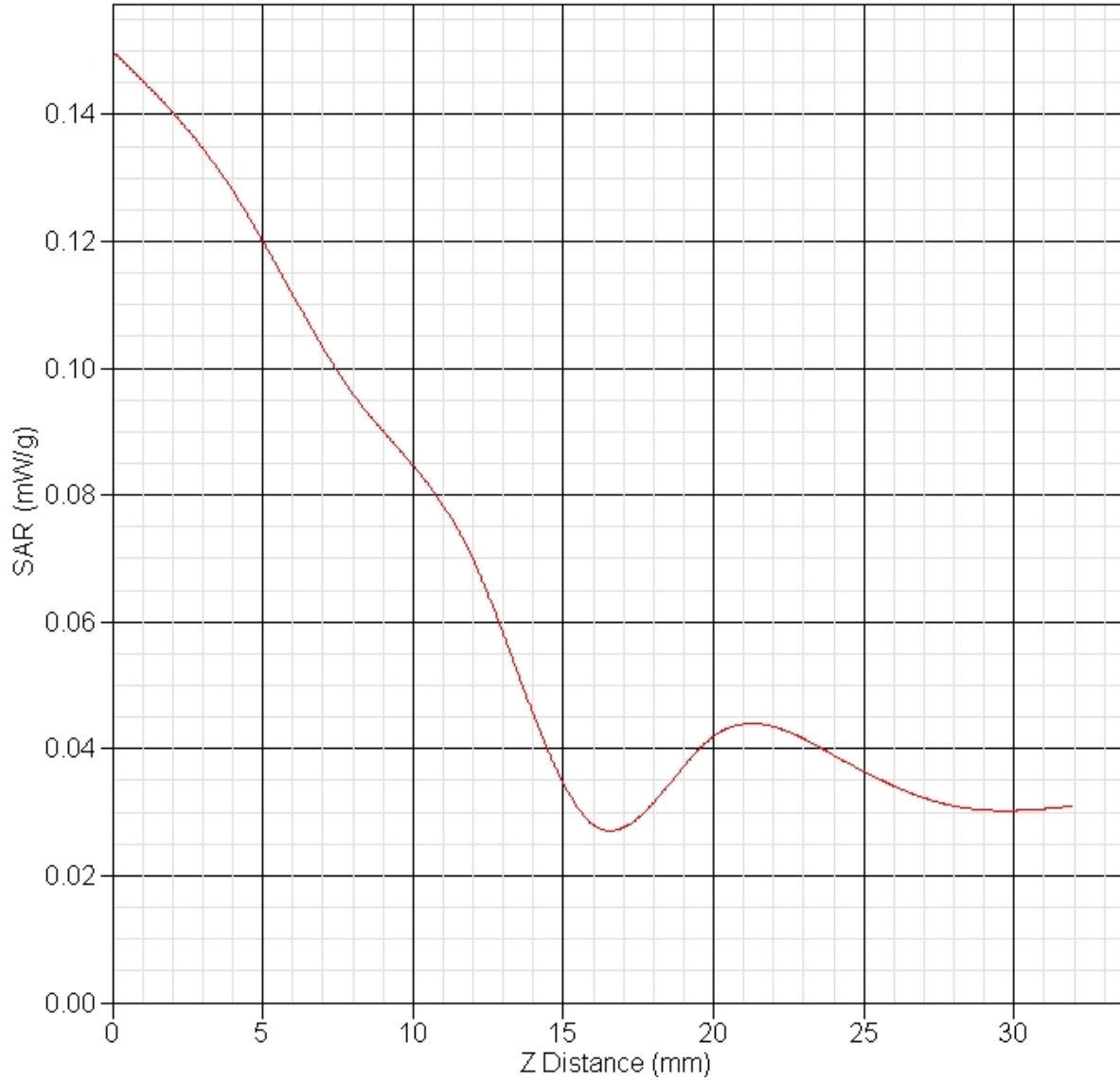

WiMAX SAR Test Report

DQ4_12_UQ16_12_10M

Report Date : 03-Jun-2009
 By Operator : 123
 Measurement Date : 03-Jun-2009
 Starting Time : 03-Jun-2009 06:21:42 PM
 End Time : 03-Jun-2009 06:33:10 PM
 Scanning Time : 688 secs

Product Data
 Device Name : Mini-Cooper-Tyco-5363-back
 Serial No. : 2102291500010
 Type : Other
 Model : Tyco WiMAX
 Frequency : 2600.00 MHz
 Max. Transmit Pwr : 1 W
 Drift Time : 0 min(s)
 Length : 40 mm
 Width : 90 mm
 Depth : 25 mm
 Antenna Type : Internal
 Orientation : Touch
 Power Drift-Start : 0.122 W/kg
 Power Drift-Finish: 0.114 W/kg
 Power Drift (%) : -5.92
 Picture : C:\alsas\bitmap\Mini-Cooper-5363-back.bmp

Phantom Data
 Name : APREL-Uni
 Type : Uni-Phantom
 Size (mm) : 280 x 280 x 200
 Serial No. : User Define
 Location : Center
 Description : U

Tissue Data
 Type : BODY
 Serial No. : 2600-B
 Frequency : 2600.00 MHz
 Last Calib. Date : 03-Jun-2009
 Temperature : 20.00 °C
 Ambient Temp. : 20.00 °C
 Humidity : 50.00 RH%
 Epsilon : 50.41 F/m
 Sigma : 2.23 S/m
 Density : 1000.00 kg/cu. m

Probe Data

Name : .E30
 Model : E30
 Type : E-Field Triangle
 Serial No. : 222
 Last Calib. Date : 16-Jan-2009
 Frequency : 2600.00 MHz
 Duty Cycle Factor: 2.7
 Conversion Factor: 3.8
 Probe Sensitivity: 1.20 1.20 1.20 $\mu\text{V}/(\text{V}/\text{m})^2$
 Compression Point: 95.00 mV
 Offset : 1.56 mm

Measurement Data

Crest Factor : 1
 Scan Type : Complete
 Tissue Temp. : 21.00 °C
 Ambient Temp. : 23.00 °C
 Set-up Date : 03-Jun-2009
 Set-up Time : 6:21:16 PM
 Area Scan : 5x7x1 : Measurement x=10mm, y=10mm, z=4mm
 Zoom Scan : 5x5x8 : Measurement x=8mm, y=8mm, z=4mm

Other Data

DUT Position : Touch
 Separation : 0
 Channel : High



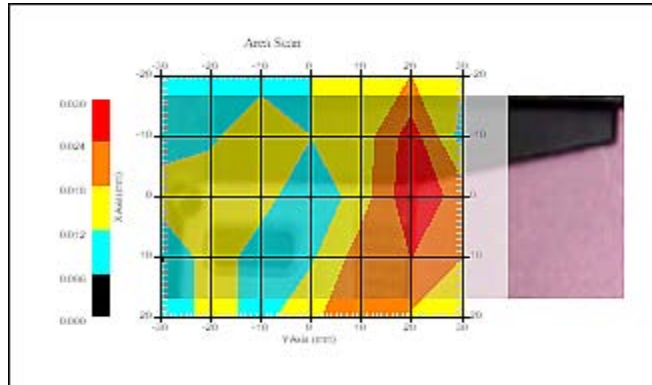
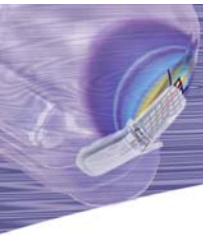

1 gram SAR value : 0.117 W/kg
 Zoom Scan Peak SAR : 0.330 W/kg





SAR & HAC Instruments for Wireless • Consulting • Research • Standards • Compliance • Training

Exposure Assessment Measurement Uncertainty

Source of Uncertainty	Tolerance Value	Probability Distribution	Divisor	c_i^{-1} (1-g)	c_i^{-1} (10-g)	Standard Uncertainty (1-g) %	Standard Uncertainty (10-g) %
Measurement System							
Probe Calibration	3.5	normal	1	1	1	3.5	3.5
Axial Isotropy	3.7	rectangular	•3	$(1-cp)^{1/2}$	$(1-cp)^{1/2}$	1.5	1.5
Hemispherical Isotropy	10.9	rectangular	•3	•cp	•cp	4.4	4.4
Boundary Effect	1.0	rectangular	•3	1	1	0.6	0.6
Linearity	4.7	rectangular	•3	1	1	2.7	2.7
Detection Limit	1.0	rectangular	•3	1	1	0.6	0.6
Readout Electronics	1.0	normal	1	1	1	1.0	1.0
Response Time	0.8	rectangular	•3	1	1	0.5	0.5
Integration Time	1.7	rectangular	•3	1	1	1.0	1.0
RF Ambient Condition	3.0	rectangular	•3	1	1	1.7	1.7
Probe Positioner Mech.	0.4	rectangular	•3	1	1	0.2	0.2
Restriction							
Probe Positioning with respect to Phantom Shell	2.9	rectangular	•3	1	1	1.7	1.7
Extrapolation and Integration	3.7	rectangular	•3	1	1	2.1	2.1
Test Sample Positioning	4.0	normal	1	1	1	4.0	4.0
Device Holder Uncertainty	2.0	normal	1	1	1	2.0	2.0
Drift of Output Power	5.9	rectangular	•3	1	1	2.6	2.6
Phantom and Setup							
Phantom Uncertainty(shape & thickness tolerance)	3.4	rectangular	•3	1	1	2	2
Liquid Conductivity(target)	5.0	rectangular	•3	0.7	0.5	2	1.4
Liquid Conductivity(meas.)	1.4	normal	1	0.7	0.5	1.4	1.1
Liquid Permittivity(target)	5.0	rectangular	•3	0.6	0.5	1.7	1.4
Liquid Permittivity(meas.)	1.4	normal	1	0.6	0.5	1.2	0.9
Combined Uncertainty		RSS				10.9	9.4
Combined Uncertainty (coverage factor=2)		Normal (k=2)				21.8	18.8



SAR-Z Axis

at Hotspot x:0.13 y:-10.09

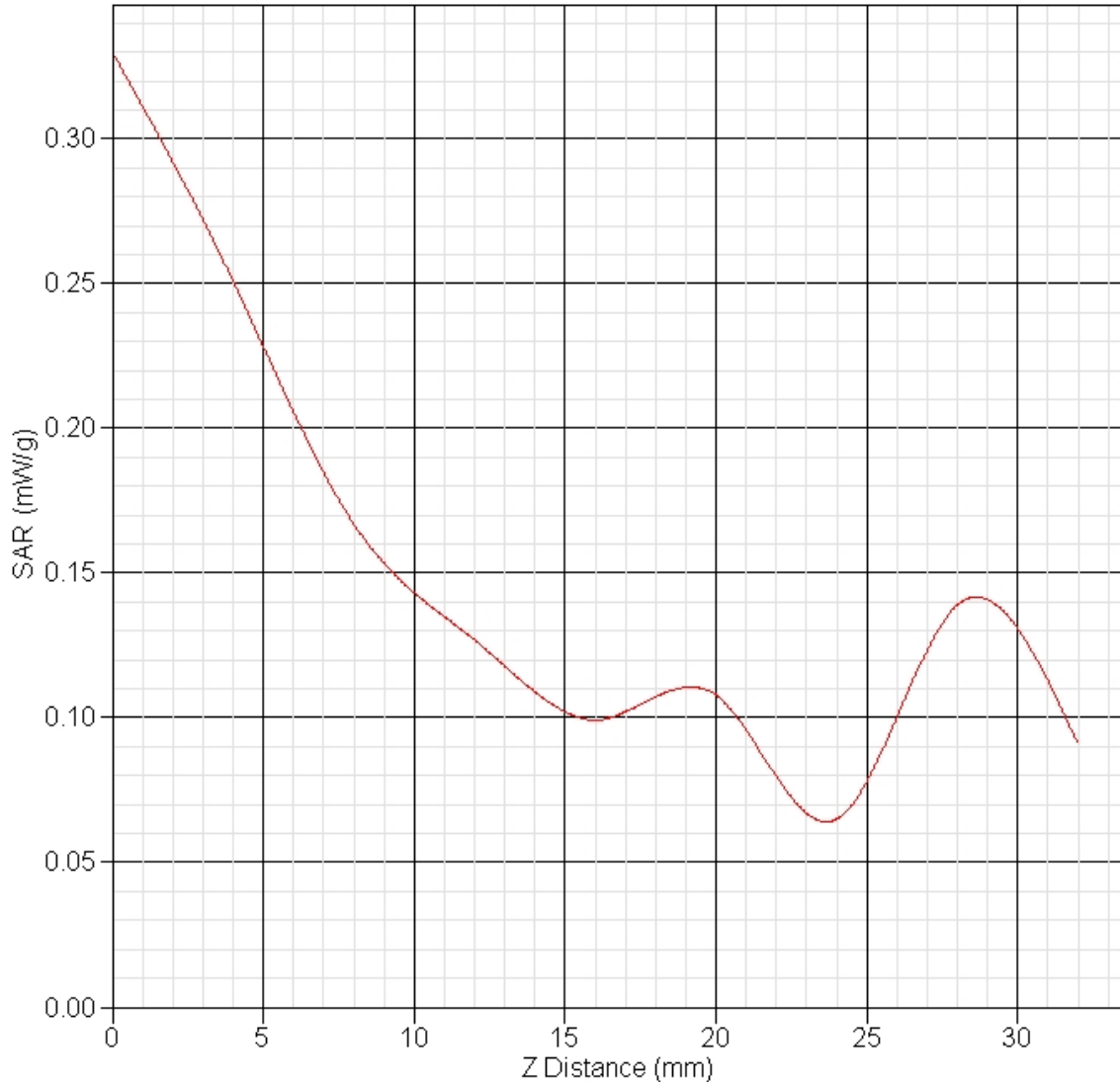

WiMAX SAR Test Report

DQ4_12_UQ16_34_5M

Report Date : 15-May-2009
 By Operator : 123
 Measurement Date : 15-May-2009
 Starting Time : 15-May-2009 04:26:27 PM
 End Time : 15-May-2009 04:37:58 PM
 Scanning Time : 691 secs

Product Data

Device Name : Mini-Cooper-Galtronics-5361-back
 Serial No. : 2102291500009
 Type : Other
 Model : Galtronics - WiMax
 Frequency : 2600.00 MHz
 Max. Transmit Pwr : 1 W
 Drift Time : 0 min(s)
 Length : 40 mm
 Width : 90 mm
 Depth : 15 mm
 Antenna Type : Internal
 Orientation : Touch
 Power Drift-Start : 0.016 W/kg
 Power Drift-Finish: 0.014 W/kg
 Power Drift (%) : -6.937
 Picture : C:\alsas\bitmap\Mini-Cooper-5361-bak.bmp

Phantom Data

Name : APREL-Uni
 Type : Uni-Phantom
 Size (mm) : 280 x 280 x 200
 Serial No. : User Define
 Location : Center
 Description : U

Tissue Data

Type : BODY
 Serial No. : 2600-B
 Frequency : 2600.00 MHz
 Last Calib. Date : 15-May-2009
 Temperature : 20.00 °C
 Ambient Temp. : 20.00 °C
 Humidity : 50.00 RH%
 Epsilon : 51.41 F/m
 Sigma : 2.23 S/m
 Density : 1000.00 kg/cu. m

Probe Data

Name : .E30
 Model : E30
 Type : E-Field Triangle
 Serial No. : 222
 Last Calib. Date : 16-Jan-2009
 Frequency : 2600.00 MHz
 Duty Cycle Factor: 4.29
 Conversion Factor: 3.8
 Probe Sensitivity: 1.20 1.20 1.20 $\mu\text{V}/(\text{V}/\text{m})^2$
 Compression Point: 95.00 mV
 Offset : 1.56 mm

Measurement Data

Crest Factor : 1
 Scan Type : Complete
 Tissue Temp. : 21.00 °C
 Ambient Temp. : 23.00 °C
 Set-up Date : 15-May-2009
 Set-up Time : 4:25:50 PM
 Area Scan : 5x7x1 : Measurement x=10mm, y=10mm, z=4mm
 Zoom Scan : 5x5x8 : Measurement x=8mm, y=8mm, z=4mm

Other Data

DUT Position : Touch
 Separation : 0
 Channel : High



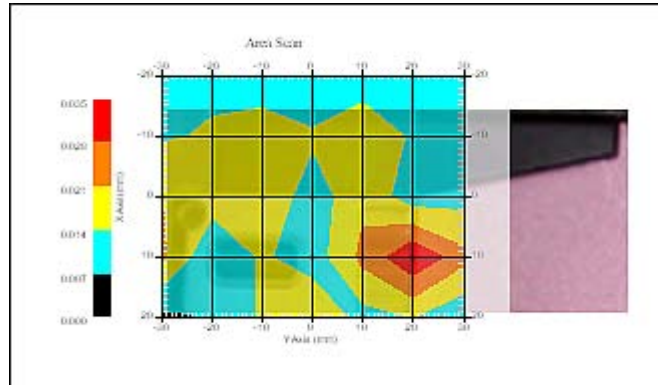

1 gram SAR value : 0.040 W/kg
 Zoom Scan Peak SAR : 0.160 W/kg





SAR & HAC Instruments for Wireless • Consulting • Research • Standards • Compliance • Training

Exposure Assessment Measurement Uncertainty

Source of Uncertainty	Tolerance Value	Probability Distribution	Divisor	c_i^{-1} (1-g)	c_i^{-1} (10-g)	Standard Uncertainty (1-g) %	Standard Uncertainty (10-g) %
Measurement System							
Probe Calibration	3.5	normal	1	1	1	3.5	3.5
Axial Isotropy	3.7	rectangular	•3	$(1-cp)^{1/2}$	$(1-cp)^{1/2}$	1.5	1.5
Hemispherical Isotropy	10.9	rectangular	•3	•cp	•cp	4.4	4.4
Boundary Effect	1.0	rectangular	•3	1	1	0.6	0.6
Linearity	4.7	rectangular	•3	1	1	2.7	2.7
Detection Limit	1.0	rectangular	•3	1	1	0.6	0.6
Readout Electronics	1.0	normal	1	1	1	1.0	1.0
Response Time	0.8	rectangular	•3	1	1	0.5	0.5
Integration Time	1.7	rectangular	•3	1	1	1.0	1.0
RF Ambient Condition	3.0	rectangular	•3	1	1	1.7	1.7
Probe Positioner Mech.	0.4	rectangular	•3	1	1	0.2	0.2
Restriction							
Probe Positioning with respect to Phantom Shell	2.9	rectangular	•3	1	1	1.7	1.7
Extrapolation and Integration	3.7	rectangular	•3	1	1	2.1	2.1
Test Sample Positioning	4.0	normal	1	1	1	4.0	4.0
Device Holder Uncertainty	2.0	normal	1	1	1	2.0	2.0
Drift of Output Power	7.0	rectangular	•3	1	1	2.6	2.6
Phantom and Setup							
Phantom Uncertainty(shape & thickness tolerance)	3.4	rectangular	•3	1	1	2	2
Liquid Conductivity(target)	5.0	rectangular	•3	0.7	0.5	2	1.4
Liquid Conductivity(meas.)	1.4	normal	1	0.7	0.5	1.4	1.1
Liquid Permittivity(target)	5.0	rectangular	•3	0.6	0.5	1.7	1.4
Liquid Permittivity(meas.)	1.4	normal	1	0.6	0.5	1.2	0.9
Combined Uncertainty		RSS				10.9	9.4
Combined Uncertainty (coverage factor=2)		Normal (k=2)				21.8	18.8



SAR-Z Axis at Hotspot x:18.16 y:11.90

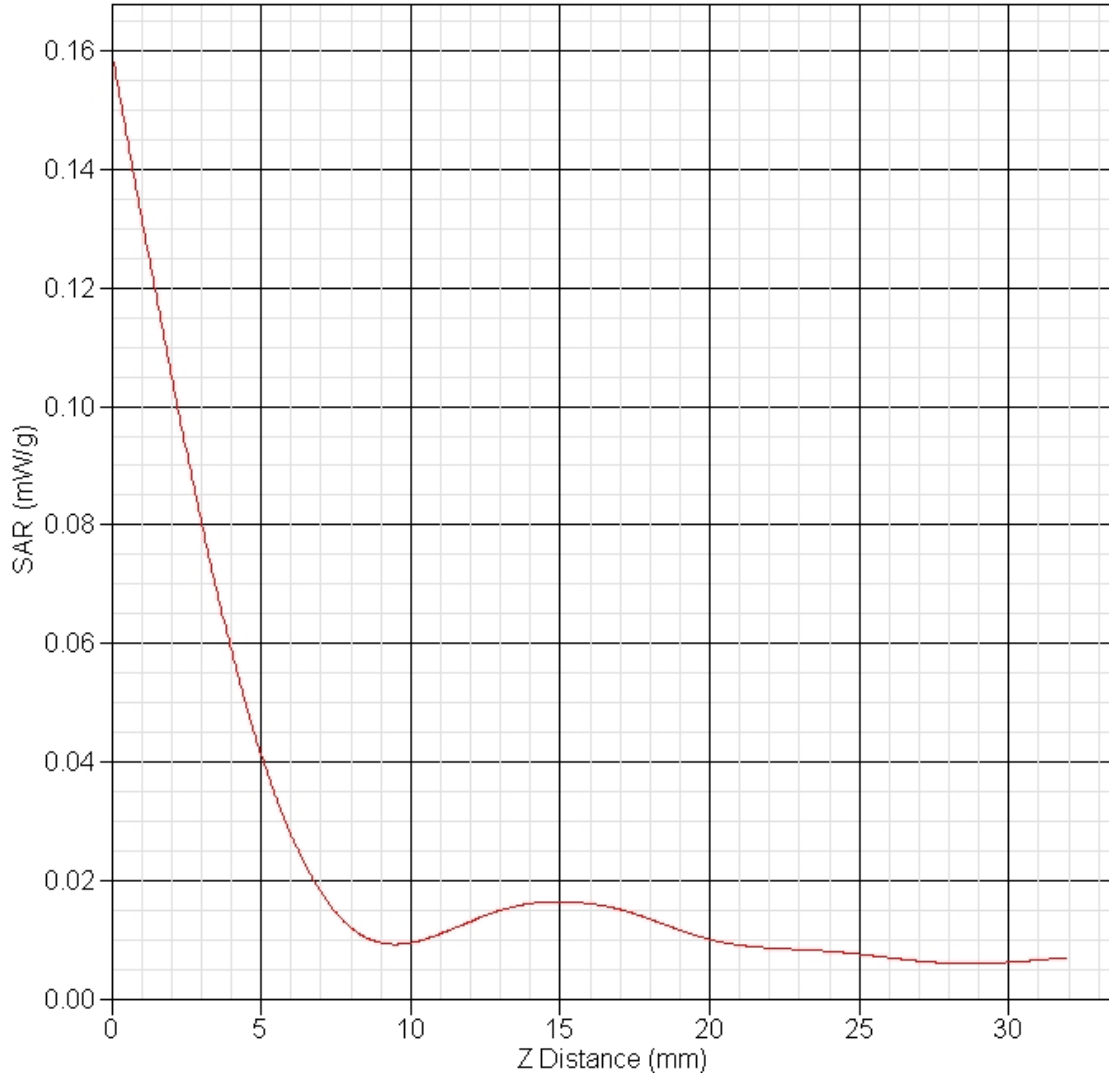

SAR Test Report

Report Date : 17-Dec-2008
 By Operator : 123
 Measurement Date : 17-Dec-2008
 Starting Time : 17-Dec-2008 02:04:10 PM
 End Time : 17-Dec-2008 03:23:37 PM
 Scanning Time : xxxx secs

Product Data
 Device Name : Minicooper
 Serial No. :
 Type : Other
 Model : WLE2C7
 Frequency : 5200.00 MHz
 Max. Transmit Pwr : 1 W
 Drift Time : 0 min(s)
 Length : 105 mm
 Width : 75 mm
 Depth : 25 mm
 Antenna Type : Internal
 Orientation : Touch
 Power Drift-Start : 0.012 W/kg
 Power Drift-Finish : 0.011 W/kg
 Power Drift (%) : -4.446
 Picture : C:\alsas\bitmap\Welch-Auden-back.bmp

Phantom Data
 Name : APREL-Uni
 Type : Uni-Phantom
 Size (mm) : 280 x 280 x 200
 Serial No. : User Define
 Location : Center
 Description : U

Tissue Data
 Type : BODY
 Serial No. : 5200-B
 Frequency : 5200.00 MHz
 Last Calib. Date : 15-Apr-2009
 Temperature : 20.00 °C
 Ambient Temp. : 20.00 °C
 Humidity : 40.00 RH%
 Epsilon : 47.24 F/m
 Sigma : 5.16 S/m
 Density : 1000.00 kg/cu. m

Probe Data
 Name : .E30
 Model : E30
 Type : E-Field Triangle
 Serial No. : 222
 Last Calib. Date : 16-Jan-2008
 Frequency : 5200.00 MHz
 Duty Cycle Factor: 1
 Conversion Factor: 3.3
 Probe Sensitivity: 1.20 1.20 1.20 $\mu\text{V}/(\text{V/m})^2$
 Compression Point: 95.00 mV
 Offset : 1.56 mm

Measurement Data
 Crest Factor : 1
 Scan Type : Complete
 Tissue Temp. : 21.00 °C
 Ambient Temp. : 23.00 °C
 Set-up Date : 17-Apr-2009
 Set-up Time : 2:00:53 PM
 Area Scan : 9x5x1 : Measurement x=10mm, y=10mm, z=2mm
 Zoom Scan : 9x9x17 : Measurement x=4mm, y=4mm, z=2mm

Other Data
 DUT Position : Touch
 Separation : 0
 Channel : Low



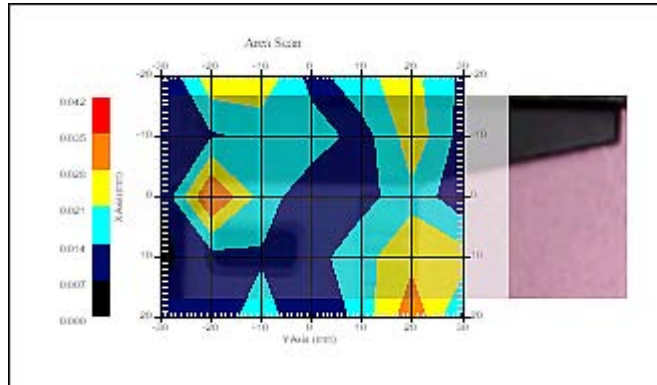

1 gram SAR value : 0.066 W/kg
 Zoom Scan Peak SAR : 1.520 W/kg





SAR & HAC Instruments for Wireless • Consulting • Research • Standards • Compliance • Training

Exposure Assessment Measurement Uncertainty

Source of Uncertainty	Tolerance Value	Probability Distribution	Divisor	c_i^{-1} (1-g)	c_i^{-1} (10-g)	Standard Uncertainty (1-g) %	Standard Uncertainty (10-g) %
Measurement System							
Probe Calibration	3.5	normal	1	1	1	3.5	3.5
Axial Isotropy	3.7	rectangular	•3	$(1-cp)^{1/2}$	$(1-cp)^{1/2}$	1.5	1.5
Hemispherical Isotropy	10.9	rectangular	•3	•cp	•cp	4.4	4.4
Boundary Effect	1.0	rectangular	•3	1	1	0.6	0.6
Linearity	4.7	rectangular	•3	1	1	2.7	2.7
Detection Limit	1.0	rectangular	•3	1	1	0.6	0.6
Readout Electronics	1.0	normal	1	1	1	1.0	1.0
Response Time	0.8	rectangular	•3	1	1	0.5	0.5
Integration Time	1.7	rectangular	•3	1	1	1.0	1.0
RF Ambient Condition	3.0	rectangular	•3	1	1	1.7	1.7
Probe Positioner Mech.	0.4	rectangular	•3	1	1	0.2	0.2
Restriction							
Probe Positioning with respect to Phantom Shell	2.9	rectangular	•3	1	1	1.7	1.7
Extrapolation and Integration	3.7	rectangular	•3	1	1	2.1	2.1
Test Sample Positioning	4.0	normal	1	1	1	4.0	4.0
Device Holder Uncertainty	2.0	normal	1	1	1	2.0	2.0
Drift of Output Power	4.4	rectangular	•3	1	1	2.1	2.1
Phantom and Setup							
Phantom Uncertainty(shape & thickness tolerance)	3.4	rectangular	•3	1	1	2	2
Liquid Conductivity(target)	5.0	rectangular	•3	0.7	0.5	2	1.4
Liquid Conductivity(meas.)	2.2	normal	1	0.7	0.5	1.6	1.1
Liquid Permittivity(target)	5.0	rectangular	•3	0.6	0.5	1.7	1.4
Liquid Permittivity(meas.)	0.9	normal	1	0.6	0.5	0.5	0.4
Combined Uncertainty		RSS				9.9	8.4
Combined Uncertainty (coverage factor=2)		Normal (k=2)				19.8	16.8



SAR-Z Axis at Hotspot x:0.12 y:-0.15

