

# RF Exposure Lab

802 N. Twin Oaks Valley Road, Suite 105 • San Marcos, CA 92069 • U.S.A.

TEL (760) 471-2100 • FAX (760) 471-2121

<http://www.rfexposurelab.com>

## CERTIFICATE OF COMPLIANCE SAR EVALUATION

Intel Mobile Communication  
100 Center Point Circle, Suite 200  
Columbia, SC 29210

Dates of Test: January 23, 2018  
Test Report Number: SAR.20180108

FCC ID:	PD93168NG (Contains Model 3168NGW)
IC Certificate:	1000M-3168NG (Contains Model 3168NGW)
Model(s):	TPN-W131
Test Sample:	Engineering Unit Same as Production
Serial Number:	Eng 1
Equipment Type:	Wireless Module Installed in Notebook/Tablet
Classification:	Portable Transmitter Next to Body
TX Frequency Range:	2412 – 2462 MHz; 5180 – 5320 MHz; 5500 – 5700 MHz; 5745 – 5825 MHz
Frequency Tolerance:	± 2.5 ppm
Maximum RF Output:	2450 MHz (b) – 17.50 dB, 2450 MHz (g) – 17.50 dB, 2450 MHz (n20) – 17.50 dB, 2450 MHz (n40) – 17.50 dB, 5250 MHz (a) – 16.50 dB, 5250 MHz (n20) – 16.50 dB, 5250 MHz (n40) – 16.50 dB, 5250 MHz (ac) – 13.50 dB, 5600 MHz (a) – 16.50 dB, 5600 MHz (n20) – 16.50 dB, 5600 MHz (n40) – 16.50 dB, 5600 MHz (ac) – 15.00 dB, 5800 MHz (a) – 16.50 dB, 5800 MHz (n20) – 16.50 dB, 5800 MHz (n40) – 16.50 dB, 5800 MHz (ac) – 15.00 dB Conducted
Signal Modulation:	DSSS, OFDM
Antenna Type:	Inpaq, P/N 025.901AQ.0001 (Tx1) & 025.901AR.0001 (Tx2); PIFA Antenna
Application Type:	Certification
FCC Rule Parts:	Part 2, 15C, 15E
KDB Test Methodology:	KDB 447498 D01 v06, KDB 248227 v02r02, KDB 616217 D04 v01r02
Industry Canada:	RSS-102 Issue 5, Safety Code 6
Maximum SAR Value:	1.05 W/kg Reported
Maximum Simultaneous SAR:	1.12 W/kg Reported
Separation Distance:	4.5 mm

This wireless mobile and/or portable device has been shown to be compliant for localized specific absorption rate (SAR) for uncontrolled environment/general exposure limits specified in ANSI/IEEE Std. C95.1-1992 and had been tested in accordance with the measurement procedures specified in IEEE 1528-2013 and IEC 62209-2:2010 (See test report).

I attest to the accuracy of the data. All measurements were performed by myself or were made under my supervision and are correct to the best of my knowledge and belief. I assume full responsibility for the completeness of these measurements and vouch for the qualifications of all persons taking them.

RF Exposure Lab, LLC certifies that no party to this application is subject to a denial of Federal benefits that includes FCC benefits pursuant to Section 5301 of the Anti-Drug Abuse Act of 1988, 21 U.S.C. 853(a).



Jay M. Moulton  
Vice President



Testing Cert. # 2387.01

## Table of Contents

1.	Introduction .....	3
	SAR Definition [5].....	4
2.	SAR Measurement Setup.....	5
	Robotic System.....	5
	System Hardware.....	5
	System Electronics.....	6
	Probe Measurement System.....	6
3.	Probe and Dipole Calibration.....	14
4.	Phantom & Simulating Tissue Specifications.....	15
	Head & Body Simulating Mixture Characterization .....	15
5.	ANSI/IEEE C95.1 – 1992 RF Exposure Limits [2].....	16
	Uncontrolled Environment .....	16
	Controlled Environment.....	16
6.	Measurement Uncertainty .....	17
7.	System Validation.....	18
	Tissue Verification.....	18
	Test System Verification.....	18
8.	SAR Test Data Summary .....	19
	Procedures Used To Establish Test Signal .....	19
	Device Test Condition .....	19
	SAR Data Summary – 2450 MHz Body 802.11b & BT .....	30
	SAR Data Summary – 5250 MHz Body 802.11a .....	31
	SAR Data Summary – 5600 MHz Body 802.11a .....	32
	SAR Data Summary – 5800 MHz Body 802.11a .....	33
	SAR Data Summary – Simultaneous Evaluation .....	34
9.	Test Equipment List.....	35
10.	Conclusion .....	36
11.	References.....	37
	Appendix A – System Validation Plots and Data .....	38
	Appendix B – SAR Test Data Plots .....	48
	Appendix C – SAR Test Setup Photos .....	53
	Appendix D – Probe Calibration Data Sheets.....	58
	Appendix E – Dipole Calibration Data Sheets .....	97
	Appendix F – Phantom Calibration Data Sheets .....	122
	Appendix G – Validation Summary.....	124

## 1. Introduction

This measurement report shows compliance of the Intel Mobile Communications Model 3168NGW installed in HP Model TPN-W131 FCC ID: PD93168NG with FCC Part 2, 1093, ET Docket 93-62 Rules for mobile and portable devices and IC Certificate: 1000M-3168NG with RSS102 Issue 5 & Safety Code 6. The FCC have adopted the guidelines for evaluating the environmental effects of radio frequency radiation in ET Docket 93-62 on August 6, 1996 to protect the public and workers from the potential hazards of RF emissions due to FCC regulated portable devices. [1], [6]

The test results recorded herein are based on a single type test of Intel Mobile Communications Model 3168NGW installed in HP Model TPN-W131 and therefore apply only to the tested sample.

The test procedures, as described in ANSI C95.1 – 1999 Standard for Safety Levels with Respect to Human Exposure to Radio Frequency Electromagnetic Fields, 3 kHz to 300 GHz [2], ANSI C95.3 – 2002 Recommended Practice for the Measurement of Potentially Hazardous Electromagnetic Fields [3], IEEE Std.1528 – 2013 Recommended Practice [4], and Industry Canada Safety Code 6 Limits of Human Exposure to Radiofrequency Electromagnetic Fields in the Frequency Range from 3kHz to 300 GHz were employed.

The following table indicates all the wireless technologies operating in the 3168NGW installed in HP Model TN-W131 Wireless Modem. The table also shows the tolerance for the power level for each mode.

Band	Technology	3GPP Nominal Power dBm	Setpoint Nominal Power dBm	Tolerance dBm	Lower Tolerance dBm	Upper Tolerance dBm
WLAN – 2.4 GHz	802.11bgn	N/A	16.0	±1.5	14.5	17.5
WLAN – 5 GHz Band I, II, III, IV	802.11a	N/A	15.0	±1.5	13.5	16.5

**SAR Definition [5]**

Specific Absorption Rate is defined as the time derivative (rate) of the incremental energy ( $dW$ ) absorbed by (dissipated in) an incremental mass ( $dm$ ) contained in a volume element ( $dV$ ) of a given density ( $\rho$ ).

$$SAR = \frac{d}{dt} \left( \frac{dW}{dm} \right) = \frac{d}{dt} \left( \frac{dW}{\rho dV} \right)$$

SAR is expressed in units of watts per kilogram (W/kg). SAR can be related to the electric field at a point by

$$SAR = \frac{\sigma |E|^2}{\rho}$$

where:

$\sigma$  = conductivity of the tissue (S/m)

$\rho$  = mass density of the tissue (kg/m<sup>3</sup>)

$E$  = rms electric field strength (V/m)

## 2. SAR Measurement Setup

### Robotic System

These measurements are performed using the DASY52 automated dosimetric assessment system. The DASY52 is made by Schmid & Partner Engineering AG (SPEAG) in Zurich, Switzerland and consists of high precision robotics system (Staubli), robot controller, Intel Core2 computer, near-field probe, probe alignment sensor, and the generic twin phantom containing the brain equivalent material. The robot is a six-axis industrial robot performing precise movements to position the probe to the location (points) of maximum electromagnetic field (EMF) (see Fig. 2.1).

### System Hardware

A cell controller system contains the power supply, robot controller teach pendant (Joystick), and a remote control used to drive the robot motors. The PC consists of the HP Intel Core2 computer with Windows XP system and SAR Measurement Software DASY52, A/D interface card, monitor, mouse, and keyboard. The Staubli Robot is connected to the cell controller to allow software manipulation of the robot. A data acquisition electronic (DAE) circuit that performs the signal amplification, signal multiplexing, AD-conversion, offset measurements, mechanical surface detection, collision detection, etc. is connected to the Electro-optical coupler (EOC). The EOC performs the conversion from the optical into digital electric signal of the DAE and transfers data to the PC plug-in card.

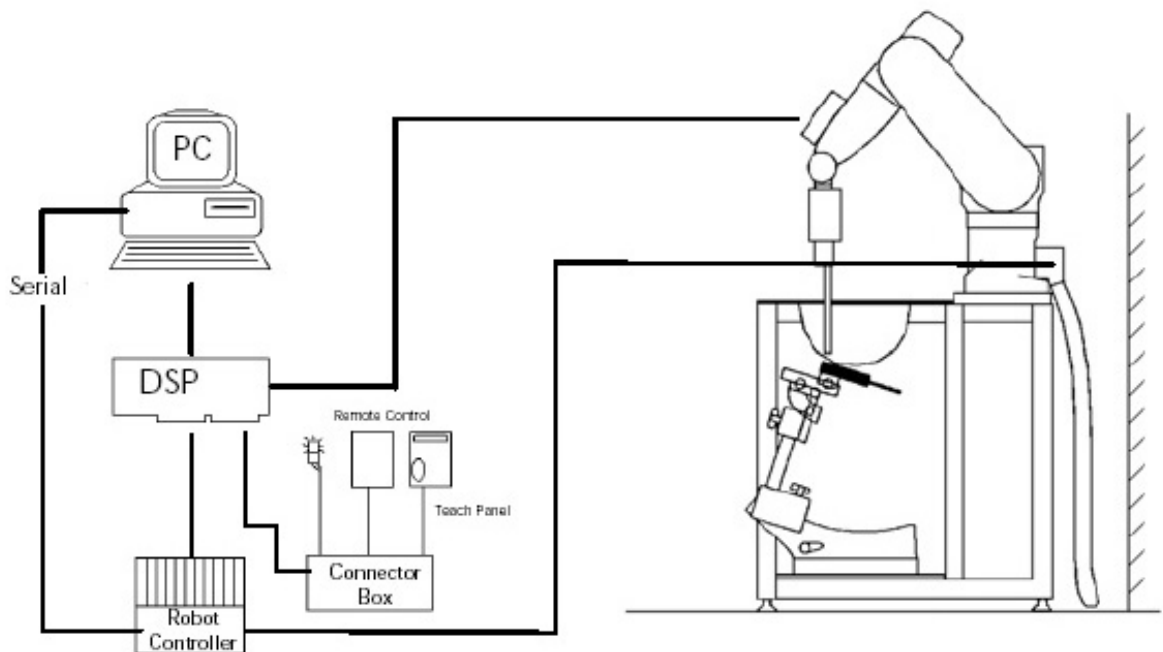

**Figure 2.1 SAR Measurement System Setup**

## System Electronics

The DAE4 consists of a highly sensitive electrometer-grade preamplifier with auto-zeroing, a channel and gain-switching multiplexer, a fast 16 bit AD-converter and a command decoder and control logic unit. Transmission to the PC-card is accomplished through an optical downlink for data and status information and an optical uplink for commands and clock lines. The mechanical probe mounting device includes two different sensor systems for frontal and sidewise probe contacts. They are also used for mechanical surface detection and probe collision detection. The robot uses its own controller with a built in VME-bus computer. The system is described in detail in.

## Probe Measurement System

The SAR measurements were conducted with the dosimetric probe EX3DV4, designed in the classical triangular configuration (see Fig. 2.2) and optimized for dosimetric evaluation. The probe is constructed using the thick film technique; with printed resistive lines on ceramic substrates. The probe is equipped with an optical multi fiber line ending at the front of the probe tip. (see Fig. 2.3) It is connected to the EOC box on the robot arm and provides an automatic detection of the phantom surface. Half of the fibers are connected to a pulsed infrared transmitter, the other half to a synchronized receiver. As the probe approaches the surface, the reflection from the surface produces a coupling from the transmitting to the receiving fibers. This reflection increases first during the approach, reaches maximum and then decreases. If the probe is flatly touching the surface, the coupling is zero. The distance of the coupling maximum to the surface is independent of the surface reflectivity and largely independent of the surface to probe angle. The DASY52 software reads the reflection during a software approach and looks for the maximum using a 2nd order fitting. The approach is stopped at reaching the maximum.



**DAE System**

**Probe Specifications**

**Calibration:** In air from 10 MHz to 6.0 GHz  
In brain and muscle simulating tissue at Frequencies of 450 MHz, 835 MHz, 1750 MHz, 1900 MHz, 2450 MHz, 2600 MHz, 3500 MHz, 5200 MHz, 5300 MHz, 5600 MHz, 5800 MHz

**Frequency:** 10 MHz to 6 GHz

**Linearity:**  $\pm 0.2$ dB (30 MHz to 6 GHz)

**Dynamic:** 10 mW/kg to 100 W/kg

**Range:** Linearity:  $\pm 0.2$ dB

**Dimensions:** Overall length: 330 mm

**Tip length:** 20 mm

**Body diameter:** 12 mm

**Tip diameter:** 2.5 mm

**Distance from probe tip to sensor center:** 1 mm

**Application:** SAR Dosimetry Testing  
Compliance tests of wireless device



Figure 2.2 Triangular Probe Configurations



Figure 2.3 Probe Thick-Film Technique



## Probe Calibration Process

### Dosimetric Assessment Procedure

Each probe is calibrated according to a dosimetric assessment procedure described in with accuracy better than +/- 10%. The spherical isotropy was evaluated with the procedure described in and found to be better than +/-0.25dB. The sensitivity parameters (Norm X, Norm Y, Norm Z), the diode compression parameter (DCP) and the conversion factor (Conv F) of the probe is tested.

### Free Space Assessment

The free space E-field from amplified probe outputs is determined in a test chamber. This is performed in a TEM cell for frequencies below 1 GHz, and in a waveguide above 1GHz for free space. For the free space calibration, the probe is placed in the volumetric center of the cavity at the proper orientation with the field. The probe is then rotated 360 degrees until the three channels show the maximum reading. The power density readings equates to 1 mW/cm<sup>2</sup>.

### Temperature Assessment \*

E-field temperature correlation calibration is performed in a flat phantom filled with the appropriate simulated brain tissue. The measured free space E-field in the medium, correlates to temperature rise in a dielectric medium. For temperature correlation calibration a RF transparent thermistor based temperature probe is used in conjunction with the E-field probe

$$SAR = C \frac{\Delta T}{\Delta t}$$

$$SAR = \frac{|E|^2 \cdot \sigma}{\rho}$$

where:

where:

$\Delta t$  = exposure time (30 seconds),

$\sigma$  = simulated tissue conductivity,

C = heat capacity of tissue (brain or muscle),

$\rho$  = Tissue density (1.25 g/cm<sup>3</sup> for brain tissue)

$\Delta T$  = temperature increase due to RF exposure.

SAR is proportional to  $\Delta T / \Delta t$ , the initial rate of tissue heating, before thermal diffusion takes place.

Now it's possible to quantify the electric field in the simulated tissue by equating the thermally derived SAR to the E- field;

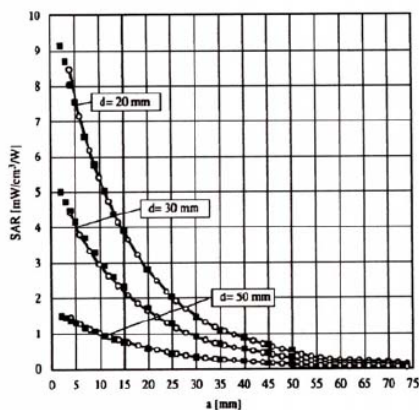

**Figure 2.4 E-Field and Temperature Measurements at 900MHz**

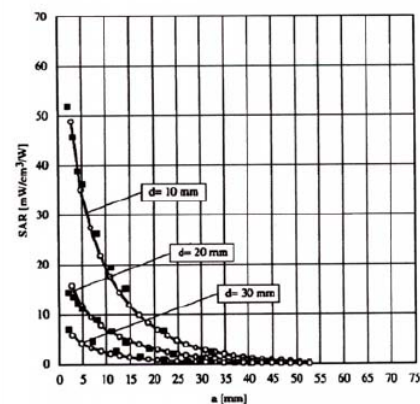

**Figure 2.5 E-Field and Temperature Measurements at 1800MHz**



## Data Extrapolation

The DASY52 software automatically executes the following procedures to calculate the field units from the microvolt readings at the probe connector. The first step of the evaluation is a linearization of the filtered input signal to account for the compression characteristics of the detector diode. The compensation depends on the input signal, the diode type and the DC-transmission factor from the diode to the evaluation electronics. If the exciting field is pulsed, the crest factor of the signal must be known to correctly compensate for peak power. The formula for each channel can be given like below;

$$V_i = U_i + U_i^2 \cdot \frac{cf}{dcp_i}$$

with  $V_i$  = compensated signal of channel i (i=x,y,z)  
 $U_i$  = input signal of channel i (i=x,y,z)  
 $cf$  = crest factor of exciting field (DASY parameter)  
 $dcp_i$  = diode compression point (DASY parameter)

From the compensated input signals the primary field data for each channel can be evaluated:

E-field probes:

$$E_i = \sqrt{\frac{V_i}{Norm_i \cdot ConvF}}$$

with  $V_i$  = compensated signal of channel i (i = x,y,z)  
 $Norm_i$  = sensor sensitivity of channel i (i = x,y,z)  
 $\mu V/(V/m)^2$  for E-field probes  
 $ConvF$  = sensitivity of enhancement in solution  
 $E_i$  = electric field strength of channel i in V/m

The RSS value of the field components gives the total field strength (Hermetian magnitude):

$$E_{tot} = \sqrt{E_x^2 + E_y^2 + E_z^2}$$

The primary field data are used to calculate the derived field units.

$$SAR = E_{tot}^2 \cdot \frac{\sigma}{\rho \cdot 1000}$$

with  $SAR$  = local specific absorption rate in W/g  
 $E_{tot}$  = total field strength in V/m  
 $\sigma$  = conductivity in [mho/m] or [Siemens/m]  
 $\rho$  = equivalent tissue density in g/cm<sup>3</sup>

The power flow density is calculated assuming the excitation field to be a free space field.

$$P_{free} = \frac{E_{tot}^2}{3770}$$

with  $P_{pwe}$  = equivalent power density of a plane wave in W/cm<sup>2</sup>  
 $E_{tot}$  = total electric field strength in V/m

## Scanning procedure

- The DASY installation includes predefined files with recommended procedures for measurements and system check. They are read-only document files and destined as fully defined but unmeasured masks. All test positions (head or body-worn) are tested with the same configuration of test steps differing only in the grid definition for the different test positions.
- The „reference“ and „drift“ measurements are located at the beginning and end of the batch process. They measure the field drift at one single point in the liquid over the complete procedure. The indicated drift is mainly the variation of the DUT's output power and should vary max. +/- 5 %.
- The highest integrated SAR value is the main concern in compliance test applications. These values can mostly be found at the inner surface of the phantom and cannot be measured directly due to the sensor offset in the probe. To extrapolate the surface values, the measurement distances to the surface must be known accurately. A distance error of 0.5mm could produce SAR errors of 6% at 1800 MHz. Using predefined locations for measurements is not accurate enough. Any shift of the phantom (e.g., slight deformations after filling it with liquid) would produce high uncertainties. For an automatic and accurate detection of the phantom surface, the DASY5 system uses the mechanical surface detection. The detection is always at touch, but the probe will move backward from the surface the indicated distance before starting the measurement.
- The „area scan“ measures the SAR above the DUT or verification dipole on a parallel plane to the surface. It is used to locate the approximate location of the peak SAR with 2D spline interpolation. The robot performs a stepped movement along one grid axis while the local electrical field strength is measured by the probe. The probe is touching the surface of the SAM during acquisition of measurement values. The scan uses different grid spacings for different frequency measurements. Standard grid spacing for head measurements in frequency ranges  $\leq 2$ GHz is 15 mm in x - and y- dimension. For higher frequencies a finer resolution is needed, thus for the grid spacing is reduced according the following table:

Area scan grid spacing for different frequency ranges	
Frequency range	Grid spacing
$\leq 2$ GHz	$\leq 15$ mm
2 – 4 GHz	$\leq 12$ mm
4 – 6 GHz	$\leq 10$ mm

Grid spacing and orientation have no influence on the SAR result. For special applications where the standard scan method does not find the peak SAR within the grid, e.g. mobile phones with flip cover, the grid can be adapted in orientation. Results of this coarse scan are shown in annex B.

- A „zoom scan“ measures the field in a volume around the 2D peak SAR value acquired in the previous „coarse“ scan. It uses a fine meshed grid where the robot moves the probe in steps along all the 3 axis (x,y and z-axis) starting at the bottom of the Phantom. The grid spacing for the cube measurement is varied according to the measured frequency range, the dimensions are given in the following table:

<b>Zoom scan grid spacing and volume for different frequency ranges</b>			
Frequency range	Grid spacing for x, y axis	Grid spacing for z axis	Minimum zoom scan volume
≤ 2 GHz	≤ 8 mm	≤ 5 mm	≥ 30 mm
2 – 3 GHz	≤ 5 mm	≤ 5 mm	≥ 28 mm
3 – 4 GHz	≤ 5 mm	≤ 4 mm	≥ 28 mm
4 – 5 GHz	≤ 4 mm	≤ 3 mm	≥ 25 mm
5 – 6 GHz	≤ 4 mm	≤ 2 mm	≥ 22 mm

DASY is also able to perform repeated zoom scans if more than 1 peak is found during area scan. In this document, the evaluated peak 1g and 10g averaged SAR values are shown in the 2D-graphics in annex B. Test results relevant for the specified standard (see section 3) are shown in table form in section 7.

## Spatial Peak SAR Evaluation

The spatial peak SAR - value for 1 and 10 g is evaluated after the Cube measurements have been done. The basis of the evaluation are the SAR values measured at the points of the fine cube grid consisting of all points in the three directions x, y and z. The algorithm that finds the maximal averaged volume is separated into three different stages.

- The data between the dipole center of the probe and the surface of the phantom are extrapolated. This data cannot be measured since the center of the dipole is 1 to 2.7 mm away from the tip of the probe and the distance between the surface and the lowest measuring point is about 1 mm (see probe calibration sheet). The extrapolated data from a cube measurement can be visualized by selecting 'Graph Evaluated'.
- The maximum interpolated value is searched with a straight-forward algorithm. Around this maximum the SAR - values averaged over the spatial volumes (1g or 10 g) are computed using the 3d-spline interpolation algorithm. If the volume cannot be evaluated (i.e., if a part of the grid was cut off by the boundary of the measurement area) the evaluation will be started on the corners of the bottom plane of the cube.
- All neighboring volumes are evaluated until no neighboring volume with a higher average value is found.

## Extrapolation

The extrapolation is based on a least square algorithm [W. Gander, Computermathematik, p.168-180]. Through the points in the first 3 cm along the z-axis, polynomials of order four are calculated. These polynomials are then used to evaluate the points between the surface and the probe tip. The points, calculated from the surface, have a distance of 1 mm from each other.

## Interpolation

The interpolation of the points is done with a 3d-Spline. The 3d-Spline is composed of three one-dimensional splines with the "Not a knot"-condition [W. Gander, Computermathematik, p.141-150] (x, y and z -direction) [Numerical Recipes in C, Second Edition, p.123ff ].

## Volume Averaging

At First the size of the cube is calculated. Then the volume is integrated with the trapezoidal algorithm. 8000 points (20x20x20) are interpolated to calculate the average.

## Advanced Extrapolation

DASY uses the advanced extrapolation option which is able to compensate boundary effects on E-field probes.

**SAM PHANTOM**

The SAM Twin Phantom V4.0 is constructed of a fiberglass shell integrated in a wooden table. The shape of the shell is based on data from an anatomical study designed to determine the maximum exposure in at least 90% of all users. It enables the dosimetric evaluation of left and right hand phone usage as well as body mounted usage at the flat phantom region. A cover prevents the evaporation of the liquid. Reference markings on the Phantom allow the complete setup of all predefined phantom positions and measurement grids by manually teaching three points in the robot. (see Fig. 2.6)

**Phantom Specification**

**Phantom:** SAM Twin Phantom (V4.0)  
**Shell Material:** Vivac Composite  
**Thickness:**  $2.0 \pm 0.2$  mm



**Figure 2.6 SAM Twin Phantom**

**Device Holder for Transmitters**

In combination with the SAM Twin Phantom V4.0 the Mounting Device (see Fig. 2.7), enables the rotation of the mounted transmitter in spherical coordinates whereby the rotation point is the ear opening. The devices can be easily, accurately, and repeatedly positioned according to the FCC, CENELEC, IEC and IEEE specifications. The device holder can be locked at different phantom locations (left head, right head, flat phantom).



**Figure 2.7 Mounting Device**

Note: A simulating human hand is not used due to the complex anatomical and geometrical structure of the hand that may produce infinite number of configurations. To produce the worst-case condition (the hand absorbs antenna output power), the hand is omitted during the tests.

### **3. Probe and Dipole Calibration**

**See Appendix D and E.**

## 4. Phantom & Simulating Tissue Specifications

### Head & Body Simulating Mixture Characterization

The head and body mixtures consist of the material based on the table listed below. The mixture is calibrated to obtain proper dielectric constant (permittivity) and conductivity of the desired tissue. Body tissue parameters that have not been specified in IEEE1528-2013 are derived from the issue dielectric parameters computed from the 4-Cole-Cole equations.

**Table 4.1 Typical Composition of Ingredients for Tissue**

Ingredients	Simulating Tissue				
	2450 MHz Body	5250 MHz Body	5600 MHz Body	5785 MHz Body	
Mixing Percentage					
Water	73.20	Proprietary Mixture Procured from Speag			
Sugar	0.00				
Salt	0.04				
HEC	0.00				
Bactericide	0.00				
DGBE	26.70				
Dielectric Constant	Target	52.70	48.96	48.47	48.25
Conductivity (S/m)	Target	1.95	5.35	5.77	5.96



## 5. ANSI/IEEE C95.1 – 1992 RF Exposure Limits [2]

### Uncontrolled Environment

Uncontrolled Environments are defined as locations where there is the exposure of individuals who have no knowledge or control of their exposure. The general population/uncontrolled exposure limits are applicable to situations in which the general public may be exposed or in which persons who are exposed as a consequence of their employment may not be made fully aware of the potential for exposure or cannot exercise control over their exposure. Members of the general public would come under this category when exposure is not employment-related; for example, in the case of a wireless transmitter that exposes persons in its vicinity.

### Controlled Environment

Controlled Environments are defined as locations where there is exposure that may be incurred by persons who are aware of the potential for exposure, (i.e. as a result of employment or occupation). In general, occupational/controlled exposure limits are applicable to situations in which persons are exposed as a consequence of their employment, who have been made fully aware of the potential for exposure and can exercise control over their exposure. This exposure category is also applicable when the exposure is of a transient nature due to incidental passage through a location where the exposure levels may be higher than the general population/uncontrolled limits, but the exposed person is fully aware of the potential for exposure and can exercise control over his or her exposure by leaving the area or by some other appropriate means.

**Table 5.1 Human Exposure Limits**

	UNCONTROLLED ENVIRONMENT General Population (W/kg) or (mW/g)	CONTROLLED ENVIROMENT Professional Population (W/kg) or (mW/g)
SPATIAL PEAK SAR <sup>1</sup> Head	1.60	8.00
SPATIAL AVERAGE SAR <sup>2</sup> Whole Body	0.08	0.40
SPATIAL PEAK SAR <sup>3</sup> Hands, Feet, Ankles, Wrists	4.00	20.00

<sup>1</sup> The Spatial Peak value of the SAR averaged over any 1 gram of tissue (defined as a tissue volume in the shape of a cube) and over the appropriate averaging time.

<sup>2</sup> The Spatial Average value of the SAR averaged over the whole body.

<sup>3</sup> The Spatial Peak value of the SAR averaged over any 10 grams of tissue (defined as a tissue volume in the shape of a cube) and over the appropriate averaging time.

## 6. Measurement Uncertainty

Measurement uncertainty table is not required per KDB 865664 D01 v01r04 section 2.8.2 page 12. SAR measurement uncertainty analysis is required in the SAR report only when the highest measured SAR in a frequency band is  $\geq 1.5$  W/kg for 1-g SAR. The equivalent ratio (1.5/1.6) should be applied to extremity and occupational exposure conditions. The highest reported value is less than 1.5 W/kg. Therefore, the measurement uncertainty table is not required.

## 7. System Validation

### Tissue Verification

**Table 7.1 Measured Tissue Parameters**

		2450 MHz Body		5200 MHz Body	
Date(s)		Jan. 23, 2018		Jan. 23, 2018	
Liquid Temperature (°C)	20.0	Target	Measured	Target	Measured
Dielectric Constant: $\epsilon$		52.70	52.58	49.01	48.94
Conductivity: $\sigma$		1.95	2.00	5.30	5.34
		5600 MHz Body		5800 MHz Body	
Date(s)		Jan. 23, 2018		Jan. 23, 2018	
Liquid Temperature (°C)	20.0	Target	Measured	Target	Measured
Dielectric Constant: $\epsilon$		48.47	48.36	48.20	48.05
Conductivity: $\sigma$		5.77	5.80	6.00	6.04

See Appendix A for data printout.

### Test System Verification

Prior to assessment, the system is verified to the  $\pm 10\%$  of the specifications at the test frequency by using the system kit. Power is normalized to 1 watt. (Graphic Plots Attached)

**Table 7.2 System Dipole Validation Target & Measured**

	Test Frequency	Targeted SAR <sub>1g</sub> (W/kg)	Measure SAR <sub>1g</sub> (W/kg)	Tissue Used for Verification	Deviation Target and Fast SAR to SAR (%)	Plot Number
23-Jan-2018	2450 MHz	52.10	52.00	Body	- 0.19	1
23-Jan-2018	5200 MHz	77.40	78.10	Body	+ 0.90	2
23-Jan-2018	5600 MHz	80.70	81.90	Body	+ 1.49	3
23-Jan-2018	5800 MHz	78.80	79.10	Body	+ 0.38	4

See Appendix A for data plots.

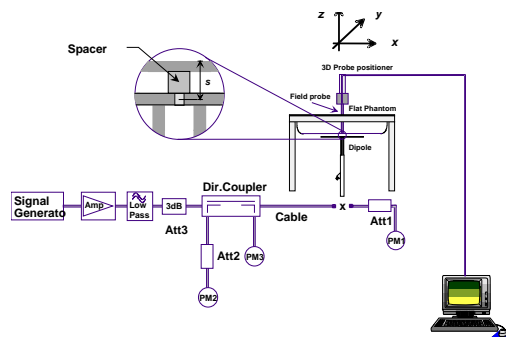

**Figure 7.1 Dipole Validation Test Setup**

## 8. SAR Test Data Summary

### See Measurement Result Data Pages

See Appendix B for SAR Test Data Plots.  
See Appendix C for SAR Test Setup Photos.

### Procedures Used To Establish Test Signal

The device was either placed into simulated transmit mode using the manufacturer's test codes or the actual transmission is activated through a base station simulator or similar equipment. See data pages for actual procedure used in measurement.

### Device Test Condition

In order to verify that the device was tested at full power, conducted output power measurements were performed before and after each SAR measurement to confirm the output power unless otherwise noted. If a conducted power deviation of more than 5% occurred, the test was repeated. The power drift of each test is measured at the start of the test and again at the end of the test. The drift percentage is calculated by the formula  $((\text{end}/\text{start})-1)*100$  and rounded to three decimal places. The drift percentage is calculated into the resultant SAR value on the data sheet for each test.

The EUT was tested in the tablet configuration of the device. The EUT was tested on all sides of the device where the antenna was within 25 mm of that side. All measurements were conducted with the side of the device in direct contact with the phantom. For sides of the antenna which were not measured in this report, the SAR was conducted on the module in the modular approval with the maximum distance of 8 mm on all six sides of the antenna. Data is located in the original modular report. Therefore, the requirements mentioned in RSS-102 Supplementary Procedures (SPR)-001 – SAR Testing Requirements with Regards to Bystanders for Laptop Type Computers with Antennas Built-In on Display Screen (Laptop/Tablet Mode) are covered.

The Bluetooth transmitter does simultaneously transmit with the WiFi transmitter. When the BT is turned on, it transmits on Aux and the WiFi transmits on Main. Simultaneous transmission is evaluated on page 34.

The main antenna was evaluated for stand-alone SAR per RSS-102 Issue 5 for BT. Please see data sheet summary on page 30.

The data rates used when evaluating the WiFi transmitter were the lowest data rates for each mode. The device was operating at its maximum output power at the lowest data rate for all measurements.

The tablet was using the Intel test utility DRTU Version 10.1720.0-05195 and the device driver was version 19.50.1.6.

The antenna was on a minimum of 10 cm of Styrofoam during each test. The following is a pictorial drawing of the locations and separation distances.

**Location and Separation Distances Diagrams**

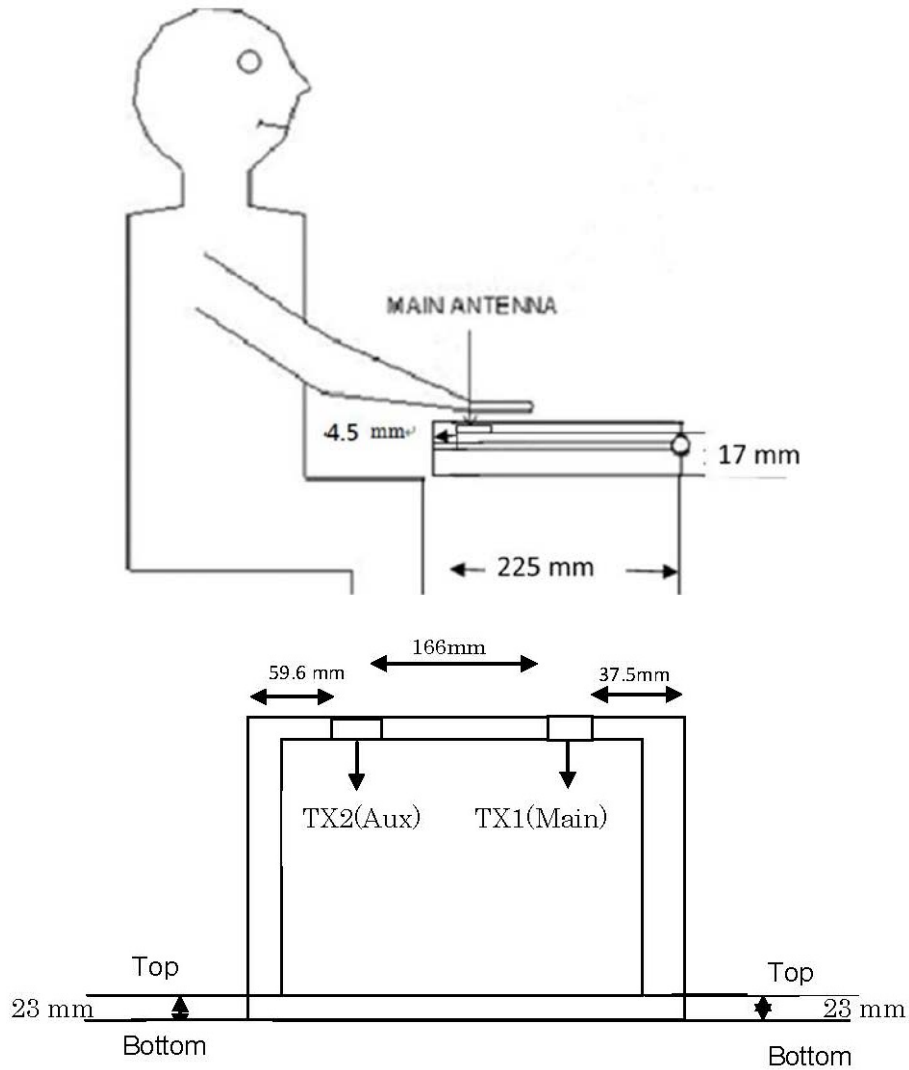

Band	Mode	Bandwidth (MHz)	Channel	Frequency (MHz)	Data Rate	Antenna	Avg Power (dBm)	Tune-up Pwr (dBm)
2450 MHz	802.11b	20	2	2417	1 Mbps	Chain A	17.45	17.50
			6	2437			17.50	17.50
			10	2457			17.50	17.50
	802.11g	20	2	2417	6 Mbps	Chain A	17.47	17.50
			6	2437			17.44	17.50
			10	2457			17.44	17.50
	802.11n	20	2	2417	HTO	Chain A	17.45	17.50
			6	2437			17.37	17.50
			10	2457			17.40	17.50
	802.11n	40	4	2427	HTO	Chain A	17.45	17.50
			6	2437			17.37	17.50
			8	2447			17.40	17.50
5.15-5.25 GHz	802.11a	20	38	5190	6 Mbps	Chain A	16.42	16.50
			40	5200			16.50	16.50
			44	5220			16.50	16.50
			46	5230			16.47	16.50
	802.11n	20	38	5190	HTO	Chain A	16.41	16.50
			40	5200			16.38	16.50
			44	5220			16.39	16.50
			46	5230			16.35	16.50
	802.11n	40	40	5200	HTO	Chain A	16.42	16.50
			46	5230			16.44	16.50
	802.11ac	80	42	5210	VHTO	Chain A	13.42	13.50
			54	5270			16.45	16.50
5.25-5.35 GHz	802.11a	20	56	5280	6 Mbps	Chain A	16.50	16.50
			60	5300			16.50	16.50
			62	5310			16.47	16.50
			54	5270			16.42	16.50
	802.11n	20	56	5280	HTO	Chain A	16.39	16.50
			60	5300			16.38	16.50
			62	5310			16.40	16.50
			54	5270			16.32	16.50
	802.11n	40	60	5300	HTO	Chain A	16.34	16.50
			58	5290			13.35	13.50
	802.11ac	80	58	5290	VHTO	Chain A	13.35	13.50

Band	Mode	Bandwidth (MHz)	Channel	Frequency (MHz)	Data Rate	Antenna	Avg Power (dBm)	Tune-up Pwr (dBm)
5600 MHz	802.11a	20	102	5510	6 Mbps	Chain A	16.42	16.50
			104	5520			16.50	16.50
			108	5540			16.45	16.50
			112	5560			16.47	16.50
			116	5580			16.50	16.50
			120	5600			16.41	16.50
			124	5620			16.50	16.50
			128	5640			16.48	16.50
			132	5660			16.44	16.50
			136	5680			16.50	16.50
			138	5690			16.40	16.50
			802.11n	20			102	5510
	104	5520			16.33	16.50		
	108	5540			16.35	16.50		
	112	5560			16.36	16.50		
	116	5580			16.34	16.50		
	120	5600			16.40	16.50		
	124	5620			16.41	16.50		
	128	5640			16.34	16.50		
	132	5660			16.31	16.50		
	136	5680			16.39	16.50		
	138	5690			16.38	16.50		
	802.11n	40			104	5520	HTO	Chain A
			110	5550	16.40	16.50		
			118	5580	16.42	16.50		
			126	5610	16.37	16.50		
	802.11ac	80	132	5660	VHTO	Chain A	16.38	16.50
			106	5530			14.88	15.00
			122	5610			14.92	15.00
			138	5690			14.86	15.00

Band	Mode	Bandwidth (MHz)	Channel	Frequency (MHz)	Data Rate	Antenna	Avg Power (dBm)	Tune-up Pwr (dBm)
5800 MHz	802.11a	20	149	5745	6 Mbps	Chain A	16.50	16.50
			153	5765			16.42	16.50
			157	5785			16.50	16.50
			161	5805			16.44	16.50
			165	5825			16.50	16.50
	802.11n	20	150	5750	HT0	Chain A	16.38	16.50
			153	5765			16.37	16.50
			157	5785			16.40	16.50
			161	5805			16.32	16.50
	802.11n	40	164	5820	HT0	Chain A	16.34	16.50
			152	5760			16.42	16.50
	802.11ac	80	159	5795	VHT0	Chain A	16.45	16.50
			155	5775			14.92	15.00

Band	Mode	Channel	Frequency (MHz)	Data Rate	Antenna	Avg Power (dBm)	Tune-up Pwr (dBm)
2450 MHz	Bluetooth v4.0	0	2402	Basic Rate GFSK	Chain B	11.40	11.50
		39	2441			11.47	11.50
		78	2480			11.42	11.50
		0	2402	EDR $\pi/4$ DQPSK		11.42	11.50
		39	2441			11.43	11.50
		78	2480			11.38	11.50
		0	2402	EDR 8-DPSK		11.44	11.50
		39	2441			11.41	11.50
		78	2480			11.43	11.50
		0	2402	Low Energy GFSK		8.99	9.00
		39	2441			8.88	9.00
		78	2480			8.93	9.00



**Figure 8.1 Test Reduction Table – 2.4 GHz Main Inpaq**

Mode	Side	Required Channel	Tested/Reduced
802.11b	Back	1 – 2412 MHz	Reduced <sup>1</sup>
		6 – 2437 MHz	Tested
		11 – 2462 MHz	Reduced <sup>1</sup>
	Top	1 – 2412 MHz	Reduced <sup>2</sup>
		6 – 2437 MHz	Tested
		11 – 2462 MHz	Tested
	Right, Left, Bottom	1 – 2412 MHz	Reduced <sup>4</sup>
		6 – 2437 MHz	Reduced <sup>4</sup>
		11 – 2462 MHz	Reduced <sup>4</sup>
802.11g	Back	1 – 2412 MHz	Reduced <sup>3</sup>
		6 – 2437 MHz	Reduced <sup>3</sup>
		11 – 2462 MHz	Reduced <sup>3</sup>
	Top	1 – 2412 MHz	Reduced <sup>3</sup>
		6 – 2437 MHz	Reduced <sup>3</sup>
		11 – 2462 MHz	Reduced <sup>3</sup>
	Right, Left, Bottom	1 – 2412 MHz	Reduced <sup>3</sup>
		6 – 2437 MHz	Reduced <sup>3</sup>
		11 – 2462 MHz	Reduced <sup>3</sup>
802.11n	Back	1 – 2412 MHz	Reduced <sup>3</sup>
		6 – 2437 MHz	Reduced <sup>3</sup>
		11 – 2462 MHz	Reduced <sup>3</sup>
	Top	1 – 2412 MHz	Reduced <sup>3</sup>
		6 – 2437 MHz	Reduced <sup>3</sup>
		11 – 2462 MHz	Reduced <sup>3</sup>
	Right, Left, Bottom	1 – 2412 MHz	Reduced <sup>4</sup>
		6 – 2437 MHz	Reduced <sup>4</sup>
		11 – 2462 MHz	Reduced <sup>4</sup>

Reduced<sup>1</sup> – When the reported SAR is ≤ 0.4 W/kg, SAR is not required for the remaining test configuration per KDB 248227 D01 v02r02 section 5.1.1 1) page 9.

Reduced<sup>2</sup> – When the reported SAR is >0.4 W/kg, test the next highest configuration until the SAR value is ≤ 0.8 W/kg per KDB 248227 D01 v02r02 section 5.1.1 2) page 9.

Reduced<sup>3</sup> – When the highest reported SAR for DSSS is adjusted by the ratio of OFDM to DSSS specified maximum output power and the adjusted SAR is ≤ 1.2 W/kg, SAR is not required per KDB 248227 D01 v02r02 section 5.2.2 2) page 10.

Reduced<sup>4</sup> – When the antenna is more than 25 mm from a side, the test can be reduced per KDB447498 D01 v06 section 4.3.1 1) page 11. See below for calculations.

**Calculations for test exclusion for Bottom, Right and Left side.**

Maximum power: 56.2 mW  
 Bottom Edge distance: 213.7 mm  
 Right Side distance: 37.5 mm  
 Left Side distance: 255.6 mm

The closest distance is from the right side. Therefore, if the right side is excluded the bottom and left would also be excluded.

$[(56.2)/(37.5)*\sqrt{2.462}] = 2.4$  which is less than 3.0

**Figure 8.2 Test Reduction Table – 5.1 GHz Main Inpaq**

Mode	Side	Required Channel	Tested/Reduced
802.11a 5150 MHz	Back	36 – 5180 MHz	Reduced <sup>1</sup>
		40 – 5200 MHz	Reduced <sup>1</sup>
		44 – 5220 MHz	Reduced <sup>1</sup>
		48 – 5240 MHz	Reduced <sup>1</sup>
	Top	36 – 5180 MHz	Reduced <sup>1</sup>
		40 – 5200 MHz	Reduced <sup>1</sup>
		44 – 5220 MHz	Reduced <sup>1</sup>
		48 – 5240 MHz	Reduced <sup>1</sup>
	Right, Left, Bottom	36 – 5180 MHz	Reduced <sup>2</sup>
		40 – 5200 MHz	Reduced <sup>2</sup>
		44 – 5220 MHz	Reduced <sup>2</sup>
		48 – 5240 MHz	Reduced <sup>2</sup>
802.11n 5150 MHz	Back	36 – 5180 MHz	Reduced <sup>1</sup>
		40 – 5200 MHz	Reduced <sup>1</sup>
		44 – 5220 MHz	Reduced <sup>1</sup>
		48 – 5240 MHz	Reduced <sup>1</sup>
	Top	36 – 5180 MHz	Reduced <sup>1</sup>
		40 – 5200 MHz	Reduced <sup>1</sup>
		44 – 5220 MHz	Reduced <sup>1</sup>
		48 – 5240 MHz	Reduced <sup>1</sup>
	Right, Left, Bottom	36 – 5180 MHz	Reduced <sup>2</sup>
		40 – 5200 MHz	Reduced <sup>2</sup>
		44 – 5220 MHz	Reduced <sup>2</sup>
		48 – 5240 MHz	Reduced <sup>2</sup>
802.11ac 5210 MHz	Back	42 – 5210 MHz	Reduced <sup>1</sup>
	Top	42 – 5210 MHz	Reduced <sup>1</sup>
	Right, Left, Bottom	42 – 5210 MHz	Reduced <sup>2</sup>

Reduced<sup>1</sup> – When the adjusted SAR is ≤ 1.2 W/kg, SAR is not required for the UNII-1 with the same or lower maximum output power in that test configuration per KDB 248227 D01 v02r02 section 5.3.1 1) page 11.

Reduced<sup>2</sup> – When the antenna is more than 25 mm from a side, the test can be reduced per KDB447498 D01 v06 section 4.3.1 1) page 11. See below for calculations.

**Calculations for test exclusion for Bottom, Right and Left side.**

Maximum power: 44.7 mW  
 Bottom Edge distance: 213.7 mm  
 Right Side distance: 37.5 mm  
 Left Side distance: 255.6 mm

The closest distance is from the right side. Therefore, if the right side is excluded the bottom and left would also be excluded.

$$[(44.7)/(37.5)*\sqrt{5.24}] = 2.7 \text{ which is less than } 3.0$$

**Figure 8.3 Test Reduction Table – 5.2 GHz Main Inpaq**

Mode	Side	Required Channel	Tested/Reduced
802.11a 5150 MHz	Back	52 – 5260 MHz	Reduced <sup>1</sup>
		56 – 5280 MHz	Reduced <sup>1</sup>
		60 – 5300 MHz	Tested
		64 – 5320 MHz	Reduced <sup>1</sup>
	Top	52 – 5260 MHz	Reduced <sup>3</sup>
		56 – 5280 MHz	Tested
		60 – 5300 MHz	Tested
		64 – 5320 MHz	Reduced <sup>3</sup>
	Right, Left, Bottom	52 – 5260 MHz	Reduced <sup>2</sup>
		56 – 5280 MHz	Reduced <sup>2</sup>
		60 – 5300 MHz	Reduced <sup>2</sup>
		64 – 5320 MHz	Reduced <sup>2</sup>
802.11n 5150 MHz	Back	52 – 5260 MHz	Reduced <sup>1</sup>
		56 – 5280 MHz	Reduced <sup>1</sup>
		60 – 5300 MHz	Reduced <sup>1</sup>
		64 – 5320 MHz	Reduced <sup>1</sup>
	Top	52 – 5260 MHz	Reduced <sup>3</sup>
		56 – 5280 MHz	Reduced <sup>3</sup>
		60 – 5300 MHz	Reduced <sup>3</sup>
		64 – 5320 MHz	Reduced <sup>3</sup>
	Right, Left, Bottom	52 – 5260 MHz	Reduced <sup>2</sup>
		56 – 5280 MHz	Reduced <sup>2</sup>
		60 – 5300 MHz	Reduced <sup>2</sup>
		64 – 5320 MHz	Reduced <sup>2</sup>
802.11ac 5210 MHz	Back	58 – 5290 MHz	Reduced <sup>1</sup>
	Top	58 – 5290 MHz	Reduced <sup>3</sup>
	Right, Left, Bottom	58 – 5290 MHz	Reduced <sup>2</sup>

Reduced<sup>1</sup> – When the reported SAR is ≤ 0.4 W/kg, SAR is not required for the remaining test configuration per KDB 248227 D01 v02r02 section 5.1.1 1) page 9.

Reduced<sup>2</sup> – When the antenna is more than 25 mm from a side, the test can be reduced per KDB447498 D01 v06 section 4.3.1 1) page 11. See below for calculations.

Reduced<sup>3</sup> – When the reported SAR is >0.8 W/kg, test the next highest configuration until the SAR value is ≤ 1.2 W/kg per KDB 248227 D01 v02r02 section 5.1.1 3) page 9.

Reduced<sup>4</sup> – When the reported SAR is >0.4 W/kg, test the next highest configuration until the SAR value is ≤ 0.8 W/kg per KDB 248227 D01 v02r02 section 5.1.1 2) page 9.

**Calculations for test exclusion for Bottom, Right and Left side.**

Maximum power: 44.7 mW  
 Bottom Edge distance: 213.7 mm  
 Right Side distance: 37.5 mm  
 Left Side distance: 255.6 mm

The closest distance is from the right side. Therefore, if the right side is excluded the bottom and left would also be excluded.

$[(44.7)/(37.5)*\sqrt{5.32}] = 2.8$  which is less than 3.0

**Figure 8.4 Test Reduction Table – 5.6 GHz Main Inpaq**

Mode	Side	Required Channel	Tested/Reduced
802.11a 5600 MHz	Back	100 – 5500 MHz	Reduced <sup>4</sup>
		104 – 5520 MHz	Reduced <sup>4</sup>
		108 – 5540 MHz	Reduced <sup>4</sup>
		112 – 5560 MHz	Reduced <sup>4</sup>
		116 – 5580 MHz	Reduced <sup>4</sup>
		120 – 5600 MHz	Reduced <sup>4</sup>
		124 – 5620 MHz	Tested
		128 – 5640 MHz	Reduced <sup>4</sup>
		132 – 5660 MHz	Reduced <sup>4</sup>
		136 – 5680 MHz	Reduced <sup>4</sup>
	140 – 5700 MHz	Reduced <sup>4</sup>	
	Top	100 – 5500 MHz	Reduced <sup>2</sup>
		104 – 5520 MHz	Reduced <sup>2</sup>
		108 – 5540 MHz	Reduced <sup>2</sup>
		112 – 5560 MHz	Reduced <sup>2</sup>
		116 – 5580 MHz	Tested
		120 – 5600 MHz	Reduced <sup>2</sup>
		124 – 5620 MHz	Tested
		128 – 5640 MHz	Reduced <sup>2</sup>
		132 – 5660 MHz	Reduced <sup>2</sup>
		136 – 5680 MHz	Reduced <sup>2</sup>
	140 – 5700 MHz	Reduced <sup>2</sup>	
	Right, Left, Bottom	100 – 5500 MHz	Reduced <sup>3</sup>
		104 – 5520 MHz	Reduced <sup>3</sup>
		108 – 5540 MHz	Reduced <sup>3</sup>
		112 – 5560 MHz	Reduced <sup>3</sup>
		116 – 5580 MHz	Reduced <sup>3</sup>
		120 – 5600 MHz	Reduced <sup>3</sup>
		124 – 5620 MHz	Reduced <sup>3</sup>
		128 – 5640 MHz	Reduced <sup>3</sup>
		132 – 5660 MHz	Reduced <sup>3</sup>
		136 – 5680 MHz	Reduced <sup>3</sup>
	140 – 5700 MHz	Reduced <sup>3</sup>	

Reduced<sup>1</sup> – When the reported SAR is >0.4 W/kg, test the next highest configuration until the SAR value is ≤ 0.8 W/kg per KDB 248227 D01 v02r02 section 5.1.1 2) page 9.

Reduced<sup>2</sup> – When the reported SAR is >0.8 W/kg, test the next highest configuration until the SAR value is ≤ 1.2 W/kg per KDB 248227 D01 v02r02 section 5.1.1 3) page 9.

Reduced<sup>3</sup> – When the antenna is more than 25 mm from a side, the test can be reduced per KDB447498 D01 v06 section 4.3.1 1) page 11. See below for calculations.

Reduced<sup>4</sup> – When the reported SAR is ≤ 0.4 W/kg, SAR is not required for the remaining test configuration per KDB 248227 D01 v02r02 section 5.1.1 1) page 9.

**Calculations for test exclusion for Bottom, Right and Left side.**

Maximum power: 44.7 mW  
 Bottom Edge distance: 213.7 mm  
 Right Side distance: 37.5 mm  
 Left Side distance: 255.6 mm

The closest distance is from the right side. Therefore, if the right side is excluded the bottom and left would also be excluded.

$$[(44.7)/(37.5)^2 \sqrt{5.70}] = 2.9 \text{ which is less than } 3.0$$

**Figure 8.5 Test Reduction Table – 5.6 GHz Main Inpaq**

Mode	Side	Required Channel	Tested/Reduced
802.11n 5600 MHz	Back	100 – 5500 MHz	Reduced <sup>4</sup>
		104 – 5520 MHz	Reduced <sup>4</sup>
		108 – 5540 MHz	Reduced <sup>4</sup>
		112 – 5560 MHz	Reduced <sup>4</sup>
		116 – 5580 MHz	Reduced <sup>4</sup>
		120 – 5600 MHz	Reduced <sup>4</sup>
		124 – 5620 MHz	Reduced <sup>4</sup>
		128 – 5640 MHz	Reduced <sup>4</sup>
		132 – 5660 MHz	Reduced <sup>4</sup>
		136 – 5680 MHz	Reduced <sup>4</sup>
	140 – 5700 MHz	Reduced <sup>4</sup>	
	Top	100 – 5500 MHz	Reduced <sup>2</sup>
		104 – 5520 MHz	Reduced <sup>2</sup>
		108 – 5540 MHz	Reduced <sup>2</sup>
		112 – 5560 MHz	Reduced <sup>2</sup>
		116 – 5580 MHz	Reduced <sup>2</sup>
		120 – 5600 MHz	Reduced <sup>2</sup>
		124 – 5620 MHz	Reduced <sup>2</sup>
		128 – 5640 MHz	Reduced <sup>2</sup>
		132 – 5660 MHz	Reduced <sup>2</sup>
		136 – 5680 MHz	Reduced <sup>2</sup>
	140 – 5700 MHz	Reduced <sup>2</sup>	
	Right, Left, Bottom	100 – 5500 MHz	Reduced <sup>3</sup>
		104 – 5520 MHz	Reduced <sup>3</sup>
		108 – 5540 MHz	Reduced <sup>3</sup>
		112 – 5560 MHz	Reduced <sup>3</sup>
		116 – 5580 MHz	Reduced <sup>3</sup>
		120 – 5600 MHz	Reduced <sup>3</sup>
		124 – 5620 MHz	Reduced <sup>3</sup>
		128 – 5640 MHz	Reduced <sup>3</sup>
132 – 5660 MHz		Reduced <sup>3</sup>	
136 – 5680 MHz		Reduced <sup>3</sup>	
140 – 5700 MHz	Reduced <sup>3</sup>		

Reduced<sup>1</sup> – When the reported SAR is >0.4 W/kg, test the next highest configuration until the SAR value is ≤ 0.8 W/kg per KDB 248227 D01 v02r02 section 5.1.1 2) page 9.

Reduced<sup>2</sup> – When the reported SAR is >0.8 W/kg, test the next highest configuration until the SAR value is ≤ 1.2 W/kg per KDB 248227 D01 v02r02 section 5.1.1 3) page 9.

Reduced<sup>3</sup> – When the antenna is more than 25 mm from a side, the test can be reduced per KDB447498 D01 v06 section 4.3.1 1) page 11. See below for calculations.

Reduced<sup>4</sup> – When the reported SAR is ≤ 0.4 W/kg, SAR is not required for the remaining test configuration per KDB 248227 D01 v02r02 section 5.1.1 1) page 9.

**Calculations for test exclusion for Bottom, Right and Left side.**

Maximum power: 44.7 mW  
 Bottom Edge distance: 213.7 mm  
 Right Side distance: 37.5 mm  
 Left Side distance: 255.6 mm

The closest distance is from the right side. Therefore, if the right side is excluded the bottom and left would also be excluded.

$$[(44.7)/(37.5)*\sqrt{5.70}] = 2.9 \text{ which is less than } 3.0$$

**Figure 8.6 Test Reduction Table – 5.6 GHz Main Inpaq**

Mode	Side	Required Channel	Tested/Reduced
802.11ac 5600 MHz	Back	106 – 5530 MHz	Reduced <sup>4</sup>
		122 – 5610 MHz	Reduced <sup>4</sup>
		138 – 5690 MHz	Reduced <sup>4</sup>
	Top	106 – 5530 MHz	Reduced <sup>2</sup>
		122 – 5610 MHz	Reduced <sup>2</sup>
		138 – 5690 MHz	Reduced <sup>2</sup>
	Right, Left, Bottom	106 – 5530 MHz	Reduced <sup>3</sup>
		122 – 5610 MHz	Reduced <sup>3</sup>
		138 – 5690 MHz	Reduced <sup>3</sup>

Reduced<sup>1</sup> – When the reported SAR is >0.4 W/kg, test the next highest configuration until the SAR value is ≤ 0.8 W/kg per KDB 248227 D01 v02r02 section 5.1.1 2) page 9.

Reduced<sup>2</sup> – When the reported SAR is >0.8 W/kg, test the next highest configuration until the SAR value is ≤ 1.2 W/kg per KDB 248227 D01 v02r02 section 5.1.1 3) page 9.

Reduced<sup>3</sup> – When the antenna is more than 25 mm from a side, the test can be reduced per KDB447498 D01 v06 section 4.3.1 1) page 11. See below for calculations.

Reduced<sup>4</sup> – When the reported SAR is ≤ 0.4 W/kg, SAR is not required for the remaining test configuration per KDB 248227 D01 v02r02 section 5.1.1 1) page 9.

**Calculations for test exclusion for Bottom, Right and Left side.**

Maximum power: 44.7 mW  
 Bottom Edge distance: 213.7 mm  
 Right Side distance: 37.5 mm  
 Left Side distance: 255.6 mm

The closest distance is from the right side. Therefore, if the right side is excluded the bottom and left would also be excluded.

$[(44.7)/(37.5)^* \sqrt{5.70}] = 2.9$  which is less than 3.0

**Figure 8.7 Test Reduction Table – 5.8 GHz Main Inpaq**

Mode	Side	Required Channel	Tested/Reduced
802.11a 5800 MHz	Back	149 – 5745 MHz	Reduced <sup>1</sup>
		153 – 5765 MHz	Reduced <sup>1</sup>
		157 – 5785 MHz	Tested
		161 – 5805 MHz	Reduced <sup>1</sup>
	Top	165 – 5825 MHz	Reduced <sup>1</sup>
		149 – 5745 MHz	Reduced <sup>3</sup>
		153 – 5765 MHz	Reduced <sup>3</sup>
		157 – 5785 MHz	Tested
	Right, Left, Bottom	161 – 5805 MHz	Reduced <sup>3</sup>
		165 – 5825 MHz	Tested
		149 – 5745 MHz	Reduced <sup>4</sup>
		153 – 5765 MHz	Reduced <sup>4</sup>
802.11n 5800 MHz	Back	157 – 5785 MHz	Reduced <sup>1</sup>
		161 – 5805 MHz	Reduced <sup>1</sup>
		165 – 5825 MHz	Reduced <sup>1</sup>
		149 – 5745 MHz	Reduced <sup>3</sup>
	Top	153 – 5765 MHz	Reduced <sup>3</sup>
		157 – 5785 MHz	Reduced <sup>3</sup>
		161 – 5805 MHz	Reduced <sup>3</sup>
		165 – 5825 MHz	Reduced <sup>3</sup>
	Right, Left, Bottom	149 – 5745 MHz	Reduced <sup>4</sup>
		153 – 5765 MHz	Reduced <sup>4</sup>
		157 – 5785 MHz	Reduced <sup>4</sup>
		161 – 5805 MHz	Reduced <sup>4</sup>
802.11ac 5800 MHz	Back	165 – 5825 MHz	Reduced <sup>4</sup>
	Top	155 – 5775 MHz	Reduced <sup>1</sup>
	Right, Left, Bottom	155 – 5775 MHz	Reduced <sup>3</sup>

Reduced<sup>1</sup> – When the reported SAR is ≤ 0.4 W/kg, SAR is not required for the remaining test configuration per KDB 248227 D01 v02r02 section 5.1.1 1) page 9.

Reduced<sup>2</sup> – When the reported SAR is > 0.4 W/kg, test next highest output power channel until SAR ≤ 0.8 W/kg then all remaining test configurations are not required per KDB 248227 D01 v02r02 section 5.1.1 2) page 9.

Reduced<sup>3</sup> – When the reported SAR is >0.8 W/kg, test the next highest configuration until the SAR value is ≤ 1.2 W/kg per KDB 248227 D01 v02r02 section 5.1.1 3) page 9.

Reduced<sup>4</sup> – When the antenna is more than 25 mm from a side, the test can be reduced per KDB447498 D01 v06 section 4.3.1 1) page 11. See below for calculations.

**Calculations for test exclusion for Bottom, Right and Left side.**

Maximum power: 44.7 mW  
 Bottom Edge distance: 213.7 mm  
 Right Side distance: 37.5 mm  
 Left Side distance: 255.6 mm

The closest distance is from the right side. Therefore, if the right side is excluded the bottom and left would also be excluded.

$[(44.7)/(37.5)^* \sqrt{5.825}] = 2.9 \text{ mW}$  which is less than 3.0



**SAR Data Summary – 2450 MHz Body 802.11b & BT**

**MEASUREMENT RESULTS**

Plot	Gap	Antenna	Position	Frequency		Modulation	Antenna	End Power	Measured SAR (W/kg)	Reported SAR (W/kg)
				MHz	Ch.			(dBm)		
-----	0 mm	Inpaq	Back	2437	6	DSSS	Main	17.50	0.136	0.14
-----			Top	2437	6	DSSS	Main	17.50	0.431	0.43
1			Top	2462	11	DSSS	Main	17.50	0.532	0.53
-----			Back	2437	6	GFSK	Aux	11.47	0.0217	0.02
-----			Top	2440	39	GFSK	Aux	11.47	0.0654	0.07

**Body**  
**1.6 W/kg (mW/g)**  
 averaged over 1 gram

1. Battery is fully charged for all tests.  
 Power Measured  Conducted  ERP  EIRP
2. SAR Measurement  
 Phantom Configuration  Left Head  Eli4  Right Head  
 SAR Configuration  Head  Body
3. Test Signal Call Mode  Test Code  Base Station Simulator
4. Test Configuration  With Belt Clip  Without Belt Clip  N/A
5. Tissue Depth is at least 15.0 cm



Jay M. Moulton  
 Vice President

**SAR Data Summary – 5250 MHz Body 802.11a**

**MEASUREMENT RESULTS**

Plot	Gap	Antenna	Position	Frequency		Modulation	Antenna	End Power	Measured SAR (W/kg)	Reported SAR (W/kg)
				MHz	Ch.			(dBm)		
-----	0 mm	Inpaq	Back	5300	60	OFDM	Main	16.50	0.112	0.11
-----			Top	5280	56	OFDM	Main	16.50	1.02	1.02
2				5300	60	OFDM		16.50	1.05	1.05
-----			Repeat	5300	60	OFDM	Main	16.50	1.03	1.03

**Body**  
**1.6 W/kg (mW/g)**  
averaged over 1 gram

1. Battery is fully charged for all tests.  
 Power Measured  Conducted  ERP  EIRP
2. SAR Measurement  
 Phantom Configuration  Left Head  Eli4  Right Head  
 SAR Configuration  Head  Body
3. Test Signal Call Mode  Test Code  Base Station Simulator
4. Test Configuration  With Belt Clip  Without Belt Clip  N/A
5. Tissue Depth is at least 15.0 cm

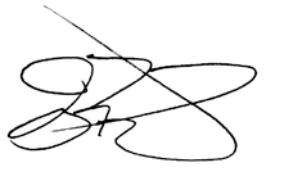

Jay M. Moulton  
 Vice President

**SAR Data Summary – 5600 MHz Body 802.11a**

**MEASUREMENT RESULTS**

Plot	Gap	Antenna	Position	Frequency		Modulation	Antenna	End Power (dBm)	Measured SAR (W/kg)	Reported SAR (W/kg)
				MHz	Ch.					
-----	0 mm	Inpaq	Back	5620	124	OFDM	Main	16.50	0.155	0.16
3			Top	5580	116	OFDM	Main	16.50	1.02	1.02
-----				5620	124	OFDM		16.50	1.01	1.01
-----			Repeat	5580	116	OFDM	Main	16.50	1.00	1.00

**Body**  
**1.6 W/kg (mW/g)**  
averaged over 1 gram

1. Battery is fully charged for all tests.  
 Power Measured  Conducted  ERP  EIRP
2. SAR Measurement  
 Phantom Configuration  Left Head  Eli4  Right Head  
 SAR Configuration  Head  Body
3. Test Signal Call Mode  Test Code  Base Station Simulator
4. Test Configuration  With Belt Clip  Without Belt Clip  N/A
5. Tissue Depth is at least 15.0 cm



Jay M. Moulton  
 Vice President

**SAR Data Summary – 5800 MHz Body 802.11a**

**MEASUREMENT RESULTS**

Plot	Gap	Antenna	Position	Frequency		Modulation	Antenna	End Power (dBm)	Measured SAR (W/kg)	Reported SAR (W/kg)
				MHz	Ch.					
----	0 mm	Inpaq	Back	5785	157	OFDM	Main	16.50	0.142	0.14
4			Top	5785	157	OFDM	Main	16.50	0.873	0.87
----				5825	165	OFDM		16.50	0.822	0.82
----			Repeated	5785	157	OFDM	Main	16.50	0.858	0.86

**Body**  
**1.6 W/kg (mW/g)**  
averaged over 1 gram

1. Battery is fully charged for all tests.  
 Power Measured       Conducted       ERP       EIRP
2. SAR Measurement  
 Phantom Configuration       Left Head       Eli4       Right Head  
 SAR Configuration       Head       Body
3. Test Signal Call Mode       Test Code       Base Station Simulator
4. Test Configuration       With Belt Clip       Without Belt Clip       N/A
5. Tissue Depth is at least 15.0 cm



Jay M. Moulton  
 Vice President

## SAR Data Summary – Simultaneous Evaluation

MEASUREMENT RESULTS – BT								
Frequency		Modulation	Frequency		Modulation	SAR <sub>1</sub>	SAR <sub>2</sub>	SAR Total
MHz	Ch.		MHz	Ch.				
2462	11	DSSS	2440	39	GFSK	0.53	0.07	0.60
5300	60	OFDM	2440	39	GFSK	1.05	0.07	1.12
5580	116	OFDM	2440	39	GFSK	1.02	0.07	1.09
5785	157	OFDM	2440	39	GFSK	0.87	0.07	0.94

**Body**  
**1.6 W/kg (mW/g)**  
averaged over 1 gram

The sum of the two transmitters is less than the limit; therefore, the simultaneous transmission meets the requirements of KDB447498 D01 v06 section 4.3.2 page 11.

## 9. Test Equipment List

**Table 9.1 Equipment Specifications**

Type	Calibration Due Date	Calibration Done Date	Serial Number
Staubli Robot TX60L	N/A	N/A	F07/55M6A1/A/01
Measurement Controller CS8c	N/A	N/A	1012
ELI4 Flat Phantom	N/A	N/A	1065
Device Holder	N/A	N/A	N/A
Data Acquisition Electronics 4	08/21/2018	08/21/2017	759
SPEAG E-Field Probe EX3DV4	08/18/2018	08/18/2017	3693
Speag Validation Dipole D2450V2	08/10/2018	08/10/2015	881
Speag Validation Dipole D5GHzV2	08/11/2018	08/11/2015	1119
Agilent N1911A Power Meter	05/20/2019	03/20/2017	GB45100254
Agilent N1922A Power Sensor	06/21/2019	06/21/2017	MY45240464
Advantest R3261A Spectrum Analyzer	03/26/2019	03/20/2017	31720068
Agilent (HP) 8350B Signal Generator	03/26/2019	03/20/2017	2749A10226
Agilent (HP) 83525A RF Plug-In	03/26/2019	03/20/2017	2647A01172
Agilent (HP) 8753C Vector Network Analyzer	03/26/2019	03/20/2017	3135A01724
Agilent (HP) 85047A S-Parameter Test Set	03/26/2019	03/20/2017	2904A00595
Agilent (HP) 8960 Base Station Sim.	03/30/2019	03/30/2017	MY48360364
Anritsu MT8820C	07/27/2019	07/27/2017	6201176199
Agilent 778D Dual Directional Coupler	N/A	N/A	MY48220184
MiniCircuits BW-N20W5+ Fixed 20 dB Attenuator	N/A	N/A	N/A
MiniCircuits SPL-10.7+ Low Pass Filter	N/A	N/A	R8979513746
Aprel Dielectric Probe Assembly	N/A	N/A	0011
Body Equivalent Matter (2450 MHz)	N/A	N/A	N/A
Body Equivalent Matter (5 GHz)	N/A	N/A	N/A

## 10. Conclusion

The SAR measurement indicates that the EUT complies with the RF radiation exposure limits of the FCC/IC. These measurements are taken to simulate the RF effects exposure under worst-case conditions. Precise laboratory measures were taken to assure repeatability of the tests. The tested device complies with the requirements in respect to all parameters subject to the test. The test results and statements relate only to the item(s) tested.

Please note that the absorption and distribution of electromagnetic energy in the body is a very complex phenomena that depends on the mass, shape, and size of the body; the orientation of the body with respect to the field vectors; and, the electrical properties of both the body and the environment. Other variables that may play a substantial role in possible biological effects are those that characterize the environment (e.g. ambient temperature, air velocity, relative humidity, and body insulation) and those that characterize the individual (e.g. age, gender, activity level, debilitation, or disease). Because innumerable factors may interact to determine the specific biological outcome of an exposure to electromagnetic fields, any protection guide shall consider maximal amplification of biological effects as a result of field-body interactions, environmental conditions, and physiological variables.

## 11. References

- [1] Federal Communications Commission, ET Docket 93-62, Guidelines for Evaluating the Environmental Effects of Radio Frequency Radiation, August 1996
- [2] ANSI/IEEE C95.1 – 1992, American National Standard Safety Levels with respect to Human Exposure to Radio Frequency Electromagnetic Fields, 300kHz to 100GHz, New York: IEEE, 1992.
- [3] ANSI/IEEE C95.3 – 2002, IEEE Recommended Practice for the Measurement of Potentially Hazardous Electromagnetic Fields – RF and Microwave, New York: IEEE, 2002.
- [4] International Electrotechnical Commission, IEC 62209-2 (Edition 1.0), Human Exposure to radio frequency fields from hand-held and body mounted wireless communication devices – Human models, instrumentation, and procedures – Part 2: Procedure to determine the specific absorption rate (SAR) for wireless communication devices used in close proximity to the human body (frequency range of 30 MHz to 6 GHz), March 2010.
- [5] IEEE Standard 1528 – 2013, IEEE Recommended Practice for Determining the Peak-Spatial Average Specific Absorption Rate (SAR) in the Human Head from Wireless Communication Devices: Measurement Techniques, June 2013.
- [6] Industry Canada, RSS – 102 Issue 5, Radio Frequency Exposure Compliance of Radiocommunication Apparatus (All Frequency Bands), March 2015.
- [7] Health Canada, Safety Code 6, Limits of Human Exposure to Radiofrequency Electromagnetic Fields in the Frequency Range from 3kHz to 300 GHz, 2009.



## Appendix A – System Validation Plots and Data

```
*****  
Test Result for UIM Dielectric Parameter  
Tue 23/Jan/2018  
Freq Frequency(GHz)  
FCC_eH Limits for Head Epsilon  
FCC_sH Limits for Head Sigma  
FCC_eB Limits for Body Epsilon  
FCC_sB Limits for Body Sigma  
Test_e Epsilon of UIM  
Test_s Sigma of UIM  
*****  
Freq          FCC_eB FCC_sB Test_e Test_s  
2.4100        52.75  1.91  52.66  1.95  
2.4120        52.748 1.912 52.656 1.952*  
2.4200        52.74  1.92  52.64  1.96  
2.4300        52.73  1.93  52.62  1.97  
2.4370        52.716 1.937 52.606 1.984*  
2.4400        52.71  1.94  52.60  1.99  
2.4500        52.70  1.95  52.58  2.00  
2.4600        52.69  1.96  52.57  2.01  
2.4620        52.686 1.964 52.566 2.012*  
2.4700        52.67  1.98  52.55  2.02  
2.4800        52.66  1.99  52.53  2.03
```

\* value interpolated

\*\*\*\*\*

Test Result for UIM Dielectric Parameter

Tue 23/Jan/2018

Freq Frequency(GHz)

FCC\_eH Limits for Head Epsilon

FCC\_sH Limits for Head Sigma

FCC\_eB Limits for Body Epsilon

FCC\_sB Limits for Body Sigma

Test\_e Epsilon of UIM

Test\_s Sigma of UIM

\*\*\*\*\*

Freq	FCC_eB	FCC_sB	Test_e	Test_s
5.1000	49.15	5.18	49.09	5.22
5.1200	49.12	5.21	49.06	5.25
5.1400	49.10	5.23	49.03	5.27
5.1600	49.07	5.25	49.00	5.29
5.1800	49.04	5.28	48.97	5.31
5.2000	49.01	5.30	48.94	5.34
5.2100	49.00	5.31	48.93	5.35*
5.2200	48.99	5.32	48.92	5.36
5.2400	48.96	5.35	48.89	5.38
5.2600	48.93	5.37	48.86	5.41
5.2800	48.91	5.39	48.84	5.43
5.2900	48.895	5.405	48.825	5.44*
5.3000	48.88	5.42	48.81	5.45
5.3200	48.85	5.44	48.78	5.48
5.3400	48.82	5.46	48.75	5.50
5.3600	48.80	5.49	48.72	5.52
5.3800	48.77	5.51	48.69	5.54
5.4000	48.74	5.53	48.66	5.57
5.4200	48.72	5.56	48.63	5.59
5.4400	48.69	5.58	48.60	5.61
5.4600	48.66	5.60	48.57	5.63
5.4800	48.63	5.63	48.54	5.66
5.5000	48.61	5.65	48.51	5.68
5.5200	48.58	5.67	48.48	5.70
5.5400	48.55	5.70	48.45	5.73
5.5600	48.53	5.72	48.42	5.75
5.5800	48.50	5.74	48.39	5.77
5.6000	48.47	5.77	48.36	5.80
5.6100	48.455	5.78	48.345	5.815*
5.6200	48.44	5.79	48.33	5.83
5.6400	48.42	5.81	48.30	5.85
5.6600	48.39	5.84	48.27	5.87
5.6800	48.36	5.86	48.24	5.90
5.7000	48.34	5.88	48.21	5.93
5.7200	48.31	5.91	48.18	5.95
5.7400	48.28	5.93	48.15	5.97
5.7450	48.273	5.935	48.143	5.978*
5.7600	48.25	5.95	48.12	6.00
5.7750	48.235	5.973	48.098	6.023*
5.7800	48.23	5.98	48.09	6.03
5.7850	48.223	5.985	48.08	6.033*
5.8000	48.20	6.00	48.05	6.04
5.8200	48.17	6.02	48.02	6.06
5.8250	48.165	6.028	48.013	6.068*
5.8400	48.15	6.05	47.99	6.09

\* value interpolated

# RF Exposure Lab

## Plot 1

**DUT: Dipole 2450 MHz D2450V2; Type: D2450V2; Serial: D2450V2 - SN: 881**

Communication System: CW; Frequency: 2450 MHz; Duty Cycle: 1:1  
 Medium: MSL2450; Medium parameters used:  $f = 2450 \text{ MHz}$ ;  $\sigma = 2 \text{ S/m}$ ;  $\epsilon_r = 52.58$ ;  $\rho = 1000 \text{ kg/m}^3$   
 Phantom section: Flat Section

Test Date: Date: 1/23/2018; Ambient Temp: 23 °C; Tissue Temp: 21 °C  
 Probe: EX3DV4 - SN3693; ConvF(7.26, 7.26, 7.26); Calibrated: 8/18/2017;  
 Sensor-Surface: 2mm (Mechanical Surface Detection)  
 Electronics: DAE4 Sn759; Calibrated: 8/21/2017  
 Phantom: ELI v4.0; Type: QDOVA001BB; Serial: 2037  
 Measurement SW: DASY52, Version 52.10 (0); SEMCAD X Version 14.6.10 (7417)

### Procedure Notes:

**Body Verification/2450 MHz/Area Scan (61x101x1):** Interpolated grid:  $dx=1.200 \text{ mm}$ ,  $dy=1.200 \text{ mm}$   
 Maximum value of SAR (interpolated) = 8.85 W/kg

**Body Verification/2450 MHz/Zoom Scan (7x7x7)/Cube 0:** Measurement grid:  $dx=5\text{mm}$ ,  $dy=5\text{mm}$ ,  $dz=5\text{mm}$   
 Reference Value = 54.243 V/m; Power Drift = -0.01 dB  
 Peak SAR (extrapolated) = 11.1 W/kg  
 $P_{in}=100 \text{ mW}$   
**SAR(1 g) = 5.2 W/kg; SAR(10 g) = 2.41 W/kg**  
 Maximum value of SAR (measured) = 8.93 W/kg

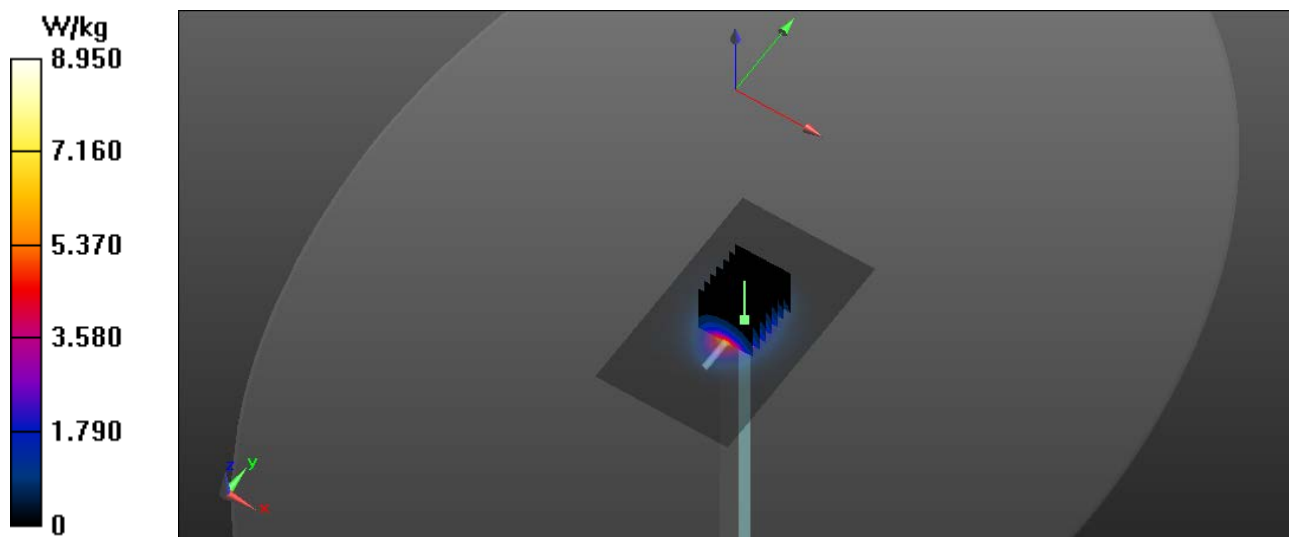

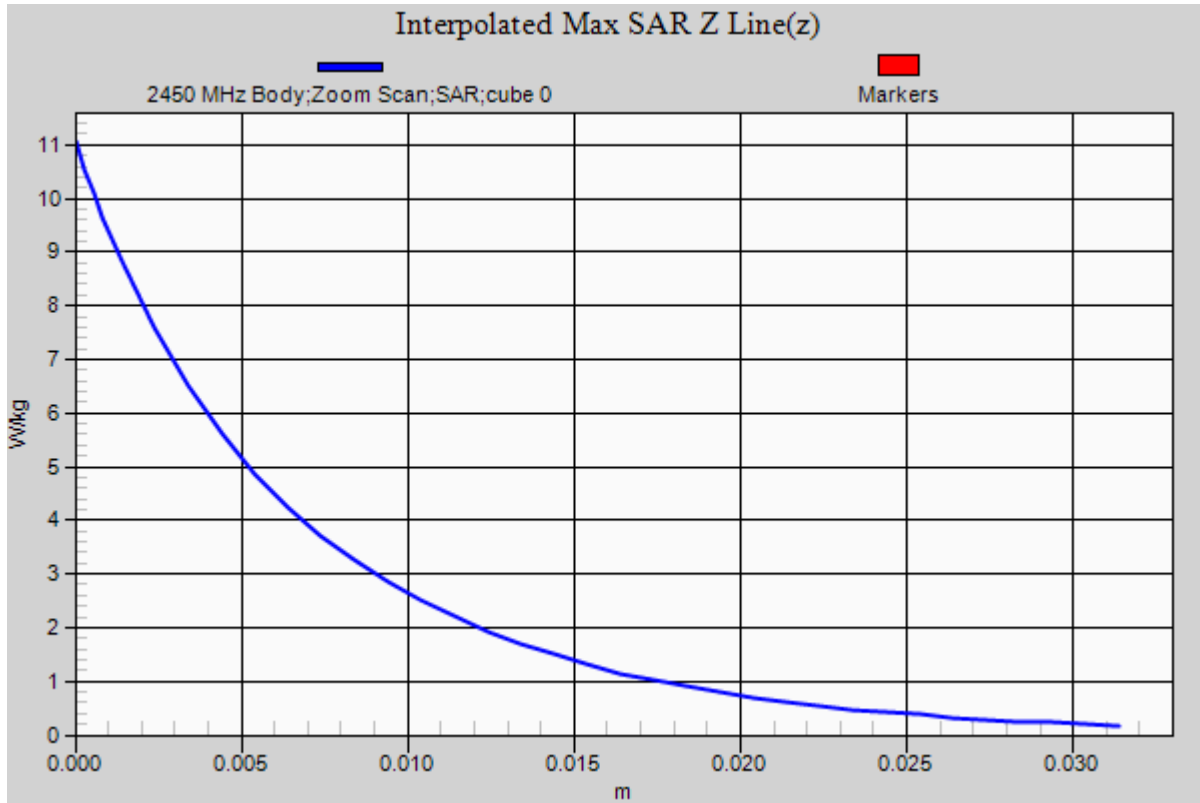

# RF Exposure Lab

## Plot 2

**DUT: Dipole D5GHzV2; Type: D5GHzV2; Serial: D5GHzV2 - SN: 1119**

Communication System: CW; Frequency: 5200 MHz; Duty Cycle: 1:1  
 Medium: MSL 3-6 GHz; Medium parameters used:  $f = 5200$  MHz;  $\sigma = 5.34$  S/m;  $\epsilon_r = 48.94$ ;  $\rho = 1000$  kg/m<sup>3</sup>  
 Phantom section: Flat Section

Test Date: Date: 1/23/2018; Ambient Temp: 23 °C; Tissue Temp: 21 °C  
 Probe: EX3DV4 - SN3693; ConvF(4.7, 4.7, 4.7); Calibrated: 8/18/2017;  
 Sensor-Surface: 2mm (Mechanical Surface Detection)  
 Electronics: DAE4 Sn759; Calibrated: 8/21/2017  
 Phantom: ELI v4.0; Type: QDOVA001BB; Serial: 2037  
 Measurement SW: DASY52, Version 52.10 (0); SEMCAD X Version 14.6.10 (7417)

### Procedure Notes:

**Body Verification/5200 MHz/Area Scan (61x81x1):** Interpolated grid: dx=1.000 mm, dy=1.000 mm  
 Maximum value of SAR (interpolated) = 1.76 W/kg

**Body Verification/5200 MHz/Zoom Scan (7x7x12)/Cube 0:** Measurement grid: dx=4mm, dy=4mm, dz=2mm  
 Reference Value = 13.429 V/m; Power Drift = -0.01 dB  
 Peak SAR (extrapolated) = 3.08 W/kg  
 Pin=10 mW  
**SAR(1 g) = 0.781 W/kg; SAR(10 g) = 0.231 W/kg**  
 Maximum value of SAR (measured) = 1.87 W/kg

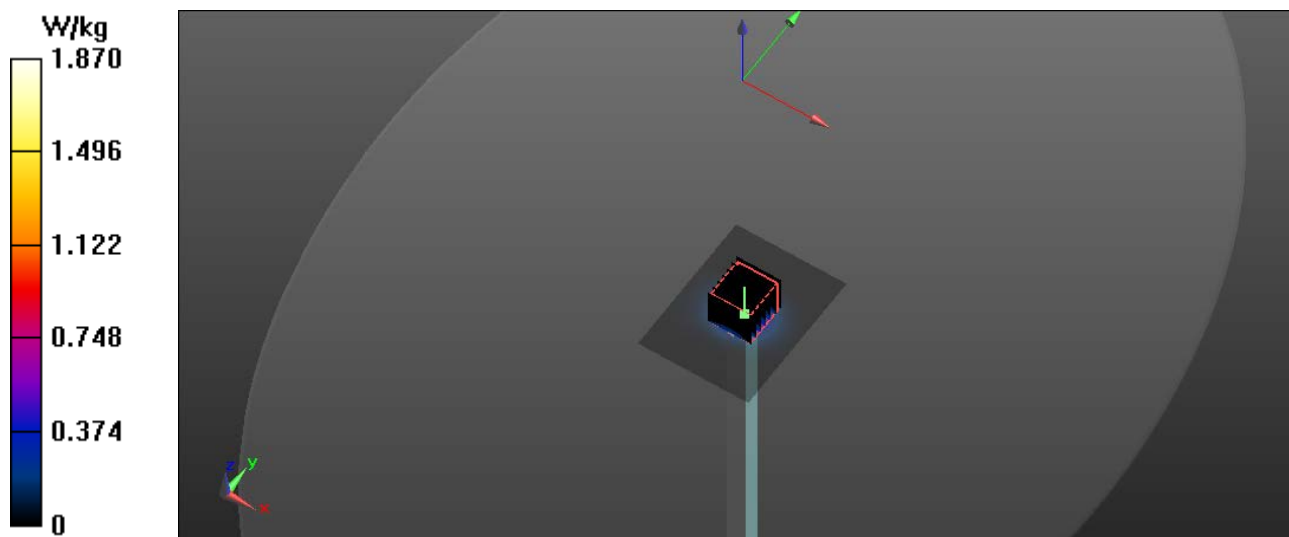

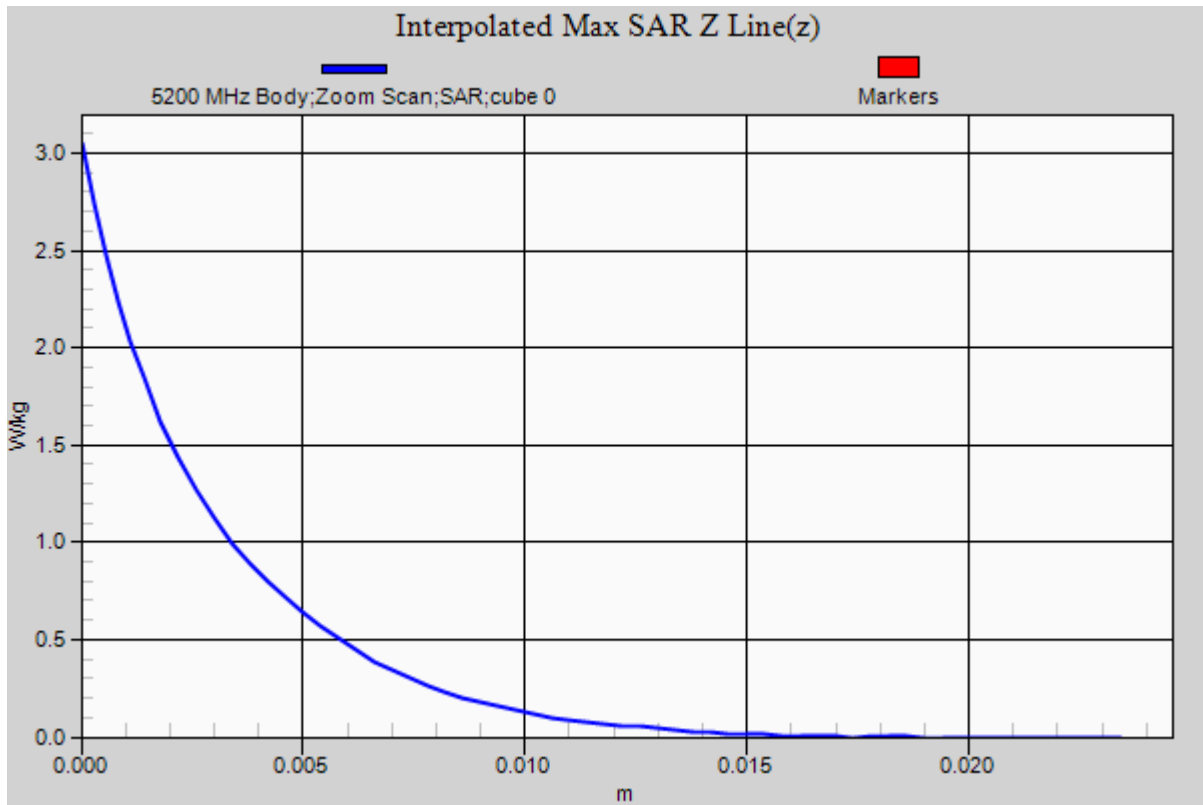

# RF Exposure Lab

## Plot 3

**DUT: Dipole D5GHzV2; Type: D5GHzV2; Serial: D5GHzV2 - SN: 1119**

Communication System: CW; Frequency: 5600 MHz; Duty Cycle: 1:1  
 Medium: MSL 3-6 GHz; Medium parameters used:  $f = 5600$  MHz;  $\sigma = 5.8$  S/m;  $\epsilon_r = 48.36$ ;  $\rho = 1000$  kg/m<sup>3</sup>  
 Phantom section: Flat Section

Test Date: Date: 1/23/2018; Ambient Temp: 23 °C; Tissue Temp: 21 °C  
 Probe: EX3DV4 - SN3693; ConvF(4, 4, 4); Calibrated: 8/18/2017;  
 Sensor-Surface: 2mm (Mechanical Surface Detection)  
 Electronics: DAE4 Sn759; Calibrated: 8/21/2017  
 Phantom: ELI v4.0; Type: QDOVA001BB; Serial: 2037  
 Measurement SW: DASY52, Version 52.10 (0); SEMCAD X Version 14.6.10 (7417)

### Procedure Notes:

**Body Verification/5600 MHz/Area Scan (61x81x1):** Interpolated grid: dx=1.000 mm, dy=1.000 mm  
 Maximum value of SAR (interpolated) = 1.89 W/kg

**Body Verification/5600 MHz/Zoom Scan (7x7x12)/Cube 0:** Measurement grid: dx=4mm, dy=4mm, dz=2mm  
 Reference Value = 12.967 V/m; Power Drift = -0.03 dB  
 Peak SAR (extrapolated) = 3.35 W/kg  
 Pin=10 mW  
**SAR(1 g) = 0.819 W/kg; SAR(10 g) = 0.218 W/kg**  
 Maximum value of SAR (measured) = 2.03 W/kg

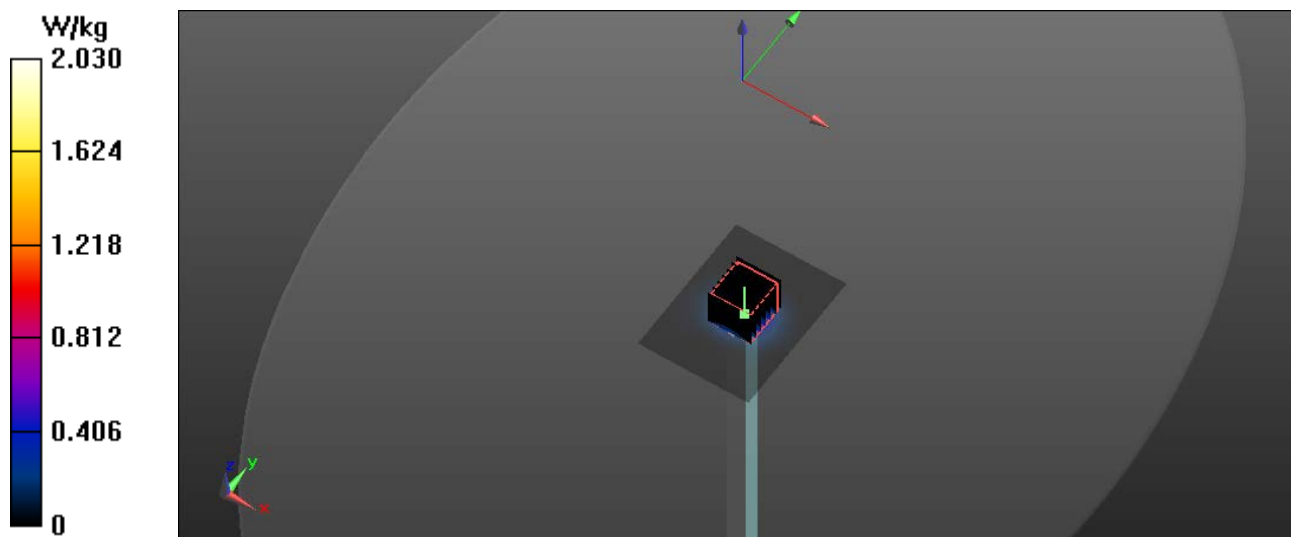

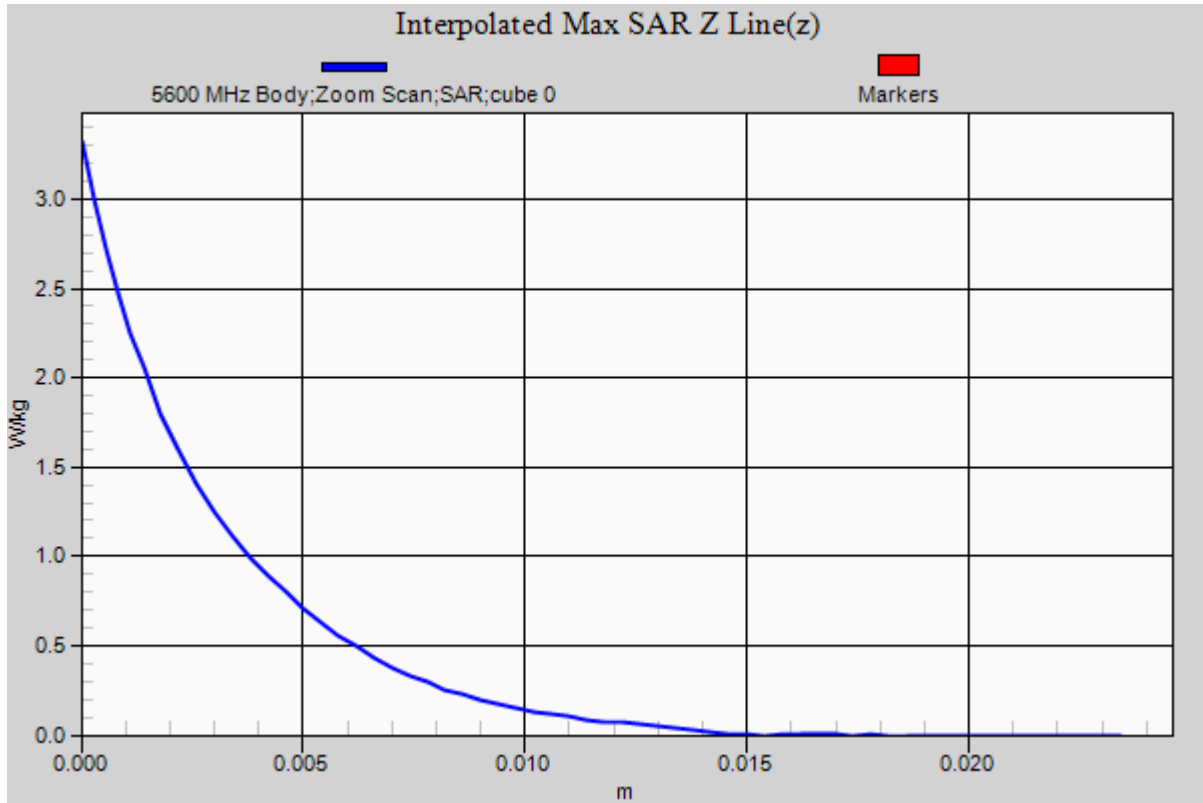



# RF Exposure Lab

## Plot 4

**DUT: Dipole D5GHzV2; Type: D5GHzV2; Serial: D5GHzV2 - SN: 1119**

Communication System: CW; Frequency: 5800 MHz; Duty Cycle: 1:1  
Medium: MSL 3-6 GHz; Medium parameters used:  $f = 5800 \text{ MHz}$ ;  $\sigma = 6.04 \text{ S/m}$ ;  $\epsilon_r = 48.05$ ;  $\rho = 1000 \text{ kg/m}^3$   
Phantom section: Flat Section

Test Date: Date: 1/23/2018; Ambient Temp: 23 °C; Tissue Temp: 21 °C  
Probe: EX3DV4 - SN3693; ConvF(4.21, 4.21, 4.21); Calibrated: 8/18/2017;  
Sensor-Surface: 2mm (Mechanical Surface Detection)  
Electronics: DAE4 Sn759; Calibrated: 8/21/2017  
Phantom: ELI v4.0; Type: QDOVA001BB; Serial: 2037  
Measurement SW: DASY52, Version 52.10 (0); SEMCAD X Version 14.6.10 (7417)

v

### Procedure Notes:

**Body Verification/5800 MHz/Area Scan (61x81x1):** Interpolated grid:  $dx=1.000 \text{ mm}$ ,  $dy=1.000 \text{ mm}$   
Maximum value of SAR (interpolated) = 1.69 W/kg

**Body Verification/5800 MHz/Zoom Scan (7x7x12)/Cube 0:** Measurement grid:  $dx=4\text{mm}$ ,  $dy=4\text{mm}$ ,  $dz=2\text{mm}$   
Reference Value = 12.497 V/m; Power Drift = 0.01 dB  
Peak SAR (extrapolated) = 2.87 W/kg  
 $P_{in}=10 \text{ mW}$   
**SAR(1 g) = 0.791 W/kg; SAR(10 g) = 0.229 W/kg**  
Maximum value of SAR (measured) = 1.79 W/kg

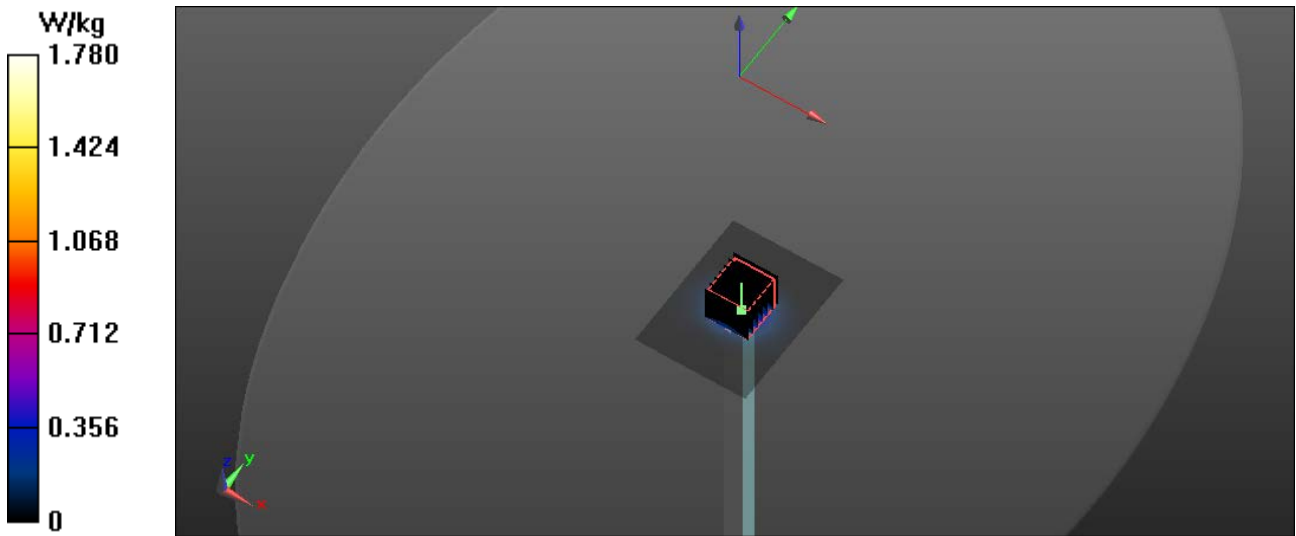

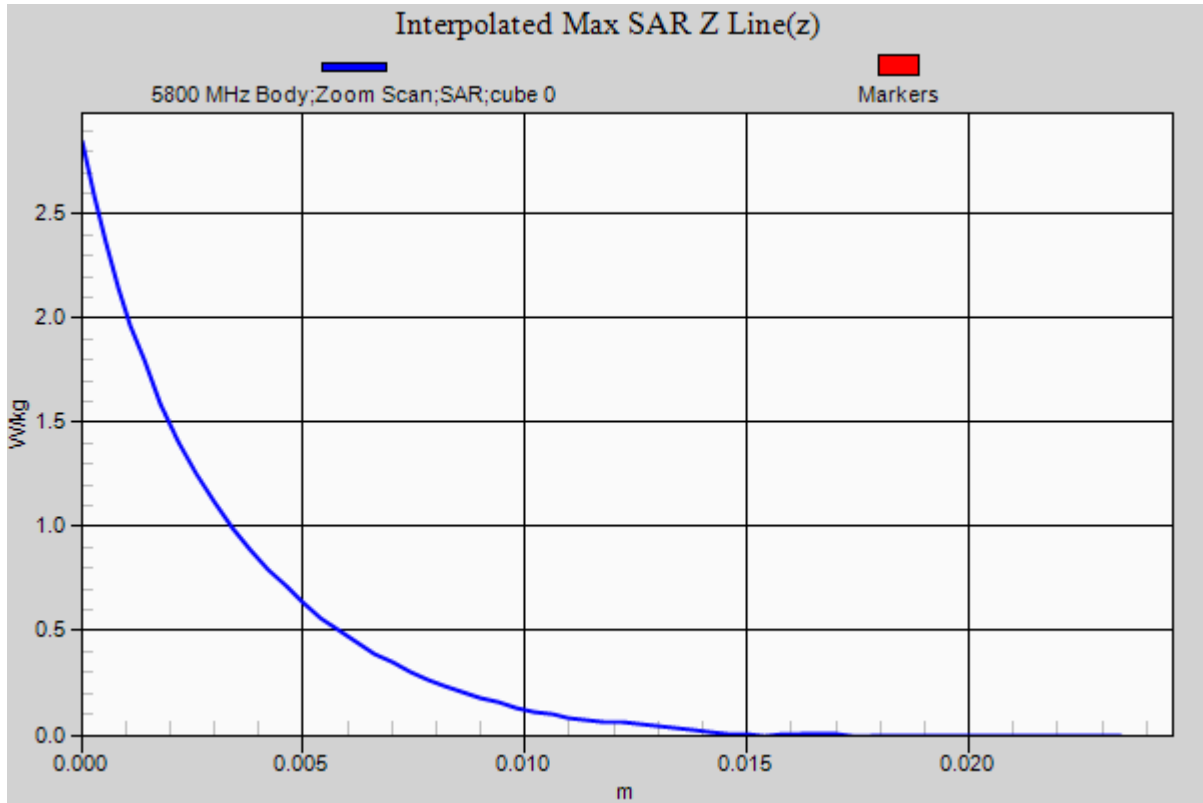

## **Appendix B – SAR Test Data Plots**

# RF Exposure Lab

## Plot 1

**DUT: TPN-W131; Type: Tablet PC; Serial: Eng 1**

Communication System: WiFi 802.11b (DSSS, 1 Mbps); Frequency: 2462 MHz; Duty Cycle: 1:1  
 Medium: MSL2450; Medium parameters used (interpolated):  $f = 2462$  MHz;  $\sigma = 2.012$  S/m;  $\epsilon_r = 52.566$ ;  $\rho = 1000$  kg/m<sup>3</sup>  
 Phantom section: Flat Section

Test Date: Date: 1/23/2018; Ambient Temp: 23 °C; Tissue Temp: 21 °C

Probe: EX3DV4 - SN3693; ConvF(7.26, 7.26, 7.26); Calibrated: 8/18/2017;  
 Sensor-Surface: 2mm (Mechanical Surface Detection)  
 Electronics: DAE4 Sn759; Calibrated: 8/21/2017  
 Phantom: ELI v5.0; Type: QDOVA002AA; Serial: 2037  
 Measurement SW: DASY52, Version 52.10 (0); SEMCAD X Version 14.6.10 (7417)

### Procedure Notes:

**2450 MHz Inpaq/Tablet Top Tx1 High/Area Scan (7x9x1):** Measurement grid: dx=10mm, dy=10mm

[Info: Interpolated medium parameters used for SAR evaluation.](#)

Maximum value of SAR (measured) = 0.906 W/kg

**2450 MHz Inpaq/Tablet Top Tx1 High/Zoom Scan (7x7x7)/Cube 0:** Measurement grid: dx=5mm, dy=5mm, dz=5mm

Reference Value = 7.035 V/m; Power Drift = -0.02 dB

Peak SAR (extrapolated) = 1.37 W/kg

**SAR(1 g) = 0.532 W/kg**

[Info: Interpolated medium parameters used for SAR evaluation.](#)

Maximum value of SAR (measured) = 0.879 W/kg

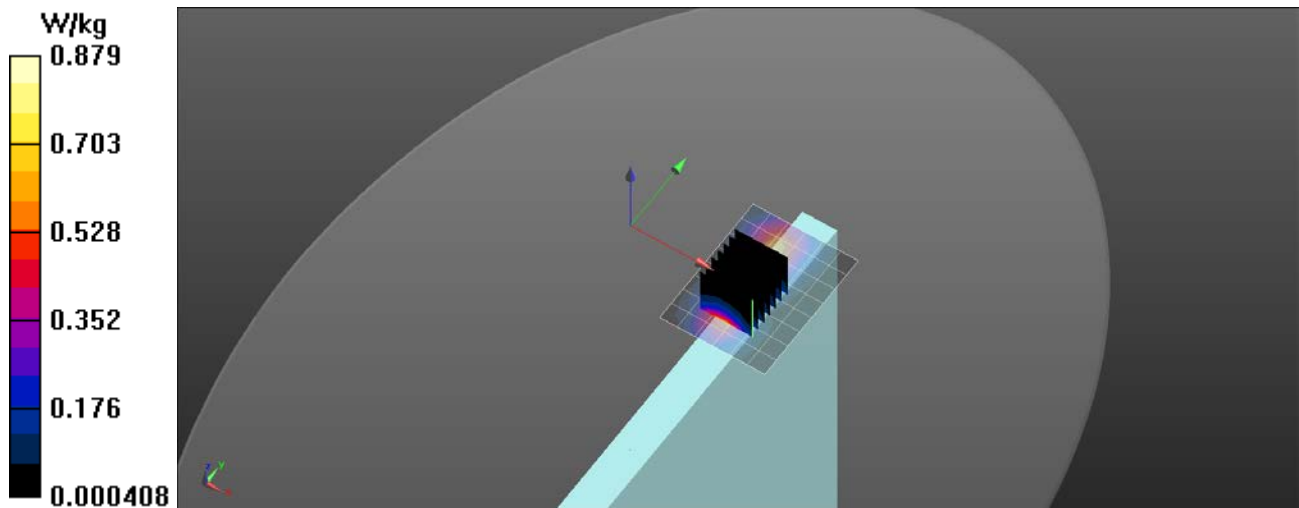

# RF Exposure Lab

## Plot 2

**DUT: TPN-W131; Type: Tablet PC; Serial: Eng 1**

Communication System: WiFi 802.11a (OFDM, 6 Mbps); Frequency: 5300 MHz; Duty Cycle: 1:1  
Medium: MSL 3-6 GHz; Medium parameters used:  $f = 5300$  MHz;  $\sigma = 5.45$  S/m;  $\epsilon_r = 48.81$ ;  $\rho = 1000$  kg/m<sup>3</sup>  
Phantom section: Flat Section

Test Date: Date: 1/23/2018; Ambient Temp: 23 °C; Tissue Temp: 21 °C

Probe: EX3DV4 - SN3693; ConvF(4.46, 4.46, 4.46); Calibrated: 8/18/2017;  
Sensor-Surface: 2mm (Mechanical Surface Detection)  
Electronics: DAE4 Sn759; Calibrated: 8/21/2017  
Phantom: ELI v5.0; Type: QDOVA002AA; Serial: 2037  
Measurement SW: DASY52, Version 52.10 (0); SEMCAD X Version 14.6.10 (7417)

### Procedure Notes:

**5200 MHz Inpaq/Tablet Top Tx1 60/Area Scan (7x9x1):** Measurement grid: dx=10mm, dy=10mm  
Maximum value of SAR (measured) = 2.01 W/kg

**5200 MHz Inpaq/Tablet Top Tx1 60/Zoom Scan (7x7x12)/Cube 0:** Measurement grid: dx=4mm, dy=4mm, dz=2mm  
Reference Value = 7.278 V/m; Power Drift = -0.03 dB  
Peak SAR (extrapolated) = 4.91 W/kg  
**SAR(1 g) = 1.05 W/kg**  
Maximum value of SAR (measured) = 2.23 W/kg

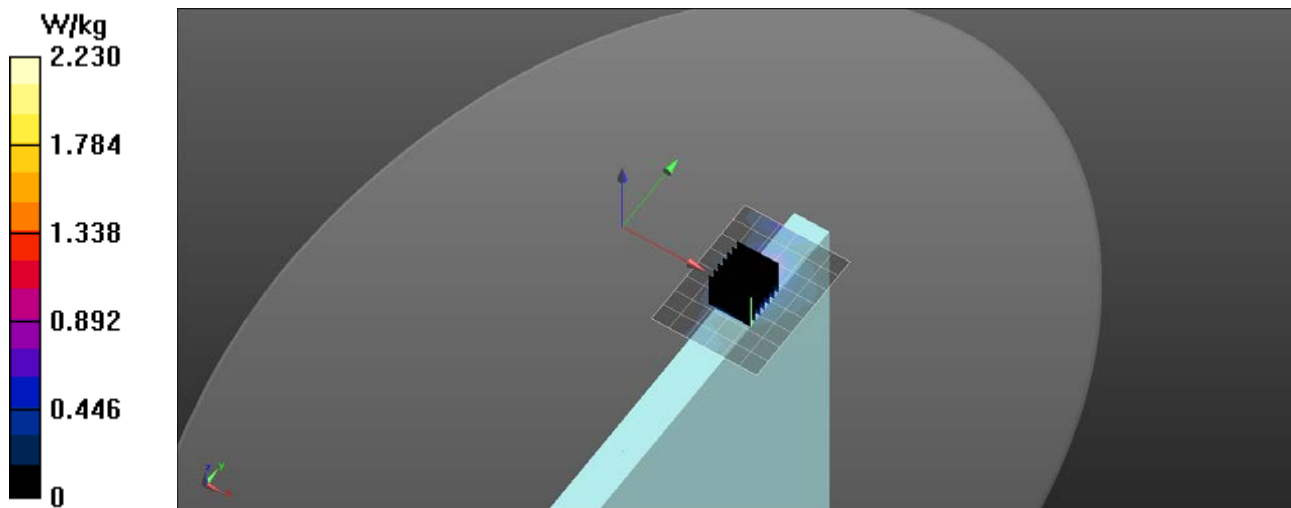

# RF Exposure Lab

## Plot 3

**DUT: TPN-W131; Type: Tablet PC; Serial: Eng 1**

Communication System: WiFi 802.11a (OFDM, 6 Mbps); Frequency: 5580 MHz; Duty Cycle: 1:1  
Medium: MSL 3-6 GHz; Medium parameters used:  $f = 5580$  MHz;  $\sigma = 5.77$  S/m;  $\epsilon_r = 48.39$ ;  $\rho = 1000$  kg/m<sup>3</sup>  
Phantom section: Flat Section

Test Date: Date: 1/23/2018; Ambient Temp: 23 °C; Tissue Temp: 21 °C

Probe: EX3DV4 - SN3693; ConvF(4, 4, 4); Calibrated: 8/18/2017;  
Sensor-Surface: 2mm (Mechanical Surface Detection)  
Electronics: DAE4 Sn759; Calibrated: 8/21/2017  
Phantom: ELI v5.0; Type: QDOVA002AA; Serial: 2037  
Measurement SW: DASY52, Version 52.10 (0); SEMCAD X Version 14.6.10 (7417)

### Procedure Notes:

**5600 MHz Inpaq/Tablet Top Tx1 116/Area Scan (7x9x1):** Measurement grid: dx=10mm, dy=10mm  
Maximum value of SAR (measured) = 1.82 W/kg

**5600 MHz Inpaq/Tablet Top Tx1 116/Zoom Scan (7x7x12)/Cube 0:** Measurement grid: dx=4mm, dy=4mm, dz=2mm  
Reference Value = 1.463 V/m; Power Drift = -0.01 dB  
Peak SAR (extrapolated) = 4.93 W/kg  
**SAR(1 g) = 1.02 W/kg**  
Maximum value of SAR (measured) = 2.21 W/kg

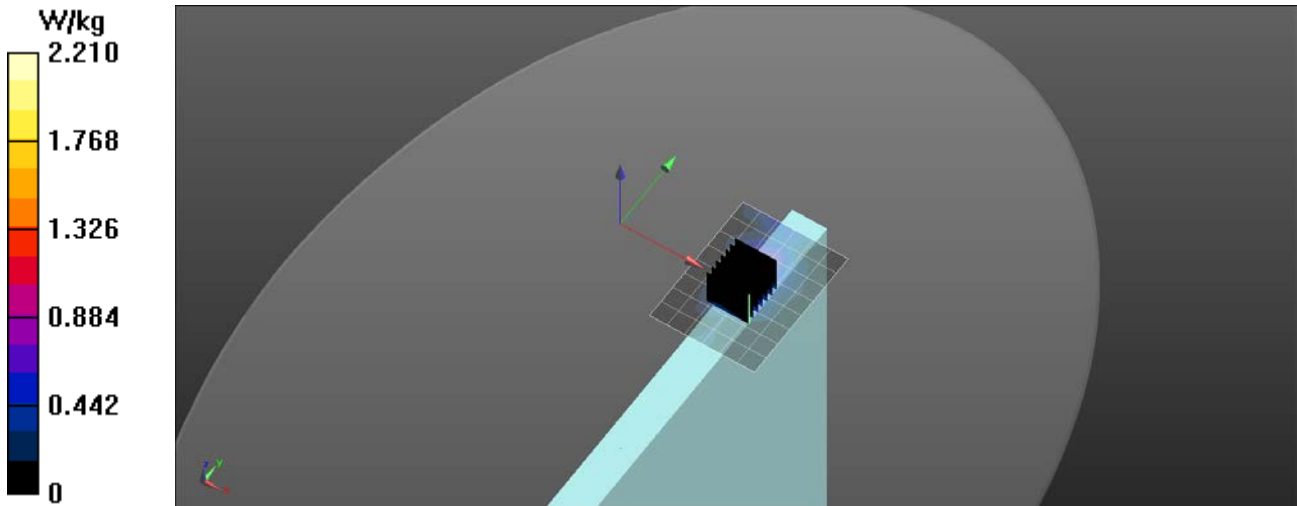

# RF Exposure Lab

## Plot 4

**DUT: TPN-W131; Type: Tablet PC; Serial: Eng 1**

Communication System: WiFi 802.11a (OFDM, 6 Mbps); Frequency: 5785 MHz; Duty Cycle: 1:1  
Medium: MSL 3-6 GHz; Medium parameters used (interpolated):  $f = 5785$  MHz;  $\sigma = 6.033$  S/m;  $\epsilon_r = 48.08$ ;  $\rho = 1000$  kg/m<sup>3</sup>  
Phantom section: Flat Section

Test Date: Date: 1/23/2018; Ambient Temp: 23 °C; Tissue Temp: 21 °C

Probe: EX3DV4 - SN3693; ConvF(4.21, 4.21, 4.21); Calibrated: 8/18/2017;  
Sensor-Surface: 2mm (Mechanical Surface Detection)  
Electronics: DAE4 Sn759; Calibrated: 8/21/2017  
Phantom: ELI v5.0; Type: QDOVA002AA; Serial: 2037  
Measurement SW: DASY52, Version 52.10 (0); SEMCAD X Version 14.6.10 (7417)

### Procedure Notes:

**5800 MHz Inpaq/Tablet Top Tx1 157/Area Scan (7x9x1):** Measurement grid: dx=10mm, dy=10mm

[Info: Interpolated medium parameters used for SAR evaluation.](#)

Maximum value of SAR (measured) = 1.48 W/kg

**5800 MHz Inpaq/Tablet Top Tx1 157/Zoom Scan (7x7x12)/Cube 0:** Measurement grid: dx=4mm, dy=4mm, dz=2mm

Reference Value = 0.3590 V/m; Power Drift = 0.03 dB

Peak SAR (extrapolated) = 5.14 W/kg

**SAR(1 g) = 0.873 W/kg**

[Info: Interpolated medium parameters used for SAR evaluation.](#)

Maximum value of SAR (measured) = 1.83 W/kg

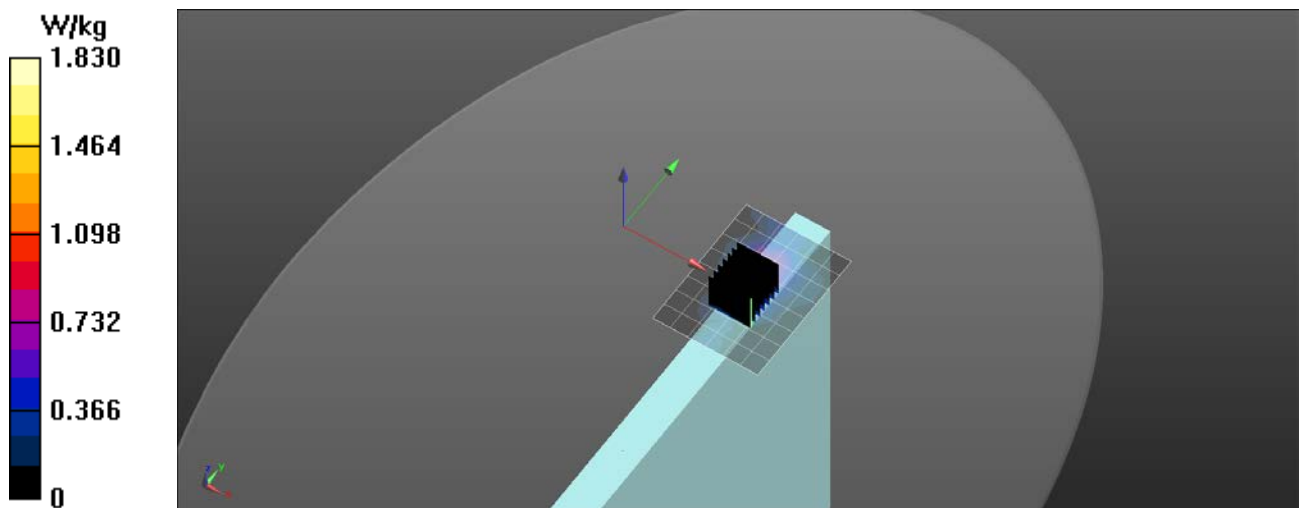

## Appendix D – Probe Calibration Data Sheets



*Jm*

**Calibration Laboratory of  
Schmid & Partner  
Engineering AG**  
Zeughausstrasse 43, 8004 Zurich, Switzerland



**S** Schweizerischer Kalibrierdienst  
**S** Service suisse d'étalonnage  
**S** Servizio svizzero di taratura  
**S** Swiss Calibration Service

Accredited by the Swiss Accreditation Service (SAS)  
The Swiss Accreditation Service is one of the signatories to the EA  
Multilateral Agreement for the recognition of calibration certificates

Accreditation No.: **SCS 0108**

Client **RF Exposure Lab**

Certificate No: **EX3-3693\_Aug17**

## CALIBRATION CERTIFICATE

Object **EX3DV4 - SN:3693**

Calibration procedure(s) **QA CAL-01.v9, QA CAL-12.v9, QA CAL-14.v4, QA CAL-23.v5,  
QA CAL-25.v6  
Calibration procedure for dosimetric E-field probes**

Calibration date: **August 18, 2017**

This calibration certificate documents the traceability to national standards, which realize the physical units of measurements (SI).  
The measurements and the uncertainties with confidence probability are given on the following pages and are part of the certificate.

All calibrations have been conducted in the closed laboratory facility: environment temperature (22 ± 3)°C and humidity < 70%.

Calibration Equipment used (M&TE critical for calibration)

Primary Standards	ID	Cal Date (Certificate No.)	Scheduled Calibration
Power meter NRP	SN: 104778	04-Apr-17 (No. 217-02521/02522)	Apr-18
Power sensor NRP-Z91	SN: 103244	04-Apr-17 (No. 217-02521)	Apr-18
Power sensor NRP-Z91	SN: 103245	04-Apr-17 (No. 217-02525)	Apr-18
Reference 20 dB Attenuator	SN: S5277 (20x)	07-Apr-17 (No. 217-02528)	Apr-18
Reference Probe ES3DV2	SN: 3013	31-Dec-16 (No. ES3-3013_Dec16)	Dec-17
DAE4	SN: 660	7-Dec-16 (No. DAE4-660_Dec16)	Dec-17
Secondary Standards	ID	Check Date (in house)	Scheduled Check
Power meter E4419B	SN: GB41293874	06-Apr-16 (in house check Jun-16)	In house check: Jun-18
Power sensor E4412A	SN: MY41498087	06-Apr-16 (in house check Jun-16)	In house check: Jun-18
Power sensor E4412A	SN: 000110210	06-Apr-16 (in house check Jun-16)	In house check: Jun-18
RF generator HP 8648C	SN: US3642U01700	04-Aug-99 (in house check Jun-16)	In house check: Jun-18
Network Analyzer HP 8753E	SN: US37390585	18-Oct-01 (in house check Oct-16)	In house check: Oct-17

Calibrated by:	Name <b>Jeton Kastrati</b>	Function <b>Laboratory Technician</b>	Signature 
Approved by:	Name <b>Katja Pokovic</b>	Function <b>Technical Manager</b>	

Issued: August 22, 2017

This calibration certificate shall not be reproduced except in full without written approval of the laboratory.



Accredited by the Swiss Accreditation Service (SAS)

Accreditation No.: **SCS 0108**

The Swiss Accreditation Service is one of the signatories to the EA  
Multilateral Agreement for the recognition of calibration certificates

### Glossary:

TSL	tissue simulating liquid
NORM <sub>x,y,z</sub>	sensitivity in free space
ConvF	sensitivity in TSL / NORM <sub>x,y,z</sub>
DCP	diode compression point
CF	crest factor (1/duty_cycle) of the RF signal
A, B, C, D	modulation dependent linearization parameters
Polarization $\varphi$	$\varphi$ rotation around probe axis
Polarization $\vartheta$	$\vartheta$ rotation around an axis that is in the plane normal to probe axis (at measurement center), i.e., $\vartheta = 0$ is normal to probe axis
Connector Angle	information used in DASY system to align probe sensor X to the robot coordinate system

### Calibration is Performed According to the Following Standards:

- IEEE Std 1528-2013, "IEEE Recommended Practice for Determining the Peak Spatial-Averaged Specific Absorption Rate (SAR) in the Human Head from Wireless Communications Devices: Measurement Techniques", June 2013
- IEC 62209-1, "Measurement procedure for the assessment of Specific Absorption Rate (SAR) from hand-held and body-mounted devices used next to the ear (frequency range of 300 MHz to 6 GHz)", July 2016
- IEC 62209-2, "Procedure to determine the Specific Absorption Rate (SAR) for wireless communication devices used in close proximity to the human body (frequency range of 30 MHz to 6 GHz)", March 2010
- KDB 865664, "SAR Measurement Requirements for 100 MHz to 6 GHz"

### Methods Applied and Interpretation of Parameters:

- NORM<sub>x,y,z</sub>**: Assessed for E-field polarization  $\vartheta = 0$  ( $f \leq 900$  MHz in TEM-cell;  $f > 1800$  MHz: R22 waveguide). NORM<sub>x,y,z</sub> are only intermediate values, i.e., the uncertainties of NORM<sub>x,y,z</sub> does not affect the E<sup>2</sup>-field uncertainty inside TSL (see below ConvF).
- NORM(f)<sub>x,y,z</sub>** = NORM<sub>x,y,z</sub> \* frequency\_response (see Frequency Response Chart). This linearization is implemented in DASY4 software versions later than 4.2. The uncertainty of the frequency response is included in the stated uncertainty of ConvF.
- DCP<sub>x,y,z</sub>**: DCP are numerical linearization parameters assessed based on the data of power sweep with CW signal (no uncertainty required). DCP does not depend on frequency nor media.
- PAR**: PAR is the Peak to Average Ratio that is not calibrated but determined based on the signal characteristics
- A<sub>x,y,z</sub>; B<sub>x,y,z</sub>; C<sub>x,y,z</sub>; D<sub>x,y,z</sub>; VR<sub>x,y,z</sub>**: A, B, C, D are numerical linearization parameters assessed based on the data of power sweep for specific modulation signal. The parameters do not depend on frequency nor media. VR is the maximum calibration range expressed in RMS voltage across the diode.
- ConvF and Boundary Effect Parameters**: Assessed in flat phantom using E-field (or Temperature Transfer Standard for  $f \leq 800$  MHz) and inside waveguide using analytical field distributions based on power measurements for  $f > 800$  MHz. The same setups are used for assessment of the parameters applied for boundary compensation (alpha, depth) of which typical uncertainty values are given. These parameters are used in DASY4 software to improve probe accuracy close to the boundary. The sensitivity in TSL corresponds to NORM<sub>x,y,z</sub> \* ConvF whereby the uncertainty corresponds to that given for ConvF. A frequency dependent ConvF is used in DASY version 4.4 and higher which allows extending the validity from  $\pm 50$  MHz to  $\pm 100$  MHz.
- Spherical isotropy (3D deviation from isotropy)**: in a field of low gradients realized using a flat phantom exposed by a patch antenna.
- Sensor Offset**: The sensor offset corresponds to the offset of virtual measurement center from the probe tip (on probe axis). No tolerance required.
- Connector Angle**: The angle is assessed using the information gained by determining the NORM<sub>x</sub> (no uncertainty required).

# Probe EX3DV4

## SN:3693

Manufactured: April 22, 2009  
Calibrated: August 18, 2017

Calibrated for DASY/EASY Systems  
(Note: non-compatible with DASY2 system!)

## DASY/EASY - Parameters of Probe: EX3DV4 - SN:3693

### Basic Calibration Parameters

	Sensor X	Sensor Y	Sensor Z	Unc (k=2)
Norm ( $\mu\text{V}/(\text{V}/\text{m})^2$ ) <sup>A</sup>	0.39	0.32	0.35	$\pm 10.1 \%$
DCP (mV) <sup>B</sup>	95.1	97.9	107.8	

### Modulation Calibration Parameters

UID	Communication System Name		A dB	B dB $\sqrt{\mu\text{V}}$	C	D dB	VR mV	Unc <sup>E</sup> (k=2)
0	CW	X	0.0	0.0	1.0	0.00	153.2	$\pm 3.5 \%$
		Y	0.0	0.0	1.0		144.5	
		Z	0.0	0.0	1.0		151.4	

Note: For details on UID parameters see Appendix.

### Sensor Model Parameters

	C1 fF	C2 fF	$\alpha$ $\text{V}^{-1}$	T1 $\text{ms}\cdot\text{V}^{-2}$	T2 $\text{ms}\cdot\text{V}^{-1}$	T3 ms	T4 $\text{V}^{-2}$	T5 $\text{V}^{-1}$	T6
X	33.42	257.2	37.63	9.549	1.014	5.071	0	0.481	1.008
Y	36.13	269.4	35.53	11.22	0.702	5.041	0.308	0.41	1.005
Z	28.36	204.6	33.61	4.581	0.465	5.032	0.705	0.298	1.004

The reported uncertainty of measurement is stated as the standard uncertainty of measurement multiplied by the coverage factor  $k=2$ , which for a normal distribution corresponds to a coverage probability of approximately 95%.

<sup>A</sup> The uncertainties of Norm X,Y,Z do not affect the  $E^2$ -field uncertainty inside TSL (see Pages 5 and 6).

<sup>B</sup> Numerical linearization parameter: uncertainty not required.

<sup>E</sup> Uncertainty is determined using the max. deviation from linear response applying rectangular distribution and is expressed for the square of the field value.

## DASY/EASY - Parameters of Probe: EX3DV4 - SN:3693

### Calibration Parameter Determined in Head Tissue Simulating Media

f (MHz) <sup>C</sup>	Relative Permittivity <sup>F</sup>	Conductivity (S/m) <sup>F</sup>	ConvF X	ConvF Y	ConvF Z	Alpha <sup>G</sup>	Depth <sup>G</sup> (mm)	Unc (k=2)
150	52.3	0.76	11.31	11.31	11.31	0.00	1.00	± 13.3 %
220	49.0	0.81	10.54	10.54	10.54	0.00	1.00	± 13.3 %
450	43.5	0.87	9.78	9.78	9.78	0.13	1.60	± 13.3 %
750	41.9	0.89	9.55	9.55	9.55	0.36	1.03	± 12.0 %
1750	40.1	1.37	8.15	8.15	8.15	0.28	0.85	± 12.0 %
1900	40.0	1.40	7.85	7.85	7.85	0.30	0.85	± 12.0 %
2300	39.5	1.67	7.44	7.44	7.44	0.38	0.85	± 12.0 %
2450	39.2	1.80	7.05	7.05	7.05	0.31	0.84	± 12.0 %
5200	36.0	4.66	5.09	5.09	5.09	0.35	1.80	± 13.1 %
5300	35.9	4.76	4.83	4.83	4.83	0.35	1.80	± 13.1 %
5500	35.6	4.96	4.85	4.85	4.85	0.40	1.80	± 13.1 %
5600	35.5	5.07	4.70	4.70	4.70	0.40	1.80	± 13.1 %
5800	35.3	5.27	4.65	4.65	4.65	0.40	1.80	± 13.1 %

<sup>C</sup> Frequency validity above 300 MHz of ± 100 MHz only applies for DASY v4.4 and higher (see Page 2), else it is restricted to ± 50 MHz. The uncertainty is the RSS of the ConvF uncertainty at calibration frequency and the uncertainty for the indicated frequency band. Frequency validity below 300 MHz is ± 10, 25, 40, 50 and 70 MHz for ConvF assessments at 30, 64, 128, 150 and 220 MHz respectively. Above 5 GHz frequency validity can be extended to ± 110 MHz.

<sup>F</sup> At frequencies below 3 GHz, the validity of tissue parameters ( $\epsilon$  and  $\sigma$ ) can be relaxed to ± 10% if liquid compensation formula is applied to measured SAR values. At frequencies above 3 GHz, the validity of tissue parameters ( $\epsilon$  and  $\sigma$ ) is restricted to ± 5%. The uncertainty is the RSS of the ConvF uncertainty for indicated target tissue parameters.

<sup>G</sup> Alpha/Depth are determined during calibration. SPEAG warrants that the remaining deviation due to the boundary effect after compensation is always less than ± 1% for frequencies below 3 GHz and below ± 2% for frequencies between 3-6 GHz at any distance larger than half the probe tip diameter from the boundary.

## DASY/EASY - Parameters of Probe: EX3DV4 - SN:3693

### Calibration Parameter Determined in Body Tissue Simulating Media

f (MHz) <sup>C</sup>	Relative Permittivity <sup>F</sup>	Conductivity (S/m) <sup>F</sup>	ConvF X	ConvF Y	ConvF Z	Alpha <sup>G</sup>	Depth <sup>G</sup> (mm)	Unc (k=2)
150	61.9	0.80	10.76	10.76	10.76	0.00	1.00	± 13.3 %
220	60.2	0.86	10.08	10.08	10.08	0.00	1.00	± 13.3 %
450	56.7	0.94	10.19	10.19	10.19	0.10	1.30	± 13.3 %
750	55.5	0.96	9.35	9.35	9.35	0.50	0.85	± 12.0 %
1750	53.4	1.49	7.77	7.77	7.77	0.37	0.85	± 12.0 %
1900	53.3	1.52	7.54	7.54	7.54	0.30	0.96	± 12.0 %
2300	52.9	1.81	7.41	7.41	7.41	0.38	0.84	± 12.0 %
2450	52.7	1.95	7.26	7.26	7.26	0.34	0.89	± 12.0 %
5200	49.0	5.30	4.70	4.70	4.70	0.35	1.90	± 13.1 %
5300	48.9	5.42	4.46	4.46	4.46	0.40	1.90	± 13.1 %
5500	48.6	5.65	4.04	4.04	4.04	0.40	1.90	± 13.1 %
5600	48.5	5.77	4.00	4.00	4.00	0.40	1.90	± 13.1 %
5800	48.2	6.00	4.21	4.21	4.21	0.40	1.90	± 13.1 %

<sup>C</sup> Frequency validity above 300 MHz of ± 100 MHz only applies for DASY v4.4 and higher (see Page 2), else it is restricted to ± 50 MHz. The uncertainty is the RSS of the ConvF uncertainty at calibration frequency and the uncertainty for the indicated frequency band. Frequency validity below 300 MHz is ± 10, 25, 40, 50 and 70 MHz for ConvF assessments at 30, 64, 128, 150 and 220 MHz respectively. Above 5 GHz frequency validity can be extended to ± 110 MHz.

<sup>F</sup> At frequencies below 3 GHz, the validity of tissue parameters ( $\epsilon$  and  $\sigma$ ) can be relaxed to ± 10% if liquid compensation formula is applied to measured SAR values. At frequencies above 3 GHz, the validity of tissue parameters ( $\epsilon$  and  $\sigma$ ) is restricted to ± 5%. The uncertainty is the RSS of the ConvF uncertainty for indicated target tissue parameters.

<sup>G</sup> Alpha/Depth are determined during calibration. SPEAG warrants that the remaining deviation due to the boundary effect after compensation is always less than ± 1% for frequencies below 3 GHz and below ± 2% for frequencies between 3-6 GHz at any distance larger than half the probe tip diameter from the boundary.

# Frequency Response of E-Field (TEM-Cell:ifi110 EXX, Waveguide: R22)

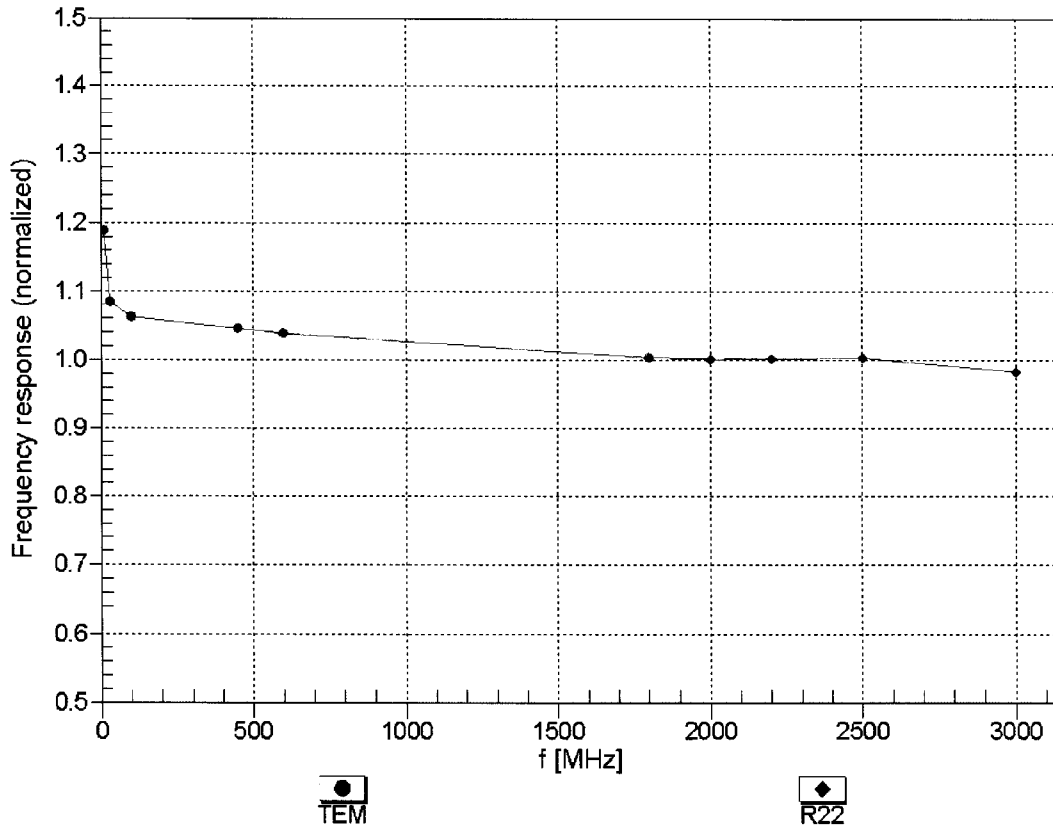

Uncertainty of Frequency Response of E-field:  $\pm 6.3\%$  (k=2)

### Receiving Pattern ( $\phi$ ), $\theta = 0^\circ$

f=600 MHz,TEM

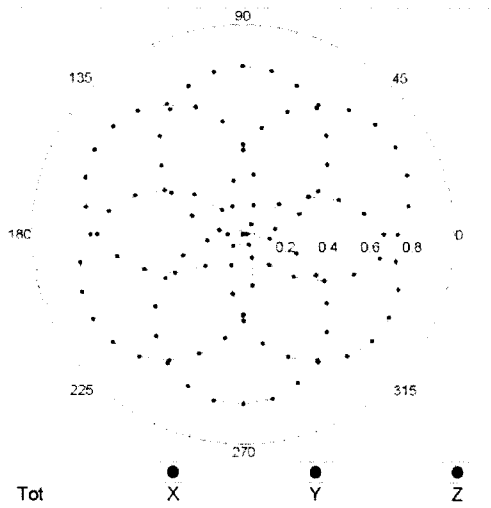

f=1800 MHz,R22

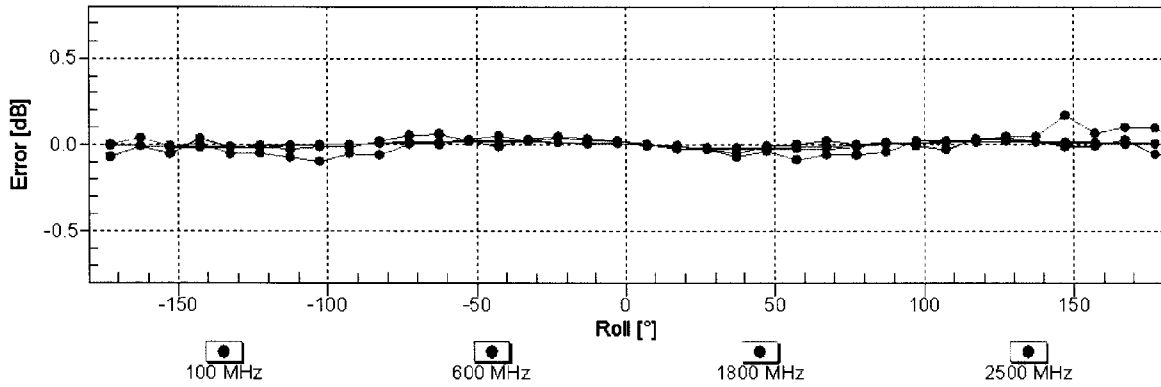
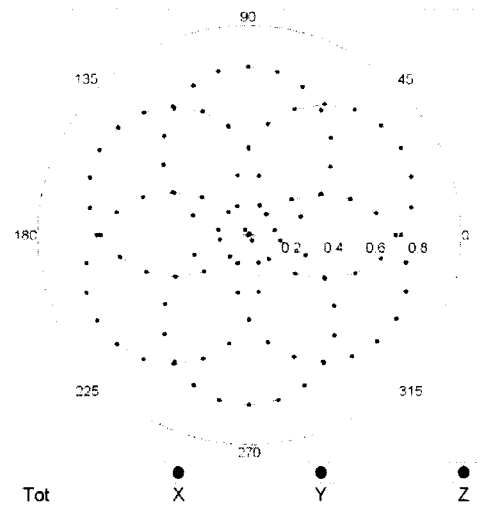

Uncertainty of Axial Isotropy Assessment:  $\pm 0.5\%$  (k=2)



### Dynamic Range $f(\text{SAR}_{\text{head}})$ (TEM cell , $f_{\text{eval}} = 1900 \text{ MHz}$ )

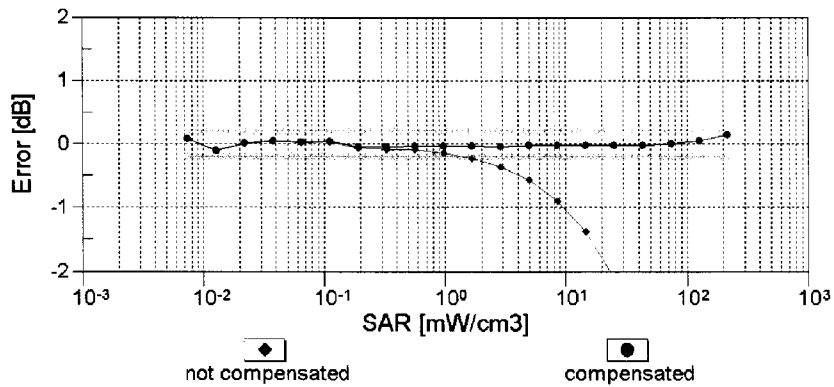
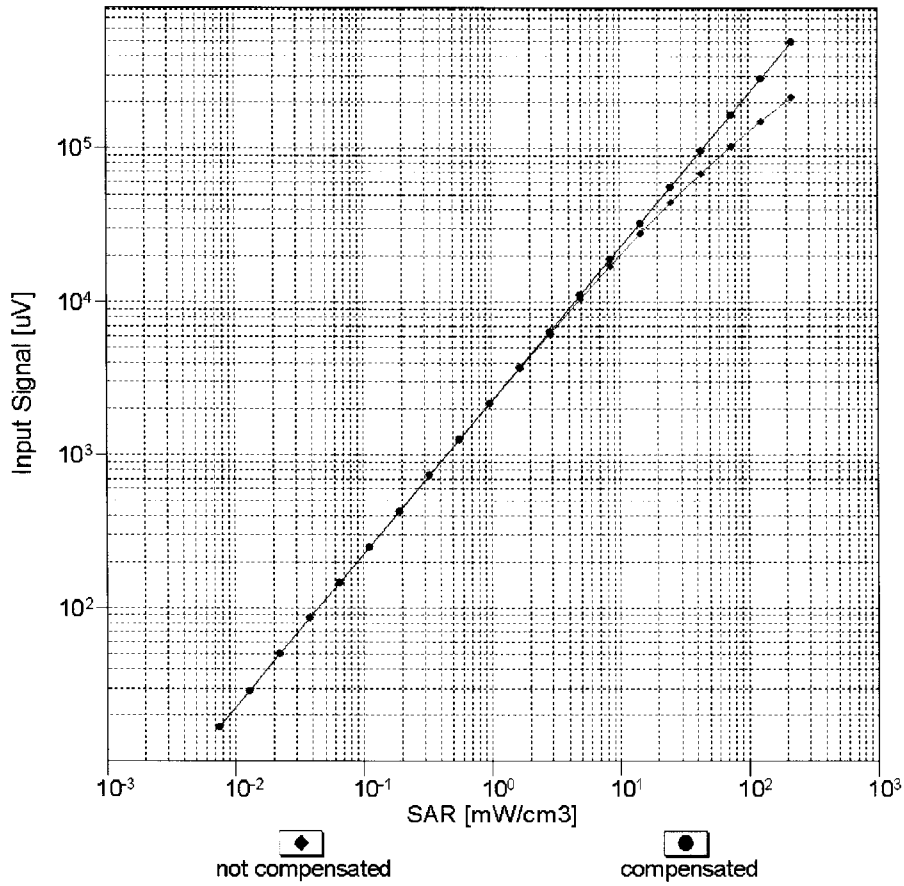

Uncertainty of Linearity Assessment:  $\pm 0.6\%$  ( $k=2$ )

# Conversion Factor Assessment

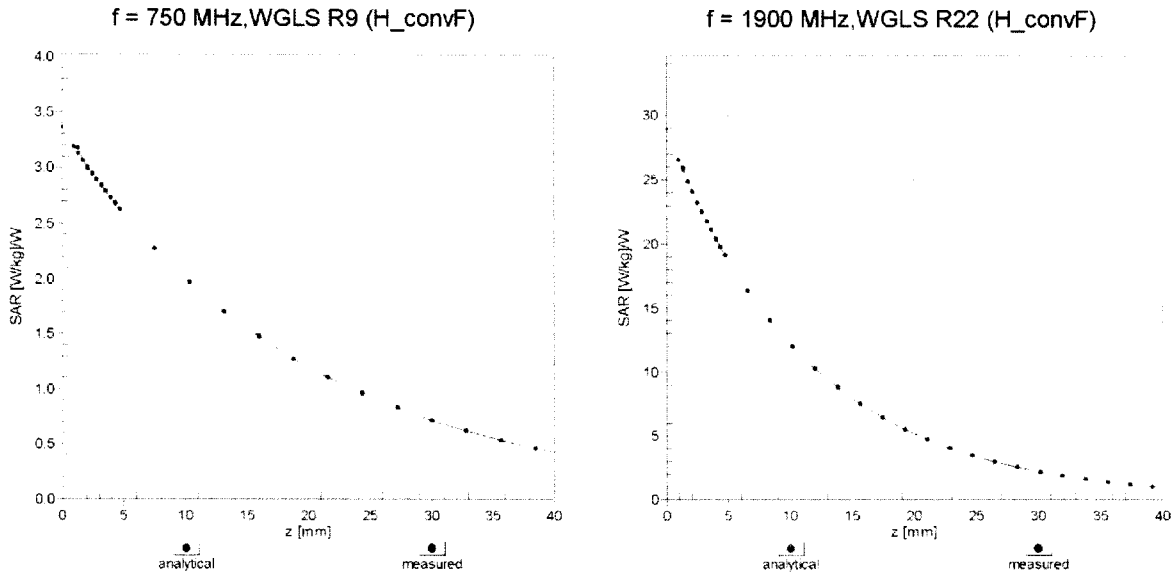

## Deviation from Isotropy in Liquid Error ( $\phi, \theta$ ), f = 900 MHz

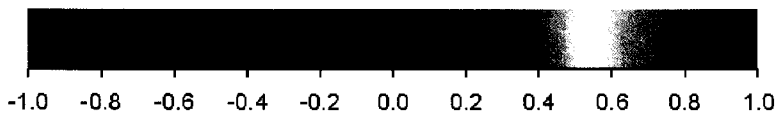
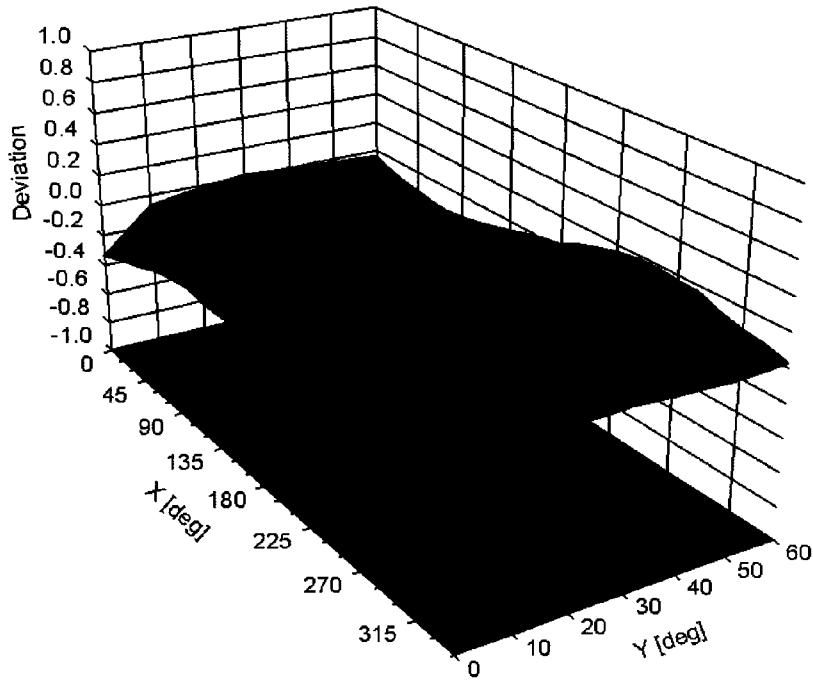

Uncertainty of Spherical Isotropy Assessment:  $\pm 2.6\%$  (k=2)

## DASY/EASY - Parameters of Probe: EX3DV4 - SN:3693

### Other Probe Parameters

Sensor Arrangement	Triangular
Connector Angle (°)	107.3
Mechanical Surface Detection Mode	enabled
Optical Surface Detection Mode	disabled
Probe Overall Length	337 mm
Probe Body Diameter	10 mm
Tip Length	9 mm
Tip Diameter	2.5 mm
Probe Tip to Sensor X Calibration Point	1 mm
Probe Tip to Sensor Y Calibration Point	1 mm
Probe Tip to Sensor Z Calibration Point	1 mm
Recommended Measurement Distance from Surface	1.4 mm

**Appendix: Modulation Calibration Parameters**

UID	Communication System Name		A dB	B dB $\sqrt{\mu}$ V	C	D dB	VR mV	Max Unc <sup>E</sup> (k=2)
0	CW	X	0.00	0.00	1.00	0.00	153.2	$\pm 3.5\%$
		Y	0.00	0.00	1.00		144.5	
		Z	0.00	0.00	1.00		151.4	
10010- CAA	SAR Validation (Square, 100ms, 10ms)	X	2.46	65.57	10.33	10.00	20.0	$\pm 9.6\%$
		Y	2.58	66.85	10.94		20.0	
		Z	1.86	62.99	8.17		20.0	
10011- CAB	UMTS-FDD (WCDMA)	X	0.96	69.29	15.51	0.00	150.0	$\pm 9.6\%$
		Y	0.93	66.88	14.68		150.0	
		Z	0.96	69.60	15.68		150.0	
10012- CAB	IEEE 802.11b WiFi 2.4 GHz (DSSS, 1 Mbps)	X	1.07	64.52	15.65	0.41	150.0	$\pm 9.6\%$
		Y	1.12	63.74	15.00		150.0	
		Z	1.05	64.42	15.37		150.0	
10013- CAB	IEEE 802.11g WiFi 2.4 GHz (DSSS-OFDM, 6 Mbps)	X	4.64	67.04	17.28	1.46	150.0	$\pm 9.6\%$
		Y	4.69	66.78	16.99		150.0	
		Z	4.48	67.08	16.97		150.0	
10021- DAC	GSM-FDD (TDMA, GMSK)	X	100.00	113.55	27.40	9.39	50.0	$\pm 9.6\%$
		Y	100.00	113.18	27.01		50.0	
		Z	100.00	106.64	23.61		50.0	
10023- DAC	GPRS-FDD (TDMA, GMSK, TN 0)	X	100.00	113.06	27.24	9.57	50.0	$\pm 9.6\%$
		Y	100.00	112.70	26.84		50.0	
		Z	32.97	94.20	20.54		50.0	
10024- DAC	GPRS-FDD (TDMA, GMSK, TN 0-1)	X	100.00	111.50	25.18	6.56	60.0	$\pm 9.6\%$
		Y	100.00	111.79	25.25		60.0	
		Z	100.00	104.88	21.52		60.0	
10025- DAC	EDGE-FDD (TDMA, 8PSK, TN 0)	X	3.89	66.96	23.84	12.57	50.0	$\pm 9.6\%$
		Y	4.25	70.19	25.75		50.0	
		Z	3.28	63.68	21.63		50.0	
10026- DAC	EDGE-FDD (TDMA, 8PSK, TN 0-1)	X	8.05	89.16	31.60	9.56	60.0	$\pm 9.6\%$
		Y	7.77	88.25	31.17		60.0	
		Z	5.87	82.94	28.96		60.0	
10027- DAC	GPRS-FDD (TDMA, GMSK, TN 0-1-2)	X	100.00	110.68	23.90	4.80	80.0	$\pm 9.6\%$
		Y	100.00	112.16	24.62		80.0	
		Z	100.00	104.54	20.49		80.0	
10028- DAC	GPRS-FDD (TDMA, GMSK, TN 0-1-2-3)	X	100.00	109.55	22.62	3.55	100.0	$\pm 9.6\%$
		Y	100.00	113.50	24.48		100.0	
		Z	100.00	104.05	19.54		100.0	
10029- DAC	EDGE-FDD (TDMA, 8PSK, TN 0-1-2)	X	5.29	80.16	27.01	7.80	80.0	$\pm 9.6\%$
		Y	5.14	79.09	26.35		80.0	
		Z	3.96	74.93	24.59		80.0	
10030- CAA	IEEE 802.15.1 Bluetooth (GFSK, DH1)	X	100.00	108.68	23.35	5.30	70.0	$\pm 9.6\%$
		Y	100.00	109.67	23.80		70.0	
		Z	100.00	101.79	19.60		70.0	
10031- CAA	IEEE 802.15.1 Bluetooth (GFSK, DH3)	X	0.42	62.17	5.93	1.88	100.0	$\pm 9.6\%$
		Y	100.00	107.91	20.81		100.0	
		Z	0.20	60.00	3.98		100.0	

10032-CAA	IEEE 802.15.1 Bluetooth (GFSK, DH5)	X	0.21	60.00	3.06	1.17	100.0	± 9.6 %
		Y	100.00	108.51	20.18		100.0	
		Z	17.50	60.55	1.43		100.0	
10033-CAA	IEEE 802.15.1 Bluetooth (PI/4-DQPSK, DH1)	X	26.75	102.90	26.12	5.30	70.0	± 9.6 %
		Y	11.41	91.98	23.49		70.0	
		Z	8.40	86.52	20.27		70.0	
10034-CAA	IEEE 802.15.1 Bluetooth (PI/4-DQPSK, DH3)	X	3.04	75.65	15.32	1.88	100.0	± 9.6 %
		Y	2.84	75.48	16.17		100.0	
		Z	1.44	68.36	11.69		100.0	
10035-CAA	IEEE 802.15.1 Bluetooth (PI/4-DQPSK, DH5)	X	1.53	69.13	12.32	1.17	100.0	± 9.6 %
		Y	1.81	71.22	14.21		100.0	
		Z	0.97	65.45	10.03		100.0	
10036-CAA	IEEE 802.15.1 Bluetooth (8-DPSK, DH1)	X	68.65	116.35	29.55	5.30	70.0	± 9.6 %
		Y	17.31	98.26	25.40		70.0	
		Z	14.64	93.89	22.52		70.0	
10037-CAA	IEEE 802.15.1 Bluetooth (8-DPSK, DH3)	X	2.53	73.73	14.61	1.88	100.0	± 9.6 %
		Y	2.51	74.11	15.65		100.0	
		Z	1.27	67.18	11.19		100.0	
10038-CAA	IEEE 802.15.1 Bluetooth (8-DPSK, DH5)	X	1.60	69.92	12.78	1.17	100.0	± 9.6 %
		Y	1.84	71.62	14.51		100.0	
		Z	0.99	65.91	10.38		100.0	
10039-CAB	CDMA2000 (1xRTT, RC1)	X	0.74	63.41	8.92	0.00	150.0	± 9.6 %
		Y	1.23	68.14	12.51		150.0	
		Z	0.60	62.45	7.98		150.0	
10042-CAB	IS-54 / IS-136 FDD (TDMA/FDM, PI/4-DQPSK, Halfrate)	X	100.00	108.18	24.00	7.78	50.0	± 9.6 %
		Y	100.00	108.88	24.22		50.0	
		Z	10.97	81.94	15.63		50.0	
10044-CAA	IS-91/EIA/TIA-553 FDD (FDMA, FM)	X	0.00	65.90	22.17	0.00	150.0	± 9.6 %
		Y	0.01	122.92	0.71		150.0	
		Z	0.13	128.48	4.69		150.0	
10048-CAA	DECT (TDD, TDMA/FDM, GFSK, Full Slot, 24)	X	14.87	85.35	21.09	13.80	25.0	± 9.6 %
		Y	23.17	91.69	22.64		25.0	
		Z	6.22	71.44	14.68		25.0	
10049-CAA	DECT (TDD, TDMA/FDM, GFSK, Double Slot, 12)	X	24.31	94.02	22.62	10.79	40.0	± 9.6 %
		Y	43.77	101.49	24.30		40.0	
		Z	6.49	74.97	14.88		40.0	
10056-CAA	UMTS-TDD (TD-SCDMA, 1.28 Mcps)	X	18.56	94.19	24.49	9.03	50.0	± 9.6 %
		Y	19.55	95.88	25.17		50.0	
		Z	13.54	87.88	21.18		50.0	
10058-DAC	EDGE-FDD (TDMA, 8PSK, TN 0-1-2-3)	X	4.17	75.85	24.49	6.55	100.0	± 9.6 %
		Y	4.09	74.81	23.76		100.0	
		Z	3.25	71.57	22.39		100.0	
10059-CAB	IEEE 802.11b WiFi 2.4 GHz (DSSS, 2 Mbps)	X	1.13	66.04	16.48	0.61	110.0	± 9.6 %
		Y	1.16	64.80	15.58		110.0	
		Z	1.07	65.37	15.92		110.0	
10060-CAB	IEEE 802.11b WiFi 2.4 GHz (DSSS, 5.5 Mbps)	X	100.00	137.72	34.95	1.30	110.0	± 9.6 %
		Y	14.15	108.54	28.54		110.0	
		Z	100.00	142.16	36.45		110.0	

10061-CAB	IEEE 802.11b WiFi 2.4 GHz (DSSS, 11 Mbps)	X	5.68	93.99	26.90	2.04	110.0	± 9.6 %
		Y	2.72	79.85	21.80		110.0	
		Z	2.32	80.40	22.21		110.0	
10062-CAB	IEEE 802.11a/h WiFi 5 GHz (OFDM, 6 Mbps)	X	4.40	66.89	16.61	0.49	100.0	± 9.6 %
		Y	4.48	66.72	16.41		100.0	
		Z	4.27	67.05	16.40		100.0	
10063-CAB	IEEE 802.11a/h WiFi 5 GHz (OFDM, 9 Mbps)	X	4.43	67.03	16.74	0.72	100.0	± 9.6 %
		Y	4.50	66.82	16.51		100.0	
		Z	4.29	67.16	16.50		100.0	
10064-CAB	IEEE 802.11a/h WiFi 5 GHz (OFDM, 12 Mbps)	X	4.66	67.22	16.93	0.86	100.0	± 9.6 %
		Y	4.74	67.02	16.71		100.0	
		Z	4.50	67.31	16.67		100.0	
10065-CAB	IEEE 802.11a/h WiFi 5 GHz (OFDM, 18 Mbps)	X	4.55	67.11	17.04	1.21	100.0	± 9.6 %
		Y	4.62	66.89	16.79		100.0	
		Z	4.38	67.12	16.73		100.0	
10066-CAB	IEEE 802.11a/h WiFi 5 GHz (OFDM, 24 Mbps)	X	4.57	67.14	17.22	1.46	100.0	± 9.6 %
		Y	4.64	66.91	16.95		100.0	
		Z	4.38	67.08	16.86		100.0	
10067-CAB	IEEE 802.11a/h WiFi 5 GHz (OFDM, 36 Mbps)	X	4.87	67.48	17.74	2.04	100.0	± 9.6 %
		Y	4.93	67.19	17.44		100.0	
		Z	4.65	67.30	17.29		100.0	
10068-CAB	IEEE 802.11a/h WiFi 5 GHz (OFDM, 48 Mbps)	X	4.92	67.43	17.92	2.55	100.0	± 9.6 %
		Y	4.97	67.13	17.61		100.0	
		Z	4.70	67.27	17.49		100.0	
10069-CAB	IEEE 802.11a/h WiFi 5 GHz (OFDM, 54 Mbps)	X	4.98	67.46	18.11	2.67	100.0	± 9.6 %
		Y	5.04	67.15	17.79		100.0	
		Z	4.74	67.23	17.63		100.0	
10071-CAB	IEEE 802.11g WiFi 2.4 GHz (DSSS/OFDM, 9 Mbps)	X	4.75	67.16	17.60	1.99	100.0	± 9.6 %
		Y	4.79	66.87	17.29		100.0	
		Z	4.57	67.14	17.25		100.0	
10072-CAB	IEEE 802.11g WiFi 2.4 GHz (DSSS/OFDM, 12 Mbps)	X	4.72	67.47	17.83	2.30	100.0	± 9.6 %
		Y	4.76	67.14	17.49		100.0	
		Z	4.51	67.32	17.42		100.0	
10073-CAB	IEEE 802.11g WiFi 2.4 GHz (DSSS/OFDM, 18 Mbps)	X	4.81	67.75	18.22	2.83	100.0	± 9.6 %
		Y	4.83	67.34	17.84		100.0	
		Z	4.58	67.54	17.76		100.0	
10074-CAB	IEEE 802.11g WiFi 2.4 GHz (DSSS/OFDM, 24 Mbps)	X	4.84	67.77	18.41	3.30	100.0	± 9.6 %
		Y	4.84	67.30	18.00		100.0	
		Z	4.61	67.56	17.94		100.0	
10075-CAB	IEEE 802.11g WiFi 2.4 GHz (DSSS/OFDM, 36 Mbps)	X	4.88	67.82	18.68	3.82	90.0	± 9.6 %
		Y	4.87	67.35	18.27		90.0	
		Z	4.64	67.56	18.18		90.0	
10076-CAB	IEEE 802.11g WiFi 2.4 GHz (DSSS/OFDM, 48 Mbps)	X	4.93	67.72	18.87	4.15	90.0	± 9.6 %
		Y	4.91	67.23	18.44		90.0	
		Z	4.68	67.42	18.33		90.0	
10077-CAB	IEEE 802.11g WiFi 2.4 GHz (DSSS/OFDM, 54 Mbps)	X	4.97	67.84	18.99	4.30	90.0	± 9.6 %
		Y	4.95	67.34	18.55		90.0	
		Z	4.72	67.54	18.46		90.0	

10081-CAB	CDMA2000 (1xRTT, RC3)	X	0.36	60.00	6.17	0.00	150.0	± 9.6 %
		Y	0.59	63.42	9.69		150.0	
		Z	0.32	60.00	5.85		150.0	
10082-CAB	IS-54 / IS-136 FDD (TDMA/FDM, PI/4-DQPSK, Fullrate)	X	0.70	60.00	4.28	4.77	80.0	± 9.6 %
		Y	0.71	60.00	4.47		80.0	
		Z	0.69	60.00	2.91		80.0	
10090-DAC	GPRS-FDD (TDMA, GMSK, TN 0-4)	X	100.00	111.63	25.26	6.56	60.0	± 9.6 %
		Y	100.00	111.84	25.29		60.0	
		Z	100.00	104.97	21.57		60.0	
10097-CAB	UMTS-FDD (HSDPA)	X	1.79	69.48	15.83	0.00	150.0	± 9.6 %
		Y	1.75	68.01	15.37		150.0	
		Z	1.85	70.58	16.07		150.0	
10098-CAB	UMTS-FDD (HSUPA, Subtest 2)	X	1.75	69.43	15.81	0.00	150.0	± 9.6 %
		Y	1.71	67.95	15.34		150.0	
		Z	1.81	70.51	16.05		150.0	
10099-DAC	EDGE-FDD (TDMA, 8PSK, TN 0-4)	X	8.10	89.27	31.64	9.56	60.0	± 9.6 %
		Y	7.82	88.37	31.21		60.0	
		Z	5.91	83.06	29.00		60.0	
10100-CAD	LTE-FDD (SC-FDMA, 100% RB, 20 MHz, QPSK)	X	2.93	70.65	16.93	0.00	150.0	± 9.6 %
		Y	2.91	69.88	16.50		150.0	
		Z	2.88	71.00	17.02		150.0	
10101-CAD	LTE-FDD (SC-FDMA, 100% RB, 20 MHz, 16-QAM)	X	3.00	67.51	15.97	0.00	150.0	± 9.6 %
		Y	3.06	67.25	15.75		150.0	
		Z	2.95	67.78	15.94		150.0	
10102-CAD	LTE-FDD (SC-FDMA, 100% RB, 20 MHz, 64-QAM)	X	3.11	67.54	16.09	0.00	150.0	± 9.6 %
		Y	3.17	67.28	15.86		150.0	
		Z	3.06	67.84	16.07		150.0	
10103-CAD	LTE-TDD (SC-FDMA, 100% RB, 20 MHz, QPSK)	X	6.12	76.61	21.08	3.98	65.0	± 9.6 %
		Y	6.02	75.69	20.46		65.0	
		Z	5.04	74.42	19.98		65.0	
10104-CAD	LTE-TDD (SC-FDMA, 100% RB, 20 MHz, 16-QAM)	X	5.76	73.36	20.41	3.98	65.0	± 9.6 %
		Y	5.82	73.01	20.04		65.0	
		Z	4.97	71.67	19.37		65.0	
10105-CAD	LTE-TDD (SC-FDMA, 100% RB, 20 MHz, 64-QAM)	X	5.43	72.01	20.10	3.98	65.0	± 9.6 %
		Y	5.60	72.12	19.94		65.0	
		Z	4.63	70.08	18.95		65.0	
10108-CAE	LTE-FDD (SC-FDMA, 100% RB, 10 MHz, QPSK)	X	2.52	70.18	16.82	0.00	150.0	± 9.6 %
		Y	2.51	69.21	16.32		150.0	
		Z	2.46	70.52	16.90		150.0	
10109-CAE	LTE-FDD (SC-FDMA, 100% RB, 10 MHz, 16-QAM)	X	2.65	67.63	15.85	0.00	150.0	± 9.6 %
		Y	2.71	67.20	15.60		150.0	
		Z	2.60	68.02	15.83		150.0	
10110-CAE	LTE-FDD (SC-FDMA, 100% RB, 5 MHz, QPSK)	X	2.00	69.56	16.26	0.00	150.0	± 9.6 %
		Y	2.00	68.38	15.78		150.0	
		Z	1.95	69.96	16.28		150.0	
10111-CAE	LTE-FDD (SC-FDMA, 100% RB, 5 MHz, 16-QAM)	X	2.44	69.32	16.14	0.00	150.0	± 9.6 %
		Y	2.45	68.42	15.85		150.0	
		Z	2.47	70.27	16.29		150.0	

10112-CAE	LTE-FDD (SC-FDMA, 100% RB, 10 MHz, 64-QAM)	X	2.78	67.70	15.93	0.00	150.0	± 9.6 %
		Y	2.84	67.29	15.69		150.0	
		Z	2.74	68.15	15.94		150.0	
10113-CAE	LTE-FDD (SC-FDMA, 100% RB, 5 MHz, 64-QAM)	X	2.59	69.51	16.30	0.00	150.0	± 9.6 %
		Y	2.60	68.63	16.01		150.0	
		Z	2.62	70.47	16.44		150.0	
10114-CAB	IEEE 802.11n (HT Greenfield, 13.5 Mbps, BPSK)	X	4.85	67.15	16.53	0.00	150.0	± 9.6 %
		Y	4.92	67.07	16.34		150.0	
		Z	4.74	67.31	16.39		150.0	
10115-CAB	IEEE 802.11n (HT Greenfield, 81 Mbps, 16-QAM)	X	5.09	67.20	16.55	0.00	150.0	± 9.6 %
		Y	5.17	67.14	16.39		150.0	
		Z	4.96	67.32	16.38		150.0	
10116-CAB	IEEE 802.11n (HT Greenfield, 135 Mbps, 64-QAM)	X	4.93	67.32	16.54	0.00	150.0	± 9.6 %
		Y	5.01	67.26	16.37		150.0	
		Z	4.80	67.45	16.39		150.0	
10117-CAB	IEEE 802.11n (HT Mixed, 13.5 Mbps, BPSK)	X	4.83	67.05	16.49	0.00	150.0	± 9.6 %
		Y	4.92	67.03	16.34		150.0	
		Z	4.72	67.21	16.36		150.0	
10118-CAB	IEEE 802.11n (HT Mixed, 81 Mbps, 16-QAM)	X	5.18	67.45	16.68	0.00	150.0	± 9.6 %
		Y	5.24	67.32	16.48		150.0	
		Z	5.01	67.45	16.45		150.0	
10119-CAB	IEEE 802.11n (HT Mixed, 135 Mbps, 64-QAM)	X	4.93	67.35	16.56	0.00	150.0	± 9.6 %
		Y	5.00	67.26	16.38		150.0	
		Z	4.81	67.49	16.41		150.0	
10140-CAD	LTE-FDD (SC-FDMA, 100% RB, 15 MHz, 16-QAM)	X	3.12	67.54	15.99	0.00	150.0	± 9.6 %
		Y	3.19	67.29	15.77		150.0	
		Z	3.06	67.85	15.96		150.0	
10141-CAD	LTE-FDD (SC-FDMA, 100% RB, 15 MHz, 64-QAM)	X	3.25	67.75	16.21	0.00	150.0	± 9.6 %
		Y	3.32	67.47	15.98		150.0	
		Z	3.20	68.12	16.21		150.0	
10142-CAD	LTE-FDD (SC-FDMA, 100% RB, 3 MHz, QPSK)	X	1.74	69.31	15.23	0.00	150.0	± 9.6 %
		Y	1.76	68.27	15.08		150.0	
		Z	1.70	69.77	15.16		150.0	
10143-CAD	LTE-FDD (SC-FDMA, 100% RB, 3 MHz, 16-QAM)	X	2.16	69.07	14.68	0.00	150.0	± 9.6 %
		Y	2.25	68.80	15.00		150.0	
		Z	2.14	69.68	14.51		150.0	
10144-CAD	LTE-FDD (SC-FDMA, 100% RB, 3 MHz, 64-QAM)	X	1.74	65.28	12.23	0.00	150.0	± 9.6 %
		Y	1.92	65.76	12.95		150.0	
		Z	1.60	65.02	11.63		150.0	
10145-CAE	LTE-FDD (SC-FDMA, 100% RB, 1.4 MHz, QPSK)	X	0.58	60.00	6.08	0.00	150.0	± 9.6 %
		Y	0.77	61.39	8.08		150.0	
		Z	0.51	60.00	5.48		150.0	
10146-CAE	LTE-FDD (SC-FDMA, 100% RB, 1.4 MHz, 16-QAM)	X	0.86	60.00	5.96	0.00	150.0	± 9.6 %
		Y	1.06	60.98	7.22		150.0	
		Z	0.74	60.00	5.02		150.0	
10147-CAE	LTE-FDD (SC-FDMA, 100% RB, 1.4 MHz, 64-QAM)	X	0.87	60.00	6.02	0.00	150.0	± 9.6 %
		Y	1.11	61.42	7.56		150.0	
		Z	0.75	60.00	5.07		150.0	



10149-CAD	LTE-FDD (SC-FDMA, 50% RB, 20 MHz, 16-QAM)	X	2.66	67.71	15.91	0.00	150.0	± 9.6 %
		Y	2.72	67.28	15.65		150.0	
		Z	2.62	68.12	15.90		150.0	
10150-CAD	LTE-FDD (SC-FDMA, 50% RB, 20 MHz, 64-QAM)	X	2.79	67.78	15.99	0.00	150.0	± 9.6 %
		Y	2.84	67.35	15.74		150.0	
		Z	2.75	68.24	16.00		150.0	
10151-CAD	LTE-TDD (SC-FDMA, 50% RB, 20 MHz, QPSK)	X	6.77	80.29	22.54	3.98	65.0	± 9.6 %
		Y	6.33	78.29	21.53		65.0	
		Z	5.47	77.85	21.33		65.0	
10152-CAD	LTE-TDD (SC-FDMA, 50% RB, 20 MHz, 16-QAM)	X	5.33	73.49	19.97	3.98	65.0	± 9.6 %
		Y	5.34	72.96	19.59		65.0	
		Z	4.49	71.58	18.77		65.0	
10153-CAD	LTE-TDD (SC-FDMA, 50% RB, 20 MHz, 64-QAM)	X	5.80	74.93	21.00	3.98	65.0	± 9.6 %
		Y	5.76	74.19	20.51		65.0	
		Z	4.93	73.13	19.88		65.0	
10154-CAE	LTE-FDD (SC-FDMA, 50% RB, 10 MHz, QPSK)	X	2.06	70.10	16.57	0.00	150.0	± 9.6 %
		Y	2.05	68.80	16.03		150.0	
		Z	2.02	70.56	16.62		150.0	
10155-CAE	LTE-FDD (SC-FDMA, 50% RB, 10 MHz, 16-QAM)	X	2.44	69.38	16.19	0.00	150.0	± 9.6 %
		Y	2.45	68.46	15.88		150.0	
		Z	2.48	70.36	16.35		150.0	
10156-CAE	LTE-FDD (SC-FDMA, 50% RB, 5 MHz, QPSK)	X	1.50	68.47	14.19	0.00	150.0	± 9.6 %
		Y	1.57	67.97	14.49		150.0	
		Z	1.45	68.72	13.95		150.0	
10157-CAE	LTE-FDD (SC-FDMA, 50% RB, 5 MHz, 16-QAM)	X	1.49	64.88	11.44	0.00	150.0	± 9.6 %
		Y	1.72	65.90	12.60		150.0	
		Z	1.33	64.34	10.66		150.0	
10158-CAE	LTE-FDD (SC-FDMA, 50% RB, 10 MHz, 64-QAM)	X	2.60	69.64	16.38	0.00	150.0	± 9.6 %
		Y	2.61	68.72	16.07		150.0	
		Z	2.64	70.64	16.53		150.0	
10159-CAE	LTE-FDD (SC-FDMA, 50% RB, 5 MHz, 64-QAM)	X	1.55	65.11	11.61	0.00	150.0	± 9.6 %
		Y	1.80	66.26	12.82		150.0	
		Z	1.39	64.54	10.79		150.0	
10160-CAD	LTE-FDD (SC-FDMA, 50% RB, 15 MHz, QPSK)	X	2.57	69.60	16.63	0.00	150.0	± 9.6 %
		Y	2.56	68.57	16.14		150.0	
		Z	2.47	69.70	16.54		150.0	
10161-CAD	LTE-FDD (SC-FDMA, 50% RB, 15 MHz, 16-QAM)	X	2.67	67.78	15.84	0.00	150.0	± 9.6 %
		Y	2.73	67.32	15.62		150.0	
		Z	2.63	68.26	15.83		150.0	
10162-CAD	LTE-FDD (SC-FDMA, 50% RB, 15 MHz, 64-QAM)	X	2.79	68.04	16.00	0.00	150.0	± 9.6 %
		Y	2.85	67.55	15.77		150.0	
		Z	2.75	68.57	16.01		150.0	
10166-CAE	LTE-FDD (SC-FDMA, 50% RB, 1.4 MHz, QPSK)	X	3.17	69.79	19.57	3.01	150.0	± 9.6 %
		Y	3.20	68.89	18.78		150.0	
		Z	2.95	69.14	18.87		150.0	
10167-CAE	LTE-FDD (SC-FDMA, 50% RB, 1.4 MHz, 16-QAM)	X	3.80	72.70	19.93	3.01	150.0	± 9.6 %
		Y	3.79	71.51	19.09		150.0	
		Z	3.55	72.23	19.31		150.0	

10168-CAE	LTE-FDD (SC-FDMA, 50% RB, 1.4 MHz, 64-QAM)	X	4.49	76.44	22.00	3.01	150.0	± 9.6 %
		Y	4.31	74.34	20.75		150.0	
		Z	4.29	76.38	21.59		150.0	
10169-CAD	LTE-FDD (SC-FDMA, 1 RB, 20 MHz, QPSK)	X	2.59	68.04	18.76	3.01	150.0	± 9.6 %
		Y	2.62	67.42	18.09		150.0	
		Z	2.53	67.98	18.27		150.0	
10170-CAD	LTE-FDD (SC-FDMA, 1 RB, 20 MHz, 16-QAM)	X	3.49	74.23	21.37	3.01	150.0	± 9.6 %
		Y	3.41	72.75	20.32		150.0	
		Z	3.58	75.13	21.26		150.0	
10171-AAD	LTE-FDD (SC-FDMA, 1 RB, 20 MHz, 64-QAM)	X	2.78	69.29	18.02	3.01	150.0	± 9.6 %
		Y	2.80	68.69	17.44		150.0	
		Z	2.71	69.37	17.54		150.0	
10172-CAD	LTE-TDD (SC-FDMA, 1 RB, 20 MHz, QPSK)	X	5.88	87.05	27.69	6.02	65.0	± 9.6 %
		Y	5.30	83.58	25.79		65.0	
		Z	3.26	76.76	23.19		65.0	
10173-CAD	LTE-TDD (SC-FDMA, 1 RB, 20 MHz, 16-QAM)	X	13.70	99.60	29.81	6.02	65.0	± 9.6 %
		Y	8.94	90.25	26.22		65.0	
		Z	7.04	88.51	25.48		65.0	
10174-CAD	LTE-TDD (SC-FDMA, 1 RB, 20 MHz, 64-QAM)	X	8.59	90.19	26.23	6.02	65.0	± 9.6 %
		Y	7.13	85.48	24.05		65.0	
		Z	3.88	78.05	21.26		65.0	
10175-CAE	LTE-FDD (SC-FDMA, 1 RB, 10 MHz, QPSK)	X	2.56	67.69	18.48	3.01	150.0	± 9.6 %
		Y	2.59	67.13	17.84		150.0	
		Z	2.49	67.60	17.97		150.0	
10176-CAE	LTE-FDD (SC-FDMA, 1 RB, 10 MHz, 16-QAM)	X	3.50	74.26	21.39	3.01	150.0	± 9.6 %
		Y	3.41	72.77	20.34		150.0	
		Z	3.59	75.16	21.28		150.0	
10177-CAG	LTE-FDD (SC-FDMA, 1 RB, 5 MHz, QPSK)	X	2.58	67.83	18.56	3.01	150.0	± 9.6 %
		Y	2.61	67.26	17.92		150.0	
		Z	2.51	67.74	18.05		150.0	
10178-CAE	LTE-FDD (SC-FDMA, 1 RB, 5 MHz, 16-QAM)	X	3.47	74.07	21.28	3.01	150.0	± 9.6 %
		Y	3.39	72.61	20.24		150.0	
		Z	3.55	74.95	21.17		150.0	
10179-CAE	LTE-FDD (SC-FDMA, 1 RB, 10 MHz, 64-QAM)	X	3.09	71.56	19.53	3.01	150.0	± 9.6 %
		Y	3.06	70.57	18.74		150.0	
		Z	3.07	71.92	19.18		150.0	
10180-CAE	LTE-FDD (SC-FDMA, 1 RB, 5 MHz, 64-QAM)	X	2.77	69.24	17.98	3.01	150.0	± 9.6 %
		Y	2.80	68.64	17.41		150.0	
		Z	2.71	69.32	17.51		150.0	
10181-CAD	LTE-FDD (SC-FDMA, 1 RB, 15 MHz, QPSK)	X	2.57	67.81	18.56	3.01	150.0	± 9.6 %
		Y	2.61	67.24	17.92		150.0	
		Z	2.50	67.72	18.05		150.0	
10182-CAD	LTE-FDD (SC-FDMA, 1 RB, 15 MHz, 16-QAM)	X	3.47	74.04	21.27	3.01	150.0	± 9.6 %
		Y	3.38	72.59	20.23		150.0	
		Z	3.55	74.92	21.15		150.0	
10183-AAC	LTE-FDD (SC-FDMA, 1 RB, 15 MHz, 64-QAM)	X	2.77	69.22	17.97	3.01	150.0	± 9.6 %
		Y	2.79	68.62	17.39		150.0	
		Z	2.70	69.30	17.49		150.0	

10184-CAD	LTE-FDD (SC-FDMA, 1 RB, 3 MHz, QPSK)	X	2.58	67.85	18.58	3.01	150.0	± 9.6 %
		Y	2.61	67.28	17.94		150.0	
		Z	2.51	67.77	18.07		150.0	
10185-CAD	LTE-FDD (SC-FDMA, 1 RB, 3 MHz, 16-QAM)	X	3.48	74.12	21.31	3.01	150.0	± 9.6 %
		Y	3.40	72.66	20.27		150.0	
		Z	3.57	75.02	21.20		150.0	
10186-AAD	LTE-FDD (SC-FDMA, 1 RB, 3 MHz, 64-QAM)	X	2.78	69.28	18.01	3.01	150.0	± 9.6 %
		Y	2.80	68.68	17.43		150.0	
		Z	2.72	69.36	17.53		150.0	
10187-CAE	LTE-FDD (SC-FDMA, 1 RB, 1.4 MHz, QPSK)	X	2.59	67.95	18.68	3.01	150.0	± 9.6 %
		Y	2.63	67.36	18.02		150.0	
		Z	2.53	67.88	18.18		150.0	
10188-CAE	LTE-FDD (SC-FDMA, 1 RB, 1.4 MHz, 16-QAM)	X	3.60	74.88	21.75	3.01	150.0	± 9.6 %
		Y	3.49	73.27	20.64		150.0	
		Z	3.72	75.91	21.69		150.0	
10189-AAE	LTE-FDD (SC-FDMA, 1 RB, 1.4 MHz, 64-QAM)	X	2.84	69.72	18.31	3.01	150.0	± 9.6 %
		Y	2.86	69.05	17.69		150.0	
		Z	2.78	69.83	17.84		150.0	
10193-CAB	IEEE 802.11n (HT Greenfield, 6.5 Mbps, BPSK)	X	4.24	66.83	16.19	0.00	150.0	± 9.6 %
		Y	4.33	66.71	16.05		150.0	
		Z	4.17	67.21	16.12		150.0	
10194-CAB	IEEE 802.11n (HT Greenfield, 39 Mbps, 16-QAM)	X	4.38	67.05	16.33	0.00	150.0	± 9.6 %
		Y	4.48	66.96	16.18		150.0	
		Z	4.29	67.37	16.25		150.0	
10195-CAB	IEEE 802.11n (HT Greenfield, 65 Mbps, 64-QAM)	X	4.41	67.06	16.34	0.00	150.0	± 9.6 %
		Y	4.51	66.98	16.20		150.0	
		Z	4.31	67.35	16.24		150.0	
10196-CAB	IEEE 802.11n (HT Mixed, 6.5 Mbps, BPSK)	X	4.22	66.81	16.17	0.00	150.0	± 9.6 %
		Y	4.32	66.72	16.04		150.0	
		Z	4.14	67.17	16.09		150.0	
10197-CAB	IEEE 802.11n (HT Mixed, 39 Mbps, 16-QAM)	X	4.38	67.05	16.33	0.00	150.0	± 9.6 %
		Y	4.48	66.96	16.19		150.0	
		Z	4.29	67.37	16.25		150.0	
10198-CAB	IEEE 802.11n (HT Mixed, 65 Mbps, 64-QAM)	X	4.40	67.05	16.34	0.00	150.0	± 9.6 %
		Y	4.51	66.98	16.20		150.0	
		Z	4.30	67.34	16.24		150.0	
10219-CAB	IEEE 802.11n (HT Mixed, 7.2 Mbps, BPSK)	X	4.18	66.86	16.15	0.00	150.0	± 9.6 %
		Y	4.27	66.75	16.01		150.0	
		Z	4.10	67.24	16.08		150.0	
10220-CAB	IEEE 802.11n (HT Mixed, 43.3 Mbps, 16-QAM)	X	4.38	67.01	16.32	0.00	150.0	± 9.6 %
		Y	4.48	66.92	16.17		150.0	
		Z	4.28	67.32	16.23		150.0	
10221-CAB	IEEE 802.11n (HT Mixed, 72.2 Mbps, 64-QAM)	X	4.42	67.00	16.33	0.00	150.0	± 9.6 %
		Y	4.52	66.92	16.19		150.0	
		Z	4.32	67.30	16.23		150.0	
10222-CAB	IEEE 802.11n (HT Mixed, 15 Mbps, BPSK)	X	4.81	67.05	16.49	0.00	150.0	± 9.6 %
		Y	4.89	67.00	16.32		150.0	
		Z	4.70	67.21	16.35		150.0	

10223-CAB	IEEE 802.11n (HT Mixed, 90 Mbps, 16-QAM)	X	5.06	67.21	16.57	0.00	150.0	± 9.6 %
		Y	5.16	67.20	16.44		150.0	
		Z	4.91	67.28	16.38		150.0	
10224-CAB	IEEE 802.11n (HT Mixed, 150 Mbps, 64-QAM)	X	4.85	67.17	16.47	0.00	150.0	± 9.6 %
		Y	4.93	67.12	16.31		150.0	
		Z	4.74	67.36	16.35		150.0	
10225-CAB	UMTS-FDD (HSPA+)	X	2.51	66.34	14.80	0.00	150.0	± 9.6 %
		Y	2.61	66.13	14.83		150.0	
		Z	2.46	66.75	14.59		150.0	
10226-CAA	LTE-TDD (SC-FDMA, 1 RB, 1.4 MHz, 16-QAM)	X	15.41	101.95	30.62	6.02	65.0	± 9.6 %
		Y	9.61	91.66	26.78		65.0	
		Z	7.80	90.47	26.24		65.0	
10227-CAA	LTE-TDD (SC-FDMA, 1 RB, 1.4 MHz, 64-QAM)	X	15.19	100.12	29.36	6.02	65.0	± 9.6 %
		Y	9.40	90.05	25.60		65.0	
		Z	7.35	88.27	24.80		65.0	
10228-CAA	LTE-TDD (SC-FDMA, 1 RB, 1.4 MHz, QPSK)	X	7.70	93.10	29.94	6.02	65.0	± 9.6 %
		Y	6.07	86.55	26.97		65.0	
		Z	4.20	82.08	25.39		65.0	
10229-CAB	LTE-TDD (SC-FDMA, 1 RB, 3 MHz, 16-QAM)	X	13.82	99.74	29.86	6.02	65.0	± 9.6 %
		Y	9.01	90.36	26.26		65.0	
		Z	7.11	88.67	25.54		65.0	
10230-CAB	LTE-TDD (SC-FDMA, 1 RB, 3 MHz, 64-QAM)	X	13.48	97.89	28.61	6.02	65.0	± 9.6 %
		Y	8.74	88.75	25.10		65.0	
		Z	6.65	86.51	24.13		65.0	
10231-CAB	LTE-TDD (SC-FDMA, 1 RB, 3 MHz, QPSK)	X	7.23	91.68	29.37	6.02	65.0	± 9.6 %
		Y	5.81	85.62	26.55		65.0	
		Z	4.00	81.04	24.89		65.0	
10232-CAD	LTE-TDD (SC-FDMA, 1 RB, 5 MHz, 16-QAM)	X	13.79	99.72	29.85	6.02	65.0	± 9.6 %
		Y	8.99	90.35	26.26		65.0	
		Z	7.09	88.64	25.54		65.0	
10233-CAD	LTE-TDD (SC-FDMA, 1 RB, 5 MHz, 64-QAM)	X	13.43	97.83	28.60	6.02	65.0	± 9.6 %
		Y	8.72	88.71	25.09		65.0	
		Z	6.62	86.46	24.12		65.0	
10234-CAD	LTE-TDD (SC-FDMA, 1 RB, 5 MHz, QPSK)	X	6.91	90.59	28.86	6.02	65.0	± 9.6 %
		Y	5.61	84.84	26.14		65.0	
		Z	3.86	80.24	24.45		65.0	
10235-CAD	LTE-TDD (SC-FDMA, 1 RB, 10 MHz, 16-QAM)	X	13.83	99.78	29.87	6.02	65.0	± 9.6 %
		Y	9.00	90.38	26.27		65.0	
		Z	7.09	88.66	25.55		65.0	
10236-CAD	LTE-TDD (SC-FDMA, 1 RB, 10 MHz, 64-QAM)	X	13.62	98.04	28.65	6.02	65.0	± 9.6 %
		Y	8.81	88.86	25.13		65.0	
		Z	6.70	86.60	24.16		65.0	
10237-CAD	LTE-TDD (SC-FDMA, 1 RB, 10 MHz, QPSK)	X	7.24	91.74	29.39	6.02	65.0	± 9.6 %
		Y	5.81	85.65	26.56		65.0	
		Z	3.99	81.03	24.90		65.0	
10238-CAD	LTE-TDD (SC-FDMA, 1 RB, 15 MHz, 16-QAM)	X	13.76	99.70	29.84	6.02	65.0	± 9.6 %
		Y	8.97	90.32	26.25		65.0	
		Z	7.07	88.61	25.52		65.0	

10239-CAD	LTE-TDD (SC-FDMA, 1 RB, 15 MHz, 64-QAM)	X	13.37	97.78	28.58	6.02	65.0	± 9.6 %
		Y	8.69	88.67	25.08		65.0	
		Z	6.59	86.40	24.10		65.0	
10240-CAD	LTE-TDD (SC-FDMA, 1 RB, 15 MHz, QPSK)	X	7.22	91.71	29.38	6.02	65.0	± 9.6 %
		Y	5.80	85.63	26.55		65.0	
		Z	3.99	81.03	24.89		65.0	
10241-CAA	LTE-TDD (SC-FDMA, 50% RB, 1.4 MHz, 16-QAM)	X	7.92	83.31	26.43	6.98	65.0	± 9.6 %
		Y	7.39	80.86	25.11		65.0	
		Z	6.39	80.34	24.81		65.0	
10242-CAA	LTE-TDD (SC-FDMA, 50% RB, 1.4 MHz, 64-QAM)	X	7.05	80.89	25.37	6.98	65.0	± 9.6 %
		Y	6.86	79.38	24.43		65.0	
		Z	5.31	76.70	23.25		65.0	
10243-CAA	LTE-TDD (SC-FDMA, 50% RB, 1.4 MHz, QPSK)	X	5.61	76.83	24.61	6.98	65.0	± 9.6 %
		Y	5.60	75.93	23.88		65.0	
		Z	4.41	73.05	22.53		65.0	
10244-CAB	LTE-TDD (SC-FDMA, 50% RB, 3 MHz, 16-QAM)	X	4.02	70.41	14.69	3.98	65.0	± 9.6 %
		Y	4.13	70.49	14.93		65.0	
		Z	2.49	65.11	11.00		65.0	
10245-CAB	LTE-TDD (SC-FDMA, 50% RB, 3 MHz, 64-QAM)	X	3.85	69.59	14.25	3.98	65.0	± 9.6 %
		Y	4.01	69.84	14.58		65.0	
		Z	2.45	64.72	10.74		65.0	
10246-CAB	LTE-TDD (SC-FDMA, 50% RB, 3 MHz, QPSK)	X	4.04	73.92	16.51	3.98	65.0	± 9.6 %
		Y	4.21	74.30	17.06		65.0	
		Z	2.46	68.40	13.32		65.0	
10247-CAD	LTE-TDD (SC-FDMA, 50% RB, 5 MHz, 16-QAM)	X	4.12	71.43	16.28	3.98	65.0	± 9.6 %
		Y	4.26	71.62	16.65		65.0	
		Z	3.07	68.30	14.10		65.0	
10248-CAD	LTE-TDD (SC-FDMA, 50% RB, 5 MHz, 64-QAM)	X	3.99	70.52	15.86	3.98	65.0	± 9.6 %
		Y	4.18	70.90	16.31		65.0	
		Z	2.99	67.51	13.71		65.0	
10249-CAD	LTE-TDD (SC-FDMA, 50% RB, 5 MHz, QPSK)	X	7.21	83.53	21.70	3.98	65.0	± 9.6 %
		Y	6.04	80.32	20.70		65.0	
		Z	4.60	77.74	18.93		65.0	
10250-CAD	LTE-TDD (SC-FDMA, 50% RB, 10 MHz, 16-QAM)	X	5.73	77.13	21.21	3.98	65.0	± 9.6 %
		Y	5.49	75.70	20.56		65.0	
		Z	4.71	74.90	19.83		65.0	
10251-CAD	LTE-TDD (SC-FDMA, 50% RB, 10 MHz, 64-QAM)	X	5.08	73.68	19.28	3.98	65.0	± 9.6 %
		Y	5.08	73.10	19.02		65.0	
		Z	4.15	71.43	17.80		65.0	
10252-CAD	LTE-TDD (SC-FDMA, 50% RB, 10 MHz, QPSK)	X	7.72	84.95	23.95	3.98	65.0	± 9.6 %
		Y	6.57	81.27	22.47		65.0	
		Z	5.73	81.18	22.23		65.0	
10253-CAD	LTE-TDD (SC-FDMA, 50% RB, 15 MHz, 16-QAM)	X	5.25	73.10	19.66	3.98	65.0	± 9.6 %
		Y	5.27	72.57	19.33		65.0	
		Z	4.44	71.27	18.45		65.0	
10254-CAD	LTE-TDD (SC-FDMA, 50% RB, 15 MHz, 64-QAM)	X	5.65	74.31	20.52	3.98	65.0	± 9.6 %
		Y	5.63	73.63	20.11		65.0	
		Z	4.81	72.54	19.36		65.0	

10255-CAD	LTE-TDD (SC-FDMA, 50% RB, 15 MHz, QPSK)	X	6.41	79.52	22.36	3.98	65.0	± 9.6 %
		Y	6.03	77.61	21.41		65.0	
		Z	5.18	77.05	21.09		65.0	
10256-CAA	LTE-TDD (SC-FDMA, 100% RB, 1.4 MHz, 16-QAM)	X	2.62	64.77	10.66	3.98	65.0	± 9.6 %
		Y	2.89	65.71	11.45		65.0	
		Z	1.74	61.55	7.76		65.0	
10257-CAA	LTE-TDD (SC-FDMA, 100% RB, 1.4 MHz, 64-QAM)	X	2.56	64.22	10.26	3.98	65.0	± 9.6 %
		Y	2.83	65.16	11.06		65.0	
		Z	1.73	61.29	7.50		65.0	
10258-CAA	LTE-TDD (SC-FDMA, 100% RB, 1.4 MHz, QPSK)	X	2.33	65.98	11.67	3.98	65.0	± 9.6 %
		Y	2.74	67.85	13.09		65.0	
		Z	1.55	62.66	9.04		65.0	
10259-CAB	LTE-TDD (SC-FDMA, 100% RB, 3 MHz, 16-QAM)	X	4.78	73.82	18.19	3.98	65.0	± 9.6 %
		Y	4.76	73.30	18.14		65.0	
		Z	3.71	70.96	16.29		65.0	
10260-CAB	LTE-TDD (SC-FDMA, 100% RB, 3 MHz, 64-QAM)	X	4.75	73.36	17.98	3.98	65.0	± 9.6 %
		Y	4.77	72.96	17.98		65.0	
		Z	3.71	70.59	16.10		65.0	
10261-CAB	LTE-TDD (SC-FDMA, 100% RB, 3 MHz, QPSK)	X	7.00	83.14	22.24	3.98	65.0	± 9.6 %
		Y	5.96	79.88	21.10		65.0	
		Z	4.89	78.58	20.00		65.0	
10262-CAD	LTE-TDD (SC-FDMA, 100% RB, 5 MHz, 16-QAM)	X	5.70	77.00	21.13	3.98	65.0	± 9.6 %
		Y	5.47	75.60	20.50		65.0	
		Z	4.68	74.76	19.75		65.0	
10263-CAD	LTE-TDD (SC-FDMA, 100% RB, 5 MHz, 64-QAM)	X	5.08	73.66	19.27	3.98	65.0	± 9.6 %
		Y	5.07	73.07	19.02		65.0	
		Z	4.15	71.42	17.80		65.0	
10264-CAD	LTE-TDD (SC-FDMA, 100% RB, 5 MHz, QPSK)	X	7.58	84.58	23.79	3.98	65.0	± 9.6 %
		Y	6.49	81.02	22.35		65.0	
		Z	5.63	80.83	22.06		65.0	
10265-CAD	LTE-TDD (SC-FDMA, 100% RB, 10 MHz, 16-QAM)	X	5.33	73.50	19.98	3.98	65.0	± 9.6 %
		Y	5.34	72.96	19.60		65.0	
		Z	4.49	71.58	18.78		65.0	
10266-CAD	LTE-TDD (SC-FDMA, 100% RB, 10 MHz, 64-QAM)	X	5.80	74.91	20.98	3.98	65.0	± 9.6 %
		Y	5.76	74.17	20.50		65.0	
		Z	4.93	73.11	19.87		65.0	
10267-CAD	LTE-TDD (SC-FDMA, 100% RB, 10 MHz, QPSK)	X	6.75	80.22	22.51	3.98	65.0	± 9.6 %
		Y	6.31	78.24	21.51		65.0	
		Z	5.45	77.78	21.30		65.0	
10268-CAD	LTE-TDD (SC-FDMA, 100% RB, 15 MHz, 16-QAM)	X	5.93	73.37	20.49	3.98	65.0	± 9.6 %
		Y	5.99	73.01	20.12		65.0	
		Z	5.16	71.83	19.50		65.0	
10269-CAD	LTE-TDD (SC-FDMA, 100% RB, 15 MHz, 64-QAM)	X	5.93	72.96	20.33	3.98	65.0	± 9.6 %
		Y	5.99	72.64	20.00		65.0	
		Z	5.19	71.51	19.38		65.0	
10270-CAD	LTE-TDD (SC-FDMA, 100% RB, 15 MHz, QPSK)	X	6.27	76.42	21.20	3.98	65.0	± 9.6 %
		Y	6.15	75.42	20.55		65.0	
		Z	5.37	74.84	20.32		65.0	

10274-CAB	UMTS-FDD (HSUPA, Subtest 5, 3GPP Rel8.10)	X	2.38	67.09	14.90	0.00	150.0	± 9.6 %
		Y	2.44	66.67	14.85		150.0	
		Z	2.34	67.57	14.77		150.0	
10275-CAB	UMTS-FDD (HSUPA, Subtest 5, 3GPP Rel8.4)	X	1.49	69.19	15.59	0.00	150.0	± 9.6 %
		Y	1.48	67.68	15.09		150.0	
		Z	1.49	69.77	15.72		150.0	
10277-CAA	PHS (QPSK)	X	2.09	60.92	6.52	9.03	50.0	± 9.6 %
		Y	1.99	60.88	6.43		50.0	
		Z	1.56	59.12	4.50		50.0	
10278-CAA	PHS (QPSK, BW 884MHz, Rolloff 0.5)	X	3.33	66.21	11.58	9.03	50.0	± 9.6 %
		Y	3.45	67.40	12.36		50.0	
		Z	2.52	63.38	9.00		50.0	
10279-CAA	PHS (QPSK, BW 884MHz, Rolloff 0.38)	X	3.39	66.39	11.72	9.03	50.0	± 9.6 %
		Y	3.53	67.62	12.52		50.0	
		Z	2.56	63.50	9.12		50.0	
10290-AAB	CDMA2000, RC1, SO55, Full Rate	X	0.61	61.53	7.60	0.00	150.0	± 9.6 %
		Y	0.95	65.07	10.75		150.0	
		Z	0.49	60.68	6.68		150.0	
10291-AAB	CDMA2000, RC3, SO55, Full Rate	X	0.35	60.00	6.15	0.00	150.0	± 9.6 %
		Y	0.58	63.25	9.58		150.0	
		Z	0.32	60.00	5.83		150.0	
10292-AAB	CDMA2000, RC3, SO32, Full Rate	X	0.39	61.31	7.18	0.00	150.0	± 9.6 %
		Y	0.79	67.34	11.99		150.0	
		Z	0.36	61.33	6.91		150.0	
10293-AAB	CDMA2000, RC3, SO3, Full Rate	X	0.70	66.46	10.24	0.00	150.0	± 9.6 %
		Y	1.84	77.49	16.58		150.0	
		Z	0.96	69.80	11.25		150.0	
10295-AAB	CDMA2000, RC1, SO3, 1/8th Rate 25 fr.	X	24.25	96.58	25.60	9.03	50.0	± 9.6 %
		Y	13.21	88.89	23.79		50.0	
		Z	17.74	90.30	22.44		50.0	
10297-AAC	LTE-FDD (SC-FDMA, 50% RB, 20 MHz, QPSK)	X	2.54	70.33	16.91	0.00	150.0	± 9.6 %
		Y	2.52	69.32	16.40		150.0	
		Z	2.48	70.69	17.00		150.0	
10298-AAC	LTE-FDD (SC-FDMA, 50% RB, 3 MHz, QPSK)	X	0.87	62.84	9.39	0.00	150.0	± 9.6 %
		Y	1.14	64.99	11.49		150.0	
		Z	0.74	62.03	8.44		150.0	
10299-AAC	LTE-FDD (SC-FDMA, 50% RB, 3 MHz, 16-QAM)	X	1.31	62.98	9.06	0.00	150.0	± 9.6 %
		Y	1.60	64.50	10.42		150.0	
		Z	0.95	60.67	6.76		150.0	
10300-AAC	LTE-FDD (SC-FDMA, 50% RB, 3 MHz, 64-QAM)	X	1.06	60.58	7.00	0.00	150.0	± 9.6 %
		Y	1.28	61.71	8.21		150.0	
		Z	0.80	59.16	5.20		150.0	
10301-AAA	IEEE 802.16e WiMAX (29:18, 5ms, 10MHz, QPSK, PUSC)	X	4.72	67.05	17.86	4.17	50.0	± 9.6 %
		Y	4.49	65.52	17.15		50.0	
		Z	4.22	65.84	16.97		50.0	
10302-AAA	IEEE 802.16e WiMAX (29:18, 5ms, 10MHz, QPSK, PUSC, 3 CTRL symbols)	X	5.04	66.76	18.08	4.96	50.0	± 9.6 %
		Y	5.00	66.22	17.91		50.0	
		Z	4.64	66.13	17.51		50.0	

10303-AAA	IEEE 802.16e WiMAX (31:15, 5ms, 10MHz, 64QAM, PUSC)	X	4.99	67.71	18.65	4.96	50.0	± 9.6 %
		Y	4.76	65.90	17.73		50.0	
		Z	4.52	66.56	17.75		50.0	
10304-AAA	IEEE 802.16e WiMAX (29:18, 5ms, 10MHz, 64QAM, PUSC)	X	4.61	66.36	17.42	4.17	50.0	± 9.6 %
		Y	4.57	65.80	17.25		50.0	
		Z	4.26	65.88	16.92		50.0	
10305-AAA	IEEE 802.16e WiMAX (31:15, 10ms, 10MHz, 64QAM, PUSC, 15 symbols)	X	5.19	72.10	20.50	6.02	35.0	± 9.6 %
		Y	4.47	68.84	19.43		35.0	
		Z	4.13	68.52	18.41		35.0	
10306-AAA	IEEE 802.16e WiMAX (29:18, 10ms, 10MHz, 64QAM, PUSC, 18 symbols)	X	5.03	69.52	19.81	6.02	35.0	± 9.6 %
		Y	4.66	67.41	19.03		35.0	
		Z	4.34	67.36	18.35		35.0	
10307-AAA	IEEE 802.16e WiMAX (29:18, 10ms, 10MHz, QPSK, PUSC, 18 symbols)	X	4.97	69.79	19.79	6.02	35.0	± 9.6 %
		Y	4.56	67.54	18.97		35.0	
		Z	4.24	67.41	18.25		35.0	
10308-AAA	IEEE 802.16e WiMAX (29:18, 10ms, 10MHz, 16QAM, PUSC)	X	5.00	70.20	20.02	6.02	35.0	± 9.6 %
		Y	4.56	67.81	19.14		35.0	
		Z	4.23	67.67	18.42		35.0	
10309-AAA	IEEE 802.16e WiMAX (29:18, 10ms, 10MHz, 16QAM, AMC 2x3, 18 symbols)	X	5.04	69.58	19.90	6.02	35.0	± 9.6 %
		Y	4.68	67.50	19.12		35.0	
		Z	4.34	67.37	18.43		35.0	
10310-AAA	IEEE 802.16e WiMAX (29:18, 10ms, 10MHz, QPSK, AMC 2x3, 18 symbols)	X	5.02	69.73	19.86	6.02	35.0	± 9.6 %
		Y	4.62	67.52	19.04		35.0	
		Z	4.31	67.48	18.38		35.0	
10311-AAC	LTE-FDD (SC-FDMA, 100% RB, 15 MHz, QPSK)	X	2.89	69.32	16.51	0.00	150.0	± 9.6 %
		Y	2.88	68.58	16.07		150.0	
		Z	2.84	69.69	16.60		150.0	
10313-AAA	iDEN 1:3	X	3.64	73.80	16.25	6.99	70.0	± 9.6 %
		Y	3.53	73.47	16.27		70.0	
		Z	2.54	70.98	14.85		70.0	
10314-AAA	iDEN 1:6	X	11.36	92.32	25.29	10.00	30.0	± 9.6 %
		Y	6.23	84.01	23.01		30.0	
		Z	14.41	96.78	26.22		30.0	
10315-AAB	IEEE 802.11b WiFi 2.4 GHz (DSSS, 1 Mbps, 96pc duty cycle)	X	0.98	64.50	15.61	0.17	150.0	± 9.6 %
		Y	1.03	63.67	14.93		150.0	
		Z	0.98	64.65	15.49		150.0	
10316-AAB	IEEE 802.11g WiFi 2.4 GHz (ERP-OFDM, 6 Mbps, 96pc duty cycle)	X	4.29	66.82	16.34	0.17	150.0	± 9.6 %
		Y	4.37	66.68	16.16		150.0	
		Z	4.17	67.03	16.16		150.0	
10317-AAB	IEEE 802.11a WiFi 5 GHz (OFDM, 6 Mbps, 96pc duty cycle)	X	4.29	66.82	16.34	0.17	150.0	± 9.6 %
		Y	4.37	66.68	16.16		150.0	
		Z	4.17	67.03	16.16		150.0	
10400-AAC	IEEE 802.11ac WiFi (20MHz, 64-QAM, 99pc duty cycle)	X	4.33	67.02	16.29	0.00	150.0	± 9.6 %
		Y	4.44	66.95	16.15		150.0	
		Z	4.21	67.24	16.15		150.0	
10401-AAC	IEEE 802.11ac WiFi (40MHz, 64-QAM, 99pc duty cycle)	X	4.99	66.73	16.28	0.00	150.0	± 9.6 %
		Y	5.10	66.79	16.18		150.0	
		Z	4.87	66.89	16.13		150.0	



10402-AAC	IEEE 802.11ac WiFi (80MHz, 64-QAM, 99pc duty cycle)	X	5.36	67.33	16.49	0.00	150.0	± 9.6 %
		Y	5.44	67.34	16.35		150.0	
		Z	5.26	67.52	16.37		150.0	
10403-AAB	CDMA2000 (1xEV-DO, Rev. 0)	X	0.61	61.53	7.60	0.00	115.0	± 9.6 %
		Y	0.95	65.07	10.75		115.0	
		Z	0.49	60.68	6.68		115.0	
10404-AAB	CDMA2000 (1xEV-DO, Rev. A)	X	0.61	61.53	7.60	0.00	115.0	± 9.6 %
		Y	0.95	65.07	10.75		115.0	
		Z	0.49	60.68	6.68		115.0	
10406-AAB	CDMA2000, RC3, SO32, SCH0, Full Rate	X	100.00	120.88	29.11	0.00	100.0	± 9.6 %
		Y	100.00	119.48	28.73		100.0	
		Z	100.00	111.63	24.58		100.0	
10410-AAC	LTE-TDD (SC-FDMA, 1 RB, 10 MHz, QPSK, UL Subframe=2,3,4,7,8,9)	X	100.00	127.51	32.08	3.23	80.0	± 9.6 %
		Y	31.82	108.36	26.95		80.0	
		Z	62.35	116.51	27.82		80.0	
10415-AAA	IEEE 802.11b WiFi 2.4 GHz (DSSS, 1 Mbps, 99pc duty cycle)	X	0.90	63.50	14.92	0.00	150.0	± 9.6 %
		Y	0.97	62.93	14.41		150.0	
		Z	0.93	63.99	15.00		150.0	
10416-AAA	IEEE 802.11g WiFi 2.4 GHz (ERP-OFDM, 6 Mbps, 99pc duty cycle)	X	4.23	66.80	16.26	0.00	150.0	± 9.6 %
		Y	4.33	66.70	16.12		150.0	
		Z	4.15	67.12	16.17		150.0	
10417-AAA	IEEE 802.11a/h WiFi 5 GHz (OFDM, 6 Mbps, 99pc duty cycle)	X	4.23	66.80	16.26	0.00	150.0	± 9.6 %
		Y	4.33	66.70	16.12		150.0	
		Z	4.15	67.12	16.17		150.0	
10418-AAA	IEEE 802.11g WiFi 2.4 GHz (DSSS-OFDM, 6 Mbps, 99pc duty cycle, Long preamble)	X	4.23	67.03	16.33	0.00	150.0	± 9.6 %
		Y	4.32	66.91	16.17		150.0	
		Z	4.14	67.37	16.26		150.0	
10419-AAA	IEEE 802.11g WiFi 2.4 GHz (DSSS-OFDM, 6 Mbps, 99pc duty cycle, Short preamble)	X	4.24	66.95	16.31	0.00	150.0	± 9.6 %
		Y	4.34	66.84	16.16		150.0	
		Z	4.16	67.28	16.23		150.0	
10422-AAA	IEEE 802.11n (HT Greenfield, 7.2 Mbps, BPSK)	X	4.35	66.91	16.32	0.00	150.0	± 9.6 %
		Y	4.45	66.82	16.17		150.0	
		Z	4.26	67.23	16.23		150.0	
10423-AAA	IEEE 802.11n (HT Greenfield, 43.3 Mbps, 16-QAM)	X	4.47	67.16	16.40	0.00	150.0	± 9.6 %
		Y	4.57	67.08	16.26		150.0	
		Z	4.36	67.46	16.30		150.0	
10424-AAA	IEEE 802.11n (HT Greenfield, 72.2 Mbps, 64-QAM)	X	4.40	67.11	16.38	0.00	150.0	± 9.6 %
		Y	4.50	67.03	16.24		150.0	
		Z	4.30	67.40	16.28		150.0	
10425-AAA	IEEE 802.11n (HT Greenfield, 15 Mbps, BPSK)	X	5.04	67.26	16.58	0.00	150.0	± 9.6 %
		Y	5.13	67.22	16.42		150.0	
		Z	4.89	67.32	16.38		150.0	
10426-AAA	IEEE 802.11n (HT Greenfield, 90 Mbps, 16-QAM)	X	5.08	67.43	16.66	0.00	150.0	± 9.6 %
		Y	5.14	67.30	16.46		150.0	
		Z	4.92	67.46	16.45		150.0	

10427-AAA	IEEE 802.11n (HT Greenfield, 150 Mbps, 64-QAM)	X	5.02	67.13	16.51	0.00	150.0	± 9.6 %
		Y	5.11	67.10	16.36		150.0	
		Z	4.90	67.29	16.36		150.0	
10430-AAB	LTE-FDD (OFDMA, 5 MHz, E-TM 3.1)	X	4.47	74.13	19.05	0.00	150.0	± 9.6 %
		Y	4.27	72.47	18.45		150.0	
		Z	5.08	77.10	19.89		150.0	
10431-AAB	LTE-FDD (OFDMA, 10 MHz, E-TM 3.1)	X	3.84	67.47	16.10	0.00	150.0	± 9.6 %
		Y	3.94	67.28	15.99		150.0	
		Z	3.74	67.83	15.98		150.0	
10432-AAB	LTE-FDD (OFDMA, 15 MHz, E-TM 3.1)	X	4.16	67.25	16.30	0.00	150.0	± 9.6 %
		Y	4.27	67.12	16.16		150.0	
		Z	4.06	67.58	16.20		150.0	
10433-AAB	LTE-FDD (OFDMA, 20 MHz, E-TM 3.1)	X	4.42	67.15	16.40	0.00	150.0	± 9.6 %
		Y	4.52	67.06	16.26		150.0	
		Z	4.32	67.45	16.31		150.0	
10434-AAA	W-CDMA (BS Test Model 1, 64 DPCH)	X	4.64	75.00	18.70	0.00	150.0	± 9.6 %
		Y	4.40	73.39	18.26		150.0	
		Z	5.41	78.17	19.50		150.0	
10435-AAC	LTE-TDD (SC-FDMA, 1 RB, 20 MHz, QPSK, UL Subframe=2,3,4,7,8,9)	X	100.00	127.19	31.93	3.23	80.0	± 9.6 %
		Y	27.78	106.36	26.40		80.0	
		Z	42.85	111.62	26.64		80.0	
10447-AAB	LTE-FDD (OFDMA, 5 MHz, E-TM 3.1, Clipping 44%)	X	3.04	67.08	14.65	0.00	150.0	± 9.6 %
		Y	3.18	67.05	14.85		150.0	
		Z	2.91	67.25	14.30		150.0	
10448-AAB	LTE-FDD (OFDMA, 10 MHz, E-TM 3.1, Clipping 44%)	X	3.71	67.27	15.98	0.00	150.0	± 9.6 %
		Y	3.81	67.07	15.86		150.0	
		Z	3.62	67.65	15.87		150.0	
10449-AAB	LTE-FDD (OFDMA, 15 MHz, E-TM 3.1, Clipping 44%)	X	4.01	67.09	16.21	0.00	150.0	± 9.6 %
		Y	4.11	66.95	16.06		150.0	
		Z	3.92	67.43	16.12		150.0	
10450-AAB	LTE-FDD (OFDMA, 20 MHz, E-TM 3.1, Clipping 44%)	X	4.22	66.93	16.26	0.00	150.0	± 9.6 %
		Y	4.32	66.84	16.11		150.0	
		Z	4.14	67.24	16.18		150.0	
10451-AAA	W-CDMA (BS Test Model 1, 64 DPCH, Clipping 44%)	X	2.79	66.50	13.63	0.00	150.0	± 9.6 %
		Y	2.98	66.79	14.09		150.0	
		Z	2.59	66.31	13.04		150.0	
10456-AAA	IEEE 802.11ac WiFi (160MHz, 64-QAM, 99pc duty cycle)	X	6.00	67.78	16.73	0.00	150.0	± 9.6 %
		Y	6.04	67.74	16.57		150.0	
		Z	6.02	68.38	16.82		150.0	
10457-AAA	UMTS-FDD (DC-HSDPA)	X	3.60	65.57	16.01	0.00	150.0	± 9.6 %
		Y	3.68	65.45	15.84		150.0	
		Z	3.57	66.00	15.95		150.0	
10458-AAA	CDMA2000 (1xEV-DO, Rev. B, 2 carriers)	X	2.28	64.00	11.72	0.00	150.0	± 9.6 %
		Y	2.41	64.11	12.28		150.0	
		Z	1.90	62.62	10.39		150.0	
10459-AAA	CDMA2000 (1xEV-DO, Rev. B, 3 carriers)	X	4.90	70.07	18.22	0.00	150.0	± 9.6 %
		Y	4.93	69.48	18.09		150.0	
		Z	5.05	71.41	18.27		150.0	

10460-AAA	UMTS-FDD (WCDMA, AMR)	X	0.94	72.42	17.37	0.00	150.0	± 9.6 %
		Y	0.82	67.88	15.60		150.0	
		Z	0.96	72.94	17.69		150.0	
10461-AAA	LTE-TDD (SC-FDMA, 1 RB, 1.4 MHz, QPSK, UL Subframe=2,3,4,7,8,9)	X	100.00	133.76	34.95	3.29	80.0	± 9.6 %
		Y	22.54	106.56	27.45		80.0	
		Z	100.00	126.80	31.21		80.0	
10462-AAA	LTE-TDD (SC-FDMA, 1 RB, 1.4 MHz, 16-QAM, UL Subframe=2,3,4,7,8,9)	X	1.53	66.28	11.09	3.23	80.0	± 9.6 %
		Y	0.98	61.72	9.01		80.0	
		Z	0.66	60.00	6.84		80.0	
10463-AAA	LTE-TDD (SC-FDMA, 1 RB, 1.4 MHz, 64-QAM, UL Subframe=2,3,4,7,8,9)	X	0.79	60.00	7.60	3.23	80.0	± 9.6 %
		Y	0.83	60.00	7.56		80.0	
		Z	0.36	55.81	3.91		80.0	
10464-AAA	LTE-TDD (SC-FDMA, 1 RB, 3 MHz, QPSK, UL Subframe=2,3,4,7,8,9)	X	100.00	130.06	33.08	3.23	80.0	± 9.6 %
		Y	13.20	97.62	24.36		80.0	
		Z	92.51	120.86	28.60		80.0	
10465-AAA	LTE-TDD (SC-FDMA, 1 RB, 3 MHz, 16-QAM, UL Subframe=2,3,4,7,8,9)	X	1.21	64.05	10.09	3.23	80.0	± 9.6 %
		Y	0.92	61.09	8.63		80.0	
		Z	0.66	60.00	6.77		80.0	
10466-AAA	LTE-TDD (SC-FDMA, 1 RB, 3 MHz, 64-QAM, UL Subframe=2,3,4,7,8,9)	X	0.79	60.00	7.55	3.23	80.0	± 9.6 %
		Y	0.83	60.00	7.52		80.0	
		Z	0.35	55.73	3.83		80.0	
10467-AAC	LTE-TDD (SC-FDMA, 1 RB, 5 MHz, QPSK, UL Subframe=2,3,4,7,8,9)	X	100.00	130.58	33.30	3.23	80.0	± 9.6 %
		Y	16.52	100.70	25.21		80.0	
		Z	100.00	122.35	29.03		80.0	
10468-AAC	LTE-TDD (SC-FDMA, 1 RB, 5 MHz, 16-QAM, UL Subframe=2,3,4,7,8,9)	X	1.29	64.72	10.40	3.23	80.0	± 9.6 %
		Y	0.94	61.28	8.75		80.0	
		Z	0.66	60.00	6.80		80.0	
10469-AAC	LTE-TDD (SC-FDMA, 1 RB, 5 MHz, 64-QAM, UL Subframe=2,3,4,7,8,9)	X	0.79	60.00	7.55	3.23	80.0	± 9.6 %
		Y	0.83	60.00	7.52		80.0	
		Z	0.35	55.73	3.83		80.0	
10470-AAC	LTE-TDD (SC-FDMA, 1 RB, 10 MHz, QPSK, UL Subframe=2,3,4,7,8,9)	X	100.00	130.62	33.31	3.23	80.0	± 9.6 %
		Y	16.78	100.92	25.26		80.0	
		Z	100.00	122.35	29.02		80.0	
10471-AAC	LTE-TDD (SC-FDMA, 1 RB, 10 MHz, 16-QAM, UL Subframe=2,3,4,7,8,9)	X	1.27	64.59	10.33	3.23	80.0	± 9.6 %
		Y	0.93	61.24	8.72		80.0	
		Z	0.66	60.00	6.79		80.0	
10472-AAC	LTE-TDD (SC-FDMA, 1 RB, 10 MHz, 64-QAM, UL Subframe=2,3,4,7,8,9)	X	0.79	60.00	7.53	3.23	80.0	± 9.6 %
		Y	0.83	60.00	7.50		80.0	
		Z	0.35	55.70	3.80		80.0	
10473-AAC	LTE-TDD (SC-FDMA, 1 RB, 15 MHz, QPSK, UL Subframe=2,3,4,7,8,9)	X	100.00	130.57	33.29	3.23	80.0	± 9.6 %
		Y	16.58	100.74	25.21		80.0	
		Z	100.00	122.30	29.00		80.0	
10474-AAC	LTE-TDD (SC-FDMA, 1 RB, 15 MHz, 16-QAM, UL Subframe=2,3,4,7,8,9)	X	1.26	64.53	10.31	3.23	80.0	± 9.6 %
		Y	0.93	61.22	8.71		80.0	
		Z	0.66	60.00	6.78		80.0	
10475-AAC	LTE-TDD (SC-FDMA, 1 RB, 15 MHz, 64-QAM, UL Subframe=2,3,4,7,8,9)	X	0.79	60.00	7.54	3.23	80.0	± 9.6 %
		Y	0.83	60.00	7.50		80.0	
		Z	0.35	55.70	3.80		80.0	

10477-AAC	LTE-TDD (SC-FDMA, 1 RB, 20 MHz, 16-QAM, UL Subframe=2,3,4,7,8,9)	X	1.20	64.02	10.06	3.23	80.0	± 9.6 %
		Y	0.91	61.06	8.60		80.0	
		Z	0.66	60.00	6.75		80.0	
10478-AAC	LTE-TDD (SC-FDMA, 1 RB, 20 MHz, 64-QAM, UL Subframe=2,3,4,7,8,9)	X	0.79	60.00	7.52	3.23	80.0	± 9.6 %
		Y	0.83	60.00	7.49		80.0	
		Z	0.35	55.68	3.77		80.0	
10479-AAA	LTE-TDD (SC-FDMA, 50% RB, 1.4 MHz, QPSK, UL Subframe=2,3,4,7,8,9)	X	100.00	126.79	33.21	3.23	80.0	± 9.6 %
		Y	10.38	91.55	23.92		80.0	
		Z	100.00	123.17	30.88		80.0	
10480-AAA	LTE-TDD (SC-FDMA, 50% RB, 1.4 MHz, 16-QAM, UL Subframe=2,3,4,7,8,9)	X	100.00	111.12	25.93	3.23	80.0	± 9.6 %
		Y	4.86	75.90	16.60		80.0	
		Z	2.50	69.40	12.93		80.0	
10481-AAA	LTE-TDD (SC-FDMA, 50% RB, 1.4 MHz, 64-QAM, UL Subframe=2,3,4,7,8,9)	X	17.33	89.29	19.94	3.23	80.0	± 9.6 %
		Y	3.20	70.44	14.16		80.0	
		Z	1.42	63.47	9.98		80.0	
10482-AAA	LTE-TDD (SC-FDMA, 50% RB, 3 MHz, QPSK, UL Subframe=2,3,4,7,8,9)	X	2.01	67.85	13.24	2.23	80.0	± 9.6 %
		Y	2.00	67.46	13.68		80.0	
		Z	1.08	62.21	9.90		80.0	
10483-AAA	LTE-TDD (SC-FDMA, 50% RB, 3 MHz, 16-QAM, UL Subframe=2,3,4,7,8,9)	X	2.20	65.59	11.72	2.23	80.0	± 9.6 %
		Y	2.17	65.07	11.85		80.0	
		Z	1.15	60.00	7.79		80.0	
10484-AAA	LTE-TDD (SC-FDMA, 50% RB, 3 MHz, 64-QAM, UL Subframe=2,3,4,7,8,9)	X	2.02	64.43	11.18	2.23	80.0	± 9.6 %
		Y	2.09	64.36	11.51		80.0	
		Z	1.17	60.00	7.77		80.0	
10485-AAC	LTE-TDD (SC-FDMA, 50% RB, 5 MHz, QPSK, UL Subframe=2,3,4,7,8,9)	X	4.53	79.22	19.45	2.23	80.0	± 9.6 %
		Y	2.84	72.10	17.06		80.0	
		Z	2.60	72.67	16.45		80.0	
10486-AAC	LTE-TDD (SC-FDMA, 50% RB, 5 MHz, 16-QAM, UL Subframe=2,3,4,7,8,9)	X	2.56	67.74	14.01	2.23	80.0	± 9.6 %
		Y	2.53	67.08	14.11		80.0	
		Z	1.74	64.04	11.62		80.0	
10487-AAC	LTE-TDD (SC-FDMA, 50% RB, 5 MHz, 64-QAM, UL Subframe=2,3,4,7,8,9)	X	2.49	67.00	13.65	2.23	80.0	± 9.6 %
		Y	2.51	66.63	13.88		80.0	
		Z	1.72	63.54	11.33		80.0	
10488-AAC	LTE-TDD (SC-FDMA, 50% RB, 10 MHz, QPSK, UL Subframe=2,3,4,7,8,9)	X	4.03	76.67	20.22	2.23	80.0	± 9.6 %
		Y	3.18	71.86	18.18		80.0	
		Z	2.98	73.13	18.53		80.0	
10489-AAC	LTE-TDD (SC-FDMA, 50% RB, 10 MHz, 16-QAM, UL Subframe=2,3,4,7,8,9)	X	3.48	70.97	17.69	2.23	80.0	± 9.6 %
		Y	3.17	68.69	16.67		80.0	
		Z	2.92	69.30	16.55		80.0	
10490-AAC	LTE-TDD (SC-FDMA, 50% RB, 10 MHz, 64-QAM, UL Subframe=2,3,4,7,8,9)	X	3.52	70.58	17.52	2.23	80.0	± 9.6 %
		Y	3.25	68.52	16.59		80.0	
		Z	2.96	68.98	16.39		80.0	
10491-AAC	LTE-TDD (SC-FDMA, 50% RB, 15 MHz, QPSK, UL Subframe=2,3,4,7,8,9)	X	3.82	73.14	19.18	2.23	80.0	± 9.6 %
		Y	3.42	70.39	17.81		80.0	
		Z	3.09	70.86	17.98		80.0	
10492-AAC	LTE-TDD (SC-FDMA, 50% RB, 15 MHz, 16-QAM, UL Subframe=2,3,4,7,8,9)	X	3.66	69.39	17.61	2.23	80.0	± 9.6 %
		Y	3.51	67.96	16.83		80.0	
		Z	3.20	68.22	16.75		80.0	

10493-AAC	LTE-TDD (SC-FDMA, 50% RB, 15 MHz, 64-QAM, UL Subframe=2,3,4,7,8,9)	X	3.70	69.16	17.50	2.23	80.0	± 9.6 %
		Y	3.57	67.83	16.77		80.0	
		Z	3.24	68.04	16.65		80.0	
10494-AAC	LTE-TDD (SC-FDMA, 50% RB, 20 MHz, QPSK, UL Subframe=2,3,4,7,8,9)	X	4.24	74.94	19.81	2.23	80.0	± 9.6 %
		Y	3.67	71.70	18.26		80.0	
		Z	3.36	72.30	18.54		80.0	
10495-AAC	LTE-TDD (SC-FDMA, 50% RB, 20 MHz, 16-QAM, UL Subframe=2,3,4,7,8,9)	X	3.69	69.69	17.88	2.23	80.0	± 9.6 %
		Y	3.54	68.22	17.04		80.0	
		Z	3.22	68.45	17.03		80.0	
10496-AAC	LTE-TDD (SC-FDMA, 50% RB, 20 MHz, 64-QAM, UL Subframe=2,3,4,7,8,9)	X	3.75	69.34	17.76	2.23	80.0	± 9.6 %
		Y	3.62	68.01	16.98		80.0	
		Z	3.30	68.22	16.94		80.0	
10497-AAA	LTE-TDD (SC-FDMA, 100% RB, 1.4 MHz, QPSK, UL Subframe=2,3,4,7,8,9)	X	0.96	60.00	7.89	2.23	80.0	± 9.6 %
		Y	1.15	61.18	9.30		80.0	
		Z	0.83	60.00	6.90		80.0	
10498-AAA	LTE-TDD (SC-FDMA, 100% RB, 1.4 MHz, 16-QAM, UL Subframe=2,3,4,7,8,9)	X	1.15	60.00	6.67	2.23	80.0	± 9.6 %
		Y	1.20	60.00	7.47		80.0	
		Z	1.06	60.00	5.55		80.0	
10499-AAA	LTE-TDD (SC-FDMA, 100% RB, 1.4 MHz, 64-QAM, UL Subframe=2,3,4,7,8,9)	X	1.17	60.00	6.51	2.23	80.0	± 9.6 %
		Y	1.22	60.00	7.31		80.0	
		Z	1.10	60.00	5.36		80.0	
10500-AAA	LTE-TDD (SC-FDMA, 100% RB, 3 MHz, QPSK, UL Subframe=2,3,4,7,8,9)	X	4.27	78.15	19.77	2.23	80.0	± 9.6 %
		Y	2.97	71.96	17.50		80.0	
		Z	2.82	73.28	17.46		80.0	
10501-AAA	LTE-TDD (SC-FDMA, 100% RB, 3 MHz, 16-QAM, UL Subframe=2,3,4,7,8,9)	X	3.13	69.97	15.82	2.23	80.0	± 9.6 %
		Y	2.87	68.14	15.28		80.0	
		Z	2.33	67.02	13.92		80.0	
10502-AAA	LTE-TDD (SC-FDMA, 100% RB, 3 MHz, 64-QAM, UL Subframe=2,3,4,7,8,9)	X	3.10	69.46	15.52	2.23	80.0	± 9.6 %
		Y	2.89	67.91	15.09		80.0	
		Z	2.32	66.58	13.62		80.0	
10503-AAC	LTE-TDD (SC-FDMA, 100% RB, 5 MHz, QPSK, UL Subframe=2,3,4,7,8,9)	X	3.94	76.31	20.06	2.23	80.0	± 9.6 %
		Y	3.14	71.64	18.07		80.0	
		Z	2.92	72.80	18.38		80.0	
10504-AAC	LTE-TDD (SC-FDMA, 100% RB, 5 MHz, 16-QAM, UL Subframe=2,3,4,7,8,9)	X	3.45	70.79	17.60	2.23	80.0	± 9.6 %
		Y	3.15	68.57	16.60		80.0	
		Z	2.89	69.12	16.44		80.0	
10505-AAC	LTE-TDD (SC-FDMA, 100% RB, 5 MHz, 64-QAM, UL Subframe=2,3,4,7,8,9)	X	3.49	70.43	17.43	2.23	80.0	± 9.6 %
		Y	3.23	68.41	16.53		80.0	
		Z	2.93	68.82	16.30		80.0	
10506-AAC	LTE-TDD (SC-FDMA, 100% RB, 10 MHz, QPSK, UL Subframe=2,3,4,7,8,9)	X	4.19	74.72	19.70	2.23	80.0	± 9.6 %
		Y	3.64	71.54	18.18		80.0	
		Z	3.32	72.09	18.43		80.0	
10507-AAC	LTE-TDD (SC-FDMA, 100% RB, 10 MHz, 16-QAM, UL Subframe=2,3,4,7,8,9)	X	3.67	69.60	17.83	2.23	80.0	± 9.6 %
		Y	3.52	68.16	17.00		80.0	
		Z	3.21	68.36	16.97		80.0	

10508-AAC	LTE-TDD (SC-FDMA, 100% RB, 10 MHz, 64-QAM, UL Subframe=2,3,4,7,8,9)	X	3.73	69.24	17.70	2.23	80.0	± 9.6 %
		Y	3.60	67.93	16.93		80.0	
		Z	3.28	68.12	16.88		80.0	
10509-AAC	LTE-TDD (SC-FDMA, 100% RB, 15 MHz, QPSK, UL Subframe=2,3,4,7,8,9)	X	4.33	72.38	18.83	2.23	80.0	± 9.6 %
		Y	4.02	70.46	17.77		80.0	
		Z	3.67	70.70	17.93		80.0	
10510-AAC	LTE-TDD (SC-FDMA, 100% RB, 15 MHz, 16-QAM, UL Subframe=2,3,4,7,8,9)	X	4.06	68.76	17.68	2.23	80.0	± 9.6 %
		Y	3.99	67.84	17.05		80.0	
		Z	3.63	67.77	16.97		80.0	
10511-AAC	LTE-TDD (SC-FDMA, 100% RB, 15 MHz, 64-QAM, UL Subframe=2,3,4,7,8,9)	X	4.12	68.51	17.60	2.23	80.0	± 9.6 %
		Y	4.06	67.66	17.00		80.0	
		Z	3.70	67.61	16.92		80.0	
10512-AAC	LTE-TDD (SC-FDMA, 100% RB, 20 MHz, QPSK, UL Subframe=2,3,4,7,8,9)	X	4.60	74.13	19.39	2.23	80.0	± 9.6 %
		Y	4.14	71.72	18.16		80.0	
		Z	3.79	72.01	18.34		80.0	
10513-AAC	LTE-TDD (SC-FDMA, 100% RB, 20 MHz, 16-QAM, UL Subframe=2,3,4,7,8,9)	X	3.97	68.97	17.79	2.23	80.0	± 9.6 %
		Y	3.88	67.99	17.12		80.0	
		Z	3.53	67.87	17.05		80.0	
10514-AAC	LTE-TDD (SC-FDMA, 100% RB, 20 MHz, 64-QAM, UL Subframe=2,3,4,7,8,9)	X	3.99	68.53	17.64	2.23	80.0	± 9.6 %
		Y	3.92	67.65	17.02		80.0	
		Z	3.57	67.54	16.93		80.0	
10515-AAA	IEEE 802.11b WiFi 2.4 GHz (DSSS, 2 Mbps, 99pc duty cycle)	X	0.86	63.76	15.01	0.00	150.0	± 9.6 %
		Y	0.93	63.09	14.45		150.0	
		Z	0.89	64.24	15.10		150.0	
10516-AAA	IEEE 802.11b WiFi 2.4 GHz (DSSS, 5.5 Mbps, 99pc duty cycle)	X	1.36	87.46	22.75	0.00	150.0	± 9.6 %
		Y	0.54	69.72	16.60		150.0	
		Z	0.87	81.18	21.47		150.0	
10517-AAA	IEEE 802.11b WiFi 2.4 GHz (DSSS, 11 Mbps, 99pc duty cycle)	X	0.73	66.61	16.01	0.00	150.0	± 9.6 %
		Y	0.76	64.78	14.94		150.0	
		Z	0.75	66.85	16.09		150.0	
10518-AAA	IEEE 802.11a/h WiFi 5 GHz (OFDM, 9 Mbps, 99pc duty cycle)	X	4.22	66.92	16.26	0.00	150.0	± 9.6 %
		Y	4.32	66.81	16.11		150.0	
		Z	4.14	67.26	16.18		150.0	
10519-AAA	IEEE 802.11a/h WiFi 5 GHz (OFDM, 12 Mbps, 99pc duty cycle)	X	4.36	67.07	16.34	0.00	150.0	± 9.6 %
		Y	4.47	66.97	16.20		150.0	
		Z	4.26	67.39	16.25		150.0	
10520-AAA	IEEE 802.11a/h WiFi 5 GHz (OFDM, 18 Mbps, 99pc duty cycle)	X	4.22	67.01	16.26	0.00	150.0	± 9.6 %
		Y	4.32	66.91	16.11		150.0	
		Z	4.13	67.32	16.17		150.0	
10521-AAA	IEEE 802.11a/h WiFi 5 GHz (OFDM, 24 Mbps, 99pc duty cycle)	X	4.15	66.96	16.24	0.00	150.0	± 9.6 %
		Y	4.26	66.88	16.09		150.0	
		Z	4.06	67.26	16.14		150.0	
10522-AAA	IEEE 802.11a/h WiFi 5 GHz (OFDM, 36 Mbps, 99pc duty cycle)	X	4.20	67.07	16.32	0.00	150.0	± 9.6 %
		Y	4.31	66.99	16.18		150.0	
		Z	4.08	67.30	16.18		150.0	

10523-AAA	IEEE 802.11a/h WiFi 5 GHz (OFDM, 48 Mbps, 99pc duty cycle)	X	4.14	67.14	16.28	0.00	150.0	± 9.6 %
		Y	4.23	67.00	16.11		150.0	
		Z	4.06	67.51	16.23		150.0	
10524-AAA	IEEE 802.11a/h WiFi 5 GHz (OFDM, 54 Mbps, 99pc duty cycle)	X	4.15	67.07	16.34	0.00	150.0	± 9.6 %
		Y	4.26	66.95	16.18		150.0	
		Z	4.06	67.37	16.24		150.0	
10525-AAA	IEEE 802.11ac WiFi (20MHz, MCS0, 99pc duty cycle)	X	4.20	66.19	15.97	0.00	150.0	± 9.6 %
		Y	4.29	66.07	15.81		150.0	
		Z	4.13	66.56	15.92		150.0	
10526-AAA	IEEE 802.11ac WiFi (20MHz, MCS1, 99pc duty cycle)	X	4.31	66.45	16.08	0.00	150.0	± 9.6 %
		Y	4.41	66.35	15.92		150.0	
		Z	4.22	66.77	16.00		150.0	
10527-AAA	IEEE 802.11ac WiFi (20MHz, MCS2, 99pc duty cycle)	X	4.25	66.43	16.02	0.00	150.0	± 9.6 %
		Y	4.34	66.31	15.86		150.0	
		Z	4.16	66.77	15.96		150.0	
10528-AAA	IEEE 802.11ac WiFi (20MHz, MCS3, 99pc duty cycle)	X	4.26	66.44	16.06	0.00	150.0	± 9.6 %
		Y	4.36	66.33	15.89		150.0	
		Z	4.17	66.77	15.98		150.0	
10529-AAA	IEEE 802.11ac WiFi (20MHz, MCS4, 99pc duty cycle)	X	4.26	66.44	16.06	0.00	150.0	± 9.6 %
		Y	4.36	66.33	15.89		150.0	
		Z	4.17	66.77	15.98		150.0	
10531-AAA	IEEE 802.11ac WiFi (20MHz, MCS6, 99pc duty cycle)	X	4.22	66.45	16.02	0.00	150.0	± 9.6 %
		Y	4.32	66.35	15.87		150.0	
		Z	4.12	66.75	15.94		150.0	
10532-AAA	IEEE 802.11ac WiFi (20MHz, MCS7, 99pc duty cycle)	X	4.11	66.31	15.96	0.00	150.0	± 9.6 %
		Y	4.21	66.22	15.80		150.0	
		Z	4.02	66.64	15.89		150.0	
10533-AAA	IEEE 802.11ac WiFi (20MHz, MCS8, 99pc duty cycle)	X	4.27	66.54	16.06	0.00	150.0	± 9.6 %
		Y	4.36	66.41	15.90		150.0	
		Z	4.17	66.88	15.99		150.0	
10534-AAA	IEEE 802.11ac WiFi (40MHz, MCS0, 99pc duty cycle)	X	4.83	66.36	16.12	0.00	150.0	± 9.6 %
		Y	4.92	66.33	15.96		150.0	
		Z	4.73	66.59	16.01		150.0	
10535-AAA	IEEE 802.11ac WiFi (40MHz, MCS1, 99pc duty cycle)	X	4.87	66.48	16.17	0.00	150.0	± 9.6 %
		Y	4.96	66.46	16.02		150.0	
		Z	4.75	66.66	16.05		150.0	
10536-AAA	IEEE 802.11ac WiFi (40MHz, MCS2, 99pc duty cycle)	X	4.76	66.48	16.15	0.00	150.0	± 9.6 %
		Y	4.85	66.46	16.00		150.0	
		Z	4.66	66.70	16.05		150.0	
10537-AAA	IEEE 802.11ac WiFi (40MHz, MCS3, 99pc duty cycle)	X	4.84	66.54	16.18	0.00	150.0	± 9.6 %
		Y	4.91	66.45	16.00		150.0	
		Z	4.73	66.74	16.07		150.0	
10538-AAA	IEEE 802.11ac WiFi (40MHz, MCS4, 99pc duty cycle)	X	4.89	66.44	16.17	0.00	150.0	± 9.6 %
		Y	4.98	66.41	16.02		150.0	
		Z	4.77	66.62	16.04		150.0	
10540-AAA	IEEE 802.11ac WiFi (40MHz, MCS6, 99pc duty cycle)	X	4.82	66.39	16.17	0.00	150.0	± 9.6 %
		Y	4.91	66.37	16.02		150.0	
		Z	4.71	66.59	16.05		150.0	

10541-AAA	IEEE 802.11ac WiFi (40MHz, MCS7, 99pc duty cycle)	X	4.81	66.32	16.11	0.00	150.0	± 9.6 %
		Y	4.89	66.29	15.96		150.0	
		Z	4.71	66.57	16.02		150.0	
10542-AAA	IEEE 802.11ac WiFi (40MHz, MCS8, 99pc duty cycle)	X	4.96	66.42	16.18	0.00	150.0	± 9.6 %
		Y	5.05	66.39	16.03		150.0	
		Z	4.85	66.63	16.06		150.0	
10543-AAA	IEEE 802.11ac WiFi (40MHz, MCS9, 99pc duty cycle)	X	5.05	66.57	16.28	0.00	150.0	± 9.6 %
		Y	5.12	66.46	16.09		150.0	
		Z	4.92	66.71	16.13		150.0	
10544-AAA	IEEE 802.11ac WiFi (80MHz, MCS0, 99pc duty cycle)	X	5.19	66.38	16.08	0.00	150.0	± 9.6 %
		Y	5.26	66.41	15.96		150.0	
		Z	5.09	66.58	15.97		150.0	
10545-AAA	IEEE 802.11ac WiFi (80MHz, MCS1, 99pc duty cycle)	X	5.38	66.91	16.31	0.00	150.0	± 9.6 %
		Y	5.43	66.83	16.13		150.0	
		Z	5.23	66.94	16.11		150.0	
10546-AAA	IEEE 802.11ac WiFi (80MHz, MCS2, 99pc duty cycle)	X	5.22	66.50	16.11	0.00	150.0	± 9.6 %
		Y	5.29	66.53	15.99		150.0	
		Z	5.11	66.68	15.99		150.0	
10547-AAA	IEEE 802.11ac WiFi (80MHz, MCS3, 99pc duty cycle)	X	5.33	66.73	16.22	0.00	150.0	± 9.6 %
		Y	5.37	66.64	16.03		150.0	
		Z	5.21	66.86	16.08		150.0	
10548-AAA	IEEE 802.11ac WiFi (80MHz, MCS4, 99pc duty cycle)	X	5.45	67.31	16.49	0.00	150.0	± 9.6 %
		Y	5.51	67.24	16.31		150.0	
		Z	5.25	67.19	16.22		150.0	
10550-AAA	IEEE 802.11ac WiFi (80MHz, MCS6, 99pc duty cycle)	X	5.32	66.85	16.30	0.00	150.0	± 9.6 %
		Y	5.35	66.71	16.09		150.0	
		Z	5.18	66.94	16.14		150.0	
10551-AAA	IEEE 802.11ac WiFi (80MHz, MCS7, 99pc duty cycle)	X	5.20	66.44	16.06	0.00	150.0	± 9.6 %
		Y	5.29	66.50	15.95		150.0	
		Z	5.09	66.62	15.94		150.0	
10552-AAA	IEEE 802.11ac WiFi (80MHz, MCS8, 99pc duty cycle)	X	5.19	66.51	16.09	0.00	150.0	± 9.6 %
		Y	5.27	66.53	15.96		150.0	
		Z	5.10	66.75	16.00		150.0	
10553-AAA	IEEE 802.11ac WiFi (80MHz, MCS9, 99pc duty cycle)	X	5.24	66.43	16.08	0.00	150.0	± 9.6 %
		Y	5.33	66.48	15.97		150.0	
		Z	5.14	66.64	15.98		150.0	
10554-AAB	IEEE 802.11ac WiFi (160MHz, MCS0, 99pc duty cycle)	X	5.62	66.70	16.16	0.00	150.0	± 9.6 %
		Y	5.68	66.74	16.03		150.0	
		Z	5.52	66.86	16.02		150.0	
10555-AAB	IEEE 802.11ac WiFi (160MHz, MCS1, 99pc duty cycle)	X	5.71	66.93	16.26	0.00	150.0	± 9.6 %
		Y	5.77	66.97	16.13		150.0	
		Z	5.58	67.01	16.08		150.0	
10556-AAB	IEEE 802.11ac WiFi (160MHz, MCS2, 99pc duty cycle)	X	5.77	67.11	16.34	0.00	150.0	± 9.6 %
		Y	5.81	67.07	16.17		150.0	
		Z	5.62	67.15	16.14		150.0	
10557-AAB	IEEE 802.11ac WiFi (160MHz, MCS3, 99pc duty cycle)	X	5.70	66.90	16.25	0.00	150.0	± 9.6 %
		Y	5.77	66.95	16.13		150.0	
		Z	5.59	67.04	16.11		150.0	



10558-AAB	IEEE 802.11ac WiFi (160MHz, MCS4, 99pc duty cycle)	X	5.69	66.90	16.26	0.00	150.0	± 9.6 %
		Y	5.78	67.01	16.18		150.0	
		Z	5.56	67.00	16.10		150.0	
10560-AAB	IEEE 802.11ac WiFi (160MHz, MCS6, 99pc duty cycle)	X	5.72	66.86	16.28	0.00	150.0	± 9.6 %
		Y	5.80	66.93	16.18		150.0	
		Z	5.60	66.99	16.14		150.0	
10561-AAB	IEEE 802.11ac WiFi (160MHz, MCS7, 99pc duty cycle)	X	5.66	66.87	16.32	0.00	150.0	± 9.6 %
		Y	5.73	66.92	16.20		150.0	
		Z	5.53	66.96	16.15		150.0	
10562-AAB	IEEE 802.11ac WiFi (160MHz, MCS8, 99pc duty cycle)	X	5.70	66.99	16.38	0.00	150.0	± 9.6 %
		Y	5.78	67.08	16.28		150.0	
		Z	5.57	67.08	16.21		150.0	
10563-AAB	IEEE 802.11ac WiFi (160MHz, MCS9, 99pc duty cycle)	X	5.83	67.06	16.38	0.00	150.0	± 9.6 %
		Y	5.88	67.05	16.23		150.0	
		Z	5.69	67.13	16.21		150.0	
10564-AAA	IEEE 802.11g WiFi 2.4 GHz (DSSS-OFDM, 9 Mbps, 99pc duty cycle)	X	4.54	66.89	16.37	0.46	150.0	± 9.6 %
		Y	4.63	66.82	16.23		150.0	
		Z	4.43	67.15	16.24		150.0	
10565-AAA	IEEE 802.11g WiFi 2.4 GHz (DSSS-OFDM, 12 Mbps, 99pc duty cycle)	X	4.73	67.33	16.71	0.46	150.0	± 9.6 %
		Y	4.83	67.24	16.56		150.0	
		Z	4.62	67.61	16.60		150.0	
10566-AAA	IEEE 802.11g WiFi 2.4 GHz (DSSS-OFDM, 18 Mbps, 99pc duty cycle)	X	4.57	67.12	16.50	0.46	150.0	± 9.6 %
		Y	4.67	67.04	16.35		150.0	
		Z	4.45	67.36	16.36		150.0	
10567-AAA	IEEE 802.11g WiFi 2.4 GHz (DSSS-OFDM, 24 Mbps, 99pc duty cycle)	X	4.61	67.61	16.94	0.46	150.0	± 9.6 %
		Y	4.71	67.49	16.76		150.0	
		Z	4.52	67.92	16.85		150.0	
10568-AAA	IEEE 802.11g WiFi 2.4 GHz (DSSS-OFDM, 36 Mbps, 99pc duty cycle)	X	4.44	66.77	16.18	0.46	150.0	± 9.6 %
		Y	4.56	66.75	16.07		150.0	
		Z	4.30	66.87	15.96		150.0	
10569-AAA	IEEE 802.11g WiFi 2.4 GHz (DSSS-OFDM, 48 Mbps, 99pc duty cycle)	X	4.62	67.93	17.13	0.46	150.0	± 9.6 %
		Y	4.70	67.74	16.91		150.0	
		Z	4.54	68.30	17.08		150.0	
10570-AAA	IEEE 802.11g WiFi 2.4 GHz (DSSS-OFDM, 54 Mbps, 99pc duty cycle)	X	4.60	67.62	16.96	0.46	150.0	± 9.6 %
		Y	4.69	67.48	16.77		150.0	
		Z	4.49	67.91	16.87		150.0	
10571-AAA	IEEE 802.11b WiFi 2.4 GHz (DSSS, 1 Mbps, 90pc duty cycle)	X	1.06	65.12	15.94	0.46	130.0	± 9.6 %
		Y	1.10	64.13	15.18		130.0	
		Z	1.03	64.76	15.54		130.0	
10572-AAA	IEEE 802.11b WiFi 2.4 GHz (DSSS, 2 Mbps, 90pc duty cycle)	X	1.08	65.91	16.43	0.46	130.0	± 9.6 %
		Y	1.12	64.69	15.54		130.0	
		Z	1.04	65.49	16.01		130.0	
10573-AAA	IEEE 802.11b WiFi 2.4 GHz (DSSS, 5.5 Mbps, 90pc duty cycle)	X	100.00	148.16	38.24	0.46	130.0	± 9.6 %
		Y	1.56	82.04	21.65		130.0	
		Z	5.25	106.01	29.47		130.0	
10574-AAA	IEEE 802.11b WiFi 2.4 GHz (DSSS, 11 Mbps, 90pc duty cycle)	X	1.42	75.83	21.21	0.46	130.0	± 9.6 %
		Y	1.20	70.29	18.45		130.0	
		Z	1.26	74.01	20.40		130.0	

10575-AAA	IEEE 802.11g WiFi 2.4 GHz (DSSS-OFDM, 6 Mbps, 90pc duty cycle)	X	4.33	66.73	16.43	0.46	130.0	± 9.6 %
		Y	4.42	66.59	16.25		130.0	
		Z	4.21	66.91	16.24		130.0	
10576-AAA	IEEE 802.11g WiFi 2.4 GHz (DSSS-OFDM, 9 Mbps, 90pc duty cycle)	X	4.37	66.97	16.54	0.46	130.0	± 9.6 %
		Y	4.45	66.81	16.35		130.0	
		Z	4.25	67.19	16.37		130.0	
10577-AAA	IEEE 802.11g WiFi 2.4 GHz (DSSS-OFDM, 12 Mbps, 90pc duty cycle)	X	4.52	67.20	16.69	0.46	130.0	± 9.6 %
		Y	4.61	67.05	16.50		130.0	
		Z	4.39	67.40	16.51		130.0	
10578-AAA	IEEE 802.11g WiFi 2.4 GHz (DSSS-OFDM, 18 Mbps, 90pc duty cycle)	X	4.44	67.39	16.83	0.46	130.0	± 9.6 %
		Y	4.52	67.21	16.62		130.0	
		Z	4.32	67.63	16.68		130.0	
10579-AAA	IEEE 802.11g WiFi 2.4 GHz (DSSS-OFDM, 24 Mbps, 90pc duty cycle)	X	4.17	66.41	15.97	0.46	130.0	± 9.6 %
		Y	4.27	66.33	15.82		130.0	
		Z	4.03	66.48	15.71		130.0	
10580-AAA	IEEE 802.11g WiFi 2.4 GHz (DSSS-OFDM, 36 Mbps, 90pc duty cycle)	X	4.20	66.45	15.97	0.46	130.0	± 9.6 %
		Y	4.30	66.37	15.83		130.0	
		Z	4.03	66.43	15.66		130.0	
10581-AAA	IEEE 802.11g WiFi 2.4 GHz (DSSS-OFDM, 48 Mbps, 90pc duty cycle)	X	4.36	67.52	16.83	0.46	130.0	± 9.6 %
		Y	4.43	67.28	16.58		130.0	
		Z	4.25	67.77	16.69		130.0	
10582-AAA	IEEE 802.11g WiFi 2.4 GHz (DSSS-OFDM, 54 Mbps, 90pc duty cycle)	X	4.09	66.15	15.71	0.46	130.0	± 9.6 %
		Y	4.19	66.07	15.58		130.0	
		Z	3.93	66.16	15.43		130.0	
10583-AAA	IEEE 802.11a/h WiFi 5 GHz (OFDM, 6 Mbps, 90pc duty cycle)	X	4.33	66.73	16.43	0.46	130.0	± 9.6 %
		Y	4.42	66.59	16.25		130.0	
		Z	4.21	66.91	16.24		130.0	
10584-AAA	IEEE 802.11a/h WiFi 5 GHz (OFDM, 9 Mbps, 90pc duty cycle)	X	4.37	66.97	16.54	0.46	130.0	± 9.6 %
		Y	4.45	66.81	16.35		130.0	
		Z	4.25	67.19	16.37		130.0	
10585-AAA	IEEE 802.11a/h WiFi 5 GHz (OFDM, 12 Mbps, 90pc duty cycle)	X	4.52	67.20	16.69	0.46	130.0	± 9.6 %
		Y	4.61	67.05	16.50		130.0	
		Z	4.39	67.40	16.51		130.0	
10586-AAA	IEEE 802.11a/h WiFi 5 GHz (OFDM, 18 Mbps, 90pc duty cycle)	X	4.44	67.39	16.83	0.46	130.0	± 9.6 %
		Y	4.52	67.21	16.62		130.0	
		Z	4.32	67.63	16.68		130.0	
10587-AAA	IEEE 802.11a/h WiFi 5 GHz (OFDM, 24 Mbps, 90pc duty cycle)	X	4.17	66.41	15.97	0.46	130.0	± 9.6 %
		Y	4.27	66.33	15.82		130.0	
		Z	4.03	66.48	15.71		130.0	
10588-AAA	IEEE 802.11a/h WiFi 5 GHz (OFDM, 36 Mbps, 90pc duty cycle)	X	4.20	66.45	15.97	0.46	130.0	± 9.6 %
		Y	4.30	66.37	15.83		130.0	
		Z	4.03	66.43	15.66		130.0	
10589-AAA	IEEE 802.11a/h WiFi 5 GHz (OFDM, 48 Mbps, 90pc duty cycle)	X	4.36	67.52	16.83	0.46	130.0	± 9.6 %
		Y	4.43	67.28	16.58		130.0	
		Z	4.25	67.77	16.69		130.0	
10590-AAA	IEEE 802.11a/h WiFi 5 GHz (OFDM, 54 Mbps, 90pc duty cycle)	X	4.09	66.15	15.71	0.46	130.0	± 9.6 %
		Y	4.19	66.07	15.58		130.0	
		Z	3.93	66.16	15.43		130.0	

10591-AAA	IEEE 802.11n (HT Mixed, 20MHz, MCS0, 90pc duty cycle)	X	4.49	66.83	16.58	0.46	130.0	± 9.6 %
		Y	4.58	66.69	16.39		130.0	
		Z	4.38	67.05	16.41		130.0	
10592-AAA	IEEE 802.11n (HT Mixed, 20MHz, MCS1, 90pc duty cycle)	X	4.60	67.11	16.70	0.46	130.0	± 9.6 %
		Y	4.70	66.98	16.51		130.0	
		Z	4.47	67.30	16.52		130.0	
10593-AAA	IEEE 802.11n (HT Mixed, 20MHz, MCS2, 90pc duty cycle)	X	4.52	66.97	16.54	0.46	130.0	± 9.6 %
		Y	4.61	66.85	16.36		130.0	
		Z	4.39	67.15	16.35		130.0	
10594-AAA	IEEE 802.11n (HT Mixed, 20MHz, MCS3, 90pc duty cycle)	X	4.58	67.18	16.73	0.46	130.0	± 9.6 %
		Y	4.67	67.04	16.54		130.0	
		Z	4.45	67.37	16.56		130.0	
10595-AAA	IEEE 802.11n (HT Mixed, 20MHz, MCS4, 90pc duty cycle)	X	4.54	67.16	16.64	0.46	130.0	± 9.6 %
		Y	4.63	67.01	16.44		130.0	
		Z	4.41	67.33	16.45		130.0	
10596-AAA	IEEE 802.11n (HT Mixed, 20MHz, MCS5, 90pc duty cycle)	X	4.47	67.10	16.62	0.46	130.0	± 9.6 %
		Y	4.56	66.97	16.43		130.0	
		Z	4.33	67.23	16.41		130.0	
10597-AAA	IEEE 802.11n (HT Mixed, 20MHz, MCS6, 90pc duty cycle)	X	4.42	66.95	16.45	0.46	130.0	± 9.6 %
		Y	4.51	66.83	16.28		130.0	
		Z	4.29	67.09	16.24		130.0	
10598-AAA	IEEE 802.11n (HT Mixed, 20MHz, MCS7, 90pc duty cycle)	X	4.43	67.26	16.77	0.46	130.0	± 9.6 %
		Y	4.51	67.10	16.57		130.0	
		Z	4.32	67.48	16.62		130.0	
10599-AAA	IEEE 802.11n (HT Mixed, 40MHz, MCS0, 90pc duty cycle)	X	5.20	67.31	16.86	0.46	130.0	± 9.6 %
		Y	5.25	67.14	16.63		130.0	
		Z	5.07	67.41	16.66		130.0	
10600-AAA	IEEE 802.11n (HT Mixed, 40MHz, MCS1, 90pc duty cycle)	X	5.32	67.75	17.05	0.46	130.0	± 9.6 %
		Y	5.35	67.47	16.76		130.0	
		Z	5.09	67.50	16.68		130.0	
10601-AAA	IEEE 802.11n (HT Mixed, 40MHz, MCS2, 90pc duty cycle)	X	5.22	67.51	16.96	0.46	130.0	± 9.6 %
		Y	5.25	67.27	16.68		130.0	
		Z	5.07	67.56	16.73		130.0	
10602-AAA	IEEE 802.11n (HT Mixed, 40MHz, MCS3, 90pc duty cycle)	X	5.29	67.46	16.84	0.46	130.0	± 9.6 %
		Y	5.35	67.29	16.61		130.0	
		Z	5.08	67.29	16.50		130.0	
10603-AAA	IEEE 802.11n (HT Mixed, 40MHz, MCS4, 90pc duty cycle)	X	5.35	67.74	17.13	0.46	130.0	± 9.6 %
		Y	5.42	67.61	16.91		130.0	
		Z	5.13	67.56	16.79		130.0	
10604-AAA	IEEE 802.11n (HT Mixed, 40MHz, MCS5, 90pc duty cycle)	X	5.20	67.21	16.84	0.46	130.0	± 9.6 %
		Y	5.30	67.25	16.71		130.0	
		Z	5.02	67.15	16.55		130.0	
10605-AAA	IEEE 802.11n (HT Mixed, 40MHz, MCS6, 90pc duty cycle)	X	5.28	67.48	16.97	0.46	130.0	± 9.6 %
		Y	5.34	67.34	16.74		130.0	
		Z	5.07	67.33	16.64		130.0	
10606-AAA	IEEE 802.11n (HT Mixed, 40MHz, MCS7, 90pc duty cycle)	X	5.08	66.97	16.56	0.46	130.0	± 9.6 %
		Y	5.12	66.78	16.32		130.0	
		Z	4.92	66.93	16.28		130.0	

10607-AAA	IEEE 802.11ac WiFi (20MHz, MCS0, 90pc duty cycle)	X	4.35	66.22	16.25	0.46	130.0	± 9.6 %
		Y	4.42	66.04	16.04		130.0	
		Z	4.24	66.46	16.10		130.0	
10608-AAA	IEEE 802.11ac WiFi (20MHz, MCS1, 90pc duty cycle)	X	4.48	66.53	16.39	0.46	130.0	± 9.6 %
		Y	4.56	66.36	16.18		130.0	
		Z	4.35	66.73	16.22		130.0	
10609-AAA	IEEE 802.11ac WiFi (20MHz, MCS2, 90pc duty cycle)	X	4.38	66.34	16.19	0.46	130.0	± 9.6 %
		Y	4.46	66.19	15.99		130.0	
		Z	4.25	66.53	16.02		130.0	
10610-AAA	IEEE 802.11ac WiFi (20MHz, MCS3, 90pc duty cycle)	X	4.43	66.55	16.39	0.46	130.0	± 9.6 %
		Y	4.51	66.37	16.17		130.0	
		Z	4.31	66.77	16.23		130.0	
10611-AAA	IEEE 802.11ac WiFi (20MHz, MCS4, 90pc duty cycle)	X	4.34	66.31	16.21	0.46	130.0	± 9.6 %
		Y	4.42	66.16	16.01		130.0	
		Z	4.21	66.50	16.03		130.0	
10612-AAA	IEEE 802.11ac WiFi (20MHz, MCS5, 90pc duty cycle)	X	4.32	66.43	16.24	0.46	130.0	± 9.6 %
		Y	4.41	66.27	16.04		130.0	
		Z	4.18	66.54	16.03		130.0	
10613-AAA	IEEE 802.11ac WiFi (20MHz, MCS6, 90pc duty cycle)	X	4.31	66.21	16.06	0.46	130.0	± 9.6 %
		Y	4.40	66.08	15.88		130.0	
		Z	4.17	66.33	15.85		130.0	
10614-AAA	IEEE 802.11ac WiFi (20MHz, MCS7, 90pc duty cycle)	X	4.30	66.52	16.37	0.46	130.0	± 9.6 %
		Y	4.38	66.35	16.16		130.0	
		Z	4.18	66.74	16.22		130.0	
10615-AAA	IEEE 802.11ac WiFi (20MHz, MCS8, 90pc duty cycle)	X	4.32	66.10	15.94	0.46	130.0	± 9.6 %
		Y	4.41	65.96	15.76		130.0	
		Z	4.18	66.24	15.73		130.0	
10616-AAA	IEEE 802.11ac WiFi (40MHz, MCS0, 90pc duty cycle)	X	4.99	66.43	16.42	0.46	130.0	± 9.6 %
		Y	5.06	66.34	16.22		130.0	
		Z	4.86	66.54	16.23		130.0	
10617-AAA	IEEE 802.11ac WiFi (40MHz, MCS1, 90pc duty cycle)	X	5.03	66.54	16.45	0.46	130.0	± 9.6 %
		Y	5.10	66.46	16.25		130.0	
		Z	4.87	66.58	16.22		130.0	
10618-AAA	IEEE 802.11ac WiFi (40MHz, MCS2, 90pc duty cycle)	X	4.94	66.60	16.49	0.46	130.0	± 9.6 %
		Y	5.02	66.54	16.31		130.0	
		Z	4.80	66.71	16.31		130.0	
10619-AAA	IEEE 802.11ac WiFi (40MHz, MCS3, 90pc duty cycle)	X	4.99	66.52	16.38	0.46	130.0	± 9.6 %
		Y	5.03	66.34	16.14		130.0	
		Z	4.83	66.55	16.15		130.0	
10620-AAA	IEEE 802.11ac WiFi (40MHz, MCS4, 90pc duty cycle)	X	5.03	66.43	16.38	0.46	130.0	± 9.6 %
		Y	5.10	66.34	16.19		130.0	
		Z	4.87	66.44	16.14		130.0	
10621-AAA	IEEE 802.11ac WiFi (40MHz, MCS5, 90pc duty cycle)	X	5.04	66.55	16.58	0.46	130.0	± 9.6 %
		Y	5.11	66.48	16.39		130.0	
		Z	4.92	66.71	16.42		130.0	
10622-AAA	IEEE 802.11ac WiFi (40MHz, MCS6, 90pc duty cycle)	X	5.03	66.66	16.63	0.46	130.0	± 9.6 %
		Y	5.10	66.57	16.42		130.0	
		Z	4.89	66.76	16.44		130.0	

10623-AAA	IEEE 802.11ac WiFi (40MHz, MCS7, 90pc duty cycle)	X	4.92	66.17	16.23	0.46	130.0	± 9.6 %
		Y	4.99	66.10	16.04		130.0	
		Z	4.79	66.29	16.04		130.0	
10624-AAA	IEEE 802.11ac WiFi (40MHz, MCS8, 90pc duty cycle)	X	5.11	66.45	16.44	0.46	130.0	± 9.6 %
		Y	5.19	66.37	16.25		130.0	
		Z	4.97	66.53	16.23		130.0	
10625-AAA	IEEE 802.11ac WiFi (40MHz, MCS9, 90pc duty cycle)	X	5.22	66.67	16.62	0.46	130.0	± 9.6 %
		Y	5.28	66.51	16.38		130.0	
		Z	5.06	66.71	16.39		130.0	
10626-AAA	IEEE 802.11ac WiFi (80MHz, MCS0, 90pc duty cycle)	X	5.33	66.38	16.34	0.46	130.0	± 9.6 %
		Y	5.39	66.36	16.17		130.0	
		Z	5.21	66.49	16.15		130.0	
10627-AAA	IEEE 802.11ac WiFi (80MHz, MCS1, 90pc duty cycle)	X	5.59	67.13	16.68	0.46	130.0	± 9.6 %
		Y	5.61	66.95	16.43		130.0	
		Z	5.40	67.02	16.39		130.0	
10628-AAA	IEEE 802.11ac WiFi (80MHz, MCS2, 90pc duty cycle)	X	5.32	66.34	16.21	0.46	130.0	± 9.6 %
		Y	5.38	66.33	16.05		130.0	
		Z	5.18	66.39	16.00		130.0	
10629-AAA	IEEE 802.11ac WiFi (80MHz, MCS3, 90pc duty cycle)	X	5.47	66.71	16.39	0.46	130.0	± 9.6 %
		Y	5.48	66.50	16.13		130.0	
		Z	5.31	66.69	16.14		130.0	
10630-AAA	IEEE 802.11ac WiFi (80MHz, MCS4, 90pc duty cycle)	X	5.68	67.55	16.82	0.46	130.0	± 9.6 %
		Y	5.71	67.40	16.59		130.0	
		Z	5.39	67.16	16.39		130.0	
10631-AAA	IEEE 802.11ac WiFi (80MHz, MCS5, 90pc duty cycle)	X	5.64	67.57	17.04	0.46	130.0	± 9.6 %
		Y	5.70	67.49	16.83		130.0	
		Z	5.46	67.53	16.79		130.0	
10632-AAA	IEEE 802.11ac WiFi (80MHz, MCS6, 90pc duty cycle)	X	5.63	67.44	16.99	0.46	130.0	± 9.6 %
		Y	5.62	67.15	16.68		130.0	
		Z	5.46	67.43	16.75		130.0	
10633-AAA	IEEE 802.11ac WiFi (80MHz, MCS7, 90pc duty cycle)	X	5.33	66.40	16.29	0.46	130.0	± 9.6 %
		Y	5.42	66.45	16.15		130.0	
		Z	5.20	66.49	16.10		130.0	
10634-AAA	IEEE 802.11ac WiFi (80MHz, MCS8, 90pc duty cycle)	X	5.37	66.64	16.46	0.46	130.0	± 9.6 %
		Y	5.44	66.63	16.29		130.0	
		Z	5.25	66.79	16.30		130.0	
10635-AAA	IEEE 802.11ac WiFi (80MHz, MCS9, 90pc duty cycle)	X	5.21	65.78	15.73	0.46	130.0	± 9.6 %
		Y	5.29	65.83	15.61		130.0	
		Z	5.07	65.82	15.50		130.0	
10636-AAB	IEEE 802.11ac WiFi (160MHz, MCS0, 90pc duty cycle)	X	5.77	66.72	16.42	0.46	130.0	± 9.6 %
		Y	5.82	66.71	16.25		130.0	
		Z	5.64	66.78	16.21		130.0	
10637-AAB	IEEE 802.11ac WiFi (160MHz, MCS1, 90pc duty cycle)	X	5.90	67.05	16.57	0.46	130.0	± 9.6 %
		Y	5.94	67.01	16.39		130.0	
		Z	5.72	66.99	16.30		130.0	
10638-AAB	IEEE 802.11ac WiFi (160MHz, MCS2, 90pc duty cycle)	X	5.93	67.14	16.59	0.46	130.0	± 9.6 %
		Y	5.96	67.07	16.40		130.0	
		Z	5.77	67.13	16.35		130.0	

10639-AAB	IEEE 802.11ac WiFi (160MHz, MCS3, 90pc duty cycle)	X	5.87	66.96	16.54	0.46	130.0	± 9.6 %
		Y	5.92	66.95	16.38		130.0	
		Z	5.72	67.01	16.33		130.0	
10640-AAB	IEEE 802.11ac WiFi (160MHz, MCS4, 90pc duty cycle)	X	5.80	66.76	16.38	0.46	130.0	± 9.6 %
		Y	5.88	66.84	16.27		130.0	
		Z	5.64	66.74	16.13		130.0	
10641-AAB	IEEE 802.11ac WiFi (160MHz, MCS5, 90pc duty cycle)	X	5.94	66.98	16.51	0.46	130.0	± 9.6 %
		Y	5.97	66.91	16.32		130.0	
		Z	5.75	66.87	16.22		130.0	
10642-AAB	IEEE 802.11ac WiFi (160MHz, MCS6, 90pc duty cycle)	X	5.94	67.12	16.76	0.46	130.0	± 9.6 %
		Y	6.00	67.14	16.61		130.0	
		Z	5.80	67.17	16.56		130.0	
10643-AAB	IEEE 802.11ac WiFi (160MHz, MCS7, 90pc duty cycle)	X	5.79	66.79	16.48	0.46	130.0	± 9.6 %
		Y	5.85	66.80	16.33		130.0	
		Z	5.62	66.75	16.21		130.0	
10644-AAB	IEEE 802.11ac WiFi (160MHz, MCS8, 90pc duty cycle)	X	5.83	66.94	16.57	0.46	130.0	± 9.6 %
		Y	5.90	67.00	16.44		130.0	
		Z	5.67	66.93	16.32		130.0	
10645-AAB	IEEE 802.11ac WiFi (160MHz, MCS9, 90pc duty cycle)	X	5.99	67.10	16.62	0.46	130.0	± 9.6 %
		Y	6.03	67.04	16.43		130.0	
		Z	5.79	66.98	16.32		130.0	
10646-AAD	LTE-TDD (SC-FDMA, 1 RB, 5 MHz, QPSK, UL Subframe=2,7)	X	10.99	100.29	34.81	9.30	60.0	± 9.6 %
		Y	9.88	96.69	33.11		60.0	
		Z	5.76	86.83	29.52		60.0	
10647-AAC	LTE-TDD (SC-FDMA, 1 RB, 20 MHz, QPSK, UL Subframe=2,7)	X	9.57	97.81	34.14	9.30	60.0	± 9.6 %
		Y	8.70	94.40	32.46		60.0	
		Z	5.05	84.45	28.75		60.0	
10648-AAA	CDMA2000 (1x Advanced)	X	0.33	60.00	5.57	0.00	150.0	± 9.6 %
		Y	0.47	61.19	7.86		150.0	
		Z	0.30	60.00	5.23		150.0	
10652-AAB	LTE-TDD (OFDMA, 5 MHz, E-TM 3.1, Clipping 44%)	X	3.46	67.89	16.64	2.23	80.0	± 9.6 %
		Y	3.39	66.82	16.12		80.0	
		Z	3.15	67.36	16.00		80.0	
10653-AAB	LTE-TDD (OFDMA, 10 MHz, E-TM 3.1, Clipping 44%)	X	3.92	66.65	16.80	2.23	80.0	± 9.6 %
		Y	3.92	66.10	16.41		80.0	
		Z	3.65	66.30	16.32		80.0	
10654-AAB	LTE-TDD (OFDMA, 15 MHz, E-TM 3.1, Clipping 44%)	X	3.93	66.16	16.82	2.23	80.0	± 9.6 %
		Y	3.94	65.72	16.45		80.0	
		Z	3.68	65.81	16.36		80.0	
10655-AAB	LTE-TDD (OFDMA, 20 MHz, E-TM 3.1, Clipping 44%)	X	4.00	66.00	16.84	2.23	80.0	± 9.6 %
		Y	4.01	65.63	16.48		80.0	
		Z	3.76	65.63	16.38		80.0	

<sup>E</sup> Uncertainty is determined using the max. deviation from linear response applying rectangular distribution and is expressed for the square of the field value.

## **Appendix E – Dipole Calibration Data Sheets**

*Jm*

**Calibration Laboratory of  
Schmid & Partner  
Engineering AG**  
Zeughausstrasse 43, 8004 Zurich, Switzerland



**S** Schweizerischer Kalibrierdienst  
**C** Service suisse d'étalonnage  
**S** Servizio svizzero di taratura  
**S** Swiss Calibration Service

Accredited by the Swiss Accreditation Service (SAS)  
The Swiss Accreditation Service is one of the signatories to the EA  
Multilateral Agreement for the recognition of calibration certificates

Accreditation No.: **SCS 0108**

Client **RF Exposure Lab**

Certificate No: **D2450V2-881\_Aug15**

## CALIBRATION CERTIFICATE

Object **D2450V2 - SN: 881**

Calibration procedure(s) **QA CAL-05.v9  
Calibration procedure for dipole validation kits above 700 MHz**

Calibration date: **August 10, 2015**

This calibration certificate documents the traceability to national standards, which realize the physical units of measurements (SI).  
The measurements and the uncertainties with confidence probability are given on the following pages and are part of the certificate.

All calibrations have been conducted in the closed laboratory facility: environment temperature (22 ± 3)°C and humidity < 70%.

Calibration Equipment used (M&TE critical for calibration)

Primary Standards	ID #	Cal Date (Certificate No.)	Scheduled Calibration
Power meter EPM-442A	GB37480704	07-Oct-14 (No. 217-02020)	Oct-15
Power sensor HP 8481A	US37292783	07-Oct-14 (No. 217-02020)	Oct-15
Power sensor HP 8481A	MY41092317	07-Oct-14 (No. 217-02021)	Oct-15
Reference 20 dB Attenuator	SN: 5058 (20k)	01-Apr-15 (No. 217-02131)	Mar-16
Type-N mismatch combination	SN: 5047.2 / 06327	01-Apr-15 (No. 217-02134)	Mar-16
Reference Probe ES3DV3	SN: 3205	30-Dec-14 (No. ES3-3205_Dec14)	Dec-15
DAE4	SN: 601	18-Aug-14 (No. DAE4-601_Aug14)	Aug-15
Secondary Standards	ID #	Check Date (in house)	Scheduled Check
RF generator R&S SMT-06	100005	04-Aug-99 (in house check Oct-13)	In house check: Oct-16
Network Analyzer HP 8753E	US37390585 S4206	18-Oct-01 (in house check Oct-14)	In house check: Oct-15

Calibrated by: **Name: Michael Weber** **Function: Laboratory Technician**

Signature  
*M. Weber*

Approved by: **Name: Katja Pokovic** **Function: Technical Manager**

Signature  
*K. Pokovic*

Issued: August 12, 2015

This calibration certificate shall not be reproduced except in full without written approval of the laboratory.





Accredited by the Swiss Accreditation Service (SAS)

The Swiss Accreditation Service is one of the signatories to the EA  
Multilateral Agreement for the recognition of calibration certificates

Accreditation No.: **SCS 0108**

### Glossary:

TSL	tissue simulating liquid
ConvF	sensitivity in TSL / NORM x,y,z
N/A	not applicable or not measured

### Calibration is Performed According to the Following Standards:

- IEEE Std 1528-2013, "IEEE Recommended Practice for Determining the Peak Spatial-Averaged Specific Absorption Rate (SAR) in the Human Head from Wireless Communications Devices: Measurement Techniques", June 2013
- IEC 62209-1, "Procedure to measure the Specific Absorption Rate (SAR) for hand-held devices used in close proximity to the ear (frequency range of 300 MHz to 3 GHz)", February 2005
- IEC 62209-2, "Procedure to determine the Specific Absorption Rate (SAR) for wireless communication devices used in close proximity to the human body (frequency range of 30 MHz to 6 GHz)", March 2010
- KDB 865664, "SAR Measurement Requirements for 100 MHz to 6 GHz"

### Additional Documentation:

- DASY4/5 System Handbook

### Methods Applied and Interpretation of Parameters:

- Measurement Conditions:** Further details are available from the Validation Report at the end of the certificate. All figures stated in the certificate are valid at the frequency indicated.
- Antenna Parameters with TSL:** The dipole is mounted with the spacer to position its feed point exactly below the center marking of the flat phantom section, with the arms oriented parallel to the body axis.
- Feed Point Impedance and Return Loss:** These parameters are measured with the dipole positioned under the liquid filled phantom. The impedance stated is transformed from the measurement at the SMA connector to the feed point. The Return Loss ensures low reflected power. No uncertainty required.
- Electrical Delay:** One-way delay between the SMA connector and the antenna feed point. No uncertainty required.
- SAR measured:** SAR measured at the stated antenna input power.
- SAR normalized:** SAR as measured, normalized to an input power of 1 W at the antenna connector.
- SAR for nominal TSL parameters:** The measured TSL parameters are used to calculate the nominal SAR result.

The reported uncertainty of measurement is stated as the standard uncertainty of measurement multiplied by the coverage factor  $k=2$ , which for a normal distribution corresponds to a coverage probability of approximately 95%.

## Measurement Conditions

DASY system configuration, as far as not given on page 1.

<b>DASY Version</b>	DASY5	V52.8.8
<b>Extrapolation</b>	Advanced Extrapolation	
<b>Phantom</b>	Modular Flat Phantom	
<b>Distance Dipole Center - TSL</b>	10 mm	with Spacer
<b>Zoom Scan Resolution</b>	dx, dy, dz = 5 mm	
<b>Frequency</b>	2450 MHz ± 1 MHz	

## Head TSL parameters

The following parameters and calculations were applied.

	Temperature	Permittivity	Conductivity
<b>Nominal Head TSL parameters</b>	22.0 °C	39.2	1.80 mho/m
<b>Measured Head TSL parameters</b>	(22.0 ± 0.2) °C	38.1 ± 6 %	1.87 mho/m ± 6 %
<b>Head TSL temperature change during test</b>	< 0.5 °C	----	----

## SAR result with Head TSL

<b>SAR averaged over 1 cm<sup>3</sup> (1 g) of Head TSL</b>	Condition	
SAR measured	250 mW input power	13.7 W/kg
SAR for nominal Head TSL parameters	normalized to 1W	<b>53.5 W/kg ± 17.0 % (k=2)</b>

<b>SAR averaged over 10 cm<sup>3</sup> (10 g) of Head TSL</b>	condition	
SAR measured	250 mW input power	6.43 W/kg
SAR for nominal Head TSL parameters	normalized to 1W	<b>25.4 W/kg ± 16.5 % (k=2)</b>

## Body TSL parameters

The following parameters and calculations were applied.

	Temperature	Permittivity	Conductivity
<b>Nominal Body TSL parameters</b>	22.0 °C	52.7	1.95 mho/m
<b>Measured Body TSL parameters</b>	(22.0 ± 0.2) °C	50.6 ± 6 %	2.03 mho/m ± 6 %
<b>Body TSL temperature change during test</b>	< 0.5 °C	----	----

## SAR result with Body TSL

<b>SAR averaged over 1 cm<sup>3</sup> (1 g) of Body TSL</b>	Condition	
SAR measured	250 mW input power	13.4 W/kg
SAR for nominal Body TSL parameters	normalized to 1W	<b>52.1 W/kg ± 17.0 % (k=2)</b>

<b>SAR averaged over 10 cm<sup>3</sup> (10 g) of Body TSL</b>	condition	
SAR measured	250 mW input power	6.27 W/kg
SAR for nominal Body TSL parameters	normalized to 1W	<b>24.7 W/kg ± 16.5 % (k=2)</b>

## Appendix (Additional assessments outside the scope of SCS 0108)

### Antenna Parameters with Head TSL

Impedance, transformed to feed point	54.5 $\Omega$ + 2.4 j $\Omega$
Return Loss	- 26.2 dB

### Antenna Parameters with Body TSL

Impedance, transformed to feed point	50.9 $\Omega$ + 4.4 j $\Omega$
Return Loss	- 27.0 dB

### General Antenna Parameters and Design

Electrical Delay (one direction)	1.154 ns
----------------------------------	----------

After long term use with 100W radiated power, only a slight warming of the dipole near the feedpoint can be measured.

The dipole is made of standard semirigid coaxial cable. The center conductor of the feeding line is directly connected to the second arm of the dipole. The antenna is therefore short-circuited for DC-signals. On some of the dipoles, small end caps are added to the dipole arms in order to improve matching when loaded according to the position as explained in the "Measurement Conditions" paragraph. The SAR data are not affected by this change. The overall dipole length is still according to the Standard.

No excessive force must be applied to the dipole arms, because they might bend or the soldered connections near the feedpoint may be damaged.

### Additional EUT Data

Manufactured by	SPEAG
Manufactured on	August 18, 2010

#### Extended Calibration

Usage of SAR dipoles calibrated less than 3 years ago but more than 1 year ago were confirmed in maintaining return loss (< -20 dB, within 20% of prior calibration) and impedance (within 5 ohm from prior calibration) requirements per extended calibrations in KDB Publication 865664 D01 v01r04.

D2450V2 SN: 881 - Head						
Date of Measurement	Return Loss (dB)	$\Delta\%$	Impedance Real ( $\Omega$ )	$\Delta\Omega$	Impedance Imaginary (j $\Omega$ )	$\Delta\Omega$
8/10/2015	-26.2		54.5		2.4	
8/9/2016	-25.4	-3.1	52.8	-1.7	2.9	0.5
8/10/2017	-26.8	2.3	53.4	-1.1	2.6	0.2

D2450V2 SN: 881 - Body						
Date of Measurement	Return Loss (dB)	$\Delta\%$	Impedance Real ( $\Omega$ )	$\Delta\Omega$	Impedance Imaginary (j $\Omega$ )	$\Delta\Omega$
8/10/2015	-27.0		50.9		4.4	
8/9/2016	-27.5	1.9	51.6	0.7	5.2	0.8
8/10/2017	-26.4	-2.2	50.2	-0.7	4.9	0.5

## DASY5 Validation Report for Head TSL

Date: 10.08.2015

Test Laboratory: SPEAG, Zurich, Switzerland

**DUT: Dipole 2450 MHz; Type: D2450V2; Serial: D2450V2 - SN: 881**

Communication System: UID 0 - CW; Frequency: 2450 MHz

Medium parameters used:  $f = 2450$  MHz;  $\sigma = 1.87$  S/m;  $\epsilon_r = 38.1$ ;  $\rho = 1000$  kg/m<sup>3</sup>

Phantom section: Flat Section

Measurement Standard: DASY5 (IEEE/IEC/ANSI C63.19-2011)

DASY52 Configuration:

- Probe: ES3DV3 - SN3205; ConvF(4.54, 4.54, 4.54); Calibrated: 30.12.2014;
- Sensor-Surface: 3mm (Mechanical Surface Detection)
- Electronics: DAE4 Sn601; Calibrated: 18.08.2014
- Phantom: Flat Phantom 5.0 (front); Type: QD000P50AA; Serial: 1001
- DASY52 52.8.8(1222); SEMCAD X 14.6.10(7331)

### Dipole Calibration for Head Tissue/Pin=250 mW, d=10mm/Zoom Scan (7x7x7)/Cube 0:

Measurement grid: dx=5mm, dy=5mm, dz=5mm

Reference Value = 101.8 V/m; Power Drift = 0.02 dB

Peak SAR (extrapolated) = 28.0 W/kg

**SAR(1 g) = 13.7 W/kg; SAR(10 g) = 6.43 W/kg**

Maximum value of SAR (measured) = 18.1 W/kg

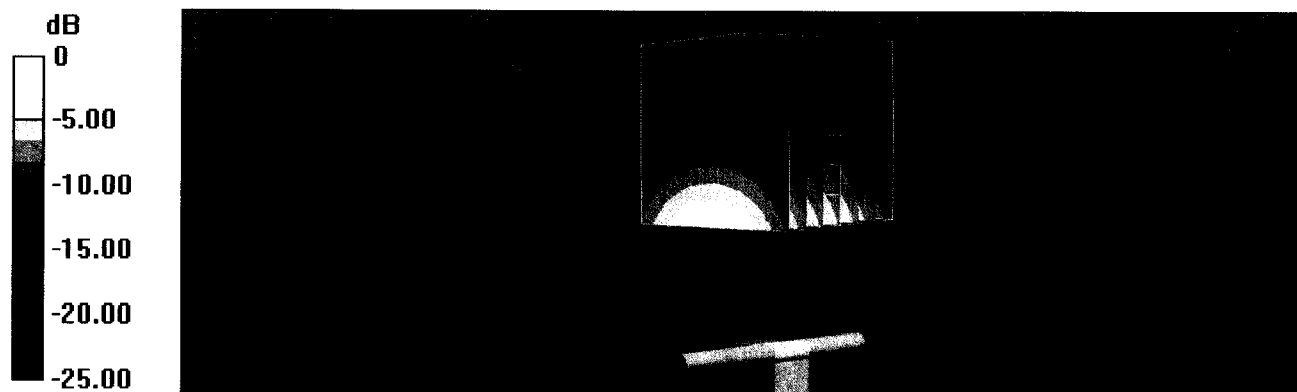

0 dB = 18.1 W/kg = 12.58 dBW/kg

# Impedance Measurement Plot for Head TSL

10 Aug 2015 15:18:07

CH1 S11 1 U FS 1: 54.469  $\Omega$  2: 4355  $\Omega$  158.22 pF 2 450.000 000 MHz

\*  
De1  
CA  
Avg  
16  
H1d

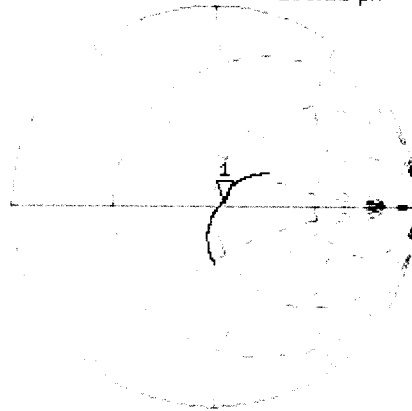

CH2 S11 LOG 5 dB/REF -20 dB 1: -26.248 dB 2 450.000 000 MHz

De1  
CA  
Avg  
16  
H1d

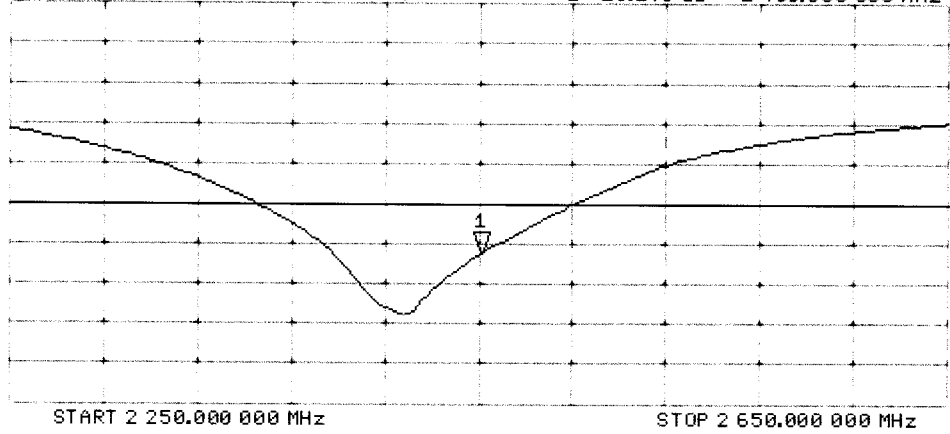

## DASY5 Validation Report for Body TSL

Date: 10.08.2015

Test Laboratory: SPEAG, Zurich, Switzerland

**DUT: Dipole 2450 MHz; Type: D2450V2; Serial: D2450V2 - SN: 881**

Communication System: UID 0 - CW; Frequency: 2450 MHz

Medium parameters used:  $f = 2450$  MHz;  $\sigma = 2.03$  S/m;  $\epsilon_r = 50.6$ ;  $\rho = 1000$  kg/m<sup>3</sup>

Phantom section: Flat Section

Measurement Standard: DASY5 (IEEE/IEC/ANSI C63.19-2011)

DASY52 Configuration:

- Probe: ES3DV3 - SN3205; ConvF(4.32, 4.32, 4.32); Calibrated: 30.12.2014;
- Sensor-Surface: 3mm (Mechanical Surface Detection)
- Electronics: DAE4 Sn601; Calibrated: 18.08.2014
- Phantom: Flat Phantom 5.0 (back); Type: QD000P50AA; Serial: 1002
- DASY52 52.8.8(1222); SEMCAD X 14.6.10(7331)

### Dipole Calibration for Body Tissue/Pin=250 mW, d=10mm/Zoom Scan (7x7x7)/Cube 0:

Measurement grid: dx=5mm, dy=5mm, dz=5mm

Reference Value = 96.26 V/m; Power Drift = -0.05 dB

Peak SAR (extrapolated) = 27.7 W/kg

**SAR(1 g) = 13.4 W/kg; SAR(10 g) = 6.27 W/kg**

Maximum value of SAR (measured) = 17.7 W/kg

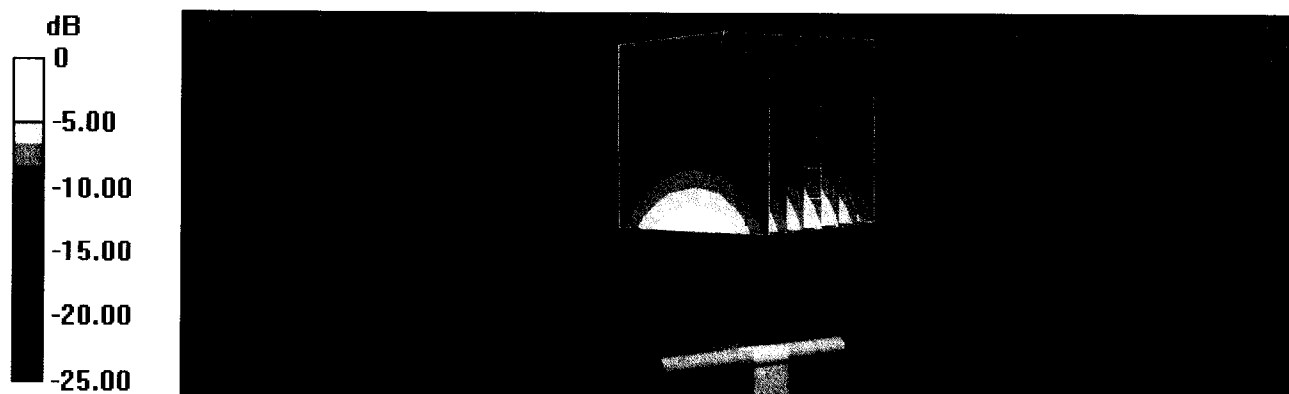

0 dB = 17.7 W/kg = 12.48 dBW/kg

# Impedance Measurement Plot for Body TSL

10 Aug 2015 15:17:39

[CH1] S11 1 U FS 1: 50.879  $\Omega$  4.4199  $\Omega$  287.12  $\mu\text{H}$  2 450.000 000 MHz

\*  
De1

CA

Avg  
16

H1 d

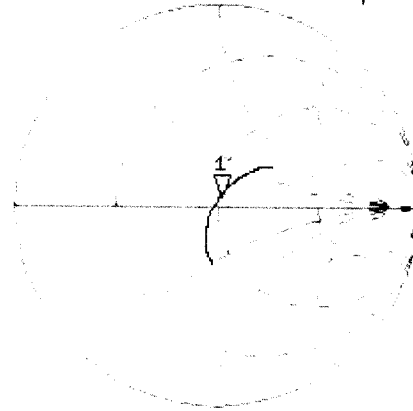

CH2 S11 LOG 5 dB/REF -20 dB 1: -27.001 dB 2 450.000 000 MHz

De1

CA

Avg  
16

H1 d

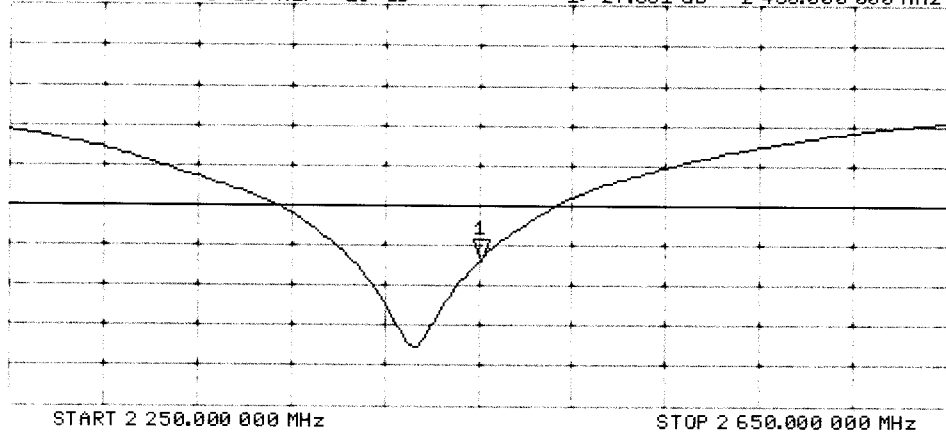

*Jm*

**Calibration Laboratory of  
Schmid & Partner  
Engineering AG**  
Zeughausstrasse 43, 8004 Zurich, Switzerland



**S** Schweizerischer Kalibrierdienst  
**C** Service suisse d'étalonnage  
**S** Servizio svizzero di taratura  
**S** Swiss Calibration Service

Accredited by the Swiss Accreditation Service (SAS)  
The Swiss Accreditation Service is one of the signatories to the EA  
Multilateral Agreement for the recognition of calibration certificates

Accreditation No.: **SCS 0108**

Client **RF Exposure Lab**

Certificate No: **D5GHzV2-1119\_Aug15**

## CALIBRATION CERTIFICATE

Object **D5GHzV2 - SN: 1119**

Calibration procedure(s) **QA CAL-22.v2**  
**Calibration procedure for dipole validation kits between 3-6 GHz**

Calibration date: **August 11, 2015**

This calibration certificate documents the traceability to national standards, which realize the physical units of measurements (SI).  
The measurements and the uncertainties with confidence probability are given on the following pages and are part of the certificate.

All calibrations have been conducted in the closed laboratory facility: environment temperature (22 ± 3)°C and humidity < 70%.

Calibration Equipment used (M&TE critical for calibration)

Primary Standards	ID #	Cal Date (Certificate No.)	Scheduled Calibration
Power meter EPM-442A	GB37480704	07-Oct-14 (No. 217-02020)	Oct-15
Power sensor HP 8481A	US37292783	07-Oct-14 (No. 217-02020)	Oct-15
Power sensor HP 8481A	MY41092317	07-Oct-14 (No. 217-02021)	Oct-15
Reference 20 dB Attenuator	SN: 5058 (20k)	01-Apr-15 (No. 217-02131)	Mar-16
Type-N mismatch combination	SN: 5047.2 / 06327	01-Apr-15 (No. 217-02134)	Mar-16
Reference Probe EX3DV4	SN: 3503	30-Dec-14 (No. EX3-3503_Dec14)	Dec-15
DAE4	SN: 601	18-Aug-14 (No. DAE4-601_Aug14)	Aug-15
Secondary Standards	ID #	Check Date (in house)	Scheduled Check
RF generator R&S SMT-06	100005	04-Aug-99 (in house check Oct-13)	In house check: Oct-16
Network Analyzer HP 8753E	US37390585 S4206	18-Oct-01 (in house check Oct-14)	In house check: Oct-15

Calibrated by: **Name** **Israe Elnaouq** **Function** **Laboratory Technician**

Approved by: **Name** **Katja Pokovic** **Function** **Technical Manager**

**Signature**  
*Israe Elnaouq*  
*Katja Pokovic*

Issued: August 11, 2015

This calibration certificate shall not be reproduced except in full without written approval of the laboratory.





Accredited by the Swiss Accreditation Service (SAS)  
The Swiss Accreditation Service is one of the signatories to the EA  
Multilateral Agreement for the recognition of calibration certificates

Accreditation No.: **SCS 0108**

**Glossary:**

TSL	tissue simulating liquid
ConvF	sensitivity in TSL / NORM x,y,z
N/A	not applicable or not measured

**Calibration is Performed According to the Following Standards:**

- IEEE Std 1528-2013, "IEEE Recommended Practice for Determining the Peak Spatial-Averaged Specific Absorption Rate (SAR) in the Human Head from Wireless Communications Devices: Measurement Techniques", June 2013
- IEC 62209-2, "Procedure to determine the Specific Absorption Rate (SAR) for wireless communication devices used in close proximity to the human body (frequency range of 30 MHz to 6 GHz)", March 2010
- KDB 865664, "SAR Measurement Requirements for 100 MHz to 6 GHz"

**Additional Documentation:**

- DASY4/5 System Handbook

**Methods Applied and Interpretation of Parameters:**

- Measurement Conditions:* Further details are available from the Validation Report at the end of the certificate. All figures stated in the certificate are valid at the frequency indicated.
- Antenna Parameters with TSL:* The dipole is mounted with the spacer to position its feed point exactly below the center marking of the flat phantom section, with the arms oriented parallel to the body axis.
- Feed Point Impedance and Return Loss:* These parameters are measured with the dipole positioned under the liquid filled phantom. The impedance stated is transformed from the measurement at the SMA connector to the feed point. The Return Loss ensures low reflected power. No uncertainty required.
- Electrical Delay:* One-way delay between the SMA connector and the antenna feed point. No uncertainty required.
- SAR measured:* SAR measured at the stated antenna input power.
- SAR normalized:* SAR as measured, normalized to an input power of 1 W at the antenna connector.
- SAR for nominal TSL parameters:* The measured TSL parameters are used to calculate the nominal SAR result.

The reported uncertainty of measurement is stated as the standard uncertainty of measurement multiplied by the coverage factor  $k=2$ , which for a normal distribution corresponds to a coverage probability of approximately 95%.

## Measurement Conditions

DASY system configuration, as far as not given on page 1.

<b>DASY Version</b>	DASY5	V52.8.8
<b>Extrapolation</b>	Advanced Extrapolation	
<b>Phantom</b>	Modular Flat Phantom V5.0	
<b>Distance Dipole Center - TSL</b>	10 mm	with Spacer
<b>Zoom Scan Resolution</b>	dx, dy = 4.0 mm, dz = 1.4 mm	Graded Ratio = 1.4 (Z direction)
<b>Frequency</b>	5200 MHz ± 1 MHz 5300 MHz ± 1 MHz 5500 MHz ± 1 MHz 5600 MHz ± 1 MHz 5800 MHz ± 1 MHz	

## Head TSL parameters at 5200 MHz

The following parameters and calculations were applied.

	Temperature	Permittivity	Conductivity
<b>Nominal Head TSL parameters</b>	22.0 °C	36.0	4.66 mho/m
<b>Measured Head TSL parameters</b>	(22.0 ± 0.2) °C	35.5 ± 6 %	4.53 mho/m ± 6 %
<b>Head TSL temperature change during test</b>	< 0.5 °C	----	----

## SAR result with Head TSL at 5200 MHz

<b>SAR averaged over 1 cm<sup>3</sup> (1 g) of Head TSL</b>	Condition	
SAR measured	100 mW input power	8.11 W/kg
SAR for nominal Head TSL parameters	normalized to 1W	<b>80.8 W/kg ± 19.9 % (k=2)</b>

<b>SAR averaged over 10 cm<sup>3</sup> (10 g) of Head TSL</b>	condition	
SAR measured	100 mW input power	2.32 W/kg
SAR for nominal Head TSL parameters	normalized to 1W	<b>23.1 W/kg ± 19.5 % (k=2)</b>

### Head TSL parameters at 5300 MHz

The following parameters and calculations were applied.

	Temperature	Permittivity	Conductivity
Nominal Head TSL parameters	22.0 °C	35.9	4.76 mho/m
Measured Head TSL parameters	(22.0 ± 0.2) °C	35.4 ± 6 %	4.63 mho/m ± 6 %
Head TSL temperature change during test	< 0.5 °C	----	----

### SAR result with Head TSL at 5300 MHz

SAR averaged over 1 cm <sup>3</sup> (1 g) of Head TSL	Condition	
SAR measured	100 mW input power	8.46 W/kg
SAR for nominal Head TSL parameters	normalized to 1W	<b>84.3 W / kg ± 19.9 % (k=2)</b>

SAR averaged over 10 cm <sup>3</sup> (10 g) of Head TSL	condition	
SAR measured	100 mW input power	2.42 W/kg
SAR for nominal Head TSL parameters	normalized to 1W	<b>24.1 W/kg ± 19.5 % (k=2)</b>

### Head TSL parameters at 5500 MHz

The following parameters and calculations were applied.

	Temperature	Permittivity	Conductivity
Nominal Head TSL parameters	22.0 °C	35.6	4.96 mho/m
Measured Head TSL parameters	(22.0 ± 0.2) °C	35.1 ± 6 %	4.82 mho/m ± 6 %
Head TSL temperature change during test	< 0.5 °C	----	----

### SAR result with Head TSL at 5500 MHz

SAR averaged over 1 cm <sup>3</sup> (1 g) of Head TSL	Condition	
SAR measured	100 mW input power	8.50 W/kg
SAR for nominal Head TSL parameters	normalized to 1W	<b>84.6 W/kg ± 19.9 % (k=2)</b>

SAR averaged over 10 cm <sup>3</sup> (10 g) of Head TSL	condition	
SAR measured	100 mW input power	2.42 W/kg
SAR for nominal Head TSL parameters	normalized to 1W	<b>24.1 W/kg ± 19.5 % (k=2)</b>

### Head TSL parameters at 5600 MHz

The following parameters and calculations were applied.

	Temperature	Permittivity	Conductivity
Nominal Head TSL parameters	22.0 °C	35.5	5.07 mho/m
Measured Head TSL parameters	(22.0 ± 0.2) °C	34.9 ± 6 %	4.93 mho/m ± 6 %
Head TSL temperature change during test	< 0.5 °C	----	----

### SAR result with Head TSL at 5600 MHz

SAR averaged over 1 cm <sup>3</sup> (1 g) of Head TSL	Condition	
SAR measured	100 mW input power	8.46 W/kg
SAR for nominal Head TSL parameters	normalized to 1W	<b>84.2 W/kg ± 19.9 % (k=2)</b>

SAR averaged over 10 cm <sup>3</sup> (10 g) of Head TSL	condition	
SAR measured	100 mW input power	2.41 W/kg
SAR for nominal Head TSL parameters	normalized to 1W	<b>24.0 W/kg ± 19.5 % (k=2)</b>

### Head TSL parameters at 5800 MHz

The following parameters and calculations were applied.

	Temperature	Permittivity	Conductivity
Nominal Head TSL parameters	22.0 °C	35.3	5.27 mho/m
Measured Head TSL parameters	(22.0 ± 0.2) °C	34.7 ± 6 %	5.14 mho/m ± 6 %
Head TSL temperature change during test	< 0.5 °C	----	----

### SAR result with Head TSL at 5800 MHz

SAR averaged over 1 cm <sup>3</sup> (1 g) of Head TSL	Condition	
SAR measured	100 mW input power	8.10 W/kg
SAR for nominal Head TSL parameters	normalized to 1W	<b>80.6 W/kg ± 19.9 % (k=2)</b>

SAR averaged over 10 cm <sup>3</sup> (10 g) of Head TSL	condition	
SAR measured	100 mW input power	2.31 W/kg
SAR for nominal Head TSL parameters	normalized to 1W	<b>23.0 W/kg ± 19.5 % (k=2)</b>

### Body TSL parameters at 5200 MHz

The following parameters and calculations were applied.

	Temperature	Permittivity	Conductivity
Nominal Body TSL parameters	22.0 °C	49.0	5.30 mho/m
Measured Body TSL parameters	(22.0 ± 0.2) °C	47.9 ± 6 %	5.43 mho/m ± 6 %
Body TSL temperature change during test	< 0.5 °C	----	----

### SAR result with Body TSL at 5200 MHz

SAR averaged over 1 cm <sup>3</sup> (1 g) of Body TSL	Condition	
SAR measured	100 mW input power	7.77 W/kg
SAR for nominal Body TSL parameters	normalized to 1W	<b>77.4 W/kg ± 19.9 % (k=2)</b>

SAR averaged over 10 cm <sup>3</sup> (10 g) of Body TSL	condition	
SAR measured	100 mW input power	2.17 W/kg
SAR for nominal Body TSL parameters	normalized to 1W	<b>21.6 W/kg ± 19.5 % (k=2)</b>

### Body TSL parameters at 5300 MHz

The following parameters and calculations were applied.

	Temperature	Permittivity	Conductivity
Nominal Body TSL parameters	22.0 °C	48.9	5.42 mho/m
Measured Body TSL parameters	(22.0 ± 0.2) °C	47.7 ± 6 %	5.56 mho/m ± 6 %
Body TSL temperature change during test	< 0.5 °C	----	----

### SAR result with Body TSL at 5300 MHz

SAR averaged over 1 cm <sup>3</sup> (1 g) of Body TSL	Condition	
SAR measured	100 mW input power	7.79 W/kg
SAR for nominal Body TSL parameters	normalized to 1W	<b>77.6 W/kg ± 19.9 % (k=2)</b>

SAR averaged over 10 cm <sup>3</sup> (10 g) of Body TSL	condition	
SAR measured	100 mW input power	2.17 W/kg
SAR for nominal Body TSL parameters	normalized to 1W	<b>21.6 W/kg ± 19.5 % (k=2)</b>

### Body TSL parameters at 5500 MHz

The following parameters and calculations were applied.

	Temperature	Permittivity	Conductivity
Nominal Body TSL parameters	22.0 °C	48.6	5.65 mho/m
Measured Body TSL parameters	(22.0 ± 0.2) °C	47.3 ± 6 %	5.82 mho/m ± 6 %
Body TSL temperature change during test	< 0.5 °C	----	----

### SAR result with Body TSL at 5500 MHz

SAR averaged over 1 cm <sup>3</sup> (1 g) of Body TSL	Condition	
SAR measured	100 mW input power	8.30 W/kg
SAR for nominal Body TSL parameters	normalized to 1W	<b>82.6 W/kg ± 19.9 % (k=2)</b>

SAR averaged over 10 cm <sup>3</sup> (10 g) of Body TSL	condition	
SAR measured	100 mW input power	2.30 W/kg
SAR for nominal Body TSL parameters	normalized to 1W	<b>22.9 W/kg ± 19.5 % (k=2)</b>

### Body TSL parameters at 5600 MHz

The following parameters and calculations were applied.

	Temperature	Permittivity	Conductivity
Nominal Body TSL parameters	22.0 °C	48.5	5.77 mho/m
Measured Body TSL parameters	(22.0 ± 0.2) °C	47.2 ± 6 %	5.95 mho/m ± 6 %
Body TSL temperature change during test	< 0.5 °C	----	----

### SAR result with Body TSL at 5600 MHz

SAR averaged over 1 cm <sup>3</sup> (1 g) of Body TSL	Condition	
SAR measured	100 mW input power	8.10 W/kg
SAR for nominal Body TSL parameters	normalized to 1W	<b>80.7 W/kg ± 19.9 % (k=2)</b>

SAR averaged over 10 cm <sup>3</sup> (10 g) of Body TSL	condition	
SAR measured	100 mW input power	2.25 W/kg
SAR for nominal Body TSL parameters	normalized to 1W	<b>22.4 W/kg ± 19.5 % (k=2)</b>

## Body TSL parameters at 5800 MHz

The following parameters and calculations were applied.

	Temperature	Permittivity	Conductivity
Nominal Body TSL parameters	22.0 °C	48.2	6.00 mho/m
Measured Body TSL parameters	(22.0 ± 0.2) °C	46.9 ± 6 %	6.23 mho/m ± 6 %
Body TSL temperature change during test	< 0.5 °C	----	----

## SAR result with Body TSL at 5800 MHz

SAR averaged over 1 cm <sup>3</sup> (1 g) of Body TSL	Condition	
SAR measured	100 mW input power	7.91 W/kg
SAR for nominal Body TSL parameters	normalized to 1W	<b>78.8 W/kg ± 19.9 % (k=2)</b>

SAR averaged over 10 cm <sup>3</sup> (10 g) of Body TSL	condition	
SAR measured	100 mW input power	2.19 W/kg
SAR for nominal Body TSL parameters	normalized to 1W	<b>21.8 W/kg ± 19.5 % (k=2)</b>

### Extended Calibration

Usage of SAR dipoles calibrated less than 3 years ago but more than 1 year ago were confirmed in maintaining return loss (< -20 dB, within 20% of prior calibration) and impedance (within 5 ohm from prior calibration) requirements per extended calibrations in KDB Publication 865664 D01 v01r04.

D5GHzV2 SN: 1119 - Head							
Date of Measurement	Frequency	Return Loss (dB)	Δ%	Impedance (Ω)	ΔΩ	Impedance Imaginary (jΩ)	ΔΩ
8/11/2015	5200 MHz	-21.5		51.6		-8.4	
8/10/2016		-21.3	-0.9	51.2	-0.4	-8.7	-0.3
8/11/2017		-22.1	2.8	50.8	-0.8	-8.1	0.3
8/11/2015	5300 MHz	-27.8		51.4		-3.9	
8/10/2016		-26.4	-5.0	49.8	-1.6	-4.8	-0.9
8/11/2017		-26.9	-3.2	50.2	-1.2	-4.2	-0.3
8/11/2015	5500 MHz	-25.8		54.2		-3.4	
8/10/2016		-24.3	-5.8	52.6	-1.6	-3.9	-0.5
8/11/2017		-25.2	-2.3	53.7	-0.5	-4.4	-1.0
8/11/2015	5600 MHz	-24.3		56.3		-1.5	
8/10/2016		-23.9	-1.6	55.0	-1.3	-2.1	-0.6
8/11/2017		-23.5	-3.3	55.9	-0.4	-1.8	-0.3
8/11/2015	5800 MHz	-23.4		56.6		-2.8	
8/10/2016		-24.3	3.8	54.9	-1.7	-4.1	-1.3
8/11/2017		-24.6	5.1	55.3	-1.3	-3.5	-0.7
D5GHzV2 SN: 1119 - Body							
Date of Measurement	Frequency	Return Loss (dB)	Δ%	Impedance Real (Ω)	ΔΩ	Impedance Imaginary (jΩ)	ΔΩ
8/11/2015	5200 MHz	-22.8		51.6		-7.2	
8/10/2016		-21.5	-5.7	51.2	-0.4	-7.9	-0.7
8/11/2017		-22.2	-2.6	50.8	-0.8	-7.5	-0.3
8/11/2015	5300 MHz	-30.8		51.1		-2.7	
8/10/2016		-29.6	-3.9	51.3	0.2	-3.2	-0.5
8/11/2017		-29.3	-4.9	50.2	-0.9	-2.4	0.3
8/11/2015	5500 MHz	-27.4		54.3		-1.3	
8/10/2016		-26.3	-4.0	53.3	-1.0	-2.0	-0.7
8/11/2017		-27.8	1.5	52.5	-1.8	-1.7	-0.4
8/11/2015	5600 MHz	-24.4		56.4		-0.1	
8/10/2016		-23.6	-3.3	55.9	-0.5	-0.9	-0.8
8/11/2017		-24.5	0.4	56.9	0.5	-0.5	-0.4
8/11/2015	5800 MHz	-23.1		57.5		-0.9	
8/10/2016		-23.9	3.5	56.6	-0.9	-1.1	-0.2
8/11/2017		-24.2	4.8	57.6	0.1	-1.2	-0.3

## Appendix (Additional assessments outside the scope of SCS 0108)

### Antenna Parameters with Head TSL at 5200 MHz

Impedance, transformed to feed point	51.6 $\Omega$ - 8.4 j $\Omega$
Return Loss	- 21.5 dB

### Antenna Parameters with Head TSL at 5300 MHz

Impedance, transformed to feed point	51.4 $\Omega$ - 3.9 j $\Omega$
Return Loss	- 27.8 dB

### Antenna Parameters with Head TSL at 5500 MHz

Impedance, transformed to feed point	54.2 $\Omega$ - 3.4 j $\Omega$
Return Loss	- 25.8 dB

### Antenna Parameters with Head TSL at 5600 MHz

Impedance, transformed to feed point	56.3 $\Omega$ - 1.5 j $\Omega$
Return Loss	- 24.3 dB

### Antenna Parameters with Head TSL at 5800 MHz

Impedance, transformed to feed point	56.6 $\Omega$ - 2.8 j $\Omega$
Return Loss	- 23.4 dB

### Antenna Parameters with Body TSL at 5200 MHz

Impedance, transformed to feed point	51.6 $\Omega$ - 7.2 j $\Omega$
Return Loss	- 22.8 dB

### Antenna Parameters with Body TSL at 5300 MHz

Impedance, transformed to feed point	51.1 $\Omega$ - 2.7 j $\Omega$
Return Loss	- 30.8 dB

### Antenna Parameters with Body TSL at 5500 MHz

Impedance, transformed to feed point	54.3 $\Omega$ - 1.3 j $\Omega$
Return Loss	- 27.4 dB

### Antenna Parameters with Body TSL at 5600 MHz

Impedance, transformed to feed point	56.4 $\Omega$ - 0.1 j $\Omega$
Return Loss	- 24.4 dB



## Antenna Parameters with Body TSL at 5800 MHz

Impedance, transformed to feed point	57.5 $\Omega$ - 0.9 j $\Omega$
Return Loss	- 23.1 dB

## General Antenna Parameters and Design

Electrical Delay (one direction)	1.206 ns
----------------------------------	----------

After long term use with 100W radiated power, only a slight warming of the dipole near the feedpoint can be measured.

The dipole is made of standard semirigid coaxial cable. The center conductor of the feeding line is directly connected to the second arm of the dipole. The antenna is therefore short-circuited for DC-signals. On some of the dipoles, small end caps are added to the dipole arms in order to improve matching when loaded according to the position as explained in the "Measurement Conditions" paragraph. The SAR data are not affected by this change. The overall dipole length is still according to the Standard.

No excessive force must be applied to the dipole arms, because they might bend or the soldered connections near the feedpoint may be damaged.

## Additional EUT Data

Manufactured by	SPEAG
Manufactured on	September 08, 2011

## DASY5 Validation Report for Head TSL

Date: 10.08.2015

Test Laboratory: SPEAG, Zurich, Switzerland

**DUT: Dipole 5GHz; Type: D5GHzV2; Serial: D5GHzV2 - SN: 1119**

Communication System: UID 0 - CW; Frequency: 5200 MHz, Frequency: 5300 MHz, Frequency: 5500 MHz, Frequency: 5600 MHz, Frequency: 5800 MHz

Medium parameters used:  $f = 5200$  MHz;  $\sigma = 4.53$  S/m;  $\epsilon_r = 35.5$ ;  $\rho = 1000$  kg/m<sup>3</sup>, Medium parameters used:  $f = 5300$  MHz;  $\sigma = 4.63$  S/m;  $\epsilon_r = 35.4$ ;  $\rho = 1000$  kg/m<sup>3</sup>, Medium parameters used:  $f = 5500$  MHz;  $\sigma = 4.82$  S/m;  $\epsilon_r = 35.1$ ;  $\rho = 1000$  kg/m<sup>3</sup>, Medium parameters used:  $f = 5600$  MHz;  $\sigma = 4.93$  S/m;  $\epsilon_r = 34.9$ ;  $\rho = 1000$  kg/m<sup>3</sup>, Medium parameters used:  $f = 5800$  MHz;  $\sigma = 5.14$  S/m;  $\epsilon_r = 34.7$ ;  $\rho = 1000$  kg/m<sup>3</sup>

Phantom section: Flat Section

Measurement Standard: DASY5 (IEEE/IEC/ANSI C63.19-2011)

DASY52 Configuration:

- Probe: EX3DV4 - SN3503; ConvF(5.51, 5.51, 5.51); Calibrated: 30.12.2014, ConvF(5.21, 5.21, 5.21); Calibrated: 30.12.2014, ConvF(5.12, 5.12, 5.12); Calibrated: 30.12.2014, ConvF(4.92, 4.92, 4.92); Calibrated: 30.12.2014, ConvF(4.9, 4.9, 4.9); Calibrated: 30.12.2014;
- Sensor-Surface: 1.4mm (Mechanical Surface Detection)
- Electronics: DAE4 Sn601; Calibrated: 18.08.2014
- Phantom: Flat Phantom 5.0 (front); Type: QD000P50AA; Serial: 1001
- DASY52 52.8.8(1222); SEMCAD X 14.6.10(7331)

**Dipole Calibration for Head Tissue/Pin=100mW, dist=10mm, f=5200 MHz/Zoom Scan, dist=1.4mm (8x8x7)/Cube 0:** Measurement grid: dx=4mm, dy=4mm, dz=1.4mm

Reference Value = 66.84 V/m; Power Drift = -0.00 dB

Peak SAR (extrapolated) = 29.5 W/kg

**SAR(1 g) = 8.11 W/kg; SAR(10 g) = 2.32 W/kg**

Maximum value of SAR (measured) = 18.6 W/kg

**Dipole Calibration for Head Tissue/Pin=100mW, dist=10mm, f=5300 MHz/Zoom Scan, dist=1.4mm (8x8x7)/Cube 0:** Measurement grid: dx=4mm, dy=4mm, dz=1.4mm

Reference Value = 67.35 V/m; Power Drift = -0.03 dB

Peak SAR (extrapolated) = 32.1 W/kg

**SAR(1 g) = 8.46 W/kg; SAR(10 g) = 2.42 W/kg**

Maximum value of SAR (measured) = 19.8 W/kg

**Dipole Calibration for Head Tissue/Pin=100mW, dist=10mm, f=5500 MHz/Zoom Scan, dist=1.4mm (8x8x7)/Cube 0:** Measurement grid: dx=4mm, dy=4mm, dz=1.4mm

Reference Value = 66.30 V/m; Power Drift = -0.00 dB

Peak SAR (extrapolated) = 33.6 W/kg

**SAR(1 g) = 8.5 W/kg; SAR(10 g) = 2.42 W/kg**

Maximum value of SAR (measured) = 20.2 W/kg

**Dipole Calibration for Head Tissue/Pin=100mW, dist=10mm, f=5600 MHz/Zoom Scan,**

**dist=1.4mm (8x8x7)/Cube 0:** Measurement grid: dx=4mm, dy=4mm, dz=1.4mm

Reference Value = 65.73 V/m; Power Drift = 0.00 dB

Peak SAR (extrapolated) = 33.5 W/kg

**SAR(1 g) = 8.46 W/kg; SAR(10 g) = 2.41 W/kg**

Maximum value of SAR (measured) = 20.0 W/kg

**Dipole Calibration for Head Tissue/Pin=100mW, dist=10mm, f=5800 MHz/Zoom Scan,**

**dist=1.4mm (8x8x7)/Cube 0:** Measurement grid: dx=4mm, dy=4mm, dz=1.4mm

Reference Value = 63.40 V/m; Power Drift = -0.00 dB

Peak SAR (extrapolated) = 33.5 W/kg

**SAR(1 g) = 8.1 W/kg; SAR(10 g) = 2.31 W/kg**

Maximum value of SAR (measured) = 19.7 W/kg

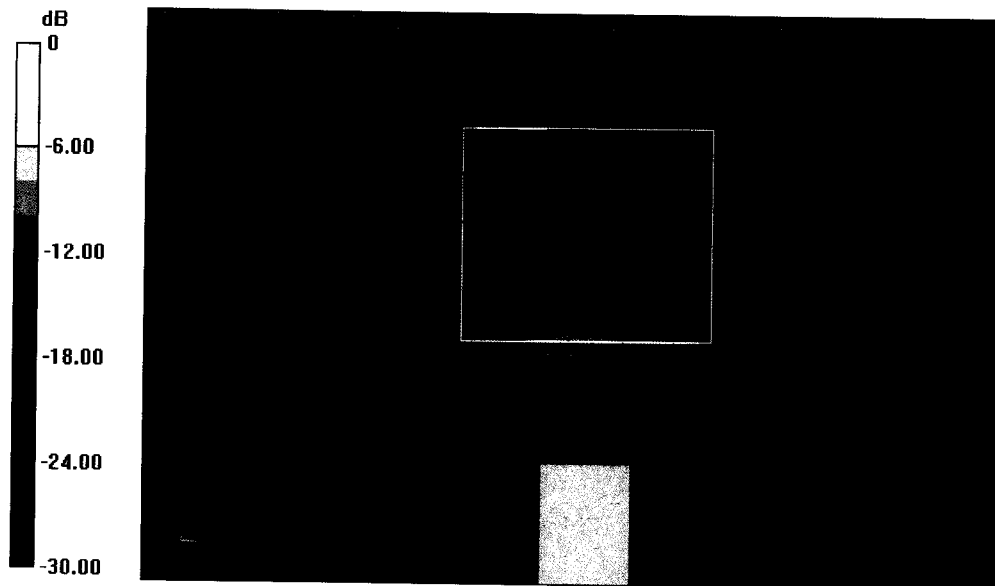

0 dB = 18.6 W/kg = 12.70 dBW/kg

# Impedance Measurement Plot for Head TSL

10 Aug 2015 14:44:08

CH1 S11 1 U FS 1: 51.607  $\Omega$  -8.4160  $\Omega$  3.6367 pF 5 200.000 000 MHz

\*  
Del  
Cor  
Avg  
16  
H1d



CH1 Markers  
2: 51.441  $\Omega$   
-3.8633  $\Omega$   
5.30000 GHz  
3: 54.195  $\Omega$   
-3.3574  $\Omega$   
5.50000 GHz  
4: 56.303  $\Omega$   
-1.5313  $\Omega$   
5.60000 GHz  
5: 56.602  $\Omega$   
-2.8145  $\Omega$   
5.80000 GHz

CH2 S11 LOG 5 dB/REF -20 dB 1: -21.510 dB 5 200.000 000 MHz

Del  
Cor  
Avg  
16  
H1d

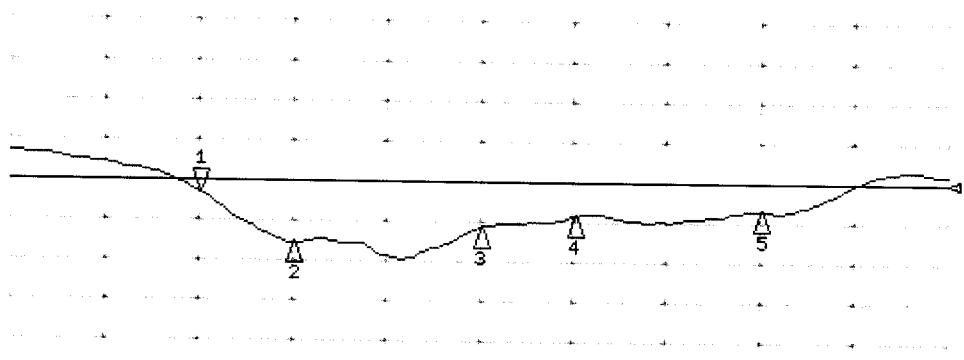

CH2 Markers  
2: -27.822 dB  
5.30000 GHz  
3: -25.751 dB  
5.50000 GHz  
4: -24.294 dB  
5.60000 GHz  
5: -23.440 dB  
5.80000 GHz

START 5 000.000 000 MHz STOP 6 000.000 000 MHz

## DASY5 Validation Report for Body TSL

Date: 11.08.2015

Test Laboratory: SPEAG, Zurich, Switzerland

**DUT: Dipole 5GHz; Type: D5GHzV2; Serial: D5GHzV2 - SN: 1119**

Communication System: UID 0 - CW; Frequency: 5200 MHz, Frequency: 5300 MHz, Frequency: 5500 MHz, Frequency: 5600 MHz, Frequency: 5800 MHz

Medium parameters used:  $f = 5200$  MHz;  $\sigma = 5.43$  S/m;  $\epsilon_r = 47.9$ ;  $\rho = 1000$  kg/m<sup>3</sup>, Medium parameters used:  $f = 5300$  MHz;  $\sigma = 5.56$  S/m;  $\epsilon_r = 47.7$ ;  $\rho = 1000$  kg/m<sup>3</sup>, Medium parameters used:  $f = 5500$  MHz;  $\sigma = 5.82$  S/m;  $\epsilon_r = 47.3$ ;  $\rho = 1000$  kg/m<sup>3</sup>, Medium parameters used:  $f = 5600$  MHz;  $\sigma = 5.95$  S/m;  $\epsilon_r = 47.2$ ;  $\rho = 1000$  kg/m<sup>3</sup>, Medium parameters used:  $f = 5800$  MHz;  $\sigma = 6.23$  S/m;  $\epsilon_r = 46.9$ ;  $\rho = 1000$  kg/m<sup>3</sup>

Phantom section: Flat Section

Measurement Standard: DASY5 (IEEE/IEC/ANSI C63.19-2011)

DASY52 Configuration:

- Probe: EX3DV4 - SN3503; ConvF(4.95, 4.95, 4.95); Calibrated: 30.12.2014, ConvF(4.78, 4.78, 4.78); Calibrated: 30.12.2014, ConvF(4.45, 4.45, 4.45); Calibrated: 30.12.2014, ConvF(4.35, 4.35, 4.35); Calibrated: 30.12.2014, ConvF(4.32, 4.32, 4.32); Calibrated: 30.12.2014;
- Sensor-Surface: 1.4mm (Mechanical Surface Detection)
- Electronics: DAE4 Sn601; Calibrated: 18.08.2014
- Phantom: Flat Phantom 5.0 (back); Type: QD000P50AA; Serial: 1002
- DASY52 52.8.8(1222); SEMCAD X 14.6.10(7331)

**Dipole Calibration for Body Tissue/Pin=100mW, dist=10mm, f=5200 MHz/Zoom Scan, dist=1.4mm (8x8x7)/Cube 0:** Measurement grid: dx=4mm, dy=4mm, dz=1.4mm

Reference Value = 60.11 V/m; Power Drift = 0.01 dB

Peak SAR (extrapolated) = 30.4 W/kg

**SAR(1 g) = 7.77 W/kg; SAR(10 g) = 2.17 W/kg**

Maximum value of SAR (measured) = 18.1 W/kg

**Dipole Calibration for Body Tissue/Pin=100mW, dist=10mm, f=5300 MHz/Zoom Scan, dist=1.4mm (8x8x7)/Cube 0:** Measurement grid: dx=4mm, dy=4mm, dz=1.4mm

Reference Value = 59.89 V/m; Power Drift = -0.01 dB

Peak SAR (extrapolated) = 31.4 W/kg

**SAR(1 g) = 7.79 W/kg; SAR(10 g) = 2.17 W/kg**

Maximum value of SAR (measured) = 18.3 W/kg

**Dipole Calibration for Body Tissue/Pin=100mW, dist=10mm, f=5500 MHz/Zoom Scan, dist=1.4mm (8x8x7)/Cube 0:** Measurement grid: dx=4mm, dy=4mm, dz=1.4mm

Reference Value = 60.26 V/m; Power Drift = 0.00 dB

Peak SAR (extrapolated) = 35.5 W/kg

**SAR(1 g) = 8.3 W/kg; SAR(10 g) = 2.3 W/kg**

Maximum value of SAR (measured) = 19.9 W/kg

**Dipole Calibration for Body Tissue/Pin=100mW, dist=10mm, f=5600 MHz/Zoom Scan, dist=1.4mm (8x8x7)/Cube 0:**

Measurement grid: dx=4mm, dy=4mm, dz=1.4mm

Reference Value = 59.24 V/m; Power Drift = 0.01 dB

Peak SAR (extrapolated) = 35.5 W/kg

**SAR(1 g) = 8.1 W/kg; SAR(10 g) = 2.25 W/kg**

**Dipole Calibration for Body Tissue/Pin=100mW, dist=10mm, f=5800 MHz/Zoom Scan, dist=1.4mm (8x8x7)/Cube 0:**

Measurement grid: dx=4mm, dy=4mm, dz=1.4mm

Reference Value = 57.15 V/m; Power Drift = 0.02 dB

Peak SAR (extrapolated) = 36.5 W/kg

**SAR(1 g) = 7.91 W/kg; SAR(10 g) = 2.19 W/kg**

Maximum value of SAR (measured) = 19.6 W/kg

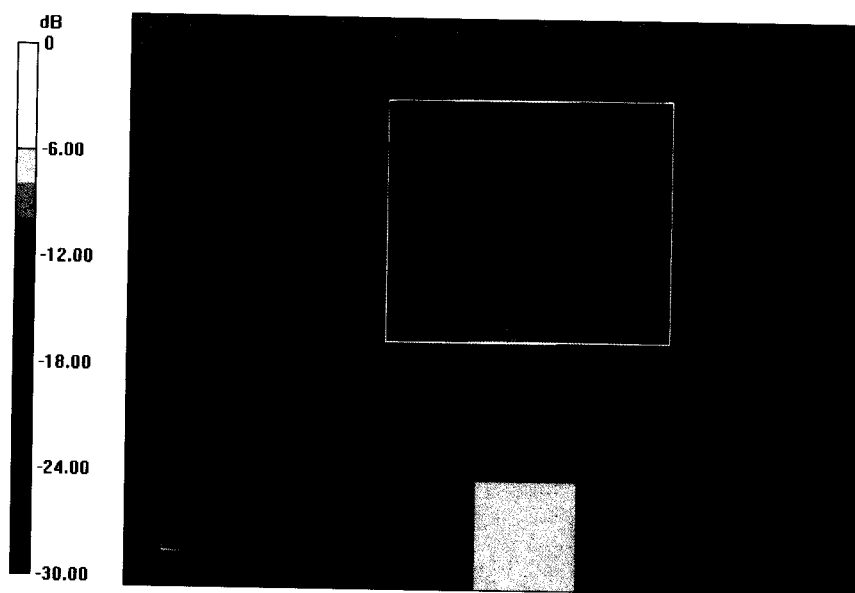

0 dB = 18.1 W/kg = 12.58 dBW/kg

# Impedance Measurement Plot for Body TSL

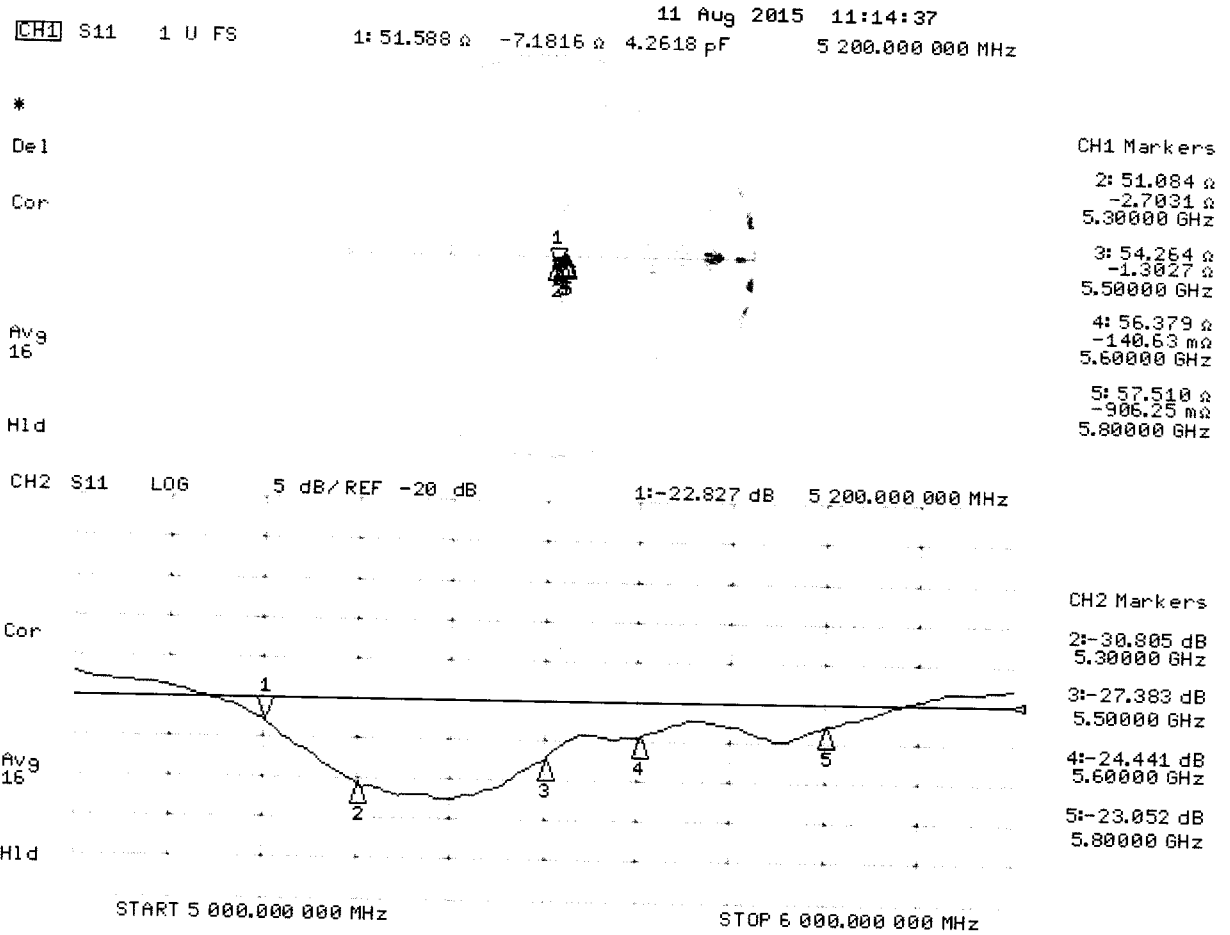

## Appendix F – Phantom Calibration Data Sheets



Zeughausstrasse 43, 8004 Zurich, Switzerland  
 Phone +41 44 245 9700, Fax +41 44 245 9779  
 info@speag.com, http://www.speag.com

## Certificate of Conformity / First Article Inspection

Item	Oval Flat Phantom ELI 4.0
Type No	QD OVA 001 B
Series No	1003 and higher
Manufacturer	Untersee Composites Knebelstrasse 8 CH-8268 Mannenbach, Switzerland

### Tests

Complete tests were made on the prototype units QD OVA 001 AA 1001, QD OVA 001 AB 1002, pre-series units QD OVA 001 BA 1003-1005 as well as on the series units QD OVA 001 BB, 1006 ff.

Test	Requirement	Details	Units tested
Material thickness	Compliant with the standard requirements	Bottom plate: 2.0mm +/- 0.2mm	all
Material parameters	Dielectric parameters for required frequencies	< 6 GHz: Rel. permittivity = 4 +/-1, Loss tangent ≤ 0.05	Material sample
Material resistivity	The material has been tested to be compatible with the liquids defined in the standards if handled and cleaned according to the instructions.	DGBE based simulating liquids. Observe Technical Note for material compatibility.	Equivalent phantoms, Material sample
Shape	Thickness of bottom material, Internal dimensions, Sagging compatible with standards from minimum frequency	Bottom elliptical 600 x 400 mm Depth 190 mm, Shape is within tolerance for filling height up to 155 mm, Eventual sagging is reduced or eliminated by support via DUT	Prototypes, Sample testing

### Standards

- [1] CENELEC EN 50361-2001, « Basic standard for the measurement of the Specific Absorption Rate related to human exposure to electromagnetic fields from mobile phones (300 MHz – 3 GHz) », July 2001
- [2] IEEE 1528-2003, "Recommended Practice for Determining the Peak Spatial-Average Specific Absorption Rate (SAR) in the Human Head from Wireless Communications Devices: Measurement Techniques, December 2003
- [3] IEC 62209 – 1, "Specific Absorption Rate (SAR) in the frequency range of 300 MHz to 3 GHz – Measurement Procedure, Part 1: Hand-held mobile wireless communication devices", February 2005
- [4] IEC 62209 – 2, Draft, "Human Exposure to Radio Frequency Fields from Handheld and Body-Mounted Wireless Communication Devices – Human models, Instrumentation and Procedures – Part 2: Procedure to determine the Specific Absorption Rate (SAR) in the head and body for 30 MHz to 6 GHz Handheld and Body-Mounted Devices used in close proximity to the Body.", February 2005
- [5] OET Bulletin 65, Supplement C, "Evaluating Compliance with FCC Guidelines for Human Exposure to Radiofrequency Electromagnetic Fields", Edition January 2001

Based on the tests above, we certify that this item is in compliance with the standards [1] to [5] if operated according to the specific requirements and considering the thickness. The dimensions are fully compliant with [4] from 30 MHz to 6 GHz. For the other standards, the minimum lower frequency limit is limited due to the dimensional requirements ([1]: 450 MHz, [2]: 300 MHz, [3]: 800 MHz, [5]: 375 MHz) and possibly further by the dimensions of the DUT.

Date 28.4.2008

Signature / Stamp

**s p e a g**  
 Schmid & Partner Engineering AG  
 Zeughausstrasse 43, 8004 Zurich, Switzerland  
 Phone +41 44 245 9700, Fax +41 44 245 9779  
 info@speag.com; http://www.speag.com

## Appendix G – Validation Summary

Per FCC KDB 865664 D02 v01r02, SAR system validation status should be documented to confirm measurement accuracy. The SAR systems (including SAR probes, system components and software versions) used for this device were validated against its performance specifications prior to the SAR measurements. Reference dipoles were used with the required tissue equivalent media for system validation according to the procedures outlined in FCC KDB 865664 D01 v01r04 and IEEE 1528-2013. Since SAR probe calibrations are frequency dependent, each probe calibration point was validated at a frequency within the valid frequency range of the probe calibration point using the system that normally operates with the probe for routine SAR measurements and according to the required tissue equivalent media.

A tabulated summary of the system validation status including the validation date(s), measurement frequencies, SAR probes and tissue dielectric parameters has been included.

**Table G-1  
SAR System Validation Summary**

SAR System #	Freq. (MHz)	Date	Probe S/N	Probe Type	Probe Cal. Point	Cond. ( $\sigma$ )	Perm. ( $\epsilon_r$ )	CW Validation			Modulation Validation			
								Sensitivity	Probe Linearity	Probe Isotropy	Modulation Type	Duty Factor	PAR	
1	2450	9/06/2017	3693	EX3DV4	2450	Body	1.96	52.64	Pass	Pass	Pass	OFDM/TDD	Pass	Pass
1	5200	9/05/2017	3693	EX3DV4	5200	Body	5.30	48.93	Pass	Pass	Pass	OFDM	N/A	Pass
1	5300	9/05/2017	3693	EX3DV4	5300	Body	5.41	48.88	Pass	Pass	Pass	OFDM	N/A	Pass
1	5500	9/05/2017	3693	EX3DV4	5500	Body	5.62	48.58	Pass	Pass	Pass	OFDM	N/A	Pass
1	5600	9/05/2017	3693	EX3DV4	5600	Body	5.74	48.43	Pass	Pass	Pass	OFDM	N/A	Pass
1	5800	9/05/2017	3693	EX3DV4	5800	Body	5.97	48.13	Pass	Pass	Pass	OFDM	N/A	Pass