



TESTING CERT #3478.01



# TEST REPORT

EUT Description	<b>Wireless Module installed in Convertible PC</b>
Brand Name	<b>Intel® Dual Band Wireless-AC 3165</b>
Model Name	<b>3165NGW</b>
Serial Number	<b>MAC: E0.94.67.59.B4.29</b> (see section 4)
FCC/IC ID	<b>FCC ID: PD93165NG &amp; PD93165NGU</b> <b>IC ID: 1000M-3165NG</b>
Antenna type	<b>Antenna: Inpaq, Type PIFA</b> <b>Main: 025.900GV.0001</b> <b>Aux: 025.900H3.0001</b>
Hardware/Software Version	<b>DRTU version: 1.7.7-01556</b> <b>Driver version: 18.12.0.1</b>
Date of Sample Receipt	<b>2016-01-04</b>
Date of Test Start/End	<b>2016-01-05 / 2016-20-01</b>
Features	<b>WiFi: 802.11 a/b/g/n/ac 2.4/5.2/5.3/5.6/5.8 GHz</b> <b>Bluetooth: BDR/EDR v2.1, Bluetooth LE v4.0</b> (see section 7)
Description	<b>Wireless Module: Intel® 3165NGW</b> <b>Platform: TPN-W117</b>

Applicant	<b>Intel Mobile Communications</b>
Address	<b>100 Center Point Circle, Suite 200 / Columbia, SC 29210 / United States</b>
Contact Person	<b>Steven Hackett</b>
Telephone/Fax/Email	<b>steven.c.hackett@intel.com</b>

Reference Standards	<b>FCC 47 CFR Part §2.1093</b> <b>RSS-102, Issue 5</b> (see section 1)	
RF Exposure Environment	<b>Portable devices - General population/uncontrolled exposure</b>	
	<b>SAR Result</b>	<b>SAR Limit</b>
Maximum SAR Result & Limit	<b>0.89 W/kg (1g)</b>	<b>1.6 W/kg (1g)</b>
Min. test separation distance	<b>3mm</b>	

Test Report number	<b>15121801.TR01</b>
Revision Control	<b>Rev. 01</b>

The test results relate only to the samples tested.

The test report shall not be reproduced in full, without written approval of the laboratory.

Issued by \_\_\_\_\_

Reviewed by \_\_\_\_\_

Cheiel IN  
(SAR Test Lead)

Jose M. FORTES  
(Technical Manager)

**Intel Mobile Communications France S.A.S – WRF Lab**  
**425 rue de Goa – Le Cargo B6 – 06600, Antibes, France**  
**Tel. +33493001400 / Fax +33493001401**

# Table of Contents

---

<b>1.</b>	<b>Standards, reference documents and applicable test methods .....</b>	<b>3</b>
<b>2.</b>	<b>General conditions, competences and guarantees .....</b>	<b>3</b>
<b>3.</b>	<b>Environmental Conditions.....</b>	<b>4</b>
<b>4.</b>	<b>Test samples.....</b>	<b>4</b>
<b>5.</b>	<b>Remarks and comments .....</b>	<b>4</b>
<b>6.</b>	<b>Document Revision History .....</b>	<b>4</b>
<b>7.</b>	<b>Equipment Under Test.....</b>	<b>5</b>
<b>8.</b>	<b>Test Verdicts summary.....</b>	<b>7</b>
<b>Annex A.</b>	<b>Test &amp; System Description .....</b>	<b>8</b>
A.1	SAR DEFINITION .....	8
A.2	SPEAG SAR MEASUREMENT SYSTEM .....	9
A.2.1	SAR MEASUREMENT SETUP.....	9
A.2.2	E-FIELD MEASUREMENT PROBE .....	10
A.2.3	SAM PHANTOM .....	10
A.2.4	FLAT PHANTOM .....	11
A.2.5	DEVICE POSITIONER.....	11
A.3	DATA EVALUATION .....	12
A.4	SYSTEM AND LIQUID CHECK.....	14
A.4.1	SYSTEM CHECK .....	14
A.4.2	LIQUID CHECK .....	15
A.5	TEST EQUIPMENT LIST.....	16
A.6	MEASUREMENT UNCERTAINTY EVALUATION.....	17
A.7	RF EXPOSURE LIMITS .....	19
<b>Annex B.</b>	<b>Test Results.....</b>	<b>20</b>
B.1	TEST CONDITIONS .....	20
B.1.1	SAR TEST POSITIONS RELATIVE TO THE PHANTOM.....	20
B.1.2	TEST SIGNAL, OUTPUT POWER AND TEST FREQUENCIES .....	20
B.1.3	EVALUATION EXCLUSION AND TEST REDUCTIONS.....	21
B.2	CONDUCTED POWER MEASUREMENTS .....	23
B.2.1	WLAN 2.4GHZ (DTS) .....	23
B.2.2	WLAN 5GHZ (UNII) .....	24
B.2.3	BLUETOOTH .....	27
B.3	TISSUE PARAMETERS MEASUREMENT.....	28
B.4	SYSTEM CHECK MEASUREMENTS.....	28
B.5	SAR TEST RESULTS.....	29
B.5.1	802.11B/G/N – 2.4GHZ - DTS .....	29
B.5.2	802.11A/N/AC – 5.3 GHZ – UNII-2A .....	29
B.5.3	802.11A/N/AC – 5.6 GHZ – UNII-2C.....	29
B.5.4	802.11A/N/AC – 5.8 GHZ – UNII-3.....	30
B.5.5	BLUETOOTH – 2.4GHZ – DSSS .....	30
B.6	SAR MEASUREMENT VARIABILITY .....	30
B.7	SIMULTANEOUS TRANSMISSION SAR EVALUATION .....	31
<b>Annex C.</b>	<b>Test System Plots .....</b>	<b>32</b>
<b>Annex D.</b>	<b>Calibration Certificates .....</b>	<b>50</b>
<b>Annex E.</b>	<b>TSL Dielectric Parameters .....</b>	<b>51</b>
<b>Annex F.</b>	<b>Photographs .....</b>	<b>55</b>

## 1. Standards, reference documents and applicable test methods

1. FCC 47 CFR Part §2.1093 - Radiofrequency radiation exposure evaluation: portable devices.
2. FCC OET KDB 248227 D01 v02r02 – SAR guidance for IEEE 802.11 (Wi-Fi) transmitters.
3. FCC OET KDB 447498 D01 v06 – RF exposure procedures and equipment authorization policies for mobile and portable devices.
4. FCC OET KDB 616217 D04 v01r02 – SAR Evaluation Considerations for Laptop, Notebook, Netbook and Tablet Computers.
5. FCC OET KDB 865664 D01 v01r04 – SAR Measurement Requirements for 100 MHz to 6 GHz.
6. FCC OET KDB 865664 D02 v01r02 – RF Exposure Compliance Reporting and Documentation Considerations.
7. IC RSS 102, Issue 5 – Radio Frequency (RF) Exposure Compliance of Radiocommunication Apparatus (All Frequency Bands).
8. IC Notice 2012-DRS0529 – SAR correction for measured conductivity and relative permittivity based on IEC 62209-2 standard.
9. IC Notice 2012-DRS1203 – Applicability of latest FCC RF Exposure KDB procedures (publication date October 24, 2012) and other procedures.
10. IC Notice 2013-DRS0911 – Latest publication of IEEE 1528-2013 and power exemption limits.
11. IEEE Std 1528-2003 - IEEE Recommended Practice for Determining the Peak Spatial-Average Specific Absorption Rate (SAR) in the Human Head from Wireless Communications Devices: Measurement Techniques.
12. IEEE Std 1528-2013 – IEEE Recommended Practice Determining the Peak Spatial-Average Specific Absorption Rate (SAR) in the Human Head from Wireless Communication Devices: Measurement Techniques.

## 2. General conditions, competences and guarantees

- ✓ Intel Mobile Communications Wireless RF Lab (Intel WRF Lab) is a testing laboratory accredited by the American Association for Laboratory Accreditation (A2LA).
- ✓ Intel Mobile Communications Wireless RF Lab (Intel WRF Lab) is an Accredited Test Firm listed by the FCC, with Designation Number FR0011.
- ✓ Intel Mobile Communications Wireless RF Lab (Intel WRF Lab) is a Registered Test Site listed by IC, with IC Assigned Code 1000Y.
- ✓ test results and interpretations.
- ✓ Intel WRF Lab is liable to the client for the maintenance of the confidentiality of all information related to the item under test and the results of the test.
- ✓ Intel WRF Lab has developed calibration and proficiency programs for its measurement equipment to ensure correlated and reliable results to its customers.
- ✓ This report is only referred to the item that has undergone the test.
- ✓ This report does not imply an approval of the product by the Certification Bodies or competent Authorities.
- ✓ Complete or partial reproduction of the report cannot be made without written permission of Intel WRF Lab.

### 3. Environmental Conditions

- ✓ All tests were performed in a laboratory with an environment which avoids influence on SAR measurements by ambient EM sources and any reflection from the environment itself, and the following limits were not exceeded during the tests:

Temperature	23°C ± 2°C
Humidity	50% ± 10%
Liquid Temperature	23°C ± 2°C

### 4. Test samples

Sample	Test Item #	Description	Model	Serial #	Date of reception
#01	15121801.S01	Wireless Module installed in Convertible PC	3165NGW+ TPN-W117	MAC: E0.94.67.59.B4.29	2016-01-04

- ✓ Sample #01 has undergone all the test(s) requested by the applicant, following the standards specified in section 0.

### 5. Remarks and comments

1. Only the plots for the test positions with the highest measured SAR per band/mode are included in *Annex C. Test System Plots*, as required per FCC OET KDB 865664 D02, paragraph 2.3.8.

### 6. Document Revision History

Revision #	Date	Details
Rev. 00	2016-01-22	First Issue
Rev. 01	2016-04-07	Platform name edited

## 7. Equipment Under Test

Brand Name	Intel® Dual Band Wireless-AC 7265
Model Name	3165NGW
FCC/IC ID	FCC ID: PD93165NG & PD93165NGU IC ID: 1000M-3165NG
Software Version	1.7.7-01556
Driver Version	18.12.0.1
Prototype / Production	Production
Host Identification	TPN-W117
Exposure Conditions	Body worn
Supported Radios	802.11a/b/g/n/ac BDR/EDR v2.1 - Bluetooth LE v4.0
Antenna Information	<b>Main WLAN:</b> PIFA antenna. WiFi 2.4GHz & 5GHz <b>Aux WLAN:</b> PIFA antenna. WiFi 2.4GHz & 5GHz and BT.  See <i>Annex F. Photographs</i> for more details on antennas location.
Simultaneous Transmission Configurations	WLAN 2.4GHz Main + BT Aux WLAN 5GHz Main + BT Aux
Additional Information	No WWAN transmitter is considered in this report
	5.60-5.65 GHz band (TDWR) is supported by the device
	Band gap is supported by the device

**Supported Radios**

Mode	Duty Cycle	Modulation	Band	UL Freq Range (MHz)	Measured Max. Conducted Power (dBm)
BDR/EDR v2.1	77%	GFSK π/4 DQPSK 8DPSK	2.4GHz	2400-2483.5	4.99
Bluetooth LE v4.0	62%	GFSK	2.4GHz	2400-2483.5	3.19
802.11b/g/n	100%	BPSK QPSK 16QAM 64QAM	2.4GHz	2400-2483.5	17.49
802.11a/n/ac	100%	BPSK QPSK 16QAM 64QAM 256QAM	5.2GHz	5150-5250	16.43
			5.3GHz	5250-5350	16.50
			5.6GHz	5475-5725	16.39
			5.8GHz	5725-5850	16.39

Maximum Output power specification + Tune up tolerance limit			Antenna	
Equipment Class	Mode	BW [MHz]	Main [dBm]	Aux [dBm]
BT	Bluetooth v2.1 BDR	20		5.50
	Bluetooth v2.1 EDR2	20		5.00
	Bluetooth v2.1 EDR3	20		5.00
	BLE	-		4.00
DTS	802.11b	20	17.50	17.50
	802.11g	20	17.50	17.50
	802.11n20	20	17.50	17.50
	802.11n40	40	17.50	17.50
UNII-1	802.11a	20	15.50	16.00
	802.11n20	20	15.50	16.00
	802.11n40	40	16.50	16.50
	802.11ac80	80	13.50	13.50
UNII-2A	802.11a	20	15.50	16.00
	802.11n20	20	15.50	16.00
	802.11n40	40	16.50	16.50
	802.11ac80	80	13.50	13.50
UNII-2C	802.11a	20	15.50	16.00
	802.11n20	20	15.50	16.00
	802.11n40	40	16.50	16.50
	802.11ac20	20	15.50	15.00
	802.11ac40	40	16.50	16.50
	802.11ac80	80	15.00	13.50
UNII-3	802.11a	20	15.50	16.00
	802.11n20	20	15.50	16.00
	802.11n40	40	16.50	16.50
	802.11ac80	80	15.00	14.00

### 8. Test Verdicts summary

Mode	Band	Highest Reported SAR (1g) (W/kg)	Verdict
802.11b/g/n	2.4GHz	0.32	P
	5.3GHz	0.68	P
	5.6GHz	0.89	P
	5.8GHz	0.76	P
Bluetooth	2.4GHz	0.03	P

P: Pass  
 F: Fail  
 NM: Not Measured  
 NA: Not Applicable

According to the FCC OET KDB 690783 D01, this is the summary of the values for the Grant Listing:

Highest Reported SAR (1g) (W/kg)			
Exposure Condition	Equipment Class		
	DTS	DSS	NII
Body Worn	0.32	0.03	0.89
Simultaneous Tx	Sum-SAR: 0.30	Sum-SAR: 0.99	Sum-SAR: 0.99

Considering the results of the performed test according to FCC 47CFR Part 2.1093 and IC RSS 102, Issue 5 the item under test is IN COMPLIANCE with the requested specifications specified in section 1. *Standards, reference documents and applicable test methods.*

# Annex A. Test & System Description

---

## A.1 SAR Definition

Specific Absorption rate is defined as the time derivative of the incremental energy (dW) absorbed by (dissipated in) and incremental mass (dm) contained in a volume element (dV) of a given density ( $\rho$ ).

$$SAR = \frac{d}{dt} \cdot \left( \frac{dW}{dm} \right) = \frac{d}{dt} \cdot \left( \frac{dW}{\rho \cdot dV} \right)$$

SAR is expressed in units of watts per kilogram (W/kg). SAR can be related to the electric field at a point by

$$SAR = \frac{\sigma |E|^2}{\rho}$$

Where:

$\sigma$  = Conductivity of the tissue (S/m)  
 $\rho$  = Mass density of the tissue (kg/m<sup>3</sup>)  
E = RMS electric field strength (V/m)



## A.2 SPEAG SAR Measurement System

### A.2.1 SAR Measurement Setup

The DASY5 system for performing compliance tests consists of the following items:

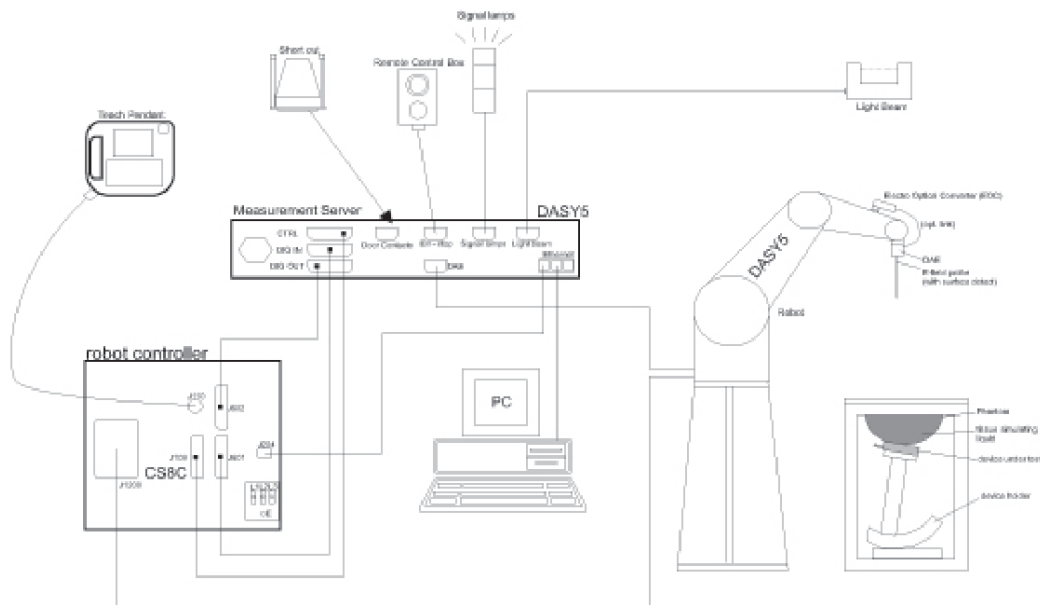

- ✓ A standard high precision 6-axis robot (Stäubli TX/RX family) with controller, teach pendant and software. It includes an arm extension for accommodating the data acquisition electronics (DAE)
- ✓ An isotropic field probe optimized and calibrated for the targeted measurements.
- ✓ A data acquisition electronics (DAE) which performs the signal amplification, signal multiplexing, AD-conversion, offset measurements, mechanical surface detection, collision detection, etc. The unit is battery powered with standard or rechargeable batteries. The signal is optically transmitted to the EOC.
- ✓ The Electro-optical Converter (EOC) performs the conversion from optical to electrical signals for the digital communication to the DAE. The EOC signal is transmitted to the measurement server.
- ✓ The function of the measurement server is to perform the time critical tasks such as signal filtering, control of the robot operation and fast movements interrupts.
- ✓ The Light Beam used is for probe alignment. This improves the (absolute) accuracy of the probe positioning.
- ✓ A computer running Win7 professional operating system and the DASY5 software.
- ✓ Remote control and teach pendant as well as additional circuitry for robot safety such as warning lamps, etc.
- ✓ The phantom, the device holder and other accessories according to the targeted measurement.
- ✓ Tissue simulating liquid.
- ✓ System Validation dipoles.
- ✓ Network emulator or RF test tool

### A.2.2 E-Field Measurement Probe

The probe is constructed using three orthogonal dipole sensors arranged on an interlocking, triangular prism core. The probe has built-in shielding against static charges and is contained within a PEEK cylindrical enclosure material at the tip.

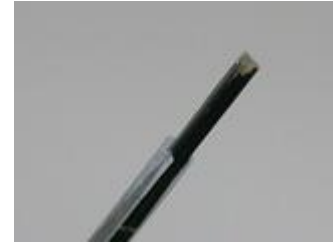

The probe's characteristics are:

Frequency Range	30MHz – 6GHz
Length	337 mm
Probe tip external diameter	2.5 mm
Typical distance between dipoles and the probe tip	1 mm
Axial Isotropy (in human-equivalent liquids)	±0.3 dB
Hemispherical Isotropy (in human-equivalent liquids)	±0.5 dB
Linearity	±0.2 dB
Maximum operating SAR	100 W/kg
Lower SAR detection threshold	0.001 W/kg

### A.2.3 SAM Phantom

The shell corresponds to the specifications of the Specific Anthropomorphic Mannequin (SAM) phantom defined in IEEE 1528 and IEC 62209-1. It enables the dosimetric evaluation of left and right hand phone usage as well as body mounted usage at the flat phantom region. A cover prevents evaporation of the liquid. Reference markings on the phantom allow the complete setup of all predefined phantom positions and measurement grids by teaching three points with the robot.

The phantom's characteristics are:

Material	Vinylester, glass fiber reinforced (VE-GF)
Shell thickness	2 mm ± 0.2 mm
Shell thickness at ERP	6 ± 0.2 mm
Filling volume	25 Liters
Dimensions	Length: 1000mm / Width: 500mm



### A.2.4 Flat Phantom

Phantom for compliance testing of handheld and body-mounted wireless devices in the frequency range of 30 MHz to 6 GHz. ELI is fully compatible with the IEC 62209-2 standard and all known tissue simulating liquids. ELI has been optimized regarding its performance and can be integrated into our standard phantom tables. A cover prevents evaporation of the liquid. Reference markings on the phantom allow installation of the complete setup, including all predefined phantom positions and measurement grids, by teaching three points. The phantom is compatible with all SPEAG dosimetric probes and dipoles.

The phantom's characteristics are:

Material	Vinylester, glass fiber reinforced (VE-GF)
Shell thickness	2 mm ± 0.2 mm
Filling volume	30 Liters approx.
Dimensions	Major axis: 600mm / Minor axis: 400mm

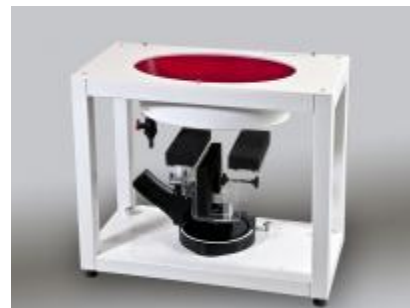

### A.2.5 Device Positioner

The SAR in the phantom is approximately inversely proportional to the square of the distance between the source and the liquid surface. For a source at 5 mm distance, a positioning uncertainty of 0.5 mm would produce a SAR uncertainty of 20%. Accurate device positioning is therefore crucial for accurate and repeatable measurements. The positions in which the devices must be measured are defined by the standards.



The DASY device holder is designed to cope with the different positions given in the standard. It has two scales for device rotation (with respect to the body axis) and device inclination (with respect to the line between the ear reference points). The rotation center for both scales is the ear reference point (ERP). Thus the device needs no repositioning when changing the angles.

The DASY device holder is constructed of low-loss POM material having the following dielectric parameters: relative permittivity  $\epsilon=3$  and loss tangent  $\delta=0.02$ . The amount of dielectric material has been reduced in the closest vicinity of the device, since measurements have suggested that the influence of the clamp on the test results could thus be lowered.



A simple but effective and easy-to-use extension for the Mounting Device; facilitates testing of larger devices according to IEC 62209-2 (e.g., laptops, cameras, etc.); lightweight and fits easily on the upper part of the Mounting Device in place of the phone positioner. The extension is fully compatible with the Twin SAM, ELI and other Flat Phantoms.

### A.3 Data Evaluation

- **Power Reference measurement**

The robot measures the E field in a specified reference position that can be either the selected section's grid reference point or a user point in this section at 4mm of the inner surface of the phantom, 2mm for frequencies above 3GHz.

- **Area Scan**

Measurement procedures for evaluating SAR from wireless handsets typically start with a coarse measurement grid to determine the approximate location of the local peak SAR values. This is known as the area-scan procedure. The SAR distribution is scanned along the inside surface of one side of the phantom head, at least for an area larger than the projection of the handset and antenna. An example grid is shown in Figure 11. The distance between the measured points and phantom surface should be less than 8 mm, and should remain constant (with variation less than  $\pm 1$  mm) during the entire scan in order to determine the locations of the local peak SAR with sufficient accuracy. The angle between the probe axis and the surface normal line is recommended but not required to be less than  $30^\circ$ . If this angle is larger than  $30^\circ$  and the closest point on the probe-tip housing to the phantom surface is closer than a probe diameter, the boundary effect may become larger and polarization dependent. This additional uncertainty needs to be analyzed and accounted for. To achieve this, modified test procedures and additional uncertainty analyses not described in this recommended practice may be required. The measurement and interpolation point spacing should be chosen such as to allow identification of the local peak locations to within one-half of the linear dimension of a side of the zoom-scan volume. Because a local peak having specific amplitude and steep gradients may produce a lower peak spatial-average SAR compared to peaks with slightly lower amplitude and less steep gradients, it is necessary to evaluate these other peaks as well. However, since the spatial gradients of local SAR peaks are a function of the wavelength inside the tissue-equivalent liquid and the incident magnetic field strength, it is not necessary to evaluate local peaks that are less than 2 dB or more below the global maximum peak. Two-dimensional spline algorithms (Brishoual et al. 2001; Press et al., 1996) are typically used to determine the peaks and gradients within the scanned area. If a peak is found at a distance from the scan border of less than one-half the edge dimension of the desired 1 g or 10 g cube, the measurement area should be enlarged if possible.

- **Zoom Scan**

To evaluate the peak spatial-average SAR values for 1 g or 10 g cubes, fine resolution volume scans, called zoom scans, are performed at the peak SAR locations identified during the area scan. The minimum zoom scan volume size should extend at least 1.5 times the edge dimension of a 1 g cube in all directions from the center of the scan volume, for both 1 g and 10 g peak spatial-average SAR evaluations. Along the phantom curved surfaces, the front face of the volume facing the tissue/liquid interface conforms to the curved boundary, to ensure that all SAR peaks are captured. The back face should be equally distorted to maintain the correct averaging mass. The flatness and orientation of the four side faces are unchanged from that of a cube whose orientation is within  $\pm 30^\circ$  of the line normal to the phantom at the center of the cube face next to the phantom surface. The peak local SAR locations that were determined in the area scan (interpolated values) should be used for the centers of the zoom scans. If a scan volume cannot be centered due to proximity of a phantom shape feature, the probe should be tilted to allow scan volume enlargement. If probe tilt is not feasible, the zoom-scan origin may be shifted, but not by more than half of the 1 g or 10 g cube edge dimension.

After the zoom-scan measurement, extrapolations from the closest measured points to the surface, for example along lines parallel to the zoom-scan centerline, and interpolations to a finer resolution between all measured and extrapolated points are performed. Extrapolation algorithm considerations are described in 6.5.3, and 3-D spline methods (Brishoual et al., 2001; Kreyszig, 1983; Press et al., 1996) can be used for interpolation. The peak spatial-average SAR is finally determined by a numerical averaging of the local SAR values in the interpolation grid, using for example a trapezoidal algorithm for the integration (averaging).

In some areas of the phantom, such as the jaw and upper head regions, the angle of the probe with respect to the line normal to the surface may be relatively large, e.g., greater than  $\pm 30^\circ$ , which could increase the boundary effect error to a larger level. In these cases, during the zoom scan a change in the orientation of the probe, the phantom, or both is recommended but not required for the duration of

the zoom scan, so that the angle between the probe axis and the line normal to the surface is within 30° for all measurement points.

- **Power Drift measurement**

The robot re-measures the E-Field in the same reference location measured at the Power Reference. The drift measurement gives the field difference in dB from the first to the last reference reading. This allows a user to monitor the power drift of the device under test that must remain within a maximum variation of  $\pm 5\%$ .

- **Post-processing**

The procedure for spatial peak SAR evaluation has been implemented according to the IEEE1528 and IEC 62209-1/2 standards. It can be conducted for 1g and 10g.

The software allows evaluations that combine measured data and robot positions, such as:

- ✓ Maximum search
- ✓ Extrapolation
- ✓ Boundary correction
- ✓ Peak search for averaged SAR

Interpolation between the measured points is performed when the resolution of the grid is not fine enough to compute the average SAR over a given mass.

Extrapolation routines are used to obtain SAR values between the lowest measurement points and the inner phantom surface. The extrapolation is determined by the surface detection distance and the probe sensor offset. Several measurements at different distances are necessary for the extrapolation.

## A.4 System and Liquid Check

### A.4.1 System Check

The system performance check verifies that the system operates within its specifications. System and operator errors can be detected and corrected. It is recommended that the system performance check be performed prior to any usage of the system in order to guarantee reproducible results.

The system performance check uses normal SAR measurements in a simplified setup with a well characterized source. This setup was selected to give a high sensitivity to all parameters that might fail or vary over time. The system check does not intend to replace the calibration of the components, but indicates situations where the system uncertainty is exceeded due to drift or failure.

In the simplified setup for system check, the EUT is replaced by a calibrated dipole and the power source is replaced by a controlled continuous wave generated by a signal generator. The calibrated dipole must be placed beneath the flat phantom section of the phantom at the correct distance.

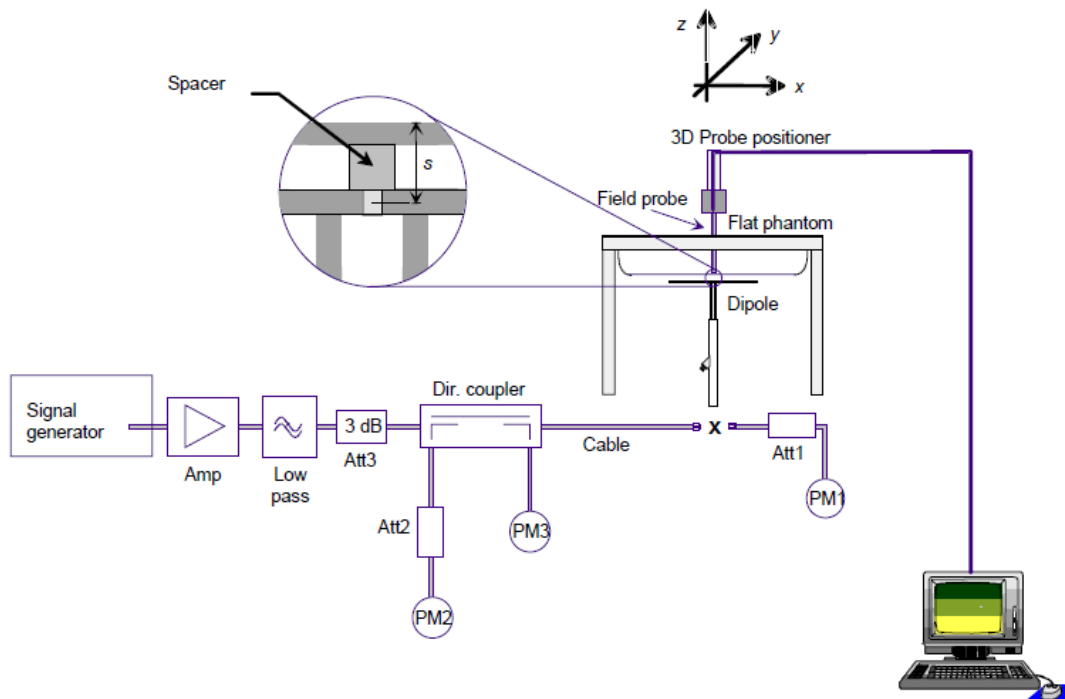

The equipment setup is shown below:

- ✓ Signal Generator
- ✓ Amplifier
- ✓ Directional coupler
- ✓ Power meter
- ✓ Calibrated dipole

The output power on dipole port must be set to 20dBm (100mW) and SAR results are normalized to a forward power of 1W to compare the values with the calibration reports results as described at IEEE 1528 and IEC 62209 standards.

#### A.4.2 Liquid Check

The dielectric parameters check is done prior to the use of the tissue simulating liquid. The verification is made by comparing the relative permittivity and conductivity to the values recommended by the applicable standards.

The liquid verification was performed using the following test setup:

- ✓ VNA (Vector Network Analyzer)
- ✓ Open-Short-Load calibration kit
- ✓ RF Cable
- ✓ Open-Ended Coaxial probe
- ✓ DAK software tool
- ✓ SAR Liquid
- ✓ De-ionized water
- ✓ Thermometer

These are the target dielectric properties of the tissue-equivalent liquid material as defined in FCC OET KDB 865664 D01.

Frequency (MHz)	Body SAR	
	$\epsilon_r$	$\sigma$ (S/m)
150	61.9	0.80
300	58.2	0.92
450	56.7	0.94
835	55.2	0.97
900	55.0	1.05
1450	54.0	1.30
1800-2000	53.3	1.52
2450	52.7	1.95
3000	52.0	2.73
5800	48.2	6.00

( $\epsilon_r$  = relative permittivity,  $\sigma$  = conductivity and  $\rho$  = 1000 kg/m<sup>3</sup>)

The measurement system implement a SAR error compensation algorithm as documented in IEEE Std 1528-2013 (equivalent to draft standard IEEE P1528-2011) to automatically compensate the measured SAR results for deviations between the measured and required tissue dielectric parameters (applied to only scale up the measured SAR, and not downward) so, according to FCC OET KDB 865664 D01, the tolerance for  $\epsilon_r$  and  $\sigma$  may be relaxed to  $\pm 10\%$ .

## A.5 Test Equipment List

### SPEAG SAR System

Device	Type/Model	Serial Number	Manufacturer	Calibration Date	Calibration Due
Dosimetric E-field Probe	EX3DV4	3978	SPEAG	2015-06-15	2016-06-15
Data Acquisition Electronics	DAE4	1429	SPEAG	2015-06-11	2016-06-11
Electro-Optical Converter	EOC60	-	SPEAG	NA	NA
Light Beam Unit	LB5 / 80	-	di-soric	NA	NA
6-axis Robot	TX60 L	F12/5MZ3A1/A/01	STAÜBLI	NA	NA
Robot Controller	CS8C	F12/5MZ3A1/C/01	STAÜBLI	NA	NA
Measurement Server	DASY5 P/N: SE UMS 011 EA	1444	SPEAG	NA	NA
SAM Phantom	Twin SAM v5.0	1838	SPEAG	NA	NA
Oval Flat Phantom	ELI v5.0	1260	SPEAG	NA	NA
Handset Positioner	P/N SD 000 H01 KA	-	SPEAG	NA	NA
Dielectric Probe Kit	DAKS-3.5	1037	SPEAG	2014-06-24	2016-06-24
Vector Reflectometer	PLANAR R140	0131013	Copper Mountain Technologies	2015-08-06	2017-08-06
2450MHz System Validation Dipole	D2450V2	937	SPEAG	2014-06-24	2016-06-24
5GHz System Validation Dipole	D5GHZv2	1164	SPEAG	2015-06-18	2017-06-18
DASY software	-	9-618AE2F1	SPEAG	NA	NA
DAKS software	-	9-2687B491	SPEAG	NA	NA

### Shared Instrumentation

Device	Type/Model	Serial Number	Manufacturer	Calibration Date	Calibration Due
Temperature & Humidity Logger	TR-702W + THA-3151	Logger: 3874009D / Sensor: 02042AD6	TandD	2014-04-30	2016-04-30
USB Power Sensor	NRP-Z81	102278	R&S	2015-09-10	2017-09-10
USB Power Sensor	NRP-Z81	102279	R&S	2015-09-10	2017-09-10
Vector Signal Generator	ESG E4438C	MY45092885	Agilent	NA	NA
Thermometer	TESTO 922	33622932	Testo	2015-09-29	2017-09-29
Power Amplifier	-	MODU-023-B- 0001	SATIMO	NA	NA
Coupler	CD0.5-8-20-30	1251-002	Amd-group	NA	NA

### Tissue Simulant Liquids

TSL	Manufacturer / Model	Freq Range (MHz)	Main Ingredients
Body 2450	SATIMO BL2450	2400-2700	Triton X-100, H <sub>2</sub> O, NaCl, DGBE
Body 5GHz	SATIMO 5000MHz	5000-6000	Triton X-100, H <sub>2</sub> O, DGMH



## A.6 Measurement Uncertainty Evaluation

<b>DASY5 Uncertainty Budget</b> According to IEEE 1528/2011 and IEC 62209-1/2011								
Error Description	Uncert. value	Prob. Dist.	Div.	( $c_i$ ) 1g	( $c_i$ ) 10g	Std. Unc. (1g)	Std. Unc. (10g)	( $v_i$ ) $v_{eff}$
<b>Measurement System</b>								
Probe Calibration	±6.55 %	N	1	1	1	±6.55 %	±6.55 %	∞
Axial Isotropy	±4.7 %	R	$\sqrt{3}$	0.7	0.7	±1.9 %	±1.9 %	∞
Hemispherical Isotropy	±9.6 %	R	$\sqrt{3}$	0.7	0.7	±3.9 %	±3.9 %	∞
Boundary Effects	±2.0 %	R	$\sqrt{3}$	1	1	±1.2 %	±1.2 %	∞
Linearity	±4.7 %	R	$\sqrt{3}$	1	1	±2.7 %	±2.7 %	∞
System Detection Limits	±1.0 %	R	$\sqrt{3}$	1	1	±0.6 %	±0.6 %	∞
Modulation Response <sup>m</sup>	±2.4 %	R	$\sqrt{3}$	1	1	±1.4 %	±1.4 %	∞
Readout Electronics	±0.3 %	N	1	1	1	±0.3 %	±0.3 %	∞
Response Time	±0.8 %	R	$\sqrt{3}$	1	1	±0.5 %	±0.5 %	∞
Integration Time	±2.6 %	R	$\sqrt{3}$	1	1	±1.5 %	±1.5 %	∞
RF Ambient Noise	±3.0 %	R	$\sqrt{3}$	1	1	±1.7 %	±1.7 %	∞
RF Ambient Reflections	±3.0 %	R	$\sqrt{3}$	1	1	±1.7 %	±1.7 %	∞
Probe Positioner	±0.8 %	R	$\sqrt{3}$	1	1	±0.5 %	±0.5 %	∞
Probe Positioning	±6.7 %	R	$\sqrt{3}$	1	1	±3.9 %	±3.9 %	∞
Max. SAR Eval.	±4.0 %	R	$\sqrt{3}$	1	1	±2.3 %	±2.3 %	∞
<b>Test Sample Related</b>								
Device Positioning	±2.9 %	N	1	1	1	±2.9 %	±2.9 %	145
Device Holder	±3.6 %	N	1	1	1	±3.6 %	±3.6 %	5
Power Drift	±5.0 %	R	$\sqrt{3}$	1	1	±2.9 %	±2.9 %	∞
Power Scaling <sup>p</sup>	±0 %	R	$\sqrt{3}$	1	1	±0.0 %	±0.0 %	∞
<b>Phantom and Setup</b>								
Phantom Uncertainty	±6.6 %	R	$\sqrt{3}$	1	1	±3.8 %	±3.8 %	∞
SAR correction	±1.9 %	R	$\sqrt{3}$	1	0.84	±1.1 %	±0.9 %	∞
Liquid Conductivity (mea.) <sup>DAK</sup>	±2.5 %	R	$\sqrt{3}$	0.78	0.71	±1.1 %	±1.0 %	∞
Liquid Permittivity (mea.) <sup>DAK</sup>	±2.5 %	R	$\sqrt{3}$	0.26	0.26	±0.3 %	±0.4 %	∞
Temp. unc. - Conductivity <sup>BB</sup>	±3.4 %	R	$\sqrt{3}$	0.78	0.71	±1.5 %	±1.4 %	∞
Temp. unc. - Permittivity <sup>BB</sup>	±0.4 %	R	$\sqrt{3}$	0.23	0.26	±0.1 %	±0.1 %	∞
Combined Std. Uncertainty						±12.3 %	±12.2 %	748
Expanded STD Uncertainty						±24.6 %	±24.5 %	

### SPEAG System Uncertainty budget (IEEE 1528-2011 & IEC 62209-1:2011)

<b>DASY5 Uncertainty Budget</b> According to IEC 62209-2/2010								
Error Description	Uncert. value	Prob. Dist.	Div.	( $c_i$ ) 1g	( $c_i$ ) 10g	Std. Unc. (1g)	Std. Unc. (10g)	( $v_i$ ) $v_{eff}$
<b>Measurement System</b>								
Probe Calibration	±6.55 %	N	1	1	1	±6.55 %	±6.55 %	∞
Axial Isotropy	±4.7 %	R	$\sqrt{3}$	0.7	0.7	±1.9 %	±1.9 %	∞
Hemispherical Isotropy	±9.6 %	R	$\sqrt{3}$	0.7	0.7	±3.9 %	±3.9 %	∞
Linearity	±4.7 %	R	$\sqrt{3}$	1	1	±2.7 %	±2.7 %	∞
Modulation Response <sup>m</sup>	±2.4 %	R	$\sqrt{3}$	1	1	±1.4 %	±1.4 %	∞
System Detection Limits	±1.0 %	R	$\sqrt{3}$	1	1	±0.6 %	±0.6 %	∞
Boundary Effects	±2.0 %	R	$\sqrt{3}$	1	1	±1.2 %	±1.2 %	∞
Readout Electronics	±0.3 %	N	1	1	1	±0.3 %	±0.3 %	∞
Response Time	±0.8 %	R	$\sqrt{3}$	1	1	±0.5 %	±0.5 %	∞
Integration Time	±2.6 %	R	$\sqrt{3}$	1	1	±1.5 %	±1.5 %	∞
RF Ambient Noise	±3.0 %	R	$\sqrt{3}$	1	1	±1.7 %	±1.7 %	∞
RF Ambient Reflections	±3.0 %	R	$\sqrt{3}$	1	1	±1.7 %	±1.7 %	∞
Probe Positioner	±0.8 %	R	$\sqrt{3}$	1	1	±0.5 %	±0.5 %	∞
Probe Positioning	±6.7 %	R	$\sqrt{3}$	1	1	±3.9 %	±3.9 %	∞
Post-processing	±4.0 %	R	$\sqrt{3}$	1	1	±2.3 %	±2.3 %	∞
<b>Test Sample Related</b>								
Device Holder	±3.6 %	N	1	1	1	±3.6 %	±3.6 %	5
Test sample Positioning	±2.9 %	N	1	1	1	±2.9 %	±2.9 %	145
Power Scaling <sup>p</sup>	±0 %	R	$\sqrt{3}$	1	1	±0.0 %	±0.0 %	∞
Power Drift	±5.0 %	R	$\sqrt{3}$	1	1	±2.9 %	±2.9 %	∞
<b>Phantom and Setup</b>								
Phantom Uncertainty	±7.9 %	R	$\sqrt{3}$	1	1	±4.6 %	±4.6 %	∞
SAR correction	±1.9 %	R	$\sqrt{3}$	1	0.84	±1.1 %	±0.9 %	∞
Liquid Conductivity (mea.) <sup>DAK</sup>	±2.5 %	R	$\sqrt{3}$	0.78	0.71	±1.1 %	±1.0 %	∞
Liquid Permittivity (mea.) <sup>DAK</sup>	±2.5 %	R	$\sqrt{3}$	0.26	0.26	±0.3 %	±0.4 %	∞
Temp. unc. - Conductivity <sup>BB</sup>	±3.4 %	R	$\sqrt{3}$	0.78	0.71	±1.5 %	±1.4 %	∞
Temp. unc. - Permittivity <sup>BB</sup>	±0.4 %	R	$\sqrt{3}$	0.23	0.26	±0.1 %	±0.1 %	∞
Combined Std. Uncertainty						±12.5 %	±12.5 %	748
Expanded STD Uncertainty						±25.1 %	±25.0 %	

**SPEAG System Uncertainty budget (IEC 62209-2:2010)**

### A.7 RF Exposure Limits

SAR assessments have been made in line with the requirements of FCC 47 CFR Part §2.1093 and RSS 102, Issue 5 on the limitation of exposure of the general population / uncontrolled exposure for portable devices.

Exposure Type	General Population / Uncontrolled Environment
Peak spatial-average SAR (averaged over any 1 gram of tissue)	<b>1.6 W/kg</b>
Whole body average SAR	<b>0.08 W/kg</b>
Peak spatial-average SAR (extremities) (averaged over any 10 grams of tissue)	<b>4.0 W/kg</b>

# Annex B. Test Results

---

## B.1 Test Conditions

### B.1.1 SAR Test positions relative to the phantom

The device under test was the Intel® Dual Band Wireless-AC 3165 card inside a convertible computer (TPN-W117) using a set of PIFA antennas. The card was operated utilizing proprietary software (DRTU version 1.7.7-01556) and each channel was measured using a broadband power meter to determine the maximum average power.

According to FCC OET KDB 616217 D04 v01r02, the back surface and edges of the tablet should be tested for SAR compliance with the tablet touching the phantom. The SAR Test Exclusion Threshold in FCC OET KDB 447498 D01 v06 can be applied to determine SAR test exclusion for adjacent edge configurations.

The closest distance from the antenna to an adjacent tablet edge is used to determine if SAR testing is required for the adjacent edges, with the adjacent edge positioned against the phantom and the edge containing the antenna positioned perpendicular to the phantom.

Considering the antenna location diagrams in Annex F and the test exclusions described before, the surfaces/edges to be measured for each antenna are:

Position	Distance	Antenna	
		Main	Aux
	0mm	<ul style="list-style-type: none"> <li>• Back face</li> <li>• Top edge</li> <li>• Left edge</li> </ul>	<ul style="list-style-type: none"> <li>• Back face</li> <li>• Top edge</li> <li>• Left edge</li> </ul>

See *B.1.3 Evaluation Exclusion and Test Reductions* for a more detailed list of the applied reductions.

### B.1.2 Test signal, Output power and Test Frequencies

The device was put into operation by using an own control software (DRTU version 1.7.7-01556) to program the test mode required for select the continuous transmission with 100% duty cycle.

The output power of the device was set to transmit at maximum power for all tests.

### B.1.3 Evaluation Exclusion and Test Reductions

#### SAR evaluation exclusion

The SAR Test Exclusion Threshold in FCC OET KDB 447498 D01 v06 can be applied to determine SAR test exclusion for adjacent edge configurations. For 100MHz to 6GHz and test separation distances  $\leq 50$ mm, the 1-g and 10-g SAR test exclusion thresholds are determined by the following formula:

$$[(\text{max. power of channel, including tune – up tolerance, mW}) / (\text{min. test separation distance, mm})] \cdot \sqrt{f_{(\text{GHz})}} \leq 3.0 \text{ for } 1g \text{ SAR, and } \leq 7.5 \text{ for } 10g \text{ extremity SAR} \quad (1)$$

Where:

- f(GHz) is the RF channel transmit frequency in GHz
- Power and distance are rounded to the nearest mW and mm before calculation
- The result is rounded to one decimal place for comparison
- The values 3.0 and 7.5 are referred to as numeric thresholds

The test exclusions are applicable only when the minimum test separation distance is  $\leq 50$  mm, and for transmission frequencies between 100 MHz and 6 GHz. When the minimum test separation distance is  $< 5$  mm, a distance of 5 mm is applied to determine SAR test exclusion.

For test separation distances  $> 50$  mm, the 1-g and 10-g SAR test exclusion thresholds are determined using the following formulas:

$$((\text{Power allowed at numeric threshold for } 50 \text{ mm in (1)}) + (\text{test separation distance} - 50 \text{ mm}) \cdot (f_{\text{MHz}}/150)) \text{mW, for } 100\text{MHz to } 1500\text{MHz} \quad (2)$$

$$((\text{Power allowed at numeric threshold for } 50 \text{ mm in (1)}) + (\text{test separation distance} - 50 \text{ mm}) \cdot 10) \text{mW, for } 1500\text{MHz and } \leq 6\text{GHz} \quad (3)$$

LAN Antenna	Band Name	Output power		Back Face	Top Edge	Right Edge	Left Edge	Bottom Edge	Back Face	Top Edge	Right Edge	Left Edge	Bottom Edge
		dBm	mW										
WLAN Main	DTS	17.5	56.2	$\leq 50$	$\leq 50$	$>50$	$<5$	$>50$	T	T	R	T	R
	UNII-1	16.5	44.7	$\leq 50$	$\leq 50$	$>50$	$<5$	$>50$	T	T	R	T	R
	UNII-2A	16.5	44.7	$\leq 50$	$\leq 50$	$>50$	$<5$	$>50$	T	T	R	T	R
	UNII-2C	16.5	44.7	$\leq 50$	$\leq 50$	$>50$	$<5$	$>50$	T	T	R	T	R
	UNII-3	16.5	44.7	$\leq 50$	$\leq 50$	$>50$	$<5$	$>50$	T	T	R	T	R
WLAN WPAN Aux	DTS	17.5	56.2	$\leq 50$	$<5$	$\leq 50$	$>50$	$>50$	T	T	R	T	R
	UNII-1	16.5	44.7	$\leq 50$	$<5$	$\leq 50$	$>50$	$>50$	T	T	R	T	R
	UNII-2A	16.5	44.7	$\leq 50$	$<5$	$\leq 50$	$>50$	$>50$	T	T	R	T	R
	UNII-2C	16.5	44.7	$\leq 50$	$<5$	$\leq 50$	$>50$	$>50$	T	T	R	T	R
	UNII-3	16.5	44.7	$\leq 50$	$<5$	$\leq 50$	$>50$	$>50$	T	T	R	T	R
	BT	5.5	3.5	$\leq 50$	$<5$	$\leq 50$	$>50$	$>50$	T	T	R	T	R

T: Tested position  
R: Reduced

See Annex F for a more detailed explanation of the separation distance related to the convertible PC.

## SAR test reduction

### General SAR test reduction

According to FCC OET KDB 447498 D01, testing of other required channels within the operating mode of a frequency band is not required when the reported 1-g or 10-g SAR for the mid-band or highest output power channel is:

- $\leq 0.8$  W/kg or 2.0 W/kg, for 1-g or 10-g respectively, when the transmission band is  $\leq 100$  MHz
- $\leq 0.6$  W/kg or 1.5 W/kg, for 1-g or 10-g respectively, when the transmission band is between 100 MHz and 200 MHz
- $\leq 0.4$  W/kg or 1.0 W/kg, for 1-g or 10-g respectively, when the transmission band is  $\geq 200$  MHz

### WLAN SAR Test reduction

Transmission Mode	SAR test exclusion/reduction
DSSS	<p>According to FCC OET KDB 248227 D01 v02r02, SAR is measured for 2.4 GHz 802.11b, SAR test reduction is determined according to the following:</p> <ul style="list-style-type: none"> <li>▪ When the reported SAR of the highest measured maximum output power channel for the exposure configuration is <math>\leq 0.8</math> W/kg, no further SAR testing is required for 802.11b DSSS in that exposure configuration.</li> <li>▪ When the reported SAR is <math>&gt; 0.8</math> W/kg, SAR is required for that exposure configuration using the next highest measured output power channel. When any reported SAR is <math>&gt; 1.2</math> W/kg, SAR is required for the third channel.</li> </ul> <p>According to FCC OET KDB 248227 D01 v02r02, SAR is not required for 2.4 GHz OFDM conditions when the highest reported SAR for DSSS is adjusted by the ratio of OFDM to DSSS specified maximum output power and the adjusted SAR is <math>\leq 1.2</math> W/kg.</p>
OFDM	<p>According to FCC OET KDB 248227 D01 v02r02, 802.11a/g/n/ac modes have the same specified maximum output power, largest channel bandwidth, lowest order modulation and lowest data rate, the lowest order 802.11 mode is selected; i.e., 802.11a is chosen over 802.11n then 802.11ac or 802.11g is chosen over 802.11n.</p> <p>According to FCC OET KDB 248227 D01 v02r02, an <i>initial test configuration</i> is determined for OFDM and DSSS transmission modes according to the channel bandwidth, modulation and data rate combination(s) with the highest maximum output power specified for production units in each standalone and aggregated frequency band. SAR is measured using the highest measured maximum output power channel. SAR test reduction for subsequent highest output test channels is determined according to reported SAR of the initial test configuration.</p> <p>The <i>initial test configuration</i> for 5 GHz OFDM transmission modes is determined by the 802.11 configuration with the highest maximum output power specified for production units, including tune-up tolerance, in each standalone and aggregated frequency band. SAR for the initial test configuration is measured using the highest maximum output power channel determined by the default power measurement procedures.</p> <p>According to FCC OET KDB 248227 D01 v02r02, when the reported SAR of the initial test configuration is <math>&gt; 0.8</math> W/kg, SAR measurement is required for subsequent next highest measured output power channel(s) in the initial test configuration until reported SAR is <math>\leq 1.2</math> W/kg or all required channels are tested.</p>

**B.2 Conducted Power Measurements**

**B.2.1 WLAN 2.4GHz (DTS)**

Band	Mode	Data Rate	Ch #	Freq [MHz]	Main		Aux		SAR Test?
					Avg Pwr [dBm]	Tune-up Pwr [dBm]	Avg Pwr [dBm]	Tune-up Pwr [dBm]	
2.4GHz (DTS)	802.11b	1Mbps	1	2412	16.43	16.50	16.20	16.50	Yes
			6	2437	17.38	17.50	17.42	17.50	
			11	2462	17.34	17.50	17.39	17.50	
	802.11g	6Mbps	1	2412	NR <sup>1</sup>	14.00	NR <sup>1</sup>	15.00	No <sup>2</sup>
			6	2437		17.50		17.50	
			11	2462		12.50		12.50	
	802.11n20	HT0	1	2412		14.00		15.00	No <sup>2</sup>
			6	2437		17.50		17.50	
			11	2462		12.50		12.50	
	802.11n40	HT0	3	2422		13.50		13.50	No <sup>2</sup>
			6	2437		17.50		17.50	
			9	2452		12.50		12.00	

Initial test configuration

1. NR: Not Required
2. As per FCC OET KDB 248227 D01, conducted output power and SAR testing are not required for 802.11g/n20/n40 channels when the highest reported SAR for DSSS is adjusted by the ratio of OFDM to DSSS specified maximum output power and the adjusted SAR is  $\leq 1.2W/kg$ .

### B.2.2 WLAN 5GHz (UNII)

#### 5.2GHz and 5.3GHz (UNII-1 and UNII-2A)

Band	Mode Data Rate	Ch #	Freq [MHz]	Main		Aux		SAR Test?
				Avg Pwr [dBm]	Tune-up Pwr [dBm]	Avg Pwr [dBm]	Tune-up Pwr [dBm]	
5.2GHz (UNII-1)	802.11a 6Mbps	36	5180	NR <sup>1</sup>	14.00	NR <sup>1</sup>	14.00	No <sup>2</sup>
		40	5200		15.50		16.00	
		44	5220		15.50		16.00	
		48	5240		15.50		16.00	
	802.11n20 HT0	36	5180		14.00		14.00	
		40	5200		15.50		16.00	
		44	5220		15.50		16.00	
	802.11n40 HT0	38	5190		12.00		13.50	
		46	5230		16.50		16.50	
	802.11ac80 VHT0	42	5210		13.50		13.50	

Initial test configuration

1. NR: Not Required
2. When the same maximum output power is specified for both bands, begin SAR measurement in U-NII-2A band by applying the OFDM SAR requirements. If the highest reported SAR for a test configuration is ≤ 1.2 W/kg, SAR is not required for U-NII-1 band (see §B.5.2 in this document).

Band	Mode Data Rate	Ch #	Freq [MHz]	Main		Aux		SAR Test?
				Avg Pwr [dBm]	Tune-up Pwr [dBm]	Avg Pwr [dBm]	Tune-up Pwr [dBm]	
5.3GHz (UNII-2A)	802.11a 6Mbps	52	5260	15.45	15.50	15.90	16.00	No <sup>2,3</sup>
		56	5280	15.21	15.50	15.69	16.00	
		60	5300	15.29	15.50	15.84	16.00	
		64	5320	13.35	13.50	13.43	13.50	
	802.11n20 HT0	52	5260	NR <sup>1</sup>	15.50	NR <sup>1</sup>	16.00	No <sup>2,3</sup>
		56	5280		15.50		16.00	
		60	5300		13.50		13.50	
	802.11n40 HT0	54	5270	16.37	16.50	16.50	16.50	Yes
		62	5310	13.41	13.50	13.20	13.50	
	802.11ac80 VHT0	58	5290	NR <sup>1</sup>	13.50	NR <sup>1</sup>	13.50	No <sup>4</sup>

Initial test configuration

1. NR: Not Required
2. Additional conducted power measurement is required when reported SAR of the initial test configuration is > 0.8 W/kg, SAR measurement is required for subsequent next highest measured output power channel(s) in the initial test configuration until reported SAR is ≤ 1.2 W/kg or all required channels are tested.
3. When multiple transmission modes (802.11a/g/n/ac) have the same specified maximum output power, largest channel bandwidth, lowest order modulation and lowest data rate, lowest order 802.11 mode is selected (i.e. a, g, n, then ac)
4. SAR is measured using the highest maximum output power specification



**5.6GHz and 5.8GHz (UNII-2C)**

Band	Mode Data Rate	Ch #	Freq [MHz]	Main		Aux		SAR Test ?		
				Avg Pwr [dBm]	Tune-up Pwr [dBm]	Avg Pwr [dBm]	Tune-up Pwr [dBm]			
5.6GHz (UNII-2C)	802.11a 6Mbps	100	5500	NR <sup>1</sup>	13.50	NR <sup>1</sup>	13.50	No <sup>3,4</sup>		
		104	5520		15.50		16.00			
		108	5540		15.50		16.00			
		112	5560		15.50		16.00			
		116	5580		15.50		16.00			
		120	5600		15.50		16.00			
		124	5620		15.50		16.00			
		128	5640		15.50		16.00			
	802.11n20 HT0	100	5500		13.50		13.50	No <sup>3,4</sup>		
		104	5520		15.50		16.00			
		108	5540		15.50		16.00			
		112	5560		15.50		16.00			
		116	5580		15.50		16.00			
		120	5600		15.50		16.00			
		124	5620		15.50		16.00			
		128	5640		15.50		16.00			
	802.11n40 HT0	102	5510		13.30		13.50	15.70	16.00	Yes
		110	5550		16.31		16.50	16.39	16.50	
		118	5590		16.38		16.50	16.35	16.50	
		126	5630		16.29		16.50	16.25	16.50	
	802.11ac80 VHT0	106	5530		NR <sup>1</sup>		13.50	NR <sup>1</sup>	13.50	No
		122	5610				15.00		13.50	

Initial test configuration

1. NR: Not Required
2. When band gap channels between UNII-2C and UNII-3 band are supported channels in UNII-2C band below 5.65 GHz are considered as one band and channels above 5.65 GHz, together with channels in 5.8 GHz U-NII-3 or §15.247 band, are considered as a separate band
3. When multiple transmission modes (802.11a/g/n/ac) have the same specified maximum output power, largest channel bandwidth, lowest order modulation and lowest data rate, lowest order 802.11 mode is selected (i.e. a, g, n, then ac)
4. When the reported SAR of the initial test configuration is > 0.8 W/kg, SAR measurement is required for subsequent next highest measured output power channel(s) in the initial test configuration until reported SAR is ≤ 1.2 W/kg or all required channels are tested.

**5.6GHz and 5.8GHz (UNII-3)**

Band	Mode Data Rate	Ch #	Freq [MHz]	Main		Aux		SAR Test ?		
				Avg Pwr [dBm]	Tune-up Pwr [dBm]	Avg Pwr [dBm]	Tune-up Pwr [dBm]			
5.6-5.8GHz (UNII-3)	802.11a 6Mbps	132	5660	NR <sup>1</sup>	15.50	NR <sup>1</sup>	16.00	No <sup>3,4</sup>		
		136	5680		15.50		16.00			
		140	5700		13.00		13.00			
		149	5745		15.50		16.00			
		153	5765		15.50		16.00			
		157	5785		15.50		16.00			
		161	5805		15.50		16.00			
		165	5825		15.50		16.00			
	802.11n20 HT0	132	5660		15.50		16.00	No <sup>3,4</sup>		
		136	5680		15.50		16.00			
		140	5700		13.00		13.00			
		149	5745		15.50		16.00			
		153	5765		15.50		16.00			
		157	5785		15.50		16.00			
		161	5805		15.50		16.00			
		165	5825		15.50		16.00			
	802.11n40 HT0	134	5670		16.35		16.50	16.22	16.50	Yes
		151	5755		16.39		16.50	16.36	16.50	
		159	5795		16.20		16.50	16.29	16.50	
	802.11ac20 VHT0	144	5720		NR <sup>1</sup>		15.50	NR <sup>1</sup>	14.50	No <sup>3,4</sup>
	802.11ac40 VHT0	142	5690		16.22		16.50	16.17	16.50	No <sup>3</sup>
	802.11ac80 VHT0	138	5690		NR <sup>1</sup>		15.00	NR <sup>1</sup>	14.00	No <sup>3,4</sup>
		155	5775		NR <sup>1</sup>		15.00	NR <sup>1</sup>	14.00	No <sup>3,4</sup>

Initial test configuration

1. NR: Not Required
2. When band gap channels between UNII-2C and UNII-3 band are supported channels in UNII-2C band below 5.65 GHz are considered as one band and channels above 5.65 GHz, together with channels in 5.8 GHz U-NII-3 or §15.247 band, are considered as a separate band
3. When multiple transmission modes (802.11a/g/n/ac) have the same specified maximum output power, largest channel bandwidth, lowest order modulation and lowest data rate, lowest order 802.11 mode is selected (i.e. a, g, n, then ac)
4. When the reported SAR of the initial test configuration is > 0.8 W/kg, SAR measurement is required for subsequent next highest measured output power channel(s) in the initial test configuration until reported SAR is ≤ 1.2 W/kg or all required channels are tested.

### B.2.3 Bluetooth

Band	Mode	Data Rate	Channel	Frequency (MHz)	Antenna	Avg Pwr [dBm]	Max output Pwr [dBm]
2.4GHz	Bluetooth v2.1	Basic rate GFSK	0	2402	Aux	3.90	5.50
			39	2441		4.97	5.50
			78	2480		4.99	5.50
	Bluetooth v2.1	Basic rate $\pi/4$ DQPSK	0	2402		NR <sup>1</sup>	5.00
			39	2441			5.00
			78	2480			5.00
	Bluetooth v2.1	Basic rate 8-DPSK	0	2402			5.00
			39	2441			5.00
			78	2480			5.00
	Bluetooth v4.0	Low energy GFSK	0	2412			4.00
			20	2437			4.00
			39	2480			4.00

Initial test configuration

1. NR: Not Required

### B.3 Tissue Parameters Measurement

#### Body TSL

Freq. (MHz)	Target Parameters		Measured TSL Parameters		Deviation (%)		Date
	$\epsilon'$	$\sigma$	$\epsilon'$	$\sigma$	$\epsilon'$	$\sigma$	
2450	52.70	1.95	48.26	2.01	-8.42	3.01	2016/01/14
2450	52.70	1.95	48.80	2.08	-7.39	6.76	2016/01/15
5300	49.03	5.35	44.85	5.40	-8.24	-0.22	2016/01/05
5300	49.03	5.35	45.05	5.24	-7.83	-3.18	2016/01/06
5600	48.47	5.76	44.50	5.65	-8.19	-1.96	2016/01/06
5600	48.48	5.79	47.19	6.06	-2.64	5.09	2016/01/15
5800	48.20	6.00	43.95	6.10	-8.62	0.13	2016/01/06
5800	48.20	6.00	46.71	6.35	-3.09	5.95	2016/01/15

See *Annex E* for more details.

### B.4 System Check Measurements

#### Body Measurements

Frequency (MHz)	Average	Target SAR (W/g)	Measured SAR (W/g)	Drift (%)	Limit (%)	Date
2450	1g	51.00	53.65	5.19	10	2016/01/15
	10g	24.00	24.71	2.97		
2450	1g	51.00	52.91	3.74		2016/01/14
	10g	24.00	24.40	1.68		
5300	1g	75.00	80.43	7.24		2016/01/05
	10g	21.00	23.08	9.90		
5300	1g	75.60	81.49	7.80		2016/01/07
	10g	21.20	23.13	9.09		
5600	1g	78.20	79.09	1.14		2016/01/15
	10g	21.70	22.23	2.42		
5600	1g	78.20	82.72	5.78		2016/01/07
	10g	21.70	23.86	9.98		
5800	1g	76.20	74.18	-2.65		2016/01/07
	10g	21.00	20.95	-0.23		
5800	1g	76.20	78.09	2.48		2016/01/15
	10g	21.00	21.95	4.54		

See *Annex C* for more details.

**B.5 SAR Test Results**

**B.5.1 802.11b/g/n – 2.4GHz - DTS**

Ant	Mode Data rate	BW (MHz)	Ch #	Freq (MHz)	Position	Correct. Factor (dB)	SAR 1g (W/kg)	Reported SAR 1g (W/kg)	Plot #
Main	802.11b 1Mbps	20	6	2437	Back-Face	0.12	0.19	0.19	
					Top Edge	0.12	0.10	0.10	
					Left Edge	0.12	0.26	0.27	1
Aux	802.11b 1Mbps	20	6	2437	Back-Face	0.08	0.24	0.25	
					Top Edge	0.08	0.32	0.32	2
					Left Edge	0.08	0.08	0.08	

**B.5.2 802.11a/n/ac – 5.3 GHz – UNII-2A**

Ant	Mode Data rate	BW (MHz)	Ch #	Freq (MHz)	Position	Correct. Factor (dB)	SAR 1g (W/kg)	Reported SAR 1g (W/kg)	Plot #
Main	802.11n40 HT0	40	54	5270	Back-Face	0.13	0.16	0.16	
					Top Edge	0.13	0.02	0.02	
					Left Edge	0.13	0.66	0.68	3
Aux	802.11n40 HT0	40	54	5270	Back-Face	0.00	0.34	0.34	
					Top Edge	0.00	0.64	0.64	4
					Right Edge	0.00	0.39	0.39	

**B.5.3 802.11a/n/ac – 5.6 GHz – UNII-2C**

Ant	Mode Data rate	BW (MHz)	Ch #	Freq (MHz)	Position	Correct. Factor (dB)	SAR 1g (W/kg)	Reported SAR 1g (W/kg)	Plot #
Main	802.11n40 HT0	40	118	5590	Back-Face	0.12	0.26	0.27	
					Top Edge	0.12	0.08	0.08	
			Left Edge	0.12	0.86	0.89	5		
Aux	802.11n40 HT0	40	110	5550	Left Edge	0.19	0.81	0.85	
					Back-Face	0.11	0.28	0.29	
					Top Edge	0.11	0.40	0.41	6
					Left Edge	0.11	0.35	0.35	

**B.5.4 802.11a/n/ac – 5.8 GHz – UNII-3**

Ant	Mode Data rate	BW (MHz)	Ch #	Freq (MHz)	Position	Correct. Factor (dB)	SAR 1g (W/kg)	Reported SAR 1g (W/kg)	Plot #
Main	802.11n40 HT0	40	151	5755	Back-Face	0.11	0.26	0.27	
					Top Edge	0.11	0.07	0.07	
					Left Edge	0.11	0.74	0.76	7
Aux	802.11n40 HT0	40	151	5755	Back-Face	0.14	0.27	0.28	
					Top Edge	0.14	0.41	0.42	
					Left Edge	0.14	0.50	0.52	8

**B.5.5 Bluetooth – 2.4GHz – DSSS**

Ant	Mode Data rate	BW (MHz)	Ch #	Freq (MHz)	Position	Correct. Factor (dB)	SAR 1g (W/kg)	Reported SAR 1g (W/kg)	Plot #
Aux	802.15 DH5	20	78	2480	Back-Face	0.51	0.02	0.03	
					Top Edge	0.51	0.02	0.02	9
					Left Edge	0.51	0.01	0.01	

**B.6 SAR Measurement Variability**

According to FCC OET KDB 865664, SAR Measurement variability is assessed when the maximum initial measured SAR is >0.8 W/kg for a certain band/mode. If the measured SAR value of the initial repeated measurement is <1.45 W/kg with <20% variation, only one repeated measurement is required to confirm that the results are not expected to have substantial variations.

A second repeated measurement is required only if the measured results for the initial repeated measurement are within 10% of the SAR limit or vary by more than 20%.

Band / Mode	Position	Channel	Freq. (MHz)	Measured SAR 1g (W/kg)	Repeated SAR 1g (W/Kg)	Ratio
802.11n40 HT0	Left Edge	118	5590	0.86	0.74	1.16

### B.7 Simultaneous Transmission SAR Evaluation

According to FCC OET KDB 447498 D01, when the sum of 1g SAR for all simultaneously transmitting antennas in an operating mode and exposure condition combination is within the SAR limit, SAR test exclusion applies to that simultaneous transmission configuration.

Chain	Position	Highest Reported SAR (1g)		
		WLAN 2.4GHz	WLAN 5GHz	Bluetooth
Main	Back-Face	0.19	0.27	
	Top Edge	0.10	0.08	
	Left Edge	0.27	0.89	
Aux	Back-Face	0.25	0.34	0.03
	Top Edge	0.32	0.64	0.02
	Left Edge	0.08	0.52	0.01

Position	Simultaneous Tx Antenna Combination		Σ SAR 1g (W/Kg)	Limit (W/kg)
	Main Antenna	Aux Antenna		
Top Edge	WLAN 2.4GHz	BT	0.30	1.6
	WLAN 5GHz	BT	0.20	
Back Face	WLAN 2.4GHz	BT	0.22	
	WLAN 5GHz	BT	0.30	
Left Edge	WLAN 2.4GHz	BT	0.10	
	WLAN 5GHz	BT	0.99	

Considering the results described above and according to the simultaneous transmission evaluation exclusions described in FCC OET KDB 447498 D01, no SAR to peak location measurements are required.

# Annex C. Test System Plots

---

1.	2.4GHz - 802.11b, CH6, Main Antenna – Left Edge .....	33
2.	2.4GHz - 802.11b, CH6, Aux Antenna – Top Edge.....	34
3.	5.3GHz - 802.11n40, CH54, Main Antenna – Left Edge .....	35
4.	5.3GHz - 802.11n40, CH54, Aux Antenna – Top Edge.....	36
5.	5.6GHz - 802.11n40, CH118, Main Antenna – Left Edge .....	37
6.	5.6GHz - 802.11n40, CH110, Aux Antenna – Top Edge.....	38
7.	5.8GHz - 802.11n40, CH134, Main Antenna – Top Edge .....	39
8.	5.8GHz - 802.11n40, CH151, Aux Antenna – Top Edge.....	40
9.	2.4GHz - 802.15, CH78, Aux Antenna – Top Edge.....	41
10.	System Check Body Liquid 2450MHz-1 .....	42
11.	System Check Body Liquid 2450MHz-2 .....	43
12.	System Check Body Liquid 5300MHz-1 .....	44
13.	System Check Body Liquid 5300MHz-2 .....	45
14.	System Check Body Liquid 5600MHz-1 .....	46
15.	System Check Body Liquid 5600MHz-2 .....	47
16.	System Check Body Liquid 5800MHz-1 .....	48
17.	System Check Body Liquid 5800MHz-2 .....	49



**1. 2.4GHz - 802.11b, CH6, Main Antenna – Left Edge**

Test Laboratory: Intel WRF Lab; Date/Time: 1/15/2016 8:59:26 AM

**DUT: 3165NGW+ TPN-W117 Type: Convertible PC; Serial: E0.94.67.59.B4.29**

Communication System: UID 0, 802.11 (0); Communication System Band: 2.4GHz; Frequency: 2437 MHz; Communication System PAR: 0 dB

Medium parameters used (interpolated):  $f = 2437$  MHz;  $\sigma = 2.064$  S/m;  $\epsilon_r = 48.843$ ;  $\rho = 1000$  kg/m<sup>3</sup>

Phantom section: Flat Section

Measurement Standard: DASYS (IEEE/IEC/ANSI C63.19-2011)

DASY Configuration:

- Probe: EX3DV4 - SN3978; ConvF(7.22, 7.22, 7.22); Calibrated: 6/15/2015;
  - Modulation Compensation:
- Sensor-Surface: 4mm (Mechanical Surface Detection),  $z = -9.0, 31.0$
- Electronics: DAE4 Sn1429; Calibrated: 6/11/2015
- Phantom: ELI v5.0 (30deg probe tilt); Type: QDOVA002BA;
- DASYS2 52.8.8(1222);

**DTS\_802.11b\_CH6-2437MHz\_Left-Edge\_Main/Area Scan (41x121x1):**

Interpolated grid:  $dx=1.200$  mm,  $dy=1.200$  mm

[Info: Interpolated medium parameters used for SAR evaluation.](#)

Maximum value of SAR (interpolated) = 0.310 W/kg

**DTS\_802.11b\_CH6-2437MHz\_Left-Edge\_Main/Zoom Scan (7x7x7)/Cube**

**0:** Measurement grid:  $dx=5$ mm,  $dy=5$ mm,  $dz=5$ mm

Reference Value = 13.43 V/m; Power Drift = -0.08 dB

Peak SAR (extrapolated) = 0.491 W/kg

**SAR(1 g) = 0.258 W/kg; SAR(10 g) = 0.135 W/kg**

[Info: Interpolated medium parameters used for SAR evaluation.](#)

Maximum value of SAR (measured) = 0.308 W/kg

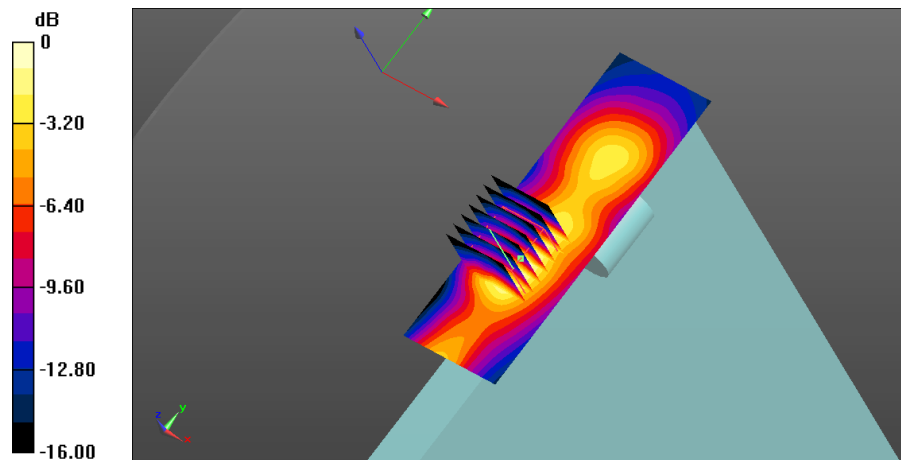

**2. 2.4GHz - 802.11b, CH6, Aux Antenna – Top Edge**

Test Laboratory: Intel WRF Lab; Date/Time: 1/14/2016 5:02:58 PM

**DUT: 3165NGW+ TPN-W117 Type: Convertible PC; Serial: E0.94.67.59.B4.29**

Communication System: UID 0, 802.11 (0); Communication System Band: 2.4GHz; Frequency: 2437 MHz; Communication System PAR: 0 dB  
 Medium parameters used (interpolated):  $f = 2437$  MHz;  $\sigma = 1.994$  S/m;  $\epsilon_r = 48.3$ ;  $\rho = 1000$  kg/m<sup>3</sup>  
 Phantom section: Flat Section  
 Measurement Standard: DASYS (IEEE/IEC/ANSI C63.19-2011)

DASY Configuration:

- Probe: EX3DV4 - SN3978; ConvF(7.22, 7.22, 7.22); Calibrated: 6/15/2015;
  - Modulation Compensation:
- Sensor-Surface: 2mm (Mechanical Surface Detection), Sensor-Surface: 4mm (Mechanical Surface Detection),  $z = -9.0, 31.0$
- Electronics: DAE4 Sn1429; Calibrated: 6/11/2015
- Phantom: ELI v5.0 (30deg probe tilt); Type: QDOVA002BA;
- DASYS52 52.8.8(1222);

**DTS\_802.11b\_CH6-2437MHz\_Top-Edge\_Aux/Area Scan (61x71x1):**

Interpolated grid:  $dx=1.000$  mm,  $dy=1.000$  mm

[Info: Interpolated medium parameters used for SAR evaluation.](#)

Maximum value of SAR (interpolated) = 0.446 W/kg

**DTS\_802.11b\_CH6-2437MHz\_Top-Edge\_Aux/Zoom Scan (7x7x7)/Cube**

**0:** Measurement grid:  $dx=5$ mm,  $dy=5$ mm,  $dz=5$ mm

Reference Value = 13.00 V/m; Power Drift = -0.25 dB

Peak SAR (extrapolated) = 0.628 W/kg

**SAR(1 g) = 0.317 W/kg; SAR(10 g) = 0.156 W/kg**

[Info: Interpolated medium parameters used for SAR evaluation.](#)

Maximum value of SAR (measured) = 0.346 W/kg

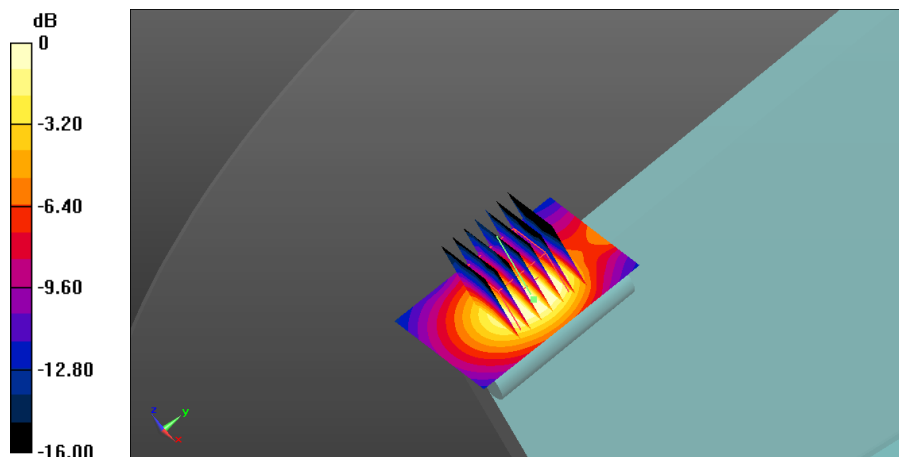

0 dB = 0.346 W/kg = -4.61 dBW/kg

**3. 5.3GHz - 802.11n40, CH54, Main Antenna – Left Edge**

Test Laboratory: Intel WRF Lab; Date/Time: 1/5/2016 5:58:30 PM

**DUT: 3165NGW+ TPN-W117 Type: Convertible PC; Serial: E0.94.67.59.B4.29**

Communication System: UID 0, 802.11 (0); Communication System Band: 5GHz; Frequency: 5270 MHz; Communication System PAR: 0 dB  
 Medium parameters used (interpolated):  $f = 5270$  MHz;  $\sigma = 5.359$  S/m;  $\epsilon_r = 44.934$ ;  $\rho = 1000$  kg/m<sup>3</sup>  
 Phantom section: Flat Section  
 Measurement Standard: DASYS5 (IEEE/IEC/ANSI C63.19-2011)

DASY Configuration:

- Probe: EX3DV4 - SN3978; ConvF(4.21, 4.21, 4.21); Calibrated: 6/15/2015;
  - Modulation Compensation:
- Sensor-Surface: 2mm (Mechanical Surface Detection),  $z = -9.0, 25.0$
- Electronics: DAE4 Sn1429; Calibrated: 6/11/2015
- Phantom: ELI v5.0 (30deg probe tilt); Type: QDOVA002BA;
- DASYS5 52.8.8(1222);

**UNII-2A\_802.11n40\_HT0\_CH54-5270MHz\_Left-Edge\_Main/Area Scan (41x71x1):** Interpolated grid:  $dx=1.000$  mm,  $dy=1.000$  mm

[Info: Interpolated medium parameters used for SAR evaluation.](#)

Maximum value of SAR (interpolated) = 1.17 W/kg

**UNII-2A\_802.11n40\_HT0\_CH54-5270MHz\_Left-Edge\_Main/Zoom Scan (8x8x12)/Cube 0:** Measurement grid:  $dx=4$ mm,  $dy=4$ mm,  $dz=2$ mm

Reference Value = 11.68 V/m; Power Drift = -0.01 dB

Peak SAR (extrapolated) = 3.37 W/kg

**SAR(1 g) = 0.662 W/kg; SAR(10 g) = 0.225 W/kg**

[Info: Interpolated medium parameters used for SAR evaluation.](#)

Maximum value of SAR (measured) = 1.24 W/kg

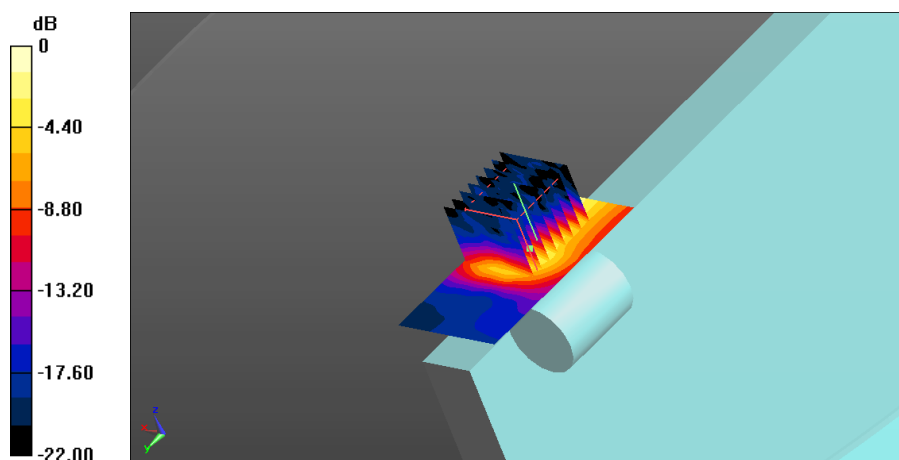

0 dB = 1.24 W/kg = 0.93 dBW/kg

**4. 5.3GHz - 802.11n40, CH54, Aux Antenna – Top Edge**

Test Laboratory: Intel WRF Lab; Date/Time: 1/7/2016 2:45:21 PM

**DUT: 3165NGW+ TPN-W117 Type: Convertible PC; Serial: E0.94.67.59.B4.29**

Communication System: UID 0, 802.11 (0); Communication System Band: 5GHz; Frequency: 5270 MHz; Communication System PAR: 0 dB  
 Medium parameters used (interpolated):  $f = 5270$  MHz;  $\sigma = 5.202$  S/m;  $\epsilon_r = 45.095$ ;  $\rho = 1000$  kg/m<sup>3</sup>  
 Phantom section: Flat Section  
 Measurement Standard: DASYS (IEEE/IEC/ANSI C63.19-2011)

DASY Configuration:

- Probe: EX3DV4 - SN3978; ConvF(4.21, 4.21, 4.21); Calibrated: 6/15/2015;
  - Modulation Compensation:
- Sensor-Surface: 2mm (Mechanical Surface Detection (Locations From Previous Scan Used)), Sensor-Surface: 2mm (Mechanical Surface Detection),  $z = 11.0, 25.0$
- Electronics: DAE4 Sn1429; Calibrated: 6/11/2015
- Phantom: ELI v5.0 (30deg probe tilt); Type: QDOVA002BA;
- DASYS 52.8.8(1222);

**UNII-2A\_802.11n40\_HT0\_CH54-5270MHz\_Top-Edge\_Aux/Area Scan (41x71x1):** Interpolated grid:  $dx=1.000$  mm,  $dy=1.000$  mm

[Info: Interpolated medium parameters used for SAR evaluation.](#)  
 Maximum value of SAR (interpolated) = 1.20 W/kg

**UNII-2A\_802.11n40\_HT0\_CH54-5270MHz\_Top-Edge\_Aux/Zoom Scan (9x9x12)/Cube 0:** Measurement grid:  $dx=4$ mm,  $dy=4$ mm,  $dz=2$ mm

Reference Value = 16.49 V/m; Power Drift = 0.04 dB  
 Peak SAR (extrapolated) = 2.65 W/kg  
**SAR(1 g) = 0.638 W/kg; SAR(10 g) = 0.225 W/kg**

[Info: Interpolated medium parameters used for SAR evaluation.](#)  
 Maximum value of SAR (measured) = 1.20 W/kg

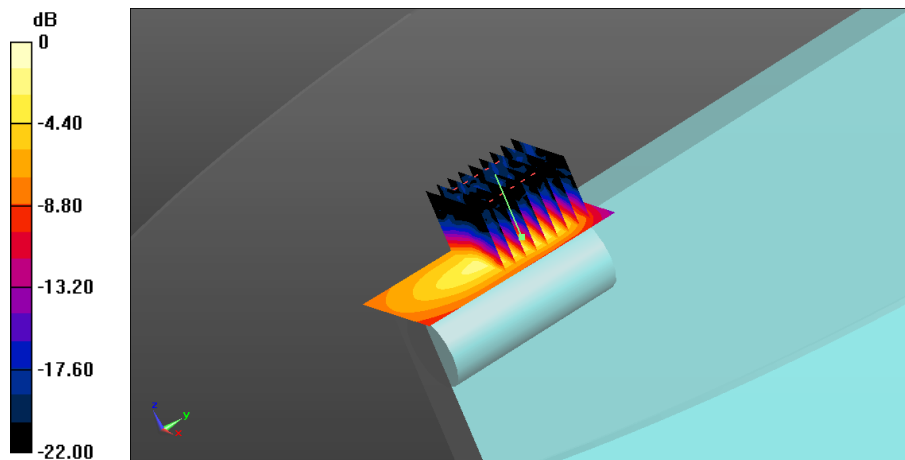

0 dB = 1.20 W/kg = 0.79 dBW/kg

**5. 5.6GHz - 802.11n40, CH118, Main Antenna – Left Edge**

Test Laboratory: Intel WRF Lab; Date/Time: 1/15/2016 12:12:48 PM

**DUT: 3165NGW+ TPN-W117 Type: Convertible PC; Serial: E0.94.67.59.B4.29**

Communication System: UID 0, 802.11 (0); Communication System Band: 5GHz; Frequency: 5590 MHz; Communication System PAR: 0 dB  
 Medium parameters used (interpolated):  $f = 5590$  MHz;  $\sigma = 6.046$  S/m;  $\epsilon_r = 47.214$ ;  $\rho = 1000$  kg/m<sup>3</sup>  
 Phantom section: Flat Section  
 Measurement Standard: DASYS (IEEE/IEC/ANSI C63.19-2011)

DASY Configuration:

- Probe: EX3DV4 - SN3978; ConvF(3.67, 3.67, 3.67); Calibrated: 6/15/2015;
  - Modulation Compensation:
- Sensor-Surface: 2mm (Mechanical Surface Detection (Locations From Previous Scan Used)), Sensor-Surface: 2mm (Mechanical Surface Detection),  $z = -9.0, 25.0$
- Electronics: DAE4 Sn1429; Calibrated: 6/11/2015
- Phantom: ELI v5.0 (30deg probe tilt); Type: QDOVA002BA;
- DASYS 52.8.8(1222);

**UNII-2C\_802.11n40\_HT0\_CH118-5590MHz\_Left\_Edge\_Main/Area Scan (41x111x1):** Interpolated grid: dx=1.000 mm, dy=1.000 mm

Info: [Interpolated medium parameters used for SAR evaluation.](#)

Maximum value of SAR (interpolated) = 1.60 W/kg

**UNII-2C\_802.11n40\_HT0\_CH118-5590MHz\_Left\_Edge\_Main /Zoom**

**Scan (8x8x12)/Cube 0:** Measurement grid: dx=4mm, dy=4mm, dz=2mm

Reference Value = 17.90 V/m; Power Drift = -0.01 dB

Peak SAR (extrapolated) = 3.60 W/kg

**SAR(1 g) = 0.862 W/kg; SAR(10 g) = 0.283 W/kg**

Info: [Interpolated medium parameters used for SAR evaluation.](#)

Maximum value of SAR (measured) = 1.73 W/kg

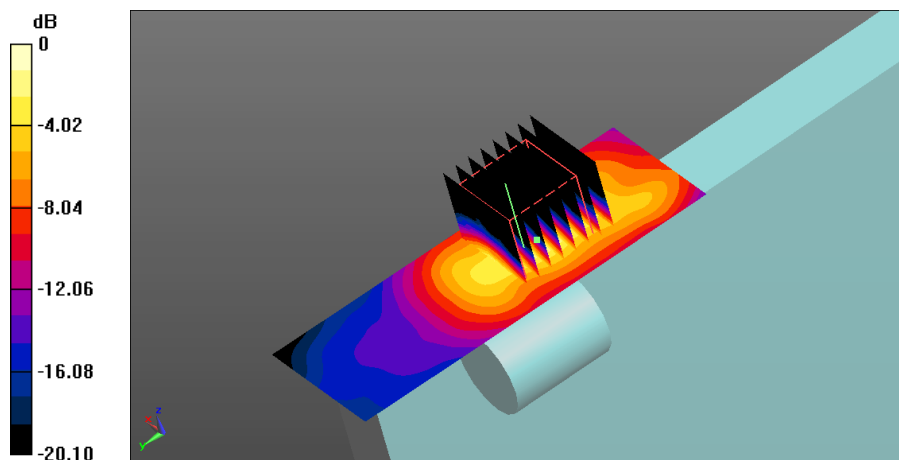

0 dB = 1.73 W/kg = 2.38 dBW/kg

**6. 5.6GHz - 802.11n40, CH110, Aux Antenna – Top Edge**

Test Laboratory: Intel WRF Lab; Date/Time: 1/7/2016 11:26:58 AM

**DUT: 3165NGW+ TPN-W117 Type: Convertible PC; Serial: E0.94.67.59.B4.29**

Communication System: UID 0, 802.11 (0); Communication System Band: 5GHz; Frequency: 5550 MHz; Communication System PAR: 0 dB  
 Medium parameters used (interpolated):  $f = 5550$  MHz;  $\sigma = 5.583$  S/m;  $\epsilon_r = 44.599$ ;  $\rho = 1000$  kg/m<sup>3</sup>  
 Phantom section: Flat Section  
 Measurement Standard: DASYS5 (IEEE/IEC/ANSI C63.19-2011)

DASY Configuration:

- Probe: EX3DV4 - SN3978; ConvF(3.97, 3.97, 3.97); Calibrated: 6/15/2015;
  - Modulation Compensation:
- Sensor-Surface: 2mm (Mechanical Surface Detection),  $z = 11.0, 25.0$
- Electronics: DAE4 Sn1429; Calibrated: 6/11/2015
- Phantom: ELI v5.0 (30deg probe tilt); Type: QDOVA002BA;
- DASYS5 52.8.8(1222);

**UNII-2C\_802.11n40\_HT0\_CH110-5550MHz\_Top-Edge\_Aux/Area Scan**

**(41x71x1):** Interpolated grid:  $dx=1.000$  mm,  $dy=1.000$  mm  
[Info: Interpolated medium parameters used for SAR evaluation.](#)  
 Maximum value of SAR (interpolated) = 0.769 W/kg

**UNII-2C\_802.11n40\_HT0\_CH110-5550MHz\_Top-Edge\_Aux/Zoom Scan**

**(9x9x12)/Cube 0:** Measurement grid:  $dx=4$ mm,  $dy=4$ mm,  $dz=2$ mm  
 Reference Value = 12.68 V/m; Power Drift = -0.11 dB  
 Peak SAR (extrapolated) = 1.38 W/kg  
**SAR(1 g) = 0.380 W/kg; SAR(10 g) = 0.145 W/kg**  
[Info: Interpolated medium parameters used for SAR evaluation.](#)  
 Maximum value of SAR (measured) = 0.765 W/kg

**UNII-2C\_802.11n40\_HT0\_CH110-5550MHz\_Top-Edge\_Aux/Zoom Scan**

**2 (9x12x12)/Cube 0:** Measurement grid:  $dx=4$ mm,  $dy=4$ mm,  $dz=2$ mm  
 Reference Value = 12.68 V/m; Power Drift = -0.11 dB  
 Peak SAR (extrapolated) = 1.82 W/kg  
**SAR(1 g) = 0.401 W/kg; SAR(10 g) = 0.144 W/kg**  
[Info: Interpolated medium parameters used for SAR evaluation.](#)  
 Maximum value of SAR (measured) = 0.756 W/kg

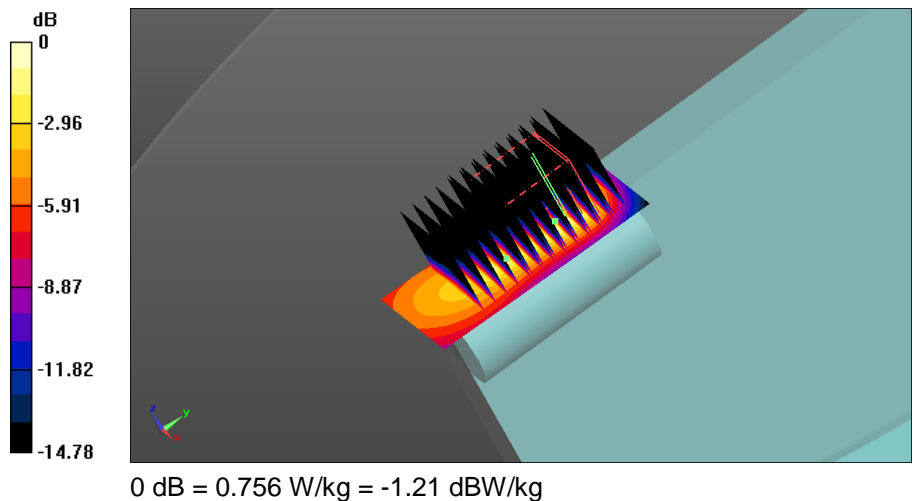

**7. 5.8GHz - 802.11n40, CH134, Main Antenna – Top Edge**

Test Laboratory: Intel WRF Lab; Date/Time: 1/7/2016 5:40:14 PM

**DUT: 3165NGW+ TPN-W117 Type: Convertible PC; Serial: E0.94.67.59.B4.29**

Communication System: UID 0, 802.11 (0); Communication System Band: 5GHz; Frequency: 5755 MHz; Communication System PAR: 0 dB  
 Medium parameters used (interpolated):  $f = 5755$  MHz;  $\sigma = 5.903$  S/m;  $\epsilon_r = 44.2$ ;  $\rho = 1000$  kg/m<sup>3</sup>  
 Phantom section: Flat Section  
 Measurement Standard: DASYS (IEEE/IEC/ANSI C63.19-2011)

DASY Configuration:

- Probe: EX3DV4 - SN3978; ConvF(4.01, 4.01, 4.01); Calibrated: 6/15/2015;
  - Modulation Compensation:
- Sensor-Surface: 2mm (Mechanical Surface Detection),  $z = -9.0, 25.0$
- Electronics: DAE4 Sn1429; Calibrated: 6/11/2015
- Phantom: ELI v5.0 (30deg probe tilt); Type: QDOVA002BA;
- DASYS 52.8.8(1222);

**UNII-3\_802.11n40\_HT0\_CH151-5775MHz\_Left-Edge\_Main/Area Scan (41x71x1):** Interpolated grid:  $dx=1.000$  mm,  $dy=1.000$  mm

Info: [Interpolated medium parameters used for SAR evaluation.](#)  
 Maximum value of SAR (interpolated) = 1.43 W/kg

**UNII-3\_802.11n40\_HT0\_CH151-5775MHz\_Left-Edge\_Main /Zoom Scan (8x8x12)/Cube 0:** Measurement grid:  $dx=4$ mm,  $dy=4$ mm,  $dz=2$ mm

Reference Value = 11.75 V/m; Power Drift = -0.10 dB  
 Peak SAR (extrapolated) = 3.44 W/kg  
**SAR(1 g) = 0.744 W/kg; SAR(10 g) = 0.240 W/kg**

Info: [Interpolated medium parameters used for SAR evaluation.](#)  
 Maximum value of SAR (measured) = 1.50 W/kg

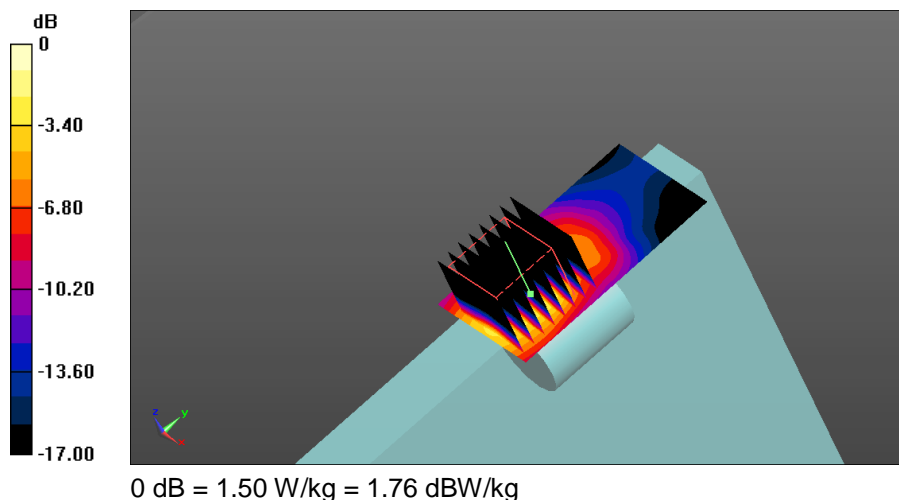

## 8. 5.8GHz - 802.11n40, CH151, Aux Antenna – Top Edge

Test Laboratory: Intel WRF Lab; Date/Time: 1/15/2016 2:36:14 PM

**DUT: 3165NGW+ TPN-W117 Type: Convertible PC; Serial: E0.94.67.59.B4.29**

Communication System: UID 0, 802.11 (0); Communication System Band: 5GHz; Frequency: 5755 MHz; Communication System PAR: 0 dB  
 Medium parameters used (interpolated):  $f = 5755$  MHz;  $\sigma = 6.287$  S/m;  $\epsilon_r = 46.819$ ;  $\rho = 1000$  kg/m<sup>3</sup>  
 Phantom section: Flat Section  
 Measurement Standard: DASYS5 (IEEE/IEC/ANSI C63.19-2011)

DASY Configuration:

- Probe: EX3DV4 - SN3978; ConvF(4.01, 4.01, 4.01); Calibrated: 6/15/2015;
  - Modulation Compensation:
- Sensor-Surface: 2mm (Mechanical Surface Detection),  $z = -9.0, 25.0$
- Electronics: DAE4 Sn1429; Calibrated: 6/11/2015
- Phantom: ELI v5.0 (30deg probe tilt); Type: QDOVA002BA;
- DASYS52 52.8.8(1222);

### UNII-3\_802.11n40\_HT0\_CH151-5775MHz\_Left-Edge\_Aux/Area Scan (41x101x1):

Interpolated grid:  $dx=1.000$  mm,  $dy=1.000$  mm

[Info: Interpolated medium parameters used for SAR evaluation.](#)

Maximum value of SAR (interpolated) = 0.843 W/kg

### UNII-3\_802.11n40\_HT0\_CH151-5775MHz\_Left-Edge\_Aux/Zoom Scan (9x9x12)/Cube 0:

Measurement grid:  $dx=4$ mm,  $dy=4$ mm,  $dz=2$ mm

Reference Value = 9.093 V/m; Power Drift = 0.33 dB

Peak SAR (extrapolated) = 2.06 W/kg

**SAR(1 g) = 0.499 W/kg; SAR(10 g) = 0.191 W/kg**

[Info: Interpolated medium parameters used for SAR evaluation.](#)

Maximum value of SAR (measured) = 0.944 W/kg

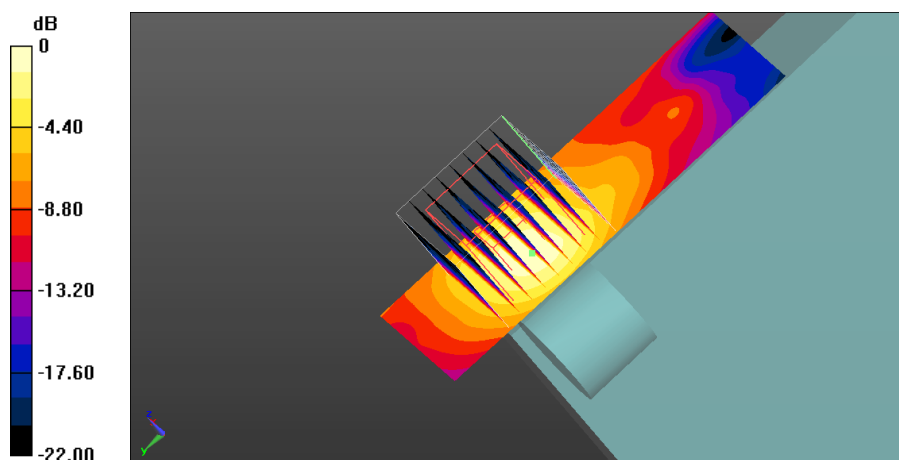

0 dB = 0.944 W/kg = -0.25 dBW/kg



**9. 2.4GHz - 802.15, CH78, Aux Antenna – Top Edge**

Test Laboratory: Intel WRF Lab; Date/Time: 1/14/2016 4:34:12 PM

**DUT: 3165NGW+ TPN-W117 Type: Convertible PC; Serial: E0.94.67.59.B4.29**

Communication System: UID 0, 802.11 (0); Communication System Band: 2.4GHz; Frequency: 2437 MHz; Communication System PAR: 0 dB  
 Medium parameters used (interpolated):  $f = 2437$  MHz;  $\sigma = 1.994$  S/m;  $\epsilon_r = 48.3$ ;  $\rho = 1000$  kg/m<sup>3</sup>  
 Phantom section: Flat Section  
 Measurement Standard: DASYS (IEEE/IEC/ANSI C63.19-2011)

DASY Configuration:

- Probe: EX3DV4 - SN3978; ConvF(7.22, 7.22, 7.22); Calibrated: 6/15/2015;
  - Modulation Compensation:
- Sensor-Surface: 2mm (Mechanical Surface Detection), Sensor-Surface: 4mm (Mechanical Surface Detection),  $z = 11.0, 31.0$
- Electronics: DAE4 Sn1429; Calibrated: 6/11/2015
- Phantom: ELI v5.0 (30deg probe tilt); Type: QDOVA002BA;
- DASYS52 52.8.8(1222);

**BT\_Aux\_01\_12\_2015 2/802.15\_CH78-2480MHz\_Top-Edge\_Aux/Area Scan (41x71x1):** Interpolated grid:  $dx=1.000$  mm,  $dy=1.000$  mm

[Info: Interpolated medium parameters used for SAR evaluation.](#)

Maximum value of SAR (interpolated) = 0.0247 W/kg

**BT\_Aux\_01\_12\_2015 2/802.15\_CH78-2480MHz\_Top-Edge\_Aux/Zoom Scan (7x7x7)/Cube 0:** Measurement grid:  $dx=5$ mm,  $dy=5$ mm,  $dz=5$ mm

Reference Value = 3.907 V/m; Power Drift = -1.82 dB

Peak SAR (extrapolated) = 0.0290 W/kg

**SAR(1 g) = 0.016 W/kg; SAR(10 g) = 0.00908 W/kg**

[Info: Interpolated medium parameters used for SAR evaluation.](#)

Maximum value of SAR (measured) = 0.0178 W/kg

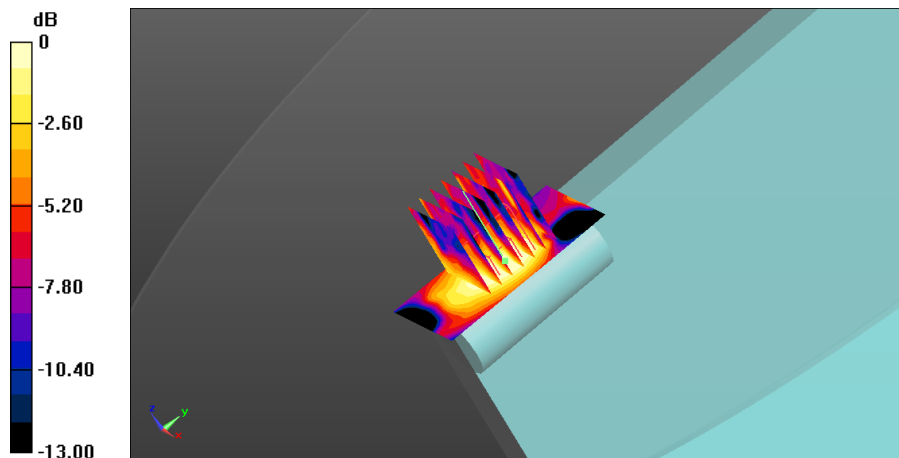

0 dB = 0.0178 W/kg = -17.50 dBW/kg

**10. System Check Body Liquid 2450MHz-1**

Test Laboratory: Intel WRF Lab; Date/Time: 1/15/2016 10:30:28 AM

**DUT: Dipole 2450 MHz D2450V2; Type: D2450V2; Serial: D2450V2 - SN: 937**

Communication System: UID 0, CW (0); Communication System Band: D2450 (2450.0 MHz);  
 Frequency: 2450 MHz; Communication System PAR: 0 dB  
 Medium parameters used:  $f = 2450$  MHz;  $\sigma = 2.082$  S/m;  $\epsilon_r = 48.804$ ;  $\rho = 1000$  kg/m<sup>3</sup>  
 Phantom section: Flat Section  
 Measurement Standard: DASYS5 (IEEE/IEC/ANSI C63.19-2011)

DASY Configuration:

- Probe: EX3DV4 - SN3978; ConvF(7.22, 7.22, 7.22); Calibrated: 6/15/2015;
  - Modulation Compensation:
- Sensor-Surface: 4mm (Mechanical Surface Detection),  $z = -9.0, 31.0$
- Electronics: DAE4 Sn1429; Calibrated: 6/11/2015
- Phantom: ELI v5.0 (30deg probe tilt); Type: QDOVA002BA;
- DASYS5 52.8.8(1222);

**System check 2450MHz/Area Scan (71x71x1):** Interpolated grid:  $dx=1.200$  mm,  $dy=1.200$  mm  
 Maximum value of SAR (interpolated) = 6.53 W/kg

**System check 2450MHz/Zoom Scan (7x7x7)/Cube 0:** Measurement grid:  
 $dx=5$ mm,  $dy=5$ mm,  $dz=5$ mm  
 Reference Value = 65.62 V/m; Power Drift = -0.27 dB  
 Peak SAR (extrapolated) = 11.1 W/kg  
**SAR(1 g) = 5.34 W/kg; SAR(10 g) = 2.46 W/kg**  
 Maximum value of SAR (measured) = 6.12 W/kg

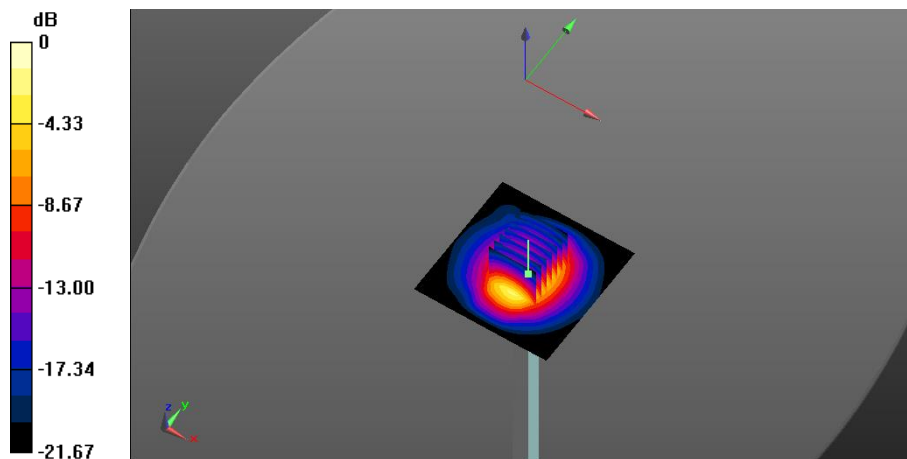

0 dB = 6.12 W/kg = 7.87 dBW/kg

**11. System Check Body Liquid 2450MHz-2**

Test Laboratory: Intel WRF Lab; Date/Time: 1/14/2016 6:22:07 PM

**DUT: Dipole 2450 MHz D2450V2; Type: D2450V2; Serial: D2450V2 - SN: 937**

Communication System: UID 0, CW (0); Communication System Band: D2450 (2450.0 MHz);  
 Frequency: 2450 MHz; Communication System PAR: 0 dB  
 Medium parameters used:  $f = 2450$  MHz;  $\sigma = 2.009$  S/m;  $\epsilon_r = 48.261$ ;  $\rho = 1000$  kg/m<sup>3</sup>  
 Phantom section: Flat Section  
 Measurement Standard: DASYS5 (IEEE/IEC/ANSI C63.19-2011)

DASY Configuration:

- Probe: EX3DV4 - SN3978; ConvF(7.22, 7.22, 7.22); Calibrated: 6/15/2015;
  - Modulation Compensation:
- Sensor-Surface: 4mm (Mechanical Surface Detection),  $z = -9.0, 31.0$
- Electronics: DAE4 Sn1429; Calibrated: 6/11/2015
- Phantom: ELI v5.0 (30deg probe tilt); Type: QDOVA002BA;
- DASYS52 52.8.8(1222);

**System-Check-2450MHz-01-13-2016/System check 2450MHz 2/Area**

**Scan (71x71x1):** Interpolated grid:  $dx=1.200$  mm,  $dy=1.200$  mm  
 Maximum value of SAR (interpolated) = 6.39 W/kg

**System-Check-2450MHz-01-13-2016/System check 2450MHz 2/Zoom**

**Scan (7x7x7)/Cube 0:** Measurement grid:  $dx=5$ mm,  $dy=5$ mm,  $dz=5$ mm  
 Reference Value = 64.75 V/m; Power Drift = -0.01 dB  
 Peak SAR (extrapolated) = 11.0 W/kg  
**SAR(1 g) = 5.29 W/kg; SAR(10 g) = 2.44 W/kg**  
 Maximum value of SAR (measured) = 6.04 W/kg

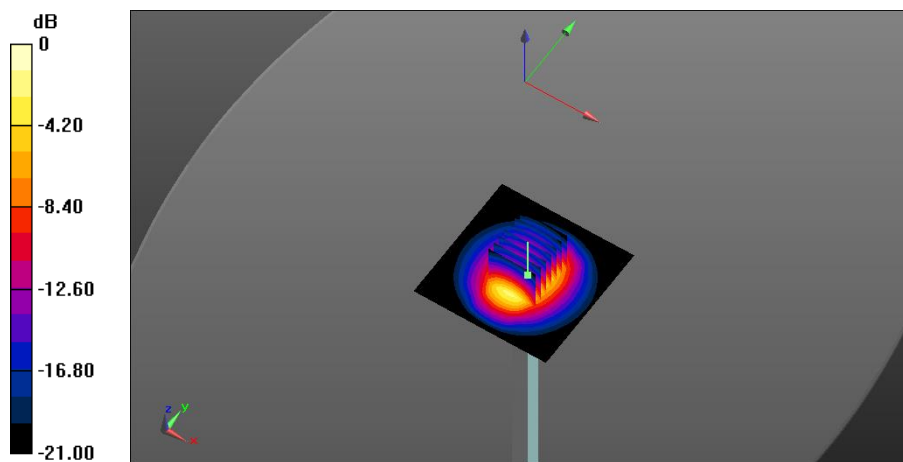

0 dB = 6.04 W/kg = 7.81 dBW/kg

**12. System Check Body Liquid 5300MHz-1**

Test Laboratory: Intel WRF Lab; Date/Time: 1/5/2016 2:44:58 PM

**DUT: Dipole D5GHzV2; Type: D5GHzV2; Serial: D5GHzV2 - SN: 1164**

Communication System: UID 0, CW (0); Communication System Band: D5GHz (5000.0 - 6000.0 MHz); Frequency: 5300 MHz; Communication System PAR: 0 dB  
 Medium parameters used:  $f = 5300$  MHz;  $\sigma = 5.404$  S/m;  $\epsilon_r = 44.852$ ;  $\rho = 1000$  kg/m<sup>3</sup>  
 Phantom section: Flat Section  
 Measurement Standard: DASYS (IEEE/IEC/ANSI C63.19-2011)

DASY Configuration:

- Probe: EX3DV4 - SN3978; ConvF(4.21, 4.21, 4.21); Calibrated: 6/15/2015;
  - Modulation Compensation:
- Sensor-Surface: 4mm (Mechanical Surface Detection),  $z = 31.0$
- Electronics: DAE4 Sn1429; Calibrated: 6/11/2015
- Phantom: ELI v5.0 (30deg probe tilt); Type: QDOVA002BA;
- DASYS52 52.8.8(1222);

**WLAN-5GHz\_01\_06\_2016/System check 5300MHz/Zoom Scan**

**(8x8x12)/Cube 0:** Measurement grid:  $dx=4$ mm,  $dy=4$ mm,  $dz=2$ mm

Reference Value = 62.18 V/m; Power Drift = -0.03 dB

Peak SAR (extrapolated) = 23.0 W/kg

**SAR(1 g) = 7.57 W/kg; SAR(10 g) = 2.19 W/kg**

Maximum value of SAR (measured) = 9.49 W/kg

**WLAN-5GHz\_01\_06\_2016/System check 5300MHz/Area Scan**

**(81x81x1):** Interpolated grid:  $dx=1.000$  mm,  $dy=1.000$  mm

Maximum value of SAR (interpolated) = 9.61 W/kg

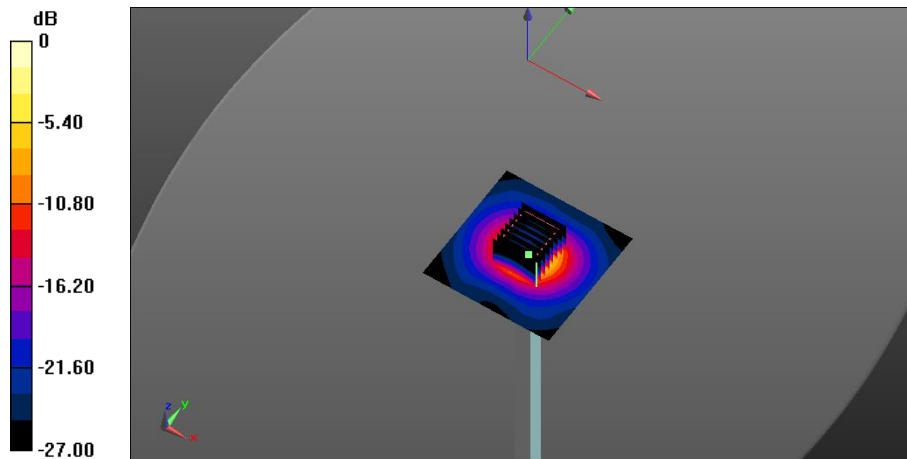

0 dB = 9.61 W/kg = 9.83 dBW/kg

### 13. System Check Body Liquid 5300MHz-2

Test Laboratory: Intel WRF Lab; Date/Time: 1/7/2016 7:01:16 PM

**DUT: Dipole D5GHzV2; Type: D5GHzV2; Serial: D5GHzV2 - SN: 1164**

Communication System: UID 0, CW (0); Communication System Band: D5GHz (5000.0 - 6000.0 MHz); Frequency: 5300 MHz; Communication System PAR: 0 dB  
 Medium parameters used:  $f = 5300$  MHz;  $\sigma = 5.244$  S/m;  $\epsilon_r = 45.051$ ;  $\rho = 1000$  kg/m<sup>3</sup>  
 Phantom section: Flat Section  
 Measurement Standard: DASYS (IEEE/IEC/ANSI C63.19-2011)

DASY Configuration:

- Probe: EX3DV4 - SN3978; ConvF(4.21, 4.21, 4.21); Calibrated: 6/15/2015;
  - Modulation Compensation:
- Sensor-Surface: 2mm (Mechanical Surface Detection),  $z = 1.0, 23.0$
- Electronics: DAE4 Sn1429; Calibrated: 6/11/2015
- Phantom: ELI v5.0 (30deg probe tilt); Type: QDOVA002BA;
- DASYS 52.8.8(1222);

**System check 5300MHz/Area Scan (81x81x1):** Interpolated grid:  $dx=1.000$  mm,  $dy=1.000$  mm  
 Maximum value of SAR (interpolated) = 16.9 W/kg

**System check 5300MHz/Zoom Scan (8x8x12)/Cube 0:** Measurement grid:  
 $dx=4$ mm,  $dy=4$ mm,  $dz=2$ mm  
 Reference Value = 62.23 V/m; Power Drift = 0.10 dB  
 Peak SAR (extrapolated) = 33.2 W/kg  
**SAR(1 g) = 8.14 W/kg; SAR(10 g) = 2.31 W/kg**  
 Maximum value of SAR (measured) = 15.8 W/kg

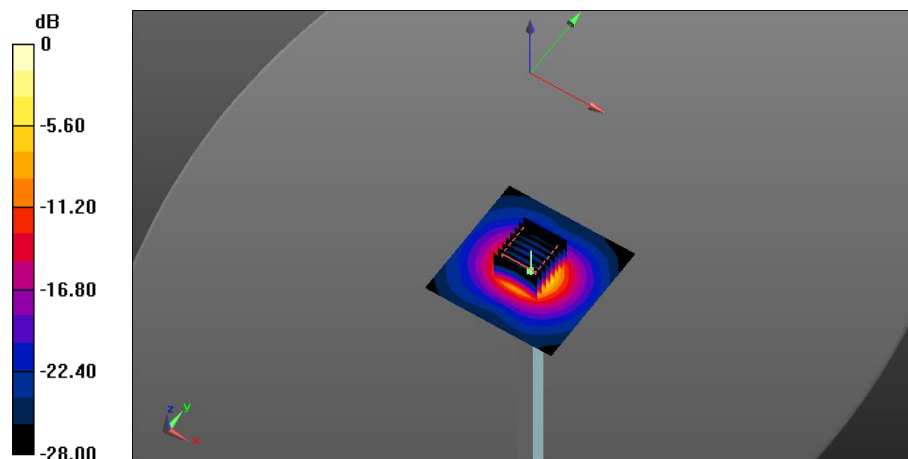

0 dB = 15.8 W/kg = 11.99 dBW/kg

**14. System Check Body Liquid 5600MHz-1**

Test Laboratory: Intel WRF Lab; Date/Time: 1/15/2016 6:14:14 PM

**DUT: Dipole D5GHzV2; Type: D5GHzV2; Serial: D5GHzV2 - SN: 1164**

Communication System: UID 0, CW (0); Communication System Band: D5GHz (5000.0 - 6000.0 MHz); Frequency: 5600 MHz; Communication System PAR: 0 dB  
 Medium parameters used:  $f = 5600$  MHz;  $\sigma = 6.06$  S/m;  $\epsilon_r = 47.19$ ;  $\rho = 1000$  kg/m<sup>3</sup>  
 Phantom section: Flat Section  
 Measurement Standard: DASYS (IEEE/IEC/ANSI C63.19-2011)

DASY Configuration:

- Probe: EX3DV4 - SN3978; ConvF(3.67, 3.67, 3.67); Calibrated: 6/15/2015;
  - Modulation Compensation:
- Sensor-Surface: 2mm (Mechanical Surface Detection (Locations From Previous Scan Used)), Sensor-Surface: 2mm (Mechanical Surface Detection),  $z = 1.0, 23.0$
- Electronics: DAE4 Sn1429; Calibrated: 6/11/2015
- Phantom: ELI v5.0 (30deg probe tilt); Type: QDOVA002BA;
- DASYS52 52.8.8(1222);

**System check 5600MHz/Area Scan (81x81x1):** Interpolated grid:  $dx=1.000$  mm,  $dy=1.000$  mm  
 Maximum value of SAR (interpolated) = 17.0 W/kg

**/System check 5600MHz/Zoom Scan (8x8x12)/Cube 0:** Measurement grid:  $dx=4$ mm,  $dy=4$ mm,  $dz=2$ mm  
 Reference Value = 57.01 V/m; Power Drift = 0.02 dB  
 Peak SAR (extrapolated) = 34.4 W/kg  
**SAR(1 g) = 7.9 W/kg; SAR(10 g) = 2.22 W/kg**  
 Maximum value of SAR (measured) = 16.1 W/kg

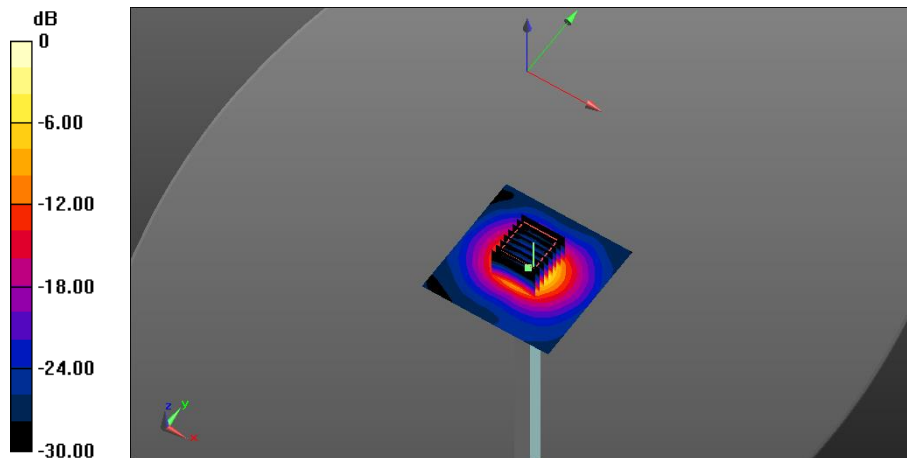

0 dB = 16.1 W/kg = 12.07 dBW/kg

**15. System Check Body Liquid 5600MHz-2**

Test Laboratory: Intel WRF Lab; Date/Time: 1/7/2016 3:18:07 PM

**DUT: Dipole D5GHzV2; Type: D5GHzV2; Serial: D5GHzV2 - SN: 1164**

Communication System: UID 0, CW (0); Communication System Band: D5GHz (5000.0 - 6000.0 MHz); Frequency: 5600 MHz; Communication System PAR: 0 dB  
 Medium parameters used:  $f = 5600$  MHz;  $\sigma = 5.842$  S/m;  $\epsilon_r = 44.027$ ;  $\rho = 1000$  kg/m<sup>3</sup>  
 Phantom section: Flat Section  
 Measurement Standard: DASYS (IEEE/IEC/ANSI C63.19-2011)

DASY Configuration:

- Probe: EX3DV4 - SN3978; ConvF(3.67, 3.67, 3.67); Calibrated: 6/15/2015;
  - Modulation Compensation:
- Sensor-Surface: 4mm (Mechanical Surface Detection),  $z = 1.0, 31.0$
- Electronics: DAE4 Sn1429; Calibrated: 6/11/2015
- Phantom: ELI v5.0 (30deg probe tilt); Type: QDOVA002BA;
- DASYS52 52.8.8(1222);

**System check 5600MHz 2/Area Scan (81x81x1):** Interpolated grid:  $dx=1.000$  mm,  $dy=1.000$  mm

Maximum value of SAR (interpolated) = 10.3 W/kg

**System check 5600MHz 2/Zoom Scan (8x8x12)/Cube 0:** Measurement grid:

$dx=4$ mm,  $dy=4$ mm,  $dz=2$ mm

Reference Value = 63.67 V/m; Power Drift = 0.01 dB

Peak SAR (extrapolated) = 27.2 W/kg

**SAR(1 g) = 8.29 W/kg; SAR(10 g) = 2.4 W/kg**

Maximum value of SAR (measured) = 9.97 W/kg

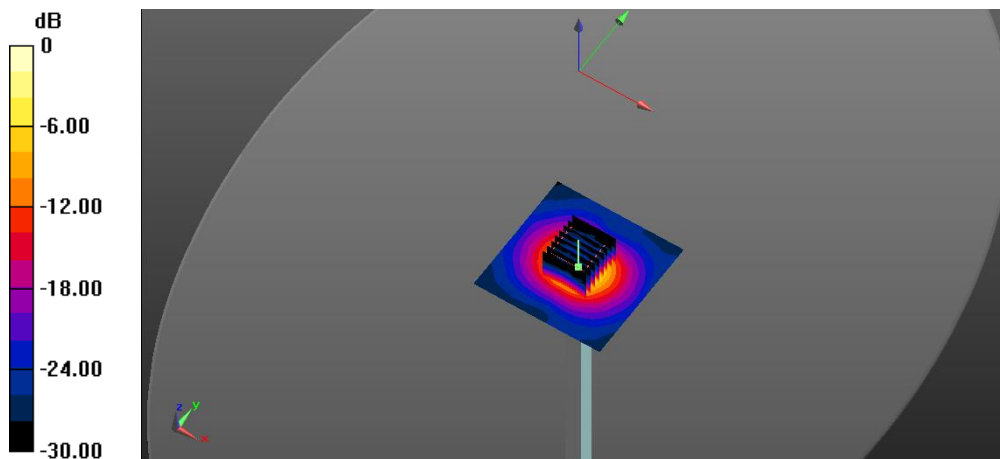

0 dB = 9.97 W/kg = 9.99 dBW/kg

**16. System Check Body Liquid 5800MHz-1**

Test Laboratory: Intel WRF Lab; Date/Time: 1/15/2016 6:43:33 PM

**DUT: Dipole D5GHzV2; Type: D5GHzV2; Serial: D5GHzV2 - SN: 1164**

Communication System: UID 0, CW (0); Communication System Band: D5GHz (5000.0 - 6000.0 MHz); Frequency: 5800 MHz; Communication System PAR: 0 dB  
 Medium parameters used:  $f = 5800$  MHz;  $\sigma = 6.357$  S/m;  $\epsilon_r = 46.709$ ;  $\rho = 1000$  kg/m<sup>3</sup>  
 Phantom section: Flat Section  
 Measurement Standard: DASYS (IEEE/IEC/ANSI C63.19-2011)

DASY Configuration:

- Probe: EX3DV4 - SN3978; ConvF(4.01, 4.01, 4.01); Calibrated: 6/15/2015;
  - Modulation Compensation:
- Sensor-Surface: 2mm (Mechanical Surface Detection (Locations From Previous Scan Used)), Sensor-Surface: 2mm (Mechanical Surface Detection),  $z = 1.0, 23.0$
- Electronics: DAE4 Sn1429; Calibrated: 6/11/2015
- Phantom: ELI v5.0 (30deg probe tilt); Type: QDOVA002BA;
- DASYS52 52.8.8(1222);

**System check 5800MHz/Area Scan (81x81x1):** Interpolated grid:  $dx=1.000$  mm,  $dy=1.000$  mm  
 Maximum value of SAR (interpolated) = 17.0 W/kg

**System check 5800MHz/Zoom Scan (8x8x12)/Cube 0:** Measurement grid:  $dx=4$ mm,  $dy=4$ mm,  $dz=2$ mm  
 Reference Value = 55.18 V/m; Power Drift = 0.03 dB  
 Peak SAR (extrapolated) = 35.4 W/kg  
**SAR(1 g) = 7.79 W/kg; SAR(10 g) = 2.19 W/kg**  
 Maximum value of SAR (measured) = 16.0 W/kg

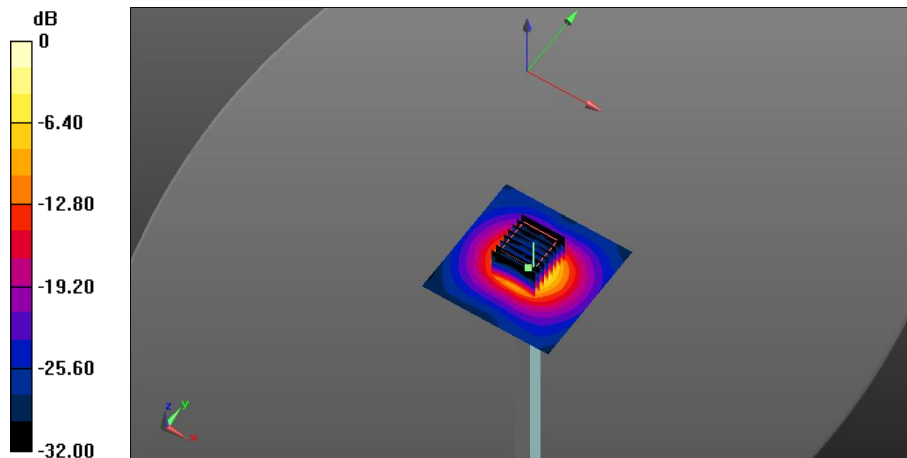

0 dB = 16.0 W/kg = 12.04 dBW/kg



**17. System Check Body Liquid 5800MHz-2**

Test Laboratory: Intel WRF Lab; Date/Time: 1/7/2016 7:57:35 PM

**DUT: Dipole D5GHzV2; Type: D5GHzV2; Serial: D5GHzV2 - SN: 1164**

Communication System: UID 0, CW (0); Communication System Band: D5GHz (5000.0 - 6000.0 MHz); Frequency: 5800 MHz; Communication System PAR: 0 dB  
 Medium parameters used:  $f = 5800 \text{ MHz}$ ;  $\sigma = 5.977 \text{ S/m}$ ;  $\epsilon_r = 44.107$ ;  $\rho = 1000 \text{ kg/m}^3$   
 Phantom section: Flat Section  
 Measurement Standard: DASy5 (IEEE/IEC/ANSI C63.19-2011)

DASY Configuration:

- Probe: EX3DV4 - SN3978; ConvF(4.01, 4.01, 4.01); Calibrated: 6/15/2015;
  - Modulation Compensation:
- Sensor-Surface: 2mm (Mechanical Surface Detection (Locations From Previous Scan Used)), Sensor-Surface: 2mm (Mechanical Surface Detection),  $z = 1.0, 23.0$
- Electronics: DAE4 Sn1429; Calibrated: 6/11/2015
- Phantom: ELI v5.0 (30deg probe tilt); Type: QDOVA002BA;
- DASy52 52.8.8(1222);

**WLAN-5GHz\_01\_07\_2016/System check 5800MHz/Area Scan**

**(81x81x1):** Interpolated grid:  $dx=1.000 \text{ mm}$ ,  $dy=1.000 \text{ mm}$

Maximum value of SAR (interpolated) = 15.6 W/kg

**WLAN-5GHz\_01\_07\_2016/System check 5800MHz/Zoom Scan**

**(8x8x12)/Cube 0:** Measurement grid:  $dx=4\text{mm}$ ,  $dy=4\text{mm}$ ,  $dz=2\text{mm}$

Reference Value = 55.53 V/m; Power Drift = 0.08 dB

Peak SAR (extrapolated) = 32.5 W/kg

**SAR(1 g) = 7.4 W/kg; SAR(10 g) = 2.09 W/kg**

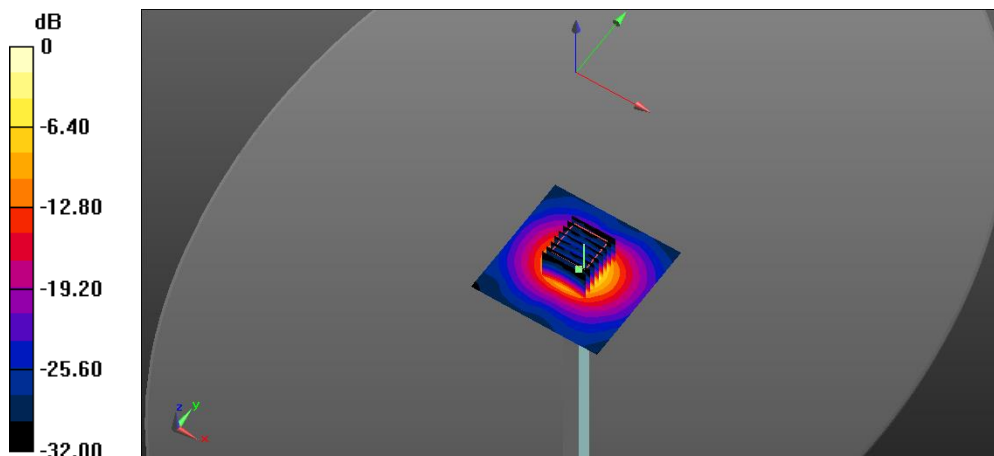

Maximum value of SAR (measured) = 14.8 W/kg



0 dB = 14.8 W/kg = 11.70 dBW/kg

# Annex D. Calibration Certificates

---

Device	Type/Model	Serial Number	Manufacturer	Calibration Certificate
Dosimetric E-field Probe	EX3DV4	3978	SPEAG	
2450MHz System Validation Dipole	D2450V2	937	SPEAG	
5GHz System Validation Dipole	D5GHzv2	1164	SPEAG	

# Annex E. TSL Dielectric Parameters

## Body 2450MHz-

Freq. (MHz)	Target		2016/01/15 Measured		2016/01/14 Measured	
	$\epsilon'$	$\sigma$	$\epsilon'$	$\sigma$	$\epsilon_2'$	$\sigma_2$
2300	52.90	1.81	49.31	1.88	48.71	1.84
2310	52.89	1.82	49.26	1.89	48.68	1.85
2320	52.87	1.82	49.20	1.90	48.65	1.86
2330	52.86	1.83	49.18	1.92	48.62	1.87
2340	52.85	1.84	49.16	1.93	48.59	1.89
2350	52.83	1.85	49.14	1.94	48.56	1.90
2360	52.82	1.86	49.12	1.96	48.53	1.91
2370	52.81	1.87	49.08	1.97	48.50	1.92
2380	52.79	1.88	49.05	1.98	48.47	1.93
2390	52.78	1.89	49.01	2.00	48.44	1.94
2400	52.77	1.90	48.98	2.01	48.41	1.95
2410	52.75	1.91	48.94	2.02	48.38	1.96
2420	52.74	1.92	48.90	2.04	48.35	1.97
2430	52.73	1.93	48.87	2.05	48.32	1.99
2440	52.71	1.94	48.83	2.07	48.29	2.00
2450	52.70	1.95	48.80	2.08	48.26	2.01
2460	52.69	1.96	48.78	2.09	48.23	2.02
2470	52.67	1.98	48.75	2.11	48.20	2.03
2480	52.66	1.99	48.71	2.12	48.17	2.04
2490	52.65	2.01	48.69	2.14	48.14	2.05
2500	52.64	2.02	48.68	2.15	48.10	2.06
2510	52.62	2.03	48.66	2.16	48.07	2.08
2520	52.61	2.05	48.65	2.18	48.04	2.09
2530	52.60	2.06	48.63	2.19	48.01	2.10
2540	52.59	2.08	48.62	2.20	47.98	2.11
2550	52.57	2.09	48.59	2.21	47.95	2.12
2560	52.56	2.11	48.52	2.22	47.92	2.13
2570	52.55	2.12	48.48	2.23	47.89	2.14
2580	52.53	2.13	48.45	2.24	47.85	2.16
2590	52.52	2.15	48.43	2.26	47.82	2.17
2600	52.51	2.16	48.41	2.27	47.79	2.18

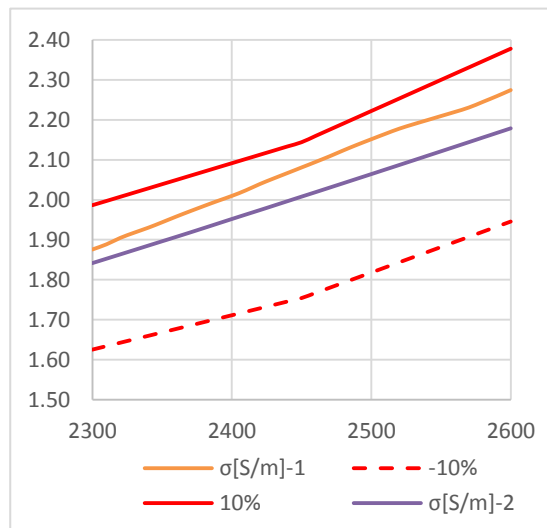
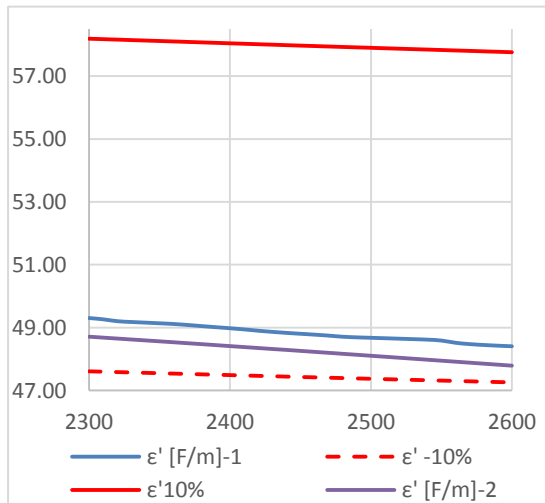

**Body 5300 MHz**

Freq. (MHz)	Target		2016/01/05 Measured		2016/01/06 Measured	
	$\epsilon'$	$\sigma$	$\epsilon'$	$\sigma$	$\epsilon_2'$	$\sigma_2$
	5000	49.29	5.06	45.66	4.93	45.51
5020	49.26	5.09	45.61	4.96	45.47	4.86
5040	49.23	5.11	45.56	5.00	45.44	4.89
5060	49.20	5.13	45.51	5.03	45.42	4.92
5080	49.18	5.16	45.45	5.06	45.39	4.95
5100	49.15	5.18	45.40	5.09	45.36	4.97
5120	49.12	5.20	45.34	5.12	45.33	5.00
5140	49.10	5.23	45.29	5.15	45.30	5.02
5160	49.07	5.25	45.24	5.19	45.26	5.05
5180	49.04	5.27	45.18	5.22	45.23	5.08
5200	49.01	5.30	45.12	5.25	45.20	5.10
5220	48.99	5.32	45.07	5.28	45.17	5.13
5240	48.96	5.34	45.01	5.31	45.14	5.16
5260	48.93	5.37	44.96	5.34	45.11	5.19
5280	48.91	5.39	44.91	5.37	45.08	5.21
5300	48.88	5.41	44.85	5.40	45.05	5.24
5320	48.85	5.44	44.80	5.43	45.02	5.27
5340	48.82	5.46	44.74	5.46	44.99	5.30
5360	48.80	5.48	44.68	5.49	44.95	5.32
5380	48.77	5.51	44.63	5.52	44.91	5.35
5400	48.74	5.53	44.58	5.54	44.88	5.37

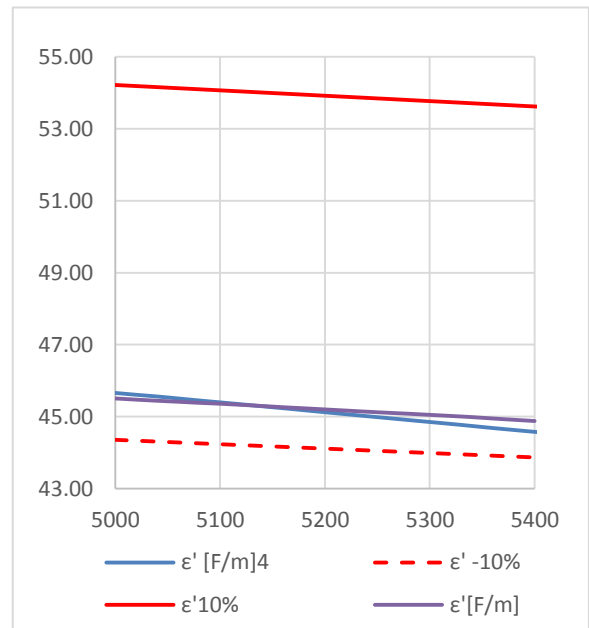
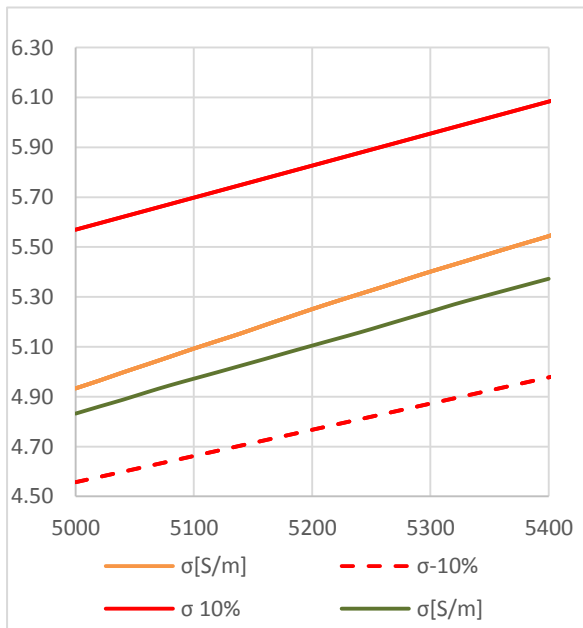

**Body 5600 MHz**

Freq. (MHz)	Target		2016/01/06		2016/01/15	
	$\epsilon'$	$\sigma$	Measured		Measured	
			$\epsilon'$	$\sigma$	$\epsilon_2'$	$\sigma_2$
5440	48.69	5.58	44.81	5.43	47.60	5.82
5460	48.66	5.60	44.77	5.46	47.55	5.85
5480	48.63	5.62	44.73	5.48	47.49	5.88
5500	48.61	5.65	44.70	5.51	47.44	5.91
5520	48.58	5.67	44.66	5.54	47.39	5.95
5540	48.55	5.69	44.62	5.57	47.35	5.98
5560	48.53	5.72	44.58	5.59	47.29	6.00
5580	48.50	5.74	44.54	5.62	47.24	6.03
5600	48.47	5.76	44.50	5.65	47.19	6.06
5620	48.44	5.79	44.46	5.68	47.14	6.09
5640	48.72	5.55	44.42	5.72	47.09	6.12
5660	48.69	5.58	44.38	5.75	47.05	6.15
5680	48.66	5.60	44.35	5.78	47.01	6.17
5700	48.63	5.62	44.31	5.81	46.96	6.20

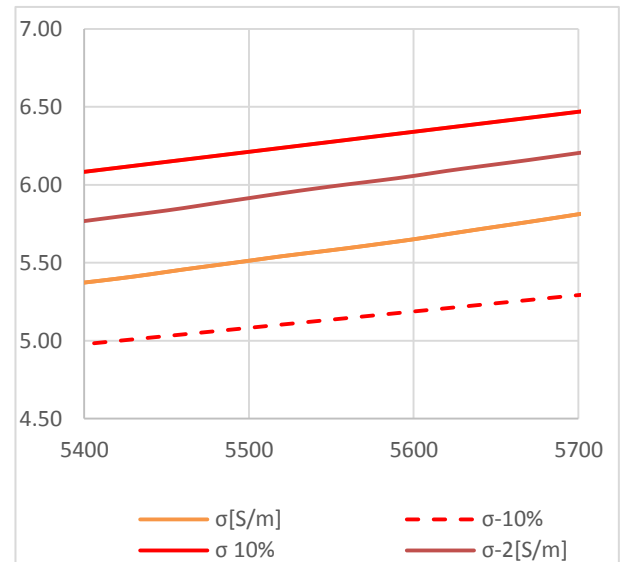
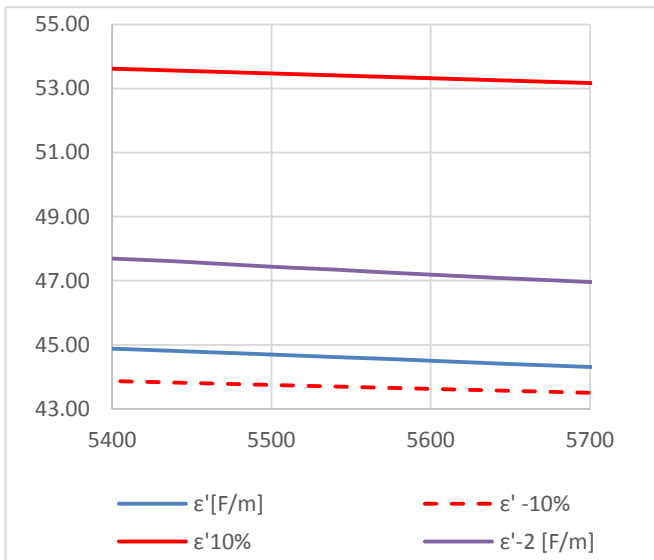

**Body 5800 MHz**

Freq. (MHz)	Target		2016/01/06 Measured		2016/01/15 Measured	
	$\epsilon'$	$\sigma$	$\epsilon'$	$\sigma$	$\epsilon_2'$	$\sigma_2$
	5700	48.34	5.88	44.31	5.81	46.96
5720	48.31	5.90	44.27	5.84	46.91	6.23
5740	48.28	5.93	44.23	5.88	46.86	6.26
5760	48.25	5.95	44.19	5.91	46.81	6.29
5780	48.23	5.97	44.15	5.94	46.75	6.32
5800	48.20	6.00	44.11	5.97	46.71	6.35

