

EMC Test Report

Application for Grant of Equipment Authorization

*Industry Canada RSS-Gen Issue 3 / RSS 210 Issue 8
FCC Part 15, Subpart E*

Model: 3160NGW

IC CERTIFICATION #: 1000M-3160NG
FCC ID: PD93160NG and PD93160NGU

APPLICANT: Intel Mobile Communications
100 Center Point Circle, Suite 200
Columbia, SC 29210, USA

TEST SITE(S): National Technical Systems - Silicon Valley
41039 Boyce Road.
Fremont, CA. 94538-2435

IC SITE REGISTRATION #: 2845B-4, 2845B-7

REPORT DATE: June 17, 2013

FINAL TEST DATES: May 22, 23, 24, 28, 29, 31, June 1, 2, 3, 5, 7 and
10, 2013

TOTAL NUMBER OF PAGES: 156

PROGRAM MGR /
TECHNICAL REVIEWER:



David W. Bare
Chief Engineer

QUALITY ASSURANCE DELEGATE /
FINAL REPORT PREPARER:



David Guidotti
Senior Technical Writer



National Technical Systems - Silicon Valley is accredited by the A2LA, certificate number 0214.26, to perform the test(s) listed in this report, except where noted otherwise. This report and the information contained herein represent the results of testing test articles identified and selected by the client performed to specifications and/or procedures selected by the client. National Technical Systems (NTS) makes no representations, expressed or implied, that such testing is adequate (or inadequate) to demonstrate efficiency, performance, reliability, or any other characteristic of the articles being tested, or similar products. This report should not be relied upon as an endorsement or certification by NTS of the equipment tested, nor does it represent any statement whatsoever as to its merchantability or fitness of the test article, or similar products, for a particular purpose. This report shall not be reproduced except in full

REVISION HISTORY

Rev#	Date	Comments	Modified By
-	06-17-2013	Initial release	-

TABLE OF CONTENTS

REVISION HISTORY2

TABLE OF CONTENTS3

SCOPE.....4

OBJECTIVE5

STATEMENT OF COMPLIANCE.....5

DEVIATIONS FROM THE STANDARDS.....5

TEST RESULTS SUMMARY6

 UNII / LELAN DEVICES6

 GENERAL REQUIREMENTS APPLICABLE TO ALL BANDS.....9

 ADDITIONAL MEASUREMENTS.....9

 MEASUREMENT UNCERTAINTIES.....10

EQUIPMENT UNDER TEST (EUT) DETAILS.....11

 ANTENNA SYSTEM11

 ENCLOSURE.....11

 MODIFICATIONS.....11

 SUPPORT EQUIPMENT.....11

 EUT INTERFACE PORTS12

 EUT OPERATION12

TEST SITE.....13

 GENERAL INFORMATION.....13

 CONDUCTED EMISSIONS CONSIDERATIONS13

 RADIATED EMISSIONS CONSIDERATIONS13

MEASUREMENT INSTRUMENTATION14

 RECEIVER SYSTEM14

 INSTRUMENT CONTROL COMPUTER.....14

 LINE IMPEDANCE STABILIZATION NETWORK (LISN).....14

 FILTERS/ATTENUATORS15

 ANTENNAS.....15

 ANTENNA MAST AND EQUIPMENT TURNTABLE.....15

 INSTRUMENT CALIBRATION.....15

TEST PROCEDURES16

 EUT AND CABLE PLACEMENT16

 CONDUCTED EMISSIONS.....16

 RADIATED EMISSIONS.....17

 CONDUCTED EMISSIONS FROM ANTENNA PORT19

 BANDWIDTH MEASUREMENTS19

 SPECIFICATION LIMITS AND SAMPLE CALCULATIONS.....20

 CONDUCTED EMISSIONS SPECIFICATION LIMITS: FCC 15.207; FCC 15.107(A), RSS GEN20

 GENERAL TRANSMITTER RADIATED EMISSIONS SPECIFICATION LIMITS21

 RECEIVER RADIATED SPURIOUS EMISSIONS SPECIFICATION LIMITS21

 FCC 15.407 (A) OUTPUT POWER LIMITS22

 OUTPUT POWER LIMITS –LELAN DEVICES.....22

 SPURIOUS EMISSIONS LIMITS –UNII AND LELAN DEVICES23

 SAMPLE CALCULATIONS - CONDUCTED EMISSIONS23

 SAMPLE CALCULATIONS - RADIATED EMISSIONS.....23

 SAMPLE CALCULATIONS - FIELD STRENGTH TO EIRP CONVERSION.....24

APPENDIX A TEST EQUIPMENT CALIBRATION DATA25

APPENDIX B TEST DATA29

END OF REPORT156

SCOPE

An electromagnetic emissions test has been performed on the Intel Mobile Communications models 3160NGW, pursuant to the following rules:

Industry Canada RSS-Gen Issue 3
RSS 210 Issue 8 “Low-power Licence-exempt Radiocommunication Devices (All Frequency Bands): Category I Equipment”
FCC Part 15, Subpart E requirements for UNII Devices

Conducted and radiated emissions data has been collected, reduced, and analyzed within this report in accordance with measurement guidelines set forth in the following reference standards and as outlined in National Technical Systems - Silicon Valley test procedures:

ANSI C63.4:2003
FCC UNII test procedure KDB 789033

The intentional radiator above has been tested in a simulated typical installation to demonstrate compliance with the relevant Industry Canada performance and procedural standards.

Final system data was gathered in a mode that tended to maximize emissions by varying orientation of EUT, orientation of power and I/O cabling, antenna search height, and antenna polarization.

Every practical effort was made to perform an impartial test using appropriate test equipment of known calibration. All pertinent factors have been applied to reach the determination of compliance.

OBJECTIVE

The primary objective of the manufacturer is compliance with the regulations outlined in the previous section.

Prior to marketing in the USA, all unlicensed transmitters and transceivers require certification. Receive-only devices operating between 30 MHz and 960 MHz are subject to either certification or a manufacturer's declaration of conformity, with all other receive-only devices exempt from the technical requirements.

Prior to marketing in Canada, Class I transmitters, receivers and transceivers require certification. Class II devices are required to meet the appropriate technical requirements but are exempt from certification requirements.

Certification is a procedure where the manufacturer submits test data and technical information to a certification body and receives a certificate or grant of equipment authorization upon successful completion of the certification body's review of the submitted documents. Once the equipment authorization has been obtained, the label indicating compliance must be attached to all identical units, which are subsequently manufactured.

Maintenance of compliance is the responsibility of the manufacturer. Any modification of the product which may result in increased emissions should be checked to ensure compliance has been maintained (i.e., printed circuit board layout changes, different line filter, different power supply, harnessing or I/O cable changes, etc.).

STATEMENT OF COMPLIANCE

The tested sample(s) of Intel Mobile Communications models 3160NGW complied with the requirements of the following regulations:

RSS 210 Issue 8 "Low-power Licence-exempt Radiocommunication Devices (All Frequency Bands): Category I Equipment"
FCC Part 15, Subpart E requirements for UNII Devices

Maintenance of compliance is the responsibility of the manufacturer. Any modifications to the product should be assessed to determine their potential impact on the compliance status of the device with respect to the standards detailed in this test report.

The test results recorded herein are based on a single type test of Intel Mobile Communications models 3160NGW and therefore apply only to the tested sample(s). The sample(s) were selected and prepared by Stephen Hackett of Intel Mobile Communications.

DEVIATIONS FROM THE STANDARDS

No deviations were made from the published requirements listed in the scope of this report.

TEST RESULTS SUMMARY**UNII / LELAN DEVICES****Operation in the 5.15 – 5.25 GHz Band**

FCC Rule Part	RSS Rule Part	Description	Measured Value / Comments	Limit / Requirement	Result
15.407(e)		Indoor operation only	Refer to user's manual	N/A	Complies
15.407(a)(2)		26dB Bandwidth	>20 MHz in all modes	N/A – limits output power if < 20MHz	N/A
15.407 (a)(1)		Output Power	a: 0.043 W n20: 0.045 W n40: 0.046 W ac80: 0.012 W (Max eirp: 0.106 W) ¹	17dBm (50 mW) (eirp < 23dBm)	Complies
	A9.2(1)	Output Power	a: 0.043 W n20: 0.045 W n40: 0.046 W ac80: 0.012 W (Max eirp: 0.106 W) ¹	16.3dBm ² 16.6 dBm ² 17.0 dBm 17.0 dBm (eirp < 23dBm)	Complies
15.407 (a)(1)	-	Power Spectral Density	a: 3.5 dBm/MHz n20: 3.4 dBm/MHz n40: 1.3 dBm/MHz ac80: -6.7 dBm/MHz	4 dBm/MHz	Complies
-	A9.2(1) / A9.4 (2)			6.4 dBm/MHz	Complies

Note 1: EIRP calculated using antenna gain of 3.6 dBi for the highest EIRP system.

Note 2: Power for RSS 210 is limited by minimum 99% bandwidth and this is the lowest limit based on the results.

Operation in the 5.25 – 5.35 GHz Band

Note: The device is restricted to indoor use only, therefore the spectral density of spurious emissions in the 5.15 – 5.25 GHz band were limited to the power spectral limits for intentional signals detailed in FCC 15.407(a)(1) and RSS 210 6.2.2 q1 (i)

FCC Rule Part	RSS Rule Part	Description	Measured Value / Comments	Limit / Requirement	Result (margin)
15.407(a)(2)		26dB Bandwidth	>20 MHz in all modes	N/A – limits output power if < 20MHz	N/A
15.407(a)(2)		Output Power	a: 0.053 W n20: 0.054 W n40: 0.027 W ac80: 0.018 W (Max eirp: 0.128 W) ¹	24dBm (250mW) (eirp < 30dBm)	Complies
	A9.2(2)	Output Power	a: 0.053 W n20: 0.054 W n40: 0.027 W ac80: 0.018 W (Max eirp: 0.128 W) ¹	23.3dBm ² 23.6 dBm ² 24.0 dBm 24.0 dBm (eirp < 30dBm)	Complies
15.407(a)(2)	-	Power Spectral Density	a: 4.5 dBm/MHz n20: 4.2 dBm/MHz n40: -1.1 dBm/MHz ac80: -3.6 dBm/MHz	11 dBm/MHz	Complies
-	A9.2(2) / A9.4 (2)	Power Spectral Density		11 dBm / MHz	Complies

Note 1: EIRP calculated using antenna gain of 3.7 dBi for the highest EIRP system.

Note 2: Power for RSS 210 is limited by minimum 99% bandwidth and this is the lowest limit based on the results.

Operation in the 5.47 – 5.725 GHz Band

FCC Rule Part	RSS Rule Part	Description	Measured Value / Comments	Limit / Requirement	Result (margin)
15.407(a) (2)		26dB Bandwidth	>20 MHz in all modes	N/A – limits output power if < 20MHz	N/A
15.407(a) (2)		Output Power	a: 0.047 W n20: 0.046 W n40: 0.046 W ac80: 0.030 W (Max eirp: 0.143 W)	24 dBm 250mW (eirp < 30dBm)	Complies
15.407(a) (2)	A9.2(3)	Output Power	a: 0.047 W n20: 0.046 W ac20: 0.035 W n40: 0.046 W ac80: 0.030 W (Max eirp: 0.143 W)	23.3dBm ² 23.6 dBm ² 22.6 dBm ² 24.0 dBm 24.0 dBm (eirp < 30dBm)	Complies
15.407(a) (2))		Power Spectral Density	a: 4.0 dBm/MHz n20: 3.5 dBm/MHz ac20: 3.5 dBm/MHz n40: 1.2 dBm/MHz	11 dBm/MHz	Complies
	A9.2(3) / A9.4 (2)	Power Spectral Density	ac40: 0.9 dBm/MHz ac80: -1.9 dBm/MHz	11 dBm / MHz	Complies
KDB 443999	A9	Non-operation in 5600 – 5650 MHz sub band	Device cannot operate in the 5600 – 5650 MHz band –refer to Operational Description and test results		Complies
Note 1: EIRP calculated using antenna gain of 4.8 dBi for the highest EIRP system.					
Note 2: Power for RSS 210 is limited by minimum 99% bandwidth and this is the lowest limit based on the results.					

Operation in the 5.725 – 5.825 GHz Band

FCC Rule Part	RSS Rule Part	Description	Measured Value / Comments	Limit / Requirement	Result (margin)
15.407(a) (3)		26dB Bandwidth	>20 MHz in all modes	N/A – limits output power if < 20MHz	N/A
15.407(a) (3)	A9.2(4)	Output Power	ac20: 0.010 W ac40: 0.002 W ac80: 0.001 W (Max eirp: 0.101 W)	30 dBm 1 W (eirp < 36dBm)	Complies
15.407(a) (3))		Power Spectral Density	ac20: 3.5 dBm/MHz ac40: -2.4 dBm/MHz	17 dBm/MHz	Complies
	A9.2(4) / A9.4 (2)	Power Spectral Density	ac80: -7.8 dBm/MHz	17 dBm / MHz	Complies
Note 1: EIRP calculated using antenna gain of 4.8 dBi for the highest EIRP system.					
Note 2: Power for RSS 210 is limited by minimum 99% bandwidth and this is the lowest limit based on the results.					

Requirements for all U-NII/LELAN bands

FCC Rule Part	RSS Rule Part	Description	Measured Value / Comments	Limit / Requirement	Result
15.407	A9.5a	Modulation	Digital Modulation is used	Digital modulation is required	Complies
15.407(b)(5) / 15.209	A9.3	Spurious Emissions	66.9 dB μ V/m @ 5462.1 MHz (-1.4 dB)	Refer to page 23	Complies
15.407(a)(6)	-	Peak Excursion Ratio	Maximum 8.4 dB	< 13dB	Complies
	A9.5 (3)	Channel Selection	Spurious emissions tested at outermost channels in each band	Device was tested on the top, bottom and center channels in each band	Complies
15			Measurements on three channels in each band		Complies
15.407 (c)	A9.5(4)	Operation in the absence of information to transmit	Operation is discontinued in the absence of information (Operational Description page 9)	Device shall automatically discontinue operation in the absence of information to transmit	Complies
15.407 (g)	A9.5 (5)	Frequency Stability	Frequency stability is better than 20ppm (Operational Description page 9)	Signal shall remain within the allocated band	Complies
15.407 (h1)	A9.4	Transmit Power Control	TPC is not required as the device operates at below 500mW eirp	The U-NII device shall have the capability to operate with a mean EIRP value lower than 24dBm (250mW)	Complies
15.407 (h2)	A9.4	Dynamic frequency Selection (device without radar detection)	Refer to separate test report, reference R92627	Channel move time < 10s Channel closing transmission time < 260ms	Complies
	A9.9g	User Manual information	Refer to Pages 20 of the user manual for details	Warning regarding interference from Satellite Systems	Complies

GENERAL REQUIREMENTS APPLICABLE TO ALL BANDS

FCC Rule Part	RSS Rule part	Description	Measured Value / Comments	Limit / Requirement	Result (margin)
15.203	-	RF Connector	Not applicable as antennas are integral in host systems	Unique or integral antenna required	Complies
15.207	RSS GEN Table 2	AC Conducted Emissions	50.6 dB μ V @ 0.208 MHz (-12.7 dB)	Refer to page 20	Complies
15.247 (b) (5) 15.407 (f)	RSS 102	RF Exposure Requirements	Refer to SAR report and RSS 102 declaration	Refer to OET 65, FCC Part 1 and RSS 102	Complies
-	RSP 100 RSS GEN 7.1.5	User Manual	Refer to User Manual for details	Statement required regarding non-interference	Complies
-	RSP 100 RSS GEN 7.1.5	User Manual	No detachable antenna	Statement for products with detachable antenna	Complies
-	RSP 100 RSS GEN 4.4.1	99% Bandwidth	a: 17.0 MHz n20: 18.2 MHz ac20: 19.0 MHz n40: 36.2 MHz ac40: 36.2 MHz ac80: 88.0 MHz	Information only	N/A

ADDITIONAL MEASUREMENTS

As both Bluetooth and 802.11 transmissions can occur simultaneously, radiated spurious measurements were made with both Bluetooth and 802.11 transmitting simultaneously.

FCC Rule Part	RSS Rule Part	Description	Measured Value / Comments	Limit / Requirement	Result
15.209	RSS 210 A8.5	Radiated Spurious Emissions	50.8 dB μ V/m @ 4960.0 MHz (-3.2 dB)	15.209 in restricted bands, all others < -20dBc or < -30dBc ^{Note 2}	Complies
Emission was second harmonic of the Bluetooth signal and not an intermodulation product, but was the highest amplitude emissions observed with both Bluetooth and Wi-Fi operating simultaneously.					

MEASUREMENT UNCERTAINTIES

ISO/IEC 17025 requires that an estimate of the measurement uncertainties associated with the emissions test results be included in the report. The measurement uncertainties given below are based on a 95% confidence level and were calculated in accordance with UKAS document LAB 34.

Measurement Type	Measurement Unit	Frequency Range	Expanded Uncertainty
RF power, conducted (power meter)	dBm	25 to 7000 MHz	± 0.52 dB
RF power, conducted (Spectrum analyzer)	dBm	25 to 7000 MHz	± 0.7 dB
Conducted emission of transmitter	dBm	25 to 26500 MHz	± 0.7 dB
Conducted emission of receiver	dBm	25 to 26500 MHz	± 0.7 dB
Radiated emission (substitution method)	dBm	25 to 26500 MHz	± 2.5 dB
Radiated emission (field strength)	dB μ V/m	25 to 1000 MHz	± 3.6 dB
		1000 to 40000 MHz	± 6.0 dB
Conducted Emissions (AC Power)	dB μ V	0.15 to 30 MHz	± 2.4 dB

EQUIPMENT UNDER TEST (EUT) DETAILS

The Intel Mobile Communications model 3160NGW is M.2 (Next Generation Form Factor) IEEE 802.11a/b/g/n/ac wireless network adapter module that supports 1x1 (SISO) operation and Bluetooth operation in Basic Rate, Enhanced Data Rate and Low Energy modes.

The card is sold under two different FCC ID numbers (see table below). The ID ending in "U" is intended to allow user install conditions and host systems must be provided with a BIOS lock feature that prevents installation of unauthorized devices.

For radio testing purposes the card was installed in a test fixture that exposed all sides of the card. For digital device testing for certification under equipment code JBP the card was installed in a test fixture external to the PC.

The samples were received on May 20, 2013 and tested on May 22, 23, 24, 28, 29, 31, June 1, 2, 3, 5, 7 and 10, 2013. The samples tested are as follows:

Company	Model	Description	Serial Number	FCC ID
Intel Mobile Communications	3160NGW	Bluetooth / IEEE 802.11a/b/g/n wireless network adapter module	BD5C22 or BD5C54	PD93160NG PD93160NGU 1000M-3160NG

ANTENNA SYSTEM

The EUT antenna is a two-antenna PIFA antenna system – Shanghai Universe Communication Electron Co., Ltd. One antenna is used for WiFi operation and one for Bluetooth operation.

The antenna connects to the EUT via a non-standard antenna connector, thereby meeting the requirements of FCC 15.203.

ENCLOSURE

The EUT has no enclosure. It is designed to be installed within the enclosure of a host computer.

MODIFICATIONS

No modifications were made to the EUT during the time the product was at National Technical Systems - Silicon Valley.

SUPPORT EQUIPMENT

The following equipment was used as support equipment for testing:

Company	Model	Description	Serial Number	FCC ID
Intel Mobile Communications	HMC-NGFF Extension REV.01	Extender board	-	N/A
Dell	Latitude D520	Laptop PC	HM9383J	N/A
or				
Dell	Latitude E5400	Laptop PC	GFZW54J	N/A

EUT INTERFACE PORTS

The I/O cabling configuration during testing was as follows:

Port	Connected To	Description	Cable(s)	
			Shielded or Unshielded	Length(m)
Laptop Mini PCIe slot	Extender Board PCIe	Ribbon	Unshielded	0.8

EUT OPERATION

The EUT was installed into a test fixture that exposed all sides of the card. The test fixture interfaced to a laptop computer for power and control. The laptop computer was used to configure the EUT to continuously transmit at a specified output power on the channel specified in the test data. For transmit mode measurements the system was configured to operate in each of the available operating modes – 802.11b, 802.11g, 802.11n (20 MHz and 40 MHz channel bandwidths), 802.11ac (20, 40 and 80 MHz channel bandwidths), Bluetooth 1Mb/s and Bluetooth 3Mb/s. In addition radiated spurious tests were repeated with the device operating in both Bluetooth and 802.11 modes to determine if any spurious emissions due to intermodulation products were created.

The data rates used for all tests were the lowest data rates for each 802.11 mode – 1Mb/s for 802.11b, 6Mb/s for 802.11a and 802.11g, 6.5MB/s for 802.11n20, and 13 Mb/s for 802.11n40 except 802.11ac80 mode was tested at 390Mb/s. The device operates at its maximum output power at the lowest data rate except for 802.11ac80 mode (this was confirmed through separate measurements – refer to test data for actual measurements). Bluetooth operation was evaluated at both 1Mb/s and 3Mb/s data rates. 2Mb/s data rate was found, through preliminary testing, to produce emissions similar to those for 3Mb/s. The PC was using the Intel test utility DRTU Version 1.6.1-628 and the device driver was version 16.0.0.49.

TEST SITE**GENERAL INFORMATION**

Final test measurements were taken at the test sites listed below. Pursuant to section 2.948 of the FCC's Rules and section 3.3 of RSP-100, construction, calibration, and equipment data has been filed with the Commission and with industry Canada.

Site	Registration Numbers		Location
	FCC	Canada	
Chamber 4	211948	2845B-4	41039 Boyce Road Fremont, CA 94538-2435
Chamber 7	A2LA accreditation	2845B-7	

ANSI C63.4:2003 recommends that ambient noise at the test site be at least 6 dB below the allowable limits. Ambient levels are below this requirement. The test site(s) contain separate areas for radiated and conducted emissions testing. Considerable engineering effort has been expended to ensure that the facilities conform to all pertinent requirements of ANSI C63.4:2003.

CONDUCTED EMISSIONS CONSIDERATIONS

Conducted emissions testing is performed in conformance with ANSI C63.4:2003. Measurements are made with the EUT connected to the public power network through a nominal, standardized RF impedance, which is provided by a line impedance stabilization network, known as a LISN. A LISN is inserted in series with each current-carrying conductor in the EUT power cord.

RADIATED EMISSIONS CONSIDERATIONS

The FCC has determined that radiation measurements made in a shielded enclosure are not suitable for determining levels of radiated emissions. Radiated measurements are performed in an open field environment or in a semi-anechoic chamber. The test sites are maintained free of conductive objects within the CISPR defined elliptical area incorporated in ANSI C63.4:2003 guidelines and meet the Normalized Site Attenuation (NSA) requirements of ANSI C63.4:2003.

MEASUREMENT INSTRUMENTATION

RECEIVER SYSTEM

An EMI receiver as specified in CISPR 16-1-1 is used for emissions measurements. The receivers used can measure over the frequency range of 9 kHz up to 2000 MHz. These receivers allow both ease of measurement and high accuracy to be achieved. The receivers have Peak, Average, and CISPR (Quasi-peak) detectors built into their design so no external adapters are necessary. The receiver automatically sets the required bandwidth for the CISPR detector used during measurements. If the repetition frequency of the signal being measured is below 20Hz, peak measurements are made in lieu of Quasi-Peak measurements.

For measurements above the frequency range of the receivers, a spectrum analyzer is utilized because it provides visibility of the entire spectrum along with the precision and versatility required to support engineering analysis. Average measurements above 1000MHz are performed on the spectrum analyzer using the linear-average method with a resolution bandwidth of 1 MHz and a video bandwidth of 10 Hz, unless the signal is pulsed in which case the average (or video) bandwidth of the measuring instrument is reduced to onset of pulse desensitization and then increased.

INSTRUMENT CONTROL COMPUTER

The receivers utilize either a Rohde & Schwarz EZM Spectrum Monitor/Controller or contain an internal Spectrum Monitor/Controller to view and convert the receiver measurements to the field strength at an antenna or voltage developed at the LISN measurement port, which is then compared directly with the appropriate specification limit. This provides faster, more accurate readings by performing the conversions described under Sample Calculations within the Test Procedures section of this report. Results are printed in a graphic and/or tabular format, as appropriate. A personal computer is used to record all measurements made with the receivers.

The Spectrum Monitor provides a visual display of the signal being measured. In addition, the controller or a personal computer run automated data collection programs which control the receivers. This provides added accuracy since all site correction factors, such as cable loss and antenna factors are added automatically.

LINE IMPEDANCE STABILIZATION NETWORK (LISN)

Line conducted measurements utilize a fifty microhenry Line Impedance Stabilization Network as the monitoring point. The LISN used also contains a 250 uH CISPR adapter. This network provides for calibrated radio frequency noise measurements by the design of the internal low pass and high pass filters on the EUT and measurement ports, respectively.

FILTERS/ATTENUATORS

External filters and precision attenuators are often connected between the receiving antenna or LISN and the receiver. This eliminates saturation effects and non-linear operation due to high amplitude transient events.

ANTENNAS

A loop antenna is used below 30 MHz. For the measurement range 30 MHz to 1000 MHz either a combination of a biconical antenna and a log periodic or a bi-log antenna is used. Above 1000 MHz, horn antennas are used. The antenna calibration factors to convert the received voltage to an electric field strength are included with appropriate cable loss and amplifier gain factors to determine an overall site factor, which is then programmed into the test receivers or incorporated into the test software.

ANTENNA MAST AND EQUIPMENT TURNTABLE

The antennas used to measure the radiated electric field strength are mounted on a non-conductive antenna mast equipped with a motor-drive to vary the antenna height. Measurements below 30 MHz are made with the loop antenna at a fixed height of 1m above the ground plane.

ANSI C63.4:2003 specifies that the test height above ground for table mounted devices shall be 80 centimeters. Floor mounted equipment shall be placed on the ground plane if the device is normally used on a conductive floor or separated from the ground plane by insulating material from 3 to 12 mm if the device is normally used on a non-conductive floor. During radiated measurements, the EUT is positioned on a motorized turntable in conformance with this requirement.

INSTRUMENT CALIBRATION

All test equipment is regularly checked to ensure that performance is maintained in accordance with the manufacturer's specifications. All antennas are calibrated at regular intervals with respect to tuned half-wave dipoles. An exhibit of this report contains the list of test equipment used and calibration information.

TEST PROCEDURES

EUT AND CABLE PLACEMENT

The regulations require that interconnecting cables be connected to the available ports of the unit and that the placement of the unit and the attached cables simulate the worst case orientation that can be expected from a typical installation, so far as practicable. To this end, the position of the unit and associated cabling is varied within the guidelines of ANSI C63.4:2003, and the worst-case orientation is used for final measurements.

CONDUCTED EMISSIONS

Conducted emissions are measured at the plug end of the power cord supplied with the EUT. Excess power cord length is wrapped in a bundle between 30 and 40 centimeters in length near the center of the cord. Preliminary measurements are made to determine the highest amplitude emission relative to the specification limit for all the modes of operation. Placement of system components and varying of cable positions are performed in each mode. A final peak mode scan is then performed in the position and mode for which the highest emission was noted on all current carrying conductors of the power cord.

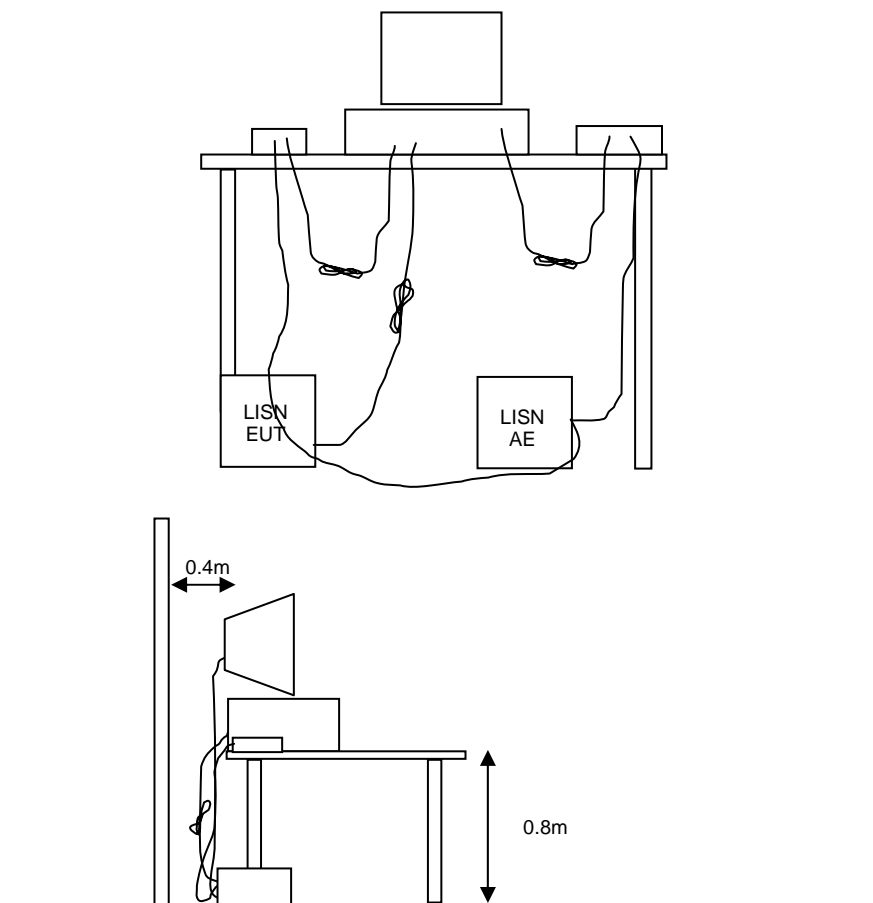

Figure 1 Typical Conducted Emissions Test Configuration

RADIATED EMISSIONS

A preliminary scan of the radiated emissions is performed in which all significant EUT frequencies are identified with the system in a nominal configuration. At least two scans are performed, one scan for each antenna polarization (horizontal and vertical; loop parallel and perpendicular to the EUT). During the preliminary scans, the EUT is rotated through 360°, the antenna height is varied (for measurements above 30 MHz) and cable positions are varied to determine the highest emission relative to the limit. Preliminary scans may be performed in a fully anechoic chamber for the purposes of identifying the frequencies of the highest emissions from the EUT.

A speaker is provided in the receiver to aid in discriminating between EUT and ambient emissions. Other methods used during the preliminary scan for EUT emissions involve scanning with near field magnetic loops, monitoring I/O cables with RF current clamps, and cycling power to the EUT.

Final maximization is a phase in which the highest amplitude emissions identified in the spectral search are viewed while the EUT azimuth angle is varied from 0 to 360 degrees relative to the receiving antenna. The azimuth, which results in the highest emission is then maintained while varying the antenna height from one to four meters (for measurements above 30 MHz, measurements below 30 MHz are made with the loop antenna at a fixed height of 1m). The result is the identification of the highest amplitude for each of the highest peaks. Each recorded level is corrected in the receiver using appropriate factors for cables, connectors, antennas, and preamplifier gain.

When testing above 18 GHz, the receive antenna is located at 1 meter from the EUT and the antenna height is restricted to a maximum of 2.5 meters.

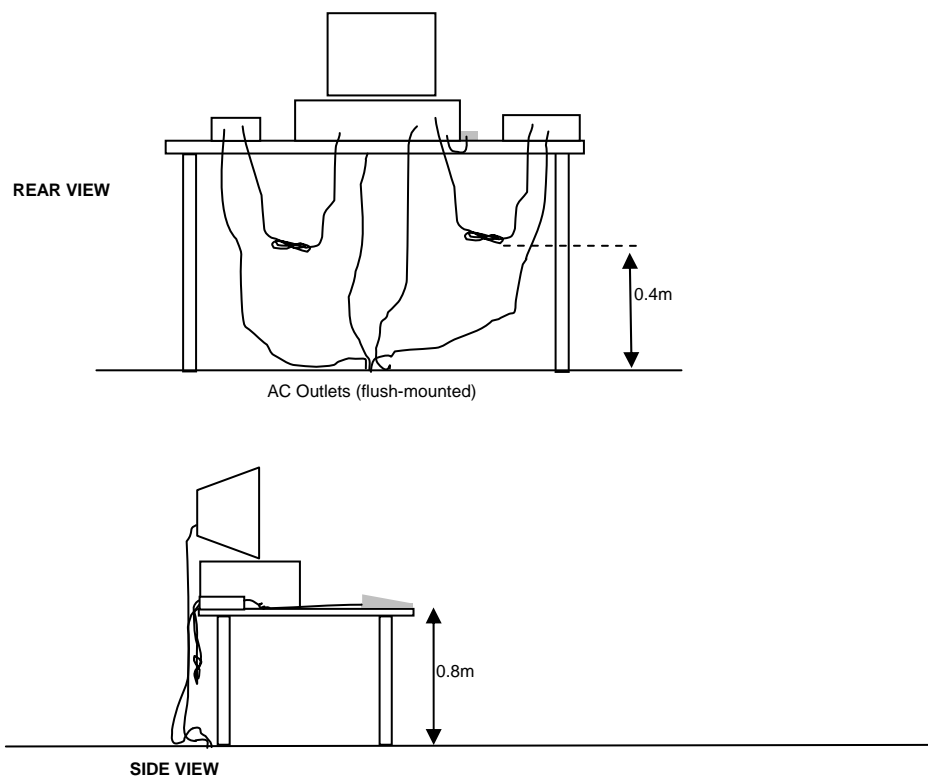

Typical Test Configuration for Radiated Field Strength Measurements

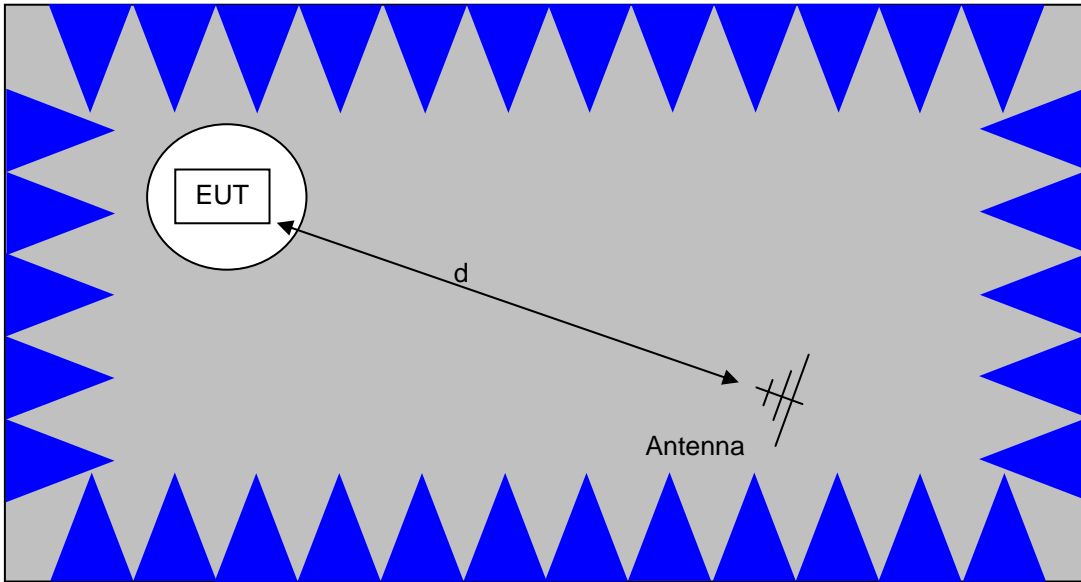

The anechoic materials on the walls and ceiling ensure compliance with the normalized site attenuation requirements of CISPR 16 / CISPR 22 / ANSI C63.4 for an alternate test site at the measurement distances used.

Floor-standing equipment is placed on the floor with insulating supports between the unit and the ground plane.

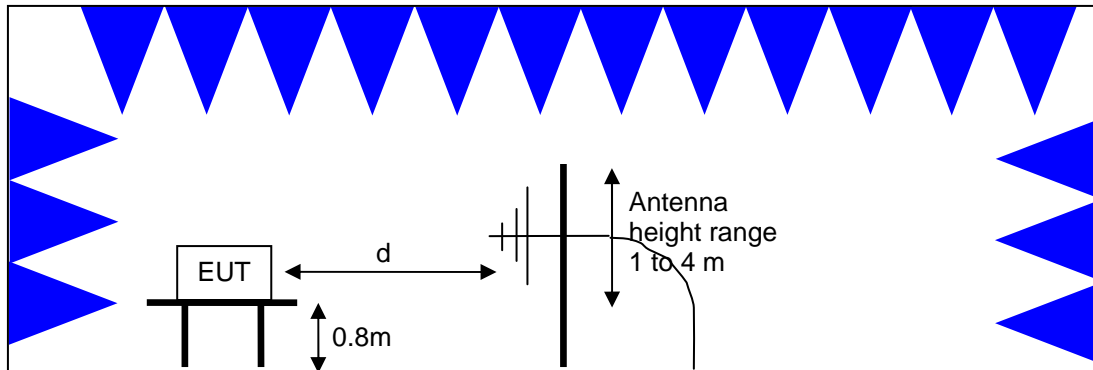

Test Configuration for Radiated Field Strength Measurements
Semi-Anechoic Chamber, Plan and Side Views

CONDUCTED EMISSIONS FROM ANTENNA PORT

Direct measurements of power, bandwidth and power spectral density are performed, where possible, with the antenna port of the EUT connected to either the power meter or spectrum analyzer via a suitable attenuator and/or filter. These are used to ensure that the front end of the measurement instrument is not overloaded by the fundamental transmission.

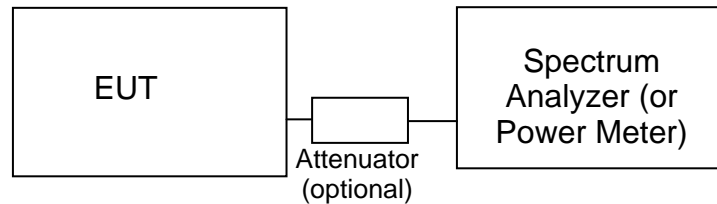
**Test Configuration for Antenna Port Measurements**

Measurement bandwidths (video and resolution) are set in accordance with the relevant standards and National Technical Systems - Silicon Valley's test procedures for the type of radio being tested. When power measurements are made using a resolution bandwidth less than the signal bandwidth the power is calculated by summing the power across the signal bandwidth using either the analyzer channel power function or by capturing the trace data and calculating the power using software. In both cases the summed power is corrected to account for the equivalent noise bandwidth (ENBW) of the resolution bandwidth used.

If power averaging is used (typically for certain digital modulation techniques), the EUT is configured to transmit continuously. Power averaging is performed using either the built-in function of the analyzer or, if the analyzer does not feature power averaging, using external software. In both cases the average power is calculated over a number of sweeps (typically 100). When the EUT cannot be configured to continuously transmit then either the analyzer is configured to perform a gated sweep to ensure that the power is averaged over periods that the device is transmitting or power averaging is disabled and a max-hold feature is used.

If a power meter is used to make output power measurements the sensor head type (peak or average) is stated in the test data table.

BANDWIDTH MEASUREMENTS

The 6dB, 20dB and/or 26dB signal bandwidth is measured in using the bandwidths recommended by ANSI C63.4. When required, the 99% bandwidth is measured using the methods detailed in RSS GEN.

SPECIFICATION LIMITS AND SAMPLE CALCULATIONS

The limits for conducted emissions are given in units of microvolts, and the limits for radiated emissions are given in units of microvolts per meter at a specified test distance. Data is measured in the logarithmic form of decibels relative to one microvolt, or dB microvolts (dBuV). For radiated emissions, the measured data is converted to the field strength at the antenna in dB microvolts per meter (dBuV/m). The results are then converted to the linear forms of uV and uV/m for comparison to published specifications.

For reference, converting the specification limits from linear to decibel form is accomplished by taking the base ten logarithm, then multiplying by 20. These limits in both linear and logarithmic form are as follows:

CONDUCTED EMISSIONS SPECIFICATION LIMITS: FCC 15.207; FCC 15.107(a), RSS GEN

The table below shows the limits for the emissions on the AC power line from an intentional radiator and a receiver.

Frequency (MHz)	Average Limit (dBuV)	Quasi Peak Limit (dBuV)
0.150 to 0.500	Linear decrease on logarithmic frequency axis between 56.0 and 46.0	Linear decrease on logarithmic frequency axis between 66.0 and 56.0
0.500 to 5.000	46.0	56.0
5.000 to 30.000	50.0	60.0

GENERAL TRANSMITTER RADIATED EMISSIONS SPECIFICATION LIMITS

The table below shows the limits for the spurious emissions from transmitters that fall in restricted bands¹ (with the exception of transmitters operating under FCC Part 15 Subpart D and RSS 210 Annex 9), the limits for all emissions from a low power device operating under the general rules of RSS 310 (tables 3 and 4), RSS 210 (table 2) and FCC Part 15 Subpart C section 15.209.

Frequency Range (MHz)	Limit (uV/m)	Limit (dBuV/m @ 3m)
0.009-0.490	2400/F _{KHz} @ 300m	67.6-20*log ₁₀ (F _{KHz}) @ 300m
0.490-1.705	24000/F _{KHz} @ 30m	87.6-20*log ₁₀ (F _{KHz}) @ 30m
1.705 to 30	30 @ 30m	29.5 @ 30m
30 to 88	100 @ 3m	40 @ 3m
88 to 216	150 @ 3m	43.5 @ 3m
216 to 960	200 @ 3m	46.0 @ 3m
Above 960	500 @ 3m	54.0 @ 3m

RECEIVER RADIATED SPURIOUS EMISSIONS SPECIFICATION LIMITS

The table below shows the limits for the spurious emissions from receivers as detailed in FCC Part 15.109, RSS 210 Table 2, RSS GEN Table 1 and RSS 310 Table 3. Note that receivers operating outside of the frequency range 30 MHz – 960 MHz are exempt from the requirements of 15.109.

Frequency Range (MHz)	Limit (uV/m @ 3m)	Limit (dBuV/m @ 3m)
30 to 88	100	40
88 to 216	150	43.5
216 to 960	200	46.0
Above 960	500	54.0

¹ The restricted bands are detailed in FCC 15.203, RSS 210 Table 1 and RSS 310 Table 2

FCC 15.407 (a) OUTPUT POWER LIMITS

The table below shows the limits for output power and output power density. Where the signal bandwidth is less than 20 MHz the maximum output power is reduced to the power spectral density limit plus 10 times the log of the bandwidth (in MHz).

Operating Frequency (MHz)	Output Power	Power Spectral Density
5150 – 5250	50mW (17 dBm)	4 dBm/MHz
5250 – 5350	250 mW (24 dBm)	11 dBm/MHz
5725 – 5825	1 Watts (30 dBm)	17 dBm/MHz

For system using antennas with gains exceeding 6dBi, the output power and power spectral density limits are reduced by 1dB for every dB the antenna gain exceeds 6dBi. Fixed point-to-point applications using the 5725 – 5825 MHz band may use antennas with gains of up to 23dBi without this limitation. If the gain exceeds 23dBi then the output power limit of 1 Watt is reduced by 1dB for every dB the gain exceeds 23dBi.

The peak excursion envelope is limited to 13dB.

OUTPUT POWER LIMITS –LELAN DEVICES

The table below shows the limits for output power and output power density defined by RSS 210. Where the signal bandwidth is less than 20 MHz the maximum output power is reduced to the power spectral density limit plus 10 times the log of the bandwidth (in MHz).

Operating Frequency (MHz)	Output Power	Power Spectral Density
5150 – 5250	200mW (23 dBm) eirp	10 dBm/MHz eirp
5250 – 5350	250 mW (24 dBm) ² 1W (30dBm) eirp	11 dBm/MHz
5470 – 5725	250 mW (24 dBm) ³ 1W (30dBm) eirp	11 dBm/MHz
5725 – 5825	1 Watts (30 dBm) 4W eirp	17 dBm/MHz

In addition, the power spectral density limit shall be reduced by 1dB for every dB the highest power spectral density exceeds the “average” power spectral density) by more than 3dB. The “average” power spectral density is determined by dividing the output power by $10\log(\text{EBW})$ where EBW is the 99% power bandwidth.

Fixed point-to-point applications using the 5725 – 5825 MHz band may use antennas with gains of up to 23dBi without this limitation. If the gain exceeds 23dBi then the output power limit of 1 Watt is reduced by 1dB for every dB the gain exceeds 23dBi.

² If EIRP exceeds 500mW the device must employ TPC

³ If EIRP exceeds 500mW the device must employ TPC

SPURIOUS EMISSIONS LIMITS –UNII and LELAN DEVICES

The spurious emissions limits for signals below 1GHz are the FCC/RSS-GEN general limits. For emissions above 1GHz, signals in restricted bands are subject to the FCC/RSS GEN general limits. All other signals have a limit of -27dBm/MHz , which is a field strength of 68.3dBuV/m/MHz at a distance of 3m. This is an average limit so the peak value of the emission may not exceed -7dBm/MHz (88.3dBuV/m/MHz at a distance of 3m). For devices operating in the 5725-5850Mhz bands under the LELAN/UNII rules, the limit within 10Mhz of the allocated band is increased to -17dBm/MHz .

SAMPLE CALCULATIONS - CONDUCTED EMISSIONS

Receiver readings are compared directly to the conducted emissions specification limit (decibel form) as follows:

$$R_r - S = M$$

where:

R_r = Receiver Reading in dBuV

S = Specification Limit in dBuV

M = Margin to Specification in +/- dB

SAMPLE CALCULATIONS - RADIATED EMISSIONS

Receiver readings are compared directly to the specification limit (decibel form). The receiver internally corrects for cable loss, preamplifier gain, and antenna factor. The calculations are in the reverse direction of the actual signal flow, thus cable loss is added and the amplifier gain is subtracted. The Antenna Factor converts the voltage at the antenna coaxial connector to the field strength at the antenna elements.

A distance factor, when used for electric field measurements above 30MHz, is calculated by using the following formula:

$$F_d = 20 * \text{LOG}_{10} (D_m/D_s)$$

where:

F_d = Distance Factor in dB

D_m = Measurement Distance in meters

D_s = Specification Distance in meters

For electric field measurements below 30MHz the extrapolation factor is either determined by making measurements at multiple distances or a theoretical value is calculated using the formula:

$$F_d = 40 * \text{LOG}_{10} (D_m/D_s)$$

Measurement Distance is the distance at which the measurements were taken and Specification Distance is the distance at which the specification limits are based. The antenna factor converts the voltage at the antenna coaxial connector to the field strength at the antenna elements.

The margin of a given emission peak relative to the limit is calculated as follows:

$$R_c = R_r + F_d$$

and

$$M = R_c - L_s$$

where:

R_r = Receiver Reading in dBuV/m

F_d = Distance Factor in dB

R_c = Corrected Reading in dBuV/m

L_s = Specification Limit in dBuV/m

M = Margin in dB Relative to Spec

SAMPLE CALCULATIONS - FIELD STRENGTH TO EIRP CONVERSION

Where the radiated electric field strength is expressed in terms of the equivalent isotropic radiated power (eirp), or where a field strength measurement of output power is made in lieu of a direct measurement, the following formula is used to convert between eirp and field strength at a distance of d (meters) from the equipment under test:

$$E = \frac{1000000 \sqrt{30 P}}{d} \quad \text{microvolts per meter}$$

where P is the eirp (Watts)

For a measurement at 3m the conversion from a logarithmic value for field strength (dBuV/m) to an eirp power (dBm) is -95.3dB.

Appendix A Test Equipment Calibration Data

<u>Manufacturer</u>	<u>Description</u>	<u>Model</u>	<u>Asset #</u>	<u>Cal Due</u>
Radio Antenna Port (Power and Spurious Emissions), 22-May-13				
Rohde & Schwarz	EMI Test Receiver, 20 Hz-7 GHz	ESIB7	1538	12/12/2013
Schwarzbeck	LISN, 4x 100A, 50 uH , decoupling network	NNLK-8121	2242	N/A
Agilent Technologies	USB Average Power Sensor	U2001A	2442	12/17/2013
Radiated Emissions, 1000 - 6,500 MHz, 22-May-13				
EMCO	Antenna, Horn, 1-18 GHz (SA40-Red)	3115	1142	8/23/2014
Rohde & Schwarz	EMI Test Receiver, 20 Hz-7 GHz	ESIB7	1538	12/12/2013
Radiated Emissions, 1,000 - 18,000 MHz, 23-May-13				
Hewlett Packard	Microwave Preamplifier, 1- 26.5GHz	8449B	263	3/27/2014
EMCO	Antenna, Horn, 1-18 GHz (SA40-Red)	3115	1142	8/23/2014
Hewlett Packard	SpecAn 9 kHz - 40 GHz, FT (SA40) Blue	8564E (84125C)	1393	5/9/2014
Micro-Tronics	Band Reject Filter, 2400-2500 MHz	BRM50702-02	2249	10/11/2013
Radiated Emissions, 1000 - 18,000 MHz, 24-May-13				
Hewlett Packard	Microwave Preamplifier, 1- 26.5GHz	8449B	263	3/27/2014
EMCO	Antenna, Horn, 1-18 GHz (SA40-Red)	3115	1142	8/23/2014
Hewlett Packard	SpecAn 9 kHz - 40 GHz, FT (SA40) Blue	8564E (84125C)	1393	5/9/2014
Hewlett Packard	High Pass filter, 8.2 GHz (Purple System)	P/N 84300-80039	1767	12/5/2013
Micro-Tronics	Band Reject Filter, 5725-5875 MHz	BRC50705-02	2241	10/4/2013
Micro-Tronics	Band Reject Filter, 2400-2500 MHz	BRM50702-02	2249	10/11/2013
Micro-Tronics	Band Reject Filter, 5150-5350 MHz	BRC50703-02	2251	10/11/2013
Radiated Emissions, 1,000 - 18,000 MHz, 28-May-13				
Hewlett Packard	Microwave Preamplifier, 1- 26.5GHz	8449B	263	3/27/2014
EMCO	Antenna, Horn, 1-18 GHz (SA40-Red)	3115	1142	8/23/2014
Hewlett Packard	SpecAn 9 kHz - 40 GHz, FT (SA40) Blue	8564E (84125C)	1393	5/9/2014
Micro-Tronics	Band Reject Filter, 5470-5725 MHz	BRC50704-02	2240	10/4/2013
Radio Antenna Port (Power and Spurious Emissions), 28-May-13				
Agilent Technologies	USB Average Power Sensor	U2001A	2442	12/17/2013
Radiated Emissions, 18,000 - 40,000 MHz, 28-May-13				
Hewlett Packard	SpecAn 9 kHz - 40 GHz, FT (SA40) Blue	8564E (84125C)	1393	5/9/2014
Hewlett Packard	Head (Inc flex cable, (1742,1743) Blue)	84125C	1620	5/15/2014

<u>Manufacturer</u>	<u>Description</u>	<u>Model</u>	<u>Asset #</u>	<u>Cal Due</u>
Hewlett Packard	HF Amplifier, 45 MHz -50 GHz (with 1620)	83051A (84125C)	1742	5/13/2014
Hewlett Packard	HF Amplifier, 45 MHz -50 GHz (with 1620)	83051A (84125C)	1743	5/13/2014
A. H. Systems	Spare System Horn, 18-40GHz	SAS-574, p/n: 2581	2162	6/8/2013
Radiated Emissions, 1000 - 12,000 MHz, 29-May-13				
Hewlett Packard	Microwave Preamplifier, 1- 26.5GHz	8449B	263	3/27/2014
EMCO	Antenna, Horn, 1-18 GHz (SA40-Red)	3115	1142	8/23/2014
Hewlett Packard	SpecAn 9 kHz - 40 GHz, FT (SA40) Blue	8564E (84125C)	1393	5/9/2014
Rohde & Schwarz	EMI Test Receiver, 20 Hz-7 GHz	ESIB7	1538	12/12/2013
Micro-Tronics	Band Reject Filter, 5470-5725 MHz	BRC50704-02	2240	10/4/2013
Micro-Tronics	Band Reject Filter, 5150-5350 MHz	BRC50703-02	2251	10/11/2013
Micro-Tronics	Band Reject Filter, 5725-5875 MHz	BRC50705-02	2241	10/4/2013
Radiated Emissions, 1000 - 25,000 MHz, 31-May-13				
Hewlett Packard	Microwave Preamplifier, 1- 26.5GHz	8449B	263	3/27/2014
EMCO	Antenna, Horn, 1-18 GHz (SA40-Red)	3115	1142	8/23/2014
Hewlett Packard	SpecAn 9 kHz - 40 GHz, FT (SA40) Blue	8564E (84125C)	1393	5/9/2014
Rohde & Schwarz	EMI Test Receiver, 20 Hz-7 GHz	ESIB7	1538	12/12/2013
Hewlett Packard	Head (Inc flex cable, (1742,1743) Blue)	84125C	1620	5/15/2014
Hewlett Packard	High Pass filter, 8.2 GHz (Purple System)	P/N 84300-80039	1767	12/5/2013
A. H. Systems	Spare System Horn, 18-40GHz	SAS-574, p/n: 2581	2162	6/8/2013
Micro-Tronics	Band Reject Filter, 2400-2500 MHz	BRM50702-02	2249	10/11/2013
Radiated Emissions, 1,000 - 26,000 MHz, 01-Jun-13				
Hewlett Packard	Microwave Preamplifier, 1- 26.5GHz	8449B	263	3/27/2014
EMCO	Antenna, Horn, 1-18 GHz (SA40-Red)	3115	1142	8/23/2014
Hewlett Packard	SpecAn 9 kHz - 40 GHz, FT (SA40) Blue	8564E (84125C)	1393	5/9/2014
Rohde & Schwarz	EMI Test Receiver, 20 Hz-7 GHz	ESIB7	1538	12/12/2013
Micro-Tronics	Band Reject Filter, 5470-5725 MHz	BRC50704-02	1681	8/31/2013
Micro-Tronics	Band Reject Filter, 5725-5875 MHz	BRC50705-02	1682	3/13/2014
Hewlett Packard	High Pass filter, 8.2 GHz (Purple System)	P/N 84300-80039	1767	12/5/2013
Micro-Tronics	Band Reject Filter, 5150-5350 MHz	BRC50703-02	2239	10/4/2013
Micro-Tronics	Band Reject Filter, 2400-2500 MHz	BRM50702-02	2249	10/11/2013

<u>Manufacturer</u>	<u>Description</u>	<u>Model</u>	<u>Asset #</u>	<u>Cal Due</u>
Radiated Emissions, 1,000 - 26,000 MHz, 01-Jun-13				
Hewlett Packard	Microwave Preamplifier, 1-26.5GHz	8449B	263	3/27/2014
EMCO	Antenna, Horn, 1-18 GHz (SA40-Red)	3115	1142	8/23/2014
Hewlett Packard	SpecAn 9 kHz - 40 GHz, FT (SA40) Blue	8564E (84125C)	1393	5/9/2014
Rohde & Schwarz	EMI Test Receiver, 20 Hz-7 GHz	ESIB7	1538	12/12/2013
Micro-Tronics	Band Reject Filter, 5470-5725 MHz	BRC50704-02	1681	8/31/2013
Micro-Tronics	Band Reject Filter, 5725-5875 MHz	BRC50705-02	1682	3/13/2014
Hewlett Packard	High Pass filter, 8.2 GHz (Purple System)	P/N 84300-80039	1767	12/5/2013
Micro-Tronics	Band Reject Filter, 5150-5350 MHz	BRC50703-02	2239	10/4/2013
Micro-Tronics	Band Reject Filter, 2400-2500 MHz	BRM50702-02	2249	10/11/2013
Radiated Emissions, 30 - 1,000 MHz, 02-Jun-13				
Rohde & Schwarz	EMI Test Receiver, 20 Hz-7 GHz	ESIB7	1538	12/12/2013
Sunol Sciences	Biconilog, 30-3000 MHz	JB3	1548	8/9/2014
Com-Power	Preamplifier, 30-1000 MHz	PA-103A	2359	2/20/2014
Radio Antenna Port (Power and Spurious Emissions), 03-Jun-13				
Agilent Technologies	USB Average Power Sensor	U2001A	2442	12/17/2013
Radiated Emissions, 1,000 - 26,000 MHz, 03-Jun-13				
Hewlett Packard	Microwave Preamplifier, 1-26.5GHz	8449B	263	3/27/2014
EMCO	Antenna, Horn, 1-18 GHz (SA40-Red)	3115	1142	8/23/2014
Hewlett Packard	SpecAn 9 kHz - 40 GHz, FT (SA40) Blue	8564E (84125C)	1393	5/9/2014
Rohde & Schwarz	EMI Test Receiver, 20 Hz-7 GHz	ESIB7	1538	12/12/2013
Micro-Tronics	Band Reject Filter, 5470-5725 MHz	BRC50704-02	1681	8/31/2013
Micro-Tronics	Band Reject Filter, 5725-5875 MHz	BRC50705-02	1682	3/13/2014
Hewlett Packard	High Pass filter, 8.2 GHz (Purple System)	P/N 84300-80039	1767	12/5/2013
Micro-Tronics	Band Reject Filter, 5150-5350 MHz	BRC50703-02	2239	10/4/2013
Micro-Tronics	Band Reject Filter, 2400-2500 MHz	BRM50702-02	2249	10/11/2013
Radio Antenna Port (Power and Spurious Emissions), 05-Jun-13				
Rohde & Schwarz	Power Meter, Single Channel	NRVS	1422	1/3/2014
Rohde & Schwarz	Power Sensor 100 uW - 2 Watts (w/ 20 dB pad, SN BJ5155)	NRV-Z32	1536	12/12/2013
Agilent Technologies	PSA, Spectrum Analyzer, (installed options, 111, 115, 123, 1DS, B7J, HYX,	E4446A	2139	3/7/2014
Agilent Technologies	USB Average Power Sensor	U2001A	2442	12/17/2013
Agilent Technologies	3Hz -44GHz PSA Spectrum Analyzer	E4446A	2796	1/28/2014

<u>Manufacturer</u>	<u>Description</u>	<u>Model</u>	<u>Asset #</u>	<u>Cal Due</u>
Conducted Emissions - AC Power Ports, 05-Jun-13				
EMCO	LISN, 10 kHz-100 MHz	3825/2	1293	2/14/2014
Rohde & Schwarz	EMI Test Receiver, 20 Hz-7 GHz	ESIB7	1538	12/12/2013
Rohde & Schwarz	Pulse Limiter	ESH3 Z2	1594	5/15/2014
Radio Antenna Port (Power and Spurious Emissions), 07-Jun-13				
Rohde & Schwarz	Power Meter, Single Channel	NRVS	1422	1/3/2014
Rohde & Schwarz	Power Sensor 100 uW - 2 Watts (w/ 20 dB pad, SN BJ5155)	NRV-Z32	1536	12/12/2013
Agilent Technologies	USB Average Power Sensor	U2001A	2442	12/17/2013
Agilent Technologies	3Hz -44GHz PSA Spectrum Analyzer	E4446A	2796	1/28/2014
Radio Antenna Port (Power and Spurious Emissions), 10-Jun-13				
Rohde & Schwarz	Power Meter, Single Channel	NRVS	1422	1/3/2014
Rohde & Schwarz	Power Sensor 100 uW - 2 Watts (w/ 20 dB pad, SN BJ5155)	NRV-Z32	1536	12/12/2013
Agilent Technologies	USB Average Power Sensor	U2001A	2442	12/17/2013
Agilent Technologies	3Hz -44GHz PSA Spectrum Analyzer	E4446A	2796	1/28/2014

Appendix B Test Data

T92301 Pages 30 - 155



EMC Test Data

Client:	Intel	Job Number:	J91968
Model:	Intel Model 3160NGW Wireless Network Adapter	T-Log Number:	J92301
		Account Manager:	Christine Krebill
Contact:	Steve Hackett		
Emissions Standard(s):	FCC 15 B, 15.247, RSS 210	Class:	B
Immunity Standard(s):	-	Environment:	-

EMC Test Data

For The

Intel

Model

Intel Model 3160NGW Wireless Network Adapter

Date of Last Test: 6/10/2013



EMC Test Data

Client:	Intel	Job Number:	J91968
Model:	Intel Model 3160NGW Wireless Network Adapter	T-Log Number:	J92301
Contact:	Steve Hackett	Project Manager:	Christine Krebill
Standard:	FCC 15 B, 15.247, RSS 210	Project Coordinator:	-
		Class:	B

Power vs. Data Rate

In normal operating modes the card uses power settings stored on EEPROM to set the output power. For a given nominal output power the actual transmit power normally is reduced as the data rate increases, therefore testing was performed at the data rate in the mode with highest power to determine compliance with the requirements.

The following power measurements were made using an average power meter and the with the device configured in a continuous transmit mode on Chain 1 at the various data rates in each mode to verify the highest power mode:

Date of Test: 5/21/2013	Config. Used: 1
Test Engineer: Jack Liu	Config Change: None
Test Location: FT CH4	Host Unit Voltage 120V/60Hz

Chain A Channel 6 for 20 MHz b and g modes
 Channel 36 / 38 / 42 for 20, 40 and 80 MHz n and ac modes

Mode	Data Rate	Power (dBm)	Power setting	Duty Cycle
802.11b	1	17.1	20.5	99%
	2	17.0		
	5.5	17.0		
	11	17.0		97%
802.11g	6	15.8	20.5	99%
	9	15.8		
	12	15.8		
	18	15.8		
	24	15.7		
	36	15.7		
	48	15.7		
	54	15.7		89%
802.11n/ac 20MHz	6.5	11.1	20.5	98%
	13	11.1		
	19.5	11.0		
	26	11.0		
	39	11.0		
	52	10.9		
	58.5	11.0		
	65	11.0		88%
78	11.1	87%		



EMC Test Data

Client:	Intel	Job Number:	J91968
Model:	Intel Model 3160NGW Wireless Network Adapter	T-Log Number:	J92301
Contact:	Steve Hackett	Project Manager:	Christine Krebill
Standard:	FCC 15 B, 15.247, RSS 210	Project Coordinator:	-
		Class:	B

Mode	Data Rate	Power (dBm)	Power setting	Duty Cycle
802.11n/ac 40MHz	13.5	11.2	20.5	97%
	27	11.0		
	40.5	11.0		
	54	11.0		
	81	11.0		
	108	11.0		
	121.5	11.1		
	135	11.2		
	162	11.2		
	180	11.2		
802.11ac 80MHz	29.3	10.8	20.5	93%
	58.5	10.9		
	87.8	11.0		
	117	11.0		
	175.5	11.2		
	234	11.2		
	266.3	11.2		
	292.5	11.1		
	351	11.2		
	390	11.2		

Note : Power setting - the software power setting used during testing, included for reference only.

Client: Intel	Job Number: J91968
Model: Intel Model 3160NGW Wireless Network Adapter	T-Log Number: J92301
	Project Manager: Christine Krebill
Contact: Steve Hackett	Project Coordinator: -
Standard: FCC 15 B, 15.247, RSS 210	Class: N/A

RSS-210 (LELAN) and FCC 15.407(UNII) Antenna Port Measurements Power, PSD, Peak Excursion, Bandwidth and Spurious Emissions

Test Specific Details

Objective: The objective of this test session is to perform final qualification testing of the EUT with respect to the specification listed above.

Date of Test: 6/7/13, 6/10/13
 Test Engineer: Jack Liu
 Test Location: Ft Lab #4A

Config. Used: 1
 Config Change: None
 Host Unit Voltage 120V/60Hz

Summary of Results

MAC Address: 001500BD5C22 DRTU Tool Version 1.6.1-628 Driver version 16.0.0.49

Run #	Test Performed	Limit	Pass / Fail	Result / Margin
1	Power, 5150 - 5250MHz	15.407(a) (1), (2)	Pass	802.11a: 42.6 mW 802.11n 20MHz: 45.2 mW 802.11n 40MHz: 45.7 mW 802.11ac 80MHz: 11.7 mW
1	PSD, 5150 - 5250MHz	15.407(a) (1), (2)	Pass	802.11a: 3.5 dBm/MHz 802.11n 20MHz: 3.4 dBm/MHz 802.11n 40MHz: 1.3 dBm/MHz 802.11ac 80MHz: -6.7 dBm/MHz
1	Power, 5250 - 5350MHz	15.407(a) (1), (2)	Pass	802.11a: 53.3 mW 802.11n 20MHz: 54.4 mW 802.11n 40MHz: 26.9 mW 802.11ac 80MHz: 18.2 mW
1	PSD, 5250 - 5350MHz	15.407(a) (1), (2)	Pass	802.11a: 4.5 dBm/MHz 802.11n 20MHz: 4.2 dBm/MHz 802.11n 40MHz: -1.1 dBm/MHz 802.11ac 80MHz: -3.6 dBm/MHz
1	Max EIRP 5250 - 5350MHz	TPC required if EIRP ≥ 500mW (27dBm). EIRP ≥ 200mW (23dBm) DFS threshold = -64dBm	-	EIRP = 21.1 dBm (127.6 mW)
1	Power, 5470 - 5725MHz	15.407(a) (1), (2)	Pass	802.11a: 47.9 mW 802.11n 20MHz: 46.8 mW 802.11n n40MHz: 45.7 mW 802.11n ac80MHz: 30.2 mW

Client: Intel	Job Number: J91968
Model: Intel Model 3160NGW Wireless Network Adapter	T-Log Number: J92301
	Project Manager: Christine Krebill
Contact: Steve Hackett	Project Coordinator: -
Standard: FCC 15 B, 15.247, RSS 210	Class: N/A

Run #	Test Performed	Limit	Pass / Fail	Result / Margin
1	PSD, 5470 - 5725MHz	15.407(a) (1), (2)	Pass	802.11a: 4 dBm/MHz 802.11n 20MHz: 3.5 dBm/MHz 802.11n 40MHz: 1.2 dBm/MHz 802.11ac 80MHz: -1.9 dBm/MHz
1	Max EIRP 5470 - 5725MHz	TPC required if EIRP ≥ 500mW (27dBm). EIRP ≥ 200mW (23dBm) DFS threshold = -64dBm.	-	EIRP = 21.6 dBm (142.9 mW)
1	26dB Bandwidth	15.407 (Information only)	-	> 20MHz for all modes
1	99% Bandwidth	RSS 210 (Information only)	N/A	802.11a: 17 MHz 802.11n 20MHz: 18.2 MHz 802.11n 40MHz: 36.1 MHz 802.11ac 80MHz: 75 MHz
1	20dB Bandwidth	15.215 (c)	Pass	20 dB Bandwidth not within 5600-5650 MHz band for all modes
2	Peak Excursion Envelope	15.407(a) (6) 13dB	Pass	8.4dB
3	Antenna Conducted - Out of Band Spurious	15.407(b) -27dBm/MHz		Not performed aconducted, Refer to UNII RE Sheet

General Test Configuration

When measuring the conducted emissions from the EUT's antenna port, the antenna port of the EUT was connected to the spectrum analyzer or power meter via a suitable attenuator to prevent overloading the measurement system. All measurements are corrected to allow for the external attenuators and cables used.

Ambient Conditions:

Temperature: 22-25 °C
Rel. Humidity: 38-40 %

Modifications Made During Testing

No modifications were made to the EUT during testing

Deviations From The Standard

No deviations were made from the requirements of the standard.

Mode	Duty Cycle	cor fact	Data rate
a	98.6%	0.06	6
n20	98.5%	0.07	HTO
n40	96.9%	0.14	HTO
ac 80	70.0%	1.55	VHT9

Client: Intel	Job Number: J91968
Model: Intel Model 3160NGW Wireless Network Adapter	T-Log Number: J92301
	Project Manager: Christine Krebill
Contact: Steve Hackett	Project Coordinator: -
Standard: FCC 15 B, 15.247, RSS 210	Class: N/A

Run #1: Bandwidth, Output Power and Power Spectral Density - Single Chain Systems

Note 1:	Output power measured using a spectrum analyzer (see plots below). RBW=1MHz, VB=3 MHz, # of points in sweep $\geq 2 \times \text{span}/\text{RBW}$, RMS detector, trace average 100 traces, power averaging on (transmitted signal was not continuous) and power integration over 40/80/100/120 MHz. As the signal is not continuous, the measurements were adjusted by adding duty cycle factor. This is based on $10\log(1/x)$, where x is the duty cycle. (method SA-2 of KDB 789033)
Note 2:	PSD measured using a spectrum analyzer (see plots below). RBW=1MHz, VB=3 MHz, # of points in sweep $\geq 2 \times \text{span}/\text{RBW}$, RMS detector, trace average 100 traces, power averaging on (transmitted signal was not continuous). As the signal is not continuous, the measurements were adjusted by adding duty cycle factor. This is based on $10\log(1/x)$, where x is the duty cycle. (method SA-2 of KDB 789033)
Note 3:	For RSS-210 the limit for the 5150 - 5250 MHz band accounts for the antenna gain as the maximum eirp allowed is 10dBm/MHz. The limits are also corrected for instances where the highest measured value of the PSD exceeds the average PSD (calculated from the measured power divided by the measured 99% bandwidth) by more than 3dB by the amount that the measured value exceeds the average by more than 3dB.
Note 4:	99% Bandwidth measured in accordance with RSS GEN - RB > 1% of span and VB $\geq 3 \times \text{RB}$

Single Chain Operation, 5150-5250MHz Band

Antenna Gain (dBi): 3.6

EIRP: 105.7 mW

20.2 dBm

Frequency (MHz)	Software Setting	Bandwidth		Output Power ¹ dBm		Power (Watts)	PSD ² dBm/MHz			Result
		26dB	99% ⁴	Measured	FCC Limit		Measured	FCC Limit	RSS Limit ³	
802.11a										
5180	27.5	28.9	17.0	15.8	17.0	0.038	3.1	4.0	6.4	Pass
5200	27.5	29.0	17.0	16.3	17.0	0.043	3.4	4.0	6.4	Pass
5240	27.0	28.9	17.0	16.2	17.0	0.042	3.5	4.0	6.4	Pass
802.11n 20MHz										
5180	27.5	28.7	18.2	16.5	17.0	0.044	3.4	4.0	6.4	Pass
5200	28.0	29.7	18.2	16.6	17.0	0.045	3.3	4.0	6.4	Pass
5240	27.5	30.7	18.2	16.5	17.0	0.044	3.4	4.0	6.4	Pass
802.11n 40MHz										
5190	23.5	42.8	36.1	13.5	17.0	0.022	-1.8	4.0	6.4	Pass
5230	28.0	43.7	36.2	16.6	17.0	0.046	1.3	4.0	6.4	Pass
802.11ac 80MHz										
5210	20.0	79.5	75.0	10.7	17.0	0.012	-6.7	4.0	6.4	Pass

Client: Intel	Job Number: J91968
Model: Intel Model 3160NGW Wireless Network Adapter	T-Log Number: J92301
	Project Manager: Christine Krebill
Contact: Steve Hackett	Project Coordinator: -
Standard: FCC 15 B, 15.247, RSS 210	Class: N/A

Frequency (MHz)	Software Setting	Bandwidth		Output Power ¹ dBm		Power (Watts)
		26dB	99% ⁴	Measured	IC Limit	
802.11a						
5180	27.5	28.9	17.0	15.8	16.3	0.038
5200	27.5	29.0	17.0	16.29	16.3	0.043
5240	27.0	28.9	17.0	16.2	16.3	0.042
802.11n 20MHz						
5180	27.5	28.7	18.2	16.5	16.6	0.044
5200	28.0	29.7	18.2	16.55	16.6	0.045
5240	27.5	30.7	18.2	16.5	16.6	0.044
802.11n 40MHz						
5190	23.5	42.8	36.1	13.5	17.0	0.022
5230	29.0	43.7	36.2	16.6	17.0	0.046
802.11ac 80MHz						
5210	20.0	79.5	75.0	10.7	17.0	0.012

Single Chain Operation, 5250-5350 MHz Band

Antenna Gain (dBi): 3.7

EIRP: 127.6 mW

21.1 dBm

Frequency (MHz)	Software Setting	Bandwidth		Output Power ¹ dBm		Power (Watts)	PSD ² dBm/MHz			Result
		26dB	99% ⁴	Measured	Limit		Measured	FCC Limit	RSS Limit ³	
802.11a										
5260	28.5	28.4	17.0	17.3	24.0	0.053	4.4	11.0	11.0	Pass
5300	28.5	30.5	17.0	17.2	24.0	0.053	4.5	11.0	11.0	Pass
5320	25.5	25.9	16.9	15.0	24.0	0.031	2.2	11.0	11.0	Pass
802.11n 20MHz										
5260	28.5	31.5	18.2	17.4	24.0	0.054	4.2	11.0	11.0	Pass
5300	28.5	32.9	18.2	17.2	24.0	0.052	3.9	11.0	11.0	Pass
5320	25.5	27.1	18.1	15.0	24.0	0.031	1.9	11.0	11.0	Pass
802.11n 40MHz										
5270	23.0	43.2	36.1	13.6	24.0	0.023	-1.8	11.0	11.0	Pass
5310	24.5	42.7	36.1	14.3	24.0	0.027	-1.1	11.0	11.0	Pass
802.11ac 80MHz										
5290	22.0	84.2	74.9	12.6	24.0	0.018	-3.6	11.0	11.0	Pass

Client: Intel	Job Number: J91968
Model: Intel Model 3160NGW Wireless Network Adapter	T-Log Number: J92301
	Project Manager: Christine Krebill
Contact: Steve Hackett	Project Coordinator: -
Standard: FCC 15 B, 15.247, RSS 210	Class: N/A

Frequency (MHz)	Software Setting	Bandwidth		Output Power ¹ dBm		Power (Watts)
		26dB	99% ⁴	Measured	IC Limit	
802.11a						
5260	27.5	28.4	17.0	17.3	23.3	0.053
5300	29.5	30.5	17.0	17.2	23.3	0.053
5320	29.0	25.9	16.9	15.0	23.3	0.031
802.11n 20MHz						
5260	27.5	31.5	18.2	17.4	23.6	0.054
5300	29.5	32.9	18.2	17.2	23.6	0.052
5320	28.5	27.1	18.1	15.0	23.6	0.031
802.11n 40MHz						
5270	23.5	43.2	36.1	13.6	24.0	0.023
5310	29.0	42.7	36.1	14.3	24.0	0.027
802.11ac 80MHz						
5290	20.0	84.2	74.9	12.6	24.0	0.018

Client: Intel	Job Number: J91968
Model: Intel Model 3160NGW Wireless Network Adapter	T-Log Number: J92301
	Project Manager: Christine Krebill
Contact: Steve Hackett	Project Coordinator: -
Standard: FCC 15 B, 15.247, RSS 210	Class: N/A

Single Chain Operation, 5470- 5725 MHz Band

Antenna Gain (dBi): 4.8 EIRP: 142.9 mW 21.6 dBm

Frequency (MHz)	Software Setting	Bandwidth		Output Power ¹ dBm		Power (Watts)	PSD ² dBm/MHz			Result
		26dB	99% ⁴	Measured	FCC Limit		Measured	FCC Limit	RSS Limit ³	
802.11a Avg Pwr met										
5500	29.5	25.9	16.9	14.6	24.0	0.029	1.8	11.0	11.0	Pass
5580	33.0	31.5	17.0	16.8	24.0	0.047	4.0	11.0	11.0	Pass
5700	29.5	26.2	16.8	13.6	24.0	0.023	0.8	11.0	11.0	Pass
802.11n 20MHz										
5500	29.5	27.5	18.1	14.5	24.0	0.028	1.6	11.0	11.0	Pass
5580	33.0	32.9	18.2	16.7	24.0	0.046	3.5	11.0	11.0	Pass
5700	29.5	26.9	18.1	13.8	24.0	0.024	0.7	11.0	11.0	Pass
802.11ac 20MHz										
UNII-2ext										
5720	34.0	22.3	14.6	15.4	24.0	0.035	3.4	11.0	11.0	Pass
UNII-3										
5720	34.0	11.5	4.4	10.0	27.6	0.010	3.5	17.0	11.0	Pass
802.11n 40MHz										
5510	26.0	41.5	36.1	11.6	24.0	0.015	-3.7	11.0	11.0	Pass
5550	33.0	47.7	36.3	16.6	24.0	0.046	1.2	11.0	11.0	Pass
5670	34.0	50.1	36.3	16.4	24.0	0.044	1.1	11.0	11.0	Pass
802.11ac 40MHz										
UNII-2ext										
5710	33.5	39.7	33.2	16.0	24.0	0.040	0.9	11.0	11.0	Pass
UNII-3										
5710	33.5	6.9	3.0	3.6	25.4	0.002	-2.4	17.0	11.0	Pass
802.11ac 80MHz										
5530	23.5	79.5	75.0	9.8	24.0	0.010	-7.3	11.0	11.0	Pass
UNII-2ext										
5690	31.0	82.8	72.8	14.8	24.0	0.030	-1.9	11.0	11.0	Pass
UNII-3										
5690	31.0	5.2	2.4	-2.3	24.2	0.001	-7.8	17.0	11.0	Pass

Client: Intel	Job Number: J91968
Model: Intel Model 3160NGW Wireless Network Adapter	T-Log Number: J92301
	Project Manager: Christine Krebill
Contact: Steve Hackett	Project Coordinator: -
Standard: FCC 15 B, 15.247, RSS 210	Class: N/A

Frequency (MHz)	Software Setting	Bandwidth		Output Power ¹ dBm		Power (Watts)
		26dB	99% ⁴	Measured	IC Limit	
802.11a						
5500	29.5	25.9	16.9	14.6	23.3	0.029
5580	33.0	31.5	17.0	16.8	23.3	0.047
5700	29.5	26.2	16.8	13.6	23.3	0.023
802.11n 20MHz						
5500	29.5	27.5	18.1	14.5	23.6	0.028
5580	33.0	32.9	18.2	16.7	23.6	0.046
5700	29.5	26.9	18.1	13.8	23.6	0.024
802.11ac 20MHz (n20 and ac20 modulation are similar power was measured on high channel for ac mode)						
5720	34.0	22.3	14.6	15.4	22.6	0.035
5720	34.0	11.5	4.4	10.0	23.4	0.010
802.11n 40MHz						
5510	26.0	41.5	36.1	11.6	24.0	0.015
5550	33.0	47.7	36.3	16.6	24.0	0.046
5670	34.0	50.1	36.3	16.4	24.0	0.044
802.11ac 40MHz (n40 and ac40 modulation are similar power was measured on high channel for ac mode)						
5710	33.5	39.7	33.2	16.0	24.0	0.040
5710	33.5	6.9	3.0	3.6	21.8	0.002
802.11ac 80MHz						
5530	23.5	79.5	75.0	9.8	24.0	0.010
5690	31.0	82.8	72.8	14.8	24.0	0.030
5690	31.0	5.2	2.4	-2.3	20.9	0.001

Note: Since the high channels operate in both UNII-2ext and UNII-3 bands, power is split and only measured in each band to compare with the limits.

Client: Intel	Job Number: J91968
Model: Intel Model 3160NGW Wireless Network Adapter	T-Log Number: J92301
	Project Manager: Christine Krebill
Contact: Steve Hackett	Project Coordinator: -
Standard: FCC 15 B, 15.247, RSS 210	Class: N/A

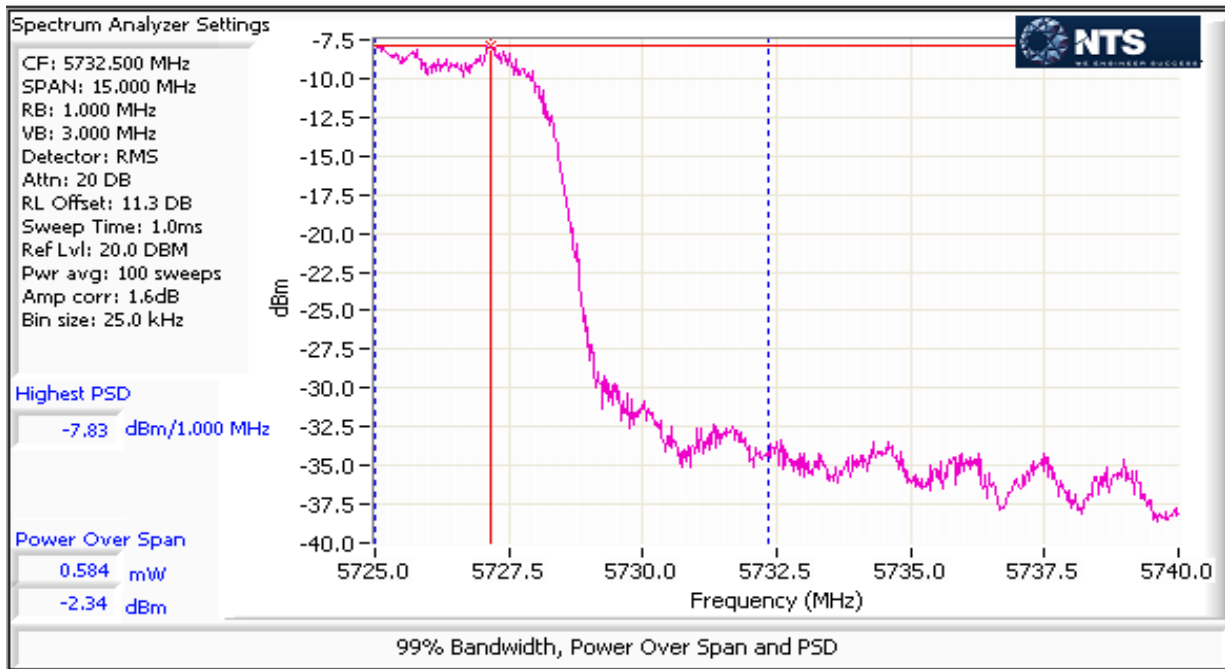
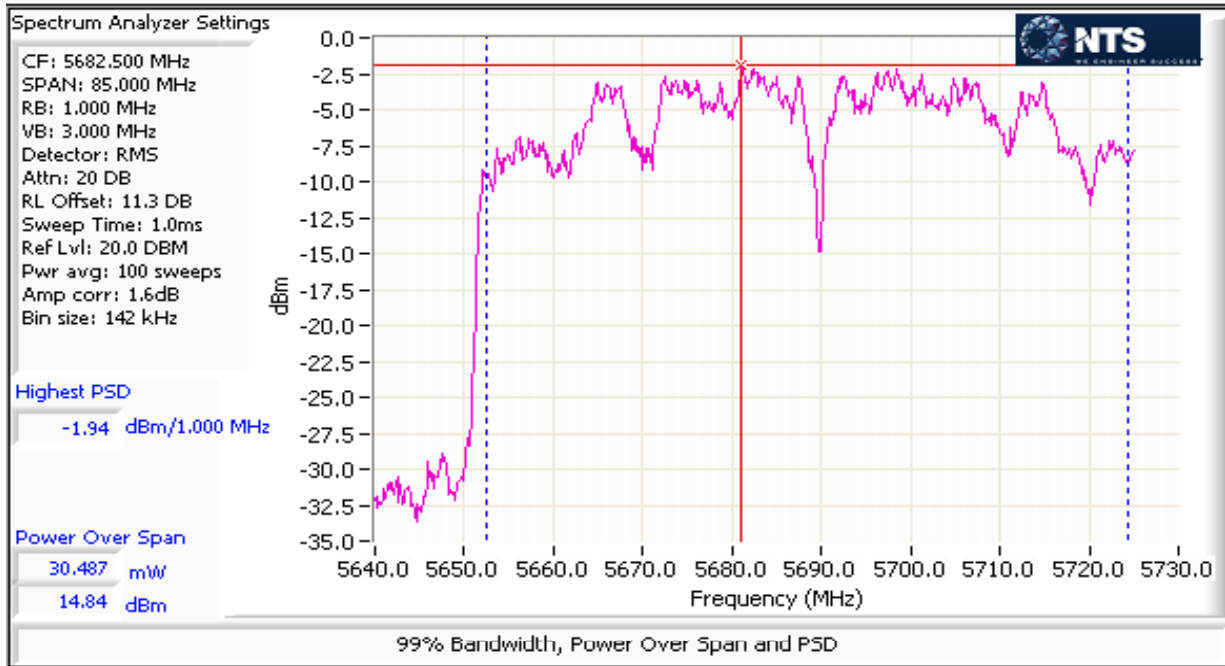

Client: Intel	Job Number: J91968
Model: Intel Model 3160NGW Wireless Network Adapter	T-Log Number: J92301
	Project Manager: Christine Krebill
Contact: Steve Hackett	Project Coordinator: -
Standard: FCC 15 B, 15.247, RSS 210	Class: N/A

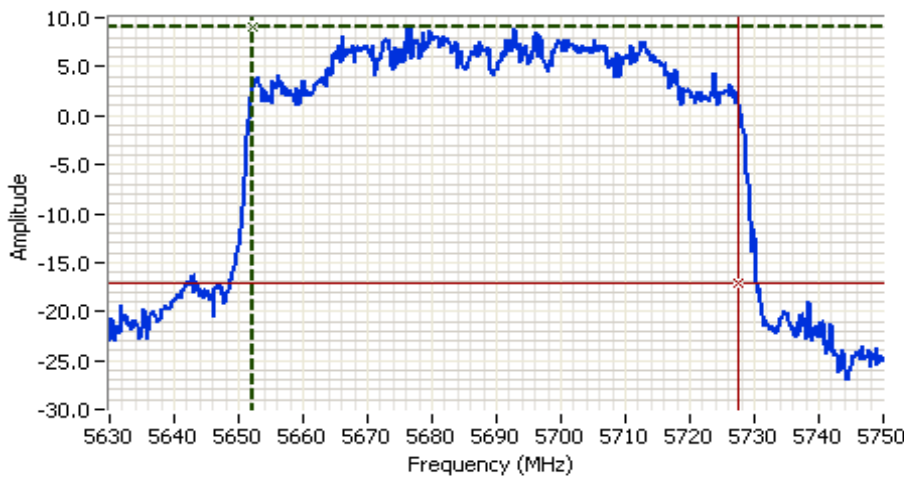

Analyzer Settings
 Agilent Technologies, E4446A
 CF: 5690.000 MHz
 SPAN: 120.000 MHz
 RB: 1.500 MHz
 VB: 4.000 MHz
 Detector: POS
 Attn: 20 DB
 RL Offset: 11.3 DB
 Sweep Time: 1.0ms
 Ref Lvl: 20.0 DBM

Comments
 802.11 ac80
 99% power BW: 75.28 MHz
 UNII-2ext 99%BW:72.84MHz
 UNII-3 99%BW:2.44MHz

Cursor 1 5652.1631 8.96
 Cursor 2 5727.4376 -17.04

Delta Freq. 75.275
 Delta Amplitude 26.00

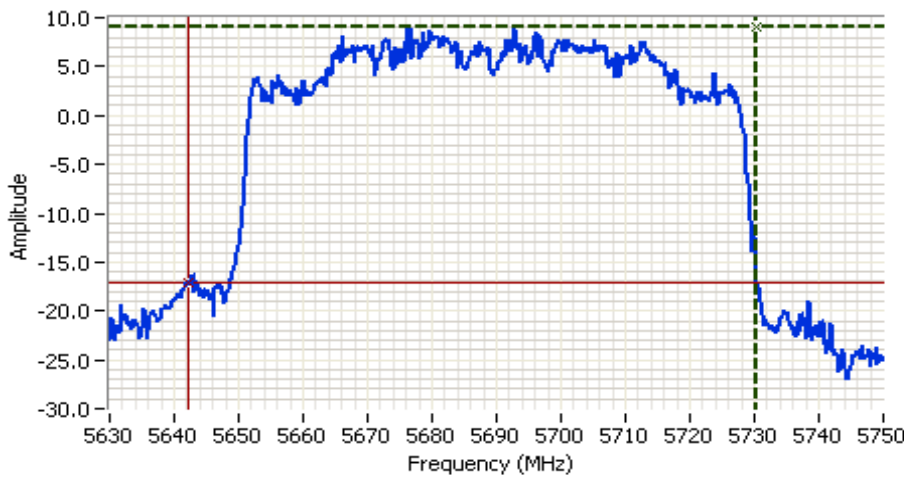

Analyzer Settings
 Agilent Technologies, E4446A
 CF: 5690.000 MHz
 SPAN: 120.000 MHz
 RB: 1.500 MHz
 VB: 4.000 MHz
 Detector: POS
 Attn: 20 DB
 RL Offset: 11.3 DB
 Sweep Time: 1.0ms
 Ref Lvl: 20.0 DBM

Comments
 802.11 ac80
 26dB BW: 88.000 MHz
 UNII-2ext 26dB BW:82.8MHz
 UNII-3 26dB BW:5.2MHz

Cursor 1 5730.2000 8.96
 Cursor 2 5642.2000 -17.04

Delta Freq. 88.000
 Delta Amplitude 26.00



Client: Intel	Job Number: J91968
Model: Intel Model 3160NGW Wireless Network Adapter	T-Log Number: J92301
	Project Manager: Christine Krebill
Contact: Steve Hackett	Project Coordinator: -
Standard: FCC 15 B, 15.247, RSS 210	Class: N/A

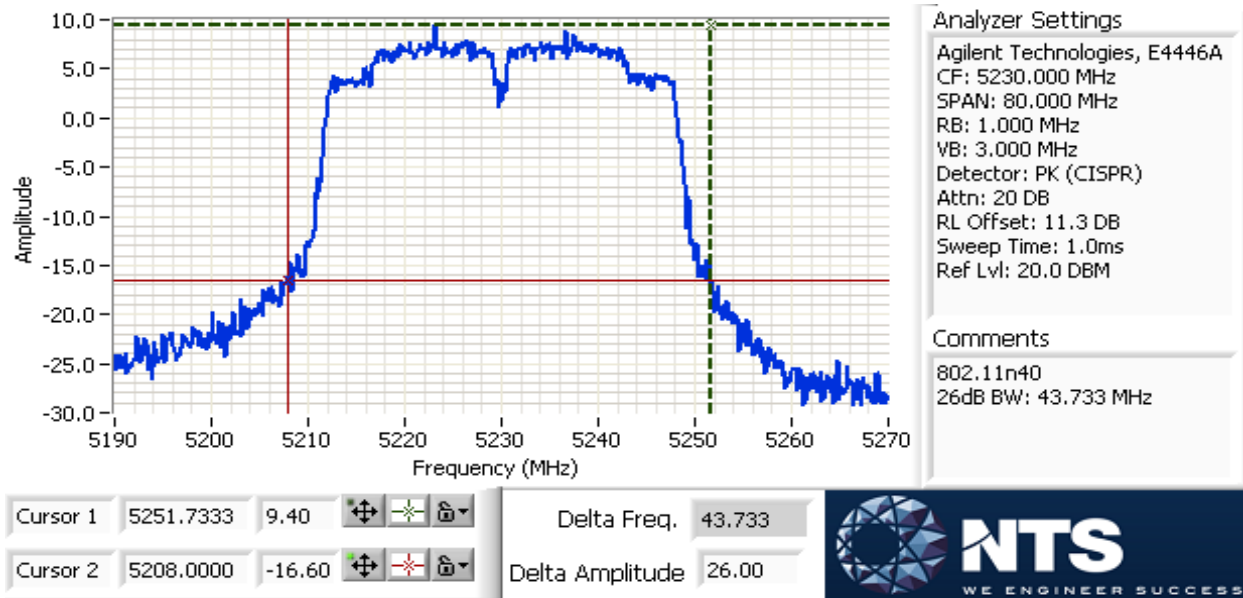
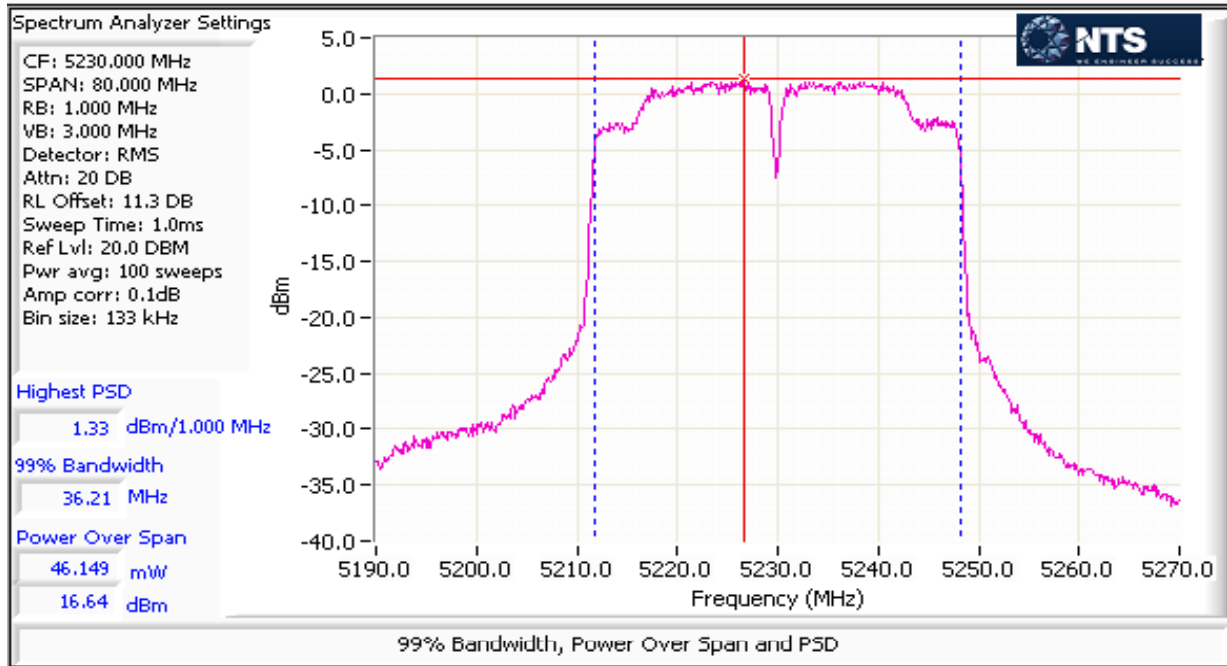

Client: Intel	Job Number: J91968
Model: Intel Model 3160NGW Wireless Network Adapter	T-Log Number: J92301
	Project Manager: Christine Krebill
Contact: Steve Hackett	Project Coordinator: -
Standard: FCC 15 B, 15.247, RSS 210	Class: N/A

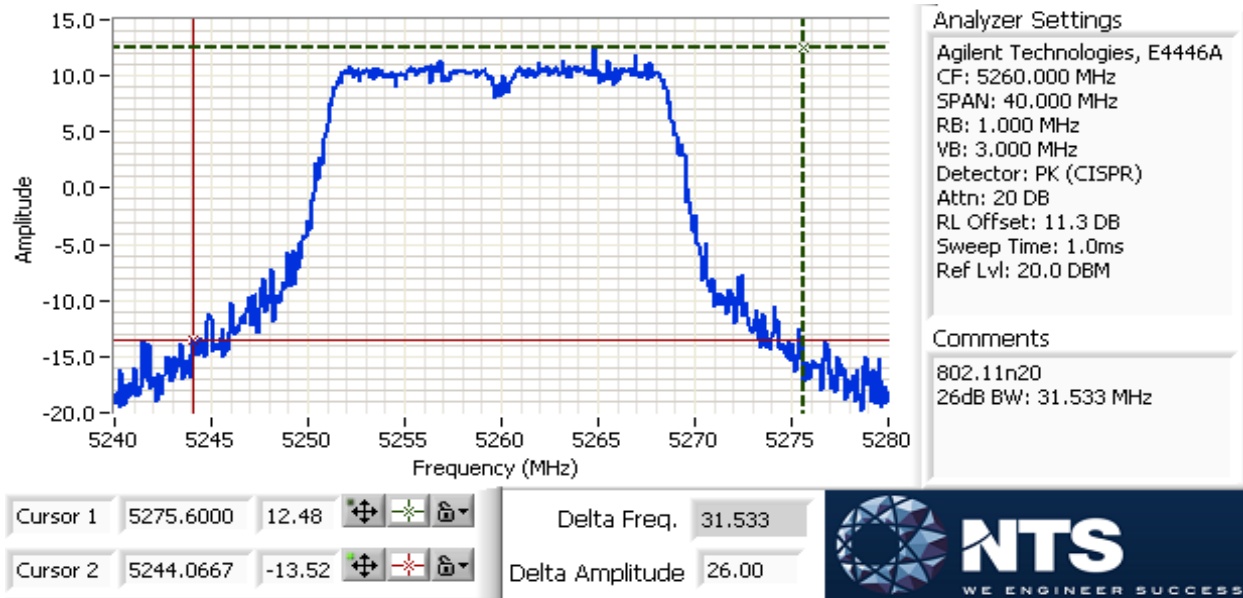
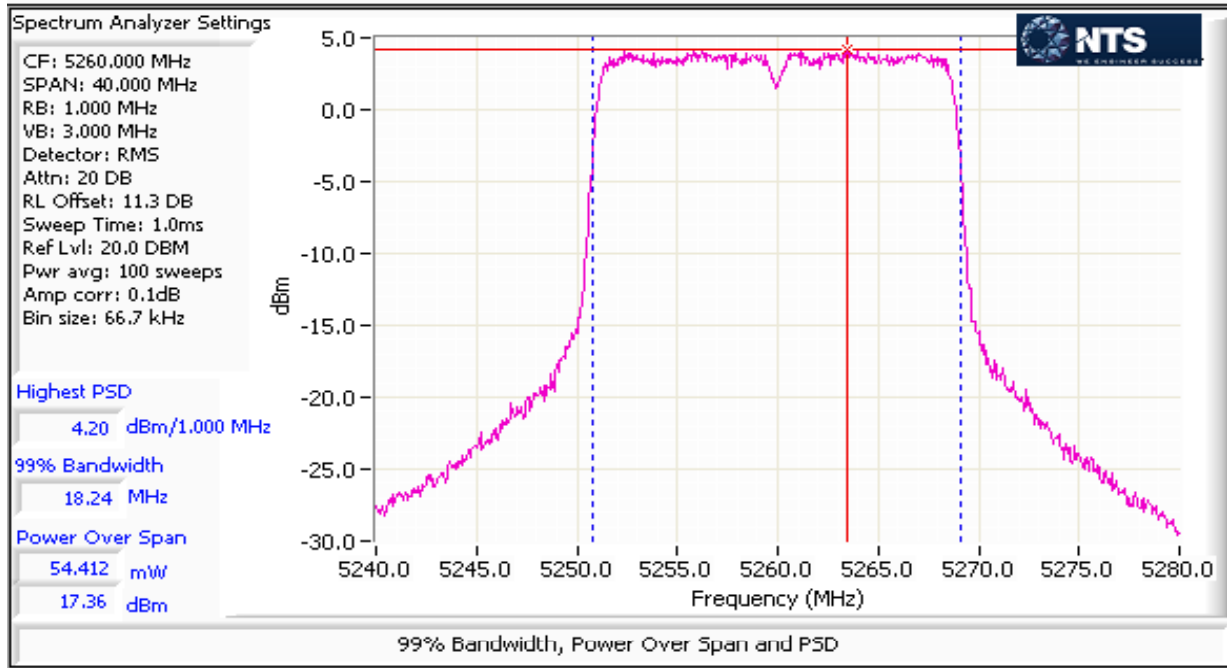

Client: Intel	Job Number: J91968
Model: Intel Model 3160NGW Wireless Network Adapter	T-Log Number: J92301
Contact: Steve Hackett	Project Manager: Christine Krebill
Standard: FCC 15 B, 15.247, RSS 210	Project Coordinator: -
	Class: N/A

Additional plots demonstrating 20dB bandwidth for channels closest to 5600 and 5650 MHz comply with 15.215(c).
 Note: If 26dB BW passes 20dB will pass.

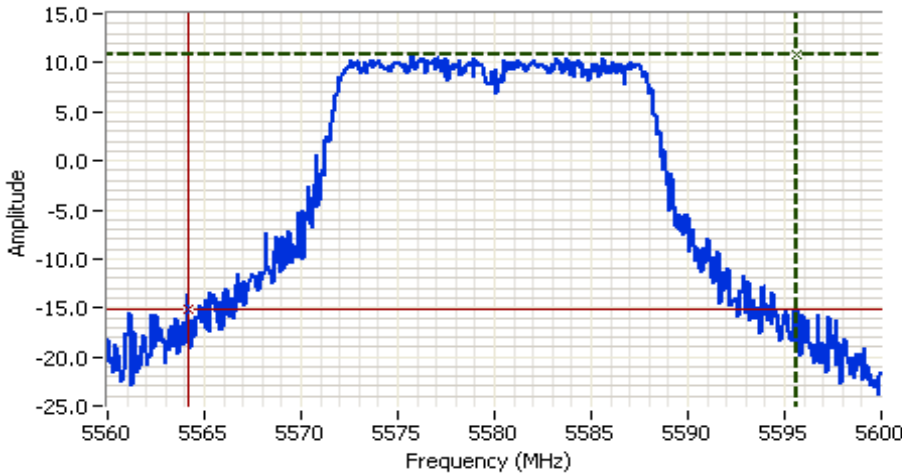

Analyzer Settings
 Agilent Technologies, E4446A
 CF: 5580.000 MHz
 SPAN: 40.000 MHz
 RB: 1.000 MHz
 VB: 3.000 MHz
 Detector: PK (CISPR)
 Attn: 20 DB
 RL Offset: 11.3 DB
 Sweep Time: 1.0ms
 Ref Lvl: 20.0 DBM

Comments
 802.11a
 26dB BW: 31.533 MHz

Cursor 1	5595.6667	10.78	Delta Freq.	31.533
Cursor 2	5564.1333	-15.22	Delta Amplitude	26.00

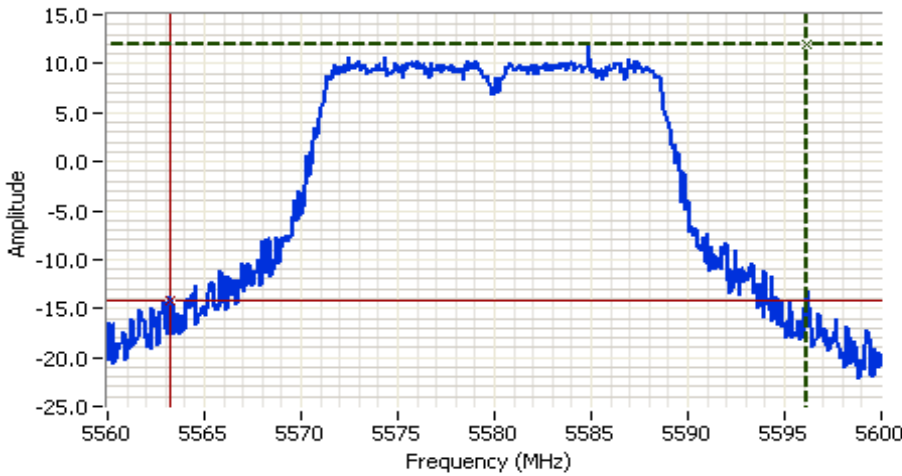

Analyzer Settings
 Agilent Technologies, E4446A
 CF: 5580.000 MHz
 SPAN: 40.000 MHz
 RB: 1.000 MHz
 VB: 3.000 MHz
 Detector: PK (CISPR)
 Attn: 20 DB
 RL Offset: 11.3 DB
 Sweep Time: 1.0ms
 Ref Lvl: 20.0 DBM

Comments
 802.11n20
 26dB BW: 32.867 MHz

Cursor 1	5596.1333	11.88	Delta Freq.	32.867
Cursor 2	5563.2667	-14.12	Delta Amplitude	26.00



Client: Intel	Job Number: J91968
Model: Intel Model 3160NGW Wireless Network Adapter	T-Log Number: J92301
	Project Manager: Christine Krebill
Contact: Steve Hackett	Project Coordinator: -
Standard: FCC 15 B, 15.247, RSS 210	Class: N/A

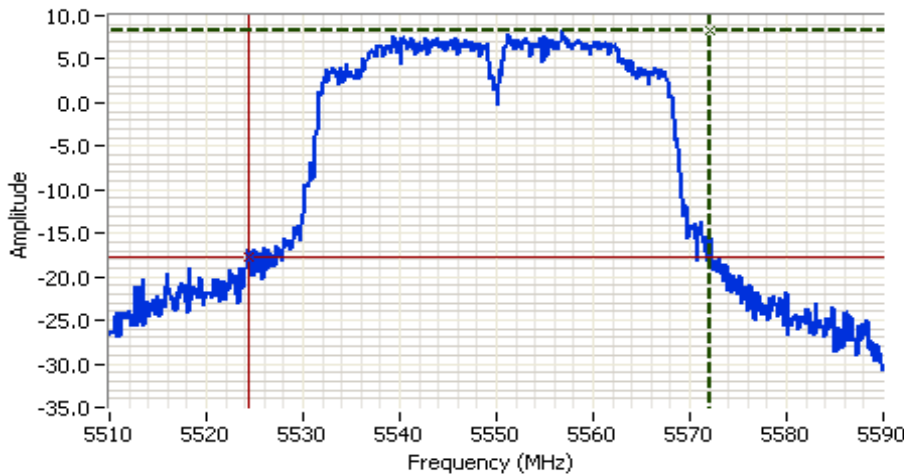

Analyzer Settings
 Agilent Technologies, E4446A
 CF: 5550.000 MHz
 SPAN: 80.000 MHz
 RB: 1.000 MHz
 VB: 3.000 MHz
 Detector: PK (CISPR)
 Attn: 20 DB
 RL Offset: 11.3 DB
 Sweep Time: 1.0ms
 Ref Lvl: 20.0 DBM

Comments
 802.11n40
 26dB BW: 47.733 MHz

Cursor 1 5572.1333 8.24
 Cursor 2 5524.4000 -17.76

Delta Freq. 47.733
 Delta Amplitude 26.00

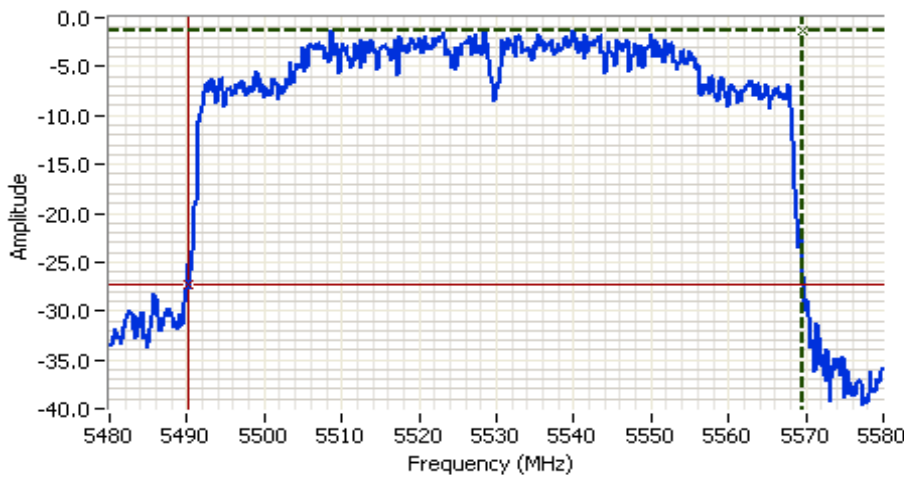

Analyzer Settings
 Agilent Technologies, E4446A
 CF: 5530.000 MHz
 SPAN: 100.000 MHz
 RB: 1.000 MHz
 VB: 3.000 MHz
 Detector: PK (CISPR)
 Attn: 20 DB
 RL Offset: 11.3 DB
 Sweep Time: 1.0ms
 Ref Lvl: 20.0 DBM

Comments
 802.11ac80
 26dB BW: 79.500 MHz

Cursor 1 5569.6667 -1.26
 Cursor 2 5490.1667 -27.26

Delta Freq. 79.500
 Delta Amplitude 26.00



Client: Intel	Job Number: J91968
Model: Intel Model 3160NGW Wireless Network Adapter	T-Log Number: J92301
Contact: Steve Hackett	Project Manager: Christine Krebill
Standard: FCC 15 B, 15.247, RSS 210	Project Coordinator: -
	Class: N/A

20 dB BW plots for closest channel to 5650 MHz

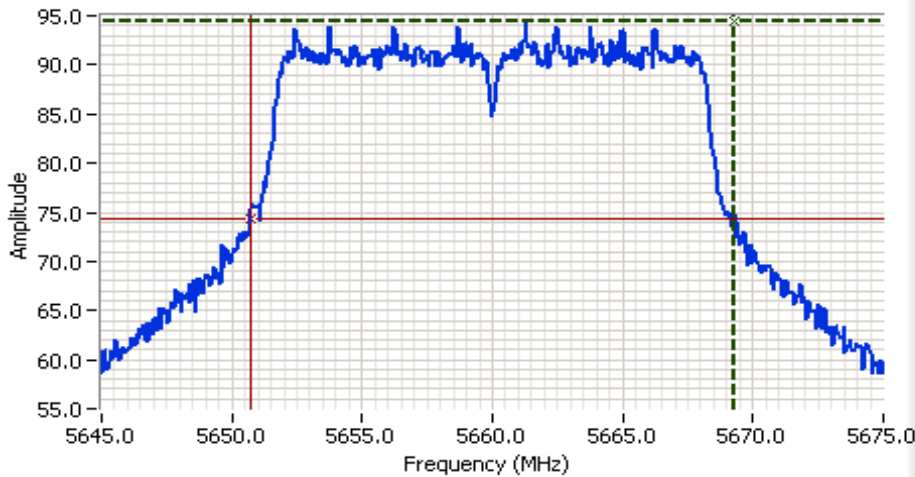

Analyzer Settings
 Rohde&Schwarz,ESI
 CF: 5660.000 MHz
 SPAN: 30.000 MHz
 RB: 200 kHz
 VB: 1.000 MHz
 Detector: POS
 Attn: 40 DB
 RL Offset: 0.0 DB
 Sweep Time: 5.0ms
 Ref Lvl: 117.0 DBUW

Comments
 20dB BW: 18.577 MHz
 802.11a

Cursor 1	5669.2886	94.39	
Cursor 2	5650.7114	74.39	

Delta Freq. 18.577
 Delta Amplitude 20.00



Analyzer Settings
 Rohde&Schwarz,ESI
 CF: 5660.000 MHz
 SPAN: 30.000 MHz
 RB: 200 kHz
 VB: 1.000 MHz
 Detector: POS
 Attn: 40 DB
 RL Offset: 0.0 DB
 Sweep Time: 5.0ms
 Ref Lvl: 117.0 DBUW

Comments
 20dB BW: 19.599 MHz
 802.11n20

Cursor 1	5669.8297	96.37	
Cursor 2	5650.2305	76.37	

Delta Freq. 19.599
 Delta Amplitude 20.00



Client: Intel	Job Number: J91968
Model: Intel Model 3160NGW Wireless Network Adapter	T-Log Number: J92301
	Project Manager: Christine Krebill
Contact: Steve Hackett	Project Coordinator: -
Standard: FCC 15 B, 15.247, RSS 210	Class: N/A

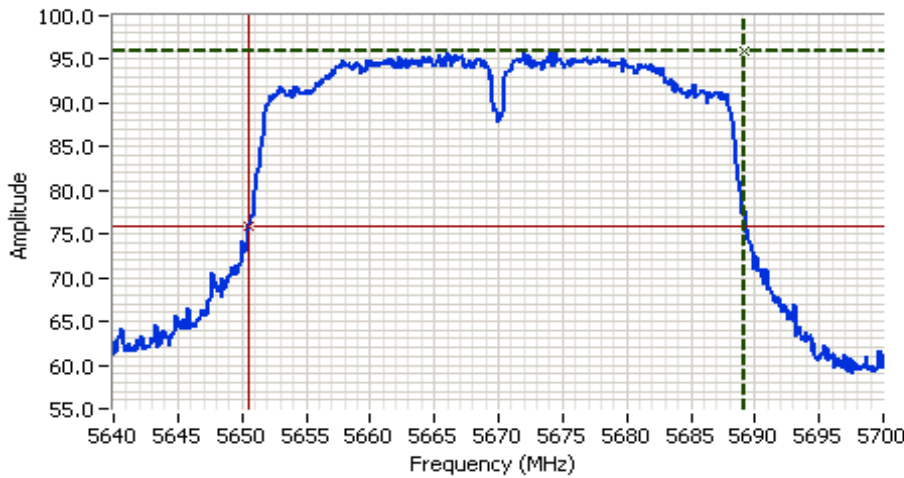

Analyzer Settings
 Rohde&Schwarz,ESI
 CF: 5670.000 MHz
 SPAN: 60.000 MHz
 RB: 500 kHz
 VB: 2.000 MHz
 Detector: POS
 Attn: 40 DB
 RL Offset: 0.0 DB
 Sweep Time: 5.0ms
 Ref Lvl: 117.0 DBUV

Comments
 20dB BW: 38.597 MHz
 802.11n40 mode

Cursor 1	5689.1784	95.87	Delta Freq.	38.597
Cursor 2	5650.5812	75.87	Delta Amplitude	20.00

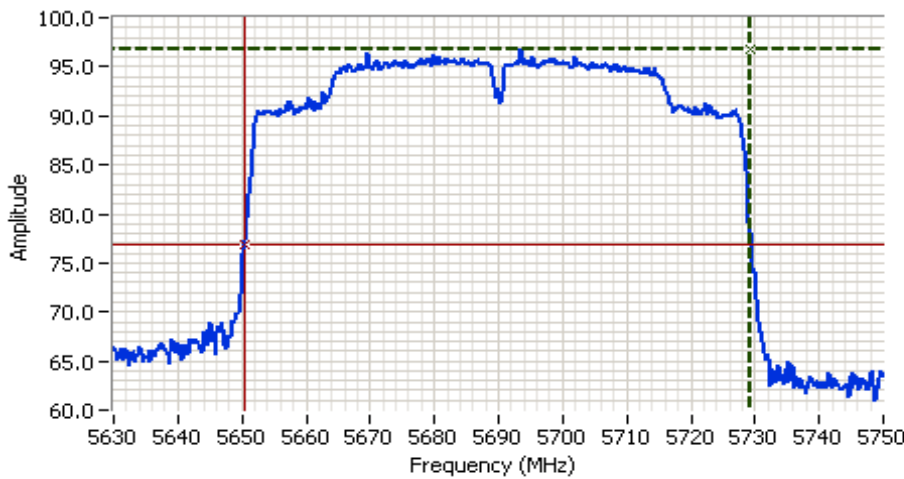

Analyzer Settings
 Rohde&Schwarz,ESI
 CF: 5690.000 MHz
 SPAN: 120.000 MHz
 RB: 1.000 MHz
 VB: 3.000 MHz
 Detector: POS
 Attn: 40 DB
 RL Offset: 0.0 DB
 Sweep Time: 5.0ms
 Ref Lvl: 117.0 DBUV

Comments
 20dB BW: 78.878 MHz
 802.11ac80 mode

Cursor 1	5729.3186	96.83	Delta Freq.	78.878
Cursor 2	5650.4409	76.83	Delta Amplitude	20.00



Client: Intel	Job Number: J91968
Model: Intel Model 3160NGW Wireless Network Adapter	T-Log Number: J92301
	Project Manager: Christine Krebill
Contact: Steve Hackett	Project Coordinator: -
Standard: FCC 15 B, 15.247, RSS 210	Class: N/A

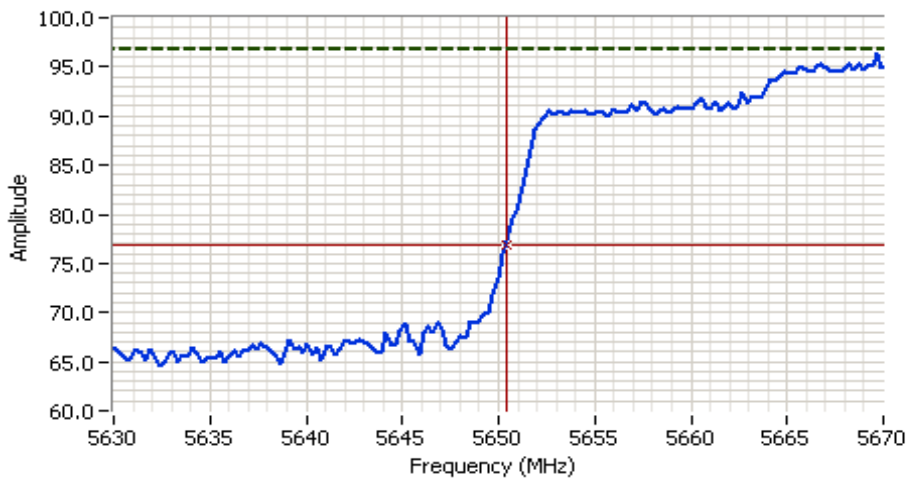

Analyzer Settings

Rohde&Schwarz,ESI
 CF: 5690.000 MHz
 SPAN: 120.000 MHz
 RB: 1.000 MHz
 VB: 3.000 MHz
 Detector: POS
 Attn: 40 DB
 RL Offset: 0.0 DB
 Sweep Time: 5.0ms
 Ref Lvl: 117.0 DBUV

Comments

20dB BW: 78.878 MHz
 802.11ac80 mode

Cursor 1	5729.3186	96.83		Delta Freq.	78.878
Cursor 2	5650.4409	76.83		Delta Amplitude	20.00



Zoom of previous plot to show compliance at 5650 MHz

Client: Intel	Job Number: J91968
Model: Intel Model 3160NGW Wireless Network Adapter	T-Log Number: J92301
	Project Manager: Christine Krebill
Contact: Steve Hackett	Project Coordinator: -
Standard: FCC 15 B, 15.247, RSS 210	Class: N/A

Run #2: Peak Excursion Measurement

a: Device meets the requirement for the peak excursion

Peak Excursion(dB)			Peak Excursion(dB)			Peak Excursion(dB)		
Freq	Value	Limit	Freq	Value	Limit	Freq	Value	Limit
(MHz)			(MHz)			(MHz)		
5180	7.0	13.0	5260	7.0	13.0	5500	7.2	13.0
5200	8.4	13.0	5300	8.2	13.0	5580	6.7	13.0
5240	7.3	13.0	5320	6.8	13.0	5700	8.2	13.0

20MHz: Device meets the requirement for the peak excursion

Peak Excursion(dB)			Peak Excursion(dB)			Peak Excursion(dB)		
Freq	Value	Limit	Freq	Value	Limit	Freq	Value	Limit
(MHz)			(MHz)			(MHz)		
5180	7.7	13.0	5260	7.0	13.0	5500	6.6	13.0
5200	7.2	13.0	5300	7.4	13.0	5580	7.7	13.0
5240	7.1	13.0	5320	7.5	13.0	5700	7.0	13.0
						5720	7.0	13.0

40MHz: Device meets the requirement for the peak excursion

Peak Excursion(dB)			Peak Excursion(dB)			Peak Excursion(dB)		
Freq	Value	Limit	Freq	Value	Limit	Freq	Value	Limit
(MHz)			(MHz)			(MHz)		
5190	7.6	13.0	5270	6.8	13.0	5510	7.4	13.0
5230	7.8	13.0	5310	7.8	13.0	5550	7.0	13.0
						5670	7.4	13.0
						5710	7.8	13.0

80MHz: Device meets the requirement for the peak excursion

Peak Excursion(dB)			Peak Excursion(dB)			Peak Excursion(dB)		
Freq	Value	Limit	Freq	Value	Limit	Freq	Value	Limit
(MHz)			(MHz)			(MHz)		
5210	8.4	13.0	5290	7.7	13.0	5530	8.3	13.0
						5690	8.0	13.0

Plots Showing Peak Excursion

Trace A: RBW = 1MHz, VBW = 3MHz, Peak hold

Trace B: Same settings as used for power/PSD measurements (RBW = 1 MHz, VBW = 3MHz, Integrated average power)

Client: Intel	Job Number: J91968
Model: Intel Model 3160NGW Wireless Network Adapter	T-Log Number: J92301
	Project Manager: Christine Krebill
Contact: Steve Hackett	Project Coordinator: -
Standard: FCC 15 B, 15.247, RSS 210	Class: N/A

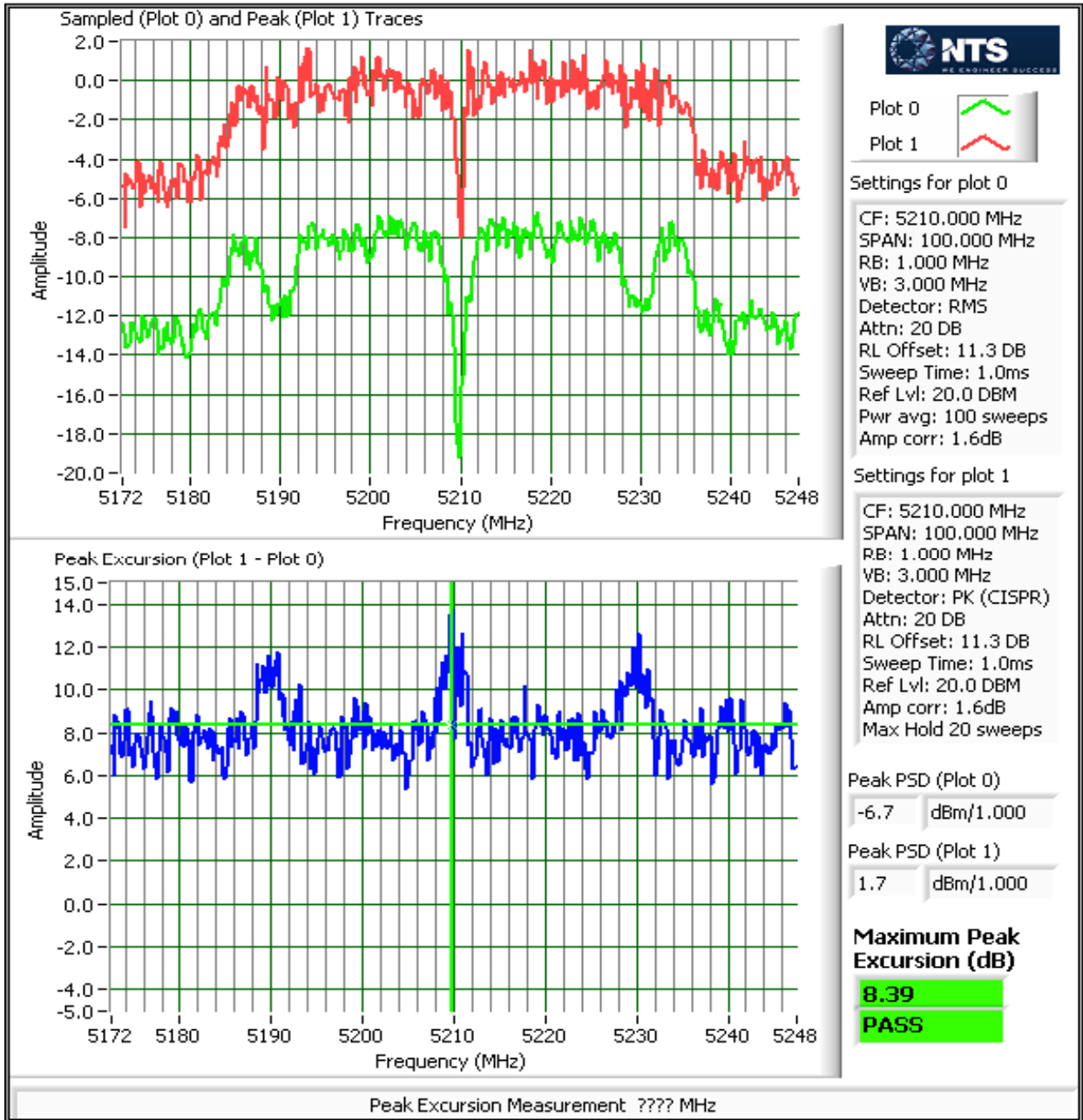



EMC Test Data

Client:	Intel	Job Number:	J91968
Model:	Intel Model 3160NGW Wireless Network Adapter	T-Log Number:	J92301
		Project Manager:	Christine Krebill
Contact:	Steve Hackett	Project Coordinator:	-
Standard:	FCC 15 B, 15.247, RSS 210	Class:	N/A

Run #3: Out Of Band Spurious Emissions - Antenna Conducted

Refer to UNII RE Sheet



EMC Test Data

Client:	Intel	Job Number:	J91968
Model:	Intel Model 3160NGW Wireless Network Adapter	T-Log Number:	J92301
Contact:	Steve Hackett	Project Manager:	Christine Krebill
Standard:	FCC 15 B, 15.247, RSS 210	Project Coordinator:	-
		Class:	N/A

RSS 210 and FCC 15.407 (UNII) Radiated Spurious Emissions

Test Specific Details

Objective: The objective of this test session is to perform final qualification testing of the EUT with respect to the specification listed above.

Date of Test: 5/21/2013
Test Engineer: R. Varelas / J. Liu
Test Location: FT Chamber #4

Config. Used: 1
Config Change: None
EUT Voltage: Host Laptop

General Test Configuration

The EUT and all local support equipment were located on the turntable for radiated spurious emissions testing. All remote support equipment was located approximately 30 meters from the EUT with all I/O connections running on top of the groundplane or routed in overhead in the GR-1089 test configuration.

For radiated emissions testing the measurement antenna was located 3 meters from the EUT.

Ambient Conditions:

Temperature: 21.4 °C
Rel. Humidity: 36 %



EMC Test Data

Client: Intel	Job Number: J91968
Model: Intel Model 3160NGW Wireless Network Adapter	T-Log Number: J92301
	Project Manager: Christine Krebill
Contact: Steve Hackett	Project Coordinator: -
Standard: FCC 15 B, 15.247, RSS 210	Class: N/A

Summary of Results

MAC Address: 001500BD5C22 DRTU Tool Version 1.6.1-628 Driver version 16.0.0.49

Run #	Mode	Channel	Power Setting	Measured Power	Test Performed	Limit	Result / Margin	
1	802.11a Chain A	5150-5250 Low	27.5	15.1	Restricted Band Edge at 5150 MHz	15.209	48.6 dBμV/m @ 5150.0 MHz (-5.4 dB)	
	802.11n20 Chain A	5150-5250 Low	27.5	15.1	Restricted Band Edge at 5150 MHz	15.209	48.6 dBμV/m @ 5150.0 MHz (-5.4 dB)	
	802.11a Chain A	5150-5250 Center	29.5	16.6	Radiated Emissions, 1 - 40 GHz	FCC 15.209 / 15 E	51.7 dBμV/m @ 1594.8 MHz(-22.3 dB)	
	802.11n20 Chain A	5150-5250 Center	29.5	16.6	Radiated Emissions, 1 - 40 GHz	FCC 15.209 / 15 E	53.0 dBμV/m @ 1194.9 MHz(-21.0 dB)	
	Worst case 20 MHz mode tested on lowest and highest channels in the band							
	802.11n20 Chain A	5150-5250 Low	28.5	16.4	Radiated Emissions, 1 - 40 GHz	FCC 15.209 / 15 E	54.8 dBμV/m @ 1197.5 MHz(-19.2 dB)	
	802.11n20 Chain A	5150-5250 High	28.5	16.6	Radiated Emissions, 1 - 40 GHz	FCC 15.209 / 15 E	52.7 dBμV/m @ 1195.8 MHz(-21.3 dB)	
	802.11n40 Chain A	5150-5250 Low	23.5	12.0	Restricted Band Edge at 5150 MHz	15.209	50.7 dBμV/m @ 5150.0 MHz (-3.3 dB)	
	802.11n40 Chain A	5150-5250 Low	23.5	12.0	Radiated Emissions, 1 - 40 GHz	FCC 15.209 / 15 E	53.9 dBμV/m @ 1195.8 MHz(-20.1 dB)	
	802.11n40 Chain A	5150-5250 High	29.0	16.5	Restricted Band Edge at 5150 MHz	15.209	45.4 dBμV/m @ 5150.0 MHz (-8.6 dB)	
	802.11n40 Chain A	5150-5250 High	29.0	16.5	Radiated Emissions, 1 - 40 GHz	FCC 15.209 / 15 E	54.9 dBμV/m @ 1197.5 MHz(-19.1 dB)	
	802.11ac80 Chain A	5210	20.0	10.1	Restricted Band Edge at 5150 MHz	15.209	52.7 dBμV/m @ 5127.5 MHz (-1.3 dB)	
	802.11ac80 Chain A	5210	20.0	10.1	Radiated Emissions, 1 - 40 GHz	FCC 15.209 / 15 E	56.0 dBμV/m @ 1196.1 MHz(-18.0 dB)	



EMC Test Data

Client:	Intel	Job Number:	J91968
Model:	Intel Model 3160NGW Wireless Network Adapter	T-Log Number:	J92301
Contact:	Steve Hackett	Project Manager:	Christine Krebill
Standard:	FCC 15 B, 15.247, RSS 210	Project Coordinator:	-
		Class:	N/A

Run #	Mode	Channel	Power Setting	Measured Power	Test Performed	Limit	Result / Margin	
2	802.11a Chain A	5250-5350 Center	28.5	16.5	Radiated Emissions, 1 - 40 GHz	FCC 15.209 / 15 E	55.9 dB μ V/m @ 1197.9 MHz(-18.1 dB)	
	802.11n20 Chain A	5250-5350 Center	28.5	16.5	Radiated Emissions, 1 - 40 GHz	FCC 15.209 / 15 E	54.2 dB μ V/m @ 1594.5 MHz(-19.8 dB)	
	Worst case 20 MHz mode tested on lowest and highest channels in the band							
	802.11a Chain A	5250-5350 Low	28.5	16.6	Radiated Emissions, 1 - 40 GHz	FCC 15.209 / 15 E	50.3 dB μ V/m @ 1996.2 MHz(-18.0 dB)	
	802.11a Chain A	5250-5350 High	28.5	16.6	Radiated Emissions, 1 - 40 GHz	FCC 15.209 / 15 E	54.3 dB μ V/m @ 1195.3 MHz(-19.7 dB)	
	802.11a Chain A	5250-5350 High	25.5	14.5	Restricted Band Edge at 5350 MHz	15.209	48.1 dB μ V/m @ 5350.0 MHz (-5.9 dB)	
	802.11n20 Chain A	5250-5350 High	25.5	14.5	Restricted Band Edge at 5350 MHz	15.209	48.9 dB μ V/m @ 5350.1 MHz (-5.1 dB)	
	802.11n40 Chain A	5250-5350 Low	23.0	12.1	Radiated Emissions, 1 - 40 GHz	FCC 15.209 / 15 E	51.1 dB μ V/m @ 1990.6 MHz(-17.2 dB)	
	802.11n40 Chain A	5250-5350 High	24.5	13.6	Radiated Emissions, 1 - 40 GHz	FCC 15.209 / 15 E	55.3 dB μ V/m @ 1197.7 MHz(-18.7 dB)	
	802.11n40 Chain A	5250-5350 High	24.5	13.6	Restricted Band Edge at 5350 MHz	15.209	49.6 dB μ V/m @ 5350.1 MHz (-4.4 dB)	
	802.11ac80 Chain A	5290	22.0	11.9	Restricted Band Edge at 5350 MHz	15.209	50.3 dB μ V/m @ 5352.5 MHz (-3.7 dB)	
	802.11ac80 Chain A	5290	22.0	11.9	Radiated Emissions, 1 - 40 GHz	FCC 15.209 / 15 E	55.0 dB μ V/m @ 1197.0 MHz(-19.0 dB)	



EMC Test Data

Client:	Intel	Job Number:	J91968
Model:	Intel Model 3160NGW Wireless Network Adapter	T-Log Number:	J92301
Contact:	Steve Hackett	Project Manager:	Christine Krebill
Standard:	FCC 15 B, 15.247, RSS 210	Project Coordinator:	-
		Class:	N/A

Run #	Mode	Channel	Power Setting	Measured Power	Test Performed	Limit	Result / Margin	
3	802.11a Chain A	5470-5725 Low	29.5	14.6	Restricted Band Edge at 5460 MHz	15.209	45.1 dB μ V/m @ 5459.9 MHz (-8.9 dB)	
	802.11a Chain A	5470-5725 Low	29.5	14.6	Band Edge 5460 - 5470 MHz	15E	63.6 dB μ V/m @ 5468.4 MHz (-4.7 dB)	
	802.11n20 Chain A	5470-5725 Low	29.5	14.6	Restricted Band Edge at 5460 MHz	15.209	45.5 dB μ V/m @ 5460.0 MHz (-8.5 dB)	
	802.11n20 Chain A	5470-5725 Low	29.5	14.6	Band Edge 5460 - 5470 MHz	15E	65.3 dB μ V/m @ 5465.6 MHz (-3.0 dB)	
	802.11a Chain A	5470-5725 Center	33.0	16.5	Radiated Emissions, 1 - 40 GHz	FCC 15.209 / 15 E	47.4 dB μ V/m @ 1993.4 MHz(-20.9 dB)	
	802.11n20 Chain A	5470-5725 Center	33.0	16.5	Radiated Emissions, 1 - 40 GHz	FCC 15.209 / 15 E	54.1 dB μ V/m @ 1244.2 MHz(-14.2 dB)	
	Worst case 20 MHz mode tested on lowest and highest channels in the band							
	802.11n20 Chain A	5470-5725 Low	32.5	16.7	Radiated Emissions, 1 - 40 GHz	FCC 15.209 / 15 E	51.0 dB μ V/m @ 1991.1 MHz(-17.3 dB)	
	802.11n20 Chain A	5470-5725 High	34.0	16.6	Radiated Emissions, 1 - 40 GHz	FCC 15.209 / 15 E	33.5 dB μ V/m @ 1600.1 MHz(-20.5 dB)	
	802.11a Chain A	5470-5725 High	29.5	13.6	Band Edge 5725MHz	15E	57.4 dB μ V/m @ 5725.1 MHz(-10.9 dB)	
	802.11n20 Chain A	5470-5725 High	29.5	13.6	Band Edge 5725MHz	15E	58.1 dB μ V/m @ 5731.3 MHz(-10.2 dB)	
	802.11ac20 Chain A	5470-5725 High	34.0	16.5	Radiated Emissions, 1 - 40 GHz	FCC 15.209 / 15 E	52.9 dB μ V/m @ 1594.7 MHz(-21.1 dB)	
	802.11n40 Chain A	5470-5725 Low	26.0	11.4	Restricted Band Edge at 5460 MHz	15.209	47.0 dB μ V/m @ 5460.0 MHz (-7.0 dB)	
	802.11n40 Chain A	5470-5725 Low	26.0	11.4	Band Edge 5460 - 5470 MHz	15E	63.9 dB μ V/m @ 5469.4 MHz (-4.4 dB)	
	802.11n40 Chain A	5470-5725 Low	26.0	11.4	Radiated Emissions, 1 - 40 GHz	FCC 15.209 / 15 E	52.5 dB μ V/m @ 1992.8 MHz(-15.8 dB)	
	802.11n40 Chain A	5470-5725 Center	33.0	16.5	Restricted Band Edge at 5460 MHz	15.209	45.8 dB μ V/m @ 5460.0 MHz (-8.2 dB)	
	802.11n40 Chain A	5470-5725 Center	33.0	16.5	Band Edge 5460 - 5470 MHz	15E	61.2 dB μ V/m @ 5468.4 MHz (-7.1 dB)	
	802.11n40 Chain A	5470-5725 Center	33.0	16.5	Radiated Emissions, 1 - 40 GHz	FCC 15.209 / 15 E	55.2 dB μ V/m @ 1199.2 MHz(-18.8 dB)	
	802.11n40 Chain A	5470-5725 High	34.0	16.4	Radiated Emissions, 1 - 40 GHz	FCC 15.209 / 15 E	50.1 dB μ V/m @ 1998.1 MHz(-18.2 dB)	
	802.11n40 Chain A	5470-5725 High	34.0	16.4	Band Edge 5725MHz	15E	57.3 dB μ V/m @ 5727.5 MHz(-11.0 dB)	



EMC Test Data

Client:	Intel	Job Number:	J91968
Model:	Intel Model 3160NGW Wireless Network Adapter	T-Log Number:	J92301
Contact:	Steve Hackett	Project Manager:	Christine Krebill
Standard:	FCC 15 B, 15.247, RSS 210	Project Coordinator:	-
		Class:	N/A

	Mode	Channel	Power Setting	Measured Power	Test Performed	Limit	Result / Margin
3	802.11ac40 Chain A	5470-5725 High	33.5	16.5	Radiated Emissions, 1 - 40 GHz	FCC 15.209 / 15 E	36.2 dBµV/m @ 1397.5 MHz(-17.8 dB)
	802.11ac80 Chain A	5530 MHz	23.5	9.5	Restricted Band Edge at 5460 MHz	15.209	52.2 dBµV/m @ 5458.8 MHz (-1.8 dB)
	802.11ac80 Chain A	5530 MHz	23.5	9.5	Restricted Band Edge at 5470 MHz	15.209	66.9 dBµV/m @ 5462.1 MHz (-1.4 dB)
	802.11ac80 Chain A	5530 MHz	23.5	9.5	Radiated Emissions, 1 - 40 GHz	FCC 15.209 / 15 E	51.2 dBµV/m @ 1997.5 MHz(-17.1 dB)
	802.11ac80 Chain A	5690 MHz	31.0	15.0	Radiated Emissions, 1 - 40 GHz	FCC 15.209 / 15 E	56.9 dBµV/m @ 1244.9 MHz(-11.4 dB)

Modifications Made During Testing

No modifications were made to the EUT during testing

Deviations From The Standard

No deviations were made from the requirements of the standard.

Test Procedure Comments:

Unless otherwise noted, average measurements above 1GHz were performed as documented in FCC KDB 789033 G) 6) d) Method VB

Antenna: <<antenna connected or state antenna port terminated>>

Duty Cycle:

Mode	Duty Cycle	cor fact	Data rate
a	98.6%	0.13	6
n20	98.5%	0.13	HT0
n40	96.9%	0.27	HT0
ac 80	70.0%	3.10	VHT9

The channels adjacent to the low/high channels are also evaluated for band edge if the power at the low/high channels are 3dB or more below the highest channel power in the band.

Note - the target and measured power are average powers (measured with average power sensor) and are used for reference purposes only. Power is set using " GAIN CONTROL" mode in the DRTU tool.



EMC Test Data

Client:	Intel	Job Number:	J91968
Model:	Intel Model 3160NGW Wireless Network Adapter	T-Log Number:	J92301
Contact:	Steve Hackett	Project Manager:	Christine Krebill
Standard:	FCC 15 B, 15.247, RSS 210	Project Coordinator:	-
		Class:	N/A

Run #1, Radiated Spurious Emissions, 1,000 - 40,000 MHz. Operation in the 5150-5250 MHz Band

Date of Test: 5/22/13, 5/23/13, 5/24/13

Test Engineer: Rafael Varelas / Jack Liu

Test Location: FT Chamber #4

Run #1a: Low Channel, 802.11a mode

Chain A	Target (dBm)	Power Settings Measured (dBm)	Software Setting
	15.0	15.1	27.5

5150 MHz Band Edge Signal Radiated Field Strength

Frequency MHz	Level dB μ V/m	Pol v/h	FCC 15.209		Detector Pk/QP/Avg	Azimuth degrees	Height meters	Comments
			Limit	Margin				
5150.000	48.6	V	54.0	-5.4	AVG	275	1.0	POS; RB 1 MHz; VB: 10 Hz
5147.840	61.2	V	74.0	-12.8	PK	275	1.0	POS; RB 1 MHz; VB: 3 MHz
5150.000	48.5	H	54.0	-5.5	AVG	162	1.0	POS; RB 1 MHz; VB: 10 Hz
5149.700	60.1	H	74.0	-13.9	PK	162	1.0	POS; RB 1 MHz; VB: 3 MHz

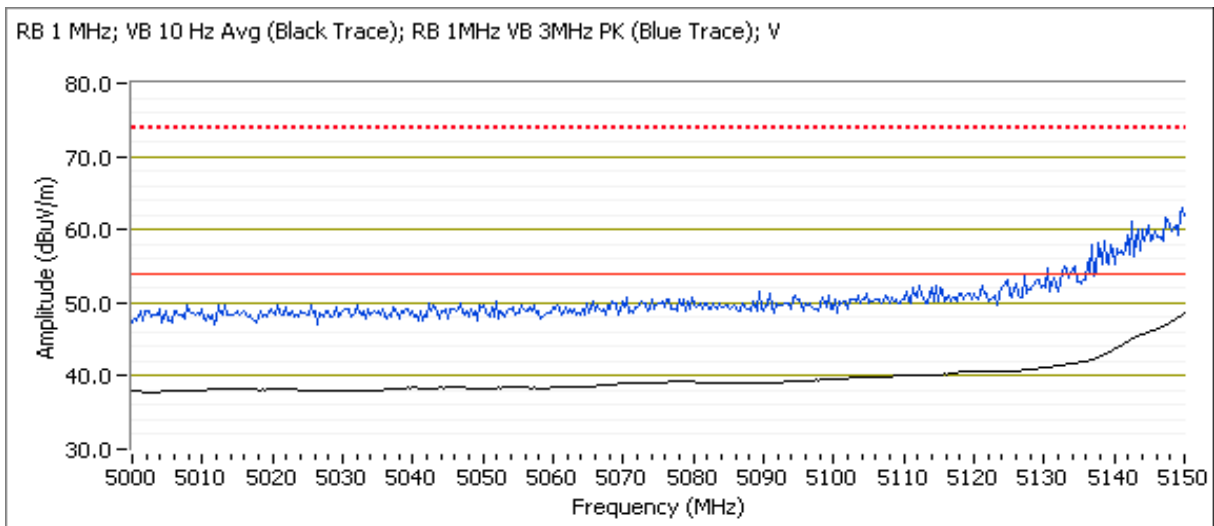



EMC Test Data

Client:	Intel	Job Number:	J91968
Model:	Intel Model 3160NGW Wireless Network Adapter	T-Log Number:	J92301
Contact:	Steve Hackett	Project Manager:	Christine Krebill
Standard:	FCC 15 B, 15.247, RSS 210	Project Coordinator:	-
		Class:	N/A

Run #1b: Low Channel, 802.11n20 mode

	Target (dBm)	Power Settings Measured (dBm)	Software Setting
Chain A	15.0	15.1	27.5

5150 MHz Band Edge Signal Radiated Field Strength

Frequency MHz	Level dB μ V/m	Pol v/h	FCC 15.209		Detector Pk/QP/Avg	Azimuth degrees	Height meters	Comments
			Limit	Margin				
5150.000	48.6	V	54.0	-5.4	AVG	327	1.1	POS; RB 1 MHz; VB: 10 Hz
5148.720	62.3	V	74.0	-11.7	PK	327	1.1	POS; RB 1 MHz; VB: 3 MHz
5150.000	48.1	H	54.0	-5.9	AVG	201	1.1	POS; RB 1 MHz; VB: 10 Hz
5150.000	60.5	H	74.0	-13.5	PK	201	1.1	POS; RB 1 MHz; VB: 3 MHz

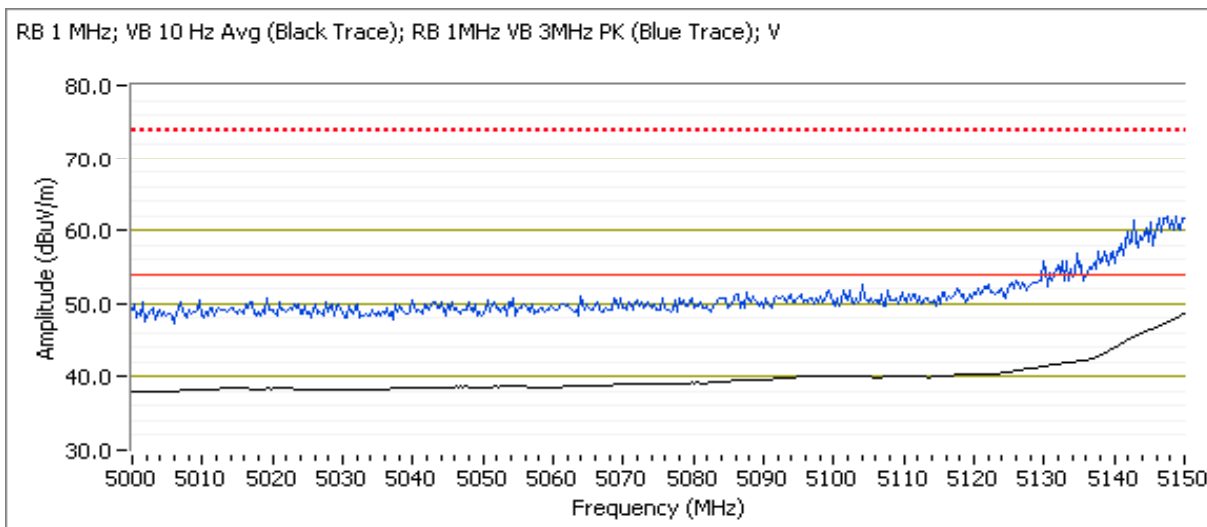

Client: Intel	Job Number: J91968
Model: Intel Model 3160NGW Wireless Network Adapter	T-Log Number: J92301
Contact: Steve Hackett	Project Manager: Christine Krebill
Standard: FCC 15 B, 15.247, RSS 210	Project Coordinator: -
	Class: N/A

Run #1c: Center Channel, 802.11a mode

	Power Settings		
	Target (dBm)	Measured (dBm)	Software Setting
Chain A	16.5	16.6	29.5

Spurious Radiated Emissions:

Frequency MHz	Level dB μ V/m	Pol v/h	15.209 / 15E		Detector Pk/QP/Avg	Azimuth degrees	Height meters	Comments
			Limit	Margin				
1594.790	51.7	V	74.0	-22.3	PK	336	0.9	RB 1 MHz;VB 3 MHz;Peak
1194.670	51.6	V	74.0	-22.4	PK	283	1.0	RB 1 MHz;VB 3 MHz;Peak
1195.870	29.8	V	54.0	-24.2	AVG	283	1.0	RB 1 MHz;VB 10 Hz;Peak
1594.360	29.6	V	54.0	-24.4	AVG	336	0.9	RB 1 MHz;VB 10 Hz;Peak
2440.720	40.7	H	68.3	-27.6	PK	198	2.2	RB 1 MHz;VB 3 MHz;Peak

- Note 1: For emissions in restricted bands, the limit of 15.209 was used which requires average and peak measurements.
- Note 2: For emissions outside of the restricted bands the limit is -27dBm/MHz eirp (68.3dB μ V/m). The measurement method required is a peak measurement (RB=1MHz, VB \geq 3MHz, peak detector).
- Note 3: Scans made between 18 - 40 GHz with the measurement antenna moved around the card and its antennas 20-50cm from the device indicated there were no significant emissions in this frequency range

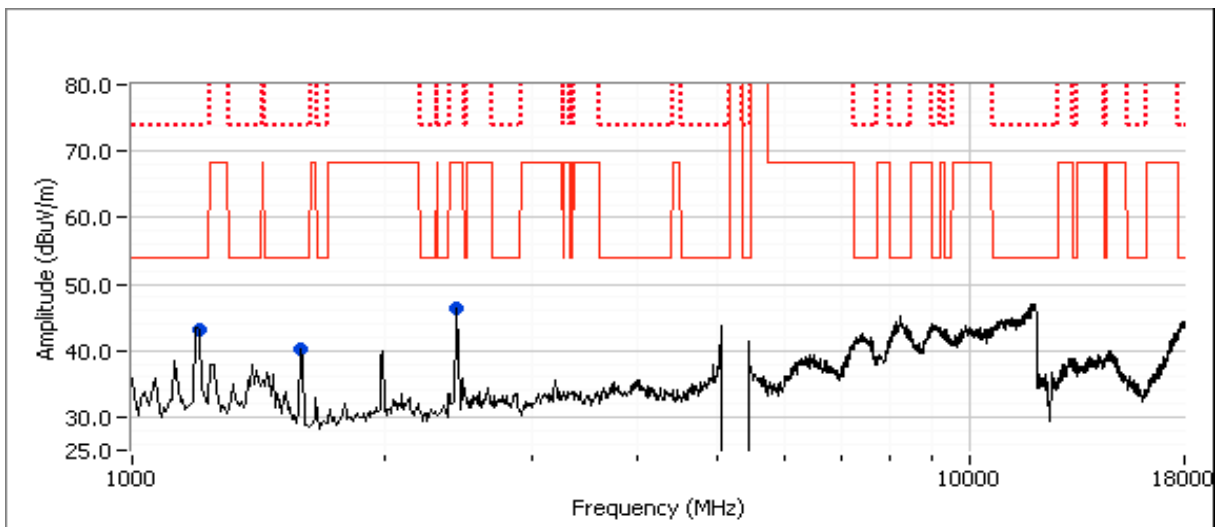

Client:	Intel	Job Number:	J91968
Model:	Intel Model 3160NGW Wireless Network Adapter	T-Log Number:	J92301
Contact:	Steve Hackett	Project Manager:	Christine Krebill
Standard:	FCC 15 B, 15.247, RSS 210	Project Coordinator:	-
		Class:	N/A

Run #1d: Center Channel, 802.11n20 mode

	Power Settings		
	Target (dBm)	Measured (dBm)	Software Setting
Chain A	16.5	16.6	29.5

Spurious Radiated Emissions:

Frequency MHz	Level dBμV/m	Pol v/h	15.209 / 15E		Detector Pk/QP/Avg	Azimuth degrees	Height meters	Comments
			Limit	Margin				
1194.880	53.0	V	74.0	-21.0	PK	19	1.2	RB 1 MHz;VB 3 MHz;Peak
1598.090	50.6	V	74.0	-23.4	PK	24	1.0	RB 1 MHz;VB 3 MHz;Peak
1198.250	30.3	V	54.0	-23.7	AVG	19	1.2	RB 1 MHz;VB 10 Hz;Peak
1598.990	27.4	V	54.0	-26.6	AVG	24	1.0	RB 1 MHz;VB 10 Hz;Peak
2449.050	41.9	V	68.3	-26.4	PK	148	0.9	RB 1 MHz;VB 3 MHz;Peak

- Note 1: For emissions in restricted bands, the limit of 15.209 was used which requires average and peak measurements.
- Note 2: For emissions outside of the restricted bands the limit is -27dBm/MHz eirp (68.3dBuV/m). The measurement method required is a peak measurement (RB=1MHz, VB≥3MHz, peak detector).
- Note 3: Scans made between 18 - 40 GHz with the measurement antenna moved around the card and its antennas 20-50cm from the device indicated there were no significant emissions in this frequency range

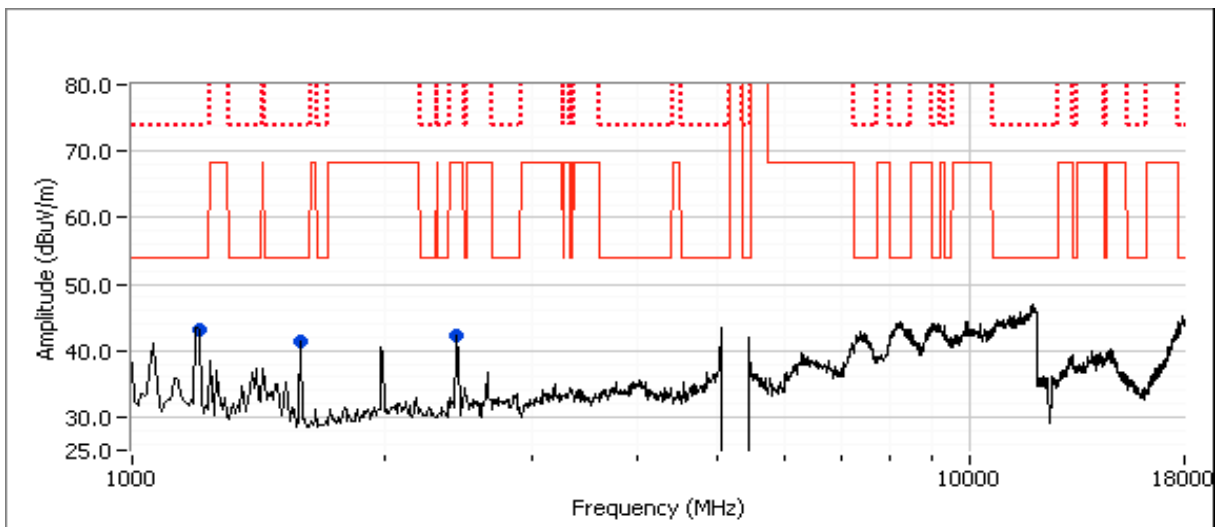

Client:	Intel	Job Number:	J91968
Model:	Intel Model 3160NGW Wireless Network Adapter	T-Log Number:	J92301
Contact:	Steve Hackett	Project Manager:	Christine Krebill
Standard:	FCC 15 B, 15.247, RSS 210	Project Coordinator:	-
		Class:	N/A

Run #1e: Low Channel, 802.11n20 Mode

Chain A	Power Settings		
	Target (dBm)	Measured (dBm)	Software Setting
Chain A	15.0	16.4	28.5

Spurious Radiated Emissions:

Frequency MHz	Level dB μ V/m	Pol v/h	15.209 / 15E		Detector Pk/QP/Avg	Azimuth degrees	Height meters	Comments
			Limit	Margin				
1197.480	54.8	V	74.0	-19.2	PK	193	1.3	RB 1 MHz;VB 3 MHz;Peak
1197.940	33.2	V	54.0	-20.8	AVG	193	1.3	RB 1 MHz;VB 10 Hz;Peak
1592.860	51.7	V	74.0	-22.3	PK	157	1.0	RB 1 MHz;VB 3 MHz;Peak
1594.590	28.3	V	54.0	-25.7	AVG	157	1.0	RB 1 MHz;VB 10 Hz;Peak
1990.950	46.7	V	68.3	-21.6	PK	73	0.9	RB 1 MHz;VB 3 MHz;Peak

Note 1: For emissions in restricted bands, the limit of 15.209 was used which requires average and peak measurements.

Note 2: For emissions outside of the restricted bands the limit is -27dBm/MHz eirp (68.3dB μ V/m). The measurement method required is a peak measurement (RB=1MHz, VB \geq 3MHz, peak detector).

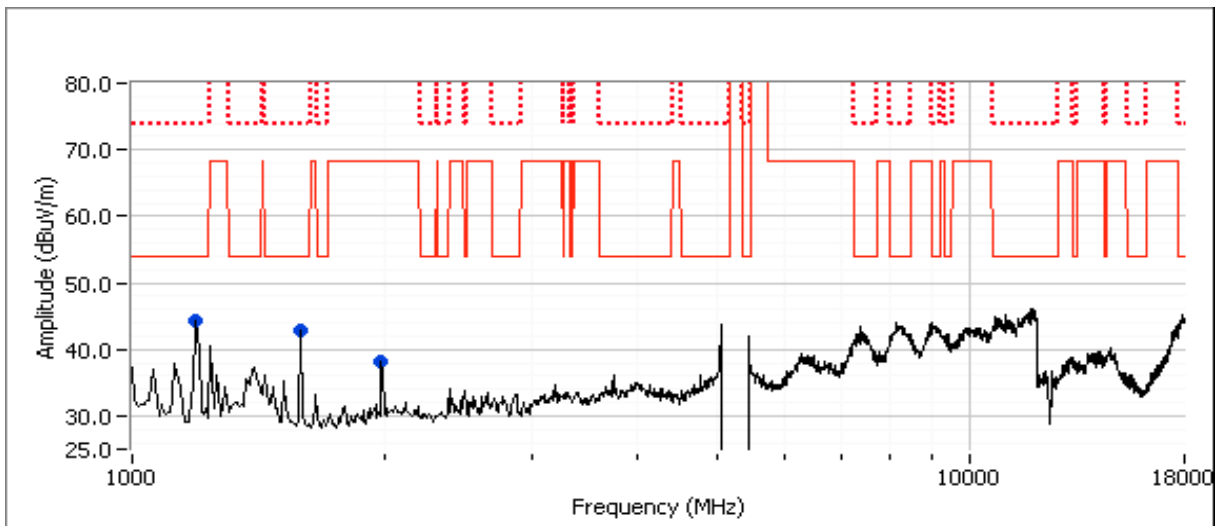

Client:	Intel	Job Number:	J91968
Model:	Intel Model 3160NGW Wireless Network Adapter	T-Log Number:	J92301
Contact:	Steve Hackett	Project Manager:	Christine Krebill
Standard:	FCC 15 B, 15.247, RSS 210	Project Coordinator:	-
		Class:	N/A

Run #1f: High Channel, 802.11n20 Mode

	Power Settings		
	Target (dBm)	Measured (dBm)	Software Setting
Chain A	16.5	16.6	28.5

Spurious Radiated Emissions:

Frequency MHz	Level dB μ V/m	Pol v/h	15.209 / 15E		Detector Pk/QP/Avg	Azimuth degrees	Height meters	Comments
			Limit	Margin				
1195.820	52.7	V	74.0	-21.3	PK	68	1.0	RB 1 MHz;VB 3 MHz;Peak
1592.710	51.7	V	74.0	-22.3	PK	199	1.0	RB 1 MHz;VB 3 MHz;Peak
1195.680	28.2	V	54.0	-25.8	AVG	68	1.0	RB 1 MHz;VB 10 Hz;Peak
1594.080	27.9	V	54.0	-26.1	AVG	199	1.0	RB 1 MHz;VB 10 Hz;Peak
1990.740	43.7	V	68.3	-24.6	PK	235	1.8	RB 1 MHz;VB 3 MHz;Peak

- Note 1: For emissions in restricted bands, the limit of 15.209 was used which requires average and peak measurements.
- Note 2: For emissions outside of the restricted bands the limit is -27dBm/MHz eirp (68.3dB μ V/m). The measurement method required is a peak measurement (RB=1MHz, VB \geq 3MHz, peak detector).

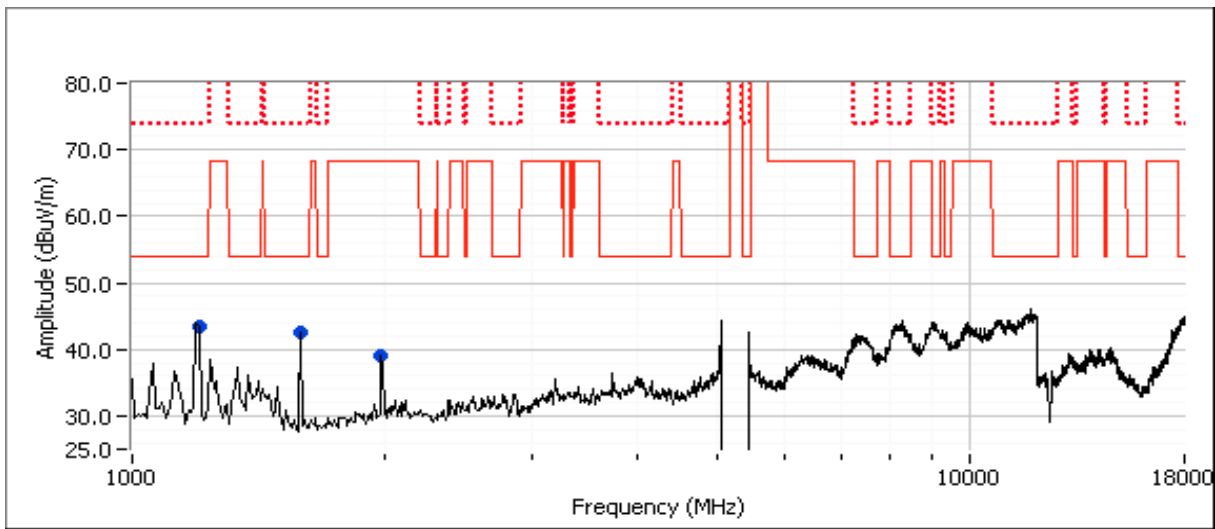



EMC Test Data

Client:	Intel	Job Number:	J91968
Model:	Intel Model 3160NGW Wireless Network Adapter	T-Log Number:	J92301
Contact:	Steve Hackett	Project Manager:	Christine Krebill
Standard:	FCC 15 B, 15.247, RSS 210	Project Coordinator:	-
		Class:	N/A

Run #1g: Low Channel, 802.11n40 mode

	Target (dBm)	Power Settings Measured (dBm)	Software Setting
Chain A	12.0	12.0	23.5

5150 MHz Band Edge Signal Radiated Field Strength

Frequency MHz	Level dB μ V/m	Pol v/h	FCC 15.209		Detector Pk/QP/Avg	Azimuth degrees	Height meters	Comments
			Limit	Margin				
5150.000	50.7	H	54.0	-3.3	AVG	160	1.0	POS; RB 1 MHz; VB: 10 Hz
5149.200	62.4	H	74.0	-11.6	PK	160	1.0	POS; RB 1 MHz; VB: 3 MHz
5150.000	49.5	V	54.0	-4.5	AVG	41	1.0	POS; RB 1 MHz; VB: 10 Hz
5149.200	62.3	V	74.0	-11.7	PK	41	1.0	POS; RB 1 MHz; VB: 3 MHz

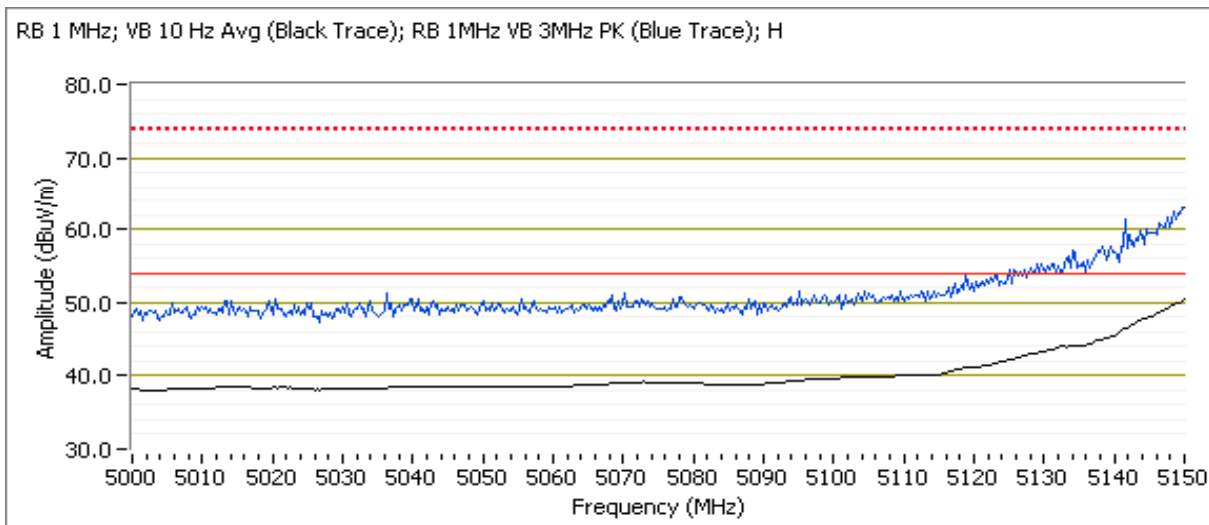



EMC Test Data

Client:	Intel	Job Number:	J91968
Model:	Intel Model 3160NGW Wireless Network Adapter	T-Log Number:	J92301
Contact:	Steve Hackett	Project Manager:	Christine Krebill
Standard:	FCC 15 B, 15.247, RSS 210	Project Coordinator:	-
		Class:	N/A

Spurious Radiated Emissions:

Frequency MHz	Level dB μ V/m	Pol v/h	15.209 / 15E		Detector Pk/QP/Avg	Azimuth degrees	Height meters	Comments
			Limit	Margin				
1195.830	53.9	V	74.0	-20.1	PK	9	1.4	RB 1 MHz;VB 3 MHz;Peak
1593.670	53.5	V	74.0	-20.5	PK	342	1.0	RB 1 MHz;VB 3 MHz;Peak
1195.130	32.4	V	54.0	-21.6	AVG	9	1.4	RB 1 MHz;VB 10 Hz;Peak
1593.430	29.9	V	54.0	-24.1	AVG	342	1.0	RB 1 MHz;VB 10 Hz;Peak
3748.780	29.0	V	54.0	-25.0	AVG	91	1.3	RB 1 MHz;VB 10 Hz;Peak
3738.810	40.1	V	74.0	-33.9	PK	91	1.3	RB 1 MHz;VB 3 MHz;Peak
2448.190	41.8	V	68.3	-26.5	PK	178	1.7	RB 1 MHz;VB 3 MHz;Peak

Note 1: For emissions in restricted bands, the limit of 15.209 was used which requires average and peak measurements.

Note 2: For emissions outside of the restricted bands the limit is -27dBm/MHz eirp (68.3dBuV/m). The measurement method required is a peak measurement (RB=1MHz, VB \geq 3MHz, peak detector).

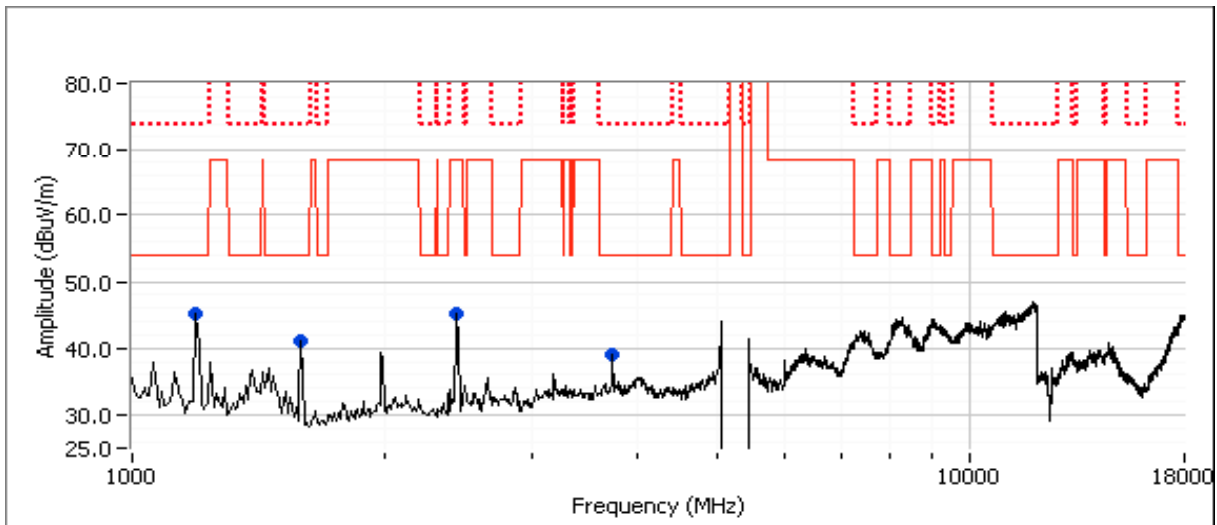



EMC Test Data

Client:	Intel	Job Number:	J91968
Model:	Intel Model 3160NGW Wireless Network Adapter	T-Log Number:	J92301
Contact:	Steve Hackett	Project Manager:	Christine Krebill
Standard:	FCC 15 B, 15.247, RSS 210	Project Coordinator:	-
		Class:	N/A

Run #1h: High Channel, 802.11n40 Mode

Chain A	Target (dBm)	Power Settings Measured (dBm)	Software Setting
	16.5	16.5	29.0

5150 MHz Band Edge Signal Radiated Field Strength

Frequency MHz	Level dB μ V/m	Pol v/h	FCC 15.209		Detector Pk/QP/Avg	Azimuth degrees	Height meters	Comments
			Limit	Margin				
5150.000	45.4	V	54.0	-8.6	AVG	330	1.0	POS; RB 1 MHz; VB: 10 Hz
5147.350	57.6	V	74.0	-16.4	PK	330	1.0	POS; RB 1 MHz; VB: 3 MHz
5149.980	45.1	H	54.0	-8.9	AVG	172	1.0	POS; RB 1 MHz; VB: 10 Hz
5147.500	58.6	H	74.0	-15.4	PK	172	1.0	POS; RB 1 MHz; VB: 3 MHz

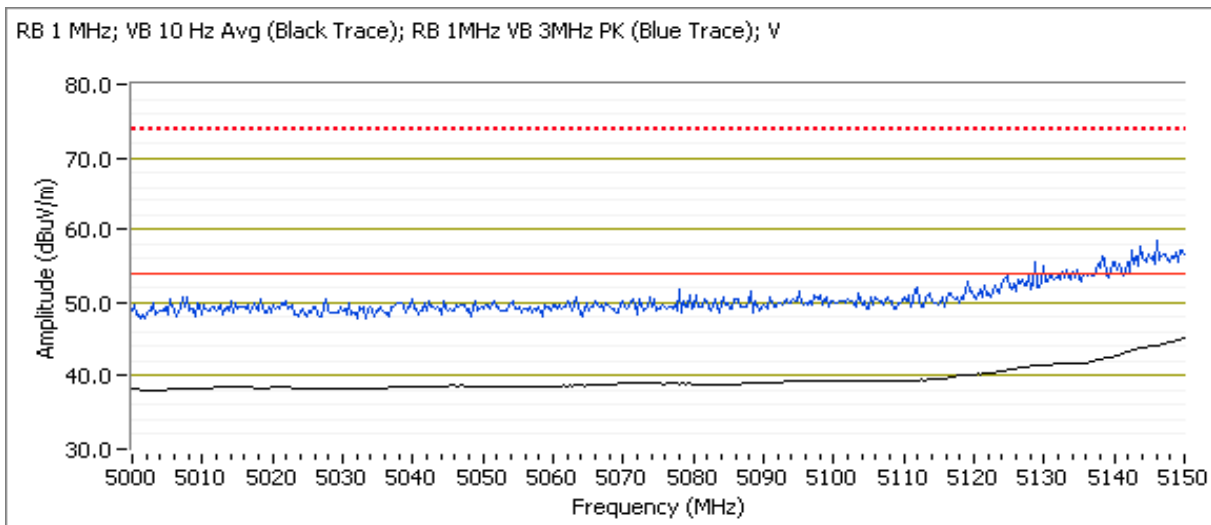

Client:	Intel	Job Number:	J91968
Model:	Intel Model 3160NGW Wireless Network Adapter	T-Log Number:	J92301
Contact:	Steve Hackett	Project Manager:	Christine Krebill
Standard:	FCC 15 B, 15.247, RSS 210	Project Coordinator:	-
		Class:	N/A

Spurious Radiated Emissions:

Frequency MHz	Level dB μ V/m	Pol v/h	15.209 / 15E		Detector Pk/QP/Avg	Azimuth degrees	Height meters	Comments
			Limit	Margin				
1197.470	54.9	V	74.0	-19.1	PK	354	1.4	RB 1 MHz;VB 3 MHz;Peak
1196.730	32.4	V	54.0	-21.6	AVG	354	1.4	RB 1 MHz;VB 10 Hz;Peak
1593.890	52.4	V	74.0	-21.6	PK	344	1.0	RB 1 MHz;VB 3 MHz;Peak
1595.720	29.8	V	54.0	-24.2	AVG	344	1.0	RB 1 MHz;VB 10 Hz;Peak
2443.180	38.6	H	68.3	-29.7	PK	28	1.1	RB 1 MHz;VB 3 MHz;Peak

- Note 1: For emissions in restricted bands, the limit of 15.209 was used which requires average and peak measurements.
- Note 2: For emissions outside of the restricted bands the limit is -27dBm/MHz eirp (68.3dBuV/m). The measurement method required is a peak measurement (RB=1MHz, VB≥3MHz, peak detector).

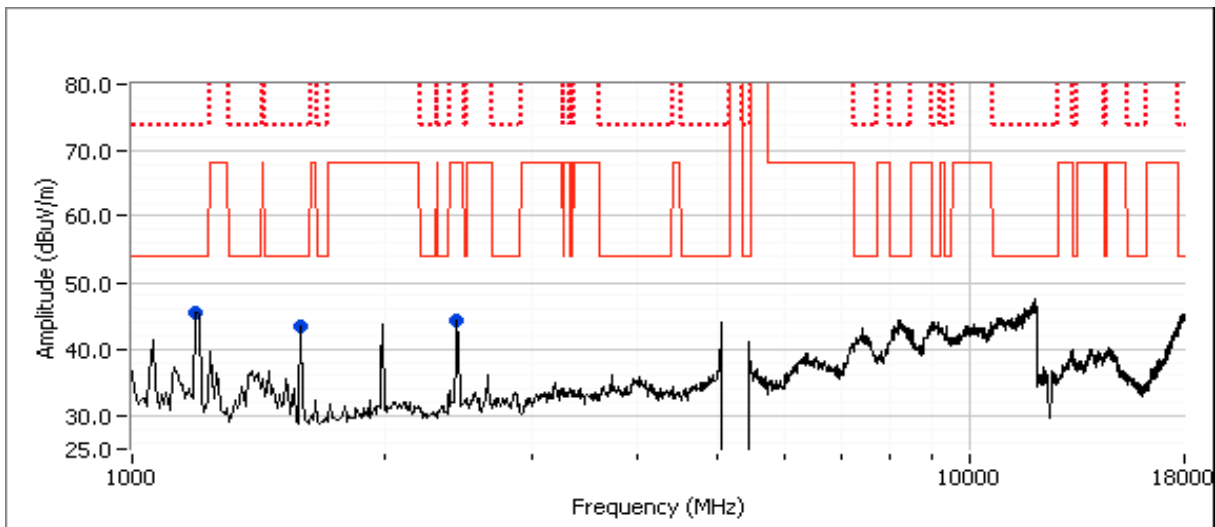



EMC Test Data

Client:	Intel	Job Number:	J91968
Model:	Intel Model 3160NGW Wireless Network Adapter	T-Log Number:	J92301
Contact:	Steve Hackett	Project Manager:	Christine Krebill
Standard:	FCC 15 B, 15.247, RSS 210	Project Coordinator:	-
		Class:	N/A

Run #1i: 5210 MHz, 802.11ac80 mode

	Target (dBm)	Power Settings Measured (dBm)	Software Setting
Chain A	10.5	10.1	20.0

5150 MHz Band Edge Signal Radiated Field Strength

Frequency MHz	Level dBμV/m	Pol v/h	FCC 15.209		Detector Pk/QP/Avg	Azimuth degrees	Height meters	Comments
			Limit	Margin				
5127.480	52.7	H	54.0	-1.3	AVG	171	1.0	power setting = 20
5126.110	65.9	H	74.0	-8.1	PK	171	1.0	power setting = 20
5127.480	52.8	V	54.0	-1.2	AVG	266	1.0	power setting = 20.5
5126.190	65.4	V	74.0	-8.6	PK	266	1.0	power setting = 20.5
5127.460	53.4	V	54.0	-0.6	AVG	266	1.0	power setting = 21.0
5126.250	65.8	V	74.0	-8.2	PK	266	1.0	power setting = 21.0

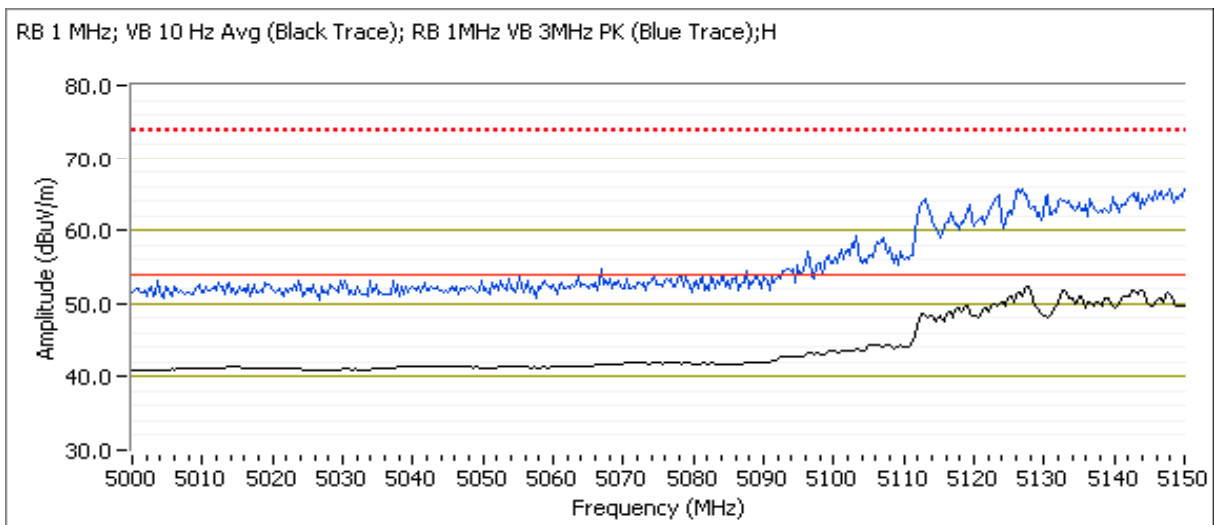

Client:	Intel	Job Number:	J91968
Model:	Intel Model 3160NGW Wireless Network Adapter	T-Log Number:	J92301
Contact:	Steve Hackett	Project Manager:	Christine Krebill
Standard:	FCC 15 B, 15.247, RSS 210	Project Coordinator:	-
		Class:	N/A

Spurious Radiated Emissions:

Frequency MHz	Level dB μ V/m	Pol v/h	15.209 / 15E		Detector Pk/QP/Avg	Azimuth degrees	Height meters	Comments
			Limit	Margin				
1196.070	56.0	V	74.0	-18.0	PK	12	1.3	RB 1 MHz;VB 3 MHz;Peak
1594.470	53.4	V	74.0	-20.6	PK	0	1.0	RB 1 MHz;VB 3 MHz;Peak
1195.400	32.6	V	54.0	-21.4	AVG	12	1.3	RB 1 MHz;VB 10 Hz;Peak
1594.000	30.4	V	54.0	-23.6	AVG	0	1.0	RB 1 MHz;VB 10 Hz;Peak
2453.340	49.6	H	68.3	-18.7	PK	13	1.5	RB 1 MHz;VB 3 MHz;Peak

- Note 1: For emissions in restricted bands, the limit of 15.209 was used which requires average and peak measurements.
- Note 2: For emissions outside of the restricted bands the limit is -27dBm/MHz eirp (68.3dBuV/m). The measurement method required is a peak measurement (RB=1MHz, VB \geq 3MHz, peak detector).

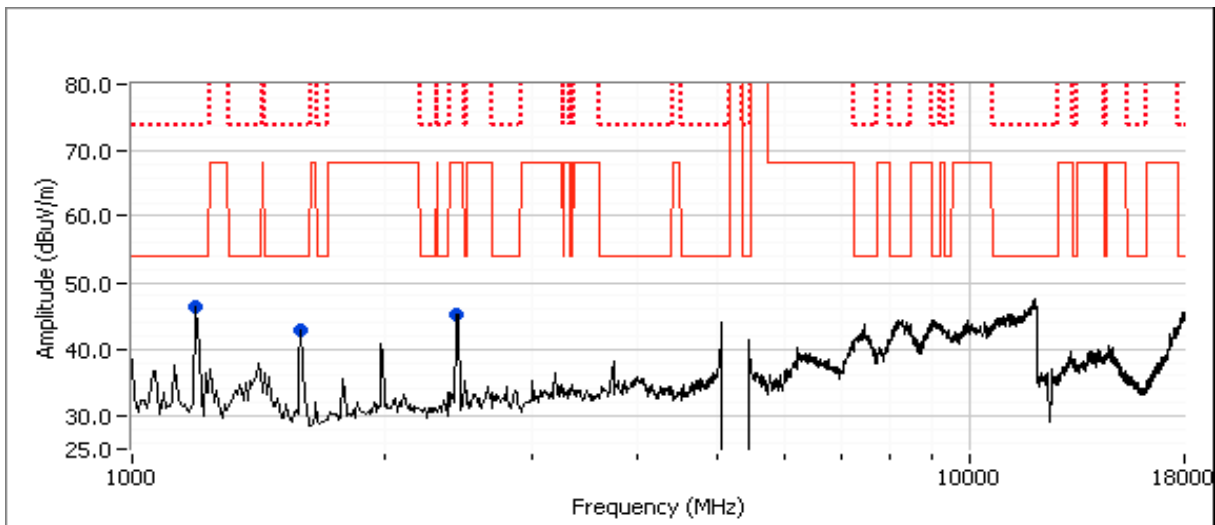



EMC Test Data

Client:	Intel	Job Number:	J91968
Model:	Intel Model 3160NGW Wireless Network Adapter	T-Log Number:	J92301
Contact:	Steve Hackett	Project Manager:	Christine Krebill
Standard:	FCC 15 B, 15.247, RSS 210	Project Coordinator:	-
		Class:	N/A

Run #2, Radiated Spurious Emissions, 30 - 40,000 MHz. Operation in the 5250-5350 MHz Band

Date of Test: 5/22/13, 5/24/13
 Test Engineer: Rafael Varelas / Jack Liu
 Test Location: FT Chamber 4

Run #2a: Center Channel, 802.11a mode

Chain A	Target (dBm)	Power Settings Measured (dBm)	Software Setting
	16.5	16.5	28.5

Spurious Radiated Emissions:

Frequency MHz	Level dB μ V/m	Pol v/h	15.209 / 15E		Detector Pk/QP/Avg	Azimuth degrees	Height meters	Comments
			Limit	Margin				
1197.870	55.9	V	74.0	-18.1	PK	16	1.4	RB 1 MHz;VB 3 MHz;Peak
1594.800	52.4	V	74.0	-21.6	PK	192	1.4	RB 1 MHz;VB 3 MHz;Peak
1204.670	31.2	V	54.0	-22.8	AVG	16	1.4	RB 1 MHz;VB 10 Hz;Peak
3736.740	50.6	H	74.0	-23.4	PK	15	1.3	RB 1 MHz;VB 3 MHz;Peak
3742.470	28.9	H	54.0	-25.1	AVG	15	1.3	RB 1 MHz;VB 10 Hz;Peak
1593.470	27.9	V	54.0	-26.1	AVG	192	1.4	RB 1 MHz;VB 10 Hz;Peak
1244.200	45.9	V	68.3	-22.4	PK	226	1.0	RB 1 MHz;VB 3 MHz;Peak

- Note 1: For emissions in restricted bands, the limit of 15.209 was used which requires average and peak measurements.
- Note 2: For emissions outside of the restricted bands the limit is -27dBm/MHz eirp (68.3dBuV/m). The measurement method required is a peak measurement (RB=1MHz, VB \geq 3MHz, peak detector).
- Note 3: Scans made between 18 - 40 GHz with the measurement antenna moved around the card and its antennas 20-50cm from the device indicated there were no significant emissions in this frequency range

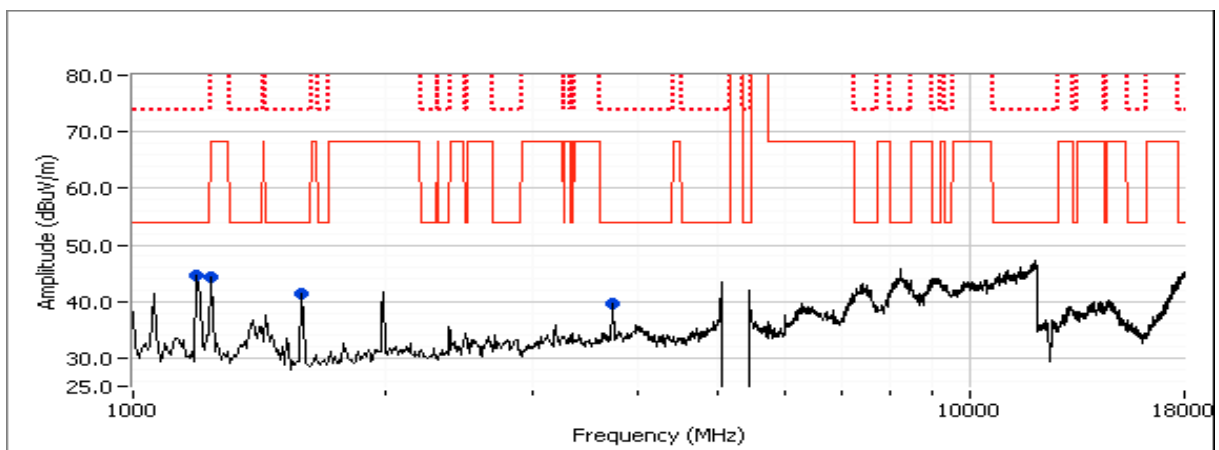

Client:	Intel	Job Number:	J91968
Model:	Intel Model 3160NGW Wireless Network Adapter	T-Log Number:	J92301
Contact:	Steve Hackett	Project Manager:	Christine Krebill
Standard:	FCC 15 B, 15.247, RSS 210	Project Coordinator:	-
		Class:	N/A

Run #2b: Center Channel, 802.11n20 mode

Chain A	Target (dBm)	Power Settings Measured (dBm)	Software Setting
	16.5	16.5	28.5

Spurious Radiated Emissions:

Frequency MHz	Level dB μ V/m	Pol v/h	15.209 / 15E		Detector Pk/QP/Avg	Azimuth degrees	Height meters	Comments
			Limit	Margin				
1594.500	54.2	V	74.0	-19.8	PK	334	1.0	RB 1 MHz;VB 3 MHz;Peak
1597.500	30.3	V	54.0	-23.7	AVG	334	1.0	RB 1 MHz;VB 10 Hz;Peak
1130.820	30.2	V	54.0	-23.8	AVG	201	1.0	RB 1 MHz;VB 10 Hz;Peak
1126.550	43.6	V	74.0	-30.4	PK	201	1.0	RB 1 MHz;VB 3 MHz;Peak

Note 1: For emissions in restricted bands, the limit of 15.209 was used which requires average and peak measurements.

Note 2: For emissions outside of the restricted bands the limit is -27dBm/MHz eirp (68.3dBuV/m). The measurement method required is a peak measurement (RB=1MHz, VB \geq 3MHz, peak detector).

Note 3: Scans made between 18 - 40 GHz with the measurement antenna moved around the card and its antennas 20-50cm from the device indicated there were no significant emissions in this frequency range

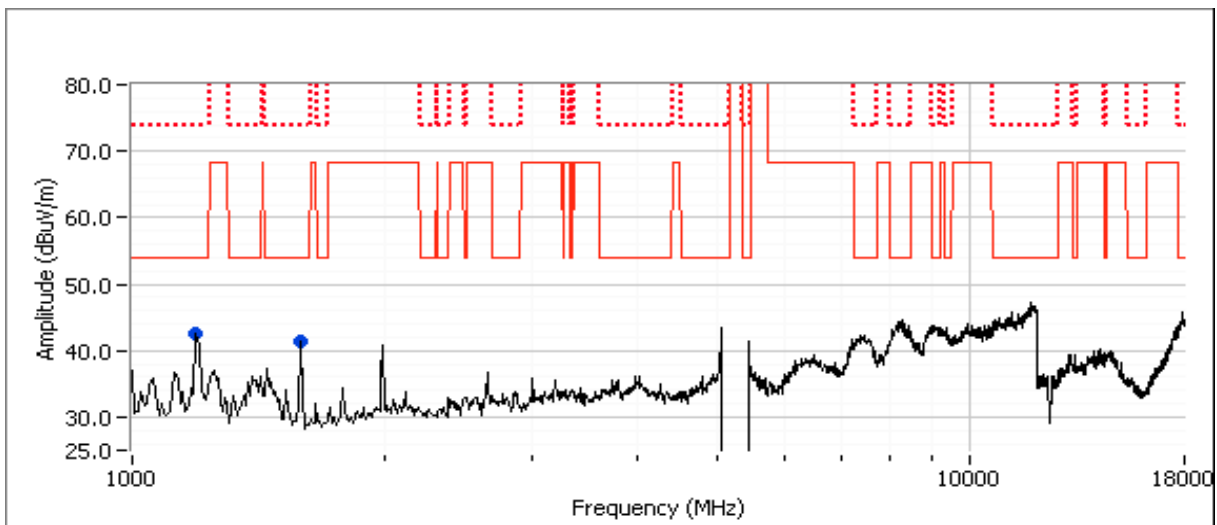

Client:	Intel	Job Number:	J91968
Model:	Intel Model 3160NGW Wireless Network Adapter	T-Log Number:	J92301
Contact:	Steve Hackett	Project Manager:	Christine Krebill
Standard:	FCC 15 B, 15.247, RSS 210	Project Coordinator:	-
		Class:	N/A

Run #2c: Low Channel, 802.11a mode

Chain A	Power Settings		Software Setting
	Target (dBm)	Measured (dBm)	
Chain A	16.5	16.6	28.5

Spurious Radiated Emissions:

Frequency MHz	Level dB μ V/m	Pol v/h	15.209 / 15E		Detector Pk/QP/Avg	Azimuth degrees	Height meters	Comments
			Limit	Margin				
1996.190	50.3	V	68.3	-18.0	PK	55	1.0	RB 1 MHz;VB 3 MHz;Peak
1598.970	51.3	V	74.0	-22.7	PK	210	1.0	RB 1 MHz;VB 3 MHz;Peak
1194.770	49.9	V	74.0	-24.1	PK	23	1.3	RB 1 MHz;VB 3 MHz;Peak
1597.340	29.5	V	54.0	-24.5	AVG	210	1.0	RB 1 MHz;VB 10 Hz;Peak
1195.110	27.7	V	54.0	-26.3	AVG	23	1.3	RB 1 MHz;VB 10 Hz;Peak

Note 1: For emissions in restricted bands, the limit of 15.209 was used which requires average and peak measurements.

Note 2: For emissions outside of the restricted bands the limit is -27dBm/MHz eirp (68.3dBuV/m). The measurement method required is a peak measurement (RB=1MHz, VB \geq 3MHz, peak detector).

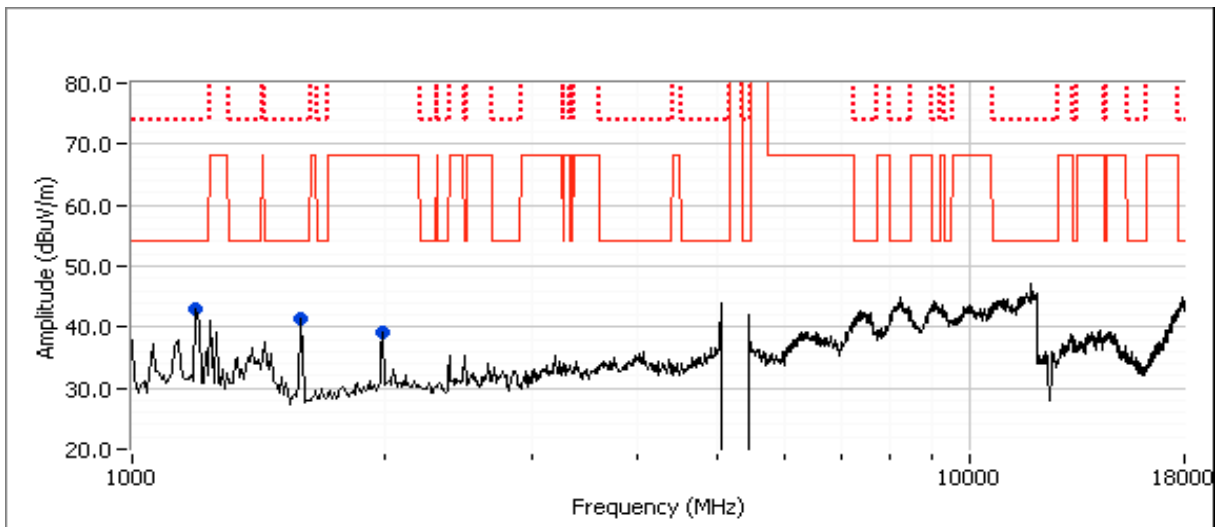

Client:	Intel	Job Number:	J91968
Model:	Intel Model 3160NGW Wireless Network Adapter	T-Log Number:	J92301
Contact:	Steve Hackett	Project Manager:	Christine Krebill
Standard:	FCC 15 B, 15.247, RSS 210	Project Coordinator:	-
		Class:	N/A

Run #2d: High Channel, 802.11a mode

Chain A	Power Settings		
	Target (dBm)	Measured (dBm)	Software Setting
Chain A	14.5	16.6	28.5

Spurious Radiated Emissions:

Frequency MHz	Level dBμV/m	Pol v/h	15.209 / 15E		Detector Pk/QP/Avg	Azimuth degrees	Height meters	Comments
			Limit	Margin				
1195.270	54.3	V	74.0	-19.7	PK	205	1.3	RB 1 MHz;VB 3 MHz;Peak
1195.310	32.0	V	54.0	-22.0	AVG	205	1.3	RB 1 MHz;VB 10 Hz;Peak
1599.130	49.4	V	74.0	-24.6	PK	218	1.0	RB 1 MHz;VB 3 MHz;Peak
1597.480	27.7	V	54.0	-26.3	AVG	218	1.0	RB 1 MHz;VB 10 Hz;Peak
1998.550	45.7	V	68.3	-22.6	PK	230	1.2	RB 1 MHz;VB 3 MHz;Peak

Note 1: For emissions in restricted bands, the limit of 15.209 was used which requires average and peak measurements.

Note 2: For emissions outside of the restricted bands the limit is -27dBm/MHz eirp (68.3dBuV/m). The measurement method required is a peak measurement (RB=1MHz, VB≥3MHz, peak detector).

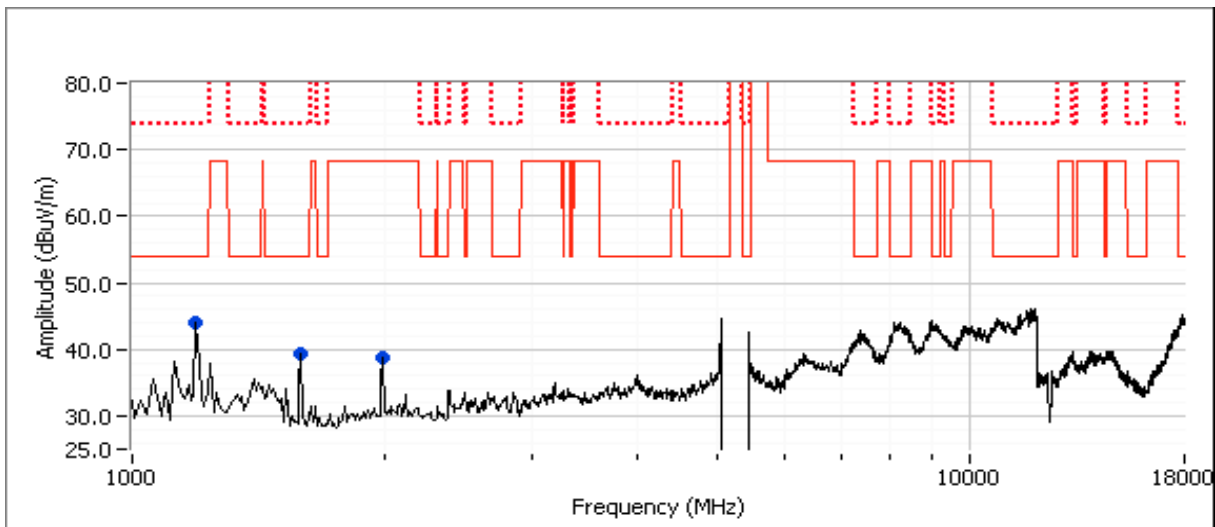



EMC Test Data

Client:	Intel	Job Number:	J91968
Model:	Intel Model 3160NGW Wireless Network Adapter	T-Log Number:	J92301
Contact:	Steve Hackett	Project Manager:	Christine Krebill
Standard:	FCC 15 B, 15.247, RSS 210	Project Coordinator:	-
		Class:	N/A

Run #2e: High Channel, 802.11a mode

Chain A	Target (dBm)	Power Settings Measured (dBm)	Software Setting
	14.5	14.5	25.5

5350 MHz Band Edge Signal Radiated Field Strength

Frequency	Level	Pol	FCC 15.209		Detector	Azimuth	Height	Comments
MHz	dB μ V/m	v/h	Limit	Margin	Pk/QP/Avg	degrees	meters	
5350.000	48.1	H	54.0	-5.9	AVG	80	1.2	POS; RB 1 MHz; VB: 10 Hz
5351.280	61.1	H	74.0	-12.9	PK	80	1.2	POS; RB 1 MHz; VB: 3 MHz
5350.000	46.8	V	54.0	-7.2	AVG	318	1.0	POS; RB 1 MHz; VB: 10 Hz
5352.320	60.9	V	74.0	-13.1	PK	318	1.0	POS; RB 1 MHz; VB: 3 MHz

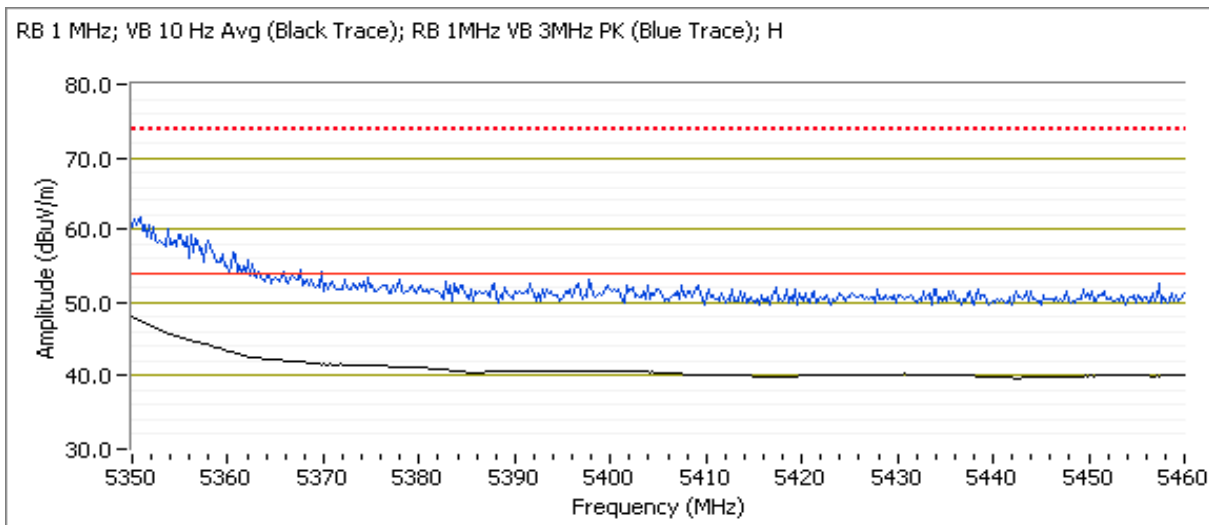



EMC Test Data

Client:	Intel	Job Number:	J91968
Model:	Intel Model 3160NGW Wireless Network Adapter	T-Log Number:	J92301
Contact:	Steve Hackett	Project Manager:	Christine Krebill
Standard:	FCC 15 B, 15.247, RSS 210	Project Coordinator:	-
		Class:	N/A

Run #2f: High Channel, 802.11n20 mode

Chain A	Power Settings		Software Setting
	Target (dBm)	Measured (dBm)	
Chain A	14.5	14.5	25.5

5350 MHz Band Edge Signal Radiated Field Strength

Frequency MHz	Level dB μ V/m	Pol v/h	FCC 15.209		Detector Pk/QP/Avg	Azimuth degrees	Height meters	Comments
			Limit	Margin				
5350.060	48.9	V	54.0	-5.1	AVG	80	1.3	POS; RB 1 MHz; VB: 10 Hz
5350.420	63.2	V	74.0	-10.8	PK	80	1.3	POS; RB 1 MHz; VB: 3 MHz
5350.000	45.9	H	54.0	-8.1	AVG	171	1.0	POS; RB 1 MHz; VB: 10 Hz
5350.320	59.1	H	74.0	-14.9	PK	171	1.0	POS; RB 1 MHz; VB: 3 MHz

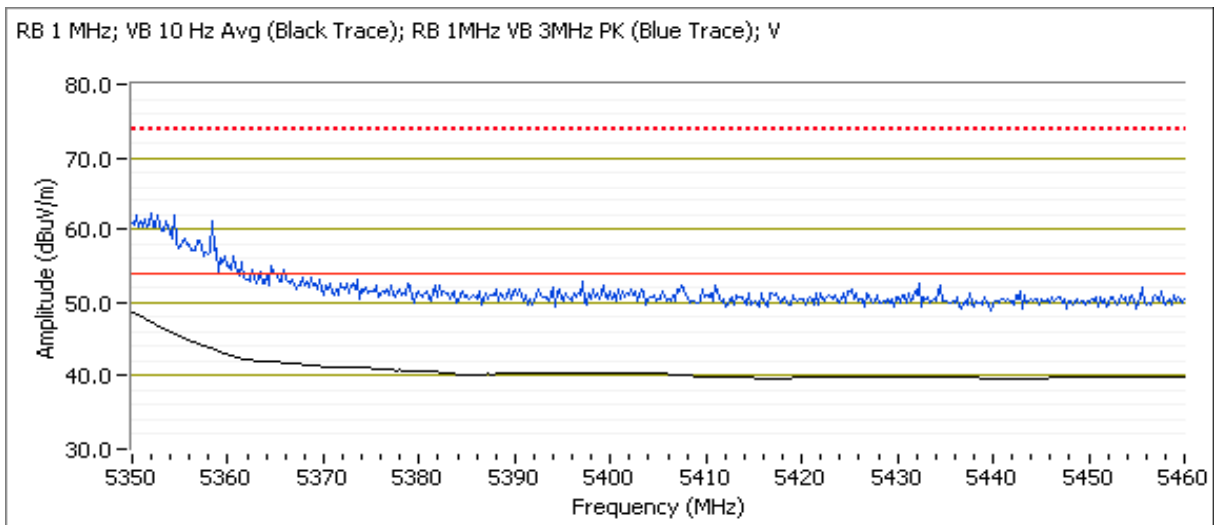

Client:	Intel	Job Number:	J91968
Model:	Intel Model 3160NGW Wireless Network Adapter	T-Log Number:	J92301
Contact:	Steve Hackett	Project Manager:	Christine Krebill
Standard:	FCC 15 B, 15.247, RSS 210	Project Coordinator:	-
		Class:	N/A

Run #2g: Low Channel, 802.11n40 mode

	Target (dBm)	Power Settings Measured (dBm)	Software Setting
Chain A	12.0	12.1	23.0

Spurious Radiated Emissions:

Frequency	Level	Pol	15.209 / 15E		Detector	Azimuth	Height	Comments
MHz	dB μ V/m	v/h	Limit	Margin	Pk/QP/Avg	degrees	meters	
1990.600	51.1	V	68.3	-17.2	PK	246	1.0	RB 1 MHz;VB 3 MHz;Peak
1596.600	53.9	V	74.0	-20.1	PK	219	1.5	RB 1 MHz;VB 3 MHz;Peak
1191.940	29.8	H	54.0	-24.2	AVG	45	1.0	RB 1 MHz;VB 10 Hz;Peak
1593.470	29.1	V	54.0	-24.9	AVG	219	1.5	RB 1 MHz;VB 10 Hz;Peak
1198.270	46.2	H	74.0	-27.8	PK	45	1.0	RB 1 MHz;VB 3 MHz;Peak

- Note 1: For emissions in restricted bands, the limit of 15.209 was used which requires average and peak measurements.
- Note 2: For emissions outside of the restricted bands the limit is -27dBm/MHz eirp (68.3dBuV/m). The measurement method required is a peak measurement (RB=1MHz, VB \geq 3MHz, peak detector).

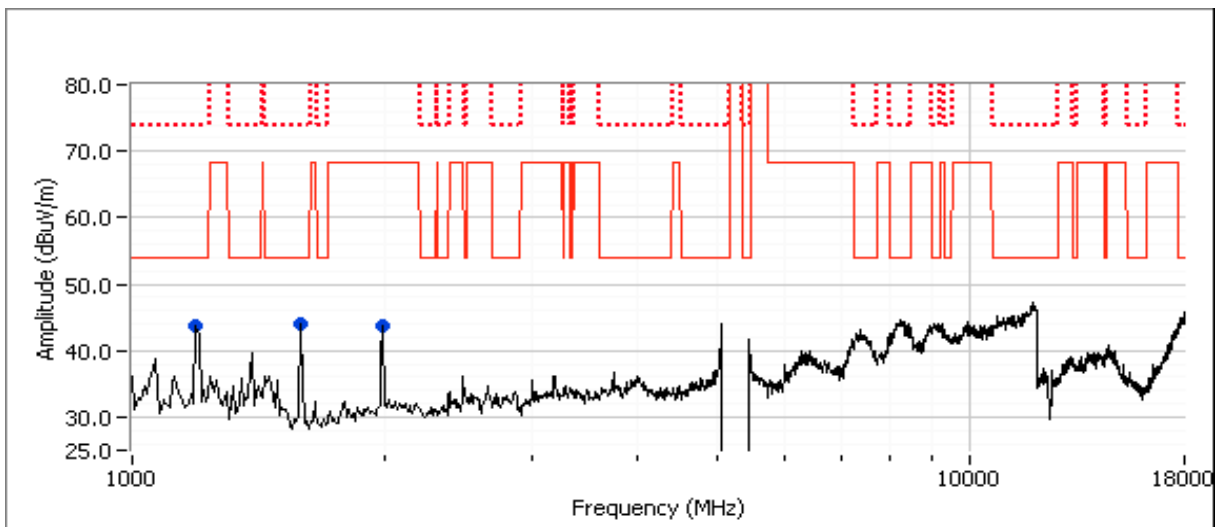



EMC Test Data

Client:	Intel	Job Number:	J91968
Model:	Intel Model 3160NGW Wireless Network Adapter	T-Log Number:	J92301
Contact:	Steve Hackett	Project Manager:	Christine Krebill
Standard:	FCC 15 B, 15.247, RSS 210	Project Coordinator:	-
		Class:	N/A

Run #2h: High Channel, 802.11n40 mode

Chain A	Power Settings		
	Target (dBm)	Measured (dBm)	Software Setting
	13.5	13.6	24.5

5350 MHz Band Edge Signal Radiated Field Strength

Frequency MHz	Level dB μ V/m	Pol v/h	FCC 15.209		Detector Pk/QP/Avg	Azimuth degrees	Height meters	Comments
			Limit	Margin				
5350.080	49.6	V	54.0	-4.4	AVG	324	1.0	POS; RB 1 MHz; VB: 10 Hz
5350.160	61.4	V	74.0	-12.6	PK	324	1.0	POS; RB 1 MHz; VB: 3 MHz
5350.000	47.4	H	54.0	-6.6	AVG	157	1.0	POS; RB 1 MHz; VB: 10 Hz
5350.800	58.6	H	74.0	-15.4	PK	157	1.0	POS; RB 1 MHz; VB: 3 MHz

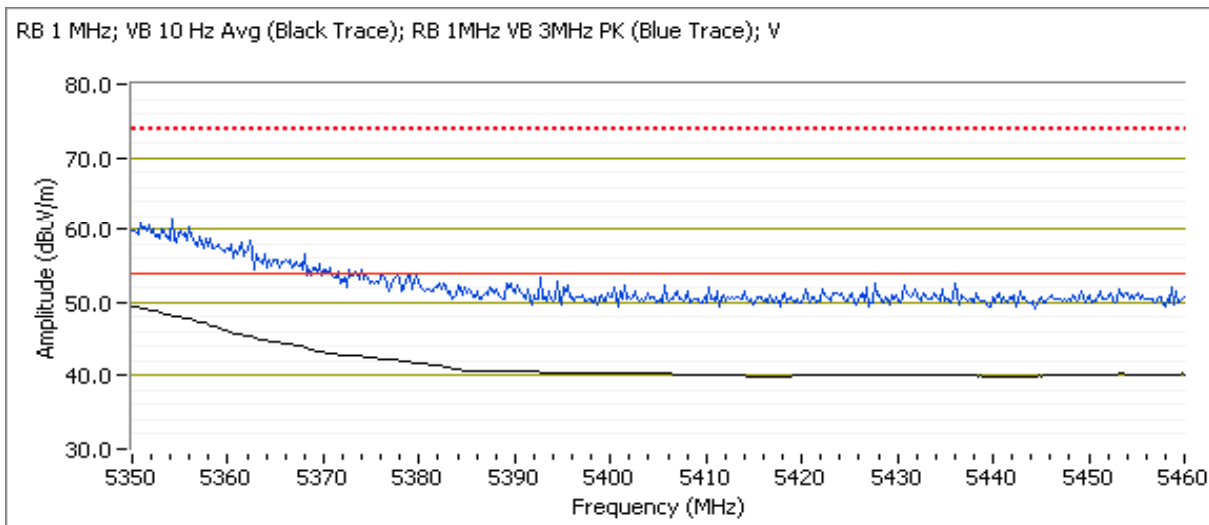

Client:	Intel	Job Number:	J91968
Model:	Intel Model 3160NGW Wireless Network Adapter	T-Log Number:	J92301
Contact:	Steve Hackett	Project Manager:	Christine Krebill
Standard:	FCC 15 B, 15.247, RSS 210	Project Coordinator:	-
		Class:	N/A

Spurious Radiated Emissions:

Frequency MHz	Level dB μ V/m	Pol v/h	15.209 / 15E		Detector Pk/QP/Avg	Azimuth degrees	Height meters	Comments
			Limit	Margin				
1197.720	55.3	V	74.0	-18.7	PK	16	1.3	RB 1 MHz;VB 3 MHz;Peak
1592.870	53.0	V	74.0	-21.0	PK	136	1.4	RB 1 MHz;VB 3 MHz;Peak
1198.600	32.1	V	54.0	-21.9	AVG	16	1.3	RB 1 MHz;VB 10 Hz;Peak
1597.000	30.3	V	54.0	-23.7	AVG	136	1.4	RB 1 MHz;VB 10 Hz;Peak
1267.170	41.2	H	68.3	-27.1	PK	152	1.3	RB 1 MHz;VB 3 MHz;Peak

- Note 1: For emissions in restricted bands, the limit of 15.209 was used which requires average and peak measurements.
- Note 2: For emissions outside of the restricted bands the limit is -27dBm/MHz eirp (68.3dBuV/m). The measurement method required is a peak measurement (RB=1MHz, VB \geq 3MHz, peak detector).

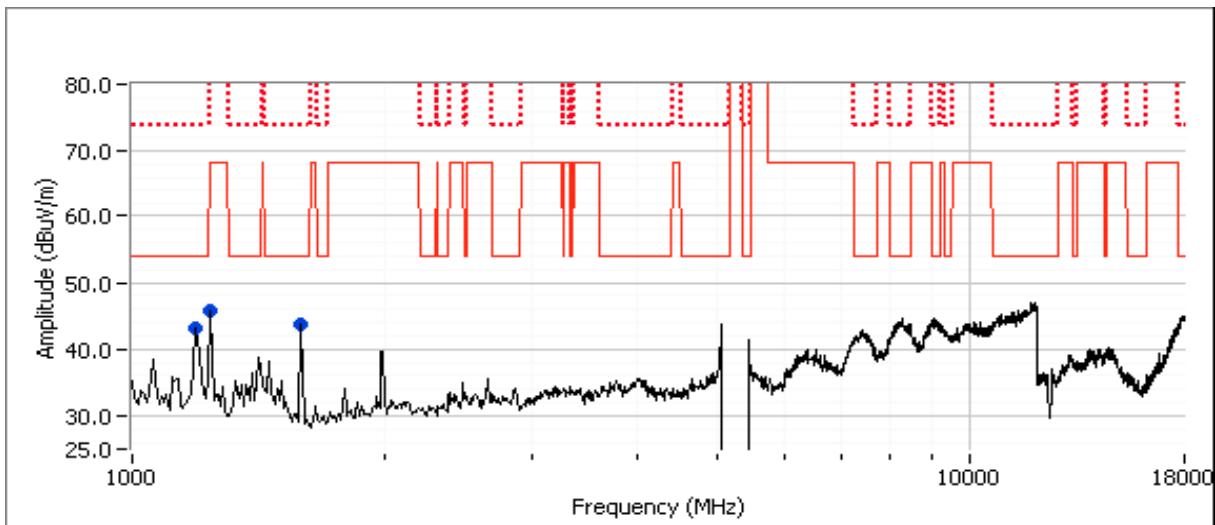



EMC Test Data

Client:	Intel	Job Number:	J91968
Model:	Intel Model 3160NGW Wireless Network Adapter	T-Log Number:	J92301
Contact:	Steve Hackett	Project Manager:	Christine Krebill
Standard:	FCC 15 B, 15.247, RSS 210	Project Coordinator:	-
		Class:	N/A

Run #2i: 5290 MHz, 802.11ac80 mode

Chain A	Power Settings		
	Target (dBm)	Measured (dBm)	Software Setting
	12.0	11.9	22.0

5350 MHz Band Edge Signal Radiated Field Strength

Frequency MHz	Level dB μ V/m	Pol v/h	FCC 15.209		Detector Pk/QP/Avg	Azimuth degrees	Height meters	Comments
			Limit	Margin				
5352.520	50.3	H	54.0	-3.7	AVG	79	1.2	POS; RB 1 MHz; VB: 10 Hz
5350.280	62.9	H	74.0	-11.1	PK	79	1.2	POS; RB 1 MHz; VB: 3 MHz
5352.560	48.3	V	54.0	-5.7	AVG	0	1.3	POS; RB 1 MHz; VB: 10 Hz
5352.160	60.5	V	74.0	-13.5	PK	0	1.3	POS; RB 1 MHz; VB: 3 MHz

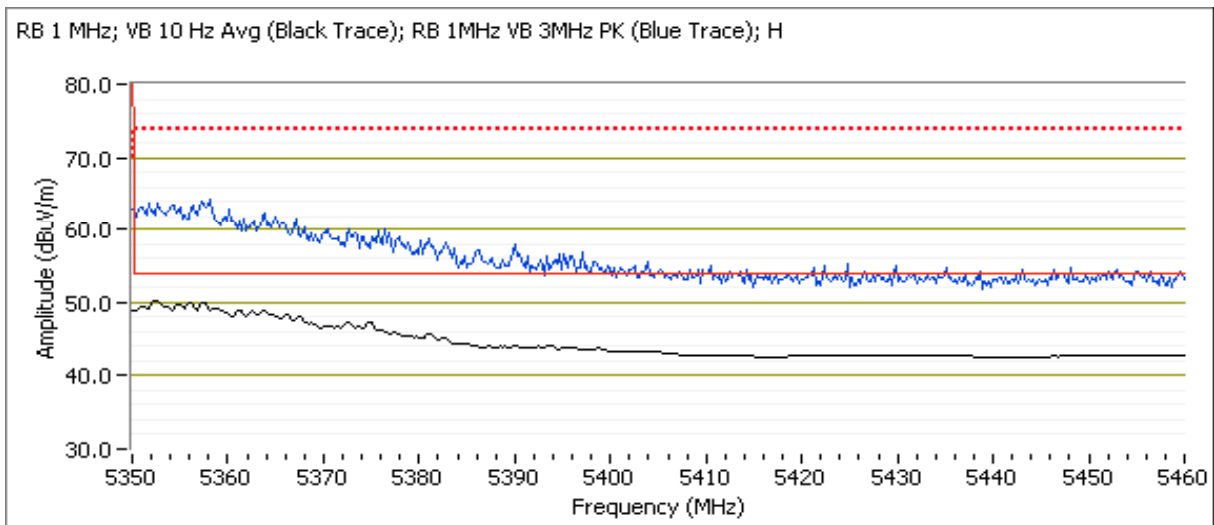

Client:	Intel	Job Number:	J91968
Model:	Intel Model 3160NGW Wireless Network Adapter	T-Log Number:	J92301
Contact:	Steve Hackett	Project Manager:	Christine Krebill
Standard:	FCC 15 B, 15.247, RSS 210	Project Coordinator:	-
		Class:	N/A

Spurious Radiated Emissions:

Frequency MHz	Level dB μ V/m	Pol v/h	15.209 / 15E		Detector Pk/QP/Avg	Azimuth degrees	Height meters	Comments
			Limit	Margin				
1196.950	55.0	V	74.0	-19.0	PK	20	1.4	RB 1 MHz;VB 3 MHz;Peak
1593.400	54.3	V	74.0	-19.7	PK	345	0.9	RB 1 MHz;VB 3 MHz;Peak
1198.020	32.2	V	54.0	-21.8	AVG	20	1.4	RB 1 MHz;VB 10 Hz;Peak
1593.800	30.6	V	54.0	-23.4	AVG	345	0.9	RB 1 MHz;VB 10 Hz;Peak

Note 1: For emissions in restricted bands, the limit of 15.209 was used which requires average and peak measurements.

Note 2: For emissions outside of the restricted bands the limit is -27dBm/MHz eirp (68.3dBuV/m). The measurement method required is a peak measurement (RB=1MHz, VB \geq 3MHz, peak detector).

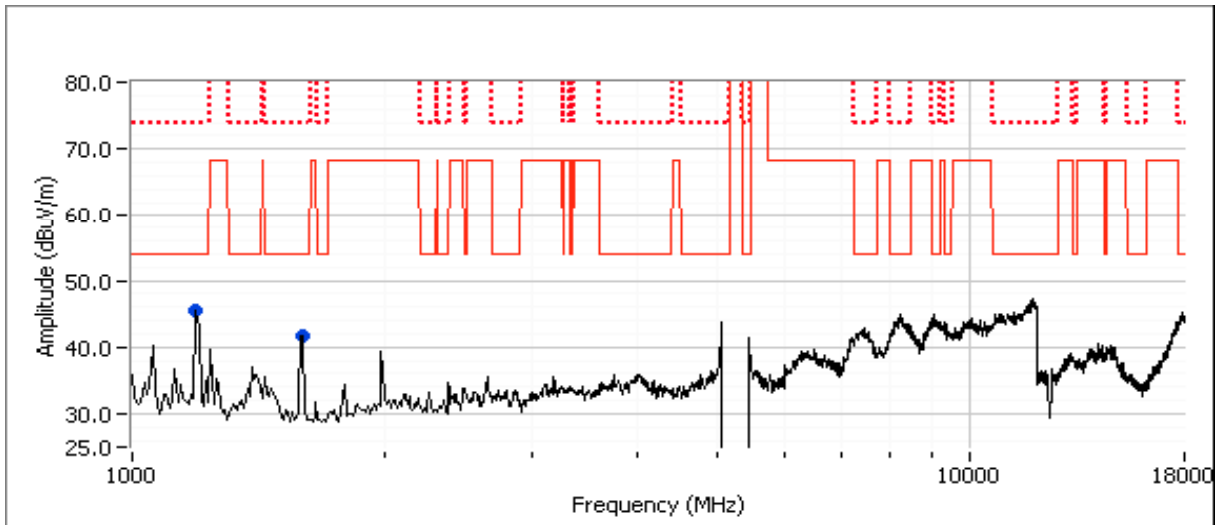



EMC Test Data

Client: Intel	Job Number: J91968
Model: Intel Model 3160NGW Wireless Network Adapter	T-Log Number: J92301
Contact: Steve Hackett	Project Manager: Christine Krebill
Standard: FCC 15 B, 15.247, RSS 210	Project Coordinator: -
	Class: N/A

Run #3, Radiated Spurious Emissions, 30 - 40,000 MHz. Operation in the 5470-5725 MHz Band

Date of Test: 5/22/13& 5/28/13 & 5/29/13

Test Engineer: Rafael Varelas/ Jack Liu

Test Location: FT Chamber #4 & #5

Run #3a: Low Channel, 802.11a mode

	Power Settings		
	Target (dBm)	Measured (dBm)	Software Setting
Chain A	14.5	14.6	29.5

5460 MHz Band Edge Signal Radiated Field Strength

Frequency MHz	Level dB μ V/m	Pol v/h	FCC 15.209		Detector Pk/QP/Avg	Azimuth degrees	Height meters	Comments
			Limit	Margin				
5459.920	45.1	H	54.0	-8.9	AVG	78	1.1	POS; RB 1 MHz; VB: 10 Hz
5458.960	58.9	H	74.0	-15.1	PK	78	1.1	POS; RB 1 MHz; VB: 3 MHz
5459.920	44.9	V	54.0	-9.1	AVG	348	1.0	POS; RB 1 MHz; VB: 10 Hz
5454.630	56.4	V	74.0	-17.6	PK	348	1.0	POS; RB 1 MHz; VB: 3 MHz

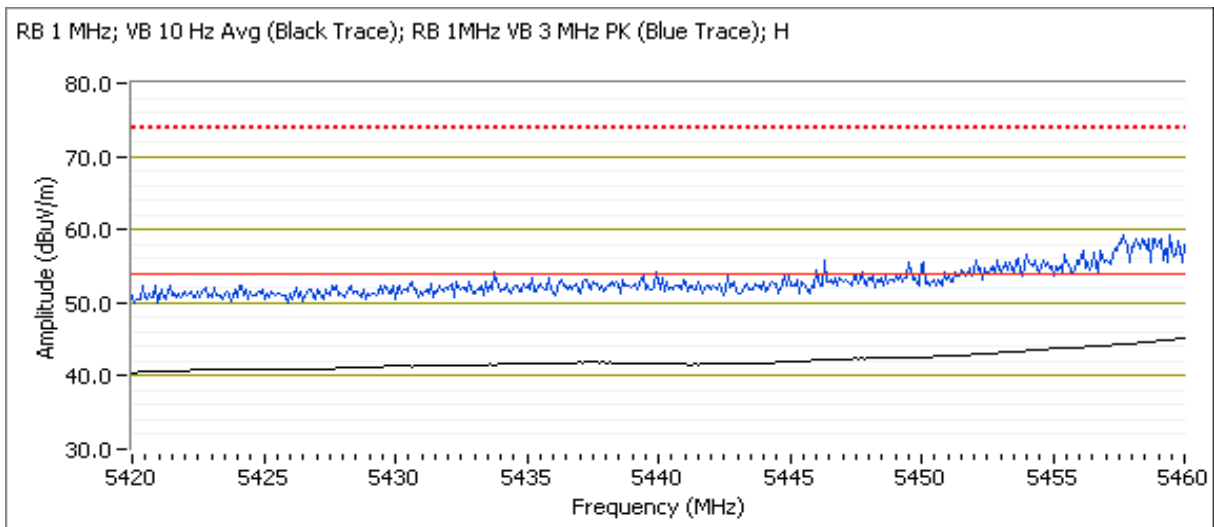

Client:	Intel	Job Number:	J91968
Model:	Intel Model 3160NGW Wireless Network Adapter	T-Log Number:	J92301
Contact:	Steve Hackett	Project Manager:	Christine Krebill
Standard:	FCC 15 B, 15.247, RSS 210	Project Coordinator:	-
		Class:	N/A

5460 - 5470 MHz Band Edge Radiated Field Strength

Frequency MHz	Level dB μ V/m	Pol v/h	15 E		Detector Pk/QP/Avg	Azimuth degrees	Height meters	Comments
			Limit	Margin				
5468.360	63.6	H	68.3	-4.7	PK	78	1.1	POS; RB 1 MHz; VB: 3 MHz
5467.860	61.6	V	68.3	-6.7	PK	348	1.0	POS; RB 1 MHz; VB: 3 MHz

For emissions in the 5460-5470MHz frequency range the limit is -27dBm/MHz eirp (68.3dBuV/m). The measurement method required is a peak measurement (RB=1MHz, VB \geq 3MHz, peak detector).

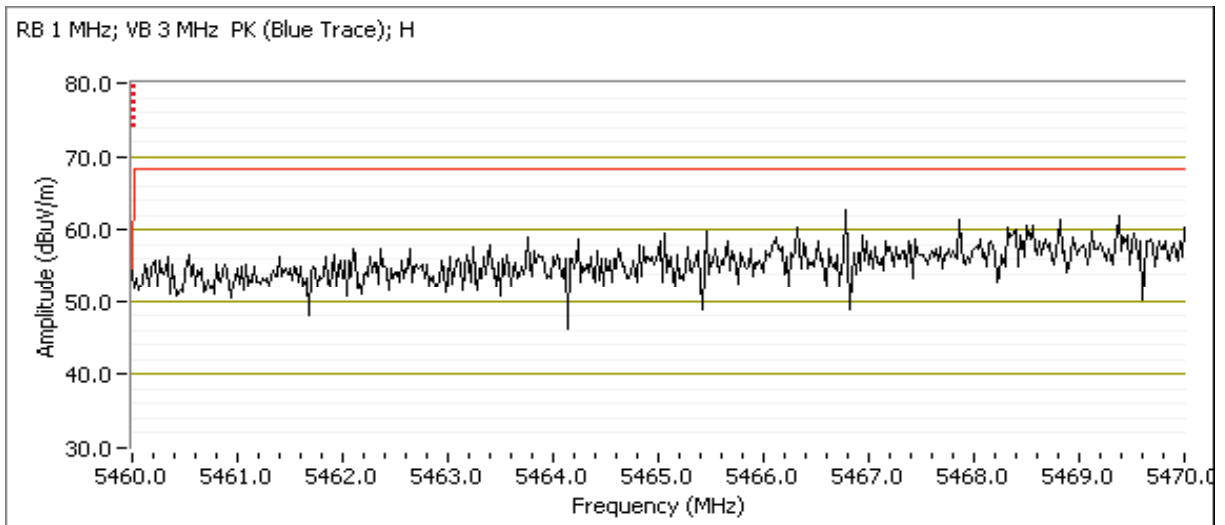



EMC Test Data

Client:	Intel	Job Number:	J91968
Model:	Intel Model 3160NGW Wireless Network Adapter	T-Log Number:	J92301
Contact:	Steve Hackett	Project Manager:	Christine Krebill
Standard:	FCC 15 B, 15.247, RSS 210	Project Coordinator:	-
		Class:	N/A

Run #3b: Low Channel, 802.11n20 mode

Chain A	Power Settings		Software Setting
	Target (dBm)	Measured (dBm)	
	14.5	14.6	29.5

5460 MHz Band Edge Signal Radiated Field Strength

Frequency MHz	Level dB μ V/m	Pol v/h	FCC 15.209		Detector Pk/QP/Avg	Azimuth degrees	Height meters	Comments
			Limit	Margin				
5460.000	45.5	V	54.0	-8.5	AVG	169	1.0	POS; RB 1 MHz; VB: 10 Hz
5456.870	56.6	V	74.0	-17.4	PK	169	1.0	POS; RB 1 MHz; VB: 3 MHz
5460.000	45.0	H	54.0	-9.0	AVG	297	1.0	POS; RB 1 MHz; VB: 10 Hz
5458.720	56.7	H	74.0	-17.3	PK	297	1.0	POS; RB 1 MHz; VB: 3 MHz

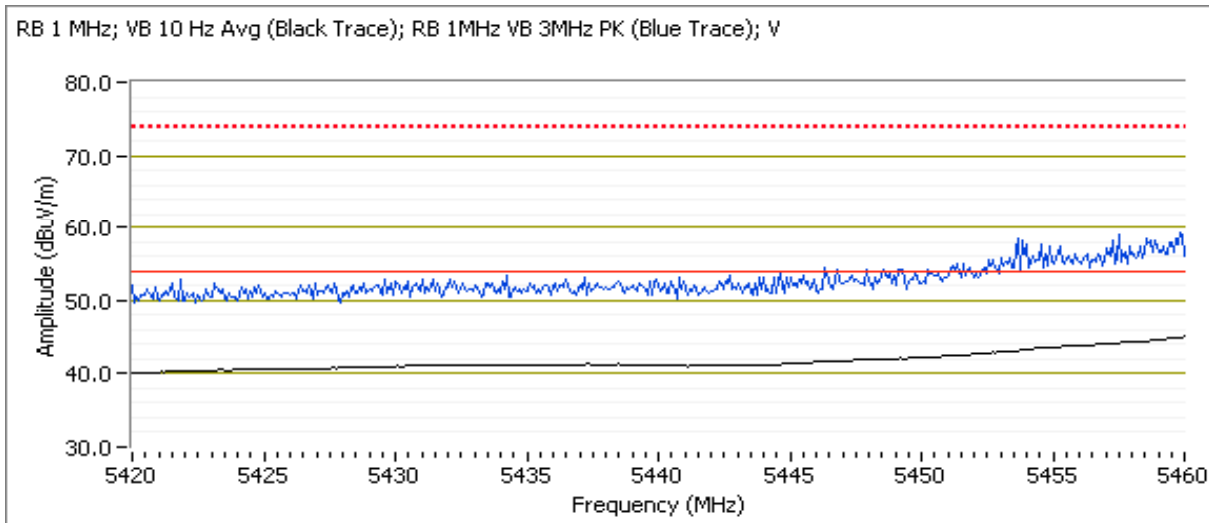



EMC Test Data

Client:	Intel	Job Number:	J91968
Model:	Intel Model 3160NGW Wireless Network Adapter	T-Log Number:	J92301
Contact:	Steve Hackett	Project Manager:	Christine Krebill
Standard:	FCC 15 B, 15.247, RSS 210	Project Coordinator:	-
		Class:	N/A

5460 - 5470 MHz Band Edge Radiated Field Strength

Frequency MHz	Level dB μ V/m	Pol v/h	15 E		Detector Pk/QP/Avg	Azimuth degrees	Height meters	Comments
			Limit	Margin				
5465.570	65.3	V	68.3	-3.0	PK	169	1.0	POS; RB 1 MHz; VB: 3 MHz
5467.090	64.3	H	68.3	-4.0	PK	297	1.0	POS; RB 1 MHz; VB: 3 MHz

For emissions in the 5460-5470MHz frequency range the limit is -27dBm/MHz eirp (68.3dBuV/m). The measurement method required is a peak measurement (RB=1MHz, VB \geq 3MHz, peak detector).

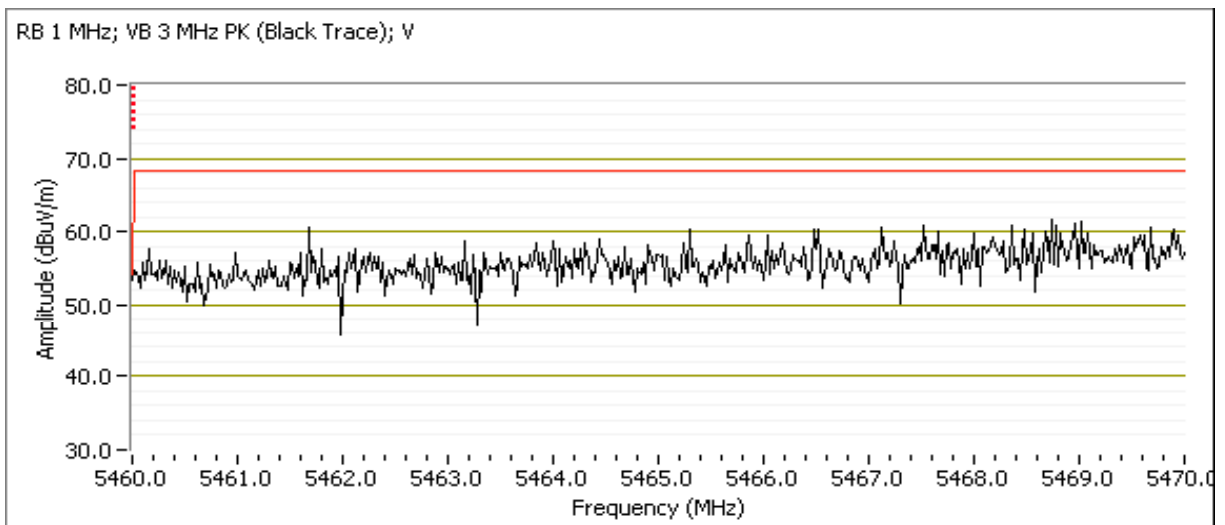

Client:	Intel	Job Number:	J91968
Model:	Intel Model 3160NGW Wireless Network Adapter	T-Log Number:	J92301
Contact:	Steve Hackett	Project Manager:	Christine Krebill
Standard:	FCC 15 B, 15.247, RSS 210	Project Coordinator:	-
		Class:	N/A

Run #3c: Center Channel, 802.11a mode

Chain A	Target (dBm)	Power Settings Measured (dBm)	Software Setting
	16.5	16.5	33.0

Spurious Radiated Emissions:

Frequency MHz	Level dBμV/m	Pol v/h	15.209 / 15E		Detector Pk/QP/Avg	Azimuth degrees	Height meters	Comments
			Limit	Margin				
1993.420	47.4	V	68.3	-20.9	PK	240	1.7	RB 1 MHz;VB 3 MHz;Peak
1197.440	48.5	V	74.0	-25.5	PK	3	1.1	RB 1 MHz;VB 3 MHz;Peak
1596.910	48.4	V	74.0	-25.6	PK	237	1.2	RB 1 MHz;VB 3 MHz;Peak
1198.900	26.7	V	54.0	-27.3	AVG	3	1.1	RB 1 MHz;VB 10 Hz;Peak
1593.180	26.5	V	54.0	-27.5	AVG	237	1.2	RB 1 MHz;VB 10 Hz;Peak

- Note 1: For emissions in restricted bands, the limit of 15.209 was used which requires average and peak measurements.
- Note 2: For emissions outside of the restricted bands the limit is -27dBm/MHz eirp (68.3dBuV/m). The measurement method required is a peak measurement (RB=1MHz, VB≥3MHz, peak detector).
- Note 3: Scans made between 18 - 40 GHz with the measurement antenna moved around the card and its antennas 20-50cm from the device indicated there were no significant emissions in this frequency range

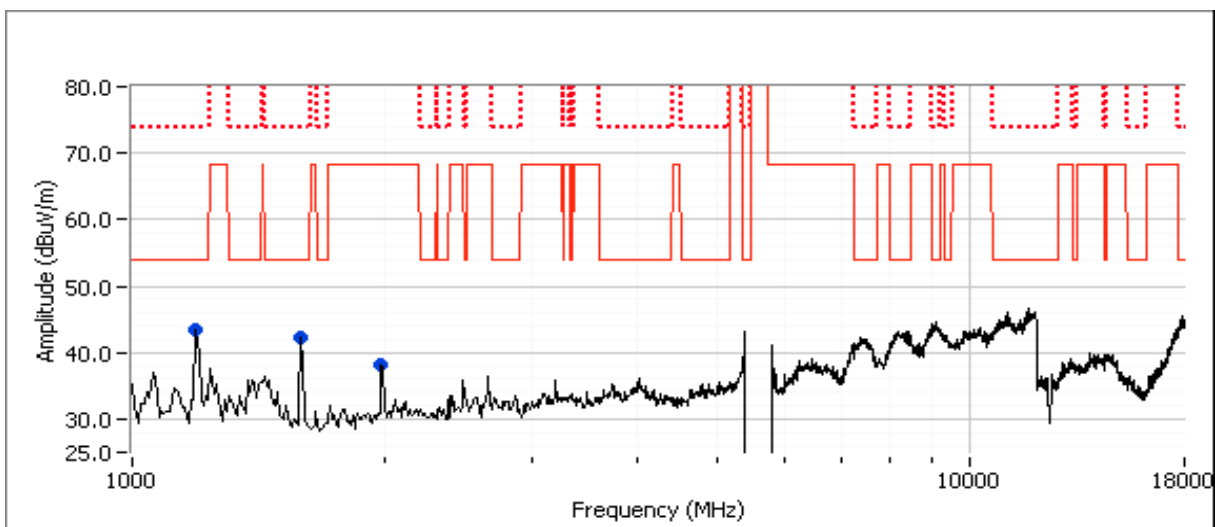

Client:	Intel	Job Number:	J91968
Model:	Intel Model 3160NGW Wireless Network Adapter	T-Log Number:	J92301
Contact:	Steve Hackett	Project Manager:	Christine Krebill
Standard:	FCC 15 B, 15.247, RSS 210	Project Coordinator:	-
		Class:	N/A

Run #3d: Center Channel, 802.11n20 mode

Chain A	Target (dBm)	Power Settings Measured (dBm)	Software Setting
	16.5	16.5	33.0

Spurious Radiated Emissions:

Frequency MHz	Level dB μ V/m	Pol v/h	15.209 / 15E		Detector Pk/QP/Avg	Azimuth degrees	Height meters	Comments
			Limit	Margin				
1244.200	54.1	V	68.3	-14.2	PK	150	0.9	RB 1 MHz;VB 3 MHz;Peak
3739.760	29.1	V	54.0	-24.9	AVG	121	1.5	RB 1 MHz;VB 10 Hz;Peak
1595.500	27.7	V	54.0	-26.3	AVG	242	1.2	RB 1 MHz;VB 10 Hz;Peak
1598.900	46.9	V	74.0	-27.1	PK	242	1.2	RB 1 MHz;VB 3 MHz;Peak
3745.130	46.8	V	74.0	-27.2	PK	121	1.5	RB 1 MHz;VB 3 MHz;Peak

- Note 1: For emissions in restricted bands, the limit of 15.209 was used which requires average and peak measurements.
- Note 2: For emissions outside of the restricted bands the limit is -27dBm/MHz eirp (68.3dBuV/m). The measurement method required is a peak measurement (RB=1MHz, VB \geq 3MHz, peak detector).
- Note 3: Scans made between 18 - 40 GHz with the measurement antenna moved around the card and its antennas 20-50cm from the device indicated there were no significant emissions in this frequency range

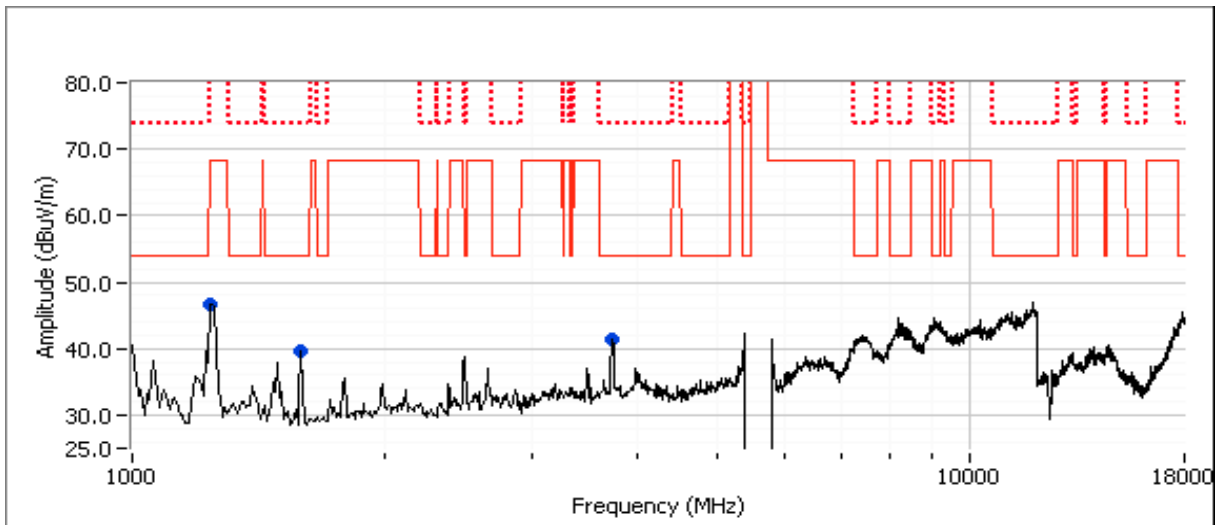

Client:	Intel	Job Number:	J91968
Model:	Intel Model 3160NGW Wireless Network Adapter	T-Log Number:	J92301
Contact:	Steve Hackett	Project Manager:	Christine Krebill
Standard:	FCC 15 B, 15.247, RSS 210	Project Coordinator:	-
		Class:	N/A

Run #3e: Low Channel, 802.11n20 mode

Chain A	Target (dBm)	Power Settings Measured (dBm)	Software Setting
	16.5	16.7	32.5

Spurious Radiated Emissions:

Frequency MHz	Level dBμV/m	Pol v/h	15.209 / 15E		Detector Pk/QP/Avg	Azimuth degrees	Height meters	Comments
			Limit	Margin				
1991.070	51.0	V	68.3	-17.3	PK	48	1.0	RB 1 MHz;VB 3 MHz;Peak
1199.410	51.1	H	74.0	-22.9	PK	53	1.4	RB 1 MHz;VB 3 MHz;Peak
1198.760	28.4	H	54.0	-25.6	AVG	53	1.4	RB 1 MHz;VB 10 Hz;Peak
1593.240	46.5	V	74.0	-27.5	PK	89	1.3	RB 1 MHz;VB 3 MHz;Peak
1593.380	26.4	V	54.0	-27.6	AVG	89	1.3	RB 1 MHz;VB 10 Hz;Peak

- Note 1: For emissions in restricted bands, the limit of 15.209 was used which requires average and peak measurements.
- Note 2: For emissions outside of the restricted bands the limit is -27dBm/MHz eirp (68.3dBuV/m). The measurement method required is a peak measurement (RB=1MHz, VB≥3MHz, peak detector).

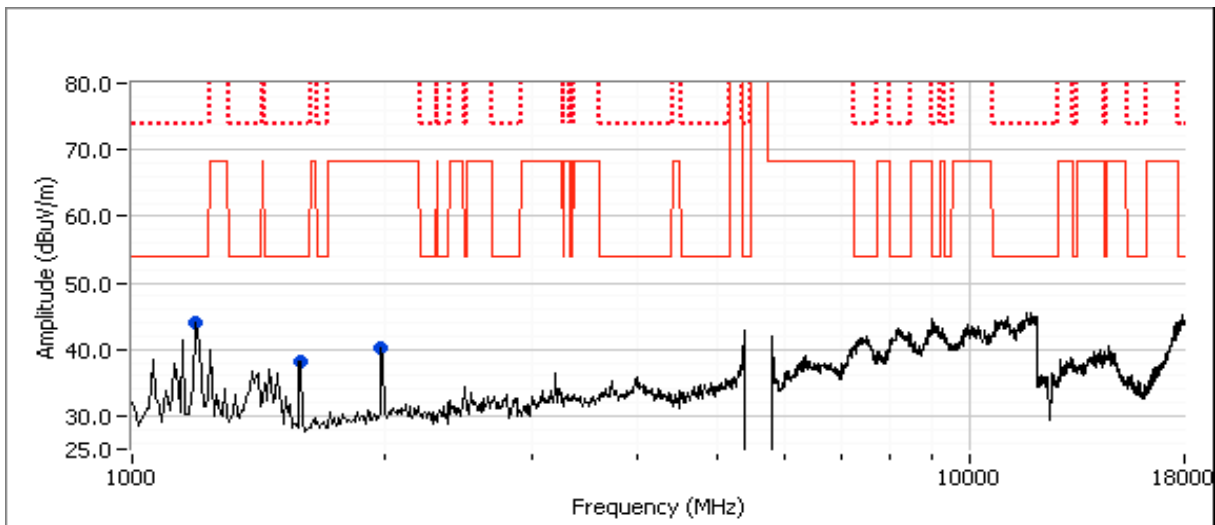

Client: Intel	Job Number: J91968
Model: Intel Model 3160NGW Wireless Network Adapter	T-Log Number: J92301
	Project Manager: Christine Krebill
Contact: Steve Hackett	Project Coordinator: -
Standard: FCC 15 B, 15.247, RSS 210	Class: N/A

Run #3f: High Channel, 802.11n20 mode

Chain A	Target (dBm)	Power Settings Measured (dBm)	Software Setting
		16.5	16.6

Spurious Radiated Emissions:

Frequency MHz	Level dB μ V/m	Pol v/h	15.209 / 15E		Detector Pk/QP/Avg	Azimuth degrees	Height meters	Comments
			Limit	Margin				
1600.110	33.5	V	54.0	-20.5	AVG	203	1.0	RB 1 MHz;VB 10 Hz;Peak
1598.870	50.9	V	74.0	-23.1	PK	203	1.0	RB 1 MHz;VB 3 MHz;Peak
1196.260	28.2	V	54.0	-25.8	AVG	193	1.4	RB 1 MHz;VB 10 Hz;Peak
1195.720	47.9	V	74.0	-26.1	PK	193	1.4	RB 1 MHz;VB 3 MHz;Peak
1996.390	45.4	V	68.3	-22.9	PK	56	1.0	RB 1 MHz;VB 3 MHz;Peak

Note 1: For emissions in restricted bands, the limit of 15.209 was used which requires average and peak measurements.

Note 2: For emissions outside of the restricted bands the limit is -27dBm/MHz eirp (68.3dBuV/m). The measurement method required is a peak measurement (RB=1MHz, VB \geq 3MHz, peak detector).

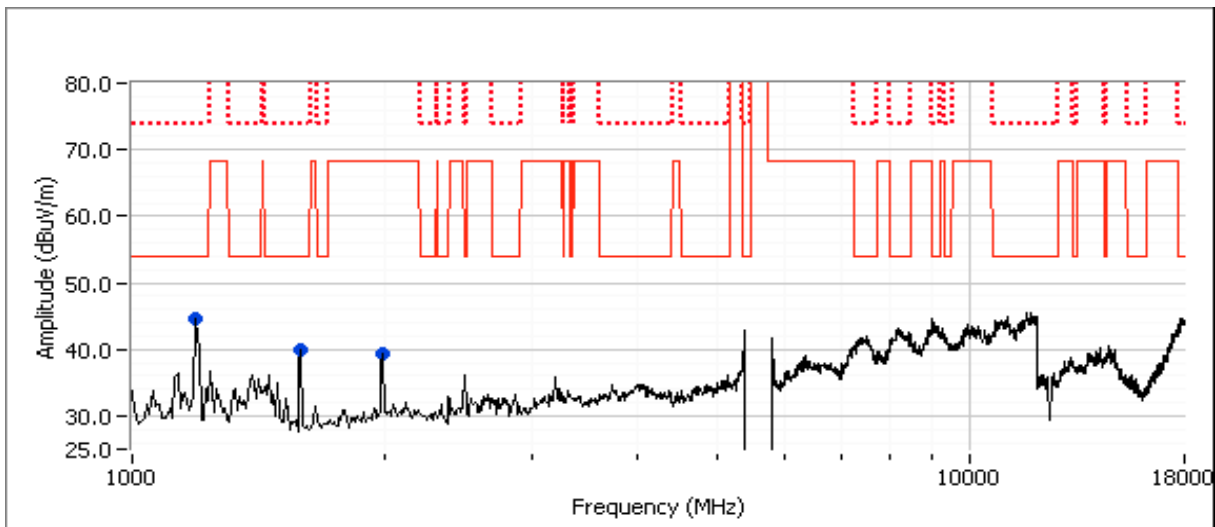



EMC Test Data

Client:	Intel	Job Number:	J91968
Model:	Intel Model 3160NGW Wireless Network Adapter	T-Log Number:	J92301
Contact:	Steve Hackett	Project Manager:	Christine Krebill
Standard:	FCC 15 B, 15.247, RSS 210	Project Coordinator:	-
		Class:	N/A

Run #3g: High Channel, 802.11a mode

	Power Settings		
	Target (dBm)	Measured (dBm)	Software Setting
Chain A	13.5	13.6	29.5

5725 MHz Band Edge Radiated Field Strength

Frequency	Level	Pol	15.209 / 15E		Detector	Azimuth	Height	Comments
MHz	dB μ V/m	v/h	Limit	Margin	Pk/QP/Avg	degrees	meters	
5725.080	57.4	V	68.3	-10.9	PK	129	1.0	POS; RB 1 MHz; VB: 3 MHz
5725.960	54.7	H	68.3	-13.6	PK	342	1.0	POS; RB 1 MHz; VB: 3 MHz

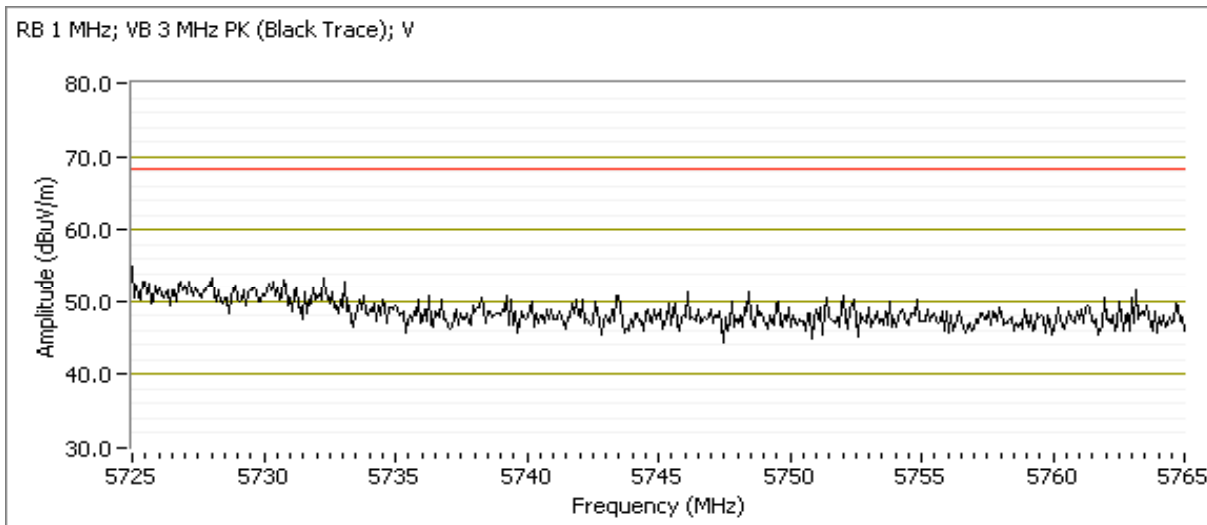



EMC Test Data

Client:	Intel	Job Number:	J91968
Model:	Intel Model 3160NGW Wireless Network Adapter	T-Log Number:	J92301
Contact:	Steve Hackett	Project Manager:	Christine Krebill
Standard:	FCC 15 B, 15.247, RSS 210	Project Coordinator:	-
		Class:	N/A

Run #3h: High Channel, 802.11n20 mode

	Power Settings		
	Target (dBm)	Measured (dBm)	Software Setting
Chain A	13.5	13.6	29.5

5725 MHz Band Edge Radiated Field Strength

Frequency MHz	Level dB μ V/m	Pol v/h	15.209 / 15E		Detector Pk/QP/Avg	Azimuth degrees	Height meters	Comments
			Limit	Margin				
5731.250	58.1	V	68.3	-10.2	PK	129	1.0	POS; RB 1 MHz; VB: 3 MHz
5727.080	57.3	H	68.3	-11.0	PK	151	1.0	POS; RB 1 MHz; VB: 3 MHz

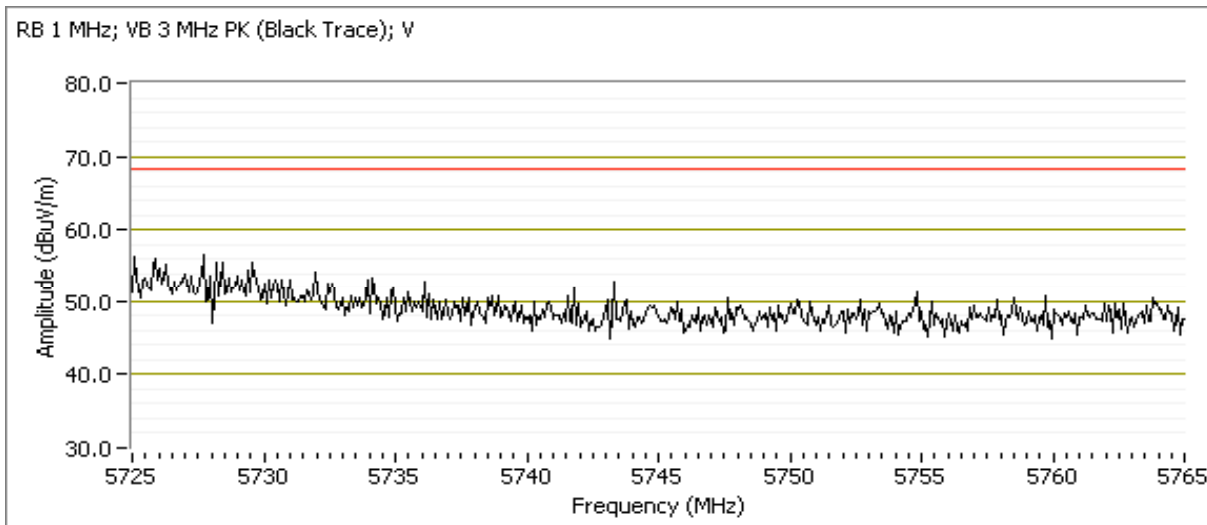

Client:	Intel	Job Number:	J91968
Model:	Intel Model 3160NGW Wireless Network Adapter	T-Log Number:	J92301
Contact:	Steve Hackett	Project Manager:	Christine Krebill
Standard:	FCC 15 B, 15.247, RSS 210	Project Coordinator:	-
		Class:	N/A

Run #3i: High Channel, 802.11 ac20 Mode

	Power Settings		
	Target (dBm)	Measured (dBm)	Software Setting
Chain A	16.5	16.5	34.0

Spurious Radiated Emissions:

Frequency MHz	Level dB μ V/m	Pol v/h	15.209 / 15E		Detector Pk/QP/Avg	Azimuth degrees	Height meters	Comments
			Limit	Margin				
1594.710	52.9	V	74.0	-21.1	PK	206	1.0	RB 1 MHz;VB 3 MHz;Peak
1198.060	50.8	V	74.0	-23.2	PK	46	1.0	RB 1 MHz;VB 3 MHz;Peak
1594.480	30.2	V	54.0	-23.8	AVG	206	1.0	RB 1 MHz;VB 10 Hz;Peak
1197.050	28.7	V	54.0	-25.3	AVG	46	1.0	RB 1 MHz;VB 10 Hz;Peak
1992.290	45.1	V	68.3	-23.2	PK	243	1.3	RB 1 MHz;VB 3 MHz;Peak

Note 1: For emissions in restricted bands, the limit of 15.209 was used which requires average and peak measurements.

Note 2: For emissions outside of the restricted bands the limit is -27dBm/MHz eirp (68.3dBuV/m). The measurement method required is a peak measurement (RB=1MHz, VB \geq 3MHz, peak detector).

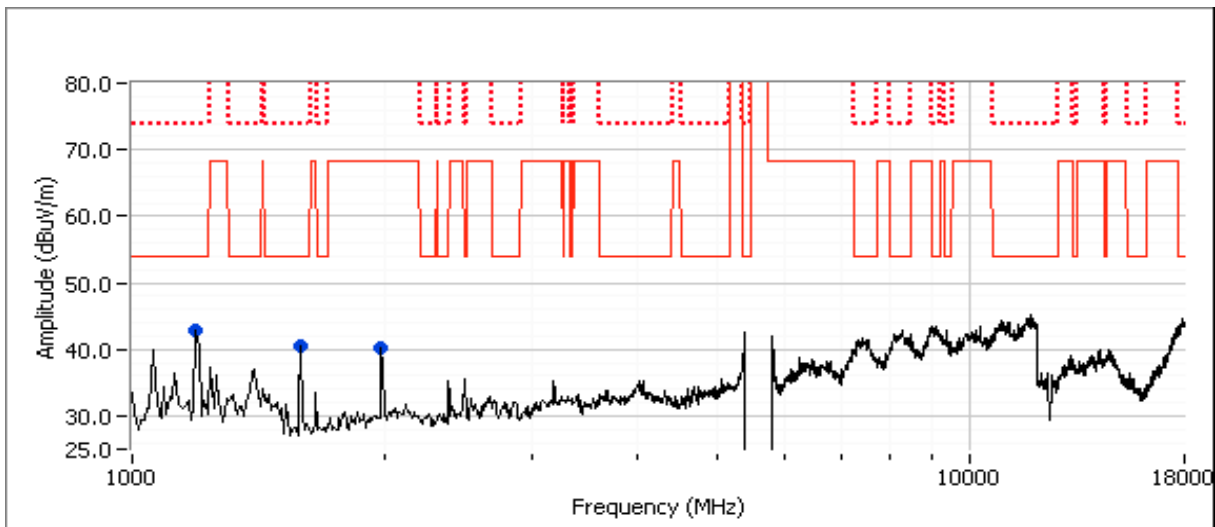

Client:	Intel	Job Number:	J91968
Model:	Intel Model 3160NGW Wireless Network Adapter	T-Log Number:	J92301
Contact:	Steve Hackett	Project Manager:	Christine Krebill
Standard:	FCC 15 B, 15.247, RSS 210	Project Coordinator:	-
		Class:	N/A

Run #3j: Low Channel, 802.11n40 mode

Chain A	Power Settings		Software Setting
	Target (dBm)	Measured (dBm)	
Chain A	11.5	11.4	26.0

5460 MHz Band Edge Signal Radiated Field Strength

Frequency MHz	Level dBμV/m	Pol v/h	FCC 15.209		Detector Pk/QP/Avg	Azimuth degrees	Height meters	Comments
			Limit	Margin				
5460.000	47.0	V	54.0	-7.0	AVG	291	1.0	POS; RB 1 MHz; VB: 10 Hz
5459.040	60.0	V	74.0	-14.0	PK	291	1.0	POS; RB 1 MHz; VB: 3 MHz
5460.000	46.9	H	54.0	-7.1	AVG	80	1.0	POS; RB 1 MHz; VB: 10 Hz
5457.350	57.8	H	74.0	-16.2	PK	80	1.0	POS; RB 1 MHz; VB: 3 MHz

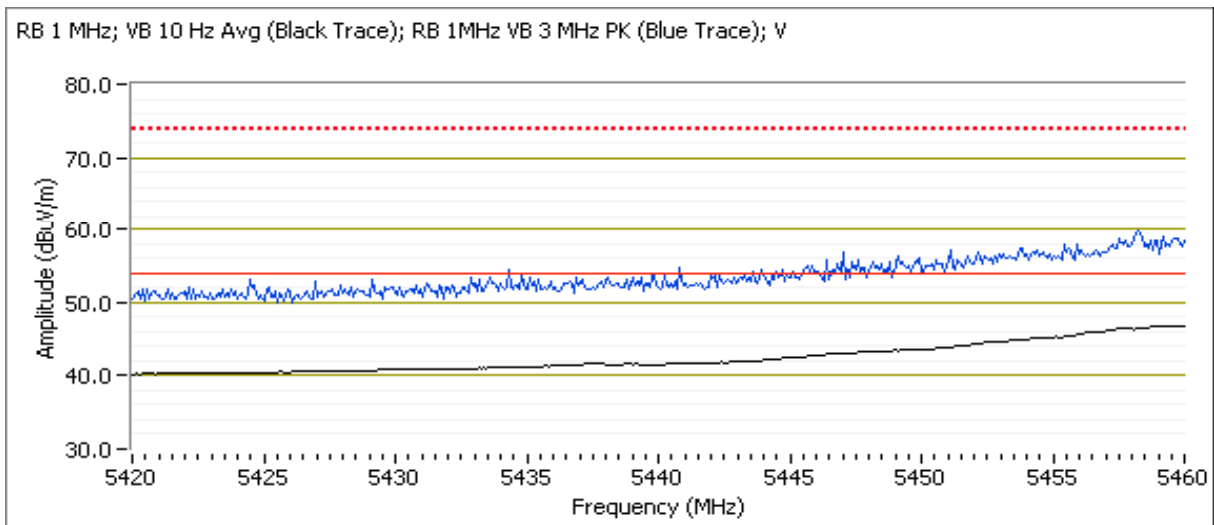



EMC Test Data

Client:	Intel	Job Number:	J91968
Model:	Intel Model 3160NGW Wireless Network Adapter	T-Log Number:	J92301
Contact:	Steve Hackett	Project Manager:	Christine Krebill
Standard:	FCC 15 B, 15.247, RSS 210	Project Coordinator:	-
		Class:	N/A

5460 - 5470 MHz Band Edge Radiated Field Strength

Frequency MHz	Level dB μ V/m	Pol v/h	15 E		Detector Pk/QP/Avg	Azimuth degrees	Height meters	Comments
			Limit	Margin				
5469.420	63.9	H	68.3	-4.4	PK	80	1.0	POS; RB 1 MHz; VB: 3 MHz
5468.740	62.9	V	68.3	-5.4	PK	291	1.0	POS; RB 1 MHz; VB: 3 MHz

For emissions in the 5460-5470MHz frequency range the limit is -27dBm/MHz eirp (68.3dBuV/m). The measurement method required is a peak measurement (RB=1MHz, VB \geq 3MHz, peak detector).

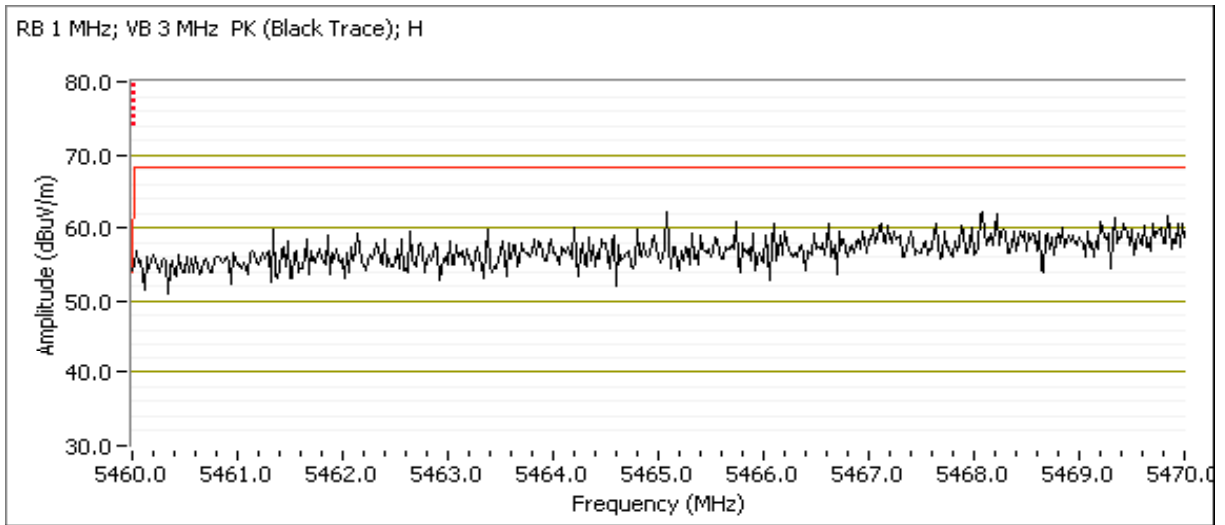

Client:	Intel	Job Number:	J91968
Model:	Intel Model 3160NGW Wireless Network Adapter	T-Log Number:	J92301
Contact:	Steve Hackett	Project Manager:	Christine Krebill
Standard:	FCC 15 B, 15.247, RSS 210	Project Coordinator:	-
		Class:	N/A

Spurious Radiated Emissions:

Frequency MHz	Level dB μ V/m	Pol v/h	15.209 / 15E		Detector Pk/QP/Avg	Azimuth degrees	Height meters	Comments
			Limit	Margin				
1992.760	52.5	V	68.3	-15.8	PK	227	1.0	RB 1 MHz;VB 3 MHz;Peak
1598.720	52.9	V	74.0	-21.1	PK	333	1.0	RB 1 MHz;VB 3 MHz;Peak
1198.090	52.0	V	74.0	-22.0	PK	5	1.6	RB 1 MHz;VB 3 MHz;Peak
1597.660	30.4	V	54.0	-23.6	AVG	333	1.0	RB 1 MHz;VB 10 Hz;Peak
1198.160	28.9	V	54.0	-25.1	AVG	5	1.6	RB 1 MHz;VB 10 Hz;Peak

- Note 1: For emissions in restricted bands, the limit of 15.209 was used which requires average and peak measurements.
- Note 2: For emissions outside of the restricted bands the limit is -27dBm/MHz eirp (68.3dBuV/m). The measurement method required is a peak measurement (RB=1MHz, VB \geq 3MHz, peak detector).

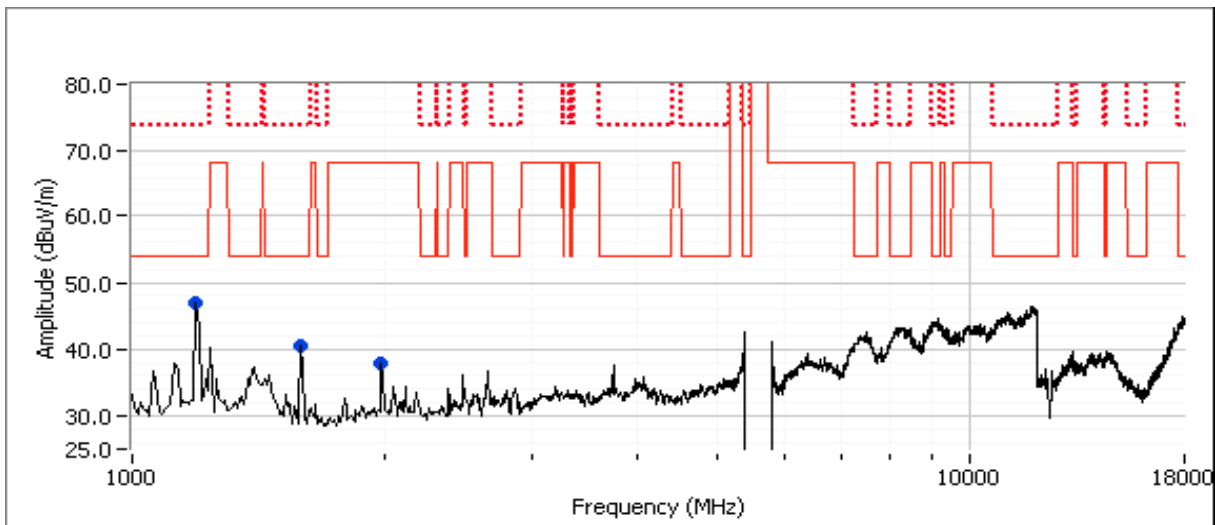



EMC Test Data

Client:	Intel	Job Number:	J91968
Model:	Intel Model 3160NGW Wireless Network Adapter	T-Log Number:	J92301
Contact:	Steve Hackett	Project Manager:	Christine Krebill
Standard:	FCC 15 B, 15.247, RSS 210	Project Coordinator:	-
		Class:	N/A

Run #3k: Center Channel, 802.11n40 mode

Chain A	Power Settings		Software Setting
	Target (dBm)	Measured (dBm)	
	16.5	16.5	33.0

5460 MHz Band Edge Signal Radiated Field Strength

Frequency MHz	Level dB μ V/m	Pol v/h	FCC 15.209		Detector Pk/QP/Avg	Azimuth degrees	Height meters	Comments
			Limit	Margin				
5460.000	45.8	H	54.0	-8.2	AVG	80	1.1	POS; RB 1 MHz; VB: 10 Hz
5457.840	58.4	H	74.0	-15.6	PK	80	1.1	POS; RB 1 MHz; VB: 3 MHz
5459.840	45.0	V	54.0	-9.0	AVG	336	1.0	POS; RB 1 MHz; VB: 10 Hz
5457.350	55.8	V	74.0	-18.2	PK	336	1.0	POS; RB 1 MHz; VB: 3 MHz

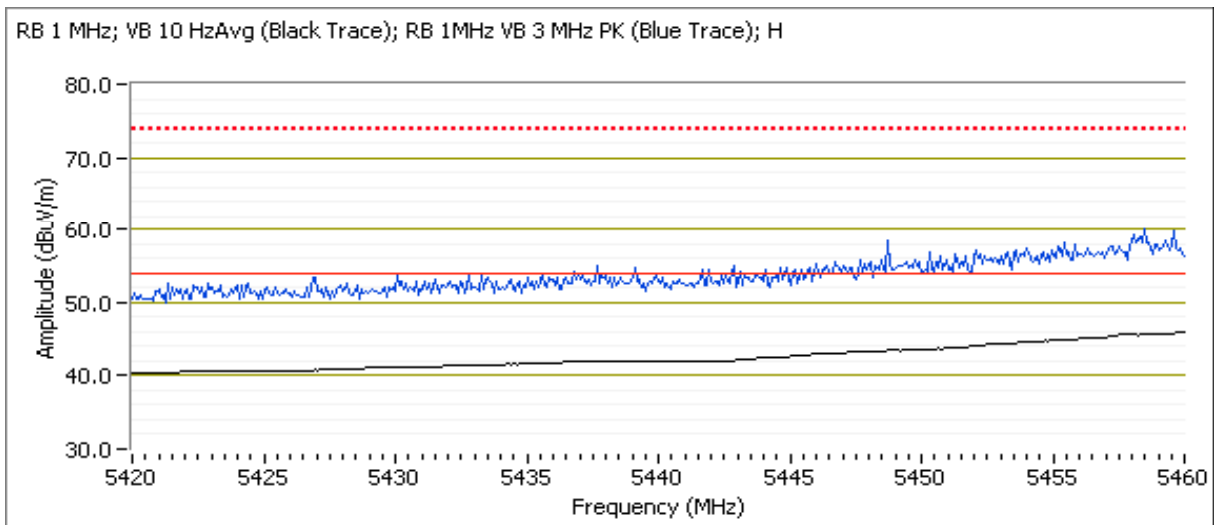

Client:	Intel	Job Number:	J91968
Model:	Intel Model 3160NGW Wireless Network Adapter	T-Log Number:	J92301
Contact:	Steve Hackett	Project Manager:	Christine Krebill
Standard:	FCC 15 B, 15.247, RSS 210	Project Coordinator:	-
		Class:	N/A

5460 - 5470 MHz Band Edge Radiated Field Strength

Frequency MHz	Level dB μ V/m	Pol v/h	15 E		Detector Pk/QP/Avg	Azimuth degrees	Height meters	Comments
			Limit	Margin				
5468.380	61.2	H	68.3	-7.1	Pk	80	1.1	POS; RB 1 MHz; VB: 3 MHz
5463.810	59.5	V	68.3	-8.8	PK	336	1.0	POS; RB 1 MHz; VB: 3 MHz

For emissions in the 5460-5470MHz frequency range the limit is -27dBm/MHz eirp (68.3dBuV/m). The measurement method required is a peak measurement (RB=1MHz, VB \geq 3MHz, peak detector).

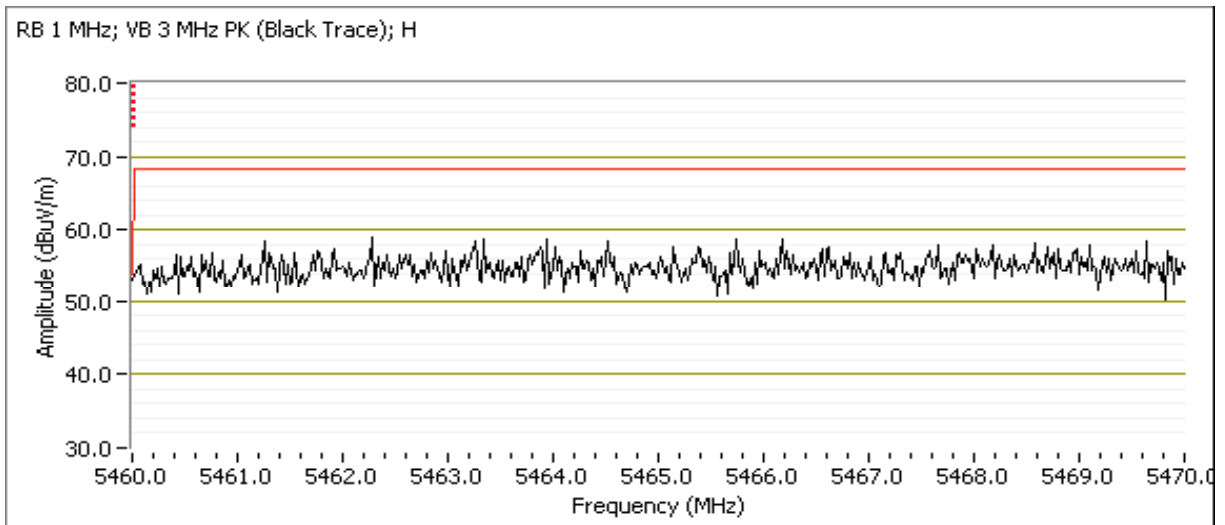

Client:	Intel	Job Number:	J91968
Model:	Intel Model 3160NGW Wireless Network Adapter	T-Log Number:	J92301
Contact:	Steve Hackett	Project Manager:	Christine Krebill
Standard:	FCC 15 B, 15.247, RSS 210	Project Coordinator:	-
		Class:	N/A

Spurious Radiated Emissions:

Frequency MHz	Level dB μ V/m	Pol v/h	15.209 / 15E		Detector Pk/QP/Avg	Azimuth degrees	Height meters	Comments
			Limit	Margin				
1199.220	55.2	V	74.0	-18.8	PK	359	1.2	RB 1 MHz;VB 3 MHz;Peak
1197.630	31.5	V	54.0	-22.5	AVG	359	1.2	RB 1 MHz;VB 10 Hz;Peak
1593.870	50.1	V	74.0	-23.9	PK	38	1.0	RB 1 MHz;VB 3 MHz;Peak
1593.670	28.5	V	54.0	-25.5	AVG	38	1.0	RB 1 MHz;VB 10 Hz;Peak
1992.590	45.9	V	68.3	-22.4	PK	221	1.5	RB 1 MHz;VB 3 MHz;Peak

- Note 1: For emissions in restricted bands, the limit of 15.209 was used which requires average and peak measurements.
- Note 2: For emissions outside of the restricted bands the limit is -27dBm/MHz eirp (68.3dBuV/m). The measurement method required is a peak measurement (RB=1MHz, VB \geq 3MHz, peak detector).
- Note 3: Scans made between 18 - 40 GHz with the measurement antenna moved around the card and its antennas 20-50cm from the device indicated there were no significant emissions in this frequency range

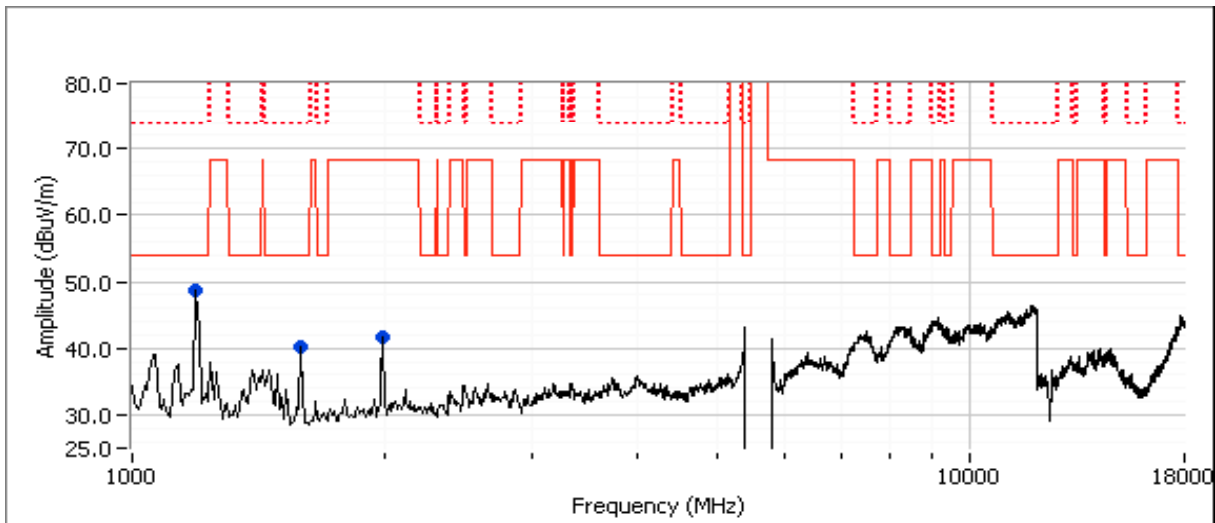

Client:	Intel	Job Number:	J91968
Model:	Intel Model 3160NGW Wireless Network Adapter	T-Log Number:	J92301
Contact:	Steve Hackett	Project Manager:	Christine Krebill
Standard:	FCC 15 B, 15.247, RSS 210	Project Coordinator:	-
		Class:	N/A

Run #31: High Channel, 802.11n40 mode, Channel 134

Chain A	Power Settings		Software Setting
	Target (dBm)	Measured (dBm)	
Chain A	16.5	16.4	34.0

Spurious Radiated Emissions:

Frequency MHz	Level dB μ V/m	Pol v/h	15.209 / 15E		Detector Pk/QP/Avg	Azimuth degrees	Height meters	Comments
			Limit	Margin				
1998.080	50.1	V	68.3	-18.2	PK	253	1.0	RB 1 MHz;VB 3 MHz;Peak
1597.270	52.9	V	74.0	-21.1	PK	139	1.4	RB 1 MHz;VB 3 MHz;Peak
1597.200	31.4	V	54.0	-22.6	AVG	139	1.4	RB 1 MHz;VB 10 Hz;Peak
1198.080	50.3	H	74.0	-23.7	PK	340	1.4	RB 1 MHz;VB 3 MHz;Peak
1198.890	28.8	H	54.0	-25.2	AVG	340	1.4	RB 1 MHz;VB 10 Hz;Peak

Note 1: For emissions in restricted bands, the limit of 15.209 was used which requires average and peak measurements.

Note 2: For emissions outside of the restricted bands the limit is -27dBm/MHz eirp (68.3dBuV/m). The measurement method required is a peak measurement (RB=1MHz, VB \geq 3MHz, peak detector).

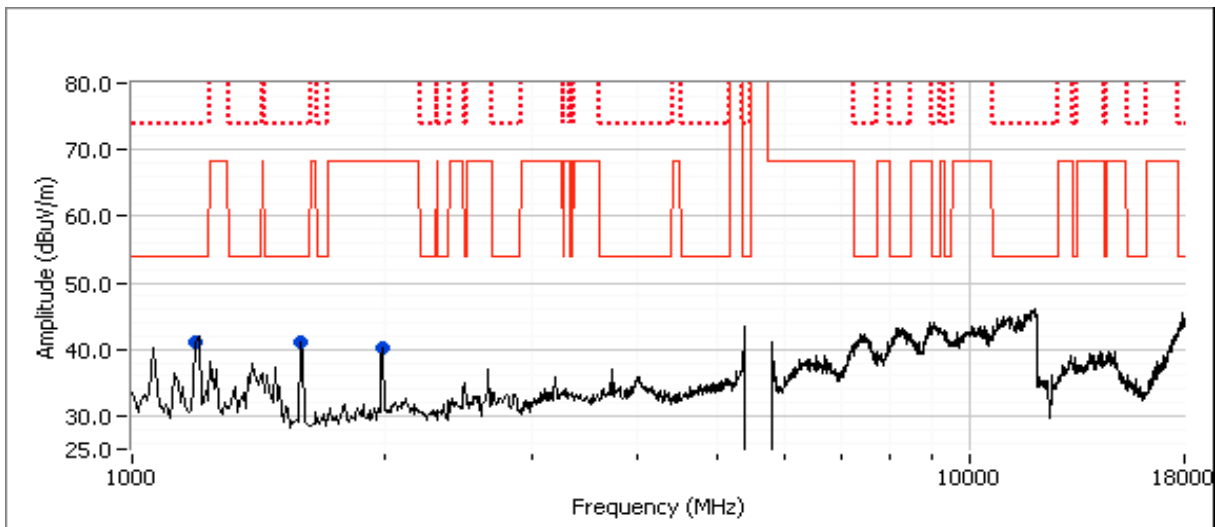



EMC Test Data

Client:	Intel	Job Number:	J91968
Model:	Intel Model 3160NGW Wireless Network Adapter	T-Log Number:	J92301
Contact:	Steve Hackett	Project Manager:	Christine Krebill
Standard:	FCC 15 B, 15.247, RSS 210	Project Coordinator:	-
		Class:	N/A

5725 MHz Band Edge Radiated Field Strength

Frequency	Level	Pol	15.209 / 15E		Detector	Azimuth	Height	Comments
MHz	dB μ V/m	v/h	Limit	Margin	Pk/QP/Avg	degrees	meters	
5727.480	57.3	V	68.3	-11.0	PK	126	1.0	POS; RB 1 MHz; VB: 3 MHz
5730.930	55.0	H	68.3	-13.3	PK	331	1.0	POS; RB 1 MHz; VB: 3 MHz

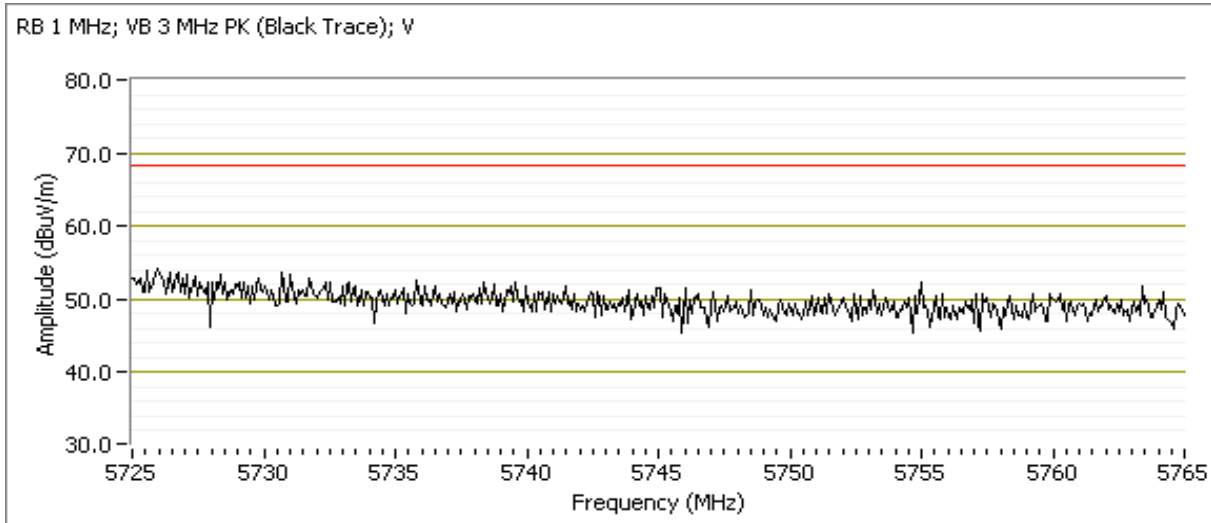

Client:	Intel	Job Number:	J91968
Model:	Intel Model 3160NGW Wireless Network Adapter	T-Log Number:	J92301
Contact:	Steve Hackett	Project Manager:	Christine Krebill
Standard:	FCC 15 B, 15.247, RSS 210	Project Coordinator:	-
		Class:	N/A

Run #3m: High Channel, 802.11 ac40 Mode

Chain A	Power Settings		Software Setting
	Target (dBm)	Measured (dBm)	
	16.5	16.5	33.5

Spurious Radiated Emissions:

Frequency MHz	Level dB μ V/m	Pol v/h	15.209 / 15E		Detector Pk/QP/Avg	Azimuth degrees	Height meters	Comments
			Limit	Margin				
1397.510	36.2	H	54.0	-17.8	AVG	224	1.0	RB 1 MHz;VB 10 Hz;Peak
1194.940	54.1	H	74.0	-19.9	PK	54	1.2	RB 1 MHz;VB 3 MHz;Peak
1598.230	31.8	H	54.0	-22.2	AVG	58	1.0	RB 1 MHz;VB 10 Hz;Peak
1195.670	31.1	H	54.0	-22.9	AVG	54	1.2	RB 1 MHz;VB 10 Hz;Peak
1598.880	49.5	H	74.0	-24.5	PK	58	1.0	RB 1 MHz;VB 3 MHz;Peak
1398.490	46.9	H	74.0	-27.1	PK	224	1.0	RB 1 MHz;VB 3 MHz;Peak

- Note 1: For emissions in restricted bands, the limit of 15.209 was used which requires average and peak measurements.
- Note 2: For emissions outside of the restricted bands the limit is -27dBm/MHz eirp (68.3dBuV/m). The measurement method required is a peak measurement (RB=1MHz, VB \geq 3MHz, peak detector).

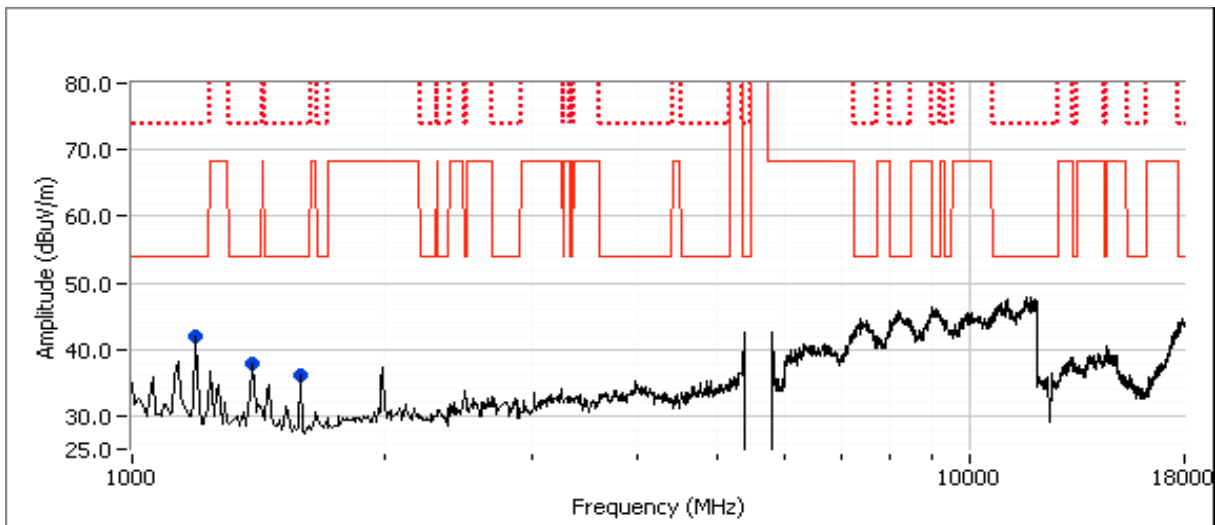



EMC Test Data

Client:	Intel	Job Number:	J91968
Model:	Intel Model 3160NGW Wireless Network Adapter	T-Log Number:	J92301
Contact:	Steve Hackett	Project Manager:	Christine Krebill
Standard:	FCC 15 B, 15.247, RSS 210	Project Coordinator:	-
		Class:	N/A

Run #3n: Low Channel, 802.11ac80 mode

	Power Settings		
	Target (dBm)	Measured (dBm)	Software Setting
Chain A	9.5	9.5	23.5

5460 MHz Band Edge Signal Radiated Field Strength

Frequency MHz	Level dBμV/m	Pol v/h	FCC 15.209		Detector Pk/QP/Avg	Azimuth degrees	Height meters	Comments
			Limit	Margin				
5458.800	52.2	H	54.0	-1.8	AVG	78	1.1	POS; RB 1 MHz; VB: 10 Hz
5457.110	65.2	H	74.0	-8.8	PK	78	1.1	POS; RB 1 MHz; VB: 3 MHz
5447.500	50.6	V	54.0	-3.4	AVG	292	1.1	POS; RB 1 MHz; VB: 10 Hz
5453.590	63.6	V	74.0	-10.4	PK	292	1.1	POS; RB 1 MHz; VB: 3 MHz

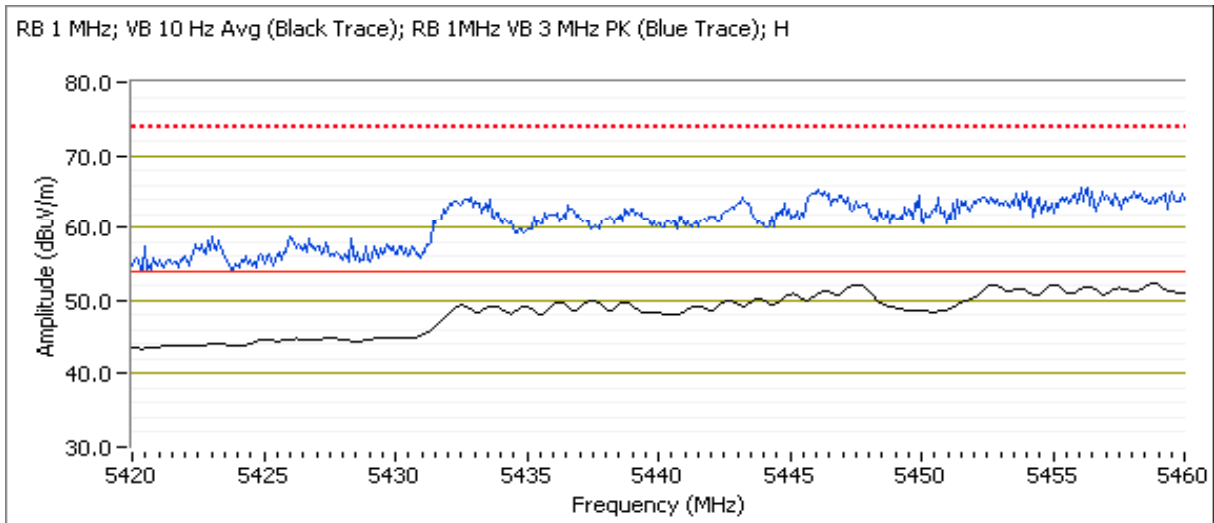



EMC Test Data

Client:	Intel	Job Number:	J91968
Model:	Intel Model 3160NGW Wireless Network Adapter	T-Log Number:	J92301
Contact:	Steve Hackett	Project Manager:	Christine Krebill
Standard:	FCC 15 B, 15.247, RSS 210	Project Coordinator:	-
		Class:	N/A

5460 - 5470 MHz Band Edge Radiated Field Strength

Frequency MHz	Level dB μ V/m	Pol v/h	15 E		Detector Pk/QP/Avg	Azimuth degrees	Height meters	Comments
			Limit	Margin				
5462.120	66.9	H	68.3	-1.4	PK	78	1.1	POS; RB 1 MHz; VB: 3 MHz
5469.740	64.2	V	68.3	-4.1	PK	292	1.1	POS; RB 1 MHz; VB: 3 MHz

For emissions in the 5460-5470MHz frequency range the limit is -27dBm/MHz eirp (68.3dBuV/m). The measurement method required is a peak measurement (RB=1MHz, VB \geq 3MHz, peak detector).

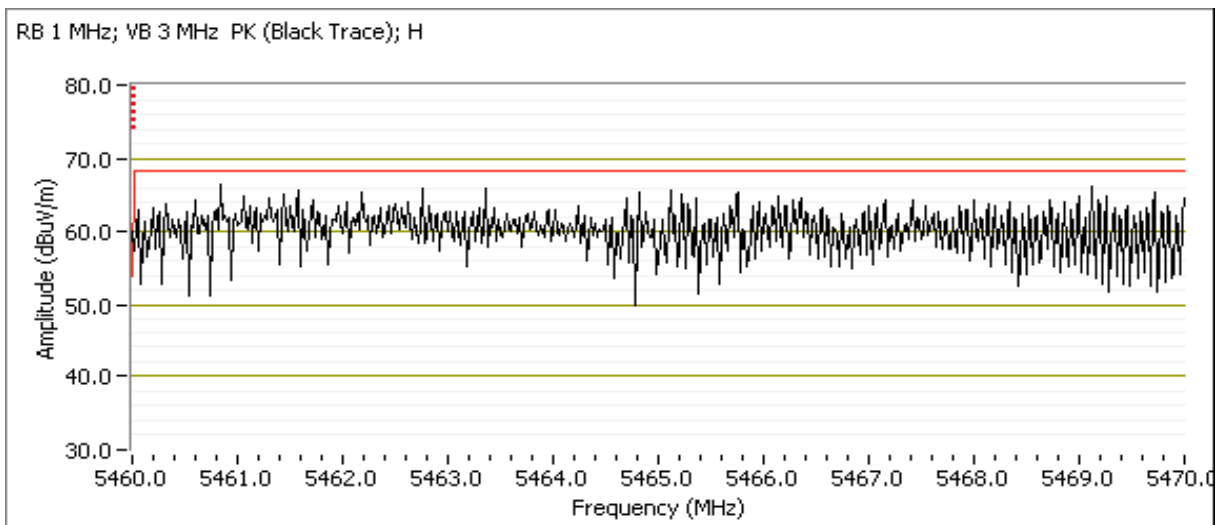

Client:	Intel	Job Number:	J91968
Model:	Intel Model 3160NGW Wireless Network Adapter	T-Log Number:	J92301
Contact:	Steve Hackett	Project Manager:	Christine Krebill
Standard:	FCC 15 B, 15.247, RSS 210	Project Coordinator:	-
		Class:	N/A

Spurious Radiated Emissions:

Frequency	Level	Pol	15.209 / 15E		Detector	Azimuth	Height	Comments
MHz	dB μ V/m	v/h	Limit	Margin	Pk/QP/Avg	degrees	meters	
1997.460	51.2	V	68.3	-17.1	PK	42	1.1	RB 1 MHz;VB 3 MHz;Peak
1194.940	51.7	V	74.0	-22.3	PK	239	1.6	RB 1 MHz;VB 3 MHz;Peak
1197.470	30.7	V	54.0	-23.3	AVG	239	1.6	RB 1 MHz;VB 10 Hz;Peak
1594.000	30.0	V	54.0	-24.0	AVG	348	1.0	RB 1 MHz;VB 10 Hz;Peak
1594.200	48.4	V	74.0	-25.6	PK	348	1.0	RB 1 MHz;VB 3 MHz;Peak

- Note 1: For emissions in restricted bands, the limit of 15.209 was used which requires average and peak measurements.
- Note 2: For emissions outside of the restricted bands the limit is -27dBm/MHz eirp (68.3dBuV/m). The measurement method required is a peak measurement (RB=1MHz, VB \geq 3MHz, peak detector).

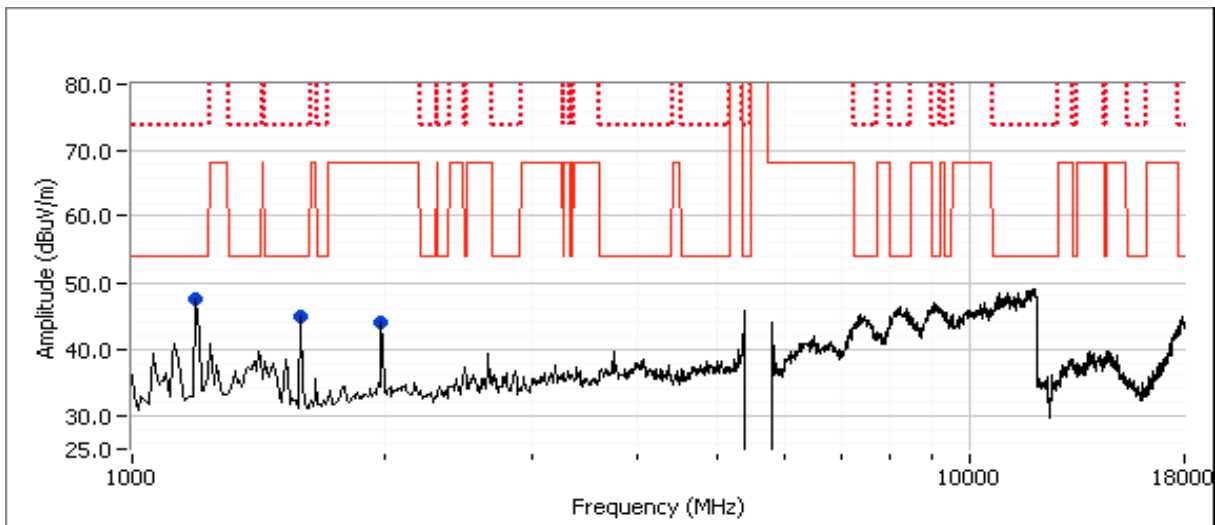

Client:	Intel	Job Number:	J91968
Model:	Intel Model 3160NGW Wireless Network Adapter	T-Log Number:	J92301
Contact:	Steve Hackett	Project Manager:	Christine Krebill
Standard:	FCC 15 B, 15.247, RSS 210	Project Coordinator:	-
		Class:	N/A

Run #30: High Channel, 802.11ac80 mode

Chain A	Target (dBm)	Power Settings Measured (dBm)	Software Setting
	15.0	15.0	31.0

Spurious Radiated Emissions:

Frequency MHz	Level dB μ V/m	Pol v/h	15.209 / 15E		Detector Pk/QP/Avg	Azimuth degrees	Height meters	Comments
			Limit	Margin				
1244.870	56.9	V	68.3	-11.4	PK	291	1.0	RB 1 MHz;VB 3 MHz;Peak
3748.000	57.3	V	74.0	-16.7	PK	192	1.0	RB 1 MHz;VB 3 MHz;Peak
1472.340	32.3	V	54.0	-21.7	AVG	194	1.5	RB 1 MHz;VB 10 Hz;Peak
3748.470	32.1	V	54.0	-21.9	AVG	192	1.0	RB 1 MHz;VB 10 Hz;Peak
1010.070	29.2	V	54.0	-24.8	AVG	4	2.1	RB 1 MHz;VB 10 Hz;Peak
2508.600	43.4	H	68.3	-24.9	PK	62	2.5	RB 1 MHz;VB 3 MHz;Peak
1477.220	48.4	V	74.0	-25.6	PK	194	1.5	RB 1 MHz;VB 3 MHz;Peak
1000.200	42.0	V	74.0	-32.0	PK	4	2.1	RB 1 MHz;VB 3 MHz;Peak

Note 1: For emissions in restricted bands, the limit of 15.209 was used which requires average and peak measurements.

Note 2: For emissions outside of the restricted bands the limit is -27dBm/MHz eirp (68.3dBuV/m). The measurement method required is a peak measurement (RB=1MHz, VB \geq 3MHz, peak detector).

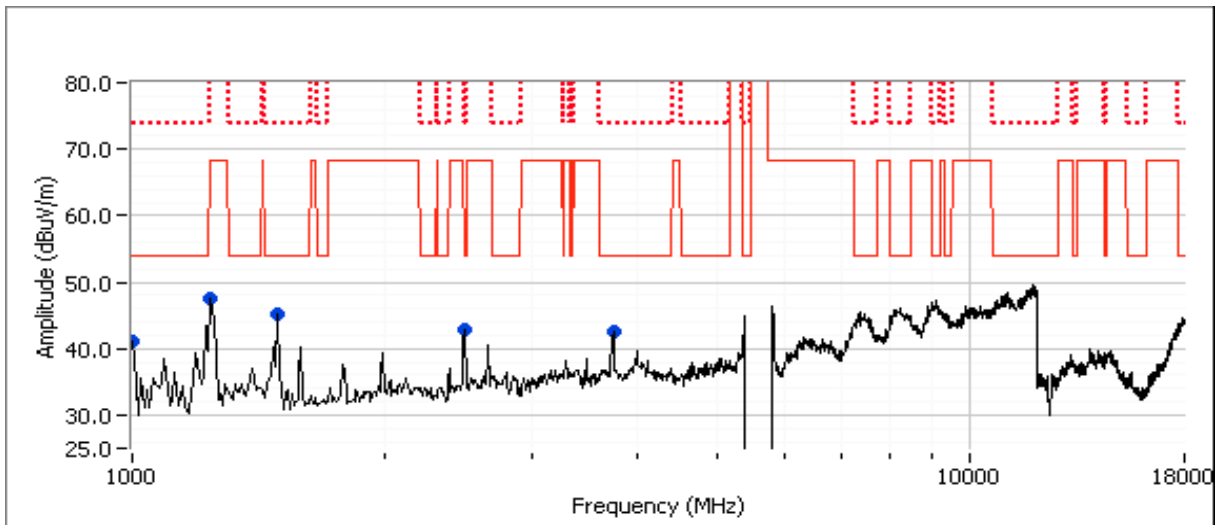

Client: Intel	Job Number: J91968
Model: Intel Model 3160NGW Wireless Network Adapter	T-Log Number: J92301
	Account Manager: Christine Krebill
Contact: Steve Hackett	
Standard: FCC 15 B, 15.247, RSS 210	Class: N/A

RSS 210 and FCC 15.247 (DTS) Radiated Spurious Emissions

Test Specific Details

Objective: The objective of this test session is to perform final qualification testing of the EUT with respect to the specification listed above.

General Test Configuration

The EUT and all local support equipment were located on the turntable for radiated spurious emissions testing.

For radiated emissions testing the measurement antenna was located 3 meters from the EUT.

Ambient Conditions:
 Temperature: 21.4 °C
 Rel. Humidity: 36 %

Summary of Results

For Wi-Fi, Chain A is used for Tx and Rx. For Bluetooth, chain B is used for Tx and Rx.

BT MAC Address: 001500BD5C22 DRTU Tool Version 1.6.1-628 Driver version 16.0.0.49

Run #	Mode	Channel	Power Setting	Measured Power	Test Performed	Limit	Result / Margin
1	BT Basic 802.11b	2402MHz 2412MHz	8 dBm 20.5	- 16.5	Radiated Emissions, 1 - 10 GHz	FCC Part 15.209 / 15.247(c)	52.9 dBµV/m @ 4823.9 MHz (-1.1 dB)
2	BT Basic 802.11b	2480MHz 2462MHz	8 dBm 21	- 16.5		FCC Part 15.209 / 15.247(c)	50.3 dBµV/m @ 2499.9 MHz (-3.7 dB)
3	BT Basic 802.11g	2402MHz 2412MHz	8 dBm 22.5	- 16.6		FCC Part 15.209 / 15.247(c)	49.1 dBµV/m @ 4804.0 MHz (-4.9 dB)
4	BT Basic 802.11g	2480MHz 2462MHz	8 dBm 22.5	- 16.4		FCC Part 15.209 / 15.247(c)	44.7 dBµV/m @ 4960.0 MHz (-9.3 dB)
Wi-Fi mode for the following runs based on the worst case mode from runs 1 through 4							
5	BT Basic 802.11b	2402MHz 2437MHz	8 dBm 20.5	- 16.4	Radiated Emissions, 1 - 10 GHz	FCC Part 15.209 / 15.247(c)	47.8 dBµV/m @ 4874.0 MHz (-6.2 dB)
6	BT Basic 802.11b	2441MHz 2412MHz	8 dBm 20.0	- 16.3		FCC Part 15.209 / 15.247(c)	52.6 dBµV/m @ 2383.0 MHz (-1.4 dB)
7	BT Basic 802.11b	2441MHz 2462MHz	8 dBm 21	- 16.5		FCC Part 15.209 / 15.247(c)	46.5 dBµV/m @ 4924.0 MHz (-7.5 dB)
8	BT Basic 802.11b	2480MHz 2437MHz	8 dBm 20.5	- 16.4		FCC Part 15.209 / 15.247(c)	51.0 dBµV/m @ 4959.9 MHz (-3.0 dB)

Client: Intel	Job Number: J91968
Model: Intel Model 3160NGW Wireless Network Adapter	T-Log Number: J92301
	Account Manager: Christine Krebill
Contact: Steve Hackett	
Standard: FCC 15 B, 15.247, RSS 210	Class: N/A

Wi-Fi mode and channel and Bluetooth channel for the following run based on the worst case mode from runs 1 through 8

9	BT EDR 802.11b	2402MHz 2437MHz	8 dBm 20.5	- 16.4	Radiated Emissions, 1 - 10 GHz	FCC Part 15.209 / 15.247(c)	44.6 dB μ V/m @ 4874.0 MHz (-9.4 dB)
10	BT EDR 802.11b	2441MHz 2412MHz	8dBm 20.5	- 16.5	Radiated Emissions, 1 - 10 GHz	FCC Part 15.209 / 15.247(c)	48.7 dB μ V/m @ 4824.0 MHz (-5.3 dB)

Bluetooth mode based on worst case mode from runs 1 through 10 combined with 802.11n20 mode at center channel in each 5 GHz band

11	BT Basic 802.11n20	2402MHz 5200MHz	8 dBm 29.5	- 16.6	Radiated Emissions, 1 - 15 GHz	FCC Part 15.209 / 15.247(c) / 15.407	50.5 dB μ V/m @ 2790.9 MHz (-3.5 dB)
12	BT Basic 802.11n20	2441MHz 5200MHz	8dBm 29.5	- 16.6	Radiated Emissions, 1 - 15 GHz	FCC Part 15.209 / 15.247(c) / 15.407	49.7 dB μ V/m @ 2751.8 MHz (-4.3 dB)
13	BT Basic 802.11n20	2480MHz 5200MHz	8dBm 29.5	- 16.6	Radiated Emissions, 1 - 15 GHz	FCC Part 15.209 / 15.247(c) / 15.407	50.7 dB μ V/m @ 4960.1 MHz (-3.3 dB)

Bluetooth mode based on worst case mode from runs 11 and 13 combined with 802.11n20 mode at center channel in each 5 GHz band

14	BT Basic 802.11n20	2402MHz 5300MHz	8 dBm 28.5	- 16.5	Radiated Emissions, 1 - 15 GHz	FCC Part 15.209 / 15.247(c) / 15.407	53.8 dB μ V/m @ 2512.9 MHz (-14.5 dB)
15	BT Basic 802.11n20	2402MHz 5580MHz	8 dBm 33	- 16.5	Radiated Emissions, 1 - 15 GHz	FCC Part 15.209 / 15.247(c) / 15.407	54.9 dB μ V/m @ 2522.0 MHz (-13.4 dB)
16	BT Basic 802.11n20	2402MHz 5785MHz	8 dBm 34.5	- 16.5	Radiated Emissions, 1 - 15 GHz	FCC Part 15.209 / 15.247(c) / 15.407	45.2 dB μ V/m @ 2522.0 MHz (-8.8 dB)
17	BT Basic 802.11n20	2480MHz 5300MHz	8 dBm 28.5	- 16.5	Radiated Emissions, 1 - 15 GHz	FCC Part 15.209 / 15.247(c) / 15.407	50.8 dB μ V/m @ 4960.0 MHz (-3.2 dB)
18	BT Basic 802.11n20	2480MHz 5580MHz	8 dBm 33.0	- 16.5	Radiated Emissions, 1 - 15 GHz	FCC Part 15.209 / 15.247(c) / 15.407	50.5 dB μ V/m @ 4960.0 MHz (-3.5 dB)
19	BT Basic 802.11n20	2480MHz 5785MHz	8 dBm 34.5	- 16.5	Radiated Emissions, 1 - 15 GHz	FCC Part 15.209 / 15.247(c) / 15.407	50.5 dB μ V/m @ 4960.1 MHz (-3.5 dB)

Modifications Made During Testing

No modifications were made to the EUT during testing

Deviations From The Standard

No deviations were made from the requirements of the standard.

Test Notes

Scans in the near field performed without the external preamplifier and band reject filter

Client: Intel	Job Number: J91968
Model: Intel Model 3160NGW Wireless Network Adapter	T-Log Number: J92301
	Account Manager: Christine Krebill
Contact: Steve Hackett	
Standard: FCC 15 B, 15.247, RSS 210	Class: N/A

Run #1: Radiated Spurious Emissions, 1-10GHz. Operating Mode: 802.11b @ 2412, BT Basic @ 2402 MHz
 Date of Test: 5/31/2013
 Test Engineer: Jack Liu / R. Varelas
 Test Location: FT Chamber# 4

	Target (dBm)	Power Settings Measured (dBm)	Software Setting
Chain A	16.5	16.5	20.5
Chain B	8.0	-	8dBm

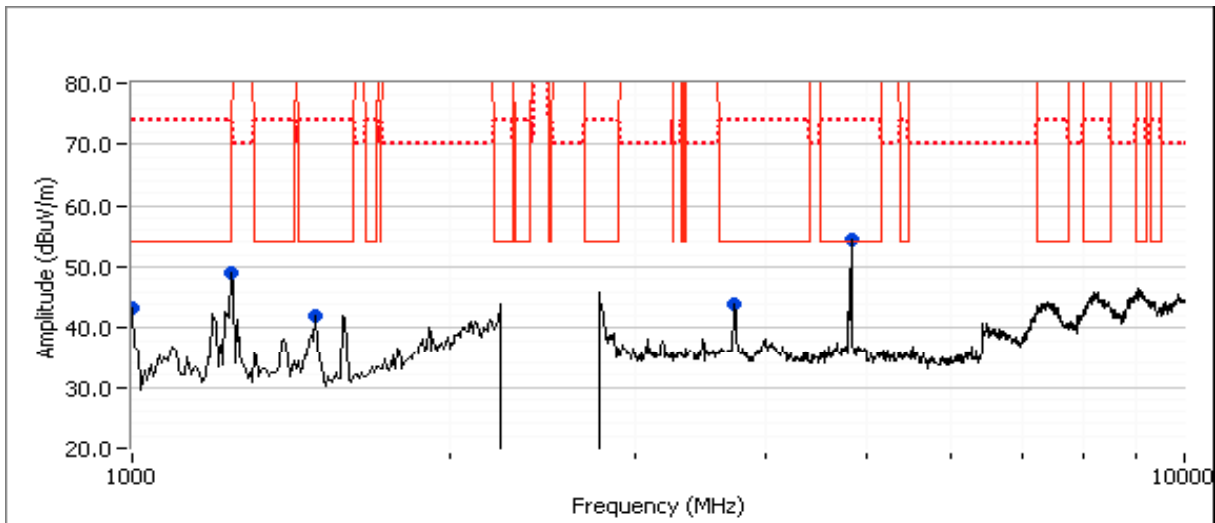

Client: Intel	Job Number: J91968
Model: Intel Model 3160NGW Wireless Network Adapter	T-Log Number: J92301
	Account Manager: Christine Krebill
Contact: Steve Hackett	
Standard: FCC 15 B, 15.247, RSS 210	Class: N/A

Preliminary Spurious Emissions excluding allocated band (Peak versus average limit)

Frequency MHz	Level dB μ V/m	Pol v/h	15.209 / 15.247		Detector Pk/QP/Avg	Azimuth degrees	Height meters	Comments
			Limit	Margin				
1240.000	49.1	V	54.0	-4.9	Peak	112	1.0	
1493.330	42.0	V	54.0	-12.0	Peak	205	1.6	
3740.000	43.8	V	54.0	-10.2	Peak	185	1.3	
4820.000	54.6	H	54.0	0.6	Peak	155	1.3	
1000.000	43.3	V	54.0	-10.7	Peak	205	1.0	

Final measurements at 3m

Frequency MHz	Level dB μ V/m	Pol v/h	15.209 / 15.247		Detector Pk/QP/Avg	Azimuth degrees	Height meters	Comments
			Limit	Margin				
4823.930	52.9	H	54.0	-1.1	AVG	155	1.3	RB 1 MHz;VB 10 Hz;Peak
4824.000	55.8	H	74.0	-18.2	PK	155	1.3	RB 1 MHz;VB 3 MHz;Peak
1245.670	31.7	V	100.0	-68.3	AVG	112	1.0	RB 1 MHz;VB 10 Hz;Peak
1249.400	56.9	V	70.0	-13.1	PK	112	1.0	RB 1 MHz;VB 3 MHz;Peak
1487.660	29.1	V	54.0	-24.9	AVG	206	1.5	RB 1 MHz;VB 10 Hz;Peak
1483.460	54.2	V	74.0	-19.8	PK	206	1.5	RB 1 MHz;VB 3 MHz;Peak
3747.870	32.5	V	54.0	-21.5	AVG	188	1.3	RB 1 MHz;VB 10 Hz;Peak
3747.600	58.1	V	74.0	-15.9	PK	188	1.3	RB 1 MHz;VB 3 MHz;Peak
1011.550	25.0	V	54.0	-29.0	AVG	295	1.5	RB 1 MHz;VB 10 Hz;Peak
1010.950	40.5	V	74.0	-33.5	PK	295	1.5	RB 1 MHz;VB 3 MHz;Peak

Spurious Radiated Emissions, 2 - 3GHz

Preliminary Scan at ~ 30cm from the product to identify potential signals (Peak versus average limit)

Preliminary Spurious Emissions at 30cm from 2-3 GHz (Peak versus average limit)

Frequency MHz	Level dB μ V/m	Pol v/h	15.209 / 15.247		Detector Pk/QP/Avg	Azimuth degrees	Height meters	Comments
			Limit	Margin				
2343.330	41.6	H	54.0	-12.4	Peak	180	1.0	
2446.670	59.7	H	120.0	-60.3	Peak	180	1.0	
2485.000	44.9	H	54.0	-9.1	Peak	180	1.0	
2505.000	47.2	H	70.0	-22.8	Peak	180	1.0	
2525.000	48.2	H	70.0	-21.8	Peak	180	1.0	

Client: Intel	Job Number: J91968
Model: Intel Model 3160NGW Wireless Network Adapter	T-Log Number: J92301
	Account Manager: Christine Krebill
Contact: Steve Hackett	
Standard: FCC 15 B, 15.247, RSS 210	Class: N/A

Final measurements at 3m

Frequency MHz	Level dB μ V/m	Pol v/h	15.209 / 15.247		Detector Pk/QP/Avg	Azimuth degrees	Height meters	Comments
			Limit	Margin				
2342.050	42.5	H	54.0	-11.5	AVG	292	1.0	POS; RB 1 MHz; VB: 10 Hz
2344.490	53.7	H	74.0	-20.3	PK	292	1.0	POS; RB 1 MHz; VB: 3 MHz
2484.220	41.9	H	54.0	-12.1	AVG	75	1.0	POS; RB 1 MHz; VB: 10 Hz
2486.260	53.5	H	74.0	-20.5	PK	75	1.0	POS; RB 1 MHz; VB: 3 MHz
2484.150	41.9	V	54.0	-12.1	AVG	83	1.0	POS; RB 1 MHz; VB: 10 Hz
2487.940	54.4	V	74.0	-19.6	PK	83	1.0	POS; RB 1 MHz; VB: 3 MHz
2338.410	42.6	V	54.0	-11.4	AVG	359	1.0	POS; RB 1 MHz; VB: 10 Hz
2343.080	54.3	V	74.0	-19.7	PK	359	1.0	POS; RB 1 MHz; VB: 3 MHz

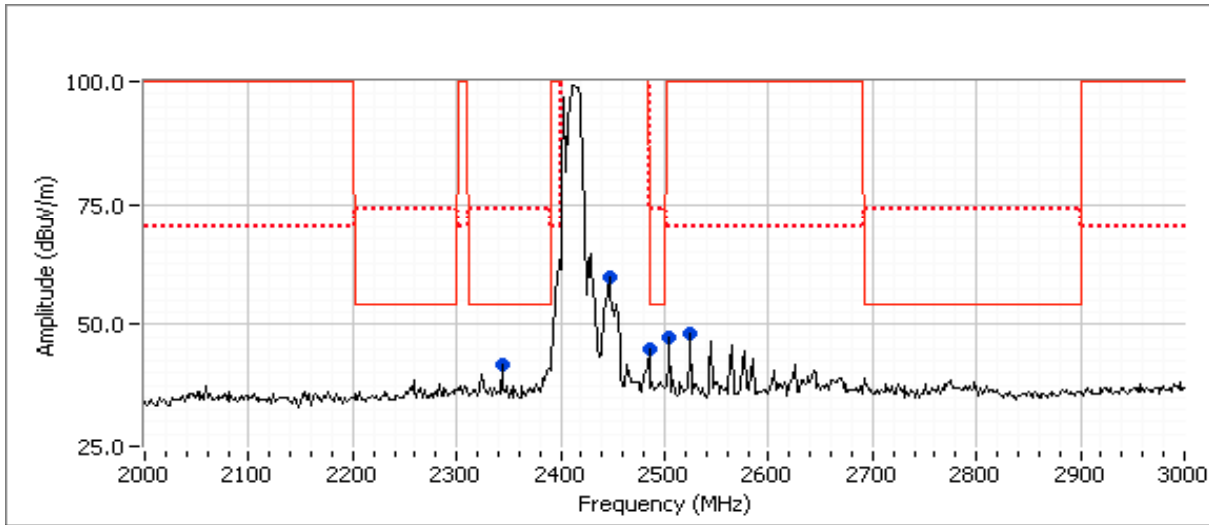

Client: Intel	Job Number: J91968
Model: Intel Model 3160NGW Wireless Network Adapter	T-Log Number: J92301
	Account Manager: Christine Krebill
Contact: Steve Hackett	
Standard: FCC 15 B, 15.247, RSS 210	Class: N/A

Run #2: Radiated Spurious Emissions, 1-10GHz. Operating Mode: 802.11b @ 2462, BT Basic @ 2480 MHz
 Date of Test: 5/31/2013
 Test Engineer: Jack Liu / R. Varelas
 Test Location: FT Chamber# 4

	Target (dBm)	Power Settings Measured (dBm)	Software Setting
Chain A	16.5	16.5	21.0
Chain B	8.0	-	8dBm

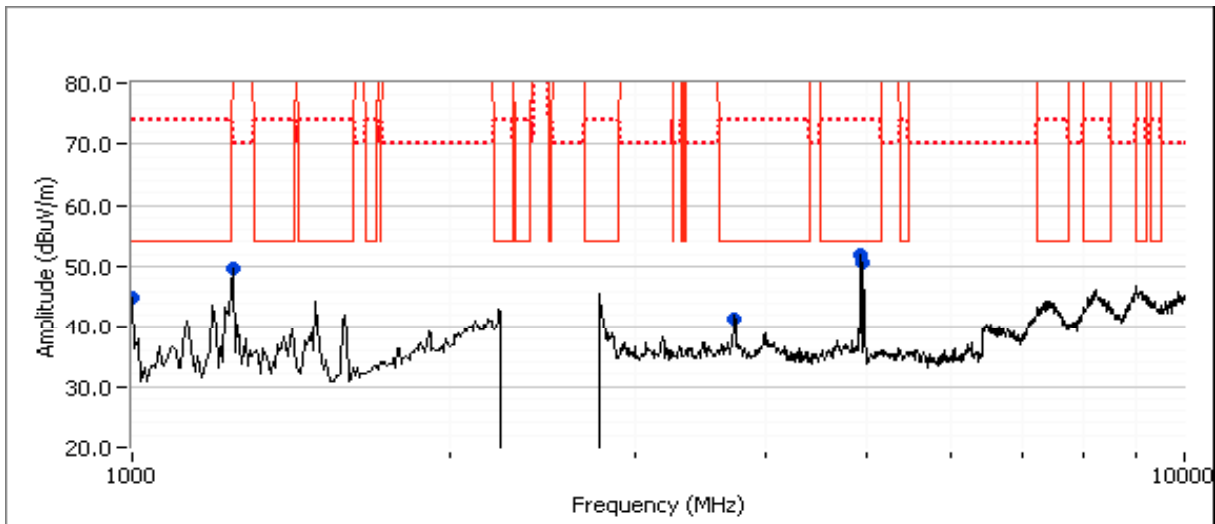

Preliminary Spurious Emissions excluding allocated band (Peak versus average limit)

Frequency	Level	Pol	15.209 / 15.247		Detector	Azimuth	Height	Comments
MHz	dB μ V/m	v/h	Limit	Margin	Pk/QP/Avg	degrees	meters	
4920.000	51.9	H	54.0	-2.1	Peak	157	1.6	
4953.330	50.6	V	54.0	-3.4	Peak	166	1.3	
1246.670	49.8	V	70.0	-20.2	Peak	105	1.0	
1000.000	44.8	V	54.0	-9.2	Peak	118	1.0	
3733.330	41.3	V	54.0	-12.7	Peak	187	1.3	

Client: Intel	Job Number: J91968
Model: Intel Model 3160NGW Wireless Network Adapter	T-Log Number: J92301
	Account Manager: Christine Krebill
Contact: Steve Hackett	
Standard: FCC 15 B, 15.247, RSS 210	Class: N/A

Final measurements at 3m

Frequency MHz	Level dB μ V/m	Pol v/h	15.209 / 15.247		Detector Pk/QP/Avg	Azimuth degrees	Height meters	Comments
			Limit	Margin				
4924.030	49.6	H	54.0	-4.4	AVG	157	1.7	RB 1 MHz;VB 10 Hz;Peak
4924.030	53.3	H	74.0	-20.7	PK	157	1.7	RB 1 MHz;VB 3 MHz;Peak
4960.030	47.4	V	54.0	-6.6	AVG	166	1.2	RB 1 MHz;VB 10 Hz;Peak
4960.010	52.7	V	74.0	-21.3	PK	166	1.2	RB 1 MHz;VB 3 MHz;Peak
1247.270	31.6	V	54.0	-22.4	AVG	103	0.9	Note 1
1249.400	55.5	V	74.0	-18.5	PK	103	0.9	Note 1
1001.600	31.0	V	54.0	-23.0	AVG	202	0.9	RB 1 MHz;VB 10 Hz;Peak
1031.470	50.4	V	74.0	-23.6	PK	202	0.9	RB 1 MHz;VB 3 MHz;Peak
3727.200	31.2	V	54.0	-22.8	AVG	321	0.9	RB 1 MHz;VB 10 Hz;Peak
3729.200	43.3	V	74.0	-30.7	PK	321	0.9	RB 1 MHz;VB 3 MHz;Peak

Note 1: Signal is not in a restricted band but the more stringent restricted band limit was used.

Client: Intel	Job Number: J91968
Model: Intel Model 3160NGW Wireless Network Adapter	T-Log Number: J92301
	Account Manager: Christine Krebill
Contact: Steve Hackett	
Standard: FCC 15 B, 15.247, RSS 210	Class: N/A

Spurious Radiated Emissions, 2 - 3GHz

Preliminary Scan at ~ 30cm from the product to identify potential signals (Peak versus average limit)

Preliminary Spurious Emissions at 30cm from 2-3 GHz (Peak versus average limit)

Frequency	Level	Pol	15.209 / 15.247		Detector	Azimuth	Height	Comments
MHz	dB μ V/m	v/h	Limit	Margin	Pk/QP/Avg	degrees	meters	
2498.330	52.1	H	54.0	-1.9	Peak	180	1.0	
2641.670	45.4	H	70.0	-24.6	Peak	180	1.0	
2621.670	43.8	H	70.0	-26.2	Peak	180	1.0	

Final measurements at 3m

Frequency	Level	Pol	15.209 / 15.247		Detector	Azimuth	Height	Comments
MHz	dB μ V/m	v/h	Limit	Margin	Pk/QP/Avg	degrees	meters	
2499.870	50.3	V	54.0	-3.7	AVG	88	0.9	POS; RB 1 MHz; VB: 10 Hz
2496.530	58.8	V	74.0	-15.2	PK	88	0.9	POS; RB 1 MHz; VB: 3 MHz
2496.400	50.2	H	54.0	-3.8	AVG	180	1.0	POS; RB 1 MHz; VB: 10 Hz
2497.880	59.0	H	74.0	-15.0	PK	180	1.0	POS; RB 1 MHz; VB: 3 MHz

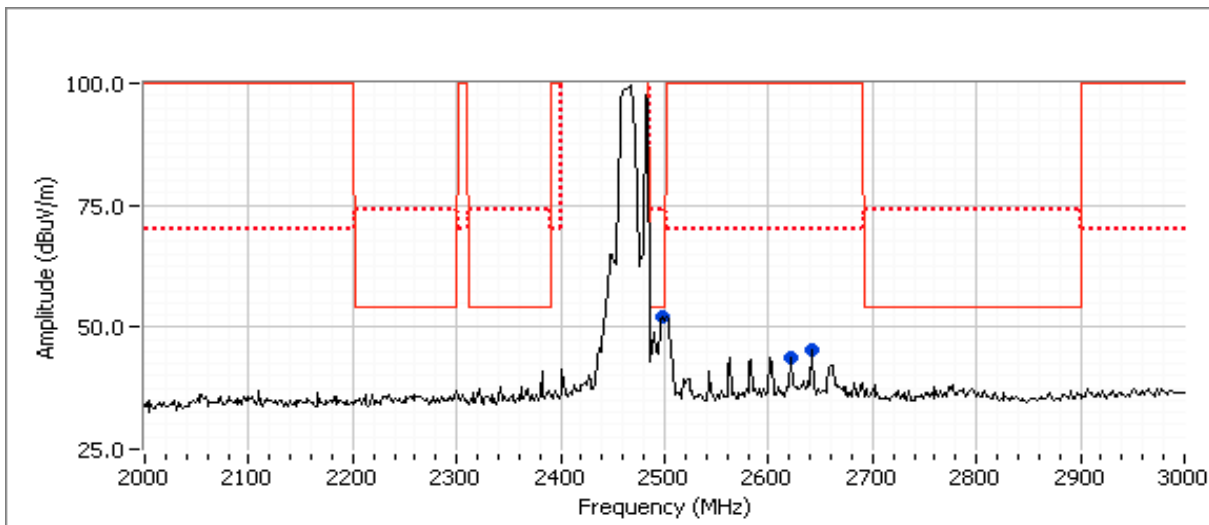

Client: Intel	Job Number: J91968
Model: Intel Model 3160NGW Wireless Network Adapter	T-Log Number: J92301
	Account Manager: Christine Krebill
Contact: Steve Hackett	
Standard: FCC 15 B, 15.247, RSS 210	Class: N/A

Run #3: Radiated Spurious Emissions, 1-10GHz. Operating Mode: 802.11g @ 2412, BT Basic @ 2402 MHz
 Date of Test: 5/31/2013
 Test Engineer: Jack Liu / R. Varelas
 Test Location: FT Chamber# 4

	Target (dBm)	Power Settings Measured (dBm)	Software Setting
Chain A	16.5	16.6	22.5
Chain B	8.0	-	8dBm

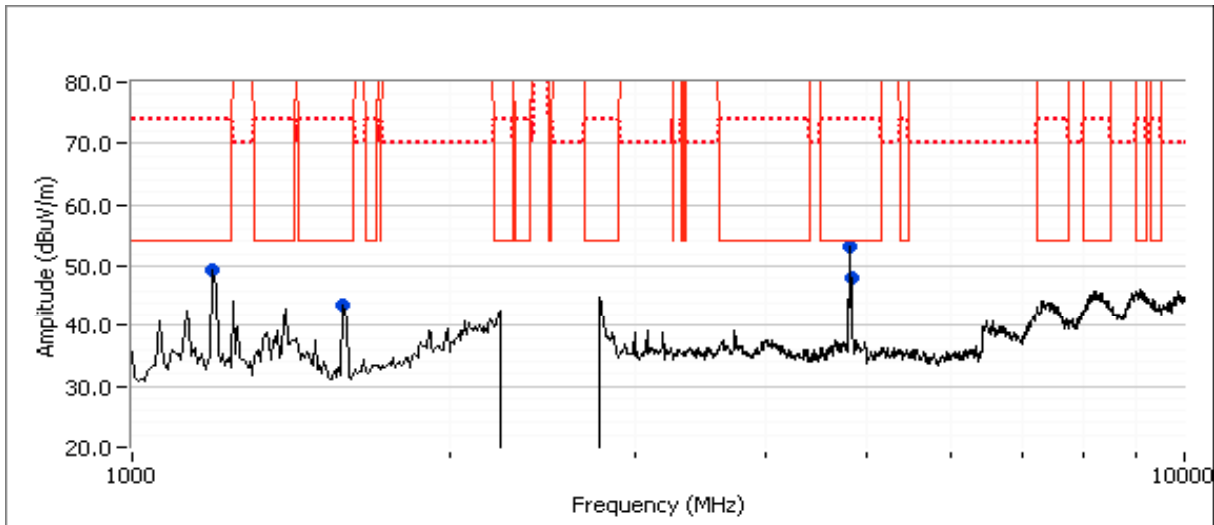

Preliminary Spurious Emissions excluding allocated band (Peak versus average limit)

Frequency	Level	Pol	15.209 / 15.247	Detector	Azimuth	Height	Comments
MHz	dB μ V/m	v/h	Limit	Pk/QP/Avg	degrees	meters	
1199.190	49.3	V	54.0	Peak	209	1.3	
1592.860	43.6	V	54.0	Peak	73	1.3	
4803.750	53.1	H	54.0	Peak	157	1.0	
4824.040	48.1	H	54.0	Peak	163	1.3	

Client: Intel	Job Number: J91968
Model: Intel Model 3160NGW Wireless Network Adapter	T-Log Number: J92301
	Account Manager: Christine Krebill
Contact: Steve Hackett	
Standard: FCC 15 B, 15.247, RSS 210	Class: N/A

Final measurements at 3m

Frequency MHz	Level dB μ V/m	Pol v/h	15.209 / 15.247		Detector Pk/QP/Avg	Azimuth degrees	Height meters	Comments
			Limit	Margin				
4803.990	49.1	H	54.0	-4.9	AVG	159	0.9	RB 1 MHz;VB 10 Hz;Peak
4803.650	53.7	H	74.0	-20.3	PK	159	0.9	RB 1 MHz;VB 3 MHz;Peak
1198.570	36.7	V	54.0	-17.3	AVG	207	1.3	RB 1 MHz;VB 10 Hz;Peak
1198.110	59.4	V	74.0	-14.6	PK	207	1.3	RB 1 MHz;VB 3 MHz;Peak
4824.420	40.6	H	54.0	-13.4	AVG	152	1.2	RB 1 MHz;VB 10 Hz;Peak
4823.710	53.7	H	74.0	-20.3	PK	152	1.2	RB 1 MHz;VB 3 MHz;Peak
1594.040	30.6	V	54.0	-23.4	AVG	71	0.9	RB 1 MHz;VB 10 Hz;Peak
1594.140	50.9	V	74.0	-23.1	PK	71	0.9	RB 1 MHz;VB 3 MHz;Peak

Spurious Radiated Emissions, 2 - 3GHz

Preliminary Scan at ~ 30cm from the product to identify potential signals (Peak versus average limit)

Preliminary Spurious Emissions at 30cm from 2-3 GHz (Peak versus average limit)

Frequency MHz	Level dB μ V/m	Pol v/h	15.209 / 15.247		Detector Pk/QP/Avg	Azimuth degrees	Height meters	Comments
			Limit	Margin				
2505.000	46.0	H	70.0	-24.0	Peak	180	1.0	
2525.000	45.9	H	70.0	-24.1	Peak	180	1.0	

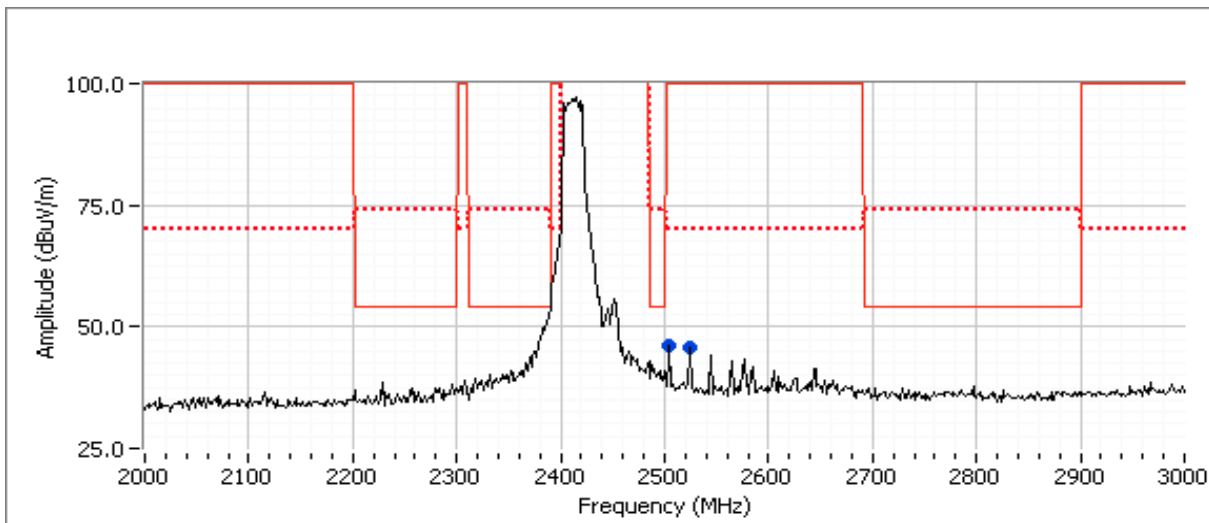

Client: Intel	Job Number: J91968
Model: Intel Model 3160NGW Wireless Network Adapter	T-Log Number: J92301
	Account Manager: Christine Krebill
Contact: Steve Hackett	
Standard: FCC 15 B, 15.247, RSS 210	Class: N/A

Run #4: Radiated Spurious Emissions, 1-10GHz. Operating Mode: 802.11g @ 2462, BT Basic @ 2480 MHz
 Date of Test: 5/31/2013
 Test Engineer: Jack Liu / R. Varelas
 Test Location: FT Chamber# 4

	Target (dBm)	Power Settings Measured (dBm)	Software Setting
Chain A	16.5	16.4	22.5
Chain B	8.0	-	8dBm

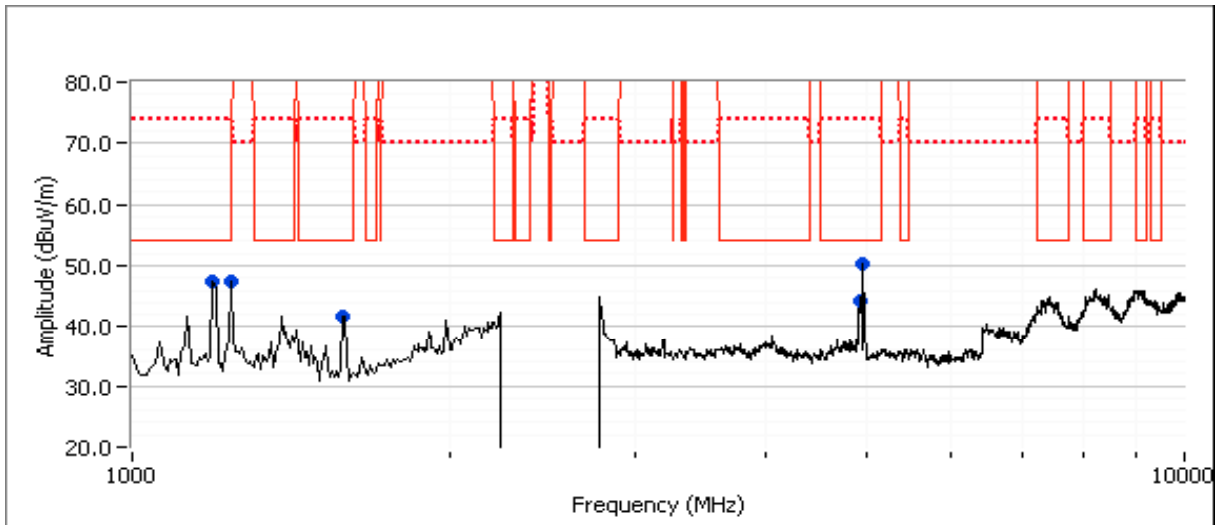

Preliminary Spurious Emissions excluding allocated band (Peak versus average limit)

Frequency	Level	Pol	15.209 / 15.247		Detector	Azimuth	Height	Comments
MHz	dB μ V/m	v/h	Limit	Margin	Pk/QP/Avg	degrees	meters	
1193.330	47.5	V	54.0	-6.5	Peak	67	1.0	
1240.000	47.6	V	54.0	-6.4	Peak	108	1.0	
1586.670	41.8	V	54.0	-12.2	Peak	174	1.0	
4953.330	50.4	V	54.0	-3.6	Peak	118	2.2	
4913.330	44.3	V	54.0	-9.7	Peak	261	1.9	

Client: Intel	Job Number: J91968
Model: Intel Model 3160NGW Wireless Network Adapter	T-Log Number: J92301
	Account Manager: Christine Krebill
Contact: Steve Hackett	
Standard: FCC 15 B, 15.247, RSS 210	Class: N/A

Final measurements at 3m

Frequency MHz	Level dB μ V/m	Pol v/h	15.209 / 15.247		Detector Pk/QP/Avg	Azimuth degrees	Height meters	Comments
			Limit	Margin				
4960.000	44.7	V	54.0	-9.3	AVG	116	2.4	RB 1 MHz;VB 10 Hz;Peak
4960.400	50.6	V	74.0	-23.4	PK	116	2.4	RB 1 MHz;VB 3 MHz;Peak
1197.460	33.9	V	54.0	-20.1	AVG	57	1.0	RB 1 MHz;VB 10 Hz;Peak
1198.730	56.8	V	74.0	-17.2	PK	57	1.0	RB 1 MHz;VB 3 MHz;Peak
1230.270	31.2	V	54.0	-22.8	AVG	73	0.9	RB 1 MHz;VB 10 Hz;Peak
1222.270	51.0	V	74.0	-23.0	PK	73	0.9	RB 1 MHz;VB 3 MHz;Peak
1597.270	32.4	V	54.0	-21.6	AVG	172	0.9	RB 1 MHz;VB 10 Hz;Peak
1598.070	54.4	V	74.0	-19.6	PK	172	0.9	RB 1 MHz;VB 3 MHz;Peak
4923.600	37.7	V	54.0	-16.3	AVG	261	1.3	RB 1 MHz;VB 10 Hz;Peak
4921.000	51.3	V	74.0	-22.7	PK	261	1.3	RB 1 MHz;VB 3 MHz;Peak

Spurious Radiated Emissions, 2 - 3GHz

Preliminary Scan at ~ 30cm from the product to identify potential signals (Peak versus average limit)

Preliminary Spurious Emissions at 30cm from 2-3 GHz (Peak versus average limit)

Frequency MHz	Level dB μ V/m	Pol v/h	15.209 / 15.247		Detector Pk/QP/Avg	Azimuth degrees	Height meters	Comments
			Limit	Margin				
2601.670	44.4	H	70.0	-25.6	Peak	180	1.0	
2621.670	45.3	H	70.0	-24.7	Peak	180	1.0	
2641.670	45.2	H	70.0	-24.8	Peak	180	1.0	

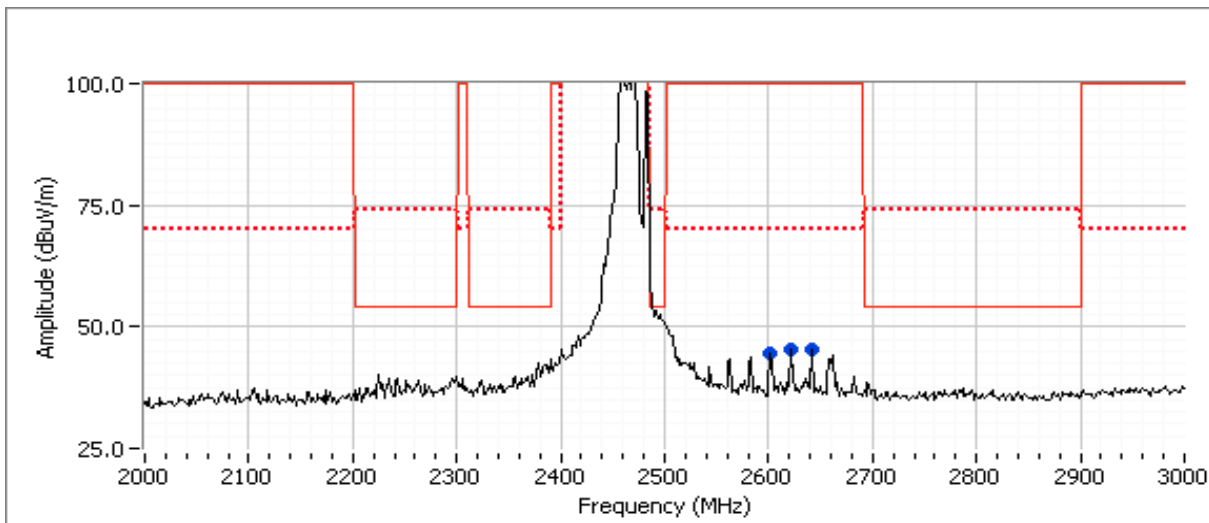

Client: Intel	Job Number: J91968
Model: Intel Model 3160NGW Wireless Network Adapter	T-Log Number: J92301
	Account Manager: Christine Krebill
Contact: Steve Hackett	
Standard: FCC 15 B, 15.247, RSS 210	Class: N/A

Run #5: Radiated Spurious Emissions, 1-10GHz. Operating Mode: 802.11b @ 2437 MHz, BT Basic @ 2402 MHz
 Date of Test: 5/31/2013
 Test Engineer: Jack Liu / R. Varelas
 Test Location: FT Chamber# 4

	Target (dBm)	Power Settings Measured (dBm)	Software Setting
Chain A	16.5	16.4	20.5
Chain B	8.0	-	8dBm

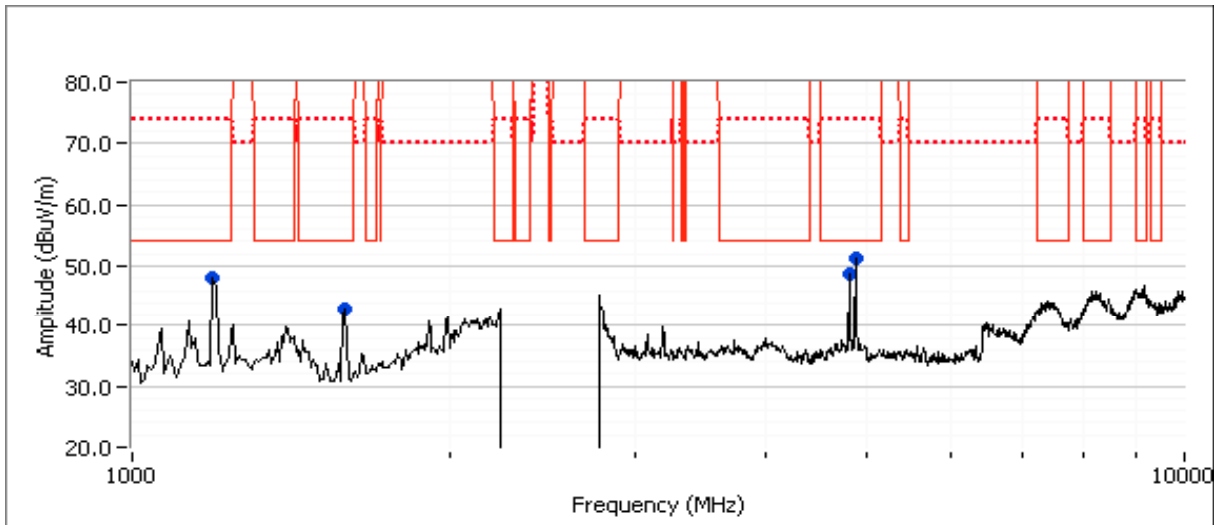

Preliminary Spurious Emissions excluding allocated band (Peak versus average limit)

Frequency	Level	Pol	15.209 / 15.247	Detector	Azimuth	Height	Comments
MHz	dB μ V/m	v/h	Limit	Pk/QP/Avg	degrees	meters	
1193.330	48.2	V	54.0	Peak	202	1.3	
1593.330	43.1	V	54.0	Peak	176	1.0	
4800.000	48.6	V	54.0	Peak	197	1.9	
4873.330	51.4	V	54.0	Peak	121	1.3	

Client: Intel	Job Number: J91968
Model: Intel Model 3160NGW Wireless Network Adapter	T-Log Number: J92301
	Account Manager: Christine Krebill
Contact: Steve Hackett	
Standard: FCC 15 B, 15.247, RSS 210	Class: N/A

Final measurements at 3m

Frequency MHz	Level dB μ V/m	Pol v/h	15.209 / 15.247		Detector Pk/QP/Avg	Azimuth degrees	Height meters	Comments
			Limit	Margin				
4873.980	47.8	V	54.0	-6.2	AVG	115	1.1	RB 1 MHz;VB 10 Hz;Peak
4874.150	51.5	V	74.0	-22.5	PK	115	1.1	RB 1 MHz;VB 3 MHz;Peak
1598.670	31.2	V	54.0	-22.8	AVG	178	0.9	RB 1 MHz;VB 10 Hz;Peak
1596.470	53.8	V	74.0	-20.2	PK	178	0.9	RB 1 MHz;VB 3 MHz;Peak
4803.970	44.2	V	54.0	-9.8	AVG	209	1.3	RB 1 MHz;VB 10 Hz;Peak
4803.650	48.9	V	74.0	-25.1	PK	209	1.3	RB 1 MHz;VB 3 MHz;Peak
1197.320	34.5	V	54.0	-19.5	AVG	200	1.4	RB 1 MHz;VB 10 Hz;Peak
1196.900	58.3	V	74.0	-15.7	PK	200	1.4	RB 1 MHz;VB 3 MHz;Peak

Spurious Radiated Emissions, 2 - 3GHz

Preliminary Scan at ~ 30cm from the product to identify potential signals (Peak versus average limit)

Preliminary Spurious Emissions at 30cm from 2-3 GHz (Peak versus average limit)

Frequency MHz	Level dB μ V/m	Pol v/h	15.209 / 15.247		Detector Pk/QP/Avg	Azimuth degrees	Height meters	Comments
			Limit	Margin				
2322.650	37.2	H	54.0	-16.8	Peak	179	1.0	
2472.950	48.2	H	120.0	-71.8	Peak	179	1.0	
2480.960	45.1	H	120.0	-74.9	Peak	179	1.0	
2502.000	43.7	H	70.0	-26.3	Peak	179	1.0	

Final measurements at 3m

Frequency MHz	Level dB μ V/m	Pol v/h	15.209 / 15.247		Detector Pk/QP/Avg	Azimuth degrees	Height meters	Comments
			Limit	Margin				
2321.960	43.2	H	54.0	-10.8	AVG	360	1.0	POS; RB 1 MHz; VB: 10 Hz
2324.080	55.4	H	74.0	-18.6	PK	360	1.0	POS; RB 1 MHz; VB: 3 MHz
2322.000	43.3	V	54.0	-10.7	AVG	170	1.0	POS; RB 1 MHz; VB: 10 Hz
2320.600	54.4	V	74.0	-19.6	PK	170	1.0	POS; RB 1 MHz; VB: 3 MHz

Client: Intel	Job Number: J91968
Model: Intel Model 3160NGW Wireless Network Adapter	T-Log Number: J92301
	Account Manager: Christine Krebill
Contact: Steve Hackett	
Standard: FCC 15 B, 15.247, RSS 210	Class: N/A

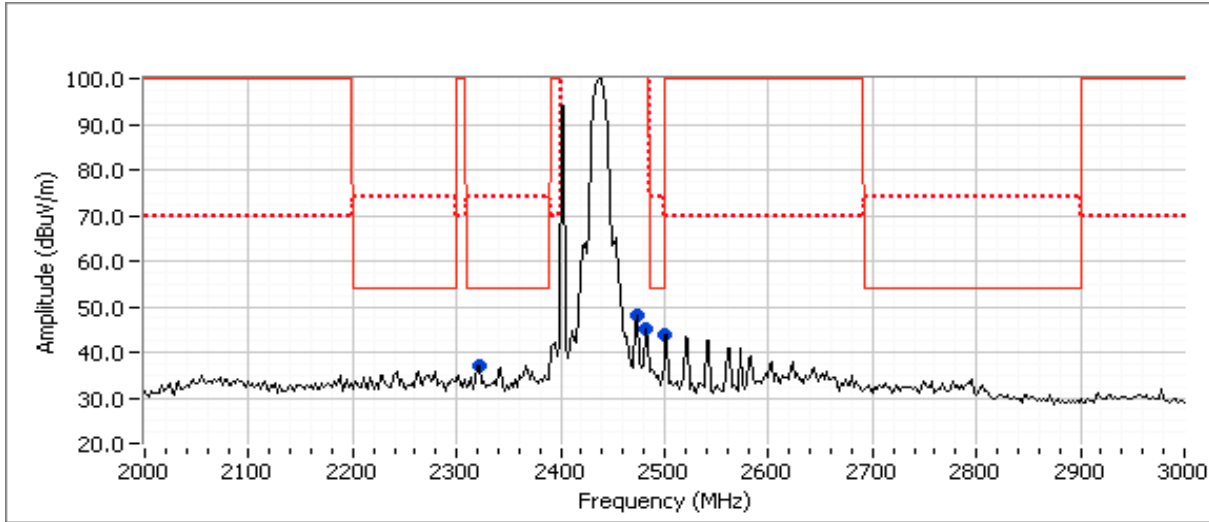

Client: Intel	Job Number: J91968
Model: Intel Model 3160NGW Wireless Network Adapter	T-Log Number: J92301
	Account Manager: Christine Krebill
Contact: Steve Hackett	
Standard: FCC 15 B, 15.247, RSS 210	Class: N/A

Run #6: Radiated Spurious Emissions, 1-10GHz. Operating Mode: 802.11b @ 2412 MHz, BT Basic @ 2441 MHz

Date of Test: 5/31/2013

Test Engineer: Jack Liu / R. Varelas

Test Location: FT Chamber# 4

	Target (dBm)	Power Settings Measured (dBm)	Software Setting
Chain A	16.5	16.3	20.0
Chain B	8.0	-	8dBm

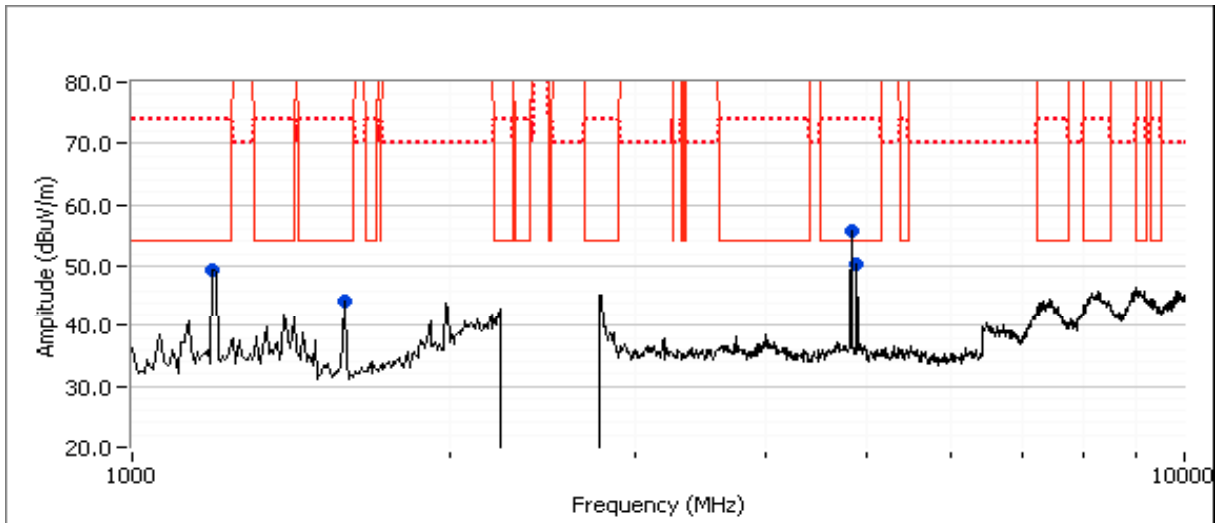

Preliminary Spurious Emissions excluding allocated band (Peak versus average limit)

Frequency MHz	Level dB μ V/m	Pol v/h	15.209 / 15.247 Limit Margin	Detector Pk/QP/Avg	Azimuth degrees	Height meters	Comments
1196.770	49.3	V	54.0 -4.7	Peak	209	1.3	
1599.430	44.4	V	54.0 -9.6	Peak	27	1.3	
4824.040	55.6	H	54.0 1.6	Peak	159	1.3	
4882.060	50.4	V	54.0 -3.6	Peak	165	1.9	

Client: Intel	Job Number: J91968
Model: Intel Model 3160NGW Wireless Network Adapter	T-Log Number: J92301
	Account Manager: Christine Krebill
Contact: Steve Hackett	
Standard: FCC 15 B, 15.247, RSS 210	Class: N/A

Final measurements at 3m

Frequency MHz	Level dB μ V/m	Pol v/h	15.209 / 15.247		Detector Pk/QP/Avg	Azimuth degrees	Height meters	Comments
			Limit	Margin				
4823.980	52.5	H	54.0	-1.5	AVG	151	0.9	RB 1 MHz;VB 10 Hz;Peak
4824.040	54.1	H	74.0	-19.9	PK	151	0.9	RB 1 MHz;VB 3 MHz;Peak
1598.780	29.4	V	54.0	-24.6	AVG	28	1.2	RB 1 MHz;VB 10 Hz;Peak
1598.930	51.2	V	74.0	-22.8	PK	28	1.2	RB 1 MHz;VB 3 MHz;Peak
4881.970	45.2	V	54.0	-8.8	AVG	172	1.0	RB 1 MHz;VB 10 Hz;Peak
4881.770	49.6	V	74.0	-24.4	PK	172	1.0	RB 1 MHz;VB 3 MHz;Peak
1195.810	37.6	V	54.0	-16.4	AVG	211	1.2	RB 1 MHz;VB 10 Hz;Peak
1197.680	58.5	V	74.0	-15.5	PK	211	1.2	RB 1 MHz;VB 3 MHz;Peak

Spurious Radiated Emissions, 2 - 3GHz

Preliminary Scan at ~ 30cm from the product to identify potential signals (Peak versus average limit)

Preliminary Spurious Emissions at 30cm from 2-3 GHz (Peak versus average limit)

Frequency MHz	Level dB μ V/m	Pol v/h	15.209 / 15.247		Detector Pk/QP/Avg	Azimuth degrees	Height meters	Comments
			Limit	Margin				
2382.770	49.1	H	54.0	-4.9	Peak	179	1.0	
2501.000	41.3	H	70.0	-28.7	Peak	179	1.0	
2541.080	42.2	H	70.0	-27.8	Peak	179	1.0	

Final measurements at 3m

Frequency MHz	Level dB μ V/m	Pol v/h	15.209 / 15.247		Detector Pk/QP/Avg	Azimuth degrees	Height meters	Comments
			Limit	Margin				
2383.030	52.6	H	54.0	-1.4	AVG	249	1.0	
2383.030	59.7	H	74.0	-14.3	PK	249	1.0	
2383.030	50.3	V	54.0	-3.7	AVG	292	1.1	
2383.210	58.7	V	74.0	-15.3	PK	292	1.1	

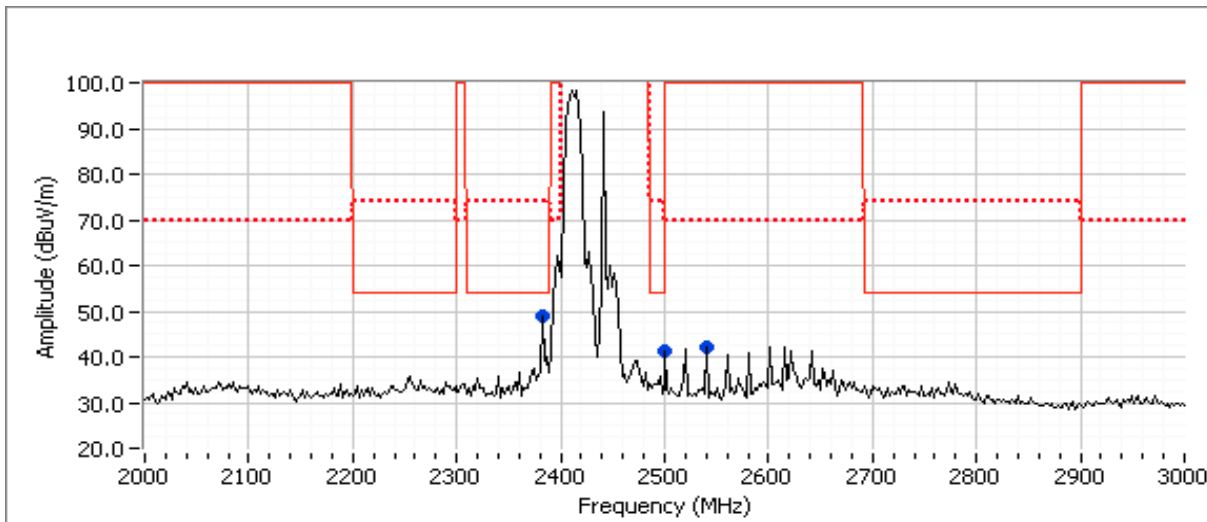

Client: Intel	Job Number: J91968
Model: Intel Model 3160NGW Wireless Network Adapter	T-Log Number: J92301
	Account Manager: Christine Krebill
Contact: Steve Hackett	
Standard: FCC 15 B, 15.247, RSS 210	Class: N/A

Run #7: Radiated Spurious Emissions, 1-10GHz. Operating Mode: 802.11b @ 2462 MHz, BT Basic @ 2440 MHz
 Date of Test: 5/31/2013
 Test Engineer: Jack Liu / R. Varelas
 Test Location: FT Chamber# 4

	Target (dBm)	Power Settings Measured (dBm)	Software Setting
Chain A	16.5	16.5	21.0
Chain B	8.0	-	8dBm

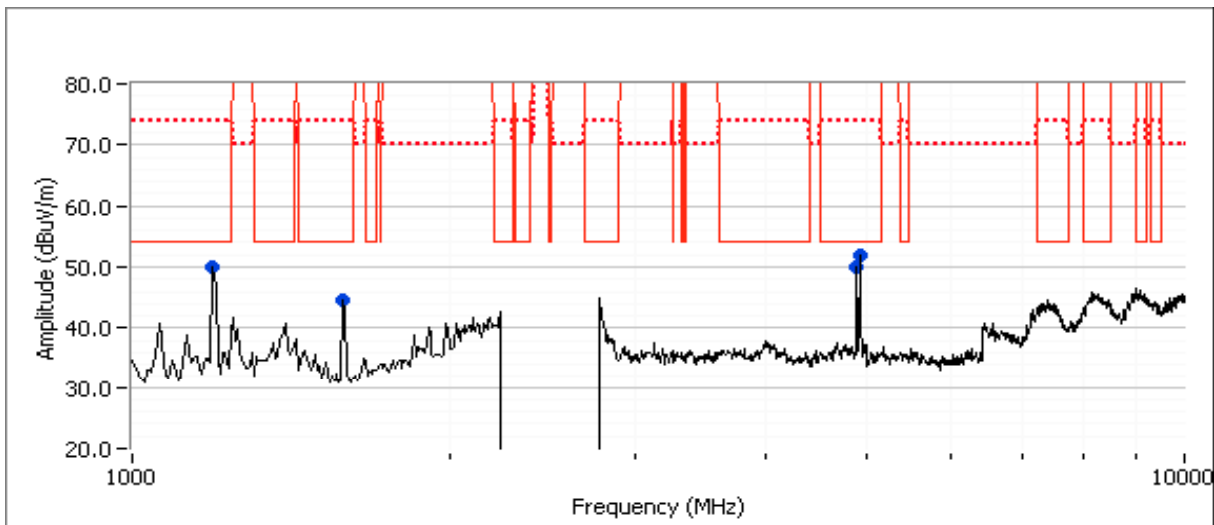

Preliminary Spurious Emissions excluding allocated band (Peak versus average limit)

Frequency	Level	Pol	15.209 / 15.247		Detector	Azimuth	Height	Comments
MHz	dB μ V/m	v/h	Limit	Margin	Pk/QP/Avg	degrees	meters	
1198.320	50.0	V	54.0	-4.0	Peak	194	1.3	
1593.100	44.5	V	54.0	-9.5	Peak	218	1.0	
4882.330	49.9	H	54.0	-4.1	Peak	164	1.3	
4924.060	51.9	V	54.0	-2.1	Peak	290	1.6	

Final measurements at 3m

Frequency	Level	Pol	15.209 / 15.247		Detector	Azimuth	Height	Comments
MHz	dB μ V/m	v/h	Limit	Margin	Pk/QP/Avg	degrees	meters	
4924.020	46.5	V	54.0	-7.5	AVG	298	1.3	RB 1 MHz;VB 10 Hz;Peak
4923.960	50.2	V	74.0	-23.8	PK	298	1.3	RB 1 MHz;VB 3 MHz;Peak
4881.950	45.6	H	54.0	-8.4	AVG	166	1.0	RB 1 MHz;VB 10 Hz;Peak
4882.080	49.8	H	74.0	-24.2	PK	166	1.0	RB 1 MHz;VB 3 MHz;Peak
1197.280	37.3	V	54.0	-16.7	AVG	196	1.4	RB 1 MHz;VB 10 Hz;Peak
1198.060	59.7	V	74.0	-14.3	PK	196	1.4	RB 1 MHz;VB 3 MHz;Peak
1593.100	31.2	V	54.0	-22.8	AVG	219	1.0	RB 1 MHz;VB 10 Hz;Peak
1593.250	54.7	V	74.0	-19.3	PK	219	1.0	RB 1 MHz;VB 3 MHz;Peak

Client: Intel	Job Number: J91968
Model: Intel Model 3160NGW Wireless Network Adapter	T-Log Number: J92301
	Account Manager: Christine Krebill
Contact: Steve Hackett	
Standard: FCC 15 B, 15.247, RSS 210	Class: N/A

Spurious Radiated Emissions, 2 - 3GHz

Preliminary Scan at ~ 30cm from the product to identify potential signals (Peak versus average limit)

Preliminary Spurious Emissions at 30cm from 2-3 GHz (Peak versus average limit)

Frequency MHz	Level dB μ V/m	Pol v/h	15.209 / 15.247		Detector Pk/QP/Avg	Azimuth degrees	Height meters	Comments
			Limit	Margin				
2340.680	37.1	H	54.0	-16.9	Peak	179	1.0	
2521.040	45.7	H	70.0	-24.3	Peak	179	1.0	
2541.080	42.5	H	70.0	-27.5	Peak	179	1.0	

Final measurements at 3m

Frequency MHz	Level dB μ V/m	Pol v/h	15.209 / 15.247		Detector Pk/QP/Avg	Azimuth degrees	Height meters	Comments
			Limit	Margin				
2340.990	44.3	H	54.0	-9.7	AVG	355	0.9	POS; RB 1 MHz; VB: 10 Hz
2341.130	54.6	H	74.0	-19.4	PK	355	0.9	POS; RB 1 MHz; VB: 3 MHz
2341.110	43.0	V	54.0	-11.0	AVG	310	1.0	POS; RB 1 MHz; VB: 10 Hz
2343.260	54.9	V	74.0	-19.1	PK	310	1.0	POS; RB 1 MHz; VB: 3 MHz

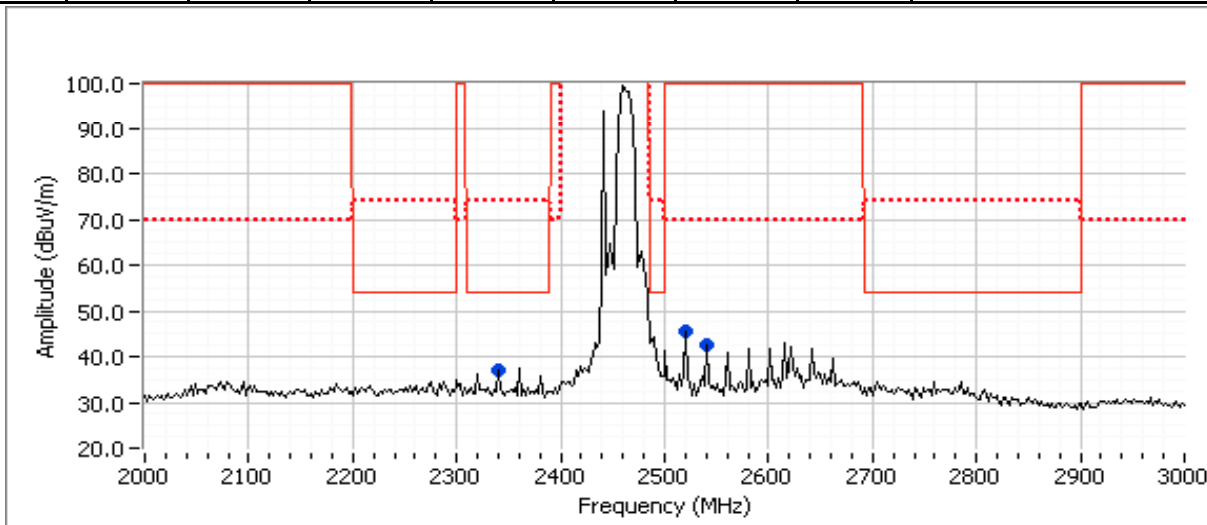

Client: Intel	Job Number: J91968
Model: Intel Model 3160NGW Wireless Network Adapter	T-Log Number: J92301
	Account Manager: Christine Krebill
Contact: Steve Hackett	
Standard: FCC 15 B, 15.247, RSS 210	Class: N/A

Run #8: Radiated Spurious Emissions, 1-10GHz. Operating Mode: 802.11b @ 2437 MHz, BT Basic @ 2480 MHz
 Date of Test: 5/31/2013
 Test Engineer: Jack Liu / R. Varelas
 Test Location: FT Chamber# 4

	Target (dBm)	Power Settings Measured (dBm)	Software Setting
Chain A	16.5	16.4	20.5
Chain B	8.0	-	8dBm

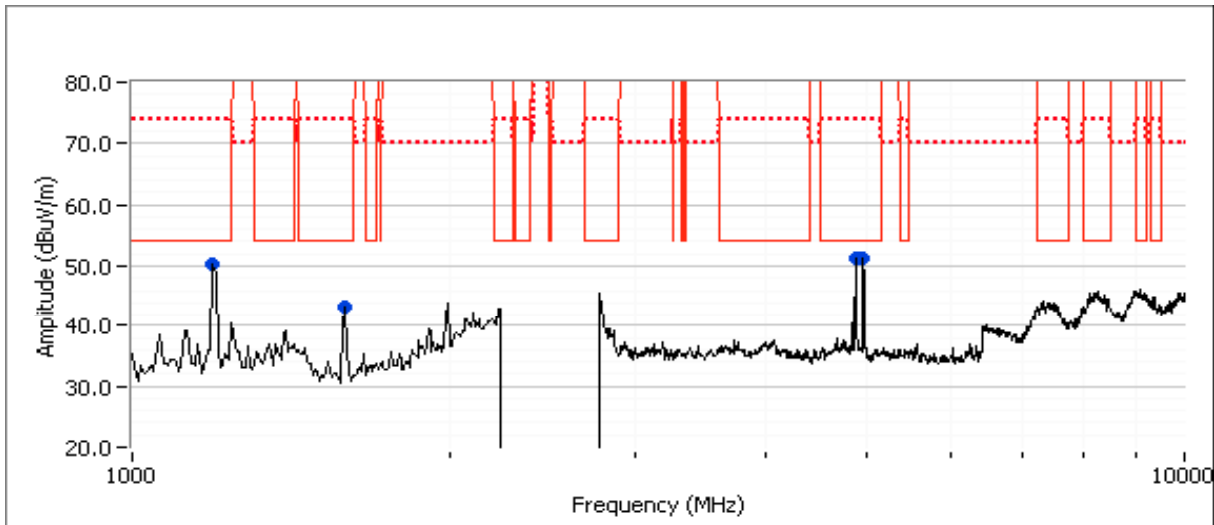

Preliminary Spurious Emissions excluding allocated band (Peak versus average limit)

Frequency	Level	Pol	15.209 / 15.247	Detector	Azimuth	Height	Comments
MHz	dB μ V/m	v/h	Limit	Pk/QP/Avg	degrees	meters	
1196.750	50.3	V	54.0	Peak	187	1.3	
1592.660	43.3	V	54.0	Peak	222	1.0	
4874.020	51.2	H	54.0	Peak	153	1.0	
4959.760	51.4	V	54.0	Peak	154	1.6	

Client: Intel	Job Number: J91968
Model: Intel Model 3160NGW Wireless Network Adapter	T-Log Number: J92301
	Account Manager: Christine Krebill
Contact: Steve Hackett	
Standard: FCC 15 B, 15.247, RSS 210	Class: N/A

Final measurements at 3m

Frequency MHz	Level dB μ V/m	Pol v/h	15.209 / 15.247		Detector Pk/QP/Avg	Azimuth degrees	Height meters	Comments
			Limit	Margin				
4959.940	51.0	V	54.0	-3.0	AVG	141	1.0	RB 1 MHz;VB 10 Hz;Peak
4960.300	55.6	V	74.0	-18.4	PK	141	1.0	RB 1 MHz;VB 3 MHz;Peak
4874.000	48.3	H	54.0	-5.7	AVG	147	1.1	RB 1 MHz;VB 10 Hz;Peak
4874.020	51.8	H	74.0	-22.2	PK	147	1.1	RB 1 MHz;VB 3 MHz;Peak
1196.260	34.7	V	54.0	-19.3	AVG	188	1.2	RB 1 MHz;VB 10 Hz;Peak
1195.650	58.8	V	74.0	-15.2	PK	188	1.2	RB 1 MHz;VB 3 MHz;Peak
1593.090	32.1	V	54.0	-21.9	AVG	223	0.9	RB 1 MHz;VB 10 Hz;Peak
1593.150	52.7	V	74.0	-21.3	PK	223	0.9	RB 1 MHz;VB 3 MHz;Peak

Spurious Radiated Emissions, 2 - 3GHz

Preliminary Scan at ~ 30cm from the product to identify potential signals (Peak versus average limit)

Preliminary Spurious Emissions at 30cm from 2-3 GHz (Peak versus average limit)

Frequency MHz	Level dB μ V/m	Pol v/h	15.209 / 15.247		Detector Pk/QP/Avg	Azimuth degrees	Height meters	Comments
			Limit	Margin				
2392.790	54.8	H	70.0	-15.2	Peak	179	1.0	
2488.980	47.7	H	54.0	-6.3	Peak	179	1.0	
2523.050	49.5	H	70.0	-20.5	Peak	179	1.0	

Final measurements at 3m

Frequency MHz	Level dB μ V/m	Pol v/h	15.209 / 15.247		Detector Pk/QP/Avg	Azimuth degrees	Height meters	Comments
			Limit	Margin				
2488.030	46.9	H	54.0	-7.1	AVG	155	1.0	POS; RB 1 MHz; VB: 10 Hz
2486.710	56.5	H	74.0	-17.5	PK	155	1.0	POS; RB 1 MHz; VB: 3 MHz
2488.030	46.8	V	54.0	-7.2	AVG	218	1.5	POS; RB 1 MHz; VB: 10 Hz
2488.350	56.5	V	74.0	-17.5	PK	218	1.5	POS; RB 1 MHz; VB: 3 MHz

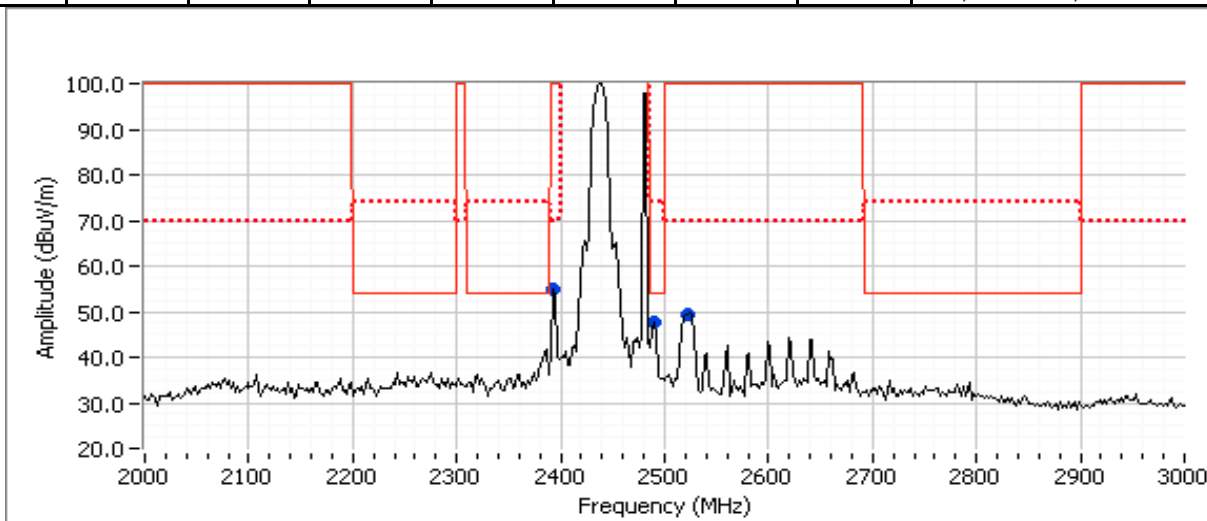

Client: Intel	Job Number: J91968
Model: Intel Model 3160NGW Wireless Network Adapter	T-Log Number: J92301
	Account Manager: Christine Krebill
Contact: Steve Hackett	
Standard: FCC 15 B, 15.247, RSS 210	Class: N/A

Run #9: Radiated Spurious Emissions, 1-10GHz. Operating Mode: 802.11b @ 2437 MHz, BT EDR @ 2402 MHz
 Date of Test: 5/31/2013
 Test Engineer: Jack Liu / R. Varelas
 Test Location: FT Chamber# 4

	Target (dBm)	Power Settings Measured (dBm)	Software Setting
Chain A	16.5	16.4	20.5
Chain B	8.0	-	8dBm

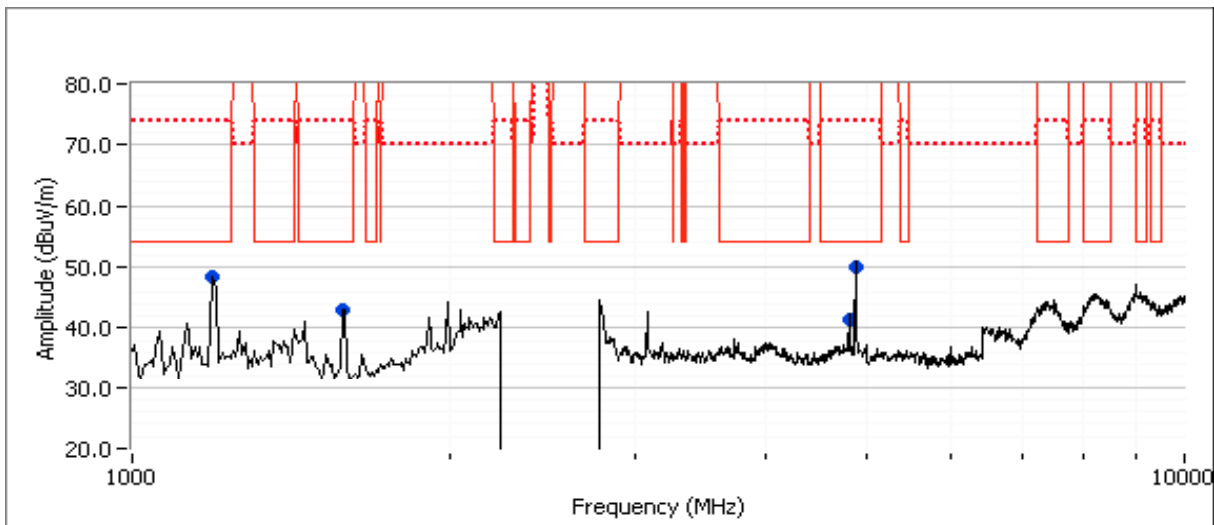

Preliminary Spurious Emissions excluding allocated band (Peak versus average limit)

Frequency	Level	Pol	15.209 / 15.247		Detector	Azimuth	Height	Comments
MHz	dBµV/m	v/h	Limit	Margin	Pk/QP/Avg	degrees	meters	
1194.860	48.5	V	54.0	-5.5	Peak	186	1.3	
1593.170	43.0	V	54.0	-11.0	Peak	215	1.0	
4804.190	41.4	H	54.0	-12.6	Peak	170	2.5	
4874.020	49.9	V	54.0	-4.1	Peak	125	1.6	

Final measurements at 3m

Frequency	Level	Pol	15.209 / 15.247		Detector	Azimuth	Height	Comments
MHz	dBµV/m	v/h	Limit	Margin	Pk/QP/Avg	degrees	meters	
4874.030	44.6	V	54.0	-9.4	AVG	103	0.9	RB 1 MHz;VB 10 Hz;Peak
4873.900	49.4	V	74.0	-24.6	PK	103	0.9	RB 1 MHz;VB 3 MHz;Peak
1593.140	30.6	V	54.0	-23.4	AVG	213	0.9	RB 1 MHz;VB 10 Hz;Peak
1593.180	54.0	V	74.0	-20.0	PK	213	0.9	RB 1 MHz;VB 3 MHz;Peak
1194.690	33.9	V	54.0	-20.1	AVG	184	1.3	RB 1 MHz;VB 10 Hz;Peak
1195.520	60.3	V	74.0	-13.7	PK	184	1.3	RB 1 MHz;VB 3 MHz;Peak
4803.960	40.6	H	54.0	-13.4	AVG	153	1.1	RB 1 MHz;VB 10 Hz;Peak
4804.030	48.5	H	74.0	-25.5	PK	153	1.1	RB 1 MHz;VB 3 MHz;Peak

Client: Intel	Job Number: J91968
Model: Intel Model 3160NGW Wireless Network Adapter	T-Log Number: J92301
	Account Manager: Christine Krebill
Contact: Steve Hackett	
Standard: FCC 15 B, 15.247, RSS 210	Class: N/A

Spurious Radiated Emissions, 2 - 3GHz

Preliminary Scan at ~ 30cm from the product to identify potential signals (Peak versus average limit)

Preliminary Spurious Emissions at 30cm from 2-3 GHz (Peak versus average limit)

Frequency	Level	Pol	15.209 / 15.247		Detector	Azimuth	Height	Comments
MHz	dB μ V/m	v/h	Limit	Margin	Pk/QP/Avg	degrees	meters	
2392.790	39.1	H	70.0	-30.9	Peak	179	1.0	
2561.120	37.9	H	70.0	-32.1	Peak	179	1.0	

Final measurements at 3m

Frequency	Level	Pol	15.209 / 15.247		Detector	Azimuth	Height	Comments
MHz	dB μ V/m	v/h	Limit	Margin	Pk/QP/Avg	degrees	meters	
-	-	-	-	-	-	-	-	-

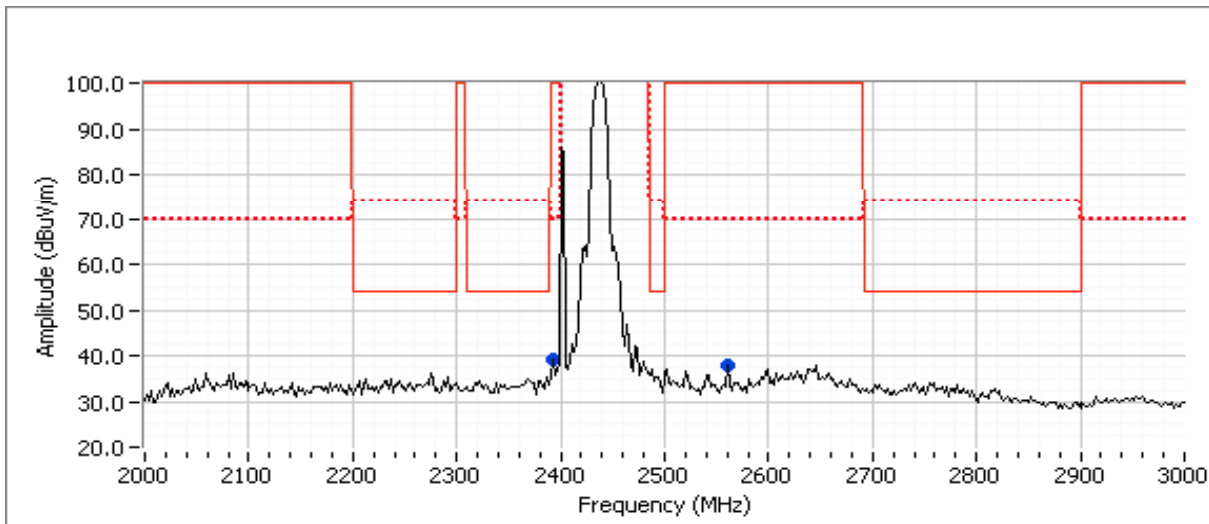

Client: Intel	Job Number: J91968
Model: Intel Model 3160NGW Wireless Network Adapter	T-Log Number: J92301
	Account Manager: Christine Krebill
Contact: Steve Hackett	
Standard: FCC 15 B, 15.247, RSS 210	Class: N/A

Run #10: Radiated Spurious Emissions, 1-10GHz. Operating Mode: 802.11b @ 2412 MHz, BT EDR @ 2441 MHz
 Date of Test: 6/3/2013
 Test Engineer: Rafael Varelas
 Test Location: FT Chamber #7

	Target (dBm)	Power Settings Measured (dBm)	Software Setting
Chain A	16.5	16.5	20.5
Chain B	8.0	-	8dBm

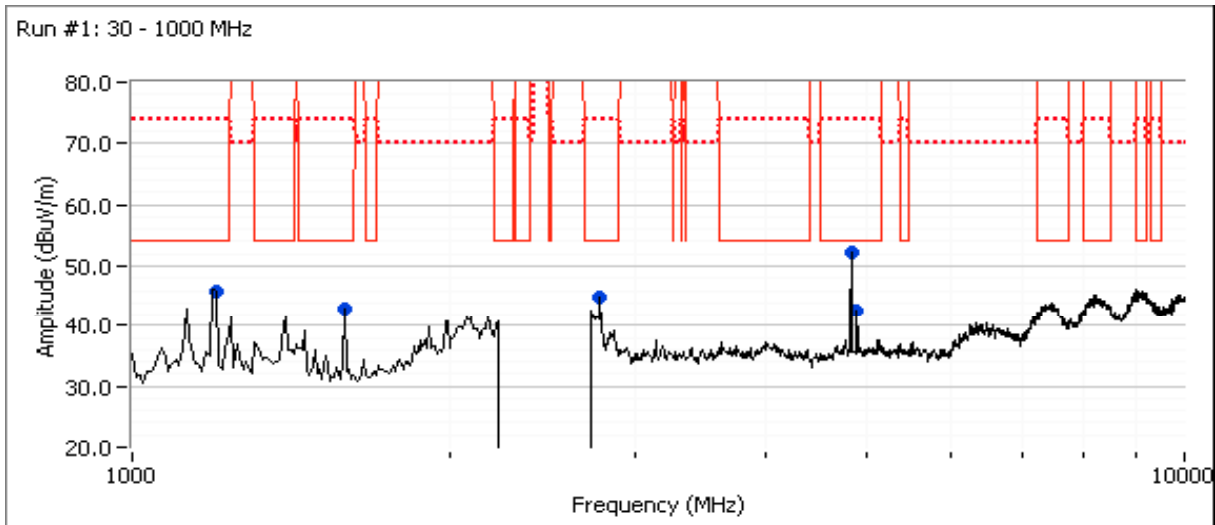

Preliminary Spurious Emissions excluding allocated band (Peak versus average limit)

Frequency	Level	Pol	15.209 / 15.247	Detector	Azimuth	Height	Comments
MHz	dB μ V/m	v/h	Limit	Margin	Pk/QP/Avg	degrees	meters
1199.580	45.7	V	54.0	-8.3	Peak	174	1.6
1596.270	42.9	V	54.0	-11.1	Peak	78	1.3
2779.340	45.0	H	54.0	-9.0	Peak	158	1.0
4824.030	52.1	V	54.0	-1.9	Peak	247	1.3
4882.360	42.6	H	54.0	-11.4	Peak	165	1.6

Client: Intel	Job Number: J91968
Model: Intel Model 3160NGW Wireless Network Adapter	T-Log Number: J92301
	Account Manager: Christine Krebill
Contact: Steve Hackett	
Standard: FCC 15 B, 15.247, RSS 210	Class: N/A

Final measurements at 3m

Frequency MHz	Level dB μ V/m	Pol v/h	15.209 / 15.247		Detector Pk/QP/Avg	Azimuth degrees	Height meters	Comments
			Limit	Margin				
4823.980	48.7	V	54.0	-5.3	AVG	247	1.3	RB 1 MHz;VB 10 Hz;Peak
4823.950	51.3	V	74.0	-22.7	PK	247	1.3	RB 1 MHz;VB 3 MHz;Peak
1200.060	34.4	V	54.0	-19.6	AVG	174	1.3	RB 1 MHz;VB 10 Hz;Peak
1199.230	56.7	V	74.0	-17.3	PK	174	1.3	RB 1 MHz;VB 3 MHz;Peak
4882.000	40.0	H	54.0	-14.0	AVG	155	1.2	RB 1 MHz;VB 10 Hz;Peak
4881.790	47.7	H	74.0	-26.3	PK	155	1.2	RB 1 MHz;VB 3 MHz;Peak
2776.460	36.1	H	54.0	-17.9	AVG	152	1.0	RB 1 MHz;VB 10 Hz;Peak
2783.270	48.2	H	74.0	-25.8	PK	152	1.0	RB 1 MHz;VB 3 MHz;Peak

Spurious Radiated Emissions, 2 - 3GHz

Preliminary Scan at ~ 30cm from the product to identify potential signals (Peak versus average limit)

Preliminary Spurious Emissions at 30cm from 2-3 GHz (Peak versus average limit)

Frequency MHz	Level dB μ V/m	Pol v/h	15.209 / 15.247		Detector Pk/QP/Avg	Azimuth degrees	Height meters	Comments
			Limit	Margin				
2385.000	45.2	V	54.0	-8.8	Peak	180	1.0	
2523.330	39.7	V	70.0	-30.3	Peak	180	1.0	
2791.670	39.5	V	54.0	-14.5	Peak	180	1.0	

Final measurements at 3m

Frequency MHz	Level dB μ V/m	Pol v/h	15.209 / 15.247		Detector Pk/QP/Avg	Azimuth degrees	Height meters	Comments
			Limit	Margin				
2382.990	47.0	H	54.0	-7.0	AVG	250	1.0	POS; RB 1 MHz; VB: 10 Hz
2382.400	57.8	H	74.0	-16.2	PK	250	1.0	POS; RB 1 MHz; VB: 3 MHz
2789.760	42.5	H	54.0	-11.5	AVG	154	1.0	POS; RB 1 MHz; VB: 10 Hz
2795.230	53.6	H	74.0	-20.4	PK	154	1.0	POS; RB 1 MHz; VB: 3 MHz
2789.720	41.9	V	54.0	-12.1	AVG	186	1.0	POS; RB 1 MHz; VB: 10 Hz
2790.440	53.3	V	74.0	-20.7	PK	186	1.0	POS; RB 1 MHz; VB: 3 MHz
2383.050	46.7	V	54.0	-7.3	AVG	288	1.1	POS; RB 1 MHz; VB: 10 Hz
2385.090	56.9	V	74.0	-17.1	PK	288	1.1	POS; RB 1 MHz; VB: 3 MHz

Client: Intel	Job Number: J91968
Model: Intel Model 3160NGW Wireless Network Adapter	T-Log Number: J92301
	Account Manager: Christine Krebill
Contact: Steve Hackett	
Standard: FCC 15 B, 15.247, RSS 210	Class: N/A

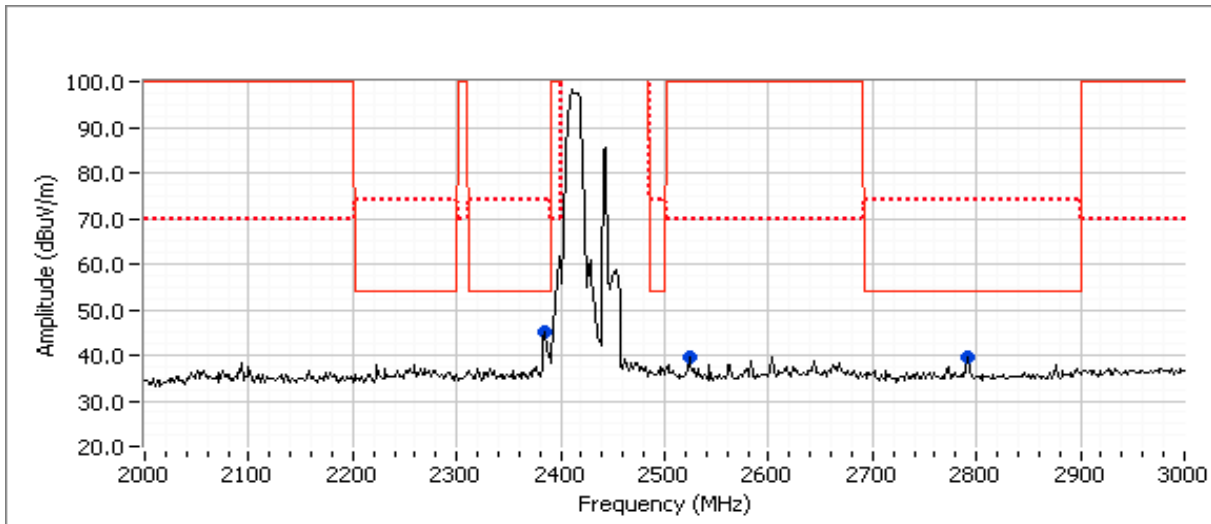

Client: Intel	Job Number: J91968
Model: Intel Model 3160NGW Wireless Network Adapter	T-Log Number: J92301
	Account Manager: Christine Krebill
Contact: Steve Hackett	
Standard: FCC 15 B, 15.247, RSS 210	Class: N/A

Run #11: Radiated Spurious Emissions, 1-15 GHz. Operating Mode: 802.11n20 @ 5200 MHz, BT Basic @ 2402 MHz
 Date of Test: 6/1/2013
 Test Engineer: Jack Liu
 Test Location: FT Chamber #4

	Target (dBm)	Power Settings Measured (dBm)	Software Setting
Chain A	16.5	16.6	29.5
Chain B	8.0	-	8dBm

Spurious Radiated Emissions, 7 - 15GHz

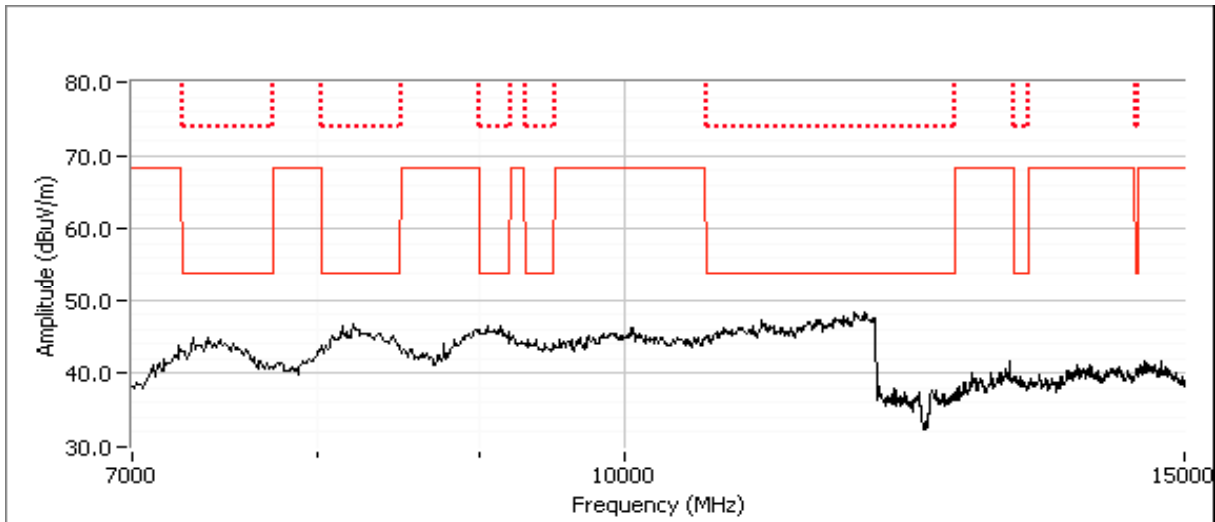

Preliminary Spurious Emissions excluding allocated band (Peak versus average limit)

Frequency	Level	Pol	15.209 / 15.247	Detector	Azimuth	Height	Comments
MHz	dB μ V/m	v/h	Limit	Margin	Pk/QP/Avg	degrees	meters
-	-	-	-	-	-	-	-

Final measurements at 3m

Frequency	Level	Pol	15.209 / 15.247	Detector	Azimuth	Height	Comments
MHz	dB μ V/m	v/h	Limit	Margin	Pk/QP/Avg	degrees	meters
-	-	-	-	-	-	-	-

Client: Intel	Job Number: J91968
Model: Intel Model 3160NGW Wireless Network Adapter	T-Log Number: J92301
	Account Manager: Christine Krebill
Contact: Steve Hackett	
Standard: FCC 15 B, 15.247, RSS 210	Class: N/A

Spurious Radiated Emissions, 1 - 7GHz

Preliminary Scan at ~ 30cm from the product to identify potential signals (Peak versus average limit)

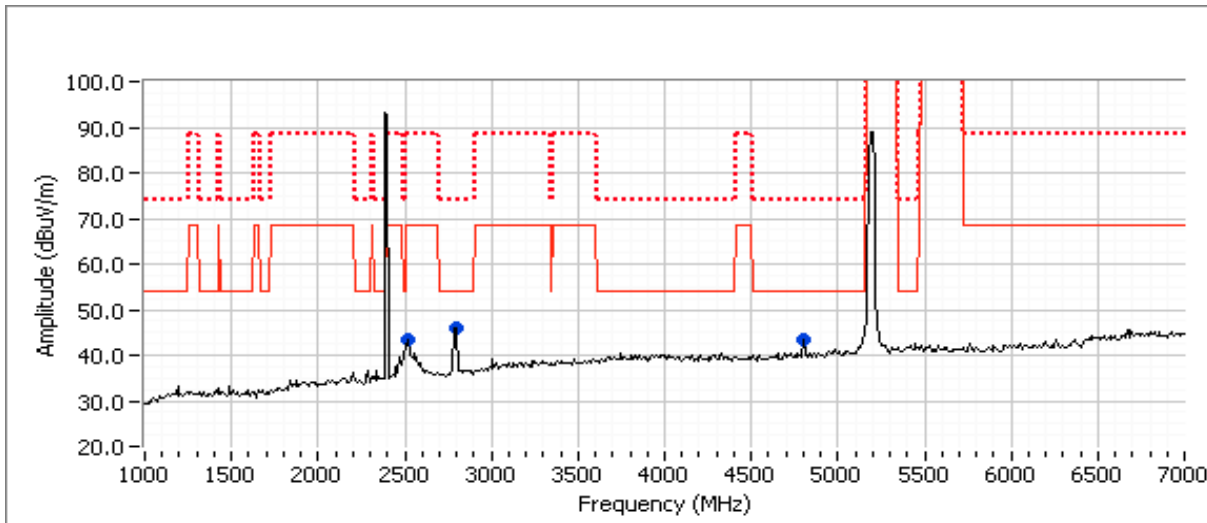

Preliminary Spurious Emissions at 30cm from 1-7 GHz (Peak versus average limit)

Frequency	Level	Pol	15.209 / 15.247		Detector	Azimuth	Height	Comments
MHz	dB μ V/m	v/h	Limit	Margin	Pk/QP/Avg	degrees	meters	
2520.000	43.2	V	68.3	-25.1	Peak	228	1.0	
2800.000	45.8	V	54.0	-8.2	Peak	240	1.0	
4800.000	43.4	V	54.0	-10.6	Peak	260	1.0	

Final measurements at 3m

Frequency	Level	Pol	15.209 / 15.247		Detector	Azimuth	Height	Comments
MHz	dB μ V/m	v/h	Limit	Margin	Pk/QP/Avg	degrees	meters	
2790.870	50.5	H	54.0	-3.5	AVG	158	1.0	POS; RB 1 MHz; VB: 10 Hz
2793.700	62.3	H	74.0	-11.7	PK	158	1.0	POS; RB 1 MHz; VB: 3 MHz
2790.990	46.6	V	54.0	-7.4	AVG	183	1.0	POS; RB 1 MHz; VB: 10 Hz
2792.290	57.6	V	74.0	-16.4	PK	183	1.0	POS; RB 1 MHz; VB: 3 MHz

Client: Intel	Job Number: J91968
Model: Intel Model 3160NGW Wireless Network Adapter	T-Log Number: J92301
	Account Manager: Christine Krebill
Contact: Steve Hackett	
Standard: FCC 15 B, 15.247, RSS 210	Class: N/A

Run #12: Radiated Spurious Emissions, 1-15 GHz. Operating Mode: 802.11n20 @ 5200 MHz, BT Basic @ 2441 MHz
 Date of Test: 6/3/2013
 Test Engineer: Rafael Varelas
 Test Location: FT Chamber #7

	Target (dBm)	Power Settings Measured (dBm)	Software Setting
Chain A	16.5	16.6	29.5
Chain B	8.0	-	8dBm

Spurious Radiated Emissions, 7 - 15GHz

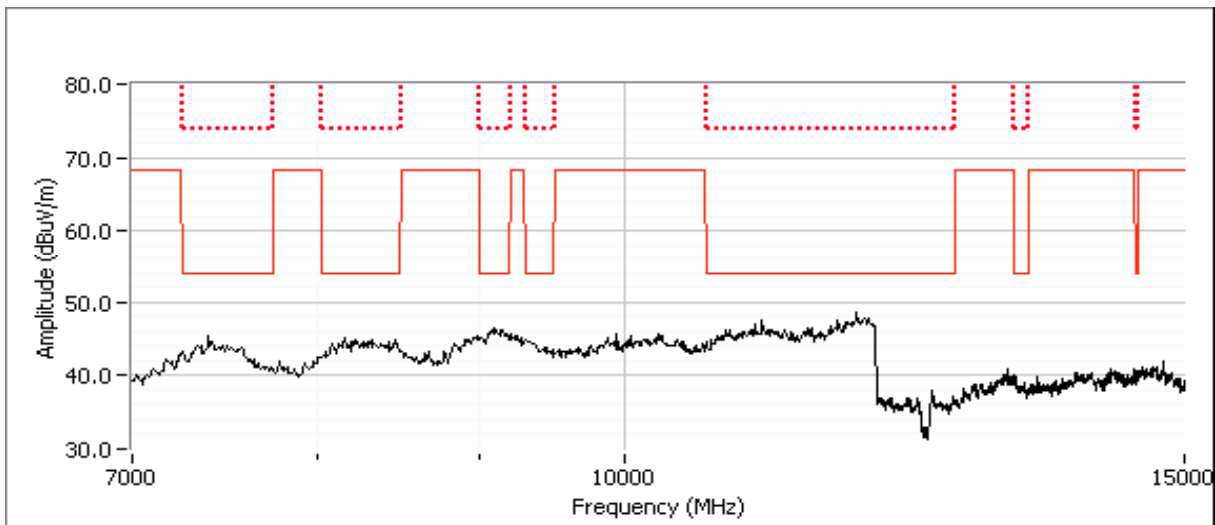

Preliminary Spurious Emissions excluding allocated band (Peak versus average limit)

Frequency	Level	Pol	15.209 / 15.247	Detector	Azimuth	Height	Comments
MHz	dBuV/m	v/h	Limit	Margin	Pk/QP/Avg	degrees	meters
-	-	-	-	-	-	-	-

Final measurements at 3m

Frequency	Level	Pol	15.209 / 15.247	Detector	Azimuth	Height	Comments
MHz	dBuV/m	v/h	Limit	Margin	Pk/QP/Avg	degrees	meters
-	-	-	-	-	-	-	-

Client: Intel	Job Number: J91968
Model: Intel Model 3160NGW Wireless Network Adapter	T-Log Number: J92301
	Account Manager: Christine Krebill
Contact: Steve Hackett	
Standard: FCC 15 B, 15.247, RSS 210	Class: N/A

Spurious Radiated Emissions, 1 - 7GHz

Preliminary Scan at ~ 30cm from the product to identify potential signals (Peak versus average limit)

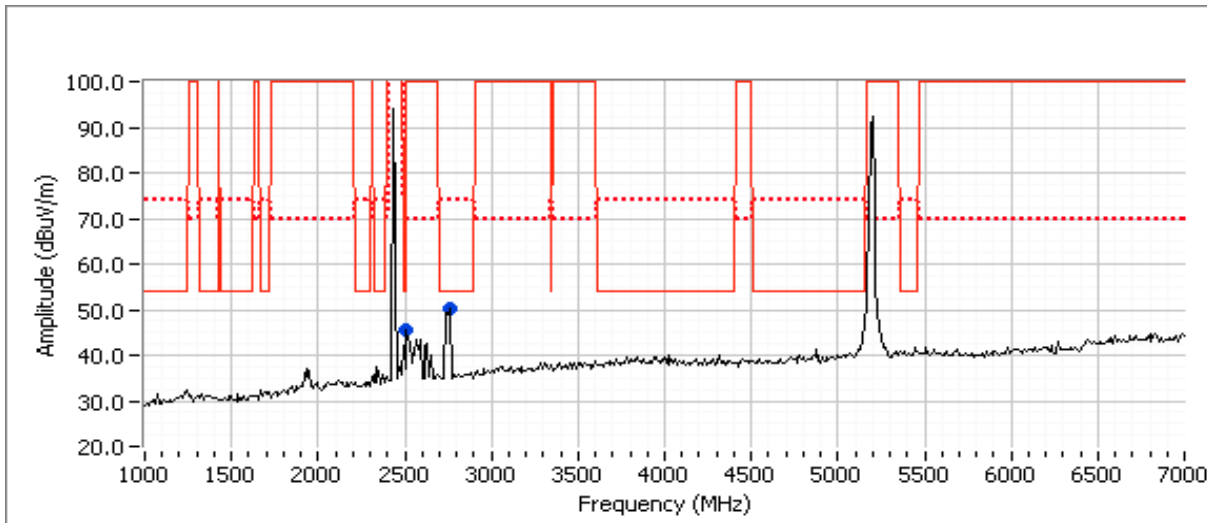

Preliminary Spurious Emissions at 30cm from 1-7 GHz (Peak versus average limit)

Frequency	Level	Pol	15.209 / 15.247		Detector	Azimuth	Height	Comments
MHz	dB μ V/m	v/h	Limit	Margin	Pk/QP/Avg	degrees	meters	
2510.000	45.7	V	70.0	-24.3	Peak	180	1.0	
2760.000	50.1	V	54.0	-3.9	Peak	180	1.0	

Final measurements at 3m

Frequency	Level	Pol	15.209 / 15.247		Detector	Azimuth	Height	Comments
MHz	dB μ V/m	v/h	Limit	Margin	Pk/QP/Avg	degrees	meters	
2751.790	49.7	H	54.0	-4.3	AVG	157	1.0	POS; RB 1 MHz; VB: 10 Hz
2752.440	60.5	H	74.0	-13.5	PK	157	1.0	POS; RB 1 MHz; VB: 3 MHz
2760.260	46.9	V	54.0	-7.1	AVG	184	1.0	POS; RB 1 MHz; VB: 10 Hz
2761.660	57.7	V	74.0	-16.3	PK	184	1.0	POS; RB 1 MHz; VB: 3 MHz

Client: Intel	Job Number: J91968
Model: Intel Model 3160NGW Wireless Network Adapter	T-Log Number: J92301
	Account Manager: Christine Krebill
Contact: Steve Hackett	
Standard: FCC 15 B, 15.247, RSS 210	Class: N/A

Run #13: Radiated Spurious Emissions, 1-15 GHz. Operating Mode: 802.11n20 @ 5200 MHz, BT Basic @ 2480 MHz
 Date of Test: 6/3/2013
 Test Engineer: Rafael Varelas
 Test Location: FT Chamber #7

	Target (dBm)	Power Settings Measured (dBm)	Software Setting
Chain A	16.5	16.6	29.5
Chain B	8.0	-	8dBm

Spurious Radiated Emissions, 7 - 15GHz

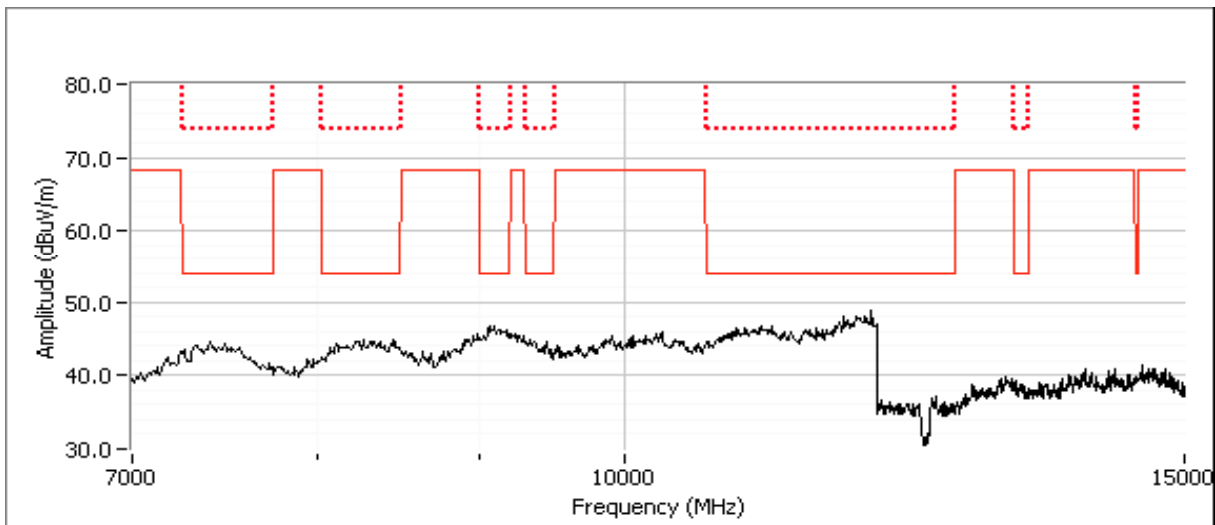

Preliminary Spurious Emissions excluding allocated band (Peak versus average limit)

Frequency	Level	Pol	15.209 / 15.247	Detector	Azimuth	Height	Comments
MHz	dB μ V/m	v/h	Limit	Margin	Pk/QP/Avg	degrees	meters
-	-	-	-	-	-	-	-

Final measurements at 3m

Frequency	Level	Pol	15.209 / 15.247	Detector	Azimuth	Height	Comments
MHz	dB μ V/m	v/h	Limit	Margin	Pk/QP/Avg	degrees	meters
-	-	-	-	-	-	-	-

Client: Intel	Job Number: J91968
Model: Intel Model 3160NGW Wireless Network Adapter	T-Log Number: J92301
	Account Manager: Christine Krebill
Contact: Steve Hackett	
Standard: FCC 15 B, 15.247, RSS 210	Class: N/A

Spurious Radiated Emissions, 1 - 7GHz

Preliminary Scan at ~ 30cm from the product to identify potential signals (Peak versus average limit)

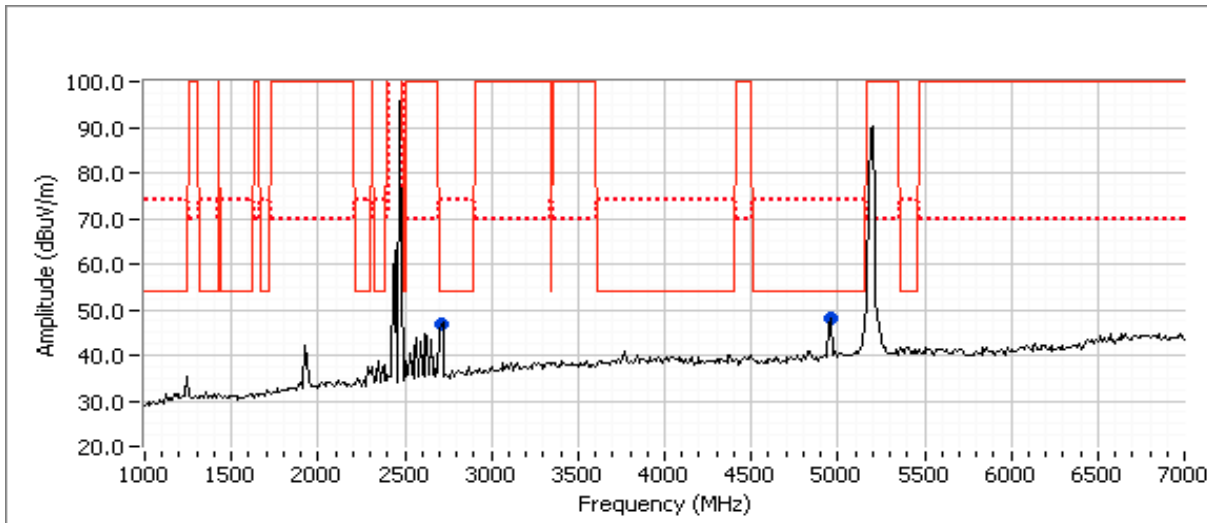

Preliminary Spurious Emissions at 30cm from 1-7 GHz (Peak versus average limit)

Frequency	Level	Pol	15.209 / 15.247		Detector	Azimuth	Height	Comments
MHz	dB μ V/m	v/h	Limit	Margin	Pk/QP/Avg	degrees	meters	
2710.000	46.9	V	54.0	-7.1	Peak	180	1.0	13
4960.000	48.1	V	54.0	-5.9	Peak	180	1.0	13

Final measurements at 3m

Frequency	Level	Pol	15.209 / 15.247		Detector	Azimuth	Height	Comments
MHz	dB μ V/m	v/h	Limit	Margin	Pk/QP/Avg	degrees	meters	
4960.050	50.7	V	54.0	-3.3	AVG	161	1.5	POS; RB 1 MHz; VB: 10 Hz
4959.830	59.6	V	74.0	-14.4	PK	161	1.5	POS; RB 1 MHz; VB: 3 MHz
4960.030	50.4	H	54.0	-3.6	AVG	117	1.1	POS; RB 1 MHz; VB: 10 Hz
4959.530	59.7	H	74.0	-14.3	PK	117	1.1	POS; RB 1 MHz; VB: 3 MHz
2712.980	48.2	H	54.0	-5.8	AVG	156	1.0	POS; RB 1 MHz; VB: 10 Hz
2715.300	58.6	H	74.0	-15.4	PK	156	1.0	POS; RB 1 MHz; VB: 3 MHz
2715.990	44.9	V	54.0	-9.1	AVG	186	1.0	POS; RB 1 MHz; VB: 10 Hz
2720.280	56.9	V	74.0	-17.1	PK	186	1.0	POS; RB 1 MHz; VB: 3 MHz

Client: Intel	Job Number: J91968
Model: Intel Model 3160NGW Wireless Network Adapter	T-Log Number: J92301
	Account Manager: Christine Krebill
Contact: Steve Hackett	
Standard: FCC 15 B, 15.247, RSS 210	Class: N/A

Run #14: Radiated Spurious Emissions, 1-15 GHz. Operating Mode: 802.11n20 @ 5300 MHz, BT Basic @ 2440 MHz
 Date of Test: 6/1/2013
 Test Engineer: Jack Liu
 Test Location: FT Chamber #4

	Target (dBm)	Power Settings Measured (dBm)	Software Setting
Chain A	16.5	16.5	28.5
Chain B	8.0	-	8dBm

Spurious Radiated Emissions, 7 - 15GHz

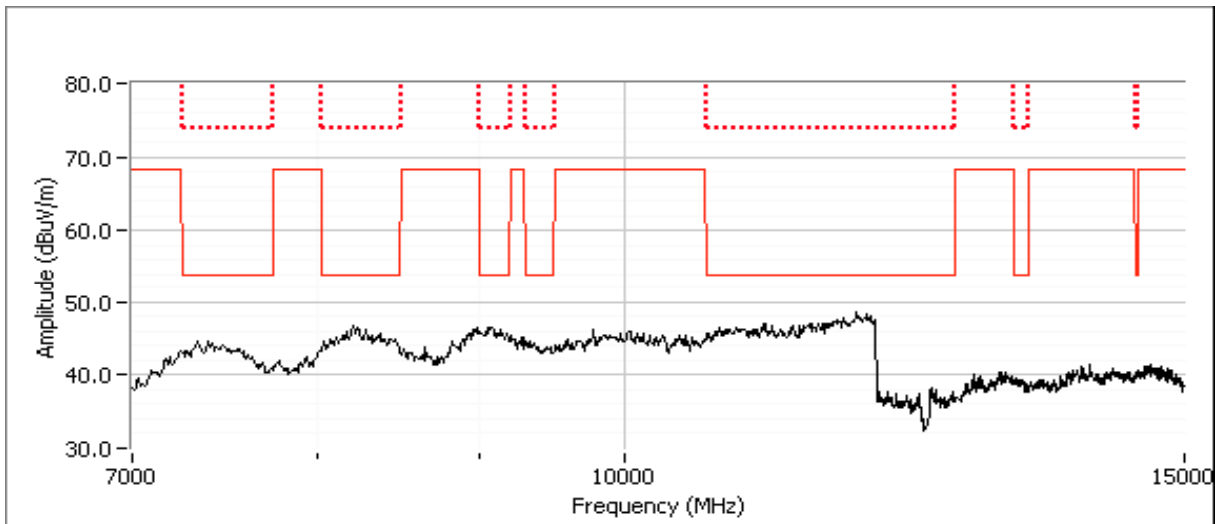

Preliminary Spurious Emissions excluding allocated band (Peak versus average limit)

Frequency	Level	Pol	15.209 / 15.247	Detector	Azimuth	Height	Comments
MHz	dBuV/m	v/h	Limit	Margin	Pk/QP/Avg	degrees	meters
-	-	-	-	-	-	-	-

Final measurements at 3m

Frequency	Level	Pol	15.209 / 15.247	Detector	Azimuth	Height	Comments
MHz	dBuV/m	v/h	Limit	Margin	Pk/QP/Avg	degrees	meters
-	-	-	-	-	-	-	-

Client: Intel	Job Number: J91968
Model: Intel Model 3160NGW Wireless Network Adapter	T-Log Number: J92301
	Account Manager: Christine Krebill
Contact: Steve Hackett	
Standard: FCC 15 B, 15.247, RSS 210	Class: N/A

Spurious Radiated Emissions, 1 - 7GHz

Preliminary Scan at ~ 30cm from the product to identify potential signals (Peak versus average limit)

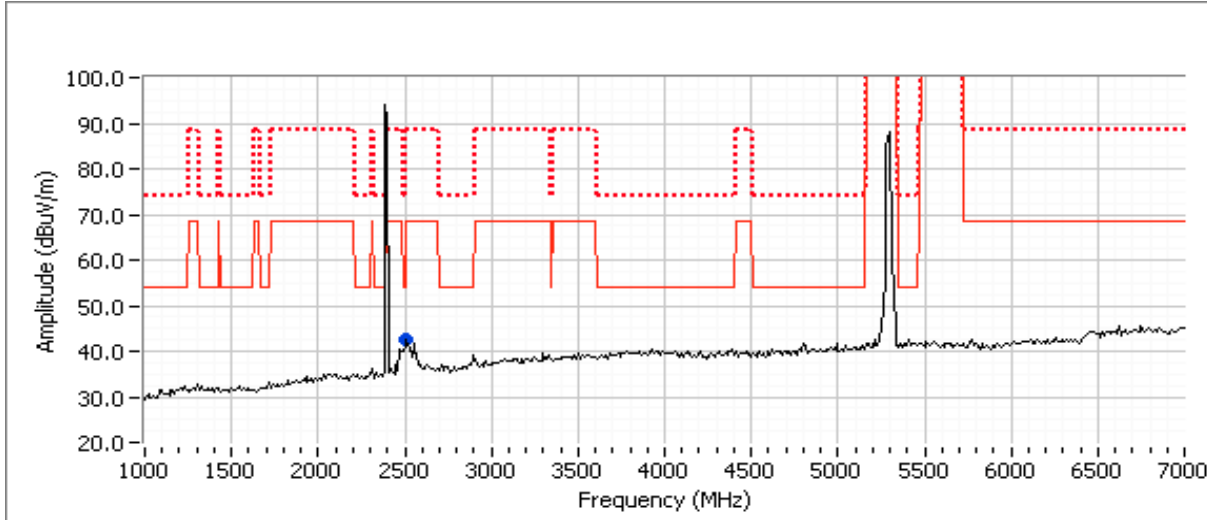

Preliminary Spurious Emissions at 30cm from 1-7 GHz (Peak versus average limit)

Frequency	Level	Pol	15.209 / 15.247	Detector	Azimuth	Height	Comments
MHz	dB μ V/m	v/h	Limit	Margin	Pk/QP/Avg	degrees	meters
2510.000	42.7	V	68.3	-25.6	Peak	227	1.0

Final measurements at 3m

Frequency	Level	Pol	15.209 / 15.247	Detector	Azimuth	Height	Comments
MHz	dB μ V/m	v/h	Limit	Margin	Pk/QP/Avg	degrees	meters
2512.860	53.8	V	68.3	-14.5	PK	278	1.0

Client: Intel	Job Number: J91968
Model: Intel Model 3160NGW Wireless Network Adapter	T-Log Number: J92301
	Account Manager: Christine Krebill
Contact: Steve Hackett	
Standard: FCC 15 B, 15.247, RSS 210	Class: N/A

Run #15: Radiated Spurious Emissions, 1-15 GHz. Operating Mode: 802.11n20 @ 5580 MHz, BT Basic @ 2440 MHz
 Date of Test: 6/1/2013
 Test Engineer: Jack Liu
 Test Location: FT Chamber #4

	Target (dBm)	Power Settings Measured (dBm)	Software Setting
Chain A	16.5	16.5	33.0
Chain B	8.0	-	8dBm

Spurious Radiated Emissions, 7 - 15GHz

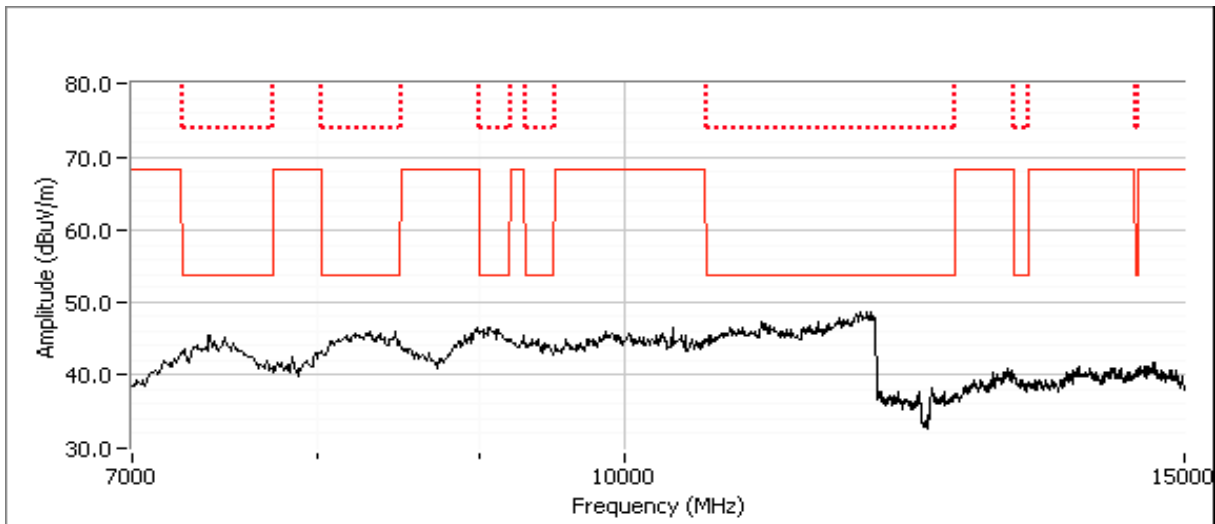

Preliminary Spurious Emissions excluding allocated band (Peak versus average limit)

Frequency	Level	Pol	15.209 / 15.247	Detector	Azimuth	Height	Comments
MHz	dBuV/m	v/h	Limit	Margin	Pk/QP/Avg	degrees	meters
-	-	-	-	-	-	-	-

Final measurements at 3m

Frequency	Level	Pol	15.209 / 15.247	Detector	Azimuth	Height	Comments
MHz	dBuV/m	v/h	Limit	Margin	Pk/QP/Avg	degrees	meters
-	-	-	-	-	-	-	-

Client: Intel	Job Number: J91968
Model: Intel Model 3160NGW Wireless Network Adapter	T-Log Number: J92301
	Account Manager: Christine Krebill
Contact: Steve Hackett	
Standard: FCC 15 B, 15.247, RSS 210	Class: N/A

Spurious Radiated Emissions, 1 - 7GHz

Preliminary Scan at ~ 30cm from the product to identify potential signals (Peak versus average limit)

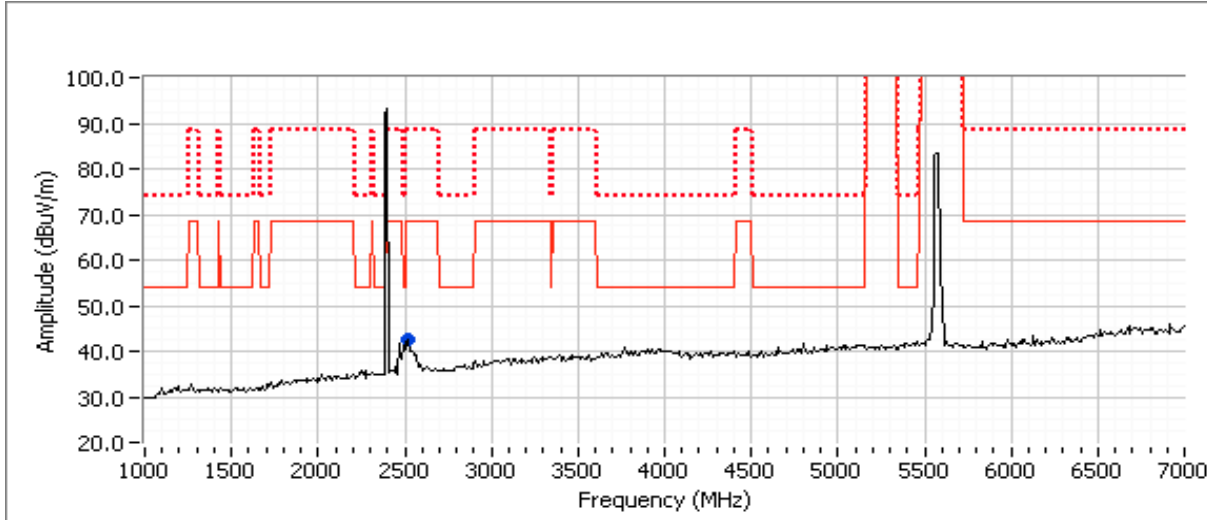

Preliminary Spurious Emissions at 30cm from 1-7 GHz (Peak versus average limit)

Frequency	Level	Pol	15.209 / 15.247	Detector	Azimuth	Height	Comments
MHz	dB μ V/m	v/h	Limit	Margin	Pk/QP/Avg	degrees	meters
2520.000	42.5	V	68.3	-25.8	Peak	230	1.3

Final measurements at 3m

Frequency	Level	Pol	15.209 / 15.247	Detector	Azimuth	Height	Comments	
MHz	dB μ V/m	v/h	Limit	Margin	Pk/QP/Avg	degrees	meters	
2522.010	54.9	V	68.3	-13.4	PK	91	1.0	POS; RB 1 MHz; VB: 3 MHz

Client: Intel	Job Number: J91968
Model: Intel Model 3160NGW Wireless Network Adapter	T-Log Number: J92301
	Account Manager: Christine Krebill
Contact: Steve Hackett	
Standard: FCC 15 B, 15.247, RSS 210	Class: N/A

Run #16: Radiated Spurious Emissions, 1-15 GHz. Operating Mode: 802.11n20 @ 5785 MHz, BT Basic @ 2441 MHz
 Date of Test: 6/1/2013
 Test Engineer: Jack Liu
 Test Location: FT Chamber #4

	Target (dBm)	Power Settings Measured (dBm)	Software Setting
Chain A	16.5	16.5	34.5
Chain B	8.0	-	8dBm

Spurious Radiated Emissions, 7 - 15GHz

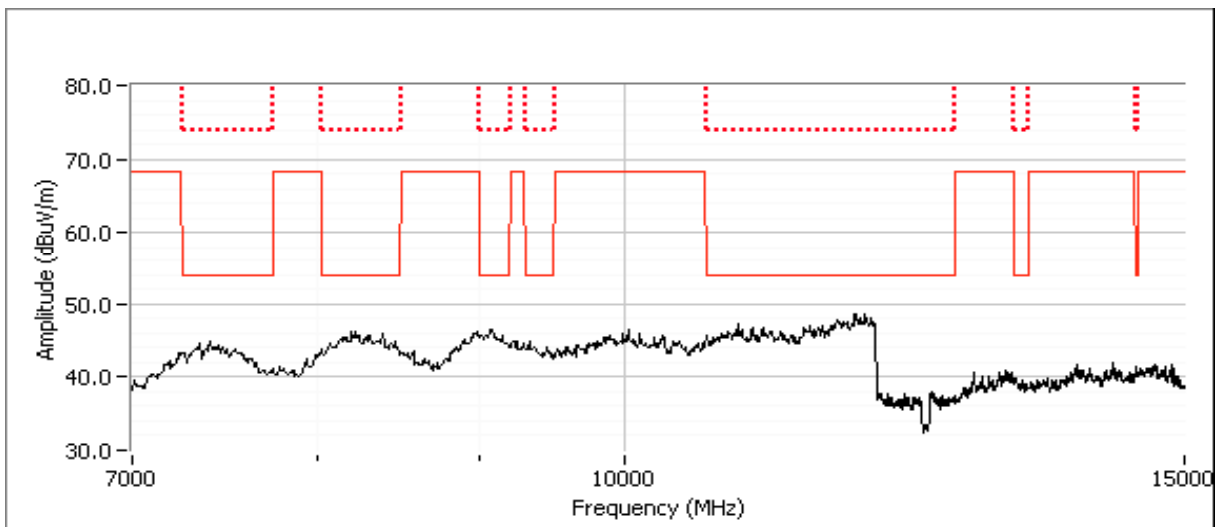

Preliminary Spurious Emissions excluding allocated band (Peak versus average limit)

Frequency	Level	Pol	15.209 / 15.247	Detector	Azimuth	Height	Comments
MHz	dBuV/m	v/h	Limit	Margin	Pk/QP/Avg	degrees	meters
-	-	-	-	-	-	-	-

Final measurements at 3m

Frequency	Level	Pol	15.209 / 15.247	Detector	Azimuth	Height	Comments
MHz	dBuV/m	v/h	Limit	Margin	Pk/QP/Avg	degrees	meters
-	-	-	-	-	-	-	-

Client: Intel	Job Number: J91968
Model: Intel Model 3160NGW Wireless Network Adapter	T-Log Number: J92301
	Account Manager: Christine Krebill
Contact: Steve Hackett	
Standard: FCC 15 B, 15.247, RSS 210	Class: N/A

Spurious Radiated Emissions, 1 - 7GHz

Preliminary Scan at ~ 30cm from the product to identify potential signals (Peak versus average limit)

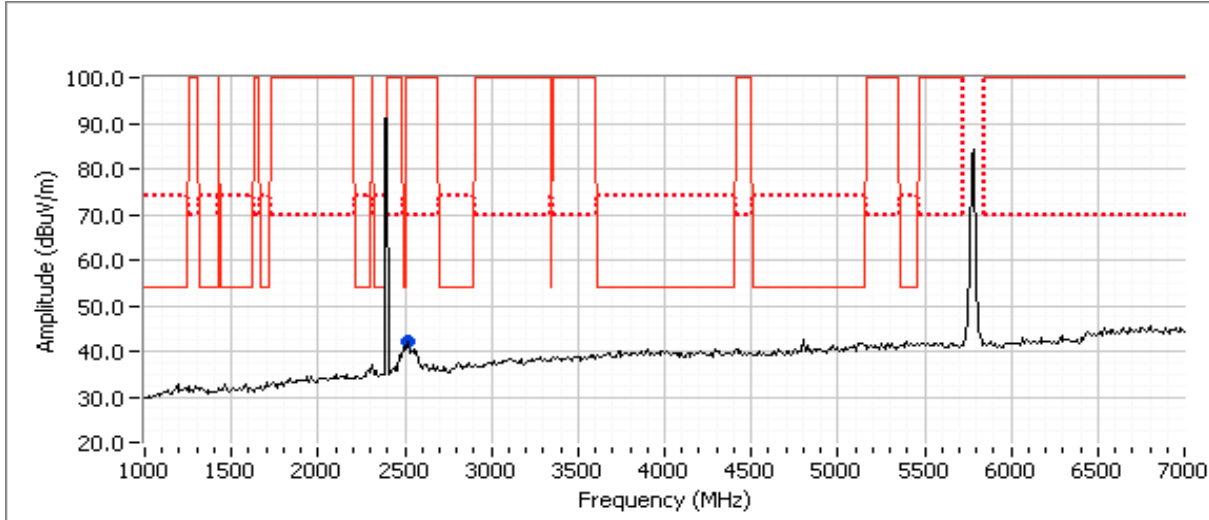

Preliminary Spurious Emissions at 30cm from 1-7 GHz (Peak versus average limit)

Frequency	Level	Pol	15.209 / 15.247	Detector	Azimuth	Height	Comments
MHz	dB μ V/m	v/h	Limit	Margin	Pk/QP/Avg	degrees	meters
2520.000	42.0	V	70.0	-28.0	Peak	224	1.0

Final measurements at 3m

Frequency	Level	Pol	15.209 / 15.247	Detector	Azimuth	Height	Comments	
MHz	dB μ V/m	v/h	Limit	Margin	Pk/QP/Avg	degrees	meters	
2522.030	45.2	V	54.0	-8.8	AVG	93	1.0	Note 1
2521.830	55.4	V	74.0	-18.6	PK	93	1.0	Note 1

Note 1: Emission is not in the restricted band, restricted band limit was used

Client: Intel	Job Number: J91968
Model: Intel Model 3160NGW Wireless Network Adapter	T-Log Number: J92301
	Account Manager: Christine Krebill
Contact: Steve Hackett	
Standard: FCC 15 B, 15.247, RSS 210	Class: N/A

Run #17: Radiated Spurious Emissions, 1-15 GHz. Operating Mode: 802.11n20 @ 5300 MHz, BT Basic @ 2480 MHz
 Date of Test: 6/3/2013
 Test Engineer: Rafael Varelas
 Test Location: FT Chamber #7

	Target (dBm)	Power Settings Measured (dBm)	Software Setting
Chain A	16.5	16.5	28.5
Chain B	8.0	-	8dBm

Spurious Radiated Emissions, 7 - 15GHz

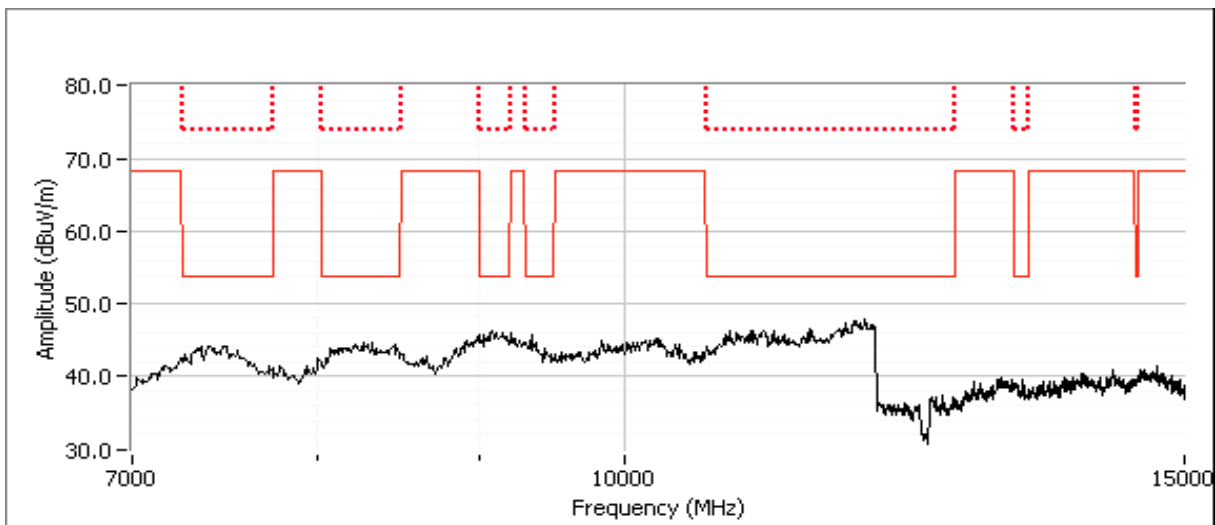

Preliminary Spurious Emissions excluding allocated band (Peak versus average limit)

Frequency	Level	Pol	15.209 / 15.247	Detector	Azimuth	Height	Comments
MHz	dBuV/m	v/h	Limit	Margin	Pk/QP/Avg	degrees	meters
-	-	-	-	-	-	-	-

Final measurements at 3m

Frequency	Level	Pol	15.209 / 15.247	Detector	Azimuth	Height	Comments
MHz	dBuV/m	v/h	Limit	Margin	Pk/QP/Avg	degrees	meters
-	-	-	-	-	-	-	-

Client: Intel	Job Number: J91968
Model: Intel Model 3160NGW Wireless Network Adapter	T-Log Number: J92301
	Account Manager: Christine Krebill
Contact: Steve Hackett	
Standard: FCC 15 B, 15.247, RSS 210	Class: N/A

Spurious Radiated Emissions, 1 - 7GHz

Preliminary Scan at ~ 30cm from the product to identify potential signals (Peak versus average limit)

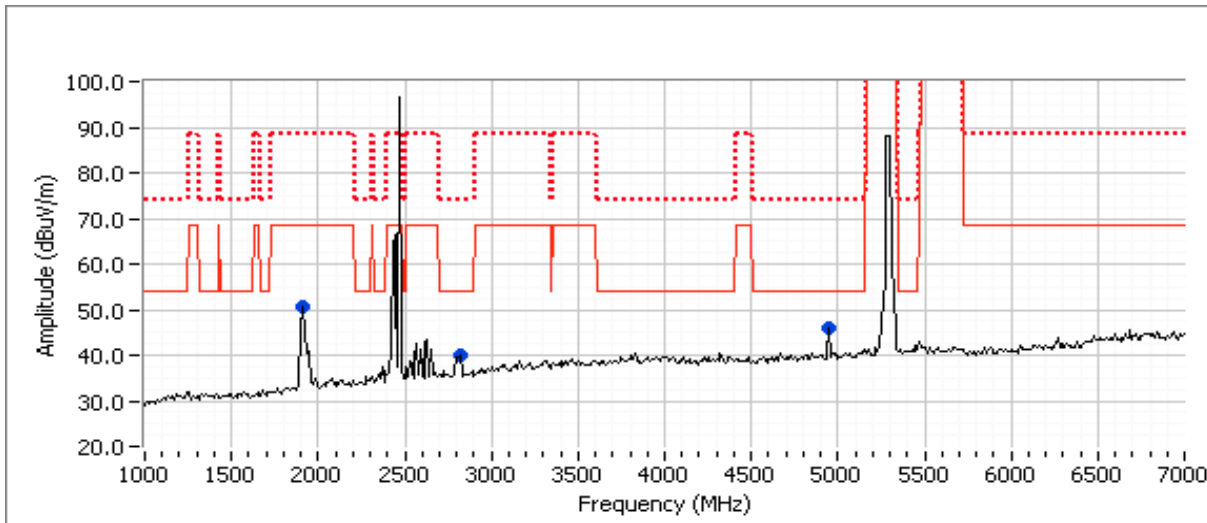

Preliminary Spurious Emissions at 30cm from 1-7 GHz (Peak versus average limit)

Frequency	Level	Pol	15.209 / 15.247		Detector	Azimuth	Height	Comments
MHz	dB μ V/m	v/h	Limit	Margin	Pk/QP/Avg	degrees	meters	
1910.000	50.5	V	68.3	-17.8	Peak	180	1.0	
2820.000	40.1	V	54.0	-13.9	Peak	180	1.0	
4950.000	46.1	V	54.0	-7.9	Peak	180	1.0	

Final measurements at 3m

Frequency	Level	Pol	15.209 / 15.247		Detector	Azimuth	Height	Comments
MHz	dB μ V/m	v/h	Limit	Margin	Pk/QP/Avg	degrees	meters	
4960.030	50.8	H	54.0	-3.2	AVG	119	1.0	POS; RB 1 MHz; VB: 10 Hz
4960.350	58.9	H	74.0	-15.1	PK	119	1.0	POS; RB 1 MHz; VB: 3 MHz
4960.030	50.6	V	54.0	-3.4	AVG	162	1.2	POS; RB 1 MHz; VB: 10 Hz
4959.870	60.4	V	74.0	-13.6	PK	162	1.2	POS; RB 1 MHz; VB: 3 MHz
1909.070	50.2	V	68.3	-18.1	PK	360	1.0	POS; RB 1 MHz; VB: 3 MHz
1911.370	49.5	H	68.3	-18.8	PK	174	1.0	POS; RB 1 MHz; VB: 3 MHz

Client: Intel	Job Number: J91968
Model: Intel Model 3160NGW Wireless Network Adapter	T-Log Number: J92301
	Account Manager: Christine Krebill
Contact: Steve Hackett	
Standard: FCC 15 B, 15.247, RSS 210	Class: N/A

Run #18: Radiated Spurious Emissions, 1-15 GHz. Operating Mode: 802.11n20 @ 5580 MHz, BT Basic @ 2480 MHz
 Date of Test: 6/3/2013
 Test Engineer: Rafael Varelas
 Test Location: FT Chamber #7

	Target (dBm)	Power Settings Measured (dBm)	Software Setting
Chain A	16.5	16.5	33.0
Chain B	8.0	-	8dBm

Spurious Radiated Emissions, 7 - 15GHz

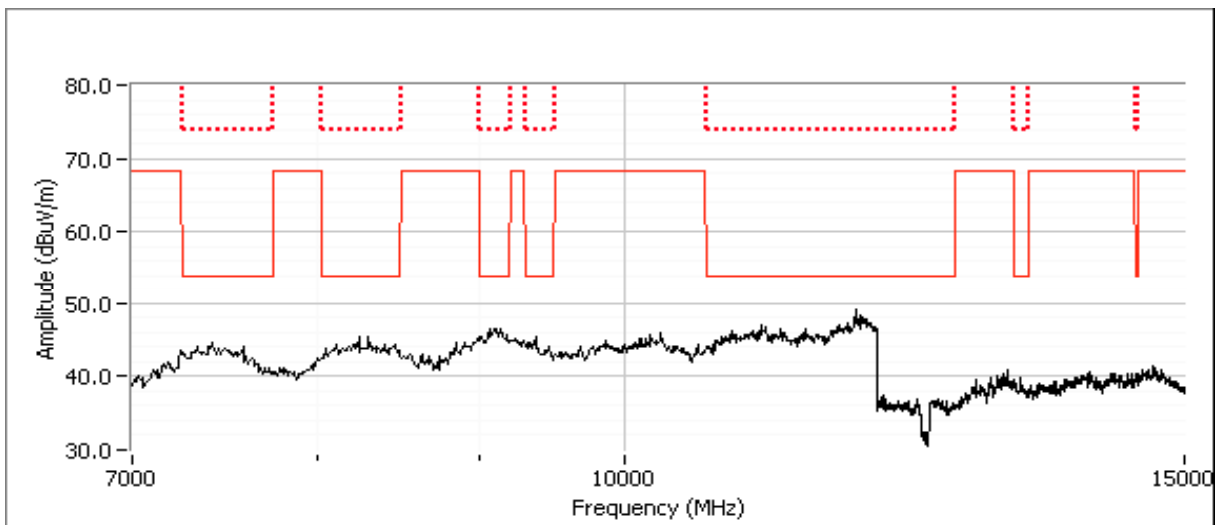

Preliminary Spurious Emissions excluding allocated band (Peak versus average limit)

Frequency	Level	Pol	15.209 / 15.247	Detector	Azimuth	Height	Comments
MHz	dB μ V/m	v/h	Limit	Margin	Pk/QP/Avg	degrees	meters
-	-	-	-	-	-	-	-

Final measurements at 3m

Frequency	Level	Pol	15.209 / 15.247	Detector	Azimuth	Height	Comments
MHz	dB μ V/m	v/h	Limit	Margin	Pk/QP/Avg	degrees	meters
-	-	-	-	-	-	-	-

Client: Intel	Job Number: J91968
Model: Intel Model 3160NGW Wireless Network Adapter	T-Log Number: J92301
	Account Manager: Christine Krebill
Contact: Steve Hackett	
Standard: FCC 15 B, 15.247, RSS 210	Class: N/A

Spurious Radiated Emissions, 1 - 7GHz

Preliminary Scan at ~ 30cm from the product to identify potential signals (Peak versus average limit)

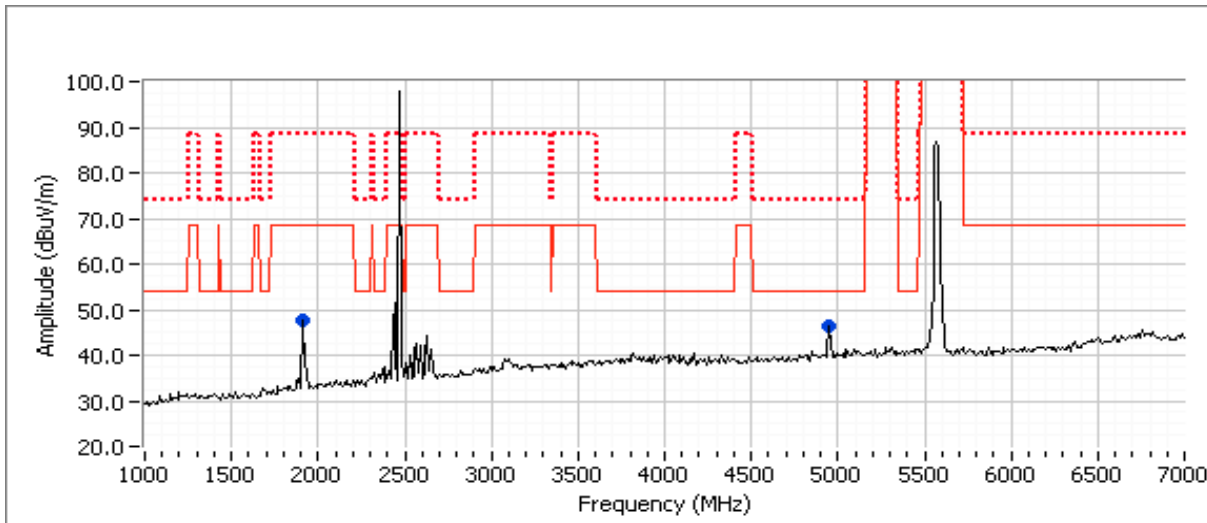

Preliminary Spurious Emissions at 30cm from 1-7 GHz (Peak versus average limit)

Frequency	Level	Pol	15.209 / 15.247		Detector	Azimuth	Height	Comments
MHz	dB μ V/m	v/h	Limit	Margin	Pk/QP/Avg	degrees	meters	
1910.000	47.6	V	68.3	-20.7	Peak	180	1.0	
4950.000	46.2	V	54.0	-7.8	Peak	180	1.0	

Final measurements at 3m

Frequency	Level	Pol	15.209 / 15.247		Detector	Azimuth	Height	Comments
MHz	dB μ V/m	v/h	Limit	Margin	Pk/QP/Avg	degrees	meters	
4960.040	50.5	H	54.0	-3.5	AVG	118	1.0	POS; RB 1 MHz; VB: 10 Hz
4960.490	59.8	H	74.0	-14.2	PK	118	1.0	POS; RB 1 MHz; VB: 3 MHz
4960.070	50.1	V	54.0	-3.9	AVG	162	1.2	POS; RB 1 MHz; VB: 10 Hz
4960.290	59.5	V	74.0	-14.5	PK	162	1.2	POS; RB 1 MHz; VB: 3 MHz
1919.800	50.0	V	68.3	-18.3	PK	22	1.0	POS; RB 1 MHz; VB: 3 MHz
1918.680	49.5	H	68.3	-18.8	PK	96	1.0	POS; RB 1 MHz; VB: 3 MHz

Client: Intel	Job Number: J91968
Model: Intel Model 3160NGW Wireless Network Adapter	T-Log Number: J92301
	Account Manager: Christine Krebill
Contact: Steve Hackett	
Standard: FCC 15 B, 15.247, RSS 210	Class: N/A

Run #19: Radiated Spurious Emissions, 1-15 GHz. Operating Mode: 802.11n20 @ 5785 MHz, BT Basic @ 2480 MHz
 Date of Test: 6/3/2013
 Test Engineer: Rafael Varelas
 Test Location: FT Chamber #7

	Target (dBm)	Power Settings Measured (dBm)	Software Setting
Chain A	16.5	16.5	34.5
Chain B	8.0	-	8dBm

Spurious Radiated Emissions, 7 - 15GHz

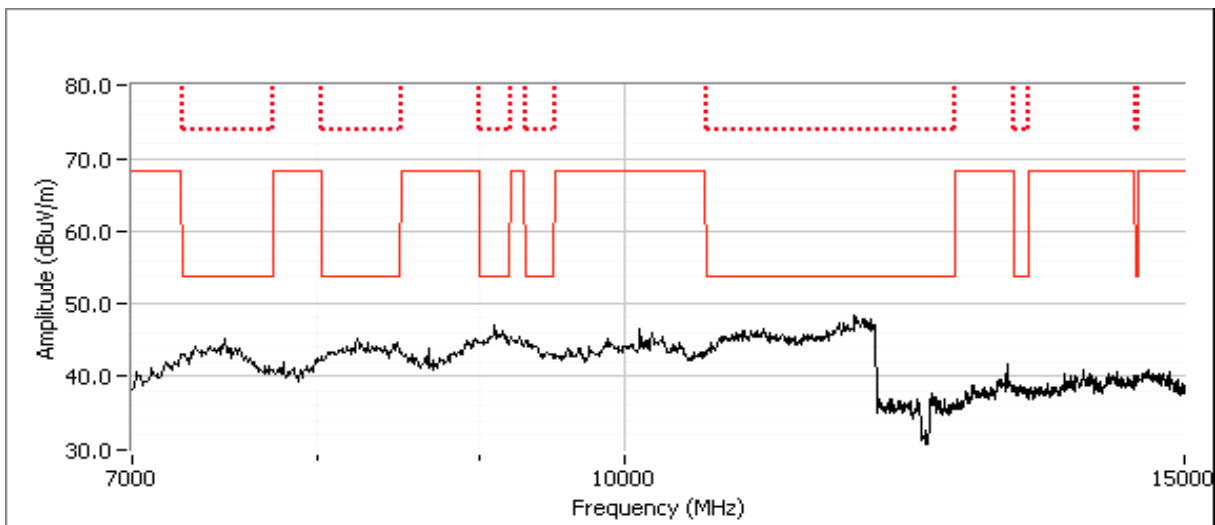

Preliminary Spurious Emissions excluding allocated band (Peak versus average limit)

Frequency	Level	Pol	15.209 / 15.247	Detector	Azimuth	Height	Comments
MHz	dB μ V/m	v/h	Limit	Margin	Pk/QP/Avg	degrees	meters
-	-	-	-	-	-	-	-

Final measurements at 3m

Frequency	Level	Pol	15.209 / 15.247	Detector	Azimuth	Height	Comments
MHz	dB μ V/m	v/h	Limit	Margin	Pk/QP/Avg	degrees	meters
-	-	-	-	-	-	-	-

Client: Intel	Job Number: J91968
Model: Intel Model 3160NGW Wireless Network Adapter	T-Log Number: J92301
	Account Manager: Christine Krebill
Contact: Steve Hackett	
Standard: FCC 15 B, 15.247, RSS 210	Class: N/A

Spurious Radiated Emissions, 1 - 7GHz

Preliminary Scan at ~ 30cm from the product to identify potential signals (Peak versus average limit)

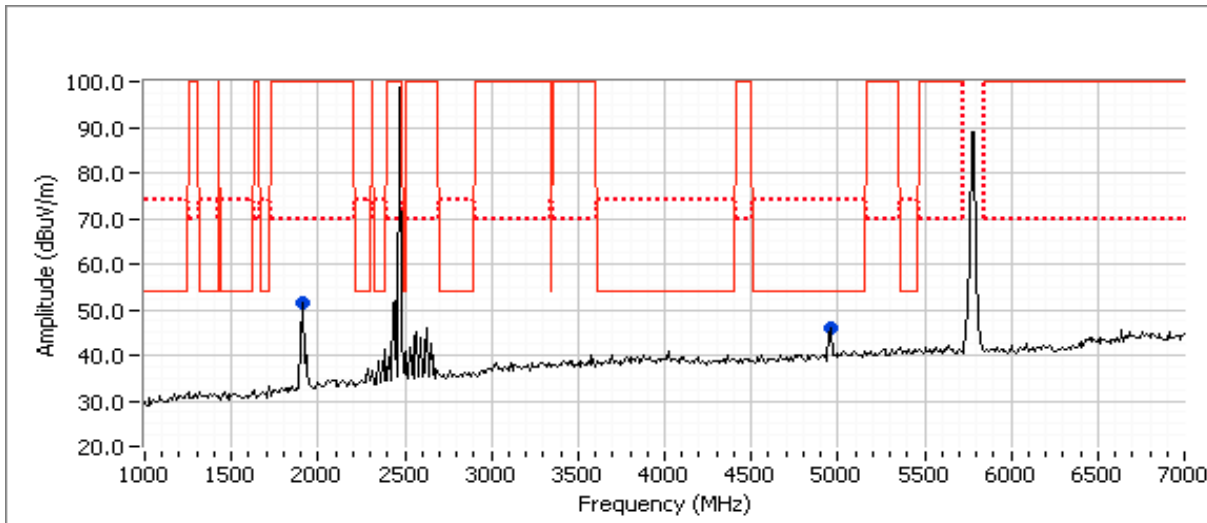

Preliminary Spurious Emissions at 30cm from 1-7 GHz (Peak versus average limit)

Frequency	Level	Pol	15.209 / 15.247		Detector	Azimuth	Height	Comments
MHz	dB μ V/m	v/h	Limit	Margin	Pk/QP/Avg	degrees	meters	
1910.000	51.3	V	70.0	-18.7	Peak	180	1.0	
4960.000	45.9	V	54.0	-8.1	Peak	180	1.0	

Final measurements at 3m

Frequency	Level	Pol	15.209 / 15.247		Detector	Azimuth	Height	Comments
MHz	dB μ V/m	v/h	Limit	Margin	Pk/QP/Avg	degrees	meters	
4960.050	50.5	V	54.0	-3.5	AVG	163	1.2	POS; RB 1 MHz; VB: 10 Hz
4960.450	59.3	V	74.0	-14.7	PK	163	1.2	POS; RB 1 MHz; VB: 3 MHz
4960.030	50.2	H	54.0	-3.8	AVG	118	1.0	POS; RB 1 MHz; VB: 10 Hz
4959.850	59.4	H	74.0	-14.6	PK	118	1.0	POS; RB 1 MHz; VB: 3 MHz
1914.740	37.8	H	54.0	-16.2	AVG	146	1.0	Note 1
1907.610	48.7	H	74.0	-25.3	PK	146	1.0	Note 1
1920.000	38.4	V	54.0	-15.6	AVG	360	1.0	Note 1
1907.370	49.1	V	74.0	-24.9	PK	360	1.0	Note 1

Note 1: Emission is not in the restricted band, restricted band limit was used



EMC Test Data

Client:	Intel	Job Number:	J91968
Model:	Intel Model 3160NGW Wireless Network Adapter	T-Log Number:	J92301
Contact:	Steve Hackett	Account Manager:	Christine Krebill
Standard:	FCC 15 B, 15.247, RSS 210	Class:	B

Radiated Emissions - Module

(Elliott Laboratories Fremont Facility, Semi-Anechoic Chamber)

Test Specific Details

Objective: The objective of this test session is to perform final qualification testing of the EUT with respect to the specification listed above.

Date of Test: 6/2/2013	Config. Used: 2
Test Engineer: Rafael Varelas	Config Change: None
Test Location: FT Chamber #4	Host Unit Voltage Host Laptop

General Test Configuration

The EUT and any local support equipment were located on the turntable for radiated emissions testing.

The test distance and extrapolation factor (if applicable) are detailed under each run description.

Note, preliminary testing indicates that the emissions were maximized by orientation of the EUT and elevation of the measurement antenna. Maximized testing indicated that the emissions were maximized by orientation of the EUT, elevation of the measurement antenna, and manipulation of the EUT's interface cables.

Ambient Conditions: Temperature: 20.8 °C
 Rel. Humidity: 35 %

Summary of Results

WiFi MAC Address: 001500BD5C54 DRTU Tool Version 1.6.1-628 Driver version 16.0.0.49

Run #	Test Performed	Limit	Result	Margin
1a - 802.11b / Bluetooth	Radiated Emissions 30 - 1000 MHz, Preliminary	15.209 / 15.247 / RSS 210	Pass	36.5 dBµV/m @ 132.74 MHz (-7.0 dB)
1b - 802.11a / Bluetooth	Radiated Emissions 30 - 1000 MHz, Preliminary	15.209 / 15.247 / 15.407 / RSS 211	Pass	35.0 dBµV/m @ 134.33 MHz (-8.5 dB)
2 - Worst Case	Radiated Emissions 30 - 1000 MHz, Maximized	15.209 / 15.247 / 15.407 / RSS 210	Pass	34.1 dBµV/m @ 225.80 MHz (-11.9 dB)

Modifications Made During Testing

No modifications were made to the EUT during testing

Deviations From The Standard

No deviations were made from the requirements of the standard.

Frequency Range	Test Distance	Limit Distance	Extrapolation Factor
30 - 1000 MHz	3	3	0.0



EMC Test Data

Client:	Intel	Job Number:	J91968
Model:	Intel Model 3160NGW Wireless Network Adapter	T-Log Number:	J92301
Contact:	Steve Hackett	Account Manager:	Christine Krebill
Standard:	FCC 15 B, 15.247, RSS 210	Class:	B

Run #1a: Preliminary Radiated Emissions, 30 - 1000 MHz
 EUT at 2437 MHz (Wi-Fi) at 16.5 dBm and 2440 MHz (Bluetooth) at maximum level

Preliminary peak readings captured during pre-scan

Frequency	Level	Pol	FCC 15.209 / RSS 210		Detector	Azimuth	Height	Comments
MHz	dB μ V/m	v/h	Limit	Margin	Pk/QP/Avg	degrees	meters	
132.742	36.5	H	43.5	-7.0	Peak	229	2.0	
56.453	29.3	V	40.0	-10.7	Peak	215	2.5	
225.795	33.7	H	46.0	-12.3	Peak	233	1.5	
297.351	36.2	V	46.0	-9.8	Peak	185	1.5	
324.003	33.1	H	46.0	-12.9	Peak	192	1.0	
800.042	33.9	V	46.0	-12.1	Peak	209	1.0	
995.918	36.0	H	54.0	-18.0	Peak	230	1.0	

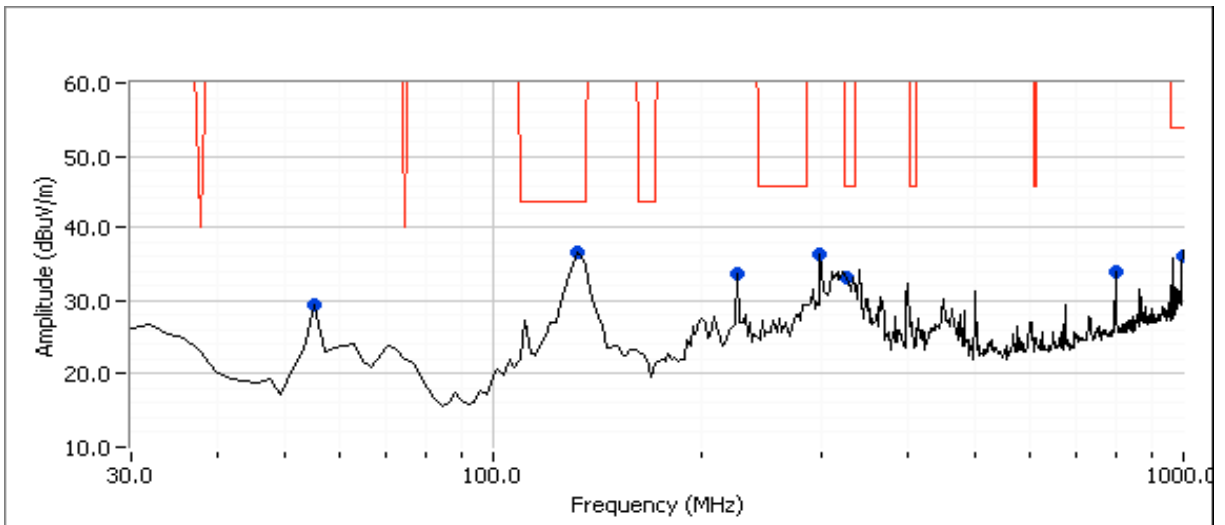

Client: Intel	Job Number: J91968
Model: Intel Model 3160NGW Wireless Network Adapter	T-Log Number: J92301
Contact: Steve Hackett	Account Manager: Christine Krebill
Standard: FCC 15 B, 15.247, RSS 210	Class: B

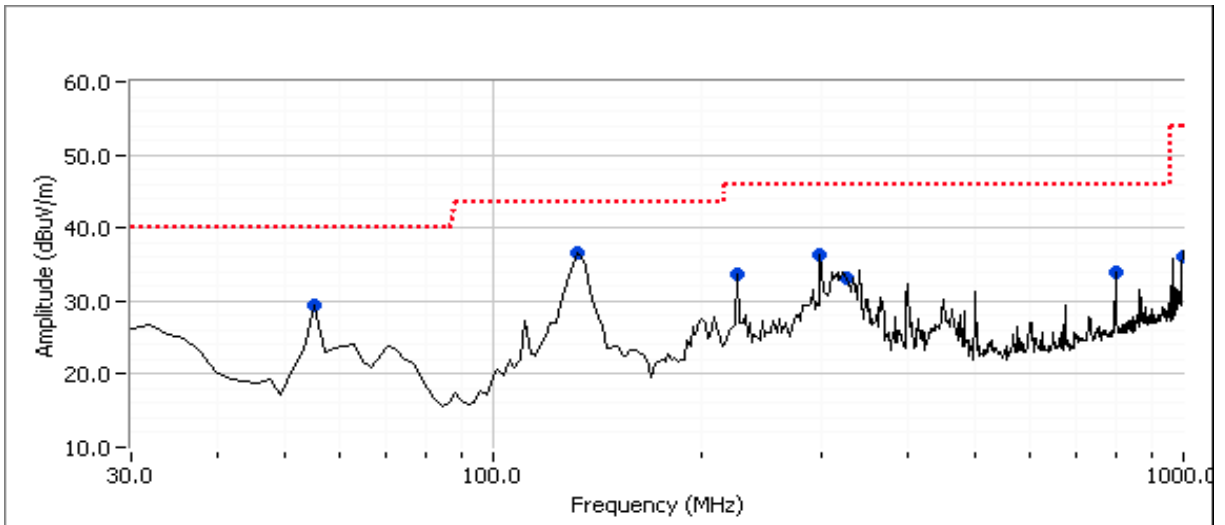



EMC Test Data

Client:	Intel	Job Number:	J91968
Model:	Intel Model 3160NGW Wireless Network Adapter	T-Log Number:	J92301
Contact:	Steve Hackett	Account Manager:	Christine Krebill
Standard:	FCC 15 B, 15.247, RSS 210	Class:	B

Run #1b: Preliminary Radiated Emissions, 30 - 1000 MHz
 EUT at 5540 MHz (Wi-Fi) at 16.5 dBm and 2440 MHz (Bluetooth) at maximum level

Preliminary peak readings captured during pre-scan

Frequency	Level	Pol	FCC 15.209 / RSS 210		Detector	Azimuth	Height	Comments
MHz	dB μ V/m	v/h	Limit	Margin	Pk/QP/Avg	degrees	meters	
134.327	35.0	H	43.5	-8.5	Peak	233	2.0	
56.453	29.6	V	40.0	-10.4	Peak	204	2.5	
225.795	34.0	H	46.0	-12.0	Peak	233	1.5	
299.028	35.7	V	46.0	-10.3	Peak	165	1.5	
328.280	36.0	H	46.0	-10.0	Peak	200	1.0	
799.945	36.8	V	46.0	-9.2	Peak	204	1.0	
985.120	37.2	H	54.0	-16.8	Peak	151	1.0	

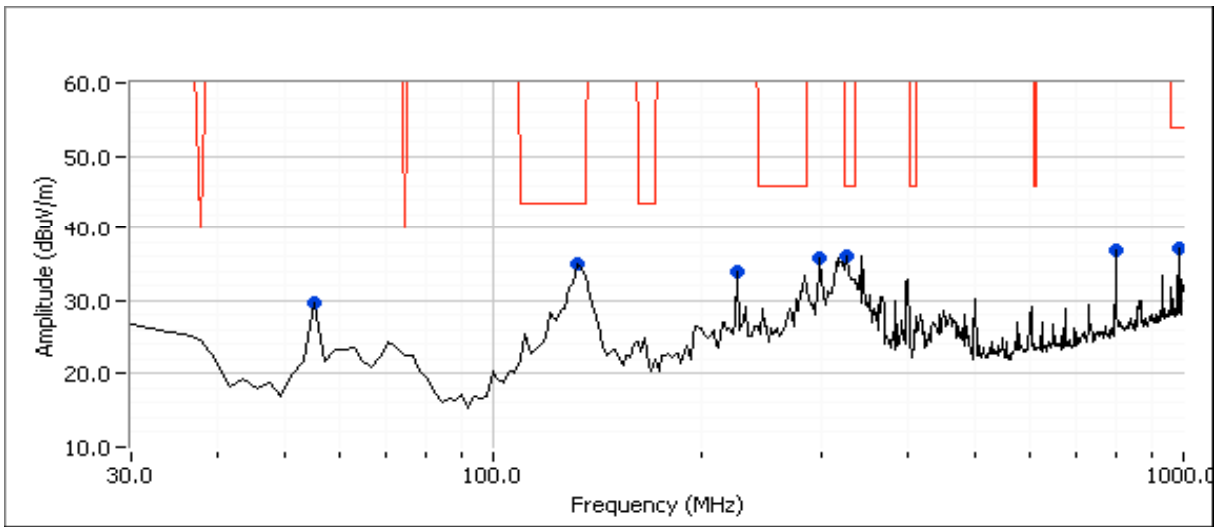

Client:	Intel	Job Number:	J91968
Model:	Intel Model 3160NGW Wireless Network Adapter	T-Log Number:	J92301
Contact:	Steve Hackett	Account Manager:	Christine Krebill
Standard:	FCC 15 B, 15.247, RSS 210	Class:	B

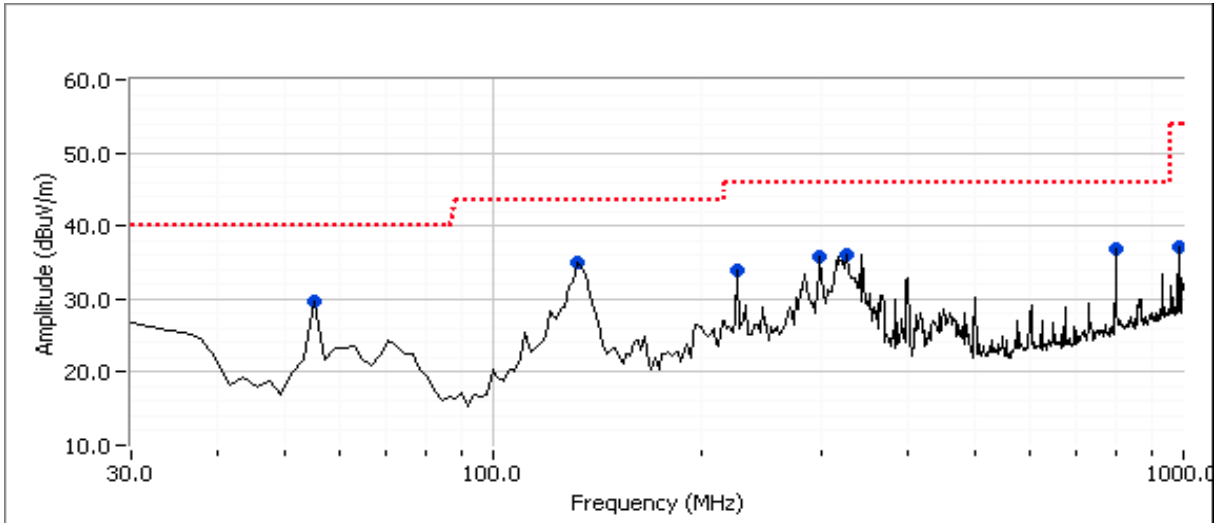

Run #2: Maximized Readings From Run #1

Maximized quasi-peak readings (includes manipulation of EUT interface cables)

Frequency MHz	Level dBµV/m	Pol v/h	FCC 15.209 / RSS 210		Detector Pk/QP/Avg	Azimuth degrees	Height meters	Comments
			Limit	Margin				
225.795	34.1	H	46.0	-11.9	QP	225	1.5	QP (1.00s)
799.945	31.7	V	46.0	-14.3	QP	205	0.9	QP (1.00s)
134.327	31.3	H	43.5	-12.2	QP	223	1.9	QP (1.00s)
56.453	27.6	V	40.0	-12.4	QP	202	1.9	QP (1.00s)
328.280	29.4	H	46.0	-16.6	QP	214	0.9	QP (1.00s)
299.028	27.7	V	46.0	-18.3	QP	180	1.0	QP (1.00s)
985.120	32.8	H	54.0	-21.2	QP	142	0.9	QP (1.00s)



EMC Test Data

Client:	Intel	Job Number:	J91968
Model:	Intel Model 3160NGW Wireless Network Adapter	T-Log Number:	J92301
Contact:	Steve Hackett	Account Manager:	Christine Krebill
Standard:	FCC 15 B, 15.247, RSS 210	Class:	B

Conducted Emissions

(Elliott Laboratories Fremont Facility, Semi-Anechoic Chamber)

Test Specific Details

Objective: The objective of this test session is to perform final qualification testing of the EUT with respect to the specification listed above.

Date of Test: 6/5/2013	Config. Used: 2
Test Engineer: Rafael Varelas	Config Change: None
Test Location: FT Chamber #4	Host Unit Voltage 120V/60Hz

General Test Configuration

The host system was located on a wooden table inside the semi-anechoic chamber, 40 cm from a vertical coupling plane and 80cm from the LISN.

Ambient Conditions:	Temperature:	21.5 °C
	Rel. Humidity:	34 %

Summary of Results

WiFi MAC Address: 001500BD5C54 DRTU Tool Version 1.6.1-628 Driver version 16.0.0.49

Run #	Test Performed	Limit	Result	Margin
1	CE, AC Power, 120V/60Hz	Class B	Pass	50.6 dBμV @ 0.208 MHz (-12.7 dB)

Modifications Made During Testing

No modifications were made to the EUT during testing

Deviations From The Standard

No deviations were made from the requirements of the standard.



EMC Test Data

Client: Intel	Job Number: J91968
Model: Intel Model 3160NGW Wireless Network Adapter	T-Log Number: J92301
	Account Manager: Christine Krebill
Contact: Steve Hackett	
Standard: FCC 15 B, 15.247, RSS 210	Class: B

Run #1: AC Power Port Conducted Emissions, 0.15 - 30MHz, 120V/60Hz

Note: The module was transmitting at 2412 MHz (Wi-Fi) at 16.5 dBm and 2441 MHz (Bluetooth) at maximum level.

Final quasi-peak and average readings

Frequency MHz	Level dB μ V	AC Line	Class B		Detector QP/Ave	Comments
			Limit	Margin		
0.208	50.6	Neutral	63.3	-12.7	QP	QP (1.00s)
0.254	46.0	Line 1	61.6	-15.6	QP	QP (1.00s)
0.208	33.8	Neutral	53.3	-19.5	AVG	AVG (0.10s)
0.254	29.5	Line 1	51.6	-22.1	AVG	AVG (0.10s)
0.360	34.4	Neutral	58.7	-24.3	QP	QP (1.00s)
0.379	31.2	Line 1	58.3	-27.1	QP	QP (1.00s)
0.619	25.5	Line 1	56.0	-30.5	QP	QP (1.00s)
0.360	17.7	Neutral	48.7	-31.0	AVG	AVG (0.10s)
0.619	14.4	Line 1	46.0	-31.6	AVG	AVG (0.10s)
0.379	16.4	Line 1	48.3	-31.9	AVG	AVG (0.10s)
0.572	22.9	Neutral	56.0	-33.1	QP	QP (1.00s)
0.572	11.9	Neutral	46.0	-34.1	AVG	AVG (0.10s)

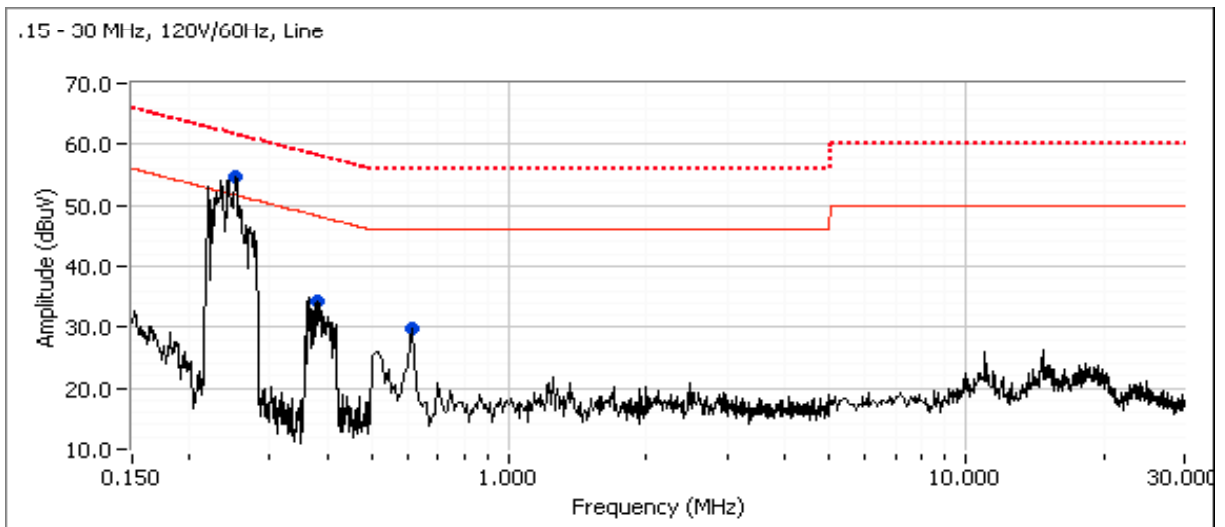

Client: Intel	Job Number: J91968
Model: Intel Model 3160NGW Wireless Network Adapter	T-Log Number: J92301
	Account Manager: Christine Krebill
Contact: Steve Hackett	
Standard: FCC 15 B, 15.247, RSS 210	Class: B

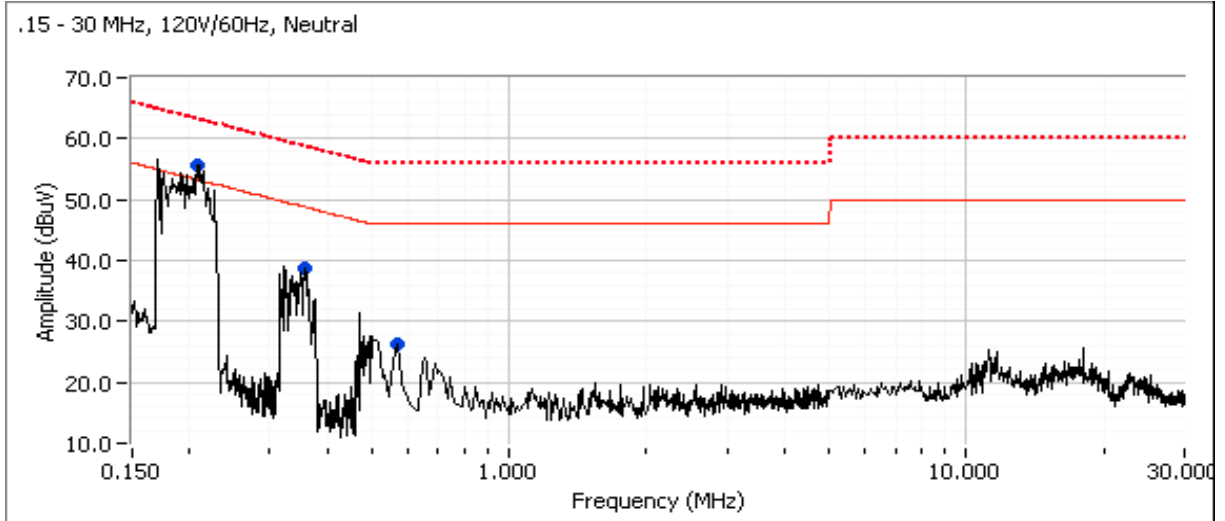

End of Report

This page is intentionally blank and marks the last page of this test report.