

*EMC Test Report  
Application for Grant of Equipment Authorization  
Industry Canada RSS-Gen Issue 3 / RSS 210 Issue 8  
FCC Part 15 Subpart C*

*Intel® Centrino® Wireless-N 2230 Models 2230BNHMW &  
2230BNHU*

IC CERTIFICATION #: 1000M-2230BNH and 1000M-2230BNHU  
FCC ID: PD92230BNH and PD92230BNHU

APPLICANT: Intel Corporation  
100 Center Point Circle Suite 200  
Columbia, SC 29210

TEST SITE(S): Elliott Laboratories  
41039 Boyce Road.  
Fremont, CA. 94538-2435

IC SITE REGISTRATION #: 2845B-3; 2845B-4, 2845B-5, 2845B-7

REPORT DATE: October 24, 2011

FINAL TEST DATES: September 21, 22, 23, 24, 27, 28, 30, October 2,  
3, 4, 10, 11, 13 and 17, 2011

TOTAL NUMBER OF PAGES: 158

PROGRAM MGR /  
TECHNICAL REVIEWER:

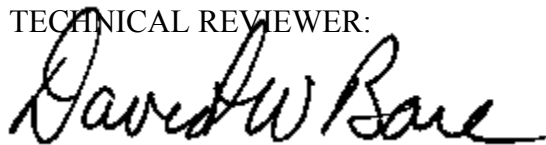

David W. Bare  
Chief Engineer

QUALITY ASSURANCE DELEGATE /  
FINAL REPORT PREPARER:

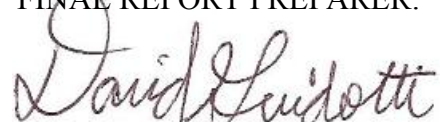

David Guidotti  
Senior Technical Writer



Testing Cert #2016.01

Elliott Laboratories is accredited by the A2LA, certificate number 2016.01, to perform the test(s) listed in this report, except where noted otherwise. This report and the information contained herein represent the results of testing test articles identified and selected by the client performed to specifications and/or procedures selected by the client. National Technical Systems (NTS) makes no representations, expressed or implied, that such testing is adequate (or inadequate) to demonstrate efficiency, performance, reliability, or any other characteristic of the articles being tested, or similar products. This report should not be relied upon as an endorsement or certification by NTS of the equipment tested, nor does it represent any statement whatsoever as to its merchantability or fitness of the test article, or similar products, for a particular purpose. This report shall not be reproduced except in full.

**REVISION HISTORY**

Rev#	Date	Comments	Modified By
-	10-24-2011	First release	

**TABLE OF CONTENTS**

<b>REVISION HISTORY .....</b>	<b>2</b>
<b>TABLE OF CONTENTS .....</b>	<b>3</b>
<b>SCOPE.....</b>	<b>4</b>
<b>OBJECTIVE .....</b>	<b>4</b>
<b>STATEMENT OF COMPLIANCE.....</b>	<b>5</b>
<b>DEVIATIONS FROM THE STANDARDS.....</b>	<b>5</b>
<b>TEST RESULTS SUMMARY .....</b>	<b>6</b>
DIGITAL TRANSMISSION SYSTEMS (2400 – 2483.5MHZ).....	6
GENERAL REQUIREMENTS APPLICABLE TO ALL BANDS.....	7
MEASUREMENT UNCERTAINTIES.....	8
<b>EQUIPMENT UNDER TEST (EUT) DETAILS.....</b>	<b>9</b>
GENERAL.....	9
ANTENNA SYSTEM .....	9
ENCLOSURE.....	9
MODIFICATIONS.....	9
SUPPORT EQUIPMENT.....	10
EUT INTERFACE PORTS .....	10
EUT OPERATION .....	10
<b>TEST SITE.....</b>	<b>11</b>
GENERAL INFORMATION.....	11
CONDUCTED EMISSIONS CONSIDERATIONS .....	11
RADIATED EMISSIONS CONSIDERATIONS .....	11
<b>MEASUREMENT INSTRUMENTATION .....</b>	<b>12</b>
RECEIVER SYSTEM .....	12
INSTRUMENT CONTROL COMPUTER .....	12
LINE IMPEDANCE STABILIZATION NETWORK (LISN).....	12
FILTERS/ATTENUATORS .....	13
ANTENNAS.....	13
ANTENNA MAST AND EQUIPMENT TURNTABLE.....	13
INSTRUMENT CALIBRATION.....	13
<b>TEST PROCEDURES .....</b>	<b>14</b>
EUT AND CABLE PLACEMENT .....	14
CONDUCTED EMISSIONS.....	14
RADIATED EMISSIONS.....	14
RADIATED EMISSIONS.....	15
CONDUCTED EMISSIONS FROM ANTENNA PORT .....	17
BANDWIDTH MEASUREMENTS .....	17
SPECIFICATION LIMITS AND SAMPLE CALCULATIONS .....	18
CONDUCTED EMISSIONS SPECIFICATION LIMITS: FCC 15.207; FCC 15.107(A), RSS GEN .....	18
GENERAL TRANSMITTER RADIATED EMISSIONS SPECIFICATION LIMITS .....	19
RECEIVER RADIATED SPURIOUS EMISSIONS SPECIFICATION LIMITS.....	19
OUTPUT POWER LIMITS – DIGITAL TRANSMISSION SYSTEMS .....	20
TRANSMIT MODE SPURIOUS RADIATED EMISSIONS LIMITS – FHSS AND DTS SYSTEMS.....	20
SAMPLE CALCULATIONS - CONDUCTED EMISSIONS .....	20
SAMPLE CALCULATIONS - RADIATED EMISSIONS.....	20
SAMPLE CALCULATIONS - FIELD STRENGTH TO EIRP CONVERSION.....	21
<b>APPENDIX A TEST EQUIPMENT CALIBRATION DATA .....</b>	<b>22</b>
<b>APPENDIX B TEST DATA .....</b>	<b>25</b>
<b>END OF REPORT .....</b>	<b>158</b>

## SCOPE

An electromagnetic emissions test has been performed on the Intel Corporation model Intel® Centrino® Wireless-N 2230 Models 2230BNHMW & 2230BNHU, pursuant to the following rules:

Industry Canada RSS-Gen Issue 3

RSS 210 Issue 8 “Low-power Licence-exempt Radiocommunication Devices (All Frequency Bands): Category I Equipment”

FCC Part 15 Subpart C

Conducted and radiated emissions data has been collected, reduced, and analyzed within this report in accordance with measurement guidelines set forth in the following reference standards and as outlined in Elliott Laboratories test procedures:

ANSI C63.4:2003

FCC DTS Measurement Procedure KDB558074, March 2005

The intentional radiator above has been tested in a simulated typical installation to demonstrate compliance with the relevant Industry Canada performance and procedural standards.

Final system data was gathered in a mode that tended to maximize emissions by varying orientation of EUT, orientation of power and I/O cabling, antenna search height, and antenna polarization.

Every practical effort was made to perform an impartial test using appropriate test equipment of known calibration. All pertinent factors have been applied to reach the determination of compliance.

## OBJECTIVE

The primary objective of the manufacturer is compliance with the regulations outlined in the previous section.

Prior to marketing in the USA, all unlicensed transmitters and transceivers require certification. Receive-only devices operating between 30 MHz and 960 MHz are subject to either certification or a manufacturer’s declaration of conformity, with all other receive-only devices exempt from the technical requirements.

Prior to marketing in Canada, Class I transmitters, receivers and transceivers require certification. Class II devices are required to meet the appropriate technical requirements but are exempt from certification requirements.

Certification is a procedure where the manufacturer submits test data and technical information to a certification body and receives a certificate or grant of equipment authorization upon successful completion of the certification body’s review of the submitted documents. Once the equipment authorization has been obtained, the label indicating compliance must be attached to all identical units, which are subsequently manufactured.

Maintenance of compliance is the responsibility of the manufacturer. Any modification of the product which may result in increased emissions should be checked to ensure compliance has been maintained (i.e., printed circuit board layout changes, different line filter, different power supply, harnessing or I/O cable changes, etc.).

### **STATEMENT OF COMPLIANCE**

The tested sample of Intel Corporation model Intel® Centrino® Wireless-N 2230 Models 2230BNHMW & 2230BNHU complied with the requirements of the following regulations:

- Industry Canada RSS-Gen Issue 3
- RSS 210 Issue 8 “Low-power Licence-exempt Radiocommunication Devices (All Frequency Bands): Category I Equipment”
- FCC Part 15 Subpart C

Maintenance of compliance is the responsibility of the manufacturer. Any modifications to the product should be assessed to determine their potential impact on the compliance status of the device with respect to the standards detailed in this test report.

The test results recorded herein are based on a single type test of Intel Corporation model Intel® Centrino® Wireless-N 2230 Models 2230BNHMW & 2230BNHU and therefore apply only to the tested sample. The sample was selected and prepared by Steve Hackett of Intel Corporation.

### **DEVIATIONS FROM THE STANDARDS**

No deviations were made from the published requirements listed in the scope of this report.

**TEST RESULTS SUMMARY****DIGITAL TRANSMISSION SYSTEMS (2400 – 2483.5MHz)**

FCC Rule Part	RSS Rule Part	Description	Measured Value / Comments	Limit / Requirement	Result
15.247(a)	RSS 210 A8.2	Digital Modulation	System uses OFDM / DSSS techniques	System must utilize a digital transmission technology	Complies
15.247 (a) (2)	RSS 210 A8.2 (1)	6dB Bandwidth	802.11b: 12.2 MHz 802.11g: 15.2 MHz HT20: 17.4 MHz HT40: 36.7 MHz BLE: 0.76 MHz	>500kHz	Complies
15.247 (b) (3)	RSS 210 A8.2 (4)	Output Power (multipoint systems)	802.11b: 0.053 W 802.11g: 0.151 W HT20: 0.044 W HT40: 0.037 W BLE: 0.004 W EIRP = 0.316 W <sup>Note 1</sup>	1Watt, EIRP limited to 4 Watts.	Complies
15.247(d)	RSS 210 A8.2 (2)	Power Spectral Density	802.11b: -8.2 dBm 802.11g: -7.5 dBm HT20: -7.7 dBm HT40: -10.8 dBm BLE: -9.3 dBm All / 3kHz	8dBm/3kHz	Complies
15.247(c)	RSS 210 A8.5	Antenna Port Spurious Emissions 30MHz – 25 GHz	All emissions below -20dBc & -30dBc limit	< -20dBc < -30dBc <sup>Note 2</sup>	Complies
15.247(c) / 15.209	RSS 210 A8.5	Radiated Spurious Emissions 30MHz – 25 GHz	53.7dBμV/m @ 2483.5MHz (-0.3dB)	15.207 in restricted bands, all others < -20dBc < -30dBc <sup>Note 2</sup>	Complies
<p>Note 1: EIRP calculated using antenna gain of 3.2 dBi for the highest EIRP system.</p> <p>Note 2: Limit of -30dBc used for MIMO mode operation because the power was measured using the UNII test procedure (maximum power averaged over a transmission burst). For single chain modes, limit used was -20dBc or -30dBc depending on method used for power measurements (peak or power averaged).</p>					

**GENERAL REQUIREMENTS APPLICABLE TO ALL BANDS**

FCC Rule Part	RSS Rule part	Description	Measured Value / Comments	Limit / Requirement	Result (margin)
15.203	-	RF Connector	u.FL unique connector	Unique or integral antenna required	Complies
15.207	RSS GEN Table 2	AC Conducted Emissions	32.1dB $\mu$ V @ 15.520MHz (-17.9dB)	Refer to page 18	Complies
15.109	RSS GEN 7.2.3 Table 1	Receiver spurious emissions	37.3dB $\mu$ V/m @ 120.01MHz	Refer to page 19	Complies
15.247 (b) (5) 15.407 (f)	RSS 102	RF Exposure Requirements	Refer to SAR Report, RSS 102 declaration and User Manual statements.	Refer to OET 65, FCC Part 1 and RSS 102	Complies
-	RSP 100 RSS GEN 7.1.5	User Manual	Refer to page 11 of the user's manual	Statement required regarding non-interference	Complies
-	RSP 100 RSS GEN 7.1.5	User Manual	Not applicable, antenna is integral to host systems.	Statement for products with detachable antenna	Complies
-	RSP 100 RSS GEN 4.4.1	99% Bandwidth	802.11b: 15.6 MHz 802.11g: 17.4 MHz HT20: 18.9 MHz HT40: 37.1 MHz BLE: 1.06 MHz	Information only	N/A

**MEASUREMENT UNCERTAINTIES**

ISO/IEC 17025 requires that an estimate of the measurement uncertainties associated with the emissions test results be included in the report. The measurement uncertainties given below are based on a 95% confidence level and were calculated in accordance with UKAS document LAB 34.

Measurement Type	Measurement Unit	Frequency Range	Expanded Uncertainty
RF power, conducted (power meter)	dBm	25 to 7000 MHz	± 0.52 dB
RF power, conducted (Spectrum analyzer)	dBm	25 to 7000 MHz	± 0.7 dB
Conducted emission of transmitter	dBm	25 to 26500 MHz	± 0.7 dB
Conducted emission of receiver	dBm	25 to 26500 MHz	± 0.7 dB
Radiated emission (substitution method)	dBm	25 to 26500 MHz	± 2.5 dB
Radiated emission (field strength)	dB $\mu$ V/m	25 to 1000 MHz	± 3.6 dB
		1000 to 40000 MHz	± 6.0 dB
Conducted Emissions (AC Power)	dB $\mu$ V	0.15 to 30 MHz	± 2.4 dB



**EQUIPMENT UNDER TEST (EUT) DETAILS****GENERAL**

The Intel® Centrino® Wireless-N 2230 Models 2230BNHMW & 2230BNHU are PCIe Half Mini Card for factor Bluetooth/IEEE 802.11b/g/n wireless network adapters. The cards support MIMO (2x2) for 802.11n modes and MISO (1x2) for 802.11b/g modes. Bluetooth only operation mode is a 1x1. When Bluetooth is operational 802.11b/g/n modes operate as SISO (1x1).

The card is sold under two different FCC/IC ID numbers (see table below). The ID's ending in "U" are intended to allow user install conditions and host systems must be provided with a BIOS locking feature that prevents installation of unauthorized devices. For radio testing purposes the card was installed in a test fixture that exposed all sides of the card. For digital device testing for certification under equipment code JBP the card was installed inside a laptop PC.

The sample was received on September 21, 2011 and tested on September 21, 22, 23, 24, 27, 28, 30, October 2, 3, 4, 10, 11, 13 and 17, 2011. The EUT consisted of the following component(s):

Company	Model	Description	Serial Number	FCC ID
Intel Corporation	2230BNHMW	PCIe Half Mini Card form factor Bluetooth / IEEE 802.11b/g/n wireless network adapter	001500825023 (JBP)	PD92230BNH PD92230BNHU 1000M-2230BNH
	2230BNHU		00150082509B (DSS, DTS)	1000M-2230BNHU

**ANTENNA SYSTEM**

The EUT antenna is a two-antenna PIFA antenna system – Shanghai Universe Communication Electron Co., Ltd for both chains (2400-2480MHz, 3.2dBi max gain).

The antenna connects to the EUT via a non-standard u.FI antenna connector, thereby meeting the requirements of FCC 15.203.

**ENCLOSURE**

The EUT does not have an enclosure as it is designed to be installed within the enclosure of a host computer or system.

**MODIFICATIONS**

No modifications were made to the EUT during the time the product was at Elliott.

**SUPPORT EQUIPMENT**

The following equipment was used as support equipment for testing:

Company	Model	Description	Serial Number	FCC ID
Intel Corporation	-	Test Fixture	D9164573K0B0	N/A
DELL	Latitude D520	Laptop PC	HM9383J	N/A
Agilent	E3610A	DC Supply	MY4001740	N/A

No remote support equipment was used during testing.

**EUT INTERFACE PORTS**

The I/O cabling configuration during testing was as follows:

Port	Connected To	Description	Cable(s)	
			Shielded or Unshielded	Length(m)
Laptop USB	Fixture USB	USB cable	Shielded	1.5
Laptop Mini PCI	Fixture PCIe	Ribbon	unshielded	0.7
DC Power	Fixture DC power	2-wire	unshielded	0.7

**EUT OPERATION**

The EUT was installed into a test fixture that exposed all sides of the card. The test fixture interfaced to a laptop computer and dc power supply. The laptop computer was used to configure the EUT to continuously transmit at a specified output power or continuously receive on the channel specified in the test data. For transmit mode measurements the system was configured to operate in each of the available operating modes – 802.11b, 802.11g, 802.11n (20 MHz channel bandwidth) and 802.11n (40MHz channel bandwidth), Bluetooth Low Energy, Bluetooth 1Mb/s and Bluetooth 3Mb/s. In addition radiated spurious tests were repeated with the device operating in both Bluetooth and 802.11 modes to determine if any spurious emissions due to intermodulation products were created.

The data rates used for all tests were the lowest data rates for each 802.11 mode – 1Mb/s for 802.11b, 6Mb/s for 802.11a and 802.11g, 6.5MB/s for 802.11n (20MHz), and 13 Mb/s for 802.11n (40MHz). The device operates at its maximum output power at the lowest data rate (this was confirmed through separate measurements – refer to test data for actual measurements). Bluetooth operation was evaluated at both 1Mb/s and 3Mb/s data rates. 2Mb/s data rate was found, through preliminary testing, to produce emissions similar to those for 3Mb/s.

Receiver spurious emissions in 802.11 modes were evaluated in single chain and multi-chain modes. Bluetooth receiver spurious were evaluated for single chain only as only SISO is supported for Bluetooth.

The PC was using the Intel test utility DRTU Version 1.5.3.0322 and driver version 15.0.0.61.

**TEST SITE****GENERAL INFORMATION**

Final test measurements were taken at the test sites listed below. Pursuant to section 2.948 of the FCC's Rules and section 3.3 of RSP-100, construction, calibration, and equipment data has been filed with the Commission and with industry Canada.

Site	Registration Numbers		Location
	FCC	Canada	
Chamber 3	769238	2845B-3	41039 Boyce Road Fremont, CA 94538-2435
Chamber 4	211948	2845B-4	
Chamber 5	211948	2845B-5	
Chamber 7	A2LA accreditation	2845B-7	

ANSI C63.4:2003 recommends that ambient noise at the test site be at least 6 dB below the allowable limits. Ambient levels are below this requirement. The test site(s) contain separate areas for radiated and conducted emissions testing. Considerable engineering effort has been expended to ensure that the facilities conform to all pertinent requirements of ANSI C63.4:2003.

**CONDUCTED EMISSIONS CONSIDERATIONS**

Conducted emissions testing is performed in conformance with ANSI C63.4:2003. Measurements are made with the EUT connected to the public power network through a nominal, standardized RF impedance, which is provided by a line impedance stabilization network, known as a LISN. A LISN is inserted in series with each current-carrying conductor in the EUT power cord.

**RADIATED EMISSIONS CONSIDERATIONS**

The FCC has determined that radiation measurements made in a shielded enclosure are not suitable for determining levels of radiated emissions. Radiated measurements are performed in an open field environment or in a semi-anechoic chamber. The test sites are maintained free of conductive objects within the CISPR defined elliptical area incorporated in ANSI C63.4:2003 guidelines and meet the Normalized Site Attenuation (NSA) requirements of ANSI C63.4:2003.

## **MEASUREMENT INSTRUMENTATION**

### **RECEIVER SYSTEM**

An EMI receiver as specified in CISPR 16-1-1 is used for emissions measurements. The receivers used can measure over the frequency range of 9 kHz up to 2000 MHz. These receivers allow both ease of measurement and high accuracy to be achieved. The receivers have Peak, Average, and CISPR (Quasi-peak) detectors built into their design so no external adapters are necessary. The receiver automatically sets the required bandwidth for the CISPR detector used during measurements. If the repetition frequency of the signal being measured is below 20Hz, peak measurements are made in lieu of Quasi-Peak measurements.

For measurements above the frequency range of the receivers, a spectrum analyzer is utilized because it provides visibility of the entire spectrum along with the precision and versatility required to support engineering analysis. Average measurements above 1000MHz are performed on the spectrum analyzer using the linear-average method with a resolution bandwidth of 1 MHz and a video bandwidth of 10 Hz, unless the signal is pulsed in which case the average (or video) bandwidth of the measuring instrument is reduced to onset of pulse desensitization and then increased.

### **INSTRUMENT CONTROL COMPUTER**

The receivers utilize either a Rohde & Schwarz EZM Spectrum Monitor/Controller or contain an internal Spectrum Monitor/Controller to view and convert the receiver measurements to the field strength at an antenna or voltage developed at the LISN measurement port, which is then compared directly with the appropriate specification limit. This provides faster, more accurate readings by performing the conversions described under Sample Calculations within the Test Procedures section of this report. Results are printed in a graphic and/or tabular format, as appropriate. A personal computer is used to record all measurements made with the receivers.

The Spectrum Monitor provides a visual display of the signal being measured. In addition, the controller or a personal computer run automated data collection programs which control the receivers. This provides added accuracy since all site correction factors, such as cable loss and antenna factors are added automatically.

### **LINE IMPEDANCE STABILIZATION NETWORK (LISN)**

Line conducted measurements utilize a fifty microhenry Line Impedance Stabilization Network as the monitoring point. The LISN used also contains a 250 uH CISPR adapter. This network provides for calibrated radio frequency noise measurements by the design of the internal low pass and high pass filters on the EUT and measurement ports, respectively.

### *FILTERS/ATTENUATORS*

External filters and precision attenuators are often connected between the receiving antenna or LISN and the receiver. This eliminates saturation effects and non-linear operation due to high amplitude transient events.

### *ANTENNAS*

A loop antenna is used below 30 MHz. For the measurement range 30 MHz to 1000 MHz either a combination of a biconical antenna and a log periodic or a bi-log antenna is used. Above 1000 MHz, horn antennas are used. The antenna calibration factors to convert the received voltage to an electric field strength are included with appropriate cable loss and amplifier gain factors to determine an overall site factor, which is then programmed into the test receivers or incorporated into the test software.

### *ANTENNA MAST AND EQUIPMENT TURNTABLE*

The antennas used to measure the radiated electric field strength are mounted on a non-conductive antenna mast equipped with a motor-drive to vary the antenna height. Measurements below 30 MHz are made with the loop antenna at a fixed height of 1m above the ground plane.

ANSI C63.4:2003 specifies that the test height above ground for table mounted devices shall be 80 centimeters. Floor mounted equipment shall be placed on the ground plane if the device is normally used on a conductive floor or separated from the ground plane by insulating material from 3 to 12 mm if the device is normally used on a non-conductive floor. During radiated measurements, the EUT is positioned on a motorized turntable in conformance with this requirement.

### *INSTRUMENT CALIBRATION*

All test equipment is regularly checked to ensure that performance is maintained in accordance with the manufacturer's specifications. All antennas are calibrated at regular intervals with respect to tuned half-wave dipoles. An exhibit of this report contains the list of test equipment used and calibration information.

## TEST PROCEDURES

### EUT AND CABLE PLACEMENT

The regulations require that interconnecting cables be connected to the available ports of the unit and that the placement of the unit and the attached cables simulate the worst case orientation that can be expected from a typical installation, so far as practicable. To this end, the position of the unit and associated cabling is varied within the guidelines of ANSI C63.4:2003, and the worst-case orientation is used for final measurements.

### CONDUCTED EMISSIONS

Conducted emissions are measured at the plug end of the power cord supplied with the EUT. Excess power cord length is wrapped in a bundle between 30 and 40 centimeters in length near the center of the cord. Preliminary measurements are made to determine the highest amplitude emission relative to the specification limit for all the modes of operation. Placement of system components and varying of cable positions are performed in each mode. A final peak mode scan is then performed in the position and mode for which the highest emission was noted on all current carrying conductors of the power cord.

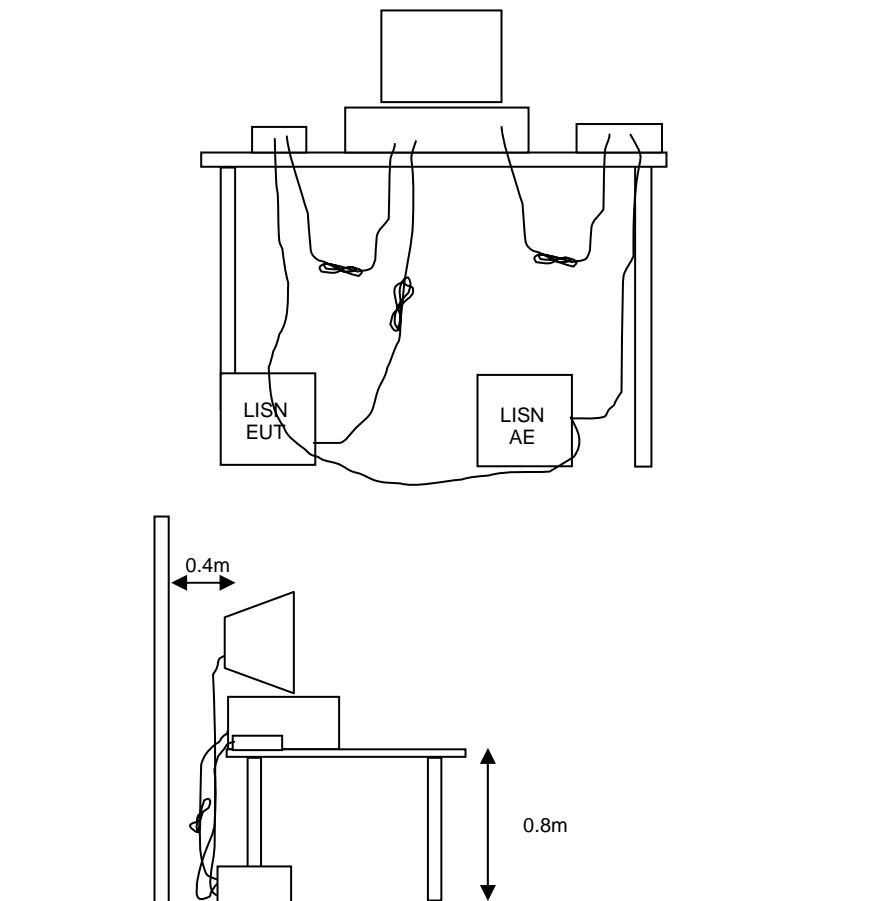

Figure 1 Typical Conducted Emissions Test Configuration

**RADIATED EMISSIONS**

A preliminary scan of the radiated emissions is performed in which all significant EUT frequencies are identified with the system in a nominal configuration. At least two scans are performed, one scan for each antenna polarization (horizontal and vertical; loop parallel and perpendicular to the EUT). During the preliminary scans, the EUT is rotated through 360°, the antenna height is varied (for measurements above 30 MHz) and cable positions are varied to determine the highest emission relative to the limit. Preliminary scans may be performed in a fully anechoic chamber for the purposes of identifying the frequencies of the highest emissions from the EUT.

A speaker is provided in the receiver to aid in discriminating between EUT and ambient emissions. Other methods used during the preliminary scan for EUT emissions involve scanning with near field magnetic loops, monitoring I/O cables with RF current clamps, and cycling power to the EUT.

Final maximization is a phase in which the highest amplitude emissions identified in the spectral search are viewed while the EUT azimuth angle is varied from 0 to 360 degrees relative to the receiving antenna. The azimuth, which results in the highest emission is then maintained while varying the antenna height from one to four meters (for measurements above 30 MHz, measurements below 30 MHz are made with the loop antenna at a fixed height of 1m). The result is the identification of the highest amplitude for each of the highest peaks. Each recorded level is corrected in the receiver using appropriate factors for cables, connectors, antennas, and preamplifier gain.

When testing above 18 GHz, the receive antenna is located at 1 meter from the EUT and the antenna height is restricted to a maximum of 2.5 meters.

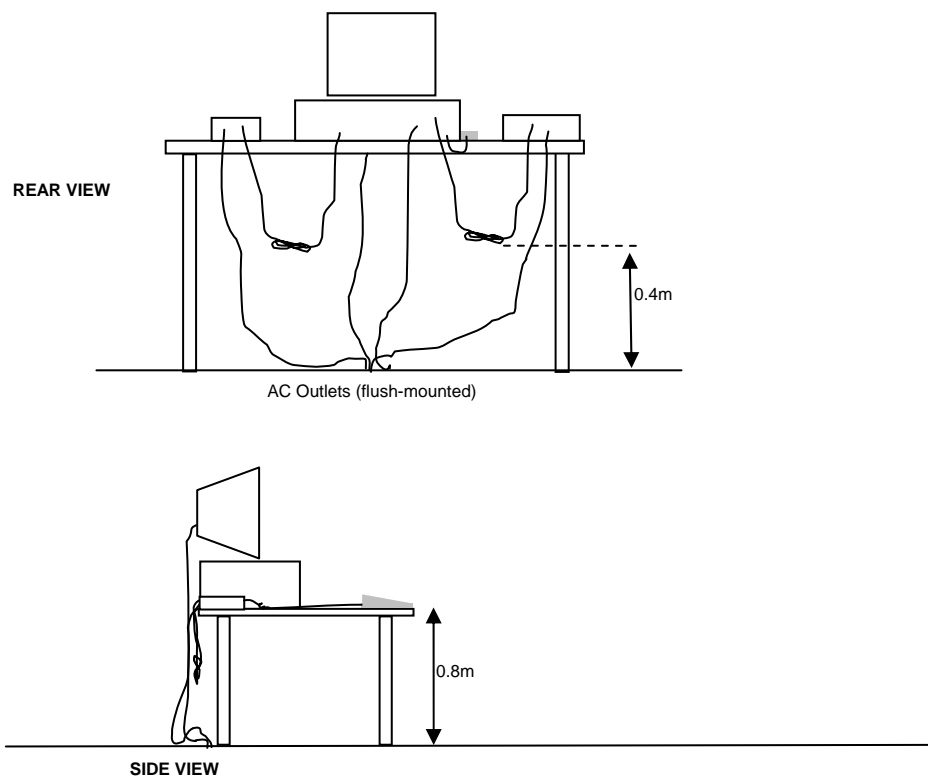

Typical Test Configuration for Radiated Field Strength Measurements

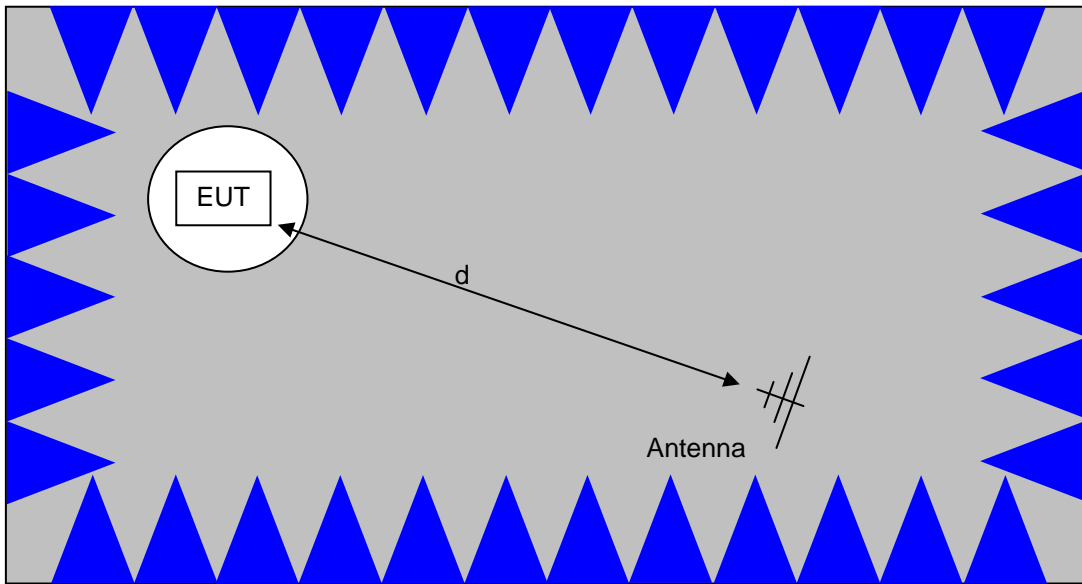

The anechoic materials on the walls and ceiling ensure compliance with the normalized site attenuation requirements of CISPR 16 / CISPR 22 / ANSI C63.4 for an alternate test site at the measurement distances used.

Floor-standing equipment is placed on the floor with insulating supports between the unit and the ground plane.

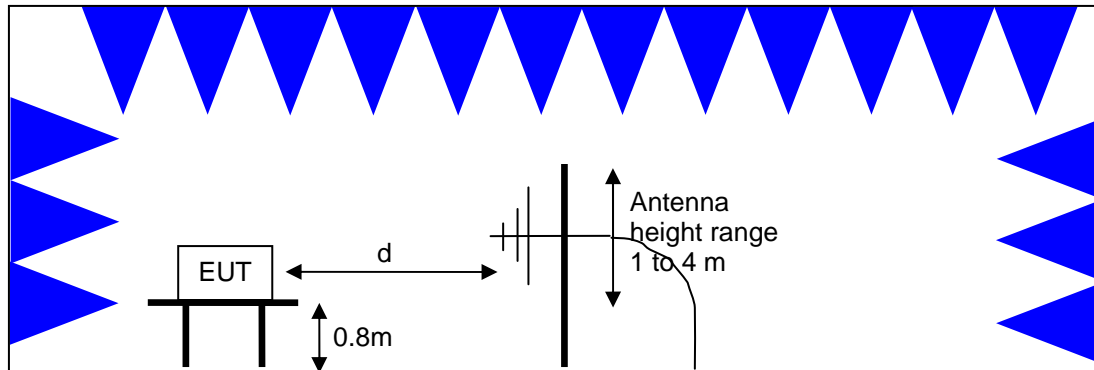

Test Configuration for Radiated Field Strength Measurements  
Semi-Anechoic Chamber, Plan and Side Views



**CONDUCTED EMISSIONS FROM ANTENNA PORT**

Direct measurements of power, bandwidth and power spectral density are performed, where possible, with the antenna port of the EUT connected to either the power meter or spectrum analyzer via a suitable attenuator and/or filter. These are used to ensure that the front end of the measurement instrument is not overloaded by the fundamental transmission.

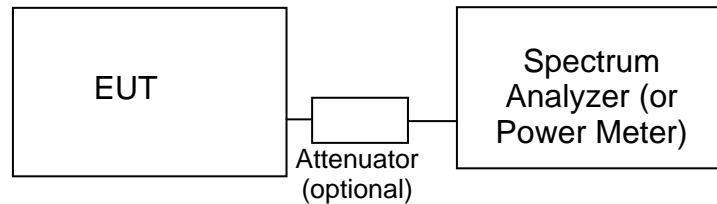
Test Configuration for Antenna Port Measurements

Measurement bandwidths (video and resolution) are set in accordance with the relevant standards and Elliott's test procedures for the type of radio being tested. When power measurements are made using a resolution bandwidth less than the signal bandwidth the power is calculated by summing the power across the signal bandwidth using either the analyzer channel power function or by capturing the trace data and calculating the power using software. In both cases the summed power is corrected to account for the equivalent noise bandwidth (ENBW) of the resolution bandwidth used.

If power averaging is used (typically for certain digital modulation techniques), the EUT is configured to transmit continuously. Power averaging is performed using either the built-in function of the analyzer or, if the analyzer does not feature power averaging, using external software. In both cases the average power is calculated over a number of sweeps (typically 100). When the EUT cannot be configured to continuously transmit then either the analyzer is configured to perform a gated sweep to ensure that the power is averaged over periods that the device is transmitting or power averaging is disabled and a max-hold feature is used.

If a power meter is used to make output power measurements the sensor head type (peak or average) is stated in the test data table.

**BANDWIDTH MEASUREMENTS**

The 6dB, 20dB and/or 26dB signal bandwidth is measured in using the bandwidths recommended by ANSI C63.4. When required, the 99% bandwidth is measured using the methods detailed in RSS GEN.

**SPECIFICATION LIMITS AND SAMPLE CALCULATIONS**

The limits for conducted emissions are given in units of microvolts, and the limits for radiated emissions are given in units of microvolts per meter at a specified test distance. Data is measured in the logarithmic form of decibels relative to one microvolt, or dB microvolts (dBuV). For radiated emissions, the measured data is converted to the field strength at the antenna in dB microvolts per meter (dBuV/m). The results are then converted to the linear forms of uV and uV/m for comparison to published specifications.

For reference, converting the specification limits from linear to decibel form is accomplished by taking the base ten logarithm, then multiplying by 20. These limits in both linear and logarithmic form are as follows:

**CONDUCTED EMISSIONS SPECIFICATION LIMITS: FCC 15.207; FCC 15.107(a), RSS GEN**

The table below shows the limits for the emissions on the AC power line from an intentional radiator and a receiver.

Frequency (MHz)	Average Limit (dBuV)	Quasi Peak Limit (dBuV)
0.150 to 0.500	Linear decrease on logarithmic frequency axis between 56.0 and 46.0	Linear decrease on logarithmic frequency axis between 66.0 and 56.0
0.500 to 5.000	46.0	56.0
5.000 to 30.000	50.0	60.0

**GENERAL TRANSMITTER RADIATED EMISSIONS SPECIFICATION LIMITS**

The table below shows the limits for the spurious emissions from transmitters that fall in restricted bands<sup>1</sup> (with the exception of transmitters operating under FCC Part 15 Subpart D and RSS 210 Annex 9), the limits for all emissions from a low power device operating under the general rules of RSS 310 (tables 3 and 4), RSS 210 (table 2) and FCC Part 15 Subpart C section 15.209.

Frequency Range (MHz)	Limit (uV/m)	Limit (dBuV/m @ 3m)
0.009-0.490	2400/F <sub>KHz</sub> @ 300m	67.6-20*log <sub>10</sub> (F <sub>KHz</sub> ) @ 300m
0.490-1.705	24000/F <sub>KHz</sub> @ 30m	87.6-20*log <sub>10</sub> (F <sub>KHz</sub> ) @ 30m
1.705 to 30	30 @ 30m	29.5 @ 30m
30 to 88	100 @ 3m	40 @ 3m
88 to 216	150 @ 3m	43.5 @ 3m
216 to 960	200 @ 3m	46.0 @ 3m
Above 960	500 @ 3m	54.0 @ 3m

**RECEIVER RADIATED SPURIOUS EMISSIONS SPECIFICATION LIMITS**

The table below shows the limits for the spurious emissions from receivers as detailed in FCC Part 15.109, RSS 210 Table 2, RSS GEN Table 1 and RSS 310 Table 3. Note that receivers operating outside of the frequency range 30 MHz – 960 MHz are exempt from the requirements of 15.109.

Frequency Range (MHz)	Limit (uV/m @ 3m)	Limit (dBuV/m @ 3m)
30 to 88	100	40
88 to 216	150	43.5
216 to 960	200	46.0
Above 960	500	54.0

<sup>1</sup> The restricted bands are detailed in FCC 15.203, RSS 210 Table 1 and RSS 310 Table 2

**OUTPUT POWER LIMITS – DIGITAL TRANSMISSION SYSTEMS**

The table below shows the limits for output power and output power density. Where the signal bandwidth is less than 20 MHz the maximum output power is reduced to the power spectral density limit plus 10 times the log of the bandwidth (in MHz).

Operating Frequency (MHz)	Output Power	Power Spectral Density
902 – 928	1 Watt (30 dBm)	8 dBm/3kHz
2400 – 2483.5	1 Watt (30 dBm)	8 dBm/3kHz
5725 – 5850	1 Watt (30 dBm)	8 dBm/3kHz

The maximum permitted output power is reduced by 1dB for every dB the antenna gain exceeds 6dBi. Fixed point-to-point applications using the 5725 – 5850 MHz band are not subject to this restriction.

**TRANSMIT MODE SPURIOUS RADIATED EMISSIONS LIMITS – FHSS and DTS SYSTEMS**

The limits for unwanted (spurious) emissions from the transmitter falling in the restricted bands are those specified in the general limits sections of FCC Part 15 and RSS 210. All other unwanted (spurious) emissions shall be at least 20dB below the level of the highest in-band signal level (30dB if the power is measured using the sample detector/power averaging method).

**SAMPLE CALCULATIONS - CONDUCTED EMISSIONS**

Receiver readings are compared directly to the conducted emissions specification limit (decibel form) as follows:

$$R_r - S = M$$

where:

$R_r$  = Receiver Reading in dBuV

$S$  = Specification Limit in dBuV

$M$  = Margin to Specification in +/- dB

**SAMPLE CALCULATIONS - RADIATED EMISSIONS**

Receiver readings are compared directly to the specification limit (decibel form). The receiver internally corrects for cable loss, preamplifier gain, and antenna factor. The calculations are in the reverse direction of the actual signal flow, thus cable loss is added and the amplifier gain is subtracted. The Antenna Factor converts the voltage at the antenna coaxial connector to the field strength at the antenna elements.

A distance factor, when used for electric field measurements above 30MHz, is calculated by using the following formula:

$$F_d = 20 * \text{LOG}_{10} (D_m/D_s)$$

where:

$F_d$  = Distance Factor in dB

$D_m$  = Measurement Distance in meters

$D_S$  = Specification Distance in meters

For electric field measurements below 30MHz the extrapolation factor is either determined by making measurements at multiple distances or a theoretical value is calculated using the formula:

$$F_d = 40 * \text{LOG}_{10} (D_m/D_s)$$

Measurement Distance is the distance at which the measurements were taken and Specification Distance is the distance at which the specification limits are based. The antenna factor converts the voltage at the antenna coaxial connector to the field strength at the antenna elements.

The margin of a given emission peak relative to the limit is calculated as follows:

$$R_c = R_r + F_d$$

and

$$M = R_c - L_s$$

where:

$R_r$  = Receiver Reading in dBuV/m

$F_d$  = Distance Factor in dB

$R_c$  = Corrected Reading in dBuV/m

$L_s$  = Specification Limit in dBuV/m

$M$  = Margin in dB Relative to Spec

#### **SAMPLE CALCULATIONS - FIELD STRENGTH TO EIRP CONVERSION**

Where the radiated electric field strength is expressed in terms of the equivalent isotropic radiated power (eirp), or where a field strength measurement of output power is made in lieu of a direct measurement, the following formula is used to convert between eirp and field strength at a distance of d (meters) from the equipment under test:

$$E = \frac{1000000 \sqrt{30 P}}{d} \quad \text{microvolts per meter}$$

where P is the eirp (Watts)

For a measurement at 3m the conversion from a logarithmic value for field strength (dBuV/m) to an eirp power (dBm) is -95.3dB.

**Appendix A Test Equipment Calibration Data****Radiated Emissions, 1,000 - 6,500 MHz, 21-Sep-11**

<u>Manufacturer</u>	<u>Description</u>	<u>Model</u>	<u>Asset #</u>	<u>Cal Due</u>
Hewlett Packard	Microwave Preamplifier, 1-26.5GHz	8449B	263	12/8/2011
EMCO	Antenna, Horn, 1-18GHz	3115	868	6/8/2012
Hewlett Packard	SpecAn 30 Hz -40 GHz, SV (SA40) Red	8564E (84125C)	1148	8/15/2012

**Radiated Emissions, 1000 - 26,500 MHz, 22 & 23-Sep-11**

<u>Manufacturer</u>	<u>Description</u>	<u>Model</u>	<u>Asset #</u>	<u>Cal Due</u>
Hewlett Packard	Microwave Preamplifier, 1-26.5GHz	8449B	785	5/18/2012
EMCO	Antenna, Horn, 1-18GHz	3115	868	6/8/2012
Hewlett Packard	SpecAn 9 kHz - 40 GHz, FT (SA40) Blue	8564E (84125C)	1393	8/9/2012
Micro-Tronics	Band Reject Filter, 2400-2500 MHz	BRM50702-02	1683	8/3/2012

**Radio Antenna Port (Power and Spurious Emissions), 24-Sep-11**

<u>Manufacturer</u>	<u>Description</u>	<u>Model</u>	<u>Asset #</u>	<u>Cal Due</u>
Hewlett Packard	SpecAn 30 Hz -40 GHz, SV (SA40) Red	8564E (84125C)	1148	8/15/2012

**Radiated Emissions, 1,000 - 6,500 MHz, 27-Sep-11**

<u>Manufacturer</u>	<u>Description</u>	<u>Model</u>	<u>Asset #</u>	<u>Cal Due</u>
EMCO	Antenna, Horn, 1-18 GHz	3115	786	12/11/2011
Hewlett Packard	Microwave Preamplifier, 1-26.5GHz	8449B	2199	2/23/2012
Hewlett Packard	SpecAn 9 kHz - 40 GHz, (SA40) Purple	8564E (84125C)	2415	7/28/2012

**Radio Antenna Port (Power and Spurious Emissions), 27-Sep-11**

<u>Manufacturer</u>	<u>Description</u>	<u>Model</u>	<u>Asset #</u>	<u>Cal Due</u>
Hewlett Packard	SpecAn 9 KHz-26.5 GHz, Non-Program	8563E	284	1/13/2012
Rohde & Schwarz	Power Meter, Dual Channel	NRVD	1539	9/9/2012
Rohde & Schwarz	Power Sensor 100 uW - 10 Watts	NRV-Z53	1555	2/2/2012
Rohde & Schwarz	Attenuator, 20 dB , 50 ohm, 10W, DC-18 GHz	20dB, 10W, Type N	1556	2/2/2012

**Radiated Emissions, 1,000 - 26,000 MHz, 28-Sep-11**

<u>Manufacturer</u>	<u>Description</u>	<u>Model</u>	<u>Asset #</u>	<u>Cal Due</u>
Hewlett Packard	Microwave Preamplifier, 1-26.5GHz	8449B	263	12/8/2011
EMCO	Antenna, Horn, 1-18 GHz	3115	487	7/6/2012
Hewlett Packard	SpecAn 30 Hz -40 GHz, SV (SA40) Red	8564E (84125C)	1148	8/15/2012
Micro-Tronics	Band Reject Filter, 2400-2500 MHz	BRM50702-02	2249	10/11/2011

**Radiated and Conducted Emissions - AC Power Ports, 28-Sep-11**

<u>Manufacturer</u>	<u>Description</u>	<u>Model</u>	<u>Asset #</u>	<u>Cal Due</u>
EMCO	LISN, 10 kHz-100 MHz, 25A	3825/2	1292	3/1/2012
Rohde & Schwarz	Pulse Limiter	ESH3 Z2	1401	4/21/2012
Fischer Custom Comm.	LISN, 50uH, 25 Amps, Dual Line	FCC-LISN-50/250-25-2-01	1575	4/21/2012
Rohde & Schwarz	EMI Test Receiver, 20 Hz-7 GHz	ESIB7	1630	4/13/2012
Sunol Sciences	Biconilog, 30-3000 MHz	JB3	2237	7/14/2012
Com-Power Corp.	Preamplifier, 30-1000 MHz	PAM-103	2380	4/13/2012

**TX Radiated Spurious, 30-Sep-11**

<u>Manufacturer</u>	<u>Description</u>	<u>Model</u>	<u>Asset #</u>	<u>Cal Due</u>
EMCO	Antenna, Horn, 1-18 GHz	3115	786	12/11/2011
Hewlett Packard	Microwave Preamplifier, 1-26.5GHz	8449B	2199	2/23/2012
Micro-Tronics	Band Reject Filter, 2400-2500 MHz	BRM50702-02	2238	10/1/2011
Hewlett Packard	SpecAn 9 kHz - 40 GHz, (SA40) Purple	8564E (84125C)	2415	7/28/2012

**Radio Antenna Port , 2-Oct-11**

<u>Manufacturer</u>	<u>Description</u>	<u>Model</u>	<u>Asset #</u>	<u>Cal Due</u>
Rohde & Schwarz	Power Meter, Single Channel	NRVS	1422	12/1/2011
Rohde & Schwarz	Power Sensor 100 uW - 10 Watts	NRV-Z53	1555	2/2/2012
Rohde & Schwarz	Attenuator, 20 dB , 50 ohm, 10W, DC-18 GHz	20dB, 10W, Type N	1556	2/2/2012
Agilent	PSA, Spectrum Analyzer, (installed options, 111, 115, 123, 1DS, B7J, HYX,	E4446A	2139	1/26/2012

**Radiated Emissions, 30 - 26,500 MHz, 30-Sep-11**

<u>Manufacturer</u>	<u>Description</u>	<u>Model</u>	<u>Asset #</u>	<u>Cal Due</u>
EMCO	Antenna, Horn, 1-18 GHz	3115	786	12/11/2011
Rohde & Schwarz	Power Meter, Dual Channel	NRVD	1071	5/26/2012
Rohde & Schwarz	Power Sensor 100 uW - 2 Watts use with 20dB attenuator sn:100059 only	NRV-Z32	1423	9/1/2012
Hewlett Packard	Microwave Preamplifier, 1-26.5GHz	8449B	2199	2/23/2012
Hewlett Packard	SpecAn 9 kHz - 40 GHz, (SA40) Purple	8564E (84125C)	2415	7/28/2012

**Radiated Emissions, 30 - 40,000 MHz, 03-Oct-11**

<u>Manufacturer</u>	<u>Description</u>	<u>Model</u>	<u>Asset #</u>	<u>Cal Due</u>
Hewlett Packard	Microwave Preamplifier, 1-26.5GHz	8449B	263	12/8/2011
EMCO	Antenna, Horn, 1-18 GHz	3115	487	7/6/2012
Hewlett Packard	SpecAn 30 Hz -40 GHz, SV (SA40) Red	8564E (84125C)	1148	8/15/2012
Hewlett Packard	High Pass filter, 3.5 GHz (Blu System)	P/N 84300-80038 (84125C)	1391	6/23/2012
Micro-Tronics	Band Reject Filter, 2400-2500 MHz	BRM50702-02	2249	10/11/2011

**Radiated Emissions, 1000 - 10,000 MHz, 05-Oct-11**

<u>Manufacturer</u>	<u>Description</u>	<u>Model</u>	<u>Asset #</u>	<u>Cal Due</u>
Hewlett Packard	Microwave Preamplifier, 1-26.5GHz	8449B	263	12/8/2011
EMCO	Antenna, Horn, 1-18 GHz	3115	487	7/6/2012
Hewlett Packard	SpecAn 30 Hz -40 GHz, SV (SA40) Red	8564E (84125C)	1148	8/15/2012
Micro-Tronics	Band Reject Filter, 2400-2500 MHz	BRM50702-02	2249	10/11/2011

**Radiated Emissions, 30 - 1,000 MHz, 04-Oct-11**

<u>Manufacturer</u>	<u>Description</u>	<u>Model</u>	<u>Asset #</u>	<u>Cal Due</u>
Rohde & Schwarz	EMI Test Receiver, 20 Hz-7 GHz	ESIB7	1630	4/13/2012
Sunol Sciences	Biconilog, 30-3000 MHz	JB3	2237	7/14/2012
Com-Power Corp.	Preamplifier, 30-1000 MHz	PAM-103	2380	4/13/2012

**Conducted Emissions - AC Power Ports, 04-Oct-11**

<u>Manufacturer</u>	<u>Description</u>	<u>Model</u>	<u>Asset #</u>	<u>Cal Due</u>
EMCO	LISN, 10 kHz-100 MHz, 25A	3825/2	1292	3/1/2012
Rohde & Schwarz	Pulse Limiter	ESH3 Z2	1401	4/21/2012
Rohde & Schwarz	EMI Test Receiver, 20 Hz-7 GHz	ESIB7	1630	4/13/2012
Fischer Custom Comm	LISN, 25A, 150kHz to 30MHz, 25 Amp,	FCC-LISN-50-25-2-09	2001	9/15/2012

**Radiated Emissions, 30 - 6,500 MHz, 10, 11-Oct-11**

<u>Manufacturer</u>	<u>Description</u>	<u>Model</u>	<u>Asset #</u>	<u>Cal Due</u>
Hewlett Packard	Microwave Preamplifier, 1-26.5GHz	8449B	263	12/8/2011
EMCO	Antenna, Horn, 1-18 GHz (SA40-Red)	3115	1142	8/2/2012
Hewlett Packard	SpecAn 30 Hz -40 GHz, SV (SA40) Red	8564E (84125C)	1148	8/15/2012

**Radiated Emissions, 30 - 6,500 MHz, 13-Oct-11**

<u>Manufacturer</u>	<u>Description</u>	<u>Model</u>	<u>Asset #</u>	<u>Cal Due</u>
Hewlett Packard	Microwave Preamplifier, 1-26.5GHz	8449B	263	12/8/2011
EMCO	Antenna, Horn, 1-18 GHz (SA40-Red)	3115	1142	8/2/2012
Hewlett Packard	SpecAn 30 Hz -40 GHz, SV (SA40) Red	8564E (84125C)	1148	8/15/2012

**Radio Antenna Port , 17-Oct-11**

<u>Manufacturer</u>	<u>Description</u>	<u>Model</u>	<u>Asset #</u>	<u>Cal Due</u>
Rohde & Schwarz	Power Meter, Single Channel	NRVS	1422	12/1/2011
Rohde & Schwarz	Power Sensor 100 uW - 10 Watts	NRV-Z53	1555	2/2/2012
Rohde & Schwarz	Attenuator, 20 dB , 50 ohm, 10W, DC-18 GHz	20dB, 10W, Type N	1556	2/2/2012
Agilent	PSA, Spectrum Analyzer, (installed options, 111, 115, 123, 1DS, B7J, HYX,	E4446A	2139	1/26/2012



## *Appendix B Test Data*

T84599 Pages 26 - 157



## EMC Test Data

Client:	Intel Corporation	Job Number:	J84364
Model:	Intel® Centrino® Wireless-N 2230	T-Log Number:	T84599
		Account Manager:	Christine Krebill
Contact:	Steve Hackett		-
Emissions Standard(s):	FCC 15.247	Class:	B
Immunity Standard(s):	-	Environment:	-

# EMC Test Data

For The

## Intel Corporation

Model

Intel® Centrino® Wireless-N 2230

Date of Last Test: 10/18/2011

Client:	Intel Corporation	Job Number:	J84364
Model:	Intel® Centrino® Wireless-N 2230	T-Log Number:	T84599
		Account Manager:	Christine Krebill
Contact:	Steve Hackett		
Standard:	FCC 15.247	Class:	N/A

## RSS 210 and FCC 15.247 (DTS) Radiated Spurious Emissions

### Test Specific Details

Objective: The objective of this test session is to perform final qualification testing of the EUT with respect to the specification listed above.

### General Test Configuration

The EUT and all local support equipment were located on the turntable for radiated spurious emissions testing.

For radiated emissions testing the measurement antenna was located 3 meters from the EUT.

**Ambient Conditions:**

Temperature:	17-20 °C
Rel. Humidity:	30-40 %

### Modifications Made During Testing

No modifications were made to the EUT during testing

### Deviations From The Standard

No deviations were made from the requirements of the standard.

If power is more than 3dB below center channel target to pass on lowest and/or highest channel, repeat measurements at target power for next lowest or highest channel

Use the **Gain Control** mode of adjusting power. Set power to within  $\pm 0.2$ dB of target (dial in closer to the target value within  $\pm 0.2$ dB if possible and not just a passing value above the target).

Note - the target and measured power are average powers (measured with average power sensor) and are used for reference purposes only. Power is set using " **GAIN CONTROL**" mode in the DRTU tool.

Client:	Intel Corporation	Job Number:	J84364
Model:	Intel® Centrino® Wireless-N 2230	T-Log Number:	T84599
Contact:	Steve Hackett	Account Manager:	Christine Krebill
Standard:	FCC 15.247	Class:	N/A

### Summary of Results - Device Operating in the 2400-2483.5 MHz Band

MAC Address: 00150082509B DRTU Tool Version 1.5.3.0322 Driver version 15.0.0.61

Run #	Mode	Channel	Target Power	Measured Power	Test Performed	Limit	Result / Margin
Run # 1	802.11b Chain A	#1 2412MHz	14.7	14.8	Restricted Band Edge at 2390 MHz	15.209	38.6dBµV/m @ 2390.0MHz (-15.4dB)
		#11 2462MHz	15.7	15.7	Restricted Band Edge at 2483.5 MHz	15.209	41.0dBµV/m @ 2483.5MHz (-13.0dB)
Run #2	802.11g Chain A	#1 2412MHz	14.2	14.3	Restricted Band Edge at 2390 MHz	15.209	45.7dBµV/m @ 2390.0MHz (-8.3dB)
		#10 2457MHz	16.7	16.8	Restricted Band Edge at 2483.5 MHz	15.209	47.1dBµV/m @ 2483.5MHz (-6.9dB)
		#11 2462MHz	14.2	14.4	Restricted Band Edge at 2483.5 MHz	15.209	52.4dBµV/m @ 2483.5MHz (-1.6dB)
Run # 3	802.11n20 Chain A	#1 2412MHz	13.2	13.3	Restricted Band Edge at 2390 MHz	15.209	46.5dBµV/m @ 2390.0MHz (-7.5dB)
		#2 2417MHz	15.7	15.7	Restricted Band Edge at 2390 MHz	15.209	42.5dBµV/m @ 2390.0MHz (-11.5dB)
		#10 2457MHz	16.7	16.8	Restricted Band Edge at 2483.5 MHz	15.209	49.8dBµV/m @ 2483.5MHz (-4.2dB)
		#11 2462MHz	13.2	13.4	Restricted Band Edge at 2483.5 MHz	15.209	50.4dBµV/m @ 2483.5MHz (-3.6dB)
Run # 4	802.11n40 Chain A	#3 2422MHz	10.7	10.7	Restricted Band Edge at 2390 MHz	15.209	47.3dBµV/m @ 2389.7MHz (-6.7dB)
		#4 2427MHz	11.7	11.9	Restricted Band Edge at 2390 MHz	15.209	53.0dBµV/m @ 2390.0MHz (-1.0dB)
		#5 2432MHz	12.7	12.8	Restricted Band Edge at 2390 MHz	15.209	47.1dBµV/m @ 2389.9MHz (-6.9dB)
		#6 2437MHz	13.7	13.8	Restricted Band Edge at 2390 MHz	15.209	46.7dBµV/m @ 2390.0MHz (-7.3dB)
		#6 2437MHz	13.7	13.8	Restricted Band Edge at 2483.5 MHz	15.209	45.4dBµV/m @ 2483.5MHz (-8.6dB)
		#7 2442MHz	13.2	13.1	Restricted Band Edge at 2483.5 MHz	15.209	52.8dBµV/m @ 2483.5MHz (-1.2dB)
		#8 2447MHz	11.7	11.9	Restricted Band Edge at 2483.5 MHz	15.209	52.0dBµV/m @ 2483.5MHz (-2.0dB)
		#9 2452MHz	10.7	10.7	Restricted Band Edge at 2483.5 MHz	15.209	47.8dBµV/m @ 2483.6MHz (-6.2dB)

Client:	Intel Corporation	Job Number:	J84364
Model:	Intel® Centrino® Wireless-N 2230	T-Log Number:	T84599
Contact:	Steve Hackett	Account Manager:	Christine Krebill
Standard:	FCC 15.247	Class:	N/A

**Run # 1, Band Edge Field Strength - 802.11b, Chain A**

Date of Test: 10/10/2011  
 Test Engineer: Joseph Cadigal

Test Location: FT Chamber#3  
 Config Change: None

**Run # 1a, EUT on Channel #1 2412MHz - 802.11b, Chain A**

	Target (dBm)	Power Settings Measured (dBm)	Software Setting
Chain A	14.7	14.8	20.5

**2390 MHz Band Edge Signal Field Strength**

Frequency	Level	Pol	15.209 / 15.247		Detector	Azimuth	Height	Comments
MHz	dB $\mu$ V/m	v/h	Limit	Margin	Pk/QP/Avg	degrees	meters	
2390.000	38.6	V	54.0	-15.4	AVG	283	1.0	RB 1 MHz;VB 10 Hz;Pk
2362.400	48.2	V	74.0	-25.8	PK	283	1.0	RB 1 MHz;VB 3 MHz;Pk
2389.870	38.6	H	54.0	-15.4	AVG	15	1.0	RB 1 MHz;VB 10 Hz;Pk
2389.800	48.1	H	74.0	-25.9	PK	15	1.0	RB 1 MHz;VB 3 MHz;Pk

RB 1 MHz; VB 10 Hz = avg (black) 1MHz=RB=VB=Pk (blue) vertical

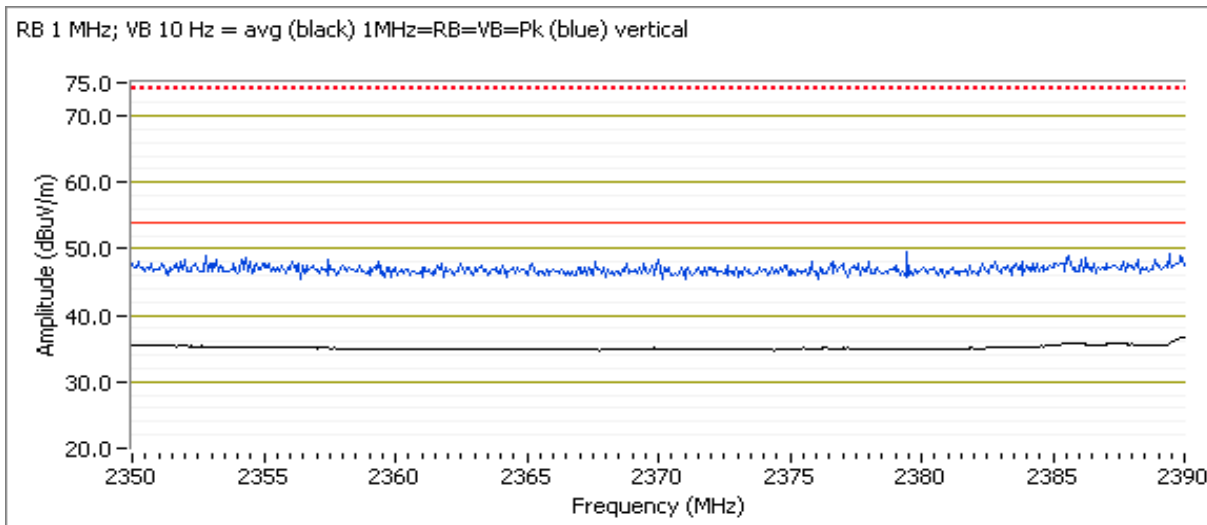

Client:	Intel Corporation	Job Number:	J84364
Model:	Intel® Centrino® Wireless-N 2230	T-Log Number:	T84599
Contact:	Steve Hackett	Account Manager:	Christine Krebill
Standard:	FCC 15.247	Class:	N/A

Run # 1b, EUT on Channel #11 2462MHz - 802.11b, Chain A

	Target (dBm)	Power Settings Measured (dBm)	Software Setting
Chain A	15.7	15.7	22.0

*2483.5 MHz Band Edge Signal Radiated Field Strength*

Frequency MHz	Level dB $\mu$ V/m	Pol v/h	15.209 / 15.247		Detector Pk/QP/Avg	Azimuth degrees	Height meters	Comments
			Limit	Margin				
2483.500	41.0	H	54.0	-13.0	AVG	360	1.0	RB 1 MHz;VB 10 Hz;Pk
2484.240	49.9	H	74.0	-24.1	PK	360	1.0	RB 1 MHz;VB 3 MHz;Pk
2483.500	40.9	V	54.0	-13.1	AVG	275	1.0	RB 1 MHz;VB 10 Hz;Pk
2484.380	49.4	V	74.0	-24.6	PK	275	1.0	RB 1 MHz;VB 3 MHz;Pk

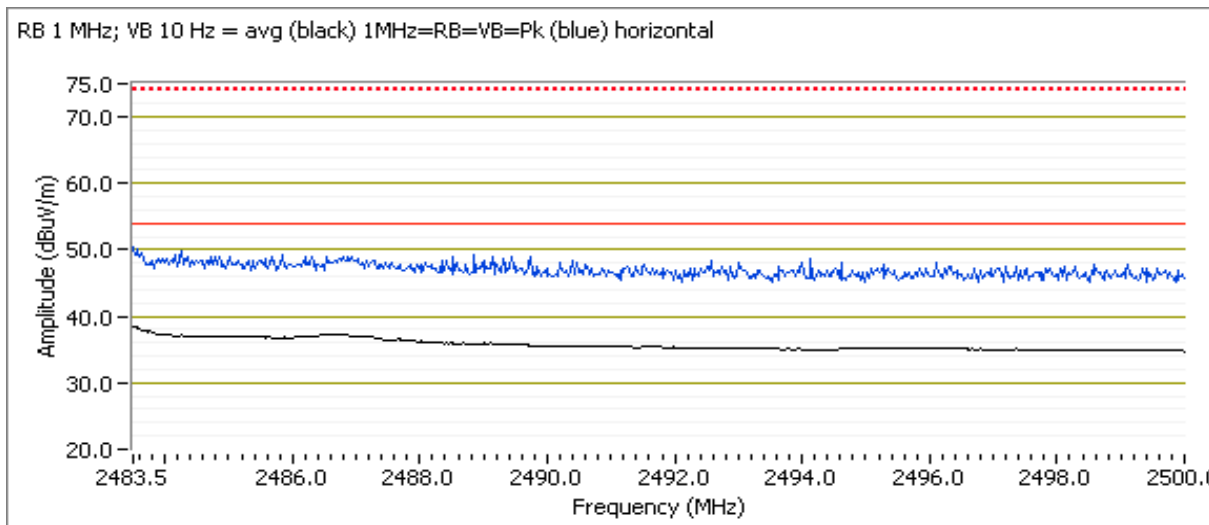

Client:	Intel Corporation	Job Number:	J84364
Model:	Intel® Centrino® Wireless-N 2230	T-Log Number:	T84599
Contact:	Steve Hackett	Account Manager:	Christine Krebill
Standard:	FCC 15.247	Class:	N/A

**Run # 2, Band Edge Field Strength - 802.11g, Chain A**

Date of Test: 9/21/2011

Test Location: FT Chamber#7

Test Engineer: M. Birgani/ Joseph Cadigal

Config Change: None

**Run # 2a, EUT on Channel #1 2412MHz - 802.11g, Chain A**

	Power Settings		
	Target (dBm)	Measured (dBm)	Software Setting
Chain A	14.2	14.3	26.0

**2390 MHz Band Edge Signal Field Strength**

Frequency	Level	Pol	15.209 / 15.247		Detector	Azimuth	Height	Comments
MHz	dB $\mu$ V/m	v/h	Limit	Margin	Pk/QP/Avg	degrees	meters	
2390.000	45.7	V	54.0	-8.3	AVG	281	1.0	RB 1 MHz;VB 10 Hz;Pk
2389.870	60.5	V	74.0	-13.5	PK	281	1.0	RB 1 MHz;VB 3 MHz;Pk
2390.000	45.1	H	54.0	-8.9	AVG	0	1.0	RB 1 MHz;VB 10 Hz;Pk
2389.670	60.3	H	74.0	-13.7	PK	0	1.0	RB 1 MHz;VB 3 MHz;Pk

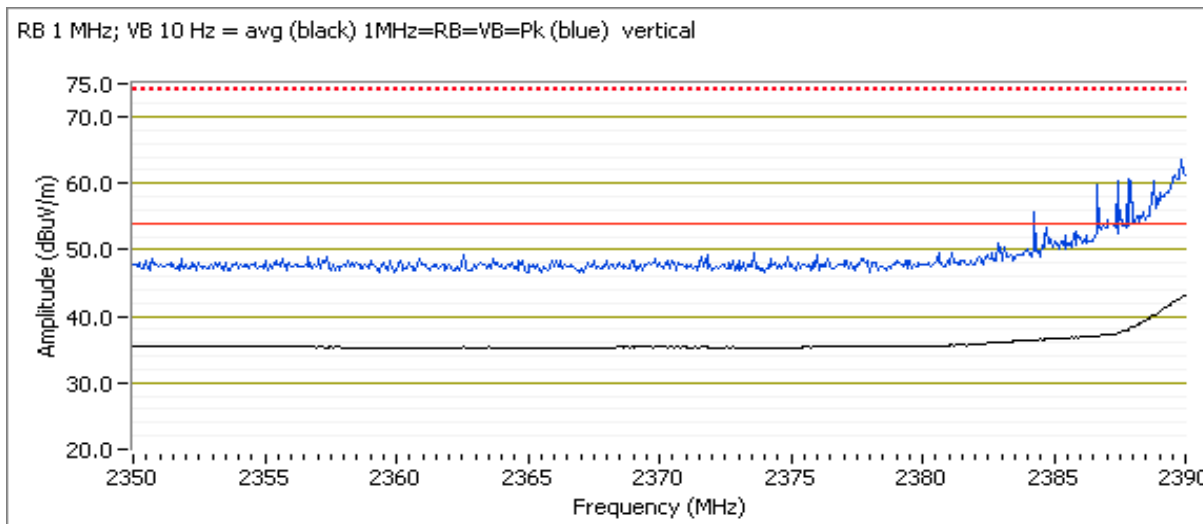

Client:	Intel Corporation	Job Number:	J84364
Model:	Intel® Centrino® Wireless-N 2230	T-Log Number:	T84599
Contact:	Steve Hackett	Account Manager:	Christine Krebill
Standard:	FCC 15.247	Class:	N/A

Run # 2b, EUT on Channel #10 2457MHz - 802.11g, Chain A

	Target (dBm)	Power Settings Measured (dBm)	Software Setting
Chain A	16.7	16.8	29.5

**2483.5 MHz Band Edge Signal Radiated Field Strength**

Frequency	Level	Pol	15.209 / 15.247		Detector	Azimuth	Height	Comments
MHz	dB $\mu$ V/m	v/h	Limit	Margin	PK/QP/Avg	degrees	meters	
2483.500	47.1	H	54.0	-6.9	AVG	303	1.1	RB 1 MHz;VB 10 Hz;Pk
2483.530	46.5	V	54.0	-7.5	AVG	275	1.0	RB 1 MHz;VB 10 Hz;Pk
2485.150	62.7	H	74.0	-11.3	PK	303	1.1	RB 1 MHz;VB 3 MHz;Pk
2485.750	61.7	V	74.0	-12.3	PK	275	1.0	RB 1 MHz;VB 3 MHz;Pk

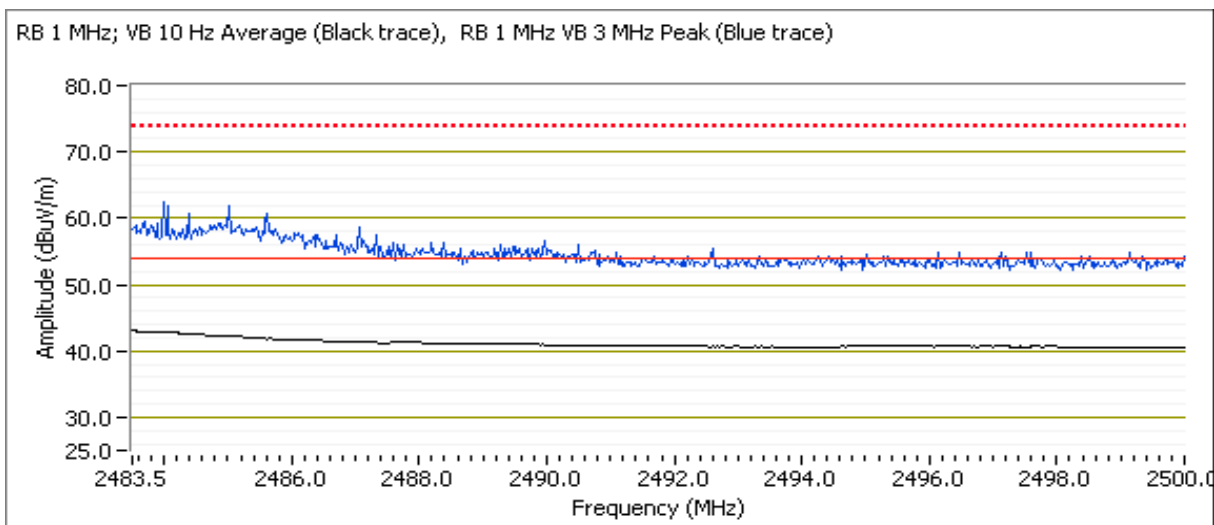



Client:	Intel Corporation	Job Number:	J84364
Model:	Intel® Centrino® Wireless-N 2230	T-Log Number:	T84599
Contact:	Steve Hackett	Account Manager:	Christine Krebill
Standard:	FCC 15.247	Class:	N/A

Run # 2c, EUT on Channel #11 2462MHz - 802.11g, Chain A

	Target (dBm)	Power Settings Measured (dBm)	Software Setting
Chain A	14.2	14.4	26.5

**2483.5 MHz Band Edge Signal Radiated Field Strength**

Frequency	Level	Pol	15.209 / 15.247		Detector	Azimuth	Height	Comments
MHz	dB $\mu$ V/m	v/h	Limit	Margin	PK/QP/Avg	degrees	meters	
2483.530	52.4	H	54.0	-1.6	AVG	28	1.0	RB 1 MHz;VB 10 Hz;Pk
2483.500	50.1	V	54.0	-3.9	AVG	280	1.1	RB 1 MHz;VB 10 Hz;Pk
2483.830	69.4	H	74.0	-4.6	PK	28	1.0	RB 1 MHz;VB 3 MHz;Pk
2483.860	66.0	V	74.0	-8.0	PK	280	1.1	RB 1 MHz;VB 3 MHz;Pk

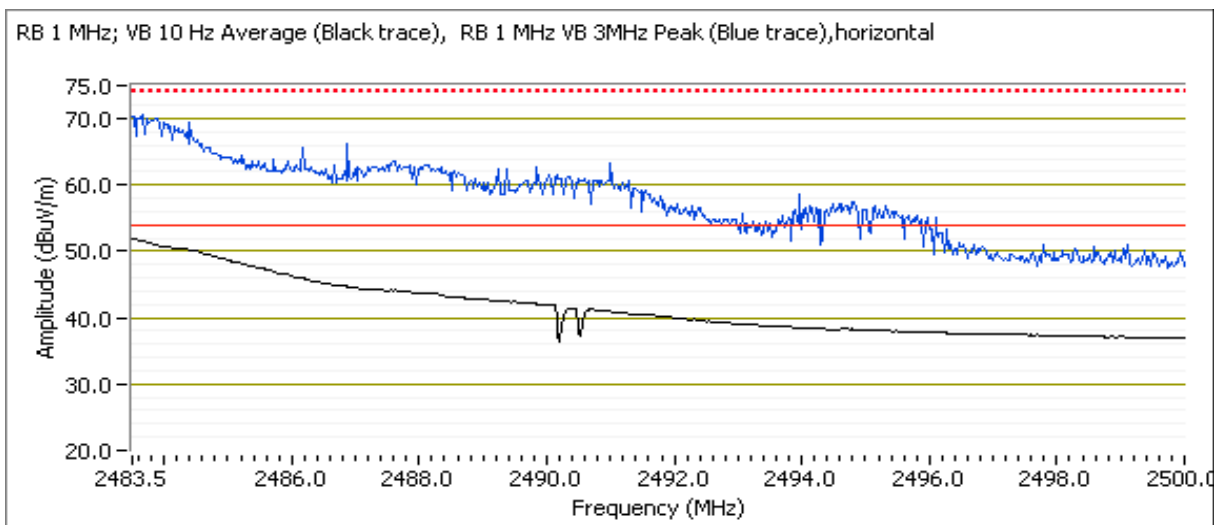

Client:	Intel Corporation	Job Number:	J84364
Model:	Intel® Centrino® Wireless-N 2230	T-Log Number:	T84599
Contact:	Steve Hackett	Account Manager:	Christine Krebill
Standard:	FCC 15.247	Class:	N/A

**Run # 3, Band Edge Field Strength - 802.11n20, Chain A**

Date of Test: 9/21/2011  
 Test Engineer: M. Birgani / Joseph Cadigal  
 Test Location: FT Chamber#7  
 Config Change: None

**Run # 3a, EUT on Channel #1 2412MHz - 802.11n20, Chain A**

	Target (dBm)	Power Settings Measured (dBm)	Software Setting
Chain A	13.2	13.3	24.0

**2390 MHz Band Edge Signal Field Strength**

Frequency	Level	Pol	15.209 / 15.247		Detector	Azimuth	Height	Comments
MHz	dB $\mu$ V/m	v/h	Limit	Margin	Pk/QP/Avg	degrees	meters	
2390.000	46.5	H	54.0	-7.5	AVG	21	1.0	RB 1 MHz;VB 10 Hz;Pk
2389.670	61.2	H	74.0	-12.8	PK	21	1.0	RB 1 MHz;VB 3 MHz;Pk
2390.000	45.7	V	54.0	-8.3	AVG	282	1.0	RB 1 MHz;VB 10 Hz;Pk
2389.930	63.0	V	74.0	-11.0	PK	282	1.0	RB 1 MHz;VB 3 MHz;Pk

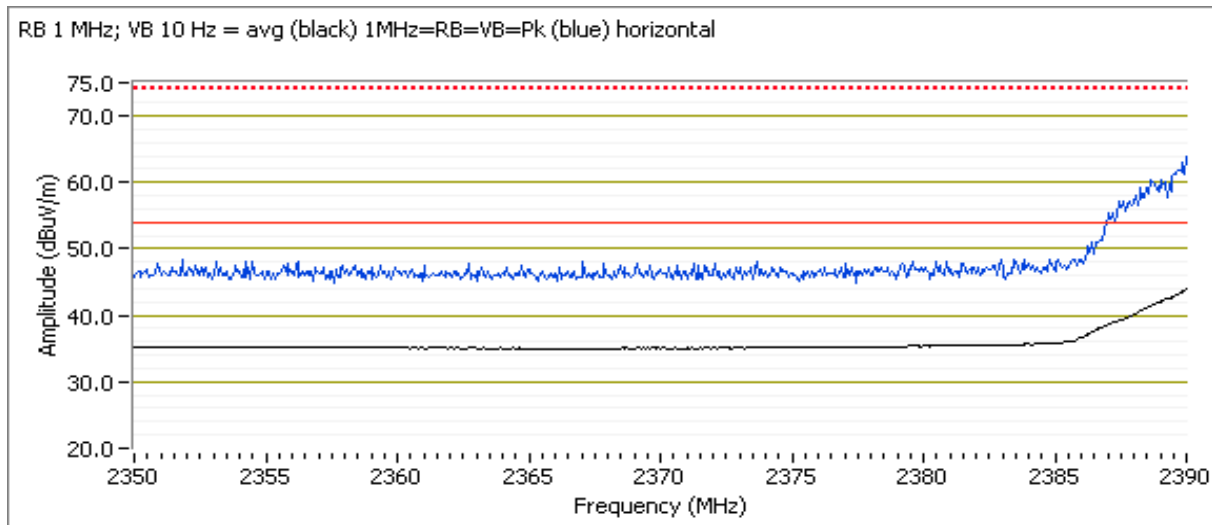

Client:	Intel Corporation	Job Number:	J84364
Model:	Intel® Centrino® Wireless-N 2230	T-Log Number:	T84599
Contact:	Steve Hackett	Account Manager:	Christine Krebill
Standard:	FCC 15.247	Class:	N/A

Run # 3b, EUT on Channel #2 2417MHz - 802.11n20, Chain A

	Target (dBm)	Power Settings Measured (dBm)	Software Setting
Chain A	15.7	15.7	27.5

2390 MHz Band Edge Signal Field Strength

Frequency	Level	Pol	15.209 / 15.247		Detector	Azimuth	Height	Comments
MHz	dB $\mu$ V/m	v/h	Limit	Margin	PK/QP/Avg	degrees	meters	
2390.000	42.5	H	54.0	-11.5	AVG	21	1.0	RB 1 MHz;VB 10 Hz;Pk
2389.800	57.0	H	74.0	-17.0	PK	21	1.0	RB 1 MHz;VB 3 MHz;Pk
2390.000	42.3	V	54.0	-11.7	AVG	281	1.0	RB 1 MHz;VB 10 Hz;Pk
2388.000	57.8	V	74.0	-16.2	PK	281	1.0	RB 1 MHz;VB 3 MHz;Pk

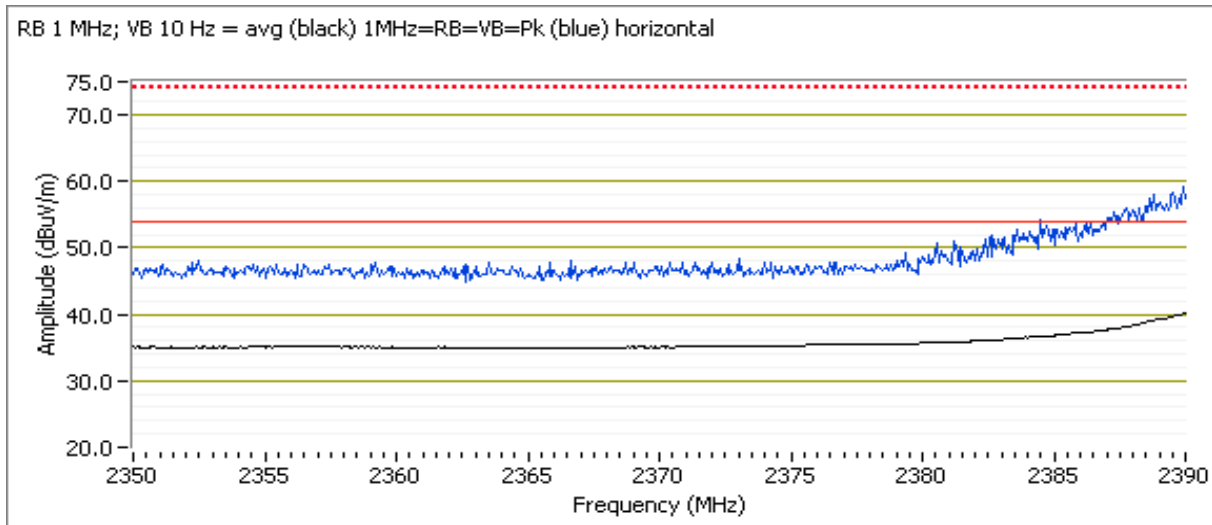

Client:	Intel Corporation	Job Number:	J84364
Model:	Intel® Centrino® Wireless-N 2230	T-Log Number:	T84599
Contact:	Steve Hackett	Account Manager:	Christine Krebill
Standard:	FCC 15.247	Class:	N/A

Run # 3c, EUT on Channel #10 2457MHz - 802.11n20, Chain A

	Target (dBm)	Power Settings Measured (dBm)	Software Setting
Chain A	16.7	16.8	29.5

**2390 MHz Band Edge Signal Field Strength**

Frequency MHz	Level dB $\mu$ V/m	Pol v/h	15.209 / 15.247		Detector PK/QP/Avg	Azimuth degrees	Height meters	Comments
			Limit	Margin				
2483.500	49.8	H	54.0	-4.2	AVG	307	1.2	RB 1 MHz;VB 10 Hz;Pk
2483.500	48.6	V	54.0	-5.4	AVG	277	1.0	RB 1 MHz;VB 10 Hz;Pk
2483.660	64.1	V	74.0	-9.9	PK	277	1.0	RB 1 MHz;VB 3 MHz;Pk
2484.380	64.0	H	74.0	-10.0	PK	307	1.2	RB 1 MHz;VB 3 MHz;Pk

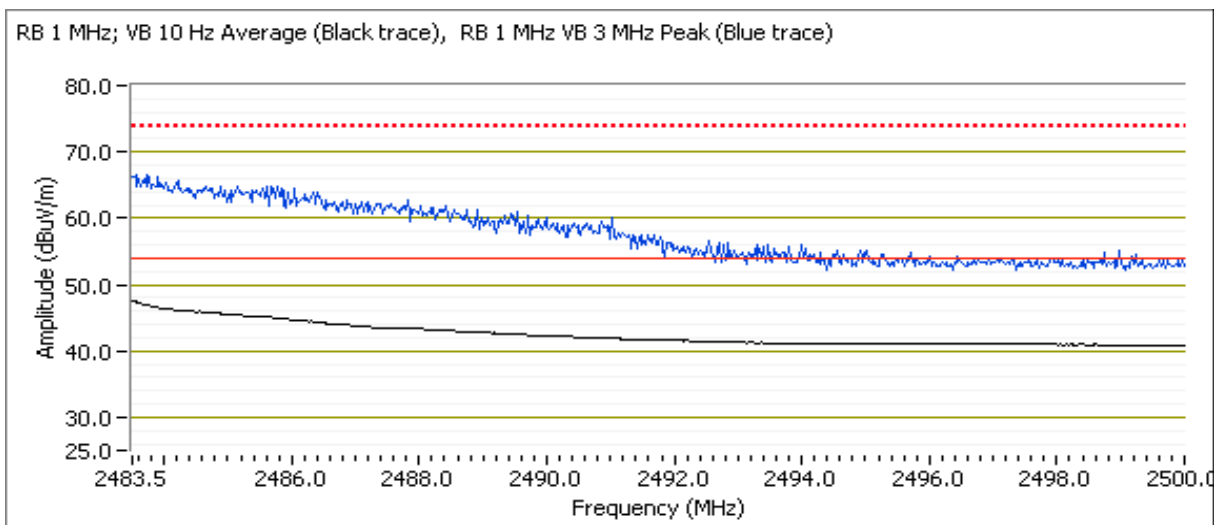

Client:	Intel Corporation	Job Number:	J84364
Model:	Intel® Centrino® Wireless-N 2230	T-Log Number:	T84599
Contact:	Steve Hackett	Account Manager:	Christine Krebill
Standard:	FCC 15.247	Class:	N/A

Run # 3d, EUT on Channel #11 2462MHz - 802.11n20, Chain A

	Target (dBm)	Power Settings Measured (dBm)	Software Setting
Chain A	13.2	13.4	25.5

### 2483.5 MHz Band Edge Signal Radiated Field Strength

Frequency	Level	Pol	15.209 / 15.247		Detector	Azimuth	Height	Comments
MHz	dB $\mu$ V/m	v/h	Limit	Margin	PK/QP/Avg	degrees	meters	
2483.530	50.4	H	54.0	-3.6	AVG	18	1.0	RB 1 MHz;VB 10 Hz;Pk
2483.500	49.9	V	54.0	-4.1	AVG	277	1.0	RB 1 MHz;VB 10 Hz;Pk
2483.640	66.9	H	74.0	-7.1	PK	18	1.0	RB 1 MHz;VB 3 MHz;Pk
2483.610	66.6	V	74.0	-7.4	PK	277	1.0	RB 1 MHz;VB 3 MHz;Pk

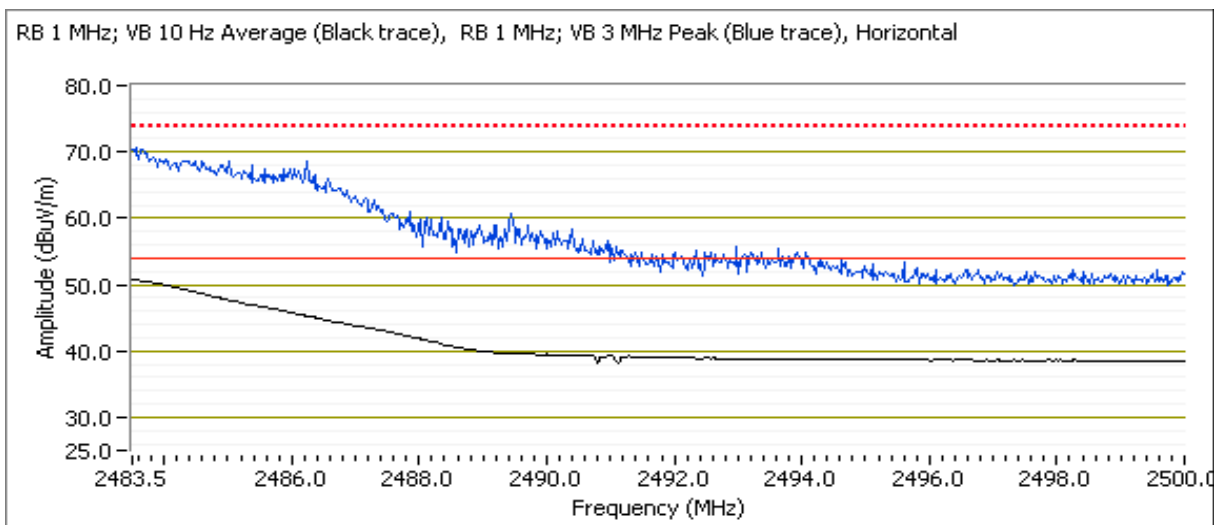

Client:	Intel Corporation	Job Number:	J84364
Model:	Intel® Centrino® Wireless-N 2230	T-Log Number:	T84599
Contact:	Steve Hackett	Account Manager:	Christine Krebill
Standard:	FCC 15.247	Class:	N/A

**Run # 4, Band Edge Field Strength - 802.11n40, Chain A**

Date of Test: 9/21/2011  
 Test Engineer: M. Birgani / Joseph Cadigal  
 Test Location: FT Chamber#7  
 Config Change: None

**Run # 4a, EUT on Channel #3 2422MHz - 802.11n40, Chain A**

	Target (dBm)	Power Settings Measured (dBm)	Software Setting
Chain A	10.7	10.7	21.5

**2390 MHz Band Edge Signal Field Strength**

Frequency	Level	Pol	15.209 / 15.247		Detector	Azimuth	Height	Comments
MHz	dB $\mu$ V/m	v/h	Limit	Margin	Pk/QP/Avg	degrees	meters	
2389.730	47.3	V	54.0	-6.7	AVG	283	1.0	RB 1 MHz;VB 10 Hz;Pk
2389.070	61.0	V	74.0	-13.0	PK	283	1.0	RB 1 MHz;VB 3 MHz;Pk
2390.000	45.7	H	54.0	-8.3	AVG	16	1.0	RB 1 MHz;VB 10 Hz;Pk
2388.730	57.5	H	74.0	-16.5	PK	16	1.0	RB 1 MHz;VB 3 MHz;Pk

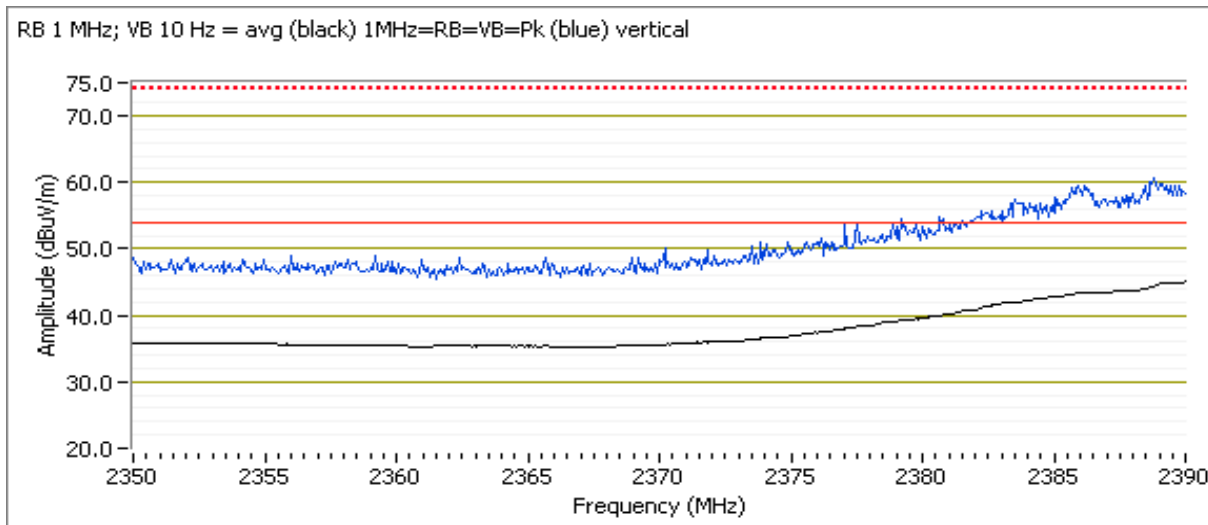

Client:	Intel Corporation	Job Number:	J84364
Model:	Intel® Centrino® Wireless-N 2230	T-Log Number:	T84599
Contact:	Steve Hackett	Account Manager:	Christine Krebill
Standard:	FCC 15.247	Class:	N/A

Run # 4b, EUT on Channel #4 2427MHz - 802.11n40, Chain A

	Target (dBm)	Power Settings Measured (dBm)	Software Setting
Chain A	11.7	11.9	23.5

*2390 MHz Band Edge Signal Field Strength*

Frequency	Level	Pol	15.209 / 15.247		Detector	Azimuth	Height	Comments
MHz	dB $\mu$ V/m	v/h	Limit	Margin	PK/QP/Avg	degrees	meters	
2390.000	53.0	V	54.0	-1.0	AVG	186	1.5	RB 1 MHz;VB 10 Hz;Pk
2389.800	51.9	H	54.0	-2.1	AVG	310	1.2	RB 1 MHz;VB 10 Hz;Pk
2388.600	65.8	V	74.0	-8.2	PK	186	1.5	RB 1 MHz;VB 3 MHz;Pk
2389.800	64.0	H	74.0	-10.0	PK	310	1.2	RB 1 MHz;VB 3 MHz;Pk

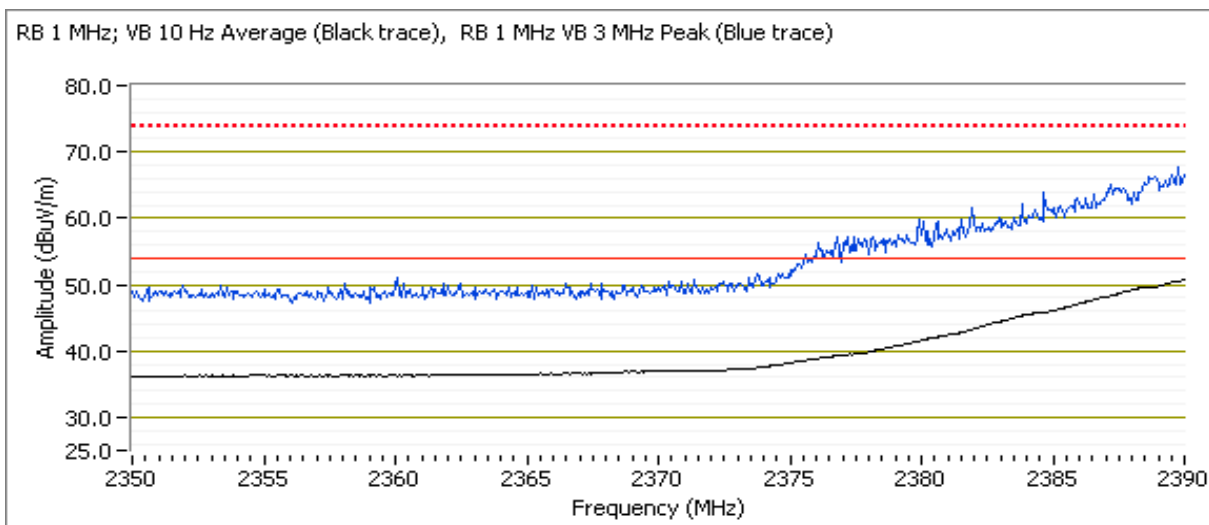

2389.600	59.1	H	54.0	5.1	AVG	310	1.2	Measured power 14.4dBm
2387.470	72.4	H	74.0	-1.6	PK	310	1.2	Measured power 14.4dBm

Client:	Intel Corporation	Job Number:	J84364
Model:	Intel® Centrino® Wireless-N 2230	T-Log Number:	T84599
Contact:	Steve Hackett	Account Manager:	Christine Krebill
Standard:	FCC 15.247	Class:	N/A

Run # 4c, EUT on Channel #5 2432MHz - 802.11n40, Chain A

	Target (dBm)	Power Settings Measured (dBm)	Software Setting
Chain A	12.7	12.8	24.0

*2390 MHz Band Edge Signal Field Strength*

Frequency	Level	Pol	15.209 / 15.247		Detector	Azimuth	Height	Comments
MHz	dB $\mu$ V/m	v/h	Limit	Margin	PK/QP/Avg	degrees	meters	
2389.930	47.1	V	54.0	-6.9	AVG	279	1.0	RB 1 MHz;VB 10 Hz;Pk
2389.800	60.2	V	74.0	-13.8	PK	279	1.0	RB 1 MHz;VB 3 MHz;Pk
2390.000	46.2	H	54.0	-7.8	AVG	17	1.0	RB 1 MHz;VB 10 Hz;Pk
2389.130	57.3	H	74.0	-16.7	PK	17	1.0	RB 1 MHz;VB 3 MHz;Pk

RB 1 MHz; VB 10 Hz = avg (black) 1MHz=RB=VB=Pk (blue) vertical

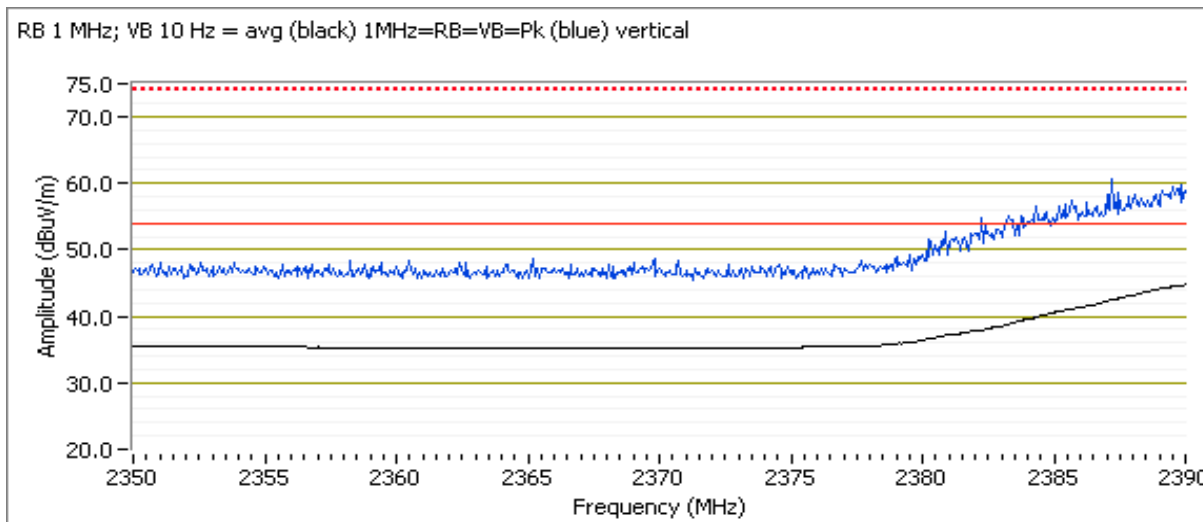



Client:	Intel Corporation	Job Number:	J84364
Model:	Intel® Centrino® Wireless-N 2230	T-Log Number:	T84599
Contact:	Steve Hackett	Account Manager:	Christine Krebill
Standard:	FCC 15.247	Class:	N/A

Run # 4d, EUT on Channel #6 2437MHz - 802.11n40, Chain A

	Target (dBm)	Power Settings Measured (dBm)	Software Setting
Chain A	13.7	13.8	25.5

*2390 MHz Band Edge Signal Field Strength*

Frequency	Level	Pol	15.209 / 15.247		Detector	Azimuth	Height	Comments
MHz	dB $\mu$ V/m	v/h	Limit	Margin	PK/QP/Avg	degrees	meters	
2390.000	46.7	H	54.0	-7.3	AVG	22	1.0	RB 1 MHz;VB 10 Hz;Pk
2389.200	60.2	H	74.0	-13.8	PK	22	1.0	RB 1 MHz;VB 3 MHz;Pk
2390.000	45.3	V	54.0	-8.7	AVG	279	1.0	RB 1 MHz;VB 10 Hz;Pk
2387.330	59.7	V	74.0	-14.3	PK	279	1.0	RB 1 MHz;VB 3 MHz;Pk

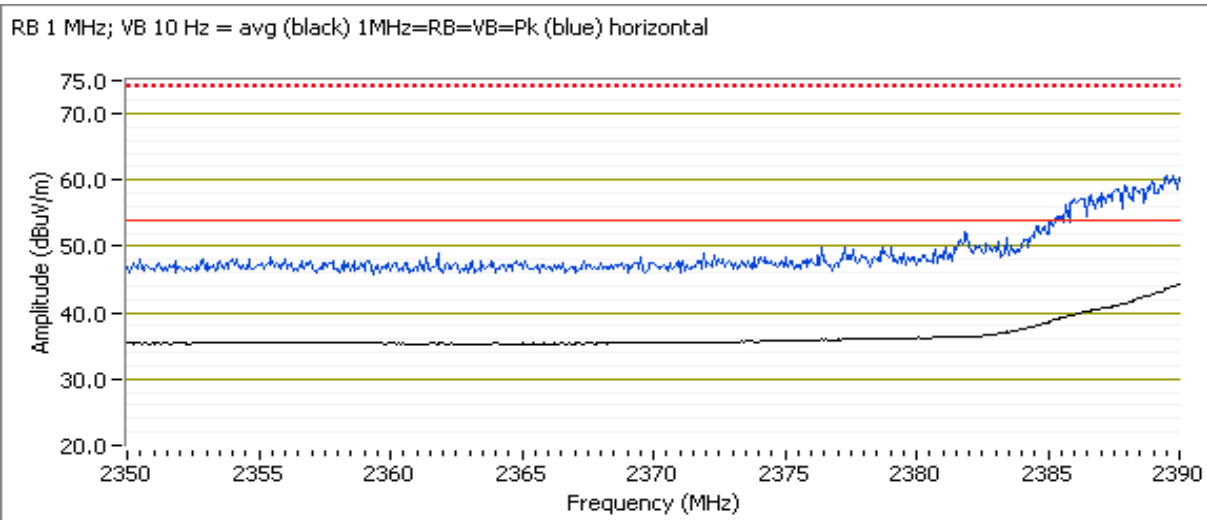

Client:	Intel Corporation	Job Number:	J84364
Model:	Intel® Centrino® Wireless-N 2230	T-Log Number:	T84599
Contact:	Steve Hackett	Account Manager:	Christine Krebill
Standard:	FCC 15.247	Class:	N/A

### 2483.5 MHz Band Edge Signal Field Strength

Frequency	Level	Pol	15.209 / 15.247		Detector	Azimuth	Height	Comments
MHz	dB $\mu$ V/m	v/h	Limit	Margin	PK/QP/Avg	degrees	meters	
2483.500	45.4	H	54.0	-8.6	AVG	21	1.0	RB 1 MHz;VB 10 Hz;Pk
2484.160	59.0	H	74.0	-15.0	PK	21	1.0	RB 1 MHz;VB 3 MHz;Pk
2483.500	45.0	V	54.0	-9.0	AVG	280	1.0	RB 1 MHz;VB 10 Hz;Pk
2483.580	59.8	V	74.0	-14.2	PK	280	1.0	RB 1 MHz;VB 3 MHz;Pk

RB 1 MHz; VB 10 Hz = avg (black) 1MHz=RB=VB=Pk (blue) vertical

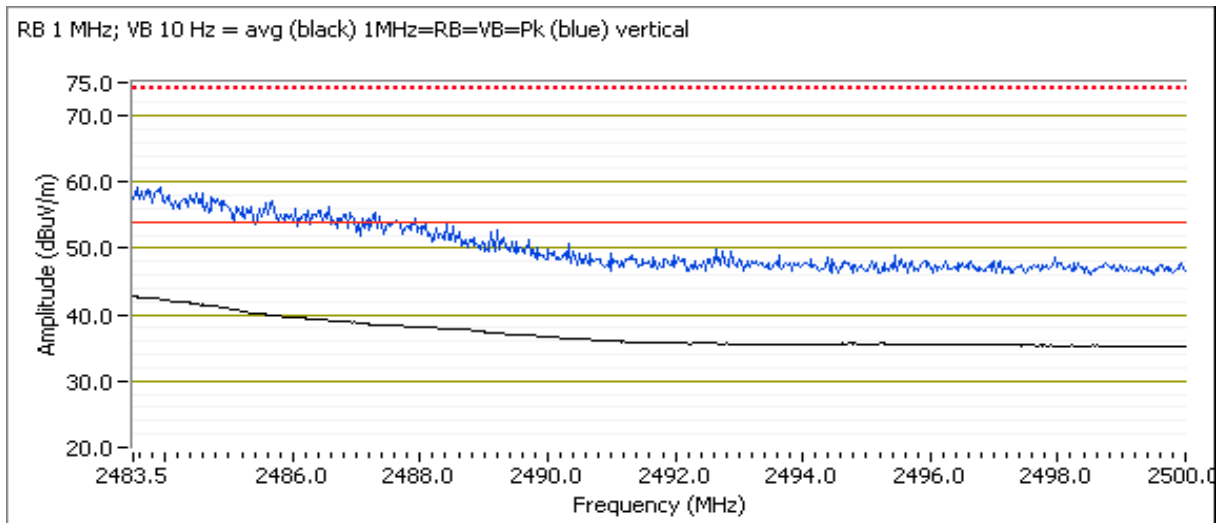

RB 1 MHz; VB 10 Hz = avg (black) 1MHz=RB=VB=Pk (blue) horizontal

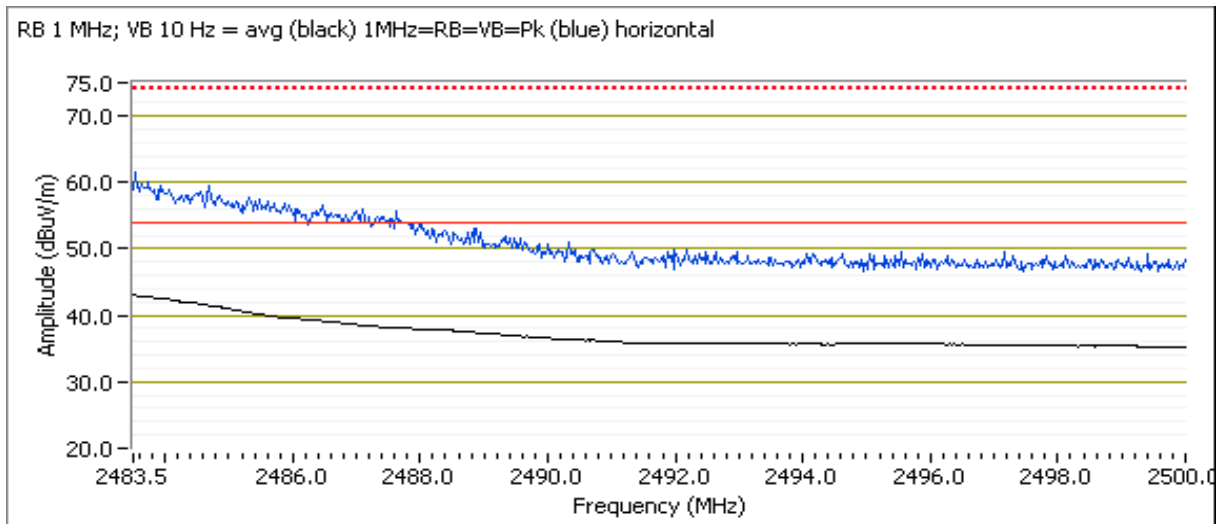

Client:	Intel Corporation	Job Number:	J84364
Model:	Intel® Centrino® Wireless-N 2230	T-Log Number:	T84599
Contact:	Steve Hackett	Account Manager:	Christine Krebill
Standard:	FCC 15.247	Class:	N/A

Run # 4e, EUT on Channel #7 2442MHz - 802.11n40, Chain A

	Target (dBm)	Power Settings Measured (dBm)	Software Setting
Chain A	13.2	13.1	24.5

*2390 MHz Band Edge Signal Field Strength*

Frequency	Level	Pol	15.209 / 15.247		Detector	Azimuth	Height	Comments
MHz	dB $\mu$ V/m	v/h	Limit	Margin	PK/QP/Avg	degrees	meters	
2483.530	52.8	V	54.0	-1.2	AVG	186	1.4	RB 1 MHz;VB 10 Hz;Pk
2483.500	48.6	H	54.0	-5.4	AVG	360	1.1	RB 1 MHz;VB 10 Hz;Pk
2483.530	64.6	V	74.0	-9.4	PK	186	1.4	RB 1 MHz;VB 3 MHz;Pk
2485.890	61.1	H	74.0	-12.9	PK	360	1.1	RB 1 MHz;VB 3 MHz;Pk

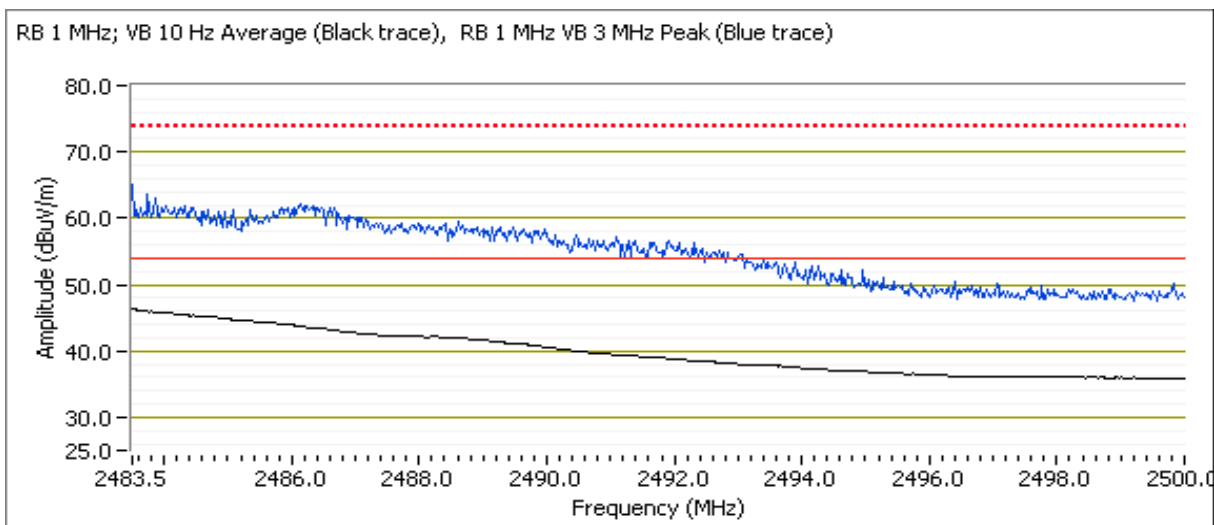

2483.500	55.9	V	54.0	1.9	AVG	186	1.4	Measured power 14.2dBm
2486.280	68.4	V	74.0	-5.6	PK	186	1.4	Measured power 14.2dBm

Client:	Intel Corporation	Job Number:	J84364
Model:	Intel® Centrino® Wireless-N 2230	T-Log Number:	T84599
Contact:	Steve Hackett	Account Manager:	Christine Krebill
Standard:	FCC 15.247	Class:	N/A

Run # 4f, EUT on Channel #8 2447MHz - 802.11n40, Chain A

	Target (dBm)	Power Settings Measured (dBm)	Software Setting
Chain A	11.7	11.9	23.0

*2390 MHz Band Edge Signal Field Strength*

Frequency	Level	Pol	15.209 / 15.247		Detector	Azimuth	Height	Comments
MHz	dB $\mu$ V/m	v/h	Limit	Margin	PK/QP/Avg	degrees	meters	
2483.530	52.0	V	54.0	-2.0	AVG	186	1.4	RB 1 MHz;VB 10 Hz;Pk
2483.530	47.9	H	54.0	-6.1	AVG	356	1.4	RB 1 MHz;VB 10 Hz;Pk
2483.770	66.1	V	74.0	-7.9	PK	186	1.4	RB 1 MHz;VB 3 MHz;Pk
2483.640	62.2	H	74.0	-11.8	PK	356	1.4	RB 1 MHz;VB 3 MHz;Pk

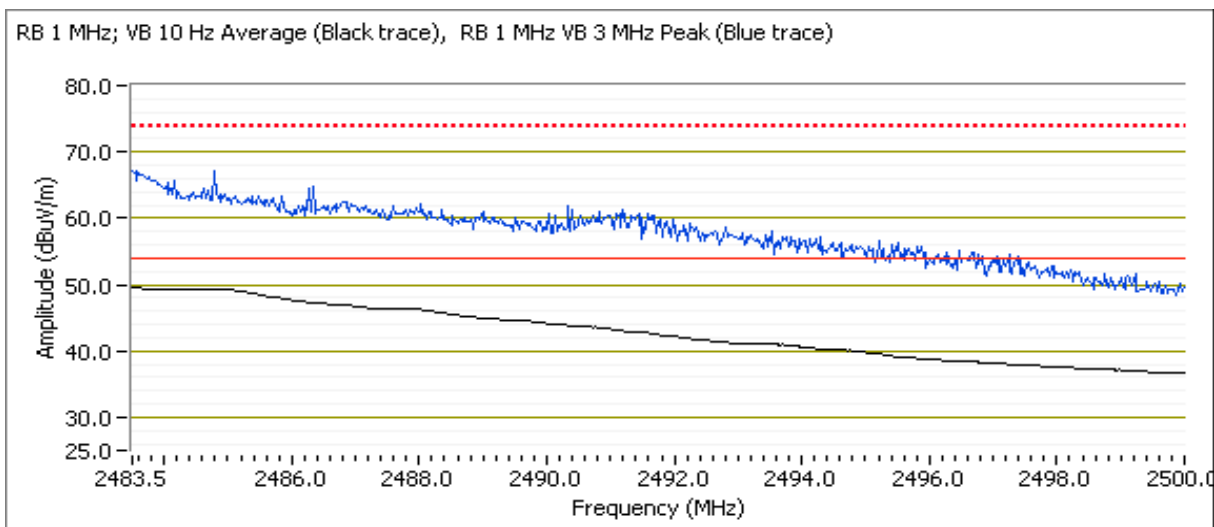

2483.530	58.6	V	54.0	4.6	AVG	186	1.4	Measured power 14.2dBm
2483.580	71.8	V	74.0	-2.2	PK	186	1.4	Measured power 14.2dBm

Client:	Intel Corporation	Job Number:	J84364
Model:	Intel® Centrino® Wireless-N 2230	T-Log Number:	T84599
Contact:	Steve Hackett	Account Manager:	Christine Krebill
Standard:	FCC 15.247	Class:	N/A

Run # 4e, EUT on Channel #9 2452MHz - 802.11n40, Chain A

	Target (dBm)	Power Settings Measured (dBm)	Software Setting
Chain A	10.7	10.7	22.0

**2483.5 MHz Band Edge Signal Radiated Field Strength**

Frequency MHz	Level dBμV/m	Pol v/h	15.209 / 15.247		Detector PK/QP/Avg	Azimuth degrees	Height meters	Comments
			Limit	Margin				
2483.640	47.8	H	54.0	-6.2	AVG	190	1.0	RB 1 MHz;VB 10 Hz;Pk
2488.370	60.5	H	74.0	-13.5	PK	190	1.0	RB 1 MHz;VB 3 MHz;Pk
2483.550	47.4	V	54.0	-6.6	AVG	274	1.0	RB 1 MHz;VB 10 Hz;Pk
2488.040	60.3	V	74.0	-13.7	PK	274	1.0	RB 1 MHz;VB 3 MHz;Pk

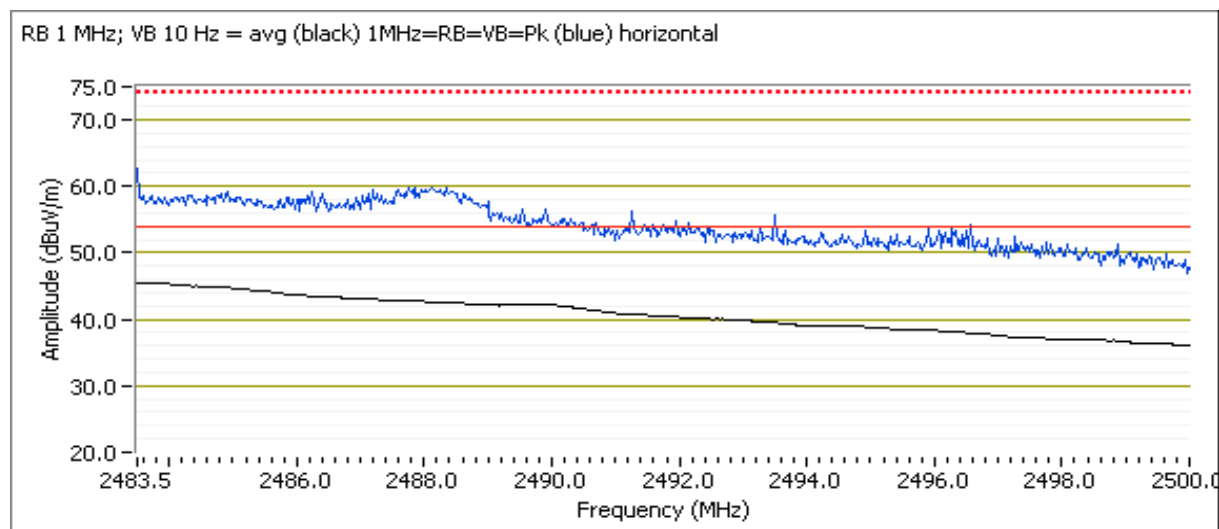

Client:	Intel Corporation	Job Number:	J84364
Model:	Intel® Centrino® Wireless-N 2230	T-Log Number:	T84599
		Account Manager:	Christine Krebill
Contact:	Steve Hackett		
Standard:	FCC 15.247	Class:	N/A

## RSS 210 and FCC 15.247 (DTS) Radiated Spurious Emissions

### Test Specific Details

Objective: The objective of this test session is to perform final qualification testing of the EUT with respect to the specification listed above.

### General Test Configuration

The EUT and all local support equipment were located on the turntable for radiated spurious emissions testing.

For radiated emissions testing the measurement antenna was located 3 meters from the EUT.

### Ambient Conditions:

Temperature: 17-20 °C  
Rel. Humidity: 30-40 %

### Modifications Made During Testing

No modifications were made to the EUT during testing

### Deviations From The Standard

No deviations were made from the requirements of the standard.

If power is more than 3dB below center channel target to pass on lowest and/or highest channel, repeat measurements at target power for next lowest or highest channel

Use the **Gain Control** mode of adjusting power. Set power to within  $\pm 0.2$ dB of target (dial in closer to the target value within  $\pm 0.2$ dB if possible and not just a passing value above the target).

Note - the target and measured power are average powers (measured with average power sensor) and are used for reference purposes only. Power is set using " **GAIN CONTROL**" mode in the DRTU tool.

Client:	Intel Corporation	Job Number:	J84364
Model:	Intel® Centrino® Wireless-N 2230	T-Log Number:	T84599
Contact:	Steve Hackett	Account Manager:	Christine Krebill
Standard:	FCC 15.247	Class:	N/A

**Summary of Results - Device Operating in the 2400-2483.5 MHz Band**

MAC Address: 00150082509B DRTU Tool Version 1.5.3.0322 Driver version 15.0.0.61

Run #	Mode	Channel	Target Power	Measured Power	Test Performed	Limit	Result / Margin
Run # 1	802.11b Chain B	#1 2412MHz	14.7	14.9	Restricted Band Edge at 2390 MHz	15.209	47.4dBµV/m @ 2389.9MHz (-6.6dB)
		#11 2462MHz	14.7	14.8	Restricted Band Edge at 2483.5 MHz	15.209	48.6dBµV/m @ 2483.5MHz (-5.4dB)
Run # 2	802.11g Chain B	#1 2412MHz	13.7	13.7	Restricted Band Edge at 2390 MHz	15.209	51.7dBµV/m @ 2389.9MHz (-2.3dB)
		#11 2462MHz	14.2	14.2	Restricted Band Edge at 2483.5 MHz	15.209	51.3dBµV/m @ 2483.6MHz (-2.7dB)
Run # 3	802.11n20 Chain B	#1 2412MHz	12.7	12.8	Restricted Band Edge at 2390 MHz	15.209	46.0dBµV/m @ 2390.0MHz (-8.0dB)
		#2 2417MHz	15.7	15.7	Restricted Band Edge at 2483.5 MHz	15.209	50.5dBµV/m @ 2389.9MHz (-3.5dB)
		#10 2457MHz	16.7	16.7	Restricted Band Edge at 2483.5 MHz	15.209	47.0dBµV/m @ 2483.5MHz (-7.0dB)
		#11 2462MHz	13.2	13.4	Restricted Band Edge at 2483.5 MHz	15.209	52.3dBµV/m @ 2483.5MHz (-1.7dB)
Run # 4	802.11n40 Chain B	#3 2422MHz	9.7	9.8	Restricted Band Edge at 2390 MHz	15.209	45.5dBµV/m @ 2389.9MHz (-8.5dB)
		#4 2427MHz	10.7	10.9	Restricted Band Edge at 2390 MHz	15.209	53.2dBµV/m @ 2390.0MHz (-0.8dB)
		#5 2432MHz	12.2	12.2	Restricted Band Edge at 2390 MHz	15.209	53.1dBµV/m @ 2389.9MHz (-0.9dB)
		#6 2437MHz	14.2	14.4	Restricted Band Edge at 2390 MHz	15.209	49.7dBµV/m @ 2390.0MHz (-4.3dB)
		#8 2447MHz	12.2	12.4	Restricted Band Edge at 2483.5 MHz	15.209	53.1dBµV/m @ 2483.5MHz (-0.9dB)
		#9 2452MHz	10.7	10.9	Restricted Band Edge at 2483.5 MHz	15.209	52.0dBµV/m @ 2483.5MHz (-2.0dB)

Client:	Intel Corporation	Job Number:	J84364
Model:	Intel® Centrino® Wireless-N 2230	T-Log Number:	T84599
Contact:	Steve Hackett	Account Manager:	Christine Krebill
Standard:	FCC 15.247	Class:	N/A

**Run # 1, Band Edge Field Strength - 802.11b, Chain B**

Date of Test: 10/11/2011      Test Location: FT Chamber#7  
 Test Engineer: Rafael Varelas      Config Change: None

**Run # 1a, EUT on Channel #1 2412MHz - 802.11b, Chain B**

	Target (dBm)	Power Settings Measured (dBm)	Software Setting
Chain B	14.7	14.9	22.5

**2390 MHz Band Edge Signal Field Strength**

Frequency	Level	Pol	15.209 / 15.247		Detector	Azimuth	Height	Comments
MHz	dB $\mu$ V/m	v/h	Limit	Margin	Pk/QP/Avg	degrees	meters	
2389.870	47.4	V	54.0	-6.6	AVG	96	1.1	RB 1 MHz;VB 10 Hz;Pk
2389.700	58.8	V	74.0	-15.2	PK	96	1.1	RB 1 MHz;VB 3 MHz;Pk
2387.350	47.4	H	54.0	-6.6	AVG	318	1.0	RB 1 MHz;VB 10 Hz;Pk
2387.120	59.2	H	74.0	-14.8	PK	318	1.0	RB 1 MHz;VB 3 MHz;Pk

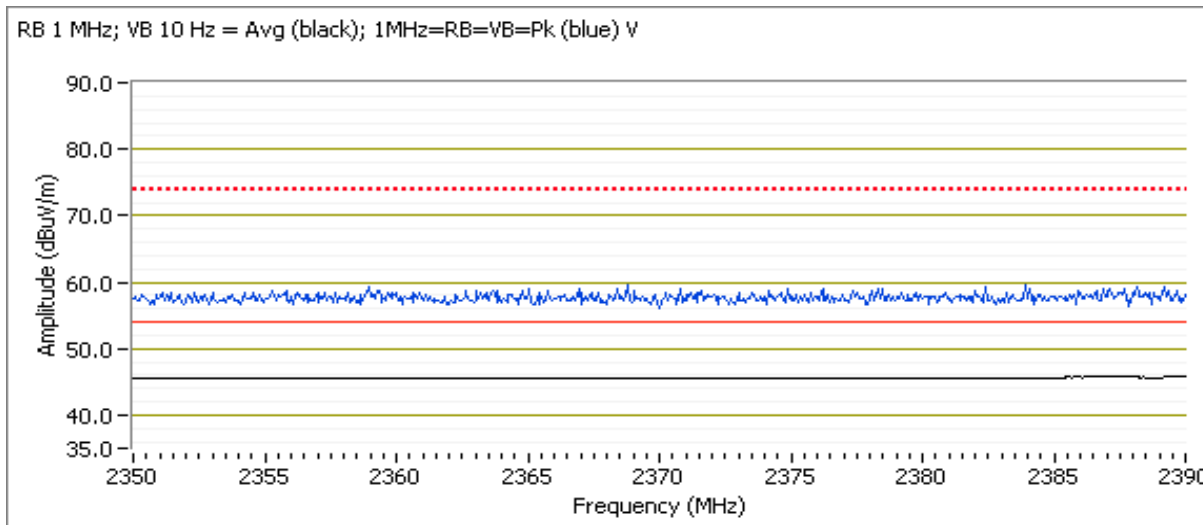



Client:	Intel Corporation	Job Number:	J84364
Model:	Intel® Centrino® Wireless-N 2230	T-Log Number:	T84599
Contact:	Steve Hackett	Account Manager:	Christine Krebill
Standard:	FCC 15.247	Class:	N/A

Run # 1b, EUT on Channel #11 2462MHz - 802.11b, Chain B

	Target (dBm)	Power Settings Measured (dBm)	Software Setting
Chain B	14.7	14.8	22.5

*2483.5 MHz Band Edge Signal Radiated Field Strength*

Frequency	Level	Pol	15.209 / 15.247		Detector	Azimuth	Height	Comments
MHz	dB $\mu$ V/m	v/h	Limit	Margin	PK/QP/Avg	degrees	meters	
2483.500	48.6	H	54.0	-5.4	AVG	357	1.0	RB 1 MHz;VB 10 Hz;Pk
2485.790	59.5	H	74.0	-14.5	PK	357	1.0	RB 1 MHz;VB 3 MHz;Pk
2483.500	47.9	V	54.0	-6.1	AVG	0	1.0	RB 1 MHz;VB 10 Hz;Pk
2483.680	59.2	V	74.0	-14.8	PK	0	1.0	RB 1 MHz;VB 3 MHz;Pk

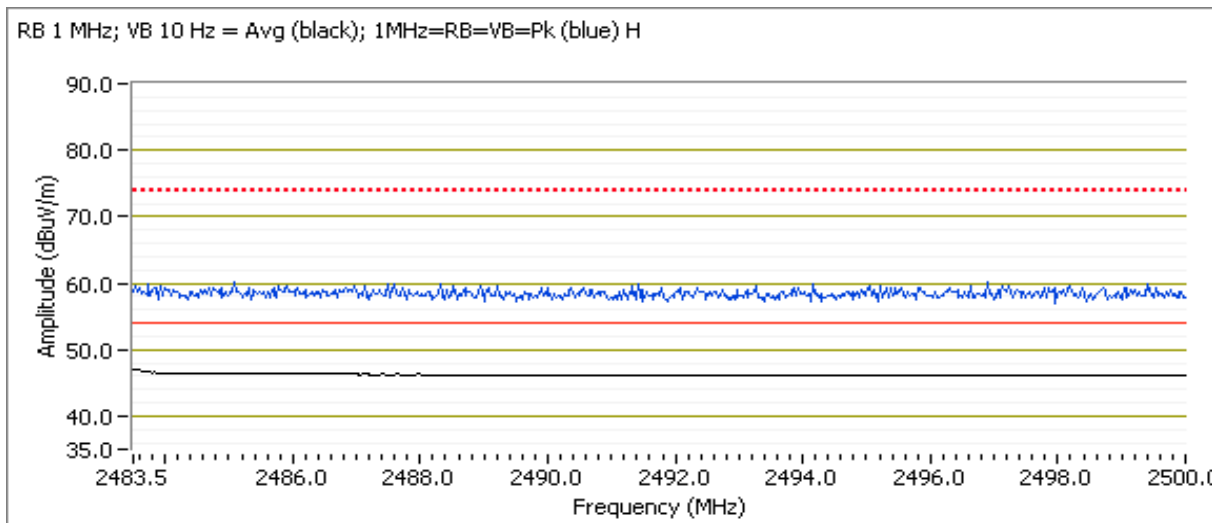

Client:	Intel Corporation	Job Number:	J84364
Model:	Intel® Centrino® Wireless-N 2230	T-Log Number:	T84599
Contact:	Steve Hackett	Account Manager:	Christine Krebill
Standard:	FCC 15.247	Class:	N/A

**Run # 2, Band Edge Field Strength - 802.11g, Chain B**

Date of Test: 10/11/2011  
 Test Engineer: Rafael Varelas  
 Test Location: FT Chamber#7  
 Config Change: None

**Run # 2a, EUT on Channel #1 2412MHz - 802.11g, Chain B**

	Target (dBm)	Power Settings Measured (dBm)	Software Setting
Chain B	13.7	13.7	26.0

*2390 MHz Band Edge Signal Field Strength*

Frequency	Level	Pol	15.209 / 15.247		Detector	Azimuth	Height	Comments
MHz	dB $\mu$ V/m	v/h	Limit	Margin	Pk/QP/Avg	degrees	meters	
2389.870	51.7	H	54.0	-2.3	AVG	349	1.0	RB 1 MHz;VB 10 Hz;Pk
2389.760	68.1	H	74.0	-5.9	PK	349	1.0	RB 1 MHz;VB 3 MHz;Pk
2389.970	50.9	V	54.0	-3.1	AVG	93	1.0	RB 1 MHz;VB 10 Hz;Pk
2389.810	66.2	V	74.0	-7.8	PK	93	1.0	RB 1 MHz;VB 3 MHz;Pk

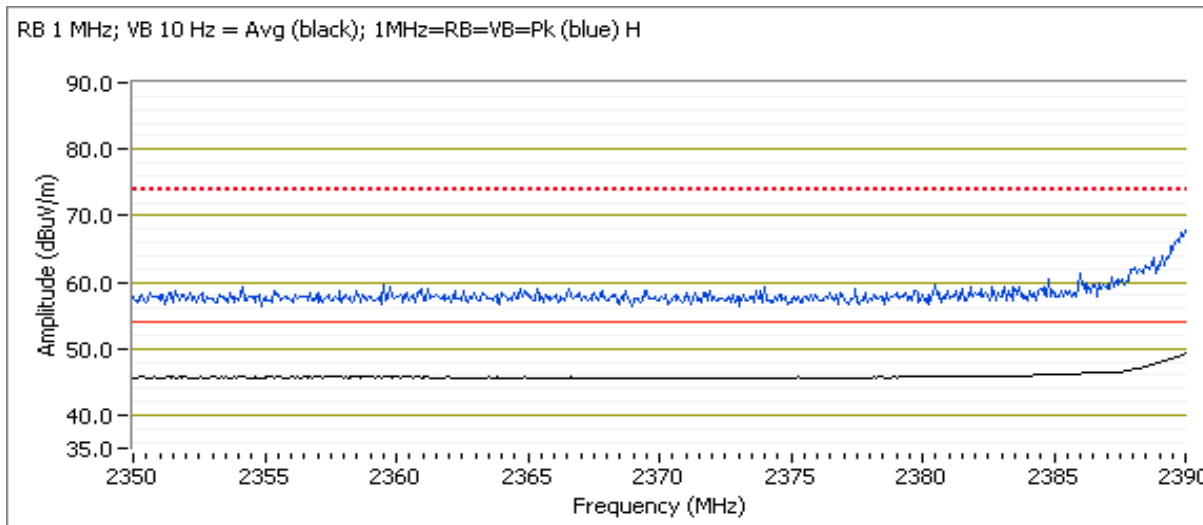

Client:	Intel Corporation	Job Number:	J84364
Model:	Intel® Centrino® Wireless-N 2230	T-Log Number:	T84599
Contact:	Steve Hackett	Account Manager:	Christine Krebill
Standard:	FCC 15.247	Class:	N/A

Run # 2b, EUT on Channel #11 2462MHz - 802.11g, Chain B

	Target (dBm)	Power Settings Measured (dBm)	Software Setting
Chain B	14.2	14.2	27.0

*2483.5 MHz Band Edge Signal Radiated Field Strength*

Frequency	Level	Pol	15.209 / 15.247		Detector	Azimuth	Height	Comments
MHz	dB $\mu$ V/m	v/h	Limit	Margin	PK/QP/Avg	degrees	meters	
2483.550	51.3	H	54.0	-2.7	AVG	354	1.0	RB 1 MHz;VB 10 Hz;Pk
2483.530	66.2	H	74.0	-7.8	PK	354	1.0	RB 1 MHz;VB 3 MHz;Pk
2483.550	50.0	V	54.0	-4.0	AVG	83	1.0	RB 1 MHz;VB 10 Hz;Pk
2484.060	66.7	V	74.0	-7.3	PK	83	1.0	RB 1 MHz;VB 3 MHz;Pk

RB 1 MHz; VB 10 Hz = Avg (black); 1MHz=RB=VB=Pk (blue) H

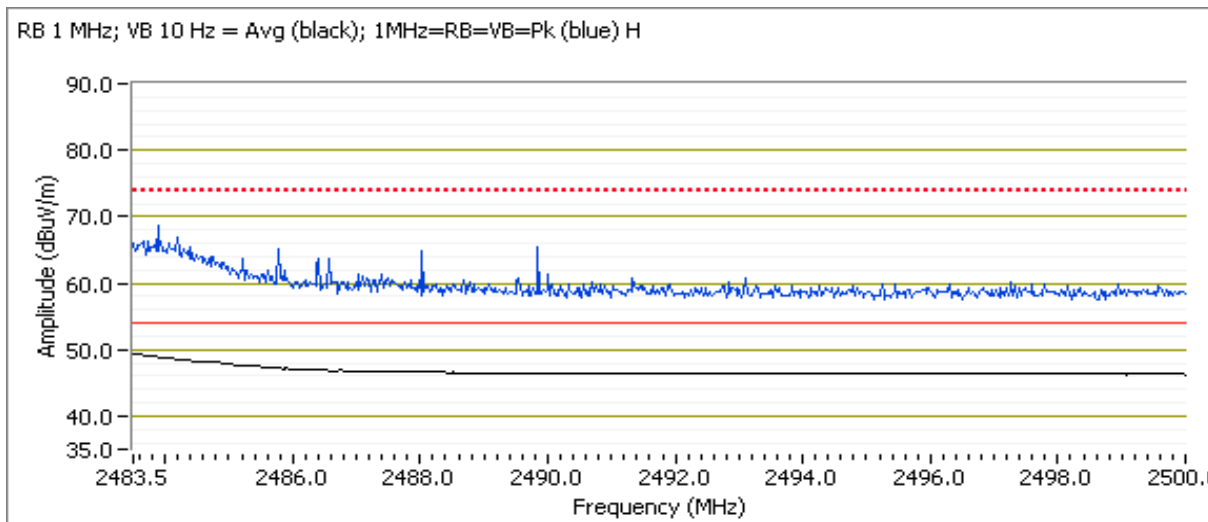

Client:	Intel Corporation	Job Number:	J84364
Model:	Intel® Centrino® Wireless-N 2230	T-Log Number:	T84599
Contact:	Steve Hackett	Account Manager:	Christine Krebill
Standard:	FCC 15.247	Class:	N/A

**Run # 3, Band Edge Field Strength - 802.11n20, Chain B**

Date of Test: 10/11 & 10/13/2011

Test Location: FT Chamber #4 & #7

Test Engineer: Rafael Varelas & Joseph Cadigal

Config Change: None

**Run # 3a, EUT on Channel #1 2412MHz - 802.11n20, Chain B**

	Target (dBm)	Power Settings Measured (dBm)	Software Setting
Chain B	12.7	12.8	24.5

**2390 MHz Band Edge Signal Field Strength**

Frequency	Level	Pol	15.209 / 15.247		Detector	Azimuth	Height	Comments
MHz	dB $\mu$ V/m	v/h	Limit	Margin	Pk/QP/Avg	degrees	meters	
2390.000	46.0	V	54.0	-8.0	AVG	110	1.0	RB 1 MHz;VB 10 Hz;Pk
2389.930	62.2	V	74.0	-11.8	PK	110	1.0	RB 1 MHz;VB 3 MHz;Pk
2390.000	45.6	H	54.0	-8.4	AVG	1	1.0	RB 1 MHz;VB 10 Hz;Pk
2389.730	62.3	H	74.0	-11.7	PK	1	1.0	RB 1 MHz;VB 3 MHz;Pk

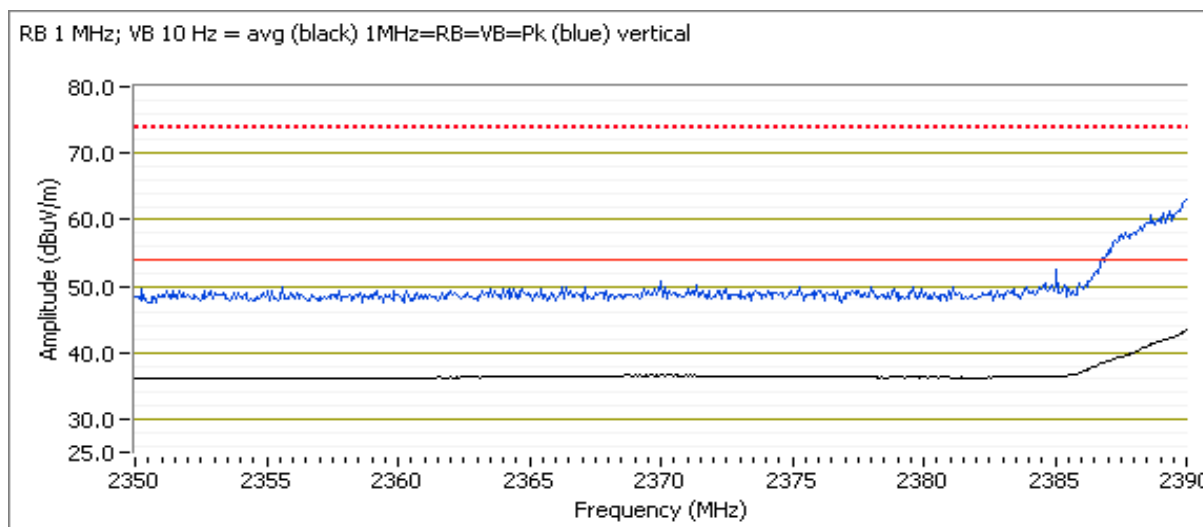

Client:	Intel Corporation	Job Number:	J84364
Model:	Intel® Centrino® Wireless-N 2230	T-Log Number:	T84599
Contact:	Steve Hackett	Account Manager:	Christine Krebill
Standard:	FCC 15.247	Class:	N/A

Run # 3b, EUT on Channel #2 2417MHz - 802.11n20, Chain B

	Target (dBm)	Power Settings Measured (dBm)	Software Setting
Chain B	15.7	15.7	28.5

*2483.5 MHz Band Edge Signal Radiated Field Strength*

Frequency	Level	Pol	15.209 / 15.247		Detector	Azimuth	Height	Comments
MHz	dB $\mu$ V/m	v/h	Limit	Margin	PK/QP/Avg	degrees	meters	
2389.890	50.5	H	54.0	-3.5	AVG	347	1.0	RB 1 MHz;VB 10 Hz;Pk
2388.670	66.4	H	74.0	-7.6	PK	347	1.0	RB 1 MHz;VB 3 MHz;Pk
2389.740	50.3	V	54.0	-3.7	AVG	93	1.0	RB 1 MHz;VB 10 Hz;Pk
2389.690	66.9	V	74.0	-7.1	PK	93	1.0	RB 1 MHz;VB 3 MHz;Pk

RB 1 MHz; VB 10 Hz = Avg (black); 1MHz=RB=VB=Pk (blue) H

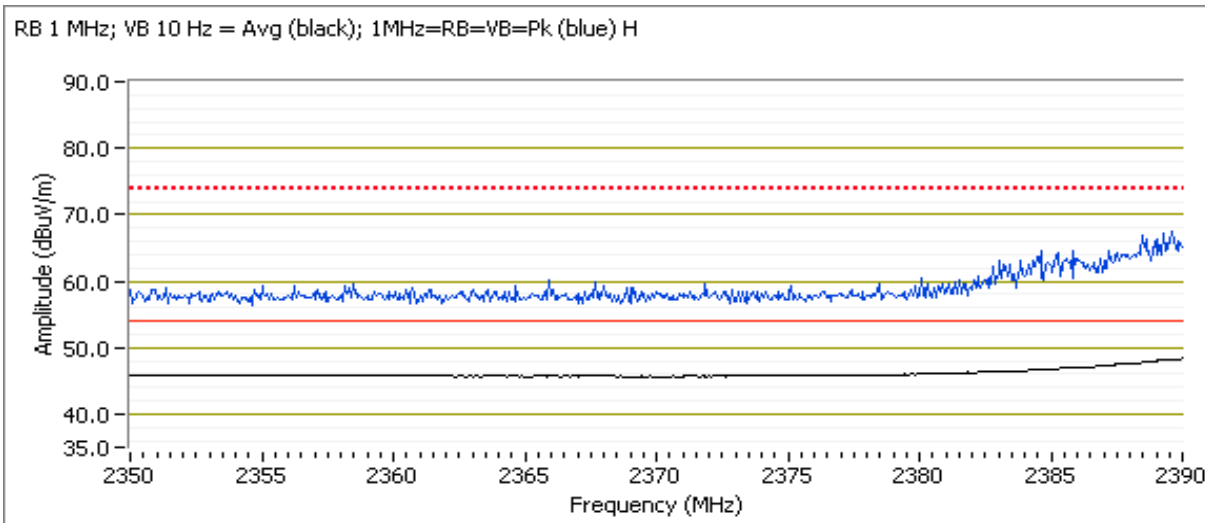

Client:	Intel Corporation	Job Number:	J84364
Model:	Intel® Centrino® Wireless-N 2230	T-Log Number:	T84599
Contact:	Steve Hackett	Account Manager:	Christine Krebill
Standard:	FCC 15.247	Class:	N/A

Run # 3c, EUT on Channel #10 2457MHz - 802.11n20, Chain B

	Target (dBm)	Power Settings Measured (dBm)	Software Setting
Chain B	16.7	16.7	31.0

*2483.5 MHz Band Edge Signal Radiated Field Strength*

Frequency	Level	Pol	15.209 / 15.247		Detector	Azimuth	Height	Comments
MHz	dB $\mu$ V/m	v/h	Limit	Margin	PK/QP/Avg	degrees	meters	
2483.500	47.0	V	54.0	-7.0	AVG	82	1.9	RB 1 MHz;VB 10 Hz;Pk
2483.500	44.4	H	54.0	-9.6	AVG	145	1.1	RB 1 MHz;VB 10 Hz;Pk
2483.580	61.6	V	74.0	-12.4	PK	82	1.9	RB 1 MHz;VB 3 MHz;Pk
2484.980	59.1	H	74.0	-14.9	PK	145	1.1	RB 1 MHz;VB 3 MHz;Pk

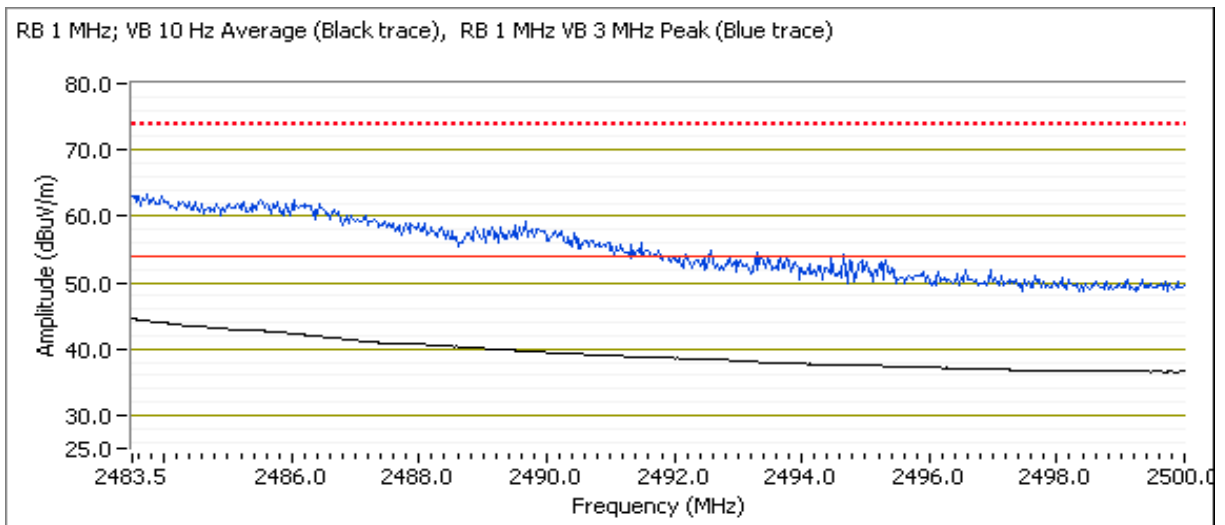

Client:	Intel Corporation	Job Number:	J84364
Model:	Intel® Centrino® Wireless-N 2230	T-Log Number:	T84599
Contact:	Steve Hackett	Account Manager:	Christine Krebill
Standard:	FCC 15.247	Class:	N/A

Run # 3d, EUT on Channel #11 2462MHz - 802.11n20, Chain B

	Target (dBm)	Power Settings Measured (dBm)	Software Setting
Chain B	13.2	13.4	26.5

**2483.5 MHz Band Edge Signal Radiated Field Strength**

Frequency	Level	Pol	15.209 / 15.247		Detector	Azimuth	Height	Comments
MHz	dB $\mu$ V/m	v/h	Limit	Margin	PK/QP/Avg	degrees	meters	
2483.530	52.3	H	54.0	-1.7	AVG	344	1.0	RB 1 MHz;VB 10 Hz;Pk
2483.530	66.8	H	74.0	-7.2	PK	344	1.0	RB 1 MHz;VB 3 MHz;Pk
2483.530	48.6	V	54.0	-5.4	AVG	92	1.7	RB 1 MHz;VB 10 Hz;Pk
2485.810	63.8	V	74.0	-10.2	PK	92	1.7	RB 1 MHz;VB 3 MHz;Pk

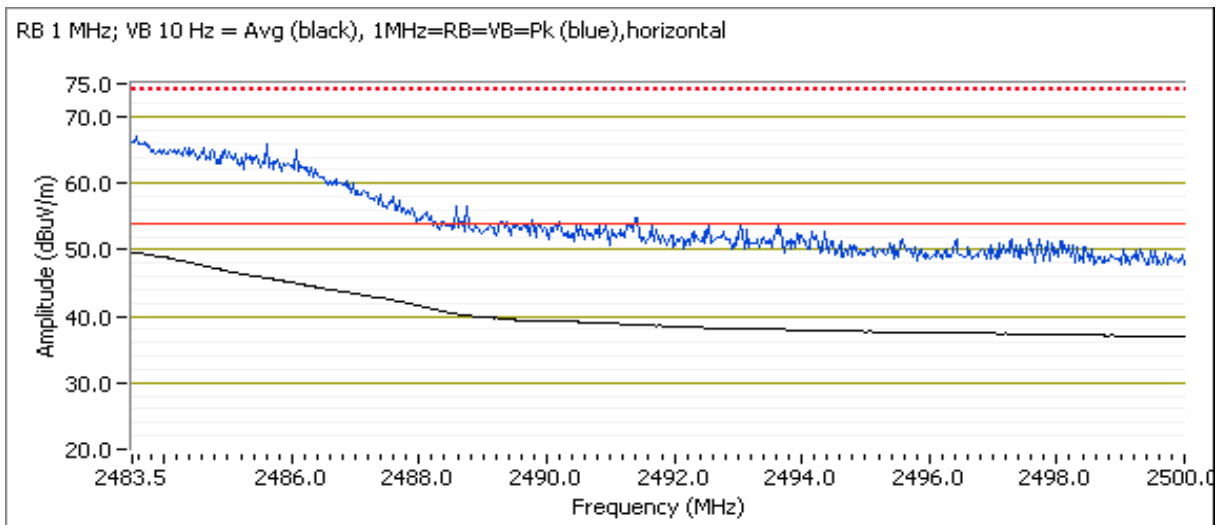

Client:	Intel Corporation	Job Number:	J84364
Model:	Intel® Centrino® Wireless-N 2230	T-Log Number:	T84599
Contact:	Steve Hackett	Account Manager:	Christine Krebill
Standard:	FCC 15.247	Class:	N/A

**Run # 4, Band Edge Field Strength - 802.11n40, Chain B**

Date of Test: 10/11 & 10/13/2011      Test Location: FT Chamber#4 & #7  
 Test Engineer: Rafael Varelas & Joseph Cadigal      Config Change: None

**Run # 4a, EUT on Channel #3 2422MHz - 802.11n40, Chain B**

	Target (dBm)	Power Settings Measured (dBm)	Software Setting
Chain B	9.7	9.8	21.5

**2390 MHz Band Edge Signal Field Strength**

Frequency	Level	Pol	15.209 / 15.247		Detector	Azimuth	Height	Comments
MHz	dB $\mu$ V/m	v/h	Limit	Margin	Pk/QP/Avg	degrees	meters	
2389.930	45.5	H	54.0	-8.5	AVG	4	1.0	RB 1 MHz;VB 10 Hz;Pk
2388.930	58.2	H	74.0	-15.8	PK	4	1.0	RB 1 MHz;VB 3 MHz;Pk
2389.870	39.7	V	54.0	-14.3	AVG	360	1.0	RB 1 MHz;VB 10 Hz;Pk
2387.930	52.5	V	74.0	-21.5	PK	360	1.0	RB 1 MHz;VB 3 MHz;Pk

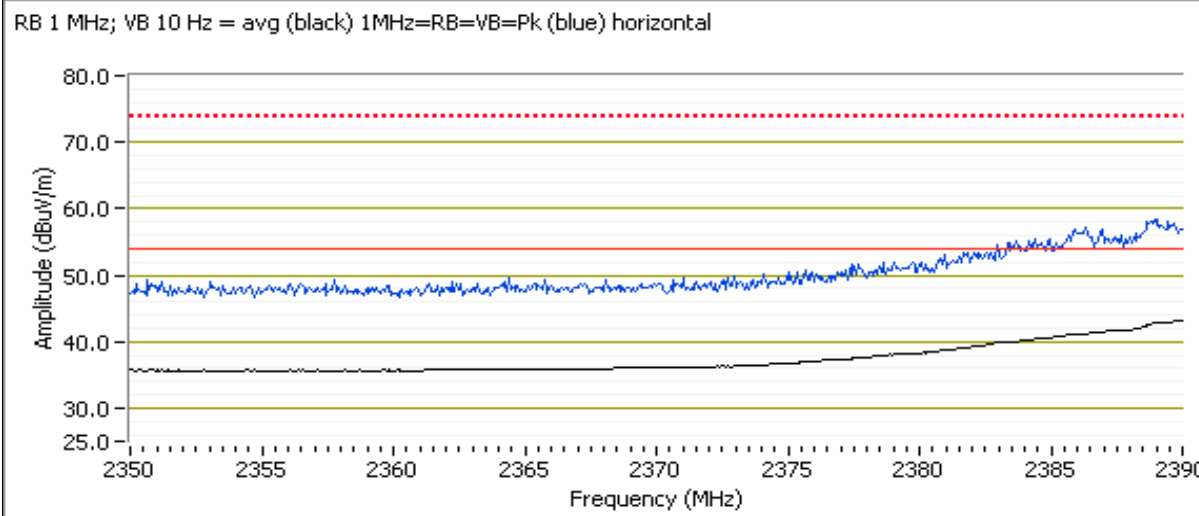



Client:	Intel Corporation	Job Number:	J84364
Model:	Intel® Centrino® Wireless-N 2230	T-Log Number:	T84599
Contact:	Steve Hackett	Account Manager:	Christine Krebill
Standard:	FCC 15.247	Class:	N/A

Run # 4b, EUT on Channel #4 2427MHz - 802.11n40, Chain B

	Target (dBm)	Power Settings Measured (dBm)	Software Setting
Chain B	10.7	10.9	23.0

*2483.5 MHz Band Edge Signal Radiated Field Strength*

Frequency	Level	Pol	15.209 / 15.247		Detector	Azimuth	Height	Comments
MHz	dB $\mu$ V/m	v/h	Limit	Margin	PK/QP/Avg	degrees	meters	
2390.000	53.2	H	54.0	-0.8	AVG	348	1.0	RB 1 MHz;VB 10 Hz;Pk
2389.740	67.4	H	74.0	-6.6	PK	348	1.0	RB 1 MHz;VB 3 MHz;Pk
2389.970	53.0	V	54.0	-1.0	AVG	92	1.0	RB 1 MHz;VB 10 Hz;Pk
2387.830	66.5	V	74.0	-7.5	PK	92	1.0	RB 1 MHz;VB 3 MHz;Pk

RB 1 MHz; VB 10 Hz = Avg (black); 1MHz=RB=VB=Pk (blue) H

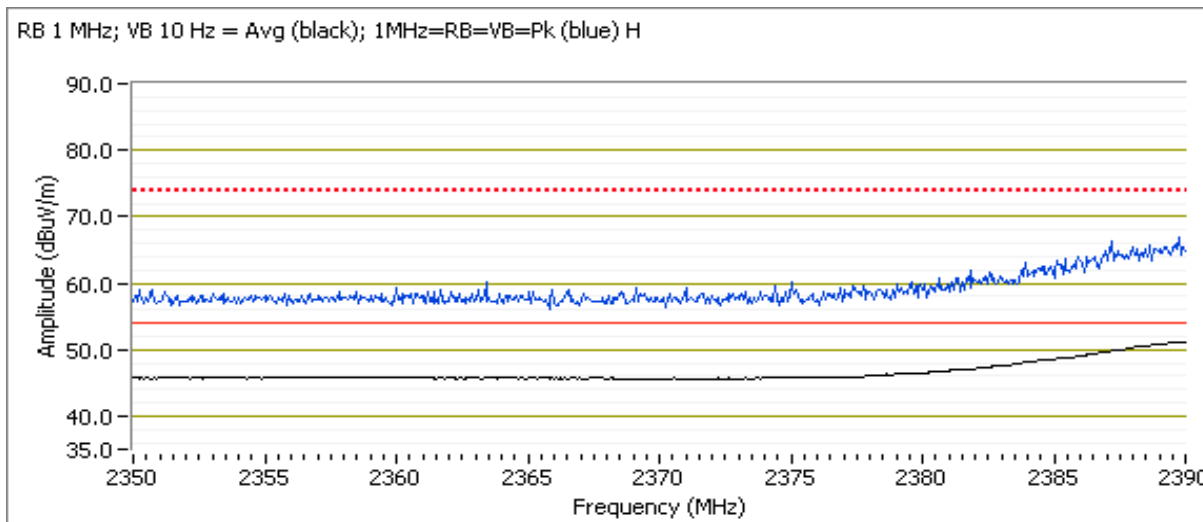

Client:	Intel Corporation	Job Number:	J84364
Model:	Intel® Centrino® Wireless-N 2230	T-Log Number:	T84599
Contact:	Steve Hackett	Account Manager:	Christine Krebill
Standard:	FCC 15.247	Class:	N/A

Run # 4c, EUT on Channel #5 2432MHz - 802.11n40, Chain B

	Target (dBm)	Power Settings Measured (dBm)	Software Setting
Chain B	12.2	12.2	24.5

*2390 MHz Band Edge Signal Radiated Field Strength*

Frequency	Level	Pol	15.209 / 15.247		Detector	Azimuth	Height	Comments
MHz	dB $\mu$ V/m	v/h	Limit	Margin	PK/QP/Avg	degrees	meters	
2389.940	53.1	H	54.0	-0.9	AVG	351	1.0	RB 1 MHz;VB 10 Hz;Pk
2389.760	67.3	H	74.0	-6.7	PK	351	1.0	RB 1 MHz;VB 3 MHz;Pk
2389.850	52.0	V	54.0	-2.0	AVG	95	1.0	RB 1 MHz;VB 10 Hz;Pk
2389.870	66.8	V	74.0	-7.2	PK	95	1.0	RB 1 MHz;VB 3 MHz;Pk

RB 1 MHz; VB 10 Hz = Avg (black); 1MHz=RB=VB=Pk (blue) H

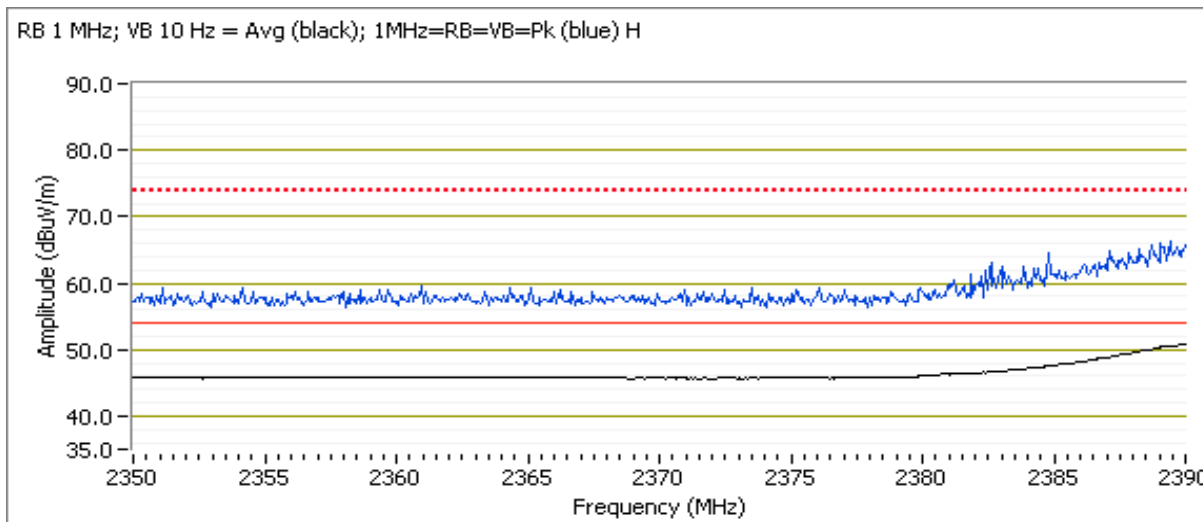

Client:	Intel Corporation	Job Number:	J84364
Model:	Intel® Centrino® Wireless-N 2230	T-Log Number:	T84599
Contact:	Steve Hackett	Account Manager:	Christine Krebill
Standard:	FCC 15.247	Class:	N/A

Run # 4d, EUT on Channel #6 2437MHz - 802.11n40, Chain B

	Target (dBm)	Power Settings Measured (dBm)	Software Setting
Chain B	14.2	14.4	27.0

*2390 MHz Band Edge Signal Radiated Field Strength*

Frequency	Level	Pol	15.209 / 15.247		Detector	Azimuth	Height	Comments
MHz	dB $\mu$ V/m	v/h	Limit	Margin	PK/QP/Avg	degrees	meters	
2390.000	49.7	H	54.0	-4.3	AVG	307	1.0	RB 1 MHz;VB 10 Hz;Pk
2390.000	49.6	V	54.0	-4.4	AVG	77	1.0	RB 1 MHz;VB 10 Hz;Pk
2389.070	65.1	H	74.0	-8.9	PK	307	1.0	RB 1 MHz;VB 3 MHz;Pk
2389.530	64.3	V	74.0	-9.7	PK	77	1.0	RB 1 MHz;VB 3 MHz;Pk

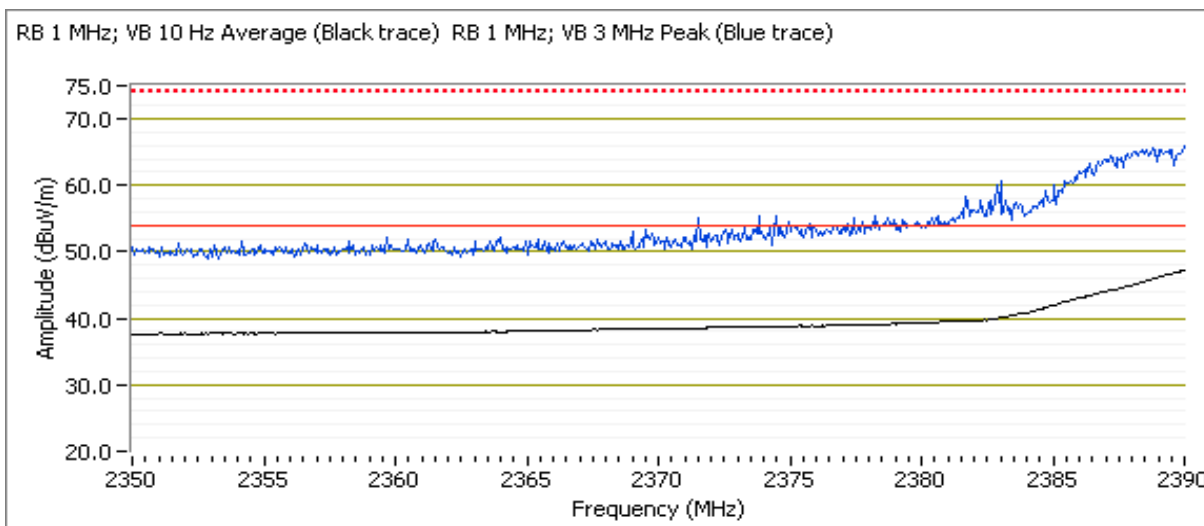

Client:	Intel Corporation	Job Number:	J84364
Model:	Intel® Centrino® Wireless-N 2230	T-Log Number:	T84599
Contact:	Steve Hackett	Account Manager:	Christine Krebill
Standard:	FCC 15.247	Class:	N/A

Run # 4e, EUT on Channel #8 2447MHz - 802.11n40, Chain B

	Target (dBm)	Power Settings Measured (dBm)	Software Setting
Chain B	12.2	12.4	25.0

**2483.5 MHz Band Edge Signal Radiated Field Strength**

Frequency	Level	Pol	15.209 / 15.247		Detector	Azimuth	Height	Comments
MHz	dB $\mu$ V/m	v/h	Limit	Margin	PK/QP/Avg	degrees	meters	
2483.500	53.1	H	54.0	-0.9	AVG	307	1.0	RB 1 MHz;VB 10 Hz;Pk
2483.500	51.0	V	54.0	-3.0	AVG	79	1.0	RB 1 MHz;VB 10 Hz;Pk
2483.750	68.1	H	74.0	-5.9	PK	307	1.0	RB 1 MHz;VB 3 MHz;Pk
2483.640	66.4	V	74.0	-7.6	PK	79	1.0	RB 1 MHz;VB 3 MHz;Pk

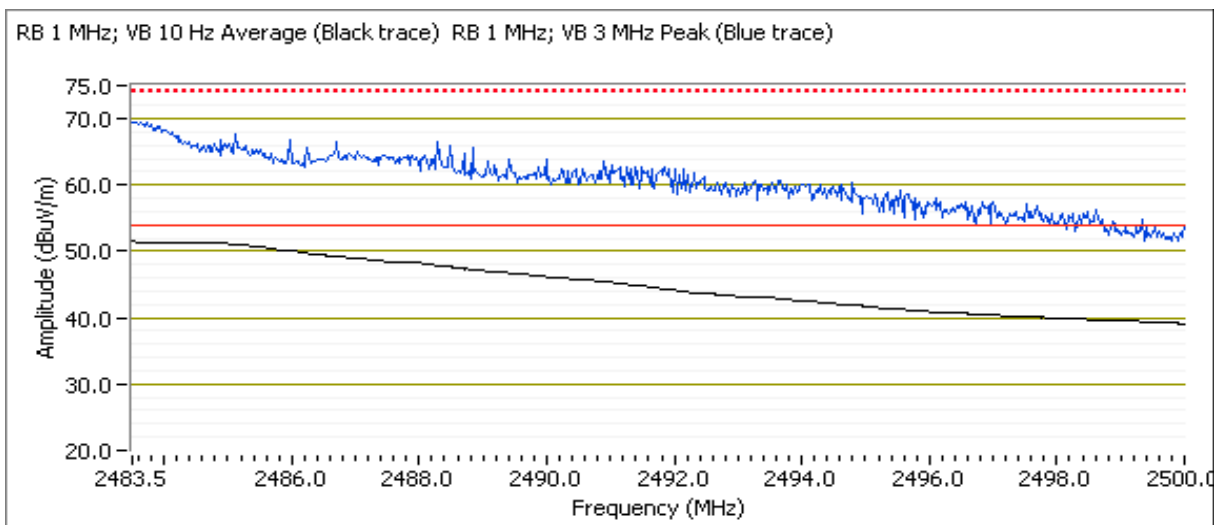

Client:	Intel Corporation	Job Number:	J84364
Model:	Intel® Centrino® Wireless-N 2230	T-Log Number:	T84599
Contact:	Steve Hackett	Account Manager:	Christine Krebill
Standard:	FCC 15.247	Class:	N/A

Run # 4b, EUT on Channel #9 2452MHz - 802.11n40, Chain B

	Target (dBm)	Power Settings Measured (dBm)	Software Setting
Chain B	10.7	10.9	23.5

**2483.5 MHz Band Edge Signal Radiated Field Strength**

Frequency MHz	Level dB $\mu$ V/m	Pol v/h	15.209 / 15.247		Detector PK/QP/Avg	Azimuth degrees	Height meters	Comments
			Limit	Margin				
2483.520	52.0	H	54.0	-2.0	AVG	354	1.0	RB 1 MHz;VB 10 Hz;Pk
2484.530	64.6	H	74.0	-9.4	PK	354	1.0	RB 1 MHz;VB 3 MHz;Pk
2483.570	50.6	V	54.0	-3.4	AVG	84	1.0	RB 1 MHz;VB 10 Hz;Pk
2483.800	63.3	V	74.0	-10.7	PK	84	1.0	RB 1 MHz;VB 3 MHz;Pk

RB 1 MHz; VB 10 Hz = Avg (black); 1MHz=RB=VB=Pk (blue) H

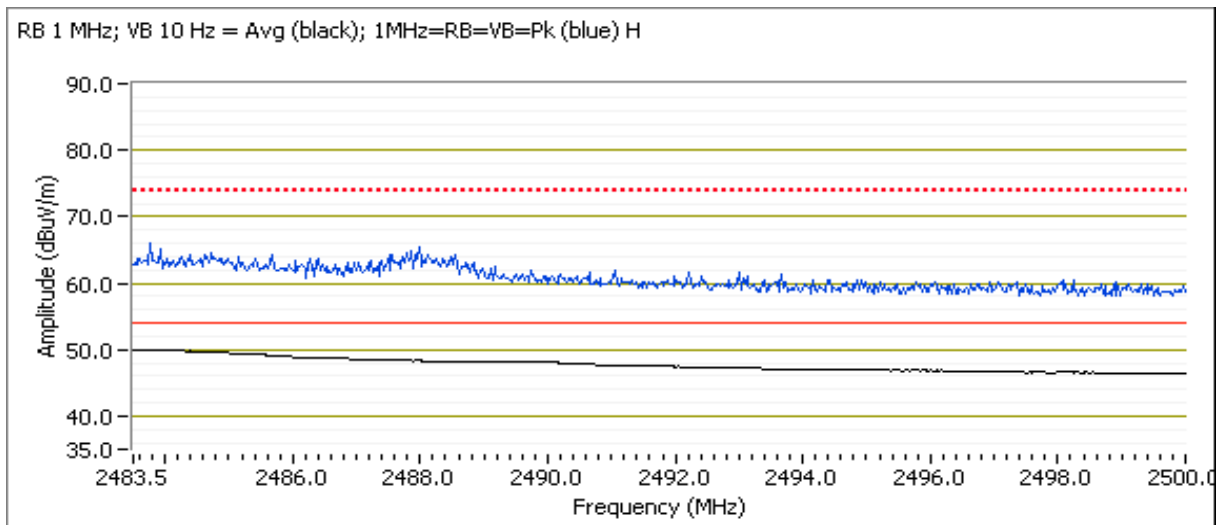

Client:	Intel Corporation	Job Number:	J84364
Model:	Intel® Centrino® Wireless-N 2230	T-Log Number:	T84599
Contact:	Steve Hackett	Account Manager:	Christine Krebill
Standard:	FCC 15.247	Class:	N/A

## RSS 210 and FCC 15.247 (DTS) Radiated Spurious Emissions

### Test Specific Details

Objective: The objective of this test session is to perform final qualification testing of the EUT with respect to the specification listed above.

### General Test Configuration

The EUT and all local support equipment were located on the turntable for radiated spurious emissions testing.

For radiated emissions testing the measurement antenna was located 3 meters from the EUT.

### Ambient Conditions:

Temperature: 17-20 °C  
Rel. Humidity: 30-40 %

### Summary of Results - Device Operating in the 2400-2483.5 MHz Band

MAC Address: 00150082509B DRTU Tool Version **1.5.3.0322** Driver version **15.0.0.61**

Run #	Mode	Channel	Target Power	Measured Power	Test Performed	Limit	Result / Margin
Run # 1	802.11n20 Chain A+B	#1 2412MHz	A: 11.2 B: 11.2	A: 11.7 B: 11.8	Restricted Band Edge at 2390 MHz	15.209	52.1dBµV/m @ 2390.0MHz (-1.9dB)
		#11 2462MHz	A: 11.7 B: 11.7	A: 12.3 B: 12.3	Restricted Band Edge at 2483.5 MHz	15.209	53.7dBµV/m @ 2483.5MHz (-0.3dB)
Run # 2	802.11n40 Chain A+B	#3 2422MHz	A: 8.2 B: 8.2	A: 8.3 B: 8.3	Restricted Band Edge at 2390 MHz	15.209	51.2dBµV/m @ 2389.8MHz (-2.8dB)
		#4 2427MHz	A: 9.2 B: 9.2	A: 10.0 B: 10.0	Restricted Band Edge at 2390 MHz	15.209	53.1dBµV/m @ 2389.5MHz (-0.9dB)
		#8 2427MHz	A: 10.7 B: 10.7	A: 10.4 B: 10.2	Restricted Band Edge at 2483.5 MHz	15.209	52.8dBµV/m @ 2484.2MHz (-1.2dB)
		#9 2452MHz	A: 8.7 B: 8.7	A: 9.3 B: 9.3	Restricted Band Edge at 2483.5 MHz	15.209	53.7dBµV/m @ 2484.5MHz (-0.3dB)

### Modifications Made During Testing

No modifications were made to the EUT during testing

### Deviations From The Standard

No deviations were made from the requirements of the standard.

Client:	Intel Corporation	Job Number:	J84364
Model:	Intel® Centrino® Wireless-N 2230	T-Log Number:	T84599
Contact:	Steve Hackett	Account Manager:	Christine Krebill
Standard:	FCC 15.247	Class:	N/A

**Run #1: Band Edge Field Strength - 802.11n20, Chain A+B**

Date of Test: 9/22/11 & 9/23/11

Test Location: FT Chamber#3

Test Engineer: J. Cadigal & J. Caizzi

Config Change: None

**Run #1a: EUT on Channel #1 2412MHz - 802.11n20, Chain A+B**

Chain	Power Settings								Software Setting
	Target (dBm)				Measured (dBm)				
	A	B	C	Total	A	B	C	Total	
	11.7	11.7		14.7	11.7	11.8		14.8	24.5 26.0

**2390 MHz Band Edge Signal Field Strength**

Frequency	Level	Pol	15.209 / 15.247		Detector	Azimuth	Height	Comments
MHz	dB $\mu$ V/m	v/h	Limit	Margin	Pk/QP/Avg	degrees	meters	
2390.000	52.1	H	54.0	-1.9	AVG	21	1.0	RB 1 MHz;VB 10 Hz;Pk
2389.070	64.6	H	74.0	-9.4	PK	21	1.0	RB 1 MHz;VB 3 MHz;Pk
2390.000	51.9	V	54.0	-2.1	AVG	74	1.0	RB 1 MHz;VB 10 Hz;Pk
2389.600	66.7	V	74.0	-7.3	PK	74	1.0	RB 1 MHz;VB 3 MHz;Pk

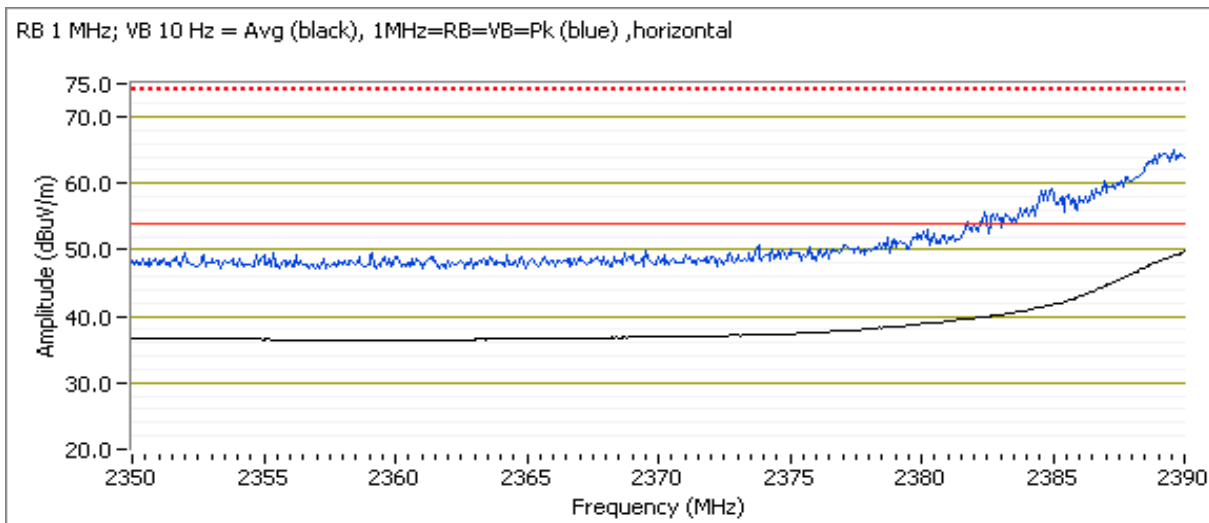

Client:	Intel Corporation	Job Number:	J84364
Model:	Intel® Centrino® Wireless-N 2230	T-Log Number:	T84599
Contact:	Steve Hackett	Account Manager:	Christine Krebill
Standard:	FCC 15.247	Class:	N/A

**Run #1b: EUT on Channel #11 2462MHz - 802.11n20, Chain A+B**

Chain	Target (dBm)				Power Settings Measured (dBm)				Software Setting
	A	B	C	Total	A	B	C	Total	
	12.2	12.2		15.2	12.3	12.3		15.3	26.5 27.5

**2483.5 MHz Band Edge Signal Radiated Field Strength**

Frequency	Level	Pol	15.209 / 15.247		Detector	Azimuth	Height	Comments
MHz	dB $\mu$ V/m	v/h	Limit	Margin	Pk/QP/Avg	degrees	meters	
2483.530	53.7	H	54.0	-0.3	AVG	15	1.04	Settings = 26.0, 27.0
2484.600	67.0	H	74.0	-7.0	PK	15	1.04	Settings = 26.0, 27.0
2483.500	51.1	V	54.0	-2.9	AVG	269	1.00	
2483.910	63.1	V	74.0	-10.9	PK	269	1.00	

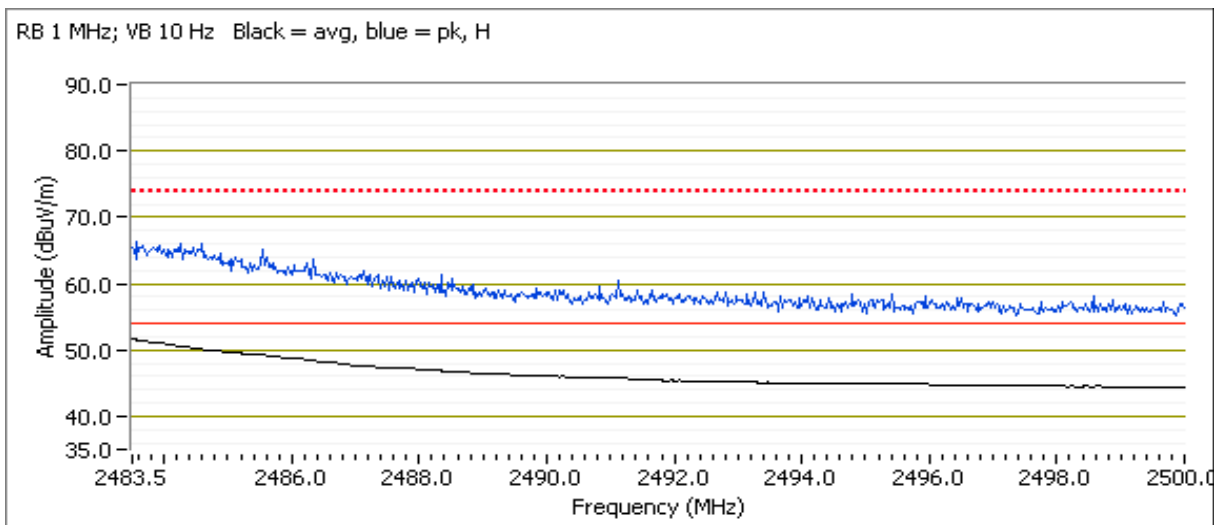

2483.580	54.3	H	54.0	0.3	AVG	15	1.01	RB 1 MHz;VB 10 Hz;Pk
2484.270	67.3	H	74.0	-6.7	PK	15	1.01	RB 1 MHz;VB 3 MHz;Pk



Client:	Intel Corporation	Job Number:	J84364
Model:	Intel® Centrino® Wireless-N 2230	T-Log Number:	T84599
Contact:	Steve Hackett	Account Manager:	Christine Krebill
Standard:	FCC 15.247	Class:	N/A

**Run #2, Band Edge Field Strength - 802.11n40, Chain A+B**

Date of Test: 9/23/11, 9/30/11  
 Test Engineer: J. Caizzi, M. Birgani  
 Test Location: FT Chamber #4  
 Config Change: None

**Run #2a: EUT on Channel #3 2422 MHz - 802.11n40, Chain A+B**

Chain	Target (dBm)				Power Settings Measured (dBm)				Software Setting
	A	B	C	Total	A	B	C	Total	
	8.2	8.2		11.2	8.3	8.3		11.3	21.0, 23.0

**2390 MHz Band Edge Signal Field Strength**

Frequency	Level	Pol	15.209 / 15.247		Detector	Azimuth	Height	Comments
MHz	dB $\mu$ V/m	v/h	Limit	Margin	Pk/QP/Avg	degrees	meters	
2389.800	51.2	H	54.0	-2.8	AVG	65	1.00	RB 1 MHz;VB 10 Hz;Pk
2389.930	64.8	H	74.0	-9.2	PK	65	1.00	RB 1 MHz;VB 3 MHz;Pk
2390.000	50.8	V	54.0	-3.2	AVG	177	1.19	RB 1 MHz;VB 10 Hz;Pk
2389.000	63.4	V	74.0	-10.6	PK	177	1.19	RB 1 MHz;VB 3 MHz;Pk

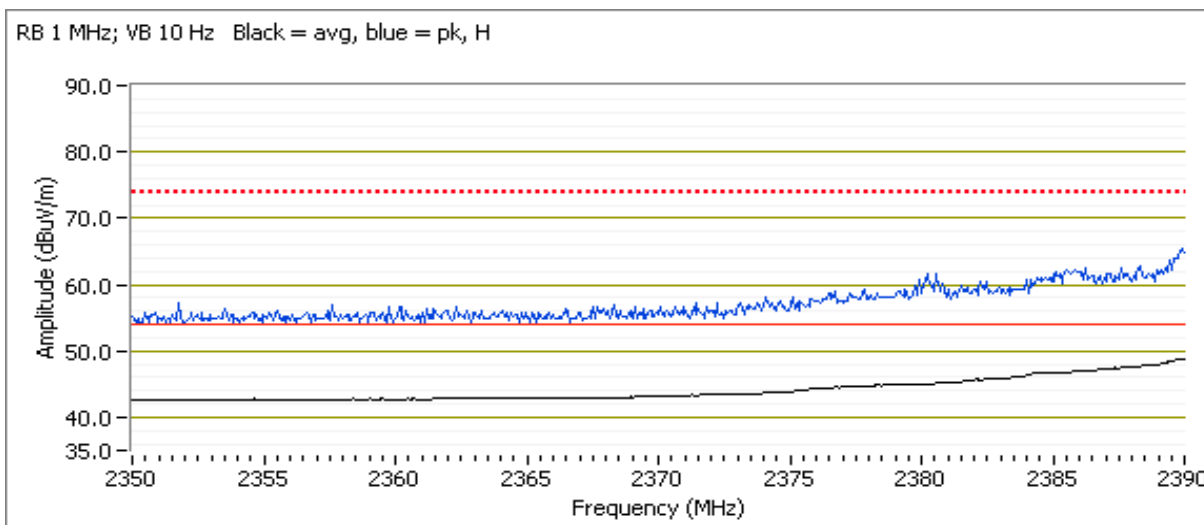

Client:	Intel Corporation	Job Number:	J84364
Model:	Intel® Centrino® Wireless-N 2230	T-Log Number:	T84599
Contact:	Steve Hackett	Account Manager:	Christine Krebill
Standard:	FCC 15.247	Class:	N/A

**Run #2b: EUT on Channel #4 2427MHz - 802.11n40, Chain A+B**

Chain	Target (dBm)				Power Settings Measured (dBm)				Software Setting
	A	B	C	Total	A	B	C	Total	
	12.7	12.7		15.7	10.0	10.0		13.0	23.5, 25.0

**2483.5 MHz Band Edge Signal Radiated Field Strength**

Frequency	Level	Pol	15.209 / 15.247		Detector	Azimuth	Height	Comments
MHz	dB $\mu$ V/m	v/h	Limit	Margin	PK/QP/Avg	degrees	meters	
2389.530	53.1	H	54.0	-0.9	AVG	308	1.4	RB 1 MHz;VB 10 Hz;Pk
2389.670	50.2	V	54.0	-3.8	AVG	282	1.1	RB 1 MHz;VB 10 Hz;Pk
2390.000	67.3	H	74.0	-6.7	PK	308	1.4	RB 1 MHz;VB 3 MHz;Pk
2386.730	63.6	V	74.0	-10.4	PK	282	1.1	RB 1 MHz;VB 3 MHz;Pk

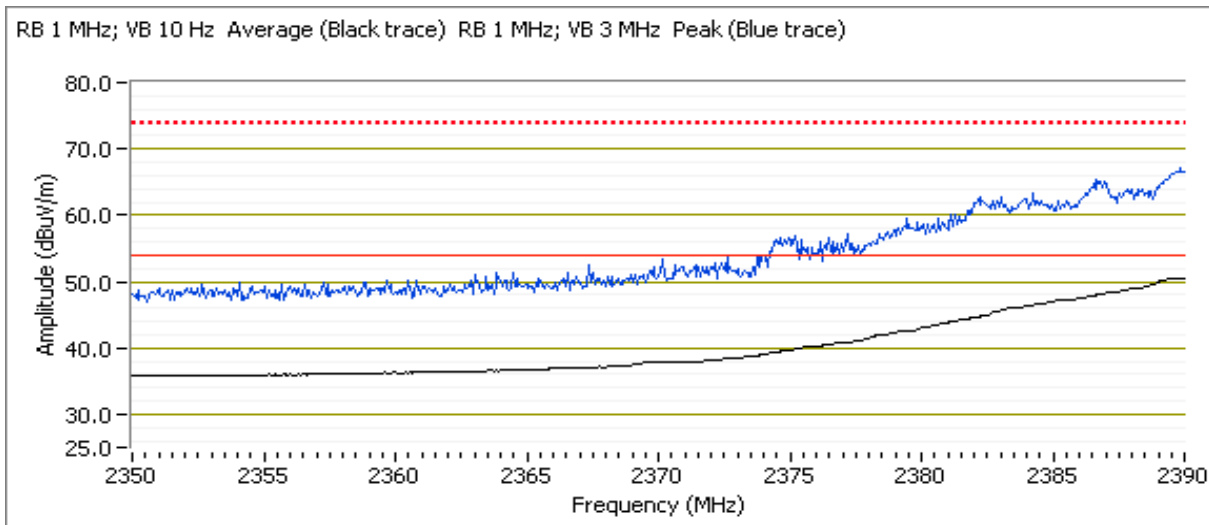

2389.670	56.3	H	54.0	2.3	AVG	308	1.4	RB 1 MHz;VB 10 Hz;Pk
2389.870	68.8	H	74.0	-5.2	PK	308	1.4	RB 1 MHz;VB 3 MHz;Pk

Client:	Intel Corporation	Job Number:	J84364
Model:	Intel® Centrino® Wireless-N 2230	T-Log Number:	T84599
Contact:	Steve Hackett	Account Manager:	Christine Krebill
Standard:	FCC 15.247	Class:	N/A

**Run #2c: EUT on Channel #8 2447MHz - 802.11n40, Chain A+B**

Chain	Target (dBm)				Power Settings Measured (dBm)				Software Setting
	A	B	C	Total	A	B	C	Total	
	12.7	12.7		15.7	10.4	10.2		13.3	24.0, 25.0

**2483.5 MHz Band Edge Signal Radiated Field Strength**

Frequency	Level	Pol	15.209 / 15.247		Detector	Azimuth	Height	Comments
MHz	dB $\mu$ V/m	v/h	Limit	Margin	PK/QP/Avg	degrees	meters	
2484.160	52.8	H	54.0	-1.2	AVG	297	1.4	RB 1 MHz;VB 10 Hz;Pk
2483.500	50.6	V	54.0	-3.4	AVG	284	1.0	RB 1 MHz;VB 10 Hz;Pk
2484.710	66.3	H	74.0	-7.7	PK	297	1.4	RB 1 MHz;VB 3 MHz;Pk
2484.960	63.2	V	74.0	-10.8	PK	284	1.0	RB 1 MHz;VB 3 MHz;Pk

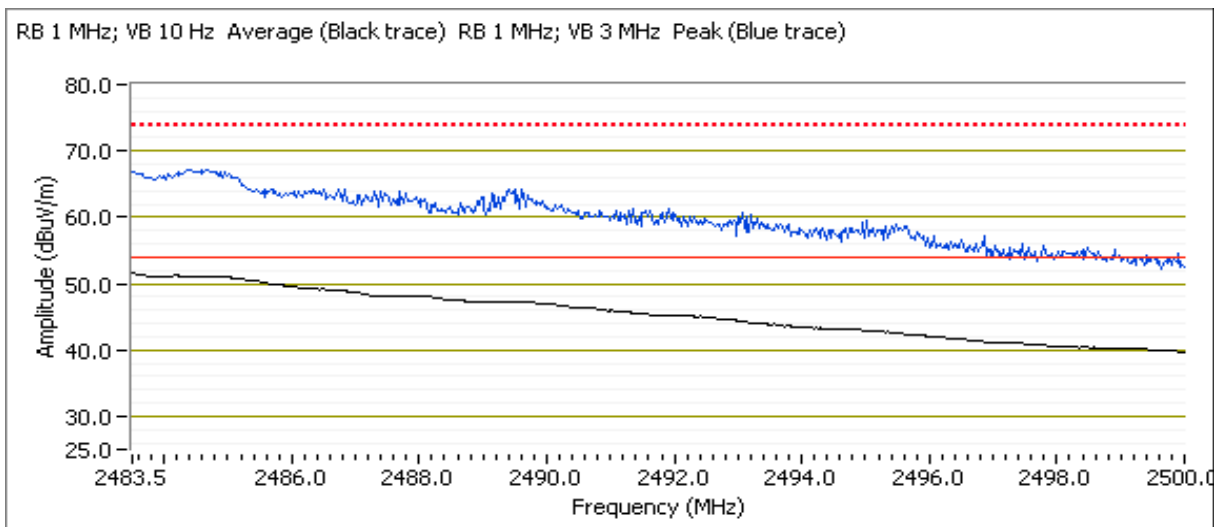

2483.530	57.3	H	54.0	3.3	AVG	297	1.4	RB 1 MHz;VB 10 Hz;Pk
2483.580	70.7	H	74.0	-3.3	PK	297	1.4	RB 1 MHz;VB 3 MHz;Pk

Client:	Intel Corporation	Job Number:	J84364
Model:	Intel® Centrino® Wireless-N 2230	T-Log Number:	T84599
Contact:	Steve Hackett	Account Manager:	Christine Krebill
Standard:	FCC 15.247	Class:	N/A

**Run #2d: EUT on Channel #9 2452MHz - 802.11n40, Chain A+B**

Chain	Target (dBm)				Power Settings Measured (dBm)				Software Setting
	A	B	C	Total	A	B	C	Total	
	9.2	9.2		12.2	9.3	9.3		12.3	22.5, 24.5

**2483.5 MHz Band Edge Signal Radiated Field Strength**

Frequency	Level	Pol	15.209 / 15.247		Detector	Azimuth	Height	Comments
MHz	dB $\mu$ V/m	v/h	Limit	Margin	Pk/QP/Avg	degrees	meters	
2484.460	53.7	H	54.0	-0.3	AVG	15	1.02	RB 1 MHz;VB 10 Hz;Pk
2484.050	67.8	H	74.0	-6.2	PK	15	1.02	RB 1 MHz;VB 3 MHz;Pk
2484.460	50.2	V	54.0	-3.8	AVG	282	1.00	RB 1 MHz;VB 10 Hz;Pk
2484.600	63.0	V	74.0	-11.0	PK	282	1.00	RB 1 MHz;VB 3 MHz;Pk

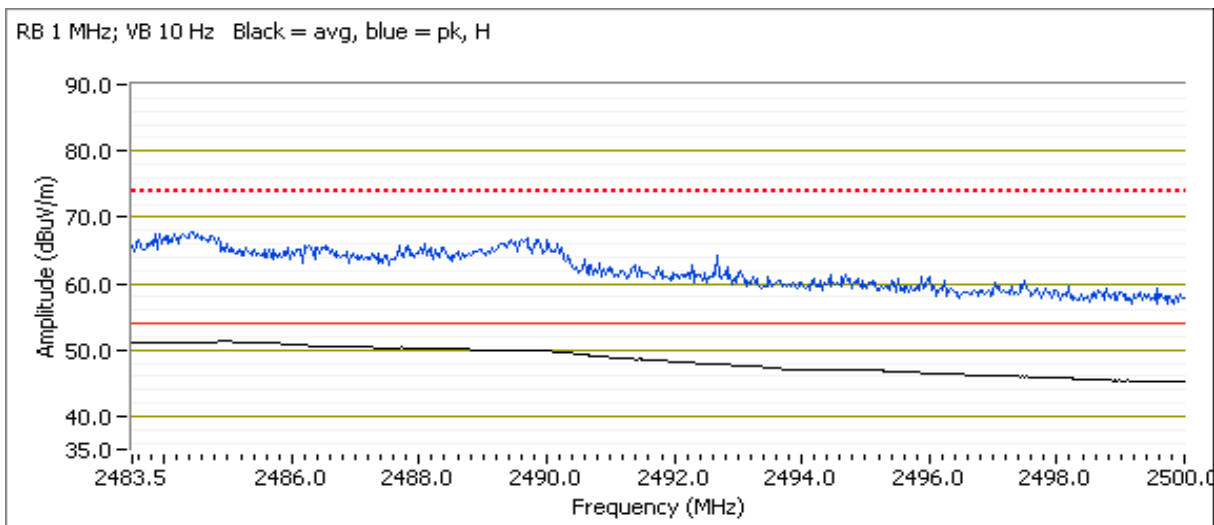

Client:	Intel Corporation	Job Number:	J84364
Model:	Intel® Centrino® Wireless-N 2230	T-Log Number:	T84599
		Account Manager:	Christine Krebill
Contact:	Steve Hackett		
Standard:	FCC 15.247	Class:	N/A

**RSS 210 and FCC 15.247 (DTS) Antenna Port Measurements  
Power, PSD, Bandwidth and Spurious Emissions**

**Test Specific Details**

Objective: The objective of this test session is to perform final qualification testing of the EUT with respect to the specification listed above.

Date of Test: 9/24/11, 9/30/11  
 Test Engineer: J. Cadigal, M. Birgani  
 Test Location: FT Chamber#4 and 5

Config. Used: 1  
 Config Change: None  
 Host Unit Voltage 120V/60Hz

**General Test Configuration**

The EUT was connected to the spectrum analyzer or power meter via a suitable attenuator. All measurements were made on a single chain.

All measurements have been corrected to allow for the external attenuators used.

**Ambient Conditions:**

Temperature: 17-20 °C  
 Rel. Humidity: 30-40 %

**Summary of Results**

MAC Address: 00150082509B DRTU Tool Version **1.5.3.0322** Driver version **15.0.0.61**

Run #	Pwr setting	Avg Pwr	Test Performed	Limit	Pass / Fail	Result / Margin
1			Output Power	15.247(b)	Pass	802.11b: 38.2 mW 802.11g: 135 mW HT20: 44.3 mW HT40: 24.0 mW
2			Power spectral Density (PSD)	15.247(d)	Pass	-8.33 dBm/3kHz
3			Minimum 6dB Bandwidth	15.247(a)	Pass	12.3 MHz
3			99% Bandwidth	RSS GEN	-	802.11b: 15.6 MHz 802.11g: 17.4 MHz HT20: 18.9 MHz HT40: 37.1 MHz
4			Spurious emissions	15.247(b)	Pass	All emissions below dBc requirement

**Modifications Made During Testing**

No modifications were made to the EUT during testing

**Deviations From The Standard**

No deviations were made from the requirements of the standard.

Client:	Intel Corporation	Job Number:	J84364
Model:	Intel® Centrino® Wireless-N 2230	T-Log Number:	T84599
Contact:	Steve Hackett	Account Manager:	Christine Krebill
Standard:	FCC 15.247	Class:	N/A

**Run #1: Output Power**

Power Setting <sup>2</sup>	Frequency (MHz)	Output Power		Antenna Gain (dBi)	Result	EIRP		Output Power	
		(dBm) <sup>1</sup>	mW			dBm	W	(dBm) <sup>3</sup>	mW
<b>802.11b Mode</b>									
20.0	2412	14.5	28.1	3.2	Pass	17.7	0.059	14.9	30.9
21.5	2437	15.8	38.2	3.2	Pass	19.0	0.080	15.9	38.9
22.0	2462	15.6	36.1	3.2	Pass	18.8	0.075	15.8	38.0
<b>802.11g Mode (Peak Power)</b>									
24.5	2412	19.9	97.7	3.2	Pass	23.1	0.204	14.4	27.2
28.0	2437	21.3	134.9	3.2	Pass	24.5	0.282	16.9	49.0
25.5	2462	19.6	91.2	3.2	Pass	22.8	0.191	14.3	26.9
<b>HT20 Mode</b>									
23.5	2412	13.1	20.2	3.2	Pass	16.3	0.042	13.4	21.9
28.0	2437	16.5	44.3	3.2	Pass	19.7	0.092	16.6	45.7
24.5	2462	13.1	20.3	3.2	Pass	16.3	0.042	13.3	21.4
<b>HT40 Mode</b>									
20.5	2422	10.4	11.0	3.2	Pass	13.6	0.023	10.6	11.5
24.5	2437	13.8	24.0	3.2	Pass	17.0	0.050	13.9	24.5
22.0	2452	10.8	11.9	3.2	Pass	14.0	0.025	10.9	12.3

Note 1:	Output power measured using a spectrum analyzer (see plots below) with RBW=1MHz, VB=3 MHz, sample detector, power averaging on (transmitted signal was continuous) and power integration over <b>50 MHz</b> (option #2, method 1 in KDB 558074, equivalent to method. Out of band requirement is -30dBc. For 802.11g, power was measured using a peak power meter. Out of band requirement is -20dBc.
Note 2:	Power setting - the software power setting used during testing, included for reference only.
Note 3:	Power measured using average power meter and is included for reference only.

Client:	Intel Corporation	Job Number:	J84364
Model:	Intel® Centrino® Wireless-N 2230	T-Log Number:	T84599
Contact:	Steve Hackett	Account Manager:	Christine Krebill
Standard:	FCC 15.247	Class:	N/A

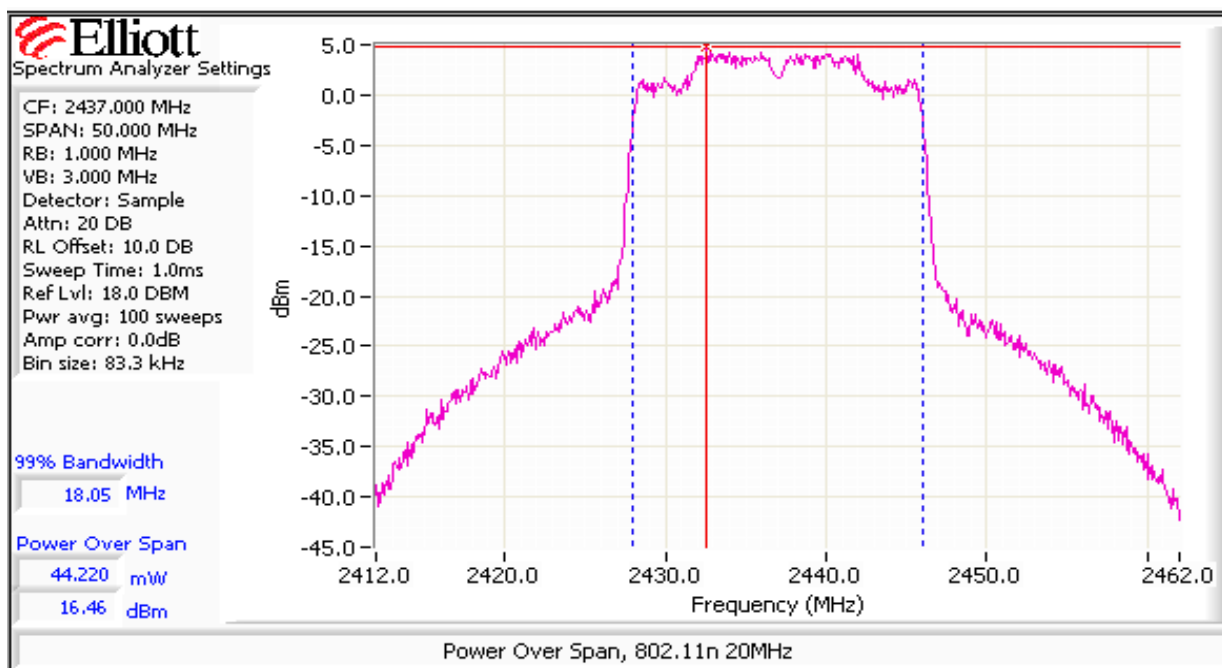
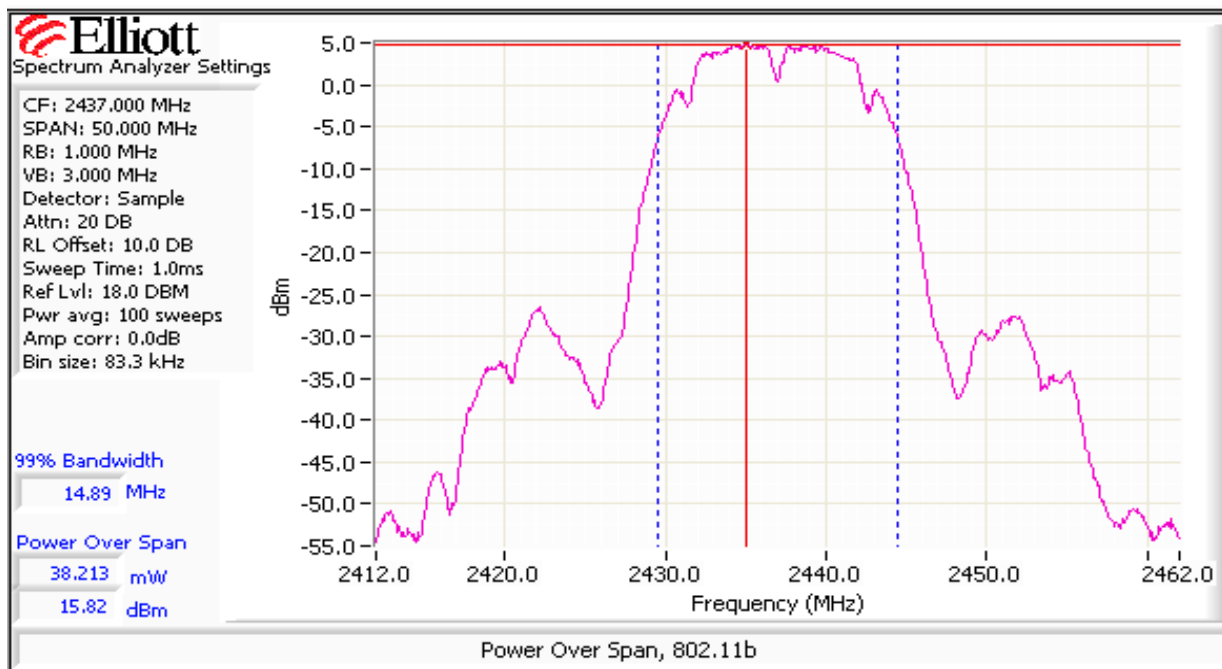

Client:	Intel Corporation	Job Number:	J84364
Model:	Intel® Centrino® Wireless-N 2230	T-Log Number:	T84599
Contact:	Steve Hackett	Account Manager:	Christine Krebill
Standard:	FCC 15.247	Class:	N/A

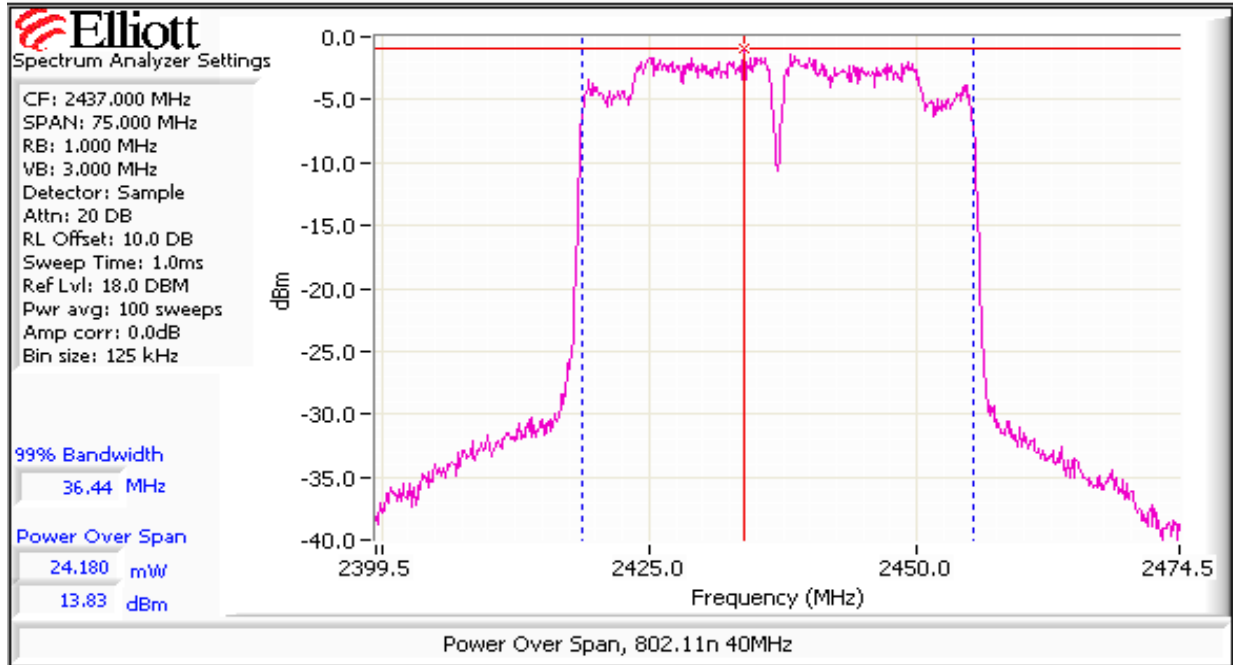



Client:	Intel Corporation	Job Number:	J84364
Model:	Intel® Centrino® Wireless-N 2230	T-Log Number:	T84599
Contact:	Steve Hackett	Account Manager:	Christine Krebill
Standard:	FCC 15.247	Class:	N/A

### Run #2: Power spectral Density

Mode	Power Setting	Frequency (MHz)	PSD	Limit	Result
			(dBm/3kHz) <small>Note 1</small>	dBm/3kHz	
802.11b	23.0	2412	-8.3	8.0	Pass
	23.0	2437	-8.3	8.0	Pass
	23.0	2462	-11.0	8.0	Pass
802.11g	27.5	2412	-8.5	8.0	Pass
	28.0	2437	-8.7	8.0	Pass
	26.5	2462	-10.2	8.0	Pass
HT20	25.0	2412	-10.7	8.0	Pass
	28.5	2437	-8.7	8.0	Pass
	25.5	2462	-12.3	8.0	Pass
HT40	22.0	2422	-17.5	8.0	Pass
	28.5	2437	-11.0	8.0	Pass
	23.0	2452	-15.3	8.0	Pass

Note 1: Power spectral density measured using RB=3 kHz, VB=10kHz, analyzer with peak detector and with a sweep time set to ensure a dwell time of at least 1 second per 3kHz. The measurement is made at the frequency of PPSD determined from preliminary scans using RB=3kHz using multiple sweeps at a faster rate over the 6dB bandwidth of the signal.

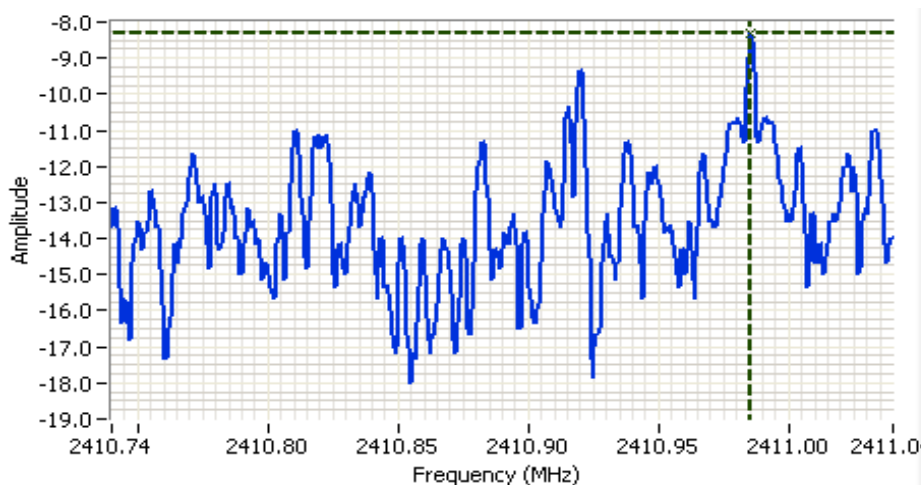

#### Analyzer Settings

HP8564E  
 CF: 2410.890 MHz  
 SPAN: 300 kHz  
 RB: 3.00 kHz  
 VB: 10.0 kHz  
 Detector: POS  
 Attn: 10 DB  
 RL Offset: 11.0 DB  
 Sweep Time: 100.0s  
 Ref Lvl: 11.0 DBM

#### Comments

PSD = -8.33dBm/3kHz  
 802.11b  
 chain A

Cursor 1	2410.9855	-8.33	↕	↔	🔒
	0.0000	0.00	↕	↔	🔒

Client: Intel Corporation	Job Number: J84364
Model: Intel® Centrino® Wireless-N 2230	T-Log Number: T84599
	Account Manager: Christine Krebill
Contact: Steve Hackett	
Standard: FCC 15.247	Class: N/A

**Run #3: Signal Bandwidth**

Mode	Power Setting	Frequency (MHz)	Resolution Bandwidth	Bandwidth (MHz)	
				6dB	99%
802.11b	23.0	2412	100kHz	12.3	15.6
	23.0	2437	100kHz	12.3	15.5
	23.0	2462	100kHz	12.2	15.4
802.11g	27.5	2412	100kHz	15.5	17.4
	28.0	2437	100kHz	15.3	17.4
	26.5	2462	100kHz	15.2	17.2
HT20	25.0	2412	100kHz	17.4	18.7
	28.5	2437	100kHz	17.8	18.9
	25.5	2462	100kHz	17.7	18.6
HT40	22.0	2422	100kHz	36.8	37.0
	28.5	2437	100kHz	36.8	37.1
	23.0	2452	100kHz	36.7	36.9

Note 1: 99% bandwidth measured in accordance with RSS GEN, with RB > 1% of the span and VB > 3xRB



**Analyzer Settings**

HP8564E  
 CF: 2412.000 MHz  
 SPAN: 50.000 MHz  
 RB: 100 kHz  
 VB: 100 kHz  
 Detector: POS  
 Attn: 10 DB  
 RL Offset: 11.0 DB  
 Sweep Time: 50.0ms  
 Ref Lvl: 11.0 DBM

**Comments**

6dB BW: 12.250 MHz  
 802.11b chain A

Cursor 1	2418.5000	6.50	
Cursor 2	2406.2500	0.50	

Delta Freq. 12.250

Delta Amplitude 6.00



Client:	Intel Corporation	Job Number:	J84364
Model:	Intel® Centrino® Wireless-N 2230	T-Log Number:	T84599
Contact:	Steve Hackett	Account Manager:	Christine Krebill
Standard:	FCC 15.247	Class:	N/A

Run #4: Out of Band Spurious Emissions

Frequency (MHz)	Limit	Result
2412	-30dBc	Pass
2437	-30dBc	Pass
2462	-30dBc	Pass

Plots for low channel, 802.11b, power setting(s) = 23

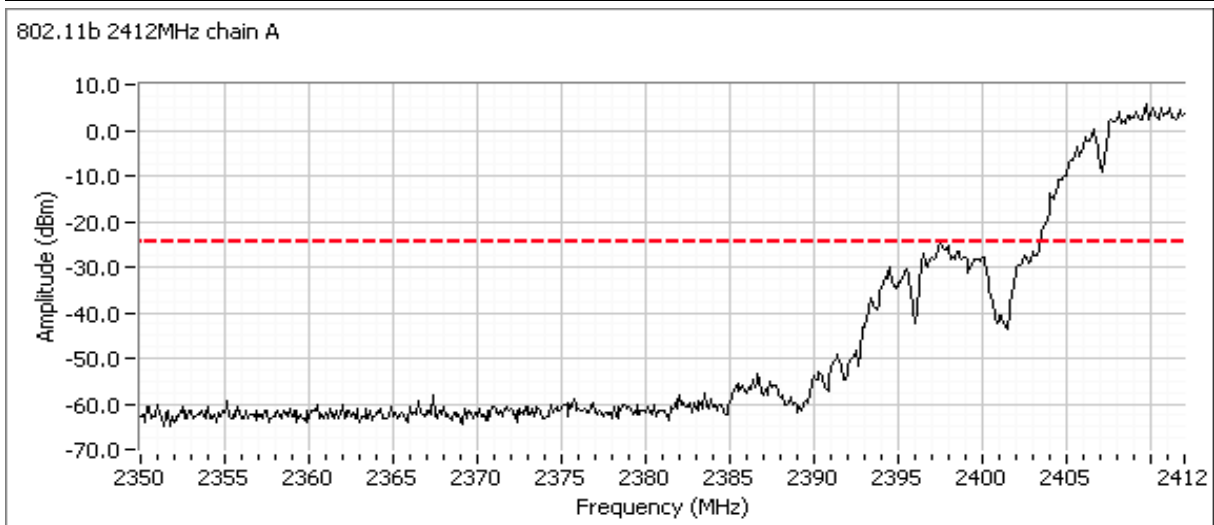
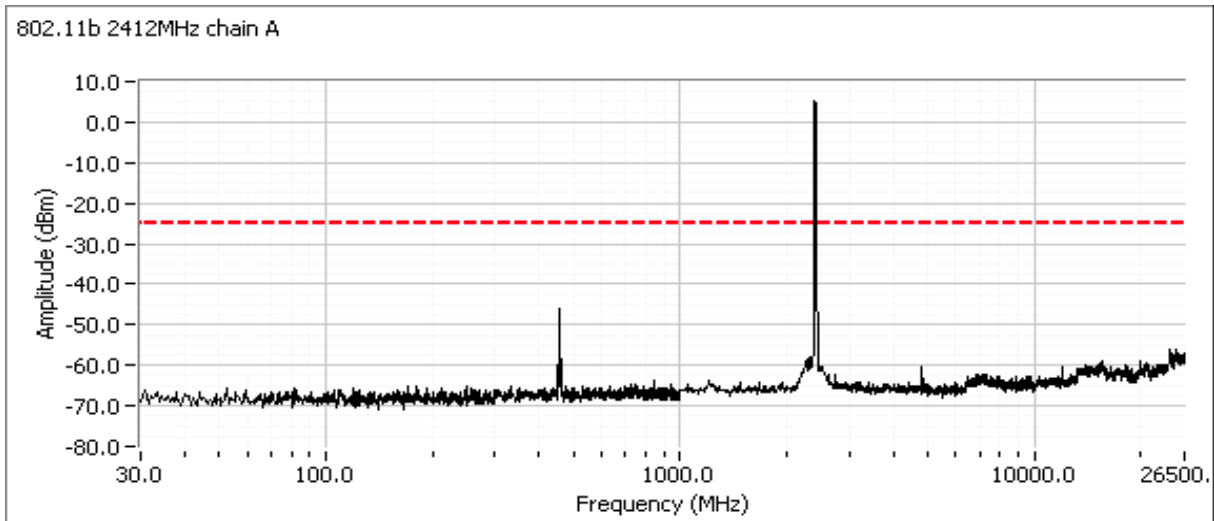

Additional plot showing compliance with -30dBc limit from 2390 MHz to 2400 MHz. Radiated measurements used to show compliance with the limits in the restricted band below 2390 MHz.

Client:	Intel Corporation	Job Number:	J84364
Model:	Intel® Centrino® Wireless-N 2230	T-Log Number:	T84599
Contact:	Steve Hackett	Account Manager:	Christine Krebill
Standard:	FCC 15.247	Class:	N/A

Plots for center channel 802.11b, power setting(s) = 23

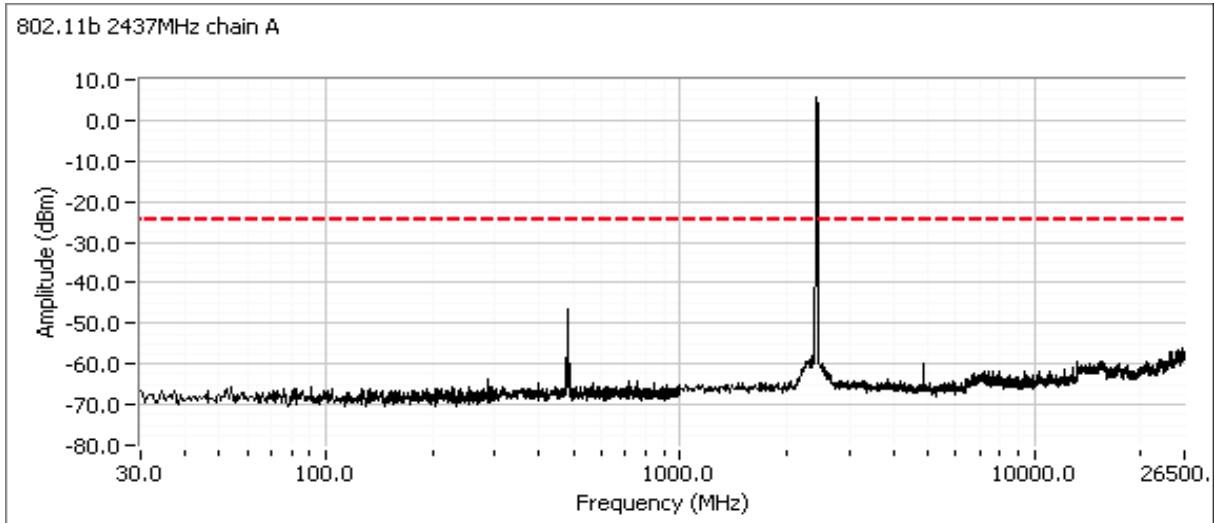

Plots for high channel, 802.11b, power setting(s) = 23

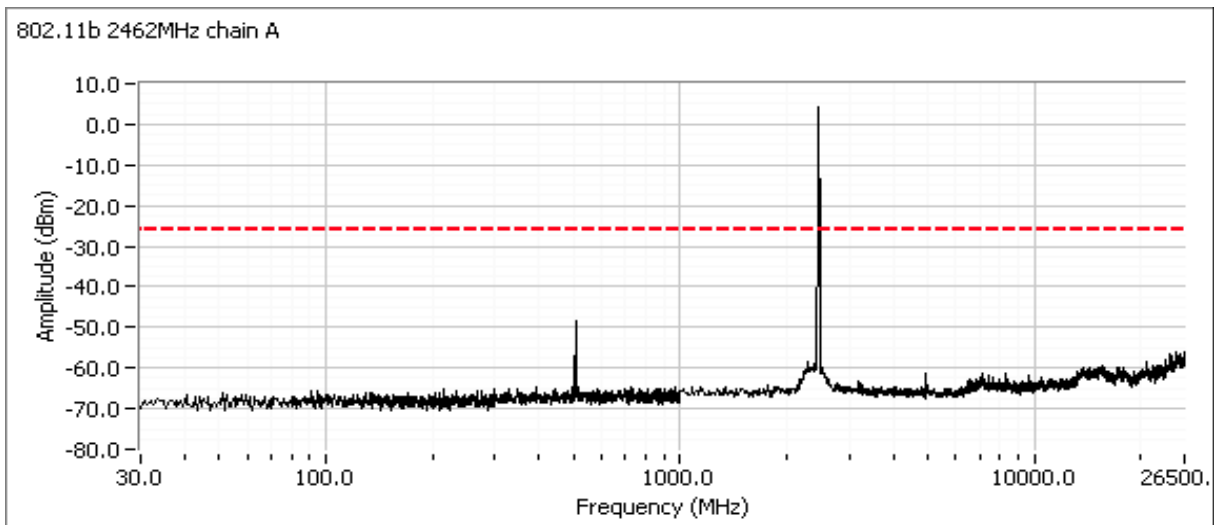

Client:	Intel Corporation	Job Number:	J84364
Model:	Intel® Centrino® Wireless-N 2230	T-Log Number:	T84599
Contact:	Steve Hackett	Account Manager:	Christine Krebill
Standard:	FCC 15.247	Class:	N/A

Frequency (MHz)	Limit	Result
2412	-20dBc	Pass
2437	-20dBc	Pass
2462	-20dBc	Pass

Plots for low channel, 802.11g, power setting(s) = 27.5

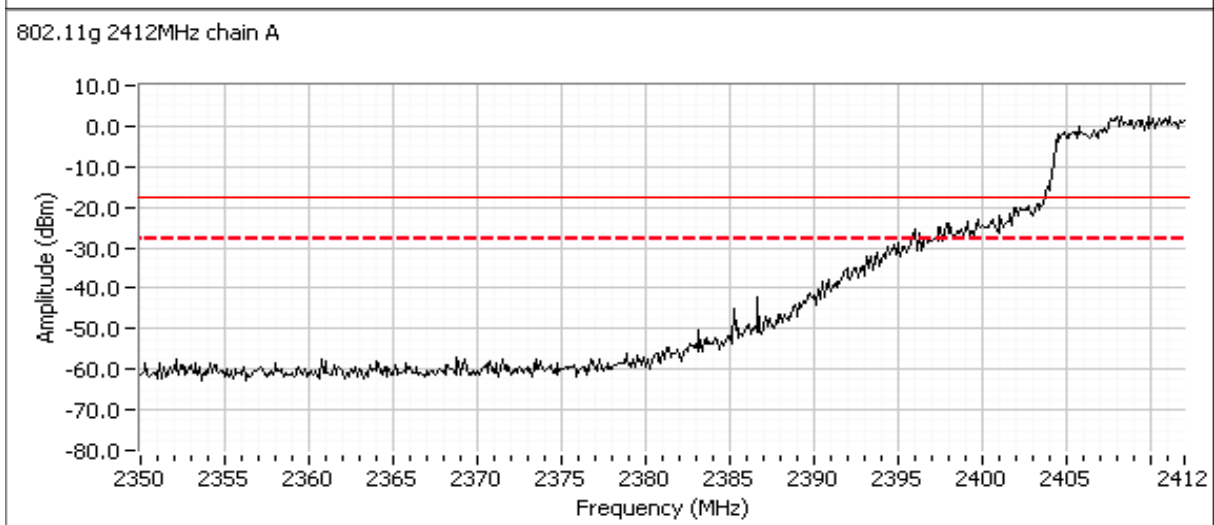
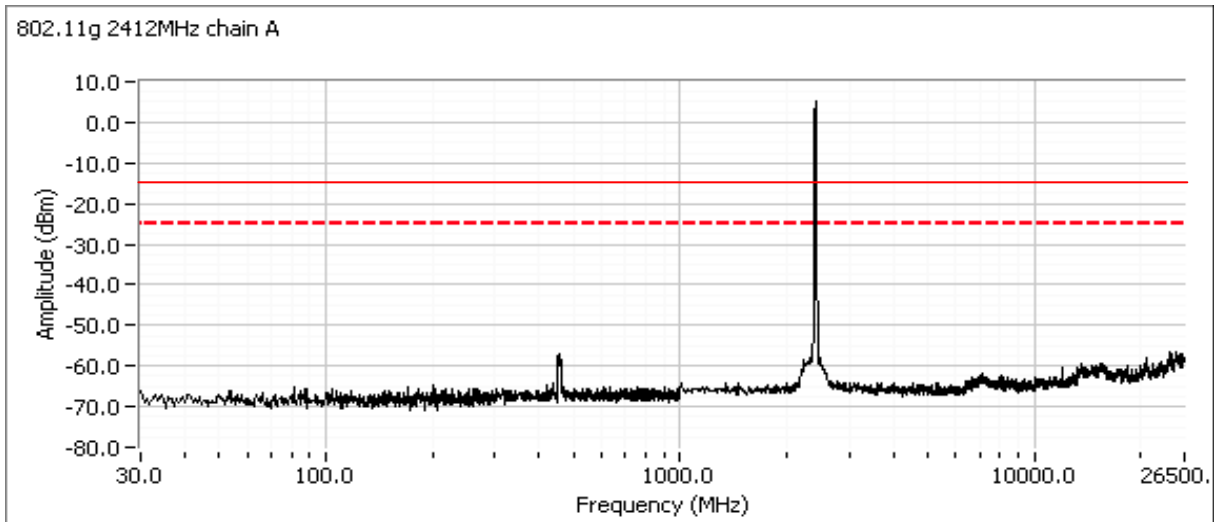

Additional plot showing compliance with -20dBc limit from 2390 MHz to 2400 MHz. Radiated measurements used to show compliance with the limits in the restricted band below 2390 MHz.

Client:	Intel Corporation	Job Number:	J84364
Model:	Intel® Centrino® Wireless-N 2230	T-Log Number:	T84599
Contact:	Steve Hackett	Account Manager:	Christine Krebill
Standard:	FCC 15.247	Class:	N/A

Plots for center channel 802.11g, power setting(s) = 28

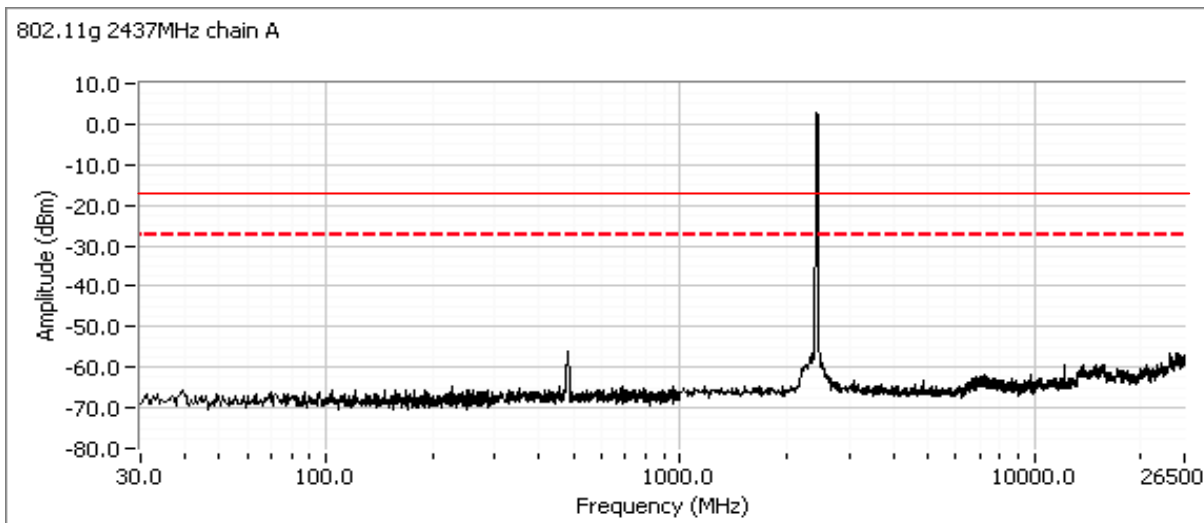

Plots for high channel, 802.11g, power setting(s) = 26.5

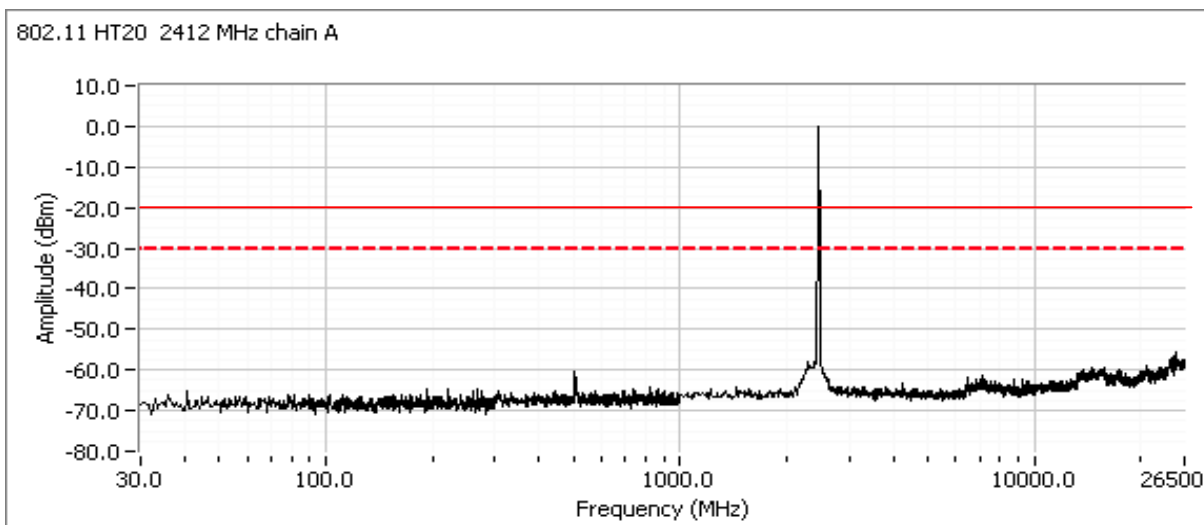

Client:	Intel Corporation	Job Number:	J84364
Model:	Intel® Centrino® Wireless-N 2230	T-Log Number:	T84599
Contact:	Steve Hackett	Account Manager:	Christine Krebill
Standard:	FCC 15.247	Class:	N/A

Frequency (MHz)	Limit	Result
2412	-30dBc	Pass
2437	-30dBc	Pass
2462	-30dBc	Pass

Plots for low channel, HT20, power setting(s) = 25

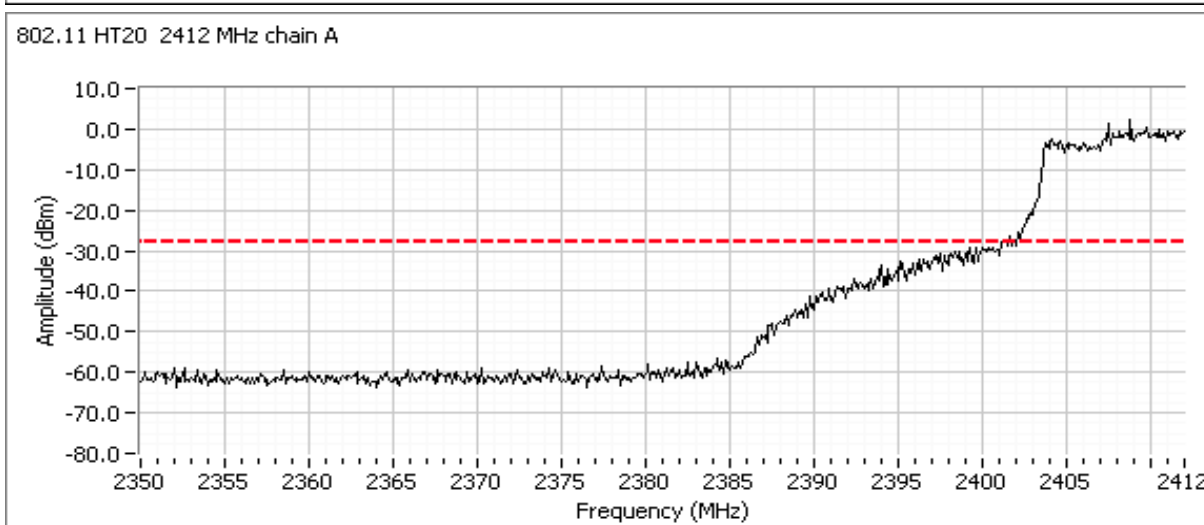
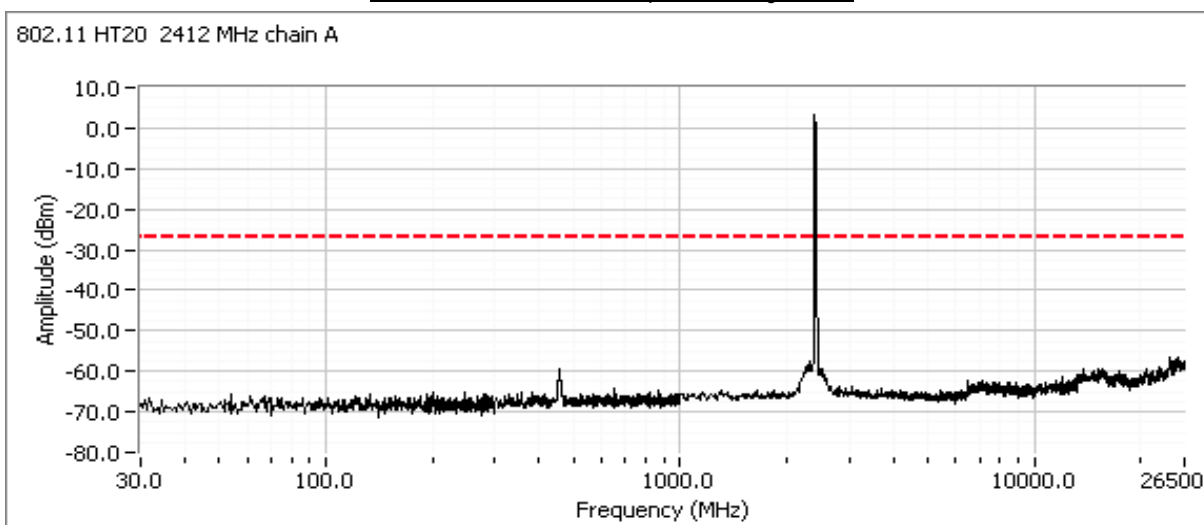

Additional plot showing compliance with -30dBc limit from 2390 MHz to 2400 MHz. Radiated measurements used to show compliance with the limits in the restricted band below 2390 MHz.

Client:	Intel Corporation	Job Number:	J84364
Model:	Intel® Centrino® Wireless-N 2230	T-Log Number:	T84599
Contact:	Steve Hackett	Account Manager:	Christine Krebill
Standard:	FCC 15.247	Class:	N/A

Plots for center channel HT20, power setting(s) = 28.5

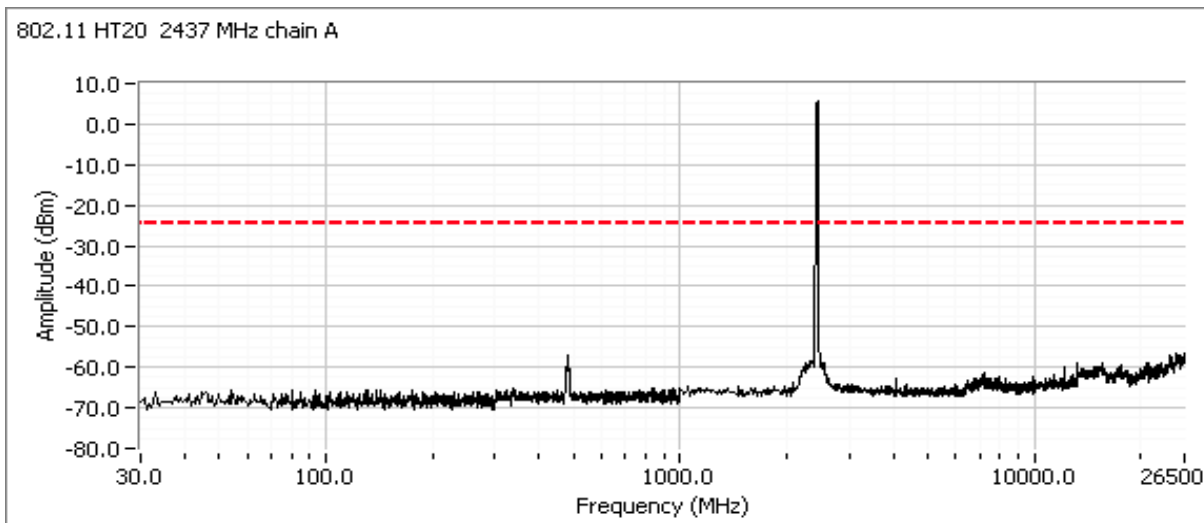

Plots for high channel, HT20, power setting(s) = 25.5

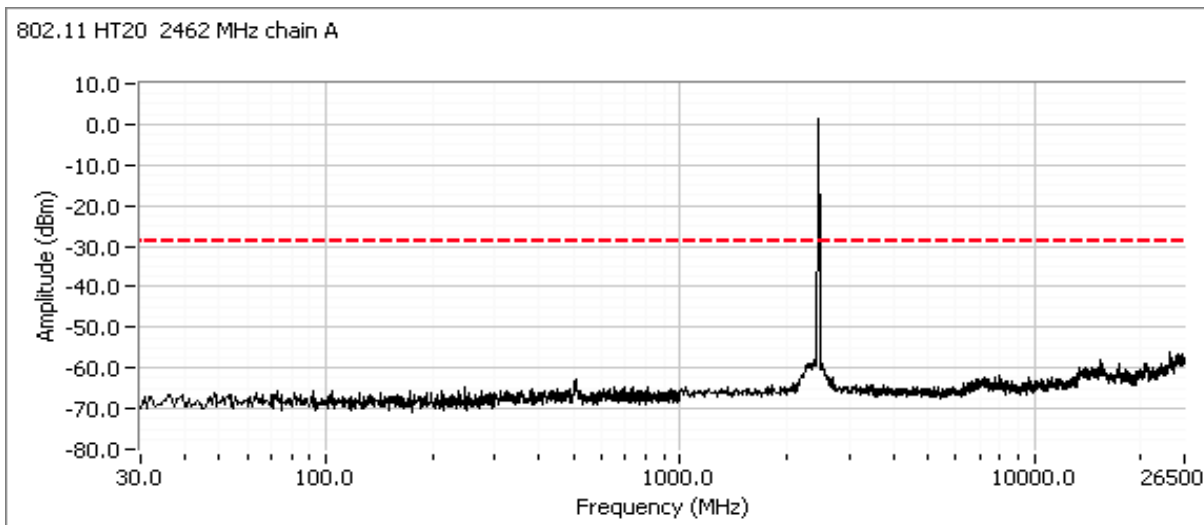



Client:	Intel Corporation	Job Number:	J84364
Model:	Intel® Centrino® Wireless-N 2230	T-Log Number:	T84599
Contact:	Steve Hackett	Account Manager:	Christine Krebill
Standard:	FCC 15.247	Class:	N/A

Frequency (MHz)	Limit	Result
2422	-30dBc	Pass
2437	-30dBc	Pass
2452	-30dBc	Pass

Plots for low channel, HT40, power setting(s) = 22

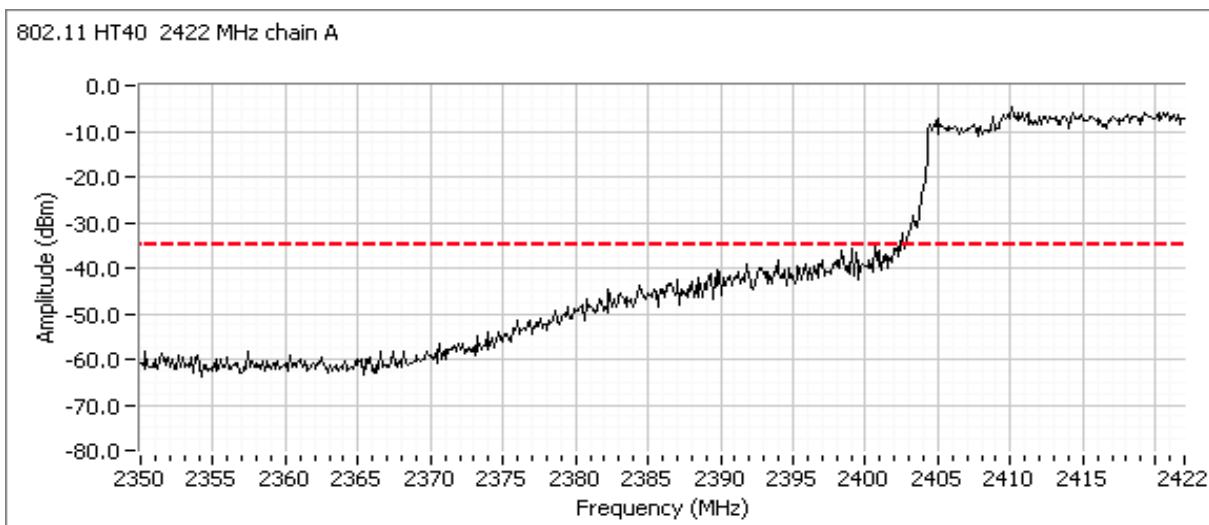
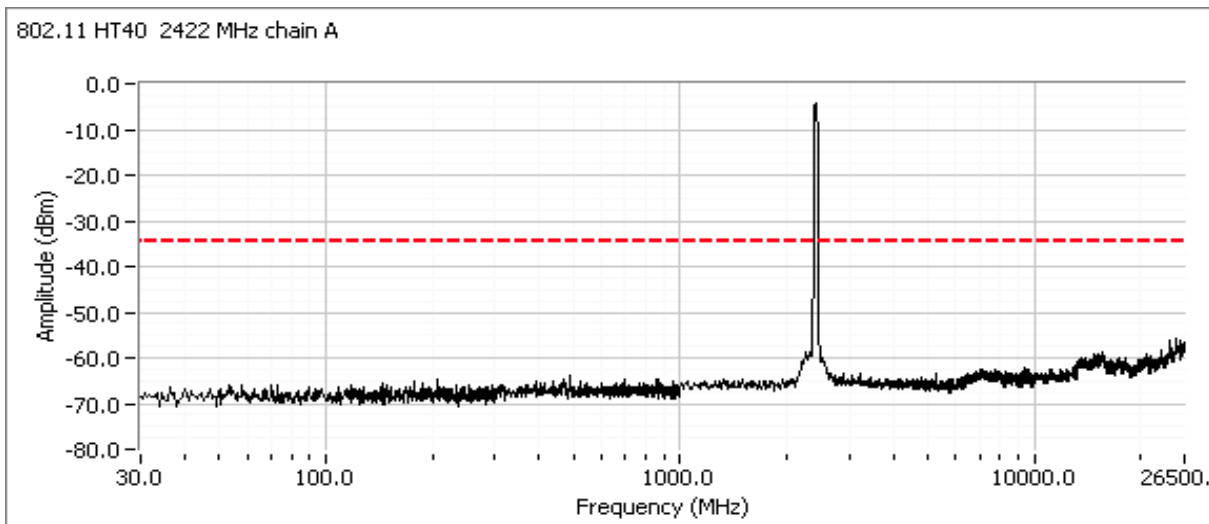

Additional plot showing compliance with -30dBc limit from 2390 MHz to 2400 MHz. Radiated measurements used to show compliance with the limits in the restricted band below 2390 MHz.

Client:	Intel Corporation	Job Number:	J84364
Model:	Intel® Centrino® Wireless-N 2230	T-Log Number:	T84599
Contact:	Steve Hackett	Account Manager:	Christine Krebill
Standard:	FCC 15.247	Class:	N/A

Plots for center channel HT40, power setting(s) = 28.5

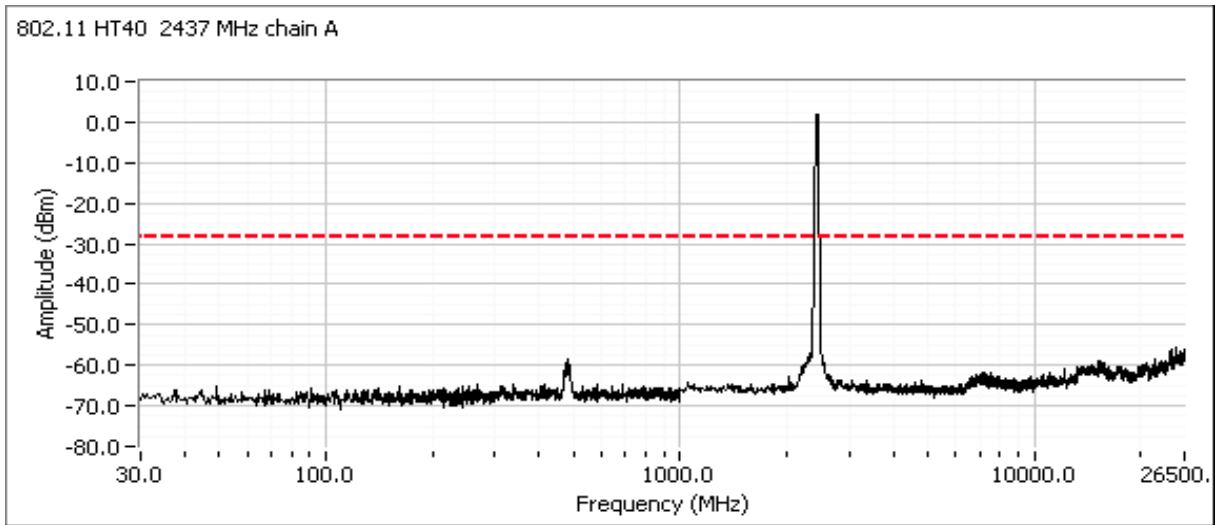

Plots for high channel, HT40, power setting(s) = 23

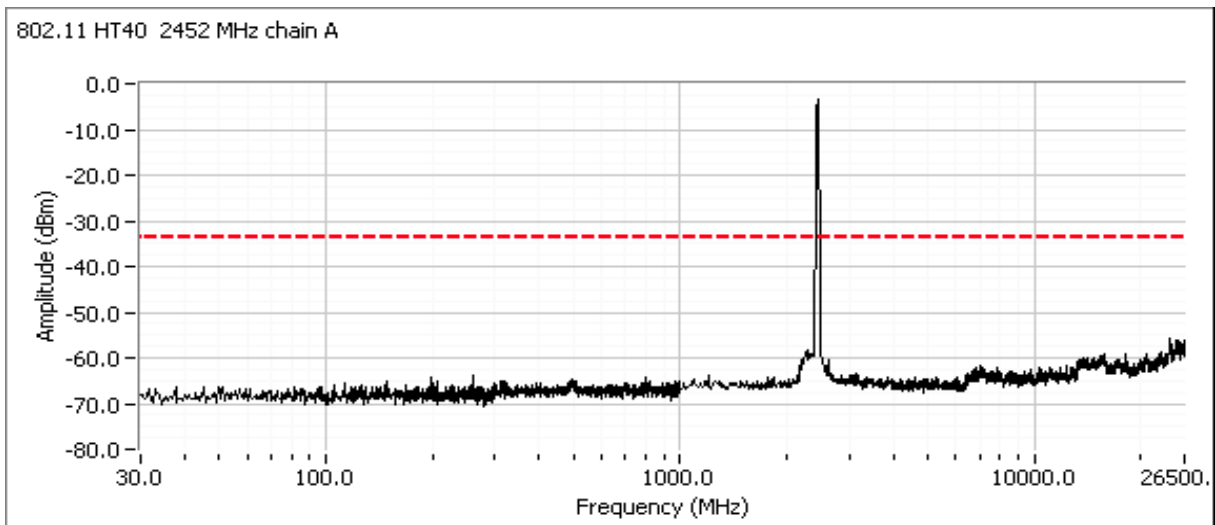

Client:	Intel Corporation	Job Number:	J84364
Model:	Intel® Centrino® Wireless-N 2230	T-Log Number:	T84599
Contact:	Steve Hackett	Account Manager:	Christine Krebill
Standard:	FCC 15.247	Class:	N/A

**RSS 210 and FCC 15.247 (DTS) Antenna Port Measurements  
Power, PSD, Bandwidth and Spurious Emissions**

**Test Specific Details**

Objective: The objective of this test session is to perform final qualification testing of the EUT with respect to the specification listed above.

Date of Test: 9/27/11, 9/30/11  
Test Engineer: D. Bare, M. Birgani  
Test Location: Fremont Chamber #7

Config. Used: 1  
Config Change: None  
Host Unit Voltage 120V/60Hz

**General Test Configuration**

The EUT was connected to the spectrum analyzer or power meter via a suitable attenuator. All measurements were made on a single chain.

All measurements have been corrected to allow for the external attenuators used.

**Ambient Conditions:**

Temperature: 20-25 °C  
Rel. Humidity: 30-40 %

**Summary of Results**

MAC Address: 00150082509B DRTU Tool Version **1.5.3.0322** Driver version **15.0.0.61**

Run #	Pwr setting	Avg Pwr	Test Performed	Limit	Pass / Fail	Result / Margin
1			Output Power	15.247(b)	Pass	802.11b: 52.5 mW 802.11g: 151.4 mW HT20: 38.9 mW HT40: 20.6 mW
2			Power spectral Density (PSD)	15.247(d)	Pass	-7.5 dBm/3kHz
3			Minimum 6dB Bandwidth	15.247(a)	Pass	12.3 MHz
3			99% Bandwidth	RSS GEN	-	802.11b: 15.4 MHz 802.11g: 17.3 MHz HT20: 18.6 MHz HT40: 36.9 MHz
4			Spurious emissions	15.247(b)	Pass	All emissions below dBc requirement

**Modifications Made During Testing**

No modifications were made to the EUT during testing

**Deviations From The Standard**

No deviations were made from the requirements of the standard.

Client:	Intel Corporation	Job Number:	J84364
Model:	Intel® Centrino® Wireless-N 2230	T-Log Number:	T84599
Contact:	Steve Hackett	Account Manager:	Christine Krebill
Standard:	FCC 15.247	Class:	N/A

**Run #1: Output Power**

Power Setting <sup>2</sup>	Frequency (MHz)	Output Power		Antenna Gain (dBi)	Result	EIRP		Output Power	
		(dBm) <sup>1</sup>	mW			dBm	W	(dBm) <sup>3</sup>	mW
<b>802.11b Mode (Peak Power)</b>									
21.5	2412	16.0	39.8	3.2	Pass	19.2	0.001	14.8	30.2
23.5	2437	17.2	52.5	3.2	Pass	20.4	0.110	15.7	37.2
24.0	2462	17.2	52.5	3.2	Pass	20.4	0.110	15.7	37.2
<b>802.11g Mode (Peak Power)</b>									
26.5	2412	20.4	109.6	3.2	Pass	23.6	0.229	14.4	27.5
30.0	2437	21.8	151.4	3.2	Pass	25.0	0.316	16.8	47.9
27.5	2462	20.4	109.6	3.2	Pass	23.6	0.229	14.3	26.9
<b>HT20 Mode</b>									
25.5	2412	12.8	18.9	3.2	Pass	16.0	0.040	13.4	21.9
30.0	2437	15.9	38.9	3.2	Pass	19.1	0.081	16.8	47.9
26.5	2462	12.0	15.7	3.2	Pass	15.2	0.033	13.3	21.4
<b>HT40 Mode</b>									
21.5	2422	9.1	8.2	3.2	Pass	12.3	0.017	9.8	9.5
26.5	2437	13.1	20.6	3.2	Pass	16.3	0.043	14.0	25.1
23.5	2452	9.9	9.7	3.2	Pass	13.1	0.020	10.9	12.3

Note 1:	Output power measured using a spectrum analyzer (see plots below) with RBW=1MHz, VB=3 MHz, sample detector, power averaging on (transmitted signal was continuous) and power integration over 50 MHz (option #2, method 1 in KDB 558074, equivalent to method. Out of band requirement is -30dBc. For 802.11b and 802.11g, power was measured using a peak power meter. Out of band requirement is -20dBc.
Note 2:	Power setting - the software power setting used during testing, included for reference only.
Note 3:	Power measured using average power meter and is included for reference only.

Client:	Intel Corporation	Job Number:	J84364
Model:	Intel® Centrino® Wireless-N 2230	T-Log Number:	T84599
Contact:	Steve Hackett	Account Manager:	Christine Krebill
Standard:	FCC 15.247	Class:	N/A

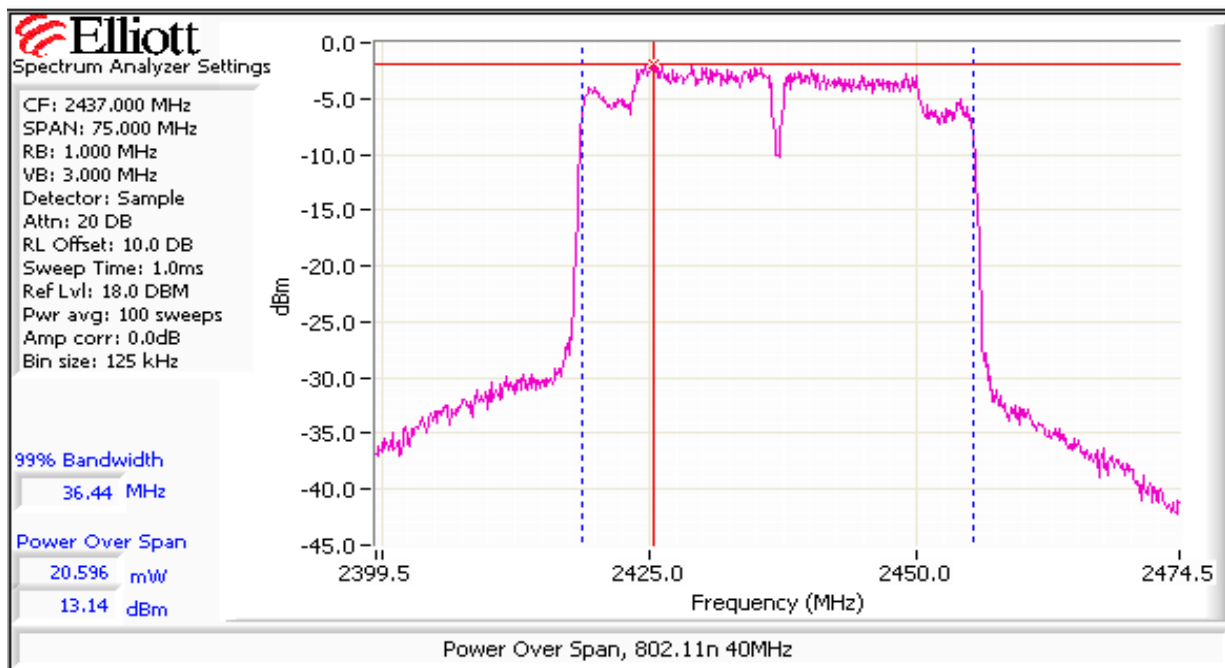
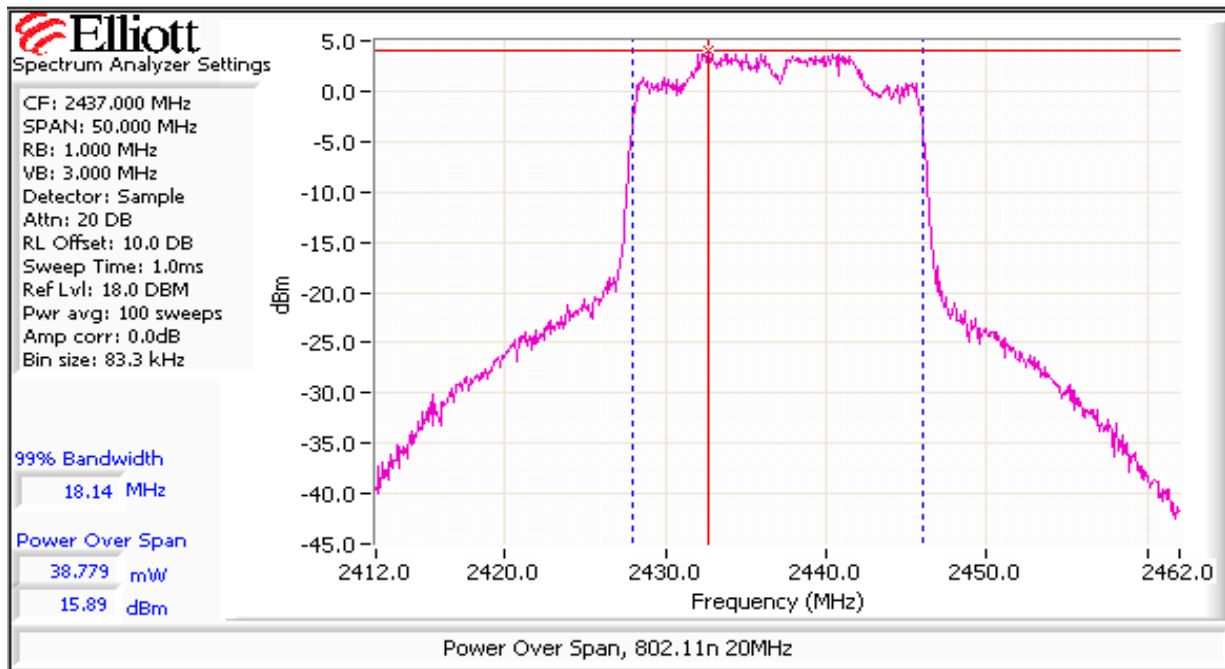

Client:	Intel Corporation	Job Number:	J84364
Model:	Intel® Centrino® Wireless-N 2230	T-Log Number:	T84599
Contact:	Steve Hackett	Account Manager:	Christine Krebill
Standard:	FCC 15.247	Class:	N/A

### Run #2: Power spectral Density

Mode	Power Setting	Frequency (MHz)	PSD	Limit	Result
			(dBm/3kHz) <small>Note 1</small>	dBm/3kHz	
802.11b	24.5	2412	-10.2	8.0	Pass
	24.5	2437	-8.2	8.0	Pass
	25.5	2462	-9.0	8.0	Pass
802.11g	27.5	2412	-7.5	8.0	Pass
	30.0	2437	-7.8	8.0	Pass
	28.5	2462	-9.2	8.0	Pass
HT20	25.0	2412	-12.3	8.0	Pass
	30.0	2437	-7.7	8.0	Pass
	26.5	2462	-10.5	8.0	Pass
HT40	22.0	2422	-18.7	8.0	Pass
	28.5	2437	-10.8	8.0	Pass
	24.5	2452	-16.7	8.0	Pass

Note 1: Power spectral density measured using RB=3 kHz, VB=10kHz, analyzer with peak detector and with a sweep time set to ensure a dwell time of at least 1 second per 3kHz. The measurement is made at the frequency of PPSD determined from preliminary scans using RB=3kHz using multiple sweeps at a faster rate over the 6dB bandwidth of the signal.

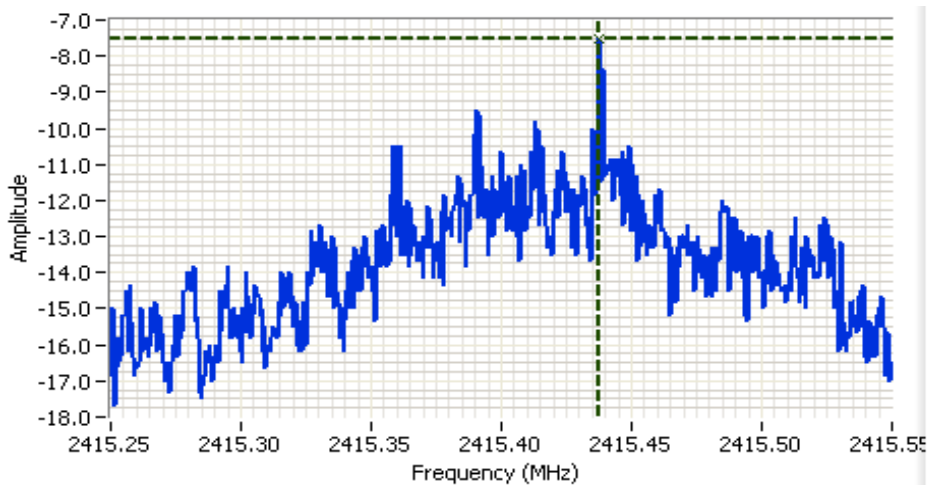

**Analyzer Settings**

HP8563E  
 CF: 2415.400 MHz  
 SPAN: 300 kHz  
 RB: 3.00 kHz  
 VB: 10.0 kHz  
 Detector: POS  
 Attn: 20 DB  
 RL Offset: 11.0 DB  
 Sweep Time: 100.0s  
 Ref Lvl: 21.0 DBM

**Comments**

Cursor 1 2415.4375 -7.50 ↕ ✖ 🔒

0.0000 0.00 ↕ 🔒



Client: Intel Corporation	Job Number: J84364
Model: Intel® Centrino® Wireless-N 2230	T-Log Number: T84599
Contact: Steve Hackett	Account Manager: Christine Krebill
Standard: FCC 15.247	Class: N/A

### Run #3: Signal Bandwidth

Mode	Power Setting	Frequency (MHz)	Resolution Bandwidth	Bandwidth (MHz)	
				6dB	99%
802.11b	24.5	2412	300k/1MHz	12.3	15.4
	24.5	2437	300k/1MHz	12.3	15.4
	25.5	2462	300k/1MHz	12.3	15.3
802.11g	27.5	2412	300k/1MHz	15.7	17.2
	29.5	2437	300k/1MHz	15.5	17.3
	28.5	2462	300k/1MHz	16.1	17.2
HT20	25	2412	300k/1MHz	17.8	18.6
	29	2437	300k/1MHz	17.7	18.6
	26.5	2462	300k/1MHz	17.5	18.6
HT40	22	2422	300k/1MHz	36.2	36.9
	28.5	2437	300k/1MHz	36.3	36.9
	24.5	2452	300k/1MHz	36.3	36.8

Note 1: 99% bandwidth measured in accordance with RSS GEN, with RB > 1% of the span and VB > 3xRB



#### Analyzer Settings

HP8563E  
CF: 2412.000 MHz  
SPAN: 50.000 MHz  
RB: 300 kHz  
VB: 1.000 MHz  
Detector: POS  
Attn: 20 DB  
RL Offset: 11.0 DB  
Sweep Time: 50.0ms  
Ref Lvl: 21.0 DBM

#### Comments

6dB BW: 12.250 MHz

Cursor 1	2418.3333	7.00	
Cursor 2	2406.0833	1.00	

Delta Freq. 12.250

Delta Amplitude 6.00



Client:	Intel Corporation	Job Number:	J84364
Model:	Intel® Centrino® Wireless-N 2230	T-Log Number:	T84599
Contact:	Steve Hackett	Account Manager:	Christine Krebill
Standard:	FCC 15.247	Class:	N/A

**Run #4: Out of Band Spurious Emissions**  
 802.11b

Frequency (MHz)	Limit	Result
2412	-20dBc	Pass
2437	-20dBc	Pass
2462	-20dBc	Pass

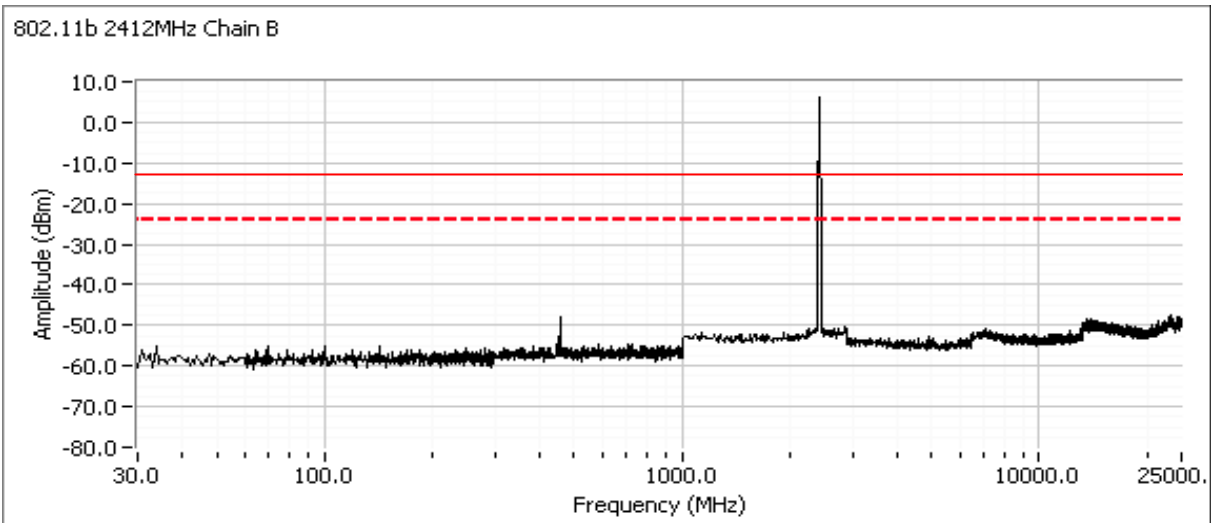



Client:	Intel Corporation	Job Number:	J84364
Model:	Intel® Centrino® Wireless-N 2230	T-Log Number:	T84599
Contact:	Steve Hackett	Account Manager:	Christine Krebill
Standard:	FCC 15.247	Class:	N/A

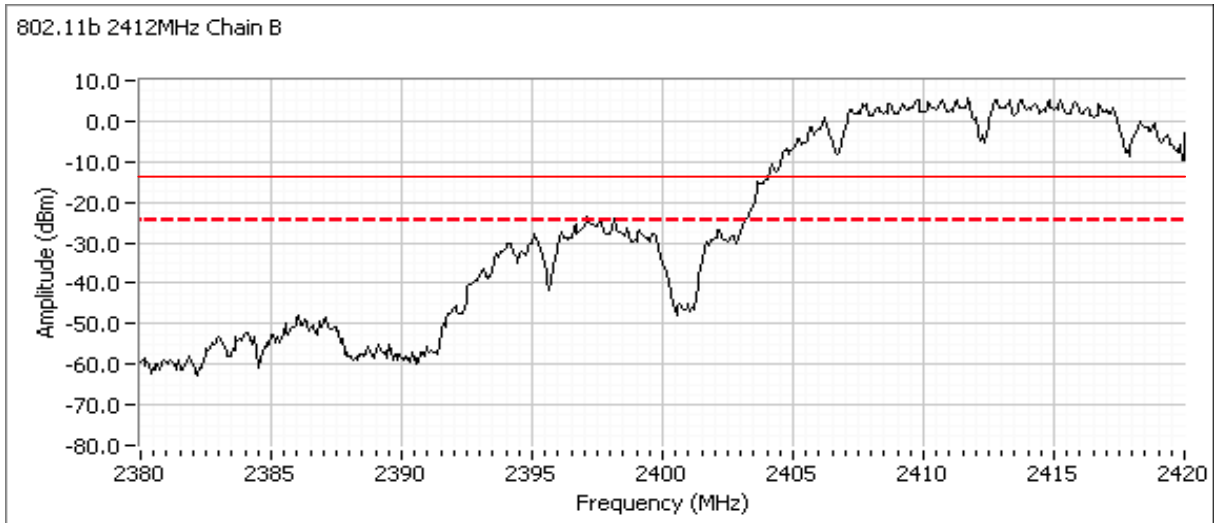

Additional plot showing compliance with -20dBc limit from 2390 MHz to 2400 MHz. Radiated measurements used to show compliance with the limits in the restricted band below 2390 MHz.

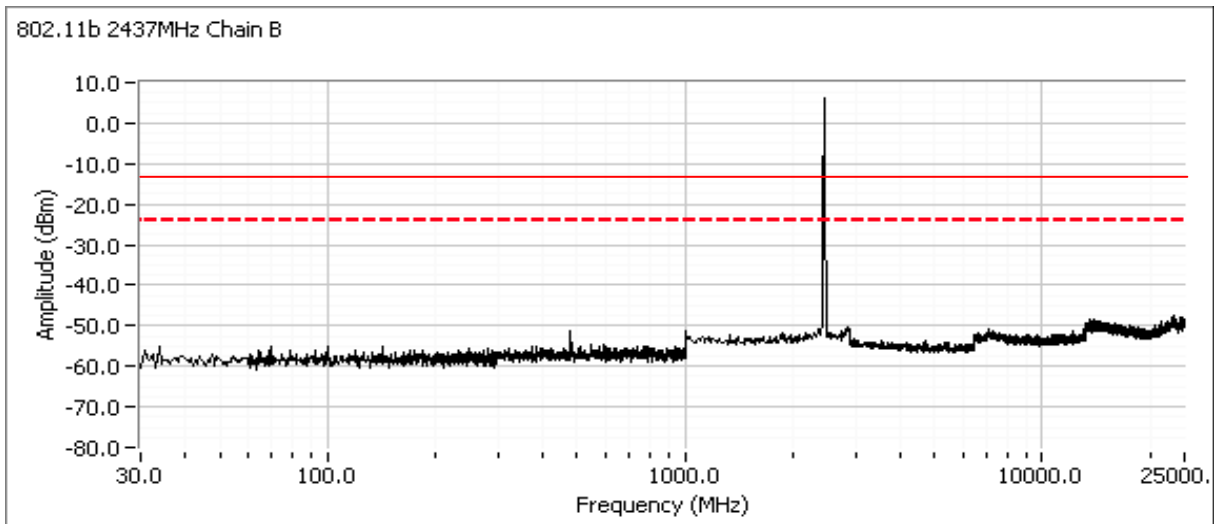

Plots for center channel 802.11b, power setting(s) = 24.5

Client:	Intel Corporation	Job Number:	J84364
Model:	Intel® Centrino® Wireless-N 2230	T-Log Number:	T84599
Contact:	Steve Hackett	Account Manager:	Christine Krebill
Standard:	FCC 15.247	Class:	N/A

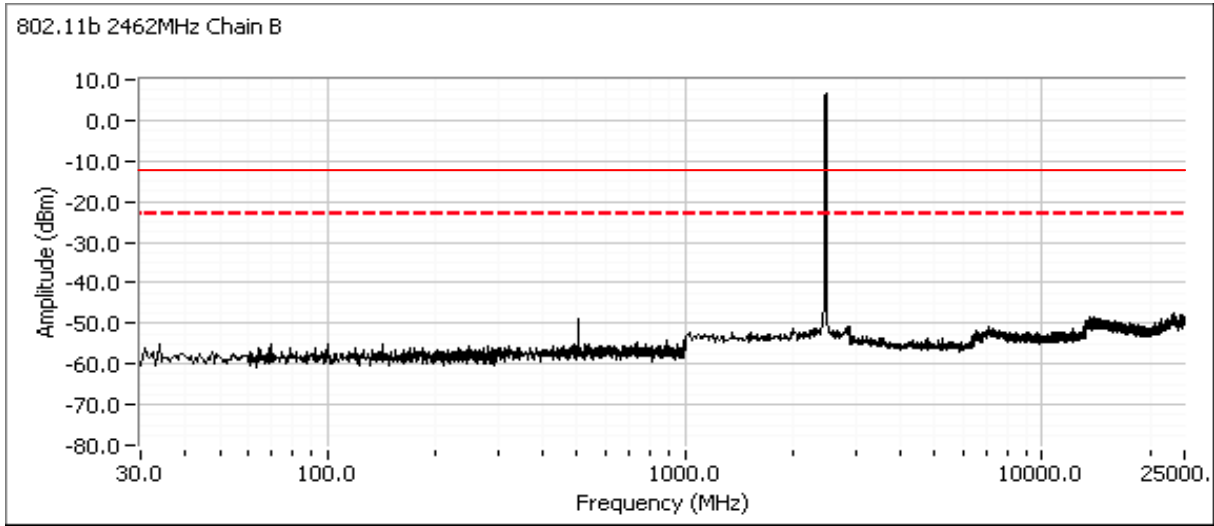

Plots for high channel, 802.11b, power setting(s) = 25.5

802.11g

Frequency (MHz)	Limit	Result
2412	-20dBc	Pass
2437	-20dBc	Pass
2462	-20dBc	Pass

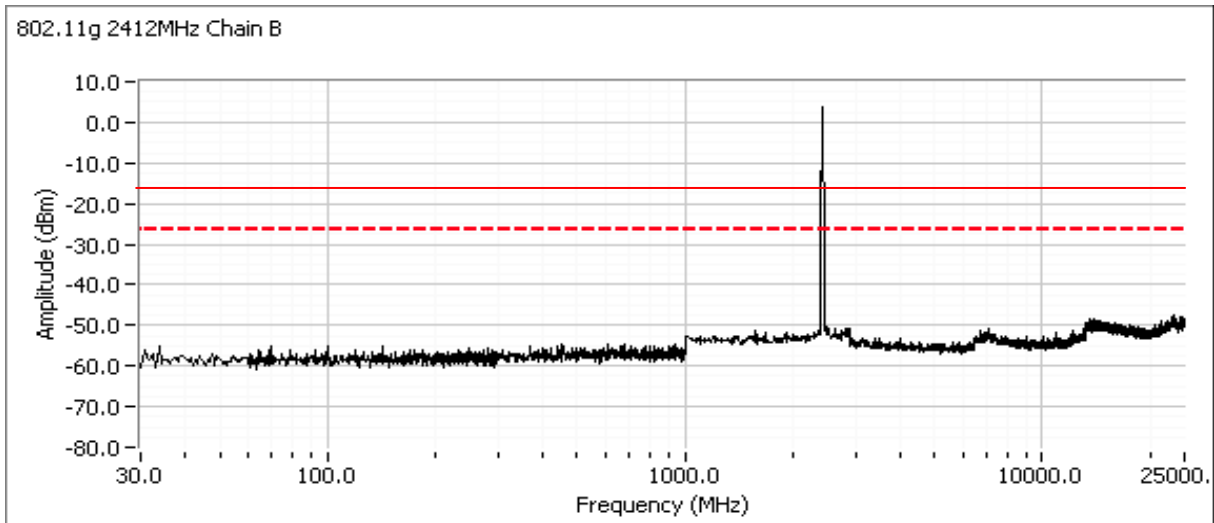

Plots for low channel, 802.11g, power setting(s) = 27.5

Client:	Intel Corporation	Job Number:	J84364
Model:	Intel® Centrino® Wireless-N 2230	T-Log Number:	T84599
Contact:	Steve Hackett	Account Manager:	Christine Krebill
Standard:	FCC 15.247	Class:	N/A

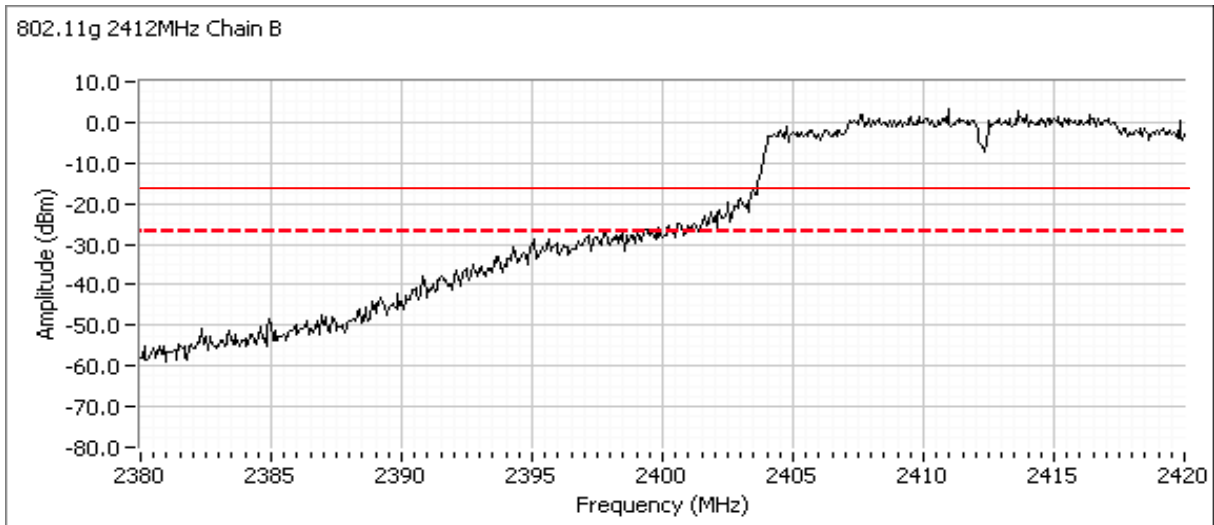

Additional plot showing compliance with -20dBc limit from 2390 MHz to 2400 MHz. Radiated measurements used to show compliance with the limits in the restricted band below 2390 MHz.

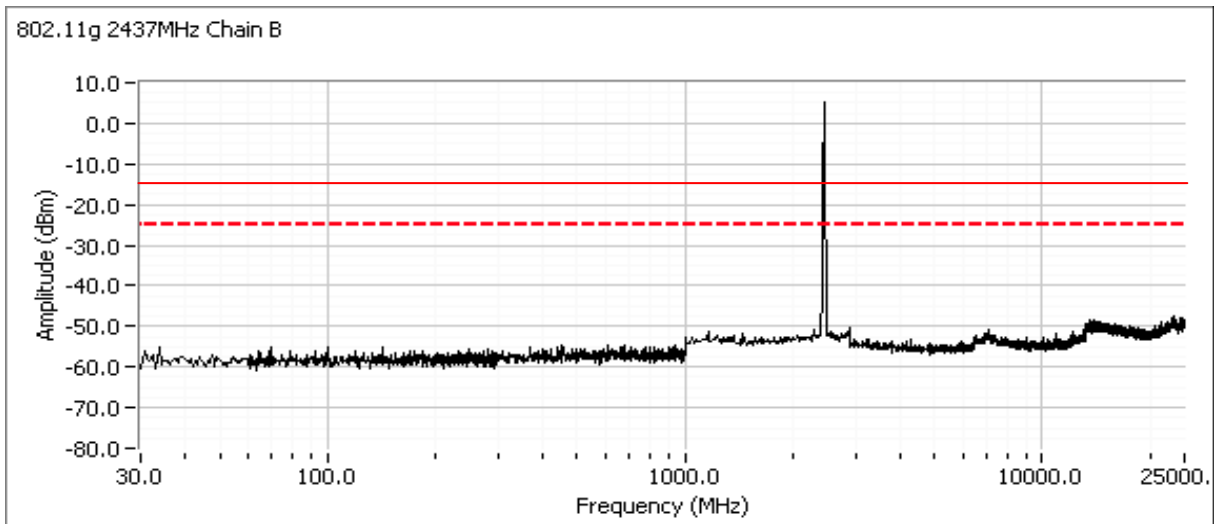

Plots for center channel 802.11g, power setting(s) = 29.5

Client:	Intel Corporation	Job Number:	J84364
Model:	Intel® Centrino® Wireless-N 2230	T-Log Number:	T84599
Contact:	Steve Hackett	Account Manager:	Christine Krebill
Standard:	FCC 15.247	Class:	N/A

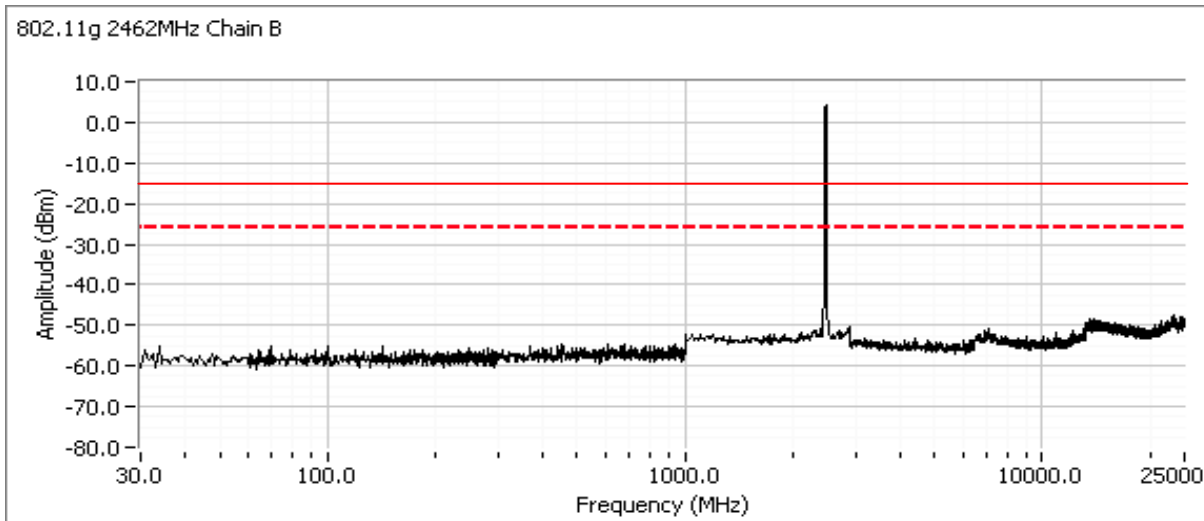

Plots for high channel, 802.11g, power setting(s) = 28.5

### 802.11n 20MHz Mode

Frequency (MHz)	Limit	Result
2412	-30dBc	Pass
2437	-30dBc	Pass
2462	-30dBc	Pass

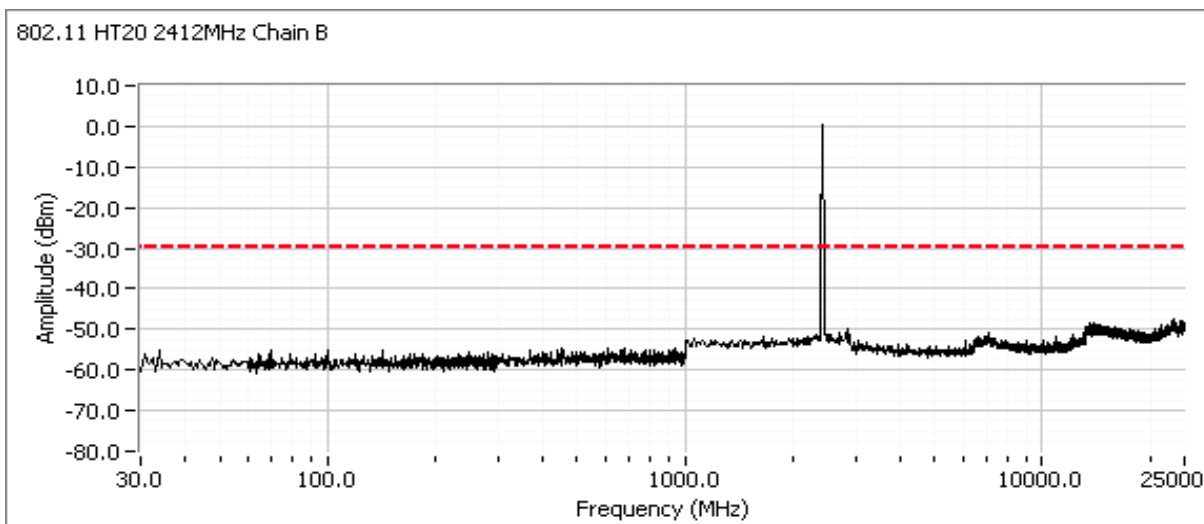

Plots for low channel, HT20, power setting(s) = 25

Client:	Intel Corporation	Job Number:	J84364
Model:	Intel® Centrino® Wireless-N 2230	T-Log Number:	T84599
Contact:	Steve Hackett	Account Manager:	Christine Krebill
Standard:	FCC 15.247	Class:	N/A

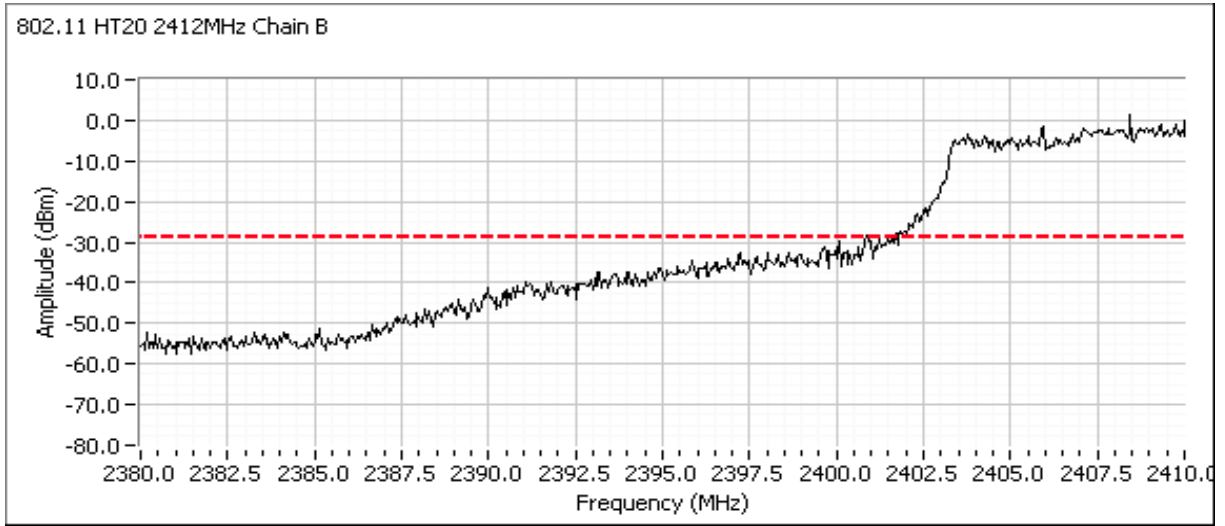

Additional plot showing compliance with -30dBc limit from 2390 MHz to 2400 MHz. Radiated measurements used to show compliance with the limits in the restricted band below 2390 MHz.

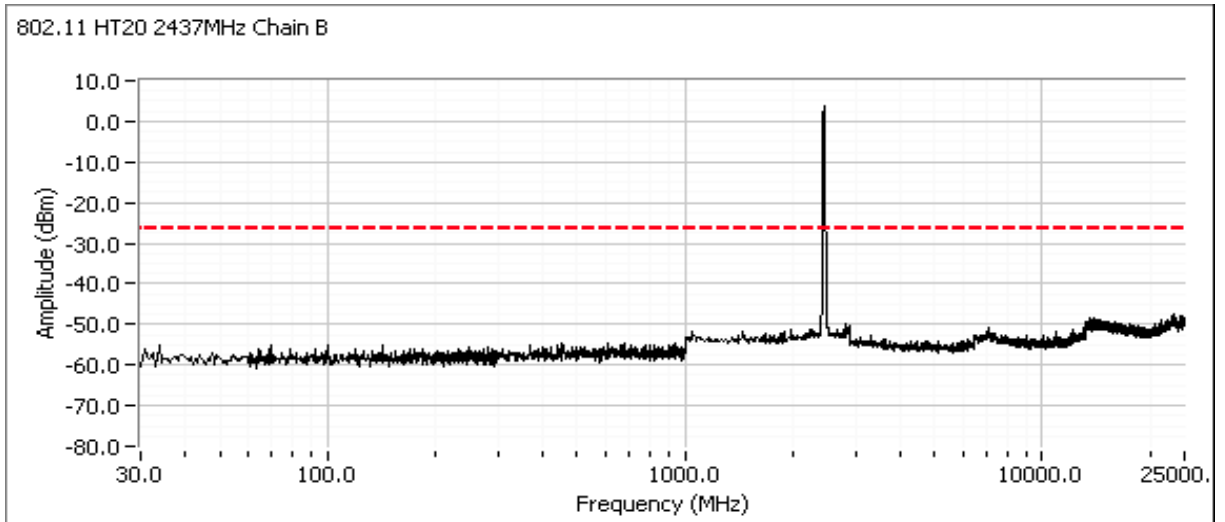

Plots for center channel HT20, power setting(s) = 29

Client:	Intel Corporation	Job Number:	J84364
Model:	Intel® Centrino® Wireless-N 2230	T-Log Number:	T84599
Contact:	Steve Hackett	Account Manager:	Christine Krebill
Standard:	FCC 15.247	Class:	N/A

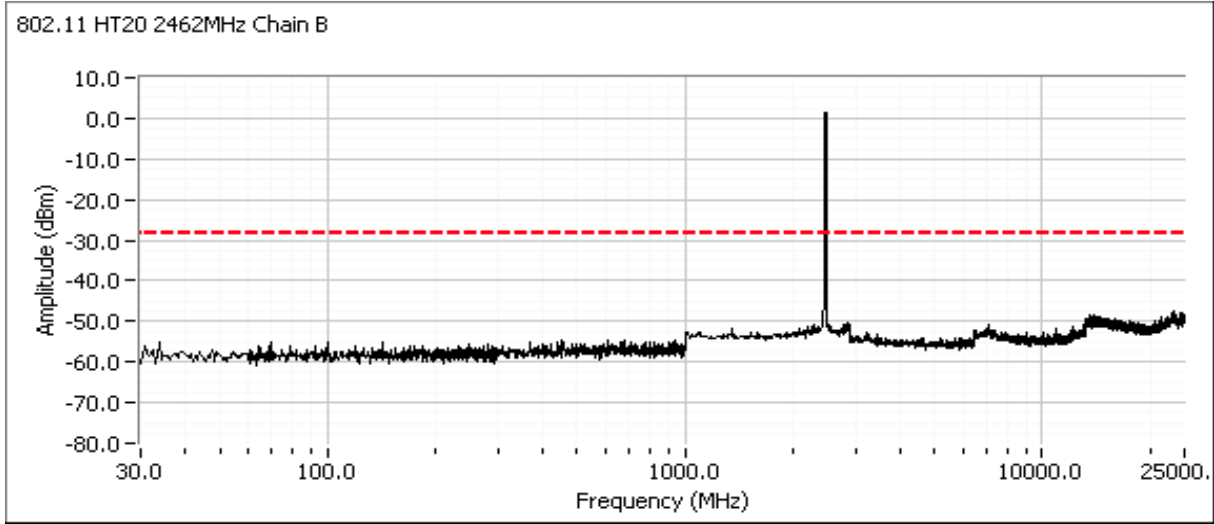

Plots for high channel, HT20, power setting(s) = 26.5

802.11n 40MHz Mode

Frequency (MHz)	Limit	Result
2422	-30dBc	Pass
2437	-30dBc	Pass
2452	-30dBc	Pass

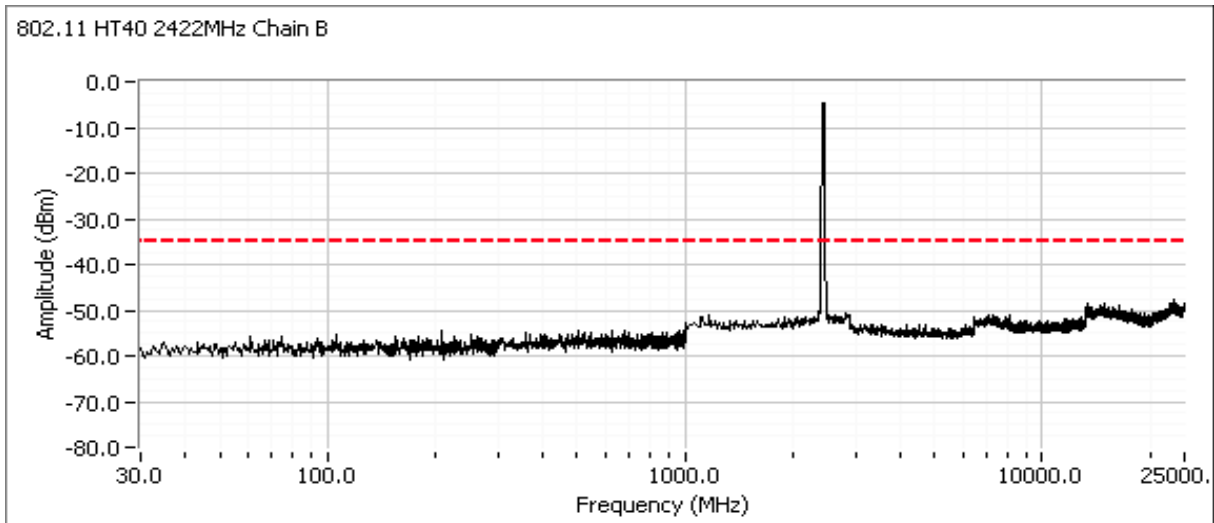

Plots for low channel, HT40, power setting(s) = 22

Client:	Intel Corporation	Job Number:	J84364
Model:	Intel® Centrino® Wireless-N 2230	T-Log Number:	T84599
Contact:	Steve Hackett	Account Manager:	Christine Krebill
Standard:	FCC 15.247	Class:	N/A

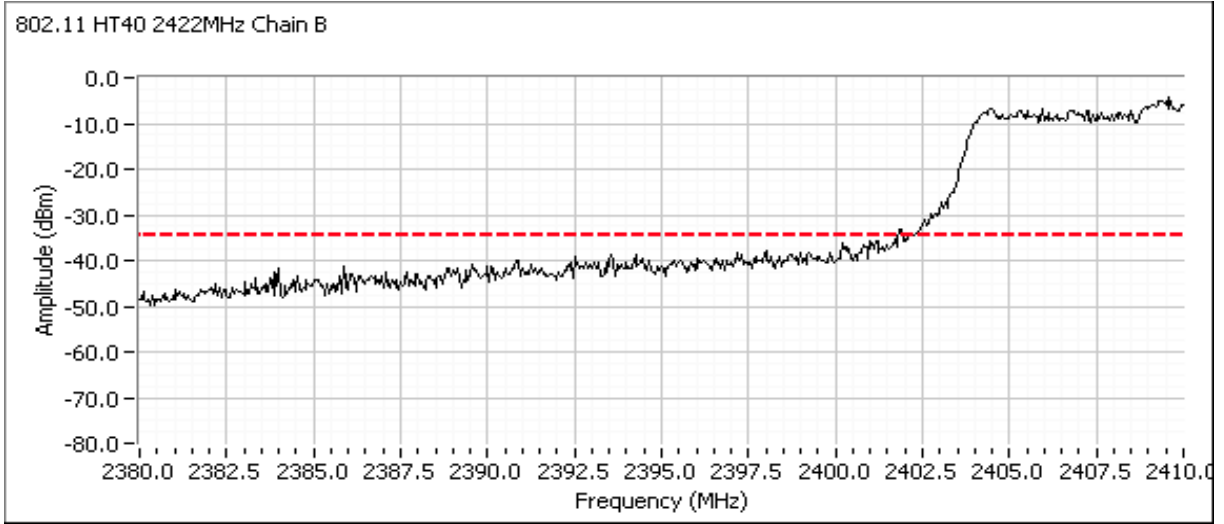

Additional plot showing compliance with -30dBc limit from 2390 MHz to 2400 MHz. Radiated measurements used to show compliance with the limits in the restricted band below 2390 MHz.

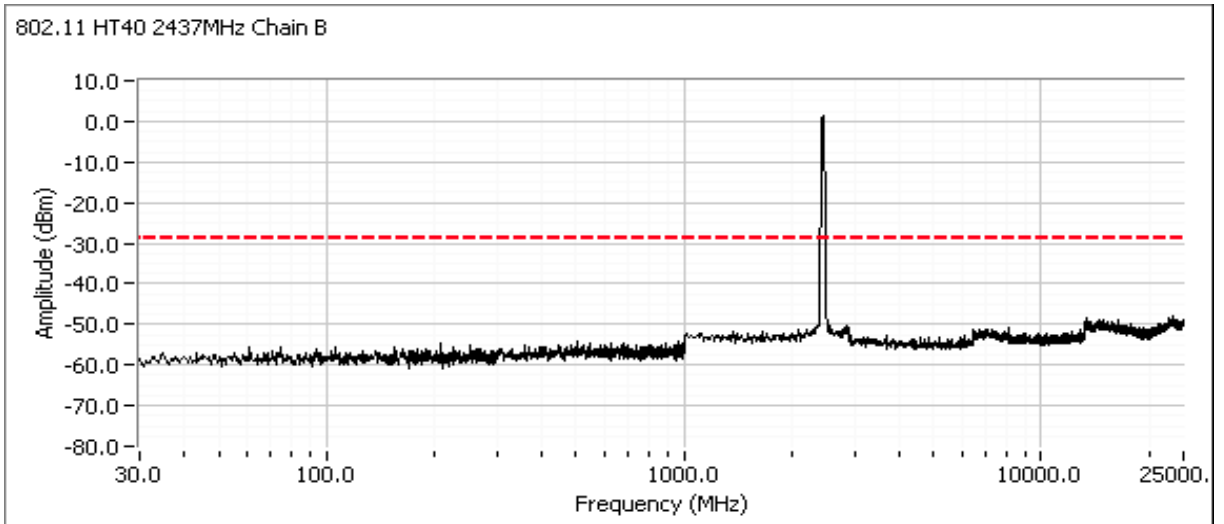

Plots for center channel HT40, power setting(s) = 28.5

Client:	Intel Corporation	Job Number:	J84364
Model:	Intel® Centrino® Wireless-N 2230	T-Log Number:	T84599
Contact:	Steve Hackett	Account Manager:	Christine Krebill
Standard:	FCC 15.247	Class:	N/A

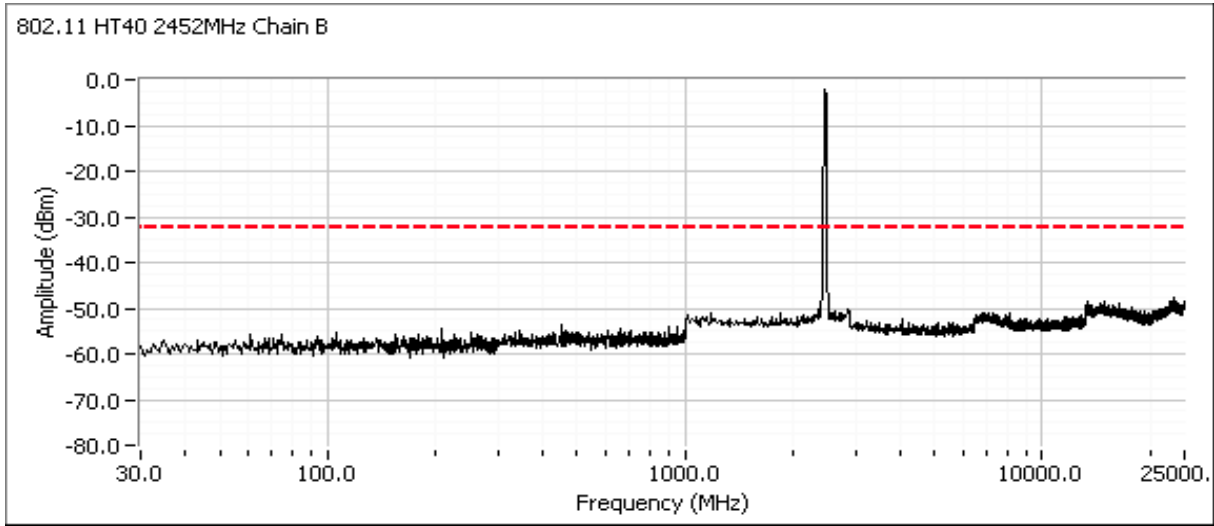

Plots for high channel, HT40, power setting(s) = 24.5



Client:	Intel Corporation	Job Number:	J84364
Model:	Intel® Centrino® Wireless-N 2230	T-Log Number:	T84599
		Account Manager:	Christine Krebill
Contact:	Steve Hackett		
Standard:	FCC 15.247	Class:	N/A

**RSS 210 and FCC 15.247 (DTS) Antenna Port Measurements  
MIMO and Smart Antenna Systems  
Power, PSD, Bandwidth and Spurious Emissions**

**Test Specific Details**

Objective: The objective of this test session is to perform final qualification testing of the EUT with respect to the specification listed above.

Date of Test: 10/17/2011  
Test Engineer: Rafael Varelas  
Test Location: FT Lab #4

Config. Used: 1  
Config Change: None  
EUT Voltage: 3.3Vdc

**General Test Configuration**

The EUT was connected to the spectrum analyzer or power meter via a suitable attenuator. All measurements were made on a single chain.

All measurements have been corrected to allow for the external attenuators used.

**Ambient Conditions:**

Temperature: 18-21 °C  
Rel. Humidity: 30-40 %

**Summary of Results**

MAC Address: 00150082509B DRTU Tool Version **1.5.3.0322** Driver version **15.0.0.61**

Run #	Pwr setting	Test Performed	Limit	Pass / Fail	Result / Margin
<b>Chain A + B</b>					
1	26.5/28.5	Output Power	15.247(b)	Pass	HT20: 0.043mW HT40: 0.037mW
2	26.5/28.5	Power spectral Density (PSD)	15.247(d)	Pass	HT20: -9.1 dBm/3kHz HT40: -12.1 dBm/3kHz

**Modifications Made During Testing**

No modifications were made to the EUT during testing

**Deviations From The Standard**

No deviations were made from the requirements of the standard.

Client:	Intel Corporation	Job Number:	J84364
Model:	Intel® Centrino® Wireless-N 2230	T-Log Number:	T84599
Contact:	Steve Hackett	Account Manager:	Christine Krebill
Standard:	FCC 15.247	Class:	N/A

**Run #1a: Output Power - Chain A + B**  
 Operating Mode: 802.11n 20  
 Transmitted signal on chain is coherent ? No

2412 MHz	Chain 1	Chain 2	Chain 3	Chain 4	Total Across All Chains		Limit	
Power Setting <sup>Note 3</sup>	23.5	25.5						
Output Power (dBm) <sup>Note 1</sup>	10.9	10.7			13.8 dBm	0.024 W	30.0 dBm	1.000 W
Antenna Gain (dBi) <sup>Note 2</sup>	3.2	3.2				3.2 dBi	Pass	
eirp (dBm) <sup>Note 2</sup>	14.1	13.9			17.0 dBm	0.050 W		

2437 MHz	Chain 1	Chain 2	Chain 3	Chain 4	Total Across All Chains		Limit	
Power Setting <sup>Note 3</sup>	26.5	28.5						
Output Power (dBm) <sup>Note 1</sup>	13.1	13.5			16.3 dBm	0.043 W	30.0 dBm	1.000 W
Antenna Gain (dBi) <sup>Note 2</sup>	3.2	3.2				3.2 dBi	Pass	
eirp (dBm) <sup>Note 2</sup>	16.3	16.7			19.5 dBm	0.089 W		

2462 MHz	Chain 1	Chain 2	Chain 3	Chain 4	Total Across All Chains		Limit	
Power Setting <sup>Note 3</sup>	25.5	27.5						
Output Power (dBm) <sup>Note 1</sup>	11.5	11.6			14.6 dBm	0.029 W	30.0 dBm	1.000 W
Antenna Gain (dBi) <sup>Note 2</sup>	3.2	3.2				3.2 dBi	Pass	
eirp (dBm) <sup>Note 2</sup>	14.7	14.8			17.8 dBm	0.060 W		

- Note 1: Output power measured using a spectrum analyzer (see plots below) with RBW=1MHz, VB=3 MHz, sample detector, power averaging on (transmitted signal was continuous) and power integration over **50 MHz** (option #2, method 1 in KDB 558074, equivalent to method 1 of DA-02-2138A1 for U-NII devices). Spurious limit becomes **-30dBc**.
- Note 2: As there is no coherency between chains the total EIRP is the sum of the individual EIRPs and effective antenna gain equals the eirp divide by the sum of the power on each chain.
- Note 3: Power setting - if a single number the same power setting was used for each chain. If multiple numbers the power setting for each chain is separated by a comma (e.g. x,y would indicate power setting x for chain 1, power setting y for chain 2).

Client:	Intel Corporation	Job Number:	J84364
Model:	Intel® Centrino® Wireless-N 2230	T-Log Number:	T84599
Contact:	Steve Hackett	Account Manager:	Christine Krebill
Standard:	FCC 15.247	Class:	N/A

**Run #1b: Output Power - Chain A + B**  
 Operating Mode: 802.11n 40  
 Transmitted signal on chain is coherent ? No

2422 MHz	Chain 1	Chain 2	Chain 3	Chain 4	Total Across All Chains		Limit	
Power Setting <sup>Note 3</sup>	20.5	22.5						
Output Power (dBm) <sup>Note 1</sup>	8.2	8.2			11.2 dBm	0.013 W	30.0 dBm	1.000 W
Antenna Gain (dBi) <sup>Note 2</sup>	3.2	3.2				3.2 dBi	Pass	
eirp (dBm) <sup>Note 2</sup>	11.4	11.4			14.4 dBm	0.028 W		

2437 MHz	Chain 1	Chain 2	Chain 3	Chain 4	Total Across All Chains		Limit	
Power Setting <sup>Note 3</sup>	26.0	28.0						
Output Power (dBm) <sup>Note 1</sup>	12.6	12.7			15.7 dBm	0.037 W	30.0 dBm	1.000 W
Antenna Gain (dBi) <sup>Note 2</sup>	3.2	3.2				3.2 dBi	Pass	
eirp (dBm) <sup>Note 2</sup>	15.8	15.9			18.9 dBm	0.077 W		

2452 MHz	Chain 1	Chain 2	Chain 3	Chain 4	Total Across All Chains		Limit	
Power Setting <sup>Note 3</sup>	21.5	23.5						
Output Power (dBm) <sup>Note 1</sup>	8.8	8.5			11.7 dBm	0.015 W	30.0 dBm	1.000 W
Antenna Gain (dBi) <sup>Note 2</sup>	3.2	3.2				3.2 dBi	Pass	
eirp (dBm) <sup>Note 2</sup>	12	11.7			14.9 dBm	0.031 W		

- Note 1: Output power measured using a spectrum analyzer (see plots below) with RBW=1MHz, VB=3 MHz, sample detector, power averaging on (transmitted signal was continuous) and power integration over **50 MHz** (option #2, method 1 in KDB 558074, equivalent to method 1 of DA-02-2138A1 for U-NII devices). Spurious limit becomes **-30dBc**.
- Note 2: As there is no coherency between chains the total EIRP is the sum of the individual EIRPs and effective antenna gain equals the eirp divide by the sum of the power on each chain.
- Note 3: Power setting - if a single number the same power setting was used for each chain. If multiple numbers the power setting for each chain is separated by a comma (e.g. x,y would indicate power setting x for chain 1, power setting y for chain 2).

Client:	Intel Corporation	Job Number:	J84364
Model:	Intel® Centrino® Wireless-N 2230	T-Log Number:	T84599
Contact:	Steve Hackett	Account Manager:	Christine Krebill
Standard:	FCC 15.247	Class:	N/A

**Run #2a: Power spectral Density**

802.11n20

Power Setting	Frequency (MHz)	PSD (dBm/3kHz) <sup>Note 1</sup>				Total	Limit dBm/3kHz	Result
		Chain 1	Chain 2	Chain 3	Chain 4			
23.5/25.5	2416.0811	-14.6	-14.0			-11.3	8.0	Pass
26.5/28.5	2439.8273	-11.8	-12.4			-9.1	8.0	Pass
25.5/27.5	2464.7737	-13.2	-13.9			-10.5	8.0	Pass

Note 1: Power spectral density measured using RB=3 kHz, VB=10kHz, analyzer with peak detector and with a sweep time set to ensure a dwell time of at least 1 second per 3kHz. The measurement is made at the frequency of PPSD determined from preliminary scans using RB=3kHz using multiple sweeps at a faster rate over the 6dB bandwidth of the signal.

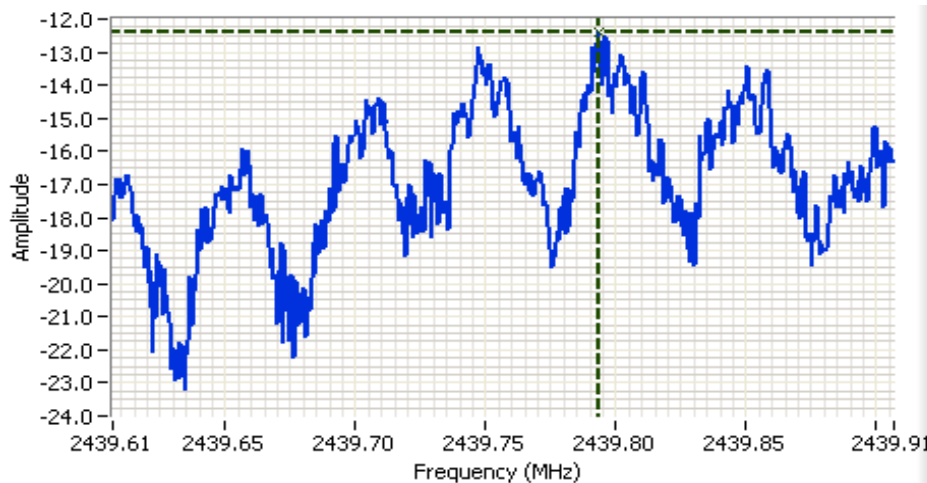

**Analyzer Settings**

Agilent Technologies, E4446A  
 CF: 2439.757 MHz  
 SPAN: 300 kHz  
 RB: 3.00 kHz  
 VB: 10.0 kHz  
 Detector: POS  
 Attn: 20 DB  
 RL Offset: 10.0 DB  
 Sweep Time: 100.0s  
 Ref Lvl: -9.0 DBM

**Comments**

PSD: -12.4 dBm/3kHz  
 802.11n20, Chain B

Cursor 1    2439.7932    -12.39    [Move] [Star] [Lock]

0.0000    0.00    [Move] [Lock]



Client:	Intel Corporation	Job Number:	J84364
Model:	Intel® Centrino® Wireless-N 2230	T-Log Number:	T84599
Contact:	Steve Hackett	Account Manager:	Christine Krebill
Standard:	FCC 15.247	Class:	N/A

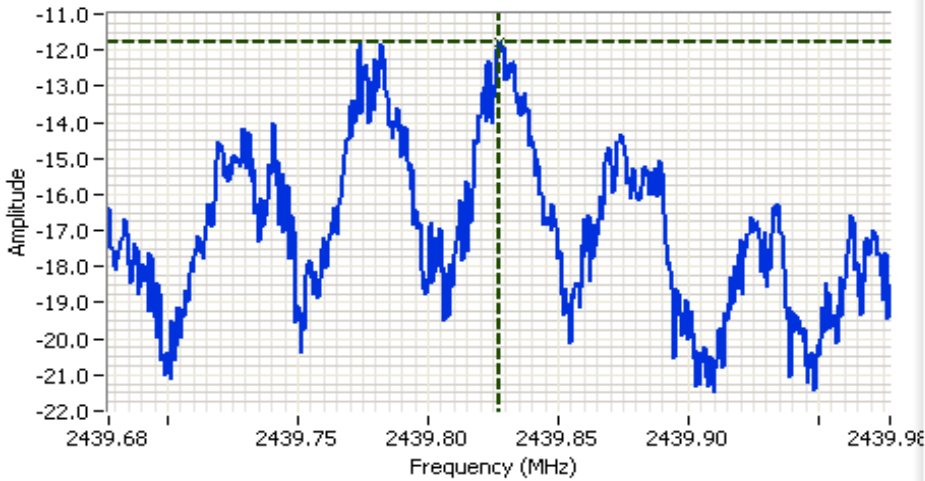

**Analyzer Settings**  
 Agilent Technologies, E4446A  
 CF: 2439.827 MHz  
 SPAN: 300 kHz  
 RB: 3.00 kHz  
 VB: 10.0 kHz  
 Detector: POS  
 Attn: 20 DB  
 RL Offset: 10.0 DB  
 Sweep Time: 100.0s  
 Ref Lvl: -9.0 DBM

**Comments**  
 PSD: -11.8 dBm/3kHz  
 802.11n20, Chain A

Cursor 1	2439.8273	-11.77	
	0.0000	0.00	

Client:	Intel Corporation	Job Number:	J84364
Model:	Intel® Centrino® Wireless-N 2230	T-Log Number:	T84599
Contact:	Steve Hackett	Account Manager:	Christine Krebill
Standard:	FCC 15.247	Class:	N/A

**Run #2b: Power spectral Density**

802.11n40

Power Setting	Frequency (MHz)	PSD (dBm/3kHz) <sup>Note 1</sup>				Total	Limit dBm/3kHz	Result
		Chain 1	Chain 2	Chain 3	Chain 4			
20.5/22.5	2424.8392	-19.5	-19.9			-16.7	8.0	Pass
26.0/28.0	2439.7453	-15.3	-14.9			-12.1	8.0	Pass
21.5/23.5	2454.8409	-19.2	-19.3			-16.2	8.0	Pass

Note 1: Power spectral density measured using RB=3 kHz, VB=10kHz, analyzer with peak detector and with a sweep time set to ensure a dwell time of at least 1 second per 3kHz. The measurement is made at the frequency of PPSD determined from preliminary scans using RB=3kHz using multiple sweeps at a faster rate over the 6dB bandwidth of the signal.

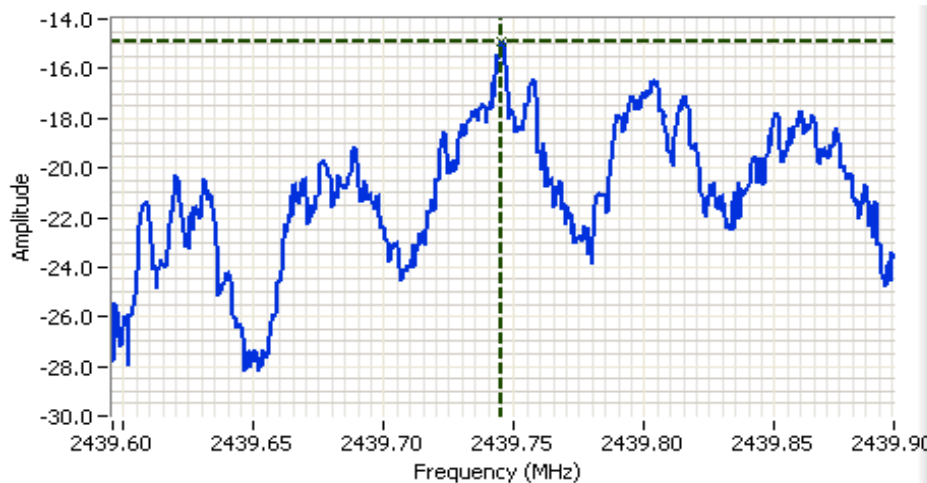

**Analyzer Settings**

Agilent Technologies, E4446A  
 CF: 2439.746 MHz  
 SPAN: 300 kHz  
 RB: 3.00 kHz  
 VB: 10.0 kHz  
 Detector: POS  
 Attn: 20 DB  
 RL Offset: 10.0 DB  
 Sweep Time: 100.0s  
 Ref Lvl: 1.0 DBM

**Comments**

PSD: -14.9 dBm/3kHz  
 802.11n40, Chain B

Cursor 1    2439.7453    -14.89    [Move] [Lock] [Reset]

0.0000    0.00    [Move] [Lock] [Reset]



Client:	Intel Corporation	Job Number:	J84364
Model:	Intel® Centrino® Wireless-N 2230	T-Log Number:	T84599
Contact:	Steve Hackett	Account Manager:	Christine Krebill
Standard:	FCC 15.247	Class:	N/A

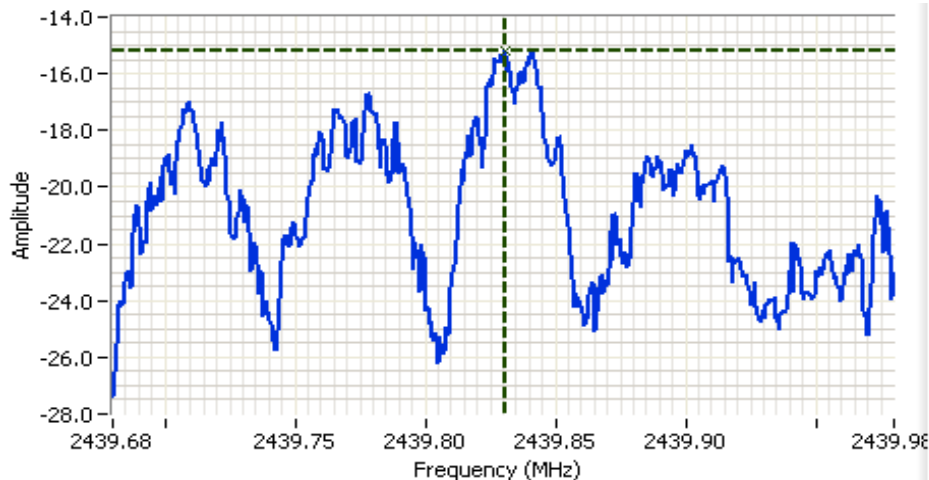

### Analyzer Settings

Agilent Technologies, E4446A  
 CF: 2439.830 MHz  
 SPAN: 300 kHz  
 RB: 3.00 kHz  
 VB: 10.0 kHz  
 Detector: POS  
 Attn: 20 DB  
 RL Offset: 10.0 DB  
 Sweep Time: 100.0s  
 Ref Lvl: 1.0 DBM

### Comments

PSD: -15.3 dBm/3kHz  
 802.11n40, Chain A

Cursor 1	2439.8306	-15.23	⊕	✖	🔒
	0.0000	0.00	⊕	✖	🔒



Client:	Intel Corporation	Job Number:	J84364
Model:	Intel® Centrino® Wireless-N 2230	T-Log Number:	T84599
		Account Manager:	Christine Krebill
Contact:	Steve Hackett		
Standard:	FCC 15.247	Class:	N/A

## RSS 210 and FCC 15.247 (DTS) Radiated Spurious Emissions

### Test Specific Details

Objective: The objective of this test session is to perform final qualification testing of the EUT with respect to the specification listed above.

### General Test Configuration

The EUT and all local support equipment were located on the turntable for radiated spurious emissions testing. The EUT was installed into a test fixture such that the EUT was exposed (i.e. outside of a host PC).

For radiated emissions testing the measurement antenna was located 3 meters from the EUT.

### Ambient Conditions:

Temperature: 30-50 °C

Rel. Humidity: 18-26 %

### Modifications Made During Testing

No modifications were made to the EUT during testing

### Deviations From The Standard

No deviations were made from the requirements of the standard.

Note - the target and measured power are average powers (measured with average power sensor) and are used for reference purposes only. Power is set using "GAIN CONTROL" mode in the DRTU tool.

Use the Gain Control mode of adjusting power. Set power to within ±0.2dB of target (dial in closer to the target value within ± 0.2dB if possible and not just a passing value above the target).



Client:	Intel Corporation	Job Number:	J84364
Model:	Intel® Centrino® Wireless-N 2230	T-Log Number:	T84599
Contact:	Steve Hackett	Account Manager:	Christine Krebill
Standard:	FCC 15.247	Class:	N/A

### Summary of Results - Device Operating in the 2400-2483.5 MHz Band

MAC Address: 00150082509B DRTU Tool Version 1.5.3.0322 Driver version 15.0.0.61

Run #	Mode	Channel	Target Power	Measured Power	Test Performed	Limit	Result / Margin
Run #1	802.11b Chain A	#1 2412MHz	15.7	16.6	Radiated Emissions, 1 - 26 GHz	FCC 15.209 / 15.247	48.4dBµV/m @ 3000.4MHz (-5.6dB)
		#6 2437MHz	15.7	16.3			49.1dBµV/m @ 2998.3MHz (-4.9dB)
		#11 2462MHz	15.7	16.2			49.6dBµV/m @ 2998.3MHz (-4.4dB)
	802.11b Chain B	#1 2412MHz	15.7	16.2			49.6dBµV/m @ 2998.3MHz (-4.4dB)
		#6 2437MHz	15.7	16.2			50.1dBµV/m @ 2998.3MHz (-3.9dB)
		#11 2462MHz	15.7	16.4			37.5dBµV/m @ 1595.6MHz (-16.5dB)

Scans on center channel in all three OFDM modes to determine the worst case. Note that for n20 and n40 mode the output power was set to 16.7dBm per chain, the maximum power per chain in MIMO mode would be 13.5dBm, however as the single chain power could be 16.7dBm the scans were run at the higher single-chain power level but with both chains active.

Run #2	802.11g Chain A	#6 2437MHz	16.7	16.7	Radiated Emissions, 1 - 26 GHz	FCC 15.209 / 15.247	50.3dBµV/m @ 9750.0MHz (-3.7dB)
	802.11g Chain B	#6 2437MHz	16.7	16.8			50.1dBµV/m @ 2998.3MHz (-3.9dB)
	802.11n20 Chain A+B	#6 2437MHz	16.7	a: 16.5 b: 16.5			51.1dBµV/m @ 3000.3MHz (-2.9dB)
	802.11n40 Chain A+B	#6 2437MHz	16.7	a: 16.6 b: 16.5			51.8dBµV/m @ 3000.3MHz (-2.2dB)

Top and bottom channels in worst case OFDM mode:

Run # 3	802.11n40 Chain A+B	#3 2422MHz	16.7	a: 16.7 b: 16.7	Radiated Emissions, 1 - 26 GHz	FCC 15.209 / 15.247	40.7dBµV/m @ 6005.0MHz (-13.3dB)
		#9 2452MHz	16.7	a: 16.8 b: 16.7			46.5dBµV/m @ 2998.3MHz (-7.5dB)

### Receiver Spurious Emissions

Run # 4	Receive Chain A,B, A+B	#6 Chain A	-	-	Radiated Emissions, 1 - 7.5 GHz	RSS 210	47.3dBµV/m @ 3000.3MHz (-6.7dB)
		#6 Chain B	-	-			48.4dBµV/m @ 6000.7MHz (-5.6dB)
		#6 Chain A+B	-	-			46.1dBµV/m @ 5999.9MHz (-7.9dB)

Client:	Intel Corporation	Job Number:	J84364
Model:	Intel® Centrino® Wireless-N 2230	T-Log Number:	T84599
Contact:	Steve Hackett	Account Manager:	Christine Krebill
Standard:	FCC 15.247	Class:	N/A

Note: Scans made between 12.5 - 26GHz with the measurement antenna moved around the card and its antennas 20-50cm from the device indicated there were no significant emissions in this frequency range

**Run # 1, Radiated Spurious Emissions, 1-26GHz, 802.11b, Chain A**

Date of Test: 9/28/2011

Test Location: FT Chamber #5

Test Engineer: M. Birgani

Config Change: None

**Run # 1a: EUT on Channel #1 2412MHz - 802.11b, Chain A**

	Target (dBm)	Power Settings Measured (dBm)	Software Setting
Chain A	15.7	16.6	23.0

**Spurious Radiated Emissions:**

Frequency MHz	Level dBμV/m	Pol v/h	15.209/15.247		Detector Pk/QP/Avg	Azimuth degrees	Height meters	Comments
			Limit	Margin				
3000.430	48.4	V	54.0	-5.6	PK	204	1.0	Peak reading with average limit
6000.410	47.0	V	54.0	-7.0	PK	129	1.0	Peak reading with average limit
1597.340	42.2	V	54.0	-11.8	AVG	187	1.0	RB 1 MHz;VB 10 Hz;Pk
1000.330	35.6	V	54.0	-18.4	AVG	187	1.6	RB 1 MHz;VB 10 Hz;Pk
1592.960	54.7	V	74.0	-19.3	PK	187	1.0	RB 1 MHz;VB 3 MHz;Pk
1000.770	51.0	V	74.0	-23.0	PK	187	1.6	RB 1 MHz;VB 3 MHz;Pk

Note 1 For emissions in restricted bands, the limit of 15.209 was used. For all other emissions, the limit is -30dBc for peak measurements in a measurement bandwidth of 100kHz.

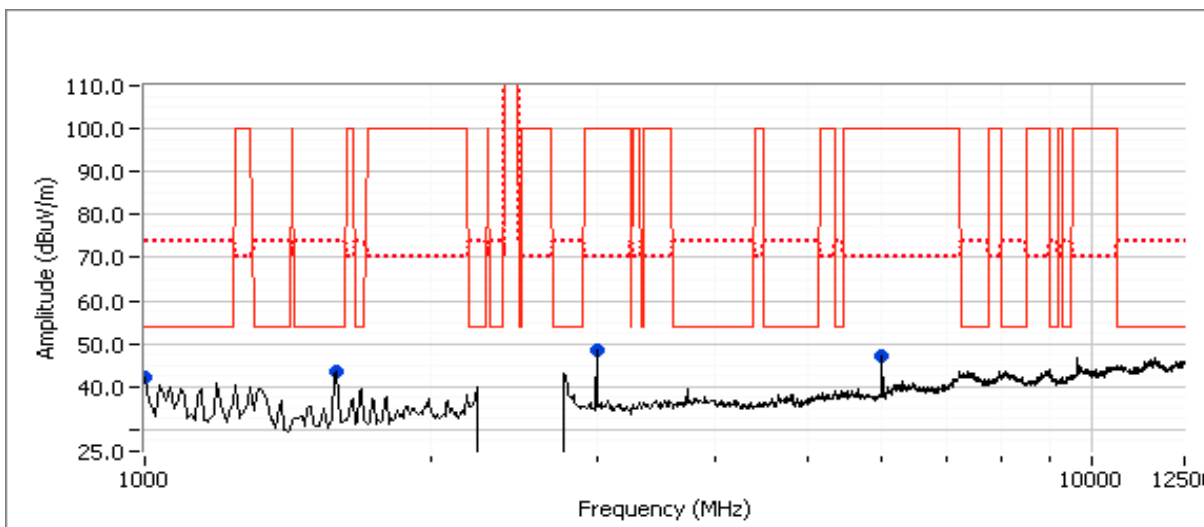

Client:	Intel Corporation	Job Number:	J84364
Model:	Intel® Centrino® Wireless-N 2230	T-Log Number:	T84599
Contact:	Steve Hackett	Account Manager:	Christine Krebill
Standard:	FCC 15.247	Class:	N/A

Run # 1b: EUT on Channel #6 2437MHz - 802.11b, Chain A

	Target (dBm)	Power Settings Measured (dBm)	Software Setting
Chain A	15.7	16.3	23.0

*Spurious Radiated Emissions:*

Frequency MHz	Level dBμV/m	Pol v/h	15.209/15.247		Detector Pk/QP/Avg	Azimuth degrees	Height meters	Comments
			Limit	Margin				
2998.330	49.1	V	54.0	-4.9	PK	201	1.0	Peak reading with average limit
5995.830	48.1	V	54.0	-5.9	PK	121	1.0	Peak reading with average limit
1597.340	42.2	V	54.0	-11.8	AVG	187	1.0	RB 1 MHz;VB 10 Hz;Pk
1592.960	54.7	V	74.0	-19.3	PK	187	1.0	RB 1 MHz;VB 3 MHz;Pk

Note 1 For emissions in restricted bands, the limit of 15.209 was used. For all other emissions, the limit is -30dBc for peak measurements in a measurement bandwidth of 100kHz.

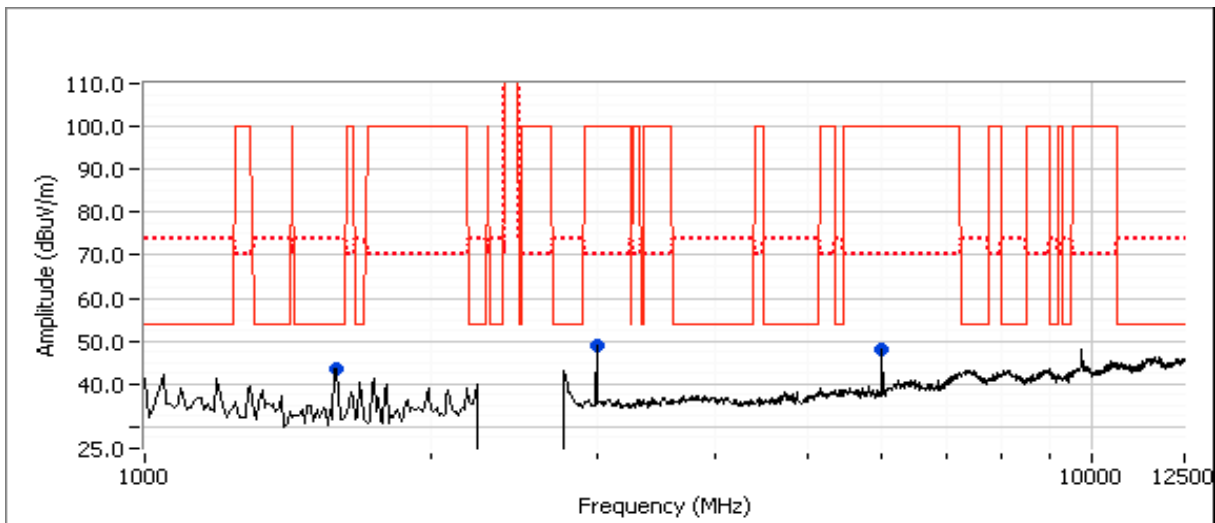

Client:	Intel Corporation	Job Number:	J84364
Model:	Intel® Centrino® Wireless-N 2230	T-Log Number:	T84599
Contact:	Steve Hackett	Account Manager:	Christine Krebill
Standard:	FCC 15.247	Class:	N/A

Run # 1c: EUT on Channel #11 2462MHz - 802.11b, Chain A

	Target (dBm)	Power Settings Measured (dBm)	Software Setting
Chain A	15.7	16.2	23.0

*Spurious Radiated Emissions:*

Frequency MHz	Level dB $\mu$ V/m	Pol v/h	15.209/15.247		Detector Pk/QP/Avg	Azimuth degrees	Height meters	Comments
			Limit	Margin				
2998.330	49.6	V	54.0	-4.4	PK	193	1.0	Peak reading with average limit
5995.830	48.1	V	54.0	-5.9	PK	123	1.0	Peak reading with average limit
1597.340	42.2	V	54.0	-11.8	AVG	187	1.0	RB 1 MHz;VB 10 Hz;Pk
1197.800	36.4	V	54.0	-17.6	AVG	132	1.0	RB 1 MHz;VB 10 Hz;Pk
1592.960	54.7	V	74.0	-19.3	PK	187	1.0	RB 1 MHz;VB 3 MHz;Pk
1199.530	48.9	V	74.0	-25.1	PK	132	1.0	RB 1 MHz;VB 3 MHz;Pk

Note 1 For emissions in restricted bands, the limit of 15.209 was used. For all other emissions, the limit is -30dBc for peak measurements in a measurement bandwidth of 100kHz.

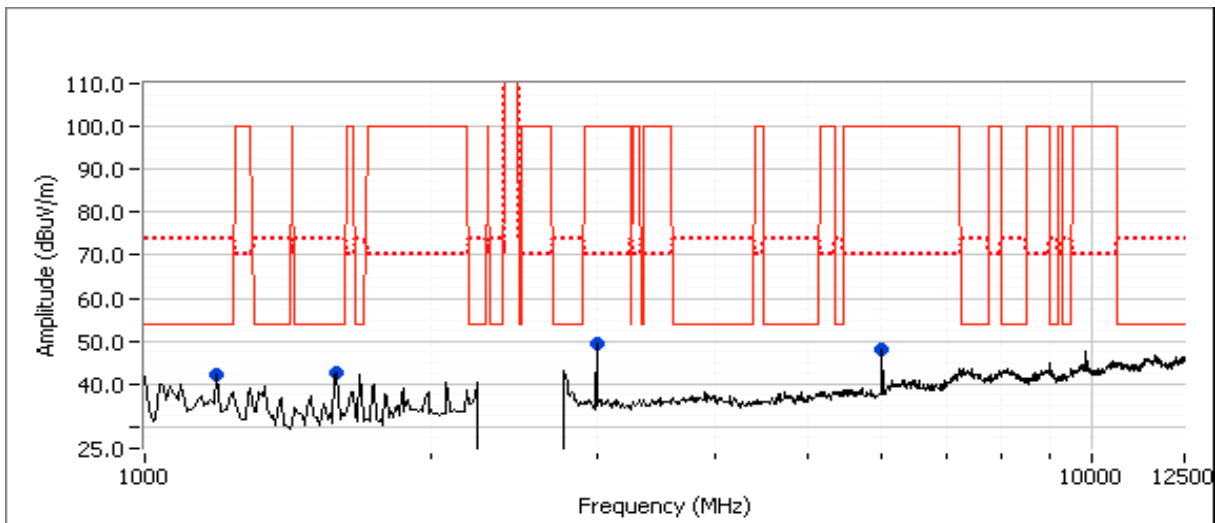

Client:	Intel Corporation	Job Number:	J84364
Model:	Intel® Centrino® Wireless-N 2230	T-Log Number:	T84599
Contact:	Steve Hackett	Account Manager:	Christine Krebill
Standard:	FCC 15.247	Class:	N/A

Run # 1d: EUT on Channel #1 2412MHz - 802.11b, Chain B

	Target (dBm)	Power Settings Measured (dBm)	Software Setting
Chain B	15.7	16.2	24.5

*Spurious Radiated Emissions:*

Frequency	Level	Pol	15.209/15.247		Detector	Azimuth	Height	Comments
MHz	dB $\mu$ V/m	v/h	Limit	Margin	Pk/QP/Avg	degrees	meters	
2998.330	49.6	V	54.0	-4.4	PK	203	1.0	Peak reading with average limit
5995.830	48.1	V	54.0	-5.9	PK	113	1.0	Peak reading with average limit
1597.340	42.2	V	54.0	-11.8	AVG	187	1.0	RB 1 MHz;VB 10 Hz;Pk
1592.960	54.7	V	74.0	-19.3	PK	187	1.0	RB 1 MHz;VB 3 MHz;Pk

Note 1 For emissions in restricted bands, the limit of 15.209 was used. For all other emissions, the limit is -30dBc for peak measurements in a measurement bandwidth of 100kHz.

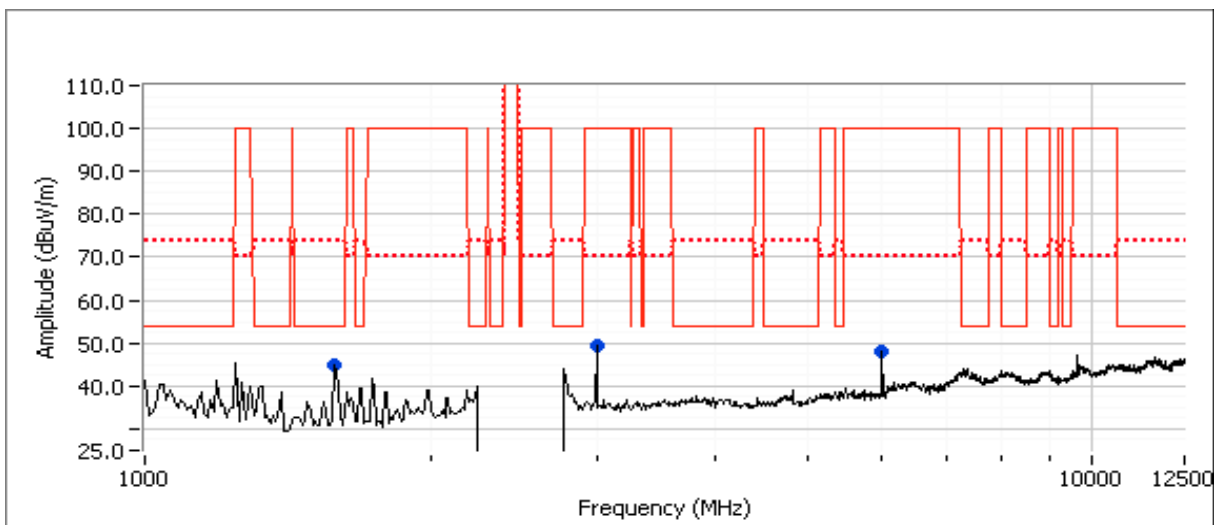

Client:	Intel Corporation	Job Number:	J84364
Model:	Intel® Centrino® Wireless-N 2230	T-Log Number:	T84599
Contact:	Steve Hackett	Account Manager:	Christine Krebill
Standard:	FCC 15.247	Class:	N/A

Run # 1e: EUT on Channel #6 2437MHz - 802.11b, Chain B

	Target (dBm)	Power Settings Measured (dBm)	Software Setting
Chain B	15.7	16.2	24.5

*Spurious Radiated Emissions:*

Frequency MHz	Level dBμV/m	Pol v/h	15.209/15.247		Detector Pk/QP/Avg	Azimuth degrees	Height meters	Comments
			Limit	Margin				
2998.330	50.1	V	54.0	-3.9	PK	197	1.0	Peak reading with average limit
5995.830	48.3	V	54.0	-5.7	PK	112	1.0	Peak reading with average limit
1596.360	42.4	V	54.0	-11.6	AVG	100	1.0	RB 1 MHz;VB 10 Hz;Pk
1593.210	53.7	V	74.0	-20.3	PK	100	1.0	RB 1 MHz;VB 3 MHz;Pk

Note 1 For emissions in restricted bands, the limit of 15.209 was used. For all other emissions, the limit is -30dBc for peak measurements in a measurement bandwidth of 100kHz.

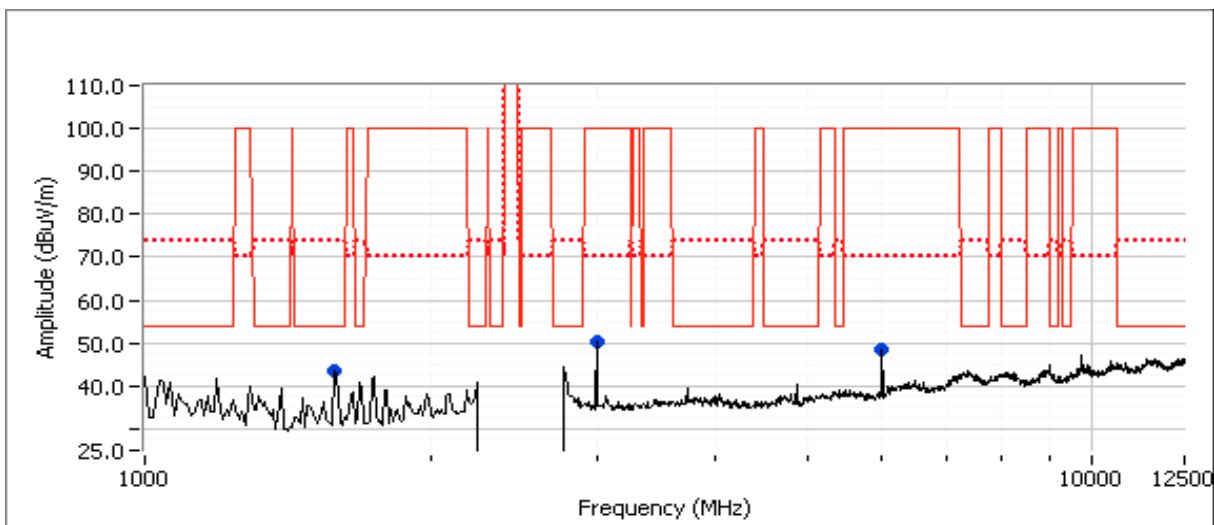

Client:	Intel Corporation	Job Number:	J84364
Model:	Intel® Centrino® Wireless-N 2230	T-Log Number:	T84599
Contact:	Steve Hackett	Account Manager:	Christine Krebill
Standard:	FCC 15.247	Class:	N/A

Run # 1f: EUT on Channel #11 2462MHz - 802.11b, Chain B

	Target (dBm)	Power Settings Measured (dBm)	Software Setting
Chain B	15.7	16.4	25.5

*Spurious Radiated Emissions:*

Frequency MHz	Level dB $\mu$ V/m	Pol v/h	15.209/15.247		Detector Pk/QP/Avg	Azimuth degrees	Height meters	Comments
			Limit	Margin				
2461.670	101.6	V	-	-	PK	113	1.0	Fundamental
1595.640	37.5	V	54.0	-16.5	AVG	273	1.0	RB 1 MHz;VB 10 Hz;Pk
1870.830	52.5	H	71.6	-19.1	PK	19	2.2	RB 1 MHz;VB 3 MHz;Pk
2998.330	49.7	V	71.6	-21.9	PK	193	1.0	RB 1 MHz;VB 3 MHz;Pk
5995.830	47.3	V	71.6	-24.3	PK	113	1.0	RB 1 MHz;VB 3 MHz;Pk
1599.270	49.2	V	74.0	-24.8	PK	273	1.0	RB 1 MHz;VB 3 MHz;Pk

Note 1 For emissions in restricted bands, the limit of 15.209 was used. For all other emissions, the limit is -30dBc for peak measurements in a measurement bandwidth of 100kHz.

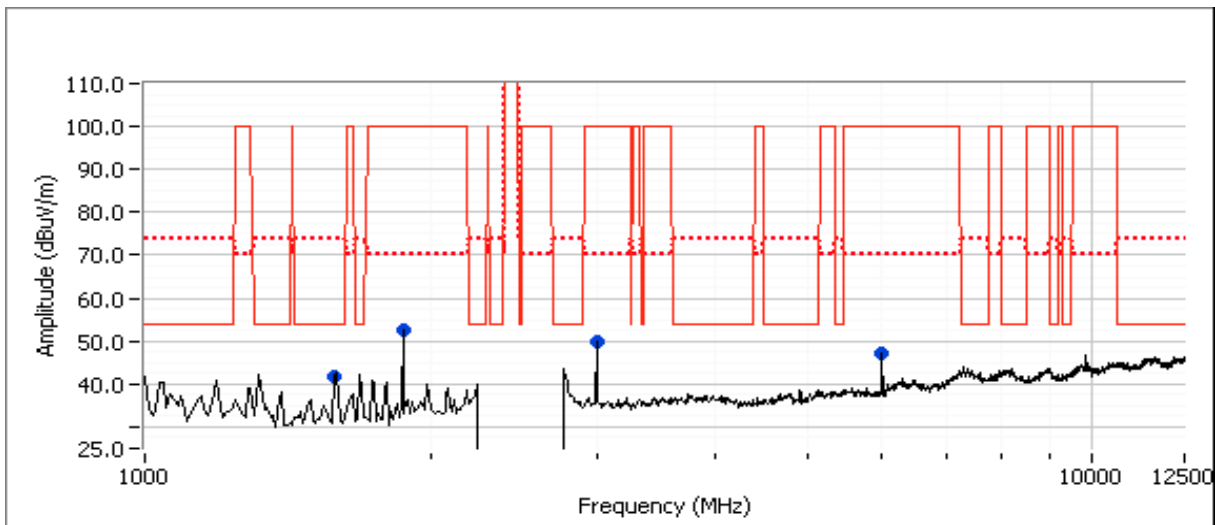

Client:	Intel Corporation	Job Number:	J84364
Model:	Intel® Centrino® Wireless-N 2230	T-Log Number:	T84599
Contact:	Steve Hackett	Account Manager:	Christine Krebill
Standard:	FCC 15.247	Class:	N/A

**Run # 2: Radiated Spurious Emissions, 1-26GHz, 802.11g, Chain A**

Date of Test: 9/28/2011      Test Location: FT Chamber #5  
 Test Engineer: M. Birgani      Config Change: None

**Run # 2a, EUT on Channel #6 2437MHz - 802.11g, Chain A**

	Target (dBm)	Power Settings Measured (dBm)	Software Setting
Chain A	16.7	16.7	29.5

**Spurious Radiated Emissions:**

Frequency	Level	Pol	15.209/15.247		Detector	Azimuth	Height	Comments
MHz	dB $\mu$ V/m	v/h	Limit	Margin	Pk/QP/Avg	degrees	meters	
9750.000	50.3	V	54.0	-3.7	PK	66	1.0	Peak reading with average limit
2998.330	49.1	V	54.0	-4.9	PK	202	1.0	Peak reading with average limit
5995.830	46.3	V	54.0	-7.7	PK	151	1.3	Peak reading with average limit
1594.630	37.7	V	54.0	-16.3	AVG	197	1.0	RB 1 MHz;VB 10 Hz;Pk
1596.060	49.5	V	74.0	-24.5	PK	197	1.0	RB 1 MHz;VB 3 MHz;Pk

Note 1      For emissions in restricted bands, the limit of 15.209 was used. For all other emissions, the limit is -30dBc for peak measurements in a measurement bandwidth of 100kHz.

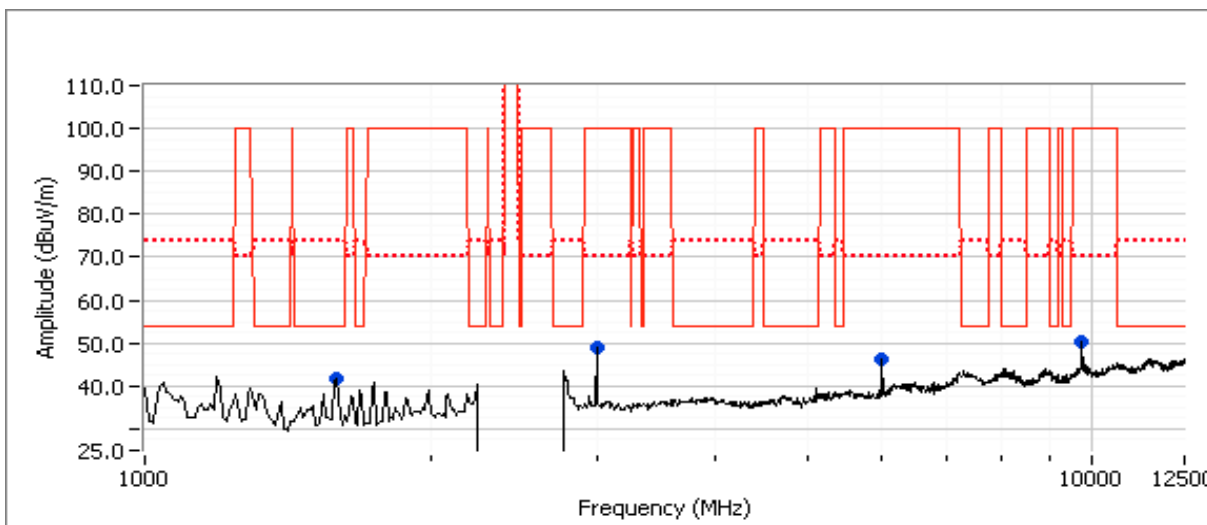



Client:	Intel Corporation	Job Number:	J84364
Model:	Intel® Centrino® Wireless-N 2230	T-Log Number:	T84599
Contact:	Steve Hackett	Account Manager:	Christine Krebill
Standard:	FCC 15.247	Class:	N/A

Run # 2b: EUT on Channel #6 2437MHz - 802.11g, Chain B

	Target (dBm)	Power Settings Measured (dBm)	Software Setting
Chain B	16.7	16.8	30.0

*Spurious Radiated Emissions:*

Frequency	Level	Pol	15.209/15.247		Detector	Azimuth	Height	Comments
MHz	dB $\mu$ V/m	v/h	Limit	Margin	Pk/QP/Avg	degrees	meters	
2998.330	50.1	V	54.0	-3.9	PK	195	1.0	Peak reading with average limit
5995.830	47.5	V	54.0	-6.5	PK	228	1.0	Peak reading with average limit
1598.530	40.2	V	54.0	-13.8	AVG	182	1.0	RB 1 MHz;VB 10 Hz;Pk
1594.000	52.2	V	74.0	-21.8	PK	182	1.0	RB 1 MHz;VB 3 MHz;Pk

Note 1 For emissions in restricted bands, the limit of 15.209 was used. For all other emissions, the limit is -30dBc for peak measurements in a measurement bandwidth of 100kHz.

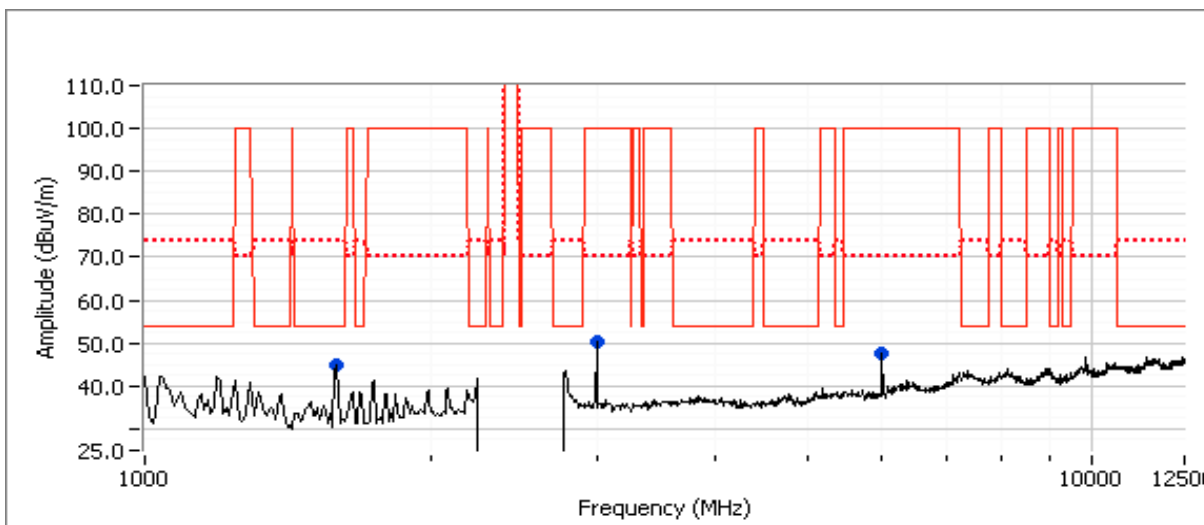

Client:	Intel Corporation	Job Number:	J84364
Model:	Intel® Centrino® Wireless-N 2230	T-Log Number:	T84599
Contact:	Steve Hackett	Account Manager:	Christine Krebill
Standard:	FCC 15.247	Class:	N/A

**Run # 2c: EUT on Channel #6 2437MHz - 802.11n20, Chain A+B**

Chain	Target (dBm)				Power Settings Measured (dBm)				Software Setting
	A	B	C	Total	A	B	C	Total	
	13.2	13.2		16.2	16.5	16.5		19.5	31.5, 32

**Spurious Radiated Emissions:**

Frequency	Level	Pol	15.209/15.247		Detector	Azimuth	Height	Comments
MHz	dB $\mu$ V/m	v/h	Limit	Margin	Pk/QP/Avg	degrees	meters	
3000.320	51.1	H	54.0	-2.9	PK	215	1.0	Peak reading with average limit
6000.660	51.1	V	54.0	-2.9	PK	160	1.0	Peak reading with average limit

Note 1

For emissions in restricted bands, the limit of 15.209 was used. For all other emissions, the limit is -30dBc for peak measurements in a measurement bandwidth of 100kHz.

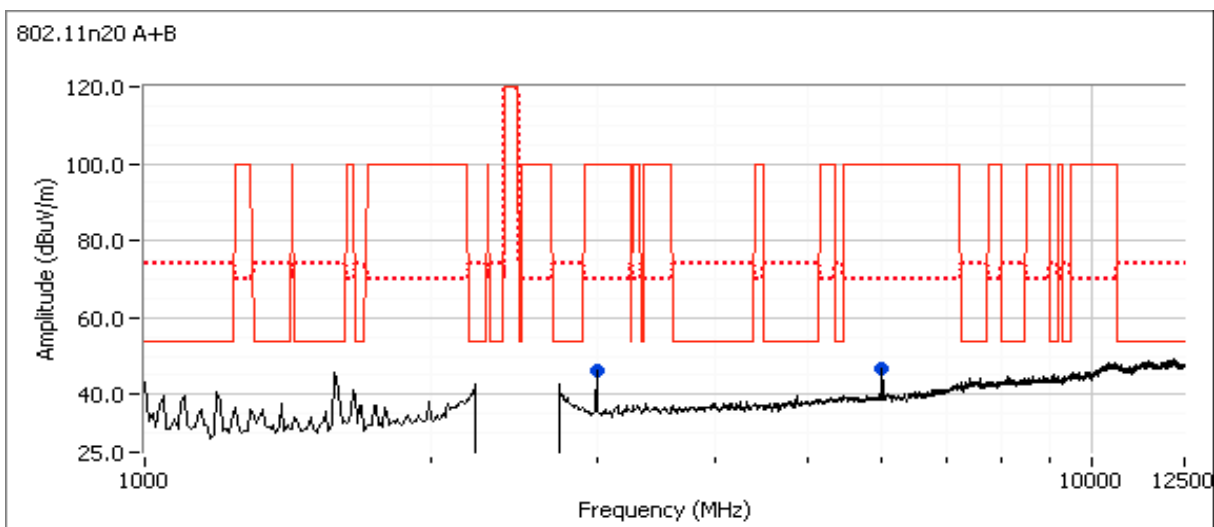

Client:	Intel Corporation	Job Number:	J84364
Model:	Intel® Centrino® Wireless-N 2230	T-Log Number:	T84599
Contact:	Steve Hackett	Account Manager:	Christine Krebill
Standard:	FCC 15.247	Class:	N/A

**Run # 2d: EUT on Channel #6 2437MHz - 802.11n40, Chain A+B**

Chain	Target (dBm)				Power Settings Measured (dBm)				Software Setting
	A	B	C	Total	A	B	C	Total	
	12.7	12.7		15.7	16.6	16.5		19.6	31.5, 32.5

**Spurious Radiated Emissions:**

Frequency	Level	Pol	15.209/15.247		Detector	Azimuth	Height	Comments
MHz	dB $\mu$ V/m	v/h	Limit	Margin	PK/QP/Avg	degrees	meters	
3000.340	51.8	H	54.0	-2.2	PK	215	1.0	Peak reading with average limit
6000.460	50.8	V	54.0	-3.2	PK	160	1.0	Peak reading with average limit

Note 1

For emissions in restricted bands, the limit of 15.209 was used. For all other emissions, the limit is -30dBc for peak measurements in a measurement bandwidth of 100kHz.

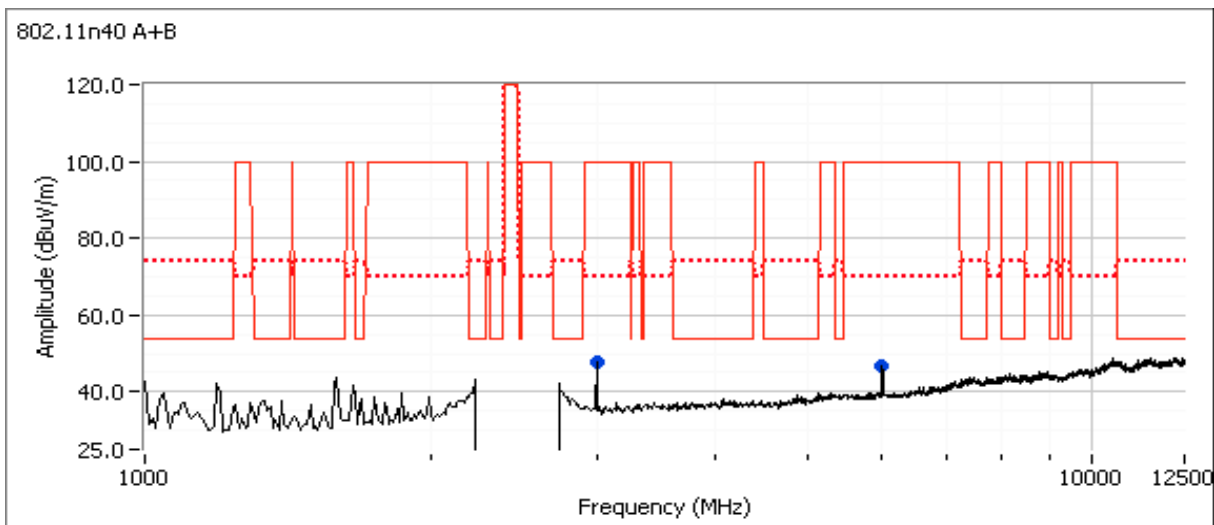

Client:	Intel Corporation	Job Number:	J84364
Model:	Intel® Centrino® Wireless-N 2230	T-Log Number:	T84599
Contact:	Steve Hackett	Account Manager:	Christine Krebill
Standard:	FCC 15.247	Class:	N/A

**Run # 3: Radiated Spurious Emissions, 1-26GHz, 802.11n40, Chain A+B**

Date of Test: 9/30/2011

Test Location: FTChamber #4

Test Engineer: Mark Hill, M. Birgani

Config Change: -

**Run # 3a: EUT on Channel #3 2422MHz - 802.11n40, Chain A+B**

Chain	Target (dBm)				Power Settings Measured (dBm)				Software Setting
	A	B	C	Total	A	B	C	Total	
	8.2	8.2		11.2	16.7	16.7		19.7	32, 32.5

**Spurious Radiated Emissions:**

Frequency	Level	Pol	15.209/15.247		Detector	Azimuth	Height	Comments
MHz	dB $\mu$ V/m	v/h	Limit	Margin	PK/QP/Avg	degrees	meters	
6005.000	40.7	V	54.0	-13.3	Peak	61	1.0	Note1, Pk reading with Avg limit
2998.330	37.5	V	54.0	-16.5	Peak	32	1.0	Note1, Pk reading with Avg limit

Note 1

For emissions in restricted bands, the limit of 15.209 was used. For all other emissions, the limit is -30dBc for peak measurements in a measurement bandwidth of 100kHz.

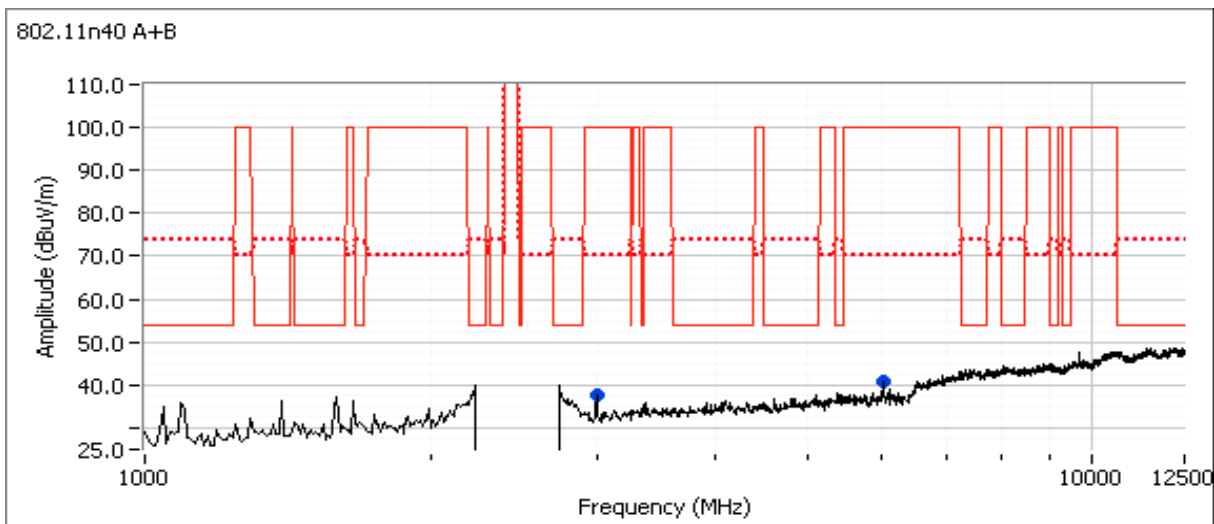

Client:	Intel Corporation	Job Number:	J84364
Model:	Intel® Centrino® Wireless-N 2230	T-Log Number:	T84599
Contact:	Steve Hackett	Account Manager:	Christine Krebill
Standard:	FCC 15.247	Class:	N/A

**Run # 3c: EUT on Channel #9 2452MHz - 802.11n40, Chain A+B**

Chain	Target (dBm)				Power Settings Measured (dBm)				Software Setting
	A	B	C	Total	A	B	C	Total	
	8.7	8.7		11.7	16.8	16.7		19.8	32.5,32.5

**Spurious Radiated Emissions:**

Frequency	Level	Pol	15.209/15.247		Detector	Azimuth	Height	Comments
MHz	dB $\mu$ V/m	v/h	Limit	Margin	Pk/QP/Avg	degrees	meters	
2998.330	46.5	V	54.0	-7.5	Peak	193	1.3	Note1, Pk reading with Avg limit
5995.830	45.2	V	54.0	-8.8	Peak	137	1.0	Note1, Pk reading with Avg limit

Note 1

For emissions in restricted bands, the limit of 15.209 was used. For all other emissions, the limit is -30dBc for peak measurements in a measurement bandwidth of 100kHz.

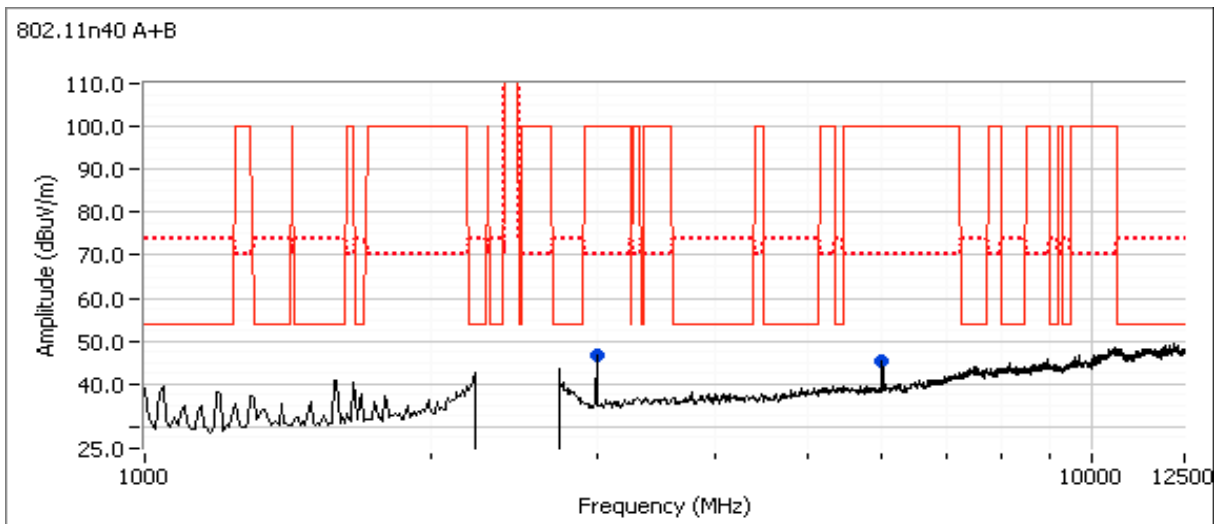

Client:	Intel Corporation	Job Number:	J84364
Model:	Intel® Centrino® Wireless-N 2230	T-Log Number:	T84599
Contact:	Steve Hackett	Account Manager:	Christine Krebill
Standard:	FCC 15.247	Class:	N/A

**Run # 4, Radiated Spurious Emissions, 1-26GHz, Receive, Chain A, B, A+B**

Date of Test: 9/30/2011

Test Location: FTChamber #4

Test Engineer: M. Birgani

Config Change: -

**Run # 4a: EUT on Channel #6 2437MHz - Receive, Chain A**

Frequency MHz	Level dB $\mu$ V/m	Pol v/h	RSS 210		Detector Pk/QP/Avg	Azimuth degrees	Height meters	Comments
			Limit	Margin				
3000.320	47.3	V	54.0	-6.7	AVG	244	1.1	RB 1 MHz;VB 10 Hz;Pk
6000.650	43.7	V	54.0	-10.3	AVG	135	1.0	RB 1 MHz;VB 10 Hz;Pk
3000.310	51.7	V	74.0	-22.3	PK	244	1.1	RB 1 MHz;VB 3 MHz;Pk
1599.900	31.5	V	54.0	-22.5	AVG	221	1.0	RB 1 MHz;VB 10 Hz;Pk
6000.690	49.5	V	74.0	-24.5	PK	135	1.0	RB 1 MHz;VB 3 MHz;Pk
1599.870	41.5	V	74.0	-32.5	PK	221	1.0	RB 1 MHz;VB 3 MHz;Pk

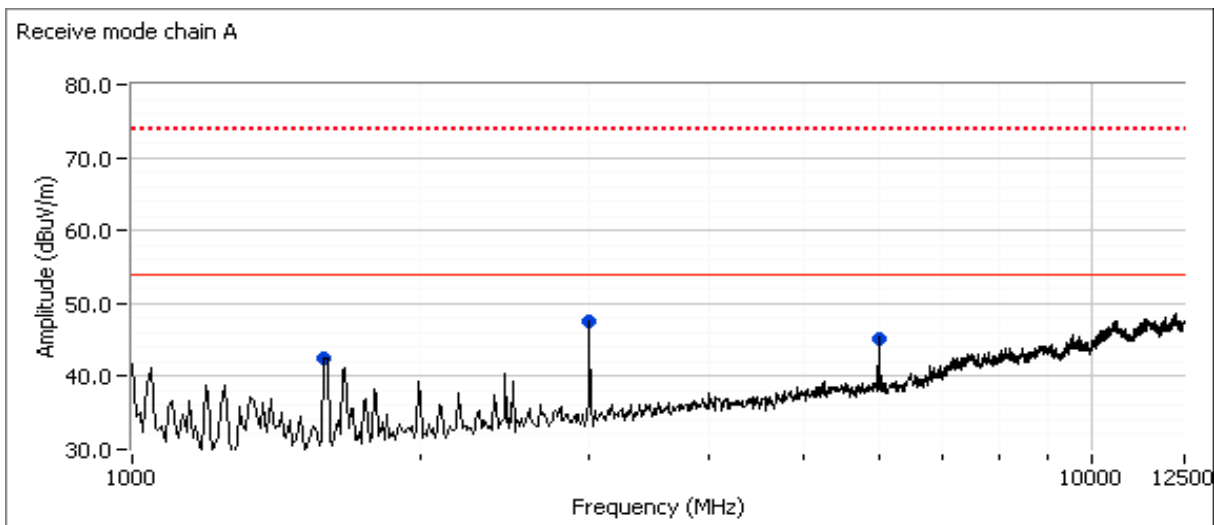

Client:	Intel Corporation	Job Number:	J84364
Model:	Intel® Centrino® Wireless-N 2230	T-Log Number:	T84599
Contact:	Steve Hackett	Account Manager:	Christine Krebill
Standard:	FCC 15.247	Class:	N/A

**Run # 4b: EUT on Channel #6 2437MHz - Receive, Chain B**

Frequency MHz	Level dB $\mu$ V/m	Pol v/h	RSS 210		Detector PK/QP/Avg	Azimuth degrees	Height meters	Comments
			Limit	Margin				
6000.700	48.4	V	54.0	-5.6	AVG	157	0.9	RB 1 MHz;VB 10 Hz;Pk
3000.330	46.2	V	54.0	-7.8	AVG	203	0.9	RB 1 MHz;VB 10 Hz;Pk
1593.770	37.3	V	54.0	-16.7	AVG	196	0.9	RB 1 MHz;VB 10 Hz;Pk
1660.450	32.8	V	54.0	-21.2	AVG	203	0.9	RB 1 MHz;VB 10 Hz;Pk
6000.610	52.1	V	74.0	-21.9	PK	157	0.9	RB 1 MHz;VB 3 MHz;Pk
3000.360	51.4	V	74.0	-22.6	PK	203	0.9	RB 1 MHz;VB 3 MHz;Pk
1594.820	50.9	V	74.0	-23.1	PK	196	0.9	RB 1 MHz;VB 3 MHz;Pk
1247.200	29.0	V	54.0	-25.0	AVG	137	1.0	RB 1 MHz;VB 10 Hz;Pk
1250.170	48.5	V	74.0	-25.5	PK	137	1.0	RB 1 MHz;VB 3 MHz;Pk
1661.460	48.2	V	74.0	-25.8	PK	203	0.9	RB 1 MHz;VB 3 MHz;Pk

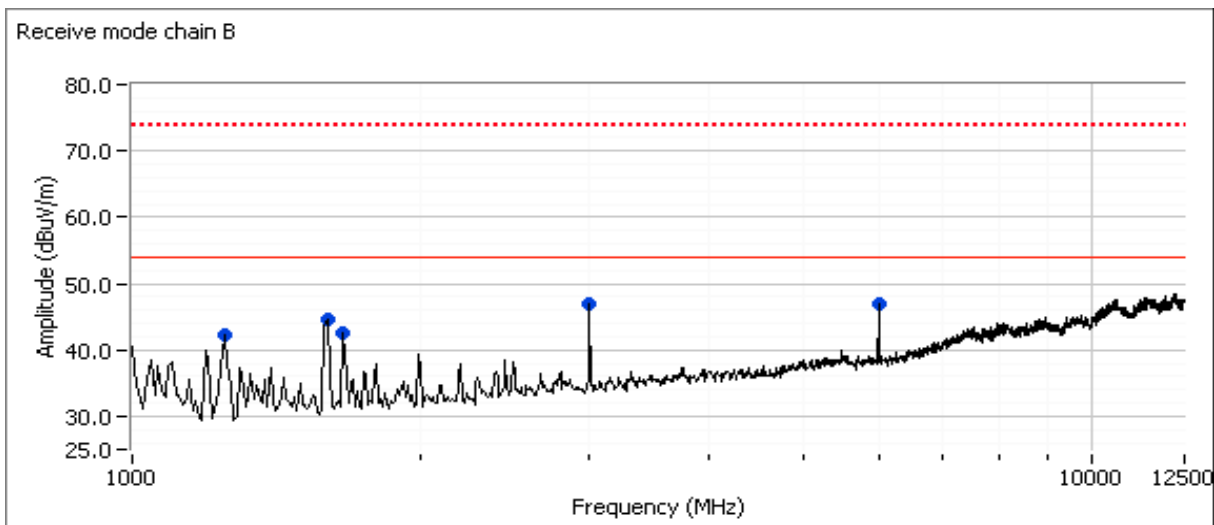

Client:	Intel Corporation	Job Number:	J84364
Model:	Intel® Centrino® Wireless-N 2230	T-Log Number:	T84599
Contact:	Steve Hackett	Account Manager:	Christine Krebill
Standard:	FCC 15.247	Class:	N/A

**Run # 4c: EUT on Channel #6 2437MHz - Receive, Chain A+B**

Frequency MHz	Level dB $\mu$ V/m	Pol v/h	RSS 210		Detector Pk/QP/Avg	Azimuth degrees	Height meters	Comments
			Limit	Margin				
5999.940	46.1	V	54.0	-7.9	AVG	143	1.0	RB 1 MHz;VB 10 Hz;Pk
3000.320	43.0	H	54.0	-11.0	AVG	212	1.0	RB 1 MHz;VB 10 Hz;Pk
1594.120	37.9	V	54.0	-16.1	AVG	203	1.0	RB 1 MHz;VB 10 Hz;Pk
1592.760	52.1	V	74.0	-21.9	PK	203	1.0	RB 1 MHz;VB 3 MHz;Pk
1000.030	32.0	V	54.0	-22.0	AVG	218	1.0	RB 1 MHz;VB 10 Hz;Pk
6000.530	51.5	V	74.0	-22.5	PK	143	1.0	RB 1 MHz;VB 3 MHz;Pk
1248.520	30.8	V	54.0	-23.2	AVG	217	1.0	RB 1 MHz;VB 10 Hz;Pk
3000.210	50.5	H	74.0	-23.5	PK	212	1.0	RB 1 MHz;VB 3 MHz;Pk
1000.160	47.8	V	74.0	-26.2	PK	218	1.0	RB 1 MHz;VB 3 MHz;Pk
1244.870	46.6	V	74.0	-27.4	PK	217	1.0	RB 1 MHz;VB 3 MHz;Pk

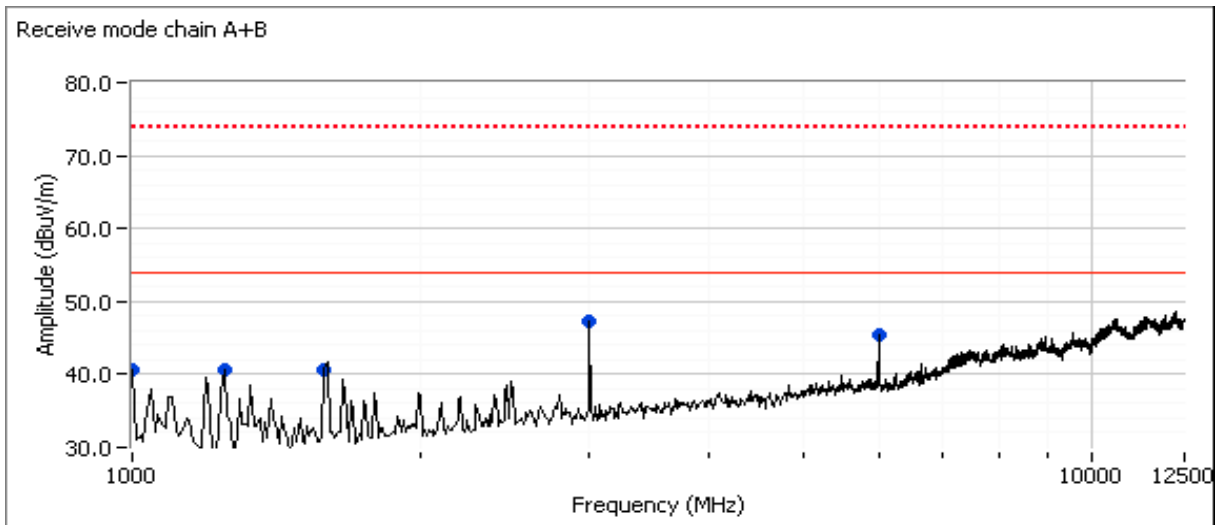



Client:	Intel Corporation	Job Number:	J84364
Model:	Intel® Centrino® Wireless-N 2230	T-Log Number:	T84599
		Account Manager:	Christine Krebill
Contact:	Steve Hackett		
Standard:	FCC 15.247	Class:	N/A

## RSS 210 and FCC 15.247 (DTS) Antenna Port Measurements - Bluetooth LE Power, PSD, Bandwidth and Spurious Emissions

### Test Specific Details

Objective: The objective of this test session is to perform final qualification testing of the EUT with respect to the specification listed above.

Date of Test: 10/2/2011  
 Test Engineer: Rafael Varelas  
 Test Location: FT Chamber #5

Config. Used: 1  
 Config Change: none  
 Host Unit Voltage 120V/60Hz

### General Test Configuration

The EUT was connected to the spectrum analyzer or power meter via a suitable attenuator. All measurements were made on a single chain.

All measurements have been corrected to allow for the external attenuators used.

**Ambient Conditions:**  
 Temperature: 18-25 °C  
 Rel. Humidity: 30-50 %

### Summary of Results

MAC Address: 00150082509B DRTU Tool Version 1.5.3.0322 Driver version 15.0.0.61

Run #	Test Performed	Limit	Pass / Fail	Result / Margin
1	Output Power	15.247(b)	Pass	0.004 W
2	Power spectral Density (PSD)	15.247(d)	Pass	-9.3 dBm/3kHz
3	Minimum 6dB Bandwidth	15.247(a)	Pass	0.76 MHz
3	99% Bandwidth	RSS GEN	-	1.06 MHz
4	Spurious emissions	15.247(b)	Pass	> 20dB below the limit

### Modifications Made During Testing

No modifications were made to the EUT during testing

### Deviations From The Standard

No deviations were made from the requirements of the standard.

Client:	Intel Corporation	Job Number:	J84364
Model:	Intel® Centrino® Wireless-N 2230	T-Log Number:	T84599
Contact:	Steve Hackett	Account Manager:	Christine Krebill
Standard:	FCC 15.247	Class:	N/A

### Run #1: Output Power

Power Setting <sup>2</sup>	Frequency (MHz)	Output Power		Antenna Gain (dBi)	Result	EIRP	
		(dBm) <sup>1</sup>	mW			dBm	W
Max	2402	5.0	3.2	3.2	Pass	8.2	0.007
Max	2440	6.0	4.0	3.2	Pass	9.2	0.008
Max	2480	5.2	3.3	3.2	Pass	8.4	0.007

Note 1: Output power measured using a peak power meter, spurious limit is -20dBc.

### Run #2: Power spectral Density

Mode	Power Setting	Frequency (MHz)	PSD	Limit dBm/3kHz	Result
			(dBm/3kHz) <sup>Note 1</sup>		
BLE	Max	2401.9492	-10.3	8.0	Pass
	Max	2439.9497	-9.3	8.0	Pass
	Max	2479.9485	-10.5	8.0	Pass

Note 1: Power spectral density measured using RB=3 kHz, VB=10kHz, analyzer with peak detector and with a sweep time set to ensure a dwell time of at least 1 second per 3kHz. The measurement is made at the frequency of PPSD determined from preliminary scans using RB=3kHz using multiple sweeps at a faster rate over the 6dB bandwidth of the signal.

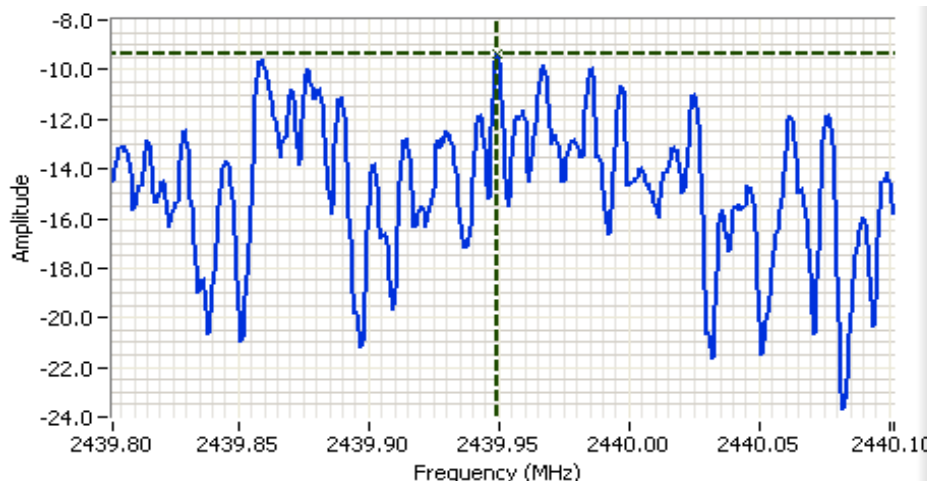

#### Analyzer Settings

HP8564E  
 CF: 2439.952 MHz  
 SPAN: 300 kHz  
 RB: 3.00 kHz  
 VB: 10.0 kHz  
 Detector: POS  
 Attn: 10 DB  
 RL Offset: 1.0 DB  
 Sweep Time: 100.0s  
 Ref Lvl: 0.5 DBM

#### Comments

PSD: -9.3 dBm/3kHz

Cursor 1	2439.9497	-9.33	
	0.0000	0.00	

Client: Intel Corporation	Job Number: J84364
Model: Intel® Centrino® Wireless-N 2230	T-Log Number: T84599
Contact: Steve Hackett	Account Manager: Christine Krebill
Standard: FCC 15.247	Class: N/A

**Run #3: Signal Bandwidth**

Mode	Power Setting	Frequency (MHz)	Resolution Bandwidth	Bandwidth (MHz)	
				6dB	99%
BLE	Max	2402	30kHz	0.76	1.06
	Max	2440	30kHz	0.76	1.05
	Max	2480	30kHz	0.76	1.05

Note 1: 99% bandwidth measured in accordance with RSS GEN, with RB > 1% of the span and VB > 3xRB

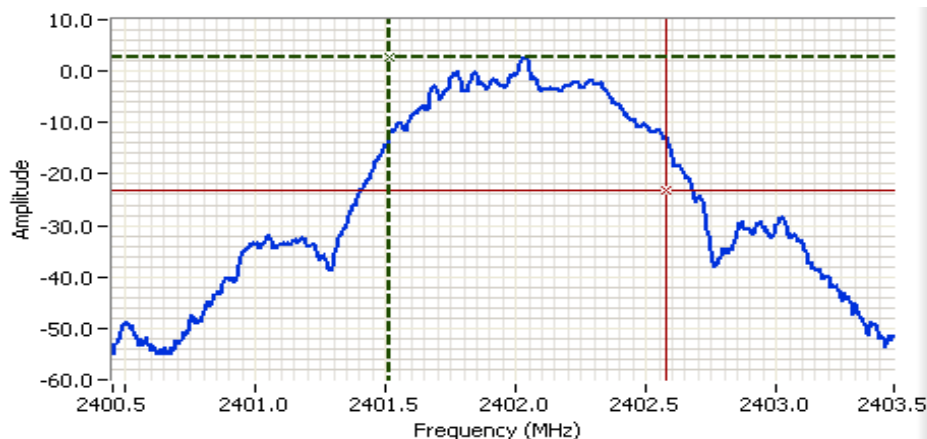

**Analyzer Settings**  
 HP8564E  
 CF: 2401.952 MHz  
 SPAN: 3.000 MHz  
 RB: 30.0 kHz  
 VB: 100 kHz  
 Detector: Normal  
 Attn: 20 DB  
 RL Offset: 1.0 DB  
 Sweep Time: 50.0ms  
 Ref Lvl: 10.2 DBM

**Comments**  
 99% BW: 1.058 MHz

Cursor 1	2401.5149	2.87		Delta Freq.	1.058
Cursor 2	2402.5731	-23.13		Delta Amplitude	26.00

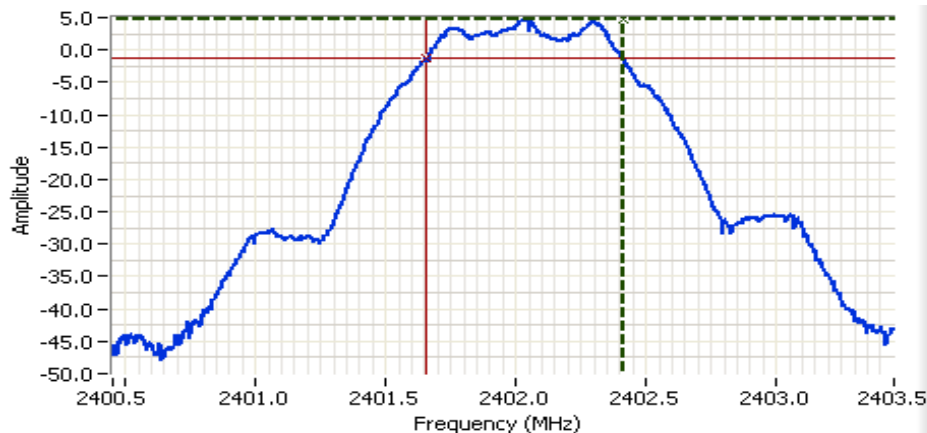

**Analyzer Settings**  
 HP8564E  
 CF: 2401.952 MHz  
 SPAN: 3.000 MHz  
 RB: 100 kHz  
 VB: 100 kHz  
 Detector: Normal  
 Attn: 20 DB  
 RL Offset: 1.0 DB  
 Sweep Time: 50.0ms  
 Ref Lvl: 10.2 DBM

**Comments**  
 6dB BW: 755 kHz

Cursor 1	2402.4117	4.70		Delta Freq.	755 kHz
Cursor 2	2401.6567	-1.30		Delta Amplitude	6.00



Client:	Intel Corporation	Job Number:	J84364
Model:	Intel® Centrino® Wireless-N 2230	T-Log Number:	T84599
Contact:	Steve Hackett	Account Manager:	Christine Krebill
Standard:	FCC 15.247	Class:	N/A

Run #4: Out of Band Spurious Emissions

Frequency (MHz)	Limit	Result
2402	-20dBc	Pass
2440	-20dBc	Pass
2480	-20dBc	Pass

Plots for low channel, power setting(s) = Max

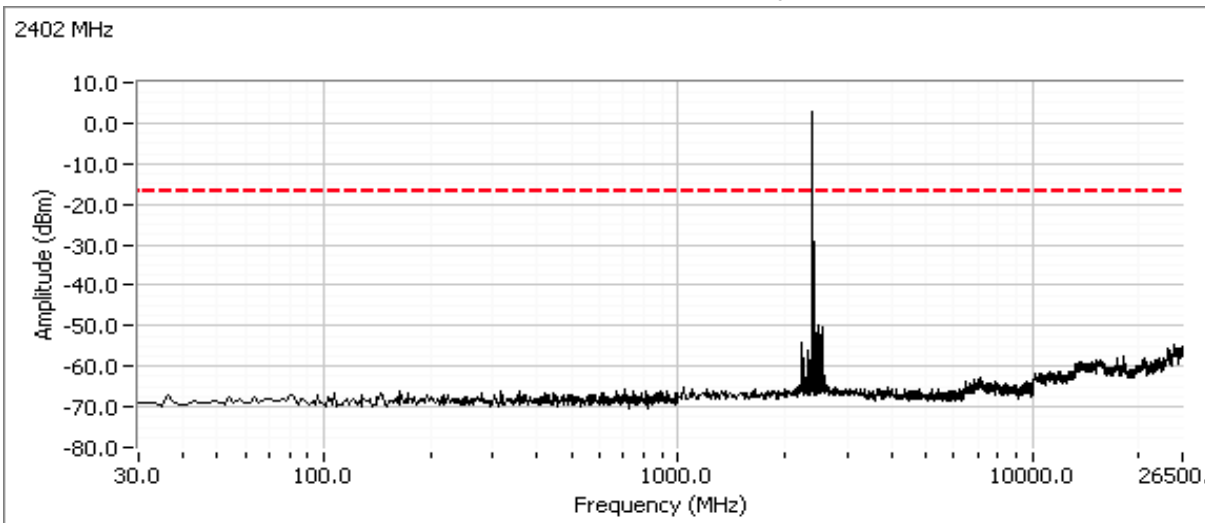

Additional plot showing compliance with -20dBc limit from 2390 MHz to 2400 MHz. Radiated measurements used to show compliance with the limits in the restricted band below 2390 MHz.

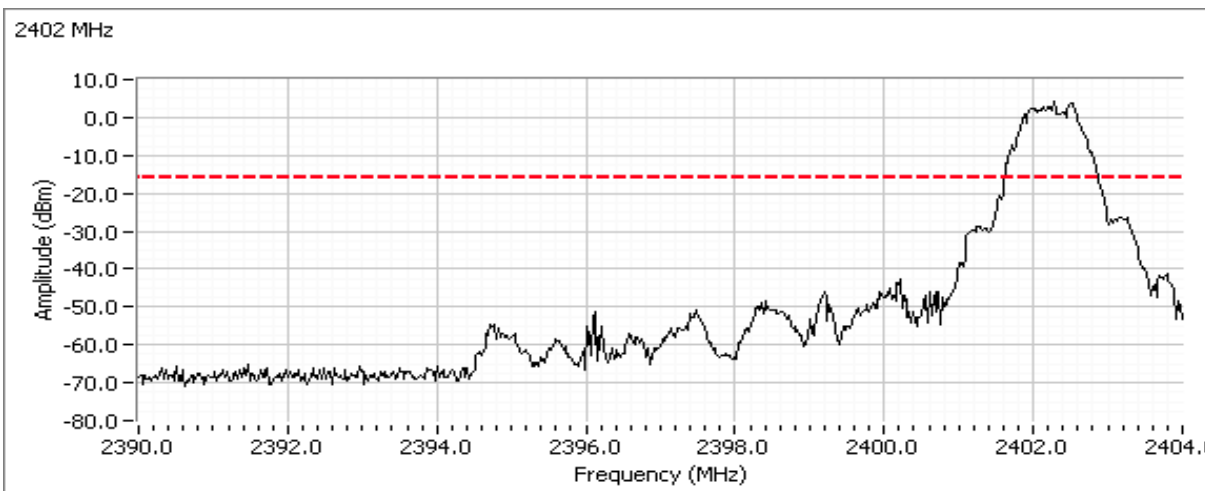

Client:	Intel Corporation	Job Number:	J84364
Model:	Intel® Centrino® Wireless-N 2230	T-Log Number:	T84599
Contact:	Steve Hackett	Account Manager:	Christine Krebill
Standard:	FCC 15.247	Class:	N/A

Plots for center channel, power setting(s) = Max

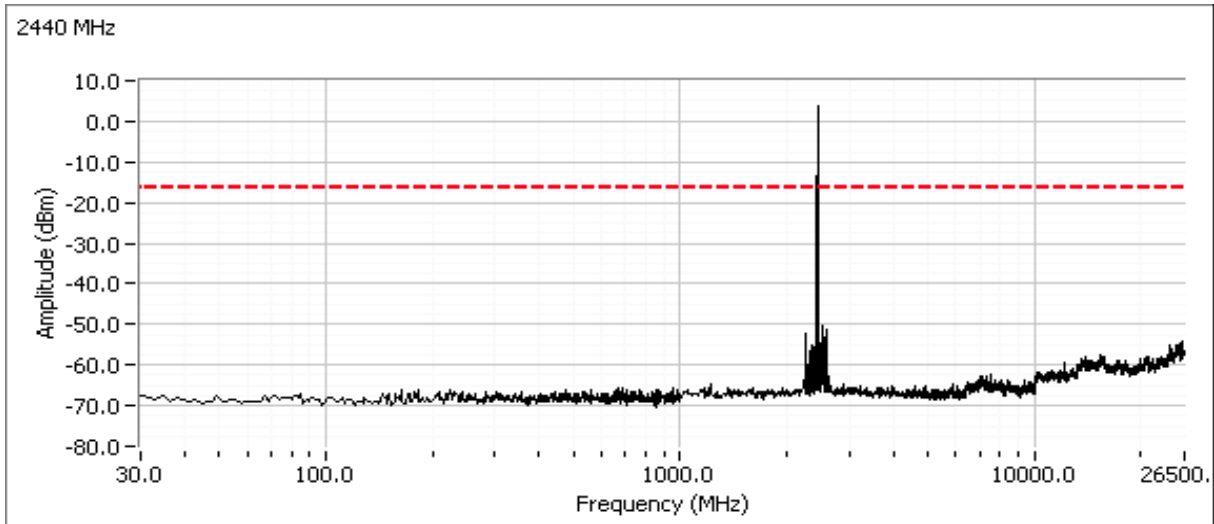

Plots for high channel, power setting(s) = Max

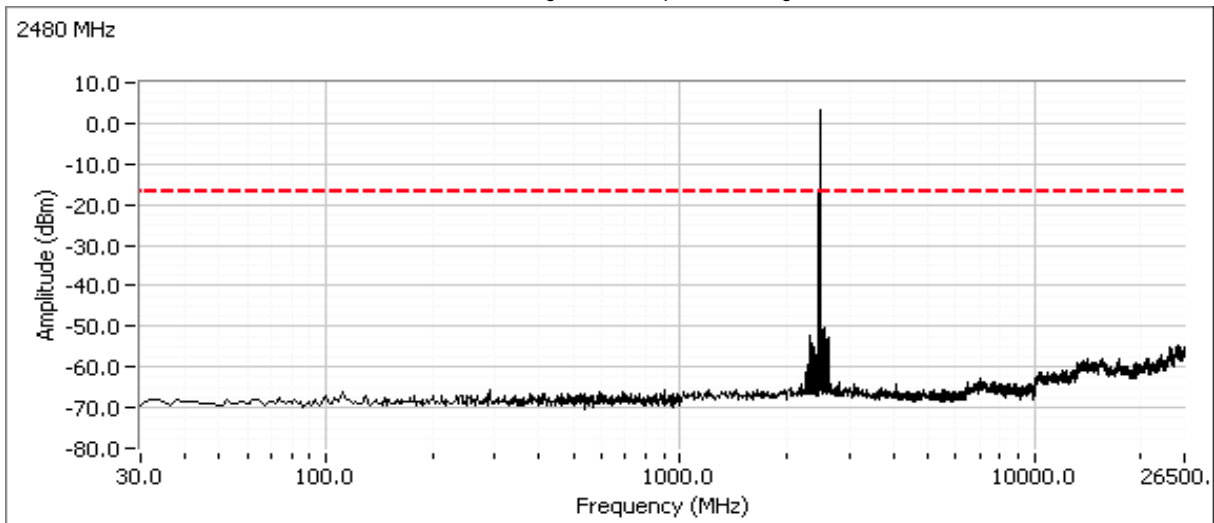

Client:	Intel Corporation	Job Number:	J84364
Model:	Intel® Centrino® Wireless-N 2230	T-Log Number:	T84599
Contact:	Steve Hackett	Account Manager:	Christine Krebill
Standard:	FCC 15.247	Class:	B

**RSS 210 and FCC 15.247 (DTS) Radiated Spurious Emissions**

**Test Specific Details**

Objective: The objective of this test session is to perform final qualification testing of the EUT with respect to the specification listed above.

**Summary of Results - Device Operating in the 2400-2483.5 MHz Band**

MAC Address: 00150082509B DRTU Tool Version 1.5.3.0322 Driver version 15.0.0.61

Target power for Bluetooth is max power without exceeding 7dBm for both integral and PIFA antennas

Run #	Mode	Channel	Power Setting	Measured Power	Test Performed	Limit	Result / Margin
1a		2402	-		Restricted Band Edge (2390 MHz)	FCC Part 15.209 / 15.247 (c)	40.6dBµV/m @ 2362.1MHz (-13.4dB)
			-		Radiated Emissions 1 -40 GHz	FCC Part 15.209 / 15.247 (c)	41.9dBµV/m @ 1593.9MHz (-12.1dB)
1b	Bluetooth Low Energy	2440	-		Radiated Emissions 1 -40 GHz	FCC Part 15.209 / 15.247 (c)	42.8dBµV/m @ 1594.4MHz (-11.2dB)
1c		2480	-		Restricted Band Edge (2483.5 MHz)	FCC Part 15.209 / 15.247 (c)	47.6dBµV/m @ 2483.5MHz (-6.4dB)
			-		Radiated Emissions 1 -40 GHz	FCC Part 15.209 / 15.247 (c)	42.0dBµV/m @ 1599.0MHz (-12.0dB)

**Ambient Conditions:** Temperature: 18 - 25 °C  
Rel. Humidity: 30 - 45 %

**Modifications Made During Testing**

No modifications were made to the EUT during testing

**Deviations From The Standard**

No deviations were made from the requirements of the standard.

Client:	Intel Corporation	Job Number:	J84364
Model:	Intel® Centrino® Wireless-N 2230	T-Log Number:	T84599
Contact:	Steve Hackett	Account Manager:	Christine Krebill
Standard:	FCC 15.247	Class:	B

**Run #1: Radiated Spurious Emissions, 1000 - 40,000 MHz. Operating Mode: Bluetooth LE**  
 Date of Test: 10/3/2011      Test Location: FT Chamber #3  
 Test Engineer: M. Birgani / R. Varelas

Note: Scans made between 10 - 40GHz with the measurement antenna moved around the card and its antennas 10-20cm from the device indicated there were no significant emissions in this frequency range. 19.696GHz was visible at 10cm but not above the noise floor of the measurement system 1 meter away. This emission does not change with Tx frequency.

**Run #1a: Low Channel @ 2402 MHz**  
**Band Edge Signal Field Strength - Direct measurement of field strength**

Frequency MHz	Level dB $\mu$ V/m	Pol v/h	15.209 / 15.247		Detector Pk/QP/Avg	Azimuth degrees	Height meters	Comments
			Limit	Margin				
2362.070	40.6	V	54.0	-13.4	AVG	85	1.0	RB 1 MHz;VB 10 Hz;Pk
2361.800	39.5	H	54.0	-14.5	AVG	168	1.0	RB 1 MHz;VB 10 Hz;Pk
2362.070	50.7	V	74.0	-23.3	PK	85	1.0	RB 1 MHz;VB 3 MHz;Pk
2380.470	49.9	H	74.0	-24.1	PK	168	1.0	RB 1 MHz;VB 3 MHz;Pk

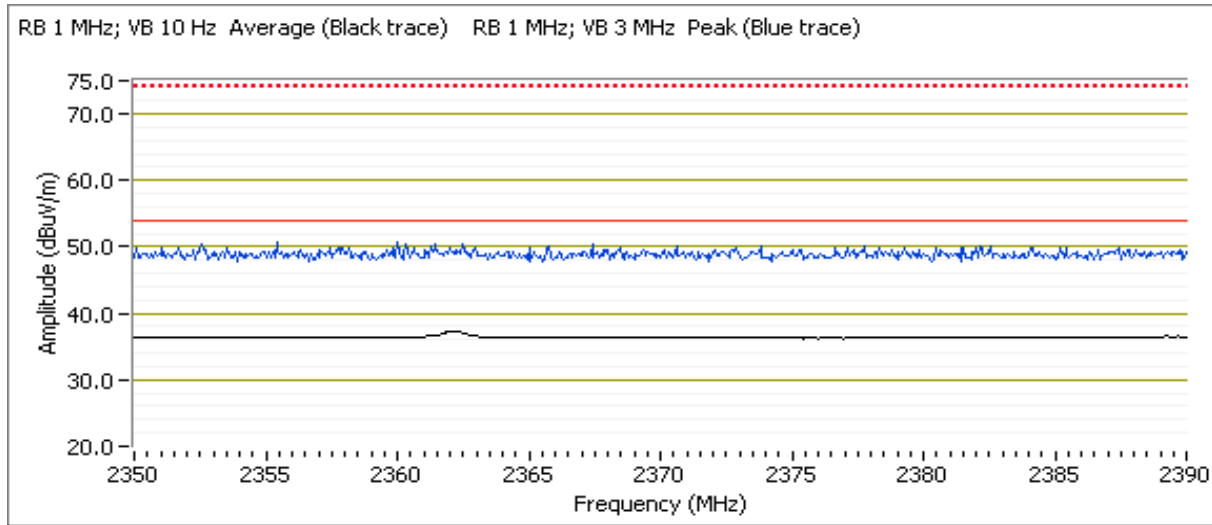

Client:	Intel Corporation	Job Number:	J84364
Model:	Intel® Centrino® Wireless-N 2230	T-Log Number:	T84599
Contact:	Steve Hackett	Account Manager:	Christine Krebill
Standard:	FCC 15.247	Class:	B

### Other Spurious Emissions

Frequency MHz	Level dB $\mu$ V/m	Pol v/h	15.209 / 15.247		Detector Pk/QP/Avg	Azimuth degrees	Height meters	Comments
			Limit	Margin				
1593.870	41.9	V	54.0	-12.1	AVG	196	1.0	RB 1 MHz;VB 10 Hz;Pk
1592.510	54.8	V	74.0	-19.2	PK	196	1.0	RB 1 MHz;VB 3 MHz;Pk
2998.330	49.1	V	70.0	-20.9	Peak	204	1.0	
5995.830	46.6	V	70.0	-23.4	Peak	164	1.0	
9848.330	50.1	V	70.0	-19.9	Peak	76	1.1	
2402.040	99.9	-	-	-	-	85	1.0	Fundamental RB=VB 100 kHz;Pk

Note 1: For emissions in restricted bands, the limit of 15.209 was used.

Note 2: Emissions not in restricted bands are measured as antenna conducted and compared to the out of band power limit.

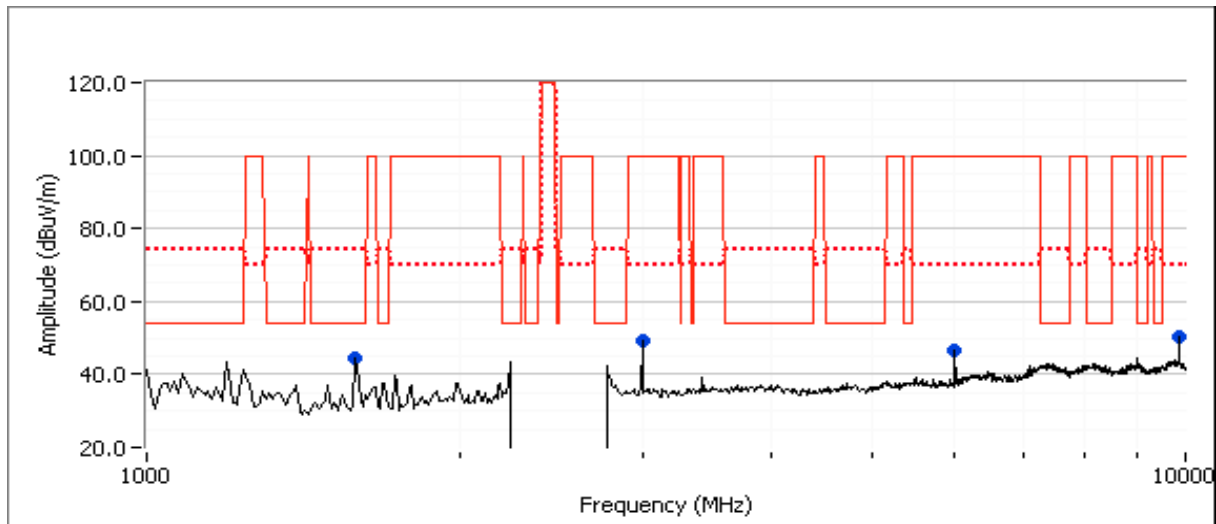



Client:	Intel Corporation	Job Number:	J84364
Model:	Intel® Centrino® Wireless-N 2230	T-Log Number:	T84599
Contact:	Steve Hackett	Account Manager:	Christine Krebill
Standard:	FCC 15.247	Class:	B

### Run #1b: Center Channel @ 2440 MHz

Frequency MHz	Level dB $\mu$ V/m	Pol v/h	15.209 / 15.247		Detector Pk/QP/Avg	Azimuth degrees	Height meters	Comments
			Limit	Margin				
1594.380	42.8	V	54.0	-11.2	AVG	198	1.0	RB 1 MHz;VB 10 Hz;Pk
1592.830	55.4	V	74.0	-18.6	PK	198	1.0	RB 1 MHz;VB 3 MHz;Pk
2998.330	48.4	H	70.0	-21.6	Peak	193	1.0	
5995.830	46.8	V	70.0	-23.2	Peak	120	1.0	
9848.330	50.7	V	70.0	-19.3	Peak	73	1.1	

Note 1: For emissions in restricted bands, the limit of 15.209 was used.

Note 2: Emissions not in restricted bands are measured as antenna conducted and compared to the out of band power limit.

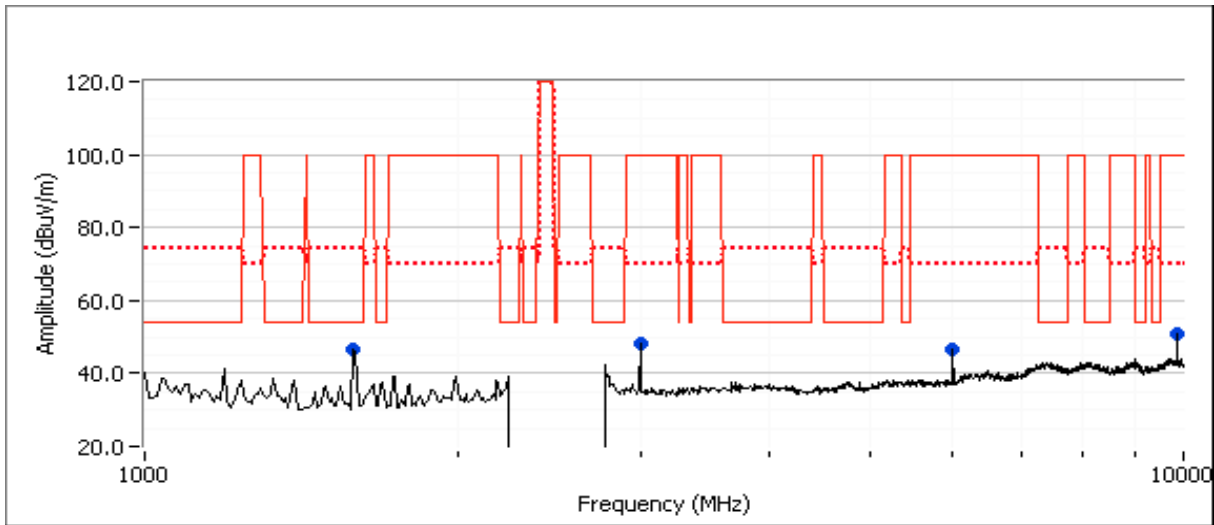

Client:	Intel Corporation	Job Number:	J84364
Model:	Intel® Centrino® Wireless-N 2230	T-Log Number:	T84599
Contact:	Steve Hackett	Account Manager:	Christine Krebill
Standard:	FCC 15.247	Class:	B

**Run #1c: High Channel @ 2480 MHz**

**Band Edge Signal Field Strength - Direct measurement of field strength**

Frequency MHz	Level dB $\mu$ V/m	Pol v/h	15.209 / 15.247		Detector Pk/QP/Avg	Azimuth degrees	Height meters	Comments
			Limit	Margin				
2483.500	47.6	H	54.0	-6.4	AVG	12	1.0	RB 1 MHz;VB 10 Hz;Pk
2483.500	43.8	V	54.0	-10.2	AVG	40	1.0	RB 1 MHz;VB 10 Hz;Pk
2483.500	55.2	H	74.0	-18.8	PK	12	1.0	RB 1 MHz;VB 3 MHz;Pk
2483.550	52.4	V	74.0	-21.6	PK	40	1.0	RB 1 MHz;VB 3 MHz;Pk

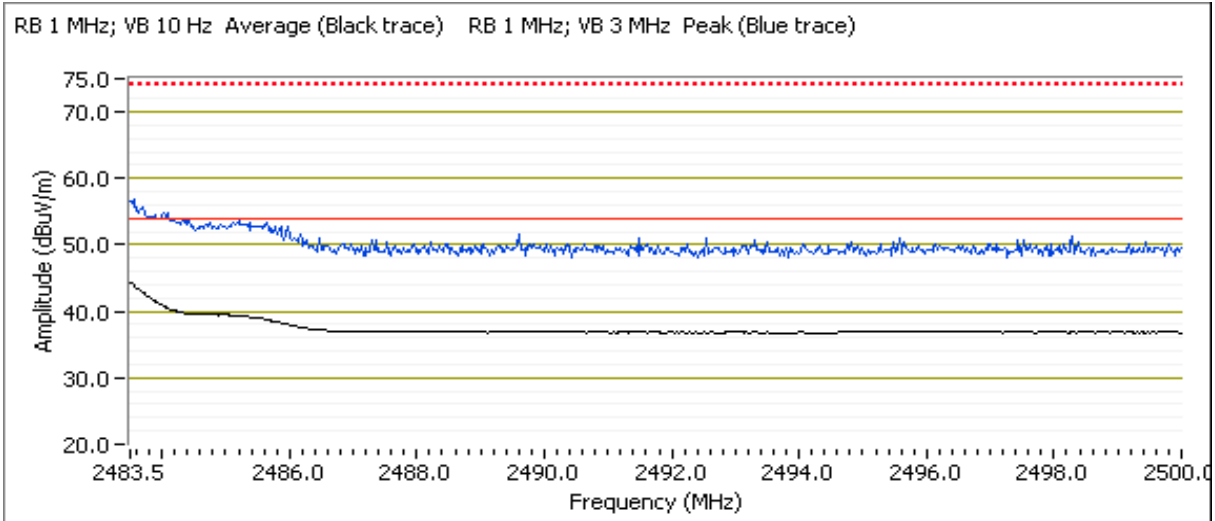

Client:	Intel Corporation	Job Number:	J84364
Model:	Intel® Centrino® Wireless-N 2230	T-Log Number:	T84599
Contact:	Steve Hackett	Account Manager:	Christine Krebill
Standard:	FCC 15.247	Class:	B

### Other Spurious Emissions

Frequency MHz	Level dB $\mu$ V/m	Pol v/h	15.209 / 15.247		Detector Pk/QP/Avg	Azimuth degrees	Height meters	Comments
			Limit	Margin				
1598.950	42.0	V	54.0	-12.0	AVG	201	1.0	RB 1 MHz;VB 10 Hz;Pk
1599.550	54.9	V	74.0	-19.1	PK	201	1.0	RB 1 MHz;VB 3 MHz;Pk
2480.010	96.2	-	-	-	-	40	1.0	Fundamental RB=VB 100 kHz;Pk
2998.330	49.6	H	70.0	-20.4	Peak	196	1.0	
5995.830	45.8	V	70.0	-24.2	Peak	111	1.1	
9848.330	49.4	V	70.0	-20.6	Peak	77	1.1	

Note 1: For emissions in restricted bands, the limit of 15.209 was used.

Note 2: Emissions not in restricted bands are measured as antenna conducted and compared to the out of band power limit.

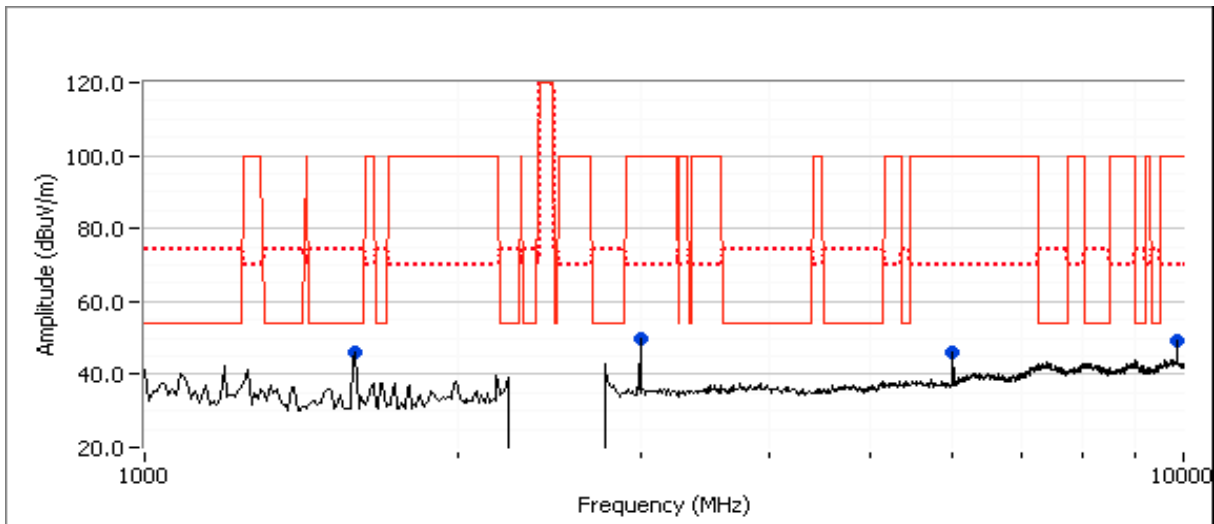

Client:	Intel Corporation	Job Number:	J84364
Model:	Intel® Centrino® Wireless-N 2230	T-Log Number:	T84599
		Account Manager:	Christine Krebill
Contact:	Steve Hackett		
Standard:	FCC 15.247	Class:	B

## RSS 210 and FCC 15.247 Radiated Spurious Emissions

### Test Specific Details

Objective: The objective of this test session is to perform final qualification testing of the EUT with respect to the specification listed above.

### General Test Configuration

The EUT and all local support equipment were located on the turntable for radiated spurious emissions testing.

For radiated emissions testing the measurement antenna was located 3 meters from the EUT.

**Ambient Conditions:**

Temperature:	17-22 °C
Rel. Humidity:	40-50 %

### Modifications Made During Testing

No modifications were made to the EUT during testing

### Deviations From The Standard

No deviations were made from the requirements of the standard.

Client:	Intel Corporation	Job Number:	J84364
Model:	Intel® Centrino® Wireless-N 2230	T-Log Number:	T84599
Contact:	Steve Hackett	Account Manager:	Christine Krebill
Standard:	FCC 15.247	Class:	B

**Summary of Results**

MAC Address: 00150082509B DRTU Tool Version 1.5.3.0322 Driver version 15.0.0.61  
 For Wi-Fi, only Chain A is used for Tx. For Bluetooth only chain B is used for Tx. Both chains are used for Rx for Wi-Fi and Bluetooth  
 Note - the target and measured power are average powers (measured with average power sensor) and are used for reference purposes only. Power is set using " GAIN CONTROL" mode in the DRTU tool.  
 Use the Gain Control mode of adjusting power. Set power to within ±0.2dB of target (dial in closer to the target value within ± 0.2dB if possible and not just a passing value above the target).

**MAC Address: DRTU Tool Version Driver version**

Run #	Mode	Channel	Power Setting	Measured Power	Test Performed	Limit	Result / Margin
1	BT Basic 802.11b	2402MHz 2412MHz	7dBm 16.5dBm	4.8 16.7	Radiated Emissions, 1 - 10 GHz	FCC Part 15.209 / 15.247( c)	47.9dBµV/m @ 2489.3MHz (-6.1dB)
2	BT Basic 802.11b	2480MHz 2462MHz	7dBm 16.5dBm	4.6 16.7		FCC Part 15.209 / 15.247( c)	49.4dBµV/m @ 2320.0MHz (-4.6dB)
3	BT Basic 802.11g	2402MHz 2412MHz	7dBm 16.5dBm	4.8 16.7		FCC Part 15.209 / 15.247( c)	47.9dBµV/m @ 2486.3MHz (-6.1dB)
4	BT Basic 802.11g	2480MHz 2462MHz	7dBm 16.5dBm	4.6 16.6		FCC Part 15.209 / 15.247( c)	49.2dBµV/m @ 2488.1MHz (-4.8dB)

Wi-Fi mode for the following runs based on the worst case mode from runs 1 through 4

5	BT Basic 802.11b	2402MHz 2437MHz	7dBm 16.5dBm	4.8 16.6	Radiated Emissions, 1 - 10 GHz	FCC Part 15.209 / 15.247( c)	47.9dBµV/m @ 2485.7MHz (-6.1dB)
6	BT Basic 802.11b	2440MHz 2412MHz	7dBm 16.5dBm	5.4 16.7		FCC Part 15.209 / 15.247( c)	48.0dBµV/m @ 2360.1MHz (-6.0dB)
7	BT Basic 802.11b	2440MHz 2462MHz	7dBm 16.5dBm	5.4 16.7		FCC Part 15.209 / 15.247( c)	48.2dBµV/m @ 2279.8MHz (-5.8dB)
8	BT Basic 802.11b	2480MHz 2437MHz	7dBm 16.5dBm	4.6 16.6		FCC Part 15.209 / 15.247( c)	48.5dBµV/m @ 2320.0MHz (-5.5dB)

Wi-Fi mode and channel and Bluetooth channel for the following run based on the worst case mode from runs 1 through 8

9	BT EDR 802.1b	2480MHz 2462MHz	7dBm 16.5dBm	1.1 16.7	Radiated Emissions, 1 - 10 GHz	FCC Part 15.209 / 15.247( c)	46.8dBµV/m @ 2320.0MHz (-7.2dB)
---	------------------	--------------------	-----------------	-------------	-----------------------------------	---------------------------------	------------------------------------

Client:	Intel Corporation	Job Number:	J84364
Model:	Intel® Centrino® Wireless-N 2230	T-Log Number:	T84599
Contact:	Steve Hackett	Account Manager:	Christine Krebill
Standard:	FCC 15.247	Class:	B

Run #1: Radiated Spurious Emissions, 1-10GHz. Operating Mode: 802.11b @ 2412, BT Basic @ 2402 MHz  
 Date of Test: 10/4/2011 Test Location: FT Chamber #3  
 Test Engineer: Rafael Varelas

**Preliminary Spurious Emissions excluding allocated band (Peak versus average limit)**

Frequency	Level	Pol	15.209 / 15.247		Detector	Azimuth	Height	Comments
MHz	dB $\mu$ V/m	v/h	Limit	Margin	Pk/QP/Avg	degrees	meters	
1594.630	47.0	V	54.0	-7.0	Peak	195	1.3	
3000.160	49.7	V	70.0	-20.3	Peak	195	1.3	
4824.150	40.0	V	54.0	-14.0	Peak	354	1.9	

**Final measurements at 3m**

Frequency	Level	Pol	15.209 / 15.247		Detector	Azimuth	Height	Comments
MHz	dB $\mu$ V/m	v/h	Limit	Margin	Pk/QP/Avg	degrees	meters	
1594.230	38.9	V	54.0	-15.1	AVG	196	1.0	RB 1 MHz;VB 10 Hz;Pk
1593.870	51.2	V	74.0	-22.8	PK	196	1.0	RB 1 MHz;VB 3 MHz;Pk
4823.930	33.4	V	54.0	-20.6	AVG	307	1.0	RB 1 MHz;VB 10 Hz;Pk
4821.520	44.1	V	74.0	-29.9	PK	307	1.0	RB 1 MHz;VB 3 MHz;Pk

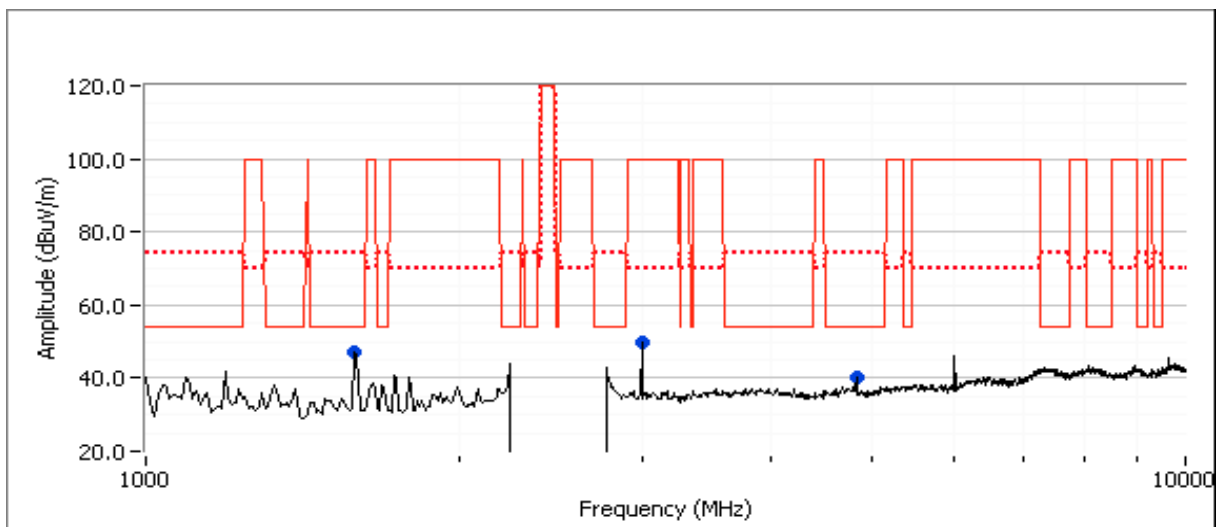

Client:	Intel Corporation	Job Number:	J84364
Model:	Intel® Centrino® Wireless-N 2230	T-Log Number:	T84599
Contact:	Steve Hackett	Account Manager:	Christine Krebill
Standard:	FCC 15.247	Class:	B

### Preliminary Spurious Emissions at 20cm from 2-3 GHz (Peak versus average limit)

Frequency MHz	Level dB $\mu$ V/m	Pol v/h	15.209 / 15.247		Detector Pk/QP/Avg	Azimuth degrees	Height meters	Comments
			Limit	Margin				
2485.000	46.3	V	54.0	-7.7	Peak	181	1.0	
2525.000	47.0	V	70.0	-23.0	Peak	181	1.0	
2243.330	41.9	V	54.0	-12.1	Peak	181	1.0	

### Final measurements at 3m

Frequency MHz	Level dB $\mu$ V/m	Pol v/h	15.209 / 15.247		Detector Pk/QP/Avg	Azimuth degrees	Height meters	Comments
			Limit	Margin				
2489.330	47.9	V	54.0	-6.1	AVG	189	1.0	RB 1 MHz;VB 10 Hz;Pk
2485.530	59.0	V	74.0	-15.0	PK	189	1.0	RB 1 MHz;VB 3 MHz;Pk
2241.980	47.4	V	54.0	-6.6	AVG	95	1.0	RB 1 MHz;VB 10 Hz;Pk
2240.960	58.1	V	74.0	-15.9	PK	95	1.0	RB 1 MHz;VB 3 MHz;Pk

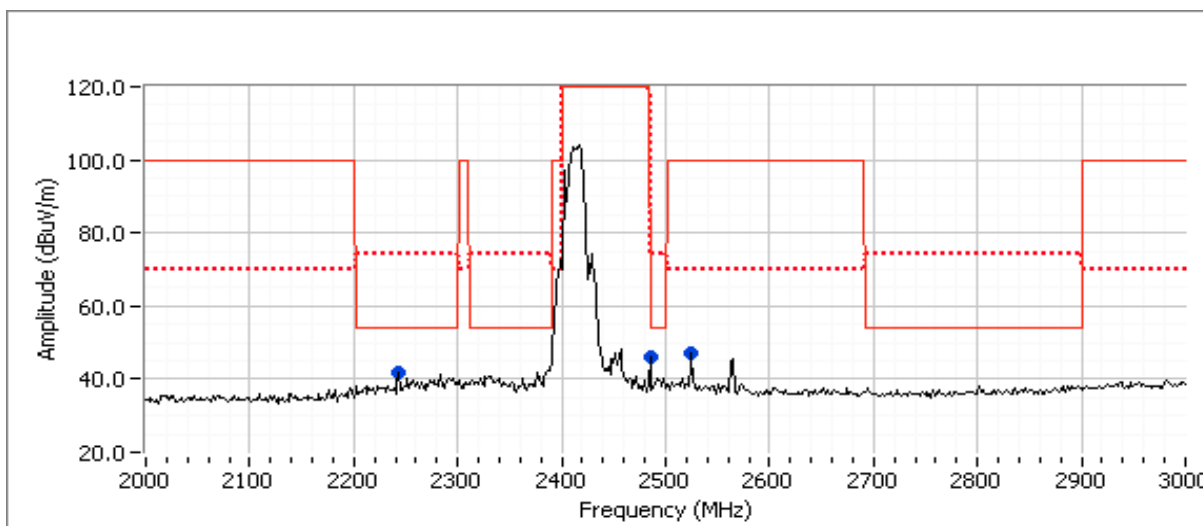

Client:	Intel Corporation	Job Number:	J84364
Model:	Intel® Centrino® Wireless-N 2230	T-Log Number:	T84599
Contact:	Steve Hackett	Account Manager:	Christine Krebill
Standard:	FCC 15.247	Class:	B

**Run #2: Radiated Spurious Emissions, 1-10GHz. Operating Mode: 802.11b @ 2462, BT Basic @ 2480 MHz**  
 Date of Test: 10/4/2011 Test Location: FT Chamber #3  
 Test Engineer: Rafael Varelas

**Preliminary Spurious Emissions excluding allocated band (Peak versus average limit)**

Frequency	Level	Pol	15.209 / 15.247		Detector	Azimuth	Height	Comments
MHz	dB $\mu$ V/m	v/h	Limit	Margin	Pk/QP/Avg	degrees	meters	
1592.900	44.3	V	54.0	-9.7	Peak	148	1.0	
3000.070	48.4	H	70.0	-21.6	Peak	192	1.3	
4923.970	42.3	V	54.0	-11.7	Peak	154	1.6	

**Final measurements at 3m**

Frequency	Level	Pol	15.209 / 15.247		Detector	Azimuth	Height	Comments
MHz	dB $\mu$ V/m	v/h	Limit	Margin	Pk/QP/Avg	degrees	meters	
4924.040	41.2	V	54.0	-12.8	AVG	144	1.0	RB 1 MHz;VB 10 Hz;Pk
4923.980	47.0	V	74.0	-27.0	PK	144	1.0	RB 1 MHz;VB 3 MHz;Pk
1594.080	37.9	V	54.0	-16.1	AVG	155	1.0	RB 1 MHz;VB 10 Hz;Pk
1594.040	51.0	V	74.0	-23.0	PK	155	1.0	RB 1 MHz;VB 3 MHz;Pk

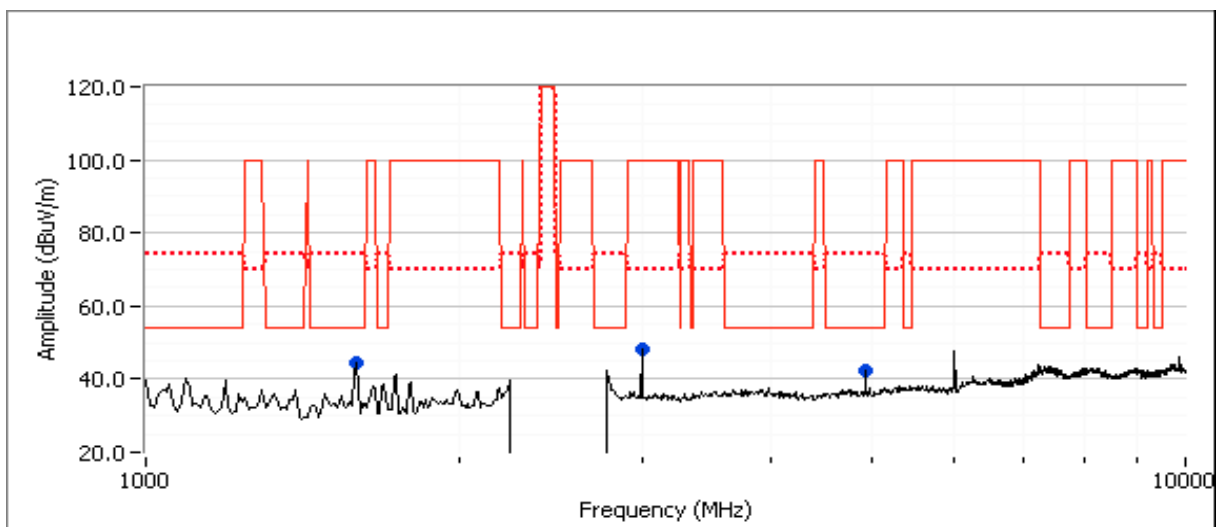



Client:	Intel Corporation	Job Number:	J84364
Model:	Intel® Centrino® Wireless-N 2230	T-Log Number:	T84599
Contact:	Steve Hackett	Account Manager:	Christine Krebill
Standard:	FCC 15.247	Class:	B

**Preliminary Spurious Emissions at 20cm from 2-3 GHz (Peak versus average limit)**

Frequency MHz	Level dB $\mu$ V/m	Pol v/h	15.209 / 15.247		Detector Pk/QP/Avg	Azimuth degrees	Height meters	Comments
			Limit	Margin				
2321.670	46.0	V	54.0	-8.0	Peak	180	1.0	
2521.670	48.3	V	70.0	-21.7	Peak	180	1.0	
2561.670	48.8	V	70.0	-21.2	Peak	180	1.0	

**Final measurements at 3m**

Frequency MHz	Level dB $\mu$ V/m	Pol v/h	15.209 / 15.247		Detector Pk/QP/Avg	Azimuth degrees	Height meters	Comments
			Limit	Margin				
2320.000	49.4	H	54.0	-4.6	AVG	110	1.4	RB 1 MHz;VB 10 Hz;Pk
2319.670	58.5	H	74.0	-15.5	PK	110	1.4	RB 1 MHz;VB 3 MHz;Pk
2320.040	48.1	V	54.0	-5.9	AVG	98	1.0	RB 1 MHz;VB 10 Hz;Pk
2320.270	58.1	V	74.0	-15.9	PK	98	1.0	RB 1 MHz;VB 3 MHz;Pk

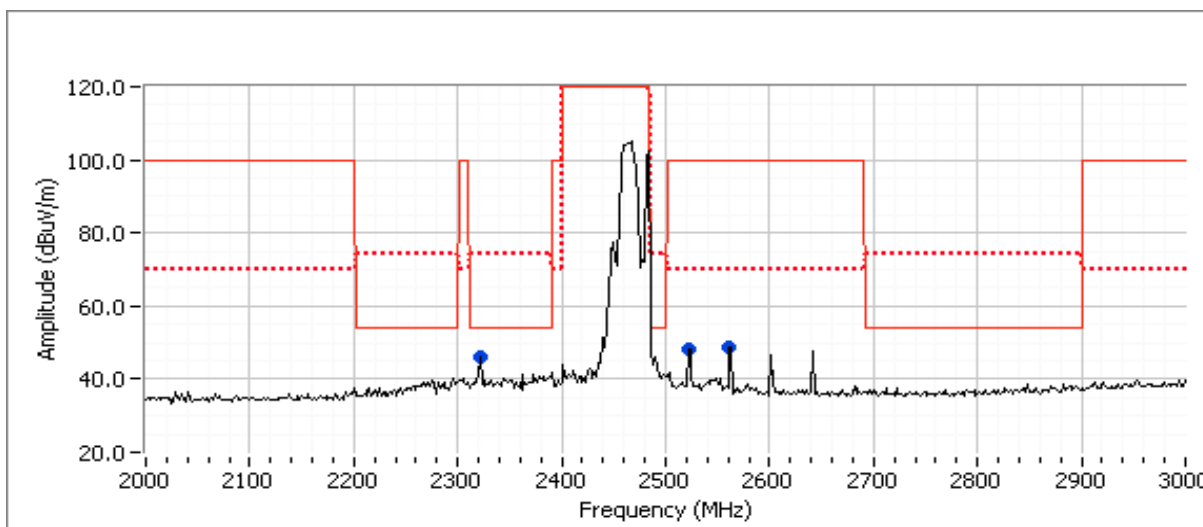

Client:	Intel Corporation	Job Number:	J84364
Model:	Intel® Centrino® Wireless-N 2230	T-Log Number:	T84599
Contact:	Steve Hackett	Account Manager:	Christine Krebill
Standard:	FCC 15.247	Class:	B

**Run #3: Radiated Spurious Emissions, 1-10GHz. Operating Mode: 802.11g @ 2412, BT Basic @ 2402 MHz**  
 Date of Test: 10/4/2011      Test Location: FT Chamber #3  
 Test Engineer: Rafael Varelas

**Preliminary Spurious Emissions excluding allocated band (Peak versus average limit)**

Frequency	Level	Pol	15.209 / 15.247		Detector	Azimuth	Height	Comments
MHz	dB $\mu$ V/m	v/h	Limit	Margin	Pk/QP/Avg	degrees	meters	
1600.130	44.2	V	54.0	-9.8	Peak	198	1.3	
3000.160	49.7	V	70.0	-20.3	Peak	198	1.3	
6000.960	48.8	V	70.0	-21.2	Peak	161	1.0	

**Final measurements at 3m**

Frequency	Level	Pol	15.209 / 15.247		Detector	Azimuth	Height	Comments
MHz	dB $\mu$ V/m	v/h	Limit	Margin	Pk/QP/Avg	degrees	meters	
1598.800	40.1	V	54.0	-13.9	AVG	199	1.0	RB 1 MHz;VB 10 Hz;Pk
1600.020	53.1	V	74.0	-20.9	PK	199	1.0	RB 1 MHz;VB 3 MHz;Pk

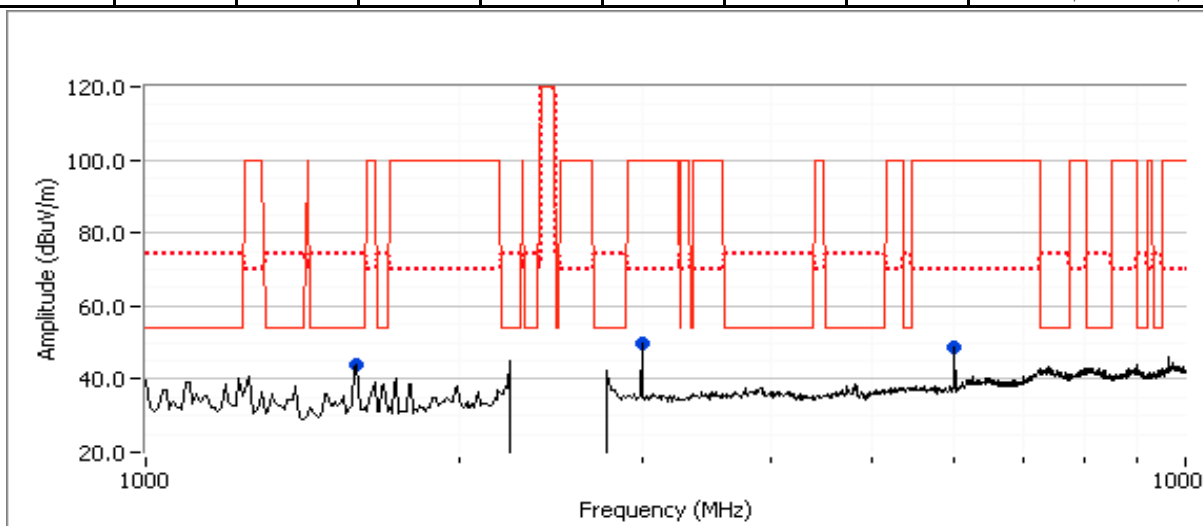

Client:	Intel Corporation	Job Number:	J84364
Model:	Intel® Centrino® Wireless-N 2230	T-Log Number:	T84599
Contact:	Steve Hackett	Account Manager:	Christine Krebill
Standard:	FCC 15.247	Class:	B

**Preliminary Spurious Emissions at 20cm from 2-3 GHz (Peak versus average limit)**

Frequency MHz	Level dB $\mu$ V/m	Pol v/h	15.209 / 15.247		Detector Pk/QP/Avg	Azimuth degrees	Height meters	Comments
			Limit	Margin				
2485.000	48.7	V	54.0	-5.3	Peak	181	1.0	
2335.000	43.9	V	54.0	-10.1	Peak	181	1.0	
2243.330	43.7	V	54.0	-10.3	Peak	181	1.0	

**Final measurements at 3m**

Frequency MHz	Level dB $\mu$ V/m	Pol v/h	15.209 / 15.247		Detector Pk/QP/Avg	Azimuth degrees	Height meters	Comments
			Limit	Margin				
2486.290	47.9	H	54.0	-6.1	AVG	9	1.2	RB 1 MHz;VB 10 Hz;Pk
2485.480	59.2	H	74.0	-14.8	PK	9	1.2	RB 1 MHz;VB 3 MHz;Pk
2486.230	47.8	V	54.0	-6.2	AVG	76	1.8	RB 1 MHz;VB 10 Hz;Pk
2486.140	59.9	V	74.0	-14.1	PK	76	1.8	RB 1 MHz;VB 3 MHz;Pk
2333.250	46.6	V	54.0	-7.4	AVG	314	1.0	RB 1 MHz;VB 10 Hz;Pk
2334.870	57.5	V	74.0	-16.5	PK	314	1.0	RB 1 MHz;VB 3 MHz;Pk
2241.910	47.4	V	54.0	-6.6	AVG	95	1.0	RB 1 MHz;VB 10 Hz;Pk
2241.760	58.4	V	74.0	-15.6	PK	95	1.0	RB 1 MHz;VB 3 MHz;Pk

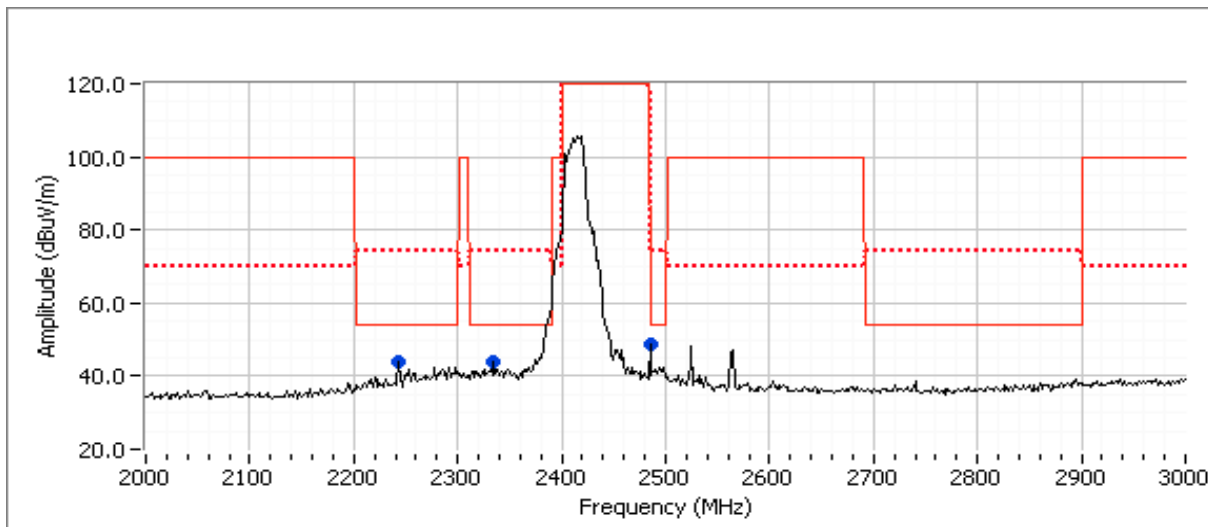

Client:	Intel Corporation	Job Number:	J84364
Model:	Intel® Centrino® Wireless-N 2230	T-Log Number:	T84599
Contact:	Steve Hackett	Account Manager:	Christine Krebill
Standard:	FCC 15.247	Class:	B

Run #4: Radiated Spurious Emissions, 1-10GHz. Operating Mode: 802.11g @ 2462, BT Basic @ 2480 MHz  
 Date of Test: 10/4/2011 Test Location: FT Chamber #3  
 Test Engineer: Rafael Varelas

**Preliminary Spurious Emissions excluding allocated band (Peak versus average limit)**

Frequency	Level	Pol	15.209 / 15.247		Detector	Azimuth	Height	Comments
MHz	dB $\mu$ V/m	v/h	Limit	Margin	Pk/QP/Avg	degrees	meters	
1595.740	45.8	V	54.0	-8.2	Peak	191	1.3	
3000.160	47.7	V	70.0	-22.3	Peak	198	1.0	
6001.050	46.8	V	70.0	-23.2	Peak	177	1.0	

**Final measurements at 3m**

Frequency	Level	Pol	15.209 / 15.247		Detector	Azimuth	Height	Comments
MHz	dB $\mu$ V/m	v/h	Limit	Margin	Pk/QP/Avg	degrees	meters	
1594.790	40.6	V	54.0	-13.4	AVG	197	1.0	RB 1 MHz;VB 10 Hz;Pk
1594.710	53.8	V	74.0	-20.2	PK	197	1.0	RB 1 MHz;VB 3 MHz;Pk

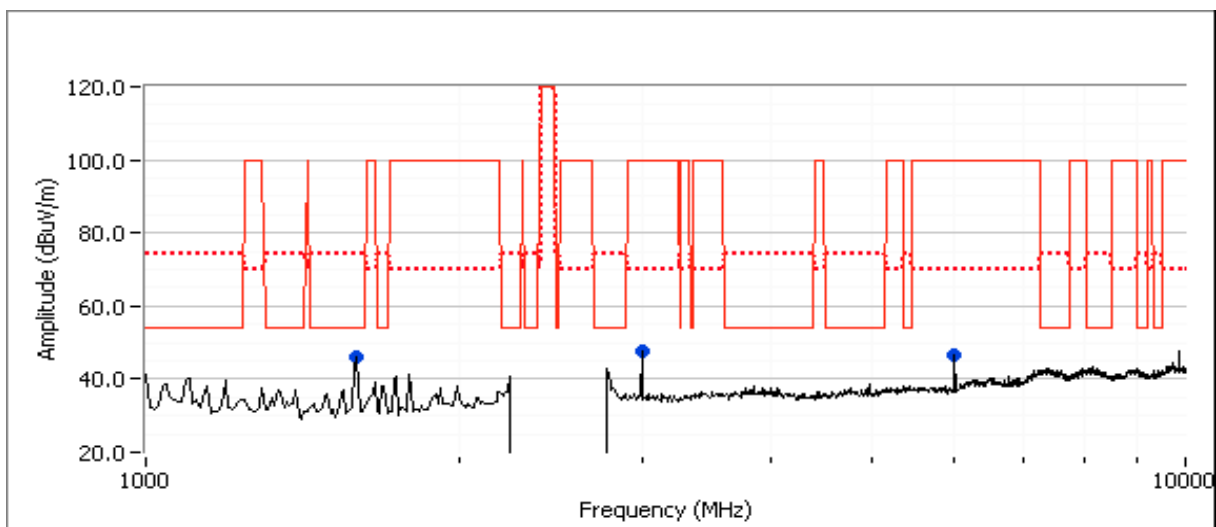

Client:	Intel Corporation	Job Number:	J84364
Model:	Intel® Centrino® Wireless-N 2230	T-Log Number:	T84599
Contact:	Steve Hackett	Account Manager:	Christine Krebill
Standard:	FCC 15.247	Class:	B

**Preliminary Spurious Emissions at 20cm from 2-3 GHz (Peak versus average limit)**

Frequency	Level	Pol	15.209 / 15.247		Detector	Azimuth	Height	Comments
MHz	dB $\mu$ V/m	v/h	Limit	Margin	Pk/QP/Avg	degrees	meters	
2493.330	52.6	V	54.0	-1.4	Peak	180	1.0	
2523.330	48.0	V	70.0	-22.0	Peak	180	1.0	
2321.670	43.3	V	54.0	-10.7	Peak	180	1.0	

**Final measurements at 3m**

Frequency	Level	Pol	15.209 / 15.247		Detector	Azimuth	Height	Comments
MHz	dB $\mu$ V/m	v/h	Limit	Margin	Pk/QP/Avg	degrees	meters	
2488.050	49.2	H	54.0	-4.8	AVG	353	1.0	RB 1 MHz;VB 10 Hz;Pk
2488.080	64.5	H	74.0	-9.5	PK	353	1.0	RB 1 MHz;VB 3 MHz;Pk
2488.000	49.1	V	54.0	-4.9	AVG	184	1.1	RB 1 MHz;VB 10 Hz;Pk
2488.300	63.0	V	74.0	-11.0	PK	184	1.1	RB 1 MHz;VB 3 MHz;Pk
2319.970	47.3	V	54.0	-6.7	AVG	191	1.0	RB 1 MHz;VB 10 Hz;Pk
2320.170	57.8	V	74.0	-16.2	PK	191	1.0	RB 1 MHz;VB 3 MHz;Pk

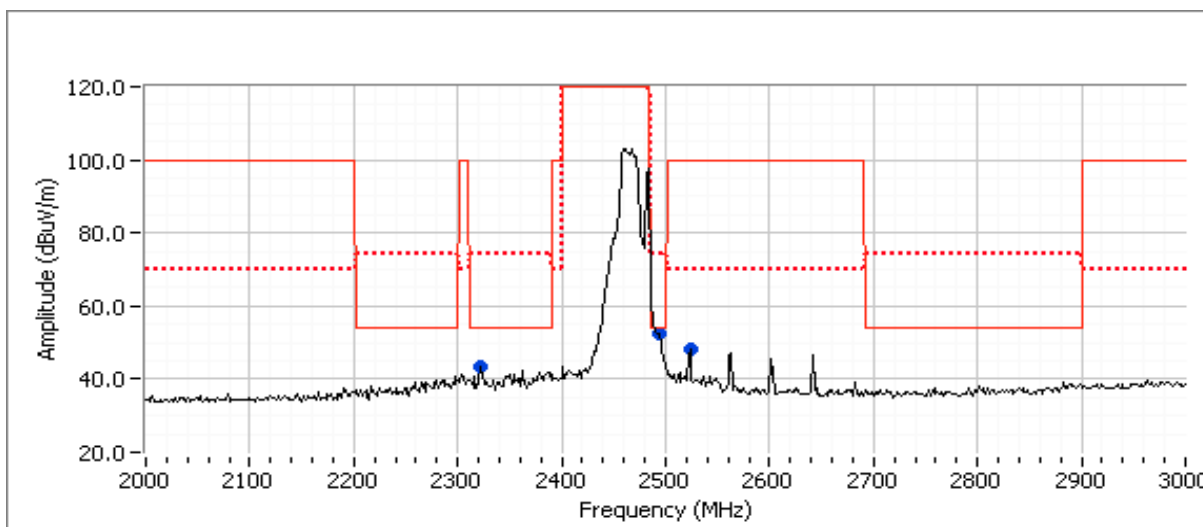

Client:	Intel Corporation	Job Number:	J84364
Model:	Intel® Centrino® Wireless-N 2230	T-Log Number:	T84599
Contact:	Steve Hackett	Account Manager:	Christine Krebill
Standard:	FCC 15.247	Class:	B

Run #5: Radiated Spurious Emissions, 1-10GHz. Operating Mode: 802.11b @ 2437, BT Basic @ 2402 MHz  
 Date of Test: 10/4/2011 Test Location: FT Chamber #3  
 Test Engineer: Rafael Varelas

**Preliminary Spurious Emissions excluding allocated band (Peak versus average limit)**

Frequency	Level	Pol	15.209 / 15.247		Detector	Azimuth	Height	Comments
MHz	dB $\mu$ V/m	v/h	Limit	Margin	Pk/QP/Avg	degrees	meters	
1592.720	43.5	V	54.0	-10.5	Peak	139	1.0	
3000.250	47.4	H	70.0	-22.6	Peak	123	1.9	
4874.100	42.5	V	54.0	-11.5	Peak	124	1.0	

**Final measurements at 3m**

Frequency	Level	Pol	15.209 / 15.247		Detector	Azimuth	Height	Comments
MHz	dB $\mu$ V/m	v/h	Limit	Margin	Pk/QP/Avg	degrees	meters	
1597.830	39.4	V	54.0	-14.6	AVG	148	1.0	RB 1 MHz;VB 10 Hz;Pk
1593.820	52.5	V	74.0	-21.5	PK	148	1.0	RB 1 MHz;VB 3 MHz;Pk
4874.000	41.9	V	54.0	-12.1	AVG	122	1.0	RB 1 MHz;VB 10 Hz;Pk
4873.840	47.7	V	74.0	-26.3	PK	122	1.0	RB 1 MHz;VB 3 MHz;Pk

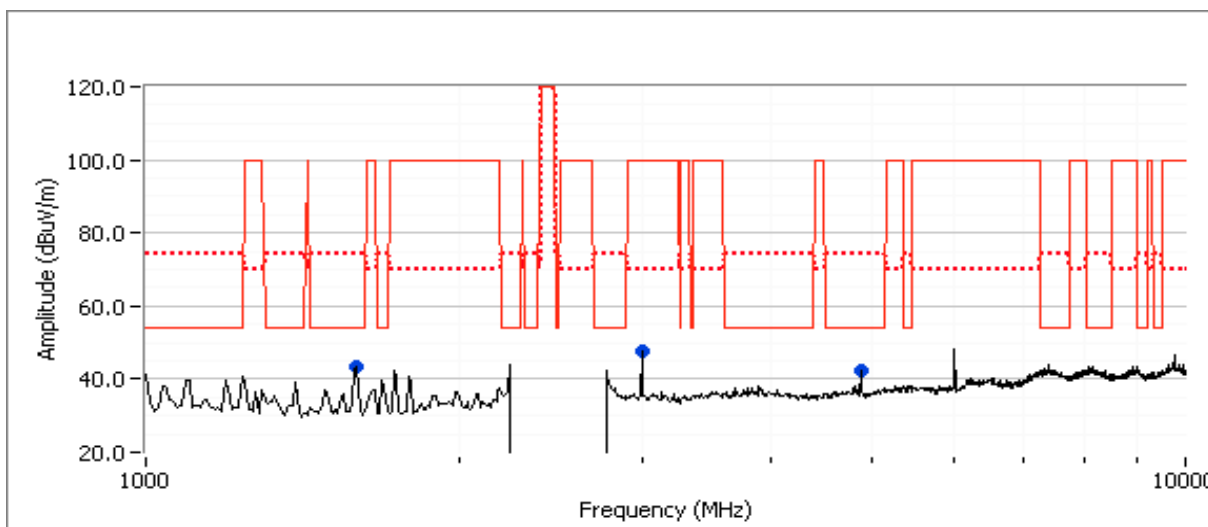

Client:	Intel Corporation	Job Number:	J84364
Model:	Intel® Centrino® Wireless-N 2230	T-Log Number:	T84599
Contact:	Steve Hackett	Account Manager:	Christine Krebill
Standard:	FCC 15.247	Class:	B

**Preliminary Spurious Emissions at 20cm from 2-3 GHz (Peak versus average limit)**

Frequency	Level	Pol	15.209 / 15.247		Detector	Azimuth	Height	Comments
MHz	dB $\mu$ V/m	v/h	Limit	Margin	Pk/QP/Avg	degrees	meters	
2243.330	43.1	V	54.0	-10.9	Peak	179	1.0	
2485.000	51.8	V	54.0	-2.2	Peak	179	1.0	
2525.000	50.5	V	70.0	-19.5	Peak	179	1.0	

**Final measurements at 3m**

Frequency	Level	Pol	15.209 / 15.247		Detector	Azimuth	Height	Comments
MHz	dB $\mu$ V/m	v/h	Limit	Margin	Pk/QP/Avg	degrees	meters	
2485.670	47.9	V	54.0	-6.1	AVG	199	1.7	RB 1 MHz;VB 10 Hz;Pk
2488.500	59.8	V	74.0	-14.2	PK	199	1.7	RB 1 MHz;VB 3 MHz;Pk
2483.580	47.6	H	54.0	-6.4	AVG	88	1.2	RB 1 MHz;VB 10 Hz;Pk
2485.570	58.7	H	74.0	-15.3	PK	88	1.2	RB 1 MHz;VB 3 MHz;Pk
2242.110	47.7	V	54.0	-6.3	AVG	90	1.0	RB 1 MHz;VB 10 Hz;Pk
2246.530	58.9	V	74.0	-15.1	PK	90	1.0	RB 1 MHz;VB 3 MHz;Pk

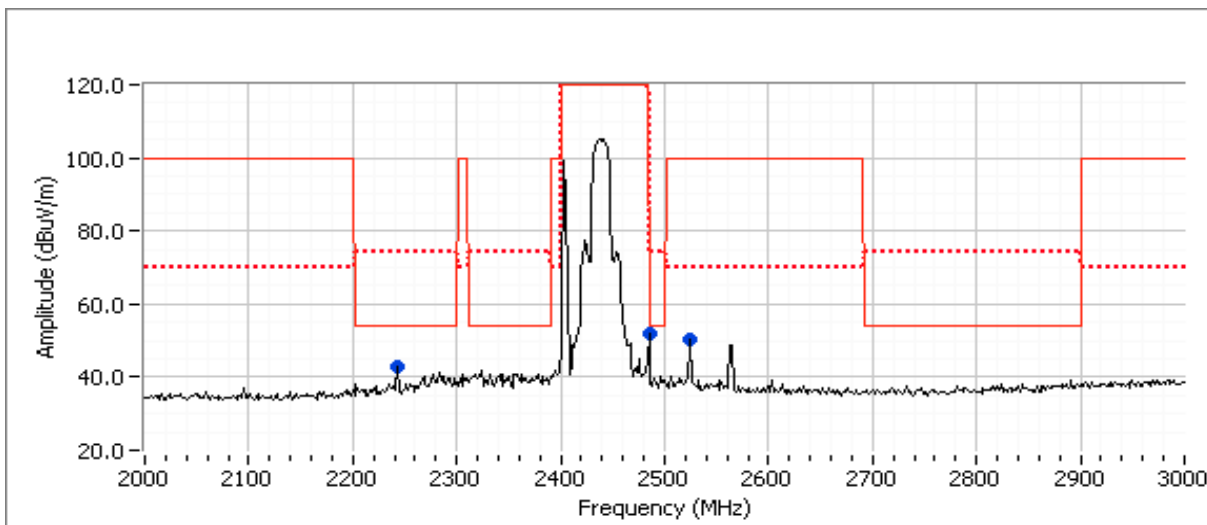

Client:	Intel Corporation	Job Number:	J84364
Model:	Intel® Centrino® Wireless-N 2230	T-Log Number:	T84599
Contact:	Steve Hackett	Account Manager:	Christine Krebill
Standard:	FCC 15.247	Class:	B

**Run #6: Radiated Spurious Emissions, 1-10GHz. Operating Mode: 802.11b @ 2412, BT Basic @ 2440 MHz**  
 Date of Test: 10/4/2011      Test Location: FT Chamber #3  
 Test Engineer: Rafael Varelas

**Preliminary Spurious Emissions excluding allocated band (Peak versus average limit)**

Frequency	Level	Pol	15.209 / 15.247		Detector	Azimuth	Height	Comments
MHz	dB $\mu$ V/m	v/h	Limit	Margin	Pk/QP/Avg	degrees	meters	
1593.990	47.1	V	54.0	-6.9	Peak	209	1.3	
3000.160	48.2	H	70.0	-21.8	Peak	191	1.3	
4824.060	40.1	V	54.0	-13.9	Peak	204	1.0	

**Final measurements at 3m**

Frequency	Level	Pol	15.209 / 15.247		Detector	Azimuth	Height	Comments
MHz	dB $\mu$ V/m	v/h	Limit	Margin	Pk/QP/Avg	degrees	meters	
1595.310	41.0	V	54.0	-13.0	AVG	204	1.0	RB 1 MHz;VB 10 Hz;Pk
1594.270	52.5	V	74.0	-21.5	PK	204	1.0	RB 1 MHz;VB 3 MHz;Pk
4823.950	38.7	V	54.0	-15.3	AVG	230	1.0	RB 1 MHz;VB 10 Hz;Pk
4824.120	46.7	V	74.0	-27.3	PK	230	1.0	RB 1 MHz;VB 3 MHz;Pk

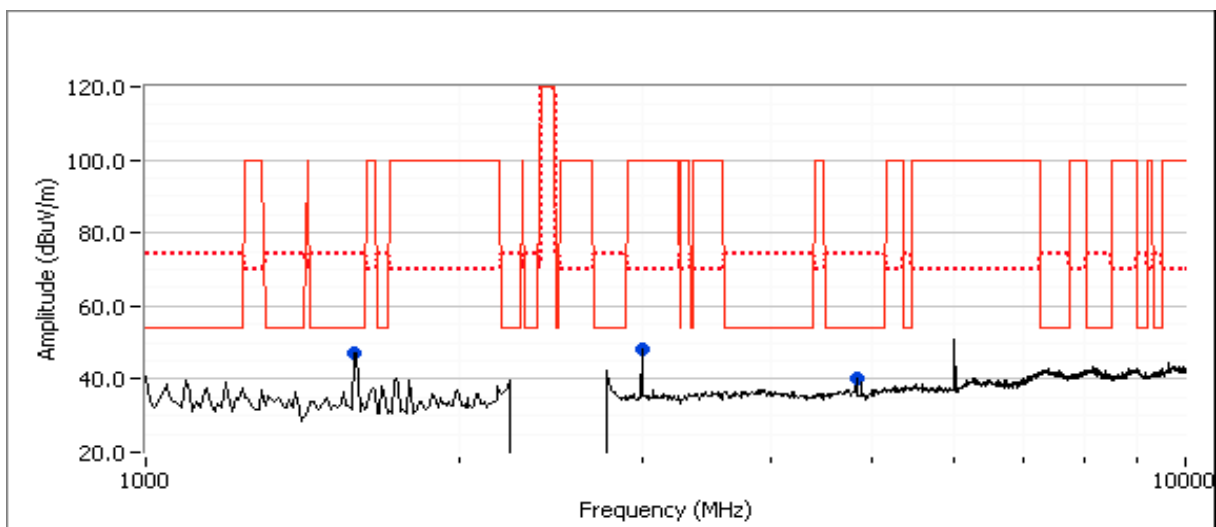



Client:	Intel Corporation	Job Number:	J84364
Model:	Intel® Centrino® Wireless-N 2230	T-Log Number:	T84599
Contact:	Steve Hackett	Account Manager:	Christine Krebill
Standard:	FCC 15.247	Class:	B

### Preliminary Spurious Emissions at 20cm from 2-3 GHz (Peak versus average limit)

Frequency MHz	Level dB $\mu$ V/m	Pol v/h	15.209 / 15.247		Detector Pk/QP/Avg	Azimuth degrees	Height meters	Comments
			Limit	Margin				
2281.670	46.1	V	54.0	-7.9	Peak	179	1.0	
2321.670	44.5	V	54.0	-9.5	Peak	179	1.0	
2361.670	44.3	V	54.0	-9.7	Peak	179	1.0	
2473.330	50.3	V	120.0	-69.7	Peak	179	1.0	

### Final measurements at 3m

Frequency MHz	Level dB $\mu$ V/m	Pol v/h	15.209 / 15.247		Detector Pk/QP/Avg	Azimuth degrees	Height meters	Comments
			Limit	Margin				
2360.050	48.0	V	54.0	-6.0	AVG	100	1.0	RB 1 MHz;VB 10 Hz;Pk
2359.540	58.7	V	74.0	-15.3	PK	100	1.0	RB 1 MHz;VB 3 MHz;Pk
2280.020	47.8	V	54.0	-6.2	AVG	92	1.0	RB 1 MHz;VB 10 Hz;Pk
2279.940	58.0	V	74.0	-16.0	PK	92	1.0	RB 1 MHz;VB 3 MHz;Pk
2320.050	47.1	V	54.0	-6.9	AVG	95	1.0	RB 1 MHz;VB 10 Hz;Pk
2324.650	57.5	V	74.0	-16.5	PK	95	1.0	RB 1 MHz;VB 3 MHz;Pk
2360.070	47.3	H	54.0	-6.7	AVG	253	1.0	RB 1 MHz;VB 10 Hz;Pk
2363.700	58.9	H	74.0	-15.1	PK	253	1.0	RB 1 MHz;VB 3 MHz;Pk

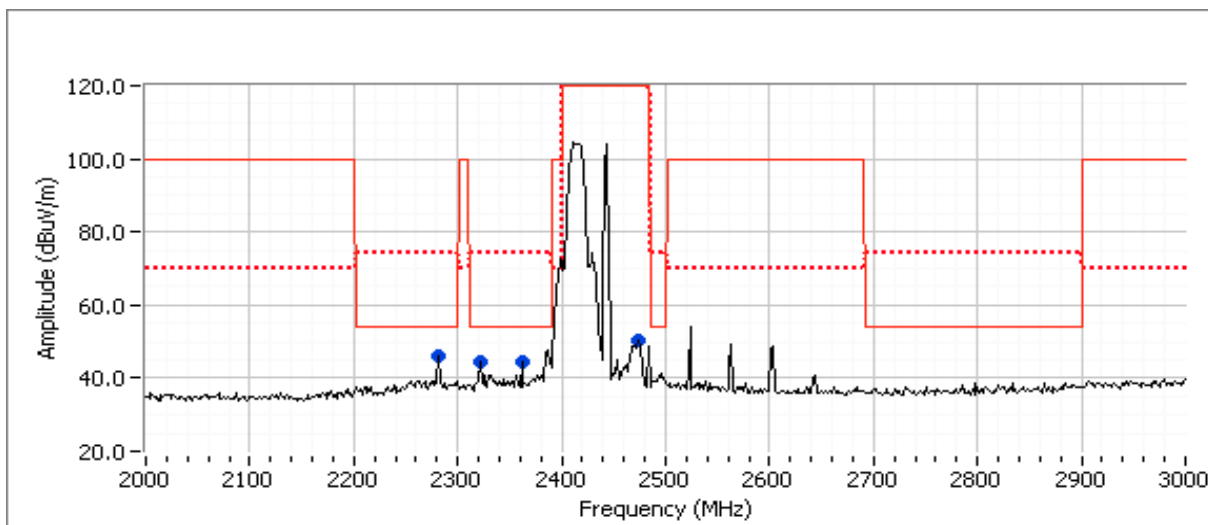

Client:	Intel Corporation	Job Number:	J84364
Model:	Intel® Centrino® Wireless-N 2230	T-Log Number:	T84599
Contact:	Steve Hackett	Account Manager:	Christine Krebill
Standard:	FCC 15.247	Class:	B

**Run #7: Radiated Spurious Emissions, 1-10GHz. Operating Mode: 802.11b @ 2462, BT Basic @ 2440 MHz**  
 Date of Test: 10/4/2011      Test Location: FT Chamber #3  
 Test Engineer: Rafael Varelas

**Preliminary Spurious Emissions excluding allocated band (Peak versus average limit)**

Frequency	Level	Pol	15.209 / 15.247		Detector	Azimuth	Height	Comments
MHz	dB $\mu$ V/m	v/h	Limit	Margin	Pk/QP/Avg	degrees	meters	
1592.530	48.5	V	54.0	-5.5	Peak	192	1.3	
3000.160	47.9	H	70.0	-22.1	Peak	201	1.3	
4923.970	42.3	V	54.0	-11.7	Peak	146	1.0	

**Final measurements at 3m**

Frequency	Level	Pol	15.209 / 15.247		Detector	Azimuth	Height	Comments
MHz	dB $\mu$ V/m	v/h	Limit	Margin	Pk/QP/Avg	degrees	meters	
4924.020	40.8	V	54.0	-13.2	AVG	144	1.0	RB 1 MHz;VB 10 Hz;Pk
4924.060	46.4	V	74.0	-27.6	PK	144	1.0	RB 1 MHz;VB 3 MHz;Pk
1593.580	39.3	V	54.0	-14.7	AVG	202	1.0	RB 1 MHz;VB 10 Hz;Pk
1593.650	52.0	V	74.0	-22.0	PK	202	1.0	RB 1 MHz;VB 3 MHz;Pk

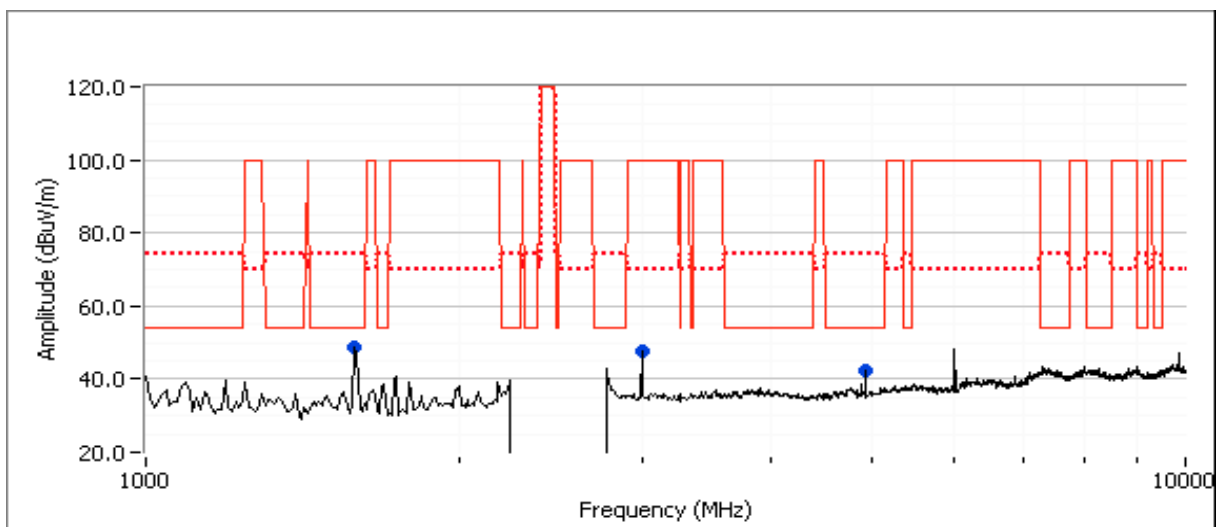

Client:	Intel Corporation	Job Number:	J84364
Model:	Intel® Centrino® Wireless-N 2230	T-Log Number:	T84599
Contact:	Steve Hackett	Account Manager:	Christine Krebill
Standard:	FCC 15.247	Class:	B

### Preliminary Spurious Emissions at 20cm from 2-3 GHz (Peak versus average limit)

Frequency MHz	Level dB $\mu$ V/m	Pol v/h	15.209 / 15.247		Detector PK/QP/Avg	Azimuth degrees	Height meters	Comments
			Limit	Margin				
2281.670	43.1	V	54.0	-10.9	Peak	181	1.0	
2521.670	49.7	V	70.0	-20.3	Peak	181	1.0	

### Final measurements at 3m

Frequency MHz	Level dB $\mu$ V/m	Pol v/h	15.209 / 15.247		Detector PK/QP/Avg	Azimuth degrees	Height meters	Comments
			Limit	Margin				
2279.820	48.2	H	54.0	-5.8	AVG	120	1.0	RB 1 MHz;VB 10 Hz;Pk
2280.320	58.3	H	74.0	-15.7	PK	120	1.0	RB 1 MHz;VB 3 MHz;Pk
2280.020	47.9	V	54.0	-6.1	AVG	94	1.0	RB 1 MHz;VB 10 Hz;Pk
2280.450	58.3	V	74.0	-15.7	PK	94	1.0	RB 1 MHz;VB 3 MHz;Pk

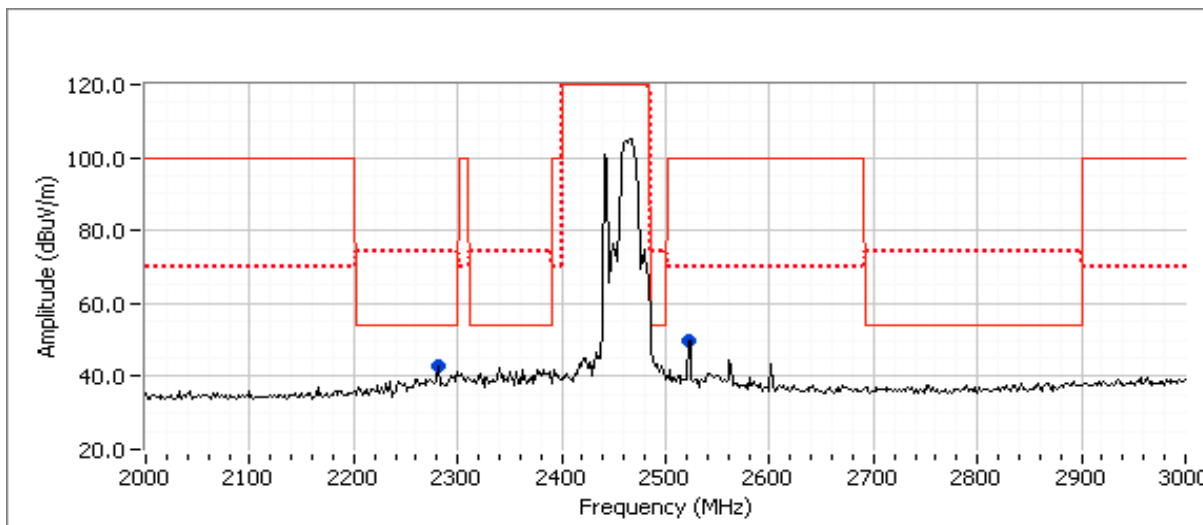

Client:	Intel Corporation	Job Number:	J84364
Model:	Intel® Centrino® Wireless-N 2230	T-Log Number:	T84599
Contact:	Steve Hackett	Account Manager:	Christine Krebill
Standard:	FCC 15.247	Class:	B

**Run #8: Radiated Spurious Emissions, 1-10GHz. Operating Mode: 802.11b @ 2437, BT Basic @ 2480 MHz**  
 Date of Test: 10/4/2011 Test Location: FT Chamber #3  
 Test Engineer: Rafael Varelas

**Preliminary Spurious Emissions excluding allocated band (Peak versus average limit)**

Frequency	Level	Pol	15.209 / 15.247		Detector	Azimuth	Height	Comments
MHz	dB $\mu$ V/m	v/h	Limit	Margin	Pk/QP/Avg	degrees	meters	
1598.660	48.1	V	54.0	-5.9	Peak	206	1.3	
3000.070	50.4	H	70.0	-19.6	Peak	191	1.3	
4874.000	41.8	V	54.0	-12.2	Peak	101	1.0	

**Final measurements at 3m**

Frequency	Level	Pol	15.209 / 15.247		Detector	Azimuth	Height	Comments
MHz	dB $\mu$ V/m	v/h	Limit	Margin	Pk/QP/Avg	degrees	meters	
1597.720	40.4	V	54.0	-13.6	AVG	204	1.0	RB 1 MHz;VB 10 Hz;Pk
1598.640	53.1	V	74.0	-20.9	PK	204	1.0	RB 1 MHz;VB 3 MHz;Pk
4873.990	40.7	V	54.0	-13.3	AVG	102	1.0	RB 1 MHz;VB 10 Hz;Pk
4873.890	47.4	V	74.0	-26.6	PK	102	1.0	RB 1 MHz;VB 3 MHz;Pk

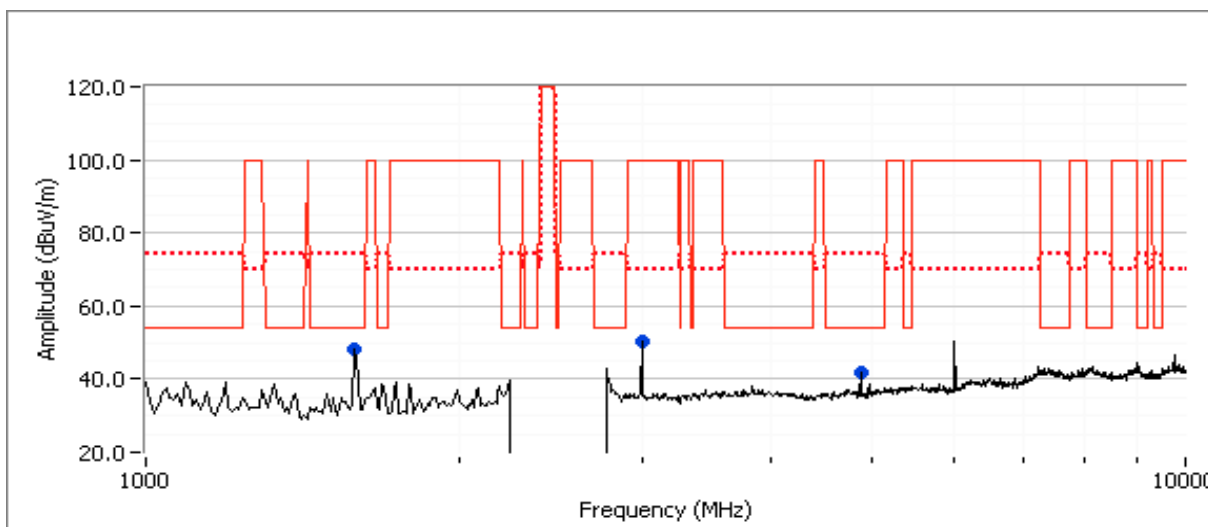

Client:	Intel Corporation	Job Number:	J84364
Model:	Intel® Centrino® Wireless-N 2230	T-Log Number:	T84599
Contact:	Steve Hackett	Account Manager:	Christine Krebill
Standard:	FCC 15.247	Class:	B

### Preliminary Spurious Emissions at 20cm from 2-3 GHz (Peak versus average limit)

Frequency MHz	Level dB $\mu$ V/m	Pol v/h	15.209 / 15.247		Detector PK/QP/Avg	Azimuth degrees	Height meters	Comments
			Limit	Margin				
2321.670	43.8	V	54.0	-10.2	Peak	181	1.0	
2521.670	48.2	V	70.0	-21.8	Peak	181	1.0	

### Final measurements at 3m

Frequency MHz	Level dB $\mu$ V/m	Pol v/h	15.209 / 15.247		Detector PK/QP/Avg	Azimuth degrees	Height meters	Comments
			Limit	Margin				
2319.950	48.5	H	54.0	-5.5	AVG	337	1.1	RB 1 MHz;VB 10 Hz;Pk
2317.150	58.1	H	74.0	-15.9	PK	337	1.1	RB 1 MHz;VB 3 MHz;Pk
2320.090	48.0	V	54.0	-6.0	AVG	100	1.0	RB 1 MHz;VB 10 Hz;Pk
2319.140	58.9	V	74.0	-15.1	PK	100	1.0	RB 1 MHz;VB 3 MHz;Pk

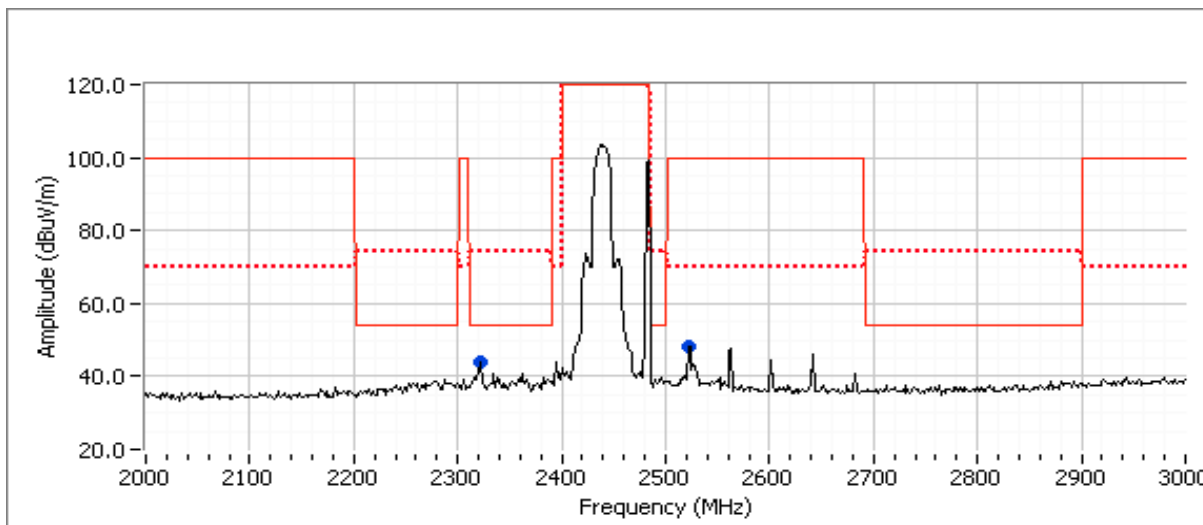

Client:	Intel Corporation	Job Number:	J84364
Model:	Intel® Centrino® Wireless-N 2230	T-Log Number:	T84599
Contact:	Steve Hackett	Account Manager:	Christine Krebill
Standard:	FCC 15.247	Class:	B

Run #9: Radiated Spurious Emissions, 1-10GHz. Operating Mode: 802.11b @ 2462, EDR @ 2480 MHz  
 Date of Test: 10/4/2011 Test Location: FT Chamber #3  
 Test Engineer: Rafael Varelas

**Preliminary Spurious Emissions excluding allocated band (Peak versus average limit)**

Frequency	Level	Pol	15.209 / 15.247		Detector	Azimuth	Height	Comments
MHz	dB $\mu$ V/m	v/h	Limit	Margin	Pk/QP/Avg	degrees	meters	
1599.950	47.7	V	54.0	-6.3	Peak	203	1.3	
3000.250	49.4	H	70.0	-20.6	Peak	190	1.3	
4923.970	41.6	V	54.0	-12.4	Peak	136	1.6	

**Final measurements at 3m**

Frequency	Level	Pol	15.209 / 15.247		Detector	Azimuth	Height	Comments
MHz	dB $\mu$ V/m	v/h	Limit	Margin	Pk/QP/Avg	degrees	meters	
1599.560	39.3	V	54.0	-14.7	AVG	201	1.0	RB 1 MHz;VB 10 Hz;Pk
1599.610	52.9	V	74.0	-21.1	PK	201	1.0	RB 1 MHz;VB 3 MHz;Pk

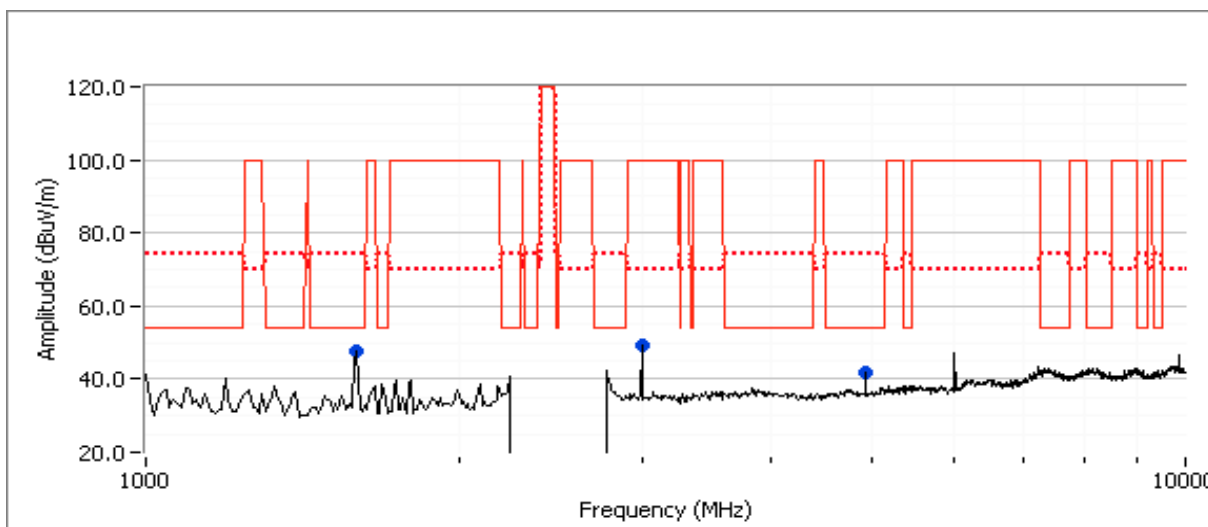

Client:	Intel Corporation	Job Number:	J84364
Model:	Intel® Centrino® Wireless-N 2230	T-Log Number:	T84599
Contact:	Steve Hackett	Account Manager:	Christine Krebill
Standard:	FCC 15.247	Class:	B

### Preliminary Spurious Emissions at 20cm from 2-3 GHz (Peak versus average limit)

Frequency MHz	Level dB $\mu$ V/m	Pol v/h	15.209 / 15.247		Detector Pk/QP/Avg	Azimuth degrees	Height meters	Comments
			Limit	Margin				
2321.670	40.6	V	54.0	-13.4	Peak	180	1.0	
2523.330	45.8	V	70.0	-24.2	Peak	180	1.0	
2563.330	45.3	V	70.0	-24.7	Peak	180	1.0	

### Final measurements at 3m

Frequency MHz	Level dB $\mu$ V/m	Pol v/h	15.209 / 15.247		Detector Pk/QP/Avg	Azimuth degrees	Height meters	Comments
			Limit	Margin				
2320.020	46.8	H	54.0	-7.2	AVG	250	1.0	RB 1 MHz;VB 10 Hz;Pk
2323.840	57.7	H	74.0	-16.3	PK	250	1.0	RB 1 MHz;VB 3 MHz;Pk
2319.800	46.8	V	54.0	-7.2	AVG	154	1.4	RB 1 MHz;VB 10 Hz;Pk
2317.590	57.5	V	74.0	-16.5	PK	154	1.4	RB 1 MHz;VB 3 MHz;Pk

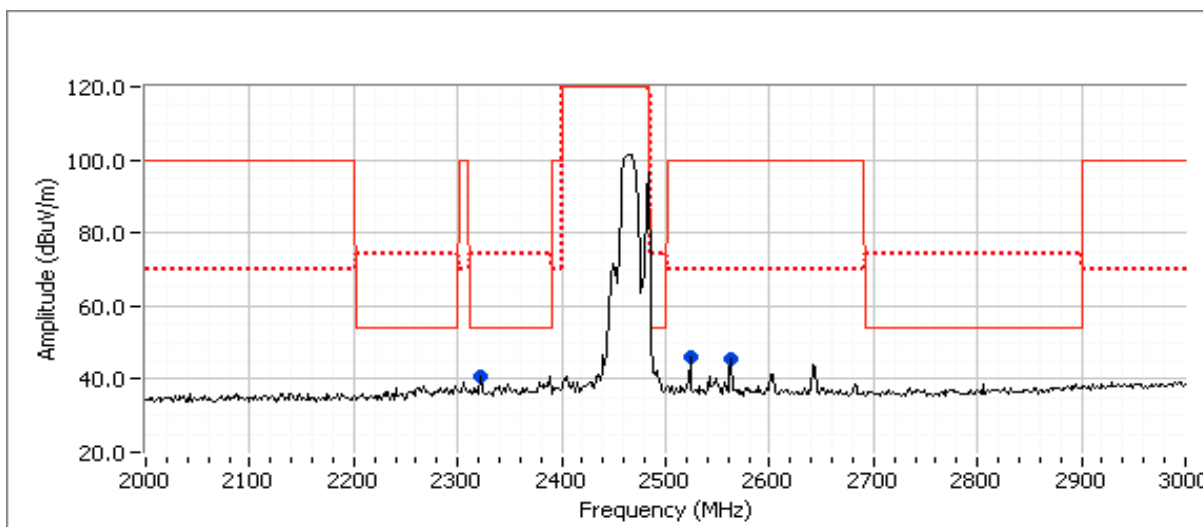

Client:	Intel Corporation	Job Number:	J84364
Model:	Intel® Centrino® Wireless-N 2230	T-Log Number:	T84599
Contact:	Steve Hackett	Account Manager:	Christine Krebill
Standard:	FCC 15.247	Class:	B

## Radiated Emissions

*(Elliott Laboratories Fremont Facility, Semi-Anechoic Chamber)*

### Test Specific Details

Objective: The objective of this test session is to perform final qualification testing of the EUT with respect to the specification listed above.

Date of Test: 10/4/2011	Config. Used: 1
Test Engineer: Rafael Varelas	Config Change: None
Test Location: FT Chamber #3	Host Unit Voltage 120V/60Hz

### General Test Configuration

The EUT and any local support equipment were located on the turntable for radiated emissions testing.

The test distance and extrapolation factor (if applicable) are detailed under each run description.

Note, preliminary testing indicates that the emissions were maximized by orientation of the EUT and elevation of the measurement antenna. Maximized testing indicated that the emissions were maximized by orientation of the EUT, elevation of the measurement antenna, and manipulation of the EUT's interface cables.

### Ambient Conditions:

Temperature:	20.8 °C
Rel. Humidity:	36 %

### Summary of Results

MAC Address: 00150082509B DRTU Tool Version 1.5.3.0322 Driver version 15.0.0.61

Run #	Test Performed	Limit	Result	Margin
2	Radiated Emissions 30 - 1000 MHz	FCC 15.209 / RSS 210	Pass	37.3dBµV/m @ 120.01MHz (-6.2dB)

Note - preliminary measurements indicated that the radiated emissions from the combination of test fixture and EUT were not affected by the modules operating frequency or mode (transmit versus receive mode). The system was therefore evaluated with the device operating at max power (16.5dBm) on Chain A at 2437MHz, 802.11b mode and max power (setting 8) on the top channel in Bluetooth mode (1Mb/s data rate).

### Modifications Made During Testing

No modifications were made to the EUT during testing

### Deviations From The Standard

No deviations were made from the requirements of the standard.



Client:	Intel Corporation	Job Number:	J84364
Model:	Intel® Centrino® Wireless-N 2230	T-Log Number:	T84599
Contact:	Steve Hackett	Account Manager:	Christine Krebill
Standard:	FCC 15.247	Class:	B

Run #1: Preliminary Radiated Emissions, 30 - 1000 MHz  
 Configured to TX , 802.11b 16.5dBm on chain A (setting 23.5) on channel 6, Bluetooth, 1Mb/s (setting 8.0)

Frequency Range	Test Distance	Limit Distance	Extrapolation Factor
30 - 1000 MHz	3	3	0.0

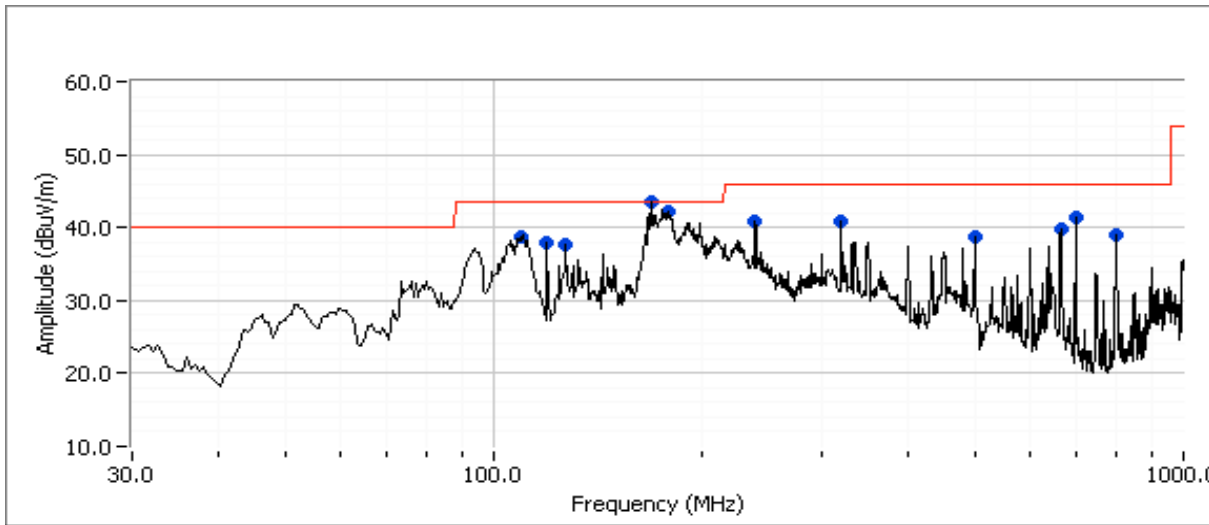

**Preliminary peak readings captured during pre-scan**

Frequency MHz	Level dBµV/m	Pol v/h	FCC Class B		Detector Pk/QP/Avg	Azimuth degrees	Height meters	Comments
			Limit	Margin				
109.992	38.8	V	43.5	-4.7	Peak	45	1.0	
120.005	38.0	V	43.5	-5.5	Peak	311	1.0	
127.340	37.7	H	43.5	-5.8	Peak	106	1.5	
170.221	43.4	H	43.5	-0.1	Peak	115	1.5	
179.812	42.1	H	43.5	-1.4	Peak	149	1.0	
240.002	40.9	H	46.0	-5.1	Peak	10	1.5	
320.051	40.9	H	46.0	-5.1	Peak	77	1.0	
498.377	38.8	V	46.0	-7.2	Peak	17	1.0	
664.945	39.7	V	46.0	-6.3	Peak	31	1.0	
697.272	41.4	H	46.0	-4.6	Peak	206	2.5	
798.470	39.1	H	46.0	-6.9	Peak	207	1.0	

Client:	Intel Corporation	Job Number:	J84364
Model:	Intel® Centrino® Wireless-N 2230	T-Log Number:	T84599
Contact:	Steve Hackett	Account Manager:	Christine Krebill
Standard:	FCC 15.247	Class:	B

**Preliminary quasi-peak readings (no manipulation of EUT interface cables)**

Frequency MHz	Level dB $\mu$ V/m	Pol v/h	FCC Class B		Detector Pk/QP/Avg	Azimuth degrees	Height meters	Comments
			Limit	Margin				
240.002	39.2	H	46.0	-6.8	QP	11	1.4	QP (1.00s)
109.992	34.4	V	43.5	-9.1	QP	45	1.0	QP (1.00s)
320.051	35.3	H	46.0	-10.7	QP	87	1.0	QP (1.00s)
127.340	27.6	H	43.5	-15.9	QP	120	1.8	QP (1.00s)
170.221	34.8	H	43.5	-8.7	QP	114	1.5	QP (1.00s)
179.812	37.2	H	43.5	-6.3	QP	149	1.2	QP (1.00s)
697.272	36.4	H	46.0	-9.6	QP	191	1.0	QP (1.00s)
120.005	37.3	V	43.5	-6.2	QP	309	1.0	QP (1.00s)

**Run #2: Maximized Readings From Run #1**

**Maximized quasi-peak readings (includes manipulation of EUT interface cables)**

Frequency Range	Test Distance	Limit Distance	Extrapolation Factor
30 - 1000 MHz	3	3	0.0

Frequency MHz	Level dB $\mu$ V/m	Pol v/h	FCC Class B		Detector Pk/QP/Avg	Azimuth degrees	Height meters	Comments
			Limit	Margin				
120.005	37.3	V	43.5	-6.2	QP	309	1.0	QP (1.00s)
179.812	37.2	H	43.5	-6.3	QP	149	1.2	QP (1.00s)
240.002	39.2	H	46.0	-6.8	QP	11	1.4	QP (1.00s)
170.221	34.8	H	43.5	-8.7	QP	114	1.5	QP (1.00s)
109.992	34.4	V	43.5	-9.1	QP	45	1.0	QP (1.00s)
697.272	36.4	H	46.0	-9.6	QP	191	1.0	QP (1.00s)

Client:	Intel Corporation	Job Number:	J84364
Model:	Intel® Centrino® Wireless-N 2230	T-Log Number:	T84599
		Account Manager:	Christine Krebill
Contact:	Steve Hackett		
Standard:	FCC 15.247	Class:	B

### Conducted Emissions

*(Elliott Laboratories Fremont Facility, Semi-Anechoic Chamber)*

#### Test Specific Details

Objective: The objective of this test session is to perform final qualification testing of the EUT with respect to the specification listed above.

Date of Test: 10/4/2011	Config. Used: 1
Test Engineer: Rafael Varelas	Config Change: None
Test Location: FT Chamber #3	Host Unit Voltage 120V/60Hz

#### General Test Configuration

The host laptop was located on a wooden table inside the semi-anechoic chamber, 40 cm from a vertical coupling plane and 80cm from the LISN. A second LISN was used for all local support equipment. Remote support equipment was located outside of the semi-anechoic chamber. Any cables running to remote support equipment were routed through metal conduit and when possible passed through a ferrite clamp upon exiting the chamber.

<b>Ambient Conditions:</b>	Temperature:	20.8 °C
	Rel. Humidity:	36 %

#### Summary of Results

MAC Address: 00150082509B DRTU Tool Version 1.5.3.0322 Driver version 15.0.0.61

Run #	Test Performed	Limit	Result	Margin
1	CE, AC Power, 120V/60Hz	RSS 210 / 15.207	Pass	32.1dBµV @ 15.520MHz (-17.9dB)

#### Modifications Made During Testing

No modifications were made to the EUT during testing

#### Deviations From The Standard

No deviations were made from the requirements of the standard.

Client:	Intel Corporation	Job Number:	J84364
Model:	Intel® Centrino® Wireless-N 2230	T-Log Number:	T84599
Contact:	Steve Hackett	Account Manager:	Christine Krebill
Standard:	FCC 15.247	Class:	B

Run #1: AC Power Port Conducted Emissions, 0.15 - 30MHz, 120V/60Hz

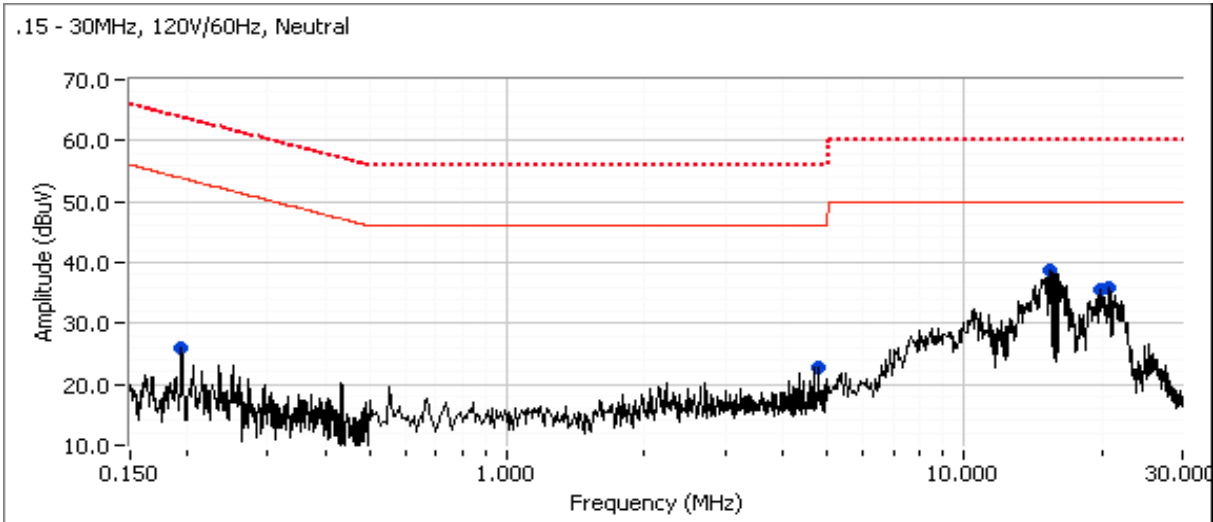
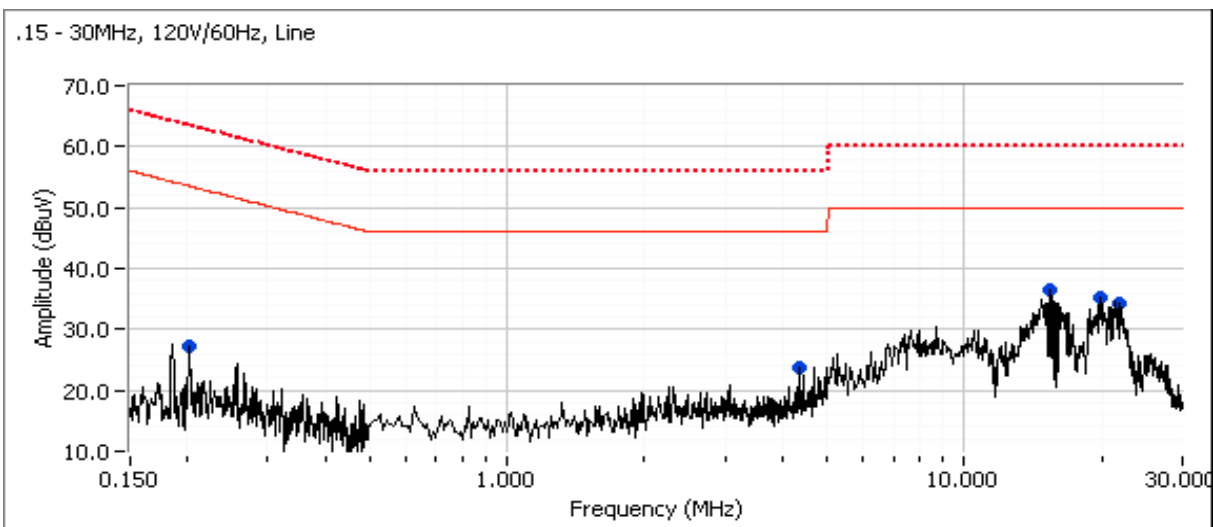

Client:	Intel Corporation	Job Number:	J84364
Model:	Intel® Centrino® Wireless-N 2230	T-Log Number:	T84599
Contact:	Steve Hackett	Account Manager:	Christine Krebill
Standard:	FCC 15.247	Class:	B

**Preliminary peak readings captured during pre-scan (peak readings vs. average limit)**

Frequency MHz	Level dB $\mu$ V	AC Line	RSS 210 / 15.207		Detector QP/Ave	Comments
			Limit	Margin		
0.204	27.3	Line 1	53.5	-26.2	Peak	
4.369	23.6	Line 1	46.0	-22.4	Peak	
15.514	36.4	Line 1	50.0	-13.6	Peak	
19.804	35.1	Line 1	50.0	-14.9	Peak	
21.840	34.3	Line 1	50.0	-15.7	Peak	
0.194	26.0	Neutral	53.9	-27.9	Peak	
4.789	22.9	Neutral	46.0	-23.1	Peak	
15.520	38.6	Neutral	50.0	-11.4	Peak	
19.806	35.4	Neutral	50.0	-14.6	Peak	
20.781	35.7	Neutral	50.0	-14.3	Peak	

**Final quasi-peak and average readings**

Frequency MHz	Level dB $\mu$ V	AC Line	RSS 210 / 15.207		Detector QP/Ave	Comments
			Limit	Margin		
15.520	32.1	Neutral	50.0	-17.9	AVG	AVG (0.10s)
15.514	31.5	Line 1	50.0	-18.5	AVG	AVG (0.10s)
19.806	28.4	Neutral	50.0	-21.6	AVG	AVG (0.10s)
15.520	37.9	Neutral	60.0	-22.1	QP	QP (1.00s)
19.804	26.8	Line 1	50.0	-23.2	AVG	AVG (0.10s)
20.781	26.6	Neutral	50.0	-23.4	AVG	AVG (0.10s)
19.806	34.8	Neutral	60.0	-25.2	QP	QP (1.00s)
15.514	34.7	Line 1	60.0	-25.3	QP	QP (1.00s)
21.840	23.4	Line 1	50.0	-26.6	AVG	AVG (0.10s)
20.781	32.8	Neutral	60.0	-27.2	QP	QP (1.00s)
19.804	32.7	Line 1	60.0	-27.3	QP	QP (1.00s)
21.840	29.2	Line 1	60.0	-30.8	QP	QP (1.00s)

*End of Report*

This page is intentionally blank and marks the last page of this test report.