

*EMC Test Report  
Application for Grant of Equipment Authorization  
Industry Canada RSS-Gen Issue 3 / RSS 210 Issue 8  
FCC Part 15 Subpart C*

*Intel® Centrino® Wireless-N 2200 models 2200BNHMW and  
2200BNHU*

IC CERTIFICATION #: 1000M-2200BNH & 1000M-2200BNHU  
FCC ID: PD92200BNH & PD92200BNHU

APPLICANT: Intel Corporation  
100 Center Point Circle Suite 200  
Columbia, SC 29210

TEST SITE(S): Elliott Laboratories  
41039 Boyce Road.  
Fremont, CA. 94538-2435

IC SITE REGISTRATION #: 2845B-4, 2845B-5

REPORT DATE: October 21, 2011

FINAL TEST DATES: September 29, 30 and October 2, 4, 5, 10 and  
12, 2011

TOTAL NUMBER OF PAGES: 124

PROGRAM MGR /  
TECHNICAL REVIEWER:

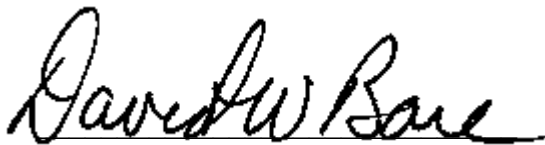

David W. Bare  
Chief Engineer

QUALITY ASSURANCE DELEGATE /  
FINAL REPORT PREPARER:

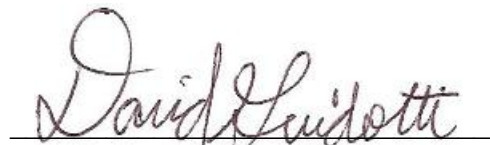

David Guidotti  
Senior Technical Writer



Testing Cert #2016.01

Elliott Laboratories is accredited by the A2LA, certificate number 2016.01, to perform the test(s) listed in this report, except where noted otherwise. This report and the information contained herein represent the results of testing test articles identified and selected by the client performed to specifications and/or procedures selected by the client. National Technical Systems (NTS) makes no representations, expressed or implied, that such testing is adequate (or inadequate) to demonstrate efficiency, performance, reliability, or any other characteristic of the articles being tested, or similar products. This report should not be relied upon as an endorsement or certification by NTS of the equipment tested, nor does it represent any statement whatsoever as to its merchantability or fitness of the test article, or similar products, for a particular purpose. This report shall not be reproduced except in full

**REVISION HISTORY**

Rev#	Date	Comments	Modified By
-	10-21-2011	First release	

**TABLE OF CONTENTS**

<b>REVISION HISTORY .....</b>	<b>2</b>
<b>TABLE OF CONTENTS .....</b>	<b>3</b>
<b>SCOPE.....</b>	<b>4</b>
<b>OBJECTIVE .....</b>	<b>4</b>
<b>STATEMENT OF COMPLIANCE.....</b>	<b>5</b>
<b>DEVIATIONS FROM THE STANDARDS.....</b>	<b>5</b>
<b>TEST RESULTS SUMMARY .....</b>	<b>6</b>
DIGITAL TRANSMISSION SYSTEMS (2400 – 2483.5MHZ).....	6
GENERAL REQUIREMENTS APPLICABLE TO ALL BANDS.....	7
MEASUREMENT UNCERTAINTIES.....	8
<b>EQUIPMENT UNDER TEST (EUT) DETAILS.....</b>	<b>9</b>
GENERAL.....	9
ANTENNA SYSTEM .....	9
ENCLOSURE.....	9
MODIFICATIONS.....	9
SUPPORT EQUIPMENT.....	10
EUT INTERFACE PORTS .....	10
EUT OPERATION .....	10
<b>TEST SITE.....</b>	<b>11</b>
GENERAL INFORMATION.....	11
CONDUCTED EMISSIONS CONSIDERATIONS .....	11
RADIATED EMISSIONS CONSIDERATIONS .....	11
<b>MEASUREMENT INSTRUMENTATION .....</b>	<b>12</b>
RECEIVER SYSTEM .....	12
INSTRUMENT CONTROL COMPUTER .....	12
LINE IMPEDANCE STABILIZATION NETWORK (LISN).....	12
FILTERS/ATTENUATORS .....	13
ANTENNAS.....	13
ANTENNA MAST AND EQUIPMENT TURNTABLE.....	13
INSTRUMENT CALIBRATION.....	13
<b>TEST PROCEDURES .....</b>	<b>14</b>
EUT AND CABLE PLACEMENT .....	14
CONDUCTED EMISSIONS.....	14
RADIATED EMISSIONS.....	14
RADIATED EMISSIONS.....	15
CONDUCTED EMISSIONS FROM ANTENNA PORT .....	17
BANDWIDTH MEASUREMENTS .....	17
SPECIFICATION LIMITS AND SAMPLE CALCULATIONS .....	18
CONDUCTED EMISSIONS SPECIFICATION LIMITS: FCC 15.207; FCC 15.107(A), RSS GEN .....	18
GENERAL TRANSMITTER RADIATED EMISSIONS SPECIFICATION LIMITS .....	19
RECEIVER RADIATED SPURIOUS EMISSIONS SPECIFICATION LIMITS.....	19
OUTPUT POWER LIMITS – DIGITAL TRANSMISSION SYSTEMS .....	20
TRANSMIT MODE SPURIOUS RADIATED EMISSIONS LIMITS – FHSS AND DTS SYSTEMS.....	20
SAMPLE CALCULATIONS - CONDUCTED EMISSIONS .....	20
SAMPLE CALCULATIONS - RADIATED EMISSIONS.....	21
SAMPLE CALCULATIONS - FIELD STRENGTH TO EIRP CONVERSION.....	22
<b>APPENDIX A TEST EQUIPMENT CALIBRATION DATA .....</b>	<b>23</b>
<b>APPENDIX B TEST DATA .....</b>	<b>24</b>
<b>END OF REPORT .....</b>	<b>124</b>

## SCOPE

An electromagnetic emissions test has been performed on the Intel Corporation model Intel® Centrino® Wireless-N 2200 models 2200BNHMW and 2200BNHU, pursuant to the following rules:

- Industry Canada RSS-Gen Issue 3
- RSS 210 Issue 8 “Low-power Licence-exempt Radiocommunication Devices (All Frequency Bands): Category I Equipment”
- FCC Part 15 Subpart C

Conducted and radiated emissions data has been collected, reduced, and analyzed within this report in accordance with measurement guidelines set forth in the following reference standards and as outlined in Elliott Laboratories test procedures:

- ANSI C63.4:2003
- FCC DTS Measurement Procedure KDB558074, March 2005

The intentional radiator above has been tested in a simulated typical installation to demonstrate compliance with the relevant Industry Canada performance and procedural standards.

Final system data was gathered in a mode that tended to maximize emissions by varying orientation of EUT, orientation of power and I/O cabling, antenna search height, and antenna polarization.

Every practical effort was made to perform an impartial test using appropriate test equipment of known calibration. All pertinent factors have been applied to reach the determination of compliance.

## OBJECTIVE

The primary objective of the manufacturer is compliance with the regulations outlined in the previous section.

Prior to marketing in the USA, all unlicensed transmitters and transceivers require certification. Receive-only devices operating between 30 MHz and 960 MHz are subject to either certification or a manufacturer’s declaration of conformity, with all other receive-only devices exempt from the technical requirements.

Prior to marketing in Canada, Class I transmitters, receivers and transceivers require certification. Class II devices are required to meet the appropriate technical requirements but are exempt from certification requirements.

Certification is a procedure where the manufacturer submits test data and technical information to a certification body and receives a certificate or grant of equipment authorization upon successful completion of the certification body’s review of the submitted documents. Once the equipment authorization has been obtained, the label indicating compliance must be attached to all identical units, which are subsequently manufactured.

Maintenance of compliance is the responsibility of the manufacturer. Any modification of the product which may result in increased emissions should be checked to ensure compliance has been maintained (i.e., printed circuit board layout changes, different line filter, different power supply, harnessing or I/O cable changes, etc.).

#### **STATEMENT OF COMPLIANCE**

The tested sample of Intel® Centrino® Wireless-N 2200 models 2200BNHMW and 2200BNHU complied with the requirements of the following regulations:

Industry Canada RSS-Gen Issue 3

RSS 210 Issue 8 "Low-power Licence-exempt Radiocommunication Devices (All Frequency Bands): Category I Equipment"

FCC Part 15 Subpart C

Maintenance of compliance is the responsibility of the manufacturer. Any modifications to the product should be assessed to determine their potential impact on the compliance status of the device with respect to the standards detailed in this test report.

The test results recorded herein are based on a single type test of Intel® Centrino® Wireless-N 2200 models 2200BNHMW and 2200BNHU and therefore apply only to the tested sample. The sample was selected and prepared by Steve Hackett of Intel Corporation.

#### **DEVIATIONS FROM THE STANDARDS**

No deviations were made from the published requirements listed in the scope of this report.

**TEST RESULTS SUMMARY****DIGITAL TRANSMISSION SYSTEMS (2400 – 2483.5MHz)**

FCC Rule Part	RSS Rule Part	Description	Measured Value / Comments	Limit / Requirement	Result
15.247(a)	RSS 210 A8.2	Digital Modulation	Systems uses OFDM / DSSS techniques	System must utilize a digital transmission technology	Complies
15.247 (a) (2)	RSS 210 A8.2 (1)	6dB Bandwidth	802.11b: 12.2 MHz 802.11g: 14.2 MHz HT20: 17.3 MHz HT40: 36.6 MHz	>500kHz	Complies
15.247 (b) (3)	RSS 210 A8.2 (4)	Output Power (multipoint systems)	802.11b: 0.049 W 802.11g: 0.100 W HT20: 0.050 W HT40: 0.038 W EIRP = 0.209 W <sup>Note 1</sup>	1 Watt, EIRP limited to 4 Watts.	Complies
15.247(d)	RSS 210 A8.2 (2)	Power Spectral Density	802.11b: -10.2 dBm 802.11g: -7.8 dBm HT20: -7.3 dBm HT40: -13.3dBm All / 3kHz	8dBm/3kHz	Complies
15.247(c)	RSS 210 A8.5	Antenna Port Spurious Emissions 30MHz – 25 GHz	All emissions below -20dBc & -30dBc limit	< -20dBc < -30dBc <sup>Note 2</sup>	Complies
15.247(c) / 15.209	RSS 210 A8.5	Radiated Spurious Emissions 30MHz – 25 GHz	53.7dB $\mu$ V/m @ 2484.6MHz (-0.3dB)	15.207 in restricted bands, all others < -20dBc < -30dBc <sup>Note 2</sup>	Complies
<p>Note 1: EIRP calculated using antenna gain of 3.2 dBi for the highest EIRP system.</p> <p>Note 2: Limit of -30dBc used for MIMO mode operation because the power was measured using the UNII test procedure (maximum power averaged over a transmission burst). For single chain modes, limit used was -20dBc or -30dBc depending on method used for power measurements (peak or power averaged).</p>					

**GENERAL REQUIREMENTS APPLICABLE TO ALL BANDS**

FCC Rule Part	RSS Rule part	Description	Measured Value / Comments	Limit / Requirement	Result (margin)
15.203	-	RF Connector	u.FL unique connector	Unique or integral antenna required	Complies
15.207	RSS GEN Table 2	AC Conducted Emissions	41.3dB $\mu$ V @ 16.177MHz (-18.7dB)	Refer to page 18	Complies
15.109	RSS GEN 7.2.3 Table 1	Receiver spurious emissions	37.9dB $\mu$ V/m @ 199.65MHz (-5.6dB)	Refer to page 19	Complies
15.247 (b) (5) 15.407 (f)	RSS 102	RF Exposure Requirements	Refer to SAR Report, RSS 102 declaration and User Manual statements.	Refer to OET 65, FCC Part 1 and RSS 102	Complies
-	RSP 100 RSS GEN 7.1.5	User Manual	Refer to page 11 of the user's manual	Statement required regarding non-interference	Complies
-	RSP 100 RSS GEN 7.1.5	User Manual	Not applicable, antenna is integral to host systems.	Statement for products with detachable antenna	Complies
-	RSP 100 RSS GEN 4.4.1	99% Bandwidth	802.11b: 15.5 MHz 802.11g: 18.6 MHz HT20: 18.9 MHz HT40: 37.3 MHz	Information only	N/A

**MEASUREMENT UNCERTAINTIES**

ISO/IEC 17025 requires that an estimate of the measurement uncertainties associated with the emissions test results be included in the report. The measurement uncertainties given below are based on a 95% confidence level and were calculated in accordance with UKAS document LAB 34.

Measurement Type	Measurement Unit	Frequency Range	Expanded Uncertainty
RF power, conducted (power meter)	dBm	25 to 7000 MHz	± 0.52 dB
RF power, conducted (Spectrum analyzer)	dBm	25 to 7000 MHz	± 0.7 dB
Conducted emission of transmitter	dBm	25 to 26500 MHz	± 0.7 dB
Conducted emission of receiver	dBm	25 to 26500 MHz	± 0.7 dB
Radiated emission (substitution method)	dBm	25 to 26500 MHz	± 2.5 dB
Radiated emission (field strength)	dB $\mu$ V/m	25 to 1000 MHz	± 3.6 dB
		1000 to 40000 MHz	± 6.0 dB
Conducted Emissions (AC Power)	dB $\mu$ V	0.15 to 30 MHz	± 2.4 dB



**EQUIPMENT UNDER TEST (EUT) DETAILS****GENERAL**

The Intel® Centrino® Wireless-N 2200 models 2200BNHMW and 2200BNHU are PCIe Half Mini Card form factor IEEE 802.11b/g/n wireless network adapters. The cards support MIMO (2x2) for 802.11n modes and MISO (1x2) for 802.11b/g modes.

The card is sold under two different FCC/IC ID numbers (see table below). The ID's ending in "U" are intended to allow user install conditions and host systems must be provided with a BIOS locking feature that prevents installation of unauthorized devices. For radio testing purposes the card was installed in a test fixture that exposed all sides of the card. For digital device testing for certification under equipment code JBP the card was installed inside a laptop PC.

The sample was received on September 27, 2011 and tested on September 29, 30 and October 2, 4, 5, 10 and 12, 2011. The EUT consisted of the following component(s):

Company	Model	Description	Serial Number	FCC ID
Intel Corporation	2200BNHMW	PCIe Half Mini Card form factor IEEE 802.11b/g/n wireless network adapter	001500825F2C (JBP)	PD92200BNH
	2200BNHU		001500825F4C (DTS)	PD92200BNHU 1000M-2200BNH 1000M-2200BNHU

**ANTENNA SYSTEM**

The EUT antenna is a two-antenna PIFA antenna system – Shanghai Universe Communication Electron Co., Ltd for both chains.

The antenna connects to the EUT via a non-standard u.FL antenna connector, thereby meeting the requirements of FCC 15.203.

**ENCLOSURE**

The EUT has no enclosure. It is designed to be installed within the enclosure of a host computer.

**MODIFICATIONS**

No modifications were made to the EUT during the time the product was at Elliott.

**SUPPORT EQUIPMENT**

The following equipment was used as local support equipment for testing:

Company	Model	Description	Serial Number	FCC ID
Intel Corporation	-	Test Fixture	D9164573K0B0	N/A
DELL	Latitude D520	Laptop PC	HM9383J	N/A
Agilent	E3610A	DC Supply	MY4001740	N/A

No remote support equipment was used for testing.

**EUT INTERFACE PORTS**

The I/O cabling configuration during emissions testing was as follows:

Port		Description	Cable(s)	
From	To		Shielded/Unshielded	Length(m)
Laptop USB	Fixture USB	USB cable	Shielded	1.5
Laptop Mini PCI	Fixture PCIe	Ribbon	unshielded	0.7
DC Power	Fixture DC power	2-wire	unshielded	0.7

**EUT OPERATION**

The EUT was installed into a test fixture that exposed all sides of the card. The test fixture interfaced to a laptop computer and dc power supply. The laptop computer was used to configure the EUT to continuously transmit at a specified output power or continuously receive on the channel specified in the test data. For transmit mode measurements the system was configured to operate in each of the available operating modes – 802.11b, 802.11g, 802.11n (20 MHz channel bandwidth) and 802.11n (40MHz channel bandwidth).

The data rates used for all tests were the lowest data rates for each 802.11 mode – 1Mb/s for 802.11b, 6Mb/s for 802.11a and 802.11g, 6.5MB/s for 802.11n (20MHz), and 13 Mb/s for 802.11n (40MHz). The device operates at its maximum output power at the lowest data rate (this was confirmed through separate measurements – refer to test data for actual measurements).

Receiver spurious emissions in 802.11 modes were evaluated in single chain and multi-chain modes.

The PC was using the Intel test utility DRTU version 1.5.3.0322 and driver version 15.0.0.61.

**TEST SITE****GENERAL INFORMATION**

Final test measurements were taken at the test sites listed below. Pursuant to section 2.948 of the FCC's Rules and section 3.3 of RSP-100, construction, calibration, and equipment data has been filed with the Commission and with industry Canada.

Site	Registration Numbers		Location
	FCC	Canada	
Chamber 4	211948	2845B-4	41039 Boyce Road Fremont, CA 94538-2435
Chamber 5	211948	2845B-5	

ANSI C63.4:2003 recommends that ambient noise at the test site be at least 6 dB below the allowable limits. Ambient levels are below this requirement. The test site(s) contain separate areas for radiated and conducted emissions testing. Considerable engineering effort has been expended to ensure that the facilities conform to all pertinent requirements of ANSI C63.4:2003.

**CONDUCTED EMISSIONS CONSIDERATIONS**

Conducted emissions testing is performed in conformance with ANSI C63.4:2003. Measurements are made with the EUT connected to the public power network through a nominal, standardized RF impedance, which is provided by a line impedance stabilization network, known as a LISN. A LISN is inserted in series with each current-carrying conductor in the EUT power cord.

**RADIATED EMISSIONS CONSIDERATIONS**

The FCC has determined that radiation measurements made in a shielded enclosure are not suitable for determining levels of radiated emissions. Radiated measurements are performed in an open field environment or in a semi-anechoic chamber. The test sites are maintained free of conductive objects within the CISPR defined elliptical area incorporated in ANSI C63.4:2003 guidelines and meet the Normalized Site Attenuation (NSA) requirements of ANSI C63.4:2003.

## **MEASUREMENT INSTRUMENTATION**

### **RECEIVER SYSTEM**

An EMI receiver as specified in CISPR 16-1-1 is used for emissions measurements. The receivers used can measure over the frequency range of 9 kHz up to 2000 MHz. These receivers allow both ease of measurement and high accuracy to be achieved. The receivers have Peak, Average, and CISPR (Quasi-peak) detectors built into their design so no external adapters are necessary. The receiver automatically sets the required bandwidth for the CISPR detector used during measurements. If the repetition frequency of the signal being measured is below 20Hz, peak measurements are made in lieu of Quasi-Peak measurements.

For measurements above the frequency range of the receivers, a spectrum analyzer is utilized because it provides visibility of the entire spectrum along with the precision and versatility required to support engineering analysis. Average measurements above 1000MHz are performed on the spectrum analyzer using the linear-average method with a resolution bandwidth of 1 MHz and a video bandwidth of 10 Hz, unless the signal is pulsed in which case the average (or video) bandwidth of the measuring instrument is reduced to onset of pulse desensitization and then increased.

### **INSTRUMENT CONTROL COMPUTER**

The receivers utilize either a Rohde & Schwarz EZM Spectrum Monitor/Controller or contain an internal Spectrum Monitor/Controller to view and convert the receiver measurements to the field strength at an antenna or voltage developed at the LISN measurement port, which is then compared directly with the appropriate specification limit. This provides faster, more accurate readings by performing the conversions described under Sample Calculations within the Test Procedures section of this report. Results are printed in a graphic and/or tabular format, as appropriate. A personal computer is used to record all measurements made with the receivers.

The Spectrum Monitor provides a visual display of the signal being measured. In addition, the controller or a personal computer run automated data collection programs which control the receivers. This provides added accuracy since all site correction factors, such as cable loss and antenna factors are added automatically.

### **LINE IMPEDANCE STABILIZATION NETWORK (LISN)**

Line conducted measurements utilize a fifty microhenry Line Impedance Stabilization Network as the monitoring point. The LISN used also contains a 250 uH CISPR adapter. This network provides for calibrated radio frequency noise measurements by the design of the internal low pass and high pass filters on the EUT and measurement ports, respectively.

### *FILTERS/ATTENUATORS*

External filters and precision attenuators are often connected between the receiving antenna or LISN and the receiver. This eliminates saturation effects and non-linear operation due to high amplitude transient events.

### *ANTENNAS*

A loop antenna is used below 30 MHz. For the measurement range 30 MHz to 1000 MHz either a combination of a biconical antenna and a log periodic or a bi-log antenna is used. Above 1000 MHz, horn antennas are used. The antenna calibration factors to convert the received voltage to an electric field strength are included with appropriate cable loss and amplifier gain factors to determine an overall site factor, which is then programmed into the test receivers or incorporated into the test software.

### *ANTENNA MAST AND EQUIPMENT TURNTABLE*

The antennas used to measure the radiated electric field strength are mounted on a non-conductive antenna mast equipped with a motor-drive to vary the antenna height. Measurements below 30 MHz are made with the loop antenna at a fixed height of 1m above the ground plane.

ANSI C63.4:2003 specifies that the test height above ground for table mounted devices shall be 80 centimeters. Floor mounted equipment shall be placed on the ground plane if the device is normally used on a conductive floor or separated from the ground plane by insulating material from 3 to 12 mm if the device is normally used on a non-conductive floor. During radiated measurements, the EUT is positioned on a motorized turntable in conformance with this requirement.

### *INSTRUMENT CALIBRATION*

All test equipment is regularly checked to ensure that performance is maintained in accordance with the manufacturer's specifications. All antennas are calibrated at regular intervals with respect to tuned half-wave dipoles. An exhibit of this report contains the list of test equipment used and calibration information.

## TEST PROCEDURES

### EUT AND CABLE PLACEMENT

The regulations require that interconnecting cables be connected to the available ports of the unit and that the placement of the unit and the attached cables simulate the worst case orientation that can be expected from a typical installation, so far as practicable. To this end, the position of the unit and associated cabling is varied within the guidelines of ANSI C63.4:2003, and the worst-case orientation is used for final measurements.

### CONDUCTED EMISSIONS

Conducted emissions are measured at the plug end of the power cord supplied with the EUT. Excess power cord length is wrapped in a bundle between 30 and 40 centimeters in length near the center of the cord. Preliminary measurements are made to determine the highest amplitude emission relative to the specification limit for all the modes of operation. Placement of system components and varying of cable positions are performed in each mode. A final peak mode scan is then performed in the position and mode for which the highest emission was noted on all current carrying conductors of the power cord.

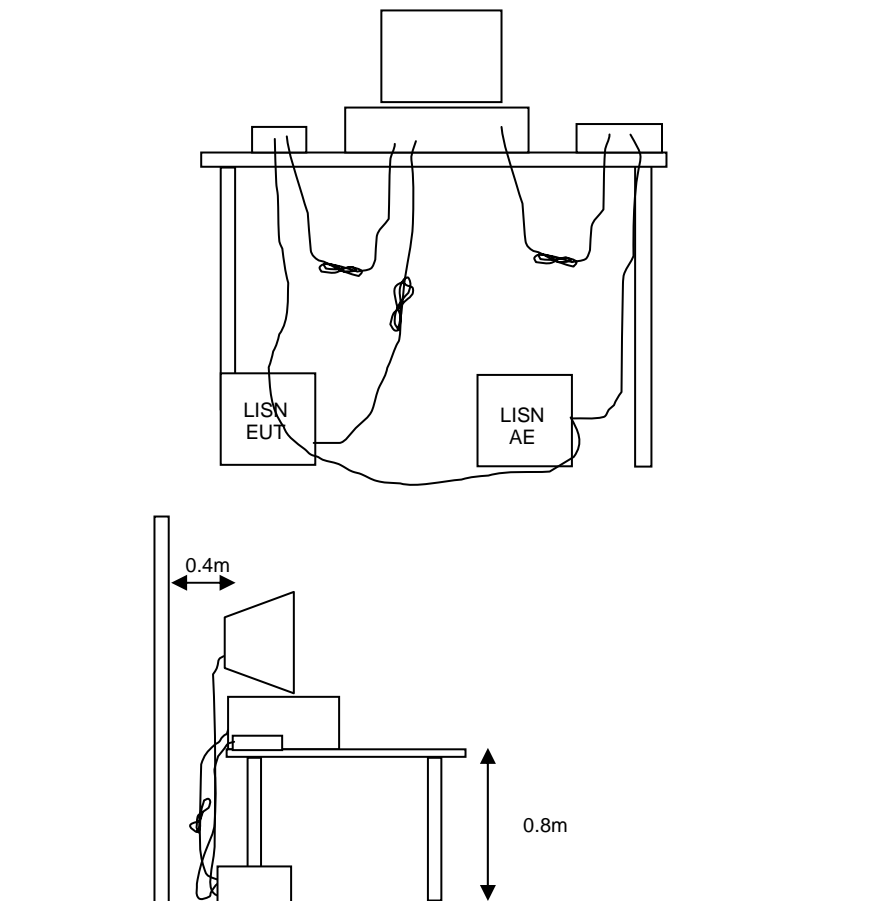

**Figure 1 Typical Conducted Emissions Test Configuration**

**RADIATED EMISSIONS**

A preliminary scan of the radiated emissions is performed in which all significant EUT frequencies are identified with the system in a nominal configuration. At least two scans are performed, one scan for each antenna polarization (horizontal and vertical; loop parallel and perpendicular to the EUT). During the preliminary scans, the EUT is rotated through 360°, the antenna height is varied (for measurements above 30 MHz) and cable positions are varied to determine the highest emission relative to the limit. Preliminary scans may be performed in a fully anechoic chamber for the purposes of identifying the frequencies of the highest emissions from the EUT.

A speaker is provided in the receiver to aid in discriminating between EUT and ambient emissions. Other methods used during the preliminary scan for EUT emissions involve scanning with near field magnetic loops, monitoring I/O cables with RF current clamps, and cycling power to the EUT.

Final maximization is a phase in which the highest amplitude emissions identified in the spectral search are viewed while the EUT azimuth angle is varied from 0 to 360 degrees relative to the receiving antenna. The azimuth, which results in the highest emission is then maintained while varying the antenna height from one to four meters (for measurements above 30 MHz, measurements below 30 MHz are made with the loop antenna at a fixed height of 1m). The result is the identification of the highest amplitude for each of the highest peaks. Each recorded level is corrected in the receiver using appropriate factors for cables, connectors, antennas, and preamplifier gain.

When testing above 18 GHz, the receive antenna is located at 1 meter from the EUT and the antenna height is restricted to a maximum of 2.5 meters.

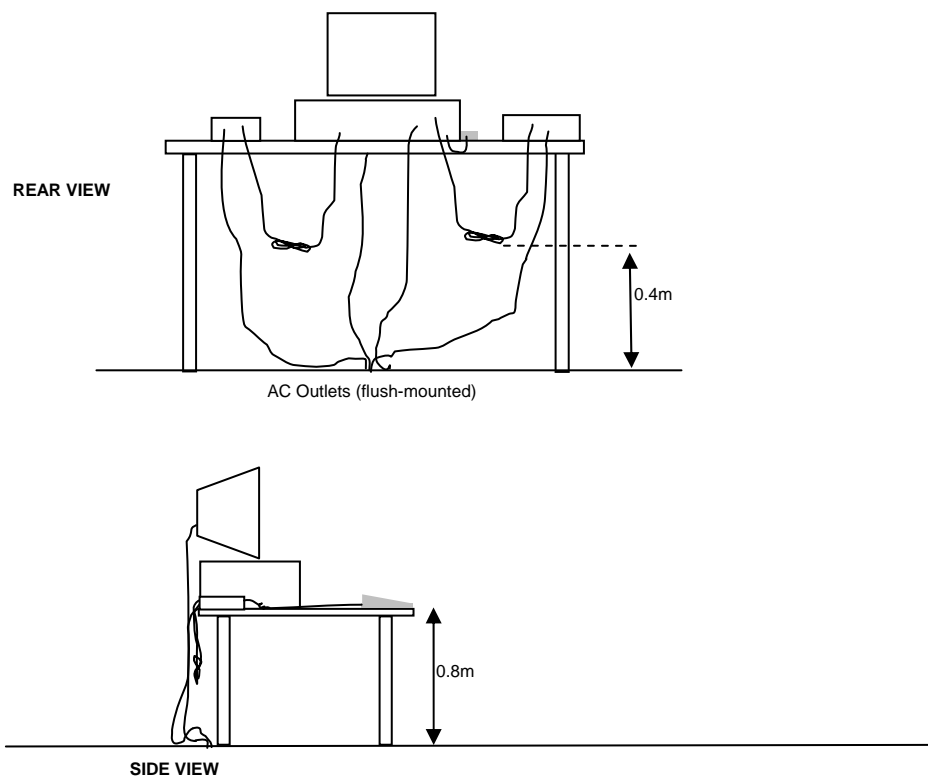

Typical Test Configuration for Radiated Field Strength Measurements

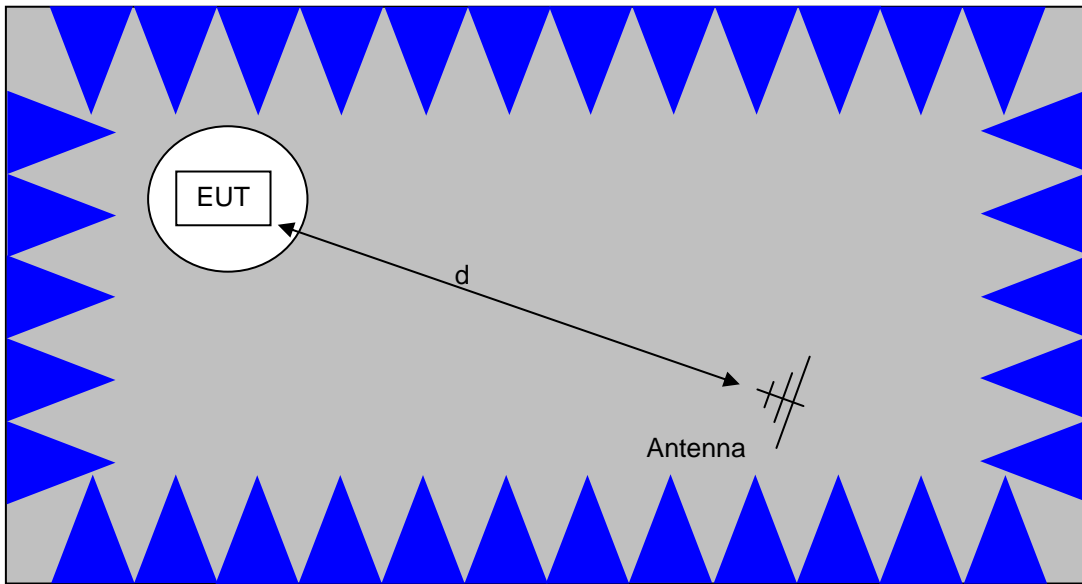

The anechoic materials on the walls and ceiling ensure compliance with the normalized site attenuation requirements of CISPR 16 / CISPR 22 / ANSI C63.4 for an alternate test site at the measurement distances used.

Floor-standing equipment is placed on the floor with insulating supports between the unit and the ground plane.

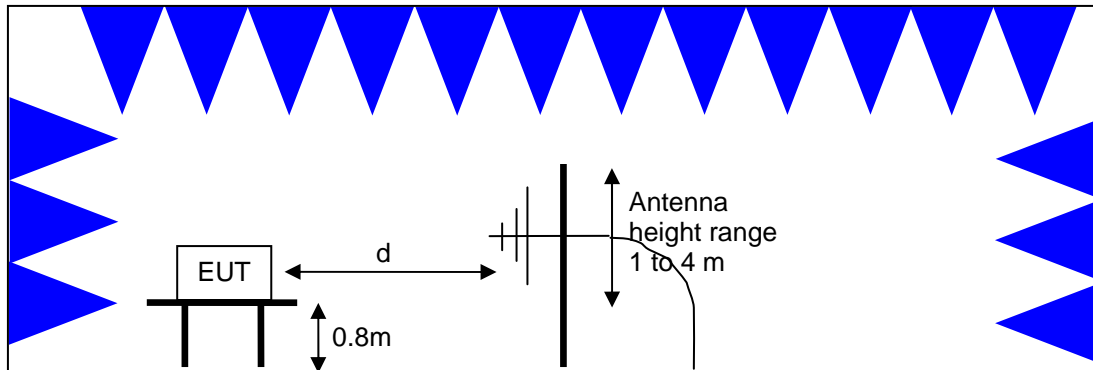

Test Configuration for Radiated Field Strength Measurements  
Semi-Anechoic Chamber, Plan and Side Views



**CONDUCTED EMISSIONS FROM ANTENNA PORT**

Direct measurements of power, bandwidth and power spectral density are performed, where possible, with the antenna port of the EUT connected to either the power meter or spectrum analyzer via a suitable attenuator and/or filter. These are used to ensure that the front end of the measurement instrument is not overloaded by the fundamental transmission.

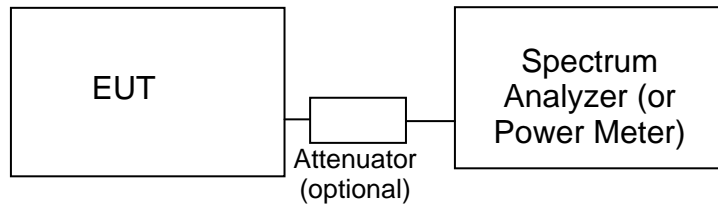
**Test Configuration for Antenna Port Measurements**

Measurement bandwidths (video and resolution) are set in accordance with the relevant standards and Elliott's test procedures for the type of radio being tested. When power measurements are made using a resolution bandwidth less than the signal bandwidth the power is calculated by summing the power across the signal bandwidth using either the analyzer channel power function or by capturing the trace data and calculating the power using software. In both cases the summed power is corrected to account for the equivalent noise bandwidth (ENBW) of the resolution bandwidth used.

If power averaging is used (typically for certain digital modulation techniques), the EUT is configured to transmit continuously. Power averaging is performed using either the built-in function of the analyzer or, if the analyzer does not feature power averaging, using external software. In both cases the average power is calculated over a number of sweeps (typically 100). When the EUT cannot be configured to continuously transmit then either the analyzer is configured to perform a gated sweep to ensure that the power is averaged over periods that the device is transmitting or power averaging is disabled and a max-hold feature is used.

If a power meter is used to make output power measurements the sensor head type (peak or average) is stated in the test data table.

**BANDWIDTH MEASUREMENTS**

The 6dB, 20dB and/or 26dB signal bandwidth is measured in using the bandwidths recommended by ANSI C63.4. When required, the 99% bandwidth is measured using the methods detailed in RSS GEN.

**SPECIFICATION LIMITS AND SAMPLE CALCULATIONS**

The limits for conducted emissions are given in units of microvolts, and the limits for radiated emissions are given in units of microvolts per meter at a specified test distance. Data is measured in the logarithmic form of decibels relative to one microvolt, or dB microvolts (dBuV). For radiated emissions, the measured data is converted to the field strength at the antenna in dB microvolts per meter (dBuV/m). The results are then converted to the linear forms of uV and uV/m for comparison to published specifications.

For reference, converting the specification limits from linear to decibel form is accomplished by taking the base ten logarithm, then multiplying by 20. These limits in both linear and logarithmic form are as follows:

**CONDUCTED EMISSIONS SPECIFICATION LIMITS: FCC 15.207; FCC 15.107(a), RSS GEN**

The table below shows the limits for the emissions on the AC power line from an intentional radiator and a receiver.

Frequency (MHz)	Average Limit (dBuV)	Quasi Peak Limit (dBuV)
0.150 to 0.500	Linear decrease on logarithmic frequency axis between 56.0 and 46.0	Linear decrease on logarithmic frequency axis between 66.0 and 56.0
0.500 to 5.000	46.0	56.0
5.000 to 30.000	50.0	60.0

**GENERAL TRANSMITTER RADIATED EMISSIONS SPECIFICATION LIMITS**

The table below shows the limits for the spurious emissions from transmitters that fall in restricted bands<sup>1</sup> (with the exception of transmitters operating under FCC Part 15 Subpart D and RSS 210 Annex 9), the limits for all emissions from a low power device operating under the general rules of RSS 310 (tables 3 and 4), RSS 210 (table 2) and FCC Part 15 Subpart C section 15.209.

Frequency Range (MHz)	Limit (uV/m)	Limit (dBuV/m @ 3m)
0.009-0.490	2400/F <sub>KHz</sub> @ 300m	67.6-20*log <sub>10</sub> (F <sub>KHz</sub> ) @ 300m
0.490-1.705	24000/F <sub>KHz</sub> @ 30m	87.6-20*log <sub>10</sub> (F <sub>KHz</sub> ) @ 30m
1.705 to 30	30 @ 30m	29.5 @ 30m
30 to 88	100 @ 3m	40 @ 3m
88 to 216	150 @ 3m	43.5 @ 3m
216 to 960	200 @ 3m	46.0 @ 3m
Above 960	500 @ 3m	54.0 @ 3m

**RECEIVER RADIATED SPURIOUS EMISSIONS SPECIFICATION LIMITS**

The table below shows the limits for the spurious emissions from receivers as detailed in FCC Part 15.109, RSS 210 Table 2, RSS GEN Table 1 and RSS 310 Table 3. Note that receivers operating outside of the frequency range 30 MHz – 960 MHz are exempt from the requirements of 15.109.

Frequency Range (MHz)	Limit (uV/m @ 3m)	Limit (dBuV/m @ 3m)
30 to 88	100	40
88 to 216	150	43.5
216 to 960	200	46.0
Above 960	500	54.0

<sup>1</sup> The restricted bands are detailed in FCC 15.203, RSS 210 Table 1 and RSS 310 Table 2

**OUTPUT POWER LIMITS – DIGITAL TRANSMISSION SYSTEMS**

The table below shows the limits for output power and output power density. Where the signal bandwidth is less than 20 MHz the maximum output power is reduced to the power spectral density limit plus 10 times the log of the bandwidth (in MHz).

Operating Frequency (MHz)	Output Power	Power Spectral Density
902 – 928	1 Watt (30 dBm)	8 dBm/3kHz
2400 – 2483.5	1 Watt (30 dBm)	8 dBm/3kHz
5725 – 5850	1 Watt (30 dBm)	8 dBm/3kHz

The maximum permitted output power is reduced by 1dB for every dB the antenna gain exceeds 6dBi. Fixed point-to-point applications using the 5725 – 5850 MHz band are not subject to this restriction.

**TRANSMIT MODE SPURIOUS RADIATED EMISSIONS LIMITS – FHSS and DTS SYSTEMS**

The limits for unwanted (spurious) emissions from the transmitter falling in the restricted bands are those specified in the general limits sections of FCC Part 15 and RSS 210. All other unwanted (spurious) emissions shall be at least 20dB below the level of the highest in-band signal level (30dB if the power is measured using the sample detector/power averaging method).

**SAMPLE CALCULATIONS - CONDUCTED EMISSIONS**

Receiver readings are compared directly to the conducted emissions specification limit (decibel form) as follows:

$$R_r - S = M$$

where:

$R_r$  = Receiver Reading in dBuV

$S$  = Specification Limit in dBuV

$M$  = Margin to Specification in +/- dB

**SAMPLE CALCULATIONS - RADIATED EMISSIONS**

Receiver readings are compared directly to the specification limit (decibel form). The receiver internally corrects for cable loss, preamplifier gain, and antenna factor. The calculations are in the reverse direction of the actual signal flow, thus cable loss is added and the amplifier gain is subtracted. The Antenna Factor converts the voltage at the antenna coaxial connector to the field strength at the antenna elements.

A distance factor, when used for electric field measurements above 30MHz, is calculated by using the following formula:

$$F_d = 20 * \text{LOG}_{10} (D_m/D_s)$$

where:

$$F_d = \text{Distance Factor in dB}$$

$$D_m = \text{Measurement Distance in meters}$$

$$D_s = \text{Specification Distance in meters}$$

For electric field measurements below 30MHz the extrapolation factor is either determined by making measurements at multiple distances or a theoretical value is calculated using the formula:

$$F_d = 40 * \text{LOG}_{10} (D_m/D_s)$$

Measurement Distance is the distance at which the measurements were taken and Specification Distance is the distance at which the specification limits are based. The antenna factor converts the voltage at the antenna coaxial connector to the field strength at the antenna elements.

The margin of a given emission peak relative to the limit is calculated as follows:

$$R_c = R_r + F_d$$

and

$$M = R_c - L_s$$

where:

$$R_r = \text{Receiver Reading in dBuV/m}$$

$$F_d = \text{Distance Factor in dB}$$

$$R_c = \text{Corrected Reading in dBuV/m}$$

$$L_s = \text{Specification Limit in dBuV/m}$$

$$M = \text{Margin in dB Relative to Spec}$$

**SAMPLE CALCULATIONS - FIELD STRENGTH TO EIRP CONVERSION**

Where the radiated electric field strength is expressed in terms of the equivalent isotropic radiated power (eirp), or where a field strength measurement of output power is made in lieu of a direct measurement, the following formula is used to convert between eirp and field strength at a distance of d (meters) from the equipment under test:

$$E = \frac{1000000 \sqrt{30 P}}{d} \quad \text{microvolts per meter}$$

where P is the eirp (Watts)

For a measurement at 3m the conversion from a logarithmic value for field strength (dBuV/m) to an eirp power (dBm) is -95.3dB.

**Appendix A Test Equipment Calibration Data****Radiated Emissions, 30 - 1,000 MHz, 29-Sep-11**

<u>Manufacturer</u>	<u>Description</u>	<u>Model</u>	<u>Asset #</u>	<u>Cal Due</u>
Sunol Sciences	Biconilog, 30-3000 MHz	JB3	1657	5/28/2012
Rohde & Schwarz	EMI Test Receiver, 20 Hz-7 GHz	ESIB7	1756	4/6/2012
Com-Power Corp.	Preamplifier, 30-1000 MHz	PA-103A	2359	2/15/2012

**Conducted Emissions - AC Power Ports, 29-Sep-11**

<u>Manufacturer</u>	<u>Description</u>	<u>Model</u>	<u>Asset #</u>	<u>Cal Due</u>
EMCO	LISN, 10 kHz-100 MHz, 25A	3825/2	1292	3/1/2012
Fischer Custom Comm.	LISN, 50uH, 25 Amps, Dual Line	FCC-LISN-50/250-25-2-01	1575	4/21/2012
Rohde & Schwarz	Pulse Limiter	ESH3 Z2	1594	5/17/2012
Rohde & Schwarz	EMI Test Receiver, 20 Hz-7 GHz	ESIB7	1756	4/6/2012

**Radiated Emissions, 1000 - 26,500 MHz, 30-Sep-11**

<u>Manufacturer</u>	<u>Description</u>	<u>Model</u>	<u>Asset #</u>	<u>Cal Due</u>
Hewlett Packard	Microwave Preamplifier, 1-26.5GHz	8449B	785	5/18/2012
EMCO	Antenna, Horn, 1-18GHz	3115	868	6/8/2012
Hewlett Packard	SpecAn 9 kHz - 40 GHz, FT (SA40) Blue	8564E (84125C)	1393	8/9/2012
Hewlett Packard	Head (Inc W1-W4, 1742 , 1743) Blue	84125C	1620	5/9/2012
A.H. Systems	Blue System Horn, 18-40GHz	SAS-574, p/n: 2581	2159	3/23/2012
Micro-Tronics	Band Reject Filter, 2400-2500 MHz	BRM50702-02	2249	10/11/2011

**Radiated Spurious Emissions, 1000 - 25,000 MHz, 05-Oct-11**

<u>Manufacturer</u>	<u>Description</u>	<u>Model</u>	<u>Asset #</u>	<u>Cal Due</u>
Hewlett Packard	Microwave Preamplifier, 1-26.5GHz	8449B	785	5/18/2012
EMCO	Antenna, Horn, 1-18GHz	3115	868	6/8/2012
Hewlett Packard	SpecAn 9 kHz - 40 GHz, FT (SA40) Blue	8564E (84125C)	1393	8/9/2012
Micro-Tronics	Band Reject Filter, 2400-2500 MHz	BRM50702-02	2238	10/4/2012

**Radiated Emissions, 1000 - 26,500 MHz, 05-Oct-11**

<u>Manufacturer</u>	<u>Description</u>	<u>Model</u>	<u>Asset #</u>	<u>Cal Due</u>
Hewlett Packard	Microwave Preamplifier, 1-26.5GHz	8449B	785	5/18/2012
EMCO	Antenna, Horn, 1-18GHz	3115	868	6/8/2012
Hewlett Packard	SpecAn 9 kHz - 40 GHz	8564E (84125C)	1393	8/9/2012
Hewlett Packard	Head (Inc W1-W4, 1742 , 1743)	84125C	1620	5/9/2012
A.H. Systems	Blue System Horn, 18-40GHz	SAS-574, p/n: 2581	2159	3/23/2012
Micro-Tronics	Band Reject Filter, 2400-2500 MHz	BRM50702-02	2238	10/4/2012

**Radiated Spurious Emissions, 1000 - 2500 MHz, 10-Oct-11**

<u>Manufacturer</u>	<u>Description</u>	<u>Model</u>	<u>Asset #</u>	<u>Cal Due</u>
Hewlett Packard	Microwave Preamplifier, 1-26.5GHz	8449B	263	12/8/2011
EMCO	Antenna, Horn, 1-18 GHz	3115	487	7/6/2012
Hewlett Packard	SpecAn 30 Hz -40 GHz	8564E (84125C)	1148	8/15/2012

## *Appendix B Test Data*

T84600 Pages 25 - 123



Client:	Intel Corporation	Job Number:	J84366
Model:	Intel® Centrino® Wireless-N 2200	T-Log Number:	T84600
		Account Manager:	Christine Krebill
Contact:	Steve Hackett		-
Emissions Standard(s):	FCC 15.247	Class:	B
Immunity Standard(s):	-	Environment:	-

## EMC Test Data

For The

### Intel Corporation

Model

Intel® Centrino® Wireless-N 2200

Date of Last Test: 10/19/2011

Client: Intel Corporation	Job Number: J84366
Model: Intel® Centrino® Wireless-N 2200	T-Log Number: T84600
	Account Manager: Christine Krebill
Contact: Steve Hackett	
Standard: FCC 15.247	Class: N/A

### RSS 210 and FCC 15.247 (DTS) Radiated Spurious Emissions

#### Test Specific Details

Objective: The objective of this test session is to perform final qualification testing of the EUT with respect to the specification listed above.

#### General Test Configuration

The EUT and all local support equipment were located on the turntable for radiated spurious emissions testing.

For radiated emissions testing the measurement antenna was located 3 meters from the EUT.

#### Ambient Conditions:

Temperature: 20 °C  
 Rel. Humidity: 37 %

#### Summary of Results - Device Operating in the 2400-2483.5 MHz Band

MAC Address: 001500825F4C DRTU Tool Version 1.5.3.0322 Driver version 15.0.0.61

Run #	Mode	Channel	Target Power	Measured Power	Test Performed	Limit	Result / Margin
Run # 1	802.11b Chain A	#1 2412MHz	15.2	15.0	Restricted Band Edge at 2390 MHz	15.209	41.4dBµV/m @ 2390.0MHz (-12.6dB)
		#11 2462MHz	15.7	15.9	Restricted Band Edge at 2483.5 MHz	15.209	47.3dBµV/m @ 2484.3MHz (-6.7dB)
Run # 2	802.11g Chain A	#1 2412MHz	14.2	14.4	Restricted Band Edge at 2390 MHz	15.209	48.3dBµV/m @ 2390.0MHz (-5.7dB)
		#11 2462MHz	14.2	14.1	Restricted Band Edge at 2483.5 MHz	15.209	50.9dBµV/m @ 2483.5MHz (-3.1dB)
Run # 3	802.11n20 Chain A	#1 2412MHz	13.2	13.0	Restricted Band Edge at 2390 MHz	15.209	49.1dBµV/m @ 2390.0MHz (-4.9dB)
		#2 2417MHz	15.7	15.9	Restricted Band Edge at 2390 MHz	15.209	46.6dBµV/m @ 2390.0MHz (-7.4dB)
		#10 2457MHz	16.7	16.8	Restricted Band Edge at 2483.5 MHz	15.209	47.9dBµV/m @ 2483.5MHz (-6.1dB)
		#11 2462MHz	13.2	13.3	Restricted Band Edge at 2483.5 MHz	15.209	52.4dBµV/m @ 2483.5MHz (-1.6dB)

Client: Intel Corporation	Job Number: J84366
Model: Intel® Centrino® Wireless-N 2200	T-Log Number: T84600
	Account Manager: Christine Krebill
Contact: Steve Hackett	
Standard: FCC 15.247	Class: N/A

Run #	Mode	Channel	Target Power	Measured Power	Test Performed	Limit	Result / Margin
Run # 4	802.11n40 Chain A	#3 2422MHz	10.2	10.2	Restricted Band Edge at 2390 MHz	15.209	48.9dBµV/m @ 2389.8MHz (-5.1dB)
		#4 2427MHz	11.2	11.2	Restricted Band Edge at 2390 MHz	15.209	48.7dBµV/m @ 2389.9MHz (-5.3dB)
		#8 2447MHz	11.7	11.7	Restricted Band Edge at 2483.5 MHz	15.209	50.0dBµV/m @ 2483.5MHz (-4.0dB)
		#9 2452MHz	10.7	10.8	Restricted Band Edge at 2483.5 MHz	15.209	49.3dBµV/m @ 2483.6MHz (-4.7dB)

If power is more than 3dB below center channel target to pass on lowest and/or highest channel, repeat measurements at target power for next lowest or highest channel

**Modifications Made During Testing**

No modifications were made to the EUT during testing

**Deviations From The Standard**

No deviations were made from the requirements of the standard.

Use the **Gain Control** mode of adjusting power. Set power to within ±0.2dB of target (dial in closer to the target value within ± 0.2dB if possible and not just a passing value above the target).

Note - the target and measured power are average powers (measured with average power sensor) and are used for reference purposes only. Power is set using " **GAIN CONTROL**" mode in the DRTU tool.

Client: Intel Corporation	Job Number: J84366
Model: Intel® Centrino® Wireless-N 2200	T-Log Number: T84600
	Account Manager: Christine Krebill
Contact: Steve Hackett	
Standard: FCC 15.247	Class: N/A

### Run # 1, Band Edge Field Strength - 802.11b, Chain A

Date of Test: 10/10/2011  
 Test Engineer: John Caizzi

Test Location: FT5  
 Config Change: none

### Run # 1a, EUT on Channel #1 2412MHz

	Target (dBm)	Power Settings	
		Measured (dBm)	Software Setting
Chain A	15.2	15.0	20.5

### 2390 MHz Band Edge Signal Field Strength

Frequency MHz	Level dBμV/m	Pol v/h	15.209 / 15.247		Detector Pk/QP/Avg	Azimuth degrees	Height meters	Comments
			Limit	Margin				
2389.730	41.0	V	54.0	-13.0	AVG	253	1.01	
2389.870	52.1	V	74.0	-21.9	PK	253	1.01	
2390.000	41.4	H	54.0	-12.6	AVG	221	1.06	
2386.470	52.5	H	74.0	-21.5	PK	221	1.06	

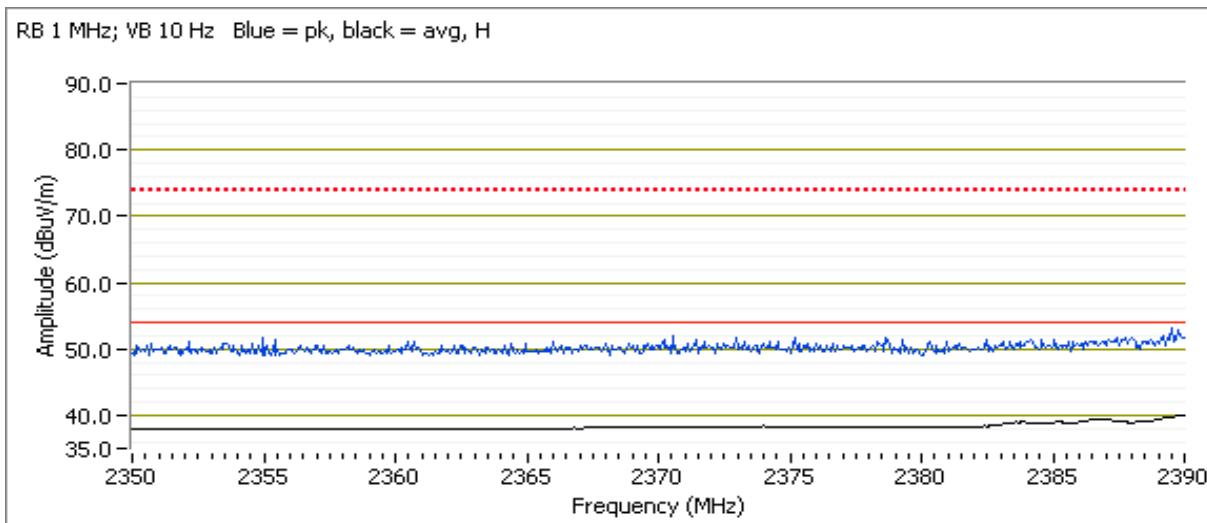

Client: Intel Corporation	Job Number: J84366
Model: Intel® Centrino® Wireless-N 2200	T-Log Number: T84600
	Account Manager: Christine Krebill
Contact: Steve Hackett	
Standard: FCC 15.247	Class: N/A

Run # 1b, EUT on Channel #11 2462MHz

	Target (dBm)	Power Settings Measured (dBm)	Software Setting
Chain A	15.7	15.9	22.0

2483.5 MHz Band Edge Signal Radiated Field Strength

Frequency MHz	Level dB $\mu$ V/m	Pol v/h	15.209 / 15.247		Detector Pk/QP/Avg	Azimuth degrees	Height meters	Comments
			Limit	Margin				
2484.320	44.0	V	54.0	-10.0	AVG	268	1.02	
2483.610	53.0	V	74.0	-21.0	PK	268	1.02	
2484.320	47.3	H	54.0	-6.7	AVG	0	1.00	
2483.770	55.1	H	74.0	-18.9	PK	0	1.00	

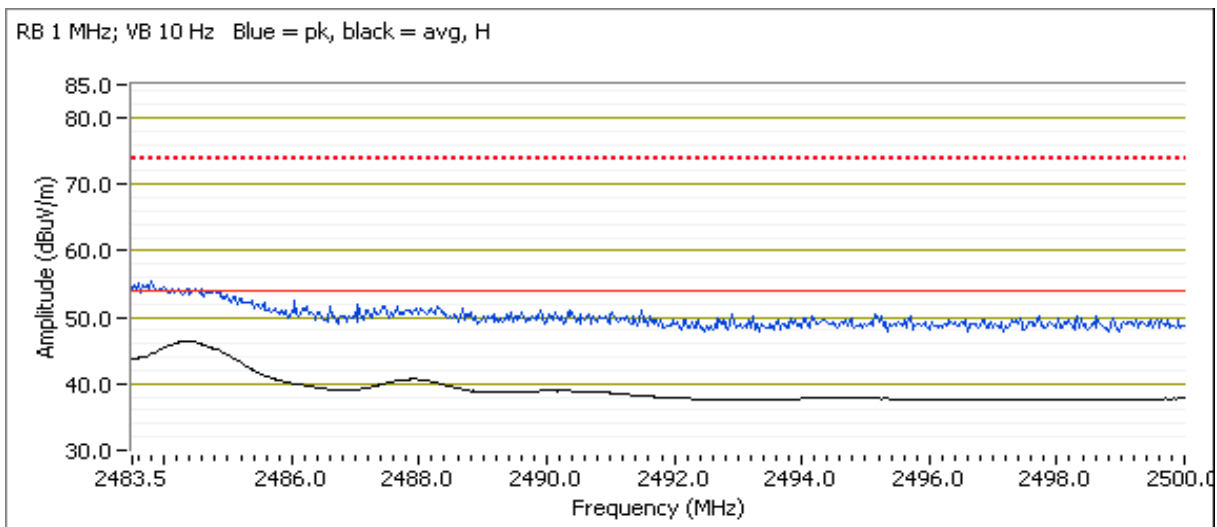

Client: Intel Corporation	Job Number: J84366
Model: Intel® Centrino® Wireless-N 2200	T-Log Number: T84600
	Account Manager: Christine Krebill
Contact: Steve Hackett	
Standard: FCC 15.247	Class: N/A

**Run # 2, Band Edge Field Strength - 802.11g, Chain A**

Date of Test: 10/10/2011  
Test Engineer: John Caizzi

Test Location: FT5  
Config Change: none

**Run # 2a, EUT on Channel #1 2412MHz**

	Target (dBm)	Power Settings Measured (dBm)	Software Setting
Chain A	14.2	14.4	25.5

**2390 MHz Band Edge Signal Field Strength**

Frequency	Level	Pol	15.209 / 15.247		Detector	Azimuth	Height	Comments
MHz	dBμV/m	v/h	Limit	Margin	Pk/OP/Avg	degrees	meters	
2389.930	47.6	V	54.0	-6.4	AVG	276	1.10	
2389.730	64.2	V	74.0	-9.8	PK	276	1.10	
2390.000	48.3	H	54.0	-5.7	AVG	43	1.04	
2389.870	64.5	H	74.0	-9.5	PK	43	1.04	

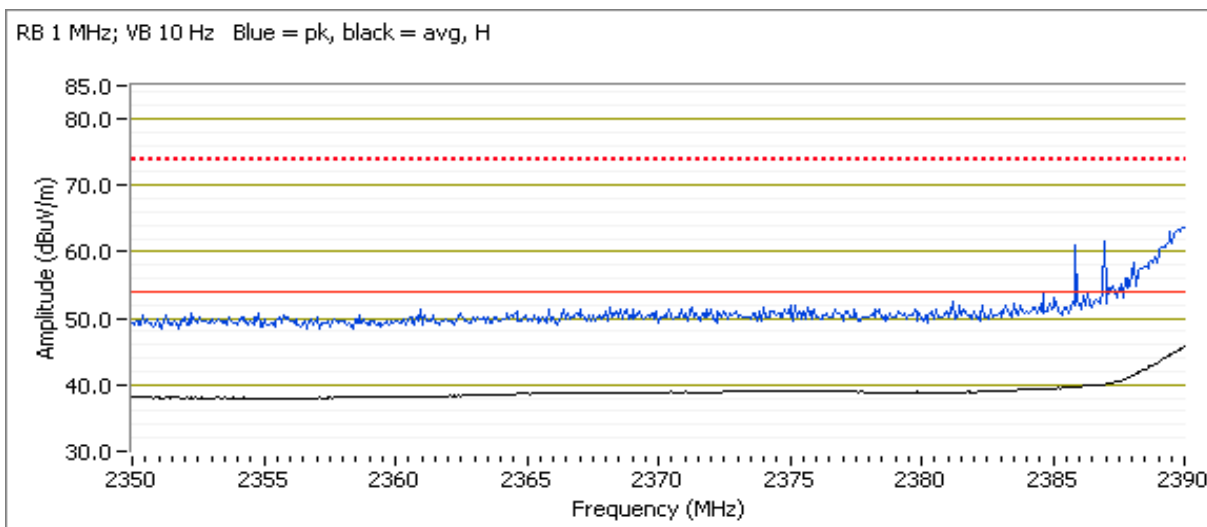

Client: Intel Corporation	Job Number: J84366
Model: Intel® Centrino® Wireless-N 2200	T-Log Number: T84600
	Account Manager: Christine Krebill
Contact: Steve Hackett	
Standard: FCC 15.247	Class: N/A

Run # 2b, EUT on Channel #11 2462MHz

	Target (dBm)	Power Settings Measured (dBm)	Software Setting
Chain A	14.2	14.1	25.5

**2483.5 MHz Band Edge Signal Radiated Field Strength**

Frequency	Level	Pol	15.209 / 15.247		Detector	Azimuth	Height	Comments
MHz	dB $\mu$ V/m	v/h	Limit	Margin	Pk/QP/Avg	degrees	meters	
2483.500	47.0	V	54.0	-7.0	AVG	266	1.07	
2483.770	62.7	V	74.0	-11.3	PK	266	1.07	
2483.500	50.9	H	54.0	-3.1	AVG	0	1.02	
2483.580	68.3	H	74.0	-5.7	PK	0	1.02	

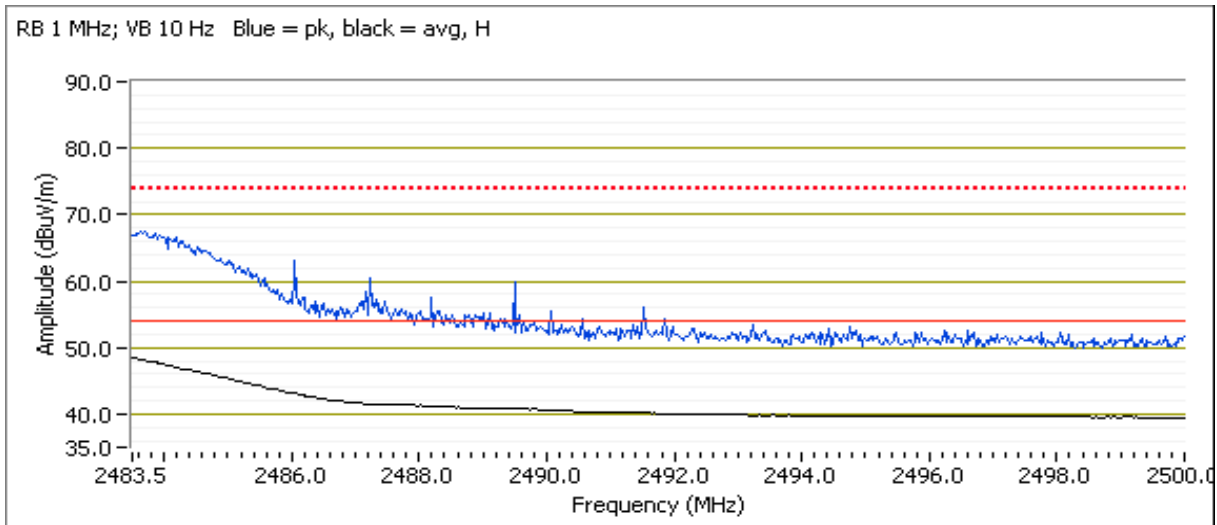

Client: Intel Corporation	Job Number: J84366
Model: Intel® Centrino® Wireless-N 2200	T-Log Number: T84600
	Account Manager: Christine Krebill
Contact: Steve Hackett	
Standard: FCC 15.247	Class: N/A

**Run # 3, Band Edge Field Strength - 802.11n20, Chain A**

Date of Test: 10/10/2011  
 Test Engineer: John Caizzi

Test Location: FT5  
 Config Change: none

**Run # 3a, EUT on Channel #1 2412MHz**

	Target (dBm)	Power Settings Measured (dBm)	Software Setting
Chain A	13.2	13.0	24.0

**2390 MHz Band Edge Signal Field Strength**

Frequency	Level	Pol	15.209 / 15.247		Detector	Azimuth	Height	Comments
MHz	dBμV/m	v/h	Limit	Margin	Pk/OP/Avg	degrees	meters	
2390.000	49.1	V	54.0	-4.9	AVG	279	1.12	
2389.600	67.9	V	74.0	-6.1	PK	279	1.12	
2389.930	49.0	H	54.0	-5.0	AVG	44	1.05	
2389.800	66.1	H	74.0	-7.9	PK	44	1.05	

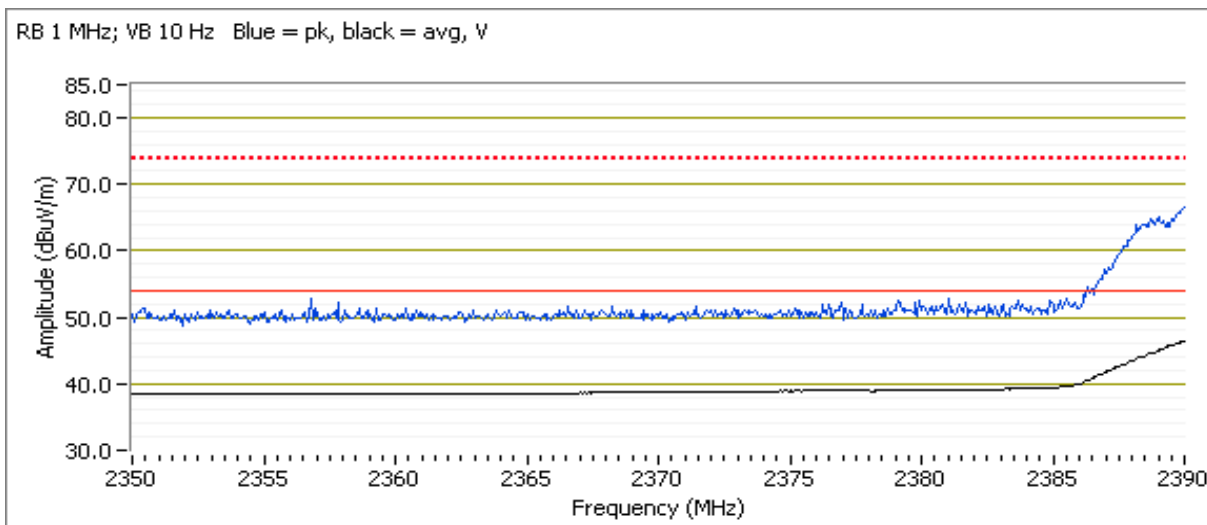



Client: Intel Corporation	Job Number: J84366
Model: Intel® Centrino® Wireless-N 2200	T-Log Number: T84600
	Account Manager: Christine Krebill
Contact: Steve Hackett	
Standard: FCC 15.247	Class: N/A

Run # 3b, EUT on Channel #2 2417MHz

	Target (dBm)	Power Settings Measured (dBm)	Software Setting
Chain A	15.7	15.9	26.5

2390 MHz Band Edge Signal Field Strength

Frequency	Level	Pol	15.209 / 15.247		Detector	Azimuth	Height	Comments
MHz	dB $\mu$ V/m	v/h	Limit	Margin	Pk/QP/Avg	degrees	meters	
2389.950	46.6	H	54.0	-7.4	AVG	247	1.0	RB 1 MHz;VB 10 Hz;Pk
2389.590	60.0	H	74.0	-14.0	PK	247	1.0	RB 1 MHz;VB 3 MHz;Pk
2389.820	46.3	V	54.0	-7.7	AVG	264	1.0	RB 1 MHz;VB 10 Hz;Pk
2389.920	59.3	V	74.0	-14.7	PK	264	1.0	RB 1 MHz;VB 3 MHz;Pk

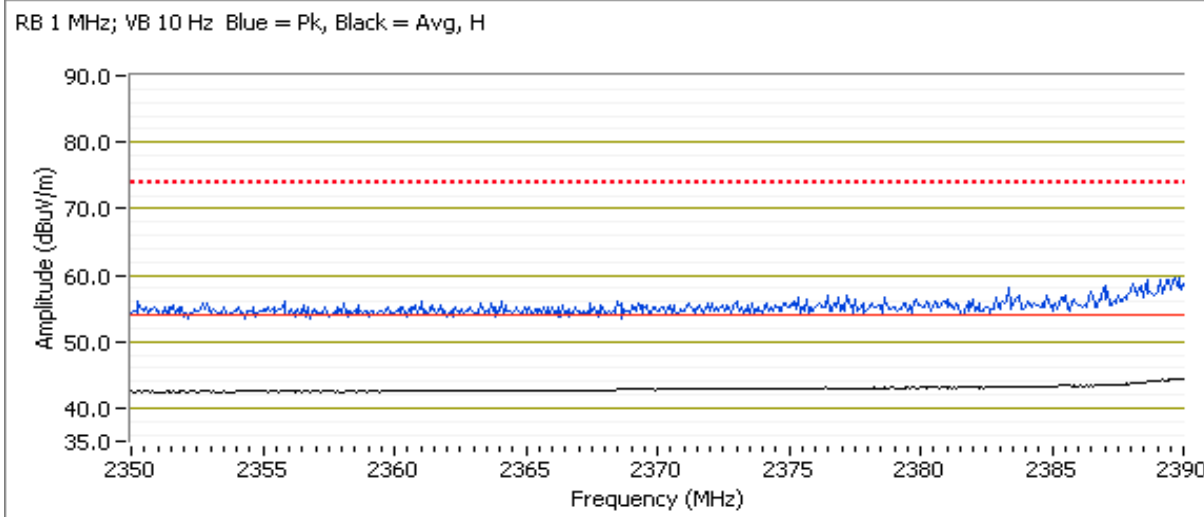

Client: Intel Corporation	Job Number: J84366
Model: Intel® Centrino® Wireless-N 2200	T-Log Number: T84600
	Account Manager: Christine Krebill
Contact: Steve Hackett	
Standard: FCC 15.247	Class: N/A

Run # 3c, EUT on Channel #10 2457MHz

	Target (dBm)	Power Settings Measured (dBm)	Software Setting
Chain A	16.7	16.8	28.0

**2483.5 MHz Band Edge Signal Radiated Field Strength**

Frequency	Level	Pol	15.209 / 15.247		Detector	Azimuth	Height	Comments
MHz	dB $\mu$ V/m	v/h	Limit	Margin	Pk/QP/Avg	degrees	meters	
2483.500	47.9	H	54.0	-6.1	AVG	47	1.0	RB 1 MHz;VB 10 Hz;Pk
2483.610	64.1	H	74.0	-9.9	PK	47	1.0	RB 1 MHz;VB 3 MHz;Pk
2483.530	38.6	V	54.0	-15.4	AVG	119	1.0	RB 1 MHz;VB 10 Hz;Pk
2484.350	50.6	V	74.0	-23.4	PK	119	1.0	RB 1 MHz;VB 3 MHz;Pk

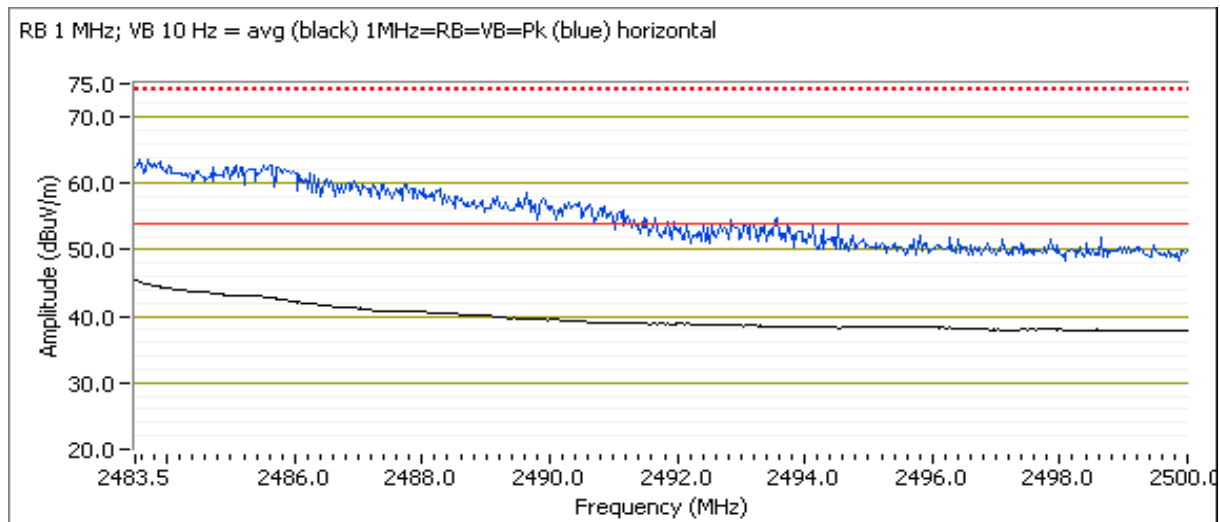

Client: Intel Corporation	Job Number: J84366
Model: Intel® Centrino® Wireless-N 2200	T-Log Number: T84600
	Account Manager: Christine Krebill
Contact: Steve Hackett	
Standard: FCC 15.247	Class: N/A

Run # 3d, EUT on Channel #11 2462MHz

	Target (dBm)	Power Settings Measured (dBm)	Software Setting
Chain A	13.2	13.3	24.5

### 2483.5 MHz Band Edge Signal Radiated Field Strength

Frequency	Level	Pol	15.209 / 15.247		Detector	Azimuth	Height	Comments
MHz	dB $\mu$ V/m	v/h	Limit	Margin	Pk/QP/Avg	degrees	meters	
2483.530	47.5	V	54.0	-6.5	AVG	273	1.06	
2483.550	63.1	V	74.0	-10.9	PK	273	1.06	
2483.500	52.4	H	54.0	-1.6	AVG	0	1.03	
2483.770	67.5	H	74.0	-6.5	PK	0	1.03	

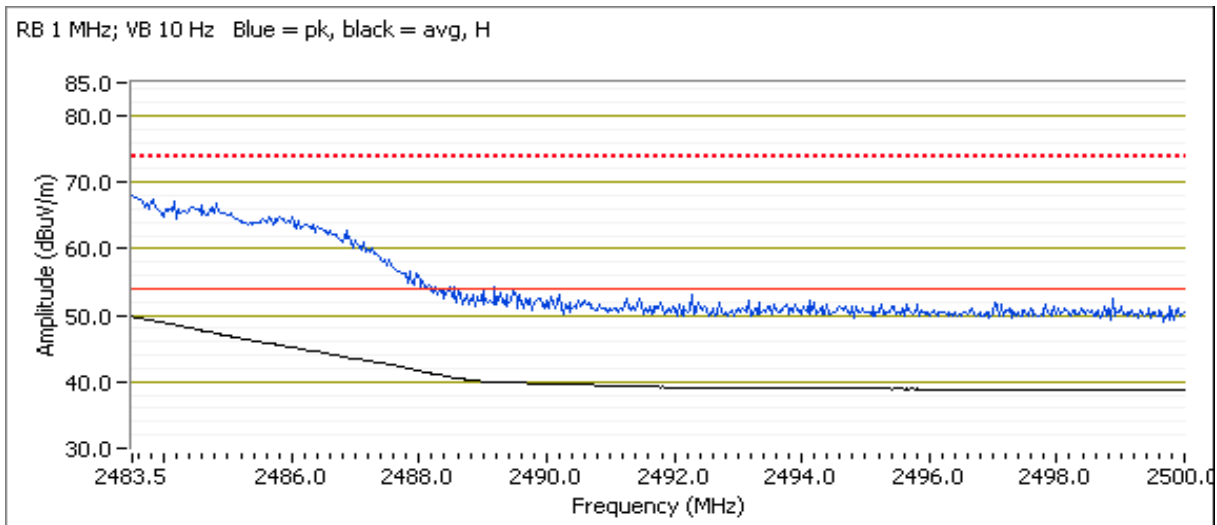

Client: Intel Corporation	Job Number: J84366
Model: Intel® Centrino® Wireless-N 2200	T-Log Number: T84600
	Account Manager: Christine Krebill
Contact: Steve Hackett	
Standard: FCC 15.247	Class: N/A

**Run # 4, Band Edge Field Strength - 802.11n40, Chain A**

Date of Test: 10/10/2011

Test Location: FT Chamber #4

Test Engineer: Rafael Varelas

Config Change: none

**Run # 4a, EUT on Channel #3 2422MHz - 802.11n40, Chain A**

	Target (dBm)	Power Settings Measured (dBm)	Software Setting
Chain A	10.2	10.2	20.0

**2390 MHz Band Edge Signal Field Strength**

Frequency	Level	Pol	15.209 / 15.247		Detector	Azimuth	Height	Comments
MHz	dB $\mu$ V/m	v/h	Limit	Margin	Pk/QP/Avg	degrees	meters	
2389.770	48.9	V	54.0	-5.1	AVG	263	1.0	RB 1 MHz;VB 10 Hz;Pk
2389.260	61.2	V	74.0	-12.8	PK	263	1.0	RB 1 MHz;VB 3 MHz;Pk
2389.990	48.4	H	54.0	-5.6	AVG	304	1.8	RB 1 MHz;VB 10 Hz;Pk
2388.510	61.5	H	74.0	-12.5	PK	304	1.8	RB 1 MHz;VB 3 MHz;Pk

RB 1 MHz; VB 10 Hz Blue = Pk, Black = Avg, V

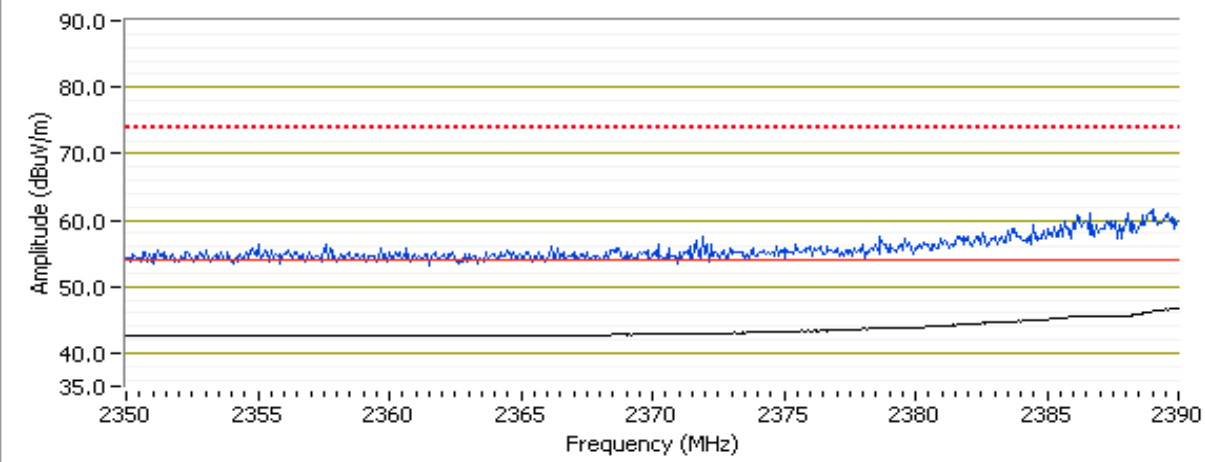

Client: Intel Corporation	Job Number: J84366
Model: Intel® Centrino® Wireless-N 2200	T-Log Number: T84600
	Account Manager: Christine Krebill
Contact: Steve Hackett	
Standard: FCC 15.247	Class: N/A

Run # 4b, EUT on Channel #4 2427MHz - 802.11n40, Chain A

	Target (dBm)	Power Settings Measured (dBm)	Software Setting
Chain A	11.2	11.2	21.0

**2390 MHz Band Edge Signal Field Strength**

Frequency MHz	Level dB $\mu$ V/m	Pol v/h	15.209 / 15.247		Detector Pk/QP/Avg	Azimuth degrees	Height meters	Comments
			Limit	Margin				
2389.850	48.7	H	54.0	-5.3	AVG	339	1.0	RB 1 MHz;VB 10 Hz;Pk
2387.200	61.0	H	74.0	-13.0	PK	339	1.0	RB 1 MHz;VB 3 MHz;Pk
2389.600	48.6	V	54.0	-5.4	AVG	263	1.0	RB 1 MHz;VB 10 Hz;Pk
2388.400	61.5	V	74.0	-12.5	PK	263	1.0	RB 1 MHz;VB 3 MHz;Pk

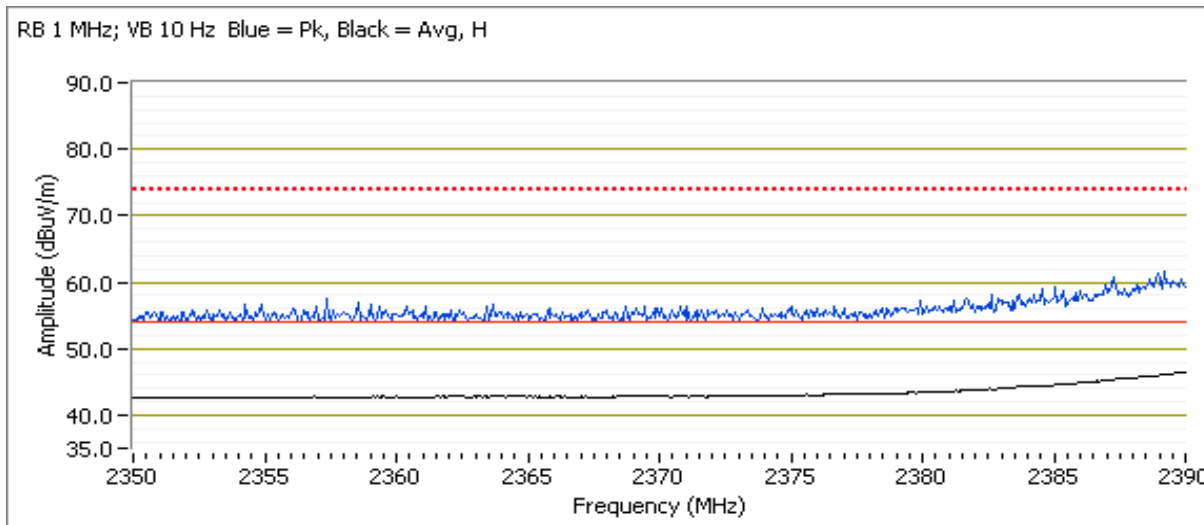

Client: Intel Corporation	Job Number: J84366
Model: Intel® Centrino® Wireless-N 2200	T-Log Number: T84600
	Account Manager: Christine Krebill
Contact: Steve Hackett	
Standard: FCC 15.247	Class: N/A

Run # 4c, EUT on Channel #8 2447MHz - 802.11n40, Chain A

	Target (dBm)	Power Settings Measured (dBm)	Software Setting
Chain A	11.7	11.7	21.5

**2483.5 MHz Band Edge Signal Radiated Field Strength**

Frequency	Level	Pol	15.209 / 15.247		Detector	Azimuth	Height	Comments
MHz	dB $\mu$ V/m	v/h	Limit	Margin	Pk/QP/Avg	degrees	meters	
2483.510	50.0	H	54.0	-4.0	AVG	310	0.9	RB 1 MHz;VB 10 Hz;Pk
2483.560	63.0	H	74.0	-11.0	PK	310	0.9	RB 1 MHz;VB 3 MHz;Pk
2483.570	47.6	V	54.0	-6.4	AVG	84	1.0	RB 1 MHz;VB 10 Hz;Pk
2484.320	60.1	V	74.0	-13.9	PK	84	1.0	RB 1 MHz;VB 3 MHz;Pk

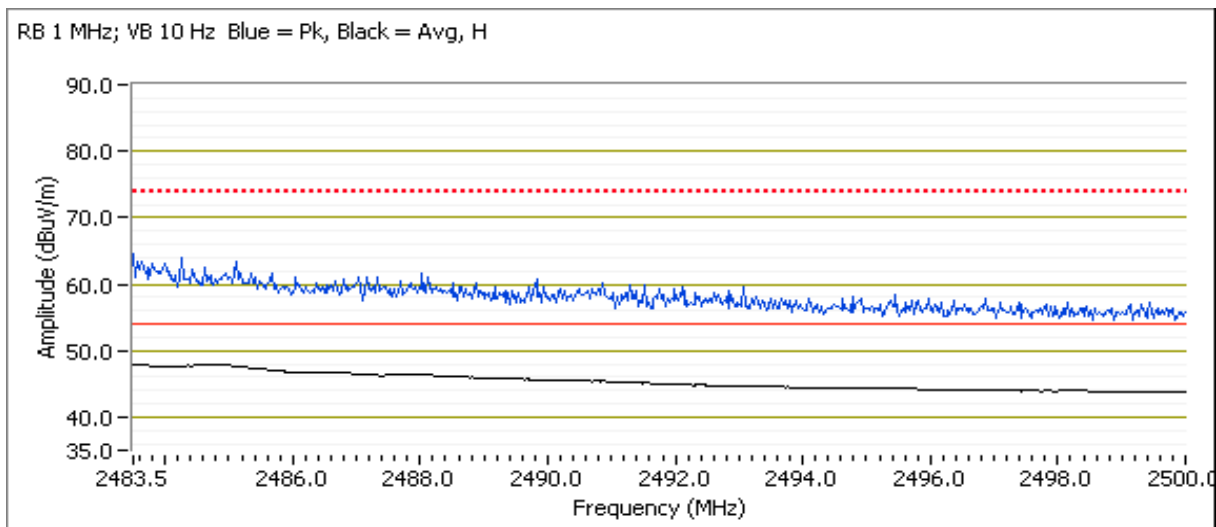

Client: Intel Corporation	Job Number: J84366
Model: Intel® Centrino® Wireless-N 2200	T-Log Number: T84600
	Account Manager: Christine Krebill
Contact: Steve Hackett	
Standard: FCC 15.247	Class: N/A

Run # 4d, EUT on Channel #9 2452MHz - 802.11n40, Chain A

	Target (dBm)	Power Settings Measured (dBm)	Software Setting
Chain A	10.7	10.8	20.5

**2483.5 MHz Band Edge Signal Radiated Field Strength**

Frequency	Level	Pol	15.209 / 15.247		Detector	Azimuth	Height	Comments
MHz	dB $\mu$ V/m	v/h	Limit	Margin	Pk/QP/Avg	degrees	meters	
2483.570	49.3	H	54.0	-4.7	AVG	245	0.9	RB 1 MHz;VB 10 Hz;Pk
2485.190	61.3	H	74.0	-12.7	PK	245	0.9	RB 1 MHz;VB 3 MHz;Pk
2483.530	48.4	V	54.0	-5.6	AVG	187	1.3	RB 1 MHz;VB 10 Hz;Pk
2483.720	61.3	V	74.0	-12.7	PK	187	1.3	RB 1 MHz;VB 3 MHz;Pk

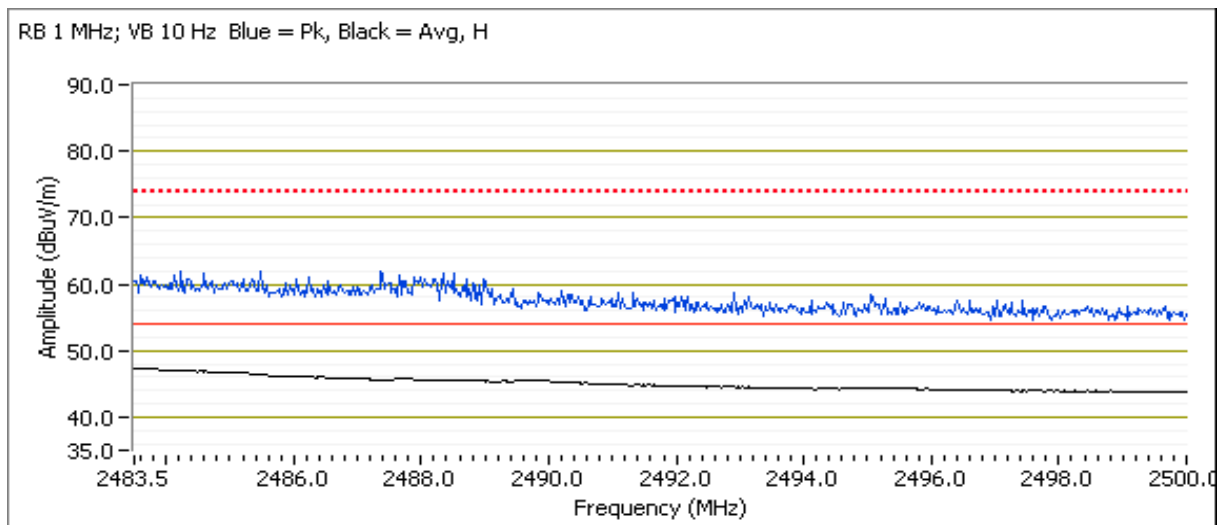

Client: Intel Corporation	Job Number: J84366
Model: Intel® Centrino® Wireless-N 2200	T-Log Number: T84600
	Account Manager: Christine Krebill
Contact: Steve Hackett	
Standard: FCC 15.247	Class: N/A

## RSS 210 and FCC 15.247 (DTS) Radiated Spurious Emissions

### Test Specific Details

Objective: The objective of this test session is to perform final qualification testing of the EUT with respect to the specification listed above.

### General Test Configuration

The EUT and all local support equipment were located on the turntable for radiated spurious emissions testing.

For radiated emissions testing the measurement antenna was located 3 meters from the EUT.

**Ambient Conditions:**

Temperature:	20 °C
Rel. Humidity:	37 %

### Summary of Results - Device Operating in the 2400-2483.5 MHz Band

MAC Address: 001500825F4C DRTU Tool Version **1.5.3.0322** Driver version **15.0.0.61**

Run #	Mode	Channel	Target Power	Measured Power	Test Performed	Limit	Result / Margin
Run # 1	802.11b Chain B	#1 2412MHz	14.7	14.7	Restricted Band Edge at 2390 MHz	15.209	45.3dB $\mu$ V/m @ 2389.4MHz (-8.7dB)
		#11 2462MHz	15.2	15.4	Restricted Band Edge at 2483.5 MHz	15.209	48.2dB $\mu$ V/m @ 2484.2MHz (-5.8dB)
Run # 2	802.11g Chain B	#1 2412MHz	13.7	13.9	Restricted Band Edge at 2390 MHz	15.209	48.9dB $\mu$ V/m @ 2390.0MHz (-5.1dB)
		#11 2462MHz	14.2	14.2	Restricted Band Edge at 2483.5 MHz	15.209	50.0dB $\mu$ V/m @ 2483.5MHz (-4.0dB)
Run # 3	802.11n20 Chain B	#1 2412MHz	12.7	12.9	Restricted Band Edge at 2390 MHz	15.209	50.6dB $\mu$ V/m @ 2390.0MHz (-3.4dB)
		#2 2417MHz	15.2	15.3	Restricted Band Edge at 2390 MHz	15.209	41.4dB $\mu$ V/m @ 2389.9MHz (-12.6dB)
		#10 2457MHz	16.7	16.8	Restricted Band Edge at 2483.5 MHz	15.209	50.6dB $\mu$ V/m @ 2483.5MHz (-3.4dB)
		#11 2462MHz	12.7	12.8	Restricted Band Edge at 2483.5 MHz	15.209	50.8dB $\mu$ V/m @ 2483.6MHz (-3.2dB)



Client: Intel Corporation	Job Number: J84366
Model: Intel® Centrino® Wireless-N 2200	T-Log Number: T84600
	Account Manager: Christine Krebill
Contact: Steve Hackett	
Standard: FCC 15.247	Class: N/A

Run #	Mode	Channel	Target Power	Measured Power	Test Performed	Limit	Result / Margin
Run # 4	802.11n40 Chain B	#3 2422MHz	9.7	9.9	Restricted Band Edge at 2390 MHz	15.209	49.4dB $\mu$ V/m @ 2390.0MHz (-4.6dB)
		#8 2447MHz	11.7	11.8	Restricted Band Edge at 2483.5 MHz	15.209	48.1dB $\mu$ V/m @ 2483.6MHz (-5.9dB)
		#9 2452MHz	10.2	10.4	Restricted Band Edge at 2483.5 MHz	15.209	50.6dB $\mu$ V/m @ 2483.6MHz (-3.4dB)

If power is more than 3dB below center channel target to pass on lowest and/or highest channel, repeat measurements at target power for next lowest or highest channel

### Modifications Made During Testing

No modifications were made to the EUT during testing

### Deviations From The Standard

No deviations were made from the requirements of the standard.

Use the **Gain Control** mode of adjusting power. Set power to within  $\pm 0.2$ dB of target (dial in closer to the target value within  $\pm 0.2$ dB if possible and not just a passing value above the target).

Note - the target and measured power are average powers (measured with average power sensor) and are used for reference purposes only. Power is set using " **GAIN CONTROL**" mode in the DRTU tool.

Client: Intel Corporation	Job Number: J84366
Model: Intel® Centrino® Wireless-N 2200	T-Log Number: T84600
	Account Manager: Christine Krebill
Contact: Steve Hackett	
Standard: FCC 15.247	Class: N/A

**Run # 1, Band Edge Field Strength - 802.11b, Chain B**

Date of Test: 10/2/2011

Test Location: FT Chamber #5

Test Engineer: Rafael Varelas

Config Change: none

**Run # 1a, EUT on Channel #1 2412MHz - 802.11b, Chain B**

	Target (dBm)	Power Settings Measured (dBm)	Software Setting
Chain B	14.7	14.7	19.5

**Fundamental Signal Field Strength**

Frequency MHz	Level dB $\mu$ V/m	Pol v/h	15.209 / 15.247		Detector Pk/QP/Avg	Azimuth degrees	Height meters	Comments
			Limit	Margin				
2410.330	100.4	H	-	-	AVG	346	1.0	RB 1 MHz;VB 10 Hz;Pk
2409.500	103.5	H	-	-	PK	346	1.0	RB 1 MHz;VB 3 MHz;Pk
2413.870	95.5	V	-	-	AVG	145	1.0	RB 1 MHz;VB 10 Hz;Pk
2414.770	98.7	V	-	-	PK	145	1.0	RB 1 MHz;VB 3 MHz;Pk

**2390 MHz Band Edge Signal Field Strength**

Frequency MHz	Level dB $\mu$ V/m	Pol v/h	15.209 / 15.247		Detector Pk/QP/Avg	Azimuth degrees	Height meters	Comments
			Limit	Margin				
2389.380	45.3	H	54.0	-8.7	AVG	348	1.0	RB 1 MHz;VB 10 Hz;Pk
2387.470	56.5	H	74.0	-17.5	PK	348	1.0	RB 1 MHz;VB 3 MHz;Pk
2389.440	44.7	V	54.0	-9.3	AVG	220	1.6	RB 1 MHz;VB 10 Hz;Pk
2387.110	56.5	V	74.0	-17.5	PK	220	1.6	RB 1 MHz;VB 3 MHz;Pk

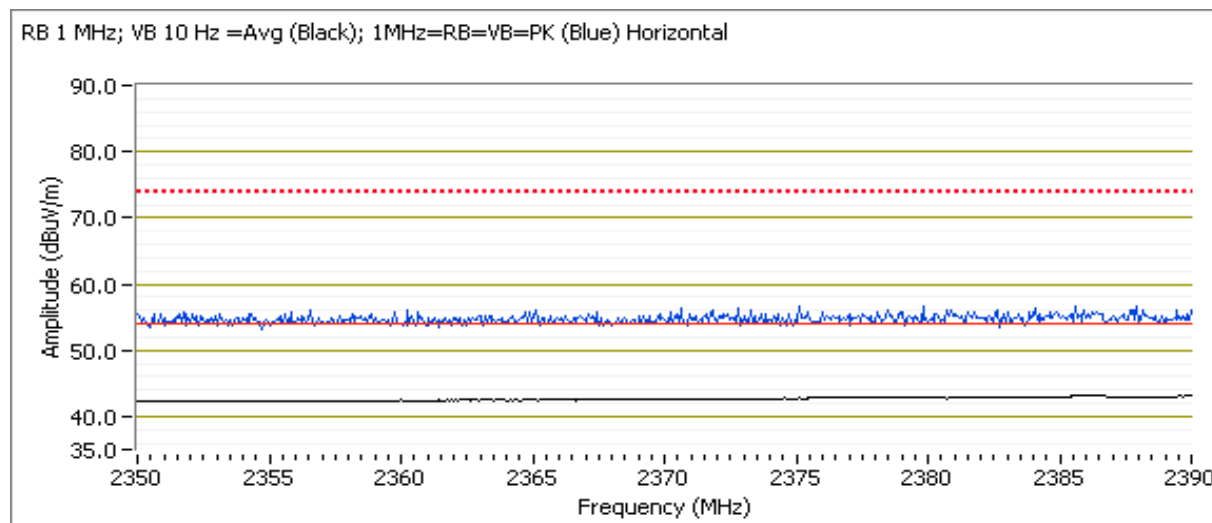

Client: Intel Corporation	Job Number: J84366
Model: Intel® Centrino® Wireless-N 2200	T-Log Number: T84600
	Account Manager: Christine Krebill
Contact: Steve Hackett	
Standard: FCC 15.247	Class: N/A

Run # 1b, EUT on Channel #11 2462MHz - 802.11b, Chain B

	Target (dBm)	Power Settings Measured (dBm)	Software Setting
Chain B	15.2	15.4	21.0

### Fundamental Signal Field Strength

Frequency	Level	Pol	15.209 / 15.247		Detector	Azimuth	Height	Comments
MHz	dB $\mu$ V/m	v/h	Limit	Margin	Pk/QP/Avg	degrees	meters	
2460.330	100.7	H	-	-	AVG	216	1.0	RB 1 MHz;VB 10 Hz;Pk
2461.130	103.8	H	-	-	PK	216	1.0	RB 1 MHz;VB 3 MHz;Pk
2460.370	96.4	V	-	-	AVG	160	1.5	RB 1 MHz;VB 10 Hz;Pk
2459.500	99.5	V	-	-	PK	160	1.5	RB 1 MHz;VB 3 MHz;Pk

### 2483.5 MHz Band Edge Signal Radiated Field Strength

Frequency	Level	Pol	15.209 / 15.247		Detector	Azimuth	Height	Comments
MHz	dB $\mu$ V/m	v/h	Limit	Margin	Pk/QP/Avg	degrees	meters	
2484.210	48.2	H	54.0	-5.8	AVG	217	1.0	RB 1 MHz;VB 10 Hz;Pk
2483.920	59.1	H	74.0	-14.9	PK	217	1.0	RB 1 MHz;VB 3 MHz;Pk
2484.380	46.0	V	54.0	-8.0	AVG	38	1.0	RB 1 MHz;VB 10 Hz;Pk
2484.400	57.6	V	74.0	-16.4	PK	38	1.0	RB 1 MHz;VB 3 MHz;Pk

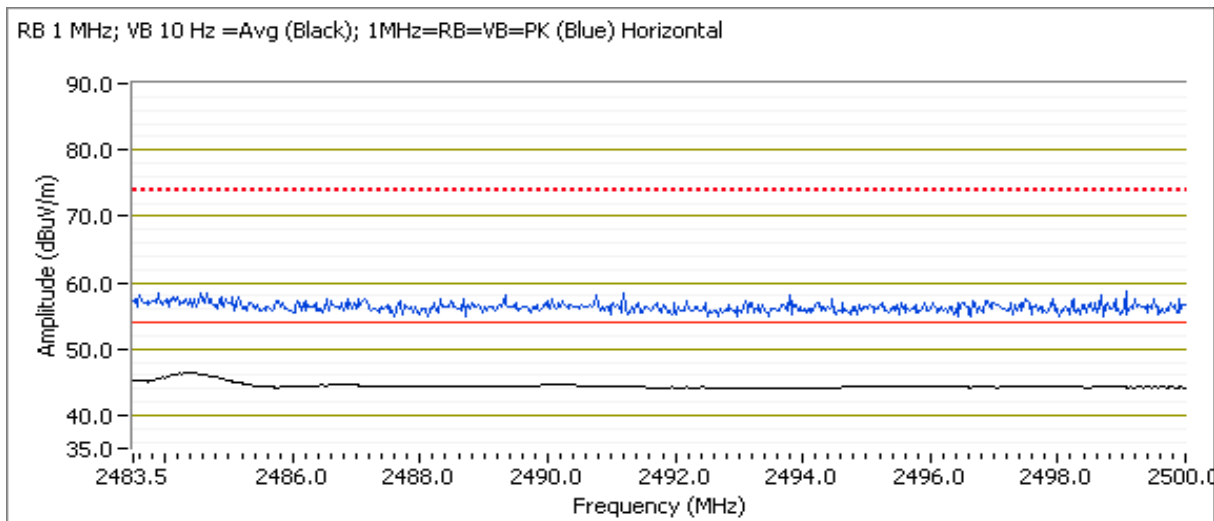

Client: Intel Corporation	Job Number: J84366
Model: Intel® Centrino® Wireless-N 2200	T-Log Number: T84600
	Account Manager: Christine Krebill
Contact: Steve Hackett	
Standard: FCC 15.247	Class: N/A

**Run # 2, Band Edge Field Strength - 802.11g, Chain B**

Date of Test: 10/2/2011

Test Location: FT Chamber #5

Test Engineer: Rafael Varelas

Config Change: none

**Run # 2a, EUT on Channel #1 2412MHz - 802.11g, Chain B**

	Target (dBm)	Power Settings Measured (dBm)	Software Setting
Chain B	13.7	13.9	24.0

**Fundamental Signal Field Strength**

Frequency	Level	Pol	15.209 / 15.247		Detector	Azimuth	Height	Comments
MHz	dBμV/m	v/h	Limit	Margin	Pk/QP/Avg	degrees	meters	
2407.600	97.9	H	-	-	AVG	344	1.0	RB 1 MHz;VB 10 Hz;Pk
2407.800	105.7	H	-	-	PK	344	1.0	RB 1 MHz;VB 3 MHz;Pk
2416.330	92.5	V	-	-	AVG	147	1.0	RB 1 MHz;VB 10 Hz;Pk
2415.430	100.7	V	-	-	PK	147	1.0	RB 1 MHz;VB 3 MHz;Pk

**2390 MHz Band Edge Signal Field Strength**

Frequency	Level	Pol	15.209 / 15.247		Detector	Azimuth	Height	Comments
MHz	dBμV/m	v/h	Limit	Margin	Pk/QP/Avg	degrees	meters	
2390.000	48.9	H	54.0	-5.1	AVG	349	1.3	RB 1 MHz;VB 10 Hz;Pk
2389.740	63.6	H	74.0	-10.4	PK	349	1.3	RB 1 MHz;VB 3 MHz;Pk
2389.900	47.0	V	54.0	-7.0	AVG	102	1.0	RB 1 MHz;VB 10 Hz;Pk
2389.570	60.8	V	74.0	-13.2	PK	102	1.0	RB 1 MHz;VB 3 MHz;Pk

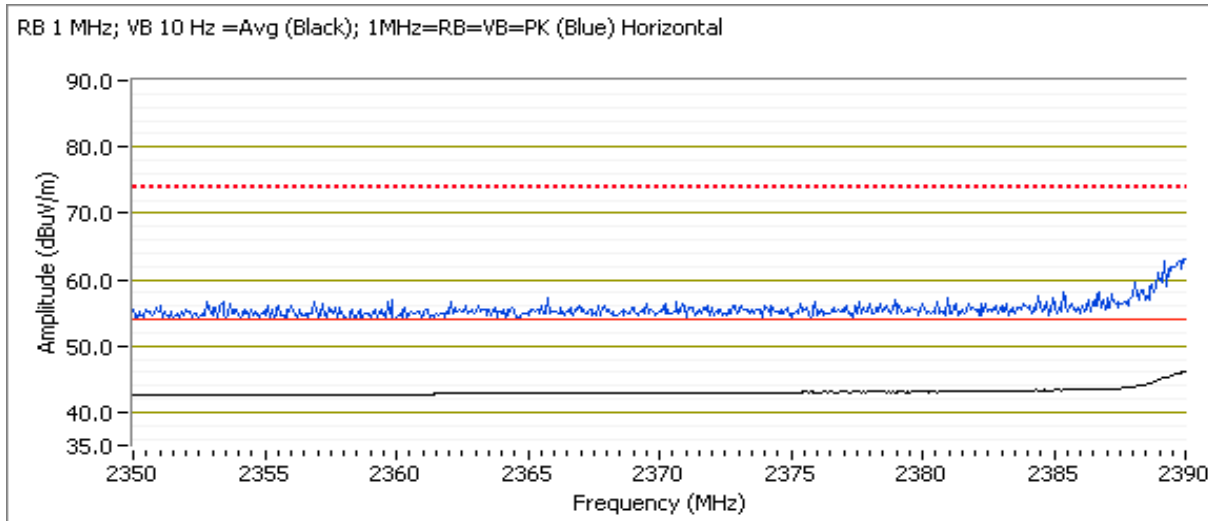

Client: Intel Corporation	Job Number: J84366
Model: Intel® Centrino® Wireless-N 2200	T-Log Number: T84600
	Account Manager: Christine Krebill
Contact: Steve Hackett	
Standard: FCC 15.247	Class: N/A

Run # 2b, EUT on Channel #11 2462MHz - 802.11g, Chain B

	Target (dBm)	Power Settings Measured (dBm)	Software Setting
Chain B	15.2	15.4	26.5

### Fundamental Signal Field Strength

Frequency	Level	Pol	15.209 / 15.247		Detector	Azimuth	Height	Comments
MHz	dB $\mu$ V/m	v/h	Limit	Margin	Pk/QP/Avg	degrees	meters	
2460.130	98.6	H	-	-	AVG	214	1.0	RB 1 MHz;VB 10 Hz;Pk
2458.770	106.5	H	-	-	PK	214	1.0	RB 1 MHz;VB 3 MHz;Pk
2457.570	95.6	V	-	-	AVG	28	1.3	RB 1 MHz;VB 10 Hz;Pk
2458.730	103.4	V	-	-	PK	28	1.3	RB 1 MHz;VB 3 MHz;Pk

### 2483.5 MHz Band Edge Signal Radiated Field Strength

Frequency	Level	Pol	15.209 / 15.247		Detector	Azimuth	Height	Comments
MHz	dB $\mu$ V/m	v/h	Limit	Margin	Pk/QP/Avg	degrees	meters	
2483.500	53.1	H	54.0	-0.9	AVG	215	1.0	RB 1 MHz;VB 10 Hz;Pk
2483.660	68.9	H	74.0	-5.1	PK	215	1.0	RB 1 MHz;VB 3 MHz;Pk
2483.510	50.2	V	54.0	-3.8	AVG	35	1.0	RB 1 MHz;VB 10 Hz;Pk
2484.090	64.4	V	74.0	-9.6	PK	35	1.0	RB 1 MHz;VB 3 MHz;Pk

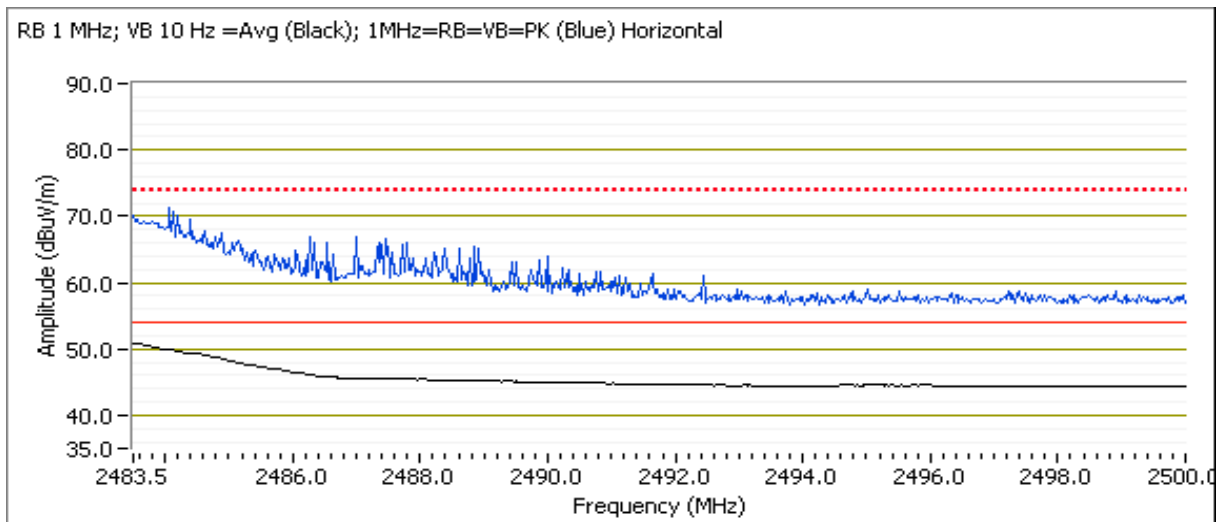

Client: Intel Corporation	Job Number: J84366
Model: Intel® Centrino® Wireless-N 2200	T-Log Number: T84600
	Account Manager: Christine Krebill
Contact: Steve Hackett	
Standard: FCC 15.247	Class: N/A

	Target (dBm)	Power Settings Measured (dBm)	Software Setting
Chain B	14.2	14.2	25.0

### Fundamental Signal Field Strength

Frequency	Level	Pol	15.209 / 15.247		Detector	Azimuth	Height	Comments
MHz	dB $\mu$ V/m	v/h	Limit	Margin	Pk/QP/Avg	degrees	meters	
2457.570	94.4	V	-	-	AVG	28	1.3	RB 1 MHz;VB 10 Hz;Pk
2458.930	102.1	V	-	-	PK	28	1.3	RB 1 MHz;VB 3 MHz;Pk
2457.500	97.8	H	-	-	AVG	217	1.0	RB 1 MHz;VB 10 Hz;Pk
2465.530	105.8	H	-	-	PK	217	1.0	RB 1 MHz;VB 3 MHz;Pk

### 2483.5 MHz Band Edge Signal Radiated Field Strength

Frequency	Level	Pol	15.209 / 15.247		Detector	Azimuth	Height	Comments
MHz	dB $\mu$ V/m	v/h	Limit	Margin	Pk/QP/Avg	degrees	meters	
2483.500	50.0	H	54.0	-4.0	AVG	230	1.0	RB 1 MHz;VB 10 Hz;Pk
2483.610	67.2	H	74.0	-6.8	PK	230	1.0	RB 1 MHz;VB 3 MHz;Pk
2483.510	48.1	V	54.0	-5.9	AVG	38	1.0	RB 1 MHz;VB 10 Hz;Pk
2483.950	62.1	V	74.0	-11.9	PK	38	1.0	RB 1 MHz;VB 3 MHz;Pk

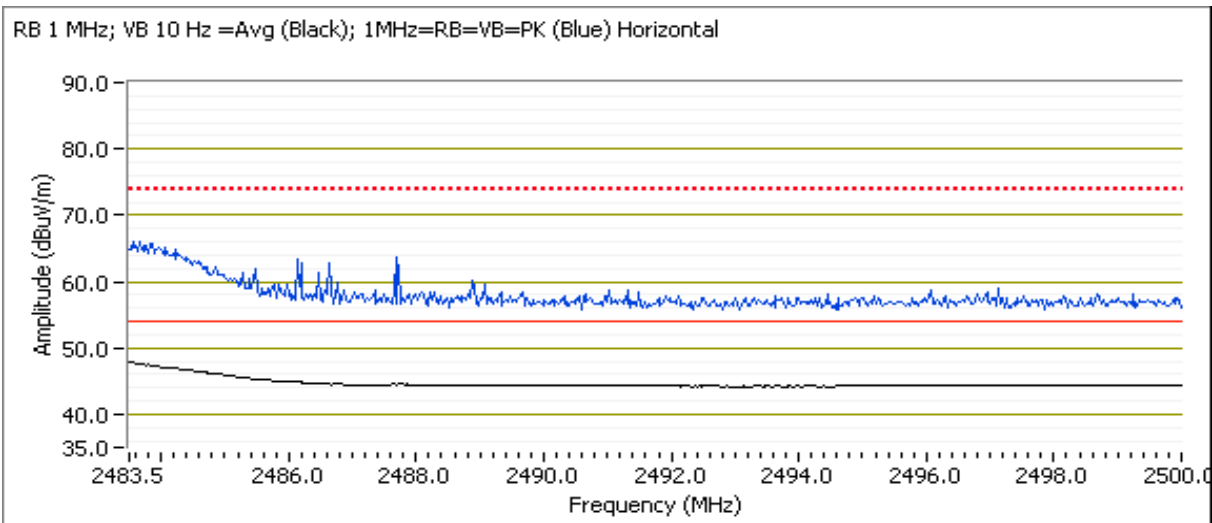

Client: Intel Corporation	Job Number: J84366
Model: Intel® Centrino® Wireless-N 2200	T-Log Number: T84600
	Account Manager: Christine Krebill
Contact: Steve Hackett	
Standard: FCC 15.247	Class: N/A

**Run # 3, Band Edge Field Strength - 802.11n20, Chain B**

Date of Test: 10/2/2011

Test Location: FT Chamber #5

Test Engineer: Rafael Varelas

Config Change: none

**Run # 3a, EUT on Channel #1 2412MHz - 802.11n20, Chain B**

	Target (dBm)	Power Settings Measured (dBm)	Software Setting
Chain B	12.7	12.9	23.0

**Fundamental Signal Field Strength**

Frequency	Level	Pol	15.209 / 15.247		Detector	Azimuth	Height	Comments
MHz	dBμV/m	v/h	Limit	Margin	Pk/QP/Avg	degrees	meters	
2407.730	96.6	H	-	-	AVG	350	1.0	RB 1 MHz;VB 10 Hz;Pk
2408.270	104.8	H	-	-	PK	350	1.0	RB 1 MHz;VB 3 MHz;Pk
2407.770	92.1	V	-	-	AVG	103	1.1	RB 1 MHz;VB 10 Hz;Pk
2409.000	100.2	V	-	-	PK	103	1.1	RB 1 MHz;VB 3 MHz;Pk

**2390 MHz Band Edge Signal Field Strength**

Frequency	Level	Pol	15.209 / 15.247		Detector	Azimuth	Height	Comments
MHz	dBμV/m	v/h	Limit	Margin	Pk/QP/Avg	degrees	meters	
2389.980	50.6	H	54.0	-3.4	AVG	346	1.3	RB 1 MHz;VB 10 Hz;Pk
2389.710	67.0	H	74.0	-7.0	PK	346	1.3	RB 1 MHz;VB 3 MHz;Pk
2389.940	48.0	V	54.0	-6.0	AVG	320	1.1	RB 1 MHz;VB 10 Hz;Pk
2389.700	62.7	V	74.0	-11.3	PK	320	1.1	RB 1 MHz;VB 3 MHz;Pk

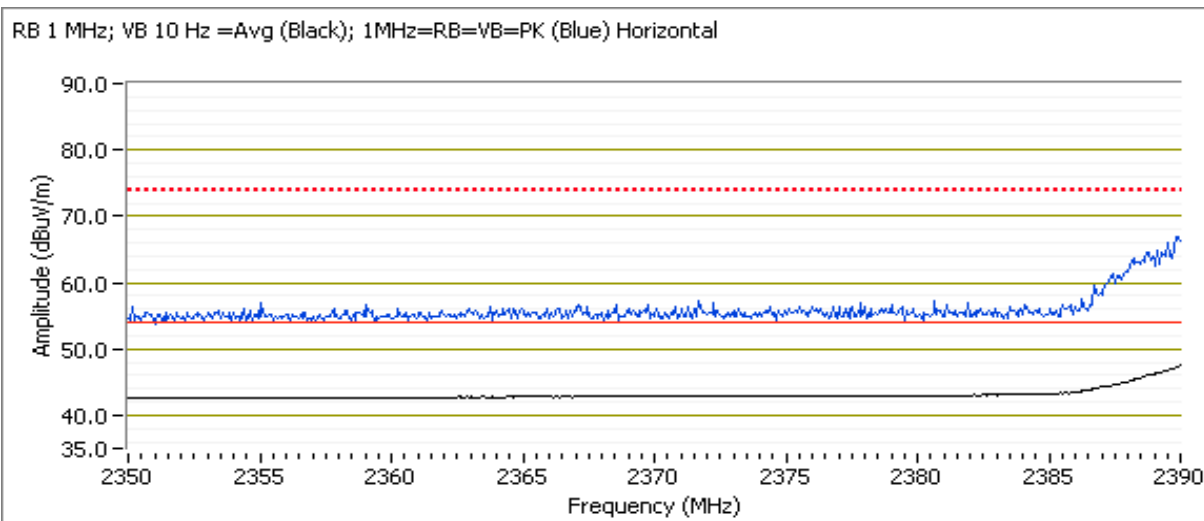

Client: Intel Corporation	Job Number: J84366
Model: Intel® Centrino® Wireless-N 2200	T-Log Number: T84600
	Account Manager: Christine Krebill
Contact: Steve Hackett	
Standard: FCC 15.247	Class: N/A

Run # 3b, EUT on Channel #11 2462MHz - 802.11n20, Chain B

	Target (dBm)	Power Settings Measured (dBm)	Software Setting
Chain B	12.7	12.8	23.5

### Fundamental Signal Field Strength

Frequency	Level	Pol	15.209 / 15.247		Detector	Azimuth	Height	Comments
MHz	dB $\mu$ V/m	v/h	Limit	Margin	Pk/QP/Avg	degrees	meters	
2465.170	96.2	H	-	-	AVG	217	1.0	RB 1 MHz;VB 10 Hz;Pk
2464.030	104.2	H	-	-	PK	217	1.0	RB 1 MHz;VB 3 MHz;Pk
2457.800	92.4	V	-	-	AVG	165	1.5	RB 1 MHz;VB 10 Hz;Pk
2457.600	100.4	V	-	-	PK	165	1.5	RB 1 MHz;VB 3 MHz;Pk

### 2483.5 MHz Band Edge Signal Radiated Field Strength

Frequency	Level	Pol	15.209 / 15.247		Detector	Azimuth	Height	Comments
MHz	dB $\mu$ V/m	v/h	Limit	Margin	Pk/QP/Avg	degrees	meters	
2483.550	50.8	H	54.0	-3.2	AVG	217	1.0	RB 1 MHz;VB 10 Hz;Pk
2483.660	65.4	H	74.0	-8.6	PK	217	1.0	RB 1 MHz;VB 3 MHz;Pk
2483.520	47.7	V	54.0	-6.3	AVG	33	1.0	RB 1 MHz;VB 10 Hz;Pk
2483.570	60.6	V	74.0	-13.4	PK	33	1.0	RB 1 MHz;VB 3 MHz;Pk

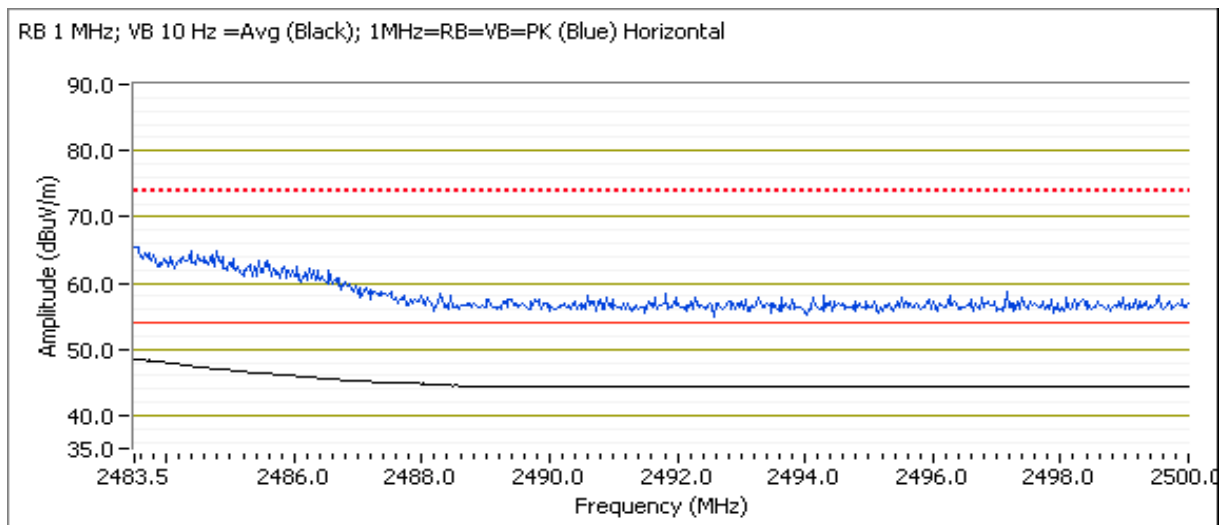



Client: Intel Corporation	Job Number: J84366
Model: Intel® Centrino® Wireless-N 2200	T-Log Number: T84600
	Account Manager: Christine Krebill
Contact: Steve Hackett	
Standard: FCC 15.247	Class: N/A

**Run # 3c, EUT on Channel #2 2417MHz - 802.11n20, Chain B**

Date of Test: 10/12/2011  
 Test Engineer: Joseph Cadigal  
 Test Location: FT Chamber #4  
 Config Change: none

	Target (dBm)	Power Settings Measured (dBm)	Software Setting
Chain B	15.2	15.3	26.0

**2390 MHz Band Edge Signal Radiated Field Strength**

Frequency	Level	Pol	15.209 / 15.247		Detector	Azimuth	Height	Comments
MHz	dB $\mu$ V/m	v/h	Limit	Margin	Pk/QP/Avg	degrees	meters	
2389.930	41.4	H	54.0	-12.6	AVG	106	1.0	RB 1 MHz;VB 10 Hz;Pk
2389.930	57.4	H	74.0	-16.6	PK	106	1.0	RB 1 MHz;VB 3 MHz;Pk
2390.000	39.8	V	54.0	-14.2	AVG	234	1.0	RB 1 MHz;VB 10 Hz;Pk
2389.800	54.5	V	74.0	-19.5	PK	234	1.0	RB 1 MHz;VB 3 MHz;Pk

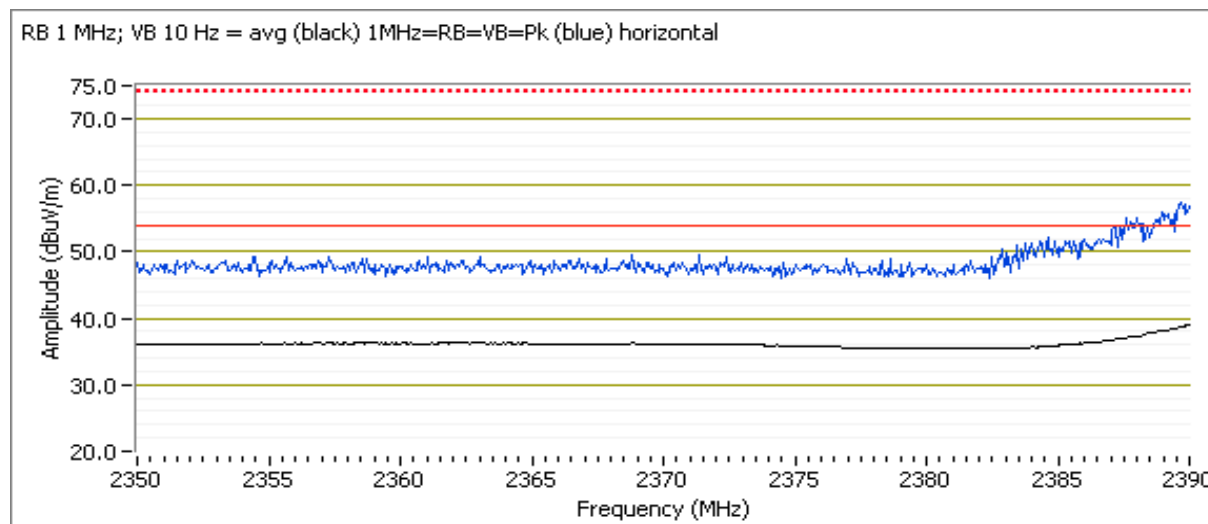

Client: Intel Corporation	Job Number: J84366
Model: Intel® Centrino® Wireless-N 2200	T-Log Number: T84600
	Account Manager: Christine Krebill
Contact: Steve Hackett	
Standard: FCC 15.247	Class: N/A

**Run # 3d, EUT on Channel #10 2457MHz - 802.11n20, Chain B**

Date of Test: 10/12/2011      Test Location: FT Chamber #4  
 Test Engineer: Joseph Cadigal      Config Change: none

	Target (dBm)	Power Settings Measured (dBm)	Software Setting
Chain B	16.7	16.8	28.5

**2483.5 MHz Band Edge Signal Radiated Field Strength**

Frequency	Level	Pol	15.209 / 15.247		Detector	Azimuth	Height	Comments
MHz	dBμV/m	v/h	Limit	Margin	Pk/QP/Avg	degrees	meters	
2483.500	50.6	H	54.0	-3.4	AVG	340	1.0	RB 1 MHz;VB 10 Hz;Pk
2485.730	66.1	H	74.0	-7.9	PK	340	1.0	RB 1 MHz;VB 3 MHz;Pk
2497.640	38.3	V	54.0	-15.7	AVG	228	1.0	RB 1 MHz;VB 10 Hz;Pk
2489.770	50.0	V	74.0	-24.0	PK	228	1.0	RB 1 MHz;VB 3 MHz;Pk

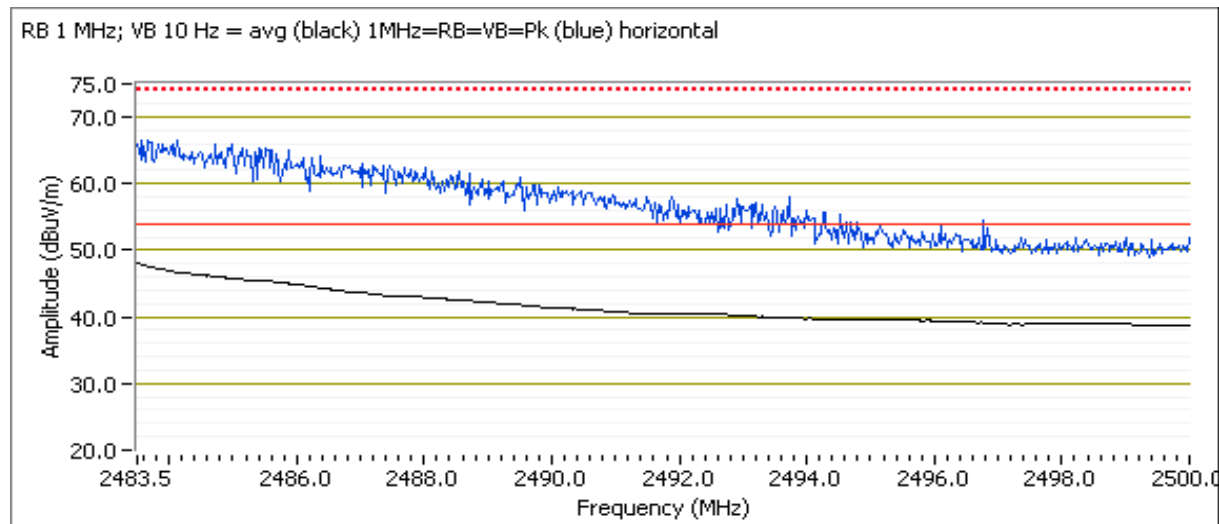

Client: Intel Corporation	Job Number: J84366
Model: Intel® Centrino® Wireless-N 2200	T-Log Number: T84600
	Account Manager: Christine Krebill
Contact: Steve Hackett	
Standard: FCC 15.247	Class: N/A

**Run # 4, Band Edge Field Strength - 802.11n40, Chain B**

Date of Test: 10/2/2011

Test Location: FT Chamber #5

Test Engineer: Rafael Varelas

Config Change: none

**Run # 4a, EUT on Channel #3 2422MHz - 802.11n40, Chain B**

	Target (dBm)	Power Settings Measured (dBm)	Software Setting
Chain B	9.7	9.9	20.0

**Fundamental Signal Field Strength**

Frequency	Level	Pol	15.209 / 15.247		Detector	Azimuth	Height	Comments
MHz	dBμV/m	v/h	Limit	Margin	Pk/QP/Avg	degrees	meters	
2430.500	91.7	H	-	-	AVG	325	1.0	RB 1 MHz;VB 10 Hz;Pk
2432.250	100.8	H	-	-	PK	325	1.0	RB 1 MHz;VB 3 MHz;Pk
2430.400	86.5	V	-	-	AVG	161	1.6	RB 1 MHz;VB 10 Hz;Pk
2434.800	94.6	V	-	-	PK	161	1.6	RB 1 MHz;VB 3 MHz;Pk

**2390 MHz Band Edge Signal Field Strength**

Frequency	Level	Pol	15.209 / 15.247		Detector	Azimuth	Height	Comments
MHz	dBμV/m	v/h	Limit	Margin	Pk/QP/Avg	degrees	meters	
2389.970	49.4	H	54.0	-4.6	AVG	313	1.0	RB 1 MHz;VB 10 Hz;Pk
2388.700	63.3	H	74.0	-10.7	PK	313	1.0	RB 1 MHz;VB 3 MHz;Pk
2390.000	48.6	V	54.0	-5.4	AVG	324	1.1	RB 1 MHz;VB 10 Hz;Pk
2389.940	61.5	V	74.0	-12.5	PK	324	1.1	RB 1 MHz;VB 3 MHz;Pk

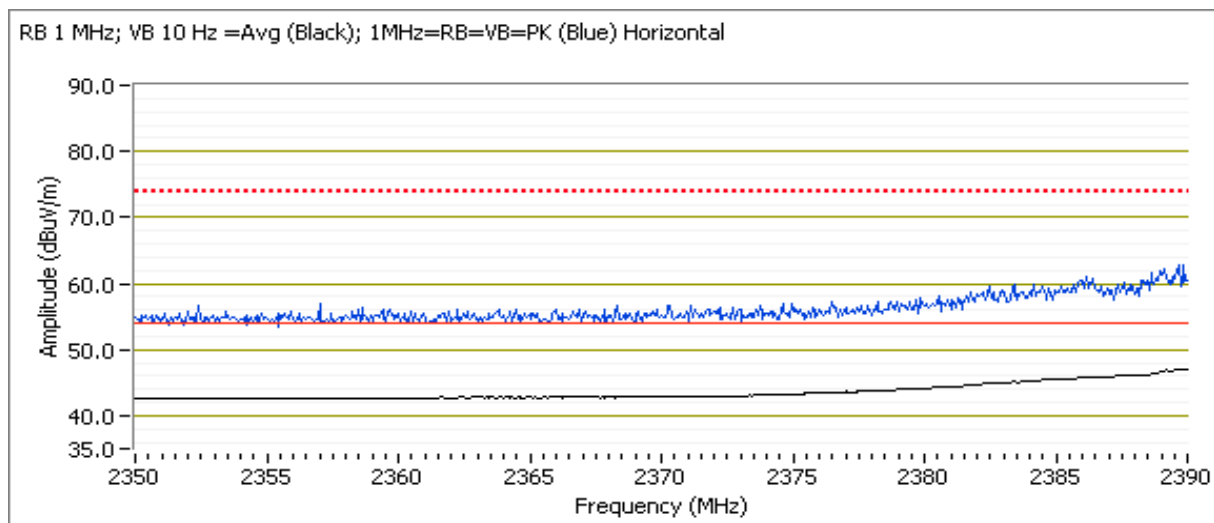

Client: Intel Corporation	Job Number: J84366
Model: Intel® Centrino® Wireless-N 2200	T-Log Number: T84600
	Account Manager: Christine Krebill
Contact: Steve Hackett	
Standard: FCC 15.247	Class: N/A

**Run # 4a, EUT on Channel #8 2447MHz - 802.11n40, Chain B**

Date of Test: 10/12/2011      Test Location: FT Chamber #4  
 Test Engineer: Joseph Cadigal      Config Change: none

	Target (dBm)	Power Settings Measured (dBm)	Software Setting
Chain B	11.7	11.8	22.5

**2483.5 MHz Band Edge Signal Field Strength**

Frequency	Level	Pol	15.209 / 15.247		Detector	Azimuth	Height	Comments
MHz	dB $\mu$ V/m	v/h	Limit	Margin	Pk/QP/Avg	degrees	meters	
2483.580	48.1	H	54.0	-5.9	AVG	307	1.0	RB 1 MHz;VB 10 Hz;Pk
2483.610	61.4	H	74.0	-12.6	PK	307	1.0	RB 1 MHz;VB 3 MHz;Pk
2484.710	41.2	V	54.0	-12.8	AVG	231	1.0	RB 1 MHz;VB 10 Hz;Pk
2483.550	54.9	V	74.0	-19.1	PK	231	1.0	RB 1 MHz;VB 3 MHz;Pk

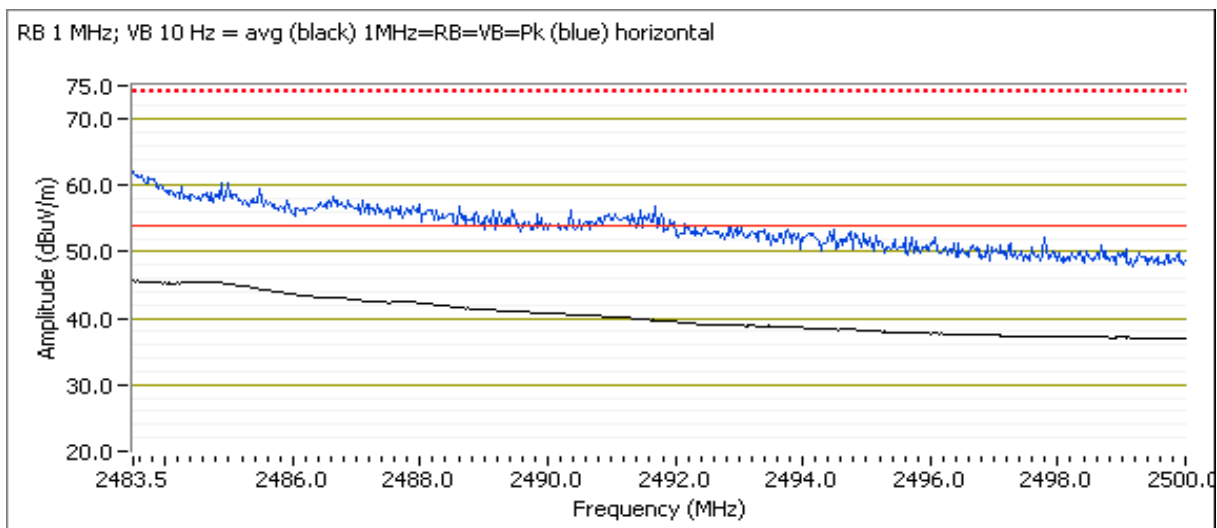

Client: Intel Corporation	Job Number: J84366
Model: Intel® Centrino® Wireless-N 2200	T-Log Number: T84600
	Account Manager: Christine Krebill
Contact: Steve Hackett	
Standard: FCC 15.247	Class: N/A

Run # 4b, EUT on Channel #9 2452MHz - 802.11n40, Chain B

	Target (dBm)	Power Settings Measured (dBm)	Software Setting
Chain B	10.2	10.4	21.0

### Fundamental Signal Field Strength

Frequency	Level	Pol	15.209 / 15.247		Detector	Azimuth	Height	Comments
MHz	dBμV/m	v/h	Limit	Margin	Pk/QP/Avg	degrees	meters	
2439.270	91.1	H	-	-	AVG	321	1.0	RB 1 MHz;VB 10 Hz;Pk
2439.670	99.1	H	-	-	PK	321	1.0	RB 1 MHz;VB 3 MHz;Pk
2440.200	87.6	V	-	-	AVG	162	1.5	RB 1 MHz;VB 10 Hz;Pk
2444.530	95.6	V	-	-	PK	162	1.5	RB 1 MHz;VB 3 MHz;Pk

### 2483.5 MHz Band Edge Signal Radiated Field Strength

Frequency	Level	Pol	15.209 / 15.247		Detector	Azimuth	Height	Comments
MHz	dBμV/m	v/h	Limit	Margin	Pk/QP/Avg	degrees	meters	
2483.580	50.6	H	54.0	-3.4	AVG	202	1.0	RB 1 MHz;VB 10 Hz;Pk
2485.820	62.3	H	74.0	-11.7	PK	202	1.0	RB 1 MHz;VB 3 MHz;Pk
2483.560	48.2	V	54.0	-5.8	AVG	29	1.0	RB 1 MHz;VB 10 Hz;Pk
2484.830	60.9	V	74.0	-13.1	PK	29	1.0	RB 1 MHz;VB 3 MHz;Pk

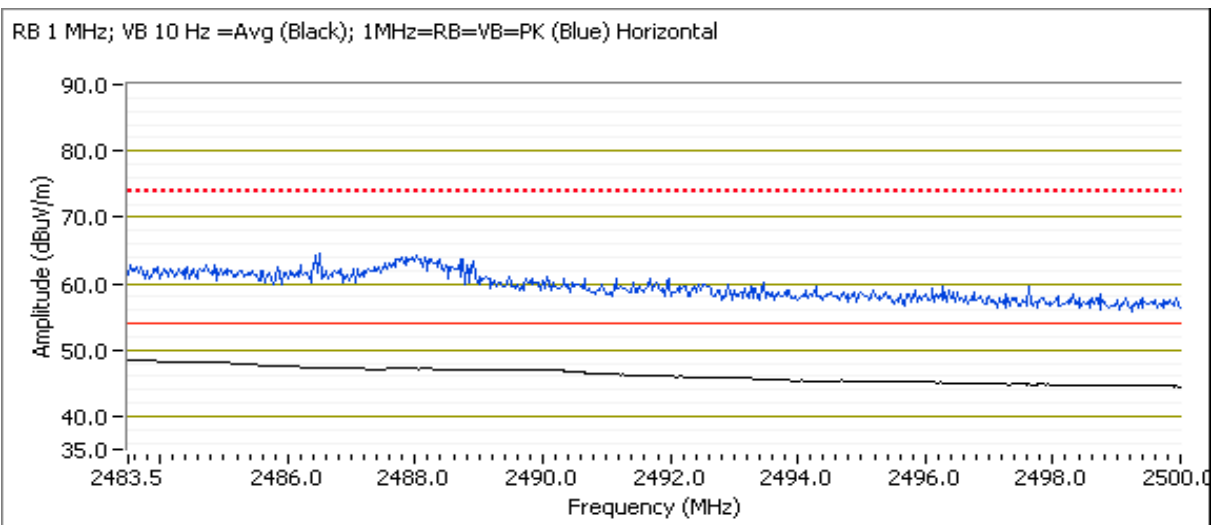

Client: Intel Corporation	Job Number: J84366
Model: Intel® Centrino® Wireless-N 2200	T-Log Number: T84600
	Account Manager: Christine Krebill
Contact: Steve Hackett	
Standard: FCC 15.247	Class: N/A

## RSS 210 and FCC 15.247 (DTS) Radiated Spurious Emissions

### Test Specific Details

Objective: The objective of this test session is to perform final qualification testing of the EUT with respect to the specification listed above.

### General Test Configuration

The EUT and all local support equipment were located on the turntable for radiated spurious emissions testing.

For radiated emissions testing the measurement antenna was located 3 meters from the EUT.

### Ambient Conditions:

Temperature: 30-50 °C  
 Rel. Humidity: 18-26 %

### Summary of Results - Device Operating in the 2400-2483.5 MHz Band

MAC Address: 001500825F4C DRTU Tool Version **1.5.3.0322** Driver version **15.0.0.61**

Run #	Mode	Channel	Target Power	Measured Power	Test Performed	Limit	Result / Margin
Run # 1	802.11n20 Chain A+B	#1 2412MHz	A: 11.7 B: 11.7	A: 11.8 B: 12.0	Restricted Band Edge at 2400 MHz	15.209	52.6dBµV/m @ 2390.0MHz (-1.4dB)
		#11 2462MHz	A: 11.7 B: 11.7	A: 11.8 B: 11.7	Restricted Band Edge at 2483.5 MHz	15.209	53.1dBµV/m @ 2483.5MHz (-0.9dB)
Run # 2	802.11n40 Chain A+B	#3 2422MHz	A: 8.2 B: 8.2	A: 8.3 B: 8.5	Restricted Band Edge at 2400 MHz	15.209	52.7dBµV/m @ 2389.6MHz (-1.3dB)
		#4 2427MHz	A: 9.7 B: 9.7	A: 9.8 B: 9.8	Restricted Band Edge at 2400 MHz	15.209	47.9dBµV/m @ 2389.6MHz (-6.1dB)
		#9 2452MHz	A: 9.7 B: 9.7	A: 9.8 B: 9.7	Restricted Band Edge at 2483.5 MHz	15.209	53.7dBµV/m @ 2484.6MHz (-0.3dB)

If power is more than 3dB below center channel target to pass on lowest and/or highest channel, repeat measurements at target power for next lowest or highest channel

### Modifications Made During Testing

No modifications were made to the EUT during testing

### Deviations From The Standard

No deviations were made from the requirements of the standard.

Note - the target and measured power are average powers (measured with average power sensor) and are used for reference purposes only. Power is set using " GAIN CONTROL" mode in the DRTU tool.

Client: Intel Corporation	Job Number: J84366
Model: Intel® Centrino® Wireless-N 2200	T-Log Number: T84600
	Account Manager: Christine Krebill
Contact: Steve Hackett	
Standard: FCC 15.247	Class: N/A

**Run #1, Band Edge Field Strength - 802.11n20, Chain A+B**

Date of Test: 9/30/2011

Test Location: FT Chamber #5

Test Engineer: Rafael Varelas

Config Change: none

**Run #1a, EUT on Channel #1 2412MHz - 802.11n20, Chain A+B**

Chain	Target (dBm)				Power Settings Measured (dBm)				Software Setting
	A	B	C	Total	A	B	C	Total	
	11.7	11.7		14.7	11.8	12.0		14.9	25.0/25.5

**Fundamental Signal Field Strength**

Frequency	Level	Pol	15.209 / 15.247		Detector	Azimuth	Height	Comments
MHz	dBμV/m	v/h	Limit	Margin	Pk/QP/Avg	degrees	meters	
2407.600	96.6	H	-	-	AVG	352	1.0	RB 1 MHz;VB 10 Hz;Pk
2407.100	106.2	H	-	-	PK	352	1.0	RB 1 MHz;VB 3 MHz;Pk
2407.430	95.2	V	-	-	AVG	191	1.2	RB 1 MHz;VB 10 Hz;Pk
2407.200	105.4	V	-	-	PK	191	1.2	RB 1 MHz;VB 3 MHz;Pk

**2390 MHz Band Edge Signal Field Strength**

Frequency	Level	Pol	15.209 / 15.247		Detector	Azimuth	Height	Comments
MHz	dBμV/m	v/h	Limit	Margin	Pk/QP/Avg	degrees	meters	
2389.950	52.6	H	54.0	-1.4	AVG	233	1.1	RB 1 MHz;VB 10 Hz;Pk
2389.730	65.2	H	74.0	-8.8	PK	233	1.1	RB 1 MHz;VB 3 MHz;Pk
2389.950	50.8	V	54.0	-3.2	AVG	278	1.1	RB 1 MHz;VB 10 Hz;Pk
2389.680	63.6	V	74.0	-10.4	PK	278	1.1	RB 1 MHz;VB 3 MHz;Pk

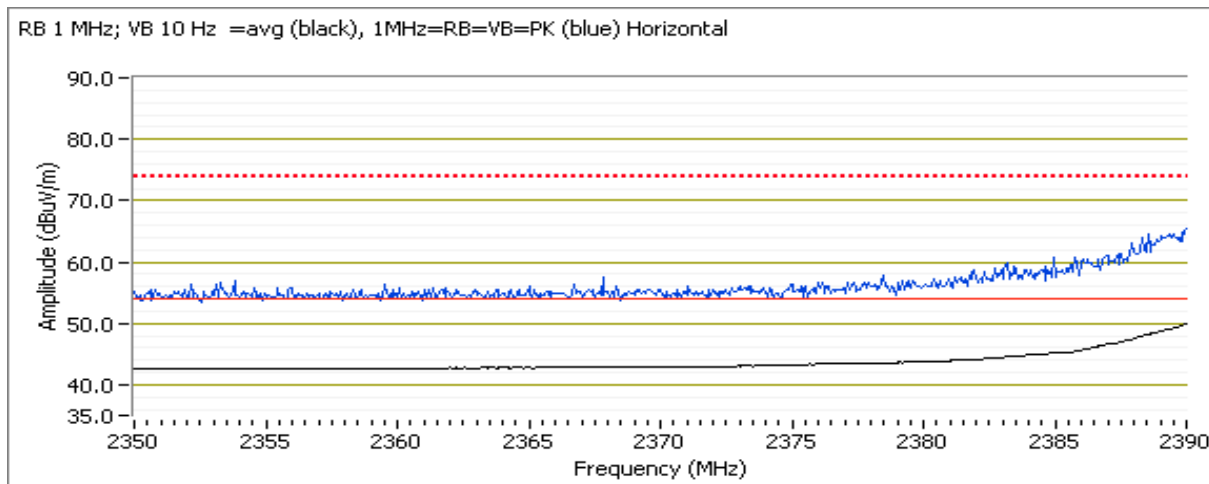

Client: Intel Corporation	Job Number: J84366
Model: Intel® Centrino® Wireless-N 2200	T-Log Number: T84600
	Account Manager: Christine Krebill
Contact: Steve Hackett	
Standard: FCC 15.247	Class: N/A

**Run #1b, EUT on Channel #11 2462MHz - 802.11n20, Chain A+B**

Chain	Target (dBm)				Power Settings Measured (dBm)				Software Setting
	A	B	C	Total	A	B	C	Total	
	11.7	11.7		14.7	11.8	11.7		14.8	25.0/25.5

**Fundamental Signal Field Strength**

Frequency	Level	Pol	15.209 / 15.247		Detector	Azimuth	Height	Comments
MHz	dBμV/m	v/h	Limit	Margin	Pk/QP/Avg	degrees	meters	
2457.630	96.0	H	-	-	AVG	349	1.0	RB 1 MHz;VB 10 Hz;Pk
2457.230	106.0	H	-	-	PK	349	1.0	RB 1 MHz;VB 3 MHz;Pk
2457.630	93.9	V	-	-	AVG	193	1.2	RB 1 MHz;VB 10 Hz;Pk
2461.500	103.3	V	-	-	PK	193	1.2	RB 1 MHz;VB 3 MHz;Pk

**2483.5 MHz Band Edge Signal Radiated Field Strength**

Frequency	Level	Pol	15.209 / 15.247		Detector	Azimuth	Height	Comments
MHz	dBμV/m	v/h	Limit	Margin	Pk/QP/Avg	degrees	meters	
2483.540	53.1	H	54.0	-0.9	AVG	4	1.0	RB 1 MHz;VB 10 Hz;Pk
2484.050	64.9	H	74.0	-9.1	PK	4	1.0	RB 1 MHz;VB 3 MHz;Pk
2483.510	50.3	V	54.0	-3.7	AVG	191	1.2	RB 1 MHz;VB 10 Hz;Pk
2484.210	62.3	V	74.0	-11.7	PK	191	1.2	RB 1 MHz;VB 3 MHz;Pk

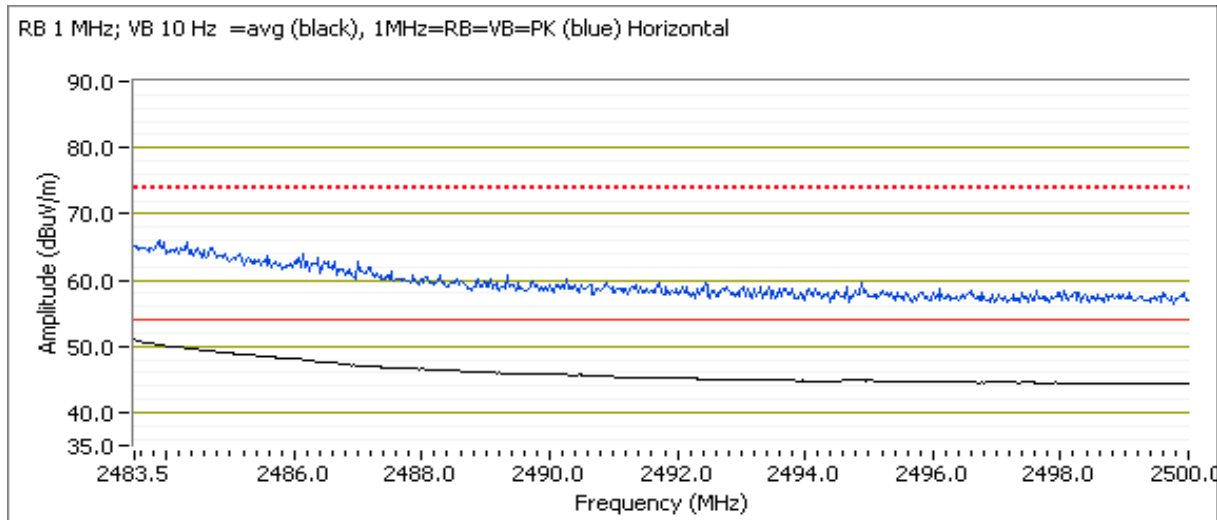



Client: Intel Corporation	Job Number: J84366
Model: Intel® Centrino® Wireless-N 2200	T-Log Number: T84600
	Account Manager: Christine Krebill
Contact: Steve Hackett	
Standard: FCC 15.247	Class: N/A

**Run #2, Band Edge Field Strength - 802.11n40, Chain A+B**

Date of Test: 9/30/2011

Test Location: FT Chamber #5

Test Engineer: Rafael Varelas

Config Change: none

**Run #2a, EUT on Channel #3 2422MHz - 802.11n40, Chain A+B**

Chain	Target (dBm)				Power Settings Measured (dBm)				Software Setting
	A	B	C	Total	A	B	C	Total	
	8.2	8.2		11.2	8.3	8.5		11.4	21.0/21.5

**Fundamental Signal Field Strength**

Frequency	Level	Pol	15.209 / 15.247		Detector	Azimuth	Height	Comments
MHz	dB $\mu$ V/m	v/h	Limit	Margin	Pk/QP/Avg	degrees	meters	
2434.130	91.0	H	-	-	AVG	353	1.0	RB 1 MHz;VB 10 Hz;Pk
2427.670	101.1	H	-	-	PK	353	1.0	RB 1 MHz;VB 3 MHz;Pk
2434.270	87.4	V	-	-	AVG	157	1.6	RB 1 MHz;VB 10 Hz;Pk
2433.470	97.5	V	-	-	PK	157	1.6	RB 1 MHz;VB 3 MHz;Pk

**2390 MHz Band Edge Signal Field Strength**

Frequency	Level	Pol	15.209 / 15.247		Detector	Azimuth	Height	Comments
MHz	dB $\mu$ V/m	v/h	Limit	Margin	Pk/QP/Avg	degrees	meters	
2389.640	52.7	H	54.0	-1.3	AVG	143	1.0	RB 1 MHz;VB 10 Hz;Pk
2389.760	67.4	H	74.0	-6.6	PK	143	1.0	RB 1 MHz;VB 3 MHz;Pk
2389.480	51.3	V	54.0	-2.7	AVG	272	1.1	RB 1 MHz;VB 10 Hz;Pk
2389.230	64.7	V	74.0	-9.3	PK	272	1.1	RB 1 MHz;VB 3 MHz;Pk

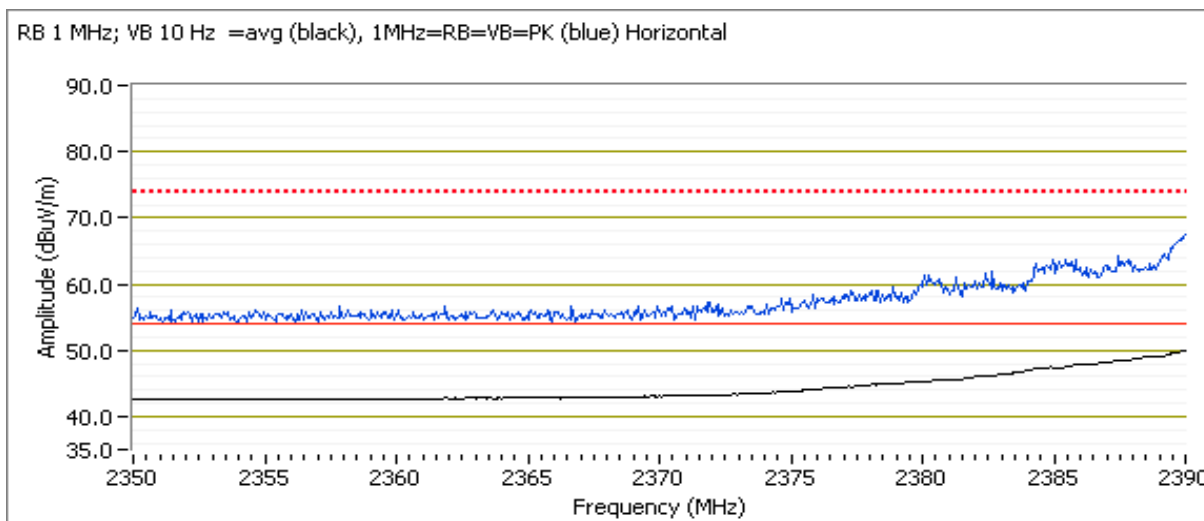

Client: Intel Corporation	Job Number: J84366
Model: Intel® Centrino® Wireless-N 2200	T-Log Number: T84600
	Account Manager: Christine Krebill
Contact: Steve Hackett	
Standard: FCC 15.247	Class: N/A

**Run #2a, EUT on Channel #3 2427MHz - 802.11n40, Chain A+B**

Date of Test: 10/12/2011      Test Location: FT Chamber #4  
 Test Engineer: Joseph Cadigal      Config Change: none

Chain	Target (dBm)				Power Settings Measured (dBm)				Software Setting
	A	B	C	Total	A	B	C	Total	
	9.7	9.7		12.7	9.8	9.8		12.8	22.0/22.5

**2390 MHz Band Edge Signal Field Strength**

Frequency	Level	Pol	15.209 / 15.247		Detector	Azimuth	Height	Comments
MHz	dB $\mu$ V/m	v/h	Limit	Margin	Pk/QP/Avg	degrees	meters	
2389.600	47.9	H	54.0	-6.1	AVG	101	1.0	RB 1 MHz;VB 10 Hz;Pk
2389.530	60.1	H	74.0	-13.9	PK	101	1.0	RB 1 MHz;VB 3 MHz;Pk
2389.470	45.8	V	54.0	-8.2	AVG	235	1.0	RB 1 MHz;VB 10 Hz;Pk
2389.530	58.3	V	74.0	-15.7	PK	235	1.0	RB 1 MHz;VB 3 MHz;Pk

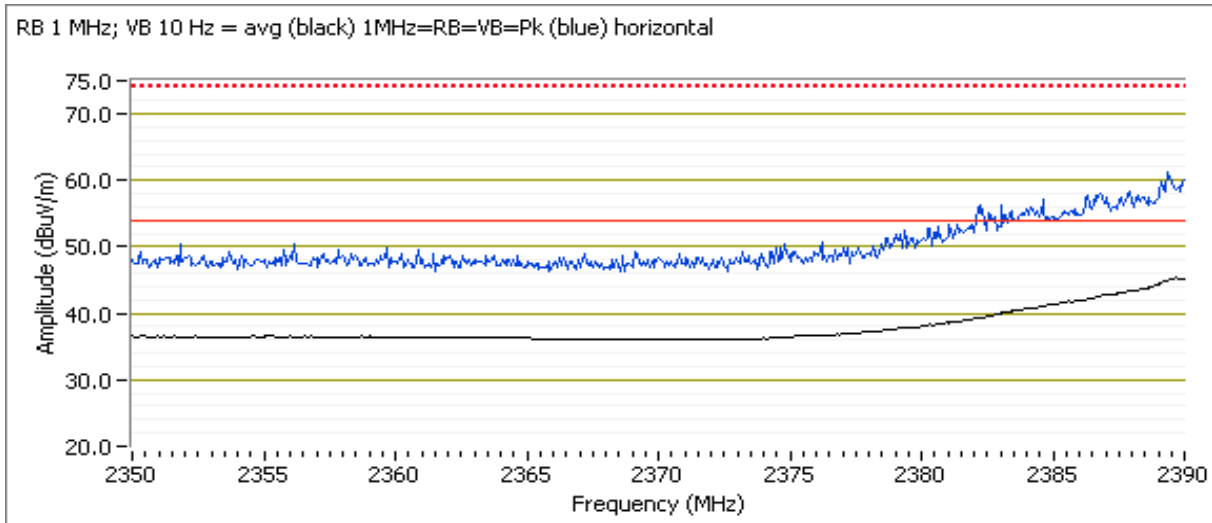

Client: Intel Corporation	Job Number: J84366
Model: Intel® Centrino® Wireless-N 2200	T-Log Number: T84600
	Account Manager: Christine Krebill
Contact: Steve Hackett	
Standard: FCC 15.247	Class: N/A

Run #2b, EUT on Channel #9 2452MHz - 802.11n40, Chain A+B

Chain	Target (dBm)				Power Settings Measured (dBm)				Software Setting
	A	B	C	Total	A	B	C	Total	
	9.7	9.7		12.7	9.8	9.7		12.8	22.5/23.0

### Fundamental Signal Field Strength

Frequency	Level	Pol	15.209 / 15.247		Detector	Azimuth	Height	Comments
MHz	dBμV/m	v/h	Limit	Margin	Pk/QP/Avg	degrees	meters	
2439.130	92.3	H	-	-	AVG	352	1.0	RB 1 MHz;VB 10 Hz;Pk
2444.670	102.0	H	-	-	PK	352	1.0	RB 1 MHz;VB 3 MHz;Pk
2450.130	88.7	V	-	-	AVG	191	1.2	RB 1 MHz;VB 10 Hz;Pk
2453.470	97.9	V	-	-	PK	191	1.2	RB 1 MHz;VB 3 MHz;Pk

### 2483.5 MHz Band Edge Signal Radiated Field Strength

Frequency	Level	Pol	15.209 / 15.247		Detector	Azimuth	Height	Comments
MHz	dBμV/m	v/h	Limit	Margin	Pk/QP/Avg	degrees	meters	
2484.590	53.7	H	54.0	-0.3	AVG	0	1.0	RB 1 MHz;VB 10 Hz;Pk
2484.530	66.3	H	74.0	-7.7	PK	0	1.0	RB 1 MHz;VB 3 MHz;Pk
2484.170	50.7	V	54.0	-3.3	AVG	194	1.6	RB 1 MHz;VB 10 Hz;Pk
2484.560	64.7	V	74.0	-9.3	PK	194	1.6	RB 1 MHz;VB 3 MHz;Pk

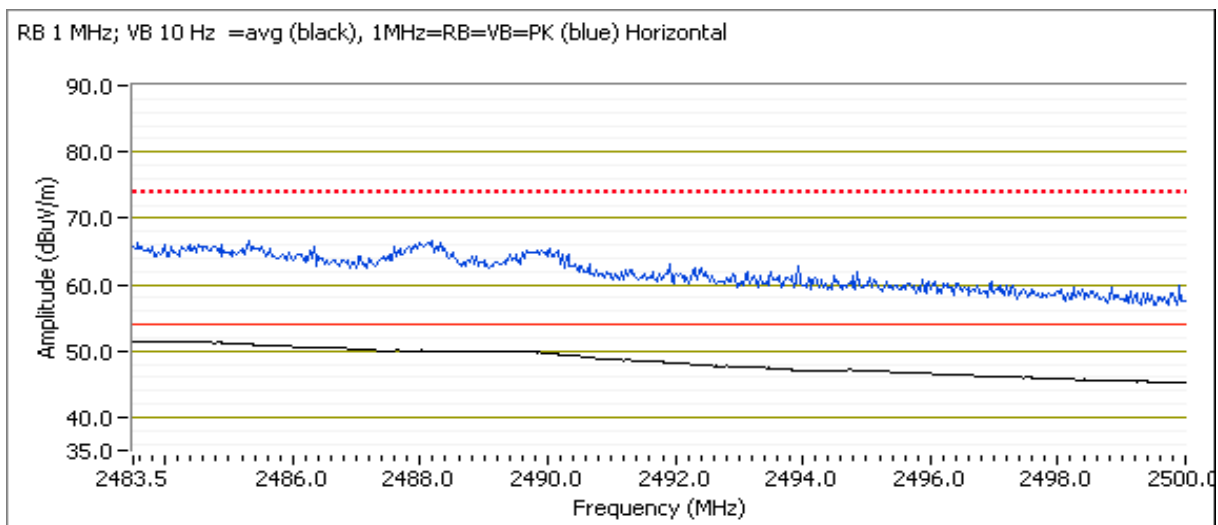

Client: Intel Corporation	Job Number: J84366
Model: Intel® Centrino® Wireless-N 2200	T-Log Number: T84600
	Account Manager: Christine Krebill
Contact: Steve Hackett	
Standard: FCC 15.247	Class: N/A

### RSS 210 and FCC 15.247 (DTS) Radiated Spurious Emissions

#### Test Specific Details

Objective: The objective of this test session is to perform final qualification testing of the EUT with respect to the specification listed above.

#### General Test Configuration

The EUT and all local support equipment were located on the turntable for radiated spurious emissions testing. The EUT was installed into a test fixture such that the EUT was exposed (i.e. outside of a host PC).

For radiated emissions testing the measurement antenna was located 3 meters from the EUT.

**Ambient Conditions:**                      Temperature:      30-50 °C  
    Rel. Humidity:    18-26 %

#### Summary of Results - Device Operating in the 2400-2483.5 MHz Band

MAC Address: 001500825F4C DRTU Tool Version **1.5.3.0322** Driver version **15.0.0.61**

Run #	Mode	Channel	Target Power	Measured Power	Test Performed	Limit	Result / Margin
Run #1	802.11b Chain A	#1 2412MHz	15.7	15.8	Radiated Emissions, 1 - 26 GHz	FCC 15.209 / 15.247	32.6dBµV/m @ 4720.7MHz (-21.4dB)
		#6 2437MHz	16.2	16.3			36.4dBµV/m @ 4874.0MHz (-17.6dB)
		#11 2462MHz	16.2	16.2			38.3dBµV/m @ 4924.0MHz (-15.7dB)
	802.11b Chain B	#1 2412MHz	15.2	15.3	Radiated Emissions, 1 - 26 GHz	FCC 15.209 / 15.247	37.0dBµV/m @ 7544.3MHz (-17.0dB)
		#6 2437MHz	15.7	15.8			36.0dBµV/m @ 1327.6MHz (-18.0dB)
		#11 2462MHz	15.7	15.8			37.1dBµV/m @ 7518.9MHz (-16.9dB)

Scans on center channel in all three OFDM modes to determine the worst case. Note that for n20 and n40 mode the output power was set to 16.5dBm per chain, the maximum power per chain in MIMO mode would be 13.5dBm, however as the single chain power could be 16.5dBm the scans were run at the higher single-chain power level but with both chains active.

Client: Intel Corporation	Job Number: J84366
Model: Intel® Centrino® Wireless-N 2200	T-Log Number: T84600
	Account Manager: Christine Krebill
Contact: Steve Hackett	
Standard: FCC 15.247	Class: N/A

Run #	Mode	Channel	Target Power	Measured Power	Test Performed	Limit	Result / Margin
Run #2	802.11g Chain A	#6 2437MHz	16.7	16.5	Radiated Emissions, 1 - 26 GHz	FCC 15.209 / 15.247	40.7dBµV/m @ 1329.9MHz (-13.3dB)
	802.11g Chain B	#6 2437MHz	16.7	16.5			41.1dBµV/m @ 7308.2MHz (-12.9dB)
	802.11n20 Chain A+B	#6 2437MHz	16.7	16.6 16.5			44.3dBµV/m @ 12183.5MHz (-9.7dB)
	802.11n40 Chain A+B	#6 2437MHz	16.7	16.5 16.6			43.3dBµV/m @ 12176.3MHz (-10.7dB)

Top and bottom channels in worst case OFDM mode:

Run # 3	802.11n20 Chain A+B	#1 2412MHz	16.7	16.5 16.6	Radiated Emissions, 1 - 26 GHz	FCC 15.209 / 15.247	47.7dBµV/m @ 12062.8MHz (-6.3dB)
		#11 2462MHz	16.7	16.8 16.5			46.4dBµV/m @ 7387.2MHz (-7.6dB)

### Receiver Spurious Emissions

Run # 4	Receive Chain A,B, A+B	#6, Chain A	-	-	Radiated Emissions, 1 - 7.5 GHz	RSS 210	30.9dBµV/m @ 3729.9MHz (-23.1dB)
		#6, Chain B	-	-			36.2dBµV/m @ 1996.5MHz (-17.8dB)
		#6, Chain A+B	-	-			34.4dBµV/m @ 1996.9MHz (-19.6dB)

Note - the target and measured power are average powers (measured with average power sensor) and are used for reference purposes only. Power is set using " GAIN CONTROL" mode in the DRTU tool.

Use the Gain Control mode of adjusting power. Set power to within ±0.2dB of target (dial in closer to the target value within ± 0.2dB if possible and not just a passing value above the target).

### Modifications Made During Testing

No modifications were made to the EUT during testing

### Deviations From The Standard

No deviations were made from the requirements of the standard.

Client: Intel Corporation	Job Number: J84366
Model: Intel® Centrino® Wireless-N 2200	T-Log Number: T84600
	Account Manager: Christine Krebill
Contact: Steve Hackett	
Standard: FCC 15.247	Class: N/A

**Run # 1, Radiated Spurious Emissions, 1-26GHz, 802.11b, Chain A**

Date of Test: 9/30/2011      Test Location:  
 Test Engineer: Rafael Varelas      Config Change: none

**Run # 1a, EUT on Channel #1 2412MHz - 802.11b, Chain A**

	Target (dBm)	Power Settings Measured (dBm)	Software Setting
Chain A	15.7	15.8	21.0

**Spurious Radiated Emissions:**

Frequency MHz	Level dBμV/m	Pol v/h	15.209/15.247		Detector Pk/QP/Avg	Azimuth degrees	Height meters	Comments
			Limit	Margin				
4720.720	32.6	H	54.0	-21.4	AVG	338	1.8	RB 1 MHz;VB 10 Hz;Pk
4738.920	43.2	H	74.0	-30.8	PK	338	1.8	RB 1 MHz;VB 3 MHz;Pk
1198.300	32.4	V	54.0	-21.6	AVG	116	1.0	RB 1 MHz;VB 10 Hz;Pk
1196.430	44.7	V	74.0	-29.3	PK	116	1.0	RB 1 MHz;VB 3 MHz;Pk

Note 1: For emissions in restricted bands, the limit of 15.209 was used. For all other emissions, the limit is -30dBc for peak measurements in a measurement bandwidth of 100kHz.

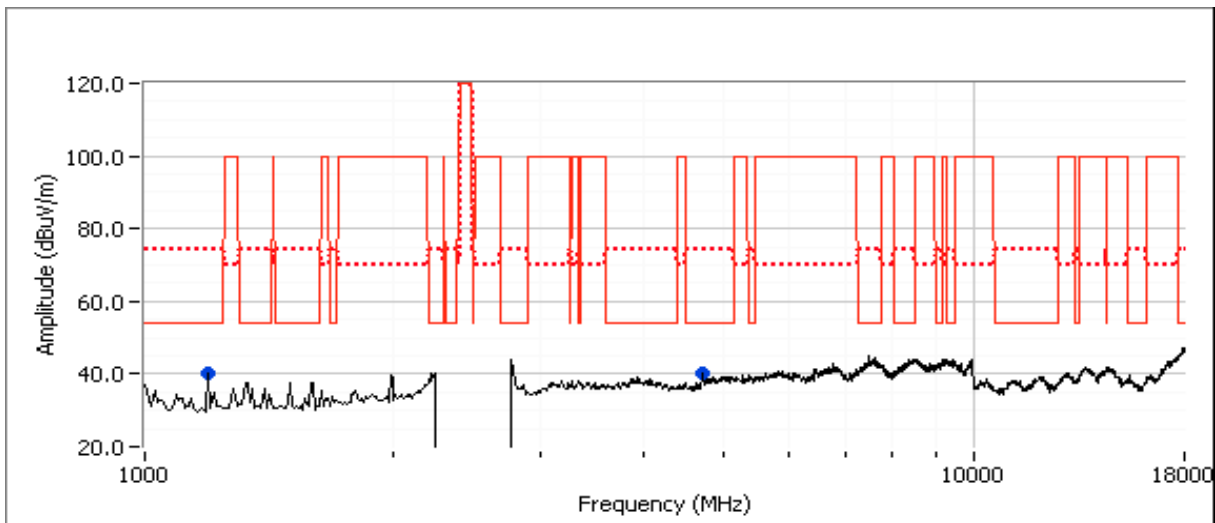

Client: Intel Corporation	Job Number: J84366
Model: Intel® Centrino® Wireless-N 2200	T-Log Number: T84600
	Account Manager: Christine Krebill
Contact: Steve Hackett	
Standard: FCC 15.247	Class: N/A

Run # 1b: , EUT on Channel #6 2437MHz - 802.11b, Chain A

	Target (dBm)	Power Settings Measured (dBm)	Software Setting
Chain A	16.2	16.3	21.5

**Spurious Radiated Emissions:**

Frequency	Level	Pol	15.209/15.247		Detector	Azimuth	Height	Comments
MHz	dB $\mu$ V/m	v/h	Limit	Margin	Pk/QP/Avg	degrees	meters	
4874.020	36.4	V	54.0	-17.6	AVG	226	1.0	RB 1 MHz;VB 10 Hz;Pk
4873.920	44.3	V	74.0	-29.7	PK	226	1.0	RB 1 MHz;VB 3 MHz;Pk
1329.380	31.0	V	54.0	-23.0	AVG	124	1.0	RB 1 MHz;VB 10 Hz;Pk
1328.310	45.1	V	74.0	-28.9	PK	124	1.0	RB 1 MHz;VB 3 MHz;Pk

Note 1: For emissions in restricted bands, the limit of 15.209 was used. For all other emissions, the limit is -30dBc for peak measurements in a measurement bandwidth of 100kHz.

Note 2: Scans made between 18 - 26GHz with the measurement antenna moved around the card and its antennas 20-50cm from the device indicated there were no significant emissions in this frequency range

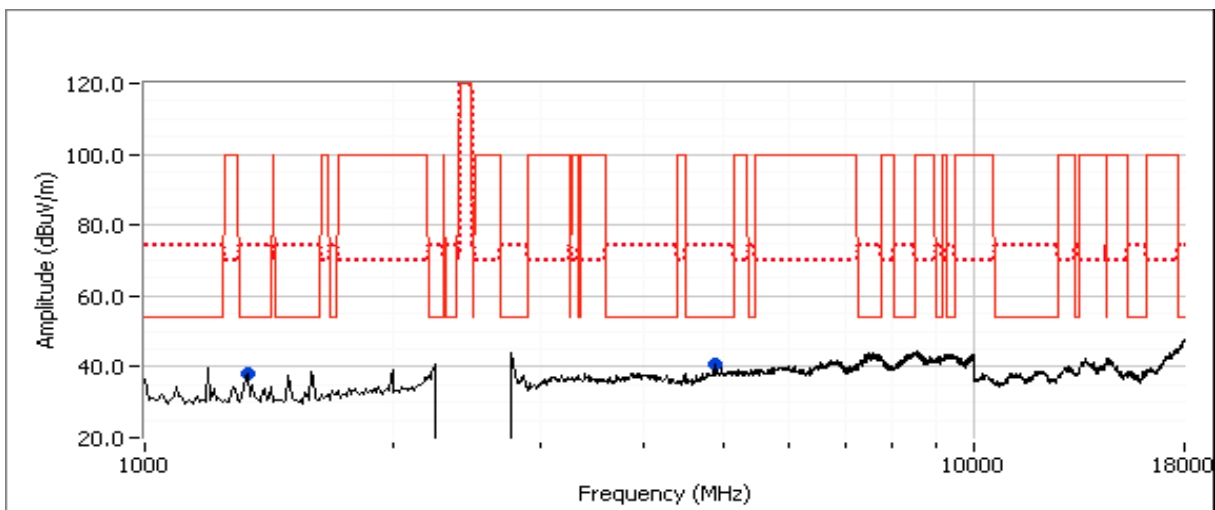

Client: Intel Corporation	Job Number: J84366
Model: Intel® Centrino® Wireless-N 2200	T-Log Number: T84600
	Account Manager: Christine Krebill
Contact: Steve Hackett	
Standard: FCC 15.247	Class: N/A

Run # 1c: , EUT on Channel #11 2462MHz - 802.11b, Chain A

	Target (dBm)	Power Settings Measured (dBm)	Software Setting
Chain A	16.2	16.2	21.5

**Spurious Radiated Emissions:**

Frequency MHz	Level dB $\mu$ V/m	Pol v/h	15.209/15.247 Limit Margin		Detector Pk/QP/Avg	Azimuth degrees	Height meters	Comments
4923.980	38.3	V	54.0	-15.7	AVG	124	1.0	RB 1 MHz;VB 10 Hz;Pk
4923.660	46.5	V	74.0	-27.5	PK	124	1.0	RB 1 MHz;VB 3 MHz;Pk
1198.450	32.5	V	54.0	-21.5	AVG	192	1.0	RB 1 MHz;VB 10 Hz;Pk
1199.410	44.4	V	74.0	-29.6	PK	192	1.0	RB 1 MHz;VB 3 MHz;Pk

Note 1: For emissions in restricted bands, the limit of 15.209 was used. For all other emissions, the limit is -30dBc for peak measurements in a measurement bandwidth of 100kHz.

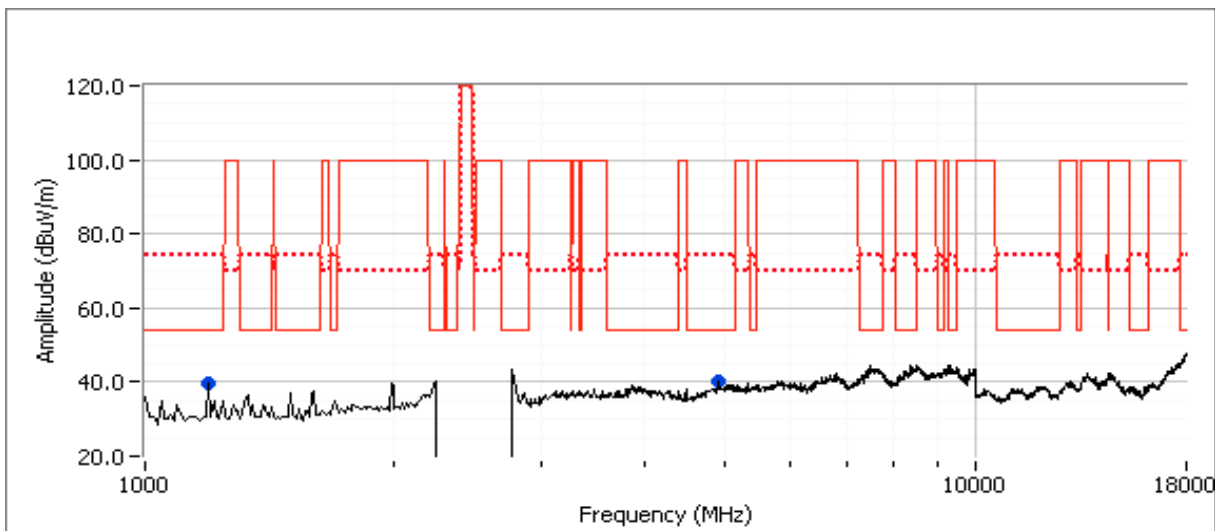



Client: Intel Corporation	Job Number: J84366
Model: Intel® Centrino® Wireless-N 2200	T-Log Number: T84600
	Account Manager: Christine Krebill
Contact: Steve Hackett	
Standard: FCC 15.247	Class: N/A

**Run # 1d, EUT on Channel #1 2412MHz - 802.11b, Chain B**

Date of Test: 10/4/2011

Test Location: FT Chamber #5

Test Engineer: Joseph Cadigal

Config Change: none

	Target (dBm)	Power Settings Measured (dBm)	Software Setting
Chain B	15.2	15.3	20.5

**Spurious Radiated Emissions:**

Frequency MHz	Level dB $\mu$ V/m	Pol v/h	15.209/15.247		Detector Pk/QP/Avg	Azimuth degrees	Height meters	Comments
			Limit	Margin				
7544.300	37.0	V	54.0	-17.0	AVG	54	1.9	RB 1 MHz;VB 10 Hz;Pk
1596.360	30.1	V	54.0	-23.9	AVG	224	1.3	RB 1 MHz;VB 10 Hz;Pk
7544.470	48.2	V	74.0	-25.8	PK	54	1.9	RB 1 MHz;VB 3 MHz;Pk
1321.880	26.3	H	54.0	-27.7	AVG	159	1.9	RB 1 MHz;VB 10 Hz;Pk
1596.670	43.6	V	74.0	-30.4	PK	224	1.3	RB 1 MHz;VB 3 MHz;Pk
1321.600	40.0	H	74.0	-34.0	PK	159	1.9	RB 1 MHz;VB 3 MHz;Pk

Note 1: For emissions in restricted bands, the limit of 15.209 was used. For all other emissions, the limit is -30dBc for peak measurements in a measurement bandwidth of 100kHz.

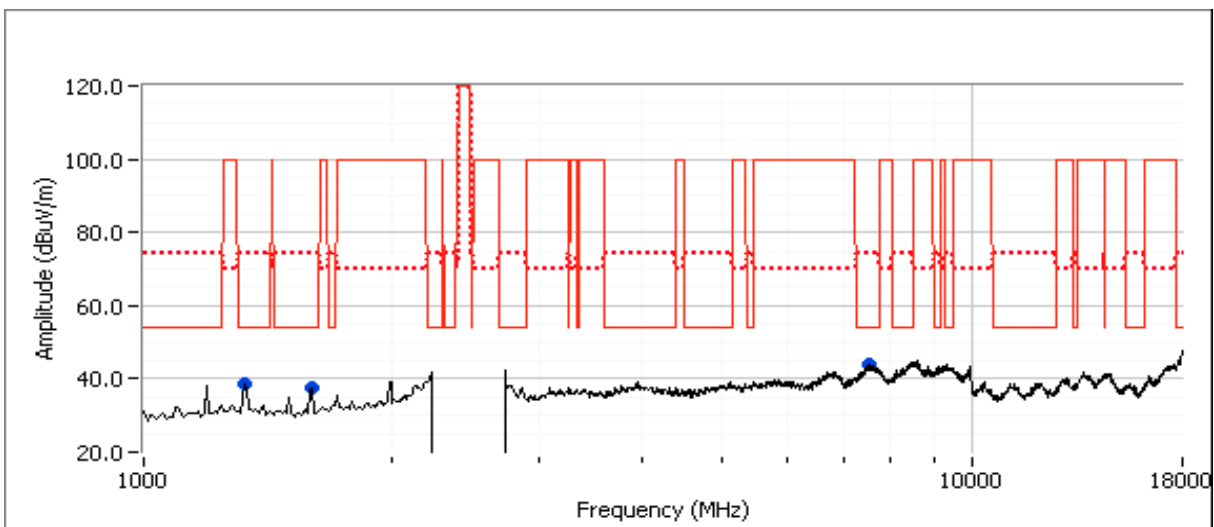

Client: Intel Corporation	Job Number: J84366
Model: Intel® Centrino® Wireless-N 2200	T-Log Number: T84600
	Account Manager: Christine Krebill
Contact: Steve Hackett	
Standard: FCC 15.247	Class: N/A

Run # 1e: , EUT on Channel #6 2437MHz - 802.11b, Chain B

	Target (dBm)	Power Settings Measured (dBm)	Software Setting
Chain B	15.7	15.8	21.0

**Spurious Radiated Emissions:**

Frequency	Level	Pol	15.209/15.247		Detector	Azimuth	Height	Comments
MHz	dB $\mu$ V/m	v/h	Limit	Margin	Pk/QP/Avg	degrees	meters	
1327.550	36.0	H	54.0	-18.0	AVG	220	1.6	RB 1 MHz;VB 10 Hz;Pk
4869.130	32.4	V	54.0	-21.6	AVG	139	1.3	RB 1 MHz;VB 10 Hz;Pk
1327.200	47.9	H	74.0	-26.1	PK	220	1.6	RB 1 MHz;VB 3 MHz;Pk
4870.510	44.4	V	74.0	-29.6	PK	139	1.3	RB 1 MHz;VB 3 MHz;Pk

Note 1: For emissions in restricted bands, the limit of 15.209 was used. For all other emissions, the limit is -30dBc for peak measurements in a measurement bandwidth of 100kHz.

Note 2: Scans made between 18 - 26GHz with the measurement antenna moved around the card and its antennas 20-50cm from the device indicated there were no significant emissions in this frequency range

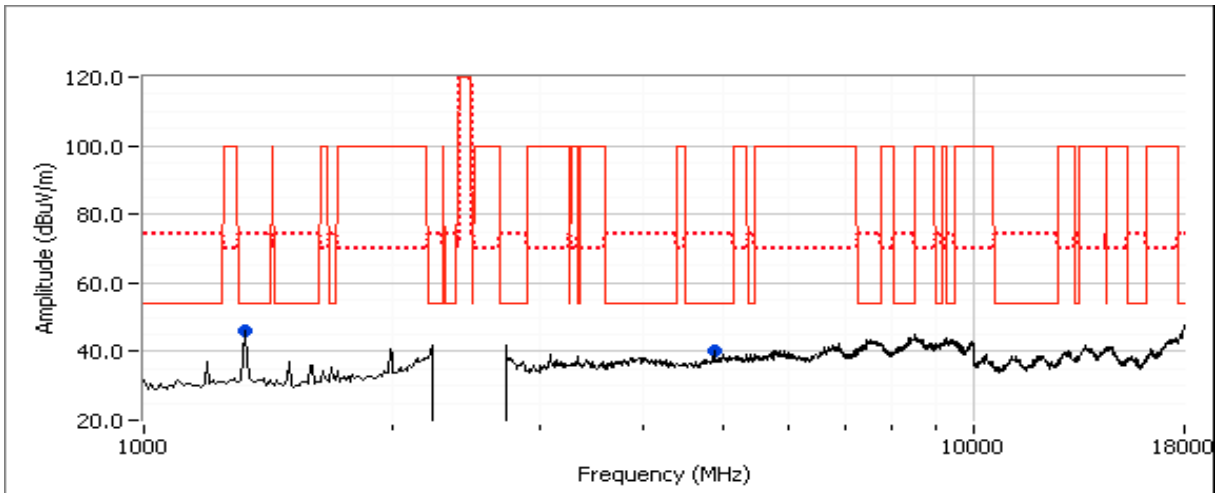

Client: Intel Corporation	Job Number: J84366
Model: Intel® Centrino® Wireless-N 2200	T-Log Number: T84600
	Account Manager: Christine Krebill
Contact: Steve Hackett	
Standard: FCC 15.247	Class: N/A

Run # 1f: , EUT on Channel #11 2462MHz - 802.11b, Chain B

	Target (dBm)	Power Settings Measured (dBm)	Software Setting
Chain B	15.7	15.8	21.5

**Spurious Radiated Emissions:**

Frequency MHz	Level dB $\mu$ V/m	Pol v/h	15.209/15.247		Detector Pk/QP/Avg	Azimuth degrees	Height meters	Comments
			Limit	Margin				
7518.880	37.1	H	54.0	-16.9	AVG	135	1.9	RB 1 MHz;VB 10 Hz;Pk
1329.860	31.0	V	54.0	-23.0	AVG	149	1.5	RB 1 MHz;VB 10 Hz;Pk
7518.830	49.0	H	74.0	-25.0	PK	135	1.9	RB 1 MHz;VB 3 MHz;Pk
4499.790	43.3	V	70.0	-26.7	PK	177	1.0	RB 1 MHz;VB 3 MHz;Pk
1329.060	45.6	V	74.0	-28.4	PK	149	1.5	RB 1 MHz;VB 3 MHz;Pk
1253.350	38.0	V	70.0	-32.0	PK	175	1.2	RB 1 MHz;VB 3 MHz;Pk
4500.000	35.1	V	100.0	-64.9	AVG	177	1.0	RB 1 MHz;VB 10 Hz;Pk
1252.440	26.1	V	100.0	-73.9	AVG	175	1.2	RB 1 MHz;VB 10 Hz;Pk

Note 1: For emissions in restricted bands, the limit of 15.209 was used. For all other emissions, the limit is -30dBc for peak measurements in a measurement bandwidth of 100kHz.

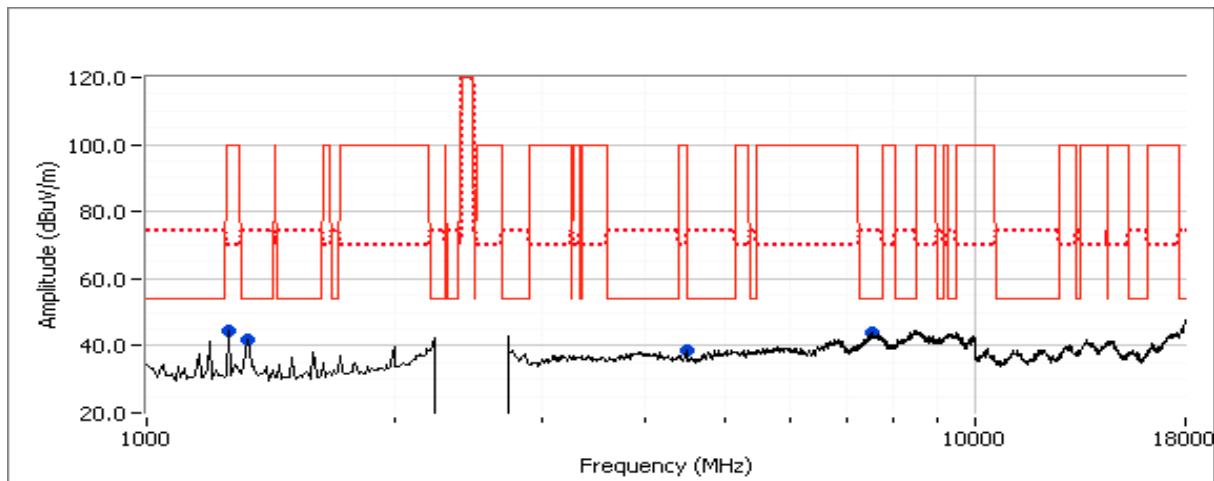

Client: Intel Corporation	Job Number: J84366
Model: Intel® Centrino® Wireless-N 2200	T-Log Number: T84600
	Account Manager: Christine Krebill
Contact: Steve Hackett	
Standard: FCC 15.247	Class: N/A

**Run # 2, Radiated Spurious Emissions, 1-26GHz, 802.11g/n20/n40**

Date of Test: 10/5/2011      Test Location: FT5  
 Test Engineer: John Caizzi      Config Change: none

**Run # 2a, EUT on Channel #6 2437MHz - 802.11g, Chain A**

	Target (dBm)	Power Settings Measured (dBm)	Software Setting
Chain A	16.7	16.5	27.5

**Spurious Radiated Emissions:**

Frequency MHz	Level dBμV/m	Pol v/h	15.209/15.247		Detector Pk/QP/Avg	Azimuth degrees	Height meters	Comments
			Limit	Margin				
1330.000	44.6	H	54.0	-9.4	Peak	251	1.9	
7316.670	43.0	V	54.0	-11.0	Peak	66	1.9	
4492.500	38.3	V	70.0	-31.7	Peak	235	1.0	
7310.200	39.4	V	54.0	-14.6	AVG	91	1.35	
7316.740	50.6	V	74.0	-23.4	PK	91	1.35	
4500.020	36.0	V	54.0	-18.0	AVG	167	1.32	
4499.950	44.2	V	70.0	-25.8	PK	167	1.32	
1329.930	40.7	H	54.0	-13.3	AVG	265	1.65	
1330.600	48.0	H	74.0	-26.0	PK	265	1.65	

Note 1: For emissions in restricted bands, the limit of 15.209 was used. For all other emissions, the limit is -30dBc for peak measurements in a measurement bandwidth of 100kHz.

Note 2: Scans made between 18 - 26GHz with the measurement antenna moved around the card and its antennas 20-50cm from the device indicated there were no significant emissions in this frequency range

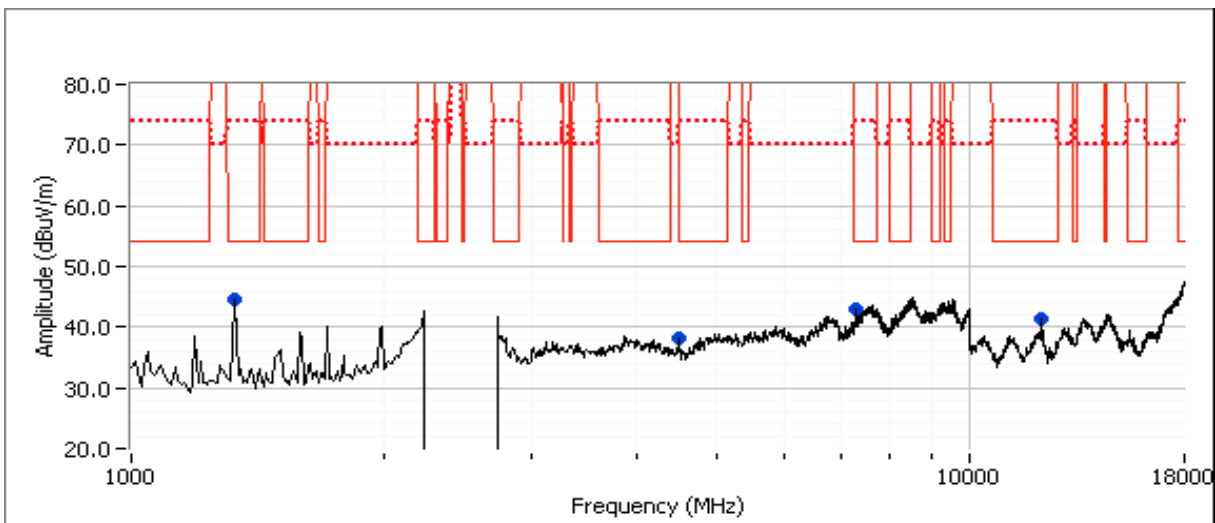

Client: Intel Corporation	Job Number: J84366
Model: Intel® Centrino® Wireless-N 2200	T-Log Number: T84600
	Account Manager: Christine Krebill
Contact: Steve Hackett	
Standard: FCC 15.247	Class: N/A

Run # 2b: , EUT on Channel #6 2437MHz - 802.11g, Chain B

	Target (dBm)	Power Settings Measured (dBm)	Software Setting
Chain A	16.7	16.5	27.5

**Spurious Radiated Emissions:**

Frequency	Level	Pol	15.209/15.247		Detector	Azimuth	Height	Comments
MHz	dB $\mu$ V/m	v/h	Limit	Margin	Pk/QP/Avg	degrees	meters	
1595.830	38.1	V	54.0	-15.9	Peak	108	1.0	
7305.000	45.3	V	54.0	-8.7	Peak	273	1.6	
1593.760	32.9	V	54.0	-21.1	AVG	171	1.07	
1593.530	46.5	V	74.0	-27.5	PK	171	1.07	
7308.200	41.1	V	54.0	-12.9	AVG	269	1.62	
7311.530	52.1	V	74.0	-21.9	PK	269	1.62	

- Note 1: For emissions in restricted bands, the limit of 15.209 was used. For all other emissions, the limit is -30dBc for peak measurements in a measurement bandwidth of 100kHz.
- Note 2: Scans made between 18 - 26GHz with the measurement antenna moved around the card and its antennas 20-50cm from the device indicated there were no significant emissions in this frequency range

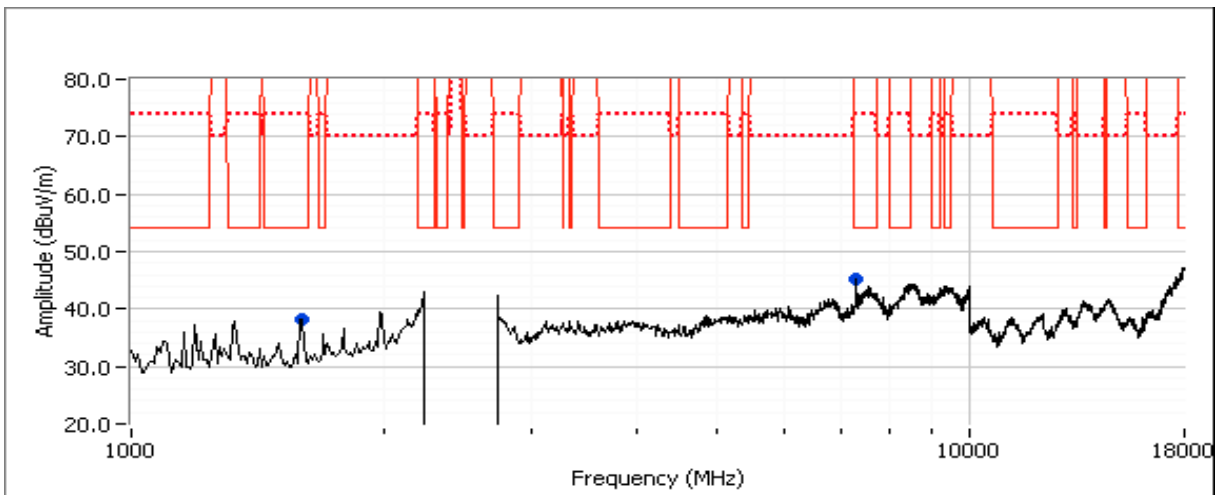

Client: Intel Corporation	Job Number: J84366
Model: Intel® Centrino® Wireless-N 2200	T-Log Number: T84600
	Account Manager: Christine Krebill
Contact: Steve Hackett	
Standard: FCC 15.247	Class: N/A

**Run # 2c: , EUT on Channel #6 2437MHz - 802.11n20, Chain A+B**

Chain	Target (dBm)				Measured (dBm)				Software Setting
	A	B	C	Total	A	B	C	Total	
	16.7	16.7		19.7	16.6	16.5		19.6	30.5/31.5

**Spurious Radiated Emissions:**

Frequency	Level	Pol	15.209/15.247		Detector	Azimuth	Height	Comments
MHz	dB $\mu$ V/m	v/h	Limit	Margin	Pk/QP/Avg	degrees	meters	
12173.330	47.5	V	54.0	-6.5	Peak	259	1.3	
7310.830	43.8	V	54.0	-10.2	Peak	245	1.3	
4868.330	42.6	V	54.0	-11.4	Peak	156	1.3	
1320.830	42.6	V	54.0	-11.4	Peak	267	1.6	
4874.010	35.9	V	54.0	-18.1	AVG	155	1.33	
4874.050	45.6	V	74.0	-28.4	PK	155	1.33	
7312.300	43.2	V	54.0	-10.8	AVG	245	2.10	
7309.560	54.1	V	74.0	-19.9	PK	245	2.10	
1330.630	37.3	V	54.0	-16.7	AVG	265	1.60	
1330.030	48.1	V	74.0	-25.9	PK	265	1.60	
12183.460	44.3	V	54.0	-9.7	AVG	220	1.21	
12180.800	56.0	V	74.0	-18.0	PK	220	1.21	

Note 1: For emissions in restricted bands, the limit of 15.209 was used. For all other emissions, the limit is -30dBc for peak measurements in a measurement bandwidth of 100kHz.

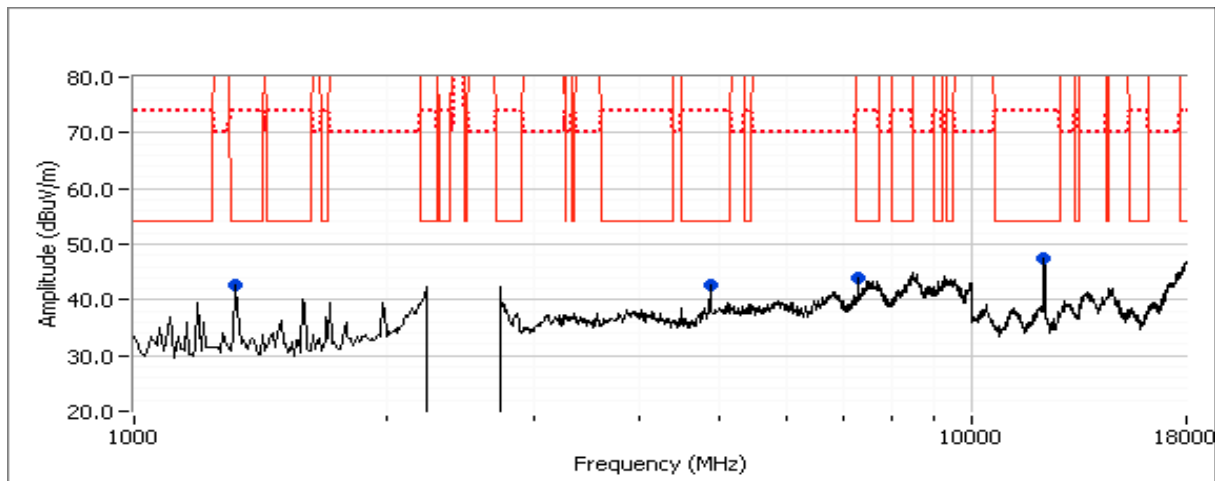

Client: Intel Corporation	Job Number: J84366
Model: Intel® Centrino® Wireless-N 2200	T-Log Number: T84600
	Account Manager: Christine Krebill
Contact: Steve Hackett	
Standard: FCC 15.247	Class: N/A

**Run # 2d: , EUT on Channel #6 2437MHz - 802.11n40, Chain A+B**

Chain	Target (dBm)				Measured (dBm)				Software Setting
	A	B	C	Total	A	B	C	Total	
	16.7	16.7		19.7	16.5	16.6		19.6	31.5/32.0

**Spurious Radiated Emissions:**

Frequency MHz	Level dBμV/m	Pol v/h	15.209/15.247		Detector Pk/QP/Avg	Azimuth degrees	Height meters	Comments
			Limit	Margin				
12186.670	47.4	V	54.0	-6.6	Peak	212	1.0	
7305.000	43.0	V	54.0	-11.0	Peak	184	1.6	
4868.330	39.4	H	54.0	-14.6	Peak	0	1.0	
1980.830	40.8	H	70.0	-29.2	Peak	217	1.0	
4873.930	35.2	H	54.0	-18.8	AVG	87	1.02	
4890.260	45.2	H	74.0	-28.8	PK	87	1.02	
7312.200	41.8	V	54.0	-12.2	AVG	253	1.61	
7311.930	53.6	V	74.0	-20.4	PK	253	1.61	
12176.340	43.3	V	54.0	-10.7	AVG	136	1.11	
12185.670	56.2	V	74.0	-17.8	PK	136	1.11	

Note 1: For emissions in restricted bands, the limit of 15.209 was used. For all other emissions, the limit is -30dBc for peak measurements in a measurement bandwidth of 100kHz.

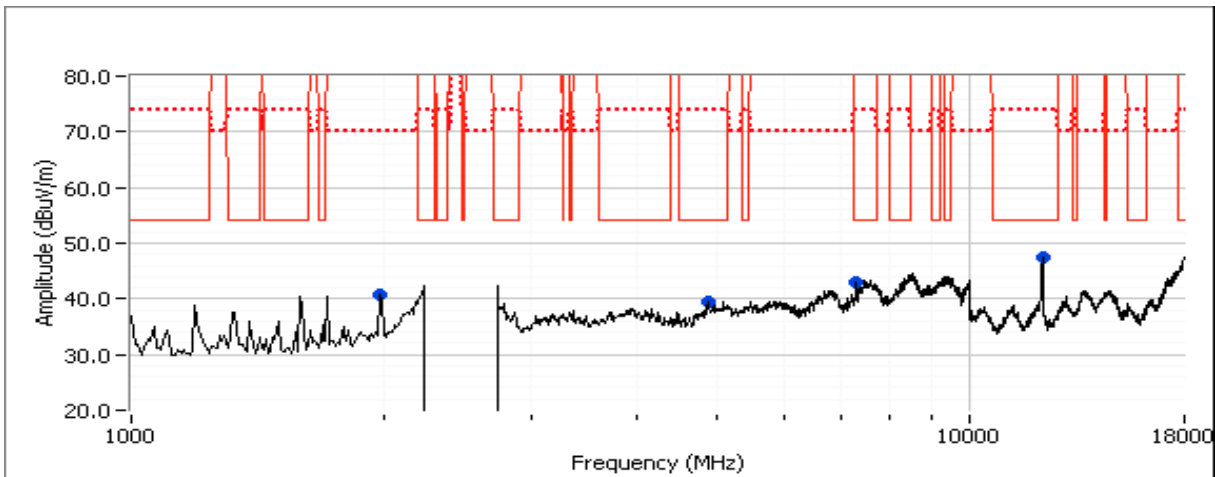

Client: Intel Corporation	Job Number: J84366
Model: Intel® Centrino® Wireless-N 2200	T-Log Number: T84600
	Account Manager: Christine Krebill
Contact: Steve Hackett	
Standard: FCC 15.247	Class: N/A

**Run # 3, Radiated Spurious Emissions, 1-26GHz, 802.11n20, Chain A+B**

Date of Test: 10/5/2011

Test Location: FT4

Test Engineer: John Caizzi / R. Varelas

Config Change: none

**Run # 3a, EUT on Channel #1, 2412MHz**

Chain	Target (dBm)				Power Settings Measured (dBm)				Software Setting
	A	B	C	Total	A	B	C	Total	
	16.7	16.7		19.7	16.5	16.6		19.6	31.0/31.5

**Spurious Radiated Emissions:**

Frequency	Level	Pol	15.209/15.247		Detector	Azimuth	Height	Comments
MHz	dB $\mu$ V/m	v/h	Limit	Margin	Pk/QP/Avg	degrees	meters	
12062.830	47.7	V	54.0	-6.3	AVG	244	1.1	RB 1 MHz;VB 10 Hz;Pk
12065.890	60.1	V	74.0	-13.9	PK	244	1.1	RB 1 MHz;VB 3 MHz;Pk
7242.380	54.6	V	70.0	-15.4	Peak	88	1.6	

Note 1: For emissions in restricted bands, the limit of 15.209 was used. For all other emissions, the limit is -30dBc for peak measurements in a measurement bandwidth of 100kHz.

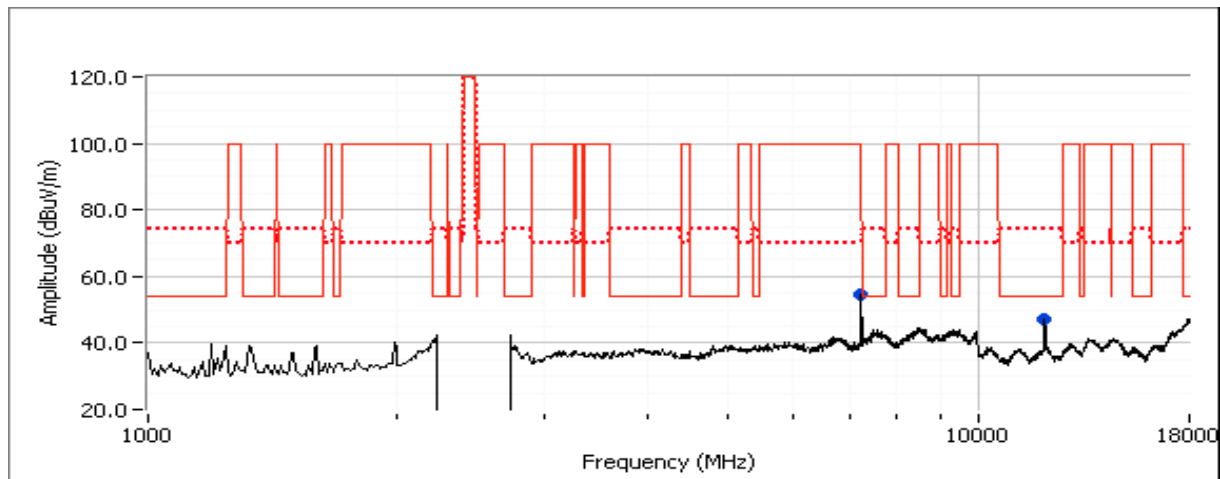



Client: Intel Corporation	Job Number: J84366
Model: Intel® Centrino® Wireless-N 2200	T-Log Number: T84600
	Account Manager: Christine Krebill
Contact: Steve Hackett	
Standard: FCC 15.247	Class: N/A

**Run # 3c: , EUT on Channel #11, 2462MHz**

Chain	Target (dBm)				Power Settings Measured (dBm)				Software Setting
	A	B	C	Total	A	B	C	Total	
	16.7	16.7		19.7	16.8	16.5		19.7	32.0/32.0

**Spurious Radiated Emissions:**

Frequency	Level	Pol	15.209/15.247		Detector	Azimuth	Height	Comments
MHz	dB $\mu$ V/m	v/h	Limit	Margin	Pk/QP/Avg	degrees	meters	
7387.200	46.4	V	54.0	-7.6	AVG	112	1.3	RB 1 MHz;VB 10 Hz;Pk
7379.860	57.2	V	74.0	-16.8	PK	112	1.3	RB 1 MHz;VB 3 MHz;Pk
12303.970	43.0	V	54.0	-11.0	AVG	172	1.5	RB 1 MHz;VB 10 Hz;Pk
12304.100	55.0	V	74.0	-19.0	PK	172	1.5	RB 1 MHz;VB 3 MHz;Pk
4923.930	36.2	V	54.0	-17.8	AVG	231	1.4	RB 1 MHz;VB 10 Hz;Pk
4923.590	45.8	V	74.0	-28.2	PK	231	1.4	RB 1 MHz;VB 3 MHz;Pk
4492.500	39.3	V	70.0	-30.7	Peak	177	1.0	

Note 1: For emissions in restricted bands, the limit of 15.209 was used. For all other emissions, the limit is -30dBc for peak measurements in a measurement bandwidth of 100kHz.

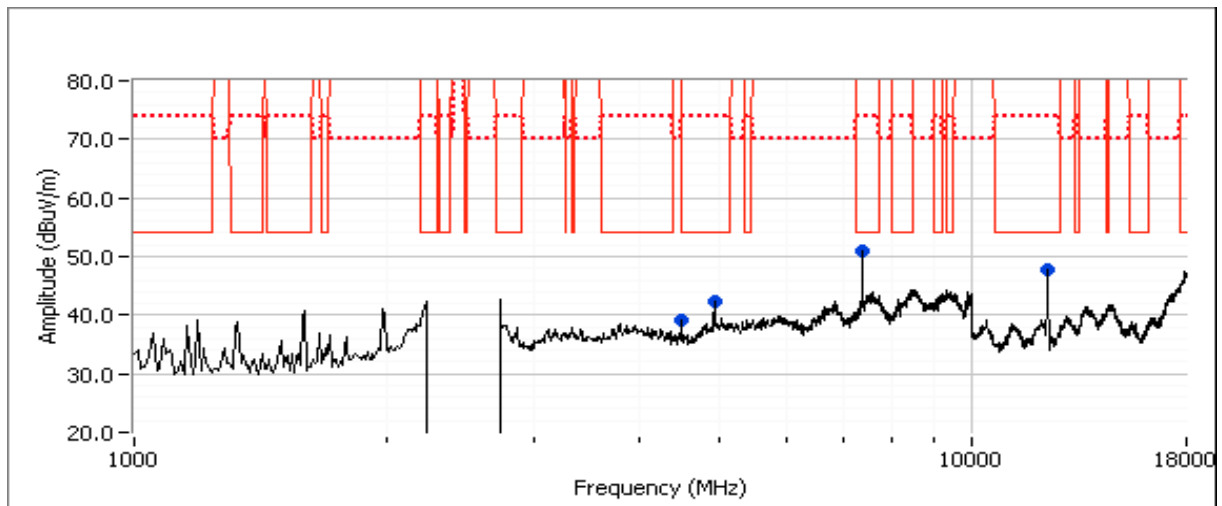

Client: Intel Corporation	Job Number: J84366
Model: Intel® Centrino® Wireless-N 2200	T-Log Number: T84600
	Account Manager: Christine Krebill
Contact: Steve Hackett	
Standard: FCC 15.247	Class: N/A

Run # 4, Radiated Spurious Emissions, 1-26GHz, Receive, Chain A, B, A+B  
 Date of Test: 10/5/2011 Test Location: FT4  
 Test Engineer: Rafaekl Varelas Config Change: none  
 Run # 4a, EUT on Channel #6 2437MHz - Receive, Chain A

Frequency MHz	Level dBμV/m	Pol v/h	RSS 210		Detector Pk/QP/Avg	Azimuth degrees	Height meters	Comments
			Limit	Margin				
3729.880	30.9	H	54.0	-23.1	AVG	226	1.0	RB 1 MHz;VB 10 Hz;Pk
3736.040	46.8	H	74.0	-27.2	PK	226	1.0	RB 1 MHz;VB 3 MHz;Pk
1248.040	28.9	V	54.0	-25.1	AVG	23	1.0	RB 1 MHz;VB 10 Hz;Pk
1245.460	51.2	V	74.0	-22.8	PK	23	1.0	RB 1 MHz;VB 3 MHz;Pk
1711.650	30.7	V	54.0	-23.3	AVG	101	1.0	RB 1 MHz;VB 10 Hz;Pk
1710.650	42.2	V	74.0	-31.8	PK	101	1.0	RB 1 MHz;VB 3 MHz;Pk

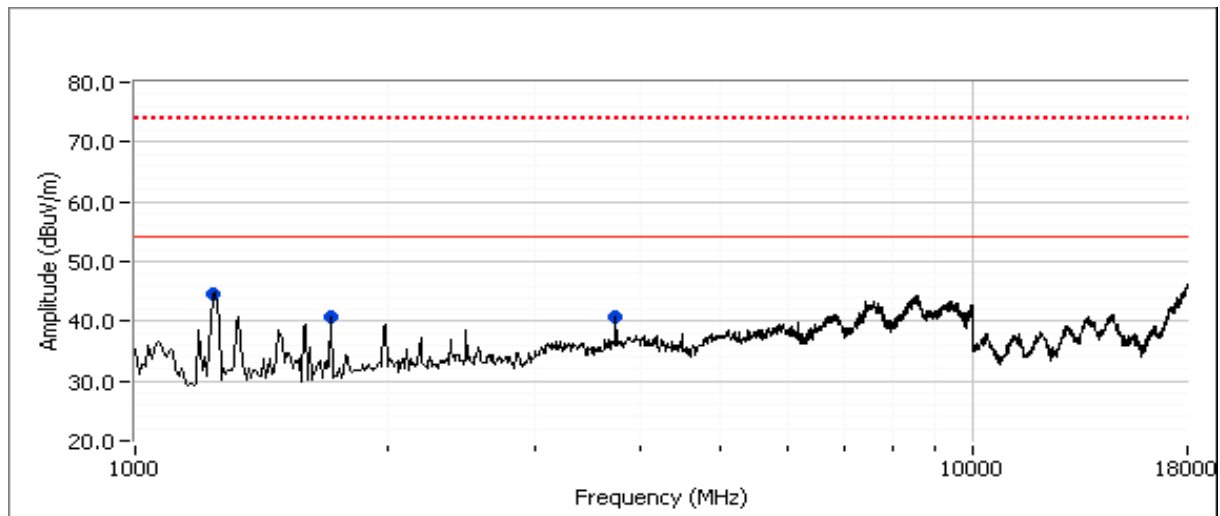

Client: Intel Corporation		Job Number: J84366
Model: Intel® Centrino® Wireless-N 2200		T-Log Number: T84600
Contact: Steve Hackett		Account Manager: Christine Krebill
Standard: FCC 15.247		Class: N/A

**Run # 4b: EUT on Channel #6 2437MHz - Receive, Chain B**

Frequency MHz	Level dB $\mu$ V/m	Pol v/h	RSS 210		Detector Pk/QP/Avg	Azimuth degrees	Height meters	Comments
			Limit	Margin				
1996.520	36.2	H	54.0	-17.8	AVG	219	1.0	RB 1 MHz;VB 10 Hz;Pk
1994.390	48.3	H	74.0	-25.7	PK	219	1.0	RB 1 MHz;VB 3 MHz;Pk
1229.520	26.6	V	54.0	-27.4	AVG	186	1.7	RB 1 MHz;VB 10 Hz;Pk
1232.860	35.8	V	74.0	-38.2	PK	186	1.7	RB 1 MHz;VB 3 MHz;Pk

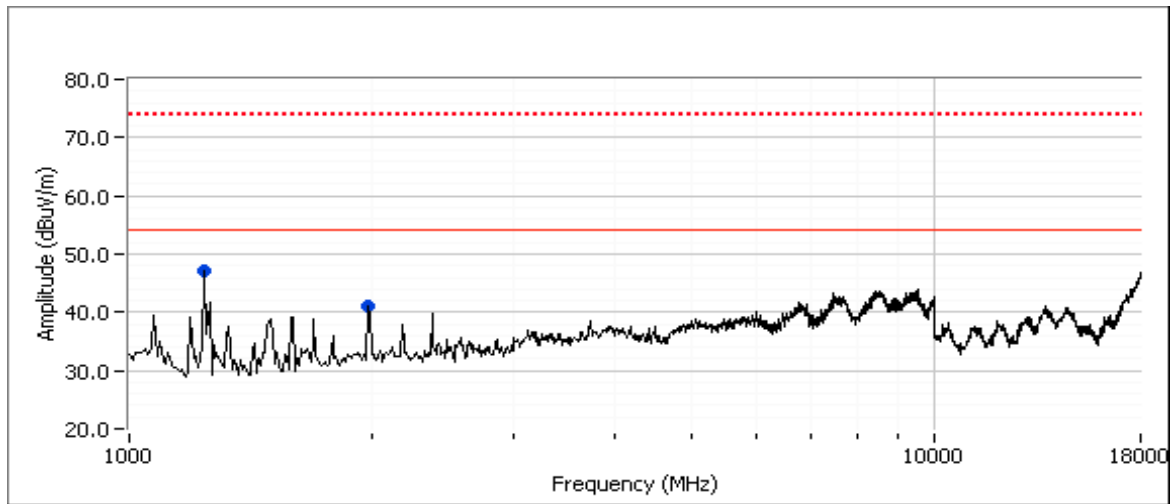

Client: Intel Corporation		Job Number: J84366
Model: Intel® Centrino® Wireless-N 2200		T-Log Number: T84600
Contact: Steve Hackett		Account Manager: Christine Krebill
Standard: FCC 15.247		Class: N/A

### Run # 4c: EUT on Channel #6 2437MHz - Receive, Chain A+B

Frequency MHz	Level dB $\mu$ V/m	Pol v/h	RSS 210		Detector Pk/QP/Avg	Azimuth degrees	Height meters	Comments
			Limit	Margin				
1996.880	34.4	H	54.0	-19.6	AVG	129	1.0	RB 1 MHz;VB 10 Hz;Pk
1997.110	47.3	H	74.0	-26.7	PK	129	1.0	RB 1 MHz;VB 3 MHz;Pk
1244.900	27.7	H	54.0	-26.3	AVG	134	1.0	RB 1 MHz;VB 10 Hz;Pk
1251.530	38.2	H	74.0	-35.8	PK	134	1.0	RB 1 MHz;VB 3 MHz;Pk

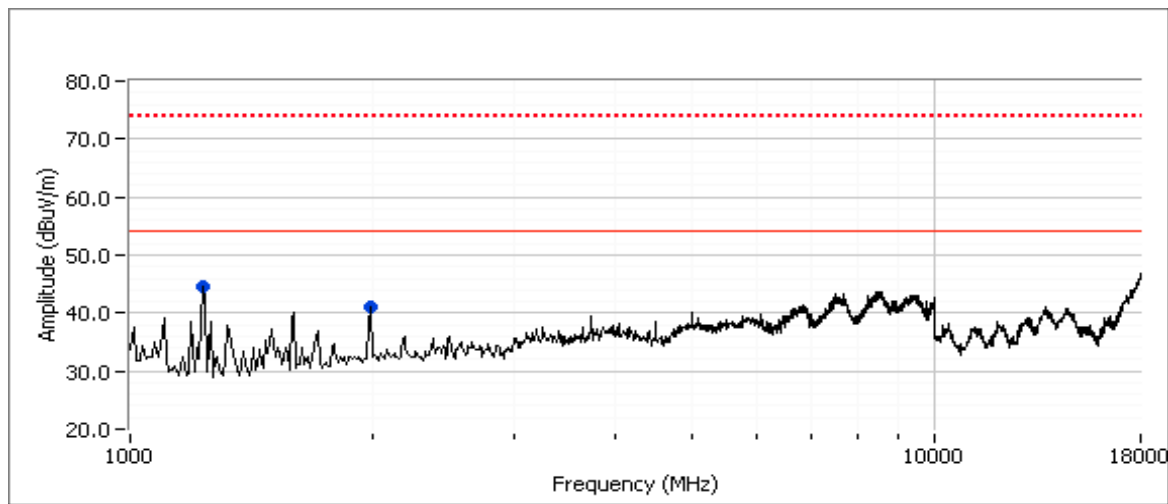

Client: Intel Corporation	Job Number: J84366
Model: Intel® Centrino® Wireless-N 2200	T-Log Number: T84600
	Account Manager: Christine Krebill
Contact: Steve Hackett	
Standard: FCC 15.247	Class: N/A

### RSS 210 and FCC 15.247 (DTS) Antenna Port Measurements Power, PSD, Bandwidth and Spurious Emissions

#### Test Specific Details

Objective: The objective of this test session is to perform final qualification testing of the EUT with respect to the specification listed above.

Date of Test: 10/5/2011 & 10/18/2011	Config. Used: 1
Test Engineer: Rafael Varelas / Joseph Cadigal	Config Change: none
Test Location: Fremont Chamber #4	EUT Voltage: 120V/60Hz

#### General Test Configuration

The EUT was connected to the spectrum analyzer or power meter via a suitable attenuator. All measurements were made on a single chain.

All measurements have been corrected to allow for the external attenuators used.

#### Ambient Conditions:

	5-Oct	18-Oct
Temperature:	20.4 °C	213 °C
Rel. Humidity:	37 %	38 %

#### Summary of Results

MAC Address: 001500825F4C DRTU Tool Version **1.5.3.0322** Driver version **15.0.0.61**

Run #	Test Performed	Limit	Pass / Fail	Result / Margin
1	Output Power	15.247(b)	Pass	802.11b: 0.036 W 802.11g: 0.100 W 802.11n20: 0.043 W 802.11n40: 0.021 W
2	Power spectral Density (PSD)	15.247(d)	Pass	-7.5 dBm/3kHz
3	Minimum 6dB Bandwidth	15.247(a)	Pass	12.3 MHz
3	99% Bandwidth	RSS GEN	-	802.11b: 15.1 MHz 802.11g: 18.6MHz 802.11n20: 17.8 MHz 802.11n40: 38.6 MHz
4	Spurious emissions	15.247(b)	Pass	All emissions below -20dBc & -30dBc limit

Client: Intel Corporation	Job Number: J84366
Model: Intel® Centrino® Wireless-N 2200	T-Log Number: T84600
	Account Manager: Christine Krebill
Contact: Steve Hackett	
Standard: FCC 15.247	Class: N/A

### Modifications Made During Testing

No modifications were made to the EUT during testing

### Deviations From The Standard

No deviations were made from the requirements of the standard.

### Run #1: Output Power

Power Setting <sup>2</sup>	Frequency (MHz)	Output Power		Antenna Gain (dBi)	Result	EIRP		Output Power		
		(dBm) <sup>1</sup>	mW			dBm	W	(dBm) <sup>3</sup>	mW	
<b>802.11b Mode</b>										
21.0	2412	15.0	31.6	3.2	Pass	18.2	0.066	15.3	33.9	
21.5	2437	15.6	36.3	3.2	Pass	18.8	0.076	15.8	38.0	
21.5	2462	15.5	35.5	3.2	Pass	18.7	0.074	15.7	37.2	

Note 1: Output power measured using a spectrum analyzer (see plots below) with RBW=1MHz, VB=3 MHz, sample detector, power averaging on (transmitted signal was continuous) and power integration over 50 MHz (option #2, method 1 in KDB 558074, equivalent to method 1 of DA-02-2138A1 for U-NII devices). Spurious limit becomes -30dBc.

Note 2: Power setting - the software power setting used during testing, included for reference only.

Note 3: Output power measured using a avg power meter

Power Setting <sup>2</sup>	Frequency (MHz)	Output Power		Antenna Gain (dBi)	Result	EIRP		Output Power		
		(dBm) <sup>1</sup>	mW			dBm	W	(dBm) <sup>3</sup>	mW	
<b>802.11g Mode</b>										
24.5	2412	19.6	91.2	3.2	Pass	22.8	0.191	14.2	26.3	
27	2437	20.0	100.0	3.2	Pass	23.2	0.209	16.3	42.7	
25	2462	19.7	93.3	3.2	Pass	22.9	0.195	14.3	26.9	

Note 1: Output power measured using a peak power meter, spurious limit is -20dBc.

Note 2: Power setting - the software power setting used during testing, included for reference only.

Note 3: Output power measured using a avg power meter

Power Setting <sup>2</sup>	Frequency (MHz)	Output Power		Antenna Gain (dBi)	Result	EIRP		Output Power		
		(dBm) <sup>1</sup>	mW			dBm	W	(dBm) <sup>3</sup>	mW	
<b>802.11n20 Mode</b>										
24	2412	12.7	18.6	3.2	Pass	15.9	0.039	13.3	21.4	
28.5	2437	16.3	43.1	3.2	Pass	19.5	0.090	16.8	47.9	
24	2462	12.5	17.7	3.2	Pass	15.7	0.037	13.2	20.9	

Note 1: Output power measured using a spectrum analyzer (see plots below) with RBW=1MHz, VB=3 MHz, sample detector, power averaging on (transmitted signal was continuous) and power integration over 50 MHz (option #2, method 1 in KDB 558074, equivalent to method 1 of DA-02-2138A1 for U-NII devices). Spurious limit becomes -30dBc.

Note 2: Power setting - the software power setting used during testing, included for reference only.

Note 3: Output power measured using a avg power meter

Client: Intel Corporation	Job Number: J84366
Model: Intel® Centrino® Wireless-N 2200	T-Log Number: T84600
	Account Manager: Christine Krebill
Contact: Steve Hackett	
Standard: FCC 15.247	Class: N/A

Power Setting <sup>2</sup>	Frequency (MHz)	Output Power		Antenna Gain (dBi)	Result	EIRP		Output Power	
		(dBm) <sup>1</sup>	mW			dBm	W	(dBm) <sup>3</sup>	mW
<b>802.11n40 Mode</b>									
20	2422	9.0	8.0	3.2	Pass	12.2	0.017	10.2	10.5
24.5	2437	13.3	21.2	3.2	Pass	16.5	0.044	13.8	24.0
20	2452	8.8	7.5	3.2	Pass	12.0	0.016	10.7	11.7

- Note 1: Output power measured using a spectrum analyzer (see plots below) with RBW=1MHz, VB=3 MHz, sample detector, power averaging on (transmitted signal was continuous) and power integration over 50 MHz (option #2, method 1 in KDB 558074, equivalent to method 1 of DA-02-2138A1 for U-NII devices). Spurious limit becomes -30dBc.
- Note 2: Power setting - the software power setting used during testing, included for reference only.
- Note 3: Output power measured using a avg power meter

### Run #2: Power spectral Density

Mode	Power Setting	Frequency (MHz)	PSD	Limit dBm/3kHz	Result
			(dBm/3kHz) <sup>Note 1</sup>		
802.11b	21.0	2412.7162	-11.0	8.0	Pass
	21.5	2436.2455	-10.3	8.0	Pass
	21.5	2462.7582	-10.2	8.0	Pass
802.11g	27.5	2416.6898	-8.6	8.0	Pass
	27.5	2432.3272	-7.8	8.0	Pass
	27.5	2466.9570	-8.2	8.0	Pass
802.11n20	24	2412	-7.5	8.0	Pass
	28.5	2437	-7.5	8.0	Pass
	24	2462	-11.0	8.0	Pass
802.11n40	20	2422	-17.0	8.0	Pass
	24.5	2437	-13.7	8.0	Pass
	20	2452	-19.0	8.0	Pass

- Note 1: Power spectral density measured using RB=3 kHz, VB=10kHz, analyzer with peak detector and with a sweep time set to ensure a dwell time of at least 1 second per 3kHz. The measurement is made at the frequency of PPSD determined from preliminary scans using RB=3kHz using multiple sweeps at a faster rate over the 6dB bandwidth of the signal.

Client: Intel Corporation	Job Number: J84366
Model: Intel® Centrino® Wireless-N 2200	T-Log Number: T84600
	Account Manager: Christine Krebill
Contact: Steve Hackett	
Standard: FCC 15.247	Class: N/A

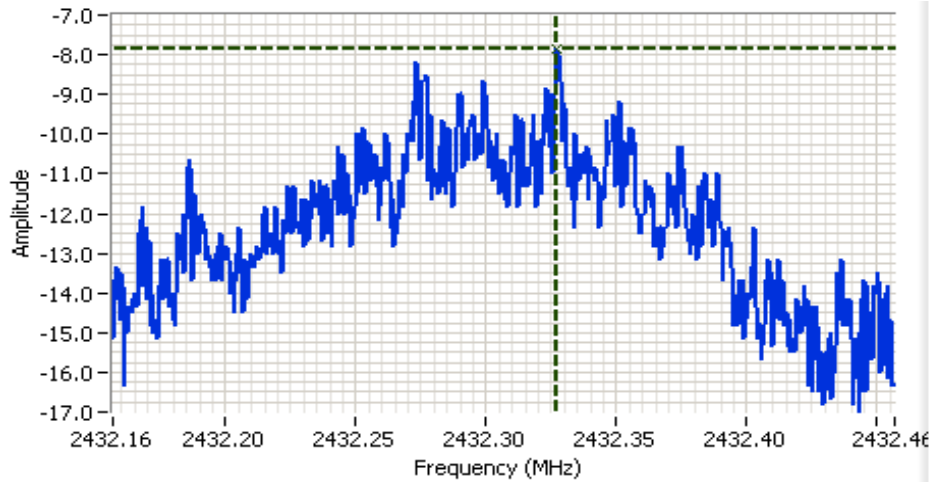

**Analyzer Settings**

HP8564E,EMICF: 2432.307 MHz  
 SPAN: 300 kHz  
 RB: 3.00 kHz  
 VB: 10.0 kHz  
 Detector: POS  
 Attn: 10 DB  
 RL Offset: 11.0 DB  
 Sweep Time: 100.0s  
 Ref Lvl: 10.5 DBM

**Comments**

PSD: -7.8 dBm/3kHz  
 802.11g

Cursor 1 2432.3272 -7.83

0.0000 0.00



**Run #3: Signal Bandwidth**

Mode	Power Setting	Frequency (MHz)	Resolution Bandwidth	Bandwidth (MHz)	
				6dB	99%
802.11b	21.0	2412	100kHz	12.3	15.1
	21.5	2437	100kHz	12.3	15.1
	21.5	2462	100kHz	12.4	15.1
802.11g	27.5	2412	100kHz	16.1	18.6
	27.5	2437	100kHz	15.8	18.3
	27.5	2462	100kHz	15.2	18.3
802.11n20	24	2412	100kHz	17.7	18.22
	28.5	2437	100kHz	17.7	18.47
	24	2462	100kHz	17.8	18.3
802.11n40	20	2422	100kHz	36.6	36.61
	24.5	2437	100kHz	36.7	36.77
	20	2452	100kHz	36.8	36.77

Note 1: 99% bandwidth measured in accordance with RSS GEN, with RB > 1% of the span and VB > 3xRB



Client: Intel Corporation	Job Number: J84366
Model: Intel® Centrino® Wireless-N 2200	T-Log Number: T84600
Contact: Steve Hackett	Account Manager: Christine Krebill
Standard: FCC 15.247	Class: N/A

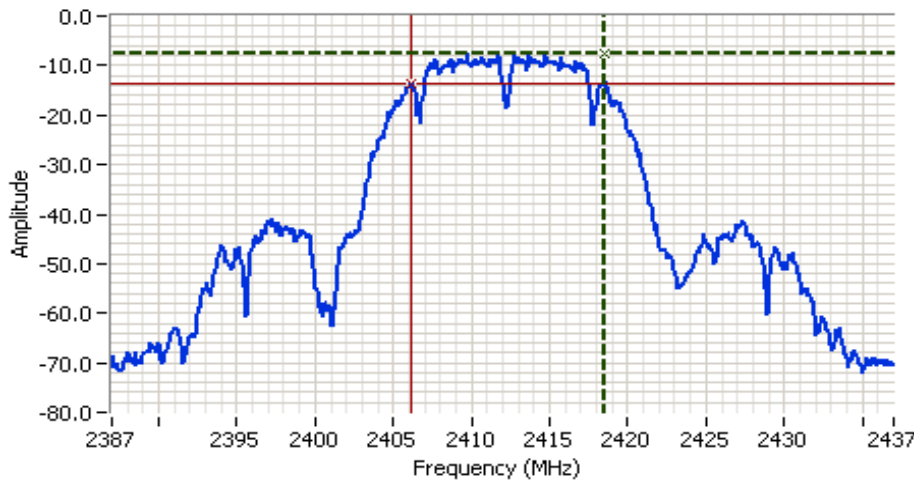

**Analyzer Settings**  
 HP8564E,EMICF: 2412.000 MHz  
 SPAN: 50.000 MHz  
 RB: 100 kHz  
 VB: 100 kHz  
 Detector: Normal  
 Attn: 10 DB  
 RL Offset: 0.0 DB  
 Sweep Time: 50.0ms  
 Ref Lvl: 0.0 DBM

**Comments**  
 6dB BW: 12.333 MHz

Cursor 1 2418.5000 -7.67  Delta Freq. 12.333  
 Cursor 2 2406.1667 -13.67  Delta Amplitude 6.00

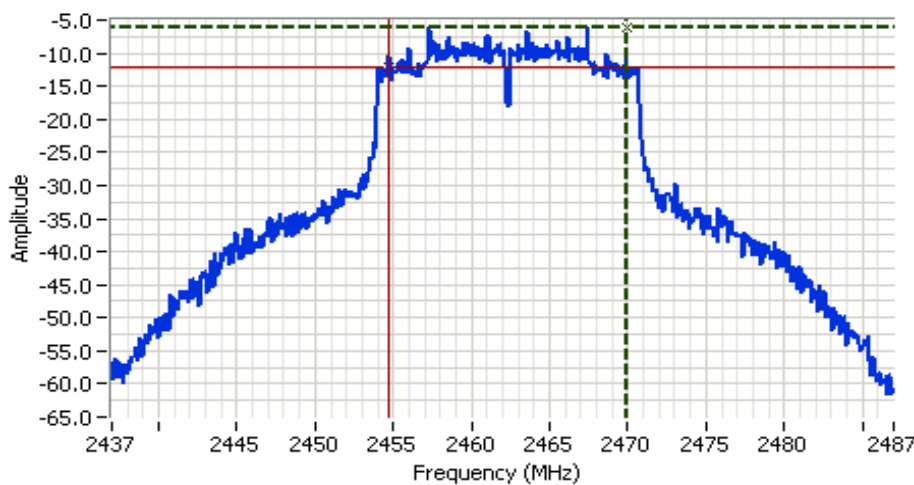

**Analyzer Settings**  
 HP8564E,EMICF: 2462.000 MHz  
 SPAN: 50.000 MHz  
 RB: 100 kHz  
 VB: 100 kHz  
 Detector: Normal  
 Attn: 10 DB  
 RL Offset: 0.0 DB  
 Sweep Time: 50.0ms  
 Ref Lvl: 0.0 DBM

**Comments**  
 6dB BW: 15.167 MHz

Cursor 1 2469.9167 -6.00  Delta Freq. 15.167  
 Cursor 2 2454.7500 -12.00  Delta Amplitude 6.00



Client: Intel Corporation	Job Number: J84366
Model: Intel® Centrino® Wireless-N 2200	T-Log Number: T84600
	Account Manager: Christine Krebill
Contact: Steve Hackett	
Standard: FCC 15.247	Class: N/A

**Run #4: Out of Band Spurious Emissions**
**802.11b Mode**

Frequency (MHz)	Limit	Result
2412	-30dBc	Pass
2437	-30dBc	Pass
2462	-30dBc	Pass

**802.11g Mode**

Frequency (MHz)	Limit	Result
2412	-20dBc	Pass
2437	-20dBc	Pass
2462	-20dBc	Pass

**802.11n20 Mode**

Frequency (MHz)	Limit	Result
2412	-30dBc	Pass
2437	-30dBc	Pass
2462	-30dBc	Pass

**802.11n40 Mode**

Frequency (MHz)	Limit	Result
2412	-30dBc	Pass
2437	-30dBc	Pass
2462	-30dBc	Pass

Client: Intel Corporation	Job Number: J84366
Model: Intel® Centrino® Wireless-N 2200	T-Log Number: T84600
	Account Manager: Christine Krebill
Contact: Steve Hackett	
Standard: FCC 15.247	Class: N/A

Plots for low channel, 802.11b, power setting(s) = 21.0

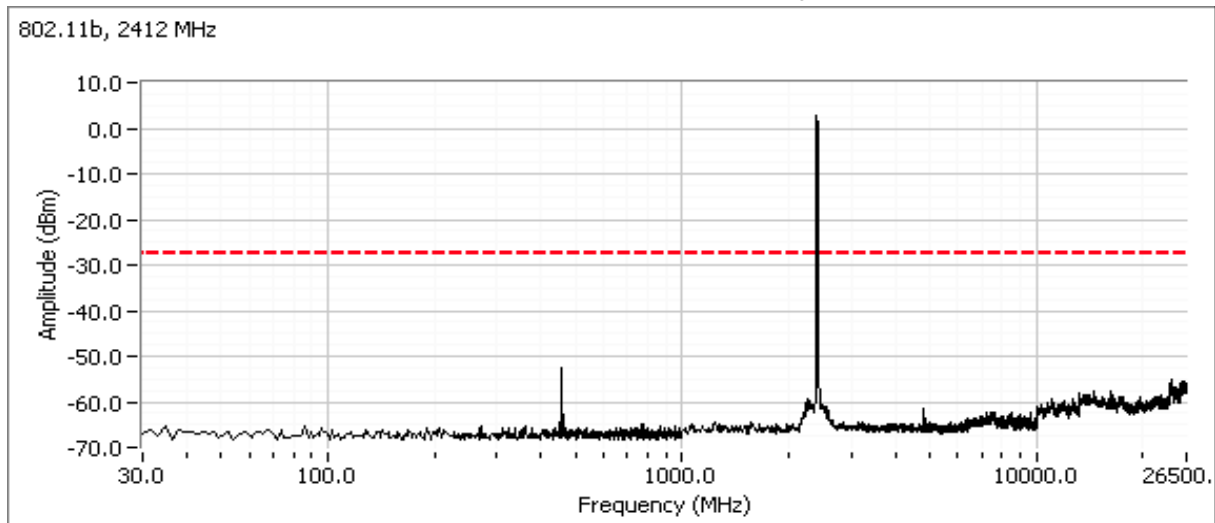

Additional plot showing compliance with -30dBc limit from 2390 MHz to 2400 MHz. Radiated measurements used to show compliance with the limits in the restricted band below 2390 MHz.

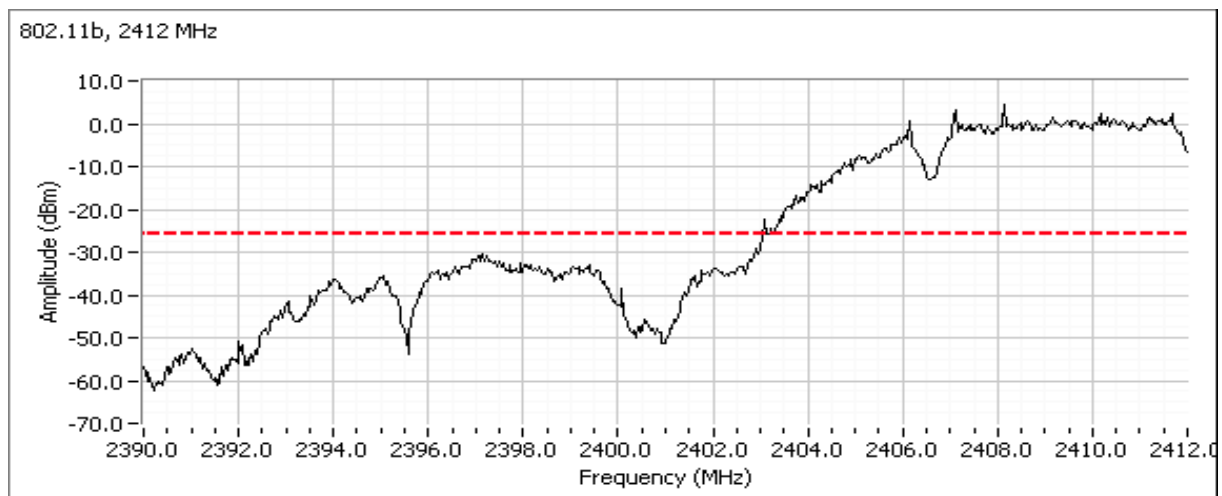

Client: Intel Corporation	Job Number: J84366
Model: Intel® Centrino® Wireless-N 2200	T-Log Number: T84600
	Account Manager: Christine Krebill
Contact: Steve Hackett	
Standard: FCC 15.247	Class: N/A

Plots for center channel 802.11b, power setting(s) = 21.5

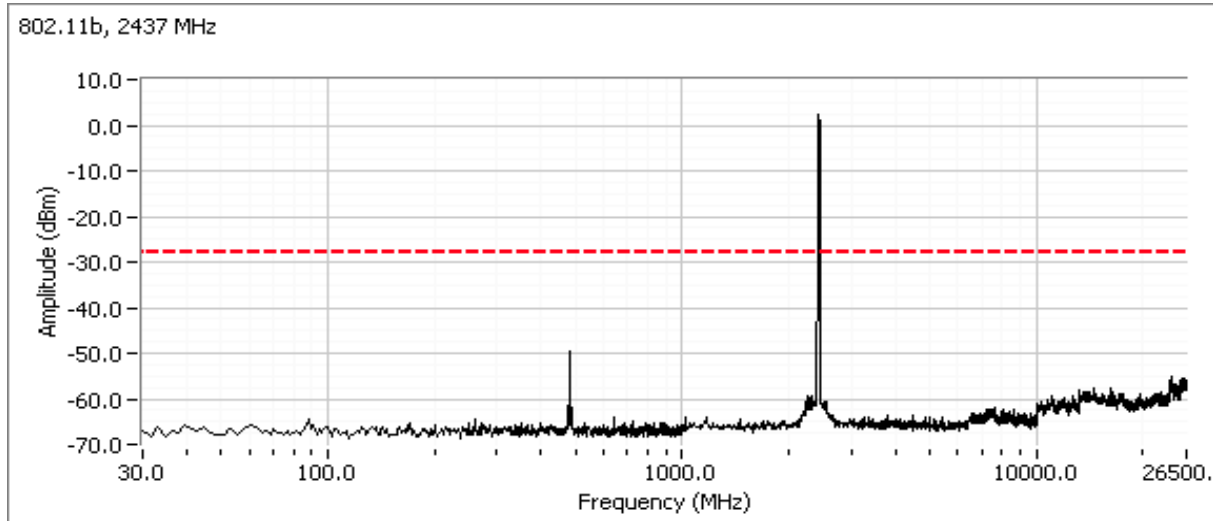

Plots for high channel, 802.11b, power setting(s) = 21.5

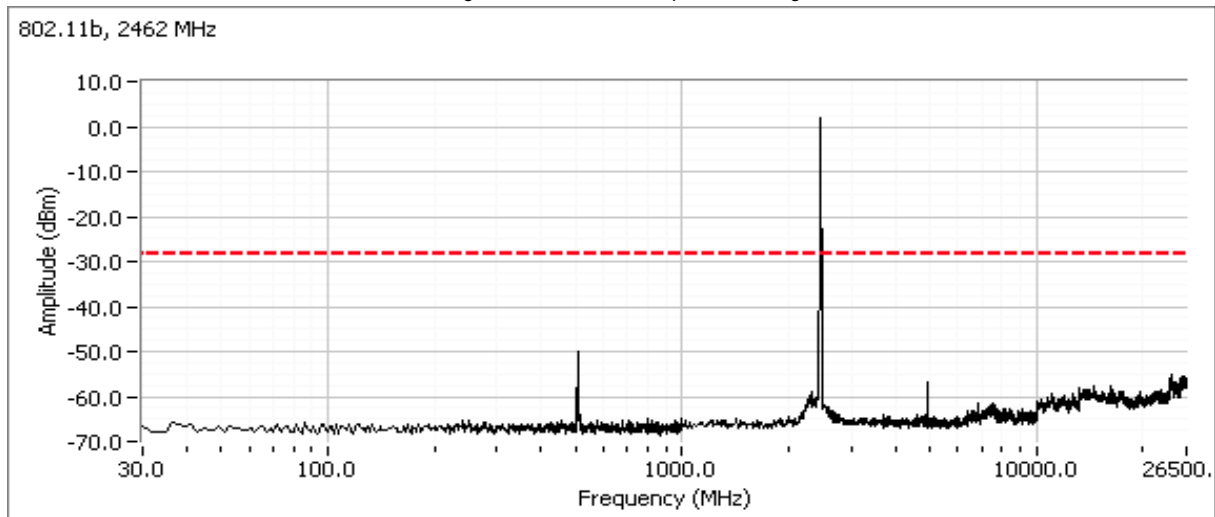

Client: Intel Corporation	Job Number: J84366
Model: Intel® Centrino® Wireless-N 2200	T-Log Number: T84600
	Account Manager: Christine Krebill
Contact: Steve Hackett	
Standard: FCC 15.247	Class: N/A

Plots for low channel, 802.11g, power setting(s) = 24.5

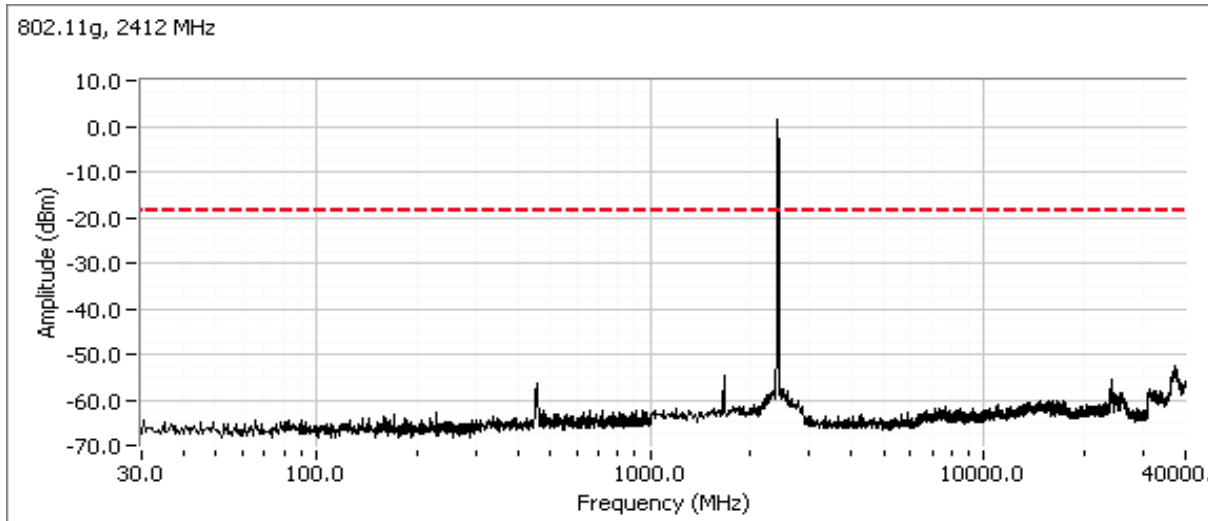

Additional plot showing compliance with -20dBc limit from 2390 MHz to 2400 MHz. Radiated measurements used to show compliance with the limits in the restricted band below 2390 MHz.

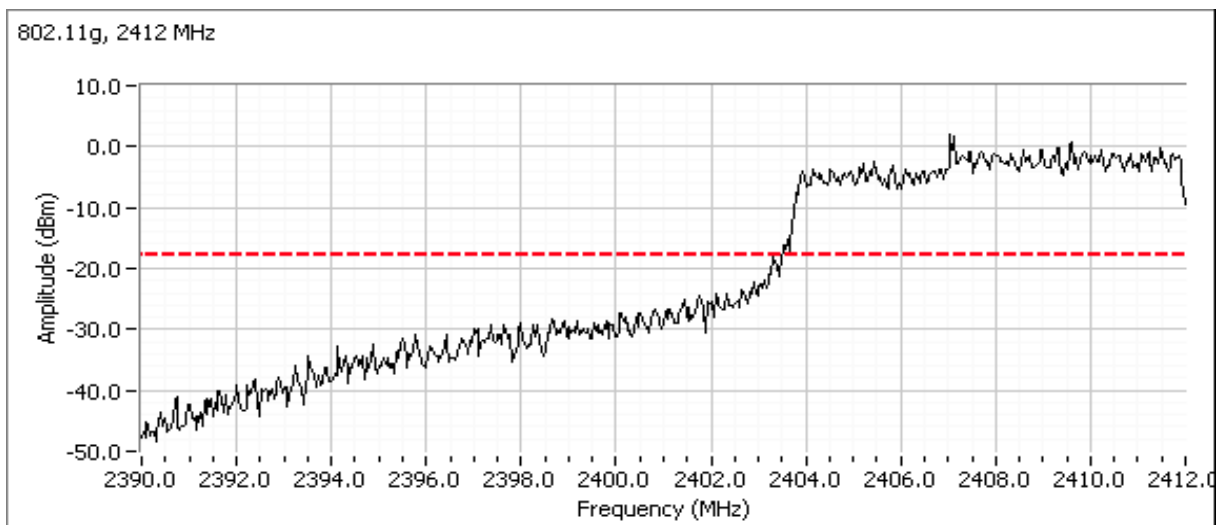

Client: Intel Corporation	Job Number: J84366
Model: Intel® Centrino® Wireless-N 2200	T-Log Number: T84600
	Account Manager: Christine Krebill
Contact: Steve Hackett	
Standard: FCC 15.247	Class: N/A

Plots for center channel 802.11g, power setting(s) = 27

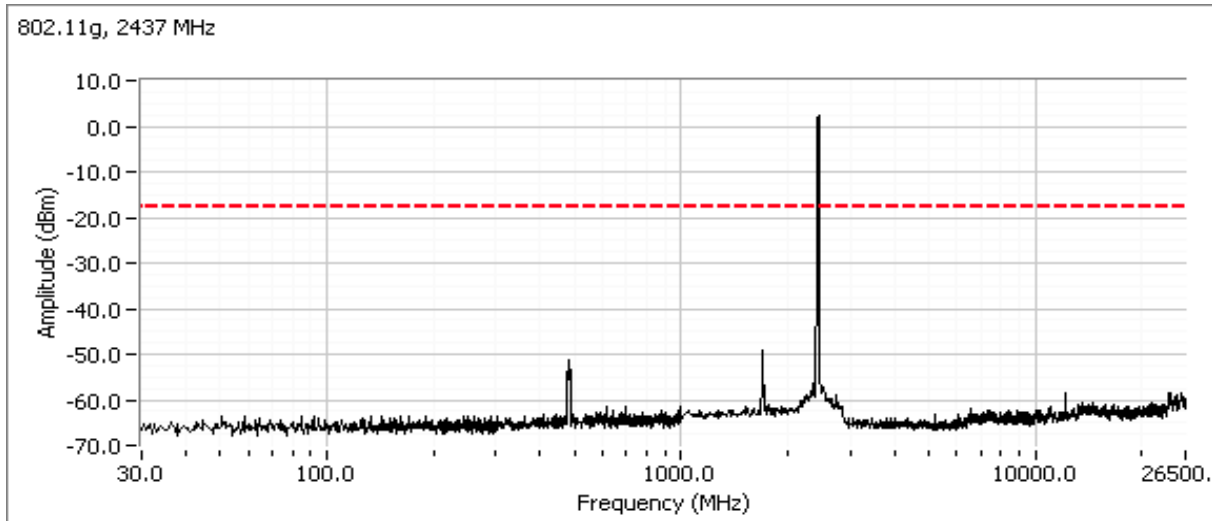

Plots for high channel, 802.11g, power setting(s) = 25

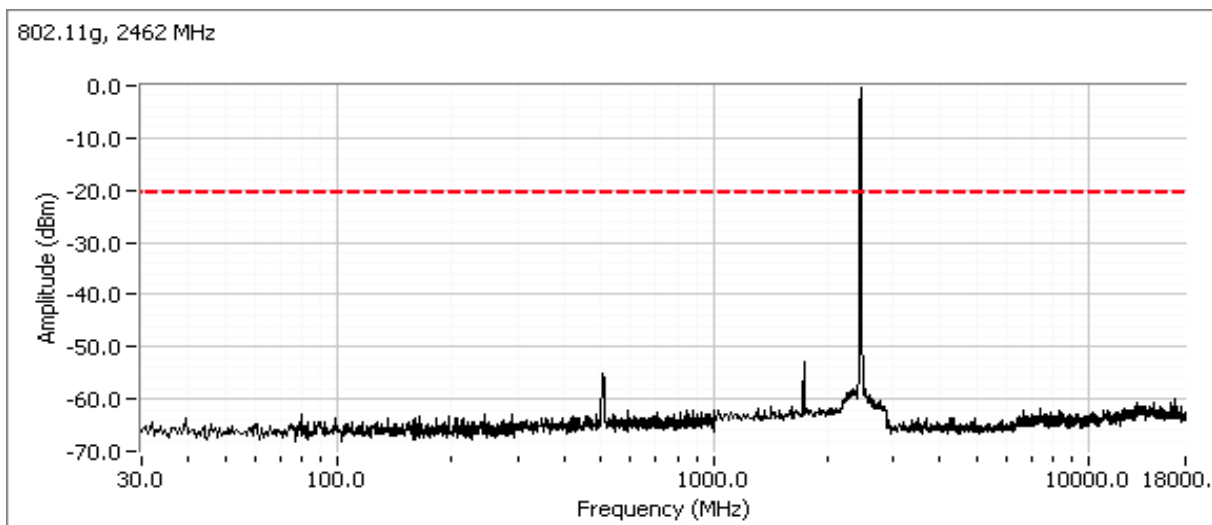

Client: Intel Corporation	Job Number: J84366
Model: Intel® Centrino® Wireless-N 2200	T-Log Number: T84600
	Account Manager: Christine Krebill
Contact: Steve Hackett	
Standard: FCC 15.247	Class: N/A

Plots for low channel, 802.11n20, power setting(s) = 24

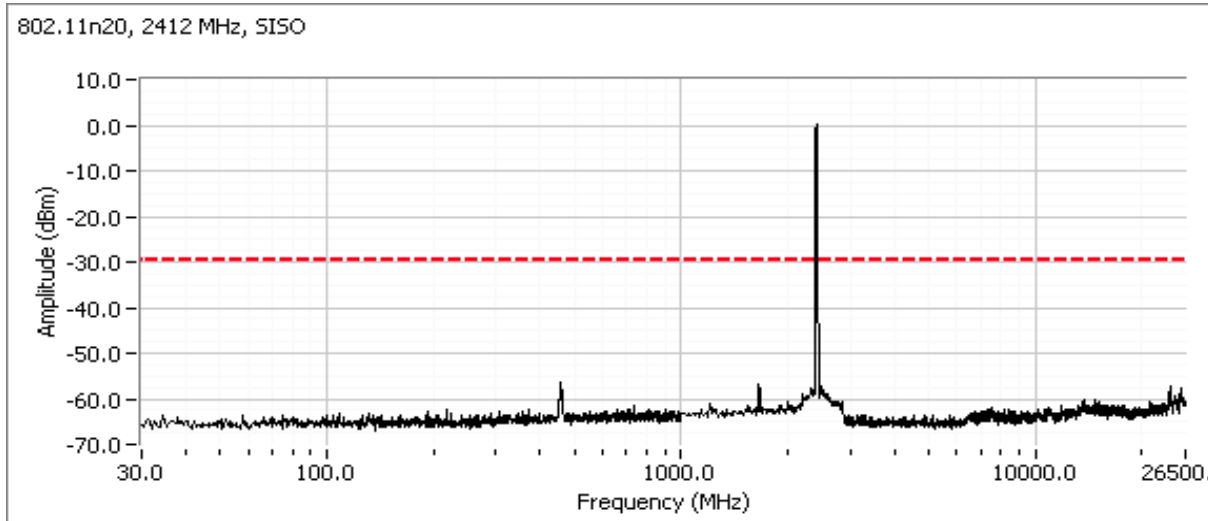

Additional plot showing compliance with -20dBc limit from 2390 MHz to 2400 MHz. Radiated measurements used to show compliance with the limits in the restricted band below 2390 MHz.

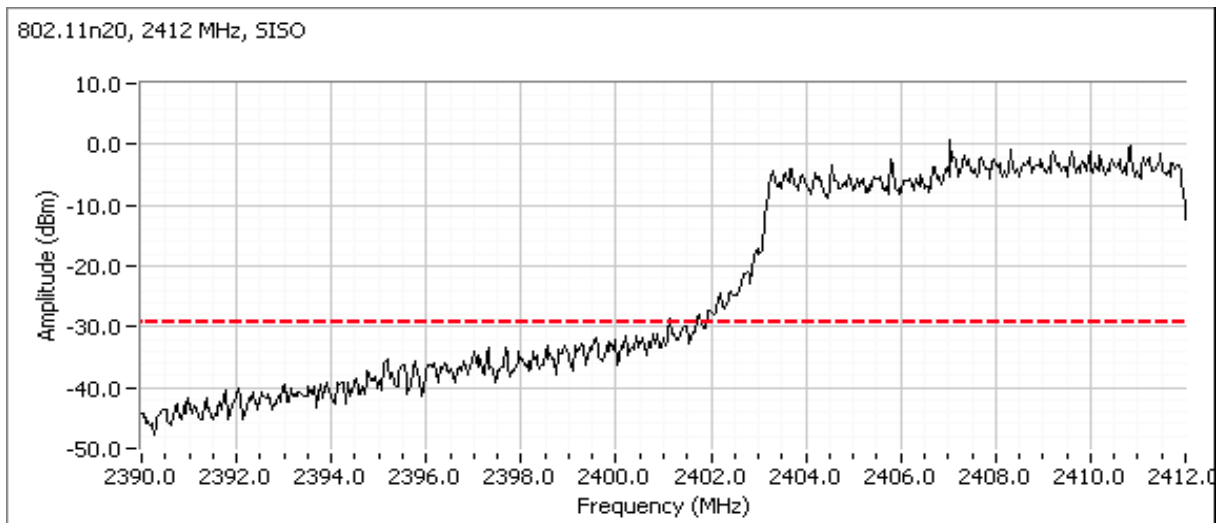

Client: Intel Corporation	Job Number: J84366
Model: Intel® Centrino® Wireless-N 2200	T-Log Number: T84600
	Account Manager: Christine Krebill
Contact: Steve Hackett	
Standard: FCC 15.247	Class: N/A

Plots for center channel 802.11n20, power setting(s) = 28.5

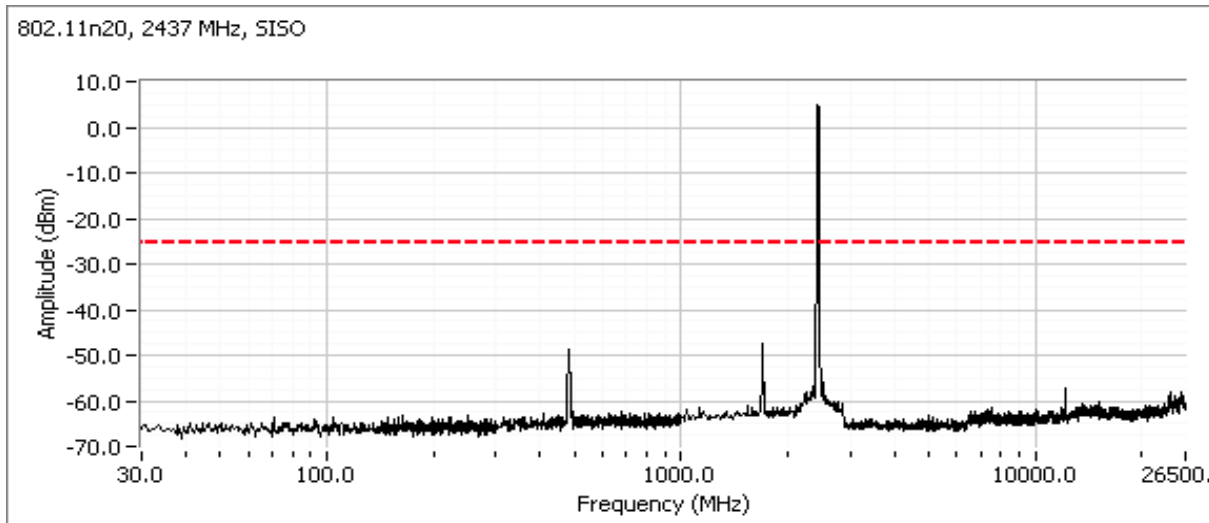

Plots for high channel, 802.11n20, power setting(s) = 24

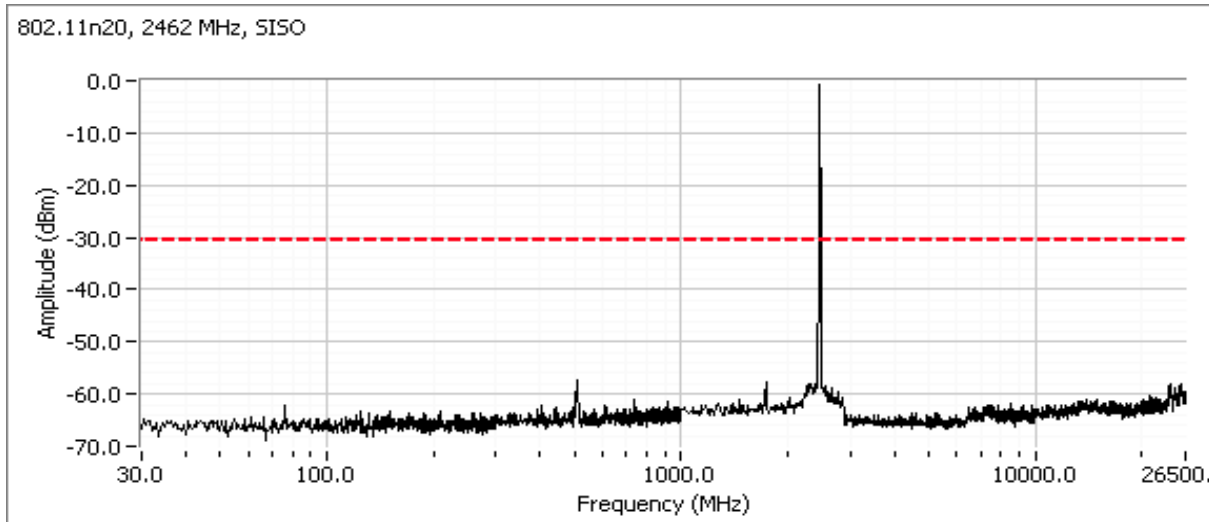



Client: Intel Corporation	Job Number: J84366
Model: Intel® Centrino® Wireless-N 2200	T-Log Number: T84600
	Account Manager: Christine Krebill
Contact: Steve Hackett	
Standard: FCC 15.247	Class: N/A

Plots for low channel, 802.11n40, power setting(s) = 20

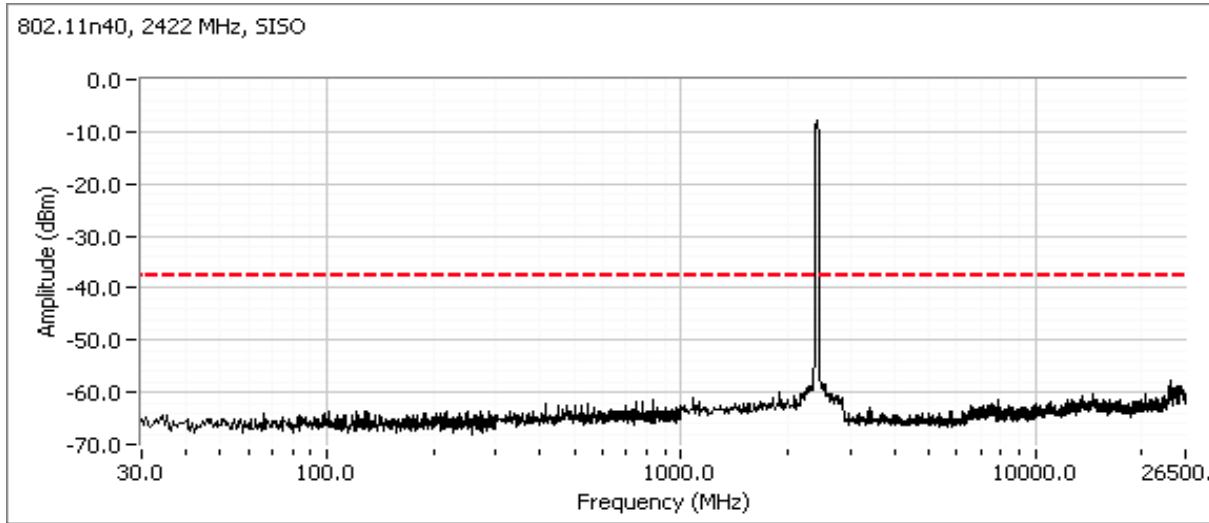

Additional plot showing compliance with -20dBc limit from 2390 MHz to 2400 MHz. Radiated measurements used to show compliance with the limits in the restricted band below 2390 MHz.

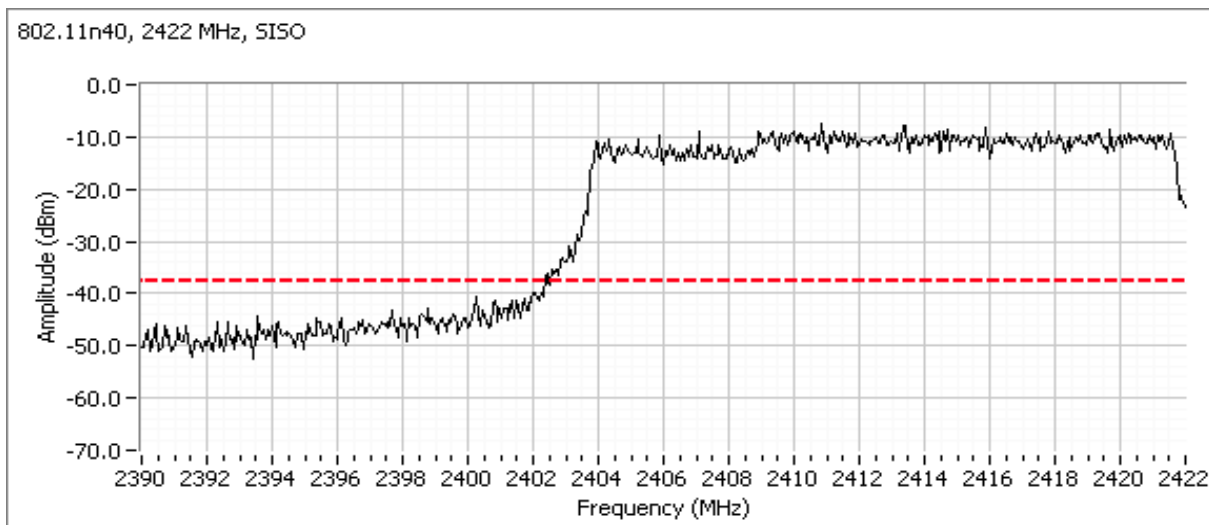

Client: Intel Corporation	Job Number: J84366
Model: Intel® Centrino® Wireless-N 2200	T-Log Number: T84600
	Account Manager: Christine Krebill
Contact: Steve Hackett	
Standard: FCC 15.247	Class: N/A

Plots for center channel 802.11n40, power setting(s) = 24.5

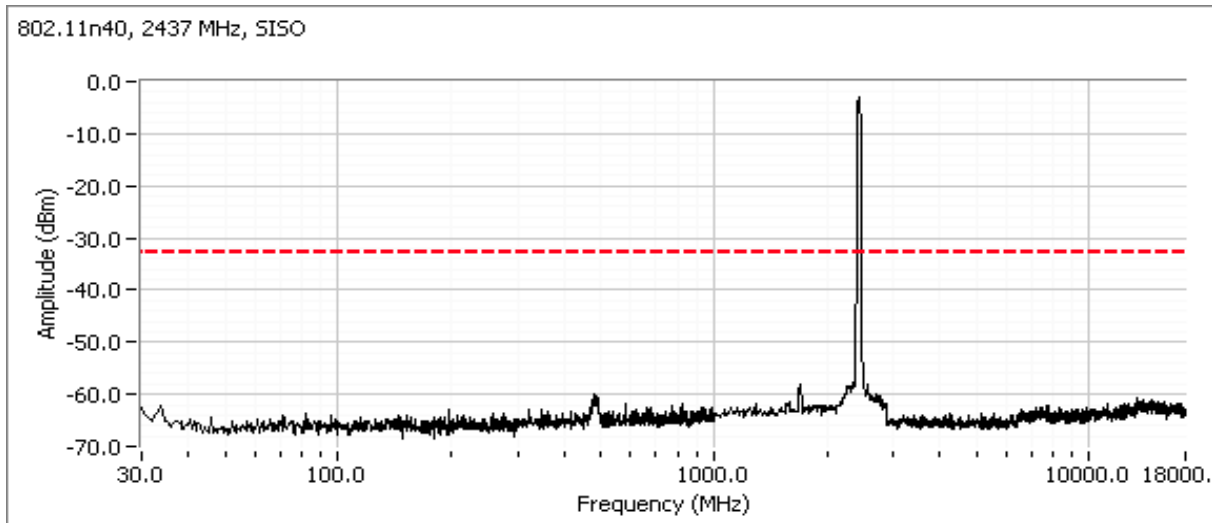

Plots for high channel, 802.11n40, power setting(s) = 20

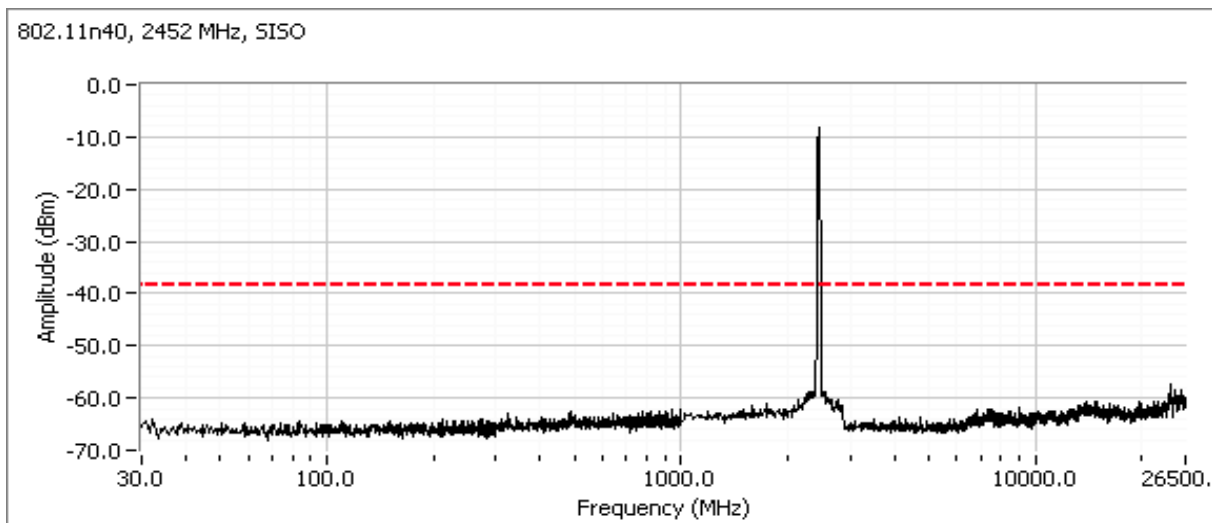

Client: Intel Corporation	Job Number: J84366
Model: Intel® Centrino® Wireless-N 2200	T-Log Number: T84600
	Account Manager: Christine Krebill
Contact: Steve Hackett	
Standard: FCC 15.247	Class: N/A

**RSS 210 and FCC 15.247 (DTS) Antenna Port Measurements  
Power, PSD, Bandwidth and Spurious Emissions**

**Test Specific Details**

Objective: The objective of this test session is to perform final qualification testing of the EUT with respect to the specification listed above.

Date of Test: 10/18/2011	Config. Used: 1
Test Engineer: Rafael Varelas	Config Change: none
Test Location: Fremont Chamber #4	EUT Voltage: 120V/60Hz

**General Test Configuration**

The EUT was connected to the spectrum analyzer or power meter via a suitable attenuator. All measurements were made on a single chain.

All measurements have been corrected to allow for the external attenuators used.

**Ambient Conditions:**

Temperature: 20.4 °C  
Rel. Humidity: 37 %

**Summary of Results**

MAC Address: 001500825F4C DRTU Tool Version 1.5.3.0322 Driver version 15.0.0.61

Run #	Test Performed	Limit	Pass / Fail	Result / Margin
1	Output Power	15.247(b)	Pass	802.11b: 0.049 W 802.11g: 0.056 W 802.11n20: 0.050 W 802.11n40: 0.028 W
2	Power spectral Density (PSD)	15.247(d)	Pass	-8.0 dBm/3kHz
3	Minimum 6dB Bandwidth	15.247(a)	Pass	12.2 MHz
3	99% Bandwidth	RSS GEN	-	802.11b: 15.5 MHz 802.11g: 17.5 MHz 802.11n20: 18.9 MHz 802.11n40: 37.1 MHz
4	Spurious emissions	15.247(b)	Pass	All emissions below -30dBc limit

**Modifications Made During Testing**

No modifications were made to the EUT during testing

**Deviations From The Standard**

No deviations were made from the requirements of the standard.

Client: Intel Corporation	Job Number: J84366
Model: Intel® Centrino® Wireless-N 2200	T-Log Number: T84600
	Account Manager: Christine Krebill
Contact: Steve Hackett	
Standard: FCC 15.247	Class: N/A

### Run #1: Output Power

Power Setting <sup>2</sup>	Frequency (MHz)	Output Power		Antenna Gain (dBi)	Result	EIRP		Output Power	
		(dBm) <sup>1</sup>	mW			dBm	W	(dBm) <sup>3</sup>	mW
<b>802.11b Mode</b>									
20.0	2412	16.1	40.7	3.2	Pass	19.3	0.085	14.7	29.5
21.0	2437	16.9	49.0	3.2	Pass	20.1	0.102	15.3	33.9
21.5	2462	16.4	43.7	3.2	Pass	19.6	0.091	15.4	34.7

- Note 1: Output power measured using a spectrum analyzer (see plots below) with RBW=1MHz, VB=3 MHz, sample detector, power averaging on (transmitted signal was continuous) and power integration over 50 MHz (option #2, method 1 in KDB 558074, equivalent to method)
- Note 2: Power setting - the software power setting used during testing, included for reference only.
- Note 3: Output power measured using a avg power meter, included for reference only.

Power Setting <sup>2</sup>	Frequency (MHz)	Output Power		Antenna Gain (dBi)	Result	EIRP		Output Power	
		(dBm) <sup>1</sup>	mW			dBm	W	(dBm) <sup>3</sup>	mW
<b>802.11g Mode</b>									
24.5	2412	14.9	30.9	3.2	Pass	18.1	0.065	13.9	24.5
28.0	2437	17.5	56.2	3.2	Pass	20.7	0.117	16.4	43.7
25.5	2462	14.5	28.2	3.2	Pass	17.7	0.059	14.2	26.3

- Note 1: Output power measured using a spectrum analyzer (see plots below) with RBW=1MHz, VB=3 MHz, sample detector, power averaging on (transmitted signal was continuous) and power integration over 50 MHz (option #2, method 1 in KDB 558074, equivalent to method 1 of DA-02-2138A1 for U-NII devices). Spurious limit becomes -30dBc.
- Note 2: Power setting - the software power setting used during testing, included for reference only.
- Note 3: Output power measured using a avg power meter, included for reference only.

Power Setting <sup>2</sup>	Frequency (MHz)	Output Power		Antenna Gain (dBi)	Result	EIRP		Output Power	
		(dBm) <sup>1</sup>	mW			dBm	W	(dBm) <sup>3</sup>	mW
<b>802.11n20 Mode</b>									
23.5	2412	14.0	25.1	3.2	Pass	17.2	0.052	12.8	19.1
28.5	2437	17.0	50.1	3.2	Pass	20.2	0.105	16.7	46.8
24.0	2462	12.8	19.1	3.2	Pass	16.0	0.040	12.8	19.1

- Note 1: Output power measured using a spectrum analyzer (see plots below) with RBW=1MHz, VB=3 MHz, sample detector, power averaging on (transmitted signal was continuous) and power integration over 50 MHz (option #2, method 1 in KDB 558074, equivalent to method 1 of DA-02-2138A1 for U-NII devices). Spurious limit becomes -30dBc.
- Note 2: Power setting - the software power setting used during testing, included for reference only.
- Note 3: Output power measured using a avg power meter

Client: Intel Corporation	Job Number: J84366
Model: Intel® Centrino® Wireless-N 2200	T-Log Number: T84600
	Account Manager: Christine Krebill
Contact: Steve Hackett	
Standard: FCC 15.247	Class: N/A

Power Setting <sup>2</sup>	Frequency (MHz)	Output Power		Antenna Gain (dBi)	Result	EIRP		Output Power	
		(dBm) <sup>1</sup>	mW			dBm	W	(dBm) <sup>3</sup>	mW
<b>802.11n40 Mode</b>									
20.0	2422	10.3	10.7	3.2	Pass	13.5	0.022	9.7	9.3
25.0	2437	14.4	27.5	3.2	Pass	17.6	0.058	13.9	24.5
21.0	2452	10.5	11.2	3.2	Pass	13.7	0.023	10.3	10.7

Note 1:	Output power measured using a spectrum analyzer (see plots below) with RBW=1MHz, VB=3 MHz, sample detector, power averaging on (transmitted signal was continuous) and power integration over <b>50 MHz</b> (option #2, method 1 in KDB 558074, equivalent to method 1 of DA-02-2138A1 for U-NII devices). Spurious limit becomes <b>-30dBc</b> .
Note 2:	Power setting - the software power setting used during testing, included for reference only.
Note 3:	Output power measured using a avg power meter

Client: Intel Corporation	Job Number: J84366
Model: Intel® Centrino® Wireless-N 2200	T-Log Number: T84600
	Account Manager: Christine Krebill
Contact: Steve Hackett	
Standard: FCC 15.247	Class: N/A

### Run #2: Power spectral Density

Mode	Power Setting	Frequency (MHz)	PSD	Limit dBm/3kHz	Result
			(dBm/3kHz) <sup>Note 1</sup>		
802.11b	20.0	2410.9803	-10.3	8.0	Pass
	21.0	2436.2448	-11.0	8.0	Pass
	21.5	2462.5345	-11.3	8.0	Pass
802.11g	24.5	2409.8013	-12.0	8.0	Pass
	28.0	2441.0683	-8.0	8.0	Pass
	25.5	2465.4328	-11.0	8.0	Pass
802.11n20	23.5	2415.0762	-10.5	8.0	Pass
	28.5	2434.7717	-9.2	8.0	Pass
	24.0	2464.4772	-11.8	8.0	Pass
802.11n40	20.0	2419.7972	-17.0	8.0	Pass
	25.0	2444.7865	-13.3	8.0	Pass
	21.0	2438.7948	-17.8	8.0	Pass

Note 1: Power spectral density measured using RB=3 kHz, VB=10kHz, analyzer with peak detector and with a sweep time set to ensure a dwell time of at least 1 second per 3kHz. The measurement is made at the frequency of PPSD determined from preliminary scans using

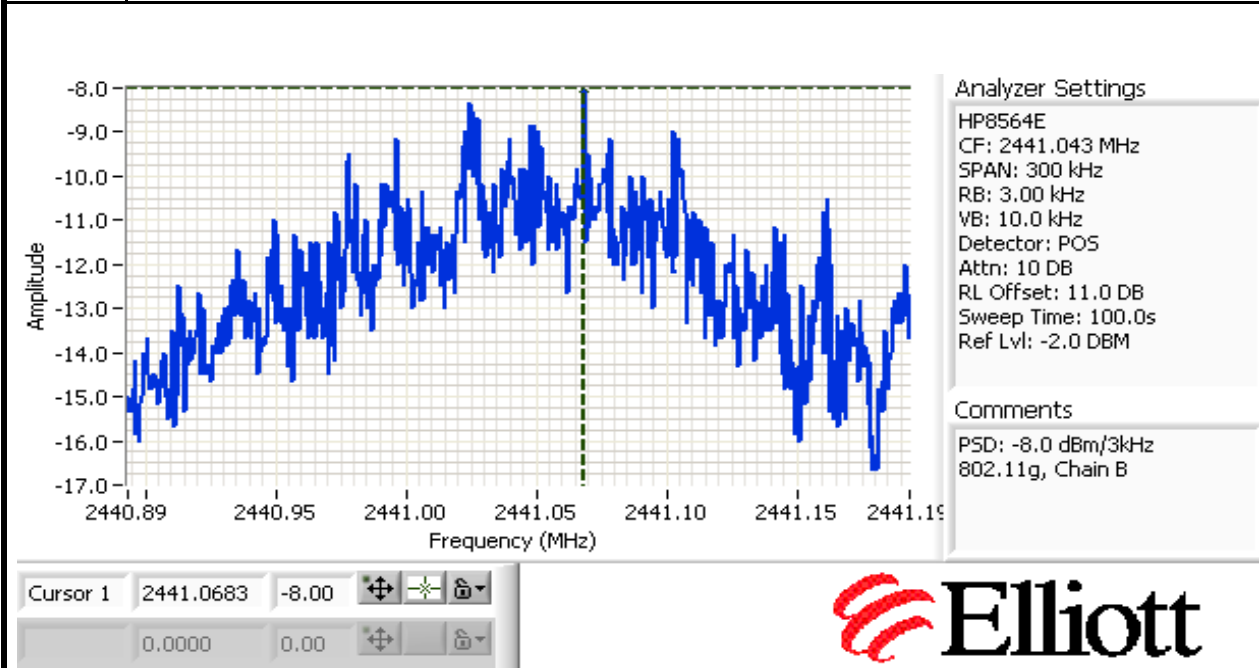

Client: Intel Corporation	Job Number: J84366
Model: Intel® Centrino® Wireless-N 2200	T-Log Number: T84600
	Account Manager: Christine Krebill
Contact: Steve Hackett	
Standard: FCC 15.247	Class: N/A

**Run #3: Signal Bandwidth**

Mode	Power Setting	Frequency (MHz)	Resolution Bandwidth	Bandwidth (MHz)	
				6dB	99%
802.11b	20.0	2412	100kHz	12.3	15.4
	21.0	2437	100kHz	12.2	15.5
	21.5	2462	100kHz	12.2	15.3
802.11g	24.5	2412	100kHz	15.4	17.3
	28.0	2437	100kHz	15.3	17.5
	25.5	2462	100kHz	14.2	17.2
802.11n20	23.5	2412	100kHz	17.3	18.7
	28.5	2437	100kHz	17.3	18.9
	24.0	2462	100kHz	17.7	18.6
802.11n40	20.0	2422	100kHz	36.7	37.1
	25.0	2437	100kHz	36.7	37.1
	21.0	2452	100kHz	36.7	36.9

Note 1: 99% bandwidth measured in accordance with RSS GEN, with RB > 1% of the span and VB > 3xRB

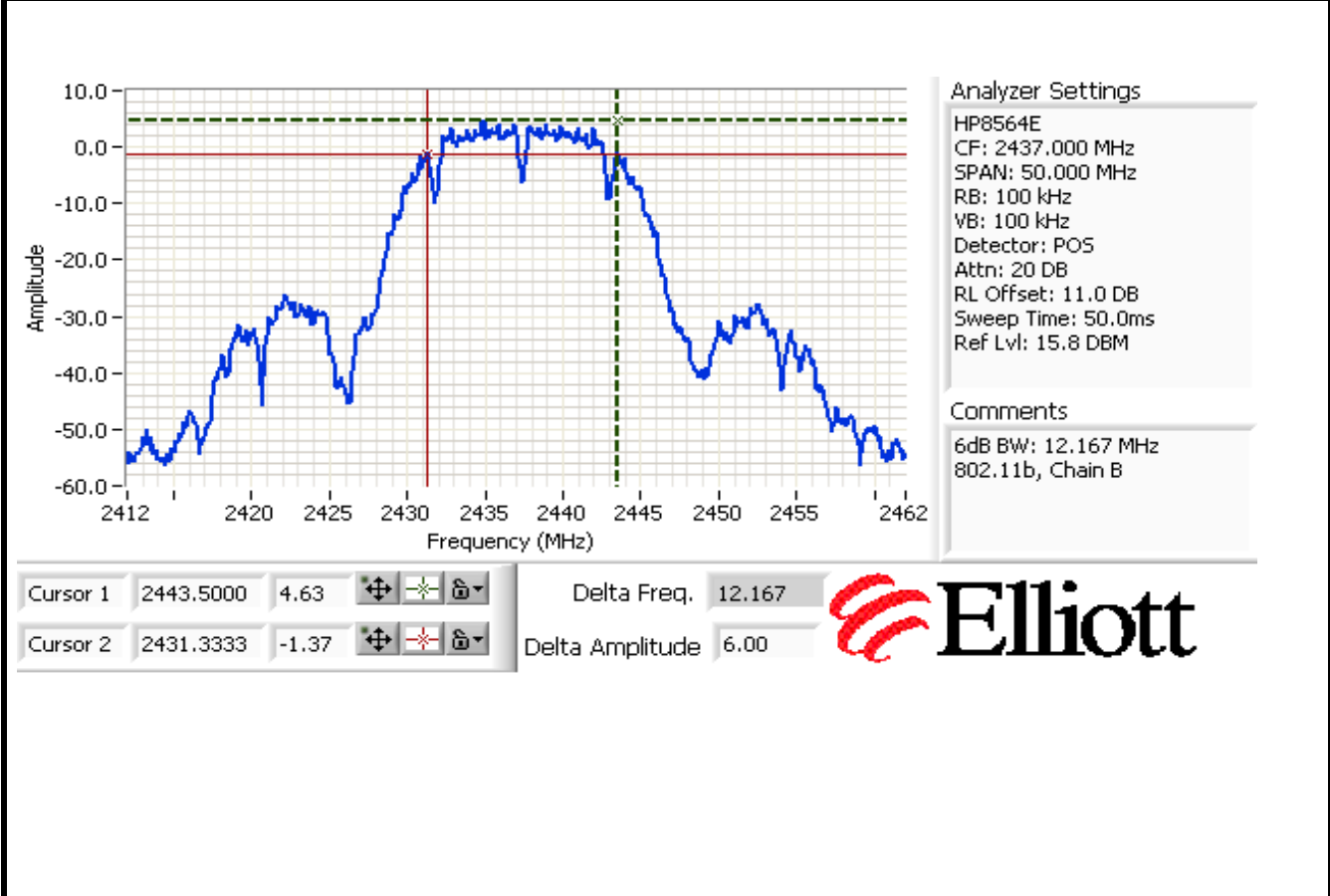

Client: Intel Corporation	Job Number: J84366
Model: Intel® Centrino® Wireless-N 2200	T-Log Number: T84600
	Account Manager: Christine Krebill
Contact: Steve Hackett	
Standard: FCC 15.247	Class: N/A

**Run #4: Out of Band Spurious Emissions**
**802.11b Mode**

Frequency (MHz)	Limit	Result
2412	-30dBc	Pass
2437	-30dBc	Pass
2462	-30dBc	Pass

**802.11g Mode**

Frequency (MHz)	Limit	Result
2412	-30dBc	Pass
2437	-30dBc	Pass
2462	-30dBc	Pass

**802.11n20 Mode**

Frequency (MHz)	Limit	Result
2412	-30dBc	Pass
2437	-30dBc	Pass
2462	-30dBc	Pass

**802.11n40 Mode**

Frequency (MHz)	Limit	Result
2422	-30dBc	Pass
2437	-30dBc	Pass
2452	-30dBc	Pass



Client: Intel Corporation	Job Number: J84366
Model: Intel® Centrino® Wireless-N 2200	T-Log Number: T84600
	Account Manager: Christine Krebill
Contact: Steve Hackett	
Standard: FCC 15.247	Class: N/A

Plots for low channel, 802.11b, power setting(s) = 20.0

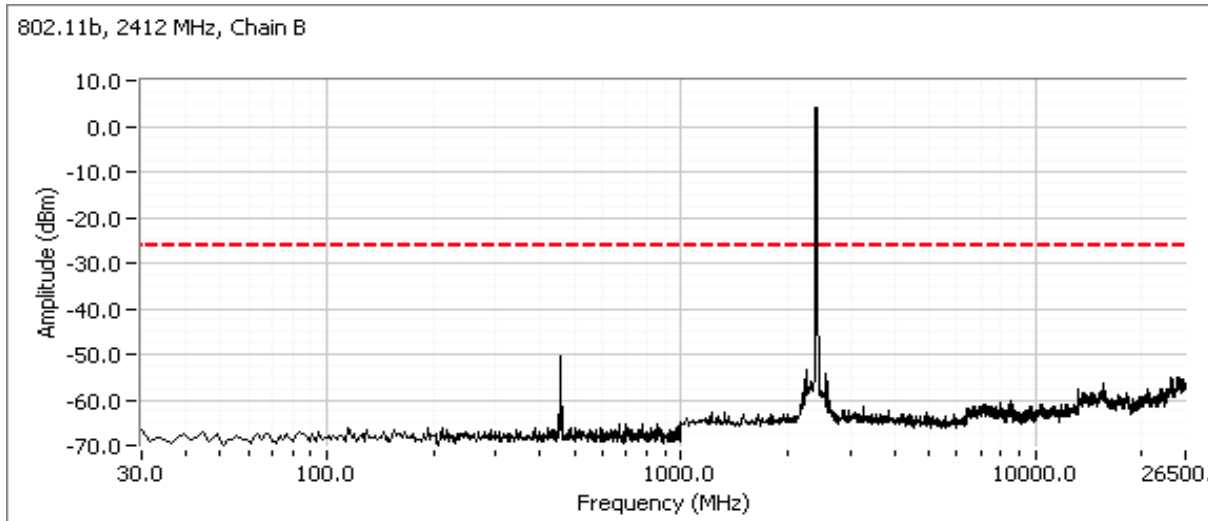

Additional plot showing compliance with -30dBc limit from 2390 MHz to 2400 MHz. Radiated measurements used to show compliance with the limits in the restricted band below 2390 MHz.

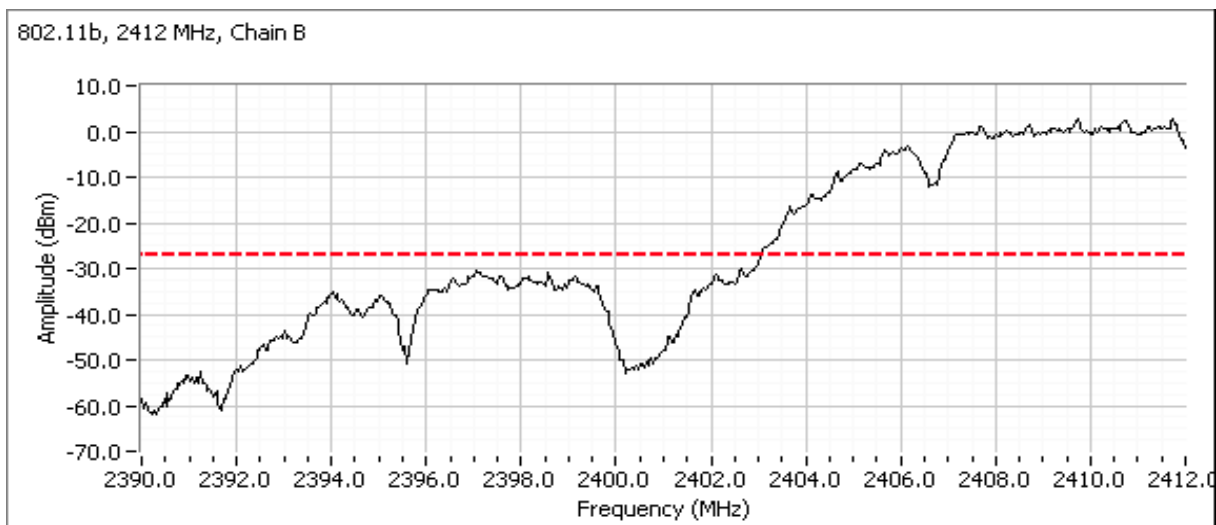

Client: Intel Corporation	Job Number: J84366
Model: Intel® Centrino® Wireless-N 2200	T-Log Number: T84600
	Account Manager: Christine Krebill
Contact: Steve Hackett	
Standard: FCC 15.247	Class: N/A

Plots for center channel 802.11b, power setting(s) = 21..0

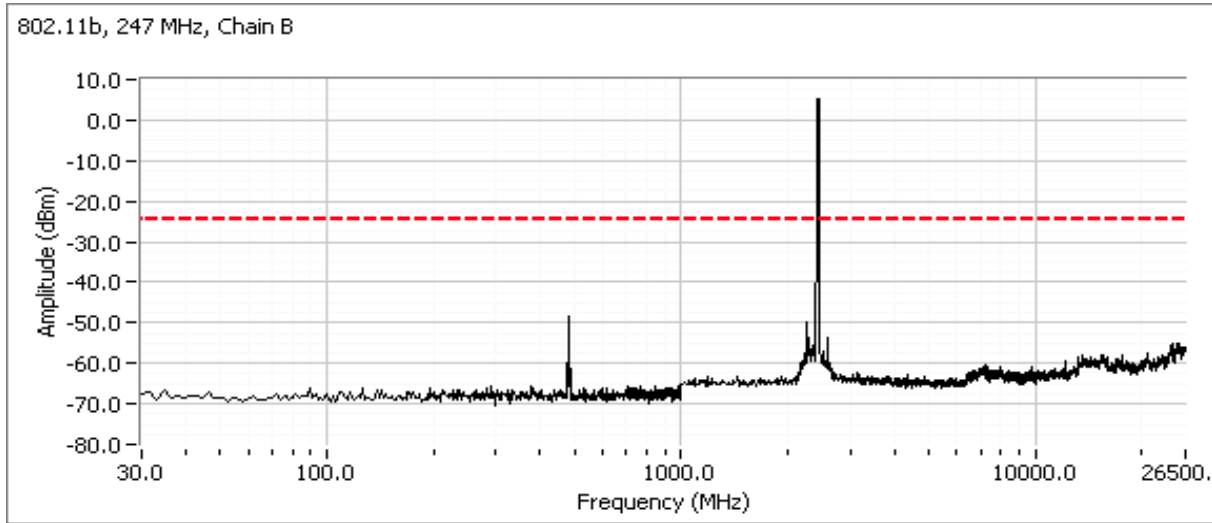

Plots for high channel, 802.11b, power setting(s) = 21.5

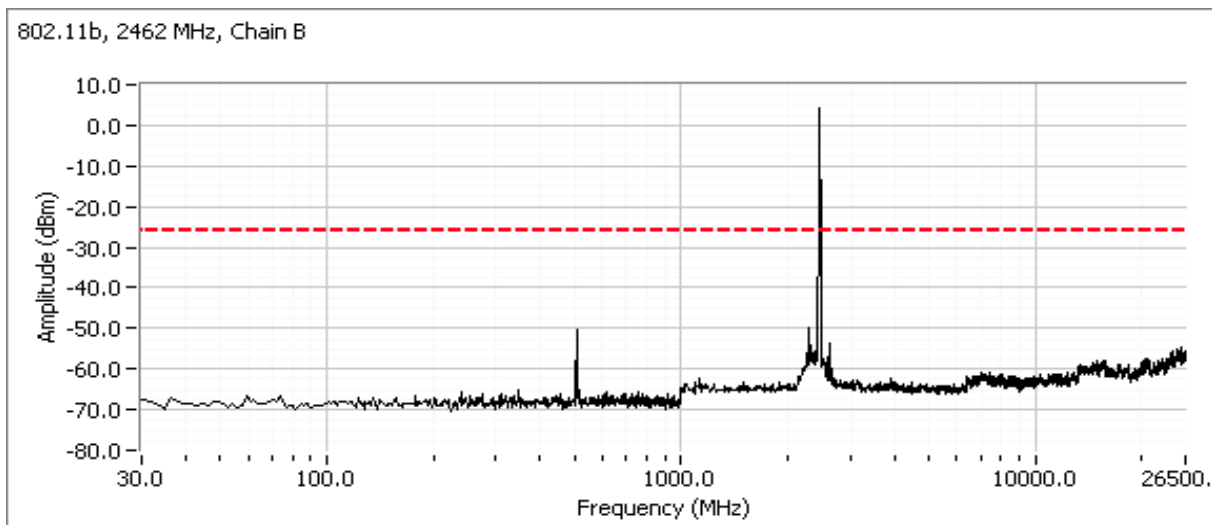

Client: Intel Corporation	Job Number: J84366
Model: Intel® Centrino® Wireless-N 2200	T-Log Number: T84600
	Account Manager: Christine Krebill
Contact: Steve Hackett	
Standard: FCC 15.247	Class: N/A

Plots for low channel, 802.11g, power setting(s) = 24.5

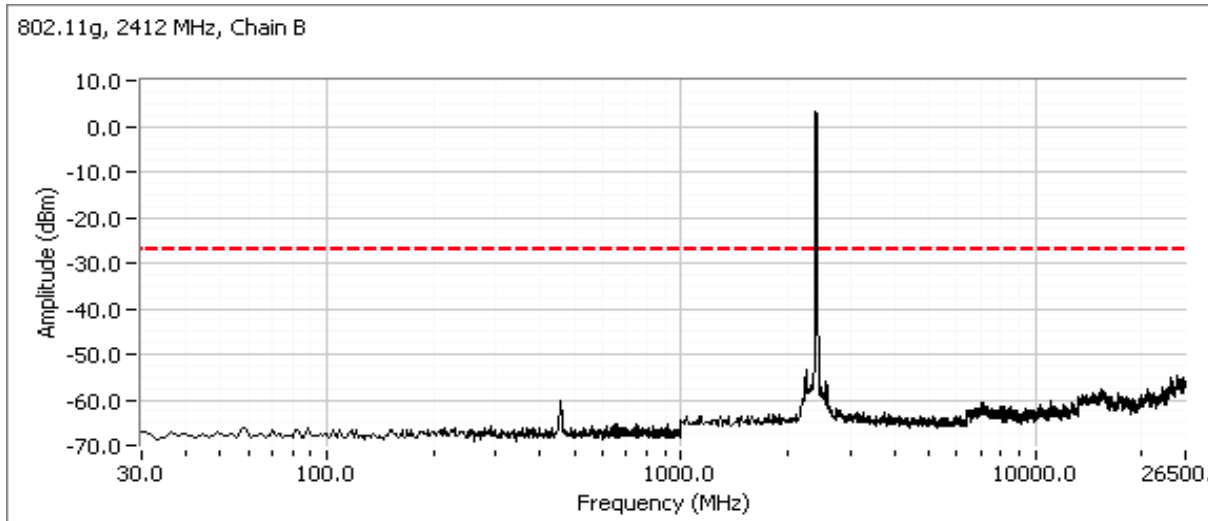

Additional plot showing compliance with -30dBc limit from 2390 MHz to 2400 MHz. Radiated measurements used to show compliance with the limits in the restricted band below 2390 MHz.

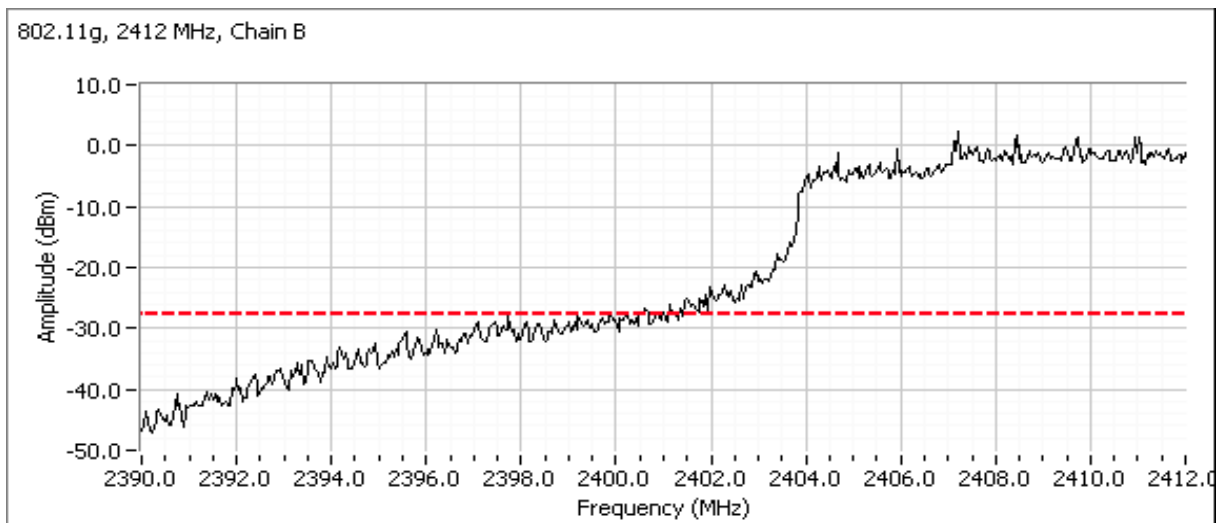

Client: Intel Corporation	Job Number: J84366
Model: Intel® Centrino® Wireless-N 2200	T-Log Number: T84600
	Account Manager: Christine Krebill
Contact: Steve Hackett	
Standard: FCC 15.247	Class: N/A

Plots for center channel 802.11g, power setting(s) = 28.0

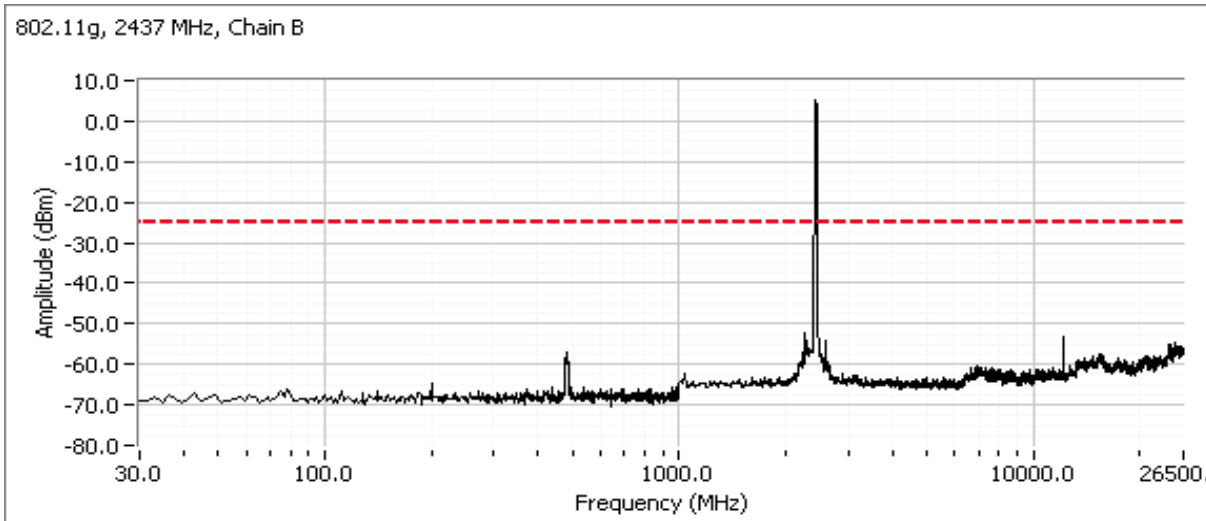

Plots for high channel, 802.11g, power setting(s) = 25.5

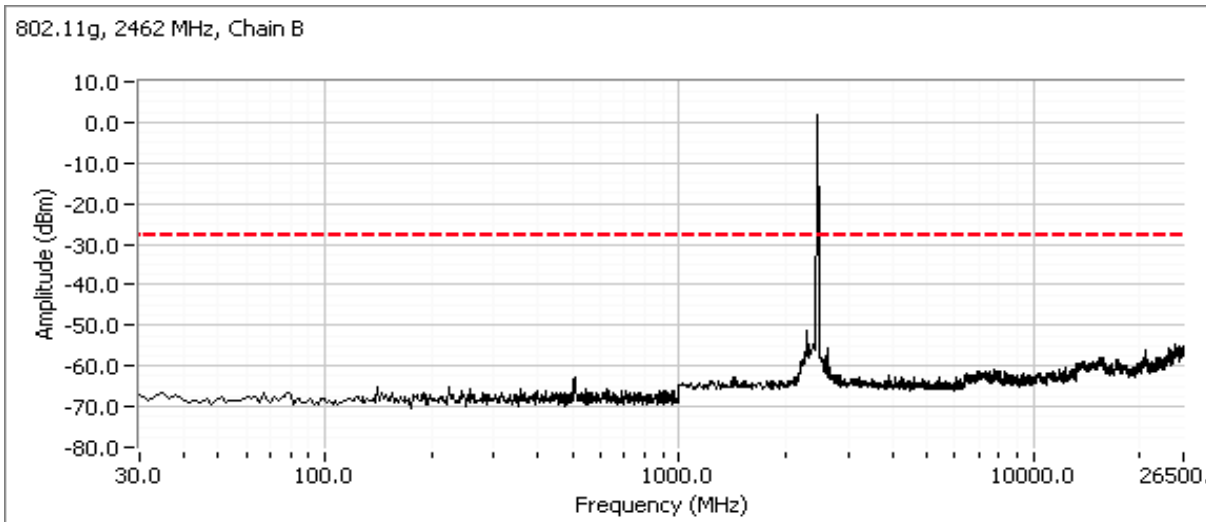

Client: Intel Corporation	Job Number: J84366
Model: Intel® Centrino® Wireless-N 2200	T-Log Number: T84600
	Account Manager: Christine Krebill
Contact: Steve Hackett	
Standard: FCC 15.247	Class: N/A

Plots for low channel, 802.11n20, power setting(s) = 23.5

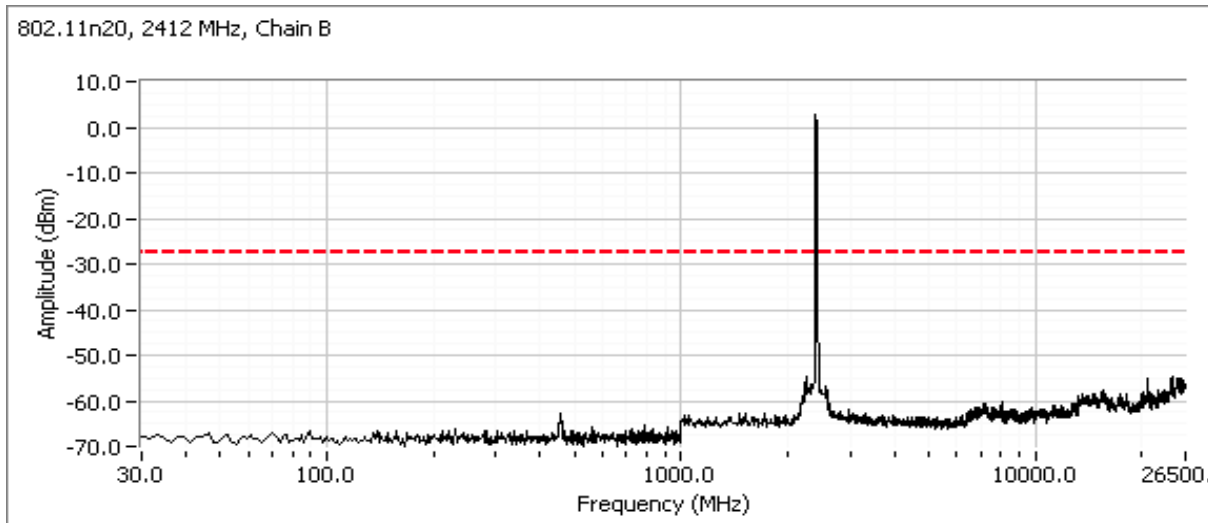

Additional plot showing compliance with -30dBc limit from 2390 MHz to 2400 MHz. Radiated measurements used to show compliance with the limits in the restricted band below 2390 MHz.

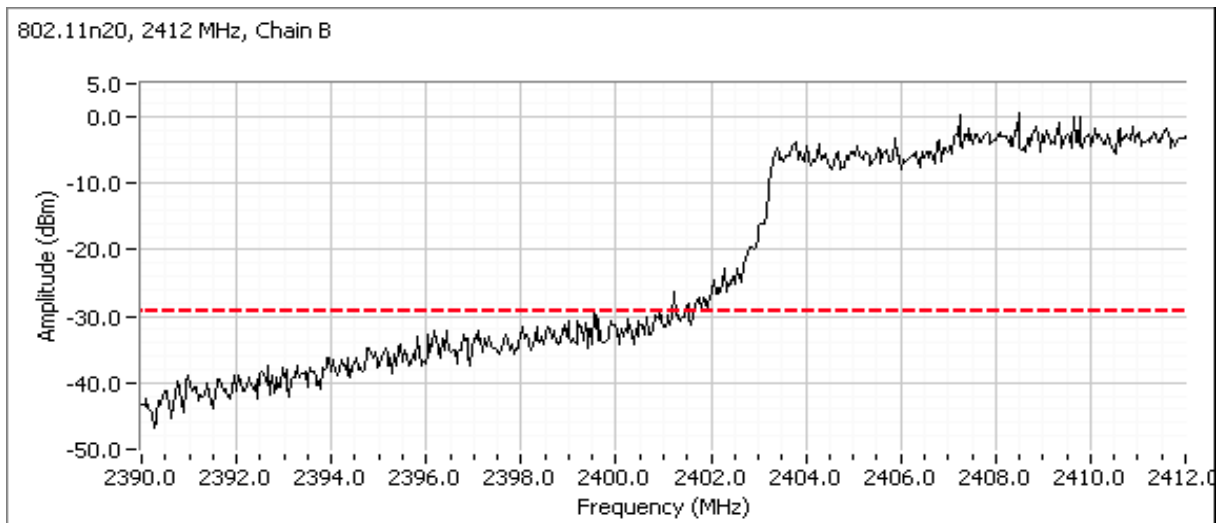

Client: Intel Corporation	Job Number: J84366
Model: Intel® Centrino® Wireless-N 2200	T-Log Number: T84600
	Account Manager: Christine Krebill
Contact: Steve Hackett	
Standard: FCC 15.247	Class: N/A

Plots for center channel 802.11n20, power setting(s) = 28.5

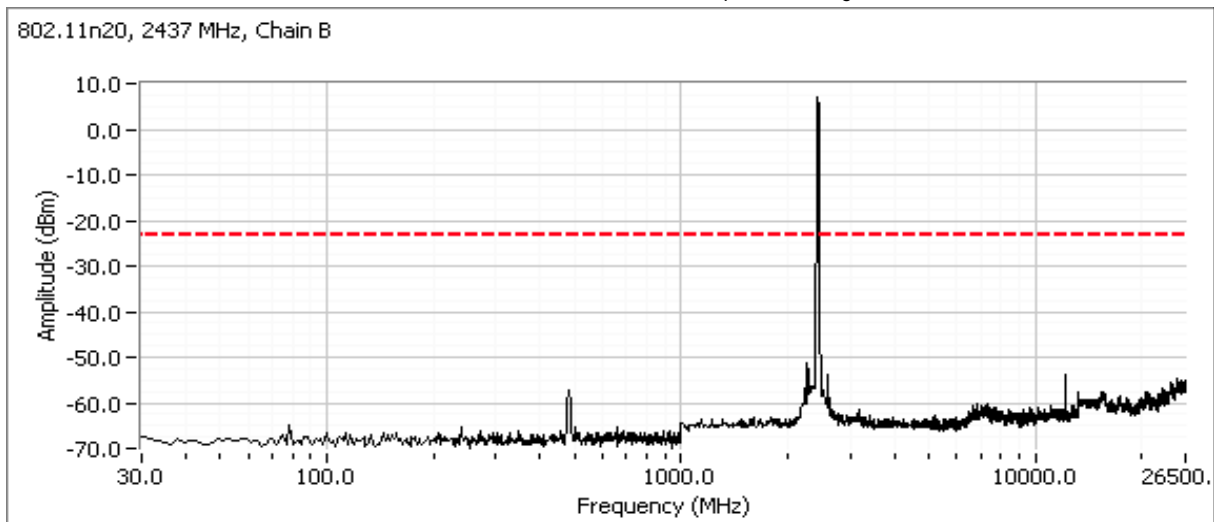

Plots for high channel, 802.11n20, power setting(s) = 24.0

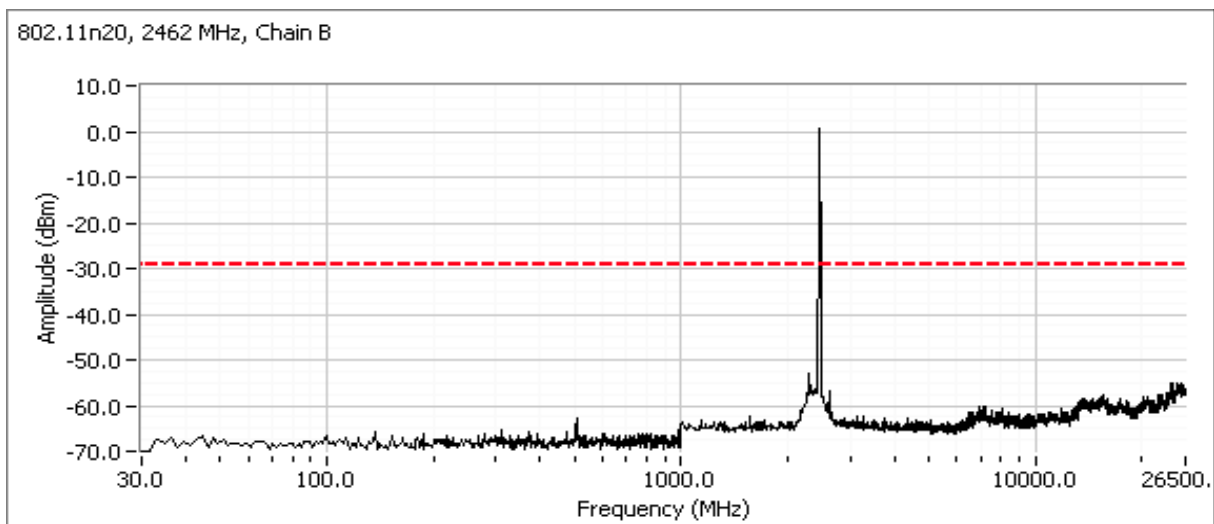

Client: Intel Corporation	Job Number: J84366
Model: Intel® Centrino® Wireless-N 2200	T-Log Number: T84600
	Account Manager: Christine Krebill
Contact: Steve Hackett	
Standard: FCC 15.247	Class: N/A

Plots for low channel, 802.11n40, power setting(s) = 20.0

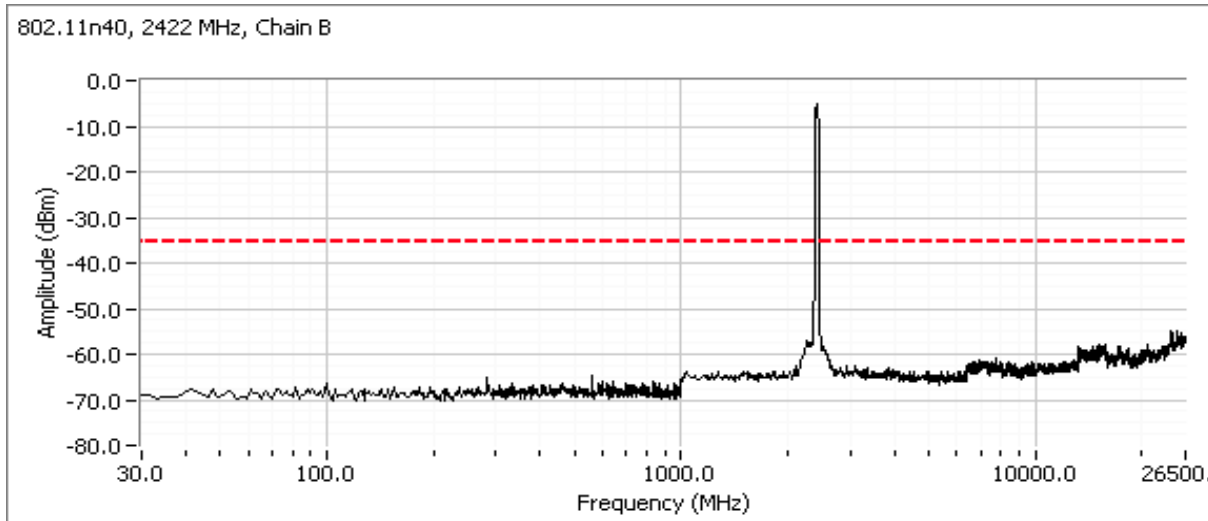

Additional plot showing compliance with -30dBc limit from 2390 MHz to 2400 MHz. Radiated measurements used to show compliance with the limits in the restricted band below 2390 MHz.

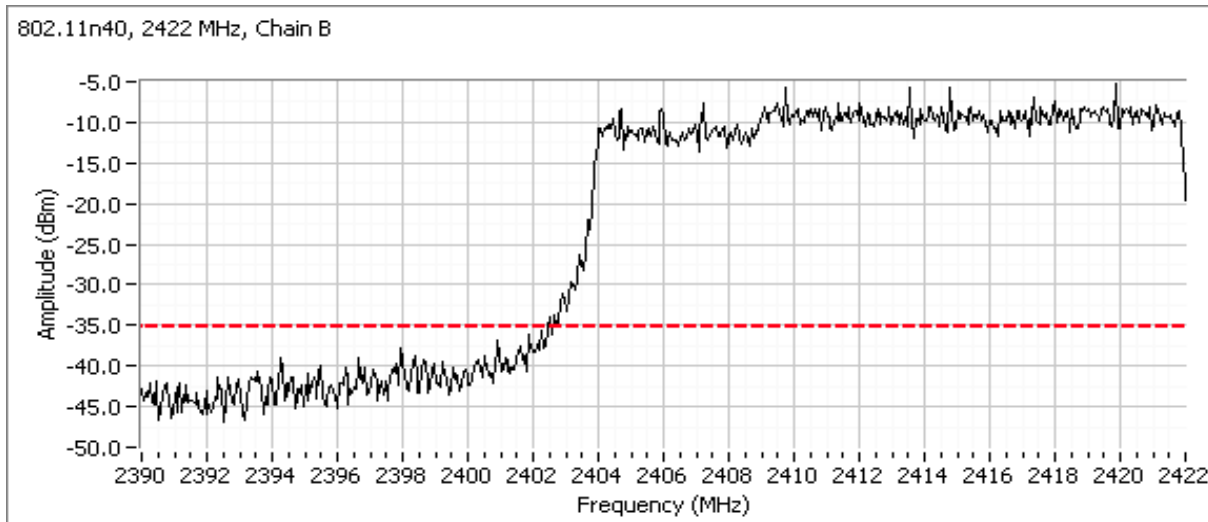

Client: Intel Corporation	Job Number: J84366
Model: Intel® Centrino® Wireless-N 2200	T-Log Number: T84600
	Account Manager: Christine Krebill
Contact: Steve Hackett	
Standard: FCC 15.247	Class: N/A

Plots for center channel 802.11n40, power setting(s) = 25.0

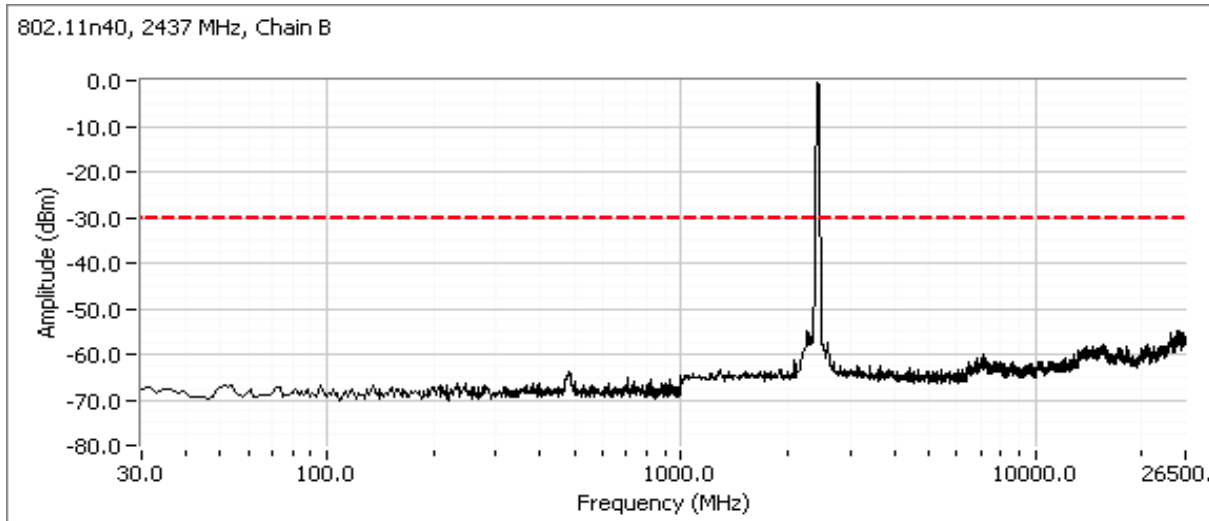

Plots for high channel, 802.11n40, power setting(s) = 21.0

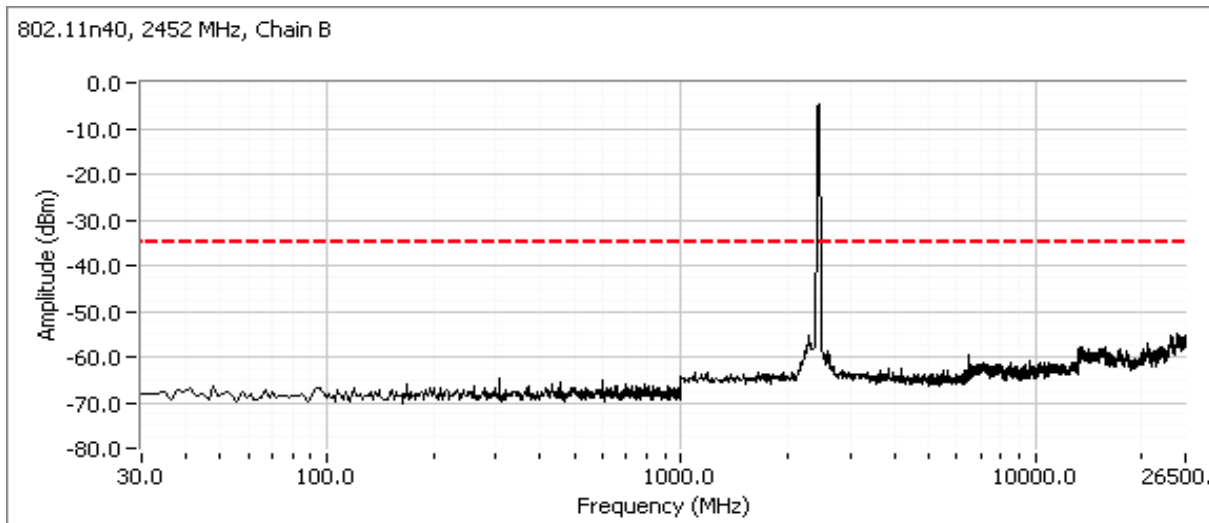



Client: Intel Corporation	Job Number: J84366
Model: Intel® Centrino® Wireless-N 2200	T-Log Number: T84600
	Account Manager: Christine Krebill
Contact: Steve Hackett	
Standard: FCC 15.247	Class: N/A

**RSS 210 and FCC 15.247 (DTS) Antenna Port Measurements  
MIMO and Smart Antenna Systems  
Power, PSD, Bandwidth and Spurious Emissions**

**Test Specific Details**

Objective: The objective of this test session is to perform final qualification testing of the EUT with respect to the specification listed above.

Date of Test: 10/10/ & 10/18/2011	Config. Used: 1
Test Engineer: Joseph Cadigal / R. Varelas	Config Change: none
Test Location: Fremont Chamber #4	EUT Voltage: 120V/60Hz

**General Test Configuration**

The EUT was connected to the spectrum analyzer or power meter via a suitable attenuator. All measurements were made on a single chain.

All measurements have been corrected to allow for the external attenuators used.

**Ambient Conditions:**

Temperature: 20.4 °C  
Rel. Humidity: 37 %

**Summary of Results**

MAC Address: 001500825F4C DRTU Tool Version **1.5.3.0322** Driver version **15.0.0.61**

Run #	Test Performed	Limit	Pass / Fail	Result / Margin
<b>Chain A + B</b>				
1	Output Power	15.247(b)	Pass	802.11n20: 0.041 W 802.11n40: 0.038 W
2	Power spectral Density (PSD)	15.247(d)	Pass	-7.3 dBm/3kHz
<b>MIMO Modes</b>				
3	Minimum 6dB Bandwidth	15.247(a)	Pass	17.7 MHz
3	99% Bandwidth	RSS GEN	Pass	802.11n20: 18.3 MHz 802.11n40: 37.3 MHz
4	Spurious emissions	15.247(b)	Pass	All emissions below -30dBc limit

**Modifications Made During Testing**

No modifications were made to the EUT during testing

**Deviations From The Standard**

No deviations were made from the requirements of the standard.

Client: Intel Corporation	Job Number: J84366
Model: Intel® Centrino® Wireless-N 2200	T-Log Number: T84600
	Account Manager: Christine Krebill
Contact: Steve Hackett	
Standard: FCC 15.247	Class: N/A

### Run #1: Output Power - Chain A + B

Operating Mode: n20 & n40 Transmitted signal on chain is coherent ? no

2412 MHz	Chain 1	Chain 2	Chain 3	Chain 4	Total Across All Chains		Limit	
Power Setting <sup>Note 3</sup>	25.0	26.0						
Output Power (dBm) <sup>Note 1</sup>	11.6	11.7			14.7 dBm	0.029 W	30.0 dBm	1.000 W
Antenna Gain (dBi) <sup>Note 2</sup>	3.2	3.2				3.2 dBi	Pass	
eirp (dBm) <sup>Note 2</sup>	14.8	14.9			17.9 dBm	0.061 W		
2437 MHz	Chain 1	Chain 2	Chain 3	Chain 4	Total Across All Chains		Limit	
Power Setting <sup>Note 3</sup>	27.5	28.0						
Output Power (dBm) <sup>Note 1</sup>	13.1	13.1			16.1 dBm	0.041 W	30.0 dBm	1.000 W
Antenna Gain (dBi) <sup>Note 2</sup>	3.2	3.2				3.2 dBi	Pass	
eirp (dBm) <sup>Note 2</sup>	16.3	16.3			19.3 dBm	0.085 W		
2462 MHz	Chain 1	Chain 2	Chain 3	Chain 4	Total Across All Chains		Limit	
Power Setting <sup>Note 3</sup>	26.0	26.5						
Output Power (dBm) <sup>Note 1</sup>	11.8	11.8			14.8 dBm	0.030 W	30.0 dBm	1.000 W
Antenna Gain (dBi) <sup>Note 2</sup>	3.2	3.2				3.2 dBi	Pass	
eirp (dBm) <sup>Note 2</sup>	15	15			18.0 dBm	0.063 W		
2422 MHz	Chain 1	Chain 2	Chain 3	Chain 4	Total Across All Chains		Limit	
Power Setting <sup>Note 3</sup>	21.5	21.5						
Output Power (dBm) <sup>Note 1</sup>	8.6	7.9			11.3 dBm	0.013 W	30.0 dBm	1.000 W
Antenna Gain (dBi) <sup>Note 2</sup>	3.2	3.2				3.2 dBi	Pass	
eirp (dBm) <sup>Note 2</sup>	11.8	11.1			14.5 dBm	0.028 W		
2437 MHz	Chain 1	Chain 2	Chain 3	Chain 4	Total Across All Chains		Limit	
Power Setting <sup>Note 3</sup>	27.0	27.0						
Output Power (dBm) <sup>Note 1</sup>	13.1	12.5			15.8 dBm	0.038 W	30.0 dBm	1.000 W
Antenna Gain (dBi) <sup>Note 2</sup>	3.2	3.2				3.2 dBi	Pass	
eirp (dBm) <sup>Note 2</sup>	16.3	15.7			19.0 dBm	0.080 W		
2452 MHz	Chain 1	Chain 2	Chain 3	Chain 4	Total Across All Chains		Limit	
Power Setting <sup>Note 3</sup>	23.0	23.5						
Output Power (dBm) <sup>Note 1</sup>	9.4	9.4			12.4 dBm	0.017 W	30.0 dBm	1.000 W
Antenna Gain (dBi) <sup>Note 2</sup>	3.2	3.2				3.2 dBi	Pass	
eirp (dBm) <sup>Note 2</sup>	12.6	12.6			15.6 dBm	0.036 W		

Note 1:	Output power measured using a spectrum analyzer (see plots below) with RBW=1MHz, VB=3 MHz, sample detector, power averaging on (transmitted signal was continuous) and power integration over 50 MHz (option #2, method 1 in KDB 558074, equivalent to method
Note 2:	As there is no coherency between chains the total EIRP is the sum of the individual EIRPs and effective antenna gain equals the eirp divide by the sum of the power on each chain.
Note 3:	Power setting - if a single number the same power setting was used - for each chain. If multiple numbers the power setting for each chain is separated by a comma (e.g. x,y would indicate power setting x for chain 1, power setting y for chain 2.

Client: Intel Corporation	Job Number: J84366
Model: Intel® Centrino® Wireless-N 2200	T-Log Number: T84600
	Account Manager: Christine Krebill
Contact: Steve Hackett	
Standard: FCC 15.247	Class: N/A

**Run #2: Power spectral Density**

Power Setting	Frequency (MHz)	PSD (dBm/3kHz) <sup>Note 1</sup>				Total	Limit dBm/3kHz	Result
		Chain 1	Chain 2	Chain 3	Chain 4			
25/26	2410.6912	-14.3	-11.3			-9.5	8.0	Pass
27.5/28	2431.9542	-10.5	-10.2			-7.3	8.0	Pass
26/26.5	2464.8255	-12.9	-13.2			-10.0	8.0	Pass
21.5/21.5	2434.7400	-19.5	-19.2			-16.3	8.0	Pass
27.0/27.0	2423.8578	-13.5	-14.0			-10.7	8.0	Pass
23.0/23.5	2439.1468	-16.7	-17.0			-13.8	8.0	Pass

Note 1: Power spectral density measured using RB=3 kHz, VB=10kHz, analyzer with peak detector and with a sweep time set to ensure a dwell time of at least 1 second per 3kHz. The measurement is made at the frequency of PPSD determined from preliminary scans using



**Analyzer Settings**

HP8564E  
CF: 2431.959 MHz  
SPAN: 300 kHz  
RB: 3.00 kHz  
VB: 10.0 kHz  
Detector: POS  
Attn: 10 DB  
RL Offset: 11.0 DB  
Sweep Time: 100.0s  
Ref Lvl: 1.8 DBM

**Comments**

PSD: -10.2 dBm/3kHz  
802.11n20, Chain B

Cursor 1	2431.9542	-10.20		
	0.0000	0.00		

Client: Intel Corporation	Job Number: J84366
Model: Intel® Centrino® Wireless-N 2200	T-Log Number: T84600
	Account Manager: Christine Krebill
Contact: Steve Hackett	
Standard: FCC 15.247	Class: N/A



### Analyzer Settings

HP8564E  
 CF: 2431.950 MHz  
 SPAN: 300 kHz  
 RB: 3.00 kHz  
 VB: 10.0 kHz  
 Detector: POS  
 Attn: 10 DB  
 RL Offset: 11.0 DB  
 Sweep Time: 100.0s  
 Ref Lvl: 1.8 DBM

### Comments

PSD: -10.5 dBm/3kHz  
 802.11n20, Chain A

Cursor 1    2431.9730    -10.53    [Move] [Lock] [Clear] [Apply]  
 0.0000    0.00    [Move] [Lock] [Clear] [Apply]



Client: Intel Corporation	Job Number: J84366
Model: Intel® Centrino® Wireless-N 2200	T-Log Number: T84600
	Account Manager: Christine Krebill
Contact: Steve Hackett	
Standard: FCC 15.247	Class: N/A

### Run #3: Signal Bandwidth

Power Setting	Frequency (MHz)	Resolution Bandwidth	Bandwidth (MHz)	
			6dB	99%
25/26	2412	100kHz	17.8/17.8	18.2
27.5/28	2437	100kHz	17.8/17.8	18.3
26/26.5	2462	100kHz	17.7/17.8	18.3
21.5/21.5	2422	100kHz	36.8/36.7	37.1/37.1
27.0/27.0	2437	100kHz	36.8/36.8	37.3/37.3
23.0/23.5	2452	100kHz	36.7/36.7	36.9/37.1

Note 1: Measured on a single chain

Note 2: 99% bandwidth measured in accordance with RSS GEN, with RB > 1% of the span and VB > 3xRB

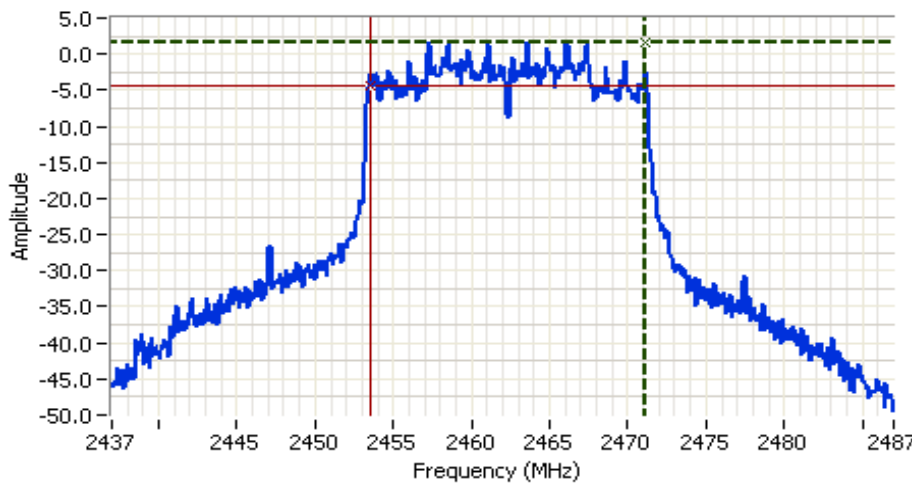

#### Analyzer Settings

HP8564E  
 CF: 2462.000 MHz  
 SPAN: 50.000 MHz  
 RB: 100 kHz  
 VB: 100 kHz  
 Detector: POS  
 Attn: 10 DB  
 RL Offset: 11.0 DB  
 Sweep Time: 50.0ms  
 Ref Lvl: 10.3 DBM

#### Comments

6dB BW: 17.667 MHz  
 802.11n20, Chain A

Cursor 1	2471.1667	1.63	Delta Freq.	17.667
Cursor 2	2453.5000	-4.37	Delta Amplitude	6.00



### Run #4: Out of Band Spurious Emissions

Power Setting Per Chain				Frequency (MHz)	Limit	Result
#1	#2	#3	#4			
25.0	26			2412	-30dBc	Pass
27.5	28			2437	-30dBc	Pass
26.0	26.5			2467	-30dBc	Pass
21.5	21.5			2422	-30dBc	Pass
27.0	27.0			2437	-30dBc	Pass
23.0	23.5			2452	-30dBc	Pass

Note 1: Measured on each chain individually

Client: Intel Corporation	Job Number: J84366
Model: Intel® Centrino® Wireless-N 2200	T-Log Number: T84600
	Account Manager: Christine Krebill
Contact: Steve Hackett	
Standard: FCC 15.247	Class: N/A

n20 mode

Plots for low channel, power setting(s) = 25.0/26

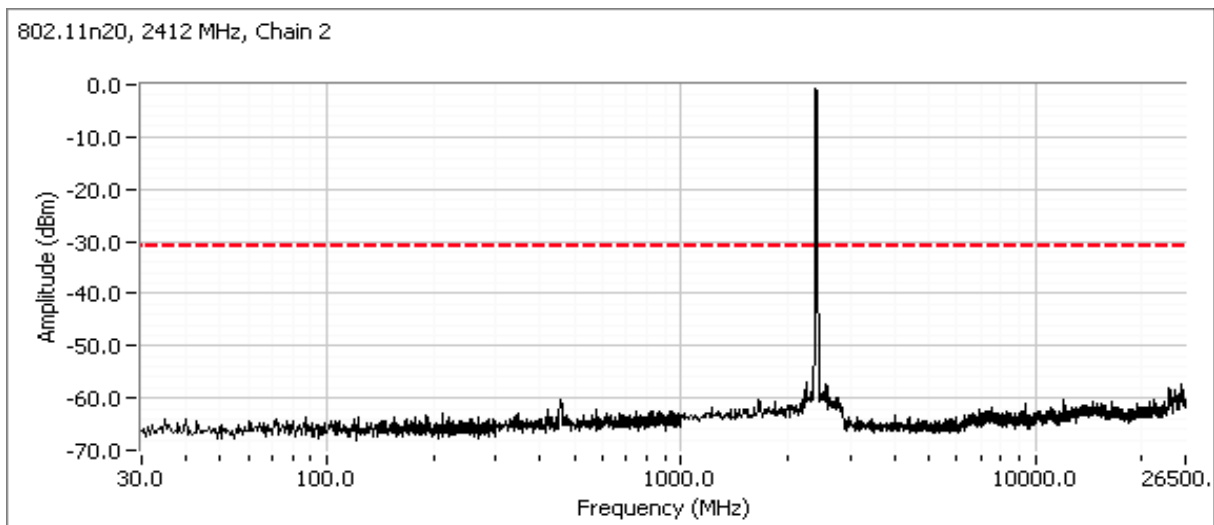
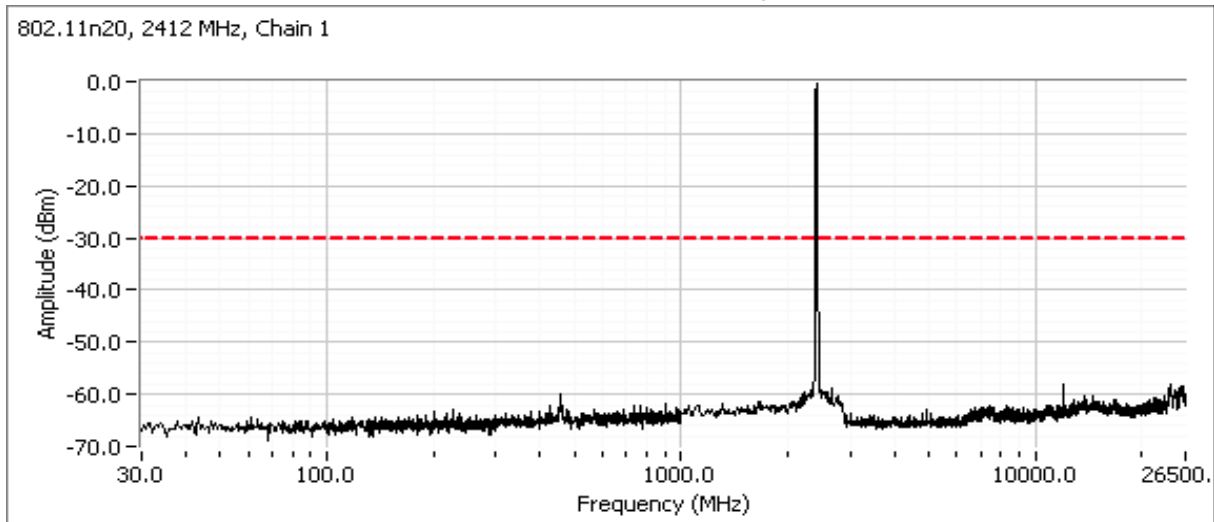

Client: Intel Corporation	Job Number: J84366
Model: Intel® Centrino® Wireless-N 2200	T-Log Number: T84600
	Account Manager: Christine Krebill
Contact: Steve Hackett	
Standard: FCC 15.247	Class: N/A

Additional plot showing compliance with -30dBc limit from 2390 MHz to 2400 MHz. Radiated measurements used to show compliance with the limits in the restricted band below 2390 MHz.

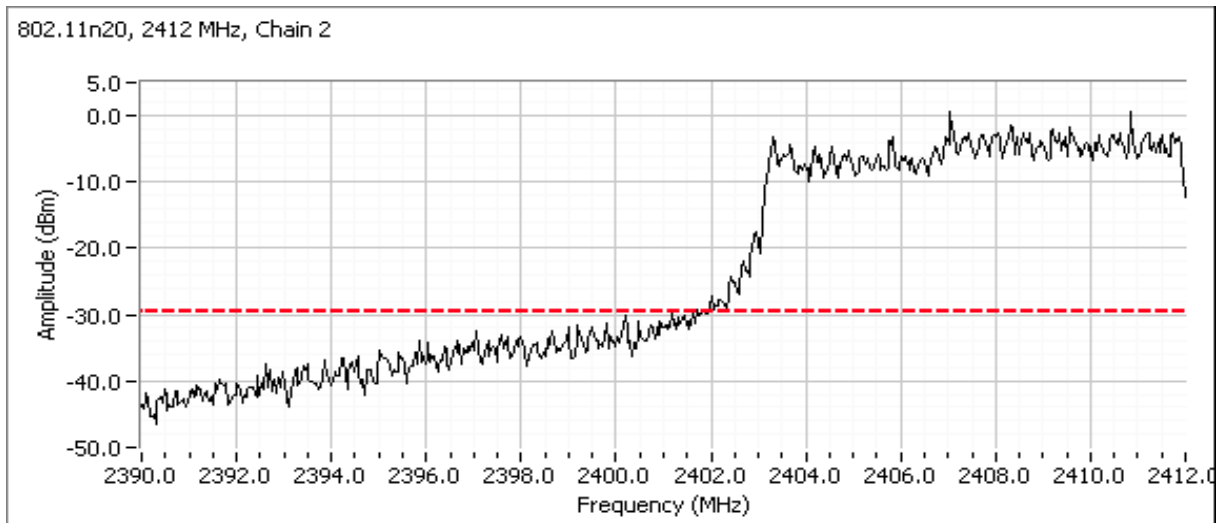
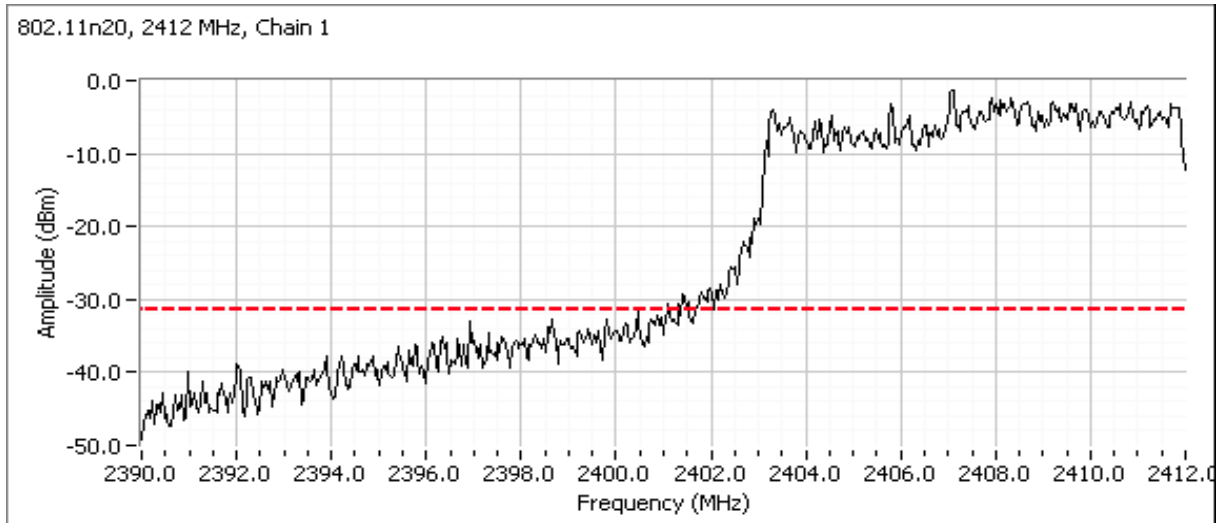

Client: Intel Corporation	Job Number: J84366
Model: Intel® Centrino® Wireless-N 2200	T-Log Number: T84600
	Account Manager: Christine Krebill
Contact: Steve Hackett	
Standard: FCC 15.247	Class: N/A

Plots for center channel, power setting(s) = 27.5/28

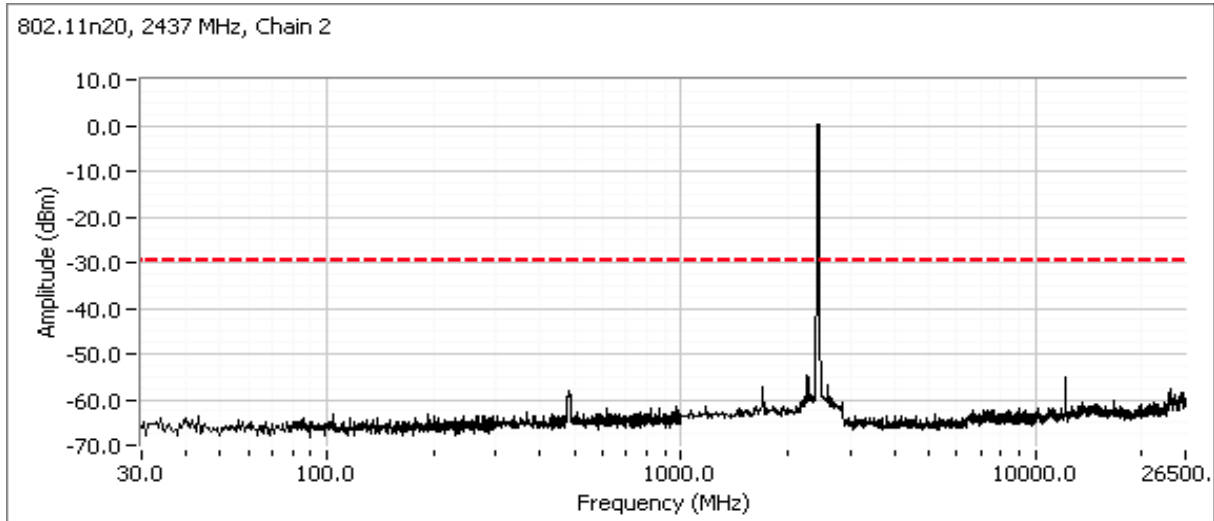
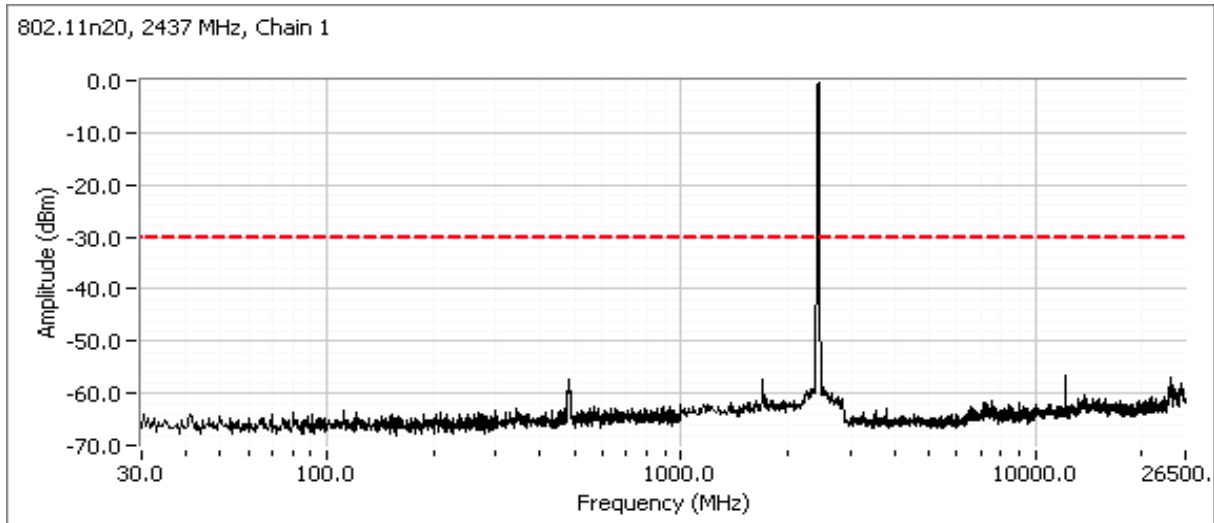



Client: Intel Corporation	Job Number: J84366
Model: Intel® Centrino® Wireless-N 2200	T-Log Number: T84600
	Account Manager: Christine Krebill
Contact: Steve Hackett	
Standard: FCC 15.247	Class: N/A

Plots for high channel, power setting(s) = 26/26.5

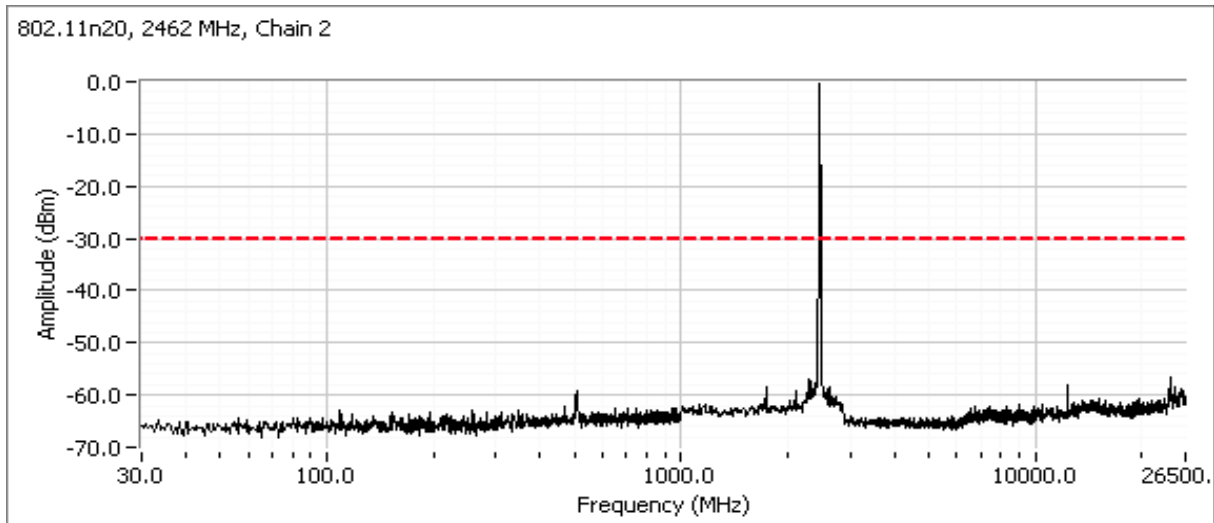
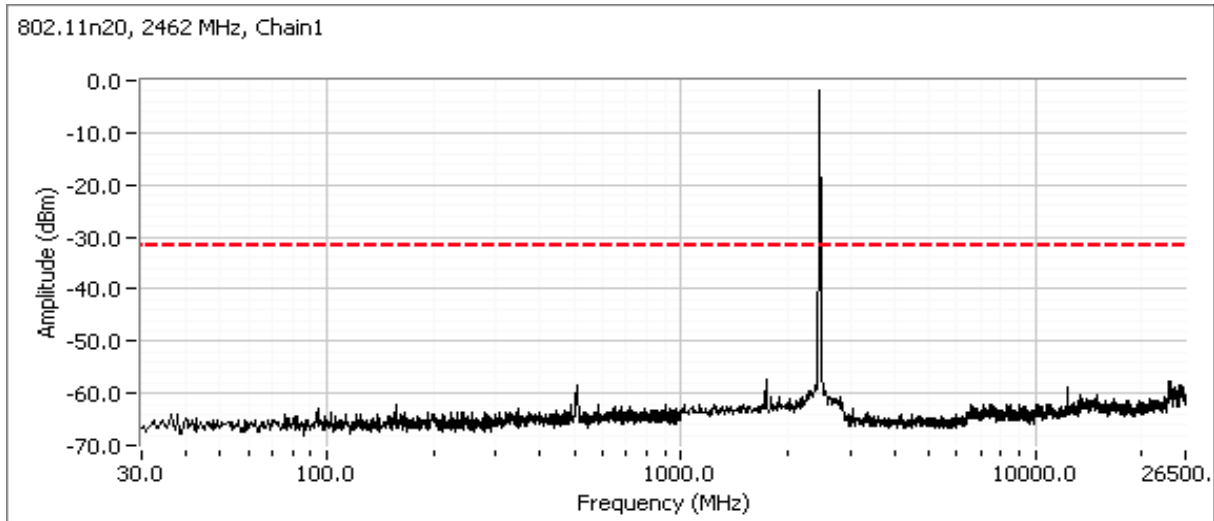

Client: Intel Corporation	Job Number: J84366
Model: Intel® Centrino® Wireless-N 2200	T-Log Number: T84600
	Account Manager: Christine Krebill
Contact: Steve Hackett	
Standard: FCC 15.247	Class: N/A

n40 mode

Plots for low channel, power setting(s) = 21.5/21.5

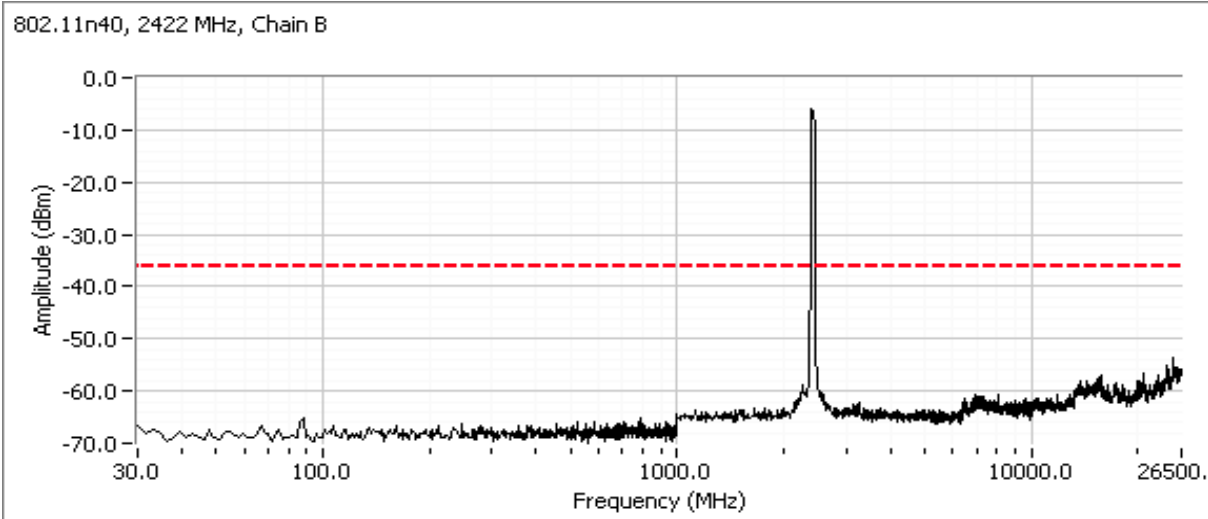
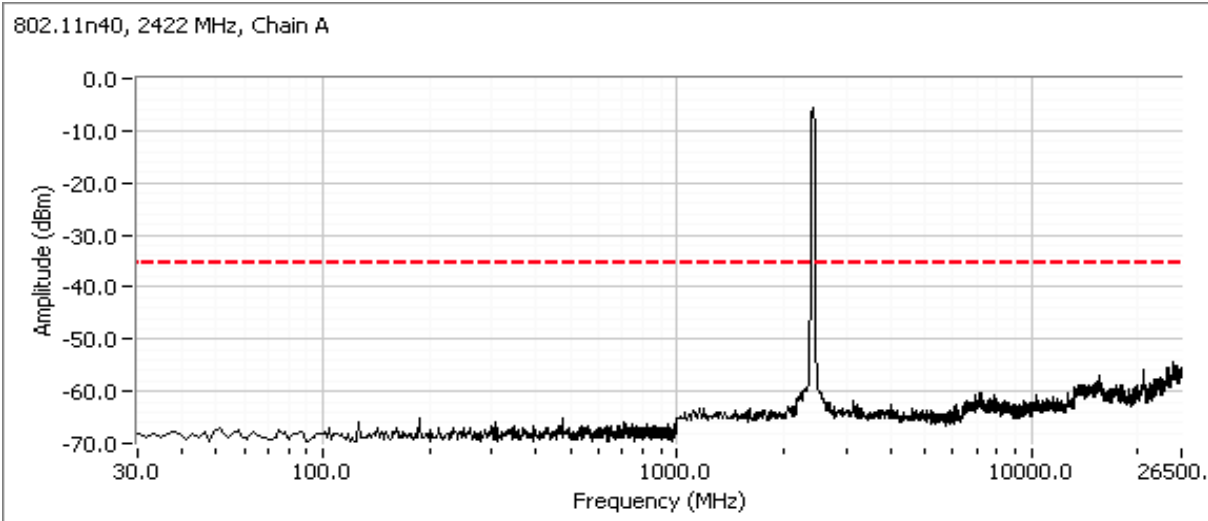

Client: Intel Corporation	Job Number: J84366
Model: Intel® Centrino® Wireless-N 2200	T-Log Number: T84600
	Account Manager: Christine Krebill
Contact: Steve Hackett	
Standard: FCC 15.247	Class: N/A

Additional plot showing compliance with -30dBc limit from 2390 MHz to 2400 MHz. Radiated measurements used to show compliance with the limits in the restricted band below 2390 MHz.

802.11n40, 2422 MHz, Chain A

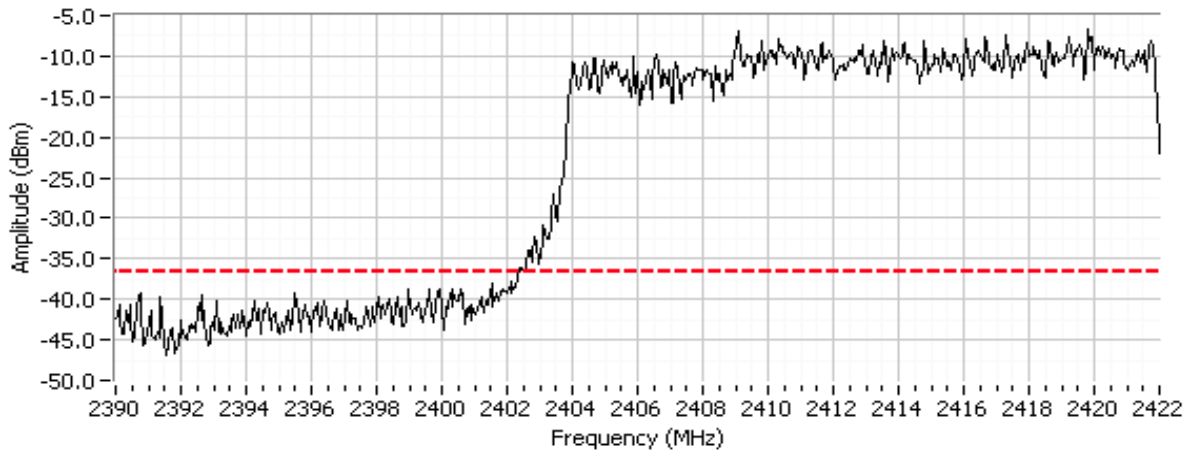

802.11n40, 2422 MHz, Chain B

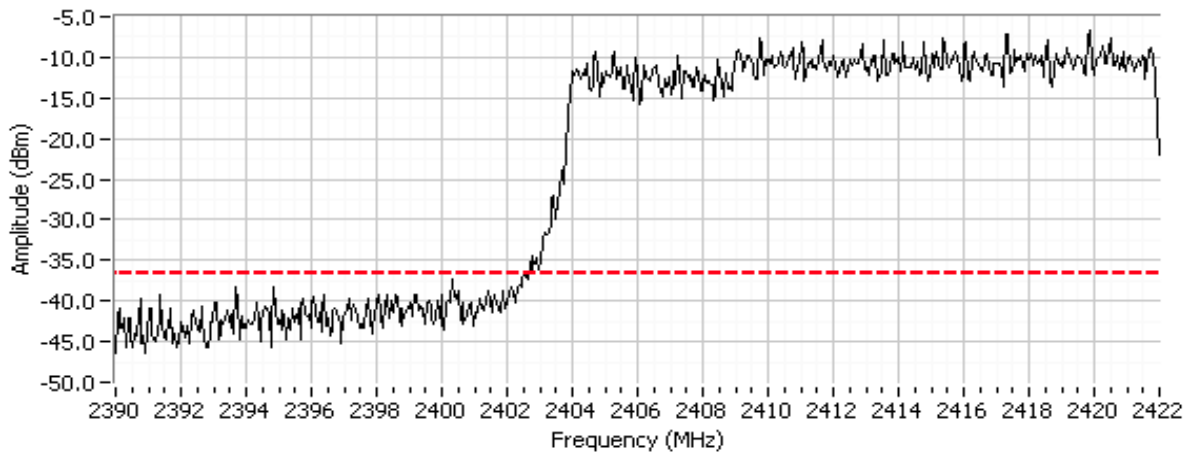

Client: Intel Corporation	Job Number: J84366
Model: Intel® Centrino® Wireless-N 2200	T-Log Number: T84600
	Account Manager: Christine Krebill
Contact: Steve Hackett	
Standard: FCC 15.247	Class: N/A

Plots for center channel, power setting(s) = 27.0/27.0

802.11n40, 2437 MHz, Chain A

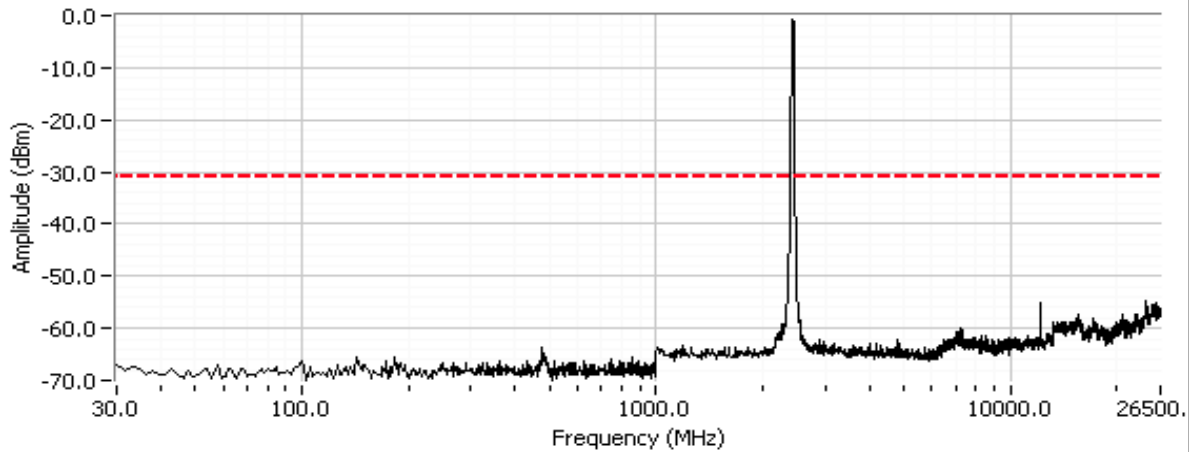

802.11n40, 2437 MHz, Chain B

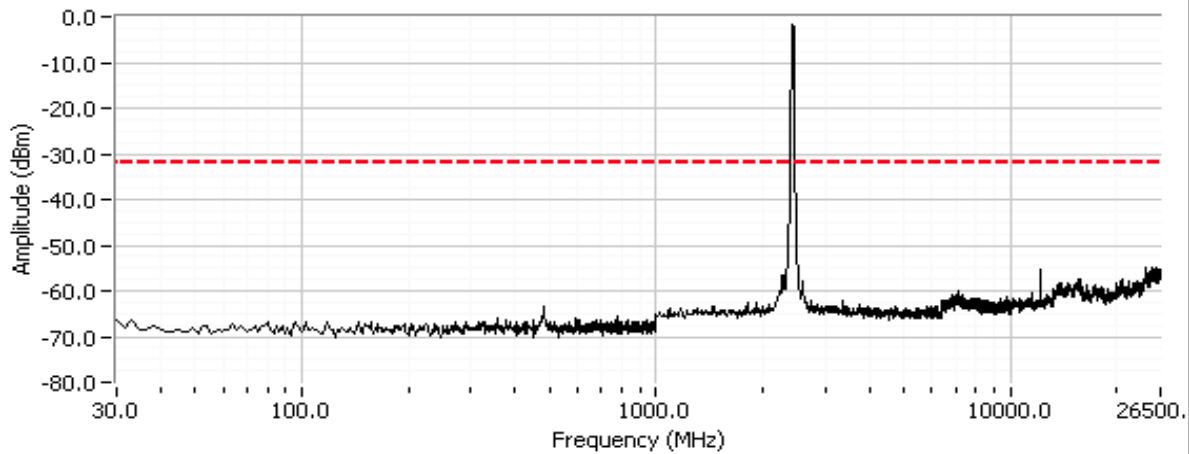

Client: Intel Corporation	Job Number: J84366
Model: Intel® Centrino® Wireless-N 2200	T-Log Number: T84600
	Account Manager: Christine Krebill
Contact: Steve Hackett	
Standard: FCC 15.247	Class: N/A

Plots for high channel, power setting(s) = 23.0/23.5

802.11n40, 2452 MHz, Chain A

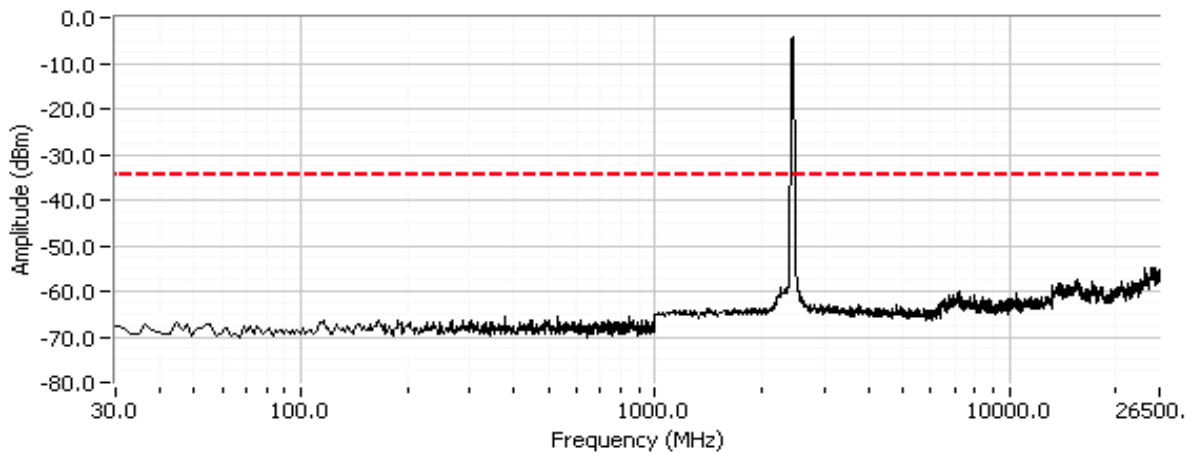

802.11n40, 2452 MHz, Chain B

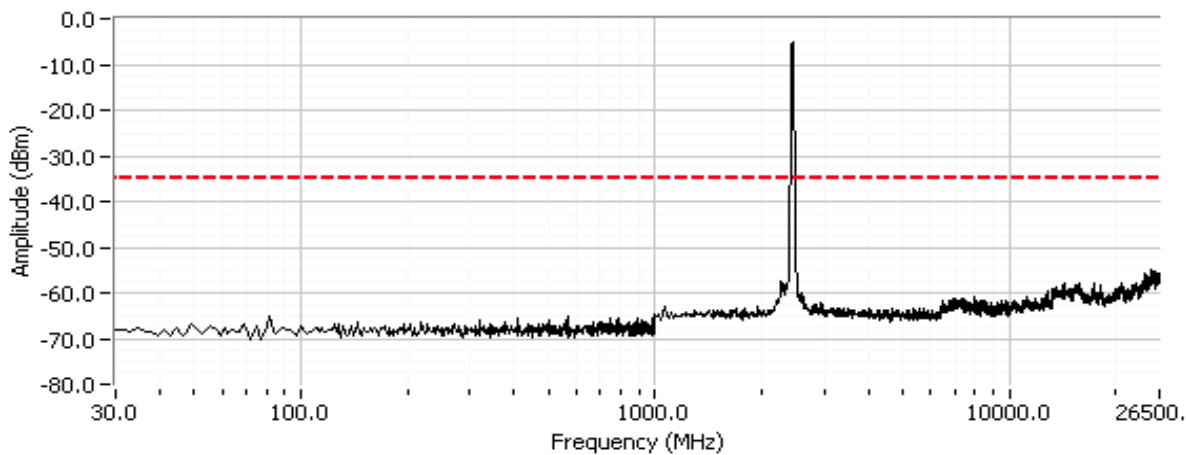

Client:	Intel Corporation	Job Number:	J84366
Model:	Intel® Centrino® Wireless-N 2200	T-Log Number:	T84600
Contact:	Steve Hackett	Account Manager:	Christine Krebill
Standard:	FCC 15.247	Class:	B

## Radiated Emissions

*(Elliott Laboratories Fremont Facility, Semi-Anechoic Chamber)*

### Test Specific Details

Objective: The objective of this test session is to perform final qualification testing of the EUT with respect to the specification listed above.

Date of Test: 9/29/2011	Config. Used: Module
Test Engineer: Joseph Cadigal	Config Change: none
Test Location: FT Chamber#5	Host Unit Voltage 120V/60Hz

### General Test Configuration

The EUT and any local support equipment were located on the turntable for radiated emissions testing. Any remote support equipment was located outside the semi-anechoic chamber. Any cables running to remote support equipment were routed through metal conduit and when possible passed through a ferrite clamp upon exiting the chamber.

The test distance and extrapolation factor (if applicable) are detailed under each run description.

Note, preliminary testing indicates that the emissions were maximized by orientation of the EUT and elevation of the measurement antenna. Maximized testing indicated that the emissions were maximized by orientation of the EUT, elevation of the measurement antenna, and manipulation of the EUT's interface cables.

### Ambient Conditions:

Temperature:	24 °C
Rel. Humidity:	38 %

### Summary of Results

MAC Address: 001500825F4C DRTU Tool Version **1.5.3.0322** Driver version **15.0.0.61**

Run #	Test Performed	Limit	Result	Margin
2	Radiated Emissions 30 - 1000 MHz	FCC 15.209 / RSS 210	Pass	37.9dBµV/m @ 199.65MHz (-5.6dB)

Note - preliminary measurements indicated that the radiated emissions from the combination of test fixture and EUT were not affected by the modules operating frequency or mode (transmit versus receive mode). The system was therefore evaluated with the device operating at max power (16.7dBm) on Chains A and B at 2437MHz, 802.11n20 mode.

### Modifications Made During Testing

No modifications were made to the EUT during testing

### Deviations From The Standard

No deviations were made from the requirements of the standard.

Client:	Intel Corporation	Job Number:	J84366
Model:	Intel® Centrino® Wireless-N 2200	T-Log Number:	T84600
Contact:	Steve Hackett	Account Manager:	Christine Krebill
Standard:	FCC 15.247	Class:	B

Run #1: Preliminary Radiated Emissions, 30 - 1000 MHz  
 Configured to TX , 802.11n20 16.7dBm on each chain (setting 27) on channel 6

Frequency Range	Test Distance	Limit Distance	Extrapolation Factor
30 - 1000 MHz	3	3	0.0

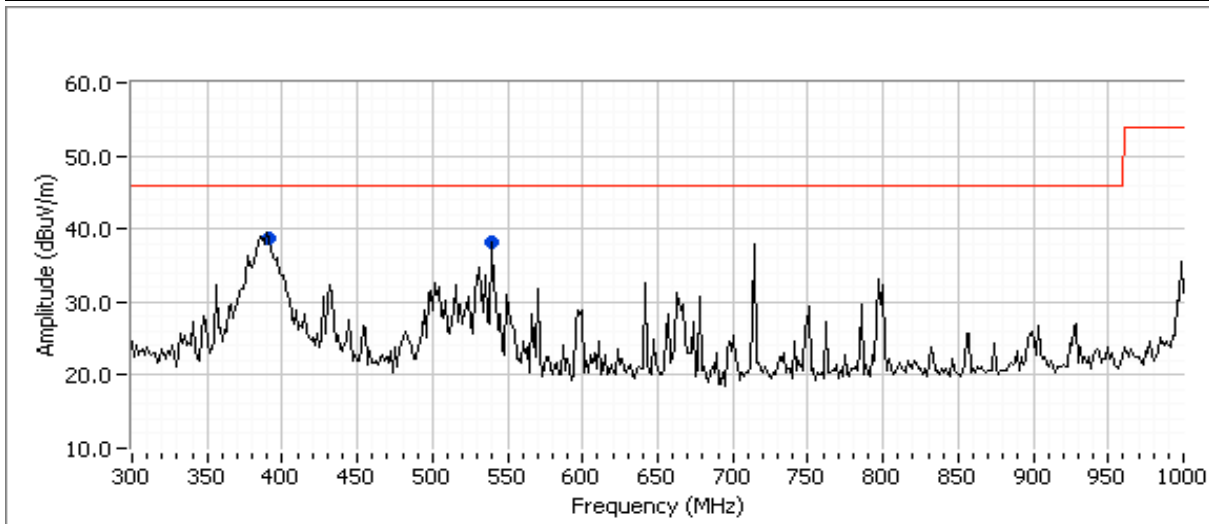
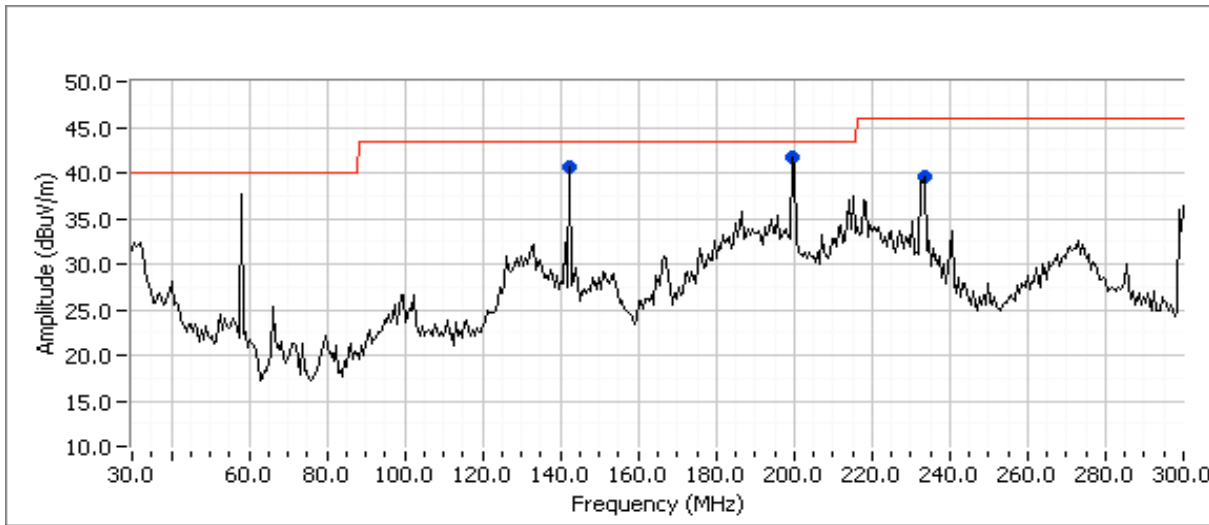

Client:	Intel Corporation	Job Number:	J84366
Model:	Intel® Centrino® Wireless-N 2200	T-Log Number:	T84600
Contact:	Steve Hackett	Account Manager:	Christine Krebill
Standard:	FCC 15.247	Class:	B

**Preliminary peak readings captured during pre-scan**

Frequency MHz	Level dB $\mu$ V/m	Pol v/h	FCC Class B		Detector Pk/QP/Avg	Azimuth degrees	Height meters	Comments
			Limit	Margin				
540.410	38.3	H	46.0	-7.7	Peak	149	2.0	
199.652	41.7	V	43.5	-1.8	Peak	175	1.0	
390.730	38.6	H	46.0	-7.4	Peak	175	1.5	
391.454	38.6	H	46.0	-7.4	Peak	175	1.5	
142.641	40.6	H	43.5	-2.9	Peak	190	3.0	
233.126	39.5	H	46.0	-6.5	Peak	223	1.5	

**Preliminary quasi-peak readings (no manipulation of EUT interface cables)**

Frequency MHz	Level dB $\mu$ V/m	Pol v/h	FCC Class B		Detector Pk/QP/Avg	Azimuth degrees	Height meters	Comments
			Limit	Margin				
540.410	19.5	H	46.0	-26.5	QP	151	2.0	QP (1.00s)
199.652	37.9	V	43.5	-5.6	QP	180	1.0	QP (1.00s)
390.730	34.4	H	46.0	-11.6	QP	171	1.5	QP (1.00s)
391.454	34.7	H	46.0	-11.3	QP	179	1.5	QP (1.00s)
142.641	25.2	H	43.5	-18.3	QP	190	3.0	QP (1.00s)
233.126	39.5	H	46.0	-6.5	QP	226	1.5	QP (1.00s)

**Run #2: Maximized Readings From Run #1**

Maximized quasi-peak readings (includes manipulation of EUT interface cables)

Frequency Range	Test Distance	Limit Distance	Extrapolation Factor
30 - 1000 MHz	3	3	0.0

Frequency MHz	Level dB $\mu$ V/m	Pol v/h	FCC Class B		Detector Pk/QP/Avg	Azimuth degrees	Height meters	Comments
			Limit	Margin				
199.652	37.9	V	43.5	-5.6	QP	180	1.0	QP (1.00s)
233.126	39.5	H	46.0	-6.5	QP	226	1.5	QP (1.00s)
391.454	34.7	H	46.0	-11.3	QP	179	1.5	QP (1.00s)
390.730	34.4	H	46.0	-11.6	QP	171	1.5	QP (1.00s)
142.641	25.2	H	43.5	-18.3	QP	190	3.0	QP (1.00s)
540.410	19.5	H	46.0	-26.5	QP	151	2.0	QP (1.00s)





Client:	Intel Corporation	Job Number:	J84366
Model:	Intel® Centrino® Wireless-N 2200	T-Log Number:	T84600
Contact:	Steve Hackett	Account Manager:	Christine Krebill
Standard:	FCC 15.247	Class:	B

Run #1: AC Power Port Conducted Emissions, 0.15 - 30MHz, 120V/60Hz

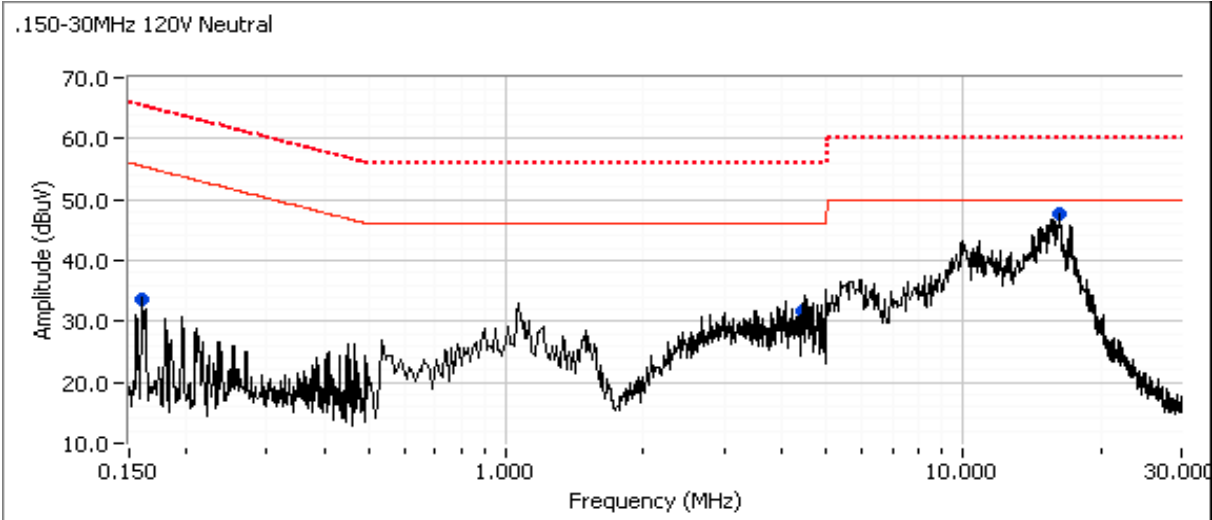
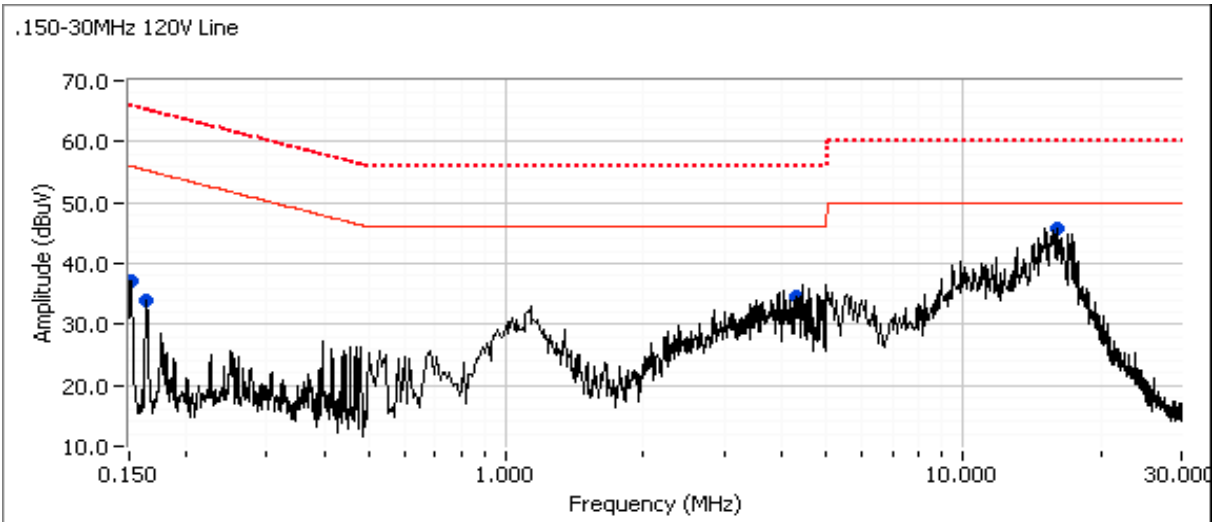

Client:	Intel Corporation	Job Number:	J84366
Model:	Intel® Centrino® Wireless-N 2200	T-Log Number:	T84600
Contact:	Steve Hackett	Account Manager:	Christine Krebill
Standard:	FCC 15.247	Class:	B

### Preliminary peak readings captured during pre-scan (peak readings vs. average limit)

Frequency MHz	Level dB $\mu$ V	AC Line	RSS 210 / 15.207		Detector QP/Ave	Comments
			Limit	Margin		
0.151	37.1	Line 1	55.9	-18.8	Peak	
0.164	33.9	Line 1	55.3	-21.4	Peak	
4.302	34.7	Line 1	46.0	-11.3	Peak	
16.100	45.9	Line 1	50.0	-4.1	Peak	
4.455	31.8	Neutral	46.0	-14.2	Peak	
16.177	47.7	Neutral	50.0	-2.3	Peak	

### Final quasi-peak and average readings

Frequency MHz	Level dB $\mu$ V	AC Line	RSS 210 / 15.207		Detector QP/Ave	Comments
			Limit	Margin		
<b>16.177</b>	<b>41.3</b>	Neutral	60.0	<b>-18.7</b>	QP	QP (1.00s)
16.177	30.7	Neutral	50.0	-19.3	AVG	AVG (0.10s)
16.100	40.6	Line 1	60.0	-19.4	QP	QP (1.00s)
16.100	29.3	Line 1	50.0	-20.7	AVG	AVG (0.10s)
4.302	28.2	Line 1	56.0	-27.8	QP	QP (1.00s)
4.455	27.0	Neutral	56.0	-29.0	QP	QP (1.00s)
4.302	16.3	Line 1	46.0	-29.7	AVG	AVG (0.10s)
4.455	13.7	Neutral	46.0	-32.3	AVG	AVG (0.10s)
0.151	27.7	Line 1	65.9	-38.2	QP	QP (1.00s)
0.164	24.9	Line 1	65.3	-40.4	QP	QP (1.00s)
0.151	11.2	Line 1	55.9	-44.7	AVG	AVG (0.10s)
0.164	10.6	Line 1	55.3	-44.7	AVG	AVG (0.10s)

*End of Report*

This page is intentionally blank and marks the last page of this test report.