

# TEST REPORT

EUT Description	<b>Wireless Module installed in 2 in 1 PC/Tablet</b>
Brand Name	<b>Intel® Model 18265 inside Dell Model P29S</b>
Model Name	<b>18265NGW</b>
FCC/IC ID	<b>PD918265NG/IC ID: 1000M-18265NG</b>
Date of Test Start/End	<b>2017-12-18 / 2017-12-22</b>
Features	<b>WiGig + 802.11 a/b/g/n/ac Wireless LAN + BDR/EDR 2.1 + BLE 4.2</b> (see section 5)

Applicant	<b>Intel Mobile Communications</b>
Address	<b>100 Center Point Circle, Suite 200 / Columbia, SC 29210 / United States</b>
Contact Person	<b>Steven Hackett</b>
Telephone/Fax/ Email	<b>steven.c.hackett@intel.com</b>

Reference Standards	<b>FCC 47 CFR Part §2.1093</b> <b>FCC 47 CFR Part §15.255(f)</b> (see section 1)
RF Exposure Environment	<b>Portable devices - General population/uncontrolled exposure</b>
Test separation distance	<b>5 mm (from probe sensor to evaluation plane)</b>

Test Report identification	<b>170512-01.TR01</b>
Revision Control	<b>This test report revision replaces any previous test report revision</b> (see section 8)

The test results relate only to the samples tested.  
The test report shall not be reproduced in full, without written approval of the laboratory.

**Intel Mobile Communications France S.A.S – WRF Lab**  
**425 rue de Goa – Le Cargo B6 - 06600, Antibes, France**  
**Tel. +33493001400 / Fax +33493001401**

# Table of Contents

---

<b>1. Standards, reference documents and applicable test methods</b>	<b>3</b>
<b>2. General conditions, competences and guarantees</b>	<b>3</b>
<b>3. Environmental Conditions</b>	<b>3</b>
<b>4. Test samples</b>	<b>3</b>
<b>5. EUT Features</b>	<b>3</b>
<b>6. Remarks and comments</b>	<b>5</b>
<b>7. Associated Documents</b>	<b>5</b>
<b>8. Document Revision History</b>	<b>5</b>
<b>Annex A. Test &amp; System Description</b>	<b>6</b>
A.1 POWER DENSITY DEFINITION	6
A.2 SPEAG FREE SPACE MEASUREMENT SYSTEM	6
A.2.1 Measurement Setup	6
A.2.2 E-Field Measurement Probe	7
A.2.3 Worst Case Linearization Error	8
A.2.4 Data Evaluation	9
A.3 SYSTEM CHECK	10
A.4 TEST EQUIPMENT LIST	11
A.4.1 System #2	11
A.4.2 Shared Equipment	11
A.5 MEASUREMENT UNCERTAINTY EVALUATION	12
<b>Annex B. Test Results</b>	<b>13</b>
B.1 TEST CONDITIONS	13
B.1.1 Test signal, Output power and Test Frequencies	13
B.1.2 Measurement configuration	13
B.2 SYSTEM CHECK MEASUREMENTS	13
B.3 TEST RESULTS	14
<b>Annex C. Test System Plots</b>	<b>15</b>
<b>Annex D. Informative Test Results vs. Simulation Results</b>	<b>Error! Bookmark not defined.</b>
<b>Annex E. Photographs</b>	<b>24</b>
E.1 TEST SETUP	24
E.2 TEST SAMPLE	25
<b>Annex F. Calibration Certificates</b>	<b>26</b>

## 1. Standards, reference documents and applicable test methods

1. FCC 47 CFR Part §2.1093 – Radiofrequency radiation exposure evaluation: portable devices.
2. FCC 47 CFR Part 15 – Subpart C – §15.255 Operation within the band 57-64 GHz.
3. SPEAG Application Note – 5G Compliance Testing with DASY6 (5GModule V1.0Beta)

## 2. General conditions, competences and guarantees

- ✓ Intel Mobile Communications France SAS Wireless RF Lab (Intel WRF Lab) is a testing laboratory competent to perform this testing.
- ✓ Intel WRF Lab only provides testing services and is committed to providing reliable, unbiased test results and interpretations.
- ✓ Intel WRF Lab is liable to the client for the maintenance of the confidentiality of all information related to the item under test and the results of the test.
- ✓ Intel WRF Lab has developed calibration and proficiency programs for its measurement equipment to ensure correlated and reliable results to its customers.
- ✓ This report is only referred to the item that has undergone the test.
- ✓ This report does not imply an approval of the product by the Certification Bodies or competent Authorities.

## 3. Environmental Conditions

- ✓ At the site where the measurements were performed the following limits were not exceeded during the tests:

Temperature	21°C ± 1°C
Humidity	30% ± 10%

## 4. Test samples

Sample	Control #	Description	Model	Serial #	Date of receipt	Note
#01	170512-01.S01	Wireless Module installed in conventional laptop	18265NGW inside P29S	N/A	2017-05-11	NA
	170512-01.S01	AC Adapter	NA	CN-02YK0F-LOC00-6BS-0192-A00	2017-05-11	NA

## 5. EUT Features

Brand Name	Intel® Model 18265 inside Dell Model P29S	
Model Name	18265NGW	
FCC/IC ID	PD918265NG/IC ID: 1000M-18265NG	
Software Version	1.9.0-06565	
Prototype / Production	Production	
Host Identification	P29S series	
Exposure Conditions	Localized free space power density	
Supported Radios	WiGig	60GHz (57.24 – 63.72 GHz)
	802.11b/g/n	2.4GHz (2400.0 – 2483.5 MHz)
	802.11a/n/ac	5.2GHz (5150.0 – 5250.0 MHz)
		5.3GHz (5250.0 – 5350.0 MHz)
		5.6GHz (5470.0 – 5725.0 MHz)
Bluetooth	2.4GHz (2400.0 – 2483.5 MHz)	
Antenna Information	RFEM3 (10101RRFW)	



Test Report N° 170512-01.TR01

**Note:** RF exposure compliance for 802.11 and Bluetooth capabilities are not addressed in this document neither the associated documents mentioned in section 7.

## 6. Remarks and comments

1. Per the location of the active antenna array (a.k.a. RFEM3) in the Dell model P29S platform, the distance between the antenna arrays to the body of an end user, at the closest contact point, will be in the near-field.
2. In order to prove that during typical use the energy goes in most cases away from the human body, several tests of beamforming behavior were performed under different use case conditions. The results are presented in the associated document [2].
3. These tests are supported by a determination of the near-field average power density performed using an EM simulation supported by a near-field measurement. An EM simulation that includes the RFEM 3 transmitter model embedded inside the Dell model P29S is used to determine the worst case configuration and the correspondent near-field power density. This worst case power density which is a conservative case considering that the energy is always oriented toward the human body is also supported by a near-field measurement. The simulation method is described in associated document [2]. The simulation results and the near-field measurement results are described in [3].
4. The worst-case power density found in simulation is supported by performing the E-field measurement in the near-field using SPEAG system. The measurement system and test results are presented in this report.

## 7. Associated Documents

- [1] 170512-Dell P29S Theory of Operation Report
- [2] 170512-Dell P29S MPE Simulation Report
- [3] 170512-Dell P29S Simulations and Measurements Comparisons and Compliance Descriptions Report

## 8. Document Revision History

Revision #	Date	Modified by	Revision Details
Rev. 00	2018-01-29	K. RIDA	First Issue

# Annex A. Test & System Description

## A.1 Power Density Definition

The power density for an electromagnetic field represents the rate of energy transfer per unit area.

The local power density (i.e. Poynting vector) at a given spatial point is deduced from electromagnetic fields by the following formula:

$$\vec{P}_{local} = \frac{1}{2} \text{Re} (\vec{E} \times \vec{H}^*)$$

Where  $\vec{E}$  is the complex electric field peak phasor and  $\vec{H}^*$  is the complex conjugate magnetic field peak phasor.

This power density is also called “single-point” or “spot power density”.

Considering that the FCC’s Maximum Permissible Exposure (MPE) limit is applicable on the average power density inside 1cm<sup>2</sup> area, the single point power densities in the evaluation plane should be averaged inside the 1cm<sup>2</sup> area.

## A.2 SPEAG free space Measurement System

### A.2.1 Measurement Setup

The DASY6 system for performing compliance tests consists of the following items:

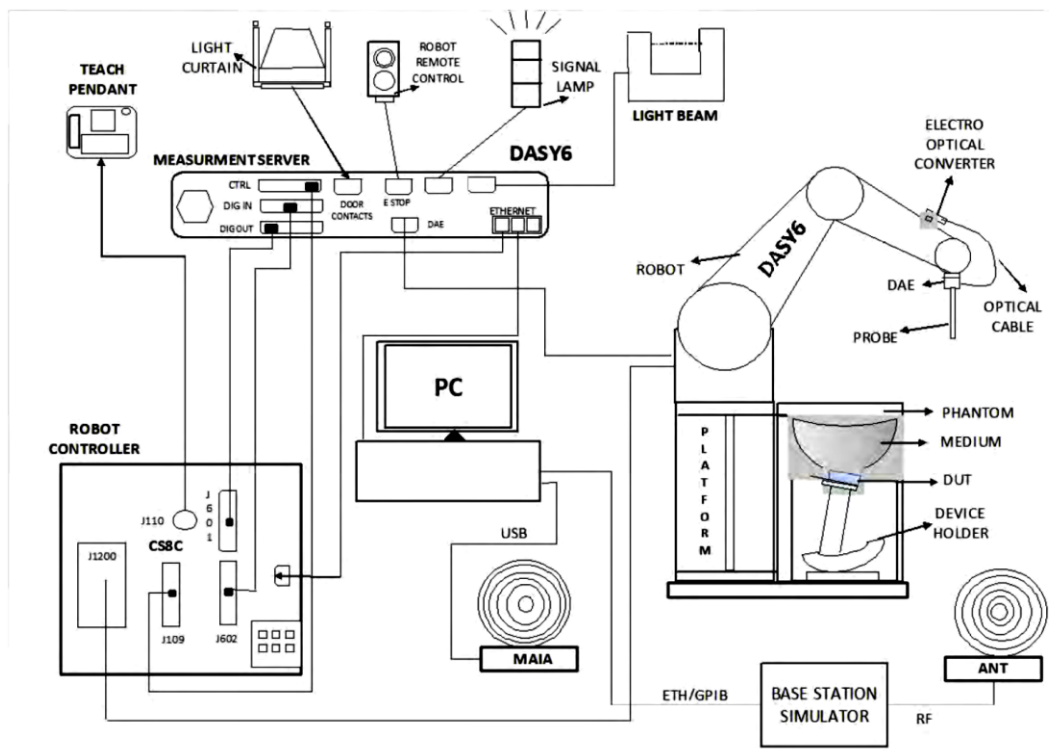

- ✓ A standard high precision 6-axis robot (Stäubli TX/RX family) with controller, teach pendant and software. It includes an arm extension for accommodating the data acquisition electronics (DAE)
- ✓ An isotropic field probe optimized and calibrated for the targeted measurements.
- ✓ A data acquisition electronics (DAE) which performs the signal amplification, signal multiplexing, AD-conversion, offset measurements, mechanical surface detection, collision detection, etc. The unit is battery powered with standard or rechargeable batteries. The signal is optically transmitted to the EOC.
- ✓ The Electro-optical Converter (EOC) performs the conversion from optical to electrical signals for the digital communication to the DAE. The EOC signal is transmitted to the measurement server.
- ✓ The function of the measurement server is to perform the time critical tasks such as signal filtering, control of the robot operation and fast movements interrupts.
- ✓ The Light Beam used is for probe alignment. This improves the (absolute) accuracy of the probe positioning.
- ✓ A computer running Win7 professional operating system and the cDASY6 software.
- ✓ Remote control and teach pendant as well as additional circuitry for robot safety such as warning lamps, etc.

### A.2.2 E-Field Measurement Probe

The probe consists of two dipoles (0.8 mm length) optimally arranged with different angles ( $\gamma_1$  and  $\gamma_2$ ) to obtain pseudo-vector information, printed on glass substrate protected by high density foam that allows low perturbation of the measured field.

Three or more measurements are taken for different probe rotational angles, deriving the amplitude and polarization information.

The probe's characteristics are:

Frequency Range	750 MHz – 110 GHz <sup>1</sup>
Length	320 mm
Probe tip external diameter	8 mm
Probe's two dipoles length	0.9mm – Diode loaded
Probe's substrate	Quartz 0.9 x 20 x 0.18mm ( $\epsilon_r=3.8$ )
Distance between diode sensors and probe's tip	1.5 mm
Axial Isotropy	$\pm 0.6$ dB
Maximum operating E-field	3000 V/m
Lower E-field detection threshold	5 V/m @ 60 GHz
Minimum Mechanical separation between probe tip and a Surface	0.5mm
Calibration reference point	Diode Sensor

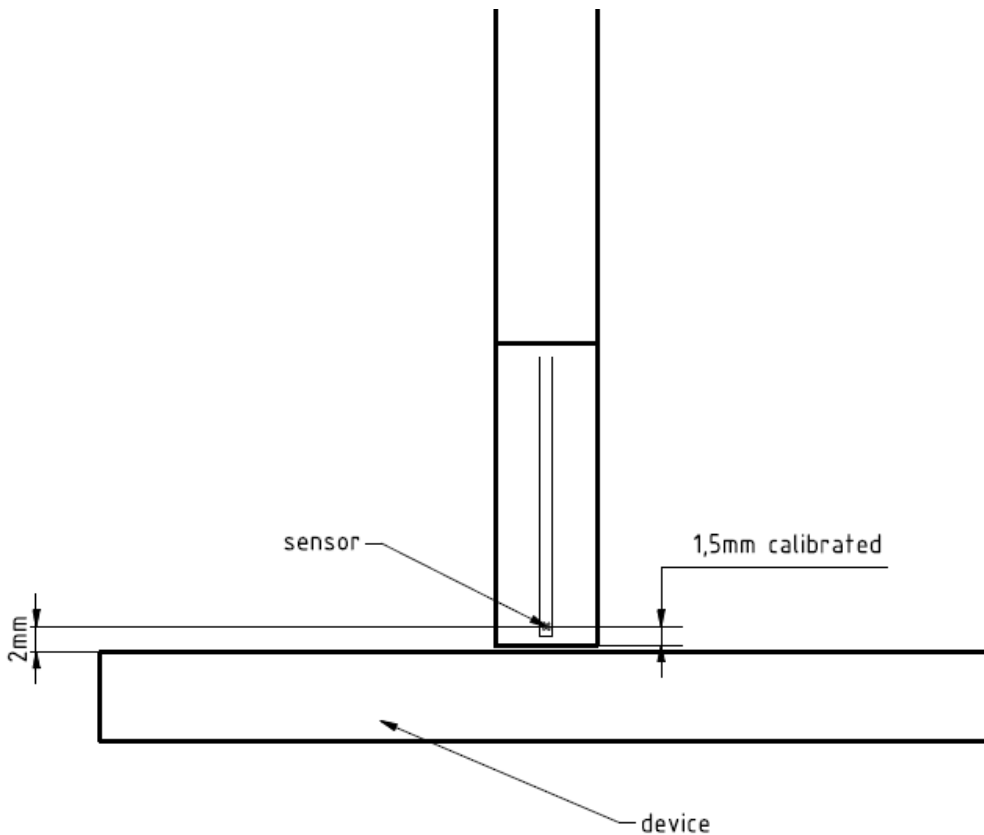

<sup>1</sup> The probe calibration range is 750 MHz – 90 GHz

### A.2.3 Worst Case Linearization Error

For continuously transmitting signals (100% duty cycle), the worst case linearization error is given by the difference between non linearized voltage and linearized voltage using CW parameters. The error is increasing with the voltage levels. In our particular case, the measured voltages averaged over the signal period are below 1mV. We use 1mV in the below calculation to have the worst case condition. The signal PAR (Peak to Average Ratio) is 6dB and the diode compression point 100mV.

The maximum voltage through the diode is given by:

$$v_{peak} = v_{meas\ avg} \times PAR_{linear}$$
$$v_{peak} = 1 \times 4 = 4\ mV$$

The linearized voltage using CW parameter is given by:

$$v_{lin\ peak} = v_{peak} + \frac{v_{peak}^2}{diode\ compression\ point}$$
$$v_{lin\ peak} = 4 + \frac{4^2}{100} = 4.16\ mV$$

The worst case linearization error is:

$$lin\ error = \frac{v_{lin\ peak} - v_{peak}}{v_{peak}} = \frac{4.16 - 4}{4} = 0.04 = 4\%$$



## **A.2.4 Data Evaluation**

### **A.2.4.1 Scan**

The scan involves the measurement of two planes with three different probe rotations. The grid steps are optimized by the software based on the test frequency. The location of the lowest measurement plane is defined by the distance of first measurement layer from device under test (DUT) entered by the user. The DUT location settings can be used to offset the center of the grid.

### **A.2.4.2 Total Field and Power Flux Density Reconstruction**

Computation of the power density in general requires knowledge of the electric (E-) and magnetic (H-) field amplitudes and phases in the plane of incidence. Reconstruction of these quantities from pseudo-vector E-field measurements is feasible, as they are constrained by Maxwell's equations.

The reconstruction algorithm developed by the system manufacturer, together with the ability of the probe to measure extremely close to the source without perturbing the field, permits reconstruction of the E- and H-fields, as well as of the power density, on measurement planes located as near as 0.5mm away in the frequency band of 60 GHz.

The average of the reconstructed power density is evaluated over a circular area in each measurement plane. The area of the circle is defined by the user; the default is 1 cm<sup>2</sup>.

### A.3 System Check

The system performance check verifies that the system operates within its specifications. System and operator errors can be detected and corrected. It is recommended that the system performance check be performed prior to any usage of the system in order to guarantee reproducible results.

The system performance check uses normal E-field measurements in a simplified setup with a well characterized source. This setup was selected to give a high sensitivity to all parameters that might fail or vary over time. The system check does not intend to replace the calibration of the components, but indicates situations where the system uncertainty is exceeded due to drift or failure.

In the simplified setup for system check, the EUT is replaced by a calibrated source and the power source is replaced by a controlled continuous wave generated by a signal generator. The calibrated source must be placed at the correct distance from the E-field probe according to the calibration certificate.



First, the power meter is connected to the output of the signal generator to measure the forward power at the location of the connector to the system check source. The signal generator is adjusted for the desired forward power to match the system check source calibration setup at the connector as read by power meter. Then the power meter is replaced by the system check source.

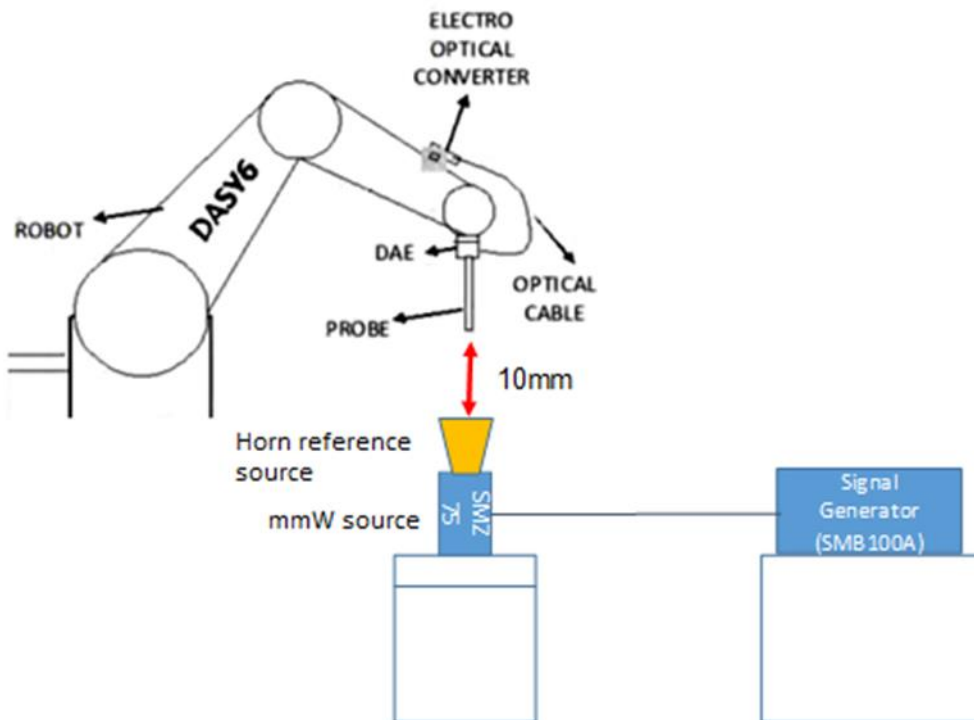

The output power on the reference source is set to 5.0 dBm (3.16 mW) and E-field results are normalized to a forward power of 10mW to compare the values with the calibration report.

## A.4 Test Equipment List

### A.4.1 System #2

ID#	Device	Type/Model	Serial #	Manufacturer	Cal. Date	Cal. Due Date
0638	Measurement SW	cDASY6 5G module v1.0.0.12565	9-5ED1AC01	SPEAG	NA	NA
0636	Light Beam Unit	LB5 / 80	1030	Di-Soric	NA	NA
0628	6-axis Robot	TX60 L	F17/RCB1/A/01	STAÜBLI	NA	NA
0631	Robot Remote Control	P/N: SE UMS 032 AA	NA	STAÜBLI	NA	NA
0632	Measurement Server	SE UMS 028 BB	1547	SPEAG	NA	NA
0633	Electro-Optical Converter	EOC60	1104	SPEAG	NA	NA
0575	E-field mm-Wave Probe	EUmmWV2	9354	SPEAG	2017-05-08	2018-05-08
0657	Data Acquisition Electronics	DAE4	1517	SPEAG	2017-05-24	2018-05-24
0658	5G Phantom	5G	NA	SPEAG	NA	NA
0635	5G Phantom table professional	Table	NA	SPEAG	NA	NA

### A.4.2 Shared Equipment

ID#	Device	Type/Model	Serial #	Manufacturer	Cal. Date	Cal. Due Date
0398	Temperature & Humidity Logger	TR-72NW-H + HHA-3151	Logger: 62180216 Sensor: 0202622A	TandD	2016-02-01	2018-02-01
0427	Frequency Multiplier, 50GHz-75GHz	SMZ75	101257	R&S	N/A	N/A
0309	Signal Generator	SMB100A	178217	R&S	2017-03-10	2019-03-10
0012	Power Meter	NRP2	101567	R&S	N/A	N/A
0014	Power Sensor	NRP-Z57	101280	R&S	2017-04-25	2019-04-25
0590	Horn reference source	PE9881-24	201715	Pasternack	2017-05-08	2019-05-08

### A.5 Measurement Uncertainty Evaluation

The system uncertainty evaluation is shown in the below table:

<b>Uncertainty Budget</b> Based on IEC 62209 Standard Family (28 - 90 GHz range)						
Error Description	Uncertainty Value (±dB)	Probability Distribution	Div.	(c <sub>i</sub> )	Std. Unc. (±dB)	(v <sub>i</sub> ) v <sub>eff</sub>
<b>Measurement System</b>						
Probe Calibration	0.43	N	1	1	0.43	∞
Hemispherical Isotropy	0.60	R	√3	1	0.35	∞
Linearity	0.20	R	√3	1	0.12	∞
System Detection Limits	0.04	R	√3	1	0.02	∞
Modulation Response*	0.17	R	√3	1	0.10	∞
Readout Electronics	0.01	N	1	1	0.01	∞
Response Time	0.03	R	√3	1	0.02	∞
Integration Time	0.11	R	√3	1	0.06	∞
RF Ambient Noise	0.04	R	√3	1	0.02	∞
RF Ambient Reflections	0.21	R	√3	1	0.12	∞
Probe Positioner	0.04	R	√3	1	0.02	∞
Probe Positioning	0.11	R	√3	1	0.06	∞
S <sub>avg</sub> Reconstruction	0.61	R	√3	1	0.35	∞
<b>Test Sample Related</b>						
Power Drift	0.57	R	√3	1	0.33	∞
Power Scaling	0.00	R	√3	1	0.00	∞
Combined Std. Uncertainty					0.77	∞
<b>Expanded Std. Uncertainty</b>					<b>1.54</b>	

\* The modulation response contribution in A.5 is calculated according to 4% linearization error of A.2.3 by :

$$Uncertainty\ Modulation\ Response\ (dB) = 10\log(1+0.04) = 0.17$$

# Annex B. Test Results

## B.1 Test Conditions

### B.1.1 Test signal, Output power and Test Frequencies

The device under test was an Intel 18265NGW WiGig module (FCC ID: PD918265NG), including an active antenna array, embedded inside the Dell model P29S.

The device was put into operation by using an Intel Proprietary software (DRTU version 1.9.0-06565).

### B.1.2 Measurement configuration

The measurements were performed at several distances from the evaluation plane (see Annex E) using the 6 worst cases power density configurations (see table below) found in the simulation among the 6 worst cases corresponding to three subsets (2 worst cases per subset). The simulation method is described in associated document [2]. The simulation results are presented in Annex D.

	Plane position	MCS index <sup>1</sup> @ Duty Cycle	Subset	Channel	Worst-case	Measurement Distance	Scan Plane size [cm <sup>2</sup> ]
Case #1	Edge plane	MCS 1 @ 100%	1	1	1	5 mm	4.75x4.75
Case #2	Edge plane	MCS 1 @ 100%	1	1	2	5 mm	4.75x4.75
Case #3	Edge plane	MCS 1 @ 100%	1	2	1	5 mm	4.59x4.59
Case #4	Edge plane	MCS 1 @ 100%	2	3	1	5 mm	4.67x4.67
Case #5	Edge plane	MCS 1 @ 100%	2	2	1	5 mm	4.59x4.59
Case #6	Edge plane	MCS 1 @ 100%	1	2	2	5 mm	4.59x4.59

## B.2 System Check Measurements

Frequency	Signal Type	Target E-field <sup>2</sup> (V/m)	Measured E-field <sup>2</sup> (V/m)	Deviation (%)	Date
60 GHz	Continuous Wave	90.3	98.16	8.71	2017-12-19

The fields presented in the System Check Measurements table are RMS values normalized to 10 mW input power. Indeed, as indicated in the calibration certificate of the reference horn antenna (see Annex F), the maximum measured E-field value at 10 mm is 67.91 V/m with 7.53 dBm (5.66 mW) source power. This is equivalent to 90.3 V/m target E-field value showed in the table above normalized to 10 dBm (10 mW) source power.

The system check measurement is performed at 5.0 dBm (3.16 mW) source power. The maximum measured E-field value is 55.2 V/m (see plot 7 in Annex C). This is equivalent to 98.16 V/m measured E-field value showed in the table above normalized to 10 dBm source power.

<sup>1</sup> MCS1 Modulation and coding scheme uses  $n/2$ -BPSK modulation

<sup>2</sup> Normalized to 10mW

**B.3 Test Results**

Test case	Distance (mm)	Max E-Field [V/m]	Max H-Field [A/m]	Max localized PD [mW/cm <sup>2</sup> ]	Spatially Averaged PD [mW/cm <sup>2</sup> ]	Plot #
Case #1	5	73.766	0.335	1.011	0.250	1
Case #2	5	96.409	0.358	1.326	0.352	2
Case #3	5	85.738	0.216	0.757	0.212	3
Case #4	5	83.156	0.249	0.942	0.246	4
Case #5	5	83.009	0.237	0.731	0.255	5
Case #6	5	66.985	0.163	0.460	0.174	6

All fields' strength showed in the table are peak values.

The measured PAPR level of the modulation used in the tests is 5 dB.

The measurement distance correspond to the distance from the probe sensor and evaluation plane boundary. The figure in section A.2.2 illustrates the measurement distance of 2 mm.

# Annex C. Test System Plots

---

1.	Case # 1 – 5 mm distance from Evaluation plane.....	16
2.	Case # 2 – 5 mm distance from Evaluation plane.....	17
3.	Case # 3 – 5 mm distance from Evaluation plane.....	18
4.	Case # 4 – 5 mm distance from Evaluation plane.....	19
5.	Case # 5 – 5 mm distance from Evaluation plane.....	20
6.	Case # 6 – 5 mm distance from Evaluation plane.....	21
7.	System Check 60 GHz.....	22

## 1. Case # 1 – 5 mm distance from Evaluation plane

**DUT: Sample 170512-01.S01; Type: RFEM-3; Serial: N/A**

Communication System: UID 0, Wi-Gig (0); Communication System Band: 60 GHz; Frequency: 58320MHz;

Communication System PAR: 0 dB

Medium parameters used:  $\sigma = 0$  S/m,  $\epsilon_r = 1$ ;  $\rho = 0$  kg/m<sup>3</sup>

Phantom section: Table Section

Measurement Standard: DASY6 (IEEE/IEC/ANSI C63.19-2011)

DASY Configuration:

- Probe: EUmmW - SN9354; ConvF(1, 1, 1); Calibrated: 2017-02-23;
  - Modulation Compensation:
- Sensor-Surface: 0mm (Fix Surface), z = 5 mm
- Electronics: DAE4 Sn1517; Calibrated: 2017-05-24
- Phantom: Cover; Type: SPEAG Phantom Cover;
- cDASY6 5G Module V1.0.0.12565;

**Channel 1-Distance-5mm/Measure Sample 170512-01.S01 (47.5x47.5):**

Resolution = 1.3 mm

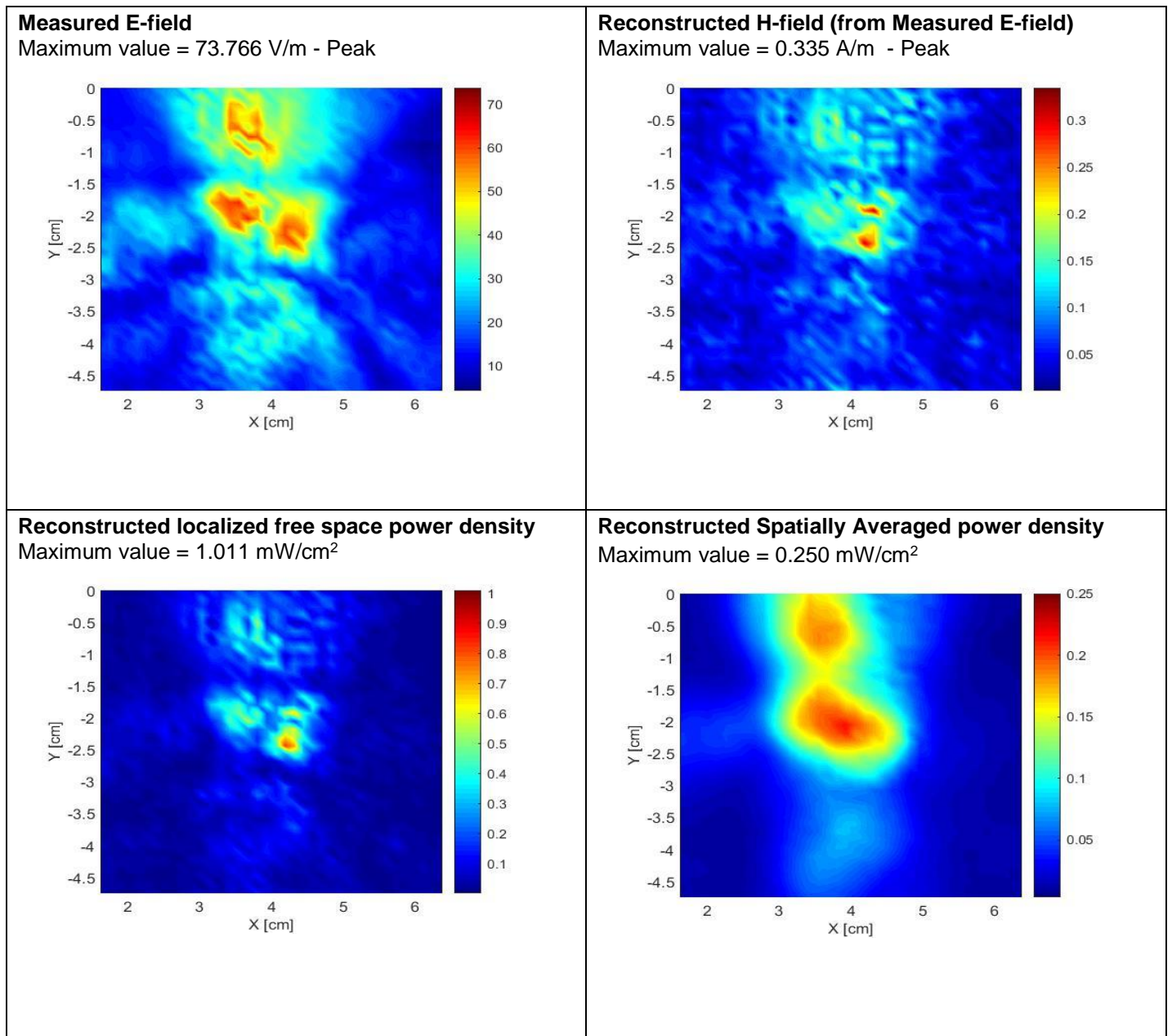



## 2. Case # 2 – 5 mm distance from Evaluation plane

**DUT: Sample 170512-01.S01; Type: RFEM-3; Serial: N/A**

Communication System: UID 0, Wi-Gig (0); Communication System Band: 60 GHz; Frequency: 58320MHz;

Communication System PAR: 0 dB

Medium parameters used:  $\sigma = 0$  S/m,  $\epsilon_r = 1$ ;  $\rho = 0$  kg/m<sup>3</sup>

Phantom section: Table Section

Measurement Standard: DASY6 (IEEE/IEC/ANSI C63.19-2011)

DASY Configuration:

- Probe: EUmmW - SN9354; ConvF(1, 1, 1); Calibrated: 2017-02-23;
  - Modulation Compensation:
- Sensor-Surface: 0mm (Fix Surface), z = 5 mm
- Electronics: DAE4 Sn1517; Calibrated: 2017-05-24
- Phantom: Cover; Type: SPEAG Phantom Cover;
- cDASY6 5G Module V1.0.0.12565;

**Channel 1-Distance-5mm/Measure Sample 170512-01.S01 (47.5x47.5):**

Resolution = 1.3 mm

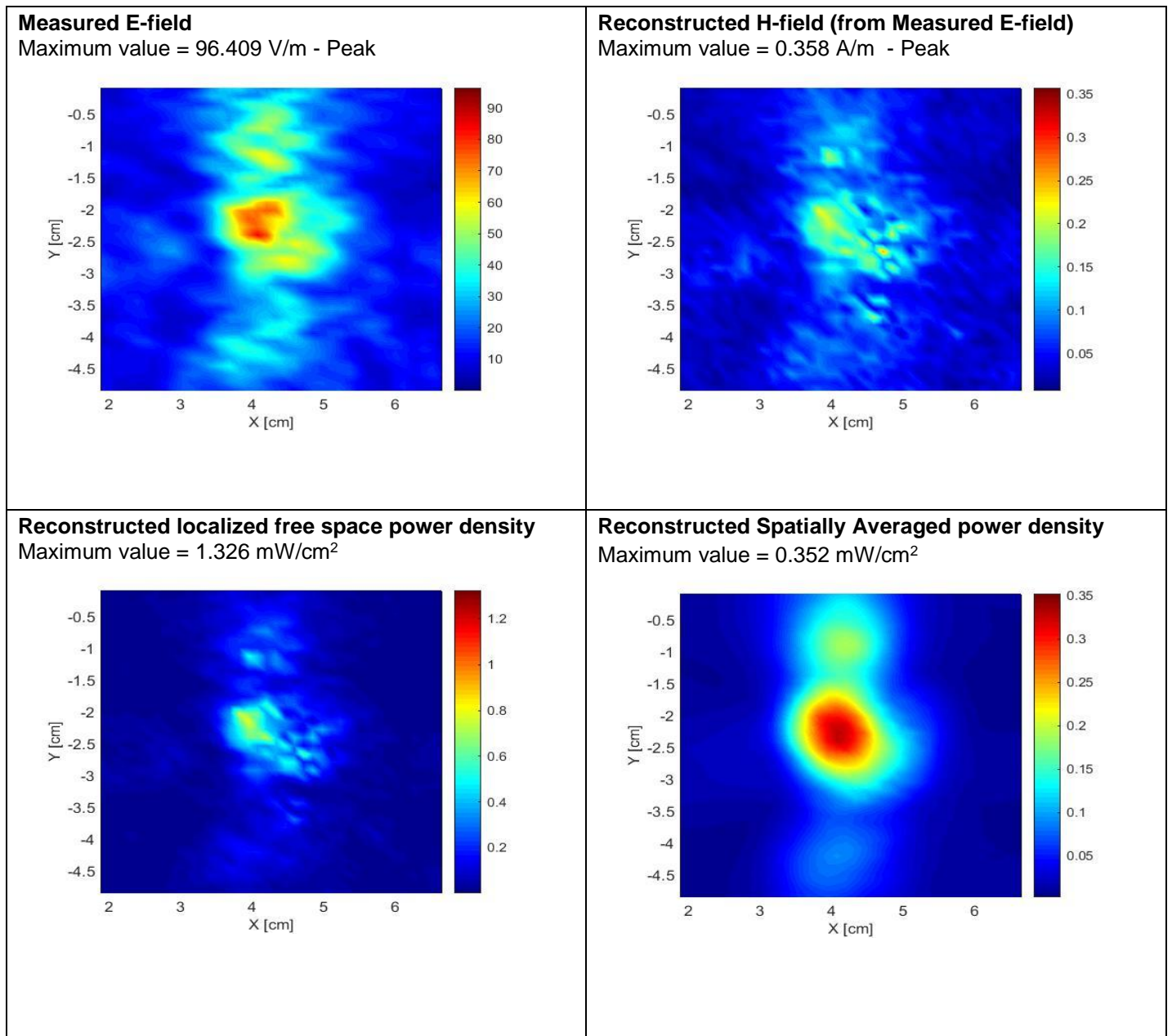

### 3. Case # 3 – 5 mm distance from Evaluation plane

**DUT: Sample 161114-01.S03; Type: RFEM-3; Serial: N/A**

Communication System: UID 0, Wi-Gig (0); Communication System Band: 60 GHz; Frequency: 60480MHz;

Communication System PAR: 0 dB

Medium parameters used:  $\sigma = 0$  S/m,  $\epsilon_r = 1$ ;  $\rho = 0$  kg/m<sup>3</sup>

Phantom section: Table Section

Measurement Standard: DASY6 (IEEE/IEC/ANSI C63.19-2011)

DASY Configuration:

- Probe: EUmmW - SN9354; ConvF(1, 1, 1); Calibrated: 2017-02-23;
  - Modulation Compensation:
- Sensor-Surface: 0mm (Fix Surface), z = 5 mm
- Electronics: DAE4 Sn1517; Calibrated: 2017-05-24
- Phantom: Cover; Type: SPEAG Phantom Cover;
- cDASY6 5G Module V1.0.0.12565;

**Channel 2-Distance-5mm/Measure Sample 170512-01.S01 (45.9x45.9):**

Resolution = 1.24 mm

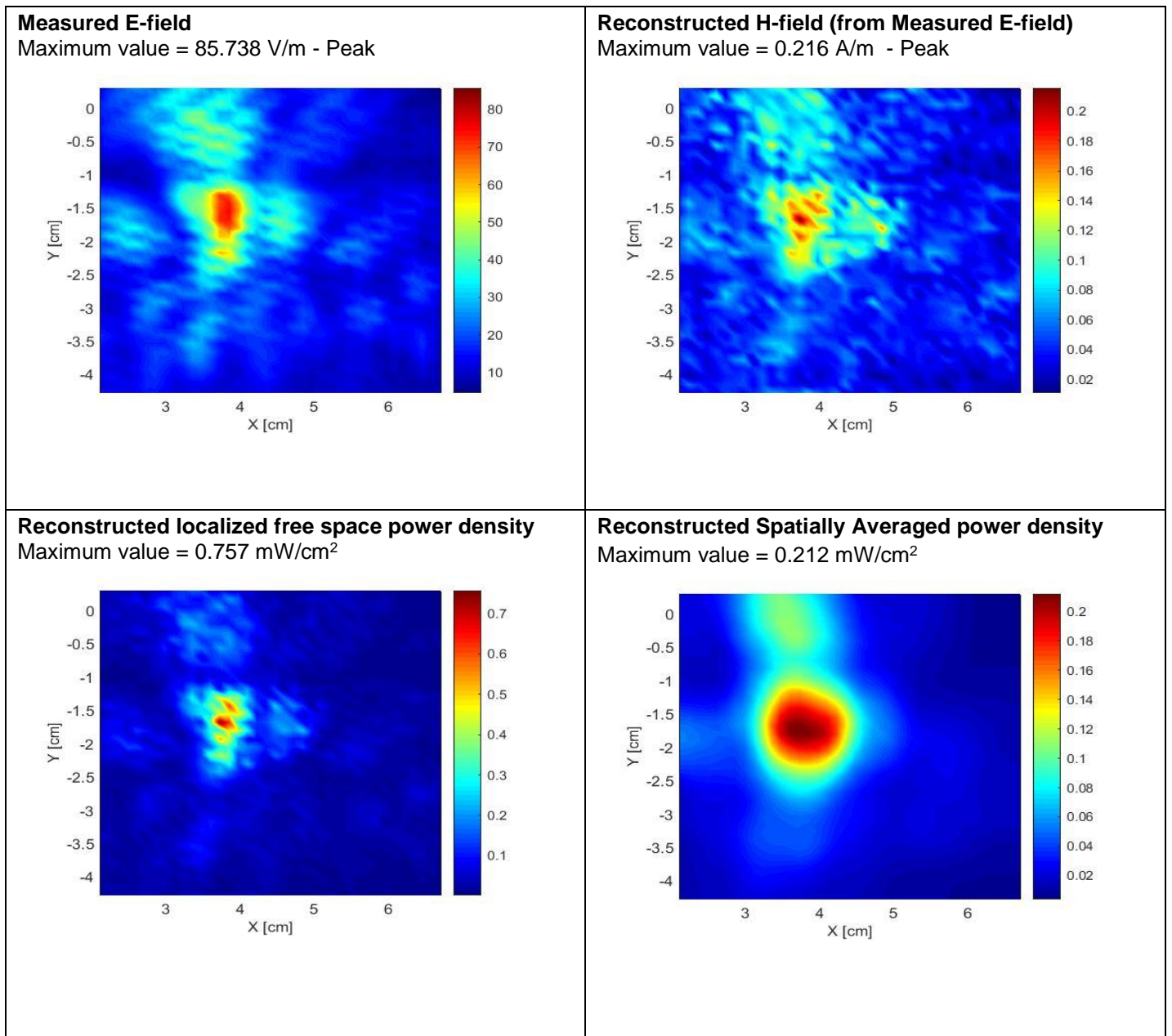

## 4. Case # 4 – 5 mm distance from Evaluation plane

**DUT: Sample 170512-01.S01; Type: RFEM-3; Serial: N/A**

Communication System: UID 0, Wi-Gig (0); Communication System Band: 60 GHz; Frequency: 62640MHz;

Communication System PAR: 0 dB

Medium parameters used:  $\sigma = 0$  S/m,  $\epsilon_r = 1$ ;  $\rho = 0$  kg/m<sup>3</sup>

Phantom section: Table Section

Measurement Standard: DASY6 (IEEE/IEC/ANSI C63.19-2011)

DASY Configuration:

- Probe: EUmmW - SN9354; ConvF(1, 1, 1); Calibrated: 2017-02-23;
  - Modulation Compensation:
- Sensor-Surface: 0mm (Fix Surface), z = 5 mm
- Electronics: DAE4 Sn1517; Calibrated: 2017-05-24
- Phantom: Cover; Type: SPEAG Phantom Cover;
- cDASY6 5G Module V1.0.0.12565;

**Channel 3-Distance-5mm/Measure Sample 170512-01.S01 (46.7x46.7):**

Resolution = 1.19 mm

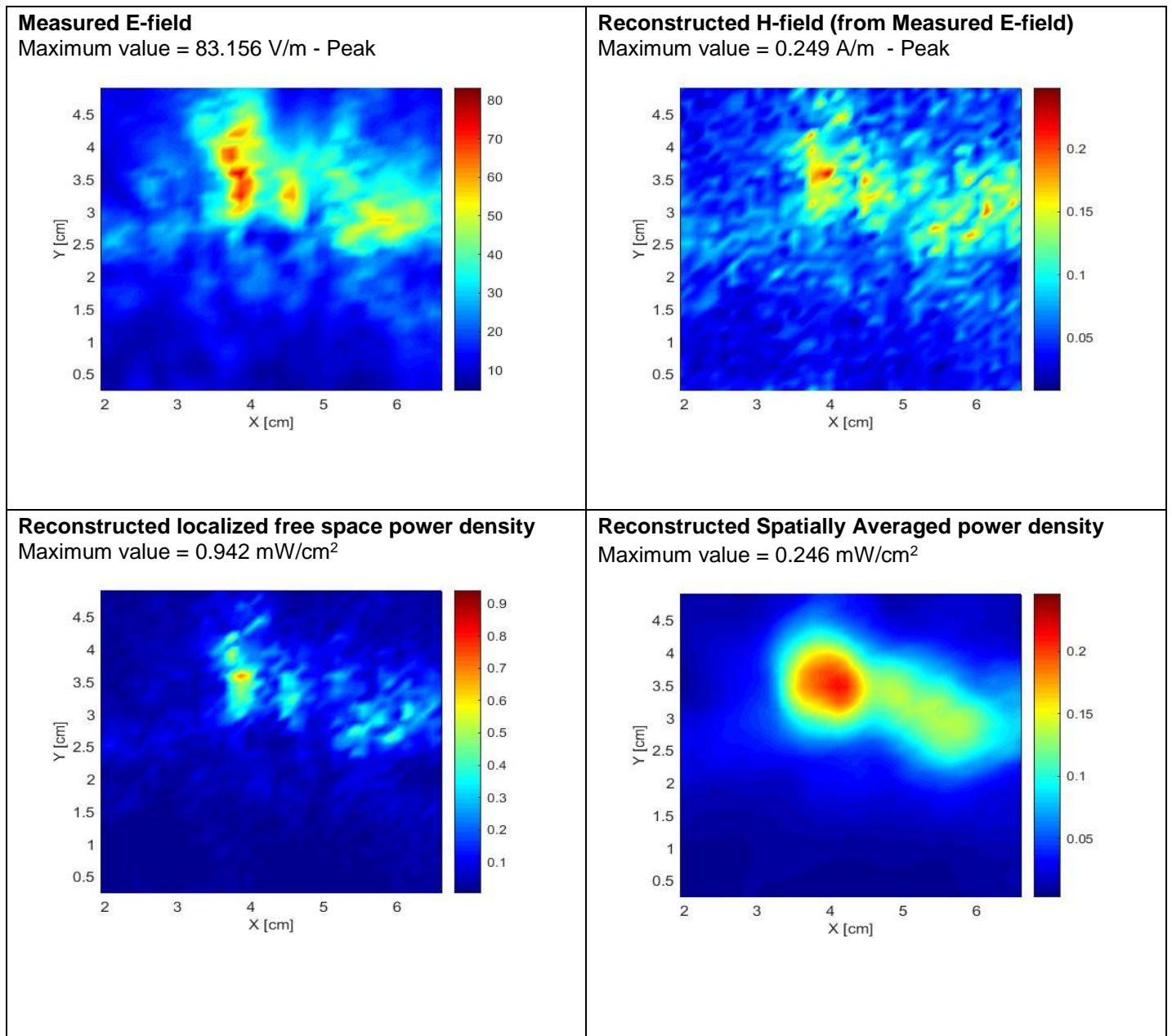

## 5. Case # 5 – 5 mm distance from Evaluation plane

**DUT: Sample 170512-01.S01; Type: RFEM-3; Serial: N/A**

Communication System: UID 0, Wi-Gig (0); Communication System Band: 60 GHz; Frequency: 60480MHz;

Communication System PAR: 0 dB

Medium parameters used:  $\sigma = 0$  S/m,  $\epsilon_r = 1$ ;  $\rho = 0$  kg/m<sup>3</sup>

Phantom section: Table Section

Measurement Standard: DASYS6 (IEEE/IEC/ANSI C63.19-2011)

DASY Configuration:

- Probe: EUmmW - SN9354; ConvF(1, 1, 1); Calibrated: 2017-02-23;
  - Modulation Compensation:
- Sensor-Surface: 0mm (Fix Surface), z = 5 mm
- Electronics: DAE4 Sn1517; Calibrated: 2017-05-24
- Phantom: Cover; Type: SPEAG Phantom Cover;
- cDASY6 5G Module V1.0.0.12565;

**Channel 2-Distance-5mm/Measure Sample 170512-01.S01 (45.9x45.9):**

Resolution = 1.24 mm

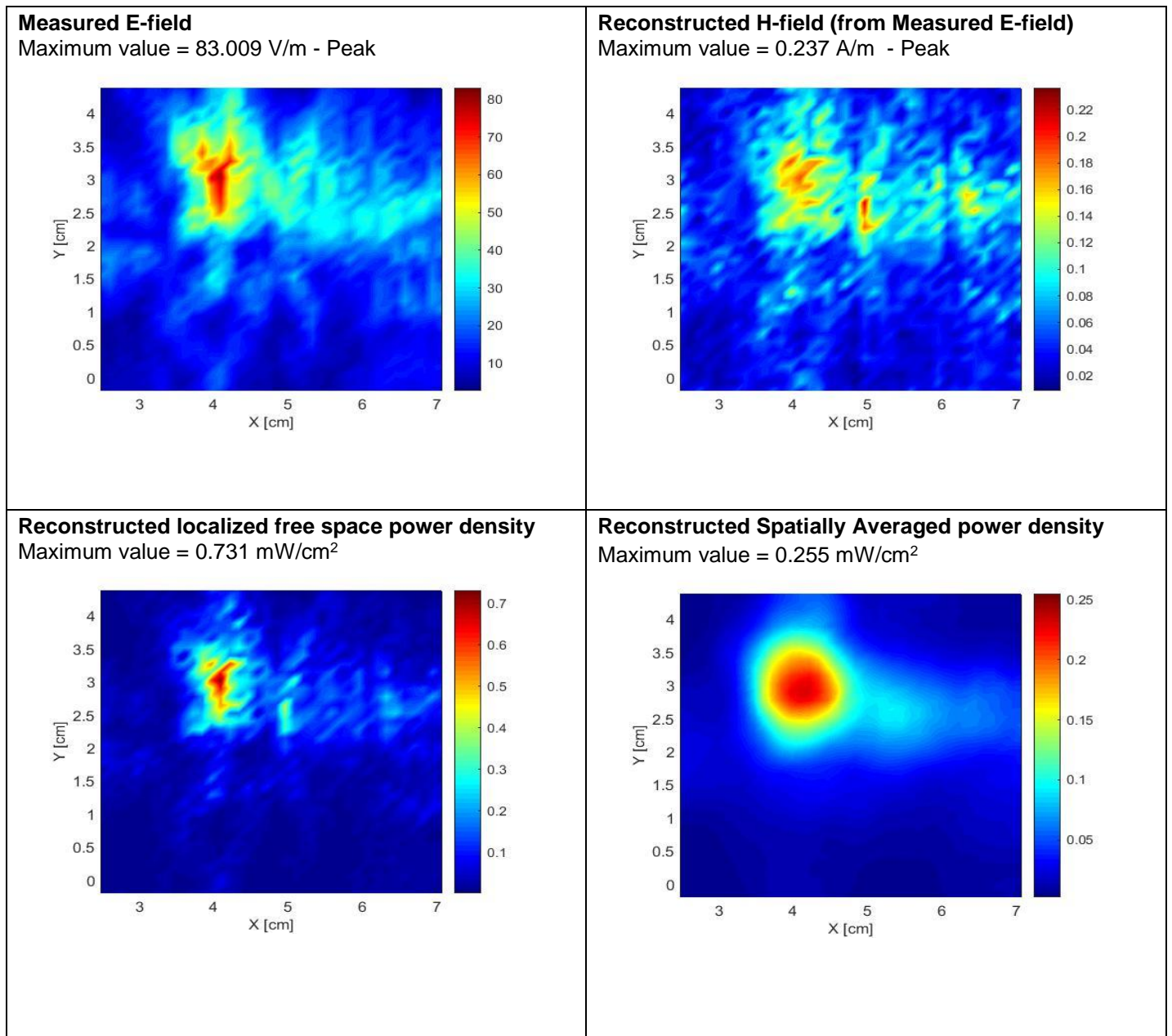

## 6. Case # 6 – 5 mm distance from Evaluation plane

**DUT: Sample 170512-01.S01; Type: RFEM-3; Serial: N/A**

Communication System: UID 0, Wi-Gig (0); Communication System Band: 60 GHz; Frequency: 60480 MHz;

Communication System PAR: 0 dB

Medium parameters used:  $\sigma = 0$  S/m,  $\epsilon_r = 1$ ;  $\rho = 0$  kg/m<sup>3</sup>

Phantom section: Table Section

Measurement Standard: DASY6 (IEEE/IEC/ANSI C63.19-2011)

DASY Configuration:

- Probe: EUmmW - SN9354; ConvF(1, 1, 1); Calibrated: 2017-02-23;
  - Modulation Compensation:
- Sensor-Surface: 0mm (Fix Surface), z = 5 mm
- Electronics: DAE4 Sn1517; Calibrated: 2017-05-24
- Phantom: Cover; Type: SPEAG Phantom Cover;
- cDASY6 5G Module V1.0.0. 12565;

**Channel 2-Distance-5mm/Measure Sample 170512-01.S01 (45.9x45.9):**

Resolution = 1.24 mm

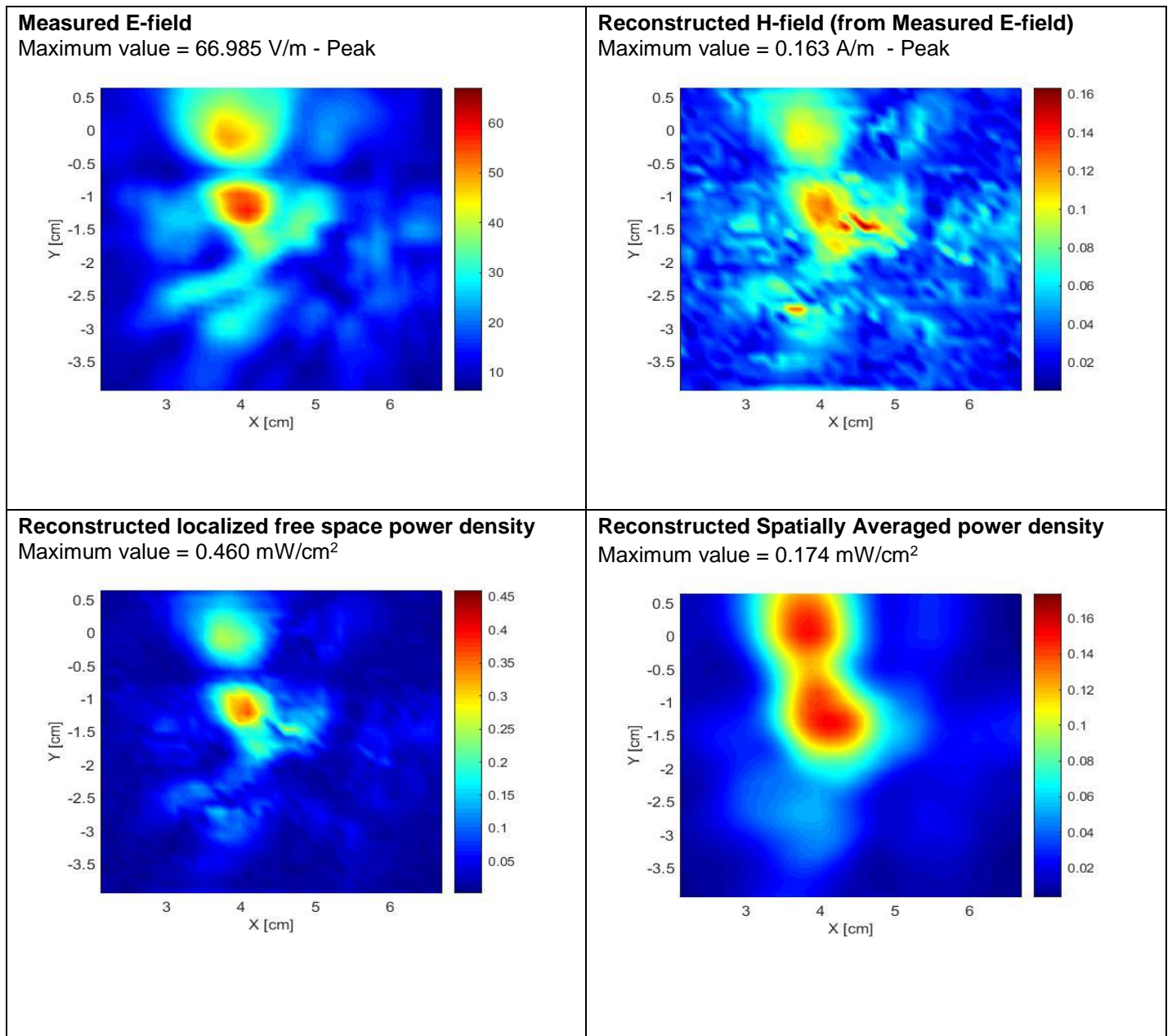

## 7. System Check 60 GHz

**DUT: Horn reference source; Type: PE9881-24; Serial: 201715**

Communication System: UID 0, Wi-Gig (0); Communication System Band: 60 GHz; Frequency: 60000 MHz;

Communication System PAR: 0 dB

Medium parameters used:  $\sigma = 0$  S/m,  $\epsilon_r = 1$ ;  $\rho = 0$  kg/m<sup>3</sup>

Phantom section: Table Section

Measurement Standard: DASY6 (IEEE/IEC/ANSI C63.19-2011)

DASY Configuration:

- Probe: EUmmW - SN9354 ; ConvF(1, 1, 1); Calibrated: 2017-02-23;
  - Modulation Compensation:
- Sensor-Surface: 0mm (Fix Surface), z = 10 mm
- Electronics: DAE4 Sn1517; Calibrated: 2017-05-24
- Phantom: Cover; Type: SPEAG Phantom Cover;
- cDASY6 5G Module V1.0.0. 12565;

**Distance-10mm/Measure Horn reference source (43.7x43.7):**

Resolution = 1.25 mm

Maximum value measured: 55.2 V/m (RMS) for 5 dBm input power.

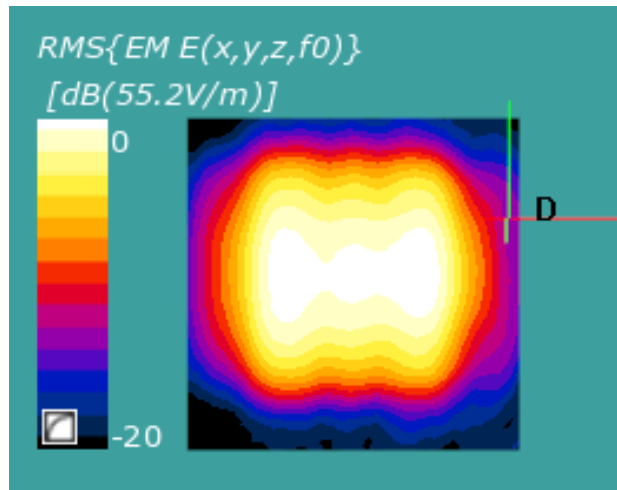

The plots below show the comparison between the calibration certificate and the system check results in terms of normalized E-field distribution and the 1D variation along the two axis of the maximum.

**Calibration Certificate**

- scan area: 30 mm x 16 mm
- Resolution: 1 mm

**System Check**

- scan area: 30 mm x 16 mm
- Resolution: 1.25 mm

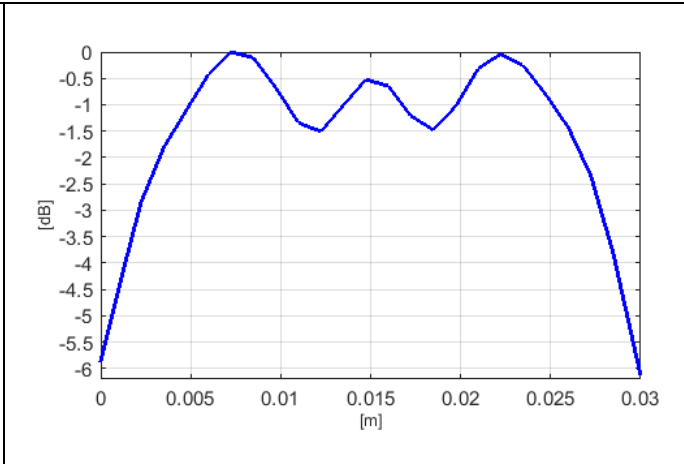
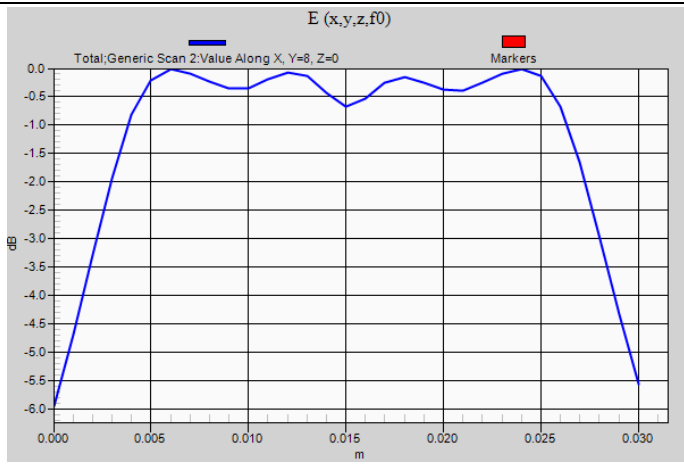
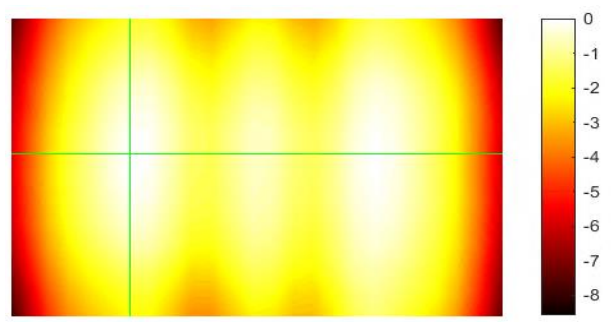
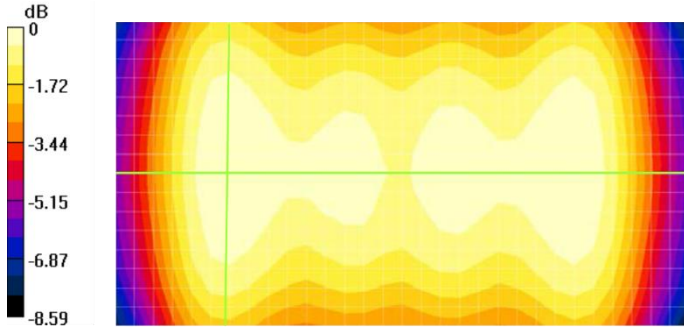

**Field variation through the maximum along the E-field polarization**

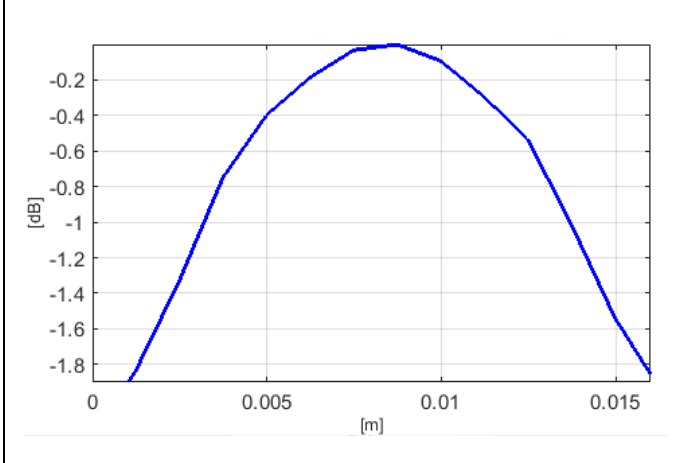
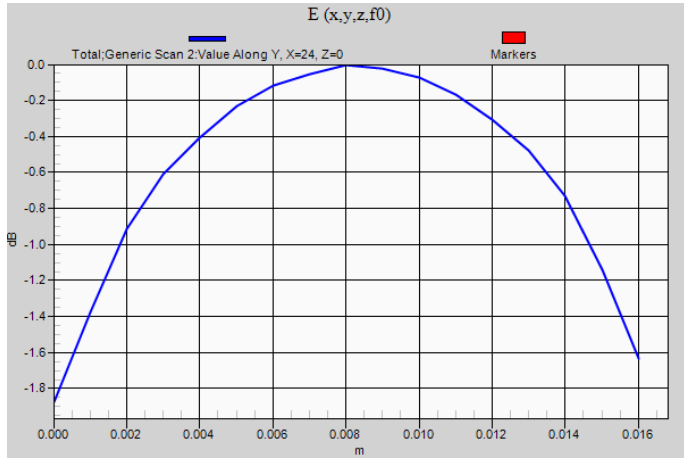

**Field variation through the maximum along the H-field polarization**

# Annex D. Photographs

## D.1 Test Setup

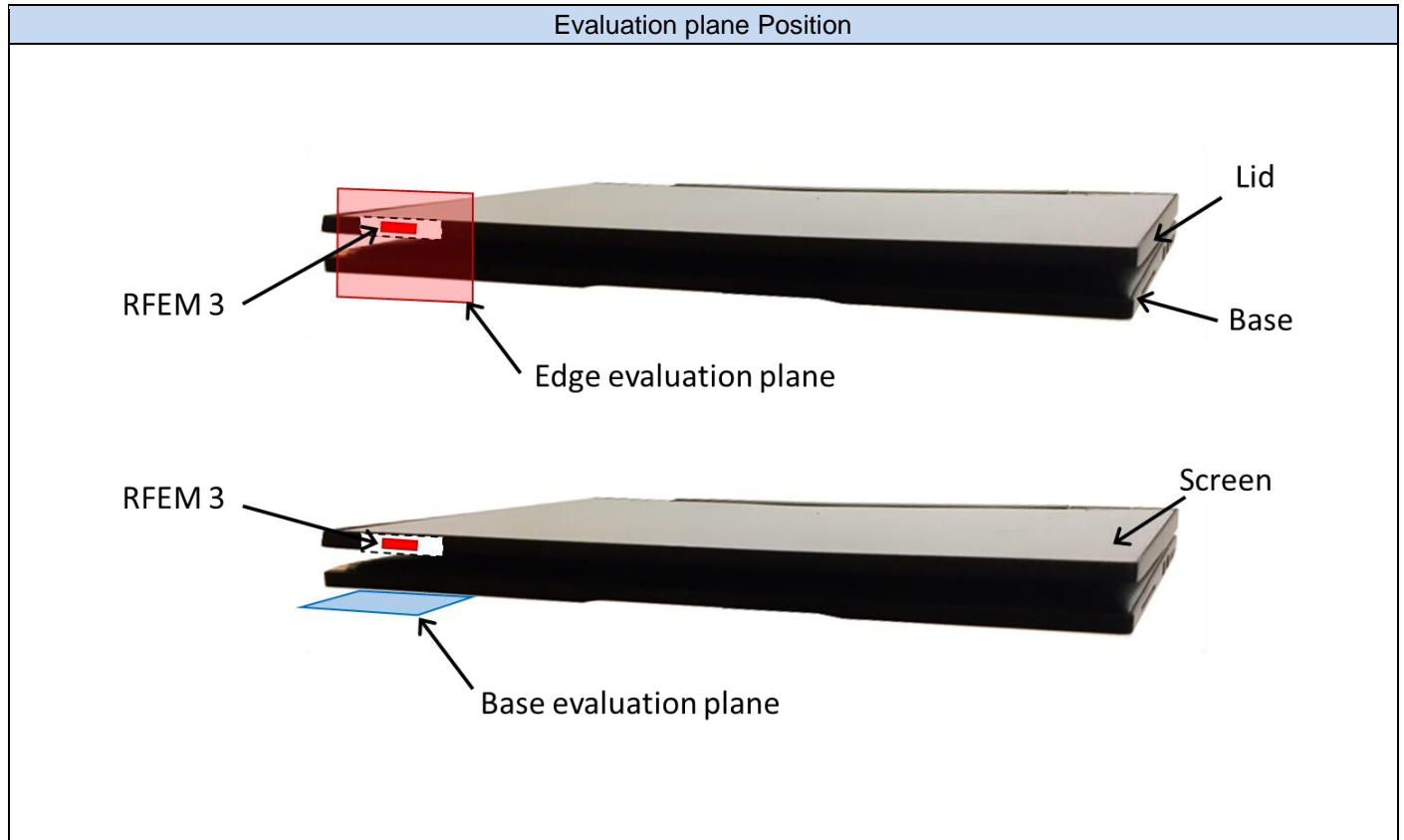



## D.2 Test Sample

### Sample #01

Tablet Mode - Front view



Tablet Mode - Bottom view

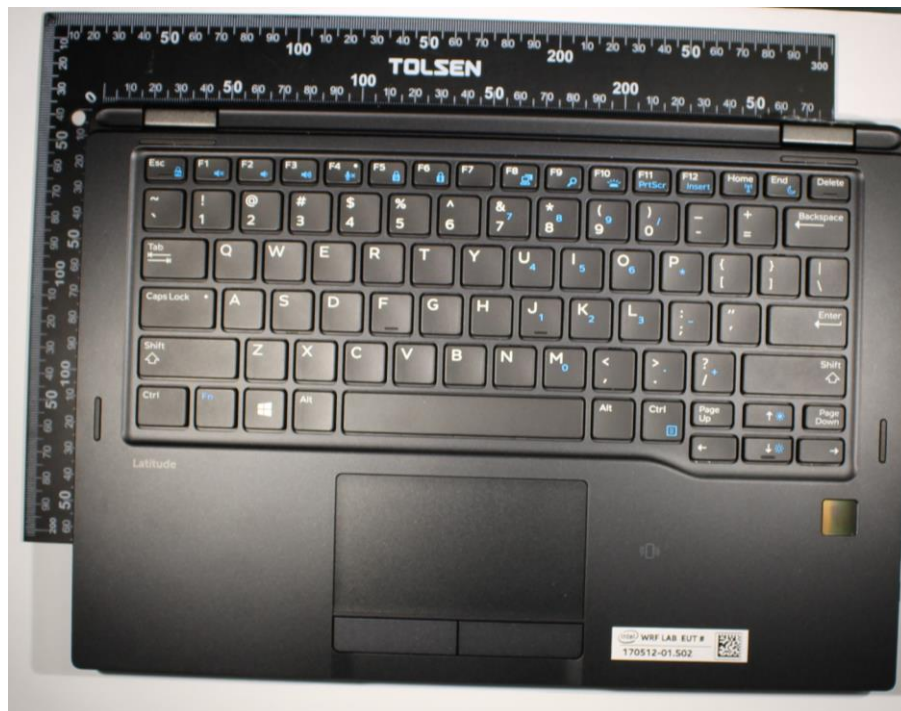

# Annex E. Calibration Certificates

---

ID	Device	Type/Model	Serial Number	Manufacturer
0575	E-field mm-Wave Probe	EUmmWV2	9354	SPEAG
0590	Horn reference source	PE9881-24	201715	Pasternack

**Calibration certificates are in attachment**