

Annex F. Photographs

Test Item #160205-05.S03

Laptop Mode



Test Positions

Laptop

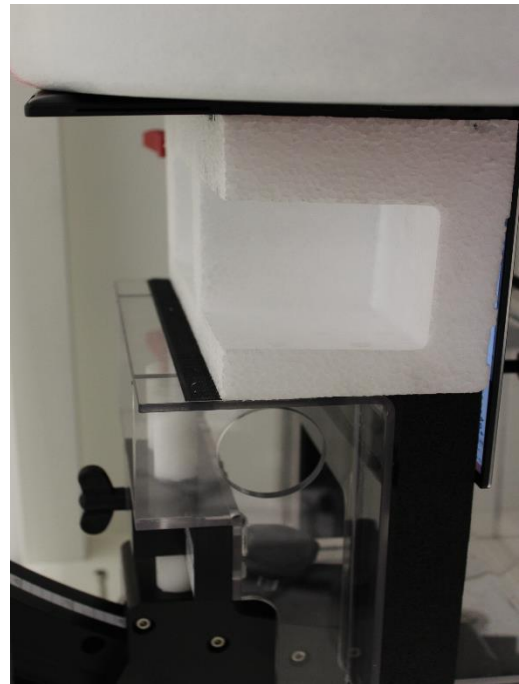
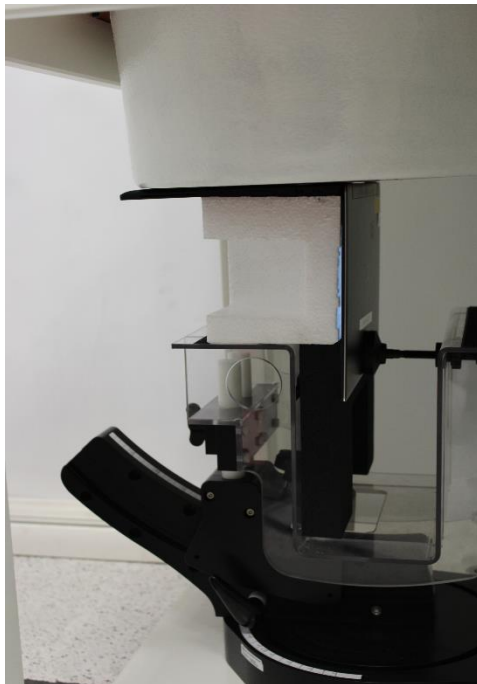

Antenna Diagrams

Overall Host Platform view

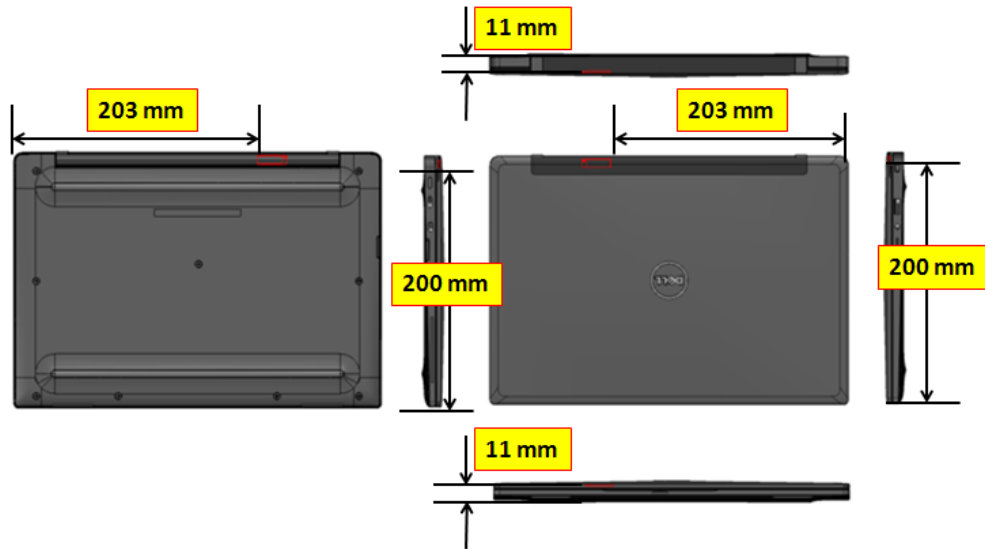

Antenna Host platform Location

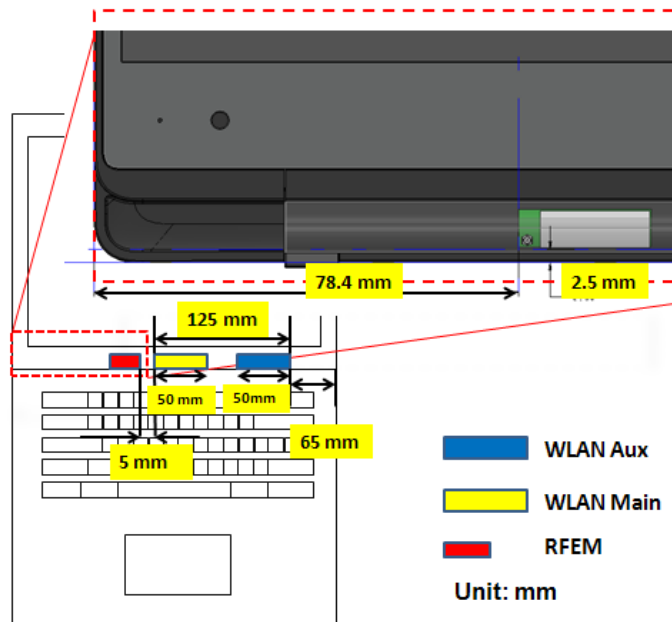

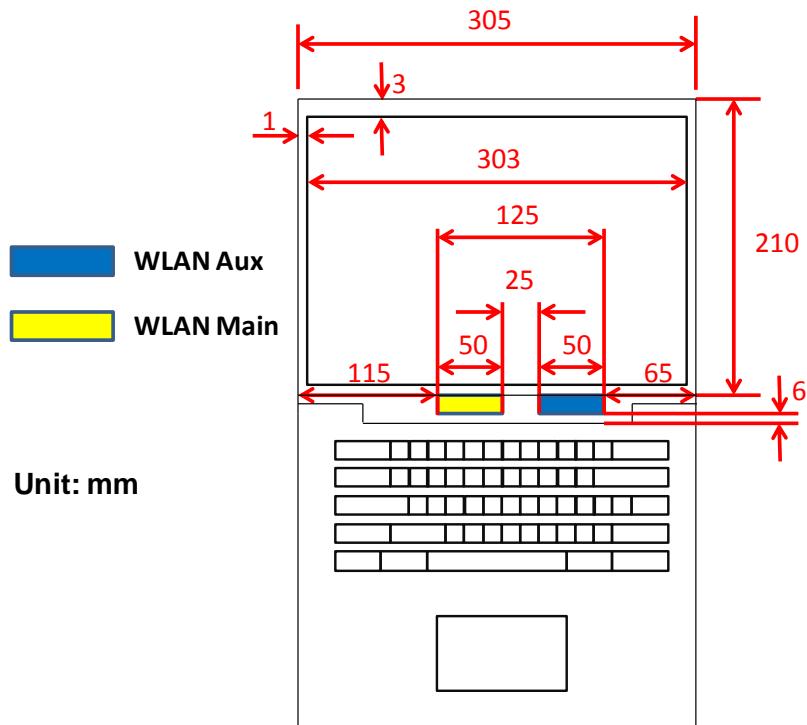

Adjacent edge positions

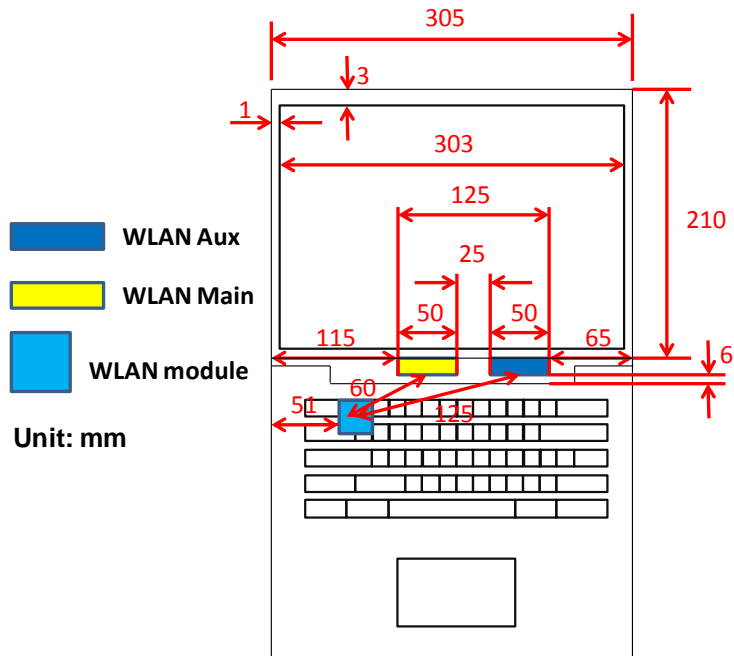

Mode Laptop

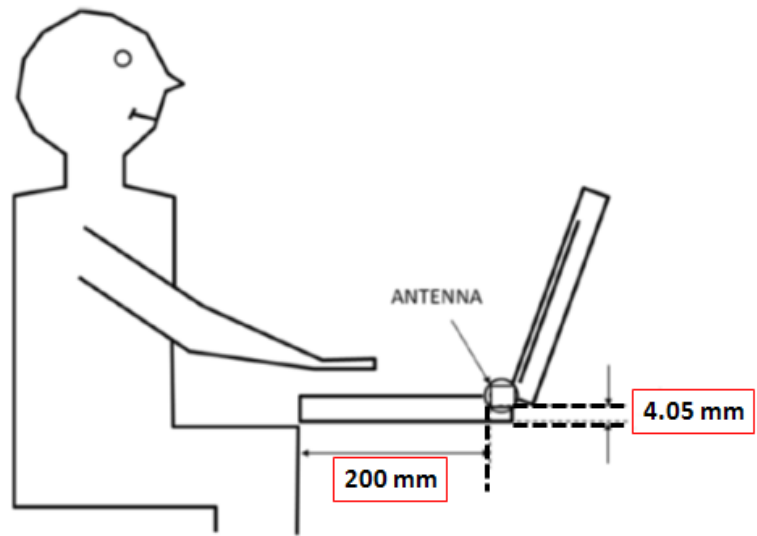

Phantom liquid level during measurements

ELI phantom Body liquid 2.4GHz

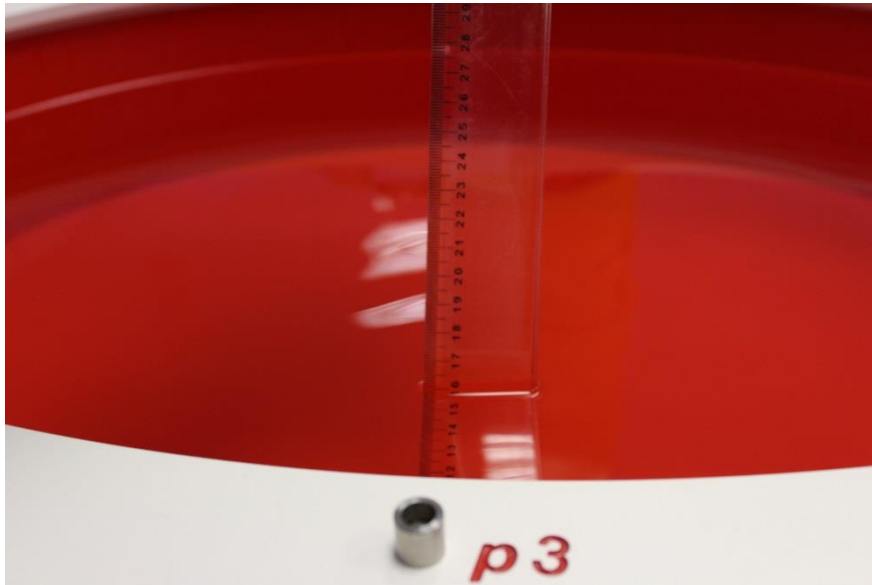

ELI phantom Body liquid 5GHz

