

# Antenna Test Report

For

**Intel project**

<b>Customer</b>	<b>Intel</b>	<b>Project</b>	<b>---</b>
<b>Band</b>	<b>2.3~2.7&amp;3.3~3.8 &amp;5.15~5.85GHz</b>	<b>Color</b>	<b>---</b>
<b>SUC PN</b>	<b>---</b>	<b>Version</b>	

<b>Issued by</b>		<b>Checked by</b>	
<b>Confirmed by</b>		<b>Date</b>	<b>2007/3/30</b>

## 1 Summary of the Test results

The test fixture was made for further testing, which was shown below.

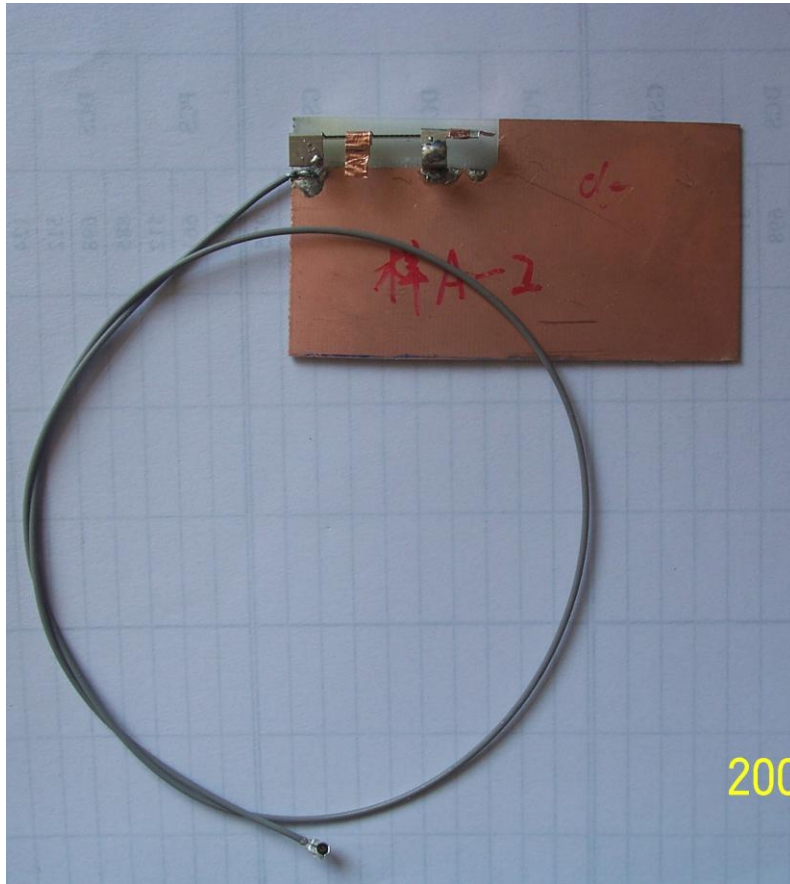

## 2. Test Result

### 2.1 RF Performance

#### 2.1.1 S11 Measurement

The S11 parameter was performed using a Hewlett Packard E5071B Network Analyzer. We use a 45cm long 1.13 cable to mitigate surface currents on the outside of the testing cable.

We used no matching circuit .

The S11 parameter was shown below, you could check it.

<b>SUC ANT S11 parameter Summary</b>						
<b>Band</b>	<b>2.3 ~2.7&amp;3.3~3.8&amp;5.15~5.85(GHz)</b>					
	2.3	2.7	3.3	3.8	5.15	5.85
<b>R.L (dB)</b>	-16.59	-11.22	-8.87	-8.96	-8.46	-10.04
<b>VSWR</b>	1.35	1.76	2.13	2.11	2.22	1.92

You could also check in detail in below figures.

**S11 parameter of sample antenna tested in free space**

# Confidential Information

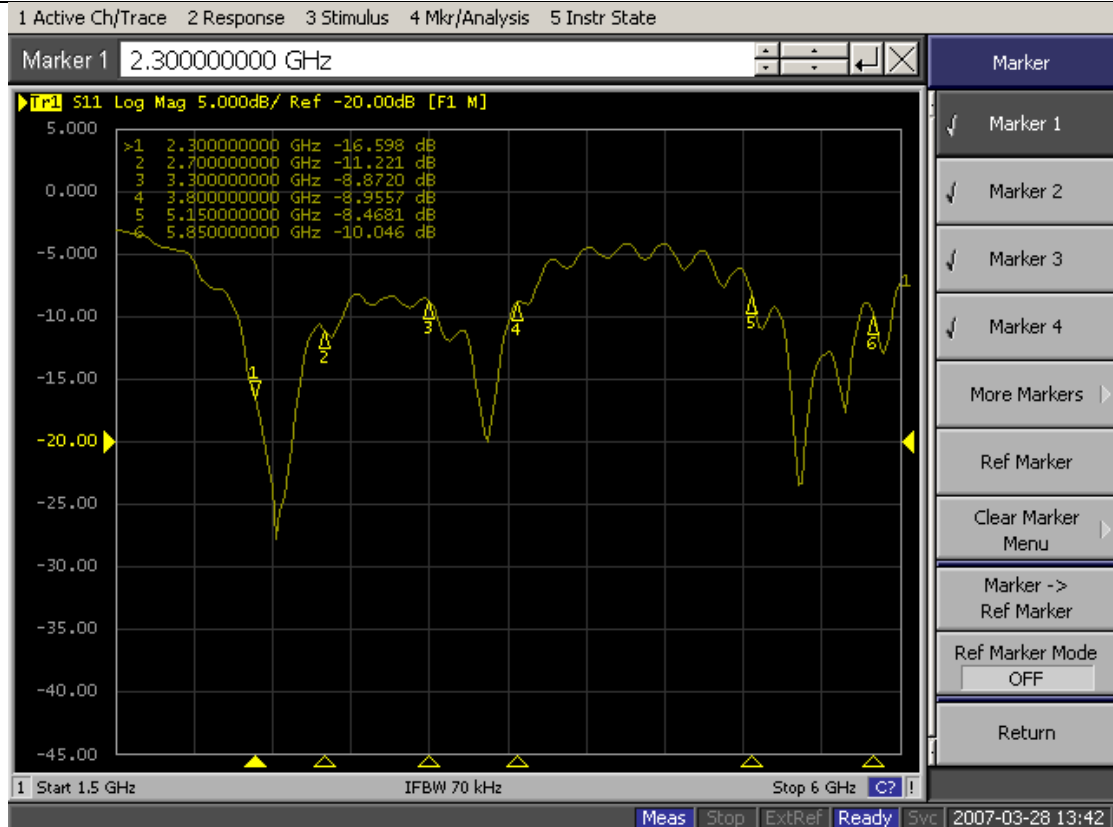

Marker

- Marker 1
- Marker 2
- Marker 3
- Marker 4
- More Markers ▶
- Ref Marker
- Clear Marker Menu ▶
- Marker -> Ref Marker
- Ref Marker Mode OFF
- Return

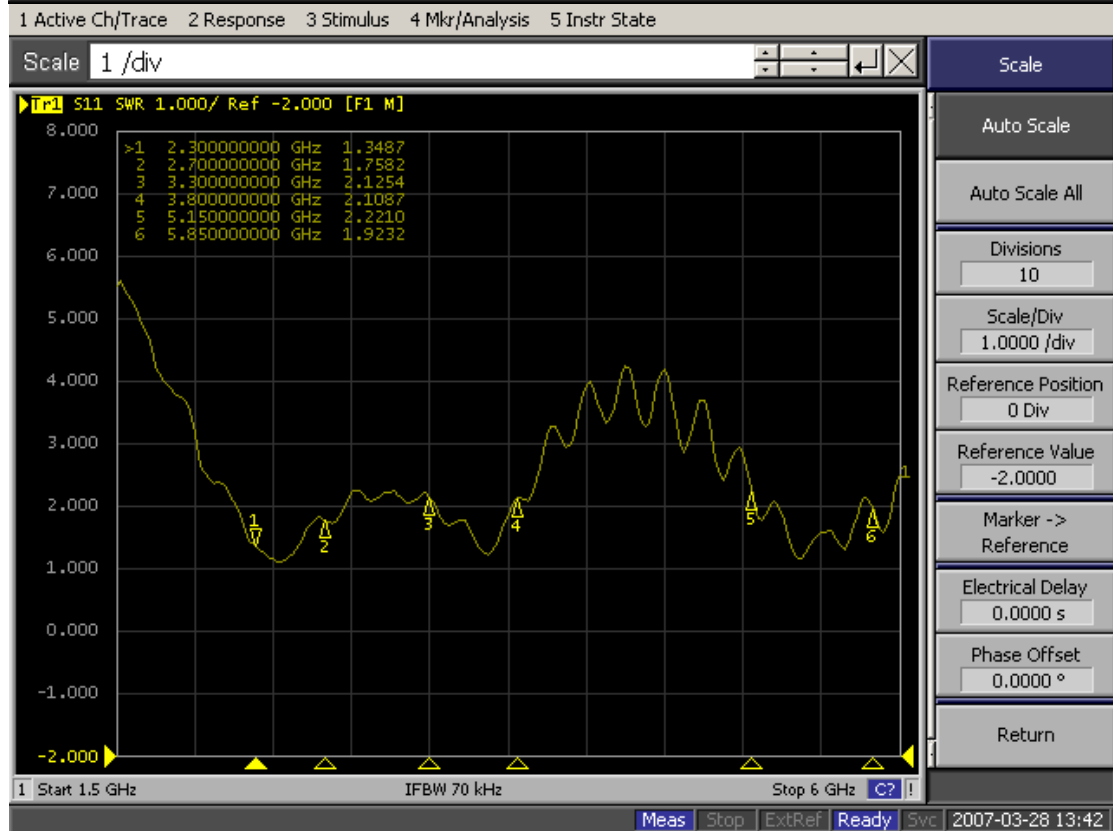

Scale

- Auto Scale
- Auto Scale All
- Divisions 10
- Scale/Div 1.0000 /div
- Reference Position 0 Div
- Reference Value -2.0000
- Marker -> Reference
- Electrical Delay 0.0000 s
- Phase Offset 0.0000 °
- Return

## 2.1.2 Radiation pattern and Gain Measurement

An anechoic chamber was used to measure radiation pattern and antenna Gain. SUC's chamber was working from 700MHz to 6GHz. The chamber provides less than -40 dB reflectivity from 700 MHz through 6 GHz. A standard horn was used to calibrate the chamber, and we also use a decoupling sleeve to reduce feed line radiation, so we can measure the antenna gain accurately.

The Gain parameter was shown below, you could check it.

<b>SUC ANT Gain parameter Summary</b>							
<b>Band</b>	<b>2.4(GHz)</b>						
	2.3	2.35	2.4	2.45	2.5	2.6	2.7
<b>MAX Gain (dBi)</b>	3.22	3.54	3.24	2.97	3.16	3.47	2.8
<b>Efficiency (%)</b>	74.48	73.72	73.39	72.52	74.29	88.94	74.38
<b>SUC ANT Gain parameter Summary</b>							
<b>Band</b>	<b>3.4 (GHz)</b>						
	3.3		3.5		3.8		
<b>MAX Gain (dBi)</b>	4.54		3.59		4.38		
<b>Efficiency (%)</b>	70.9		72.85		77.4		
<b>SUC ANT Gain parameter Summary</b>							
<b>Band</b>	<b>5.4 (GHz)</b>						
	5.15	5.25	5.35	5.45	5.75	5.85	
<b>MAX Gain (dBi)</b>	3.64	2.57	3.73	4.77	4.43	4.97	
<b>Efficiency (%)</b>	61.74	60.1	78.92	85.58	78.31	69.99	

The radiation pattern was shown below, you could check it.

**Confidential Information**

S
---

Location: **RF Chamber**  
 Temperatur ( ): **22.00**

Date: **2007-3-30**  
 Humidity (%): **65.00**

Time: **11:00:23**  
 Approved by:

**Total View**

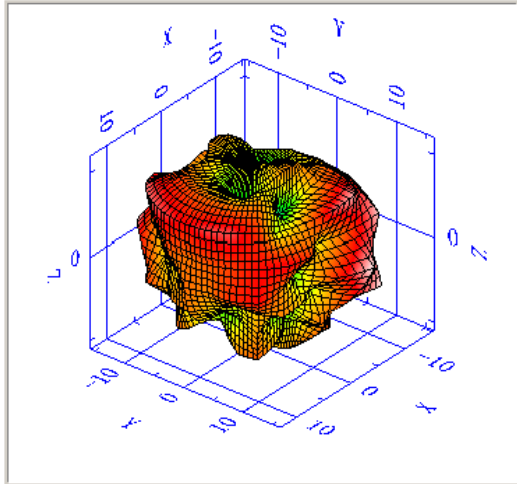

Frequency (MHz)	2300.00
TRP (dBm)	-1.28
Efficiency (%)	74.48
NHPRP +/- 45 (dBm)	-1.85
NHPRP +/- 30 (dBm)	-2.66
Directivity (dBi)	4.5
Gain (dBi)	3.22
Average Gain (dB)	-1.28
Peak EIRP (dBm)	3.22
Max. Power (dBm)	3.22
Min. Power (dBm)	-13.68
Avg. Power (dBm)	-2.17
Max. / Min. Ratio (dB)	16.89
Max. / Avg. Ratio (dB)	5.39
Min. / Avg. Ratio (dB)	-11.51

**2.3GHz**

S
---

Location: **RF Chamber**  
 Temperatur ( ): **22.00**

Date: **2007-3-30**  
 Humidity (%): **65.00**

Time: **11:00:37**  
 Approved by:

**Total View**

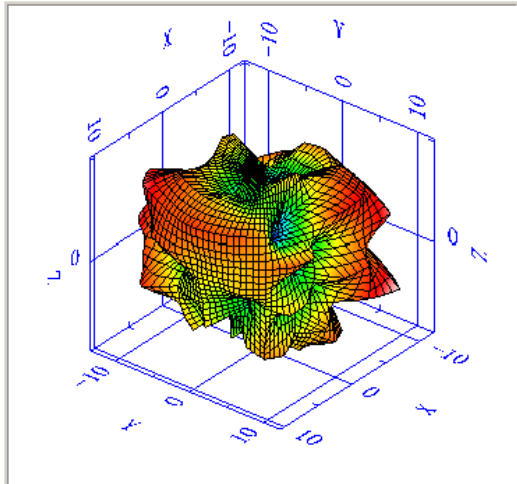

Frequency (MHz)	2350.00
TRP (dBm)	-1.32
Efficiency (%)	73.72
NHPRP +/- 45 (dBm)	-1.89
NHPRP +/- 30 (dBm)	-2.76
Directivity (dBi)	4.87
Gain (dBi)	3.54
Average Gain (dB)	-1.32
Peak EIRP (dBm)	3.54
Max. Power (dBm)	3.54
Min. Power (dBm)	-11.17
Avg. Power (dBm)	-2.18
Max. / Min. Ratio (dB)	14.72
Max. / Avg. Ratio (dB)	5.72
Min. / Avg. Ratio (dB)	-9

**2.35GHz**

## Confidential Information

Location: **RF Chamber**  
 Temperatur ( ): **22.00**

Date: **2007-3-30**  
 Humidity (%): **65.00**

Time: **11:01:28**  
 Approved by:

**Total View**

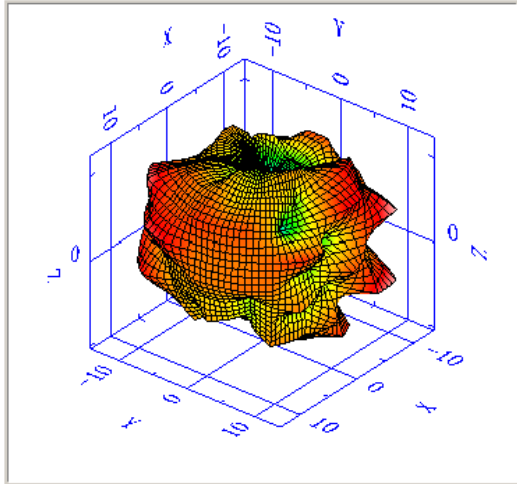

Frequency (MHz)	2400.00	Peak EIRP (dBm)	3.24
TRP (dBm)	-1.34	Max. Power (dBm)	3.24
Efficiency (%)	73.39	Min. Power (dBm)	-13.08
NHPRP +/- 45 (dBm)	-1.89	Avg. Power (dBm)	-2.21
NHPRP +/- 30 (dBm)	-2.79	Max. / Min. Ratio (dB)	16.31
Directivity (dBi)	4.58	Max. / Avg. Ratio (dB)	5.45
Gain (dBi)	3.24	Min. / Avg. Ratio (dB)	-10.87
Average Gain (dB)	-1.34		

### 2.4GHz

Location: **RF Chamber**  
 Temperatur ( ): **22.00**

Date: **2007-3-30**  
 Humidity (%): **65.00**

Time: **11:01:34**  
 Approved by:

**Total View**

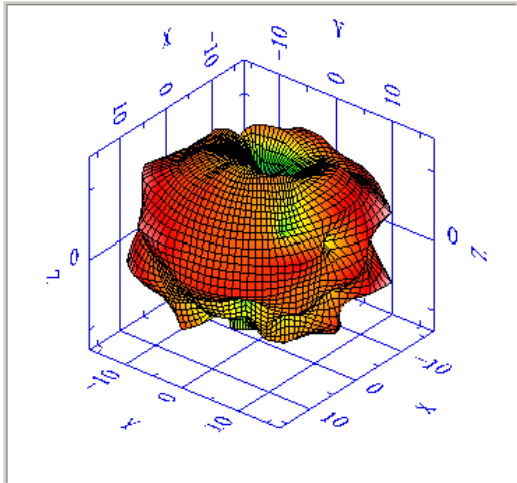

Frequency (MHz)	2450.00	Peak EIRP (dBm)	2.97
TRP (dBm)	-1.4	Max. Power (dBm)	2.97
Efficiency (%)	72.52	Min. Power (dBm)	-16.47
NHPRP +/- 45 (dBm)	-1.87	Avg. Power (dBm)	-2.28
NHPRP +/- 30 (dBm)	-2.71	Max. / Min. Ratio (dB)	19.44
Directivity (dBi)	4.37	Max. / Avg. Ratio (dB)	5.25
Gain (dBi)	2.97	Min. / Avg. Ratio (dB)	-14.19
Average Gain (dB)	-1.4		

### 2.45GHz

Confidential Information

S
---

Location: **RF Chamber**  
 Temperatur ( ): **22.00**

Date: **2007-3-30**  
 Humidity (%): **65.00**

Time: **11:01:41**  
 Approved by:

**Total View**

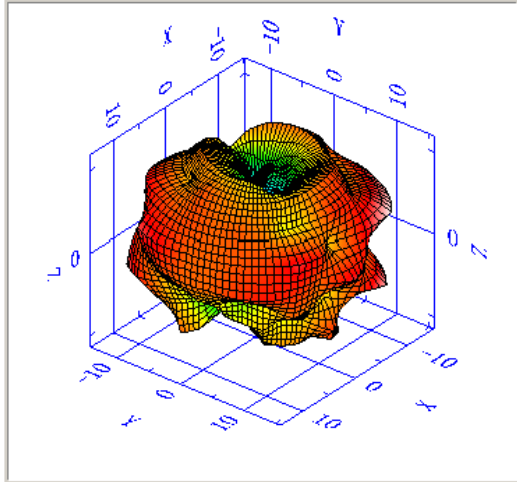

Frequency (MHz)	2500.00
TRP (dBm)	-1.29
Efficiency (%)	74.29
NHPRP +/- 45 (dBm)	-1.71
NHPRP +/- 30 (dBm)	-2.61
Directivity (dBi)	4.45
Gain (dBi)	3.16
Average Gain (dB)	-1.29
Peak EIRP (dBm)	3.16
Max. Power (dBm)	3.16
Min. Power (dBm)	-14.26
Avg. Power (dBm)	-2.22
Max. / Min. Ratio (dB)	17.42
Max. / Avg. Ratio (dB)	5.38
Min. / Avg. Ratio (dB)	-12.04

**2.5GHz**

S
---

Location: **RF Chamber**  
 Temperatur ( ): **22.00**

Date: **2007-3-30**  
 Humidity (%): **65.00**

Time: **11:01:48**  
 Approved by:

**Total View**

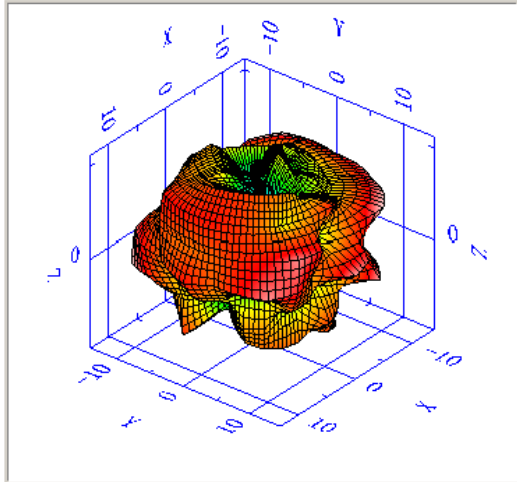

Frequency (MHz)	2600.00
TRP (dBm)	-0.51
Efficiency (%)	88.94
NHPRP +/- 45 (dBm)	-0.91
NHPRP +/- 30 (dBm)	-1.82
Directivity (dBi)	3.98
Gain (dBi)	3.47
Average Gain (dB)	-0.51
Peak EIRP (dBm)	3.47
Max. Power (dBm)	3.47
Min. Power (dBm)	-11.83
Avg. Power (dBm)	-1.32
Max. / Min. Ratio (dB)	15.29
Max. / Avg. Ratio (dB)	4.78
Min. / Avg. Ratio (dB)	-10.51

**2.6GHz**

# Confidential Information

S

Location: **RF Chamber**  
Temperatuer ( ): **22.00**

Date: **2007-3-30**  
Humidity (%): **65.00**

Time: **11:01:54**  
Approved by:

## Total View

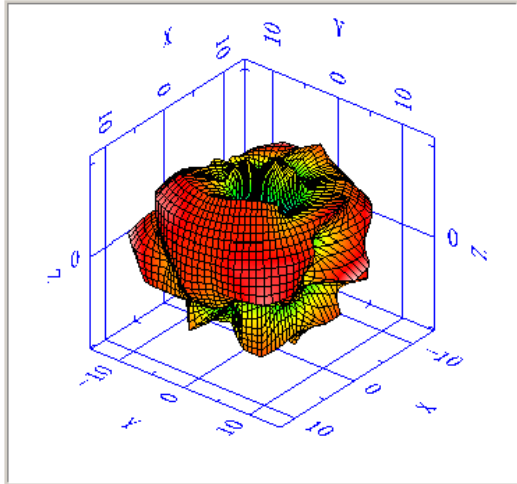

Frequency (MHz)	2700.00	Peak EIRP (dBm)	2.8
TRP (dBm)	-1.29	Max. Power (dBm)	2.8
Efficiency (%)	74.38	Min. Power (dBm)	-12.24
NHPRP +/- 45 (dBm)	-1.73	Avg. Power (dBm)	-1.98
NHPRP +/- 30 (dBm)	-2.52	Max. / Min. Ratio (dB)	15.05
Directivity (dBi)	4.09	Max. / Avg. Ratio (dB)	4.78
Gain (dBi)	2.8	Min. / Avg. Ratio (dB)	-10.27
Average Gain (dB)	-1.29		

## 2.7GHz

S

Location: **RF Chamber**  
Temperatuer ( ): **22.00**

Date: **2007-3-30**  
Humidity (%): **65.00**

Time: **11:02:03**  
Approved by:

## Total View

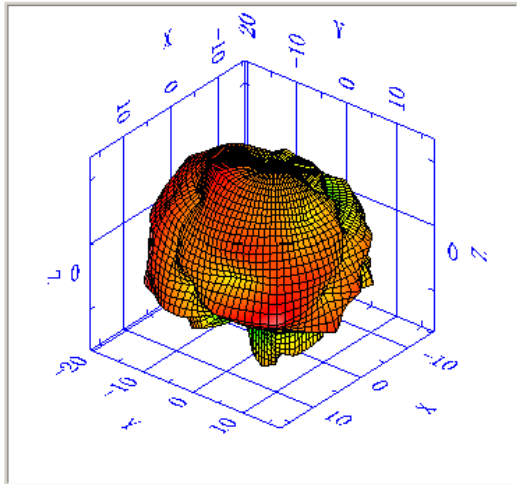

Frequency (MHz)	3300.00	Peak EIRP (dBm)	4.54
TRP (dBm)	-1.49	Max. Power (dBm)	4.54
Efficiency (%)	70.9	Min. Power (dBm)	-16.7
NHPRP +/- 45 (dBm)	-2.18	Avg. Power (dBm)	-2.05
NHPRP +/- 30 (dBm)	-2.96	Max. / Min. Ratio (dB)	21.25
Directivity (dBi)	6.04	Max. / Avg. Ratio (dB)	6.59
Gain (dBi)	4.54	Min. / Avg. Ratio (dB)	-14.65
Average Gain (dB)	-1.49		

## 3.3GHz



**Confidential Information**

S
---

Location: **RF Chamber**  
 Temperatur ( ): **22.00**

Date: **2007-3-30**  
 Humidity (%): **65.00**

Time: **11:02:14**  
 Approved by:

**Total View**

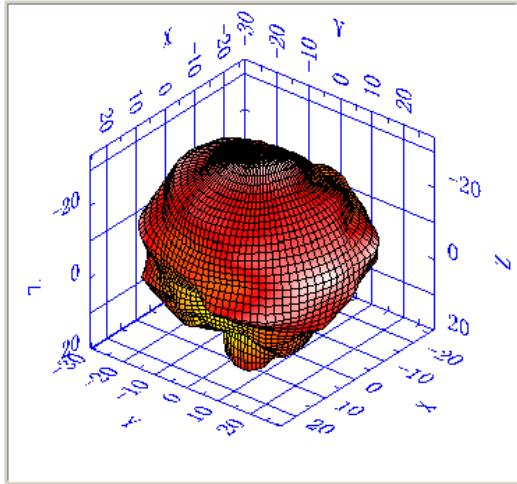

Frequency (MHz)	3500.00
TRP (dBm)	-1.38
Efficiency (%)	72.85
NHPRP +/- 45 (dBm)	-2.26
NHPRP +/- 30 (dBm)	-3.25
Directivity (dBi)	4.97
Gain (dBi)	3.59
Average Gain (dB)	-1.38
Peak EIRP (dBm)	3.59
Max. Power (dBm)	3.59
Min. Power (dBm)	-27.9
Avg. Power (dBm)	-1.23
Max. / Min. Ratio (dB)	31.49
Max. / Avg. Ratio (dB)	4.82
Min. / Avg. Ratio (dB)	-26.67

**3.5GHz**

S
---

Location: **RF Chamber**  
 Temperatur ( ): **22.00**

Date: **2007-3-30**  
 Humidity (%): **65.00**

Time: **11:02:21**  
 Approved by:

**Total View**

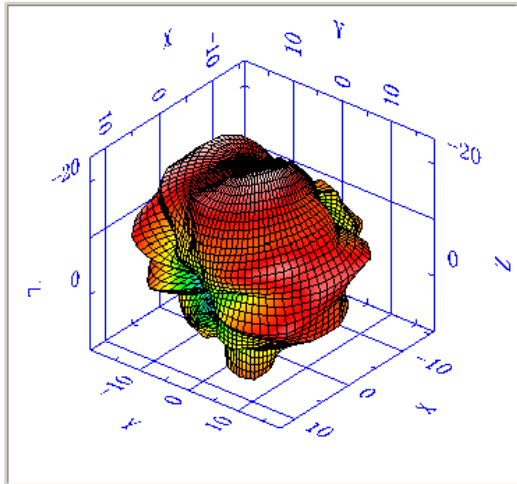

Frequency (MHz)	3800.00
TRP (dBm)	-1.11
Efficiency (%)	77.4
NHPRP +/- 45 (dBm)	-2.31
NHPRP +/- 30 (dBm)	-3.34
Directivity (dBi)	5.5
Gain (dBi)	4.38
Average Gain (dB)	-1.11
Peak EIRP (dBm)	4.38
Max. Power (dBm)	4.38
Min. Power (dBm)	-16.55
Avg. Power (dBm)	-0.69
Max. / Min. Ratio (dB)	20.93
Max. / Avg. Ratio (dB)	5.07
Min. / Avg. Ratio (dB)	-15.86

**3.8GHz**

**Confidential Information**

S
---

Location: **RF Chamber**  
 Temperatur ( ): **22.00**

Date: **2007-3-30**  
 Humidity (%): **65.00**

Time: **11:02:28**  
 Approved by:

**Total View**

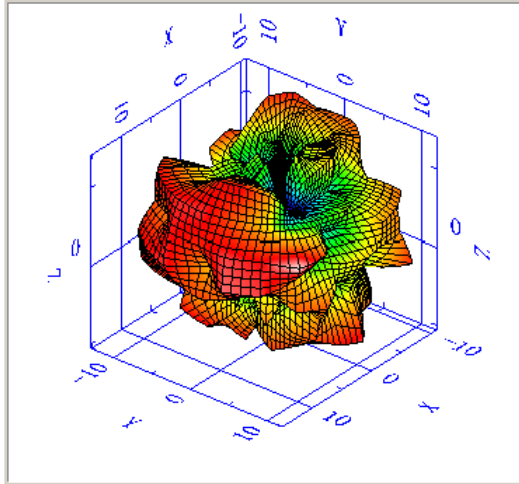

Frequency (MHz)	5150.00
TRP (dBm)	-2.09
Efficiency (%)	61.74
NHPRP +/- 45 (dBm)	-2.84
NHPRP +/- 30 (dBm)	-3.98
Directivity (dBi)	5.73
Gain (dBi)	3.64
Average Gain (dB)	-2.09
Peak EIRP (dBm)	3.64
Max. Power (dBm)	3.64
Min. Power (dBm)	-13.26
Avg. Power (dBm)	-2.36
Max. / Min. Ratio (dB)	16.89
Max. / Avg. Ratio (dB)	5.99
Min. / Avg. Ratio (dB)	-10.9

**5.15GHz**

S
---

Location: **RF Chamber**  
 Temperatur ( ): **22.00**

Date: **2007-3-30**  
 Humidity (%): **65.00**

Time: **11:02:36**  
 Approved by:

**Total View**

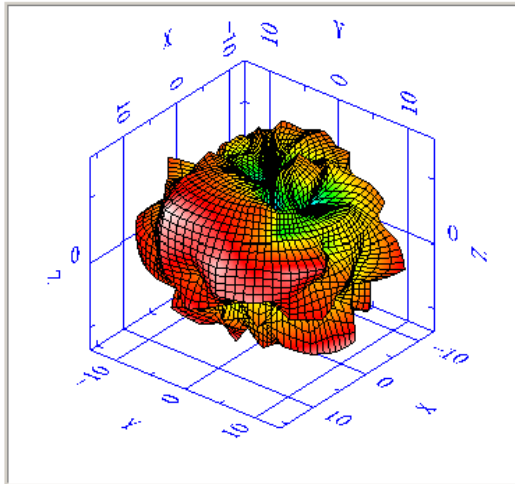

Frequency (MHz)	5250.00
TRP (dBm)	-2.21
Efficiency (%)	60.1
NHPRP +/- 45 (dBm)	-2.99
NHPRP +/- 30 (dBm)	-4.2
Directivity (dBi)	4.78
Gain (dBi)	2.57
Average Gain (dB)	-2.21
Peak EIRP (dBm)	2.57
Max. Power (dBm)	2.57
Min. Power (dBm)	-15.24
Avg. Power (dBm)	-2.57
Max. / Min. Ratio (dB)	17.81
Max. / Avg. Ratio (dB)	5.14
Min. / Avg. Ratio (dB)	-12.67

**5.25GHz**

**Confidential Information**

S
---

Location: **RF Chamber**  
 Temperatur ( ): **22.00**

Date: **2007-3-30**  
 Humidity (%): **65.00**

Time: **11:02:44**  
 Approved by:

**Total View**

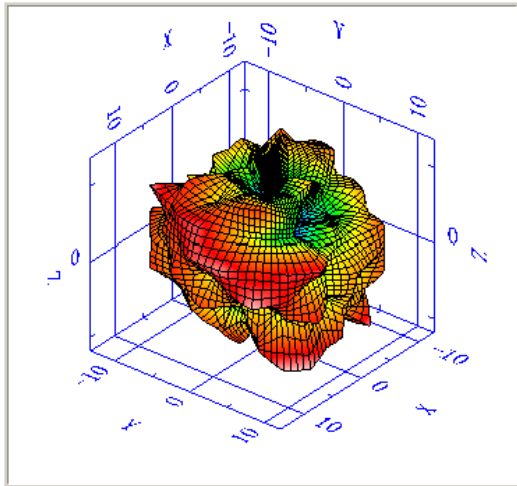

Frequency (MHz)	5350.00	Peak EIRP (dBm)	3.73
TRP (dBm)	-1.03	Max. Power (dBm)	3.73
Efficiency (%)	78.92	Min. Power (dBm)	-12.15
NHPRP +/- 45 (dBm)	-1.79	Avg. Power (dBm)	-1.42
NHPRP +/- 30 (dBm)	-3.07	Max. / Min. Ratio (dB)	15.88
Directivity (dBi)	4.76	Max. / Avg. Ratio (dB)	5.15
Gain (dBi)	3.73	Min. / Avg. Ratio (dB)	-10.73
Average Gain (dB)	-1.03		

**5.35GHz**

S
---

Location: **RF Chamber**  
 Temperatur ( ): **22.00**

Date: **2007-3-30**  
 Humidity (%): **65.00**

Time: **11:02:52**  
 Approved by:

**Total View**

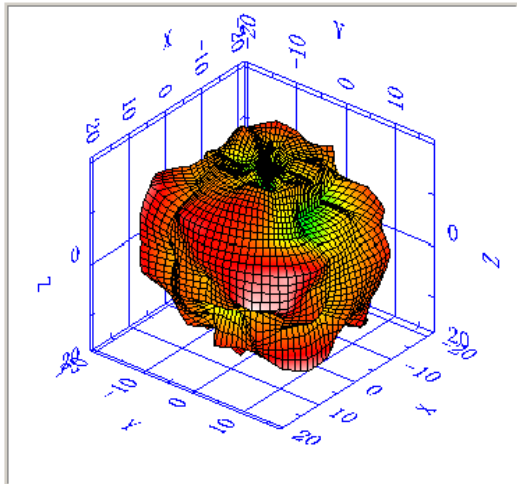

Frequency (MHz)	5450.00	Peak EIRP (dBm)	4.77
TRP (dBm)	-0.68	Max. Power (dBm)	4.77
Efficiency (%)	85.58	Min. Power (dBm)	-19.17
NHPRP +/- 45 (dBm)	-1.36	Avg. Power (dBm)	-1.07
NHPRP +/- 30 (dBm)	-2.68	Max. / Min. Ratio (dB)	23.94
Directivity (dBi)	5.44	Max. / Avg. Ratio (dB)	5.83
Gain (dBi)	4.77	Min. / Avg. Ratio (dB)	-18.11
Average Gain (dB)	-0.68		

**5.45GHz**

## Confidential Information

Location: **RF Chamber**  
 Temperatur ( ): **22.00**

Date: **2007-3-30**  
 Humidity (%): **65.00**

Time: **11:03:21**  
 Approved by:

**Total View**

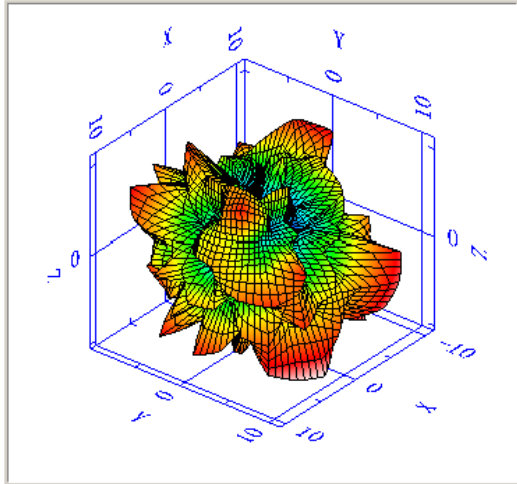

Frequency (MHz)	5750.00
TRP (dBm)	-1.06
Efficiency (%)	78.31
NHPRP +/- 45 (dBm)	-1.82
NHPRP +/- 30 (dBm)	-3.15
Directivity (dBi)	5.49
Gain (dBi)	4.43
Average Gain (dB)	-1.06
Peak EIRP (dBm)	4.43
Max. Power (dBm)	4.43
Min. Power (dBm)	-10.02
Avg. Power (dBm)	-1.21
Max. / Min. Ratio (dB)	14.45
Max. / Avg. Ratio (dB)	5.64
Min. / Avg. Ratio (dB)	-8.81

### 5.75GHz

Location: **RF Chamber**  
 Temperatur ( ): **22.00**

Date: **2007-3-30**  
 Humidity (%): **65.00**

Time: **11:03:37**  
 Approved by:

**Total View**

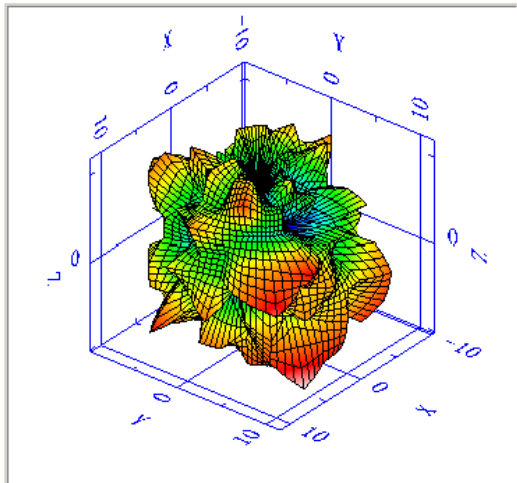

Frequency (MHz)	5850.00
TRP (dBm)	-1.55
Efficiency (%)	69.99
NHPRP +/- 45 (dBm)	-2.42
NHPRP +/- 30 (dBm)	-3.81
Directivity (dBi)	6.52
Gain (dBi)	4.97
Average Gain (dB)	-1.55
Peak EIRP (dBm)	4.97
Max. Power (dBm)	4.97
Min. Power (dBm)	-10.66
Avg. Power (dBm)	-1.54
Max. / Min. Ratio (dB)	15.63
Max. / Avg. Ratio (dB)	6.51
Min. / Avg. Ratio (dB)	-9.12

### 5.85GHz