

*EMC Test Report
Application for Grant of Equipment Authorization
Industry Canada RSS-Gen Issue 3 / RSS 210 Issue 8
FCC Part 15 Subpart C*

*Intel Centrino Wireless-N 135, models 135BNHMMW and
135BNHU*

IC CERTIFICATION #: 1000M-135BNH and 1000M-135BNHU
FCC ID: PD9135BNH and PD9135BNHU

APPLICANT: Intel Corporation
100 Center Point Circle Suite 200
Columbia, SC 29210

TEST SITE(S): Elliott Laboratories
41039 Boyce Road.
Fremont, CA. 94538-2435

IC SITE REGISTRATION #: 2845B-3; 2845B-4, 2845B-5, 2845B-7

REPORT DATE: October 13, 2011

FINAL TEST DATES: September 7, 8, 14, 15, 16, 19, 20, 21, 23 and
28, 2011

TOTAL NUMBER OF PAGES: 122

PROGRAM MGR /
TECHNICAL REVIEWER:



David W. Bare
Chief Engineer

QUALITY ASSURANCE DELEGATE /
FINAL REPORT PREPARER:

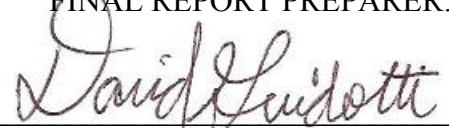

David Guidotti
Senior Technical Writer



Testing Cert #2016.01

Elliott Laboratories is accredited by the A2LA, certificate number 2016.01, to perform the test(s) listed in this report, except where noted otherwise. This report and the information contained herein represent the results of testing test articles identified and selected by the client performed to specifications and/or procedures selected by the client. National Technical Systems (NTS) makes no representations, expressed or implied, that such testing is adequate (or inadequate) to demonstrate efficiency, performance, reliability, or any other characteristic of the articles being tested, or similar products. This report should not be relied upon as an endorsement or certification by NTS of the equipment tested, nor does it represent any statement whatsoever as to its merchantability or fitness of the test article, or similar products, for a particular purpose. This report shall not be reproduced except in full.

REVISION HISTORY

Rev#	Date	Comments	Modified By
-	10-7-2011	First release	
1	10-13-2011	Reissued report to add plots for power density, 6db and 99% bandwidths and to correct typos on page 6	David Bare Dave Guidotti

TABLE OF CONTENTS

REVISION HISTORY	2
TABLE OF CONTENTS	3
SCOPE.....	4
OBJECTIVE	4
STATEMENT OF COMPLIANCE.....	5
DEVIATIONS FROM THE STANDARDS.....	5
TEST RESULTS SUMMARY	6
DIGITAL TRANSMISSION SYSTEMS (2400 – 2483.5MHZ).....	6
GENERAL REQUIREMENTS APPLICABLE TO ALL BANDS.....	6
MEASUREMENT UNCERTAINTIES.....	7
EQUIPMENT UNDER TEST (EUT) DETAILS.....	8
GENERAL.....	8
ANTENNA SYSTEM	8
ENCLOSURE.....	8
MODIFICATIONS.....	8
SUPPORT EQUIPMENT.....	9
EUT INTERFACE PORTS	9
EUT OPERATION	9
TEST SITE.....	10
GENERAL INFORMATION.....	10
CONDUCTED EMISSIONS CONSIDERATIONS	10
RADIATED EMISSIONS CONSIDERATIONS	10
MEASUREMENT INSTRUMENTATION	11
RECEIVER SYSTEM	11
INSTRUMENT CONTROL COMPUTER	11
LINE IMPEDANCE STABILIZATION NETWORK (LISN).....	11
FILTERS/ATTENUATORS	12
ANTENNAS.....	12
ANTENNA MAST AND EQUIPMENT TURNTABLE.....	12
INSTRUMENT CALIBRATION.....	12
TEST PROCEDURES	13
EUT AND CABLE PLACEMENT	13
CONDUCTED EMISSIONS.....	13
RADIATED EMISSIONS.....	13
RADIATED EMISSIONS.....	14
CONDUCTED EMISSIONS FROM ANTENNA PORT	16
BANDWIDTH MEASUREMENTS	16
SPECIFICATION LIMITS AND SAMPLE CALCULATIONS.....	17
CONDUCTED EMISSIONS SPECIFICATION LIMITS: FCC 15.207; FCC 15.107(A), RSS GEN	17
GENERAL TRANSMITTER RADIATED EMISSIONS SPECIFICATION LIMITS	18
RECEIVER RADIATED SPURIOUS EMISSIONS SPECIFICATION LIMITS.....	18
OUTPUT POWER LIMITS – DIGITAL TRANSMISSION SYSTEMS	19
TRANSMIT MODE SPURIOUS RADIATED EMISSIONS LIMITS – FHSS AND DTS SYSTEMS.....	19
SAMPLE CALCULATIONS - CONDUCTED EMISSIONS	19
SAMPLE CALCULATIONS - RADIATED EMISSIONS.....	20
SAMPLE CALCULATIONS - FIELD STRENGTH TO EIRP CONVERSION.....	21
APPENDIX A TEST EQUIPMENT CALIBRATION DATA	22
APPENDIX B TEST DATA	25
END OF REPORT	122

SCOPE

An electromagnetic emissions test has been performed on the Intel Corporation model Intel Centrino Wireless-N 135, models 135BNHMW and 135BNHU, pursuant to the following rules:

Industry Canada RSS-Gen Issue 3

RSS 210 Issue 8 "Low-power Licence-exempt Radiocommunication Devices (All Frequency Bands): Category I Equipment"

FCC Part 15 Subpart C

Conducted and radiated emissions data has been collected, reduced, and analyzed within this report in accordance with measurement guidelines set forth in the following reference standards and as outlined in Elliott Laboratories test procedures:

ANSI C63.4:2003

FCC DTS Measurement Procedure KDB558074, March 2005

The intentional radiator above has been tested in a simulated typical installation to demonstrate compliance with the relevant Industry Canada performance and procedural standards.

Final system data was gathered in a mode that tended to maximize emissions by varying orientation of EUT, orientation of power and I/O cabling, antenna search height, and antenna polarization.

Every practical effort was made to perform an impartial test using appropriate test equipment of known calibration. All pertinent factors have been applied to reach the determination of compliance.

OBJECTIVE

The primary objective of the manufacturer is compliance with the regulations outlined in the previous section.

Prior to marketing in the USA, all unlicensed transmitters and transceivers require certification. Receive-only devices operating between 30 MHz and 960 MHz are subject to either certification or a manufacturer's declaration of conformity, with all other receive-only devices exempt from the technical requirements.

Prior to marketing in Canada, Class I transmitters, receivers and transceivers require certification. Class II devices are required to meet the appropriate technical requirements but are exempt from certification requirements.

Certification is a procedure where the manufacturer submits test data and technical information to a certification body and receives a certificate or grant of equipment authorization upon successful completion of the certification body's review of the submitted documents. Once the equipment authorization has been obtained, the label indicating compliance must be attached to all identical units, which are subsequently manufactured.

Maintenance of compliance is the responsibility of the manufacturer. Any modification of the product which may result in increased emissions should be checked to ensure compliance has been maintained (i.e., printed circuit board layout changes, different line filter, different power supply, harnessing or I/O cable changes, etc.).

Testing was performed only on model Intel Centrino Wireless-N 135, models 135BNHMHW and 135BNHU.

STATEMENT OF COMPLIANCE

The tested sample of Intel Corporation model Intel Centrino Wireless-N 135, models 135BNHMHW and 135BNHU complied with the requirements of the following regulations:

Industry Canada RSS-Gen Issue 3

RSS 210 Issue 8 "Low-power Licence-exempt Radiocommunication Devices (All Frequency Bands): Category I Equipment"

FCC Part 15 Subpart C

Maintenance of compliance is the responsibility of the manufacturer. Any modifications to the product should be assessed to determine their potential impact on the compliance status of the device with respect to the standards detailed in this test report.

The test results recorded herein are based on a single type test of Intel Corporation model Intel Centrino Wireless-N 135, models 135BNHMHW and 135BNHU and therefore apply only to the tested sample. The sample was selected and prepared by Steve Hackett of Intel Corporation.

DEVIATIONS FROM THE STANDARDS

No deviations were made from the published requirements listed in the scope of this report.

TEST RESULTS SUMMARY**DIGITAL TRANSMISSION SYSTEMS (2400 – 2483.5MHz)**

FCC Rule Part	RSS Rule Part	Description	Measured Value / Comments	Limit / Requirement	Result
15.247(a)	RSS 210 A8.2	Digital Modulation	Systems uses OFDM / DSSS techniques	System must utilize a digital transmission technology	Complies
15.247 (a) (2)	RSS 210 A8.2 (1)	6dB Bandwidth	Wi-Fi: 12.5 MHz Bluetooth: 696 kHz	>500kHz	Complies
15.247 (b) (3)	RSS 210 A8.2 (4)	Output Power (multipoint systems)	802.11b: 0.043 W 802.11g: 0.029 W HT20: 0.030 W HT40: 0.014 W BLE: 0.003 W EIRP = 0.087 W ^{Note 1}	1 Watt, EIRP limited to 4 Watts.	Complies
15.247(d)	RSS 210 A8.2 (2)	Power Spectral Density	-9.4 dBm / 3kHz	8dBm/3kHz	Complies
15.247(c)	RSS 210 A8.5	Antenna Port Spurious Emissions 30MHz – 25 GHz	All emissions below -20 or 30dBc limit	<-20dBc or -30dBc ^{Note 2}	Complies
15.247(c) / 15.209	RSS 210 A8.5	Radiated Spurious Emissions 30MHz – 25 GHz	53.9dBμV/m @ 2389.8MHz (-0.1dB)	15.207 in restricted bands, all others <-20dBc or -30dBc ^{Note 2}	Complies

Note 1: EIRP calculated using antenna gain of 3.2 dBi for the highest EIRP system.

Note 2: Limit of -30dBc used because the power was measured using the UNII test procedure (maximum power averaged over a transmission burst) for some modes.

GENERAL REQUIREMENTS APPLICABLE TO ALL BANDS

FCC Rule Part	RSS Rule part	Description	Measured Value / Comments	Limit / Requirement	Result (margin)
15.203	-	RF Connector		Unique or integral antenna required	Complies
15.207	RSS GEN Table 4	AC Conducted Emissions	41.7dBμV @ 8.000MHz (-8.3dB)	Refer to page 17	Complies
15.109	RSS GEN 6.1 Table 2	Receiver spurious emissions	45.2dBμV/m @ 662.47MHz (Margin: -0.8dB)	Refer to page 18	Complies
15.247 (b) (5) 15.407 (f)	RSS GEN 5.6 RSS 102	RF Exposure Requirements	Refer to MPE calculations in Exhibit 11, RSS 102 declaration and User Manual statements.	Refer to OET 65, FCC Part 1 and RSS 102	Complies
-	RSP 100 RSS GEN 7.1	User Manual	Refer to page 11 of the user's manual	Statement required regarding non-interference	Complies
-	RSP 100 RSS GEN 7.1	User Manual	Not applicable, antenna is integral to host systems.	Statement for products with detachable antenna	Complies
-	RSP 100 RSS GEN 4.6.1	99% Bandwidth	802.11b: 15.3 MHz 802.11g: 17.1 MHz HT20: 18.3 MHz HT40: 36.8 MHz BLE: 2.61 MHz	Information only	N/A

MEASUREMENT UNCERTAINTIES

ISO/IEC 17025 requires that an estimate of the measurement uncertainties associated with the emissions test results be included in the report. The measurement uncertainties given below are based on a 95% confidence level and were calculated in accordance with UKAS document LAB 34.

Measurement Type	Measurement Unit	Frequency Range	Expanded Uncertainty
RF power, conducted (power meter)	dBm	25 to 7000 MHz	± 0.52 dB
RF power, conducted (Spectrum analyzer)	dBm	25 to 7000 MHz	± 0.7 dB
Conducted emission of transmitter	dBm	25 to 26500 MHz	± 0.7 dB
Conducted emission of receiver	dBm	25 to 26500 MHz	± 0.7 dB
Radiated emission (substitution method)	dBm	25 to 26500 MHz	± 2.5 dB
Radiated emission (field strength)	dB μ V/m	25 to 1000 MHz	± 3.6 dB
		1000 to 40000 MHz	± 6.0 dB
Conducted Emissions (AC Power)	dB μ V	0.15 to 30 MHz	± 2.4 dB

EQUIPMENT UNDER TEST (EUT) DETAILS**GENERAL**

The Intel Centrino Wireless-N 135, models 135BNHMW and 135BNHU are PCIe Half Mini Card form factor IEEE 802.11b/g/n wireless network adapters that supports 1x1 (SISO) and a Bluetooth adapter that supports Basic Rate, Enhanced Data Rate and Low Energy modes of operation.

The device is sold under model numbers 135BNHMW and 135BNHU

Model numbers with FCC ID: PD9135BNHU and IC: 1000M-135BNHU are intended for end user installation and operate with a BIOS lock feature to ensure they can only be used in the appropriate host systems to prevent unauthorized operation. Other models are only intended for OEM factory installation.

For radio testing purposes the card was installed in a test fixture that exposed all sides of the card. For digital device testing for certification under equipment code JBP the card was installed inside a laptop PC.

The sample was received on September 7, 2011 and tested on September 7, 8, 14, 15, 16, 19, 20, 21, 23 and 28, 2011. The EUT consisted of the following component(s):

Company	Model	Description	Serial Number	FCC ID
Intel Corporation	135BNHMW	PCIe Half Mini Card form factor Bluetooth / IEEE 802.11b/g/n wireless network adapter	JBP: 00150096B4F5 DTS: 00150096B40F	PD9135BNH PD9135BNHU 1000M-135BNH
	135BNHU			1000M-135BNHU

ANTENNA SYSTEM

The EUT antenna is a a two-antenna PIFA antenna system – Shanghai Universe Communication Electron Co., Ltd for both chains. There is also an option to use a trace antenna etched onto the board for Chain B Bluetooth transmit operation.

The antenna connects to the EUT via a non-standard antenna connector, thereby meeting the requirements of FCC 15.203.

Band	Antenna Gain		Comment
	PIFA	Trace	
2400-2483.5	3.2 dBi	1dBi	

ENCLOSURE

The EUT has no enclosure. It is designed to be installed within the enclosure of a host computer.

MODIFICATIONS

No modifications were made to the EUT during the time the product was at Elliott.

SUPPORT EQUIPMENT

The following equipment was used as local support equipment for testing:

Company	Model	Description	Serial Number	FCC ID
Dell	Latitude	Laptop	-	-
Intel	-	Extender board	-	-
Agilent	E3610A	Power Supply	-	-

The following equipment was used as remote support equipment for testing:

Company	Model	Description	Serial Number	FCC ID
Netgear	GS108	Hub	GS16152CB035 447	-

EUT INTERFACE PORTS

The I/O cabling configuration during emissions testing was as follows:

Port		Description	Cable(s) Shielded/Unshielded	Length(m)
From	To			
USB	Printer	USB	Shielded	2
Ethernet	Hub	CAT 5	Unshielded	10
USB / Test Fixture	Laptop	USB	Shielded	1
Ribbon / Test Fixture	Laptop	Multiwire	-	1
DC Power / Test Fixture	Power supply	2wire	-	1

EUT OPERATION

The EUT was installed into a test fixture that exposed all sides of the card. The test fixture interfaced to a laptop computer and dc power supply. The laptop computer was used to configure the EUT to continuously transmit at a specified output power or continuously receive on the channel specified in the test data. For transmit mode measurements the system was configured to operate in each of the available operating modes – 802.11b, 802.11g, 802.11n (20 MHz channel bandwidth) and 802.11n (40MHz channel bandwidth).

The data rates used for all tests were the lowest data rates for each 802.11 mode – 1Mb/s for 802.11b, 6Mb/s for 802.11a and 802.11g, 6.5MB/s for 802.11n (20MHz), and 13 Mb/s for 802.11n (40MHz). The device operates at its maximum output power at the lowest data rate.

The PC was using the Intel test utility DRTU Version 1.5.3-0320 and the device driver was version 15.0.0.51.

TEST SITE**GENERAL INFORMATION**

Final test measurements were taken at the test sites listed below. Pursuant to section 2.948 of the FCC's Rules and section 3.3 of RSP-100, construction, calibration, and equipment data has been filed with the Commission and with industry Canada.

Site	Registration Numbers		Location
	FCC	Canada	
Chamber 3	769238	2845B-3	41039 Boyce Road Fremont, CA 94538-2435
Chamber 4	211948	2845B-4	
Chamber 5	211948	2845B-5	
Chamber 7	A2LA accreditation	2845B-7	

ANSI C63.4:2003 recommends that ambient noise at the test site be at least 6 dB below the allowable limits. Ambient levels are below this requirement. The test site(s) contain separate areas for radiated and conducted emissions testing. Considerable engineering effort has been expended to ensure that the facilities conform to all pertinent requirements of ANSI C63.4:2003.

CONDUCTED EMISSIONS CONSIDERATIONS

Conducted emissions testing is performed in conformance with ANSI C63.4:2003. Measurements are made with the EUT connected to the public power network through a nominal, standardized RF impedance, which is provided by a line impedance stabilization network, known as a LISN. A LISN is inserted in series with each current-carrying conductor in the EUT power cord.

RADIATED EMISSIONS CONSIDERATIONS

The FCC has determined that radiation measurements made in a shielded enclosure are not suitable for determining levels of radiated emissions. Radiated measurements are performed in an open field environment or in a semi-anechoic chamber. The test sites are maintained free of conductive objects within the CISPR defined elliptical area incorporated in ANSI C63.4:2003 guidelines and meet the Normalized Site Attenuation (NSA) requirements of ANSI C63.4:2003.

MEASUREMENT INSTRUMENTATION

RECEIVER SYSTEM

An EMI receiver as specified in CISPR 16-1-1 is used for emissions measurements. The receivers used can measure over the frequency range of 9 kHz up to 2000 MHz. These receivers allow both ease of measurement and high accuracy to be achieved. The receivers have Peak, Average, and CISPR (Quasi-peak) detectors built into their design so no external adapters are necessary. The receiver automatically sets the required bandwidth for the CISPR detector used during measurements. If the repetition frequency of the signal being measured is below 20Hz, peak measurements are made in lieu of Quasi-Peak measurements.

For measurements above the frequency range of the receivers, a spectrum analyzer is utilized because it provides visibility of the entire spectrum along with the precision and versatility required to support engineering analysis. Average measurements above 1000MHz are performed on the spectrum analyzer using the linear-average method with a resolution bandwidth of 1 MHz and a video bandwidth of 10 Hz, unless the signal is pulsed in which case the average (or video) bandwidth of the measuring instrument is reduced to onset of pulse desensitization and then increased.

INSTRUMENT CONTROL COMPUTER

The receivers utilize either a Rohde & Schwarz EZM Spectrum Monitor/Controller or contain an internal Spectrum Monitor/Controller to view and convert the receiver measurements to the field strength at an antenna or voltage developed at the LISN measurement port, which is then compared directly with the appropriate specification limit. This provides faster, more accurate readings by performing the conversions described under Sample Calculations within the Test Procedures section of this report. Results are printed in a graphic and/or tabular format, as appropriate. A personal computer is used to record all measurements made with the receivers.

The Spectrum Monitor provides a visual display of the signal being measured. In addition, the controller or a personal computer run automated data collection programs which control the receivers. This provides added accuracy since all site correction factors, such as cable loss and antenna factors are added automatically.

LINE IMPEDANCE STABILIZATION NETWORK (LISN)

Line conducted measurements utilize a fifty microhenry Line Impedance Stabilization Network as the monitoring point. The LISN used also contains a 250 uH CISPR adapter. This network provides for calibrated radio frequency noise measurements by the design of the internal low pass and high pass filters on the EUT and measurement ports, respectively.

FILTERS/ATTENUATORS

External filters and precision attenuators are often connected between the receiving antenna or LISN and the receiver. This eliminates saturation effects and non-linear operation due to high amplitude transient events.

ANTENNAS

A loop antenna is used below 30 MHz. For the measurement range 30 MHz to 1000 MHz either a combination of a biconical antenna and a log periodic or a bi-log antenna is used. Above 1000 MHz, horn antennas are used. The antenna calibration factors to convert the received voltage to an electric field strength are included with appropriate cable loss and amplifier gain factors to determine an overall site factor, which is then programmed into the test receivers or incorporated into the test software.

ANTENNA MAST AND EQUIPMENT TURNTABLE

The antennas used to measure the radiated electric field strength are mounted on a non-conductive antenna mast equipped with a motor-drive to vary the antenna height. Measurements below 30 MHz are made with the loop antenna at a fixed height of 1m above the ground plane.

ANSI C63.4:2003 specifies that the test height above ground for table mounted devices shall be 80 centimeters. Floor mounted equipment shall be placed on the ground plane if the device is normally used on a conductive floor or separated from the ground plane by insulating material from 3 to 12 mm if the device is normally used on a non-conductive floor. During radiated measurements, the EUT is positioned on a motorized turntable in conformance with this requirement.

INSTRUMENT CALIBRATION

All test equipment is regularly checked to ensure that performance is maintained in accordance with the manufacturer's specifications. All antennas are calibrated at regular intervals with respect to tuned half-wave dipoles. An exhibit of this report contains the list of test equipment used and calibration information.

TEST PROCEDURES

EUT AND CABLE PLACEMENT

The regulations require that interconnecting cables be connected to the available ports of the unit and that the placement of the unit and the attached cables simulate the worst case orientation that can be expected from a typical installation, so far as practicable. To this end, the position of the unit and associated cabling is varied within the guidelines of ANSI C63.4:2003, and the worst-case orientation is used for final measurements.

CONDUCTED EMISSIONS

Conducted emissions are measured at the plug end of the power cord supplied with the EUT. Excess power cord length is wrapped in a bundle between 30 and 40 centimeters in length near the center of the cord. Preliminary measurements are made to determine the highest amplitude emission relative to the specification limit for all the modes of operation. Placement of system components and varying of cable positions are performed in each mode. A final peak mode scan is then performed in the position and mode for which the highest emission was noted on all current carrying conductors of the power cord.

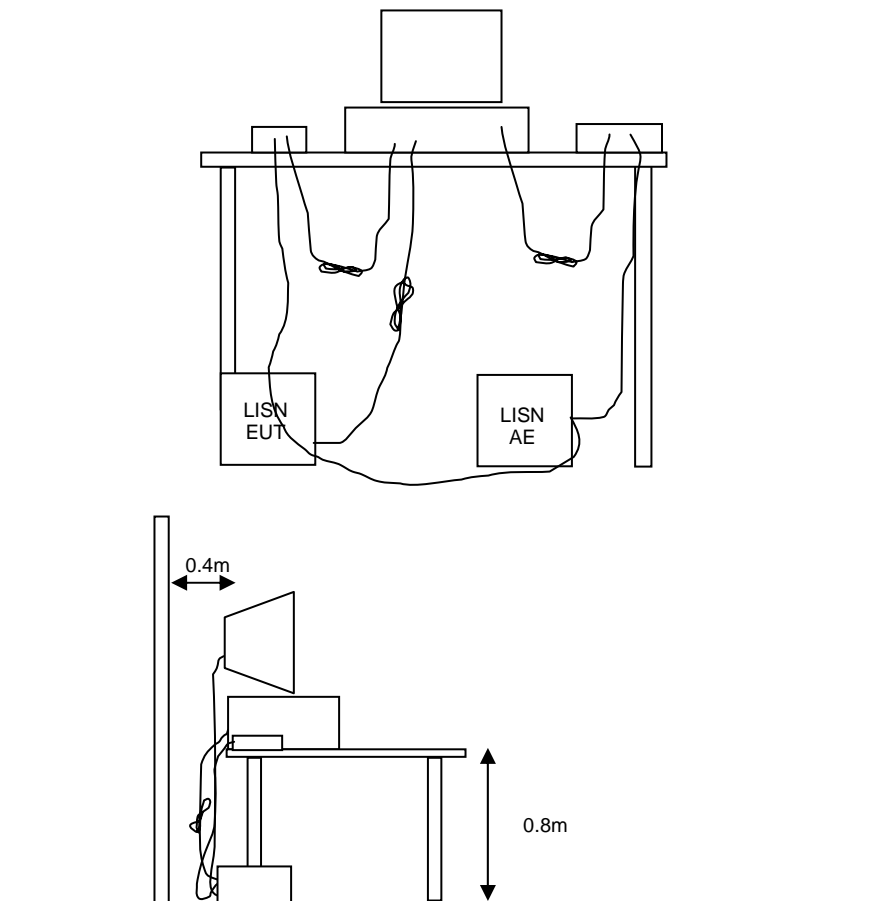

Figure 1 Typical Conducted Emissions Test Configuration

RADIATED EMISSIONS

A preliminary scan of the radiated emissions is performed in which all significant EUT frequencies are identified with the system in a nominal configuration. At least two scans are performed, one scan for each antenna polarization (horizontal and vertical; loop parallel and perpendicular to the EUT). During the preliminary scans, the EUT is rotated through 360°, the antenna height is varied (for measurements above 30 MHz) and cable positions are varied to determine the highest emission relative to the limit. Preliminary scans may be performed in a fully anechoic chamber for the purposes of identifying the frequencies of the highest emissions from the EUT.

A speaker is provided in the receiver to aid in discriminating between EUT and ambient emissions. Other methods used during the preliminary scan for EUT emissions involve scanning with near field magnetic loops, monitoring I/O cables with RF current clamps, and cycling power to the EUT.

Final maximization is a phase in which the highest amplitude emissions identified in the spectral search are viewed while the EUT azimuth angle is varied from 0 to 360 degrees relative to the receiving antenna. The azimuth, which results in the highest emission is then maintained while varying the antenna height from one to four meters (for measurements above 30 MHz, measurements below 30 MHz are made with the loop antenna at a fixed height of 1m). The result is the identification of the highest amplitude for each of the highest peaks. Each recorded level is corrected in the receiver using appropriate factors for cables, connectors, antennas, and preamplifier gain.

When testing above 18 GHz, the receive antenna is located at 1 meter from the EUT and the antenna height is restricted to a maximum of 2.5 meters.

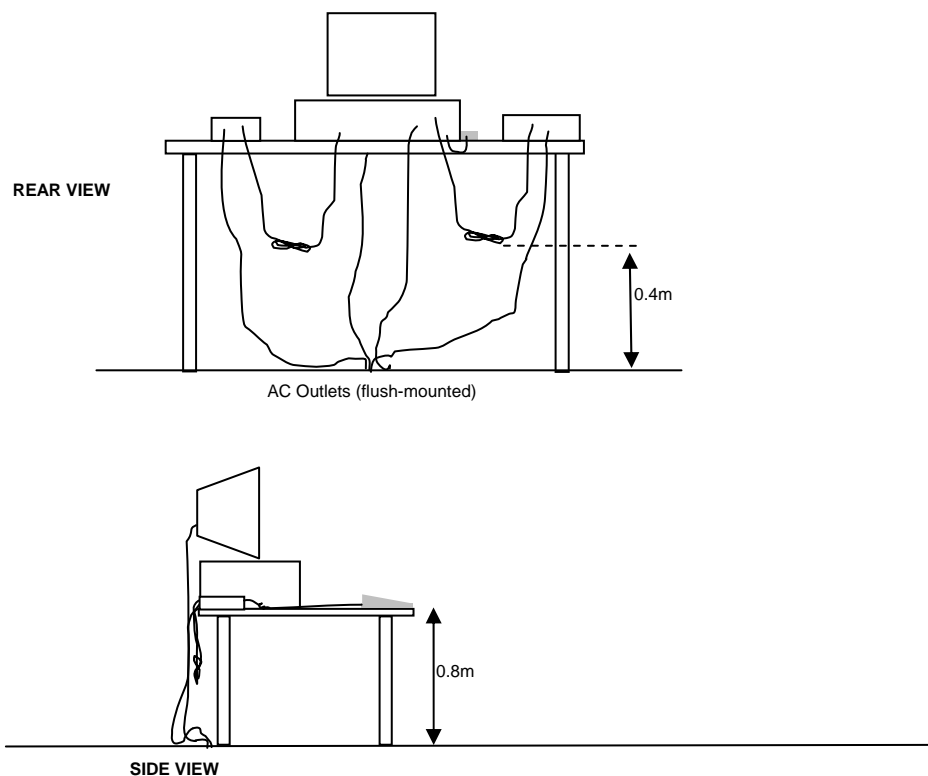

Typical Test Configuration for Radiated Field Strength Measurements

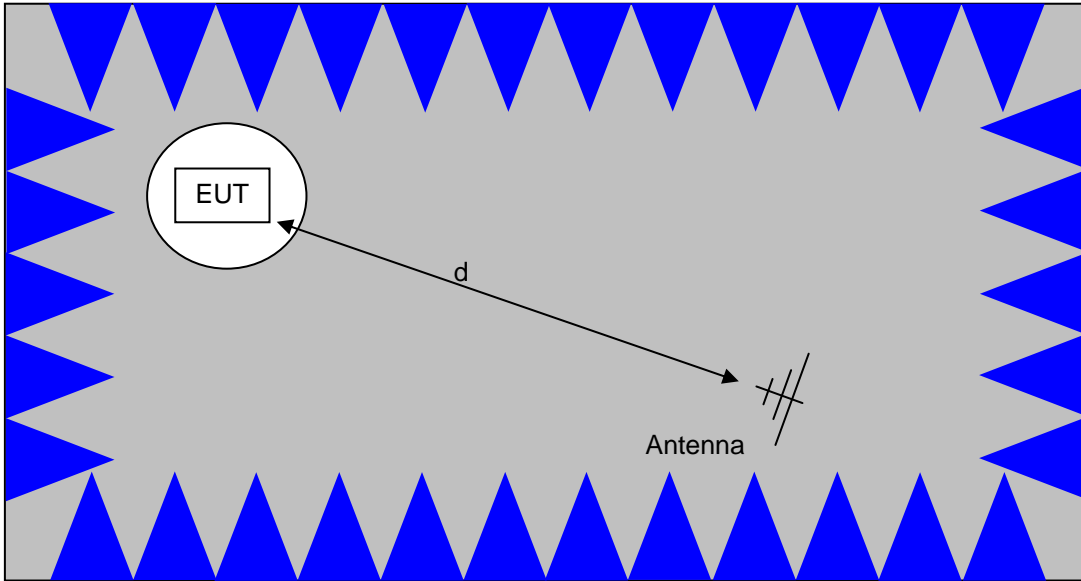

The anechoic materials on the walls and ceiling ensure compliance with the normalized site attenuation requirements of CISPR 16 / CISPR 22 / ANSI C63.4 for an alternate test site at the measurement distances used.

Floor-standing equipment is placed on the floor with insulating supports between the unit and the ground plane.

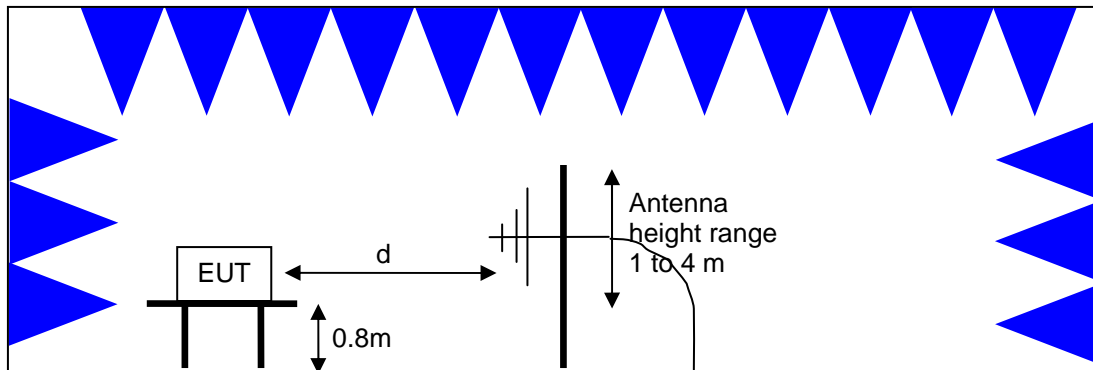

Test Configuration for Radiated Field Strength Measurements
Semi-Anechoic Chamber, Plan and Side Views

CONDUCTED EMISSIONS FROM ANTENNA PORT

Direct measurements of power, bandwidth and power spectral density are performed, where possible, with the antenna port of the EUT connected to either the power meter or spectrum analyzer via a suitable attenuator and/or filter. These are used to ensure that the front end of the measurement instrument is not overloaded by the fundamental transmission.

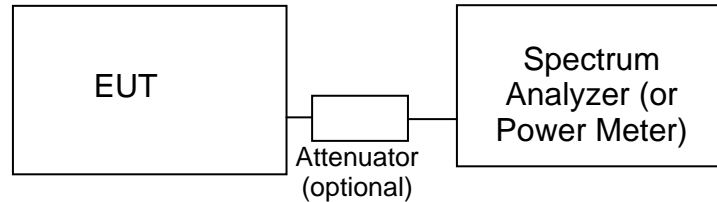
**Test Configuration for Antenna Port Measurements**

Measurement bandwidths (video and resolution) are set in accordance with the relevant standards and Elliott's test procedures for the type of radio being tested. When power measurements are made using a resolution bandwidth less than the signal bandwidth the power is calculated by summing the power across the signal bandwidth using either the analyzer channel power function or by capturing the trace data and calculating the power using software. In both cases the summed power is corrected to account for the equivalent noise bandwidth (ENBW) of the resolution bandwidth used.

If power averaging is used (typically for certain digital modulation techniques), the EUT is configured to transmit continuously. Power averaging is performed using either the built-in function of the analyzer or, if the analyzer does not feature power averaging, using external software. In both cases the average power is calculated over a number of sweeps (typically 100). When the EUT cannot be configured to continuously transmit then either the analyzer is configured to perform a gated sweep to ensure that the power is averaged over periods that the device is transmitting or power averaging is disabled and a max-hold feature is used.

If a power meter is used to make output power measurements the sensor head type (peak or average) is stated in the test data table.

BANDWIDTH MEASUREMENTS

The 6dB, 20dB and/or 26dB signal bandwidth is measured in using the bandwidths recommended by ANSI C63.4. When required, the 99% bandwidth is measured using the methods detailed in RSS GEN.

SPECIFICATION LIMITS AND SAMPLE CALCULATIONS

The limits for conducted emissions are given in units of microvolts, and the limits for radiated emissions are given in units of microvolts per meter at a specified test distance. Data is measured in the logarithmic form of decibels relative to one microvolt, or dB microvolts (dBuV). For radiated emissions, the measured data is converted to the field strength at the antenna in dB microvolts per meter (dBuV/m). The results are then converted to the linear forms of uV and uV/m for comparison to published specifications.

For reference, converting the specification limits from linear to decibel form is accomplished by taking the base ten logarithm, then multiplying by 20. These limits in both linear and logarithmic form are as follows:

CONDUCTED EMISSIONS SPECIFICATION LIMITS: FCC 15.207; FCC 15.107(a), RSS GEN

The table below shows the limits for the emissions on the AC power line from an intentional radiator and a receiver.

Frequency (MHz)	Average Limit (dBuV)	Quasi Peak Limit (dBuV)
0.150 to 0.500	Linear decrease on logarithmic frequency axis between 56.0 and 46.0	Linear decrease on logarithmic frequency axis between 66.0 and 56.0
0.500 to 5.000	46.0	56.0
5.000 to 30.000	50.0	60.0

GENERAL TRANSMITTER RADIATED EMISSIONS SPECIFICATION LIMITS

The table below shows the limits for the spurious emissions from transmitters that fall in restricted bands¹ (with the exception of transmitters operating under FCC Part 15 Subpart D and RSS 210 Annex 9), the limits for all emissions from a low power device operating under the general rules of RSS 310 (tables 3 and 4), RSS 210 (table 2) and FCC Part 15 Subpart C section 15.209.

Frequency Range (MHz)	Limit (uV/m)	Limit (dBuV/m @ 3m)
0.009-0.490	2400/F _{KHz} @ 300m	67.6-20*log ₁₀ (F _{KHz}) @ 300m
0.490-1.705	24000/F _{KHz} @ 30m	87.6-20*log ₁₀ (F _{KHz}) @ 30m
1.705 to 30	30 @ 30m	29.5 @ 30m
30 to 88	100 @ 3m	40 @ 3m
88 to 216	150 @ 3m	43.5 @ 3m
216 to 960	200 @ 3m	46.0 @ 3m
Above 960	500 @ 3m	54.0 @ 3m

RECEIVER RADIATED SPURIOUS EMISSIONS SPECIFICATION LIMITS

The table below shows the limits for the spurious emissions from receivers as detailed in FCC Part 15.109, RSS 210 Table 2, RSS GEN Table 1 and RSS 310 Table 3. Note that receivers operating outside of the frequency range 30 MHz – 960 MHz are exempt from the requirements of 15.109.

Frequency Range (MHz)	Limit (uV/m @ 3m)	Limit (dBuV/m @ 3m)
30 to 88	100	40
88 to 216	150	43.5
216 to 960	200	46.0
Above 960	500	54.0

¹ The restricted bands are detailed in FCC 15.203, RSS 210 Table 1 and RSS 310 Table 2

OUTPUT POWER LIMITS – DIGITAL TRANSMISSION SYSTEMS

The table below shows the limits for output power and output power density. Where the signal bandwidth is less than 20 MHz the maximum output power is reduced to the power spectral density limit plus 10 times the log of the bandwidth (in MHz).

Operating Frequency (MHz)	Output Power	Power Spectral Density
902 – 928	1 Watt (30 dBm)	8 dBm/3kHz
2400 – 2483.5	1 Watt (30 dBm)	8 dBm/3kHz
5725 – 5850	1 Watt (30 dBm)	8 dBm/3kHz

The maximum permitted output power is reduced by 1dB for every dB the antenna gain exceeds 6dBi. Fixed point-to-point applications using the 5725 – 5850 MHz band are not subject to this restriction.

TRANSMIT MODE SPURIOUS RADIATED EMISSIONS LIMITS – FHSS and DTS SYSTEMS

The limits for unwanted (spurious) emissions from the transmitter falling in the restricted bands are those specified in the general limits sections of FCC Part 15 and RSS 210. All other unwanted (spurious) emissions shall be at least 20dB below the level of the highest in-band signal level (30dB if the power is measured using the sample detector/power averaging method).

SAMPLE CALCULATIONS - CONDUCTED EMISSIONS

Receiver readings are compared directly to the conducted emissions specification limit (decibel form) as follows:

$$R_r - S = M$$

where:

R_r = Receiver Reading in dBuV

S = Specification Limit in dBuV

M = Margin to Specification in +/- dB

SAMPLE CALCULATIONS - RADIATED EMISSIONS

Receiver readings are compared directly to the specification limit (decibel form). The receiver internally corrects for cable loss, preamplifier gain, and antenna factor. The calculations are in the reverse direction of the actual signal flow, thus cable loss is added and the amplifier gain is subtracted. The Antenna Factor converts the voltage at the antenna coaxial connector to the field strength at the antenna elements.

A distance factor, when used for electric field measurements above 30MHz, is calculated by using the following formula:

$$F_d = 20 * \text{LOG}_{10} (D_m/D_s)$$

where:

$$F_d = \text{Distance Factor in dB}$$

$$D_m = \text{Measurement Distance in meters}$$

$$D_s = \text{Specification Distance in meters}$$

For electric field measurements below 30MHz the extrapolation factor is either determined by making measurements at multiple distances or a theoretical value is calculated using the formula:

$$F_d = 40 * \text{LOG}_{10} (D_m/D_s)$$

Measurement Distance is the distance at which the measurements were taken and Specification Distance is the distance at which the specification limits are based. The antenna factor converts the voltage at the antenna coaxial connector to the field strength at the antenna elements.

The margin of a given emission peak relative to the limit is calculated as follows:

$$R_c = R_r + F_d$$

and

$$M = R_c - L_s$$

where:

$$R_r = \text{Receiver Reading in dBuV/m}$$

$$F_d = \text{Distance Factor in dB}$$

$$R_c = \text{Corrected Reading in dBuV/m}$$

$$L_s = \text{Specification Limit in dBuV/m}$$

$$M = \text{Margin in dB Relative to Spec}$$

SAMPLE CALCULATIONS - FIELD STRENGTH TO EIRP CONVERSION

Where the radiated electric field strength is expressed in terms of the equivalent isotropic radiated power (eirp), or where a field strength measurement of output power is made in lieu of a direct measurement, the following formula is used to convert between eirp and field strength at a distance of d (meters) from the equipment under test:

$$E = \frac{1000000 \sqrt{30 P}}{d} \quad \text{microvolts per meter}$$

where P is the eirp (Watts)

For a measurement at 3m the conversion from a logarithmic value for field strength (dBuV/m) to an eirp power (dBm) is -95.3dB.

Appendix A Test Equipment Calibration Data**Radiated Emissions, 1000 - 6,500 MHz, 08-Sep-11**

<u>Manufacturer</u>	<u>Description</u>	<u>Model</u>	<u>Asset #</u>	<u>Cal Due</u>
EMCO	Antenna, Horn, 1-18 GHz	3115	487	7/6/2012
Hewlett Packard	SpecAn 9 kHz - 40 GHz, FT (SA40) Blue	8564E (84125C)	1393	8/9/2012

Radiated Emissions, 1000 - 18,000 MHz, 09-Sep-11

<u>Manufacturer</u>	<u>Description</u>	<u>Model</u>	<u>Asset #</u>	<u>Cal Due</u>
EMCO	Antenna, Horn, 1-18 GHz	3115	786	12/11/2011
Hewlett Packard	SpecAn 9 kHz - 40 GHz, FT (SA40) Blue	8564E (84125C)	1393	8/9/2012

Radiated Emissions, 1,000 - 40,000 MHz, 12-Sep-11

<u>Manufacturer</u>	<u>Description</u>	<u>Model</u>	<u>Asset #</u>	<u>Cal Due</u>
Hewlett Packard	Microwave Preamplifier, 1-26.5GHz	8449B	785	5/18/2012
EMCO	Antenna, Horn, 1-18 GHz	3115	786	12/11/2011
Hewlett Packard	SpecAn 9 kHz - 40 GHz, FT (SA40) Blue	8564E (84125C)	1393	8/9/2012
Rohde & Schwarz	EMI Test Receiver, 20 Hz-7 GHz	ESIB7	1538	11/2/2011
Hewlett Packard	Head (Inc W1-W4, 1742 , 1743) Blue	84125C	1620	5/9/2012
A.H. Systems	Blue System Horn, 18-40GHz	SAS-574, p/n: 2581	2159	3/23/2012
Sunol Sciences	Biconilog, 30-3000 MHz	JB3	2197	12/29/2011
Micro-Tronics	Band Reject Filter, 2400-2500 MHz	BRM50702-02	2249	10/11/2011

Radiated Emissions, 1000 - 40000 MHz, 12-Sep-11

<u>Manufacturer</u>	<u>Description</u>	<u>Model</u>	<u>Asset #</u>	<u>Cal Due</u>
EMCO	Antenna, Horn, 1-18 GHz	3115	487	7/6/2012
Hewlett Packard	Microwave Preamplifier, 1-26.5GHz	8449B	785	5/18/2012
Hewlett Packard	SpecAn 9 kHz - 40 GHz, FT (SA40) Blue	8564E (84125C)	1393	8/9/2012
A.H. Systems	Blue System Horn, 18-40GHz	SAS-574, p/n: 2581	2159	3/23/2012
Micro-Tronics	Band Reject Filter, 2400-2500 MHz	BRM50702-02	2249	10/11/2011

Radiated Emissions, 1000 - 18,000 MHz, 15-Sep-11

<u>Manufacturer</u>	<u>Description</u>	<u>Model</u>	<u>Asset #</u>	<u>Cal Due</u>
EMCO	Antenna, Horn, 1-18GHz	3115	868	6/8/2012
Hewlett Packard	SpecAn 30 Hz -40 GHz, SV (SA40) Red	8564E (84125C)	1148	8/15/2012

Radiated Emissions, 1000 - 40000MHz, 16-Sep-11

<u>Manufacturer</u>	<u>Description</u>	<u>Model</u>	<u>Asset #</u>	<u>Cal Due</u>
Hewlett Packard	Microwave Preamplifier, 1-26.5GHz	8449B	263	12/8/2011
EMCO	Antenna, Horn, 1-18 GHz	3115	487	7/6/2012
Hewlett Packard	SpecAn 30 Hz -40 GHz, SV (SA40) Red	8564E (84125C)	1148	8/15/2012
Micro-Tronics	Band Reject Filter, 2400-2500 MHz	BRM50702-02	2249	10/11/2011

Radiated Emissions, 1000 - 40,000 MHz, 17-Sep-11

<u>Manufacturer</u>	<u>Description</u>	<u>Model</u>	<u>Asset #</u>	<u>Cal Due</u>
---------------------	--------------------	--------------	----------------	----------------

EMCO	Antenna, Horn, 1-18 GHz	3115	487	7/6/2012
Hewlett Packard	Microwave Preamplifier, 1-26.5GHz	8449B	785	5/18/2012
Hewlett Packard	SpecAn 9 kHz - 40 GHz, FT (SA40) Blue	8564E (84125C)	1393	8/9/2012
Hewlett Packard	Head (Inc W1-W4, 1742 , 1743) Blue	84125C	1620	5/9/2012
Micro-Tronics	Band Reject Filter, 2400-2500 MHz	BRM50702-02	1683	8/3/2012
A.H. Systems	Blue System Horn, 18-40GHz	SAS-574, p/n: 2581	2159	3/23/2012

Radiated Emissions, 1000 - 40000MHz, 20-Sep-11

<u>Manufacturer</u>	<u>Description</u>	<u>Model</u>	<u>Asset #</u>	<u>Cal Due</u>
Hewlett Packard	Microwave Preamplifier, 1-26.5GHz	8449B	263	12/8/2011
EMCO	Antenna, Horn, 1-18 GHz (SA40-Red)	3115	1142	8/2/2012
Hewlett Packard	SpecAn 30 Hz -40 GHz, SV (SA40) Red	8564E (84125C)	1148	8/15/2012
Micro-Tronics	Band Reject Filter, 2400-2500 MHz	BRM50702-02	2249	10/11/2011

Radiated Emissions, 1000 - 10,000 MHz, 21-Sep-11

<u>Manufacturer</u>	<u>Description</u>	<u>Model</u>	<u>Asset #</u>	<u>Cal Due</u>
EMCO	Antenna, Horn, 1-18 GHz	3115	786	12/11/2011
Micro-Tronics	Band Reject Filter, 2400-2500 MHz	BRM50702-02	1683	8/3/2012
Hewlett Packard	Microwave Preamplifier, 1-26.5GHz	8449B	2199	2/23/2012
Hewlett Packard	SpecAn 9 kHz - 40 GHz, (SA40) Purple	8564E (84125C)	2415	7/28/2012

Radiated Emissions, 30 - 1,000 MHz, 23-Sep-11

<u>Manufacturer</u>	<u>Description</u>	<u>Model</u>	<u>Asset #</u>	<u>Cal Due</u>
Rohde & Schwarz	EMI Test Receiver, 20 Hz-7 GHz	ESIB7	1538	11/2/2011
Hewlett Packard	Preamplifier, 100 kHz - 1.3 GHz	8447D OPT 010	1826	5/17/2012
Sunol Sciences	Biconilog, 30-3000 MHz	JB3	2197	12/29/2011

Conducted Emissions - AC Power Ports, 23-Sep-11

<u>Manufacturer</u>	<u>Description</u>	<u>Model</u>	<u>Asset #</u>	<u>Cal Due</u>
EMCO	LISN, 10 kHz-100 MHz, 25A	3825/2	1292	3/1/2012
Rohde & Schwarz	Pulse Limiter	ESH3 Z2	1401	4/21/2012
Rohde & Schwarz	EMI Test Receiver, 20 Hz-7 GHz	ESIB7	1538	11/2/2011
Fischer Custom Comm	LISN, 25A, 150kHz to 30MHz, 25 Amp,	FCC-LISN-50-25-2-09	2001	9/15/2012

Radio Antenna Port (Power and Spurious Emissions), 23-Sep-11

<u>Manufacturer</u>	<u>Description</u>	<u>Model</u>	<u>Asset #</u>	<u>Cal Due</u>
Hewlett Packard	SpecAn 9 kHz - 40 GHz, (SA40) Purple	8564E (84125C)	2415	7/28/2012

Radiated Emissions, 30 - 40,000 MHz, 23-Sep-11

<u>Manufacturer</u>	<u>Description</u>	<u>Model</u>	<u>Asset #</u>	<u>Cal Due</u>
EMCO	Antenna, Horn, 1-18 GHz	3115	786	12/11/2011
Hewlett Packard	Microwave Preamplifier, 1-26.5GHz	8449B	2199	2/23/2012
Micro-Tronics	Band Reject Filter, 2400-2500 MHz	BRM50702-02	2238	10/1/2011
Hewlett Packard	SpecAn 9 kHz - 40 GHz, (SA40)	8564E (84125C)	2415	7/28/2012

Purple

Radiated Emissions, 30 - 1,000 MHz, 26-Sep-11

<u>Manufacturer</u>	<u>Description</u>	<u>Model</u>	<u>Asset #</u>	<u>Cal Due</u>
Hewlett Packard	EMC Spectrum Analyzer, 9 KHz - 22 GHz	8593EM	1319	11/22/2011
Rohde & Schwarz	Test Receiver, 9 kHz-2750 MHz	ESCS 30	1337	11/24/2011
Sunol Sciences	Biconilog, 30-3000 MHz	JB3	1548	6/24/2012
Com-Power Corp.	Preamplifier, 30-1000 MHz	PA-103	1632	4/29/2012

Conducted Emissions - AC Power Ports, 27-Sep-11

<u>Manufacturer</u>	<u>Description</u>	<u>Model</u>	<u>Asset #</u>	<u>Cal Due</u>
EMCO	LISN, 10 kHz-100 MHz, 25A	3825/2	1292	3/1/2012
EMCO	LISN, 10 kHz-100 MHz	3825/2	1293	3/1/2012
Hewlett Packard	EMC Spectrum Analyzer, 9 KHz - 22 GHz	8593EM	1319	11/22/2011
Rohde & Schwarz	Test Receiver, 9 kHz-2750 MHz	ESCS 30	1337	11/24/2011
Rohde & Schwarz	Pulse Limiter	ESH3 Z2	1401	4/21/2012

Radiated Emissions, 30 - 6,500 MHz, 29-Sep-11

<u>Manufacturer</u>	<u>Description</u>	<u>Model</u>	<u>Asset #</u>	<u>Cal Due</u>
EMCO	Antenna, Horn, 1-18 GHz	3115	487	7/6/2012
Hewlett Packard	Microwave Preamplifier, 1-26.5GHz	8449B	2199	2/23/2012
Hewlett Packard	SpecAn 9 kHz - 40 GHz, (SA40) Purple	8564E (84125C)	2415	7/28/2012

Appendix B Test Data

T84548 Pages 26 - 121



EMC Test Data

Client:	Intel	Job Number:	J84264
Model:	135BNHMW & 135BNHU	T-Log Number:	T84548
		Account Manager:	Christine Krebill
Contact:	Steve Hackett		
Emissions Standard(s):	FCC 15 B, 15.247, RSS 210	Class:	B
Immunity Standard(s):	-	Environment:	-

EMC Test Data

For The

Intel

Model

135BNHMW & 135BNHU

Date of Last Test: 9/29/2011

Client: Intel	Job Number: J84264
Model: 135BNHMW & 135BNHU	T-Log Number: T84548
	Account Manager: Christine Krebill
Contact: Steve Hackett	
Standard: FCC 15 B, 15.247, RSS 210	Class: N/A

RSS 210 and FCC 15.247 (DTS) Radiated Spurious Emissions

Test Specific Details

Objective: The objective of this test session is to perform final qualification testing of the EUT with respect to the specification listed above.

Summary of Results

MAC Address: **00150096B40F** DRTU Tool Version **1.5.3-0320** Driver version **15.0.051**

Run #	Mode	Channel	Target Power	Measured Power	Test Performed	Limit	Result / Margin
Run #2	HT20 Chain A	#1 2412 MHz	16.5	13.5	Restricted Band Edge at 2400 MHz	15.209	53.3dBµV/m @ 2390.0MHz (-0.7dB)
		#11 2462 MHz	16.5	13.9	Restricted Band Edge at 2483.5 MHz	15.209	53.6dBµV/m @ 2483.6MHz (-0.4dB)
Run #3	802.11g Chain A	#1 2412MHz	16.5	15.0	Restricted Band Edge at 2400 MHz	15.209	53.9dBµV/m @ 2390.0MHz (-0.1dB)
		#11 2462MHz	16.5	14.4	Restricted Band Edge at 2483.5 MHz	15.209	53.4dBµV/m @ 2483.5MHz (-0.6dB)
Run #4	802.11b Chain A	#1 2412MHz	16.5	16.6	Restricted Band Edge at 2400 MHz	15.209	48.9dBµV/m @ 2389.9MHz (-5.1dB)
		#11 2462MHz	16.5	16.5	Restricted Band Edge at 2483.5 MHz	15.209	47.5dBµV/m @ 2483.5MHz (-6.5dB)
Run #5	HT20 Chain A	#2 2417MHz	16.5	16.7	Restricted Band Edge at 2400 MHz	15.209	53.5dBµV/m @ 2389.9MHz (-0.5dB)
		#10 2457MHz	16.5	16.2	Restricted Band Edge at 2483.5 MHz	15.209	53.7dBµV/m @ 2483.5MHz (-0.3dB)

The channels adjacent to the low/high channels are also evaluated if the power at the low/high channels are 3dB or more below the rated power.

Note - the target and measured power are average powers (measured with average power sensor) and are used for reference purposes only. Power is set using "GAIN CONTROL" mode in the DRTU tool.

Ambient Conditions: Rel. Humidity: 15 - 55 %
Temperature: 18 - 25 °C

Modifications Made During Testing

No modifications were made to the EUT during testing

Deviations From The Standard

No deviations were made from the requirements of the standard.

Client: Intel	Job Number: J84264
Model: 135BNHMW & 135BNHU	T-Log Number: T84548
	Account Manager: Christine Krebill
Contact: Steve Hackett	
Standard: FCC 15 B, 15.247, RSS 210	Class: N/A

Run # 2, Band Edge Field Strength - HT20, Chain A

Date of Test: 9/7/2011

Test Location: FT Chamber #4

Test Engineer: Rafael Varelas

Config Change: none

Run # 2a, EUT on Channel #1 2412MHz - HT20, Chain A

	Target (dBm)	Power Settings Measured (dBm)	Software Setting
Chain A	16.5	13.5	22.0

2390 MHz Band Edge Signal Field Strength

Frequency MHz	Level dBμV/m	Pol v/h	15.209 / 15.247 Limit Margin	Detector Pk/QP/Avg	Azimuth degrees	Height meters	Comments	Setting
2390.000	53.3	V	54.0 -0.7	AVG	208	1.9	RB 1 MHz;VB 10 Hz;Pk	22.0
2389.820	71.1	V	74.0 -2.9	PK	208	1.9	RB 1 MHz;VB 3 MHz;Pk	22.0
2389.990	53.0	H	54.0 -1.0	AVG	242	1.1	RB 1 MHz;VB 10 Hz;Pk	22.0
2389.910	70.3	H	74.0 -3.7	PK	242	1.1	RB 1 MHz;VB 3 MHz;Pk	22.0

RB 1 MHz; VB 10 Hz Avg (Black Trace); PK (Blue Trace) Vertical

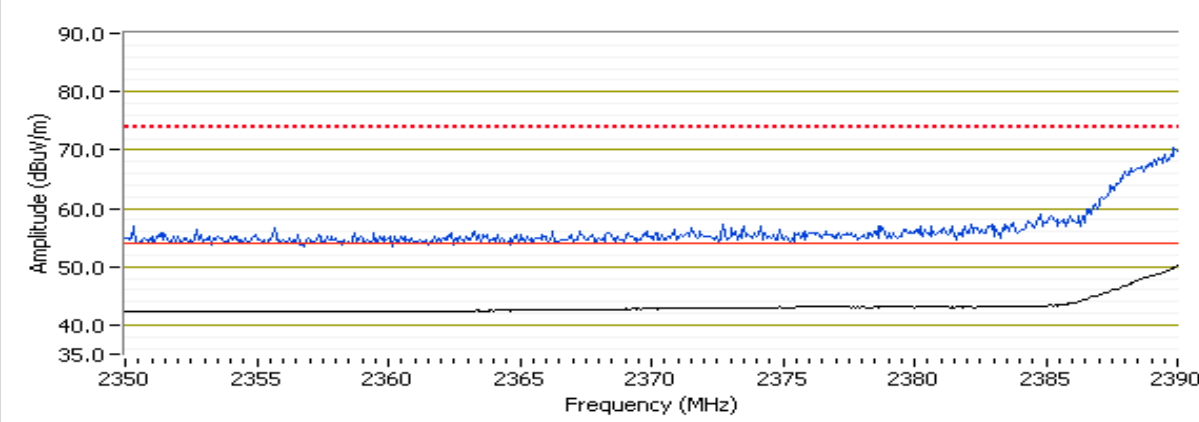

Client: Intel	Job Number: J84264
Model: 135BNHMW & 135BNHU	T-Log Number: T84548
	Account Manager: Christine Krebill
Contact: Steve Hackett	
Standard: FCC 15 B, 15.247, RSS 210	Class: N/A

Run # 2b, EUT on Channel #11 2462MHz - HT20, Chain A

	Target (dBm)	Power Settings Measured (dBm)	Software Setting
Chain A	16.5	13.9	22.5

2483.5 MHz Band Edge Signal Radiated Field Strength

Frequency MHz	Level dB μ V/m	Pol v/h	15.209 / 15.247		Detector Pk/QP/Avg	Azimuth degrees	Height meters	Comments	Setting
			Limit	Margin					
2483.550	53.6	H	54.0	-0.4	AVG	142	0.9	RB 1 MHz;VB 10 Hz;Pk	22.5
2483.630	68.0	H	74.0	-6.0	PK	142	0.9	RB 1 MHz;VB 3 MHz;Pk	22.5
2483.500	51.9	V	54.0	-2.1	AVG	272	1.1	RB 1 MHz;VB 10 Hz;Pk	22.5
2484.770	65.4	V	74.0	-8.6	PK	272	1.1	RB 1 MHz;VB 3 MHz;Pk	22.5

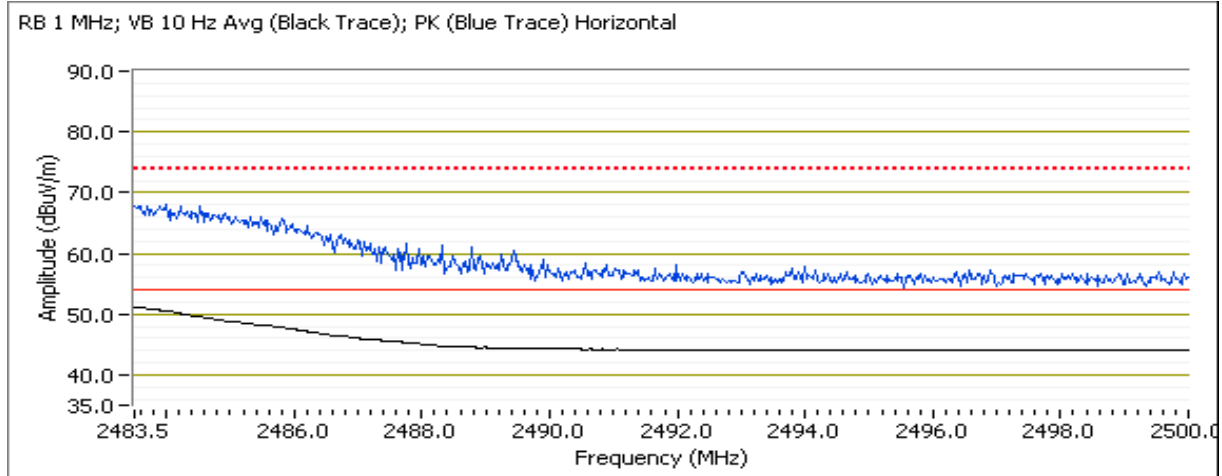

Client: Intel	Job Number: J84264
Model: 135BNHMW & 135BNHU	T-Log Number: T84548
	Account Manager: Christine Krebill
Contact: Steve Hackett	
Standard: FCC 15 B, 15.247, RSS 210	Class: N/A

Run # 3, Band Edge Field Strength - 802.11g, Chain A

Date of Test: 9/7/2011

Test Location: FT Chamber #4

Test Engineer: Rafael Varelas

Config Change: none

Run # 3a, EUT on Channel #1 2412MHz - 802.11g, Chain A

	Target (dBm)	Power Settings Measured (dBm)	Software Setting
Chain A	16.5	15.0	24.0

2390 MHz Band Edge Signal Field Strength

Frequency	Level	Pol	15.209 / 15.247		Detector	Azimuth	Height	Comments	Setting
MHz	dB μ V/m	v/h	Limit	Margin	Pk/QP/Avg	degrees	meters		
2389.960	53.9	V	54.0	-0.1	AVG	275	1.1	RB 1 MHz;VB 10 Hz;Pk	24.0
2389.730	70.0	V	74.0	-4.0	PK	275	1.1	RB 1 MHz;VB 3 MHz;Pk	24.0
2389.920	53.3	H	54.0	-0.7	AVG	314	1.0	RB 1 MHz;VB 10 Hz;Pk	24.0
2389.960	69.2	H	74.0	-4.8	PK	314	1.0	RB 1 MHz;VB 3 MHz;Pk	24.0

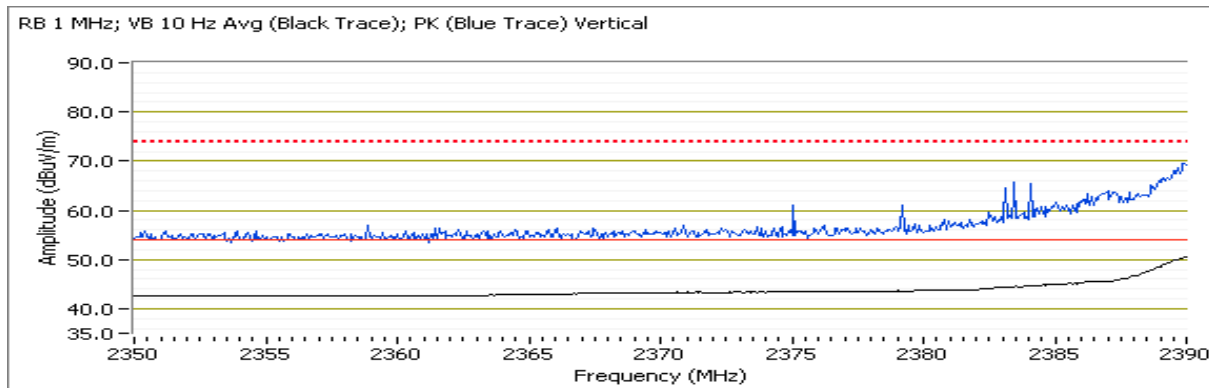

Client: Intel	Job Number: J84264
Model: 135BNHMW & 135BNHU	T-Log Number: T84548
	Account Manager: Christine Krebill
Contact: Steve Hackett	
Standard: FCC 15 B, 15.247, RSS 210	Class: N/A

Run # 3b, EUT on Channel #11 2462MHz - 802.11g, Chain A

	Target (dBm)	Power Settings Measured (dBm)	Software Setting
Chain A	16.5	14.4	23.0

2483.5 MHz Band Edge Signal Radiated Field Strength

Frequency MHz	Level dB μ V/m	Pol v/h	15.209 / 15.247		Detector Pk/QP/Avg	Azimuth degrees	Height meters	Comments	Setting
			Limit	Margin					
2483.510	53.4	H	54.0	-0.6	AVG	34	1.0	RB 1 MHz;VB 10 Hz;Pk	23.0
2483.800	68.7	H	74.0	-5.3	PK	34	1.0	RB 1 MHz;VB 3 MHz;Pk	23.0
2483.500	52.8	V	54.0	-1.2	AVG	184	1.5	RB 1 MHz;VB 10 Hz;Pk	23.0
2483.580	67.7	V	74.0	-6.3	PK	184	1.5	RB 1 MHz;VB 3 MHz;Pk	23.0

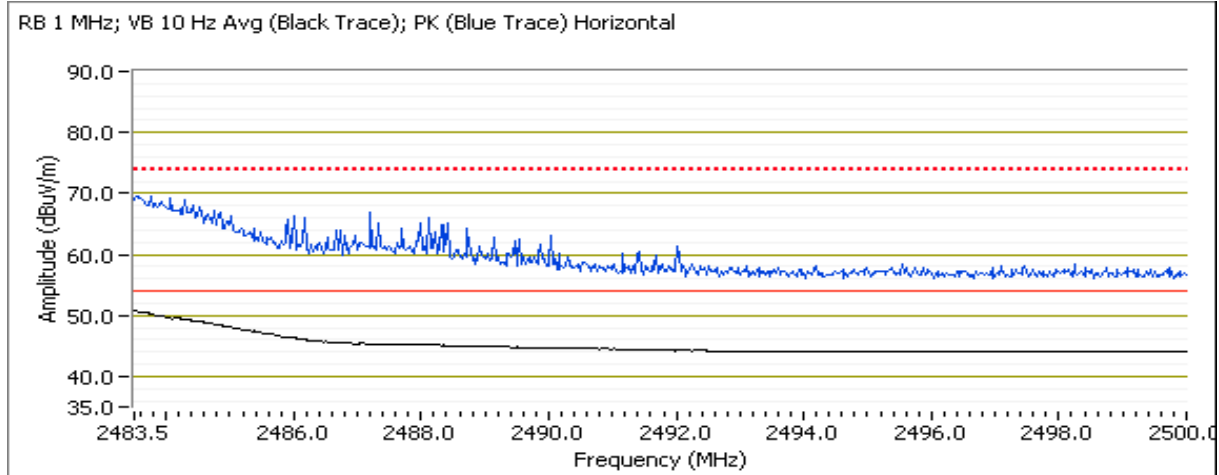

Client: Intel	Job Number: J84264
Model: 135BNHMW & 135BNHU	T-Log Number: T84548
	Account Manager: Christine Krebill
Contact: Steve Hackett	
Standard: FCC 15 B, 15.247, RSS 210	Class: N/A

Run # 4, Band Edge Field Strength - 802.11b, Chain A

Date of Test: 9/8/2011

Test Location: FT Chamber #5

Test Engineer: Rafael Varelas

Config Change: none

Run # 4a, EUT on Channel #1 2412MHz - 802.11b, Chain A

	Target (dBm)	Power Settings Measured (dBm)	Software Setting
Chain A	16.5	16.6	20.5

2390 MHz Band Edge Signal Field Strength

Frequency MHz	Level dB μ V/m	Pol v/h	15.209 / 15.247		Detector Pk/QP/Avg	Azimuth degrees	Height meters	Comments
			Limit	Margin				
2389.870	48.9	H	54.0	-5.1	AVG	243	1.1	RB 1 MHz;VB 10 Hz;Pk
2389.430	58.5	H	74.0	-15.5	PK	243	1.1	RB 1 MHz;VB 3 MHz;Pk
2389.810	47.0	V	54.0	-7.0	AVG	255	1.3	RB 1 MHz;VB 10 Hz;Pk
2389.540	57.4	V	74.0	-16.6	PK	255	1.3	RB 1 MHz;VB 3 MHz;Pk

RB 1 MHz; VB 10 Hz Avg (Black Trace); PK (Blue Trace) Horizontal

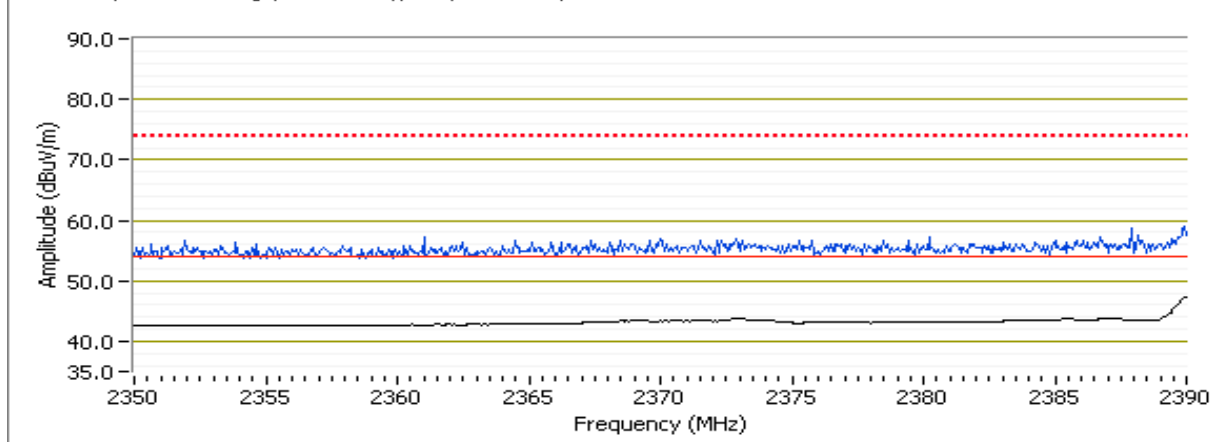

Client: Intel	Job Number: J84264
Model: 135BNHMW & 135BNHU	T-Log Number: T84548
	Account Manager: Christine Krebill
Contact: Steve Hackett	
Standard: FCC 15 B, 15.247, RSS 210	Class: N/A

Run # 4b, EUT on Channel #11 2462MHz - 802.11b, Chain A

	Target (dBm)	Power Settings Measured (dBm)	Software Setting
Chain A	16.5	16.5	20.5

2483.5 MHz Band Edge Signal Radiated Field Strength

Frequency MHz	Level dBμV/m	Pol v/h	15.209 / 15.247		Detector Pk/QP/Avg	Azimuth degrees	Height meters	Comments
			Limit	Margin				
2483.500	47.5	H	54.0	-6.5	AVG	164	1.0	RB 1 MHz;VB 10 Hz;Pk
2486.490	58.0	H	74.0	-16.0	PK	164	1.0	RB 1 MHz;VB 3 MHz;Pk
2483.540	46.9	V	54.0	-7.1	AVG	203	1.5	RB 1 MHz;VB 10 Hz;Pk
2483.670	57.5	V	74.0	-16.5	PK	203	1.5	RB 1 MHz;VB 3 MHz;Pk

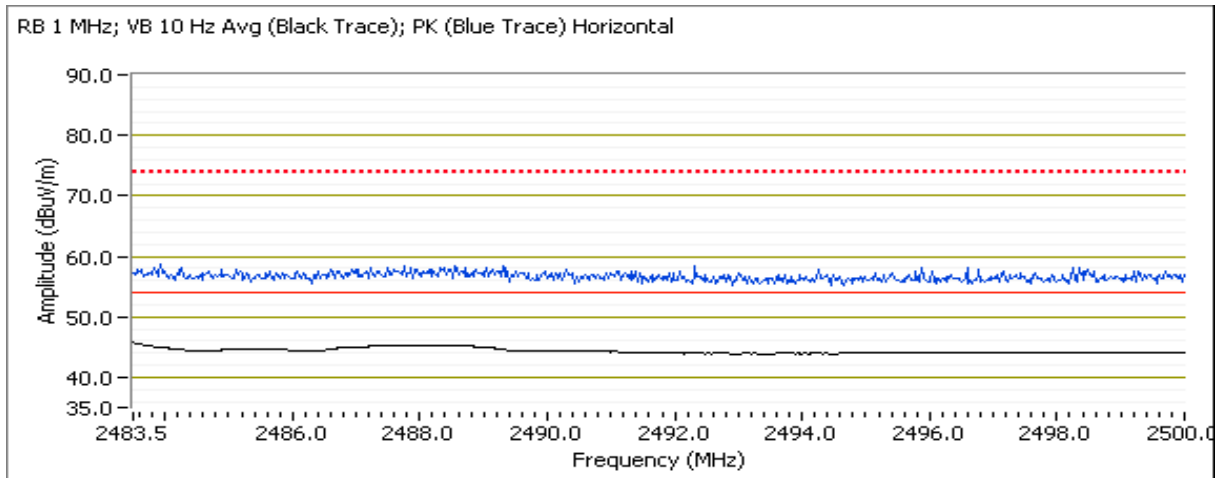

Client: Intel	Job Number: J84264
Model: 135BNHMW & 135BNHU	T-Log Number: T84548
	Account Manager: Christine Krebill
Contact: Steve Hackett	
Standard: FCC 15 B, 15.247, RSS 210	Class: N/A

Run # 5, Band Edge Field Strength - HT20, Chain A

Date of Test: 9/8/2011

Test Location: FT Chamber #5

Test Engineer: Rafael Varelas

Config Change: none

Run # 5a, EUT on Channel #2 2417MHz - HT20, Chain A

	Target (dBm)	Power Settings Measured (dBm)	Software Setting
Chain A	16.5	16.7	26.5

2390 MHz Band Edge Signal Field Strength

Frequency MHz	Level dB μ V/m	Pol v/h	15.209 / 15.247		Detector Pk/QP/Avg	Azimuth degrees	Height meters	Comments
			Limit	Margin				
2389.860	53.5	H	54.0	-0.5	AVG	236	1.2	RB 1 MHz;VB 10 Hz;Pk
2389.640	70.6	H	74.0	-3.4	PK	236	1.2	RB 1 MHz;VB 3 MHz;Pk
2389.870	50.9	V	54.0	-3.1	AVG	214	1.0	RB 1 MHz;VB 10 Hz;Pk
2389.500	67.7	V	74.0	-6.3	PK	214	1.0	RB 1 MHz;VB 3 MHz;Pk

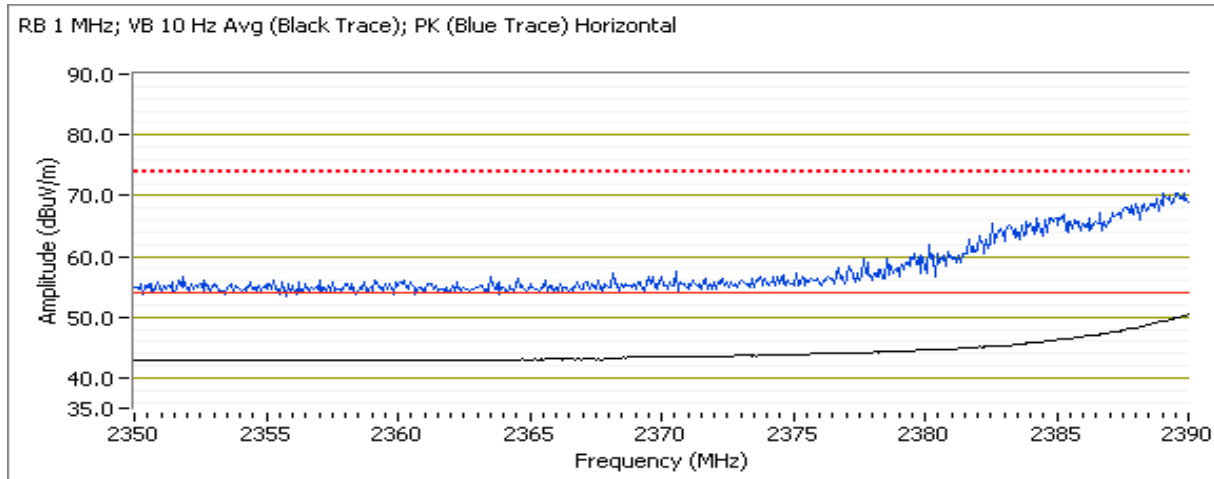

Client: Intel	Job Number: J84264
Model: 135BNHMW & 135BNHU	T-Log Number: T84548
	Account Manager: Christine Krebill
Contact: Steve Hackett	
Standard: FCC 15 B, 15.247, RSS 210	Class: N/A

Run # 5b, EUT on Channel #10 2457MHz - HT20, Chain A

	Target (dBm)	Power Settings Measured (dBm)	Software Setting
Chain A	16.5	16.2	26.0

2483.5 MHz Band Edge Signal Radiated Field Strength

Frequency MHz	Level dB μ V/m	Pol v/h	15.209 / 15.247		Detector Pk/QP/Avg	Azimuth degrees	Height meters	Comments	Setting
			Limit	Margin					
2483.500	53.7	H	54.0	-0.3	AVG	353	1.0	RB 1 MHz;VB 10 Hz;Pk	26.0
2484.690	70.7	H	74.0	-3.3	PK	353	1.0	RB 1 MHz;VB 3 MHz;Pk	26.0
2483.500	50.1	V	54.0	-3.9	AVG	200	1.5	RB 1 MHz;VB 10 Hz;Pk	26.0
2483.800	66.6	V	74.0	-7.4	PK	200	1.5	RB 1 MHz;VB 3 MHz;Pk	26.0

RB 1 MHz; VB 10 Hz Avg (Black Trace); PK (Blue Trace) Horizontal

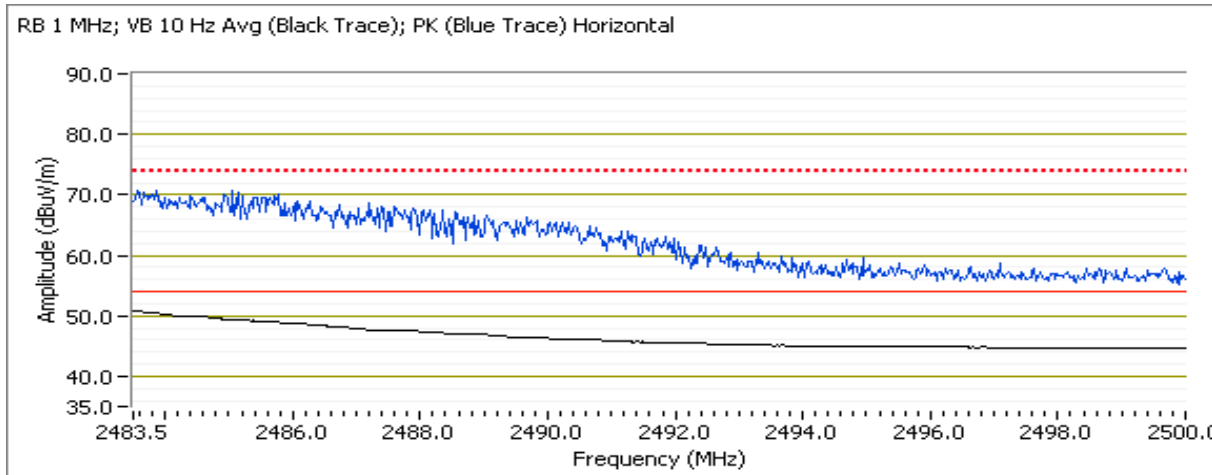

Client: Intel	Job Number: J84264
Model: 135BNHMW & 135BNHU	T-Log Number: T84548
	Account Manager: Christine Krebill
Contact: Steve Hackett	
Standard: FCC 15 B, 15.247, RSS 210	Class: N/A

RSS 210 and FCC 15.247 (DTS) Radiated Spurious Emissions

Test Specific Details

Objective: The objective of this test session is to perform final qualification testing of the EUT with respect to the specification listed above.

Summary of Results

MAC Address: **00150096B44B** DRTU Tool Version **1.5.3-0320** Driver version **15.0.051**

Run #	Mode	Channel	Target Power	Measured Power	Test Performed	Limit	Result / Margin
Run # 1	HT40 Chain A	#3 2422MHz	16.5	12.2	Restricted Band Edge at 2390 MHz	15.209	53.0dB μ V/m @ 2389.7MHz (-1.0dB)
		#9 2452MHz	16.5	13.9	Restricted Band Edge at 2483.5 MHz	15.209	52.5dB μ V/m @ 2483.5MHz (-1.5dB)
Run # 2	HT40 Chain A	#4 2427MHz	16.5	14.0	Restricted Band Edge at 2390 MHz	15.209	52.3dB μ V/m @ 2389.6MHz (-1.7dB)
		#8 2447MHz	16.5	13.1	Restricted Band Edge at 2483.5 MHz	15.209	53.1dB μ V/m @ 2483.5MHz (-0.9dB)
Run # 3	HT40 Chain A	#5 2432MHz	16.5	14.5	Restricted Band Edge at 2390 MHz	15.209	51.9dB μ V/m @ 2389.8MHz (-2.1dB)
		#7 2442MHz	16.5	14.0	Restricted Band Edge at 2483.5 MHz	15.209	53.1dB μ V/m @ 2483.5MHz (-0.9dB)
Run # 4	HT40 Chain A	#6 2437MHz	16.5	15.1	Restricted Band Edge at 2390 MHz	15.209	52.6dB μ V/m @ 2389.9MHz (-1.4dB)
				16.5	Restricted Band Edge at 2483.5 MHz	15.209	52.8dB μ V/m @ 2483.5MHz (-1.2dB)

Note - the target and measured power are average powers (measured with average power sensor) and are used for reference purposes only. Power is set using " **GAIN CONTROL**" mode in the DRTU tool.

Ambient Conditions:
 Rel. Humidity: 15 - 55 %
 Temperature: 18 - 25 °C

Modifications Made During Testing

No modifications were made to the EUT during testing

Deviations From The Standard

No deviations were made from the requirements of the standard.

Client: Intel	Job Number: J84264
Model: 135BNHMW & 135BNHU	T-Log Number: T84548
	Account Manager: Christine Krebill
Contact: Steve Hackett	
Standard: FCC 15 B, 15.247, RSS 210	Class: N/A

Run # 1, Band Edge Field Strength - HT40, Chain A

Date of Test: 9/28/2011
 Test Engineer: Joseph Cadigal
 Test Location: FT Chamber#4
 Config Change: none

Run # 1a, EUT on Channel #3 2422MHz - HT40, Chain A

	Target (dBm)	Power Settings Measured (dBm)	Software Setting
Chain A	16.5	12.2	19.5

2390 MHz Band Edge Signal Field Strength

Frequency MHz	Level dBμV/m	Pol v/h	15.209 / 15.247		Detector Pk/QP/Avg	Azimuth degrees	Height meters	Comments	Setting
			Limit	Margin					
2389.670	53.0	V	54.0	-1.0	AVG	165	1.3	RB 1 MHz;VB 10 Hz;Pk	19.5
2388.870	66.8	V	74.0	-7.2	PK	165	1.3	RB 1 MHz;VB 3 MHz;Pk	19.5
2389.600	52.8	H	54.0	-1.2	AVG	236	1.0	RB 1 MHz;VB 10 Hz;Pk	19.5
2389.470	65.3	H	74.0	-8.7	PK	236	1.0	RB 1 MHz;VB 3 MHz;Pk	19.5

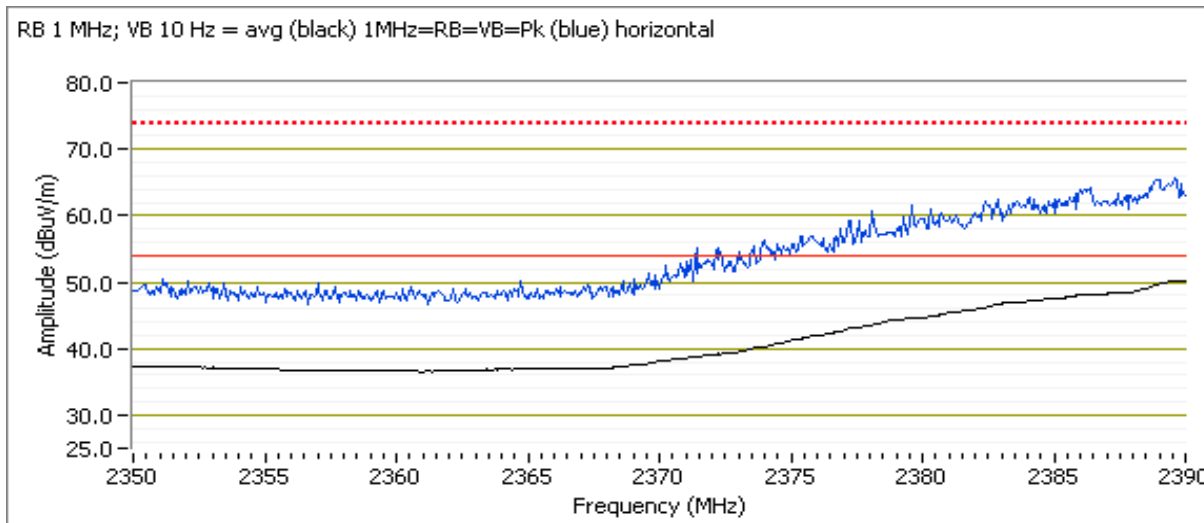

Client: Intel	Job Number: J84264
Model: 135BNHMW & 135BNHU	T-Log Number: T84548
	Account Manager: Christine Krebill
Contact: Steve Hackett	
Standard: FCC 15 B, 15.247, RSS 210	Class: N/A

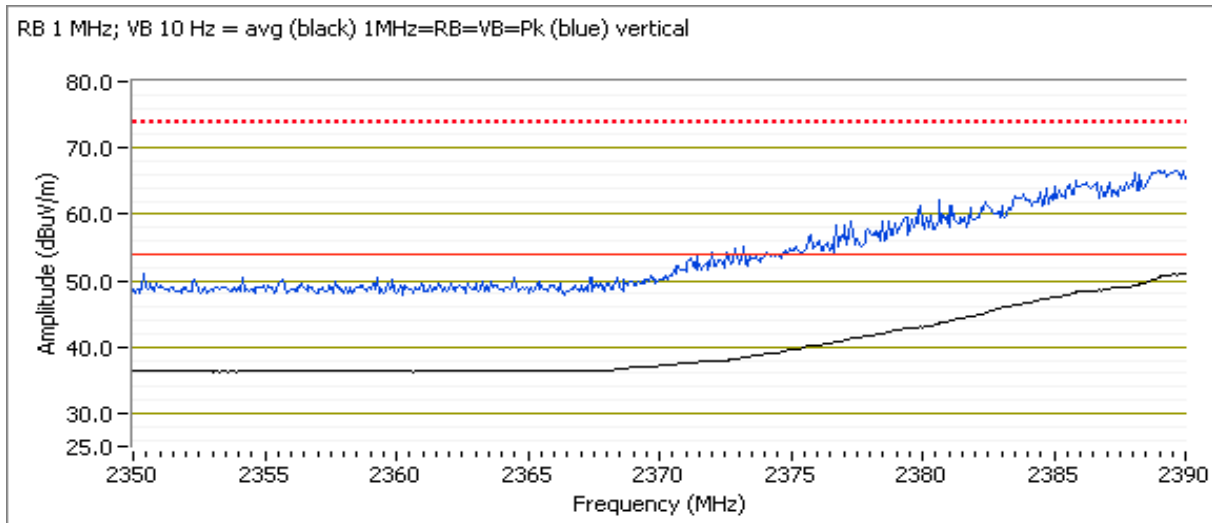

Run # 1b, EUT on Channel #9 2452MHz - HT40, Chain A

	Target (dBm)	Power Settings Measured (dBm)	Software Setting
Chain A	16.5	13.9	21.5

2483.5 MHz Band Edge Signal Radiated Field Strength

Frequency	Level	Pol	15.209 / 15.247		Detector	Azimuth	Height	Comments	Setting
MHz	dBuV/m	v/h	Limit	Margin	Pk/QP/Avg	degrees	meters		
2483.530	52.5	H	54.0	-1.5	AVG	242	1.2	RB 1 MHz;VB 10 Hz;Pk	21.5
2484.050	63.1	H	74.0	-10.9	PK	242	1.2	RB 1 MHz;VB 3 MHz;Pk	21.5
2483.500	52.5	V	54.0	-1.5	AVG	141	1.6	RB 1 MHz;VB 10 Hz;Pk	21.5
2488.150	64.1	V	74.0	-9.9	PK	141	1.6	RB 1 MHz;VB 3 MHz;Pk	21.5

Client: Intel	Job Number: J84264
Model: 135BNHMW & 135BNHU	T-Log Number: T84548
	Account Manager: Christine Krebill
Contact: Steve Hackett	
Standard: FCC 15 B, 15.247, RSS 210	Class: N/A

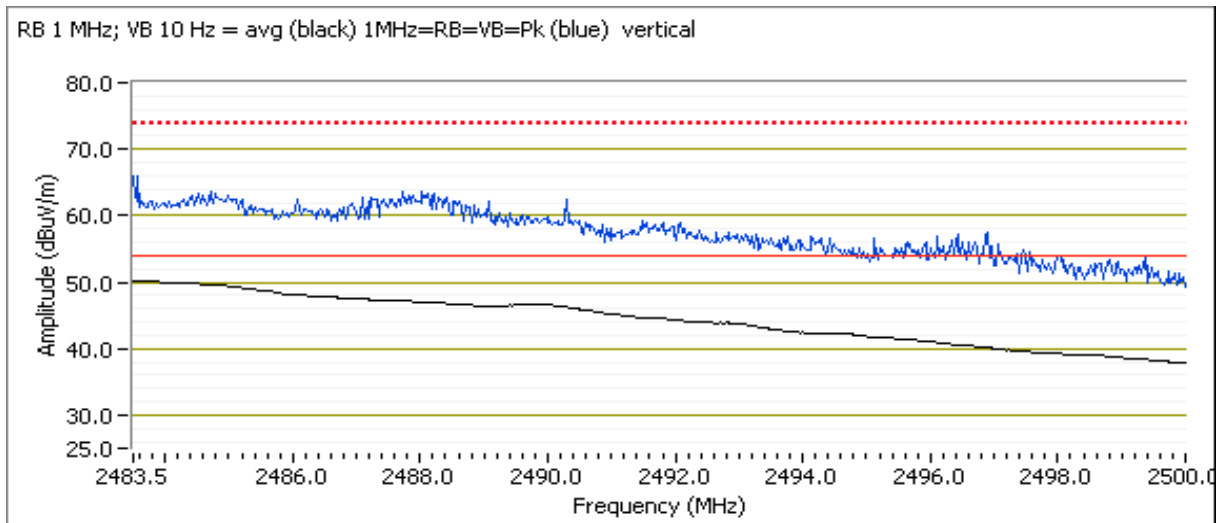
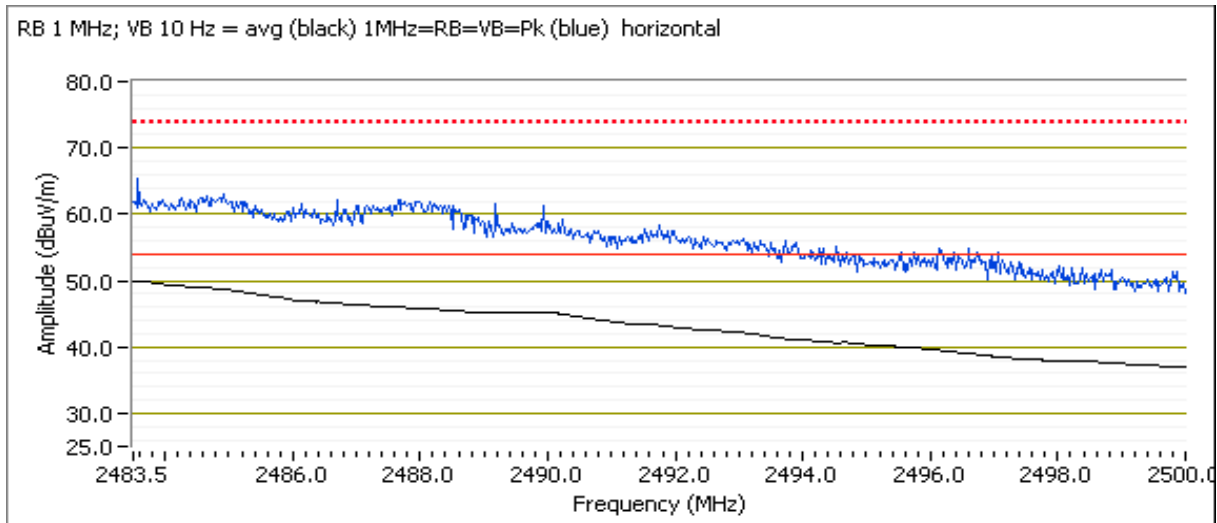

Client: Intel	Job Number: J84264
Model: 135BNHMW & 135BNHU	T-Log Number: T84548
	Account Manager: Christine Krebill
Contact: Steve Hackett	
Standard: FCC 15 B, 15.247, RSS 210	Class: N/A

Run # 2, Band Edge Field Strength - HT40, Chain A

Date of Test: 9/28/2011

Test Location: FT Chamber#4

Test Engineer: Joseph Cadigal

Config Change: none

Run # 2a, EUT on Channel #4 2427MHz - HT40, Chain A

	Target (dBm)	Power Settings Measured (dBm)	Software Setting
Chain A	16.5	14.0	20.0

Frequency MHz	Level dB μ V/m	Pol v/h	15.209 / 15.247		Detector Pk/QP/Avg	Azimuth degrees	Height meters	Comments	Setting
			Limit	Margin					
2389.600	52.3	H	54.0	-1.7	AVG	12	1.0	RB 1 MHz;VB 10 Hz;Pk	20
2389.530	64.1	H	74.0	-9.9	PK	12	1.0	RB 1 MHz;VB 3 MHz;Pk	20
2389.530	48.9	V	54.0	-5.1	AVG	162	1.0	RB 1 MHz;VB 10 Hz;Pk	20
2389.400	60.3	V	74.0	-13.7	PK	162	1.0	RB 1 MHz;VB 3 MHz;Pk	20

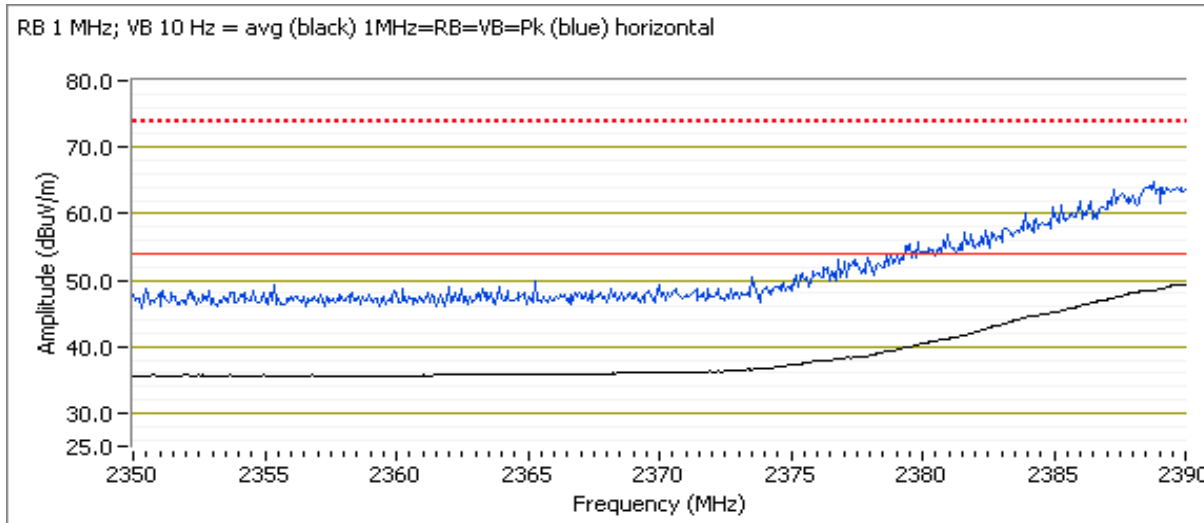

Client: Intel	Job Number: J84264
Model: 135BNHMW & 135BNHU	T-Log Number: T84548
	Account Manager: Christine Krebill
Contact: Steve Hackett	
Standard: FCC 15 B, 15.247, RSS 210	Class: N/A

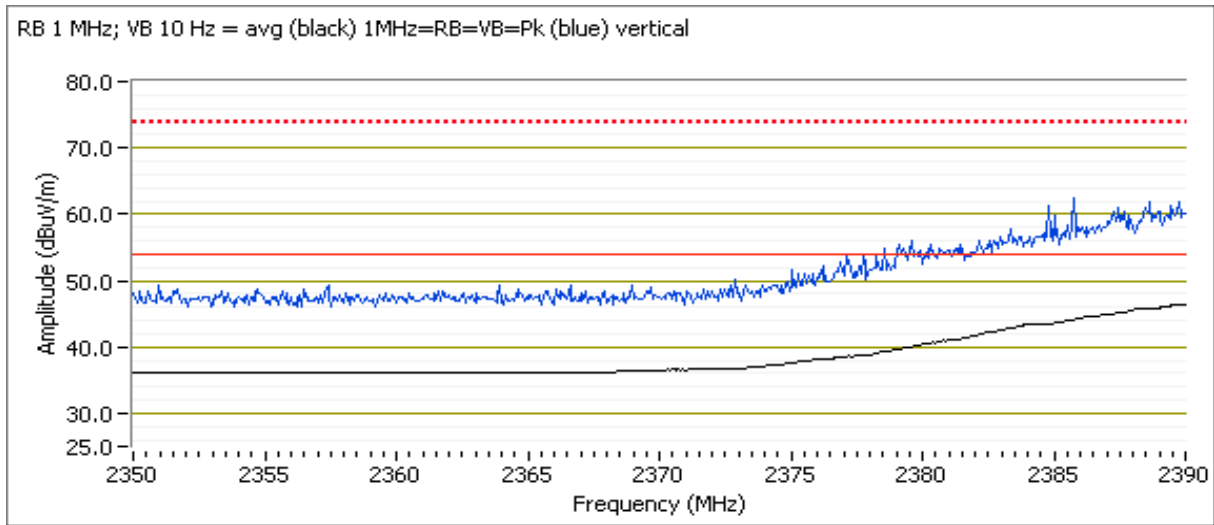

Run # 2b, EUT on Channel #8 2447MHz - HT40, Chain A

	Target (dBm)	Power Settings Measured (dBm)	Software Setting
Chain A	16.5	13.1	21.0

Frequency	Level	Pol	15.209 / 15.247	Detector	Azimuth	Height	Comments	Setting
MHz	dB μ V/m	v/h	Limit	Margin	Pk/QP/Avg	degrees	meters	
2483.530	53.1	H	54.0	-0.9	AVG	243	1.2	RB 1 MHz;VB 10 Hz;Pk
2483.660	66.5	H	74.0	-7.5	PK	243	1.2	RB 1 MHz;VB 3 MHz;Pk
2483.580	52.6	V	54.0	-1.4	AVG	210	1.5	RB 1 MHz;VB 10 Hz;Pk
2484.380	66.1	V	74.0	-7.9	PK	210	1.5	RB 1 MHz;VB 3 MHz;Pk

Client: Intel	Job Number: J84264
Model: 135BNHMW & 135BNHU	T-Log Number: T84548
	Account Manager: Christine Krebill
Contact: Steve Hackett	
Standard: FCC 15 B, 15.247, RSS 210	Class: N/A

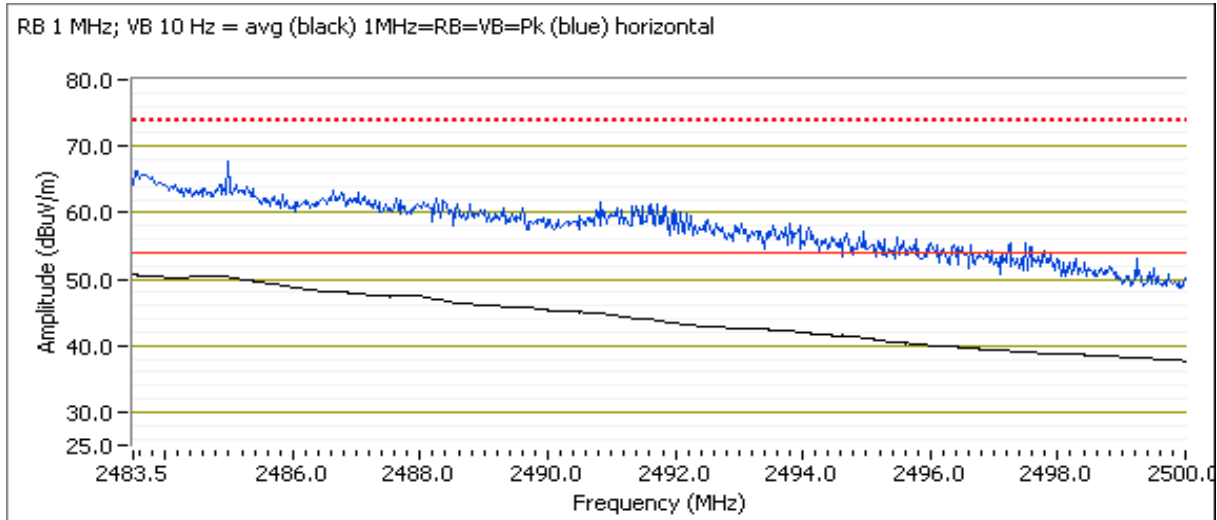
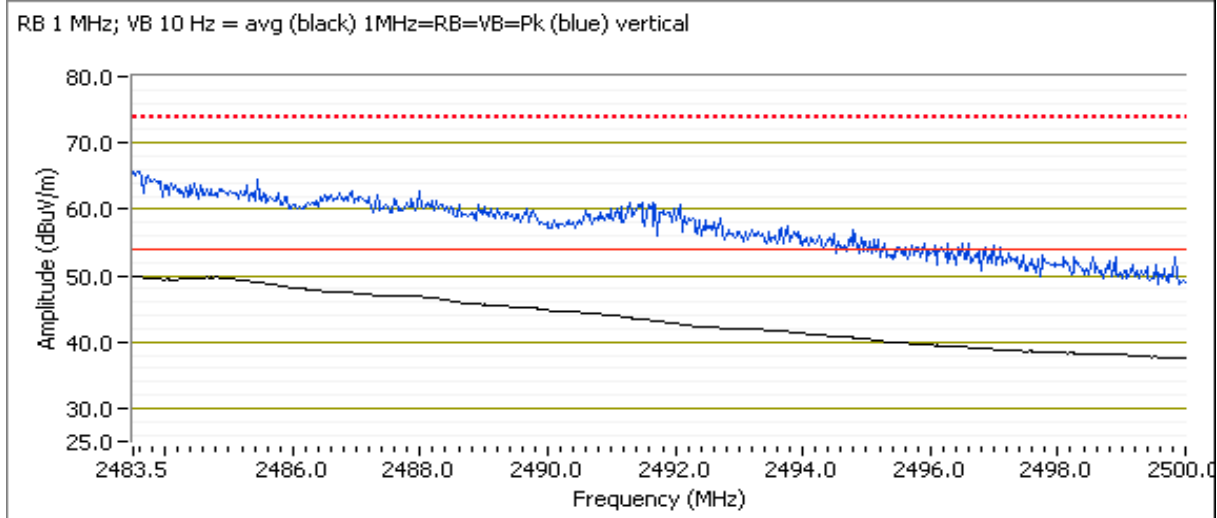

Client: Intel	Job Number: J84264
Model: 135BNHMW & 135BNHU	T-Log Number: T84548
	Account Manager: Christine Krebill
Contact: Steve Hackett	
Standard: FCC 15 B, 15.247, RSS 210	Class: N/A

Run # 3, Band Edge Field Strength - HT40, Chain A

Date of Test: 9/28/2011

Test Location: FT Chamber#4

Test Engineer: Joseph Cadigal

Config Change: none

Run # 3a, EUT on Channel #5 2432MHz - HT40, Chain A

	Target (dBm)	Power Settings Measured (dBm)	Software Setting
Chain A	16.5	14.2	22.5

Frequency MHz	Level dB μ V/m	Pol v/h	15.209 / 15.247		Detector Pk/QP/Avg	Azimuth degrees	Height meters	Comments	Setting
			Limit	Margin					
2389.800	51.9	H	54.0	-2.1	AVG	241	1.1	RB 1 MHz;VB 10 Hz;Pk	22.5
2389.270	62.0	H	74.0	-12.0	PK	241	1.1	RB 1 MHz;VB 3 MHz;Pk	22.5
2390.000	49.3	V	54.0	-4.7	AVG	255	1.1	RB 1 MHz;VB 10 Hz;Pk	22.5
2389.600	60.6	V	74.0	-13.4	PK	255	1.1	RB 1 MHz;VB 3 MHz;Pk	22.5

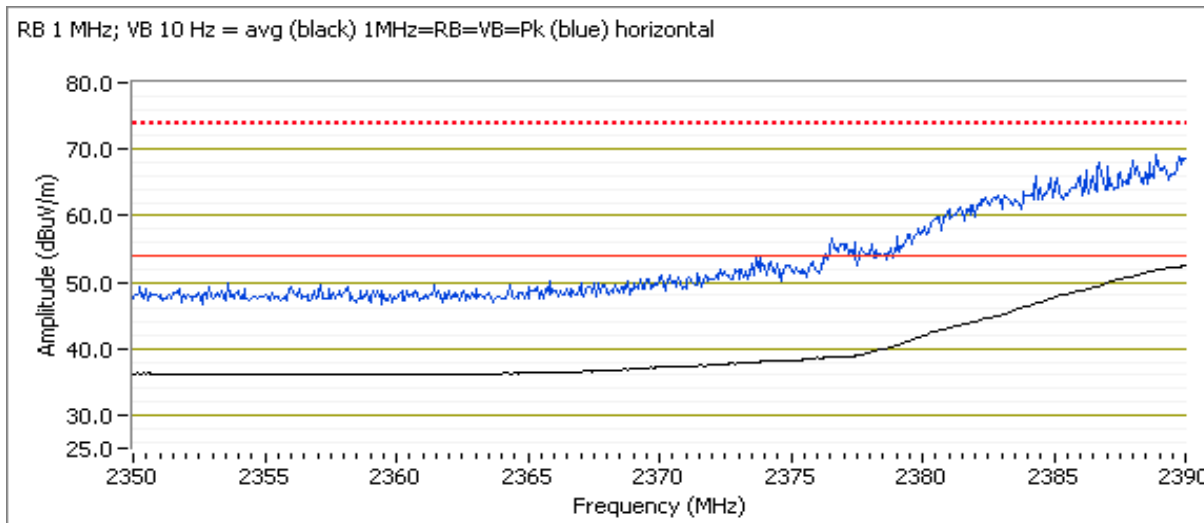

Client: Intel	Job Number: J84264
Model: 135BNHMW & 135BNHU	T-Log Number: T84548
	Account Manager: Christine Krebill
Contact: Steve Hackett	
Standard: FCC 15 B, 15.247, RSS 210	Class: N/A

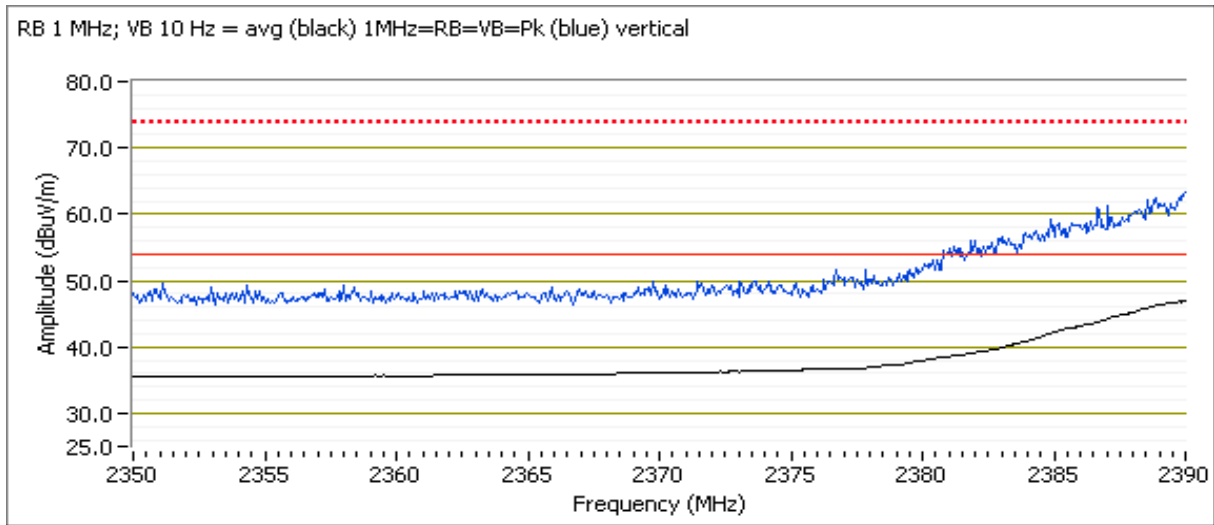

Run # 3b, EUT on Channel #7 2442MHz - HT40, Chain A

	Target (dBm)	Power Settings Measured (dBm)	Software Setting
Chain A	16.5	14.0	22.0

Frequency	Level	Pol	15.209 / 15.247	Detector	Azimuth	Height	Comments	Setting
MHz	dBuV/m	v/h	Limit	Margin	Pk/QP/Avg	degrees	meters	
2483.500	53.1	H	54.0	-0.9	AVG	242	1.1	RB 1 MHz;VB 10 Hz;Pk 22
2486.740	67.5	H	74.0	-6.5	PK	242	1.1	RB 1 MHz;VB 3 MHz;Pk 22
2483.500	47.9	V	54.0	-6.1	AVG	158	1.3	RB 1 MHz;VB 10 Hz;Pk
2486.830	61.1	V	74.0	-12.9	PK	158	1.3	RB 1 MHz;VB 3 MHz;Pk

Client: Intel	Job Number: J84264
Model: 135BNHMW & 135BNHU	T-Log Number: T84548
	Account Manager: Christine Krebill
Contact: Steve Hackett	
Standard: FCC 15 B, 15.247, RSS 210	Class: N/A

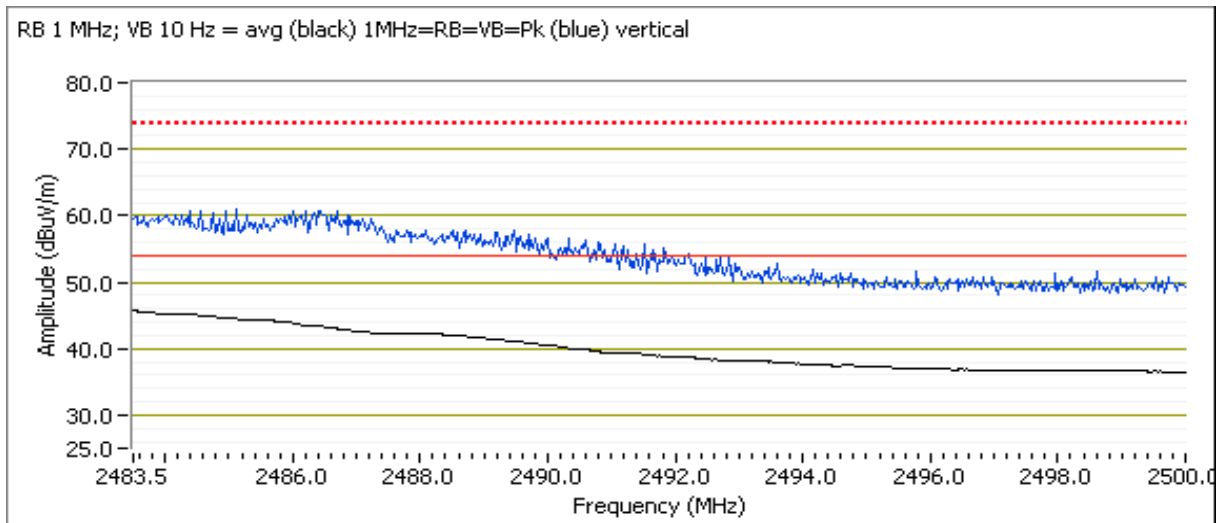
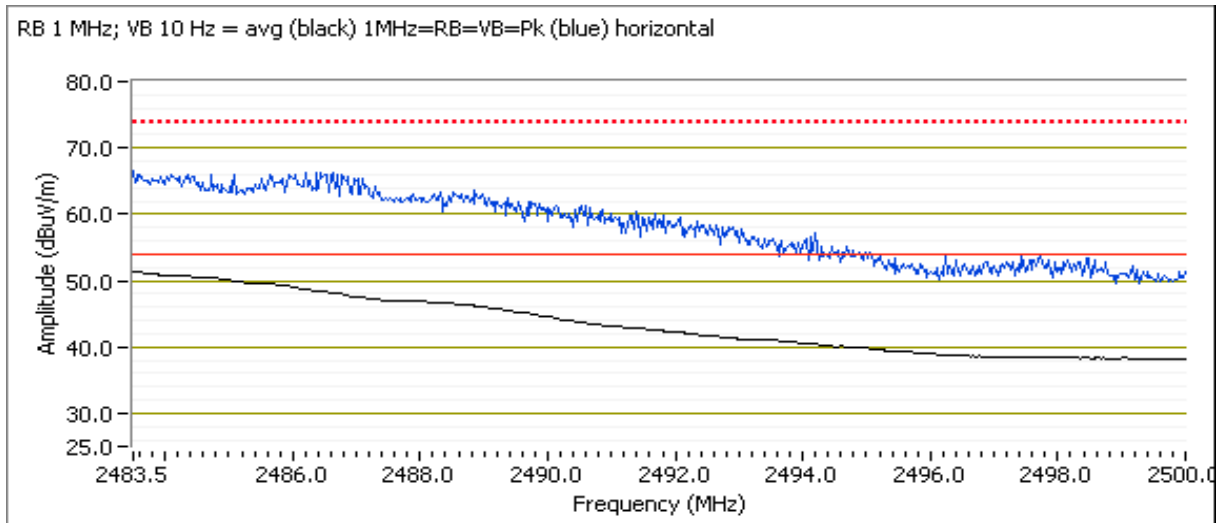

Client: Intel	Job Number: J84264
Model: 135BNHMW & 135BNHU	T-Log Number: T84548
	Account Manager: Christine Krebill
Contact: Steve Hackett	
Standard: FCC 15 B, 15.247, RSS 210	Class: N/A

Run # 4, Band Edge Field Strength - HT40, Chain A

Date of Test: 9/28/2011
 Test Engineer: Joseph Cadigal
 Test Location: FT Chamber#4
 Config Change: none

Run # 4a, EUT on Channel #6 2437MHz - HT40, Chain A

	Target (dBm)	Power Settings Measured (dBm)	Software Setting
Chain A	16.5	15.1	23.5

2390 MHz Band Edge Signal Field Strength

Frequency MHz	Level dB μ V/m	Pol v/h	15.209 / 15.247		Detector Pk/QP/Avg	Azimuth degrees	Height meters	Comments	Setting
			Limit	Margin					
2389.930	52.6	H	54.0	-1.4	AVG	242	1.2	RB 1 MHz;VB 10 Hz;Pk	23.5
2389.730	67.5	H	74.0	-6.5	PK	242	1.2	RB 1 MHz;VB 3 MHz;Pk	23.5
2390.000	46.7	V	54.0	-7.3	AVG	255	1.1	RB 1 MHz;VB 10 Hz;Pk	23.5
2389.800	59.7	V	74.0	-14.3	PK	255	1.1	RB 1 MHz;VB 3 MHz;Pk	23.5

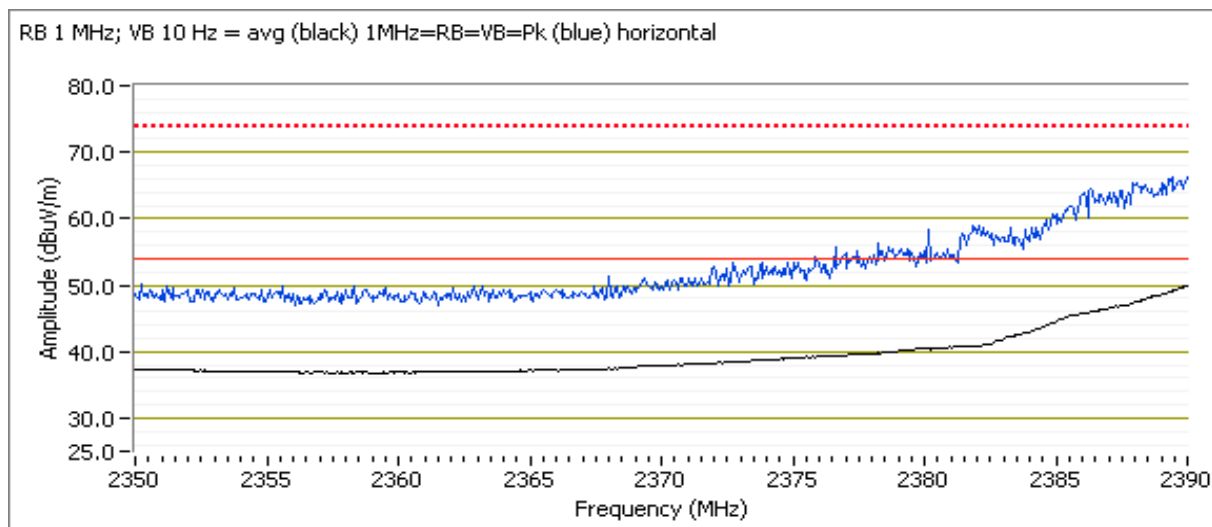

Client: Intel	Job Number: J84264
Model: 135BNHMW & 135BNHU	T-Log Number: T84548
	Account Manager: Christine Krebill
Contact: Steve Hackett	
Standard: FCC 15 B, 15.247, RSS 210	Class: N/A

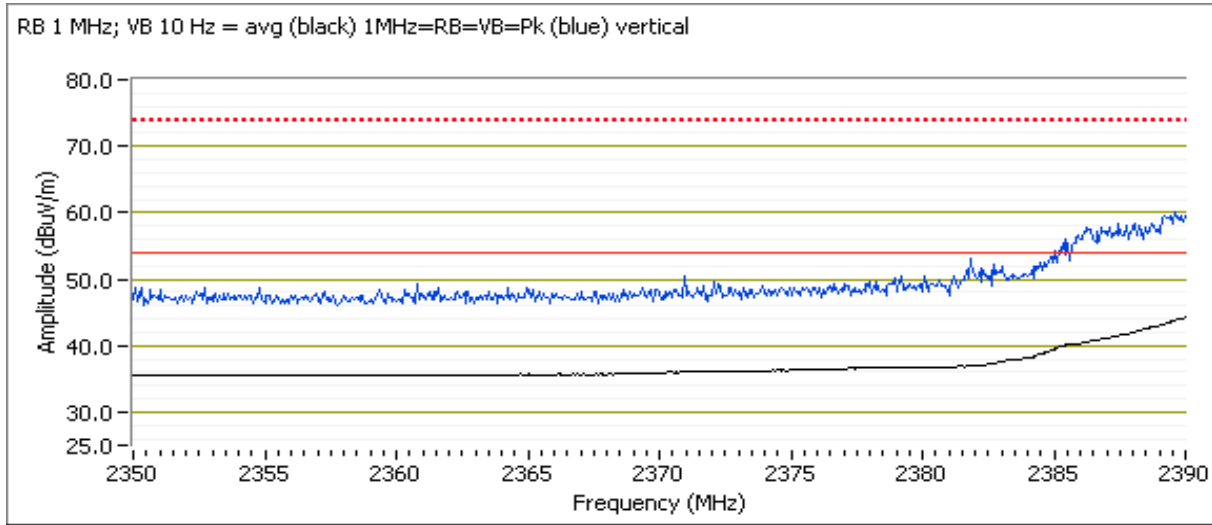

Run # 4b, EUT on Channel #6 2437MHz - HT40, Chain A

	Target (dBm)	Power Settings Measured (dBm)	Software Setting	
Chain A	16.5	16.5	25.5	Pass

2483.5 MHz Band Edge Signal Radiated Field Strength

Frequency	Level	Pol	15.209 / 15.247		Detector	Azimuth	Height	Comments	Setting
MHz	dB μ V/m	v/h	Limit	Margin	Pk/QP/Avg	degrees	meters		
2483.500	52.8	V	54.0	-1.2	AVG	255	1.1	RB 1 MHz;VB 10 Hz;Pk	25.5
2484.680	67.7	V	74.0	-6.3	PK	255	1.1	RB 1 MHz;VB 3 MHz;Pk	25.5
2483.500	48.3	H	54.0	-5.7	AVG	239	1.2	RB 1 MHz;VB 10 Hz;Pk	25.5
2483.690	61.5	H	74.0	-12.5	PK	239	1.2	RB 1 MHz;VB 3 MHz;Pk	25.5

Client: Intel	Job Number: J84264
Model: 135BNHMW & 135BNHU	T-Log Number: T84548
	Account Manager: Christine Krebill
Contact: Steve Hackett	
Standard: FCC 15 B, 15.247, RSS 210	Class: N/A

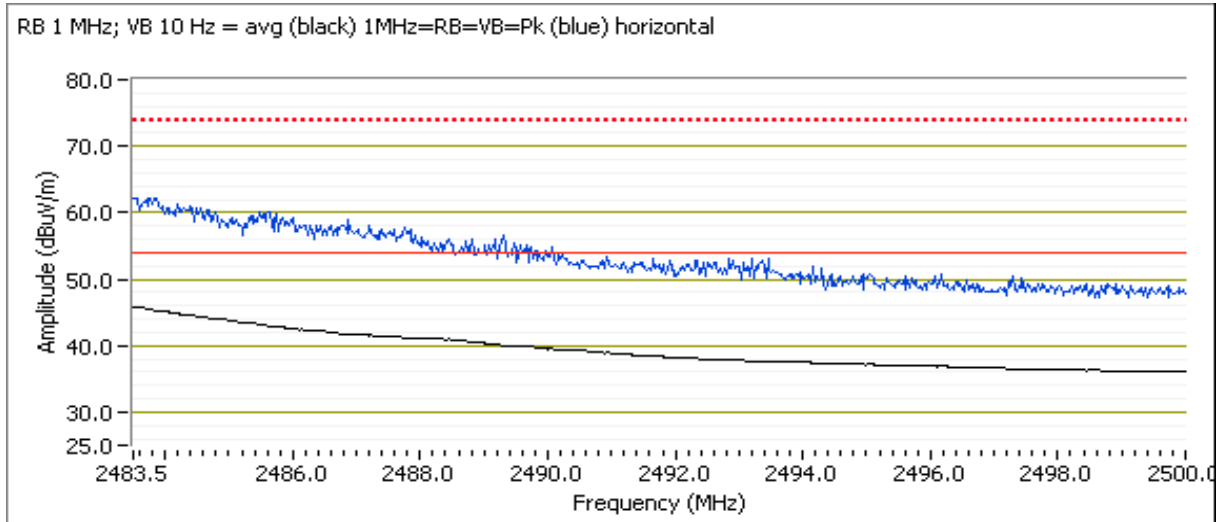
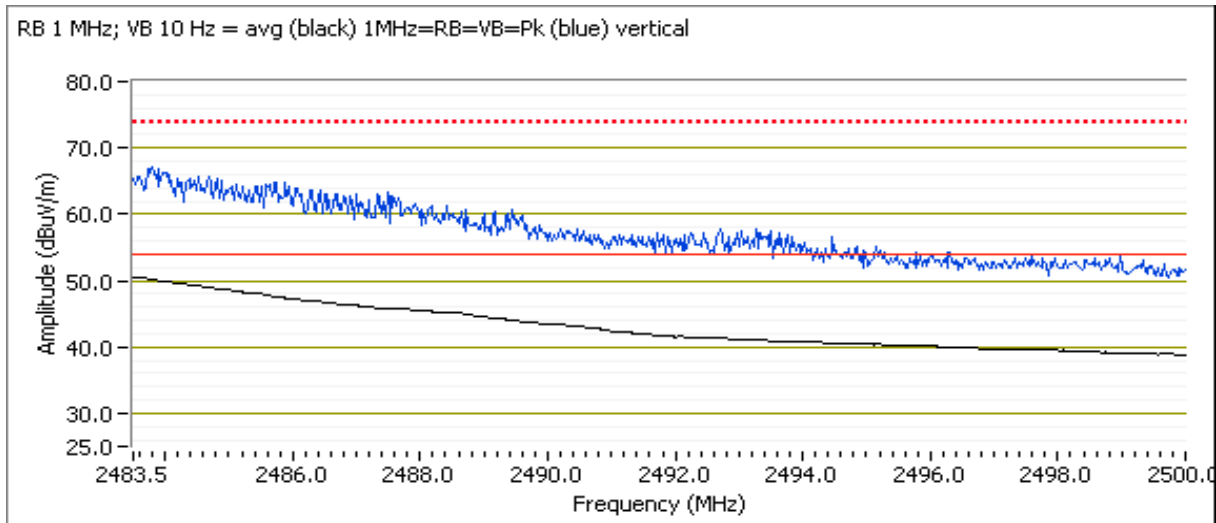

Client: Intel	Job Number: J84264
Model: 135BNHMW & 135BNHU	T-Log Number: T84548
	Account Manager: Christine Krebill
Contact: Steve Hackett	
Standard: FCC 15 B, 15.247, RSS 210	Class: N/A

RSS 210 and FCC 15.247 (DTS) Radiated Spurious Emissions

Test Specific Details

Objective: The objective of this test session is to perform final qualification testing of the EUT with respect to the specification listed above.

Ambient Conditions:

Rel. Humidity: 15 - 55 %

Temperature: 18 - 25 °C

Modifications Made During Testing

No modifications were made to the EUT during testing

Deviations From The Standard

No deviations were made from the requirements of the standard.

Client: Intel	Job Number: J84264
Model: 135BNHMW & 135BNHU	T-Log Number: T84548
	Account Manager: Christine Krebill
Contact: Steve Hackett	
Standard: FCC 15 B, 15.247, RSS 210	Class: N/A

Summary of Results

MAC Address: **00150096B40F** DRTU Tool Version **1.5.3-0320** Driver version **15.0.051**

Run #	Mode	Channel	Target Power	Measured Power	Test Performed	Limit	Result / Margin
Run # 1	802.11b Chain A	#1 2412MHz	16.5	16.5	Radiated Emissions, 1 - 40 GHz (LO at 19.2GHz requires testing to 40GHz)	FCC 15.209 / 15.247	30.4dBµV/m @ 1457.6MHz (-23.6dB)
		#6 2437MHz	16.5	16.5			41.8dBµV/m @ 1457.6MHz (-12.2dB)
		#11 2462MHz	16.5	16.5			35.5dBµV/m @ 7388.8MHz (-18.5dB)

Preliminary measurements on center channel in each OFDM mode to determine worst case.

Run # 2	OFDM Chain A	#6 HT20	16.5	16.6	Radiated Emissions, 1 - 40 GHz (LO at 19.2GHz requires testing to 40GHz)	FCC 15.209 / 15.247	42.9dBµV/m @ 1457.6MHz (-11.1dB)
		#6 802.11g	16.5	16.6			43.3dBµV/m @ 7308.6MHz (-10.7dB)
		#6 HT40	16.5	16.6			43.0dBµV/m @ 1457.5MHz (-11.0dB)

Measurements on low and high channels in worst-case OFDM mode.

Run # 3	OFDM - 802.11g Chain A	#1 2412MHz	16.5	16.8	Radiated Emissions, 1 - 40 GHz	FCC 15.209 / 15.247	46.5dBµV/m @ 7248.4MHz (-7.5dB)
		#11 2462MHz	16.5	16.8			43.6dBµV/m @ 7385.3MHz (-10.4dB)

Receive Mode - Chain A and B are supported. Chain B can also use option trace antenna integrated onto module (run 5c).

Run # 5a, 5b	Receive Chain A, B (PIFA)	2437MHz Chain A	-	-	Radiated Emissions, 1 - 40 GHz	RSS 210	38.6dBµV/m @ 2331.3MHz (-15.4dB)
		2437MHz Chain B	-	-			40.7dBµV/m @ 2330.1MHz (-13.3dB)

MAC Address: **00150096C325** (sample with integral antenna) DRTU Tool Version **1.5.3-0320** Driver version **15.0.051**

Run #5c	Receive B (Trace)	2437MHz Chain B	-	-	Radiated Emissions, 1 - 40 GHz	RSS 210	40.7dBµV/m @ 2323.5MHz (-13.3dB)
---------	-------------------	-----------------	---	---	-----------------------------------	---------	-------------------------------------

Note - the target and measured power are average powers (measured with average power sensor) and are used for reference purposes only. Power is set using " GAIN CONTROL" mode in the DRTU tool.

Use the Gain Control mode of adjusting power. Set power to within +/-0.2dB of target.

Client: Intel	Job Number: J84264
Model: 135BNHMW & 135BNHU	T-Log Number: T84548
	Account Manager: Christine Krebill
Contact: Steve Hackett	
Standard: FCC 15 B, 15.247, RSS 210	Class: N/A

Run # 1, Radiated Spurious Emissions, 1-40 GHz, 802.11b, Chain A

Date of Test: 9/15/2011
 Test Engineer: Joseph Cadigal

Test Location: FT Chamber#5
 Config Change: none

Run # 1a, EUT on Channel #1 2412MHz - 802.11b, Chain A

	Target (dBm)	Power Settings Measured (dBm)	Software Setting
Chain A	16.5	16.5	20.5

Spurious Radiated Emissions:

Frequency MHz	Level dB μ V/m	Pol v/h	15.209/15.247		Detector Pk/QP/Avg	Azimuth degrees	Height meters	Comments
			Limit	Margin				
1457.560	30.4	H	54.0	-23.6	AVG	239	1.0	RB 1 MHz;VB 10 Hz;Pk
2998.670	45.1	V	74.0	-28.9	PK	151	1.0	RB 1 MHz;VB 3 MHz;Pk
7250.780	28.9	V	54.0	-25.1	AVG	295	1.6	RB 1 MHz;VB 10 Hz;Pk
1660.310	43.2	V	74.0	-30.8	PK	348	1.0	RB 1 MHz;VB 3 MHz;Pk
7250.930	40.3	V	74.0	-33.7	PK	295	1.6	RB 1 MHz;VB 3 MHz;Pk
1457.860	33.9	H	74.0	-40.1	PK	239	1.0	RB 1 MHz;VB 3 MHz;Pk
2997.960	29.2	V	54.0	-24.8	AVG	151	1.0	RB 1 MHz;VB 10 Hz;Pk
1659.590	25.7	V	54.0	-28.3	AVG	348	1.0	RB 1 MHz;VB 10 Hz;Pk

Note 1: For emissions in restricted bands, the limit of 15.209 was used. For all other emissions, the limit is -30dBc for peak measurements in a measurement bandwidth of 100kHz.

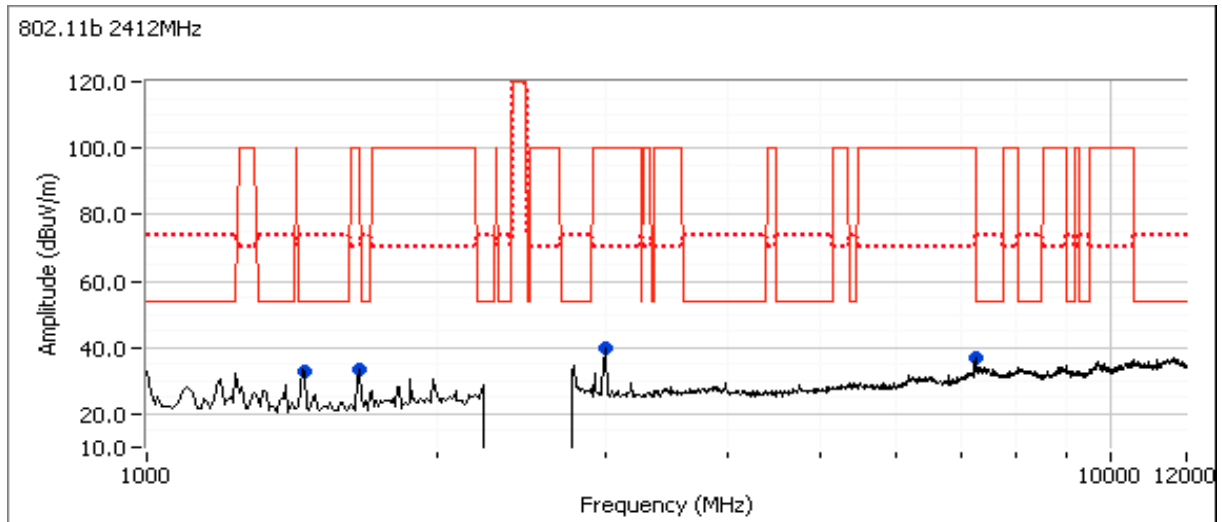

Client: Intel	Job Number: J84264
Model: 135BNHMW & 135BNHU	T-Log Number: T84548
	Account Manager: Christine Krebill
Contact: Steve Hackett	
Standard: FCC 15 B, 15.247, RSS 210	Class: N/A

Run # 1b: , EUT on Channel #6 2437MHz - 802.11b, Chain A

	Target (dBm)	Power Settings Measured (dBm)	Software Setting
Chain A	16.5	16.5	20.5

Spurious Radiated Emissions:

Frequency MHz	Level dBμV/m	Pol v/h	15.209/15.247		Detector Pk/QP/Avg	Azimuth degrees	Height meters	Comments
			Limit	Margin				
1457.590	41.8	V	54.0	-12.2	AVG	246	1.3	RB 1 MHz;VB 10 Hz;Pk
9741.460	39.6	V	54.0	-14.4	AVG	219	2.2	RB 1 MHz;VB 10 Hz;Pk
7320.690	38.3	V	54.0	-15.7	AVG	289	1.9	RB 1 MHz;VB 10 Hz;Pk
2997.660	37.8	H	54.0	-16.2	AVG	193	1.6	RB 1 MHz;VB 10 Hz;Pk
1665.040	35.3	V	54.0	-18.7	AVG	146	1.0	RB 1 MHz;VB 10 Hz;Pk
2997.220	53.2	H	74.0	-20.8	PK	193	1.6	RB 1 MHz;VB 3 MHz;Pk
9743.170	51.0	V	74.0	-23.0	PK	219	2.2	RB 1 MHz;VB 3 MHz;Pk
1664.390	50.5	V	74.0	-23.5	PK	146	1.0	RB 1 MHz;VB 3 MHz;Pk
7321.280	49.7	V	74.0	-24.3	PK	289	1.9	RB 1 MHz;VB 3 MHz;Pk
1457.620	45.3	V	74.0	-28.7	PK	246	1.3	RB 1 MHz;VB 3 MHz;Pk

- Note 1: For emissions in restricted bands, the limit of 15.209 was used. For all other emissions, the limit is -30dBc for peak measurements in a measurement bandwidth of 100kHz.
- Note 2: Scans made between 12 - 40GHz with the measurement antenna moved around the card and its antennas 20-50cm from the device indicated there were no significant emissions in this frequency range

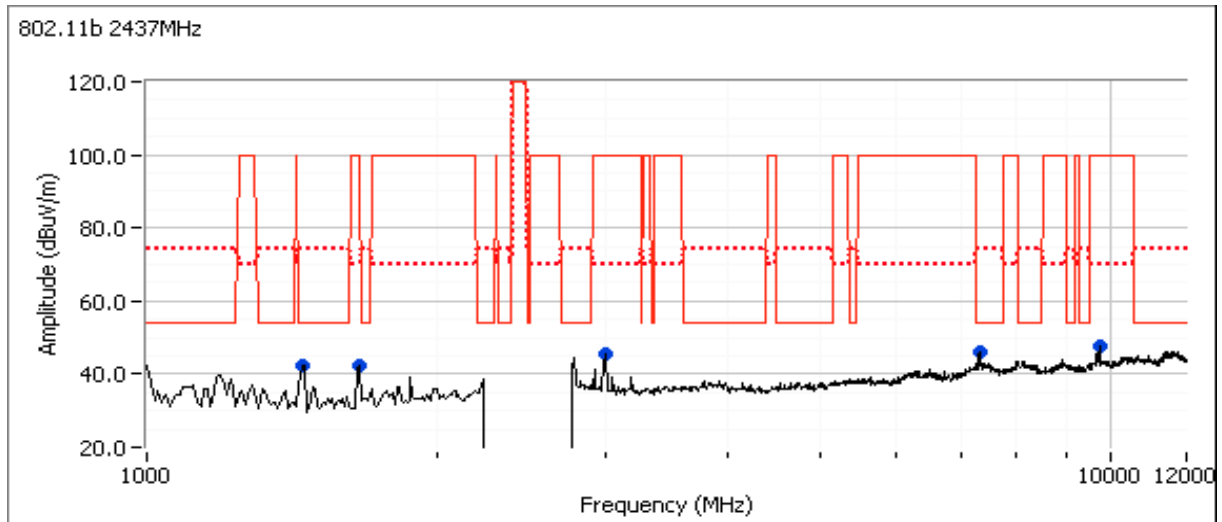

Client: Intel	Job Number: J84264
Model: 135BNHMW & 135BNHU	T-Log Number: T84548
	Account Manager: Christine Krebill
Contact: Steve Hackett	
Standard: FCC 15 B, 15.247, RSS 210	Class: N/A

Run # 1c: , EUT on Channel #11 2462MHz - 802.11b, Chain A

	Target (dBm)	Power Settings Measured (dBm)	Software Setting
Chain A	16.5	16.5	20.5

Spurious Radiated Emissions:

Frequency MHz	Level dB μ V/m	Pol v/h	15.209/15.247		Detector Pk/QP/Avg	Azimuth degrees	Height meters	Comments
			Limit	Margin				
7388.810	35.5	V	54.0	-18.5	AVG	284	1.9	RB 1 MHz;VB 10 Hz;Pk
1457.580	32.7	V	54.0	-21.3	AVG	246	1.3	RB 1 MHz;VB 10 Hz;Pk
9836.700	29.7	V	54.0	-24.3	AVG	293	1.9	RB 1 MHz;VB 10 Hz;Pk
2992.560	26.6	V	54.0	-27.4	AVG	157	1.0	RB 1 MHz;VB 10 Hz;Pk
1659.860	26.4	V	54.0	-27.6	AVG	341	1.0	RB 1 MHz;VB 10 Hz;Pk
1659.280	44.0	V	74.0	-30.0	PK	341	1.0	RB 1 MHz;VB 3 MHz;Pk
7389.870	43.9	V	74.0	-30.1	PK	284	1.9	RB 1 MHz;VB 3 MHz;Pk
2992.610	42.0	V	74.0	-32.0	PK	157	1.0	RB 1 MHz;VB 3 MHz;Pk
9838.820	41.3	V	74.0	-32.7	PK	293	1.9	RB 1 MHz;VB 3 MHz;Pk
1457.710	36.3	V	74.0	-37.7	PK	246	1.3	RB 1 MHz;VB 3 MHz;Pk

Note 1: For emissions in restricted bands, the limit of 15.209 was used. For all other emissions, the limit is -30dBc for peak measurements in a measurement bandwidth of 100kHz.

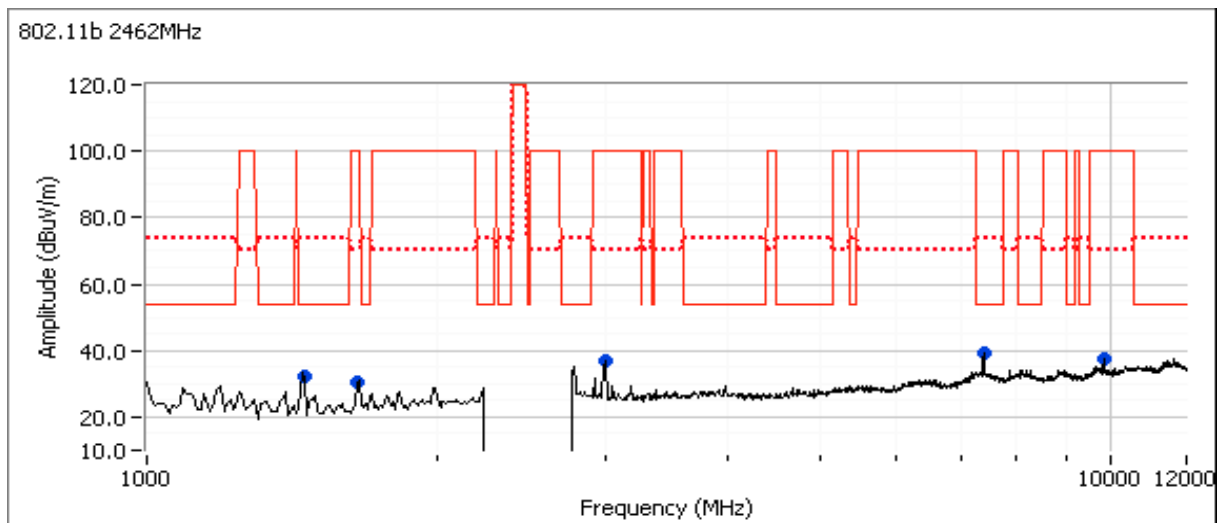

Client: Intel	Job Number: J84264
Model: 135BNHMW & 135BNHU	T-Log Number: T84548
	Account Manager: Christine Krebill
Contact: Steve Hackett	
Standard: FCC 15 B, 15.247, RSS 210	Class: N/A

Run # 2, Radiated Spurious Emissions, 1-40 GHz, OFDM, Chain A

Date of Test: 9/15/2011 Test Location: FT Chamber#5
 Test Engineer: Joseph Cadigal Config Change: none

Run # 2a, EUT on Channel #6 HT20 - OFDM, Chain A

	Target (dBm)	Power Settings Measured (dBm)	Software Setting
Chain A	16.5	16.6	26.5

Spurious Radiated Emissions:

Frequency MHz	Level dB μ V/m	Pol v/h	15.209/15.247		Detector Pk/QP/Avg	Azimuth degrees	Height meters	Comments
			Limit	Margin				
1457.570	42.9	H	54.0	-11.1	AVG	230	1.0	RB 1 MHz;VB 10 Hz;Pk
7312.970	41.9	V	54.0	-12.1	AVG	263	1.9	RB 1 MHz;VB 10 Hz;Pk
2998.970	36.6	V	54.0	-17.4	AVG	157	1.0	RB 1 MHz;VB 10 Hz;Pk
7313.620	54.3	V	74.0	-19.7	PK	263	1.9	RB 1 MHz;VB 3 MHz;Pk
2999.000	52.1	V	74.0	-21.9	PK	157	1.0	RB 1 MHz;VB 3 MHz;Pk
1231.290	29.3	V	54.0	-24.7	AVG	89	1.3	RB 1 MHz;VB 10 Hz;Pk
1230.230	47.0	V	74.0	-27.0	PK	89	1.3	RB 1 MHz;VB 3 MHz;Pk
1457.680	46.1	H	74.0	-27.9	PK	230	1.0	RB 1 MHz;VB 3 MHz;Pk

Note 1: For emissions in restricted bands, the limit of 15.209 was used. For all other emissions, the limit is -30dBc for peak measurements in a measurement bandwidth of 100kHz.

Note 2: Scans made between 12 - 40GHz with the measurement antenna moved around the card and its antennas 20-50cm from the device indicated there were no significant emissions in this frequency range

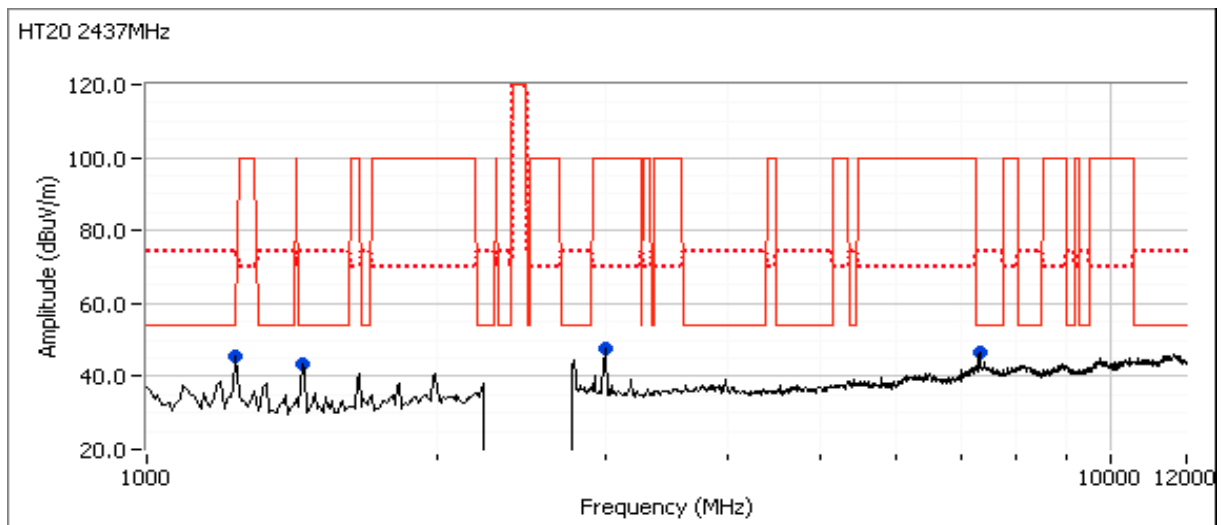

Client: Intel	Job Number: J84264
Model: 135BNHMW & 135BNHU	T-Log Number: T84548
	Account Manager: Christine Krebill
Contact: Steve Hackett	
Standard: FCC 15 B, 15.247, RSS 210	Class: N/A

Run # 2b: , EUT on Channel #6 802.11g - OFDM, Chain A

	Target (dBm)	Power Settings Measured (dBm)	Software Setting
Chain A	16.5	16.6	26.5

Spurious Radiated Emissions:

Frequency MHz	Level dB μ V/m	Pol v/h	15.209/15.247		Detector Pk/QP/Avg	Azimuth degrees	Height meters	Comments
			Limit	Margin				
7308.630	43.3	V	54.0	-10.7	AVG	285	1.9	RB 1 MHz;VB 10 Hz;Pk
1457.580	42.2	H	54.0	-11.8	AVG	231	1.0	RB 1 MHz;VB 10 Hz;Pk
2997.230	37.6	V	54.0	-16.4	AVG	154	1.0	RB 1 MHz;VB 10 Hz;Pk
7309.090	54.7	V	74.0	-19.3	PK	285	1.9	RB 1 MHz;VB 3 MHz;Pk
2996.150	53.1	V	74.0	-20.9	PK	154	1.0	RB 1 MHz;VB 3 MHz;Pk
1457.690	45.5	H	74.0	-28.5	PK	231	1.0	RB 1 MHz;VB 3 MHz;Pk

Note 1: For emissions in restricted bands, the limit of 15.209 was used. For all other emissions, the limit is -30dBc for peak measurements in a measurement bandwidth of 100kHz.

Note 2: Scans made between 12 - 40GHz with the measurement antenna moved around the card and its antennas 20-50cm from the device indicated there were no significant emissions in this frequency range

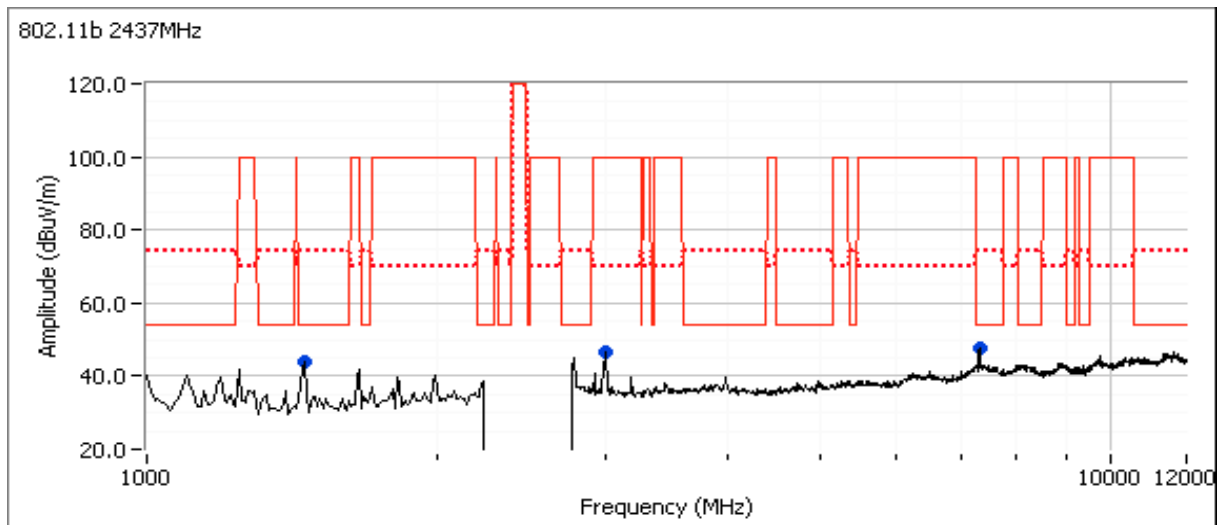

Client: Intel	Job Number: J84264
Model: 135BNHMW & 135BNHU	T-Log Number: T84548
	Account Manager: Christine Krebill
Contact: Steve Hackett	
Standard: FCC 15 B, 15.247, RSS 210	Class: N/A

Run # 2c: , EUT on Channel #6 HT40 - OFDM, Chain A

	Target (dBm)	Power Settings Measured (dBm)	Software Setting
Chain A	16.5	16.6	26.5

Spurious Radiated Emissions:

Frequency MHz	Level dB μ V/m	Pol v/h	15.209/15.247		Detector Pk/QP/Avg	Azimuth degrees	Height meters	Comments
			Limit	Margin				
1457.540	43.0	H	54.0	-11.0	AVG	231	1.0	RB 1 MHz;VB 10 Hz;Pk
7324.580	41.0	V	54.0	-13.0	AVG	284	1.9	RB 1 MHz;VB 10 Hz;Pk
2999.190	38.6	V	54.0	-15.4	AVG	150	1.0	RB 1 MHz;VB 10 Hz;Pk
2998.210	54.6	V	74.0	-19.4	PK	150	1.0	RB 1 MHz;VB 3 MHz;Pk
7325.200	52.8	V	74.0	-21.2	PK	284	1.9	RB 1 MHz;VB 3 MHz;Pk
1247.260	31.3	V	54.0	-22.7	AVG	311	2.5	RB 1 MHz;VB 10 Hz;Pk
1246.710	49.9	V	74.0	-24.1	PK	311	2.5	RB 1 MHz;VB 3 MHz;Pk
1457.540	45.6	H	74.0	-28.4	PK	231	1.0	RB 1 MHz;VB 3 MHz;Pk

Note 1: For emissions in restricted bands, the limit of 15.209 was used. For all other emissions, the limit is -30dBc for peak measurements in a measurement bandwidth of 100kHz.

Note 2: Scans made between 12 - 40GHz with the measurement antenna moved around the card and its antennas 20-50cm from the device indicated there were no significant emissions in this frequency range

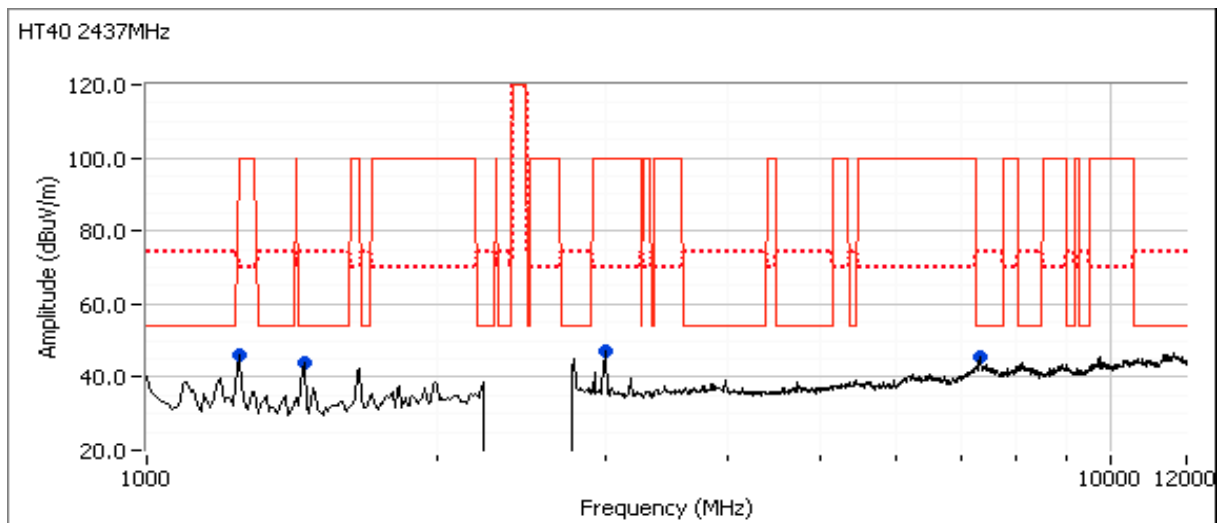

Client: Intel	Job Number: J84264
Model: 135BNHMW & 135BNHU	T-Log Number: T84548
	Account Manager: Christine Krebill
Contact: Steve Hackett	
Standard: FCC 15 B, 15.247, RSS 210	Class: N/A

Run # 3, Radiated Spurious Emissions, 1-40 GHz, OFDM, Chain A

Date of Test: 9/16/2011 Test Location: FT Chamber #3
 Test Engineer: Rafael Varelas Config Change: None

Run # 3a, EUT on Channel #1 2412MHz - OFDM, Chain A

	Target (dBm)	Power Settings Measured (dBm)	Software Setting
Chain A	16.5	16.8	27.0

Spurious Radiated Emissions:

Frequency MHz	Level dB μ V/m	Pol v/h	15.209/15.247		Detector Pk/QP/Avg	Azimuth degrees	Height meters	Comments
			Limit	Margin				
7248.360	46.5	V	54.0	-7.5	PK	287	1.3	RB 1 MHz;VB 3 MHz;Pk
1441.120	39.4	H	54.0	-14.6	PK	128	1.3	RB 1 MHz;VB 3 MHz;Pk
1192.500	38.8	V	54.0	-15.2	PK	139	1.0	RB 1 MHz;VB 3 MHz;Pk

Note 1: For emissions in restricted bands, the limit of 15.209 was used. For all other emissions, the limit is -30dBc for peak measurements in a measurement bandwidth of 100kHz.

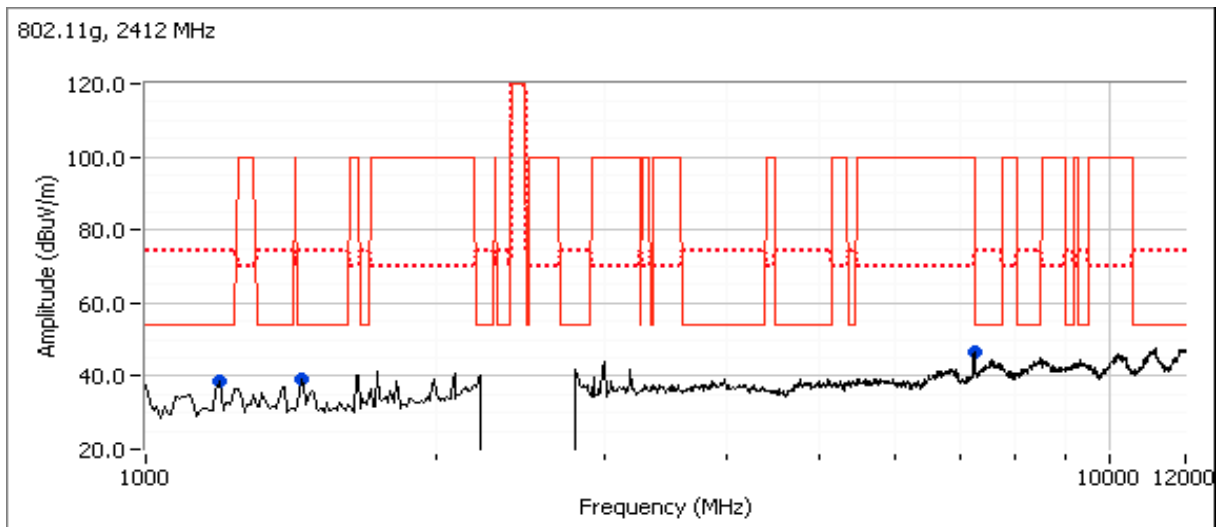

Client: Intel	Job Number: J84264
Model: 135BNHMW & 135BNHU	T-Log Number: T84548
	Account Manager: Christine Krebill
Contact: Steve Hackett	
Standard: FCC 15 B, 15.247, RSS 210	Class: N/A

Run # 3b: , EUT on Channel #11 2462MHz - OFDM, Chain A

	Target (dBm)	Power Settings Measured (dBm)	Software Setting
Chain A	16.5	16.8	27.0

Spurious Radiated Emissions:

Frequency MHz	Level dB μ V/m	Pol v/h	15.209/15.247		Detector Pk/QP/Avg	Azimuth degrees	Height meters	Comments
			Limit	Margin				
7385.260	43.6	V	54.0	-10.4	AVG	283	1.6	RB 1 MHz;VB 10 Hz;Pk
7385.660	55.5	V	74.0	-18.5	PK	283	1.6	RB 1 MHz;VB 3 MHz;Pk
1192.500	37.3	V	54.0	-16.7	PK	124	1.3	RB 1 MHz;VB 3 MHz;Pk
1457.590	39.1	V	54.0	-14.9	PK	269	1.6	RB 1 MHz;VB 3 MHz;Pk

Note 1: For emissions in restricted bands, the limit of 15.209 was used. For all other emissions, the limit is -30dBc for peak measurements in a measurement bandwidth of 100kHz.

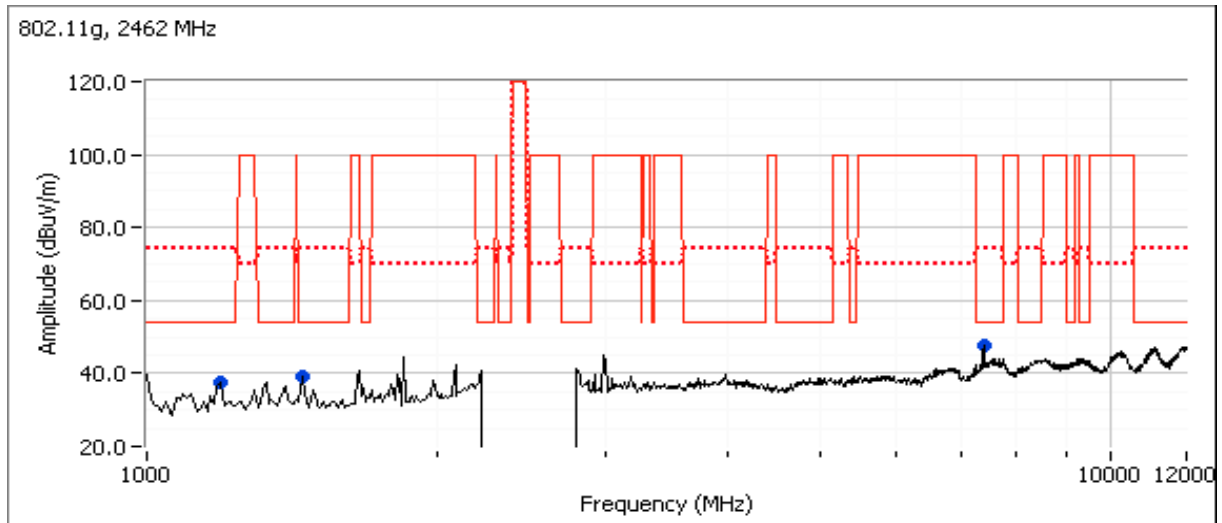

Client: Intel	Job Number: J84264
Model: 135BNHMW & 135BNHU	T-Log Number: T84548
	Account Manager: Christine Krebill
Contact: Steve Hackett	
Standard: FCC 15 B, 15.247, RSS 210	Class: N/A

Run # 5, Radiated Spurious Emissions, 1-40GHz, Receive, Chain A, B

Date of Test: 9/16/2011 Test Location: FT Chamber #3
 Test Engineer: Rafael Varelas Config Change: None

Run # 5a, EUT on Channel 2437MHz Chain A - Receive

Frequency MHz	Level dB μ V/m	Pol v/h	15.209/15.247		Detector Pk/QP/Avg	Azimuth degrees	Height meters	Comments
			Limit	Margin				
2331.260	38.6	V	54.0	-15.4	AVG	49	1.0	RB 1 MHz;VB 10 Hz;Pk
2321.830	55.6	V	74.0	-18.4	PK	49	1.0	RB 1 MHz;VB 3 MHz;Pk
1245.260	29.6	V	54.0	-24.4	AVG	310	2.0	RB 1 MHz;VB 10 Hz;Pk
1250.790	48.3	V	74.0	-25.7	PK	310	2.0	RB 1 MHz;VB 3 MHz;Pk
2986.570	37.5	V	54.0	-16.5	AVG	149	1.0	RB 1 MHz;VB 10 Hz;Pk
2986.270	54.0	V	74.0	-20.0	PK	149	1.0	RB 1 MHz;VB 3 MHz;Pk

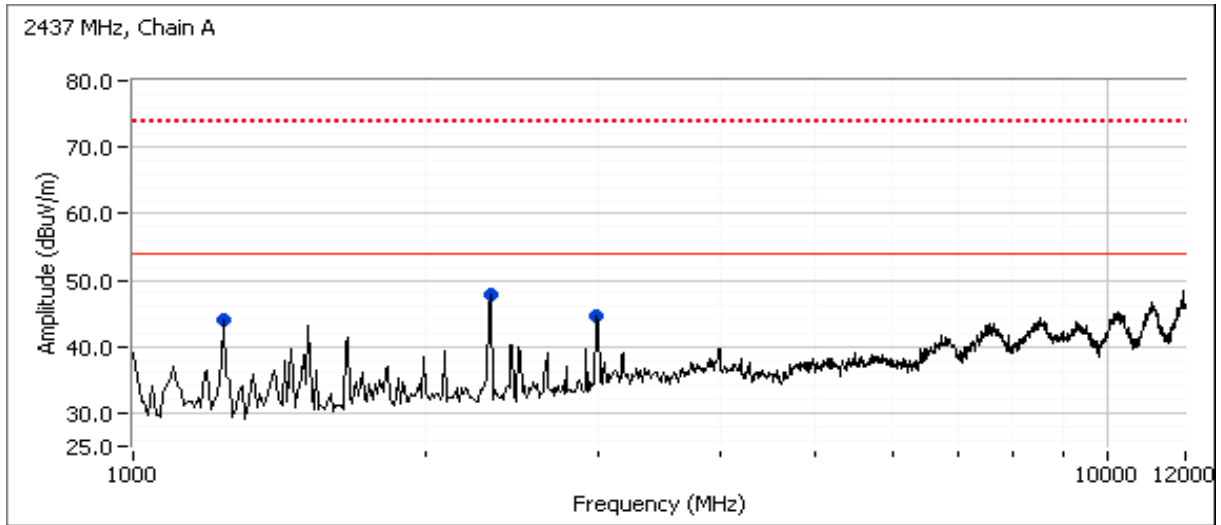

Client: Intel	Job Number: J84264
Model: 135BNHMW & 135BNHU	T-Log Number: T84548
	Account Manager: Christine Krebill
Contact: Steve Hackett	
Standard: FCC 15 B, 15.247, RSS 210	Class: N/A

Run # 5b: , EUT on Channel 2437MHz Chain B - PIFA antenna

Frequency MHz	Level dB μ V/m	Pol v/h	15.209/15.247		Detector Pk/QP/Avg	Azimuth degrees	Height meters	Comments
			Limit	Margin				
2330.130	40.7	V	54.0	-13.3	AVG	187	1.1	RB 1 MHz;VB 10 Hz;Pk
2328.460	58.7	V	74.0	-15.3	PK	187	1.1	RB 1 MHz;VB 3 MHz;Pk
2991.170	38.5	V	54.0	-15.5	AVG	146	1.0	RB 1 MHz;VB 10 Hz;Pk
2987.540	55.5	V	74.0	-18.5	PK	146	1.0	RB 1 MHz;VB 3 MHz;Pk
2449.330	40.7	H	54.0	-13.3	AVG	236	1.1	RB 1 MHz;VB 10 Hz;Pk
2433.830	40.9	H	74.0	-33.1	PK	236	1.1	RB 1 MHz;VB 3 MHz;Pk

Note 2: Scans made between 12 - 40GHz with the measurement antenna moved around the card and its antennas 20-50cm from the device indicated there were no significant emissions in this frequency range

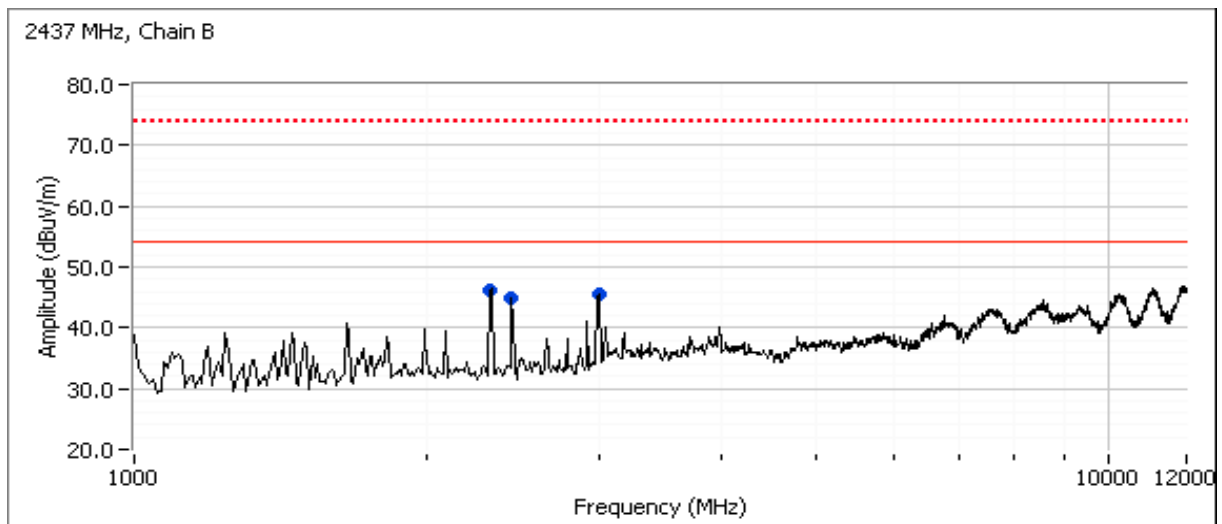

Client: Intel	Job Number: J84264
Model: 135BNHMW & 135BNHU	T-Log Number: T84548
	Account Manager: Christine Krebill
Contact: Steve Hackett	
Standard: FCC 15 B, 15.247, RSS 210	Class: N/A

Run # 5c: , EUT on Channel 2437MHz Chain B - On-board antenna

Date of Test: 9/23/2011
Test Engineer: M. Birgani

Test Location: FT Chamber #4
Config Change: None

MAC Address: **00150096C325** (sample with integral antenna) DRTU Tool Version **1.5.3-0320** Driver version **15.0.051**

Frequency MHz	Level dB μ V/m	Pol v/h	15.209/15.247		Detector Pk/QP/Avg	Azimuth degrees	Height meters	Comments
			Limit	Margin				
2323.500	40.7	V	54.0	-13.3	AVG	176	1.3	RB 1 MHz;VB 10 Hz;Pk
2992.740	38.3	V	54.0	-15.7	AVG	158	1.0	RB 1 MHz;VB 10 Hz;Pk
2325.450	57.9	V	74.0	-16.1	PK	176	1.3	RB 1 MHz;VB 3 MHz;Pk
2994.710	55.4	V	74.0	-18.6	PK	158	1.0	RB 1 MHz;VB 3 MHz;Pk
1662.420	33.5	V	54.0	-20.5	AVG	182	1.0	RB 1 MHz;VB 10 Hz;Pk
1998.940	33.1	V	54.0	-20.9	AVG	247	1.0	RB 1 MHz;VB 10 Hz;Pk
1660.970	51.4	V	74.0	-22.6	PK	182	1.0	RB 1 MHz;VB 3 MHz;Pk
1244.690	48.2	H	74.0	-25.8	PK	96	1.0	RB 1 MHz;VB 3 MHz;Pk
1245.980	26.5	H	54.0	-27.5	AVG	96	1.0	RB 1 MHz;VB 10 Hz;Pk
1997.560	46.5	V	74.0	-27.5	PK	247	1.0	RB 1 MHz;VB 3 MHz;Pk
999.267	25.6	V	54.0	-28.4	AVG	178	0.9	RB 100 kHz;VB 10 Hz;Pk
997.117	36.4	V	74.0	-37.6	PK	178	0.9	RB 100 kHz;VB 300 kHz;Pk

Note 2: Scans made between 8 - 40GHz with the measurement antenna moved around the card and its antennas 20-50cm from the device indicated there were no significant emissions in this frequency range

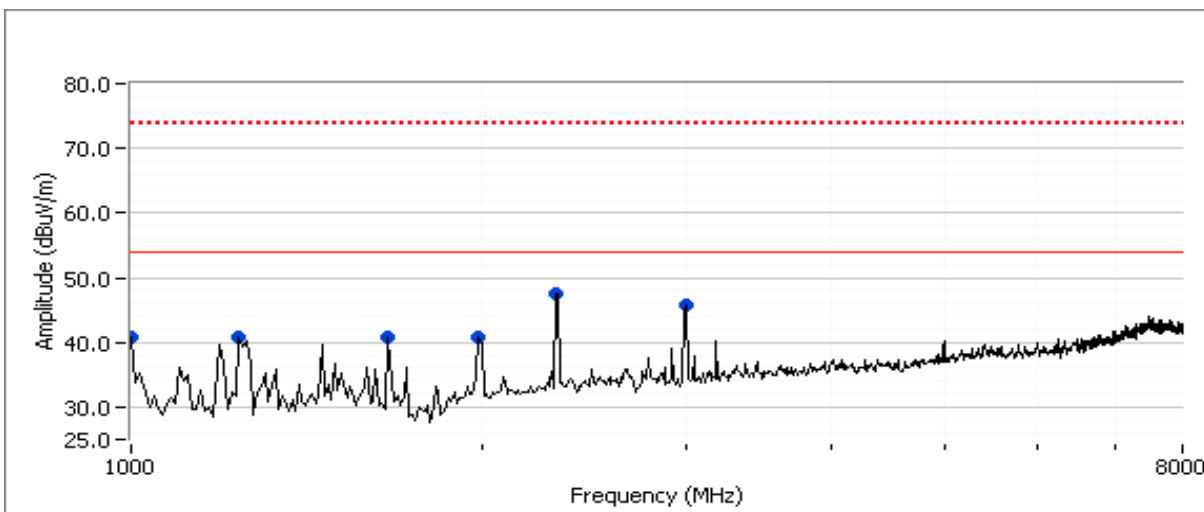

Client: Intel	Job Number: J84264
Model: 135BNHMW & 135BNHU	T-Log Number: T84548
	Account Manager: Christine Krebill
Contact: Steve Hackett	
Standard: FCC 15 B, 15.247, RSS 210	Class: N/A

RSS 210 and FCC 15.247 (DTS) Radiated Spurious Emissions (Bluetooth LE)

Test Specific Details

Objective: The objective of this test session is to perform final qualification testing of the EUT with respect to the specification listed above.

Summary of Results - Device Operating in the 2400-2483.5 MHz Band

Target power for Bluetooth is max without exceeding 7dBm. Integral antenna sample use same power settings used for PIFA antenna

Run #	Mode	Channel	Power Setting	Measured Power	Test Performed	Limit	Result / Margin
MAC Address: 00150096B40F DRTU Tool Version 1.5.3-0320 Driver version 15.0.051							
1a	LE	2402	max	4.7	Restricted Band Edge (2390 MHz)	FCC Part 15.209 / 15.247(c)	42.0dBµV/m @ 2361.9MHz (-12.0dB)
			max	4.7	Radiated Emissions 1-40 GHz	FCC Part 15.209 / 15.247(c)	39.4dBµV/m @ 1457.6MHz (-14.6dB)
1b		2441	max	4.7	Radiated Emissions 1-40 GHz	FCC Part 15.209 / 15.247(c)	50.6dBµV/m @ 1245.4MHz (-23.4dB)
1c		2480	max	4.7	Restricted Band Edge (2483.5 MHz)	FCC Part 15.209 / 15.247(c)	50.7dBµV/m @ 2483.5MHz (-3.3dB)
			max	4.7	Radiated Emissions 1-40 GHz	FCC Part 15.209 / 15.247(c)	41.5dBµV/m @ 1457.6MHz (-12.5dB)
MAC Address: 00150096C325 (sample with integral antenna) DRTU Tool Version 1.5.3-0320 Driver version 15.0.051							
2a	LE	2402	max		Restricted Band Edge (2390 MHz)	FCC Part 15.209 / 15.247(c)	42.7dBµV/m @ 2362.1MHz (-11.3dB)
			max		Radiated Emissions 1-40 GHz	FCC Part 15.209 / 15.247(c)	44.7dBµV/m @ 2989.17MHz (-9.3dB)
2b		2442	max		Radiated Emissions 1-40 GHz	FCC Part 15.209 / 15.247(c)	32.6dBµV/m @ 1457.6MHz (-21.4dB)
2c		2480	max		Restricted Band Edge (2483.5 MHz)	FCC Part 15.209 / 15.247(c)	51.3dBµV/m @ 2483.5MHz (-2.7dB)
			max		Radiated Emissions 1-40 GHz	FCC Part 15.209 / 15.247(c)	44.9dBµV/m @ 2989.2MHz (-9.1dB)

Note - measured power is average power and for reference only

Ambient Conditions: Temperature: 18-25 °C
Rel. Humidity: 30-40 %

Modifications Made During Testing

No modifications were made to the EUT during testing

Deviations From The Standard

No deviations were made from the requirements of the standard.

Client: Intel	Job Number: J84264
Model: 135BNHMW & 135BNHU	T-Log Number: T84548
	Account Manager: Christine Krebill
Contact: Steve Hackett	
Standard: FCC 15 B, 15.247, RSS 210	Class: N/A

Run #1: Radiated Spurious Emissions, 1,000 - 40,000 MHz. Operating Mode: Low Energy (LE)
 Date of Test: 9/19-20/2011 Test Location: FT Chamber#3
 Test Engineer: J. Cadigal, M. Birgani

Run #1a: Low Channel @ 2402 MHz
 Band Edge Signal Field Strength - Direct measurement of field strength

Frequency MHz	Level dB μ V/m	Pol v/h	15.209 / 15.247		Detector Pk/QP/Avg	Azimuth degrees	Height meters	Comments
			Limit	Margin				
2361.870	42.0	V	54.0	-12.0	AVG	90	1.0	RB 1 MHz;VB 10 Hz;Pk
2362.000	41.9	H	54.0	-12.1	AVG	336	1.0	RB 1 MHz;VB 10 Hz;Pk
2371.800	52.9	V	74.0	-21.1	PK	90	1.0	RB 1 MHz;VB 3 MHz;Pk
2360.870	52.8	H	74.0	-21.2	PK	336	1.0	RB 1 MHz;VB 3 MHz;Pk

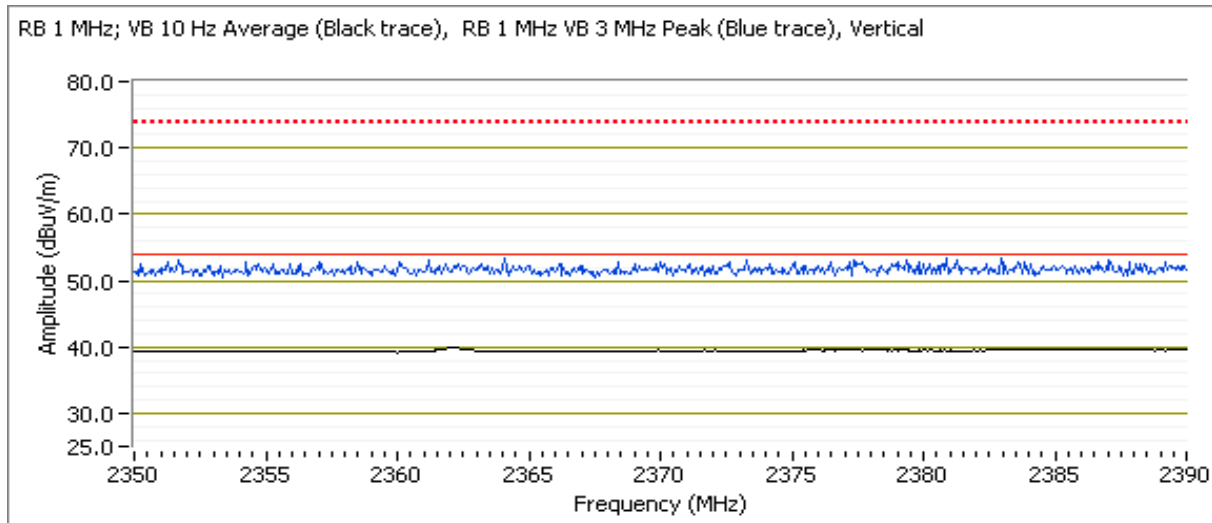

Client: Intel	Job Number: J84264
Model: 135BNHMW & 135BNHU	T-Log Number: T84548
	Account Manager: Christine Krebill
Contact: Steve Hackett	
Standard: FCC 15 B, 15.247, RSS 210	Class: N/A

Other Spurious Emissions

Frequency MHz	Level dB μ V/m	Pol v/h	15.209 / 15.247		Detector Pk/QP/Avg	Azimuth degrees	Height meters	Comments
			Limit	Margin				
1457.550	39.4	H	54.0	-14.6	AVG	244	1.3	RB 1 MHz;VB 10 Hz;Pk
2987.700	38.4	H	54.0	-15.6	AVG	198	1.0	RB 1 MHz;VB 10 Hz;Pk
1244.560	57.7	V	74.0	-16.3	PK	253	1.3	RB 1 MHz;VB 3 MHz;Pk
2988.350	55.8	H	74.0	-18.2	PK	198	1.0	RB 1 MHz;VB 3 MHz;Pk
1666.110	32.8	V	54.0	-21.2	AVG	185	1.0	RB 1 MHz;VB 10 Hz;Pk
1245.030	31.6	V	54.0	-22.4	AVG	253	1.3	RB 1 MHz;VB 10 Hz;Pk
1666.480	50.7	V	74.0	-23.3	PK	185	1.0	RB 1 MHz;VB 3 MHz;Pk
1457.660	43.2	H	74.0	-30.8	PK	244	1.3	RB 1 MHz;VB 3 MHz;Pk

- Note 1: For emissions in restricted bands, the limit of 15.209 was used. For all other emissions, the limit was set 20dB below the level of the fundamental and measured in 100kHz.
- Note 2: Signal is not in a restricted band but the more stringent restricted band limit was used.
- Note 3: Scans made between **10 - 40GHz** with the measurement antenna moved around the card and its antennas 20-50cm from the device indicated there were no significant emissions in this frequency range

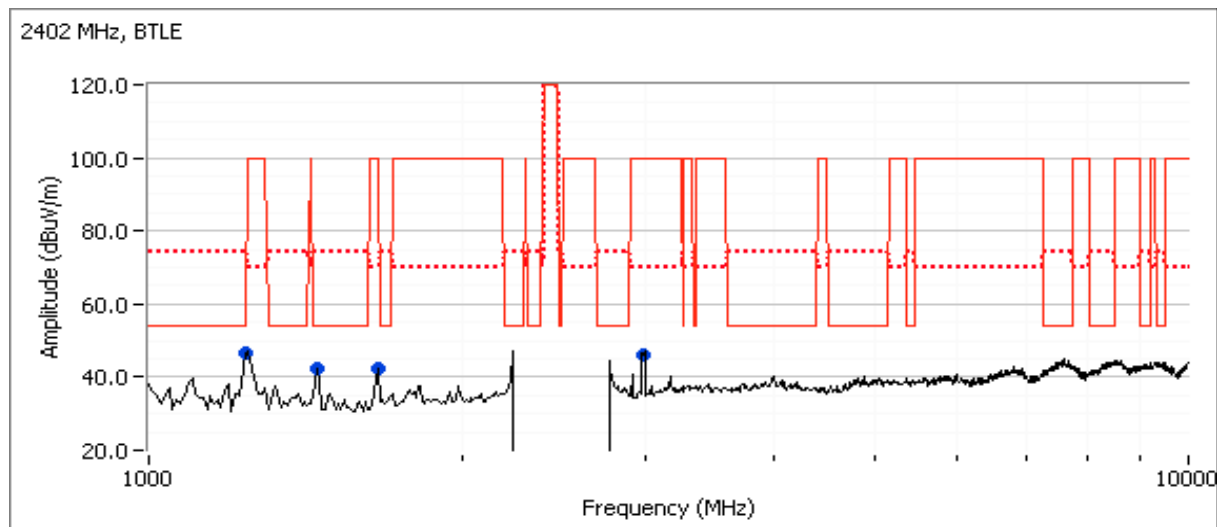

Client: Intel	Job Number: J84264
Model: 135BNHMW & 135BNHU	T-Log Number: T84548
	Account Manager: Christine Krebill
Contact: Steve Hackett	
Standard: FCC 15 B, 15.247, RSS 210	Class: N/A

Run #1b: Center Channel @ 2441 MHz

Frequency MHz	Level dB μ V/m	Pol v/h	15.209 / 15.247		Detector Pk/QP/Avg	Azimuth degrees	Height meters	Comments
			Limit	Margin				
1245.400	50.6	H	74.0	-23.4	PK	212	2.5	RB 1 MHz;VB 3 MHz;Pk
2975.590	29.8	V	54.0	-24.2	AVG	149	1.0	RB 1 MHz;VB 10 Hz;Pk
1244.550	29.8	H	54.0	-24.2	AVG	212	2.5	RB 1 MHz;VB 10 Hz;Pk
1643.390	28.3	V	54.0	-25.7	AVG	360	1.0	RB 1 MHz;VB 10 Hz;Pk
1446.940	26.5	H	54.0	-27.5	AVG	249	1.0	RB 1 MHz;VB 10 Hz;Pk
2973.360	41.5	V	74.0	-32.5	PK	149	1.0	RB 1 MHz;VB 3 MHz;Pk
1642.220	40.3	V	74.0	-33.7	PK	360	1.0	RB 1 MHz;VB 3 MHz;Pk
1445.730	39.7	H	74.0	-34.3	PK	249	1.0	RB 1 MHz;VB 3 MHz;Pk

Note 1: For emissions in restricted bands, the limit of 15.209 was used. For all other emissions, the limit was set 20dB below the level of the fundamental and measured in 100kHz.

Note 2: Signal is not in a restricted band but the more stringent restricted band limit was used.

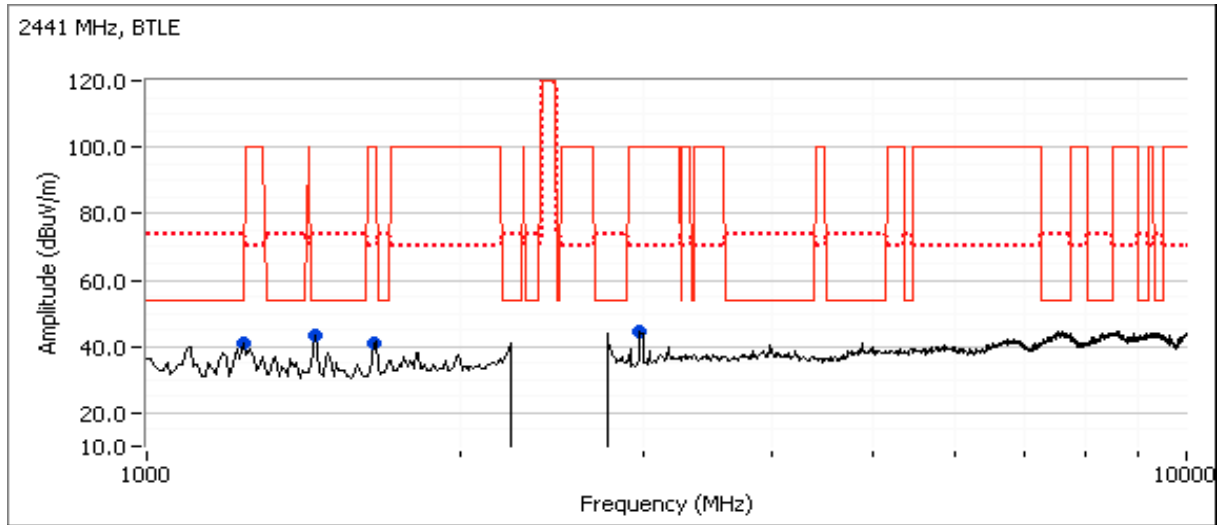

Client: Intel	Job Number: J84264
Model: 135BNHMW & 135BNHU	T-Log Number: T84548
	Account Manager: Christine Krebill
Contact: Steve Hackett	
Standard: FCC 15 B, 15.247, RSS 210	Class: N/A

Run #1c: High Channel @ 2480 MHz
Band Edge Signal Field Strength - Direct measurement of field strength

Frequency MHz	Level dB μ V/m	Pol v/h	15.209 / 15.247		Detector Pk/QP/Avg	Azimuth degrees	Height meters	Comments
			Limit	Margin				
2483.500	50.7	H	54.0	-3.3	AVG	348	1.0	RB 1 MHz;VB 10 Hz;Pk
2483.500	46.4	V	54.0	-7.6	AVG	19	1.0	RB 1 MHz;VB 10 Hz;Pk
2483.500	59.1	H	74.0	-14.9	PK	348	1.0	RB 1 MHz;VB 3 MHz;Pk
2483.500	55.9	V	74.0	-18.1	PK	19	1.0	RB 1 MHz;VB 3 MHz;Pk

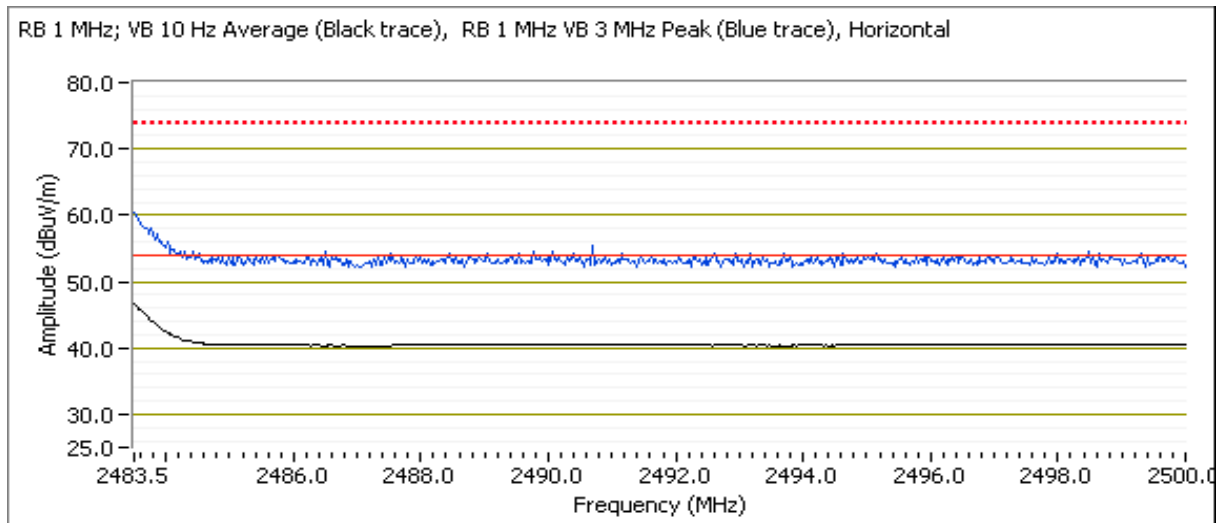

Client: Intel	Job Number: J84264
Model: 135BNHMW & 135BNHU	T-Log Number: T84548
	Account Manager: Christine Krebill
Contact: Steve Hackett	
Standard: FCC 15 B, 15.247, RSS 210	Class: N/A

Other Spurious Emissions

Frequency MHz	Level dB μ V/m	Pol v/h	15.209 / 15.247		Detector Pk/QP/Avg	Azimuth degrees	Height meters	Comments
			Limit	Margin				
1457.580	41.5	H	54.0	-12.5	AVG	246	1.0	RB 1 MHz;VB 10 Hz;Pk
2994.110	38.5	H	54.0	-15.5	AVG	188	1.0	RB 1 MHz;VB 10 Hz;Pk
2994.560	55.5	H	74.0	-18.5	PK	188	1.0	RB 1 MHz;VB 3 MHz;Pk
1244.640	54.4	H	74.0	-19.6	PK	174	1.3	RB 1 MHz;VB 3 MHz;Pk
1244.350	30.9	H	54.0	-23.1	AVG	174	1.3	RB 1 MHz;VB 10 Hz;Pk
1657.330	29.1	V	54.0	-24.9	AVG	2	1.0	RB 1 MHz;VB 10 Hz;Pk
1654.600	45.0	V	74.0	-29.0	PK	2	1.0	RB 1 MHz;VB 3 MHz;Pk
1457.550	44.4	H	74.0	-29.6	PK	246	1.0	RB 1 MHz;VB 3 MHz;Pk

Note 1: For emissions in restricted bands, the limit of 15.209 was used. For all other emissions, the limit was set 20dB below the level of the fundamental and measured in 100kHz.

Note 2: Signal is not in a restricted band but the more stringent restricted band limit was used.

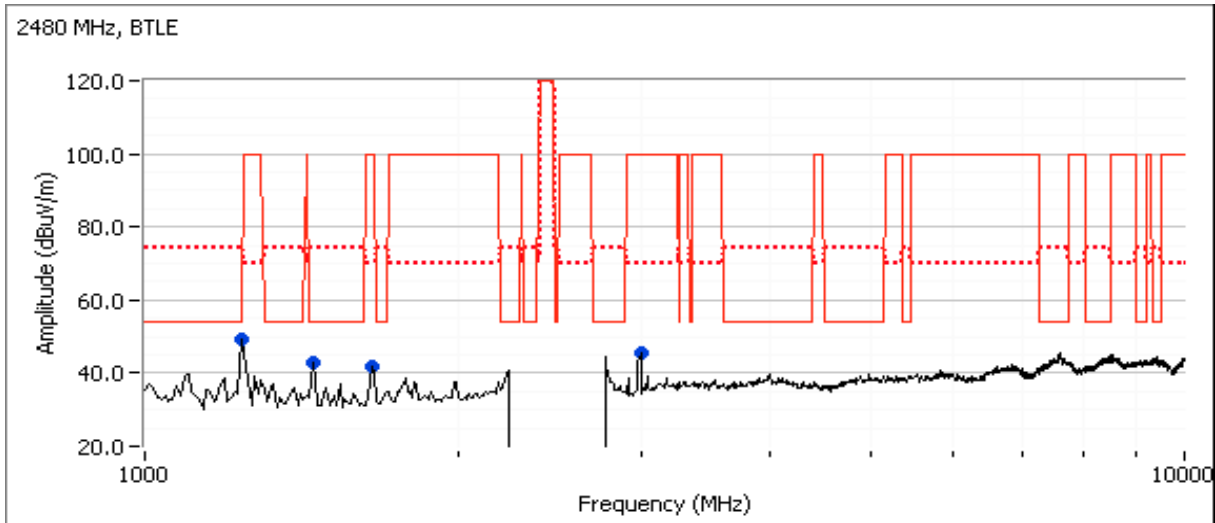

Client: Intel	Job Number: J84264
Model: 135BNHMW & 135BNHU	T-Log Number: T84548
	Account Manager: Christine Krebill
Contact: Steve Hackett	
Standard: FCC 15 B, 15.247, RSS 210	Class: N/A

Run #2: Radiated Spurious Emissions, 1,000 - 40,000 MHz. Operating Mode: Low Energy (LE)

Date of Test: 9/23/2011

Test Location: FT Chamber#4

Test Engineer: M. Birgani

MAC Address: **00150096C325** (sample with integral antenna) DRTU Tool Version **1.5.3-0320** Driver version **15.0.051**

Run #2a: Low Channel @ 2402 MHz

Band Edge Signal Field Strength - Direct measurement of field strength

Frequency MHz	Level dB μ V/m	Pol v/h	15.209 / 15.247		Detector Pk/QP/Avg	Azimuth degrees	Height meters	Comments
			Limit	Margin				
2362.070	42.7	H	54.0	-11.3	AVG	152	1.0	RB 1 MHz;VB 10 Hz;Pk
2362.070	42.0	V	54.0	-12.0	AVG	84	1.0	RB 1 MHz;VB 10 Hz;Pk
2385.600	53.1	H	74.0	-20.9	PK	152	1.0	RB 1 MHz;VB 3 MHz;Pk
2384.870	52.9	V	74.0	-21.1	PK	84	1.0	RB 1 MHz;VB 3 MHz;Pk

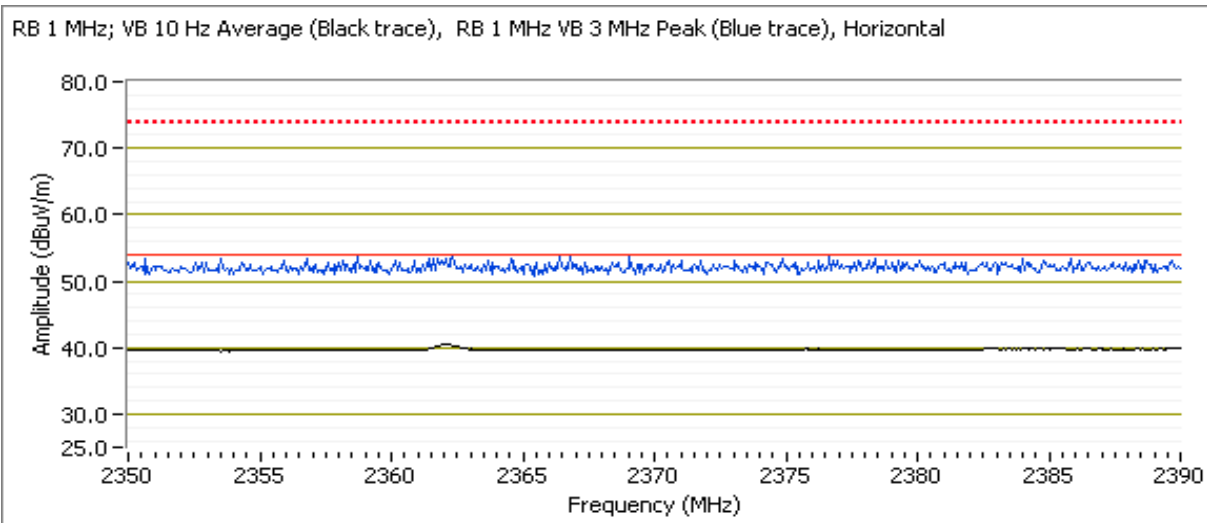

Client: Intel	Job Number: J84264
Model: 135BNHMW & 135BNHU	T-Log Number: T84548
	Account Manager: Christine Krebill
Contact: Steve Hackett	
Standard: FCC 15 B, 15.247, RSS 210	Class: N/A

Other Spurious Emissions

Frequency MHz	Level dB μ V/m	Pol v/h	15.209 / 15.247		Detector Pk/QP/Avg	Azimuth degrees	Height meters	Comments
			Limit	Margin				
2989.170	44.7	V	54.0	-9.3	PK	147	1.0	RB 1 MHz;VB 3 MHz;Pk
1247.500	41.6	H	54.0	-12.4	PK	283	1.9	RB 1 MHz;VB 3 MHz;Pk
1660.000	41.0	V	54.0	-13.0	PK	198	1.0	RB 1 MHz;VB 3 MHz;Pk
1457.600	34.0	H	54.0	-20.0	AVG	171	1.0	RB 1 MHz;VB 10 Hz;Pk
1457.700	39.5	H	74.0	-34.5	PK	171	1.0	RB 1 MHz;VB 3 MHz;Pk

- Note 1: For emissions in restricted bands, the limit of 15.209 was used. For all other emissions, the limit was set 20dB below the level of the fundamental and measured in 100kHz.
- Note 2: Signal is not in a restricted band but the more stringent restricted band limit was used.
- Note 3: Scans made between 10 - 26.5GHz with the measurement antenna moved around the card and its antennas 20-50cm from the device indicated there were no significant emissions in this frequency range

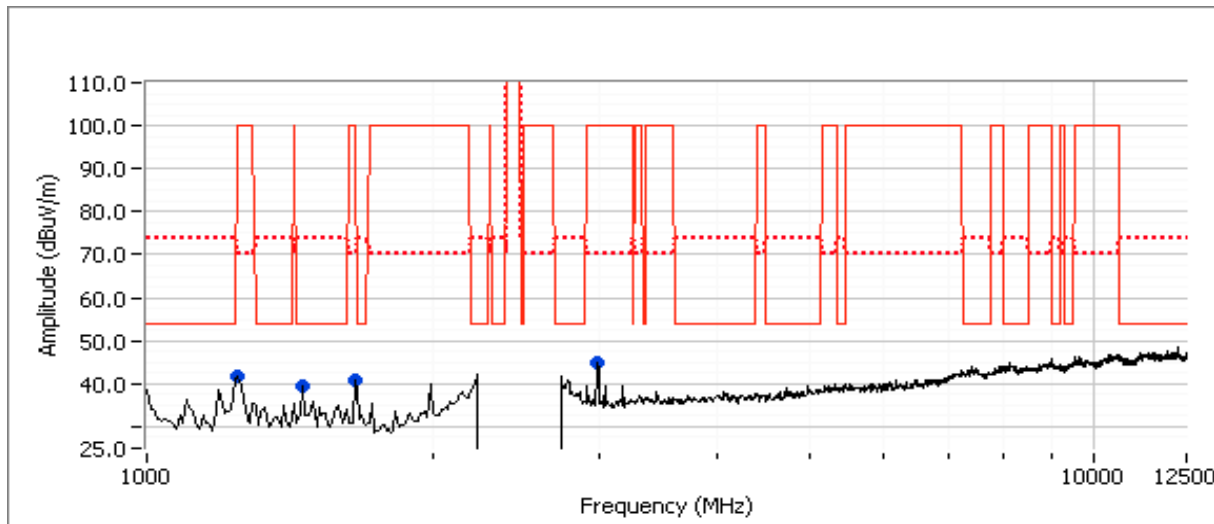

Client: Intel	Job Number: J84264
Model: 135BNHMW & 135BNHU	T-Log Number: T84548
	Account Manager: Christine Krebill
Contact: Steve Hackett	
Standard: FCC 15 B, 15.247, RSS 210	Class: N/A

Run #2b: Center Channel @ 2442 MHz
Other Spurious Emissions

Frequency MHz	Level dB μ V/m	Pol v/h	15.209 / 15.247		Detector Pk/QP/Avg	Azimuth degrees	Height meters	Comments
			Limit	Margin				
1457.550	36.6	H	54.0	-17.4	AVG	204	1.0	RB 1 MHz;VB 10 Hz;Pk
1457.460	38.8	H	74.0	-35.2	PK	204	1.0	RB 1 MHz;VB 3 MHz;Pk

- Note 1: For emissions in restricted bands, the limit of 15.209 was used. For all other emissions, the limit was set 20dB below the level of the fundamental and measured in 100kHz.
- Note 2: Signal is not in a restricted band but the more stringent restricted band limit was used.
- Note 3: Scans made between **10 - 40GHz** with the measurement antenna moved around the card and its antennas 20-50cm from the device indicated there were no significant emissions in this frequency range

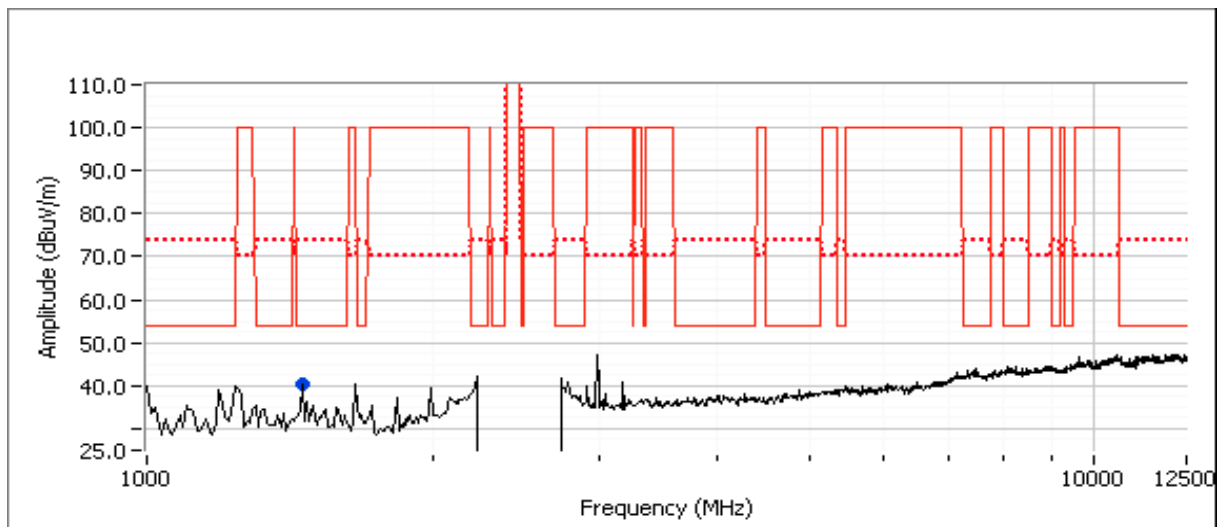

Client: Intel	Job Number: J84264
Model: 135BNHMW & 135BNHU	T-Log Number: T84548
	Account Manager: Christine Krebill
Contact: Steve Hackett	
Standard: FCC 15 B, 15.247, RSS 210	Class: N/A

Run #2c: High Channel @ 2480 MHz
Band Edge Signal Field Strength - Direct measurement of field strength

Frequency MHz	Level dB μ V/m	Pol v/h	15.209 / 15.247		Detector Pk/QP/Avg	Azimuth degrees	Height meters	Comments
			Limit	Margin				
2483.500	51.3	H	54.0	-2.7	AVG	132	1.0	RB 1 MHz;VB 10 Hz;Pk
2483.500	46.8	V	54.0	-7.2	AVG	6	1.0	RB 1 MHz;VB 10 Hz;Pk
2483.610	60.5	H	74.0	-13.5	PK	132	1.0	RB 1 MHz;VB 3 MHz;Pk
2483.580	56.1	V	74.0	-17.9	PK	6	1.0	RB 1 MHz;VB 3 MHz;Pk

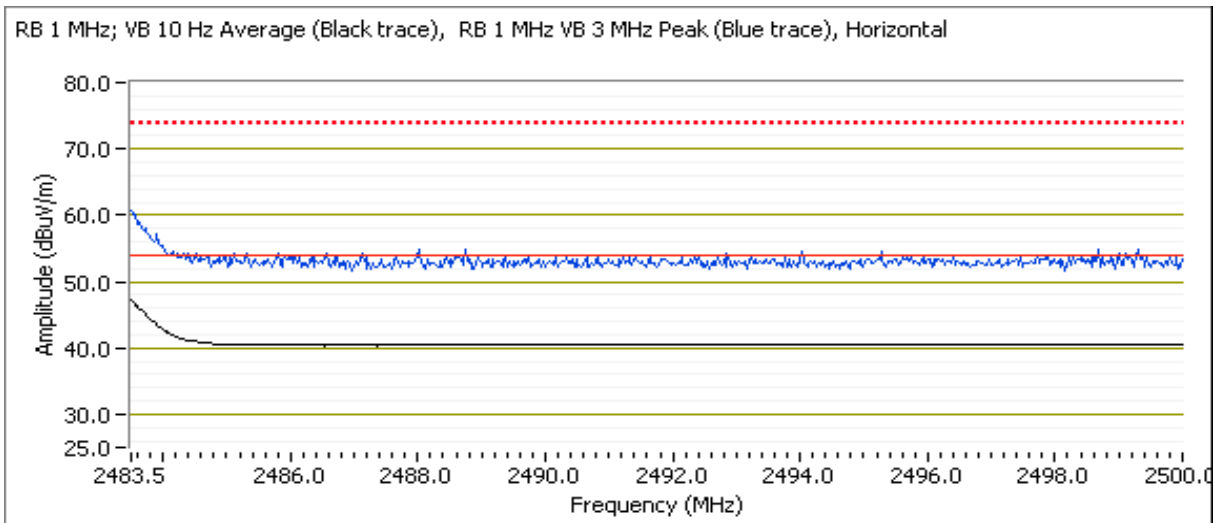

Client: Intel	Job Number: J84264
Model: 135BNHMW & 135BNHU	T-Log Number: T84548
	Account Manager: Christine Krebill
Contact: Steve Hackett	
Standard: FCC 15 B, 15.247, RSS 210	Class: N/A

Other Spurious Emissions

Frequency MHz	Level dB μ V/m	Pol v/h	15.209 / 15.247		Detector Pk/QP/Avg	Azimuth degrees	Height meters	Comments
			Limit	Margin				
2989.170	44.9	V	54.0	-9.1	Peak	157	1.0	RB 1 MHz;VB 3 MHz;Pk
1457.530	38.0	H	54.0	-16.0	AVG	219	1.2	RB 1 MHz;VB 10 Hz;Pk
1457.500	41.5	H	74.0	-32.5	PK	219	1.2	RB 1 MHz;VB 3 MHz;Pk

Note 1: For emissions in restricted bands, the limit of 15.209 was used. For all other emissions, the limit was set 20dB below the level of the fundamental and measured in 100kHz.

Note 2: Signal is not in a restricted band but the more stringent restricted band limit was used.

Note 3: Scans made between **10 - 40GHz** with the measurement antenna moved around the card and its antennas 20-50cm from the device indicated there were no significant emissions in this frequency range

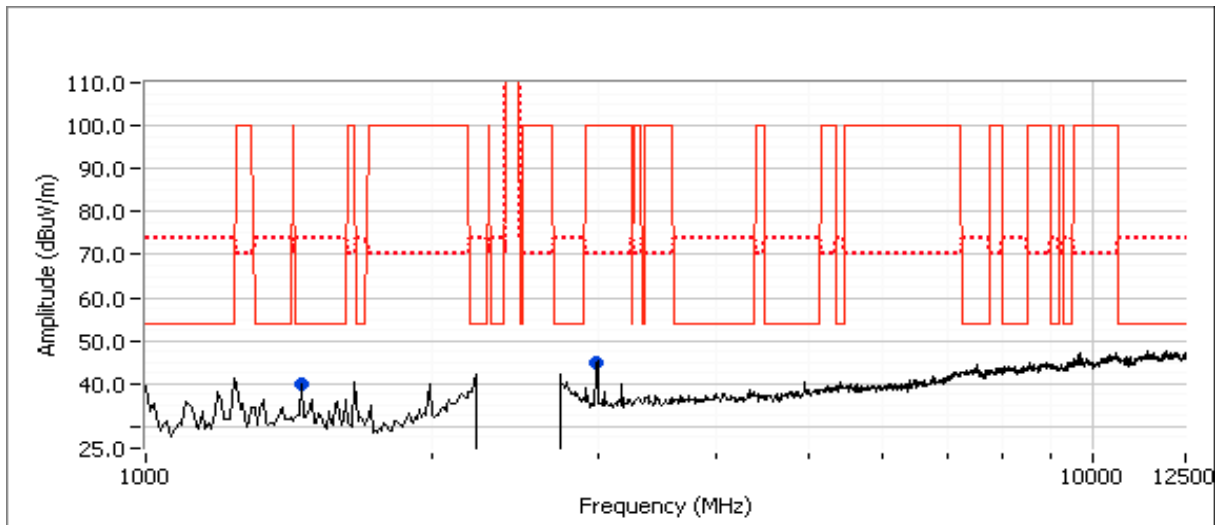

Client: Intel	Job Number: J84264
Model: 135BNHMW & 135BNHU	T-Log Number: T84548
	Account Manager: Christine Krebill
Contact: Steve Hackett	
Standard: FCC 15 B, 15.247, RSS 210	Class: N/A

RSS 210 and FCC 15.247 (DTS) Antenna Port Measurements - WiFi Power, PSD, Bandwidth and Spurious Emissions

Test Specific Details

Objective: The objective of this test session is to perform final qualification testing of the EUT with respect to the specification listed above.

Date of Test: 9/20/2011
 Test Engineer: Rafael Varelas
 Test Location: FT Chamber #3

Config. Used: 1
 Config Change: None
 Host Unit Voltage 120V/60Hz

General Test Configuration

The EUT was connected to the spectrum analyzer or power meter via a suitable attenuator. All measurements were made on a single chain.

All measurements have been corrected to allow for the external attenuators used.

Ambient Conditions:

Temperature: 21.5 °C
 Rel. Humidity: 42 %

Summary of Results

MAC Address: **00150096B40F** DRTU Tool Version **1.5.3-0320** Driver version **15.0.051**

Run #	Pwr setting	Test Performed	Limit	Pass / Fail	Result / Margin
1	20.5 (802.11b)	Output Power	15.247(b)	Pass	802.11b: 0.043 W 802.11g: 0.029 W HT20: 0.030 W HT40: 0.014 W
2	20.5 (802.11b)	Power spectral Density (PSD)	15.247(d)	Pass	-9.4 dBm/3kHz
3	20.5 (802.11b)	Minimum 6dB Bandwidth	15.247(a)	Pass	12.5 MHz
3	21.5 (HT40)	99% Bandwidth	RSS GEN	-	802.11b: 15.3 MHz 802.11g: 17.1 MHz HT20: 18.3 MHz HT40: 36.8 MHz
4	20.5 (802.11b)	Spurious emissions	15.247(b)	Pass	All Emissions below -30dBc limit

Modifications Made During Testing

No modifications were made to the EUT during testing

Deviations From The Standard

No deviations were made from the requirements of the standard.

Client: Intel	Job Number: J84264
Model: 135BNHMW & 135BNHU	T-Log Number: T84548
	Account Manager: Christine Krebill
Contact: Steve Hackett	
Standard: FCC 15 B, 15.247, RSS 210	Class: N/A

Run #1: Output Power

Power Setting ²	Frequency (MHz)	Output Power		Antenna Gain (dBi)	Result	EIRP ^{Note 2}		Output Power	
		(dBm) ¹	mW			dBm	W	(dBm) ³	mW
802.11b Mode									
20.5	2412	15.9	38.9	3.2	Pass	19.1	0.081		
20.5	2437	16.2	41.7	3.2	Pass	19.4	0.087		
20.5	2462	16.3	42.7	3.2	Pass	19.5	0.089		
802.11g Mode									
24.0	2412	12.8	19.1	3.2	Pass	16.0	0.040		
26.0	2437	14.6	28.8	3.2	Pass	17.8	0.060		
23.0	2462	12.1	16.2	3.2	Pass	15.3	0.034		
HT20									
22.0	2412	11.0	12.6	3.2	Pass	14.2	0.026		
26.5	2437	14.7	29.5	3.2	Pass	17.9	0.062		
22.5	2462	11.8	15.1	3.2	Pass	15.0	0.032		
HT40									
20.0	2422	9.9	9.8	3.2	Pass	13.1	0.020		
21.5	2437	11.4	13.8	3.2	Pass	14.6	0.029		
19.5	2452	9.5	8.9	3.2	Pass	12.7	0.019		

Note 1: Output power measured using a spectrum analyzer (see plots below) with RBW=1MHz, VB=3 MHz, sample detector, power averaging on (transmitted signal was continuous) and power integration over 50 MHz (option #2, method 1 in KDB 558074, equivalent to method 1 of DA-02-2138A1 for U-NII devices). Spurious limit becomes -30dBc.

Note 2: Power setting - the software power setting used during testing, included for reference only.

Note 3: Power measured using average power meter and is included for reference only.

Client: Intel	Job Number: J84264
Model: 135BNHMW & 135BNHU	T-Log Number: T84548
	Account Manager: Christine Krebill
Contact: Steve Hackett	
Standard: FCC 15 B, 15.247, RSS 210	Class: N/A

Run #2: Power spectral Density

Mode	Power Setting	Frequency (MHz)	PSD	Limit dBm/3kHz	Result
			(dBm/3kHz) ^{Note 1}		
802.11b	20.5	2411.1965	-9.4	8.0	Pass
	20.5	2437.699	-11.3	8.0	Pass
	20.5	2462.5405	-11.8	8.0	Pass
802.11g	24.0	2412.2737	-11.3	8.0	Pass
	26.0	2440.3865	-9.4	8.0	Pass
	23.0	2459.4945	-11.3	8.0	Pass
HT20	22.0	2411.6732	-13.0	8.0	Pass
	26.5	2434.773	-10.0	8.0	Pass
	22.5	2462.634	-12.3	8.0	Pass
HT40	20.0	2424.7787	-17.5	8.0	Pass
	21.5	2437.9218	-16.8	8.0	Pass
	19.5	2449.4775	-15.3	8.0	Pass

Note 1:

Power spectral density measured using RB=3 kHz, VB=10kHz, analyzer with peak detector and with a sweep time set to ensure a dwell time of at least 1 second per 3kHz. The measurement is made at the frequency of PPSD determined from preliminary scans using RB=3kHz using multiple sweeps at a faster rate over the 6dB bandwidth of the signal.

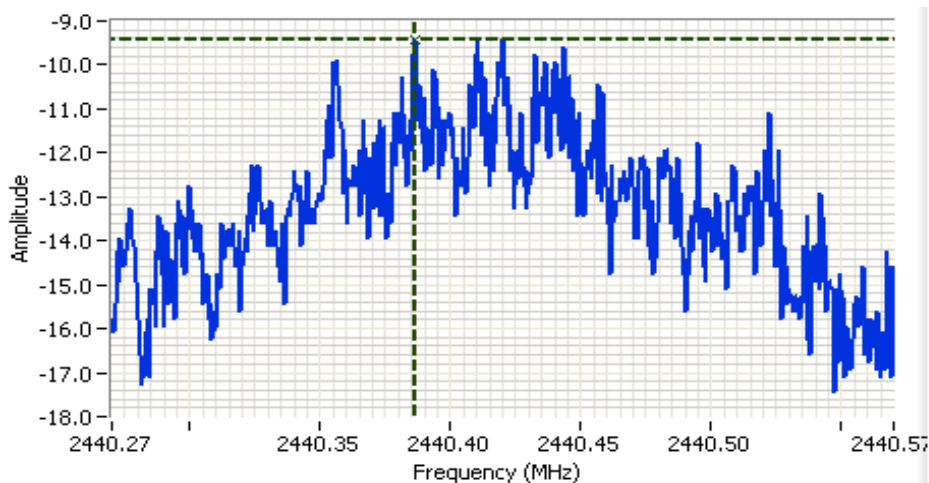

Analyzer Settings

HP8564E,EMICF: 2440.420
MHz
SPAN: 300 kHz
RB: 3.00 kHz
VB: 10.0 kHz
Detector: POS
Attn: 10 DB
RL Offset: 11.0 DB
Sweep Time: 100.0s
Ref Lvl: 5.4 DBM

Comments

PSD = -9.4 dBm/3kHz
802.11g

Cursor 1	2440.3865	-9.43	↕	↔	↕	↔
	0.0000	0.00	↕	↔	↕	↔

Client: Intel	Job Number: J84264
Model: 135BNHMW & 135BNHU	T-Log Number: T84548
	Account Manager: Christine Krebill
Contact: Steve Hackett	
Standard: FCC 15 B, 15.247, RSS 210	Class: N/A

Run #3: Signal Bandwidth

Mode	Power Setting	Frequency (MHz)	Resolution Bandwidth	Bandwidth (MHz)	
				6dB	99%
802.11b	20.5	2412	100kHz	12.5	15.3
	20.5	2437	100kHz	12.5	15.3
	20.5	2462	100kHz	12.5	15.3
802.11g	24.0	2412	100kHz	15.8	17.0
	26.0	2437	100kHz	15.3	17.1
	23.0	2462	100kHz	16.1	17.0
HT20	22.0	2412	100kHz	15.2	18.1
	26.5	2437	100kHz	16.0	18.3
	22.5	2462	100kHz	16.4	18.2
HT40	20.0	2422	100kHz	36.5	36.8
	21.5	2437	100kHz	36.2	36.8
	19.5	2452	100kHz	36.7	36.8

Note 1: 99% bandwidth measured in accordance with RSS GEN, with RB > 1% of the span and VB > 3xRB

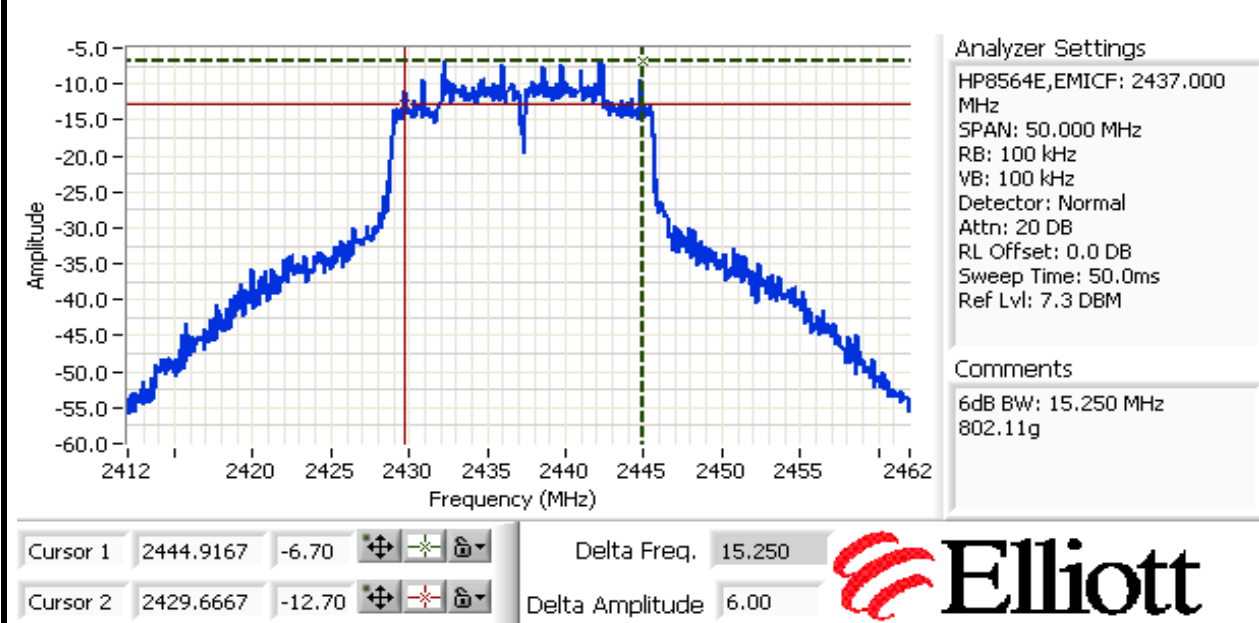

Client: Intel	Job Number: J84264
Model: 135BNHMW & 135BNHU	T-Log Number: T84548
	Account Manager: Christine Krebill
Contact: Steve Hackett	
Standard: FCC 15 B, 15.247, RSS 210	Class: N/A

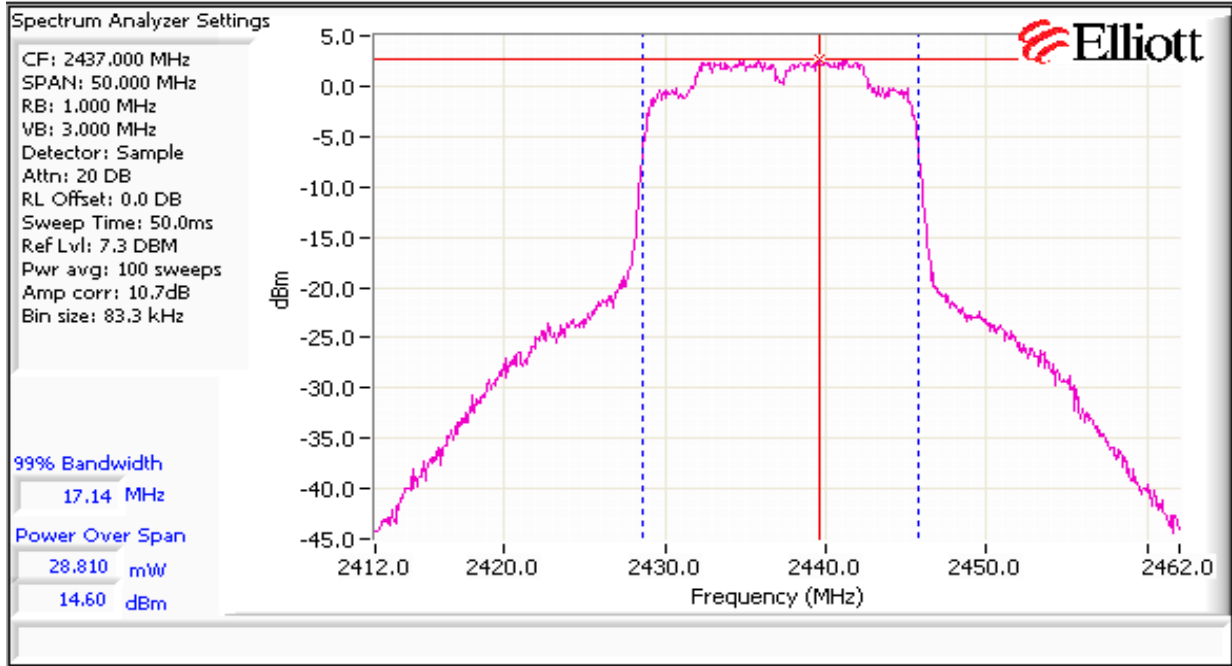

Client: Intel	Job Number: J84264
Model: 135BNHMW & 135BNHU	T-Log Number: T84548
	Account Manager: Christine Krebill
Contact: Steve Hackett	
Standard: FCC 15 B, 15.247, RSS 210	Class: N/A

Run #4: Out of Band Spurious Emissions

Frequency (MHz)	Limit	Result
2412, 2422	-30dBc	Pass
2437	-30dBc	Pass
2452, 2462	-30dBc	Pass

Plots for low channel, 802.11b

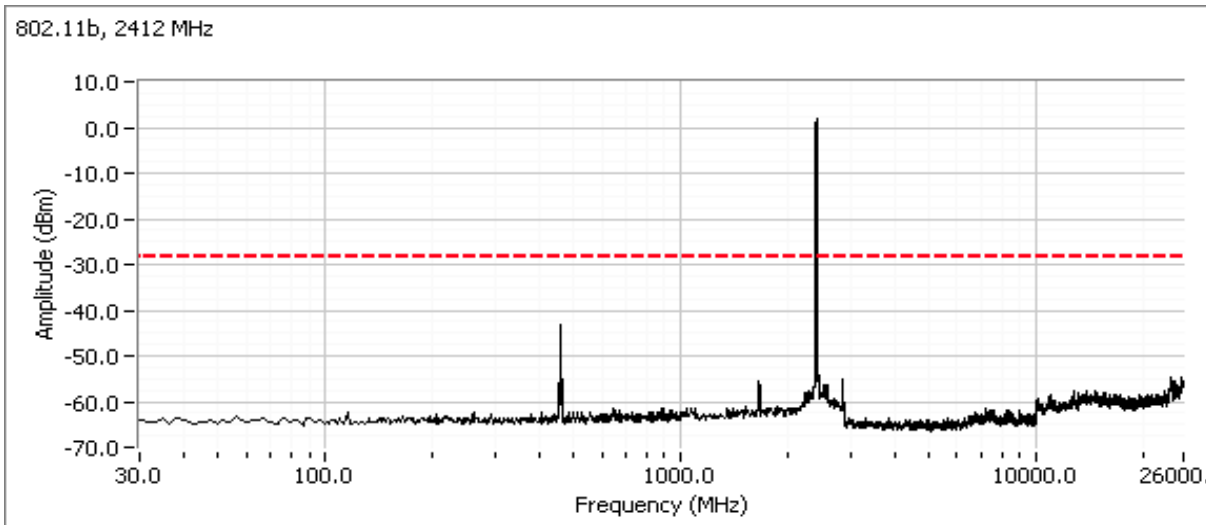

Additional plot showing compliance with -30dBc limit from 2390 MHz to 2400 MHz. Radiated measurements used to show compliance with the limits in the restricted band below 2390 MHz.

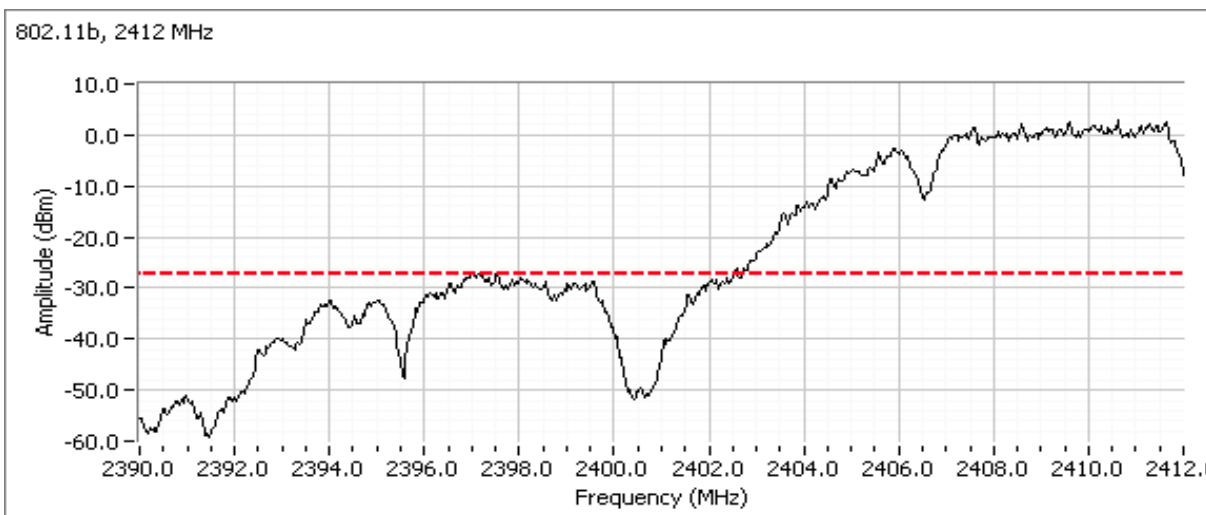

Client: Intel	Job Number: J84264
Model: 135BNHMW & 135BNHU	T-Log Number: T84548
	Account Manager: Christine Krebill
Contact: Steve Hackett	
Standard: FCC 15 B, 15.247, RSS 210	Class: N/A

Plots for center channel, 802.11b

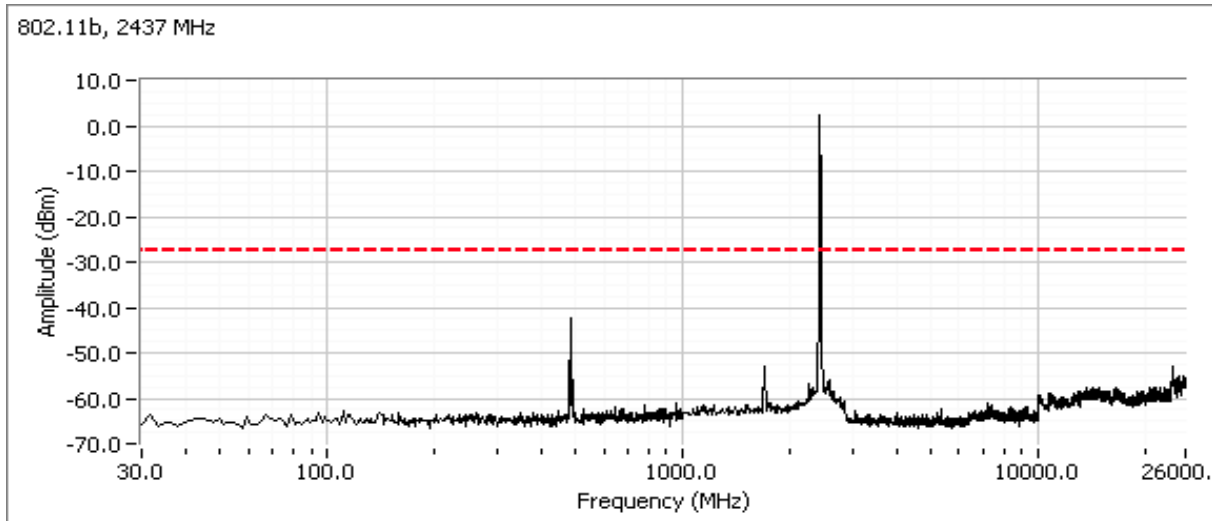

Plots for high channel, 802.11b

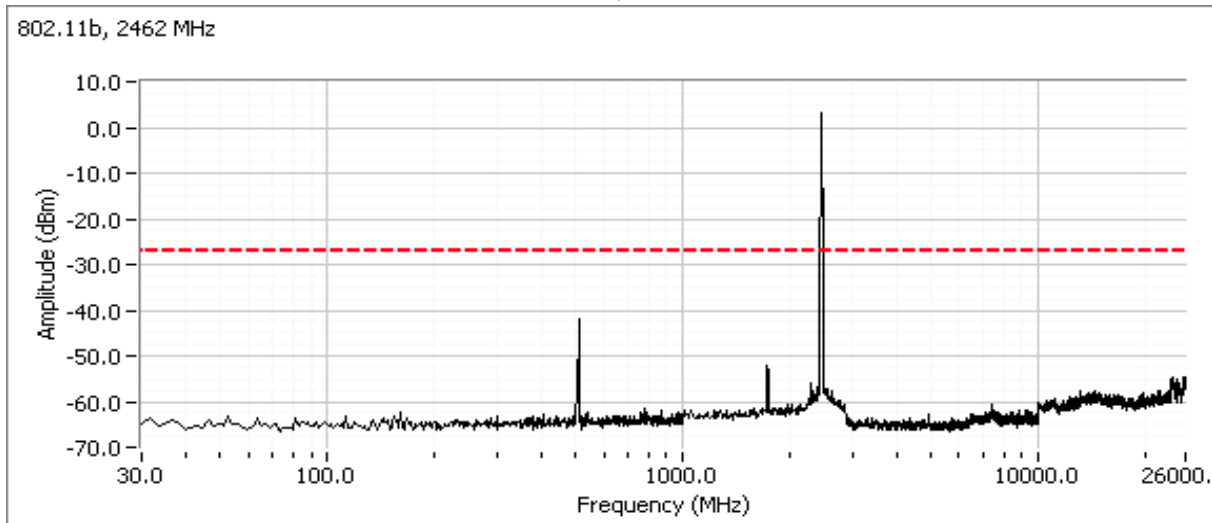

Client: Intel	Job Number: J84264
Model: 135BNHMW & 135BNHU	T-Log Number: T84548
	Account Manager: Christine Krebill
Contact: Steve Hackett	
Standard: FCC 15 B, 15.247, RSS 210	Class: N/A

Plots for low channel, 802.11g

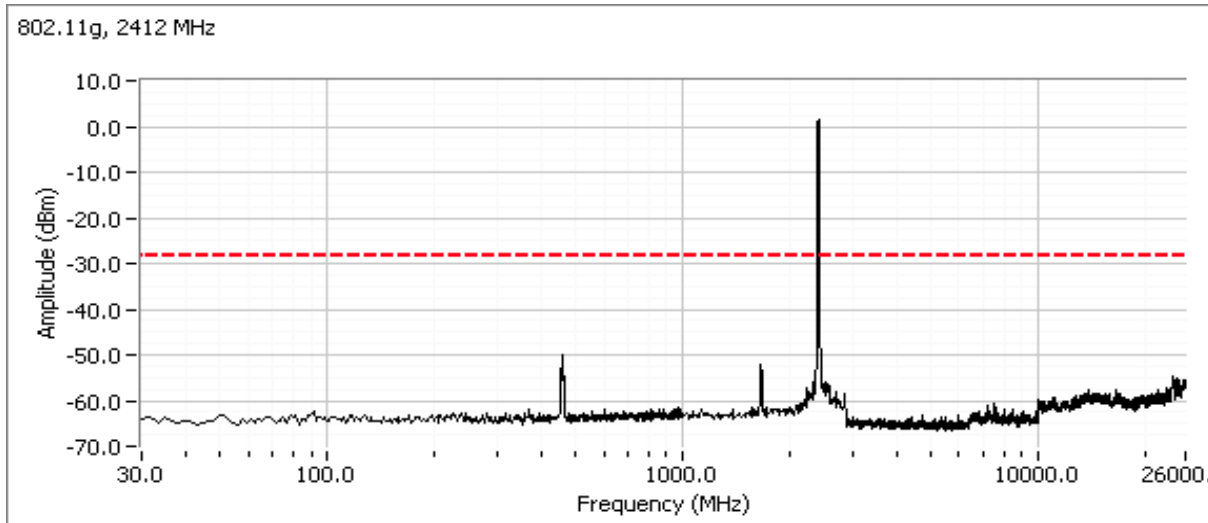

Additional plot showing compliance with -30dBc limit from 2390 MHz to 2400 MHz. Radiated measurements used to show compliance with the limits in the restricted band below 2390 MHz.

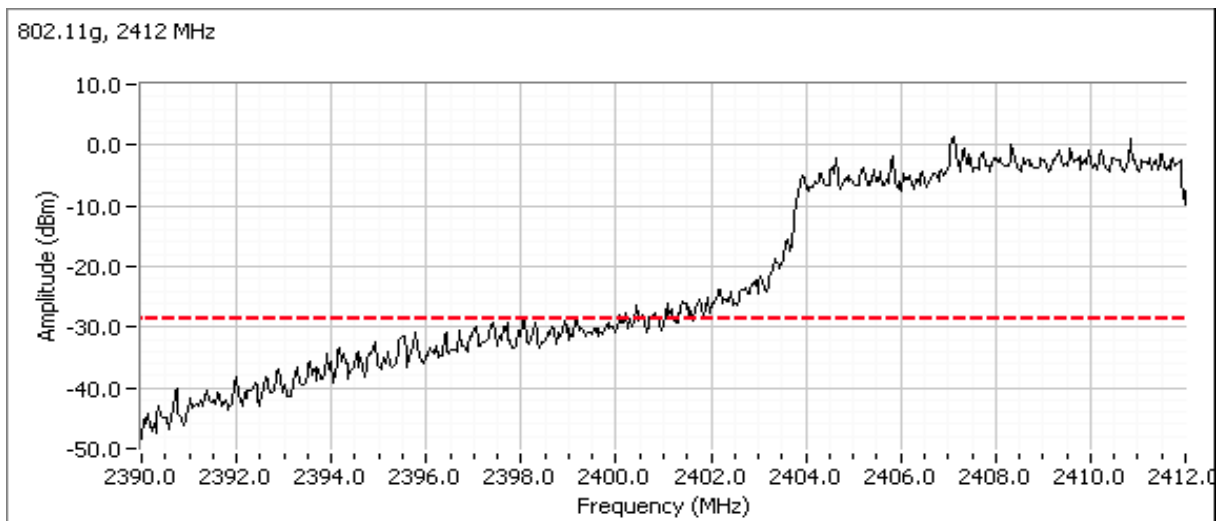

Client: Intel	Job Number: J84264
Model: 135BNHMW & 135BNHU	T-Log Number: T84548
	Account Manager: Christine Krebill
Contact: Steve Hackett	
Standard: FCC 15 B, 15.247, RSS 210	Class: N/A

Plots for center channel, 802.11g

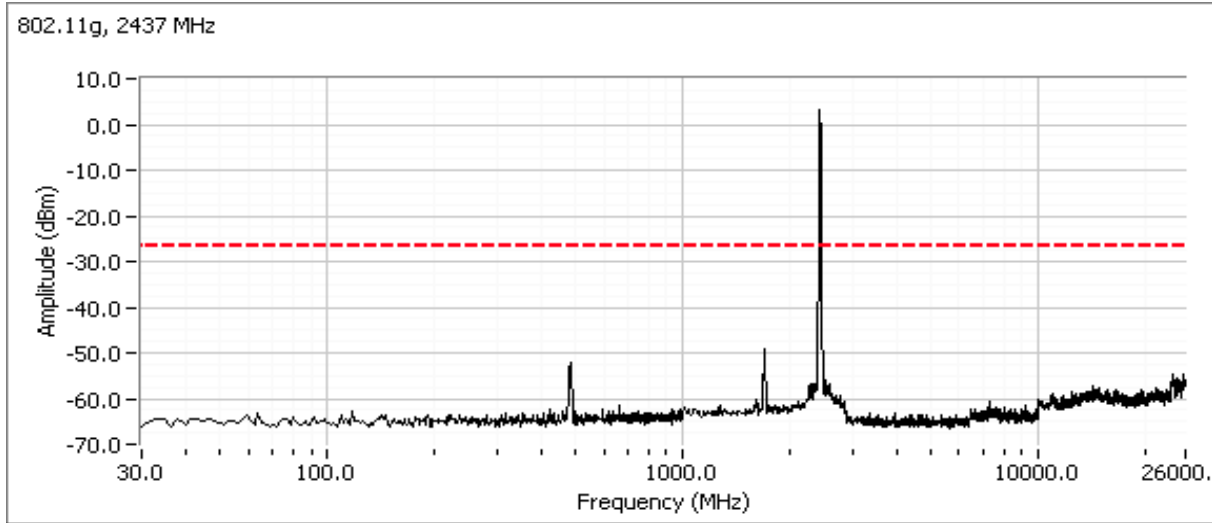

Plots for high channel, 802.11g

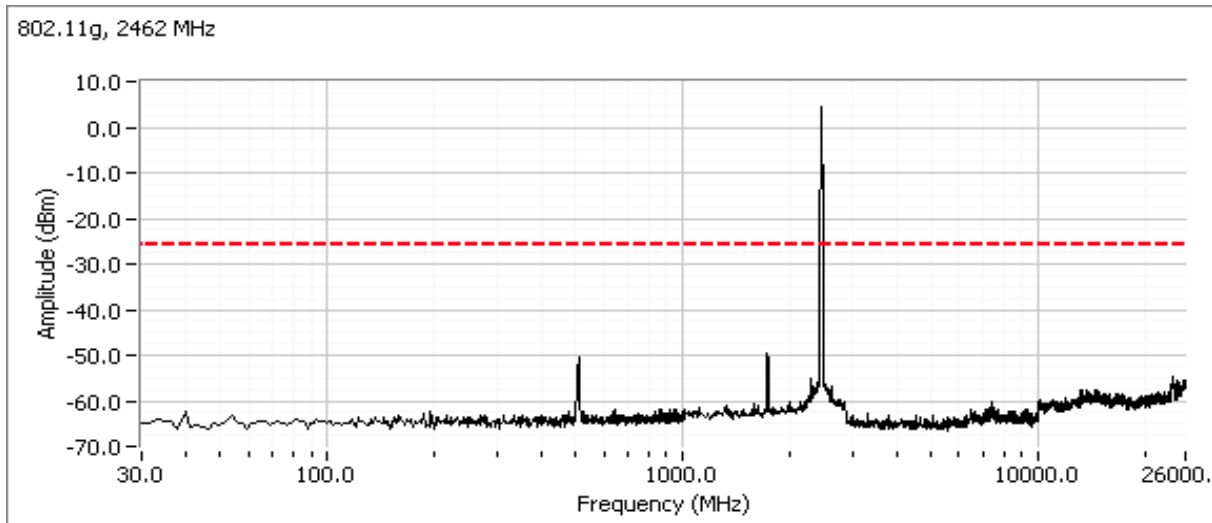

Client: Intel	Job Number: J84264
Model: 135BNHMW & 135BNHU	T-Log Number: T84548
	Account Manager: Christine Krebill
Contact: Steve Hackett	
Standard: FCC 15 B, 15.247, RSS 210	Class: N/A

Plots for low channel, HT20

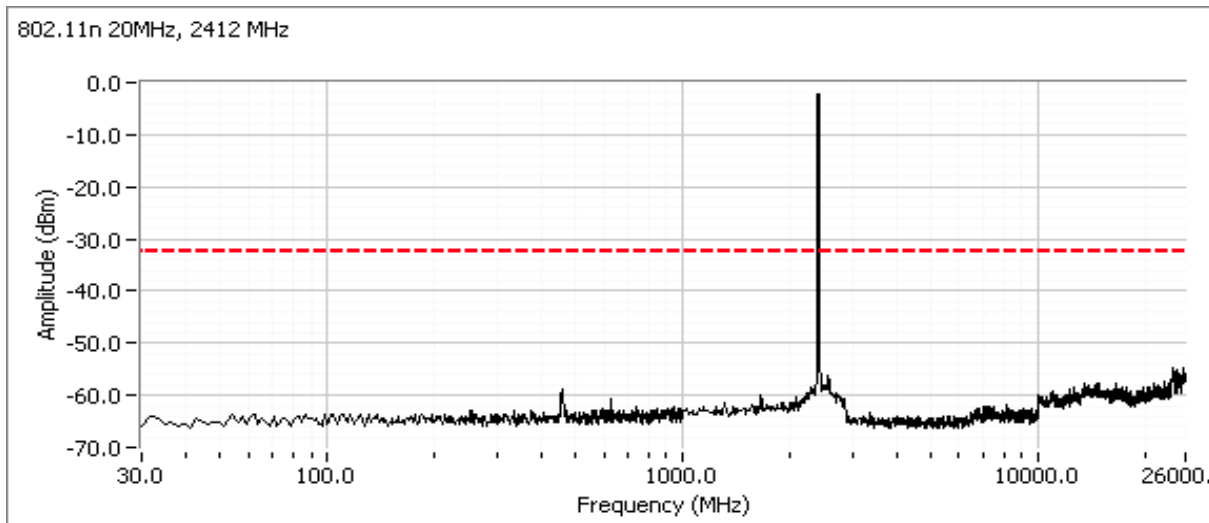

Additional plot showing compliance with -30dBc limit from 2390 MHz to 2400 MHz. Radiated measurements used to show compliance with the limits in the restricted band below 2390 MHz.

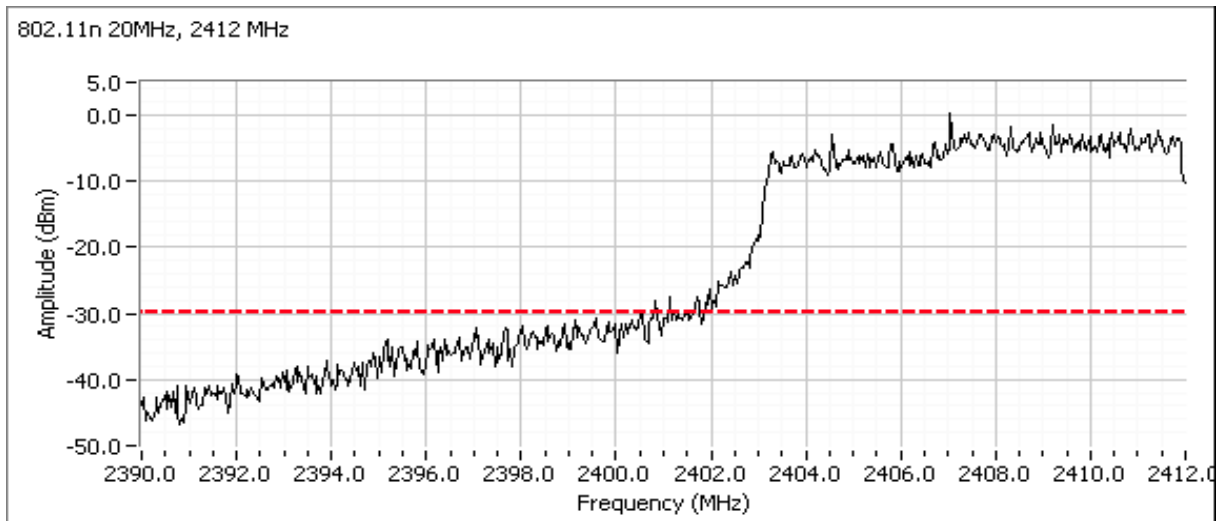

Client: Intel	Job Number: J84264
Model: 135BNHMW & 135BNHU	T-Log Number: T84548
	Account Manager: Christine Krebill
Contact: Steve Hackett	
Standard: FCC 15 B, 15.247, RSS 210	Class: N/A

Plots for center channel, HT20

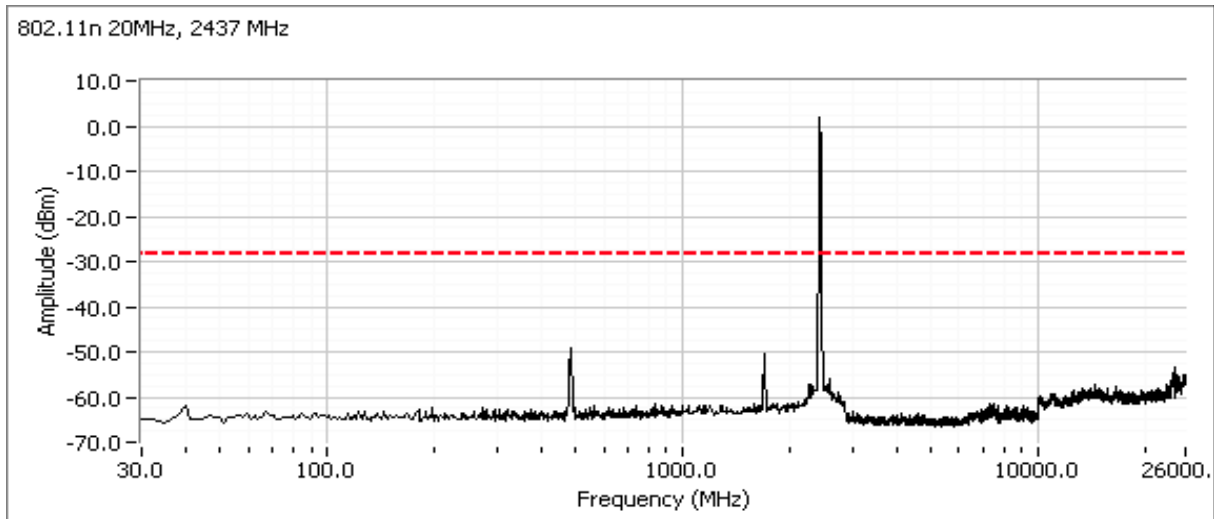

Plots for high channel, HT20

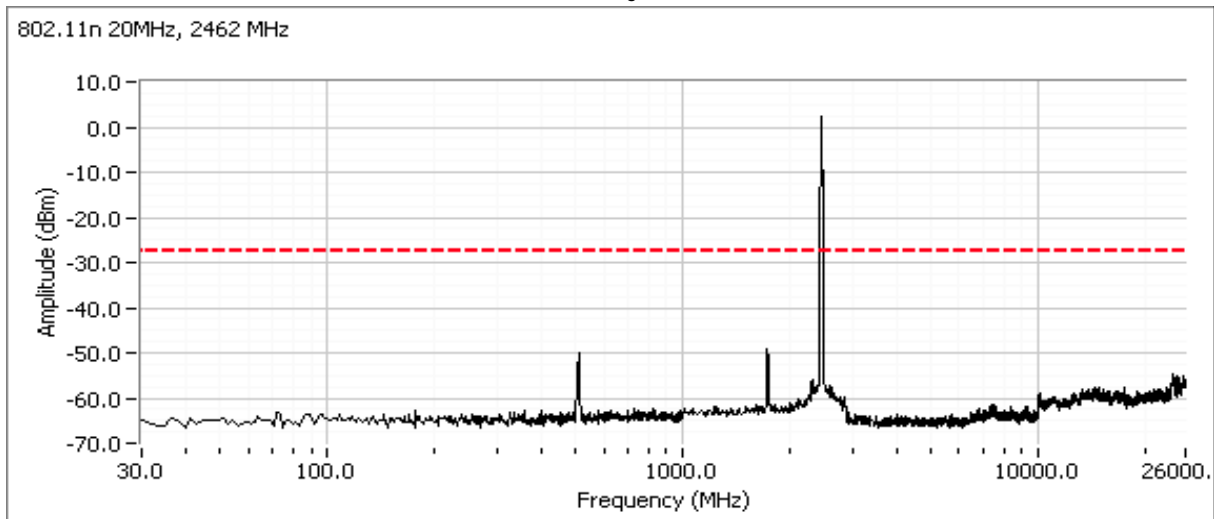

Client: Intel	Job Number: J84264
Model: 135BNHMW & 135BNHU	T-Log Number: T84548
	Account Manager: Christine Krebill
Contact: Steve Hackett	
Standard: FCC 15 B, 15.247, RSS 210	Class: N/A

Plots for low channel,HT40

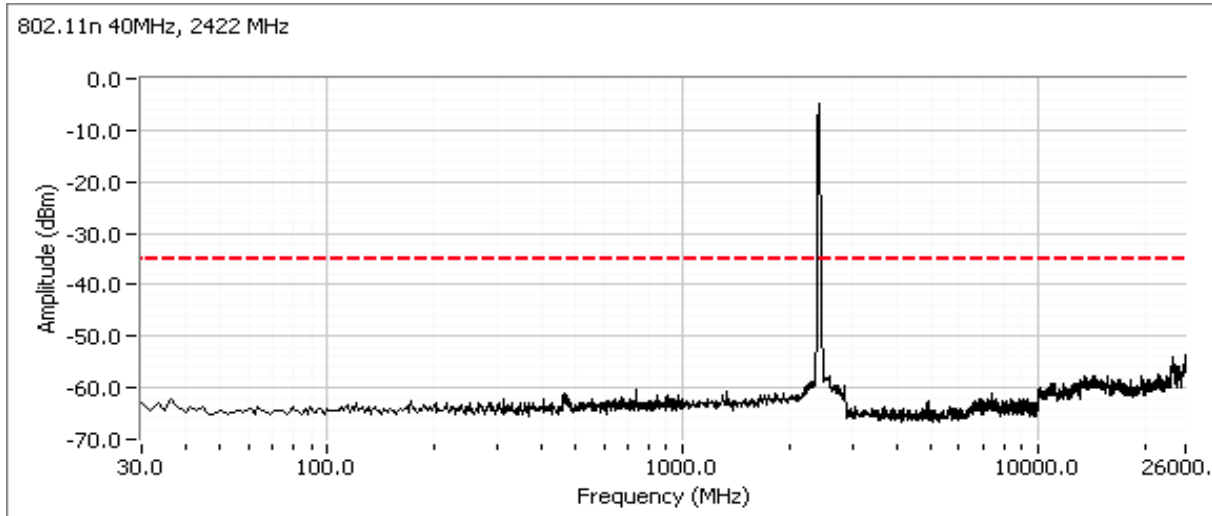

Additional plot showing compliance with -30dBc limit from 2390 MHz to 2400 MHz. Radiated measurements used to show compliance with the limits in the restricted band below 2390 MHz.

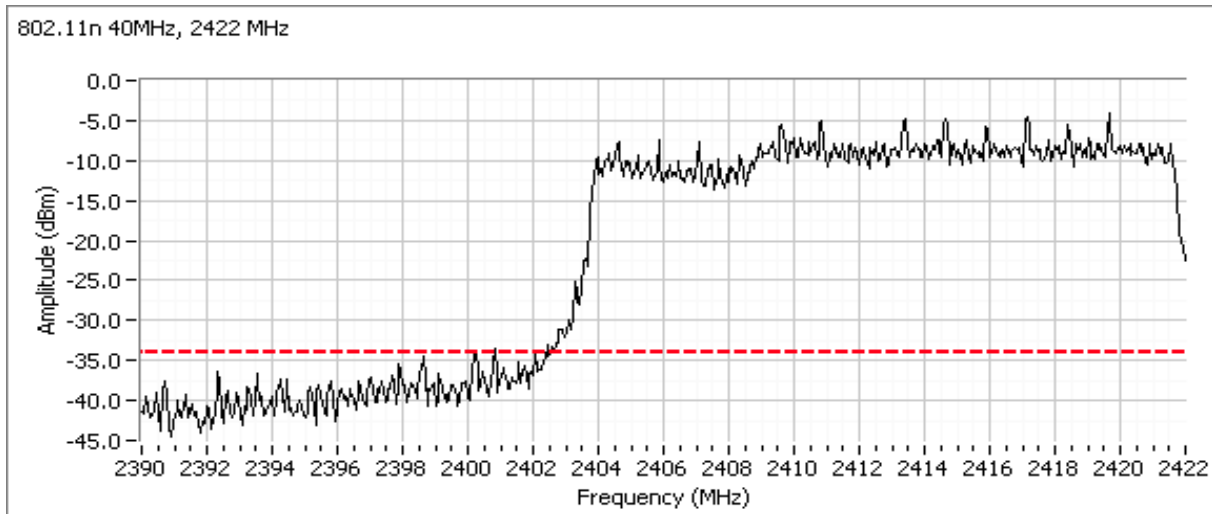

Client: Intel	Job Number: J84264
Model: 135BNHMW & 135BNHU	T-Log Number: T84548
	Account Manager: Christine Krebill
Contact: Steve Hackett	
Standard: FCC 15 B, 15.247, RSS 210	Class: N/A

Plots for center channel, HT40

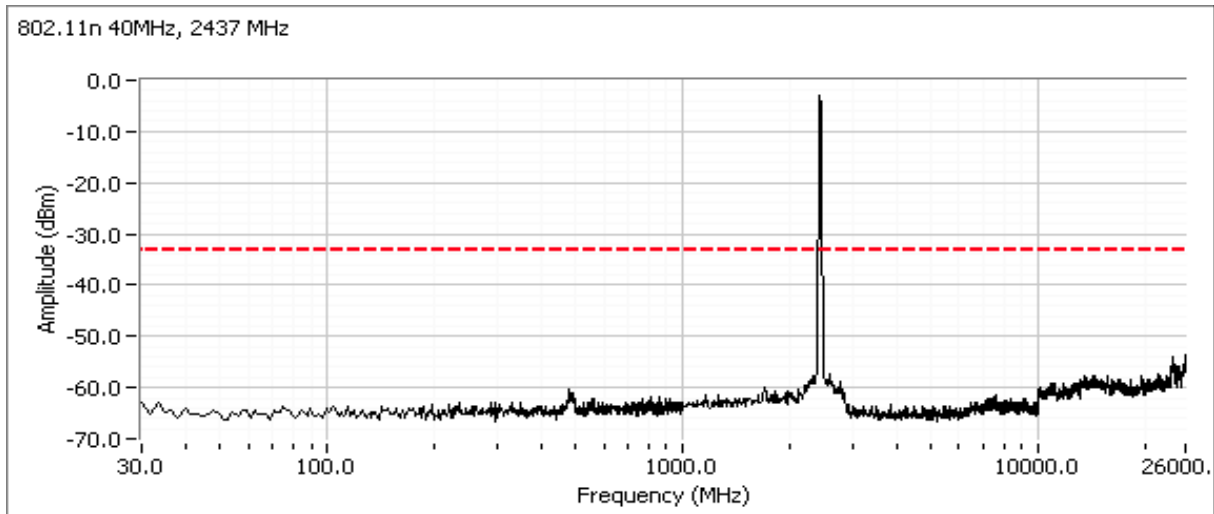

Plots for high channel, HT40

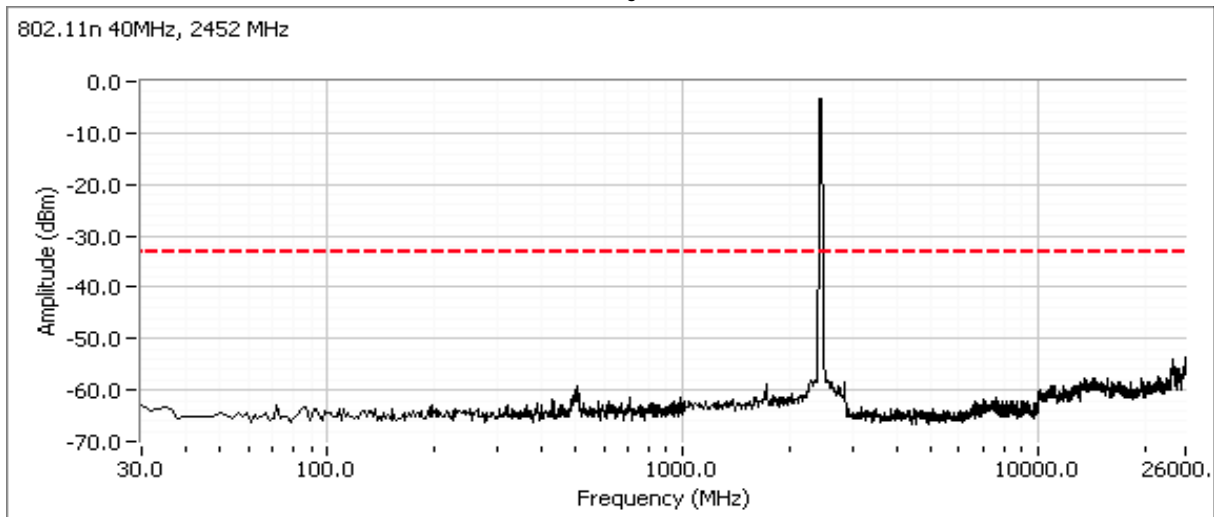

Client: Intel	Job Number: J84264
Model: 135BNHMW & 135BNHU	T-Log Number: T84548
	Account Manager: Christine Krebill
Contact: Steve Hackett	
Standard: FCC 15 B, 15.247, RSS 210	Class: N/A

RSS 210 and FCC 15.247 (DTS) Radiated Spurious Emissions

Test Specific Details

Objective: The objective of this test session is to perform final qualification testing of the EUT with respect to the specification listed above.

General Test Configuration

The EUT and all local support equipment were located on the turntable for radiated spurious emissions testing. All remote support equipment was located approximately 30 meters from the EUT with all I/O connections running on top of the groundplane or routed in overhead in the GR-1089 test configuration.

For radiated emissions testing the measurement antenna was located 3 meters from the EUT.

Ambient Conditions:
 Temperature: 21.5 °C
 Rel. Humidity: 41 %

Summary of Results

For Wi-Fi, only Chain A is used for Tx. For Bluetooth only chain B is used for Tx. Both chains are used for Rx for Wi-Fi and Bluetooth
 MAC Address: 00150096B40F DRTU Tool Version 1.5.3-0320 Driver version 15.0.0.51 - Sample with PIFA antenna

Run #	Mode	Channel	Power Setting	Measured Power	Test Performed	Limit	Result / Margin
1	BT Basic 802.1b	2402MHz 2412MHz	7dBm 16.5dBm	5.9 16.6	Radiated Emissions, 1 - 10 GHz	FCC Part 15.209 / 15.247(c)	42.6dBµV/m @ 2251.7MHz (-11.4dB)
2	BT Basic 802.1b	2480MHz 2462MHz	7dBm 16.5dBm	6.4 16.7		FCC Part 15.209 / 15.247(c)	46.8dBµV/m @ 2500.0MHz (-7.2dB)
3	BT Basic 802.11g	2402MHz 2412MHz	7dBm 16.5dBm	5.9 16.6		FCC Part 15.209 / 15.247(c)	39.7dBµV/m @ 1457.6MHz (-14.3dB)
4	BT Basic 802.1g	2480MHz 2462MHz	7dBm 16.5dBm	6.4 16.8		FCC Part 15.209 / 15.247(c)	44.7dBµV/m @ 2299.8MHz (-9.3dB)
Wi-Fi mode for the following runs based on the worst case mode from runs 1 through 4							
5	BT Basic 802.1b	2402MHz 2437MHz	7dBm 16.5dBm	5.9 16.6	Radiated Emissions, 1 - 10 GHz	FCC Part 15.209 / 15.247(c)	53.8dBµV/m @ 2365.0MHz (-0.2dB)
6	BT Basic 802.1b	2440MHz 2412MHz	7dBm 16.5dBm	6.5 16.6		FCC Part 15.209 / 15.247(c)	42.2dBµV/m @ 2868.6MHz (-11.8dB)
7	BT Basic 802.11b	2440MHz 2462MHz	7dBm 16.5dBm	6.5 16.7		FCC Part 15.209 / 15.247(c)	44.4dBµV/m @ 2299.2MHz (-9.6dB)
8	BT Basic 802.11b	2480MHz 2437MHz	7dBm 16.5dBm	6.4 16.6		FCC Part 15.209 / 15.247(c)	42.2dBµV/m @ 2278.8MHz (-11.8dB)
Wi-Fi mode and channel and Bluetooth channel for the following run based on the worst case mode from runs 1 through 8							
9	BT EDR 802.1b	2402MHz 2437MHz	7dBm 16.5dBm	2.5 16.6	Radiated Emissions, 1 - 10 GHz	FCC Part 15.209 / 15.247(c)	50.2dBµV/m @ 2370.6MHz (-3.8dB)

Client: Intel	Job Number: J84264
Model: 135BNHMW & 135BNHU	T-Log Number: T84548
	Account Manager: Christine Krebill
Contact: Steve Hackett	
Standard: FCC 15 B, 15.247, RSS 210	Class: N/A

Modifications Made During Testing

No modifications were made to the EUT during testing

Deviations From The Standard

No deviations were made from the requirements of the standard.

Run #1: Radiated Spurious Emissions, 1-10GHz. Operating Mode: 802.11b @ 2412, BT Basic @ 2402 MHz

Date of Test: 9/20/2011

Test Engineer: Rafael Varelas

Test Location: FT Chamber #3

Preliminary Spurious Emissions excluding allocated band (Peak versus average limit)

Frequency MHz	Level dB μ V/m	Pol v/h	15.209 / 15.247		Detector Pk/QP/Avg	Azimuth degrees	Height meters	Comments
			Limit	Margin				
1200.190	39.2	V	54.0	-14.8	Peak	142	1.0	
1457.690	39.0	H	54.0	-15.0	Peak	159	1.0	
7237.170	44.9	V	70.0	-25.1	Peak	290	1.3	

Final measurements at 3m

Frequency MHz	Level dB μ V/m	Pol v/h	15.209 / 15.247		Detector Pk/QP/Avg	Azimuth degrees	Height meters	Comments
			Limit	Margin				
1197.920	31.4	V	54.0	-22.6	AVG	138	1.0	RB 1 MHz;VB 10 Hz;Pk
1199.920	45.2	V	74.0	-28.8	PK	138	1.0	RB 1 MHz;VB 3 MHz;Pk

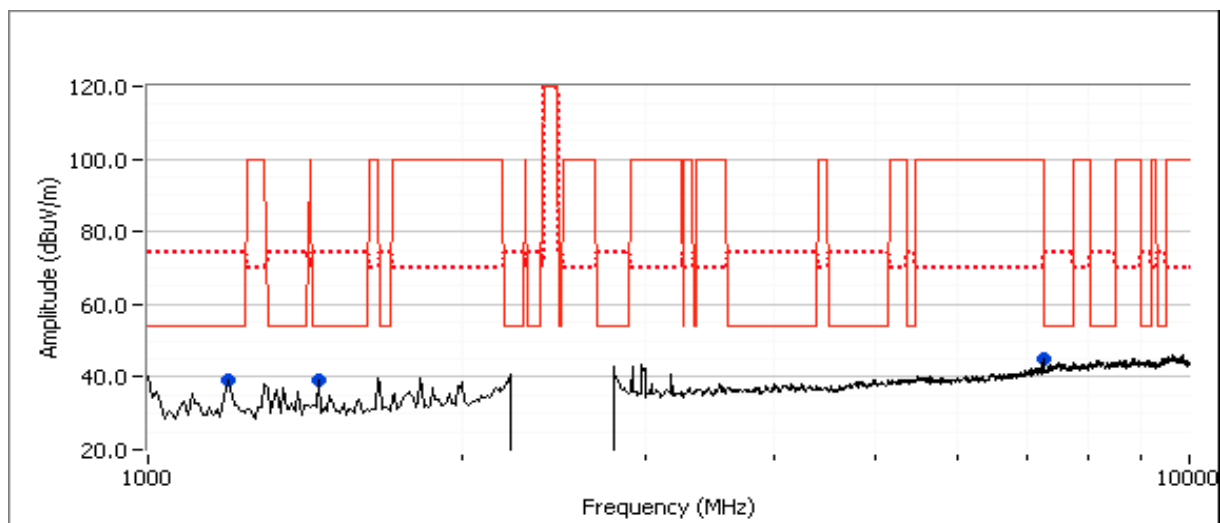

Client: Intel	Job Number: J84264
Model: 135BNHMW & 135BNHU	T-Log Number: T84548
	Account Manager: Christine Krebill
Contact: Steve Hackett	
Standard: FCC 15 B, 15.247, RSS 210	Class: N/A

Preliminary Spurious Emissions at 20cm from 2-3 GHz (Peak versus average limit)

Frequency MHz	Level dB μ V/m	Pol v/h	15.209 / 15.247		Detector Pk/QP/Avg	Azimuth degrees	Height meters	Comments
			Limit	Margin				
2251.670	42.6	V	54.0	-11.4	Peak	181	1.0	
2456.670	51.1	V	NA	NA	Peak	181	1.0	
2571.670	44.4	V	54.0	-9.6	Peak	181	1.0	

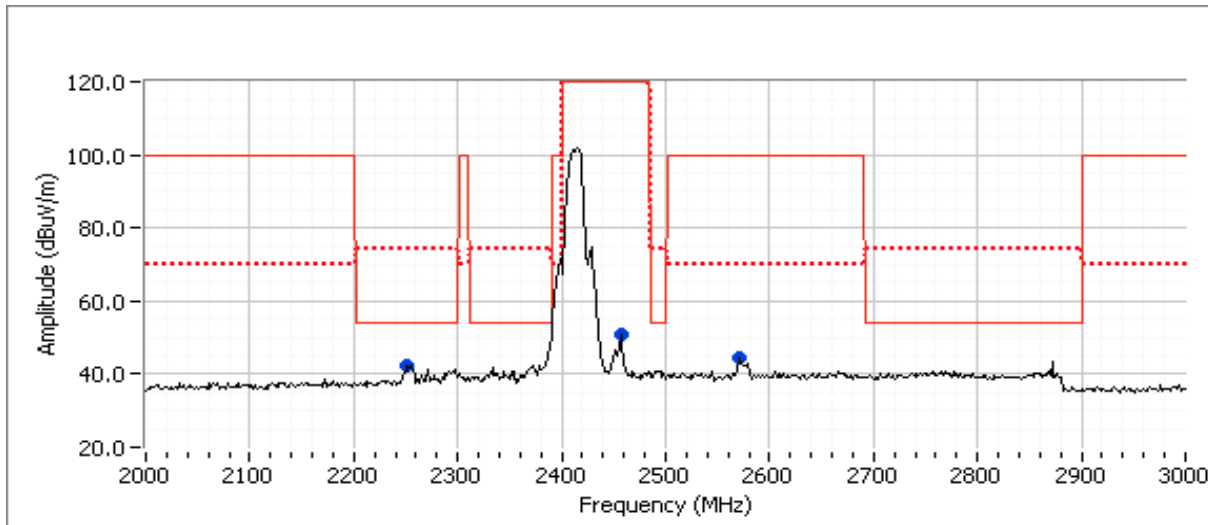

Client: Intel	Job Number: J84264
Model: 135BNHMW & 135BNHU	T-Log Number: T84548
	Account Manager: Christine Krebill
Contact: Steve Hackett	
Standard: FCC 15 B, 15.247, RSS 210	Class: N/A

Run #2: Radiated Spurious Emissions, 1-10GHz. Operating Mode: 802.11b @ 2462, BT Basic @ 2480 MHz

Date of Test: 9/20/2011

Test Engineer: Rafael Varelas

Test Location: FT Chamber #3

Preliminary Spurious Emissions excluding allocated band (Peak versus average limit)

Frequency	Level	Pol	15.209 / 15.247		Detector	Azimuth	Height	Comments
MHz	dB μ V/m	v/h	Limit	Margin	Pk/QP/Avg	degrees	meters	
1232.450	45.4	V	54.0	-8.6	Peak	0	1.3	
1457.690	40.6	H	54.0	-13.4	Peak	171	1.0	
7396.030	47.1	V	54.0	-6.9	Peak	288	1.6	

Final measurements at 3m

Frequency	Level	Pol	15.209 / 15.247		Detector	Azimuth	Height	Comments
MHz	dB μ V/m	v/h	Limit	Margin	Pk/QP/Avg	degrees	meters	
7390.630	44.1	V	54.0	-9.9	AVG	287	1.8	RB 1 MHz;VB 10 Hz;Pk
7386.060	51.7	V	74.0	-22.3	PK	287	1.8	RB 1 MHz;VB 3 MHz;Pk

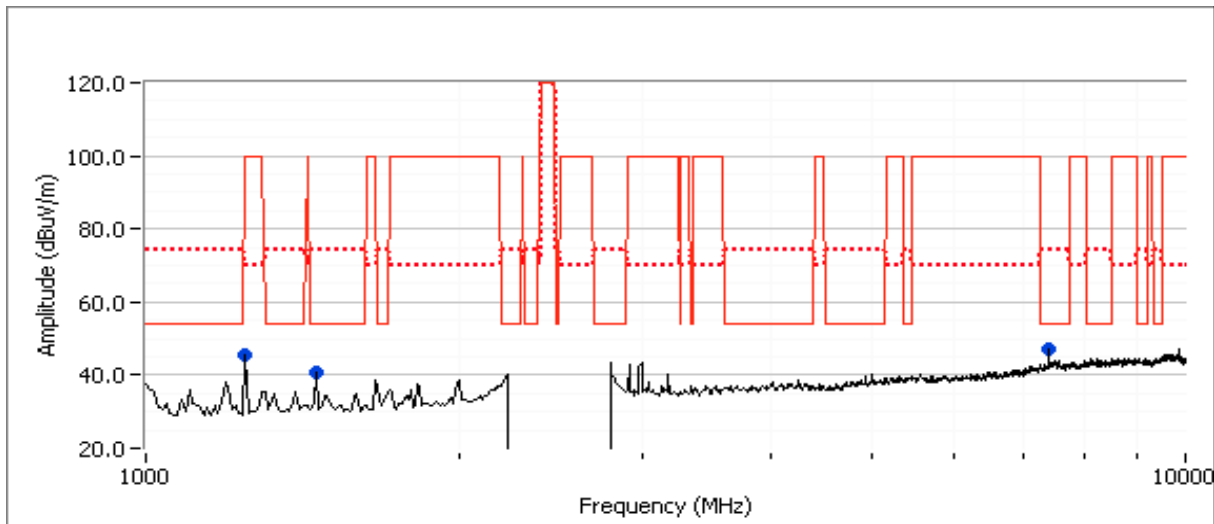

Client: Intel	Job Number: J84264
Model: 135BNHMW & 135BNHU	T-Log Number: T84548
	Account Manager: Christine Krebill
Contact: Steve Hackett	
Standard: FCC 15 B, 15.247, RSS 210	Class: N/A

Preliminary Spurious Emissions at 20cm from 2-3 GHz (Peak versus average limit)

Frequency MHz	Level dB μ V/m	Pol v/h	15.209 / 15.247		Detector Pk/QP/Avg	Azimuth degrees	Height meters	Comments
			Limit	Margin				
2305.000	44.7	V	54.0	-9.3	Peak	181	1.0	
2500.000	43.8	V	54.0	-10.2	Peak	181	1.0	

Final measurements at 3m

Frequency MHz	Level dB μ V/m	Pol v/h	15.209 / 15.247		Detector Pk/QP/Avg	Azimuth degrees	Height meters	Comments
			Limit	Margin				
2500.000	46.8	H	54.0	-7.2	AVG	352	1.0	RB 1 MHz;VB 10 Hz;Pk
2497.750	55.2	H	74.0	-18.8	PK	352	1.0	RB 1 MHz;VB 3 MHz;Pk
2495.530	40.5	V	54.0	-13.5	AVG	263	1.1	RB 1 MHz;VB 10 Hz;Pk
2495.500	50.4	V	74.0	-23.6	PK	263	1.1	RB 1 MHz;VB 3 MHz;Pk
2299.750	44.8	H	54.0	-9.2	AVG	240	1.1	RB 1 MHz;VB 10 Hz;Pk
2299.980	53.9	H	74.0	-20.1	PK	240	1.1	RB 1 MHz;VB 3 MHz;Pk

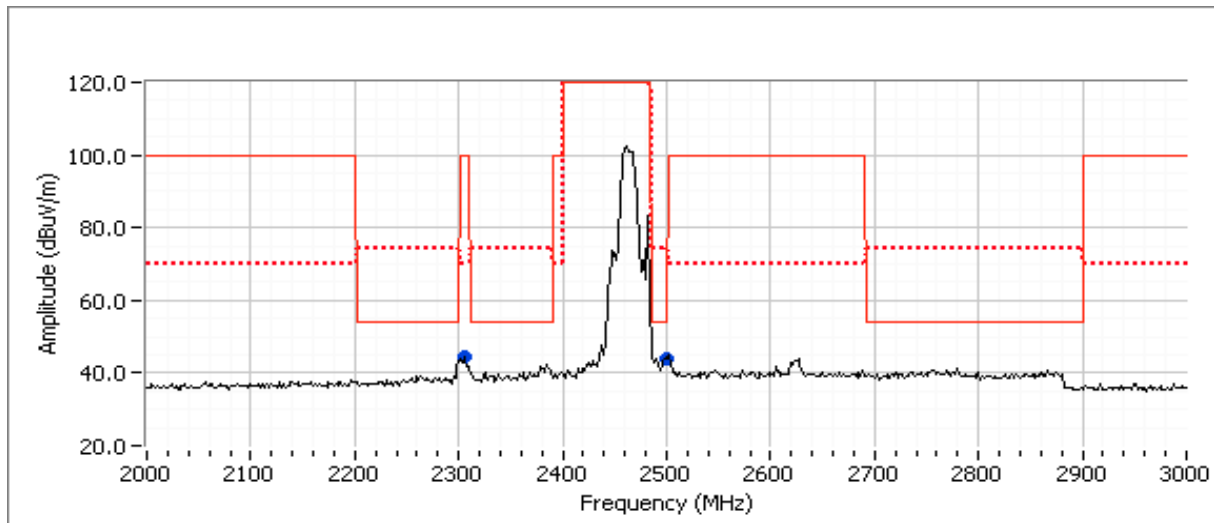

Client: Intel	Job Number: J84264
Model: 135BNHMW & 135BNHU	T-Log Number: T84548
	Account Manager: Christine Krebill
Contact: Steve Hackett	
Standard: FCC 15 B, 15.247, RSS 210	Class: N/A

Run #3: Radiated Spurious Emissions, 1-10GHz. Operating Mode: 802.11g @ 2412, BT Basic @ 2402 MHz

Date of Test: 9/20/2011

Test Engineer: Rafael Varelas

Test Location: FT Chamber #3

Preliminary Spurious Emissions excluding allocated band (Peak versus average limit)

Frequency MHz	Level dB μ V/m	Pol v/h	15.209 / 15.247		Detector Pk/QP/Avg	Azimuth degrees	Height meters	Comments
			Limit	Margin				
1457.690	38.6	H	54.0	-15.4	Peak	160	1.3	
7238.670	47.6	V	54.0	-6.4	Peak	284	1.3	Signal not in restricted band

Final measurements at 3m

Frequency MHz	Level dB μ V/m	Pol v/h	15.209 / 15.247		Detector Pk/QP/Avg	Azimuth degrees	Height meters	Comments
			Limit	Margin				
1457.560	39.7	H	54.0	-14.3	AVG	168	1.0	RB 1 MHz;VB 10 Hz;Pk
1457.550	42.9	H	74.0	-31.1	PK	168	1.0	RB 1 MHz;VB 3 MHz;Pk

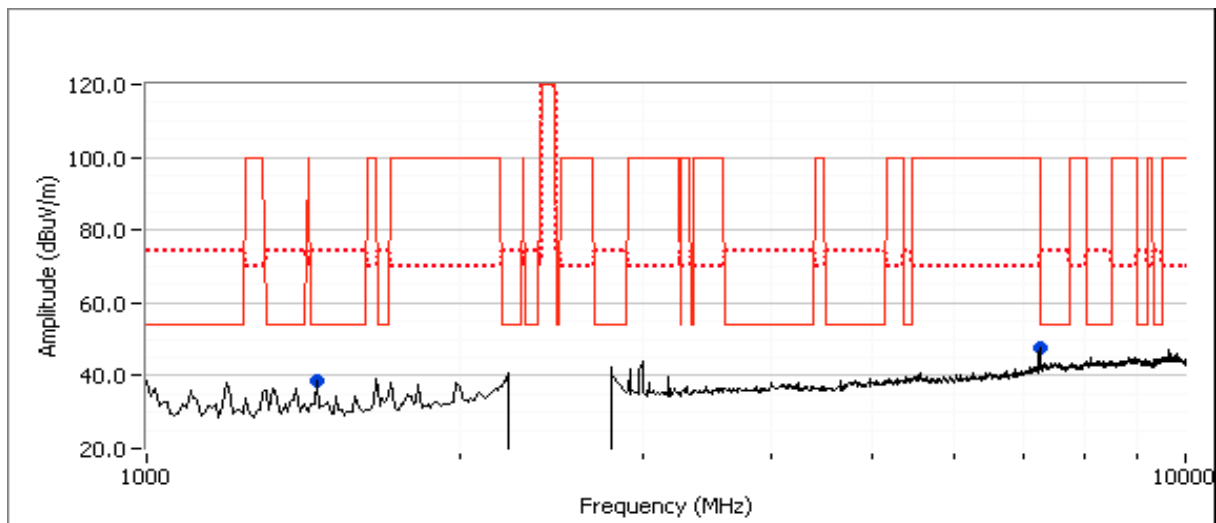

Client: Intel	Job Number: J84264
Model: 135BNHMW & 135BNHU	T-Log Number: T84548
	Account Manager: Christine Krebill
Contact: Steve Hackett	
Standard: FCC 15 B, 15.247, RSS 210	Class: N/A

Preliminary Spurious Emissions at 20cm from 2-3 GHz (Peak versus average limit)

Frequency	Level	Pol	15.209 / 15.247		Detector	Azimuth	Height	Comments
MHz	dB μ V/m	v/h	Limit	Margin	Pk/QP/Avg	degrees	meters	

Final measurements at 3m

Frequency	Level	Pol	15.209 / 15.247		Detector	Azimuth	Height	Comments
MHz	dB μ V/m	v/h	Limit	Margin	Pk/QP/Avg	degrees	meters	

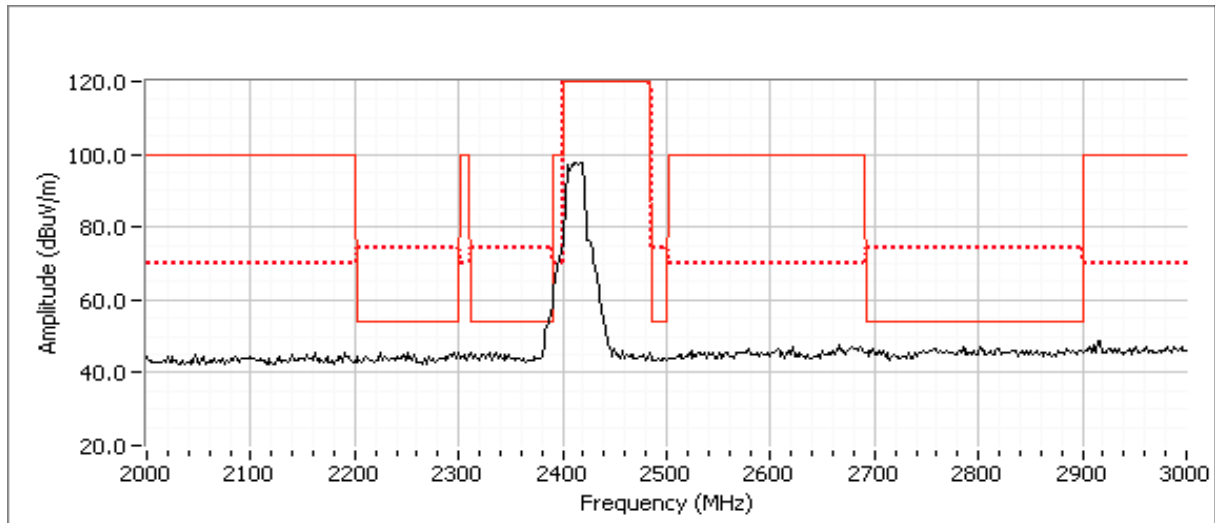

Client: Intel	Job Number: J84264
Model: 135BNHMW & 135BNHU	T-Log Number: T84548
	Account Manager: Christine Krebill
Contact: Steve Hackett	
Standard: FCC 15 B, 15.247, RSS 210	Class: N/A

Run #4: Radiated Spurious Emissions, 1-10GHz. Operating Mode: 802.11g @ 2462, BT Basic @ 2480 MHz

Date of Test: 9/20/2011

Test Engineer: Rafael Varelas

Test Location: FT Chamber #3

Preliminary Spurious Emissions excluding allocated band (Peak versus average limit)

Frequency	Level	Pol	15.209 / 15.247		Detector	Azimuth	Height	Comments
MHz	dB μ V/m	v/h	Limit	Margin	Pk/QP/Avg	degrees	meters	
1457.690	39.5	H	54.0	-14.5	Peak	160	1.0	
7381.300	48.3	V	54.0	-5.7	Peak	282	1.6	

Final measurements at 3m

Frequency	Level	Pol	15.209 / 15.247		Detector	Azimuth	Height	Comments
MHz	dB μ V/m	v/h	Limit	Margin	Pk/QP/Avg	degrees	meters	
7385.270	43.1	V	54.0	-10.9	AVG	286	1.2	RB 1 MHz;VB 10 Hz;Pk
7387.830	55.0	V	74.0	-19.0	PK	286	1.2	RB 1 MHz;VB 3 MHz;Pk

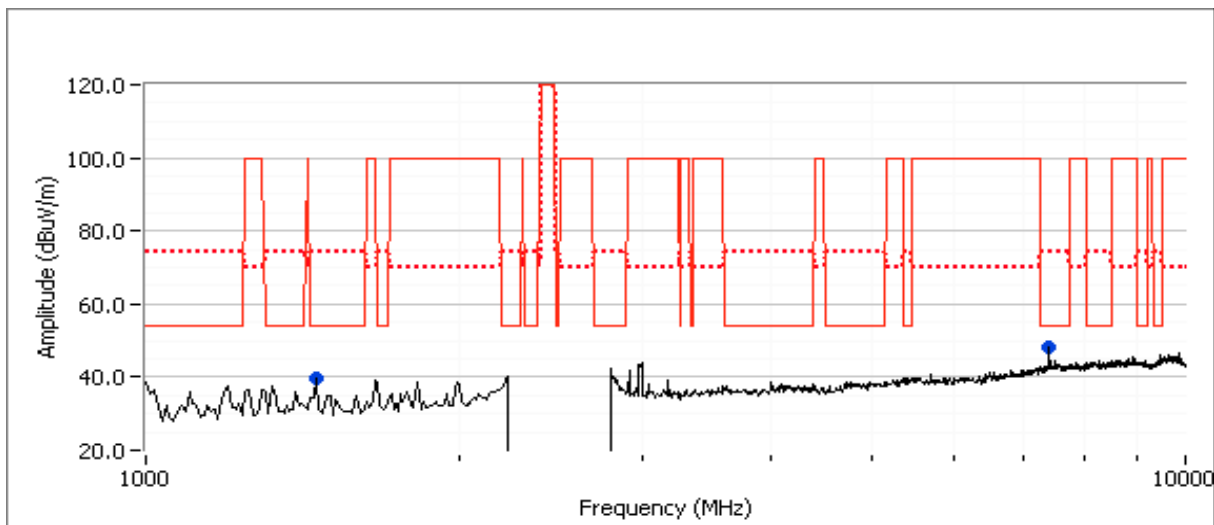

Client: Intel	Job Number: J84264
Model: 135BNHMW & 135BNHU	T-Log Number: T84548
	Account Manager: Christine Krebill
Contact: Steve Hackett	
Standard: FCC 15 B, 15.247, RSS 210	Class: N/A

Preliminary Spurious Emissions at 20cm from 2-3 GHz (Peak versus average limit)

Frequency	Level	Pol	15.209 / 15.247		Detector	Azimuth	Height	Comments
MHz	dB μ V/m	v/h	Limit	Margin	Pk/QP/Avg	degrees	meters	
2299.000	44.9	V	54.0	-9.1	Peak	179	1.0	

Final measurements at 3m

Frequency	Level	Pol	15.209 / 15.247		Detector	Azimuth	Height	Comments
MHz	dB μ V/m	v/h	Limit	Margin	Pk/QP/Avg	degrees	meters	
2299.750	44.7	H	54.0	-9.3	AVG	236	1.0	RB 1 MHz;VB 10 Hz;Pk
2298.580	54.6	H	74.0	-19.4	PK	236	1.0	RB 1 MHz;VB 3 MHz;Pk
2297.900	41.5	V	54.0	-12.5	AVG	253	1.2	RB 1 MHz;VB 10 Hz;Pk
2297.100	52.6	V	74.0	-21.4	PK	253	1.2	RB 1 MHz;VB 3 MHz;Pk

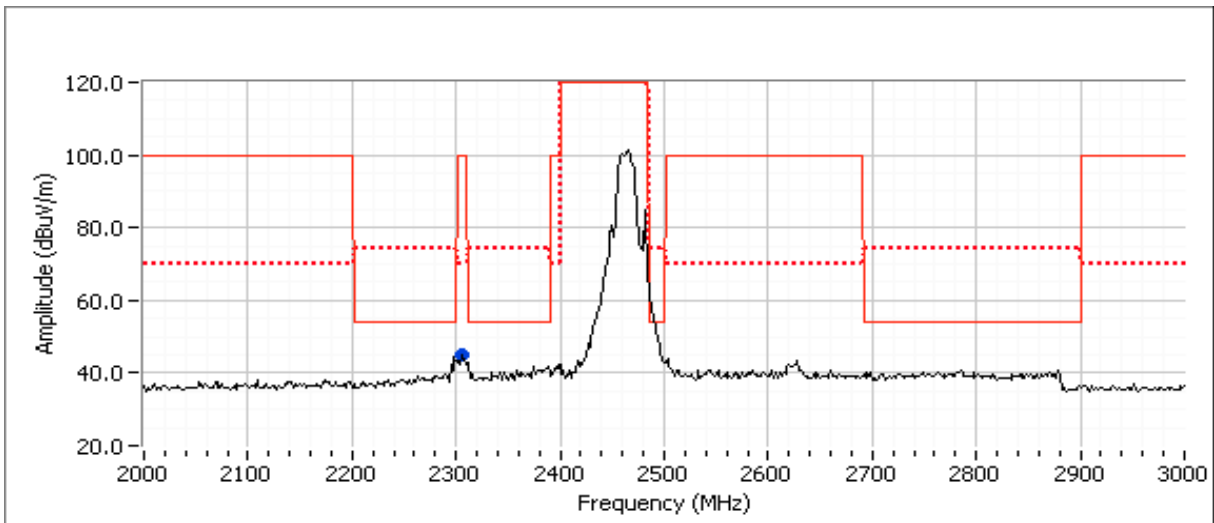

Client: Intel	Job Number: J84264
Model: 135BNHMW & 135BNHU	T-Log Number: T84548
	Account Manager: Christine Krebill
Contact: Steve Hackett	
Standard: FCC 15 B, 15.247, RSS 210	Class: N/A

Run #5: Radiated Spurious Emissions, 1-10GHz. Operating Mode: 802.11b @ 2437 MHz, BT Basic @ 2402 MHz

Date of Test: 9/20/2011

Test Engineer: Rafael Varelas

Test Location: FT Chamber #3

Preliminary Spurious Emissions excluding allocated band (Peak versus average limit)

Frequency	Level	Pol	15.209 / 15.247		Detector	Azimuth	Height	Comments
MHz	dB μ V/m	v/h	Limit	Margin	Pk/QP/Avg	degrees	meters	
1457.690	38.6	H	54.0	-15.4	Peak	161	1.3	
7317.760	45.6	V	54.0	-8.4	Peak	283	1.6	

Final measurements at 3m

Frequency	Level	Pol	15.209 / 15.247		Detector	Azimuth	Height	Comments
MHz	dB μ V/m	v/h	Limit	Margin	Pk/QP/Avg	degrees	meters	
7313.760	43.2	V	54.0	-10.8	AVG	286	1.6	RB 1 MHz;VB 10 Hz;Pk
7307.060	51.1	V	74.0	-22.9	PK	286	1.6	RB 1 MHz;VB 3 MHz;Pk

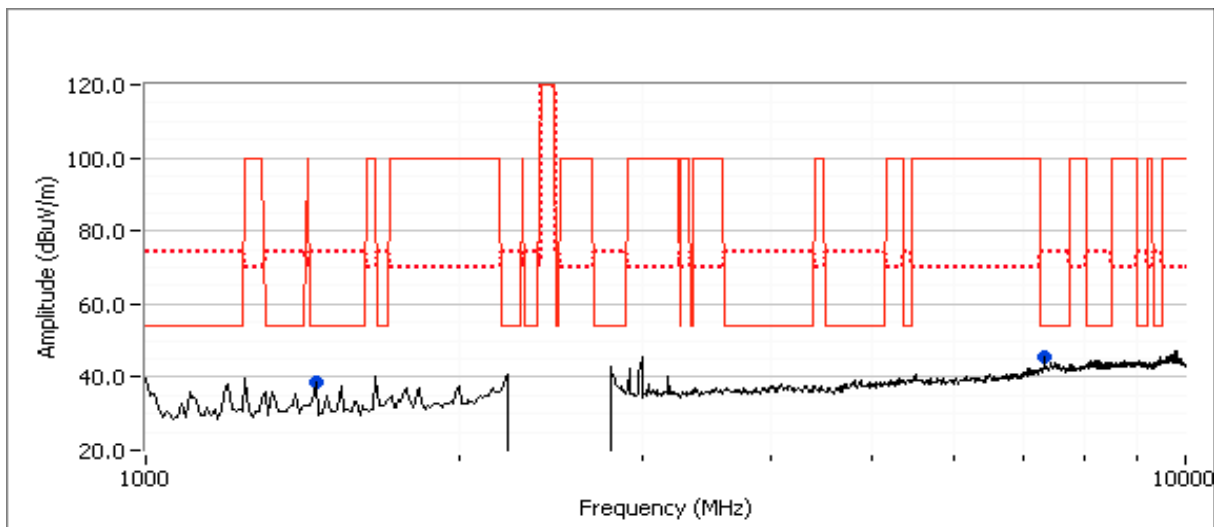

Client: Intel	Job Number: J84264
Model: 135BNHMW & 135BNHU	T-Log Number: T84548
	Account Manager: Christine Krebill
Contact: Steve Hackett	
Standard: FCC 15 B, 15.247, RSS 210	Class: N/A

Preliminary Spurious Emissions at 20cm from 2-3 GHz (Peak versus average limit)

Frequency MHz	Level dB μ V/m	Pol v/h	15.209 / 15.247		Detector Pk/QP/Avg	Azimuth degrees	Height meters	Comments
			Limit	Margin				
2280.000	42.0	V	54.0	-12.0	Peak	179	1.0	
2368.330	48.9	V	54.0	-5.1	Peak	179	1.0	

Final measurements at 3m

Frequency MHz	Level dB μ V/m	Pol v/h	15.209 / 15.247		Detector Pk/QP/Avg	Azimuth degrees	Height meters	Comments
			Limit	Margin				
2364.960	53.8	H	54.0	-0.2	AVG	345	1.3	RB 1 MHz;VB 10 Hz;Pk
2367.630	58.9	H	74.0	-15.1	PK	345	1.3	RB 1 MHz;VB 3 MHz;Pk
2364.860	51.6	V	54.0	-2.4	AVG	86	1.1	RB 1 MHz;VB 10 Hz;Pk
2369.430	57.3	V	74.0	-16.7	PK	86	1.1	RB 1 MHz;VB 3 MHz;Pk

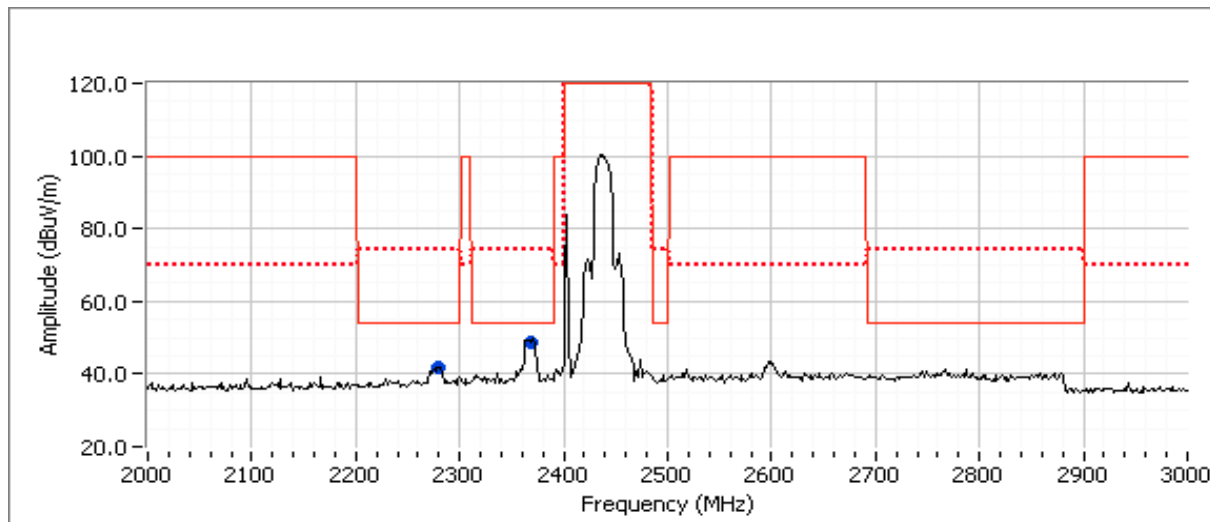

Client: Intel	Job Number: J84264
Model: 135BNHMW & 135BNHU	T-Log Number: T84548
	Account Manager: Christine Krebill
Contact: Steve Hackett	
Standard: FCC 15 B, 15.247, RSS 210	Class: N/A

Run #6: Radiated Spurious Emissions, 1-10GHz. Operating Mode: 802.11b @ 2412 MHz, BT Basic @ 2440 MHz

Date of Test: 9/20/2011

Test Engineer: Rafael Varelas

Test Location: FT Chamber #3

Preliminary Spurious Emissions excluding allocated band (Peak versus average limit)

Frequency MHz	Level dB μ V/m	Pol v/h	15.209 / 15.247		Detector Pk/QP/Avg	Azimuth degrees	Height meters	Comments
			Limit	Margin				
7237.170	44.6	V	54.0	-9.4	Peak	293	1.3	Signal not in restricted band
1457.690	38.3	H	54.0	-15.7	Peak	155	1.0	

Final measurements at 3m

Frequency MHz	Level dB μ V/m	Pol v/h	15.209 / 15.247		Detector Pk/QP/Avg	Azimuth degrees	Height meters	Comments
			Limit	Margin				
1457.560	39.5	H	54.0	-14.5	AVG	163	1.0	RB 1 MHz;VB 10 Hz;Pk
1457.550	42.9	H	74.0	-31.1	PK	163	1.0	RB 1 MHz;VB 3 MHz;Pk

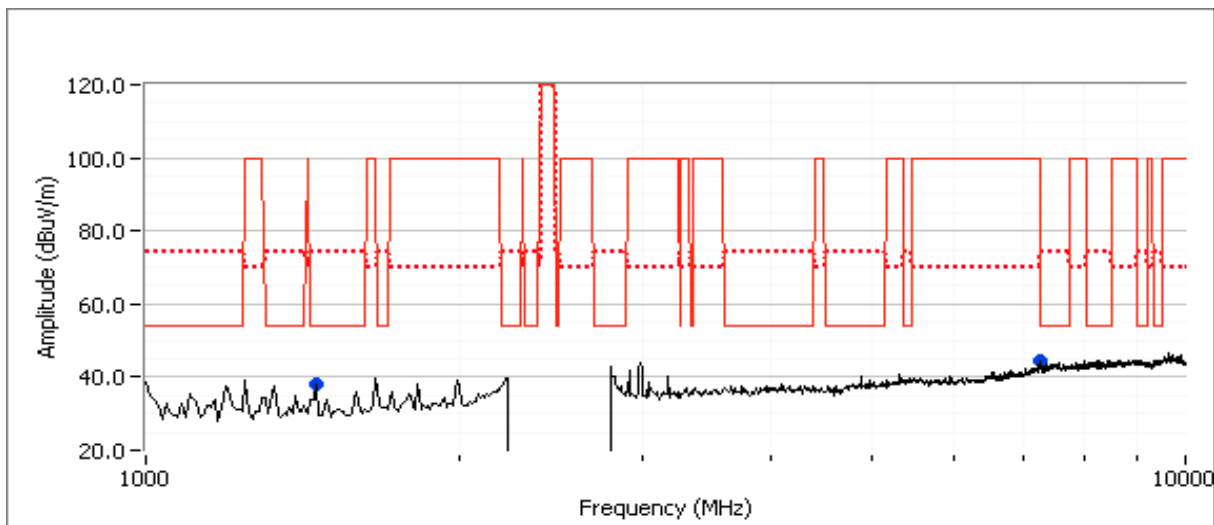

Client: Intel	Job Number: J84264
Model: 135BNHMW & 135BNHU	T-Log Number: T84548
	Account Manager: Christine Krebill
Contact: Steve Hackett	
Standard: FCC 15 B, 15.247, RSS 210	Class: N/A

Preliminary Spurious Emissions at 20cm from 2-3 GHz (Peak versus average limit)

Frequency MHz	Level dB μ V/m	Pol v/h	15.209 / 15.247		Detector Pk/QP/Avg	Azimuth degrees	Height meters	Comments
			Limit	Margin				
2255.000	44.4	V	54.0	-9.6	Peak	181	1.0	
2466.670	51.1	V	NA	NA	Peak	181	1.0	
2573.330	44.6	V	54.0	-9.4	Peak	181	1.0	
2871.670	45.2	V	54.0	-8.8	Peak	181	1.0	

Final measurements at 3m

Frequency MHz	Level dB μ V/m	Pol v/h	15.209 / 15.247		Detector Pk/QP/Avg	Azimuth degrees	Height meters	Comments
			Limit	Margin				
2868.570	42.2	H	54.0	-11.8	AVG	235	1.0	RB 1 MHz;VB 10 Hz;Pk
2868.440	49.9	H	74.0	-24.1	PK	235	1.0	RB 1 MHz;VB 3 MHz;Pk
2253.670	41.9	H	54.0	-12.1	AVG	236	1.2	RB 1 MHz;VB 10 Hz;Pk
2251.470	51.6	H	74.0	-22.4	PK	236	1.2	RB 1 MHz;VB 3 MHz;Pk
2874.770	39.5	V	54.0	-14.5	AVG	271	1.0	RB 1 MHz;VB 10 Hz;Pk
2863.870	51.0	V	74.0	-23.0	PK	271	1.0	RB 1 MHz;VB 3 MHz;Pk

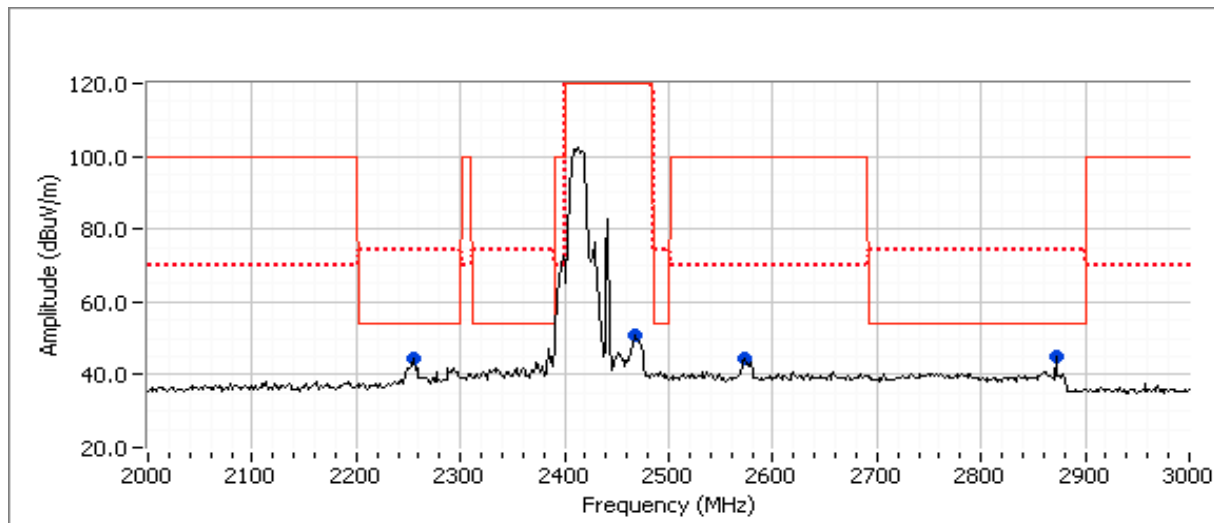

Client: Intel	Job Number: J84264
Model: 135BNHMW & 135BNHU	T-Log Number: T84548
	Account Manager: Christine Krebill
Contact: Steve Hackett	
Standard: FCC 15 B, 15.247, RSS 210	Class: N/A

Run #7: Radiated Spurious Emissions, 1-10GHz. Operating Mode: 802.11b @ 2462 MHz, BT Basic @ 2440 MHz
 Date of Test: 9/20/2011
 Test Engineer: Rafael Varelas
 Test Location: FT Chamber #3

Preliminary Spurious Emissions excluding allocated band (Peak versus average limit)

Frequency MHz	Level dB μ V/m	Pol v/h	15.209 / 15.247		Detector Pk/QP/Avg	Azimuth degrees	Height meters	Comments
			Limit	Margin				
1328.830	44.9	V	54.0	-9.1	Peak	138	1.0	
1457.690	38.6	H	54.0	-15.4	Peak	163	1.0	
7385.110	47.8	V	54.0	-6.2	Peak	283	1.6	

Final measurements at 3m

Frequency MHz	Level dB μ V/m	Pol v/h	15.209 / 15.247		Detector Pk/QP/Avg	Azimuth degrees	Height meters	Comments
			Limit	Margin				
7384.970	46.1	V	54.0	-7.9	AVG	284	1.7	RB 1 MHz;VB 10 Hz;Pk
7384.840	52.6	V	74.0	-21.4	PK	284	1.7	RB 1 MHz;VB 3 MHz;Pk
1328.200	29.3	V	54.0	-24.7	AVG	139	1.0	RB 1 MHz;VB 10 Hz;Pk
1332.160	47.1	V	74.0	-26.9	PK	139	1.0	RB 1 MHz;VB 3 MHz;Pk

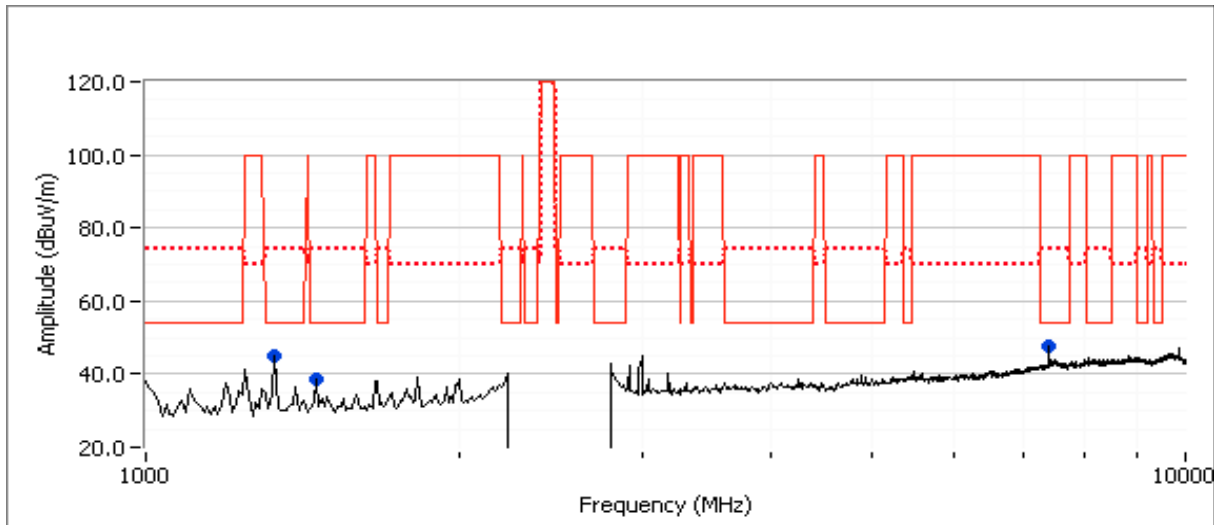

Client: Intel	Job Number: J84264
Model: 135BNHMW & 135BNHU	T-Log Number: T84548
	Account Manager: Christine Krebill
Contact: Steve Hackett	
Standard: FCC 15 B, 15.247, RSS 210	Class: N/A

Preliminary Spurious Emissions at 20cm from 2-3 GHz (Peak versus average limit)

Frequency MHz	Level dB μ V/m	Pol v/h	15.209 / 15.247		Detector Pk/QP/Avg	Azimuth degrees	Height meters	Comments
			Limit	Margin				
2299.540	43.9	V	54.0	-10.1	Peak	182	1.0	
2421.670	49.5	V	NA	NA	Peak	182	1.0	

Final measurements at 3m

Frequency MHz	Level dB μ V/m	Pol v/h	15.209 / 15.247		Detector Pk/QP/Avg	Azimuth degrees	Height meters	Comments
			Limit	Margin				
2299.230	44.4	H	54.0	-9.6	AVG	242	1.2	RB 1 MHz;VB 10 Hz;Pk
2299.540	53.3	H	74.0	-20.7	PK	242	1.2	RB 1 MHz;VB 3 MHz;Pk
2299.210	42.3	V	54.0	-11.7	AVG	272	1.2	RB 1 MHz;VB 10 Hz;Pk
2297.940	52.0	V	74.0	-22.0	PK	272	1.2	RB 1 MHz;VB 3 MHz;Pk

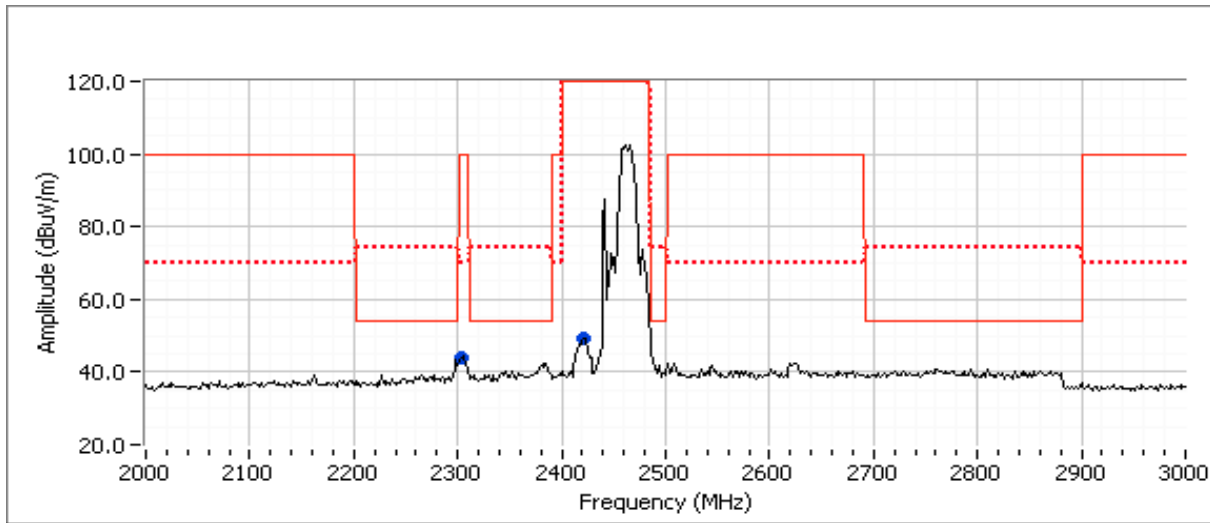

Client: Intel	Job Number: J84264
Model: 135BNHMW & 135BNHU	T-Log Number: T84548
	Account Manager: Christine Krebill
Contact: Steve Hackett	
Standard: FCC 15 B, 15.247, RSS 210	Class: N/A

Run #8: Radiated Spurious Emissions, 1-10GHz. Operating Mode: 802.11b @ 2437 MHz, BT Basic @ 2480 MHz

Date of Test: 9/20/2011

Test Engineer: Rafael Varelas

Test Location: FT Chamber #3

Preliminary Spurious Emissions excluding allocated band (Peak versus average limit)

Frequency MHz	Level dB μ V/m	Pol v/h	15.209 / 15.247		Detector Pk/QP/Avg	Azimuth degrees	Height meters	Comments
			Limit	Margin				
1457.690	38.8	H	54.0	-15.2	Peak	171	1.0	
7318.300	45.1	V	54.0	-8.9	Peak	285	1.6	

Final measurements at 3m

Frequency MHz	Level dB μ V/m	Pol v/h	15.209 / 15.247		Detector Pk/QP/Avg	Azimuth degrees	Height meters	Comments
			Limit	Margin				
7313.730	44.3	V	54.0	-9.7	AVG	288	1.6	RB 1 MHz;VB 10 Hz;Pk
7315.100	51.5	V	74.0	-22.5	PK	288	1.6	RB 1 MHz;VB 3 MHz;Pk

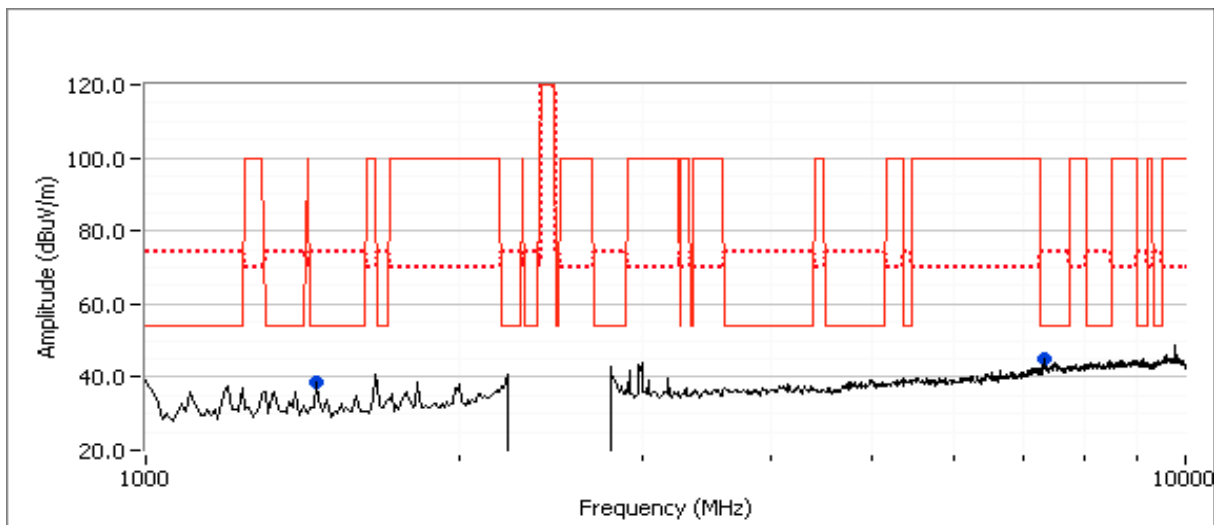

Client: Intel	Job Number: J84264
Model: 135BNHMW & 135BNHU	T-Log Number: T84548
	Account Manager: Christine Krebill
Contact: Steve Hackett	
Standard: FCC 15 B, 15.247, RSS 210	Class: N/A

Preliminary Spurious Emissions at 20cm from 2-3 GHz (Peak versus average limit)

Frequency MHz	Level dB μ V/m	Pol v/h	15.209 / 15.247		Detector Pk/QP/Avg	Azimuth degrees	Height meters	Comments
			Limit	Margin				
2280.000	42.7	V	54.0	-11.3	Peak	183	1.0	
2395.000	46.1	V	54.0	-7.9	Peak	183	1.0	signal not in restricted band
2521.670	46.4	V	54.0	-7.6	Peak	183	1.0	signal not in restricted band

Final measurements at 3m

Frequency MHz	Level dB μ V/m	Pol v/h	15.209 / 15.247		Detector Pk/QP/Avg	Azimuth degrees	Height meters	Comments
			Limit	Margin				
2278.830	42.2	H	54.0	-11.8	AVG	242	1.2	RB 1 MHz;VB 10 Hz;Pk
2279.600	51.2	H	74.0	-22.8	PK	242	1.2	RB 1 MHz;VB 3 MHz;Pk

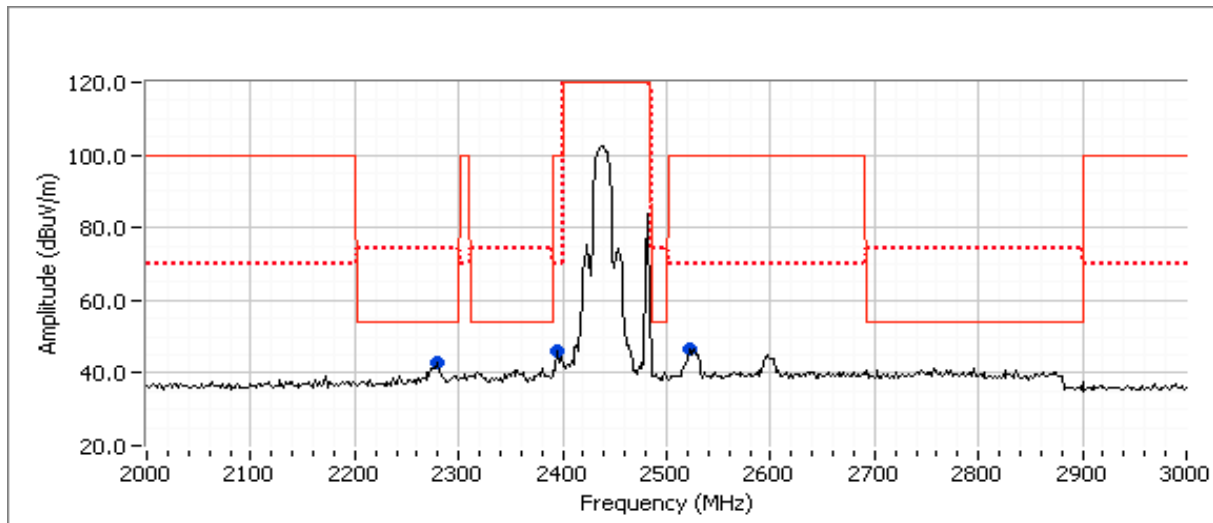

Client: Intel	Job Number: J84264
Model: 135BNHMW & 135BNHU	T-Log Number: T84548
	Account Manager: Christine Krebill
Contact: Steve Hackett	
Standard: FCC 15 B, 15.247, RSS 210	Class: N/A

Run #9: Radiated Spurious Emissions, 1-10GHz. Operating Mode: 802.11b @ 2437 MHz, BT EDR @ 2402 MHz
 Date of Test: 9/20/2011
 Test Engineer: Rafael Varelas
 Test Location: FT Chamber #3

Preliminary Spurious Emissions excluding allocated band (Peak versus average limit)

Frequency	Level	Pol	15.209 / 15.247		Detector	Azimuth	Height	Comments
MHz	dB μ V/m	v/h	Limit	Margin	Pk/QP/Avg	degrees	meters	
1458.330	37.8	H	54.0	-16.2	Peak	159	1.0	
7311.000	44.5	V	54.0	-9.5	Peak	288	1.6	

Final measurements at 3m

Frequency	Level	Pol	15.209 / 15.247		Detector	Azimuth	Height	Comments
MHz	dB μ V/m	v/h	Limit	Margin	Pk/QP/Avg	degrees	meters	
7315.560	44.4	V	54.0	-9.6	AVG	288	1.6	RB 1 MHz;VB 10 Hz;Pk
7314.930	52.1	V	74.0	-21.9	PK	288	1.6	RB 1 MHz;VB 3 MHz;Pk

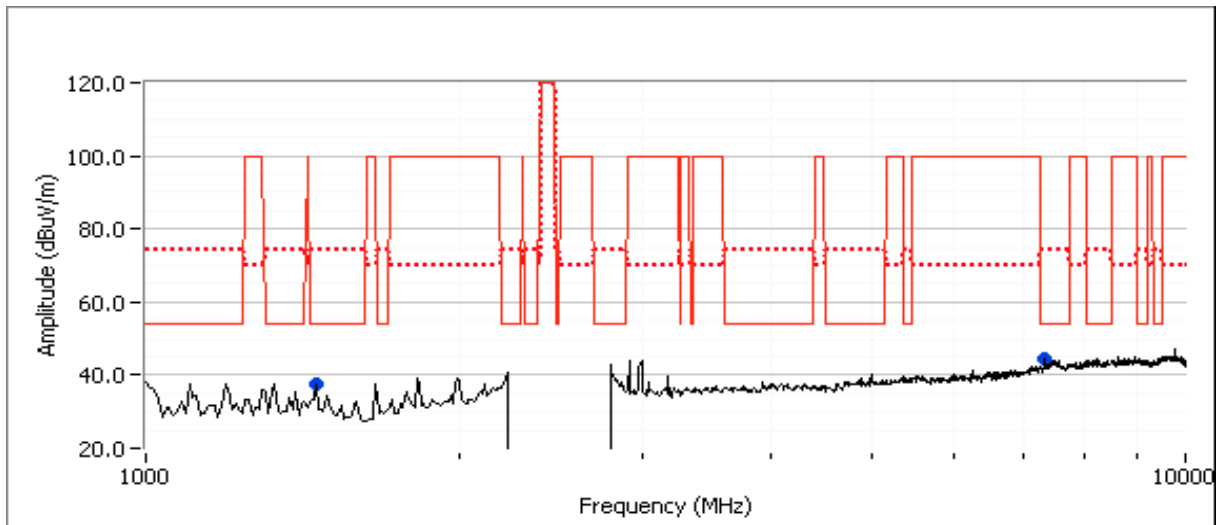

Client: Intel	Job Number: J84264
Model: 135BNHMW & 135BNHU	T-Log Number: T84548
	Account Manager: Christine Krebill
Contact: Steve Hackett	
Standard: FCC 15 B, 15.247, RSS 210	Class: N/A

Preliminary Spurious Emissions at 20cm from 2-3 GHz (Peak versus average limit)

Frequency MHz	Level dB μ V/m	Pol v/h	15.209 / 15.247		Detector Pk/QP/Avg	Azimuth degrees	Height meters	Comments
			Limit	Margin				
2276.670	43.0	V	54.0	-11.0	Peak	179	1.0	
2368.330	46.4	V	54.0	-7.6	Peak	179	1.0	
2473.330	49.4	V	NA	NA	Peak	179	1.0	
2565.000	47.1	V	54.0	-6.9	Peak	179	1.0	Signal not in restricted band

Final measurements at 3m

Frequency MHz	Level dB μ V/m	Pol v/h	15.209 / 15.247		Detector Pk/QP/Avg	Azimuth degrees	Height meters	Comments
			Limit	Margin				
2370.600	50.2	H	54.0	-3.8	AVG	345	1.0	RB 1 MHz;VB 10 Hz;Pk
2369.230	57.8	H	74.0	-16.2	PK	345	1.0	RB 1 MHz;VB 3 MHz;Pk
2278.370	42.0	H	54.0	-12.0	AVG	243	1.2	RB 1 MHz;VB 10 Hz;Pk
2278.500	51.1	H	74.0	-22.9	PK	243	1.2	RB 1 MHz;VB 3 MHz;Pk
2370.460	46.3	V	54.0	-7.7	AVG	88	1.1	RB 1 MHz;VB 10 Hz;Pk
2365.900	54.3	V	74.0	-19.7	PK	88	1.1	RB 1 MHz;VB 3 MHz;Pk

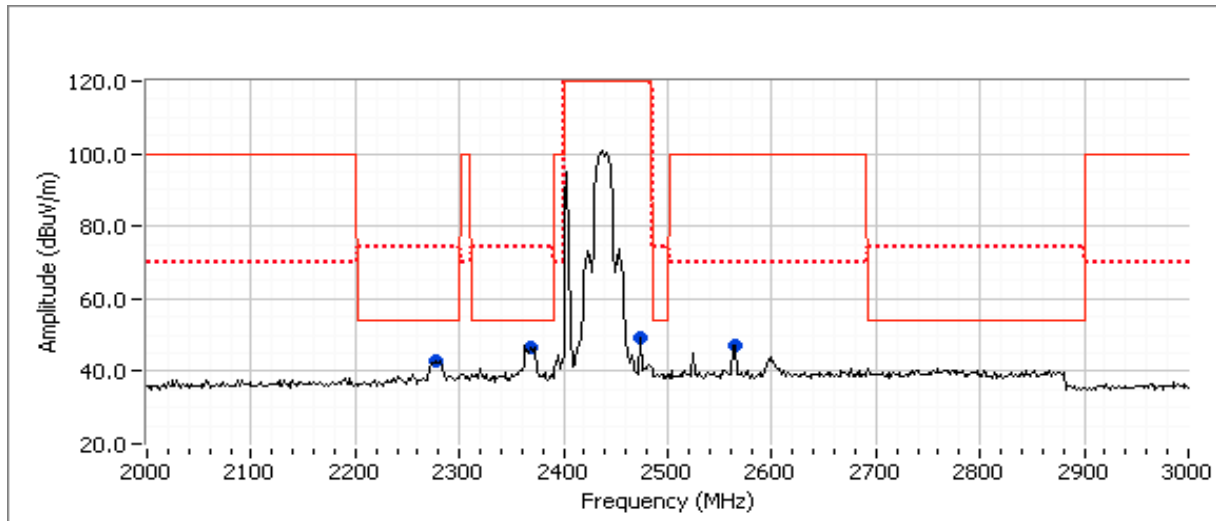

Client: Intel	Job Number: J84264
Model: 135BNHMW & 135BNHU	T-Log Number: T84548
	Account Manager: Christine Krebill
Contact: Steve Hackett	
Standard: FCC 15 B, 15.247, RSS 210	Class: N/A

RSS 210 Radiated Spurious Emissions (Bluetooth Receive Mode)

Test Specific Details

Objective: The objective of this test session is to perform final qualification testing of the EUT with respect to the specification listed above.

Summary of Results - Device Operating in the 2400-2483.5 MHz Band

Run #	Mode	Channel	Target Power	Measured Power	Test Performed	Limit	Result / Margin
MAC Address: 00150096B40F DRTU Tool Version 1.5.3-0320 Driver version 15.0.0.51 - Sample with PIFA antenna							
1	Receive PIFA	2441			Radiated Emissions, 1 - 40 GHz	RSS 210	36.8dB μ V/m @ 2332.1MHz (-17.2dB)
MAC Address: 00150096C325 DRTU Tool Version 1.5.3-0320 Driver version 15.0.0.51 - Sample with integral antenna							
2	Receive Trace	2441	-	-	Radiated Emissions, 1 - 40 GHz	RSS 210	49.0dB μ V/m @ 2320.0MHz (-5.0dB)

Ambient Conditions:
 Temperature: 18-25 °C
 Rel. Humidity: 30-40 %

Modifications Made During Testing

No modifications were made to the EUT during testing

Deviations From The Standard

No deviations were made from the requirements of the standard.

Client: Intel	Job Number: J84264
Model: 135BNHMW & 135BNHU	T-Log Number: T84548
	Account Manager: Christine Krebill
Contact: Steve Hackett	
Standard: FCC 15 B, 15.247, RSS 210	Class: N/A

Run #1: Radiated Spurious Emissions, 1000 - 40,000 MHz. Operating Mode: Receive Mode, Bluetooth, PIFA Antenna
 Date of Test: 9/21/2011 Test Location: FT Chamber #4
 Test Engineer: Joseph Cadigal

Frequency MHz	Level dB μ V/m	Pol v/h	15.209 / 15.247		Detector Pk/QP/Avg	Azimuth degrees	Height meters	Comments
			Limit	Margin				
2332.120	36.8	V	54.0	-17.2	AVG	43	1.0	RB 1 MHz;VB 10 Hz;Pk
2331.060	54.6	V	74.0	-19.4	PK	43	1.0	RB 1 MHz;VB 3 MHz;Pk
2981.310	32.6	V	54.0	-21.4	AVG	150	1.0	RB 1 MHz;VB 10 Hz;Pk
2980.420	49.3	V	74.0	-24.7	PK	150	1.0	RB 1 MHz;VB 3 MHz;Pk

Note 1: Scans made between 10 - 40GHz with the measurement antenna moved around the card and its antennas 20-50cm from the device indicated there were no significant emissions in this frequency range

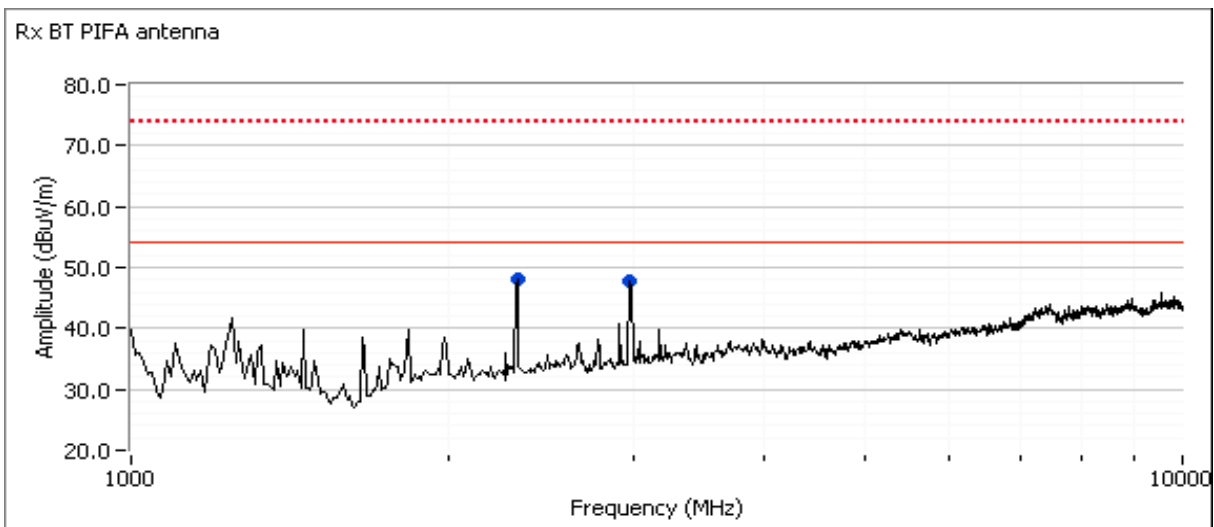

Client: Intel	Job Number: J84264
Model: 135BNHMW & 135BNHU	T-Log Number: T84548
	Account Manager: Christine Krebill
Contact: Steve Hackett	
Standard: FCC 15 B, 15.247, RSS 210	Class: N/A

Run #2: Radiated Spurious Emissions 1,000 - 40,000 MHz. Operating Mode: Receive Mode, Bluetooth, Trace Antenna

Date of Test: 9/23/2011

Test Location: FT Chamber #4

Test Engineer: M. Birgani

MAC Address: **00150096C325** DRTU Tool Version **1.5.3-0320** Driver version **15.0.0.51** - Sample with integral antenna

Frequency	Level	Pol	15.209 / 15.247		Detector	Azimuth	Height	Comments
MHz	dB μ V/m	v/h	Limit	Margin	Pk/QP/Avg	degrees	meters	
2320.000	49.0	V	54.0	-5.0	Peak	198	1.3	Peak reading vs. average limit
2989.170	45.7	V	54.0	-8.3	Peak	147	1.0	Peak reading vs. average limit
1247.500	44.1	H	54.0	-9.9	Peak	235	1.5	Peak reading vs. average limit
2915.830	41.8	H	54.0	-12.2	Peak	225	1.2	Peak reading vs. average limit
2494.170	40.6	H	54.0	-13.4	Peak	149	1.0	Peak reading vs. average limit
1990.000	39.1	V	54.0	-14.9	Peak	207	1.3	Peak reading vs. average limit

Note 1: Scans made between 12.5 - 40GHz with the measurement antenna moved around the card and its antennas 20-50cm from the device indicated there were no significant emissions in this frequency range

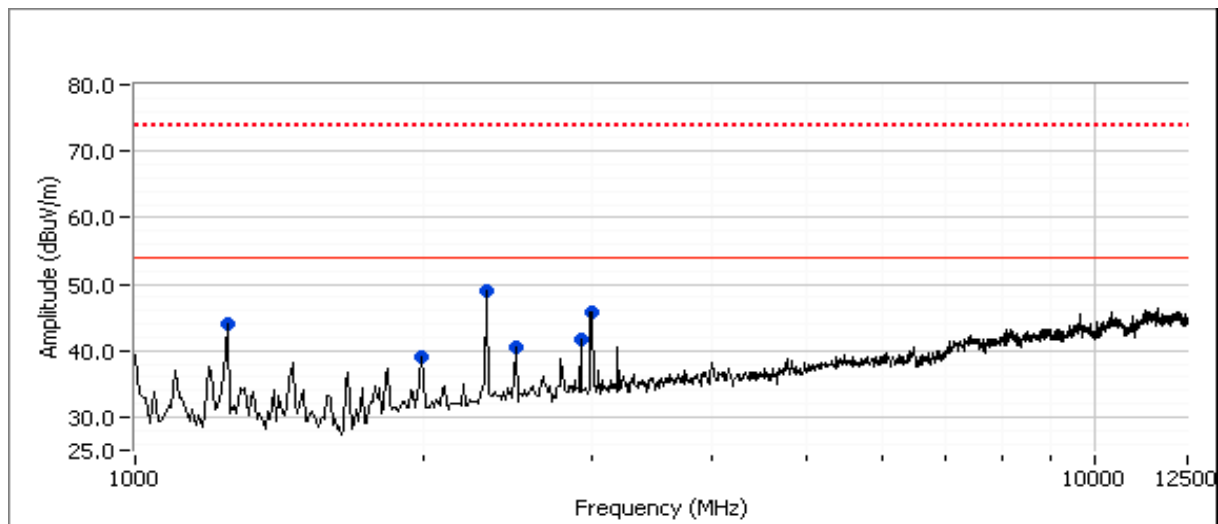

Client: Intel	Job Number: J84264
Model: 135BNHMW & 135BNHU	T-Log Number: T84548
	Account Manager: Christine Krebill
Contact: Steve Hackett	
Standard: FCC 15 B, 15.247, RSS 210	Class: N/A

RSS 210 and FCC 15.247 (DTS) Antenna Port Measurements - Bluetooth LE Power, PSD, Bandwidth and Spurious Emissions

Test Specific Details

Objective: The objective of this test session is to perform final qualification testing of the EUT with respect to the specification listed above.

Date of Test: 9/21/2011
 Test Engineer: Joseph Cadigal
 Test Location: FT Chamber#4

Config. Used: 1
 Config Change: none
 Host Unit Voltage: 120V/60Hz

General Test Configuration

The EUT was connected to the spectrum analyzer or power meter via a suitable attenuator. All measurements were made on a single chain.

All measurements have been corrected to allow for the external attenuators used.

Ambient Conditions:

Temperature: 18 - 25 °C
 Rel. Humidity: 15 - 55 %

Summary of Results

Run #	Pwr setting	Avg Pwr	Test Performed	Limit	Pass / Fail	Result / Margin
1	max	-	Output Power	15.247(b)	Pass	4.7 dBm (.003 W)
2	max	-	Power spectral Density (PSD)	15.247(d)	Pass	-30 dBm/3kHz
3	max	-	Minimum 6dB Bandwidth	15.247(a)	Pass	695kHz
3	max	-	99% Bandwidth	RSS GEN	-	2.612 MHz
4	max	-	Spurious emissions	15.247(b)	Pass	All emissions below the limit

Modifications Made During Testing

No modifications were made to the EUT during testing

Deviations From The Standard

No deviations were made from the requirements of the standard.

Client: Intel	Job Number: J84264
Model: 135BNHMW & 135BNHU	T-Log Number: T84548
	Account Manager: Christine Krebill
Contact: Steve Hackett	
Standard: FCC 15 B, 15.247, RSS 210	Class: N/A

Run #1: Output Power

Power Setting ²	Frequency (MHz)	Output Power		Antenna Gain (dBi)	Result	EIRP ^{Note 2}		Output Power	
		(dBm) ¹	mW			dBm	W	(dBm) ³	mW
max	2402	4.7	3.0	3.2	Pass	7.9	0.006	4.5	2.8
max	2440	4.7	3.0	3.2	Pass	7.9	0.006	4.5	2.8
max	2480	4.5	2.8	3.2	Pass	7.7	0.006	4.3	2.7

Note 1: Output power measured using a peak power meter, spurious limit is -20dBc.

Note 2: Power setting - the software power setting used during testing, included for reference only.

Note 3: Power measured using average power meter and is included for reference only.

Run #2: Power spectral Density

Power Setting	Frequency (MHz)	PSD	Limit	Result
		(dBm/3kHz) ^{Note 1}		
max	2402	-30.0	8.0	Pass
max	2440	-29.3	8.0	Pass
max	2480	-29.7	8.0	Pass

Note 1: Power spectral density measured using RB=3 kHz, VB=10kHz, analyzer with peak detector and with a sweep time set to ensure a dwell time of at least 1 second per 3kHz. The measurement is made at the frequency of PPSD determined from preliminary scans using RB=3kHz using multiple sweeps at a faster rate over the 6dB bandwidth of the signal.

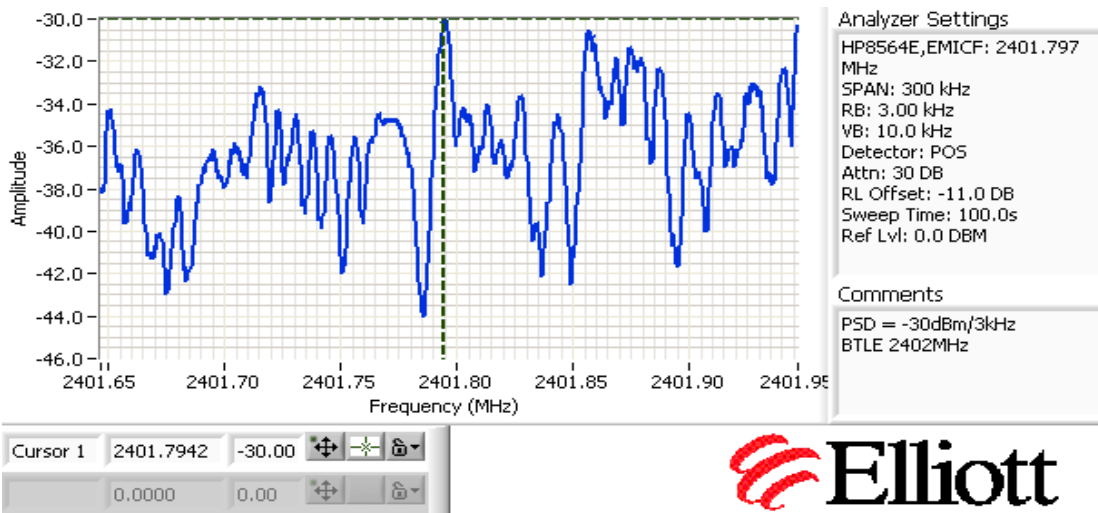

Client: Intel	Job Number: J84264
Model: 135BNHMW & 135BNHU	T-Log Number: T84548
Contact: Steve Hackett	Account Manager: Christine Krebill
Standard: FCC 15 B, 15.247, RSS 210	Class: N/A

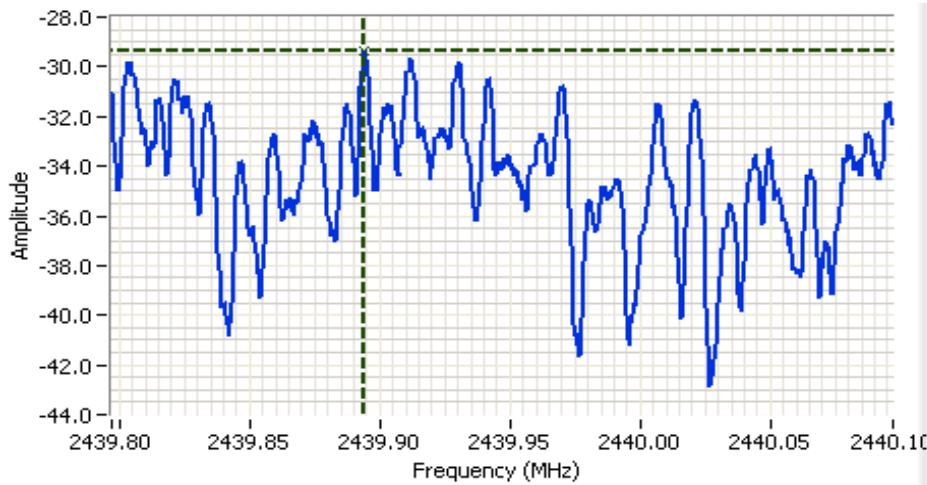

Analyzer Settings
 HP8564E,EMICF: 2439.947 MHz
 SPAN: 300 kHz
 RB: 3.00 kHz
 VB: 10.0 kHz
 Detector: POS
 Attn: 30 DB
 RL Offset: -11.0 DB
 Sweep Time: 100.0s
 Ref Lvl: 0.0 DBM

Comments
 PSD = -29.33dBm/3kHz
 BTLE 2440MHz

Cursor 1 2439.8940 -29.33 [Icons]
 0.0000 0.00 [Icons]

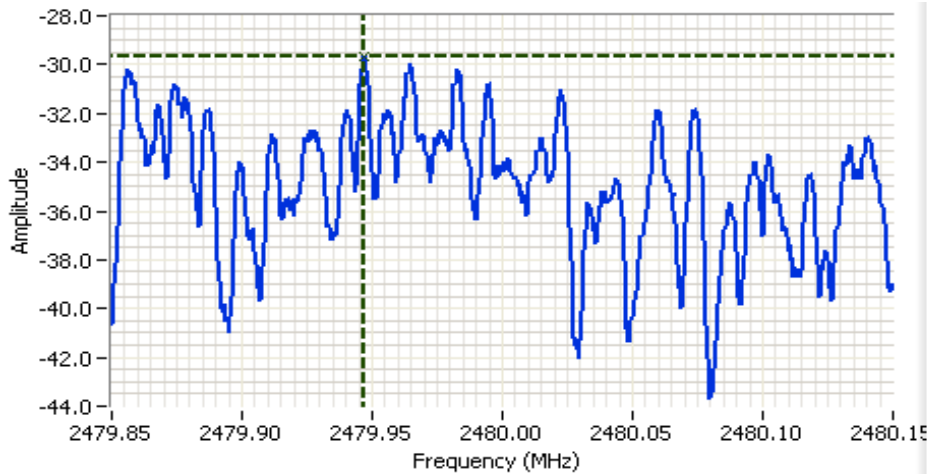

Analyzer Settings
 HP8564E,EMICF: 2480.000 MHz
 SPAN: 300 kHz
 RB: 3.00 kHz
 VB: 10.0 kHz
 Detector: POS
 Attn: 30 DB
 RL Offset: -11.0 DB
 Sweep Time: 100.0s
 Ref Lvl: 0.0 DBM

Comments
 PSD = -29.67dBm/3kHz
 BTLE 2480MHz

Cursor 1 2479.9465 -29.67 [Icons]
 0.0000 0.00 [Icons]



Client: Intel	Job Number: J84264
Model: 135BNHMW & 135BNHU	T-Log Number: T84548
Contact: Steve Hackett	Account Manager: Christine Krebill
Standard: FCC 15 B, 15.247, RSS 210	Class: N/A

Run #3: Signal Bandwidth

Power Setting	Frequency (MHz)	Resolution Bandwidth	Bandwidth (MHz)	
			6dB	99%
max	2402	100kHz	675kHz	2.596%
max	2440	100kHz	695kHz	2.612%
max	2480	100kHz	683kHz	2.579%

Note 1: 99% bandwidth measured in accordance with RSS GEN, with RB > 1% of the span and VB > 3xRB

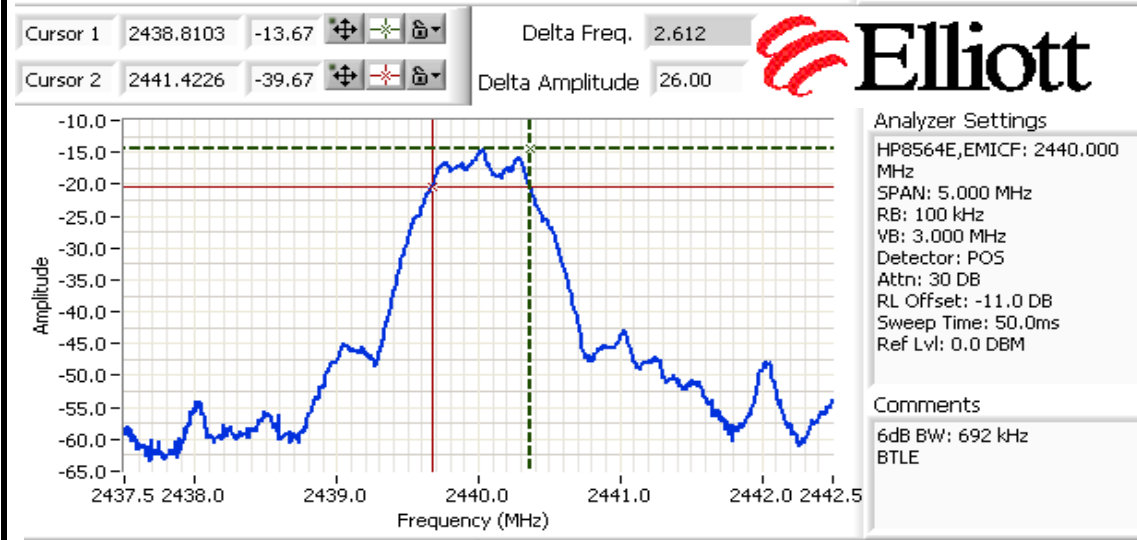
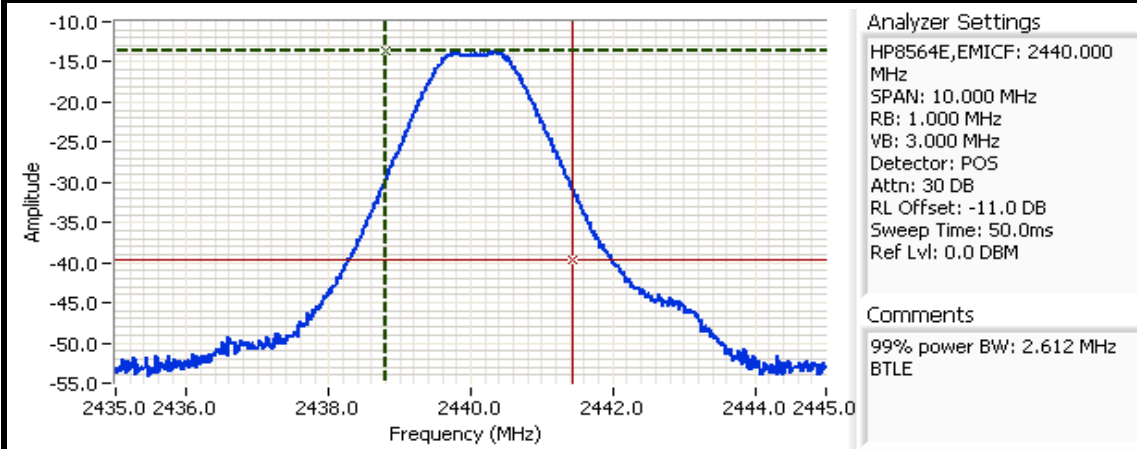

Client: Intel	Job Number: J84264
Model: 135BNHMW & 135BNHU	T-Log Number: T84548
	Account Manager: Christine Krebill
Contact: Steve Hackett	
Standard: FCC 15 B, 15.247, RSS 210	Class: N/A

Run #4: Out of Band Spurious Emissions

Frequency (MHz)	Limit	Result
2402	-20dBc	Pass
2440	-20dBc	Pass
2480	-20dBc	Pass

Plots for low channel, power setting(s) = max

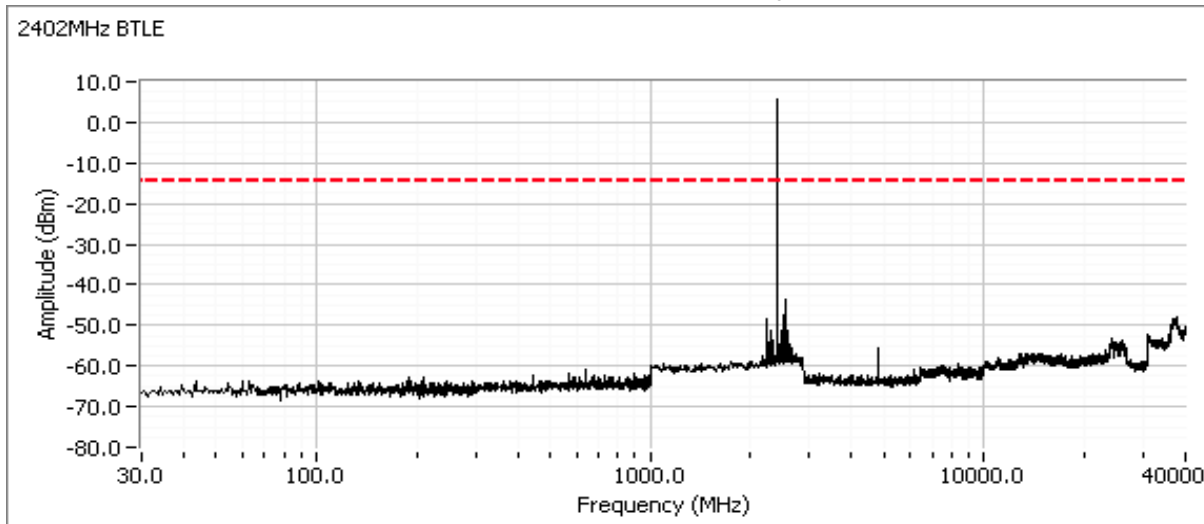

Additional plot showing compliance with -20dBc limit from 2390 MHz to 2400 MHz. Radiated measurements used to show compliance with the limits in the restricted band below 2390 MHz.

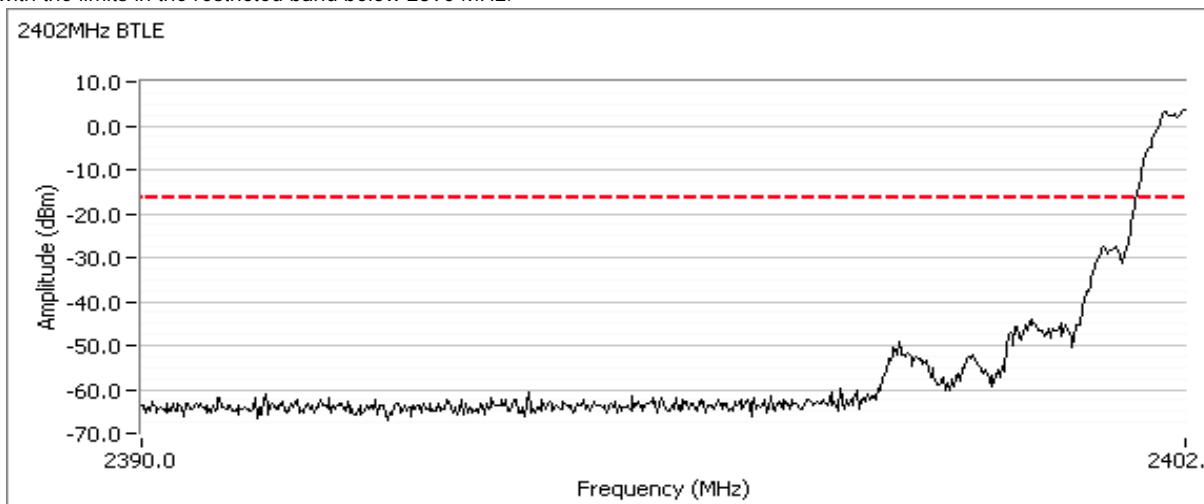

Client: Intel	Job Number: J84264
Model: 135BNHMW & 135BNHU	T-Log Number: T84548
	Account Manager: Christine Krebill
Contact: Steve Hackett	
Standard: FCC 15 B, 15.247, RSS 210	Class: N/A

Plots for center channel, power setting(s) = max

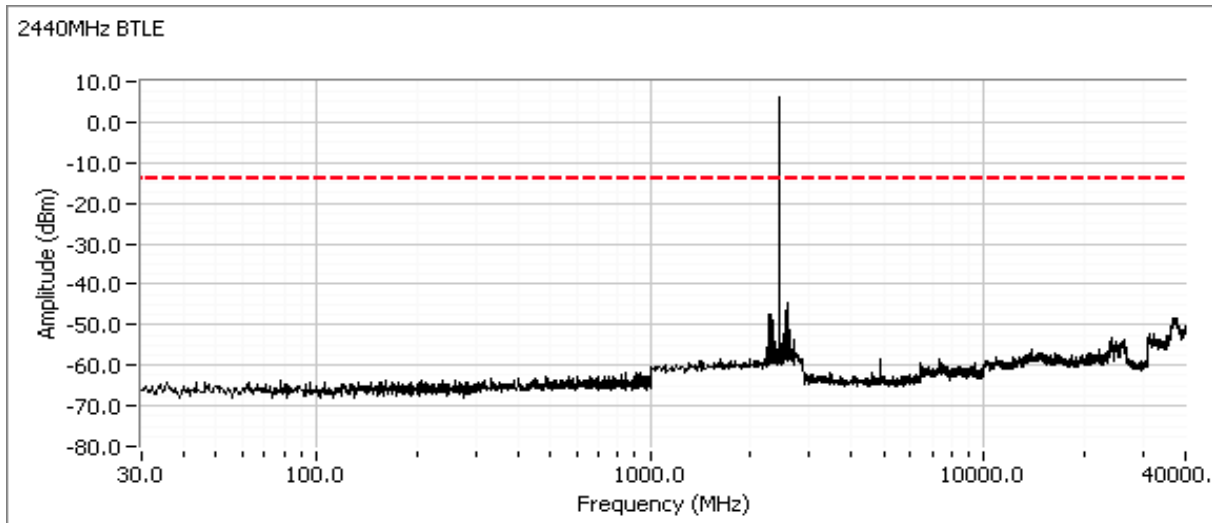

Plots for high channel, power setting(s) = max

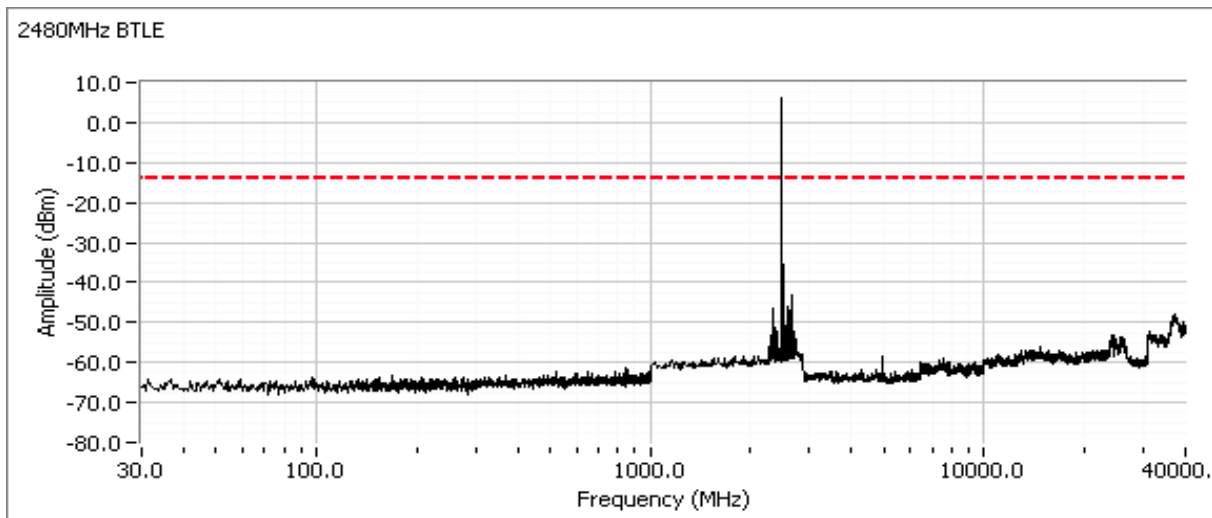

Client:	Intel	Job Number:	J84264
Model:	135BNHMW & 135BNHU	T-Log Number:	T84548
		Account Manager:	Christine Krebill
Contact:	Steve Hackett		
Standard:	FCC 15 B, 15.247, RSS 210	Class:	B

Conducted Emissions

(Elliott Laboratories Fremont Facility, Semi-Anechoic Chamber)

Test Specific Details

Objective: The objective of this test session is to perform final qualification testing of the EUT with respect to the specification listed above.

Date of Test: 9/22/2011
 Test Engineer: M. Birgani
 Test Location: FT Chamber #4

Config. Used: -
 Config Change: -
 Host Unit Voltage 120V/60Hz

General Test Configuration

The host system was located on a wooden table inside the semi-anechoic chamber, 40 cm from a vertical coupling plane and 80cm from the LISN. A second LISN was used for all local support equipment.

Ambient Conditions:

Temperature: 17-23 °C
 Rel. Humidity: 30-40 %

Summary of Results

MAC: 00150096B40F DRTU Tool Version 1.5.3-0320 Driver version 15.0.0.51

Run #	Test Performed	Limit	Result	Margin
1	CE, AC Power, 120V/60Hz	Class B	PASS	41.7dB μ V @ 8.000MHz (-8.3dB)

Modifications Made During Testing

No modifications were made to the EUT during testing

Deviations From The Standard

No deviations were made from the requirements of the standard.

Client:	Intel	Job Number:	J84264
Model:	135BNHMW & 135BNHU	T-Log Number:	T84548
Contact:	Steve Hackett	Account Manager:	Christine Krebill
Standard:	FCC 15 B, 15.247, RSS 210	Class:	B

Run #1: AC Power Port Conducted Emissions, 0.15 - 30MHz, 120V/60Hz

Note: The module was transmitting at 2437 MHz (Wi-Fi) at 17dBm and 2440 MHz (Bluetooth) at maximum level.

Final quasi-peak and average readings

Frequency MHz	Level dB μ V	AC Line	Class B		Detector QP/Ave	Comments
			Limit	Margin		
8.000	41.7	Line	50.0	-8.3	AVG	AVG (0.10s)
8.000	40.5	Neutral	50.0	-9.5	AVG	AVG (0.10s)
10.733	37.4	Neutral	50.0	-12.6	AVG	AVG (0.10s)
8.000	46.2	Line	60.0	-13.8	QP	QP (1.00s)
8.000	45.6	Neutral	60.0	-14.4	QP	QP (1.00s)
14.149	35.0	Neutral	50.0	-15.0	AVG	AVG (0.10s)
10.342	34.5	Line	50.0	-15.5	AVG	AVG (0.10s)
10.733	43.6	Neutral	60.0	-16.4	QP	QP (1.00s)
14.633	33.5	Line	50.0	-16.5	AVG	AVG (0.10s)
10.342	41.0	Line	60.0	-19.0	QP	QP (1.00s)
14.149	40.3	Neutral	60.0	-19.7	QP	QP (1.00s)
14.633	38.9	Line	60.0	-21.1	QP	QP (1.00s)
0.555	19.8	Line	56.0	-36.2	QP	QP (1.00s)
0.549	19.8	Neutral	56.0	-36.2	QP	QP (1.00s)
0.228	26.2	Line	62.5	-36.3	QP	QP (1.00s)
0.224	26.4	Neutral	62.7	-36.3	QP	QP (1.00s)
0.555	4.5	Line	46.0	-41.5	AVG	AVG (0.10s)
0.549	4.3	Neutral	46.0	-41.7	AVG	AVG (0.10s)
0.228	10.1	Line	52.5	-42.4	AVG	AVG (0.10s)
0.224	10.0	Neutral	52.7	-42.7	AVG	AVG (0.10s)

Client: Intel	Job Number: J84264
Model: 135BNHMW & 135BNHU	T-Log Number: T84548
Contact: Steve Hackett	Account Manager: Christine Krebill
Standard: FCC 15 B, 15.247, RSS 210	Class: B

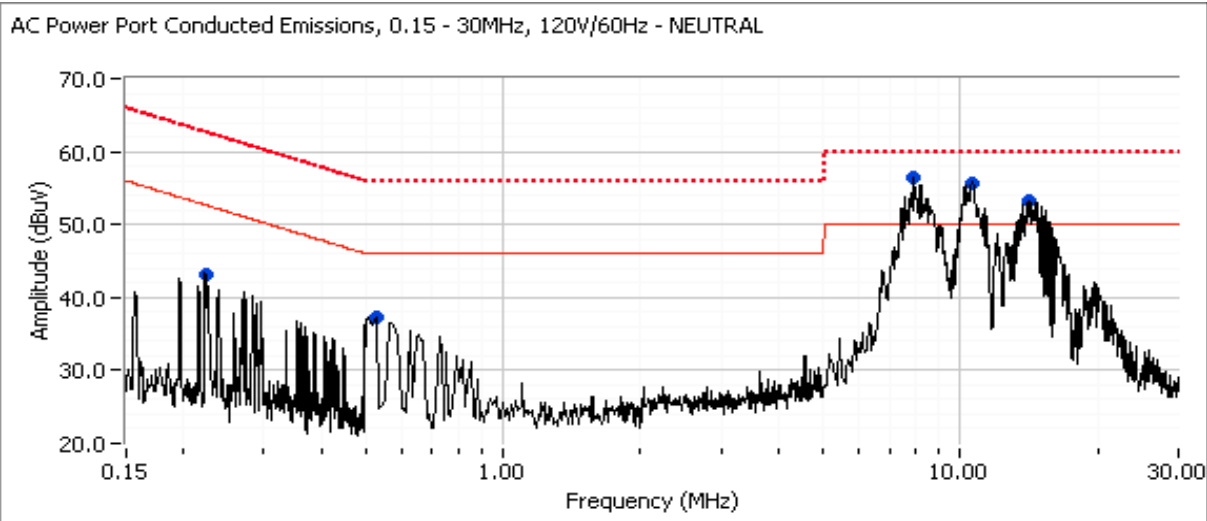
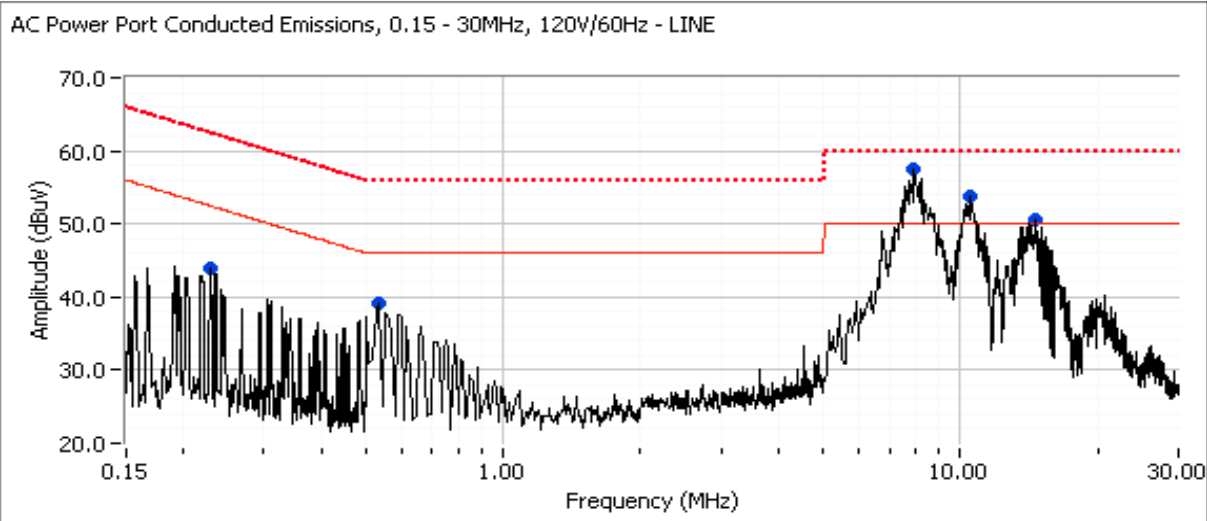

Client: Intel	Job Number: J84264
Model: 135BNHMW & 135BNHU	T-Log Number: T84548
Contact: Steve Hackett	Account Manager: Christine Krebill
Standard: FCC 15 B, 15.247, RSS 210	Class: B

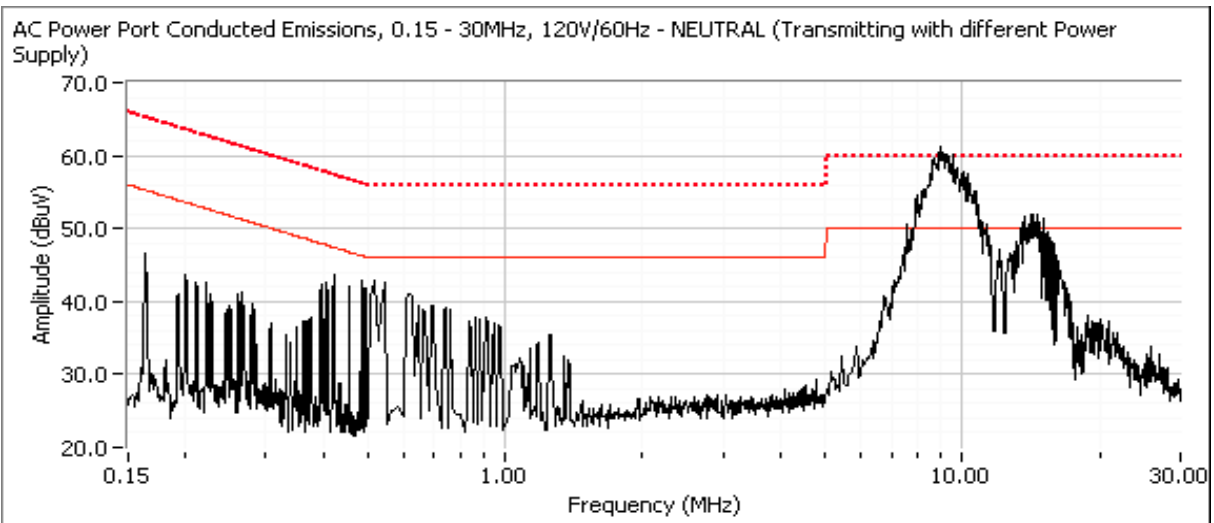
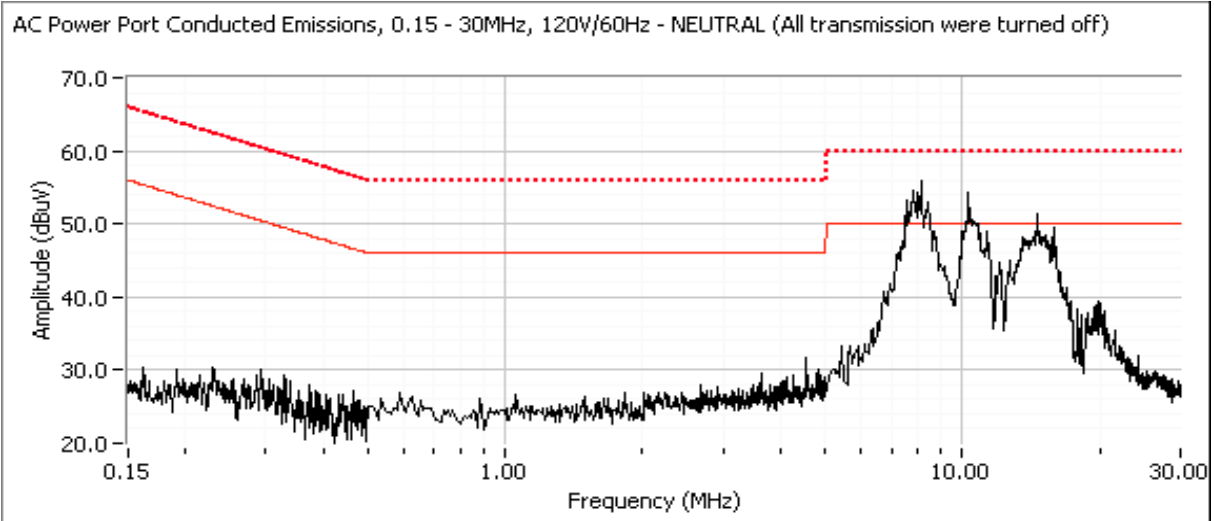

Client:	Intel	Job Number:	J84264
Model:	135BNHMW & 135BNHU	T-Log Number:	T84548
Contact:	Steve Hackett	Account Manager:	Christine Krebill
Standard:	FCC 15 B, 15.247, RSS 210	Class:	B

Radiated Emissions - Module

(Elliott Laboratories Fremont Facility, Semi-Anechoic Chamber)

Test Specific Details

Objective: The objective of this test session is to perform final qualification testing of the EUT with respect to the specification listed above.

Date of Test: 9/22/2011
 Test Engineer: M. Birgani
 Test Location: FT Chamber #4

Config. Used: 1
 Config Change: -
 Host Unit Voltage 120V/60Hz

General Test Configuration

The EUT and any local support equipment were located on the turntable for radiated emissions testing.

The test distance and extrapolation factor (if applicable) are detailed under each run description.

Note, preliminary testing indicates that the emissions were maximized by orientation of the EUT and elevation of the measurement antenna. Maximized testing indicated that the emissions were maximized by orientation of the EUT, elevation of the measurement antenna, and manipulation of the EUT's interface cables.

Ambient Conditions: Temperature: 17-22 °C
 Rel. Humidity: 30-40 %

Summary of Results

Run #	Test Performed	Limit	Result	Margin
1a - 802.11b	Radiated Emissions 30 - 1000 MHz, Preliminary	15.209 / 15.247 RSS 210	PASS	44.0dBµV/m @ 662.49MHz (Margin: -2.0dB)
1b - Bluetooth	Radiated Emissions 30 - 1000 MHz, Preliminary	15.209 / 15.247 RSS 210	PASS	45.2dBµV/m @ 662.47MHz (Margin: -0.8dB)
2 - Worst Case	Radiated Emissions 30 - 1000 MHz, Maximized	15.209 / 15.247 RSS 210	PASS	45.2dBµV/m @ 662.47MHz (Margin: -0.8dB)

Modifications Made During Testing

No modifications were made to the EUT during testing

Deviations From The Standard

No deviations were made from the requirements of the standard.

Frequency Range	Test Distance	Limit Distance	Extrapolation Factor
30 - 1000 MHz	3	3	0.0

Client:	Intel	Job Number:	J84264
Model:	135BNHMW & 135BNHU	T-Log Number:	T84548
Contact:	Steve Hackett	Account Manager:	Christine Krebill
Standard:	FCC 15 B, 15.247, RSS 210	Class:	B

Run #1a: Preliminary Radiated Emissions, 30 - 1000 MHz, EUT at 2437MHz, 802.11b Mode (16.5dBm)

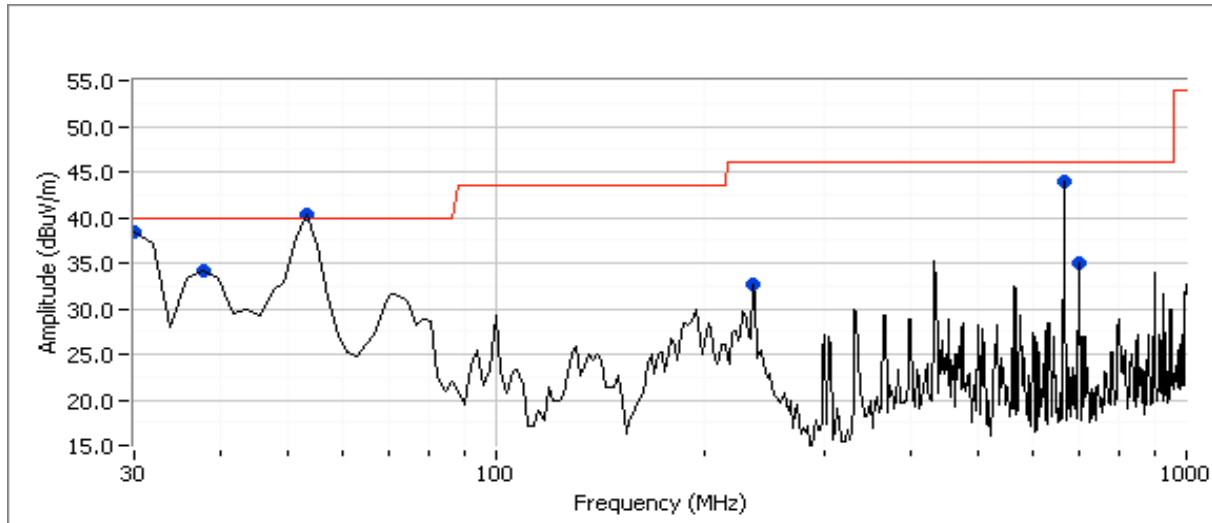

Preliminary peak readings captured during pre-scan

Frequency MHz	Level dBµV/m	Pol v/h	FCC 15.209 / RSS 210		Detector Pk/QP/Avg	Azimuth degrees	Height meters	Comments
			Limit	Margin				
54.406	40.3	V	40.0	0.3	Peak	360	1.0	
31.915	38.5	H	40.0	-1.5	Peak	244	1.0	
662.492	43.9	H	46.0	-2.1	Peak	79	1.5	
32.984	34.2	V	40.0	-5.8	Peak	88	1.0	
699.970	34.9	H	46.0	-11.1	Peak	224	1.0	
236.587	32.7	V	46.0	-13.3	Peak	136	1.0	

Preliminary quasi-peak readings (no manipulation of EUT interface cables)

Frequency MHz	Level dBµV/m	Pol v/h	FCC 15.209 / RSS 210		Detector Pk/QP/Avg	Azimuth degrees	Height meters	Comments
			Limit	Margin				
662.492	44.0	H	46.0	-2.0	QP	83	1.2	QP (1.00s)
31.915	29.5	H	40.0	-10.5	QP	253	1.0	QP (1.00s)
699.970	34.7	H	46.0	-11.3	QP	214	1.0	QP (1.00s)
32.984	26.3	V	40.0	-13.7	QP	80	1.0	QP (1.00s)
236.587	31.7	V	46.0	-14.3	QP	135	1.0	QP (1.00s)
54.406	25.3	V	40.0	-14.7	QP	5	1.0	QP (1.00s)

Client:	Intel	Job Number:	J84264
Model:	135BNHMW & 135BNHU	T-Log Number:	T84548
Contact:	Steve Hackett	Account Manager:	Christine Krebill
Standard:	FCC 15 B, 15.247, RSS 210	Class:	B

Run #1b: Preliminary Radiated Emissions, 30 - 1000 MHz, EUT at 2440MHz, Bluetooth Basic Rate

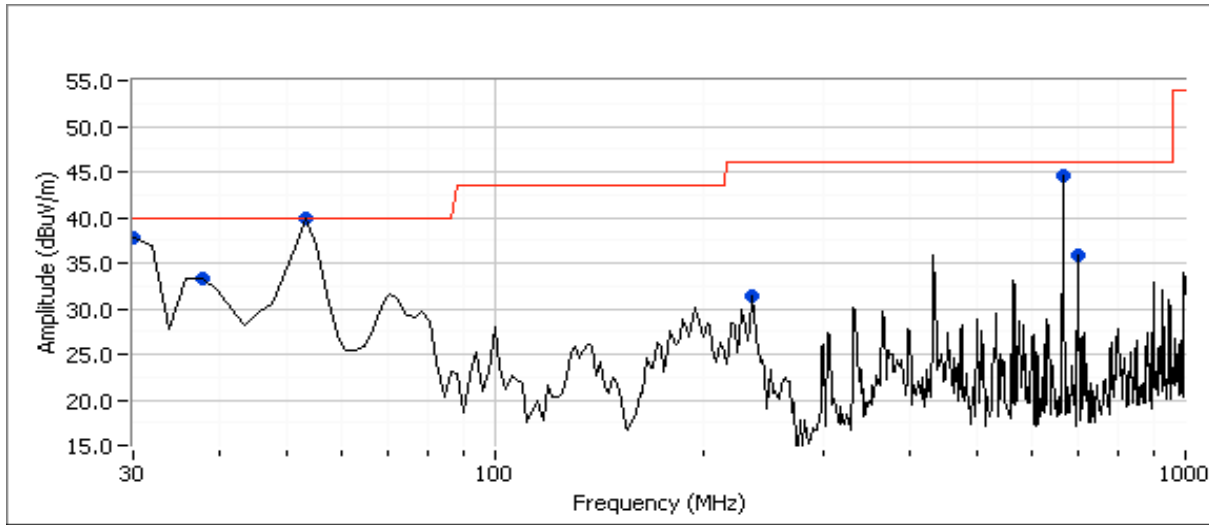

Preliminary peak readings captured during pre-scan

Frequency MHz	Level dB μ V/m	Pol v/h	FCC 15.209 / RSS 210		Detector Pk/QP/Avg	Azimuth degrees	Height meters	Comments
			Limit	Margin				
30.000	37.8	H	40.0	-2.2	Peak	246	1.0	
37.047	33.4	V	40.0	-6.6	Peak	326	1.0	
55.475	40.0	V	40.0	0.0	Peak	42	1.0	
237.073	31.4	V	46.0	-14.6	Peak	114	1.0	
662.473	44.5	H	46.0	-1.5	Peak	82	1.5	
699.990	35.9	H	46.0	-10.1	Peak	221	1.0	

Preliminary quasi-peak readings (no manipulation of EUT interface cables)

Frequency MHz	Level dB μ V/m	Pol v/h	FCC 15.209 / RSS 210		Detector Pk/QP/Avg	Azimuth degrees	Height meters	Comments
			Limit	Margin				
662.468	45.2	H	46.0	-0.8	Peak	91	1.1	QP (1.00s)
699.990	34.9	H	46.0	-11.1	Peak	223	1.0	QP (1.00s)
55.470	26.3	V	40.0	-13.7	Peak	44	1.0	QP (1.00s)
237.073	31.0	V	46.0	-15.0	Peak	112	1.0	QP (1.00s)
30.012	22.8	H	40.0	-17.2	Peak	266	1.0	QP (1.00s)
37.047	19.4	V	40.0	-20.6	Peak	300	1.0	QP (1.00s)

Client:	Intel	Job Number:	J84264
Model:	135BNHMW & 135BNHU	T-Log Number:	T84548
Contact:	Steve Hackett	Account Manager:	Christine Krebill
Standard:	FCC 15 B, 15.247, RSS 210	Class:	B

Run #2: Maximized Readings From Run #1

Maximized quasi-peak readings (includes manipulation of EUT interface cables)

Frequency	Level	Pol	FCC 15.209 / RSS 210		Detector	Azimuth	Height	Comments
MHz	dB μ V/m	v/h	Limit	Margin	Pk/QP/Avg	degrees	meters	
662.468	45.2	H	46.0	-0.8	Peak	82	1.5	
699.990	34.9	H	46.0	-11.1	Peak	221	1.0	
55.470	26.3	V	40.0	-13.7	Peak	42	1.0	
236.587	31.7	V	46.0	-14.3	QP	135	1.0	
32.984	26.3	V	40.0	-13.7	QP	80	1.0	
31.915	29.5	H	40.0	-10.5	QP	253	1.0	

End of Report

This page is intentionally blank and marks the last page of this test report.