

TEST REPORT

CERTIFICATE OF CONFORMITY

Standard: 47 CFR FCC Part 15, Subpart E (Section 15.407)

Report No.: RFBAPP-WTW-P23030958A

FCC ID: PD5-NWA1100

Product: Indoor Wireless AP

Brand: Nile Global

Model No.: NWA1100

Received Date: 2023/3/31

Test Date: 2023/4/26 ~ 2023/5/25

Issued Date: 2024/1/5

Applicant: Delta Electronics, Inc.

Address: 31-1 Shien Pan Rd., Kuei San Industrial Zone, Taoyuan City 333, Taiwan

Issued By: Bureau Veritas Consumer Products Services (H.K.) Ltd., Taoyuan Branch
Lin Kou Laboratories

Lab Address: No. 47-2, 14th Ling, Chia Pau Vil., Lin Kou Dist., New Taipei City, Taiwan

Test Location: No. 19, Hwa Ya 2nd Rd., Wen Hwa Vil., Kewi Shan Dist., Taoyuan City 33383, Taiwan

FCC Registration / 788550 / TW0003

Designation Number:

Approved by: Jeremy Lin, **Date:** 2024/1/5
Jeremy Lin / Project Engineer

This test report consists of 148 pages in total. It may be duplicated completely for legal use with the approval of the applicant. It should not be reproduced except in full, without the written approval of our laboratory. The test results in the report only apply to the tested sample. The test results in this report are traceable to the national or international standards.



Prepared by : Gina Liu / Specialist

This report is governed by, and incorporates by reference, the Conditions of Testing as posted at the date of issuance of this report at <http://www.bureauveritas.com/home/about-us/our-business/cps/about-us/terms-conditions/> and is intended for your exclusive use. Any copying or replication of this report to or for any other person or entity, or use of our name or trademark, is permitted only with our prior written permission. This report sets forth our findings solely with respect to the test samples identified herein. The results set forth in this report are not indicative or representative of the quality or characteristics of the lot from which a test sample was taken or any similar or identical product unless specifically and expressly noted. Our report includes all of the tests requested by you and the results thereof based upon the information that you provided to us. Measurement uncertainty is only provided upon request for accredited tests. Statements of conformity are based on simple acceptance criteria without taking measurement uncertainty into account, unless otherwise requested in writing. You have 60 days from date of issuance of this report to notify us of any material error or omission caused by our negligence or if you require measurement uncertainty; provided, however, that such notice shall be in writing and shall specifically address the issue you wish to raise. A failure to raise such issue within the prescribed time shall constitute your unqualified acceptance of the completeness of this report, the tests conducted and the correctness of the report contents.

Table of Contents

Release Control Record	4
1 Certificate	5
2 Summary of Test Results	6
2.1 Measurement Uncertainty	6
2.2 Supplementary Information	6
3 General Information	7
3.1 General Description of EUT	7
3.2 Antenna Description of EUT	8
3.3 Channel List	9
3.4 Test Mode Applicability and Tested Channel Detail	10
3.5 Duty Cycle of Test Signal	12
3.6 Test Program Used and Operation Descriptions	16
3.7 Connection Diagram of EUT and Peripheral Devices	16
3.8 Configuration of Peripheral Devices and Cable Connections	17
4 Test Instruments	18
4.1 26 dB Bandwidth	18
4.2 RF Output Power	18
4.3 Power Spectral Density	18
4.4 6 dB Bandwidth	18
4.5 Occupied Bandwidth	18
4.6 Frequency Stability	19
4.7 AC Power Conducted Emissions	19
4.8 Unwanted Emissions below 1 GHz	20
4.9 Unwanted Emissions above 1 GHz	21
5 Limits of Test Items	22
5.1 26 dB Bandwidth	22
5.2 RF Output Power	22
5.3 Power Spectral Density	22
5.4 6 dB Bandwidth	22
5.5 Occupied Bandwidth	22
5.6 Frequency Stability	22
5.7 AC Power Conducted Emissions	22
5.8 Unwanted Emissions below 1 GHz	23
5.9 Unwanted Emissions above 1 GHz	24
6 Test Arrangements	25
6.1 26 dB Bandwidth	25
6.1.1 Test Setup	25
6.1.2 Test Procedure	25
6.2 RF Output Power	25
6.2.1 Test Setup	25
6.2.2 Test Procedure	25
6.3 Power Spectral Density	26
6.3.1 Test Setup	26
6.3.2 Test Procedure	26
6.4 6 dB Bandwidth	26
6.4.1 Test Setup	26
6.4.2 Test Procedure	26
6.5 Occupied Bandwidth	27
6.5.1 Test Setup	27
6.5.2 Test Procedure	27
6.6 Frequency Stability	27
6.6.1 Test Setup	27
6.6.2 Test Procedure	27
6.7 AC Power Conducted Emissions	28



6.7.1	Test Setup	28
6.7.2	Test Procedure	28
6.8	Unwanted Emissions below 1 GHz	29
6.8.1	Test Setup	29
6.8.2	Test Procedure	30
6.9	Unwanted Emissions above 1 GHz	31
6.9.1	Test Setup	31
6.9.2	Test Procedure	31
7	Test Results of Test Item	32
7.1	26 dB Bandwidth	32
7.2	RF Output Power	40
7.3	Power Spectral Density	55
7.4	6 dB Bandwidth	65
7.5	Occupied Bandwidth	69
7.6	Frequency Stability	73
7.7	AC Power Conducted Emissions	75
7.8	Unwanted Emissions below 1 GHz	79
7.9	Unwanted Emissions above 1 GHz	83
8	Pictures of Test Arrangements	147
9	Information of the Testing Laboratories	148



Release Control Record

Issue No.	Description	Date Issued
RFBAPP-WTW-P23030958A	Original release.	2024/1/5

1 Certificate

Product: Indoor Wireless AP

Brand: Nile Global

Test Model: NWA1100

Sample Status: Engineering sample

Applicant: Delta Electronics, Inc.

Test Date: 2023/4/26 ~ 2023/5/25

Standard: 47 CFR FCC Part 15, Subpart E (Section 15.407)

Measurement procedure: ANSI C63.10-2013
KDB 789033 D02 General UNII Test Procedure New Rules v02r01
KDB 662911 D01 Multiple Transmitter Output v02r01

The above equipment has been tested by **Bureau Veritas Consumer Products Services (H.K.) Ltd., Taoyuan Branch**, and found compliance with the requirement of the above standards. The test record, data evaluation & Equipment Under Test (EUT) configurations represented herein are true and accurate accounts of the measurements of the sample's RF characteristics under the conditions specified in this report.

2 Summary of Test Results

47 CFR FCC Part 15, Subpart E (Section 15.407)			
Clause	Test Item	Result	Remark
15.407(a)(2)	26 dB Bandwidth	Pass	For U-NII-2A U-NII-2C Band output power limitation is determined based on 26dBc bandwidth.
15.407(a)(2) 15.407(a)(3)	RF Output Power	Pass	Meet the requirement of limit.
15.407(a)(2) 15.407(a)(3)	Power Spectral Density	Pass	Meet the requirement of limit.
15.407(e)	6 dB Bandwidth	Pass	Meet the requirement of limit. (U-NII-3 Band only)
---	Occupied Bandwidth	-	Reference only.
15.407(g)	Frequency Stability	Pass	Meet the requirement of limit.
15.407(b)(9)	AC Power Conducted Emissions	Pass	Minimum passing margin is -4.72 dB at 0.37000 MHz
15.407(b)(9)	Unwanted Emissions below 1 GHz	Pass	Minimum passing margin is -5.3 dB at 168.11 MHz
15.407(b) (2/10) 15.407(b) (3/10) 15.407(b) (4(i)/10)	Unwanted Emissions above 1 GHz	Pass	Minimum passing margin is -0.2 dB at 5350.00 MHz
15.203	Antenna Requirement	Pass	Antenna connector is Ipex(MHF) not a standard connector.

Notes:

- Determining compliance based on the results of the compliance measurement, not taking into account measurement instrumentation uncertainty.
- The "Dynamic Frequency Selection measurement" was recorded in DFS test report.

2.1 Measurement Uncertainty

Where relevant, the following measurement uncertainty levels have been estimated for tests performed on the EUT as specified in CISPR 16-4-2:

Measurement	Specification	Expanded Uncertainty (k=2) (±)
Occupied Bandwidth	-	491.896 Hz
AC Power Conducted Emissions	9 kHz ~ 30 MHz	2.99 dB
Unwanted Emissions below 1 GHz	9 kHz ~ 30 MHz	3.59 dB
	30 MHz ~ 1 GHz	3.6 dB
Unwanted Emissions above 1 GHz	1 GHz ~ 18 GHz	2.29 dB
	18 GHz ~ 40 GHz	2.29 dB

The other instruments specified are routine verified to remain within the calibrated levels, no measurement uncertainty is required to be calculated.

2.2 Supplementary Information

There is not any deviation from the test standards for the test method, and no modifications required for compliance.

3 General Information

3.1 General Description of EUT

Product	Indoor Wireless AP
Brand	Nile Global
Test Model	NWA1100
Status of EUT	Engineering sample
Power Supply Rating	100-240V, 50/60Hz 54 Vdc (From POE)
Modulation Type	64QAM, 16QAM, QPSK, BPSK for OFDM 256QAM for OFDM in 11ac mode 1024QAM for OFDMA in 11ax HE mode
Modulation Technology	OFDM, OFDMA
Transfer Rate	802.11a: 54/48/36/24/18/12/9/6Mbps 802.11n (HT20/40): 6.5 to 600Mbps (MCS0 to MCS31) 802.11ac (VHT20/40/80): up to 1773.2Mbps (MCS0 to MCS9, NSS=1 to 4) 802.11ax (HE20/40/80): up to 2400Mbps (MCS0 to MCS11, NSS=1 to 4)
Operating Frequency	5.26 GHz ~ 5.32 GHz 5.5 GHz ~ 5.72 GHz
Number of Channel	802.11a, 802.11n (HT20), 802.11ac (VHT20), 802.11ax (HE20):16 802.11n (HT40), 802.11ac (VHT40), 802.11ax (HE40):8 802.11ac (VHT80), 802.11ax (HE80), 802.11be (EHT80):4
Output Power	For Radio 2: 5.26 GHz ~ 5.32 GHz : 103.864 mW (20.169 dBm) 5.5 GHz ~ 5.72 GHz : 171.079 mW (22.33 dBm) For Radio 3: 5.26 GHz ~ 5.32 GHz : 165.595 mW (22.19 dBm) 5.5 GHz ~ 5.72 GHz : 189.134 mW (22.77 dBm)

Note:

1. The EUT uses following accessories.

POE (Support unit)		
Brand	Model	Specification
NETGEAR	GS305Pv2	DC Output : 54V,1.25A

2. There are four modules for the EUT.

Function	Radio
WLAN 2.4G (TX/RX)	1
WLAN 5G (TX/RX)	2
WLAN 2.4G & 5G & 6G (TX/RX)	3
BT LE	4
WLAN 6G (TX/RX)	5

3. Simultaneously transmission condition.

Condition	Technology		
1	WLAN 2.4G (Radio 1)	WLAN 5G (Radio 2)	WLAN 6G (Radio 5)
2	WLAN 2.4G (Radio 3)	WLAN 5G (Radio 3)	WLAN 6G (Radio 3)

Note: The emission of the simultaneous operation has been evaluated and no non-compliance was found.

4. The above EUT information is declared by manufacturer and for more detailed features description, please refers to the manufacturer's specifications or user's manual.

3.2 Antenna Description of EUT

1. The antenna information is listed as below.

Antenna Connector		Ipex(MHF)					
Antenna No.	Antenna Type	Gain (dBi)					
		2.4~2.4835GHz	5.15~5.25GHz	5.25~5.35GHz	5.47~5.725GHz	5.725~5.85GHz	
Radio 1	2G1	dipole	6.9	-	-	-	-
	2G2		6.9	-	-	-	-
	2G3		7.7	-	-	-	-
	2G4		6.4	-	-	-	-
Radio 2	5G1	dipole	-	6.7	6.7	7.2	6.6
	5G2		-	6.7	6.7	6.7	7.1
	5G3		-	7.2	7.2	7.6	7.1
	5G4		-	6.6	6.6	7.3	7.0
Radio 3	TB1	PIFA	5.1	7.2	7.2	5.9	5.9
	TB2		4.7	5.6	5.6	5.9	6.8
Radio 4	BLE		5.9	-	-	-	-

* Detail antenna specification please refer to antenna datasheet and/or antenna measurement report.

2. The EUT incorporates a MIMO function:

5 GHz Band				
Module	Modulation Mode	Beamforming Mode	TX & RX Configuration	
Radio 2	802.11a	Not Support	4TX	4RX
	802.11n (HT20)	Support	4TX	4RX
	802.11n (HT40)	Support	4TX	4RX
	802.11ac (VHT20)	Support	4TX	4RX
	802.11ac (VHT40)	Support	4TX	4RX
	802.11ac (VHT80)	Support	4TX	4RX
	802.11ax (HE20)	Support	4TX	4RX
	802.11ax (HE40)	Support	4TX	4RX
	802.11ax (HE80)	Support	4TX	4RX
Radio 3	802.11a	Not Support	2TX	2RX
	802.11n (HT20)	Not Support	2TX	2RX
	802.11n (HT40)	Not Support	2TX	2RX
	802.11ac (VHT20)	Not Support	2TX	2RX
	802.11ac (VHT40)	Not Support	2TX	2RX
	802.11ac (VHT80)	Not Support	2TX	2RX

Note:

- All of modulation mode support beamforming function except 802.11a modulation mode.
- The EUT support Beamforming and CDD mode, therefore both mode were investigated and the worst case scenario was identified. The worst case data were presented in test report.
- The modulation and bandwidth are similar for 802.11n mode for 20 MHz (40 MHz), 802.11ac mode for 20 MHz (40 MHz, 80 MHz) and 802.11ax mode for 20 MHz (40 MHz, 80 MHz), therefore the manufacturer will control the power for 802.11n/ac mode is the same as the 802.11ax or more lower than it and investigated worst case to representative mode in test report.

3.3 Channel List

FOR 5260 ~ 5320 MHz

4 channels are provided for 802.11a, 802.11n (HT20), 802.11ac (VHT20), 802.11ax (HE20):

Channel	Frequency	Channel	Frequency
52	5260 MHz	60	5300 MHz
56	5280 MHz	64	5320 MHz

2 channels are provided for 802.11n (HT40), 802.11ac (VHT40), 802.11ax (HE40):

Channel	Frequency	Channel	Frequency
54	5270 MHz	62	5310 MHz

1 channels is provided for 802.11ac (VHT80), 802.11ax (HE80):

Channel	Frequency
58	5290 MHz

FOR 5500 ~ 5720 MHz

12 channels are provided for 802.11a, 802.11n (HT20), 802.11ac (VHT20), 802.11ax (HE20):

Channel	Frequency	Channel	Frequency
100	5500 MHz	124	5620 MHz
104	5520 MHz	128	5640 MHz
108	5540 MHz	132	5660 MHz
112	5560 MHz	136	5680 MHz
116	5580 MHz	140	5700 MHz
120	5600 MHz	144	5720 MHz

6 channels are provided for 802.11n (HT40), 802.11ac (VHT40), 802.11ax (HE40):

Channel	Frequency	Channel	Frequency
102	5510 MHz	126	5630 MHz
110	5550 MHz	134	5670 MHz
118	5590 MHz	142	5710 MHz

3 channels are provided for 802.11ac (VHT80), 802.11ax (HE80):

Channel	Frequency	Channel	Frequency
106	5530 MHz	138	5690 MHz
122	5610 MHz		

3.4 Test Mode Applicability and Tested Channel Detail

Pre-Scan:	The EUT had been pre-tested on the positioned of each 3 axis (X-axis/ Y-axis/ Z-axis). Pre-scan these ways and find the worst case as a representative test condition.
Worst Case:	X-AXIS for Mode A & Z-AXIS for Mode B

Following channel(s) was (were) selected for the final test as listed below:

Test Item	EUT Configure Mode	Mode	Signal Mode	Tested Channel	Modulation	Data Rate
26dB Bandwidth	A	802.11a	CDD	52, 60, 64, 100, 116, 140, 144	BPSK	6Mb/s
		802.11ax (HE20)	CDD	52, 60, 64, 100, 116, 140, 144	BPSK	MCS0
		802.11ax (HE40)	CDD	54, 62, 102, 110, 134, 142	BPSK	MCS0
		802.11ax (HE80)	CDD	58, 106, 122, 138	BPSK	MCS0
	B	802.11a	CDD	52, 60, 64, 100, 116, 140, 144	BPSK	6Mb/s
		802.11ac (VHT20)	CDD	52, 60, 64, 100, 116, 140, 144	BPSK	MCS0
		802.11ac (VHT40)	CDD	54, 62, 102, 110, 134, 142	BPSK	MCS0
RF Output Power	A	802.11a	CDD	52, 60, 64, 100, 116, 140, 144	BPSK	6Mb/s
		802.11ax (HE20)	CDD & Beamforming	52, 60, 64, 100, 116, 140, 144	BPSK	MCS0
		802.11ax (HE40)	CDD & Beamforming	54, 62, 102, 110, 134, 142	BPSK	MCS0
		802.11ax (HE80)	CDD & Beamforming	58, 106, 122, 138	BPSK	MCS0
	B	802.11a	CDD	52, 60, 64, 100, 116, 140, 144	BPSK	6Mb/s
		802.11ac (VHT20)	CDD	52, 60, 64, 100, 116, 140, 144	BPSK	MCS0
		802.11ac (VHT40)	CDD	54, 62, 102, 110, 134, 142	BPSK	MCS0
Power Spectral Density	A	802.11a	CDD	52, 60, 64, 100, 116, 140, 144	BPSK	6Mb/s
		802.11ax (HE20)	CDD	52, 60, 64, 100, 116, 140, 144	BPSK	MCS0
		802.11ax (HE40)	CDD	54, 62, 102, 110, 134, 142	BPSK	MCS0
		802.11ax (HE80)	CDD	58, 106, 122, 138	BPSK	MCS0
	B	802.11a	CDD	52, 60, 64, 100, 116, 140, 144	BPSK	6Mb/s
		802.11ac (VHT20)	CDD	52, 60, 64, 100, 116, 140, 144	BPSK	MCS0
		802.11ac (VHT40)	CDD	54, 62, 102, 110, 134, 142	BPSK	MCS0
6 dB Bandwidth	A	802.11a	CDD	144	BPSK	6Mb/s
		802.11ax (HE20)	CDD	144	BPSK	MCS0
		802.11ax (HE40)	CDD	142	BPSK	MCS0
		802.11ax (HE80)	CDD	138	BPSK	MCS0
	B	802.11a	CDD	144	BPSK	6Mb/s
		802.11ac (VHT20)	CDD	144	BPSK	MCS0
		802.11ac (VHT40)	CDD	142	BPSK	MCS0
Occupied Bandwidth	A	802.11a	CDD	52, 60, 64, 100, 116, 140, 144	BPSK	6Mb/s
		802.11ax (HE20)	CDD	52, 60, 64, 100, 116, 140, 144	BPSK	MCS0
		802.11ax (HE40)	CDD	54, 62, 102, 110, 134, 142	BPSK	MCS0
		802.11ax (HE80)	CDD	58, 106, 122, 138	BPSK	MCS0
	B	802.11a	CDD	52, 60, 64, 100, 116, 140, 144	BPSK	6Mb/s
		802.11ac (VHT20)	CDD	52, 60, 64, 100, 116, 140, 144	BPSK	MCS0
		802.11ac (VHT40)	CDD	54, 62, 102, 110, 134, 142	BPSK	MCS0
Frequency Stability	A, B	802.11a	-	52	un-modulation	-



Test Item	EUT Configure Mode	Mode	Signal Mode	Tested Channel	Modulation	Data Rate
AC Power Conducted Emissions	A	802.11ax (HE80)	CDD	106	BPSK	MCS0
	B	802.11ac (VHT40)	CDD	142	BPSK	MCS0
Unwanted Emissions below 1 GHz	A	802.11ax (HE80)	CDD	106	BPSK	MCS0
	B	802.11ac (VHT40)	CDD	142	BPSK	MCS0
Unwanted Emissions above 1 GHz	A	802.11a	CDD	52, 60, 64, 100, 116, 140, 144	BPSK	6Mb/s
		11ax20 5G	CDD	52, 60, 64, 100, 116, 140, 144	BPSK	MCS0
		11ax40 5G	CDD	54, 62, 102, 110, 134, 142	BPSK	MCS0
		802.11ax (HE80)	CDD	58, 106, 122, 138	BPSK	MCS0
	B	802.11a	CDD	52, 60, 64, 100, 116, 140, 144	BPSK	6Mb/s
		802.11ac (VHT20)	CDD	52, 60, 64, 100, 116, 140, 144	BPSK	MCS0
		802.11ac (VHT40)	CDD	54, 62, 102, 110, 134, 142	BPSK	MCS0
		802.11ac (VHT80)	CDD	58, 106, 122, 138	BPSK	MCS0
EUT Configure Mode:	A	5G Radio 2				
	B	Scan Radio 3				

3.5 Duty Cycle of Test Signal

Mode A

802.11a: Duty cycle = 1.99 ms / 2.04 ms x 100% = 97.5%, duty factor = 10 * log (1/Duty cycle) = 0.11 dB

802.11ax (HE20): Duty cycle = 5.46 ms / 5.82 ms x 100% = 93.8%, duty factor = 10 * log (1/Duty cycle) = 0.28 dB

802.11ax (HE40): Duty cycle = 5.46 ms / 5.72 ms x 100% = 95.5%, duty factor = 10 * log (1/Duty cycle) = 0.20 dB

802.11ax (HE80): Duty cycle = 5.46 ms / 5.8 ms x 100% = 94.1%, duty factor = 10 * log (1/Duty cycle) = 0.26 dB

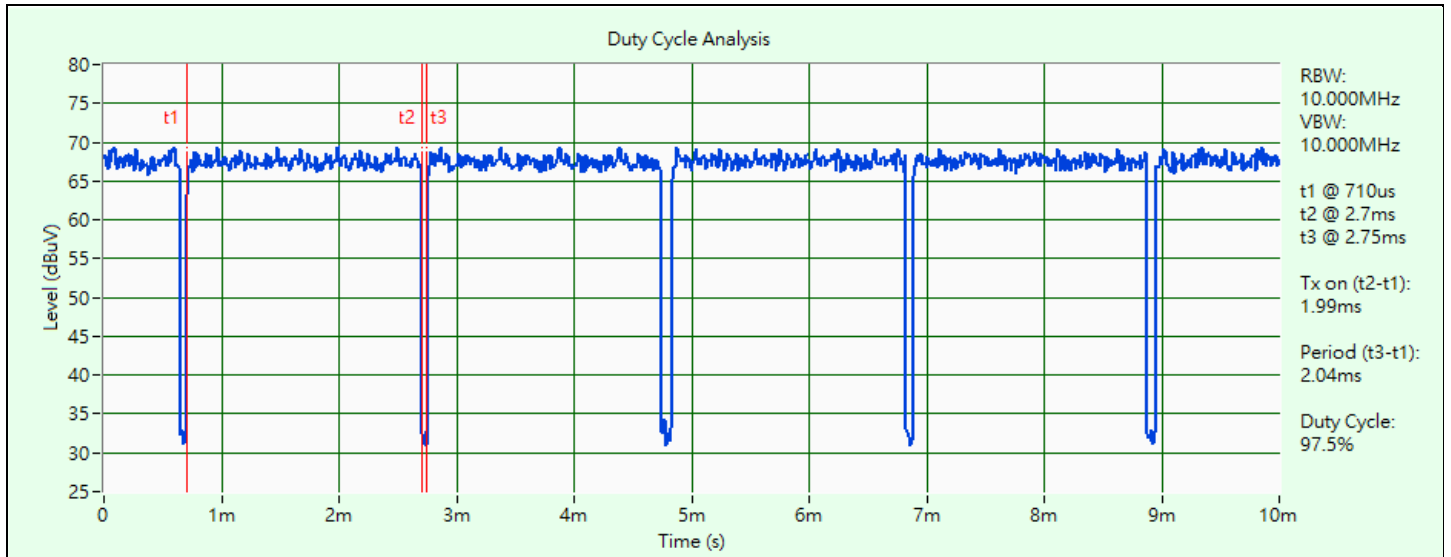

802.11a

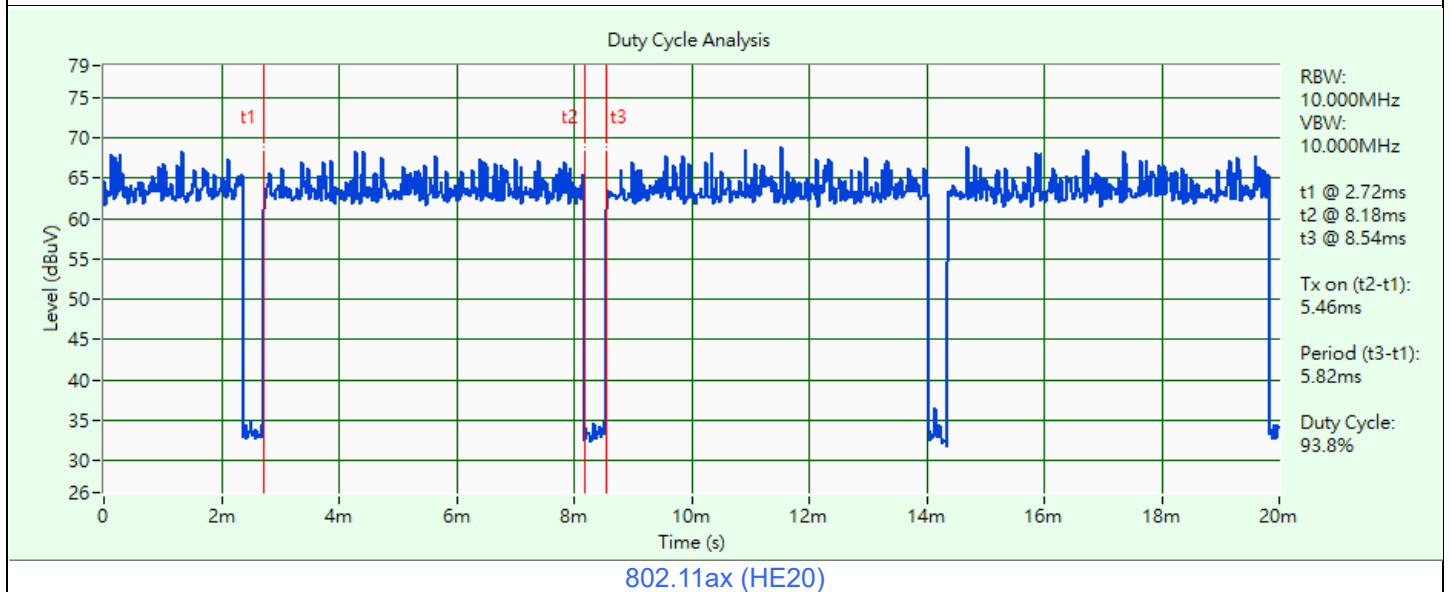

802.11ax (HE20)

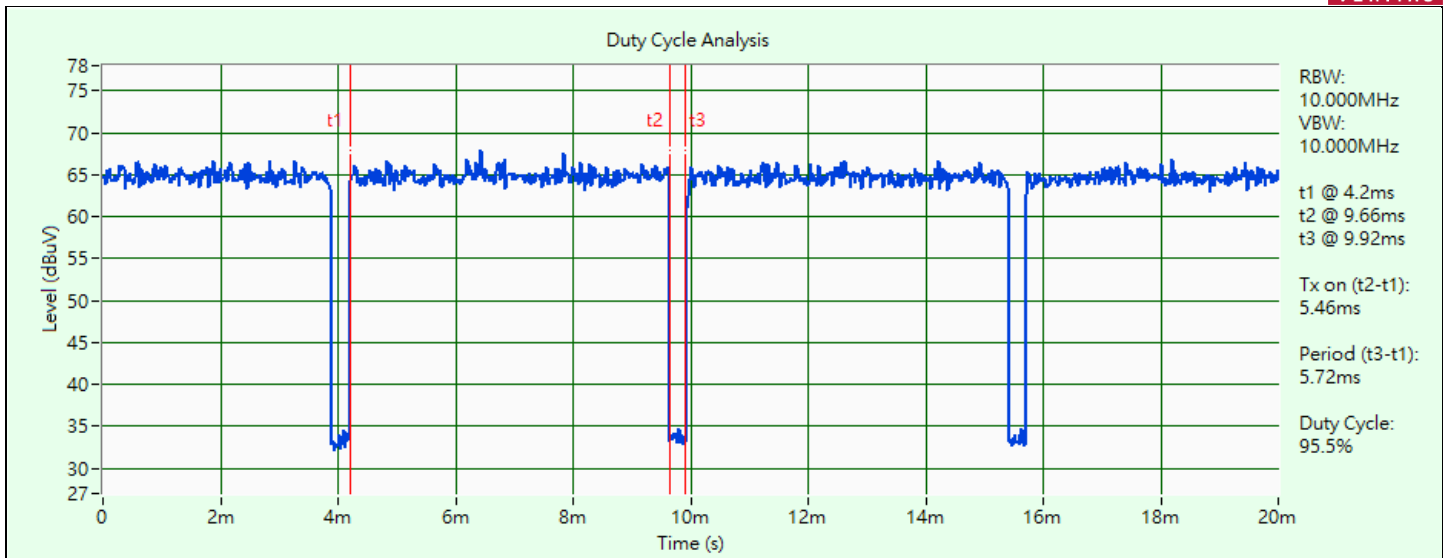

802.11ax (HE40)

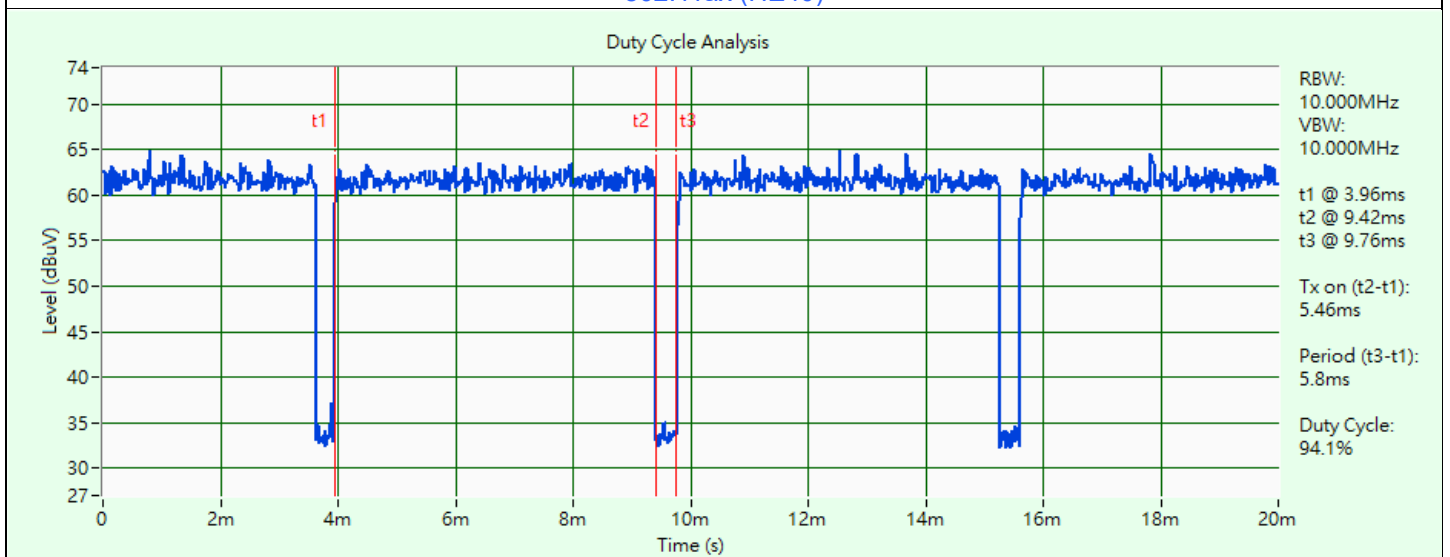

802.11ax (HE80)

Mode B

802.11a: Duty cycle = 1.985 ms / 2.075 ms x 100% = 95.7%, duty factor = 10 * log (1/Duty cycle) = 0.19 dB

802.11ac (VHT20): Duty cycle = 5.44 ms / 5.76 ms x 100% = 94.4%, duty factor = 10 * log (1/Duty cycle) = 0.25 dB

802.11ac (VHT40): Duty cycle = 5.46 ms / 5.82 ms x 100% = 93.8%, duty factor = 10 * log (1/Duty cycle) = 0.28 dB

802.11ac (VHT80): Duty cycle = 5.46 ms / 5.84 ms x 100% = 93.5%, duty factor = 10 * log (1/Duty cycle) = 0.29 dB



802.11a

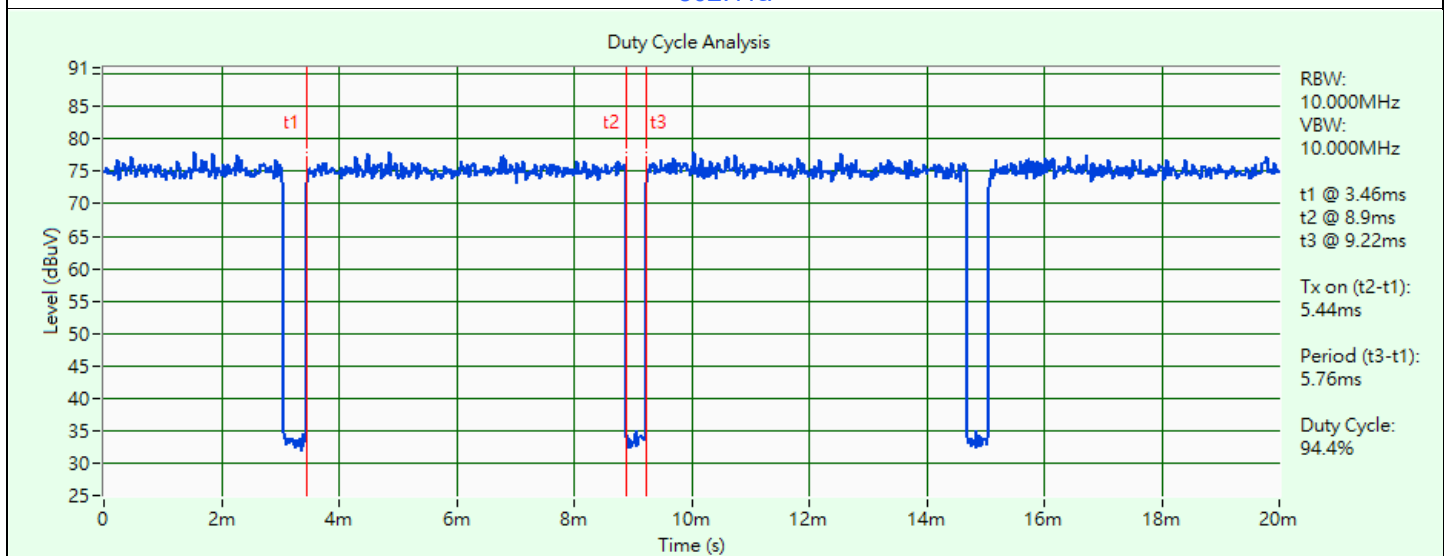

802.11ac (VHT20)

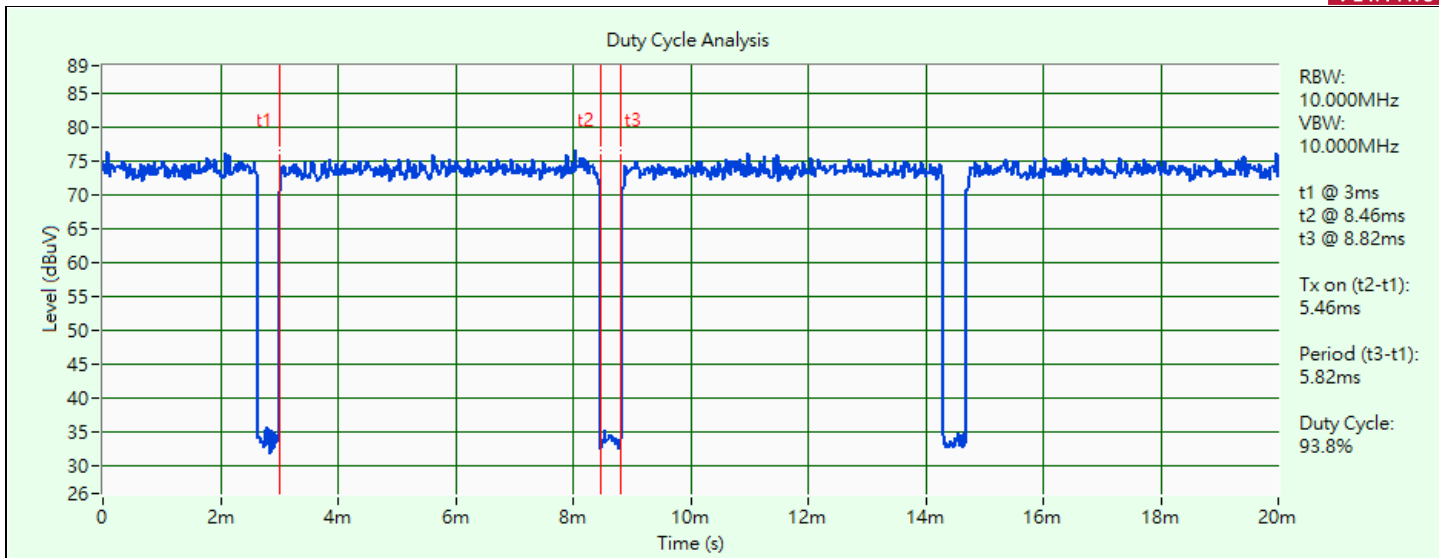

802.11ac (VHT40)

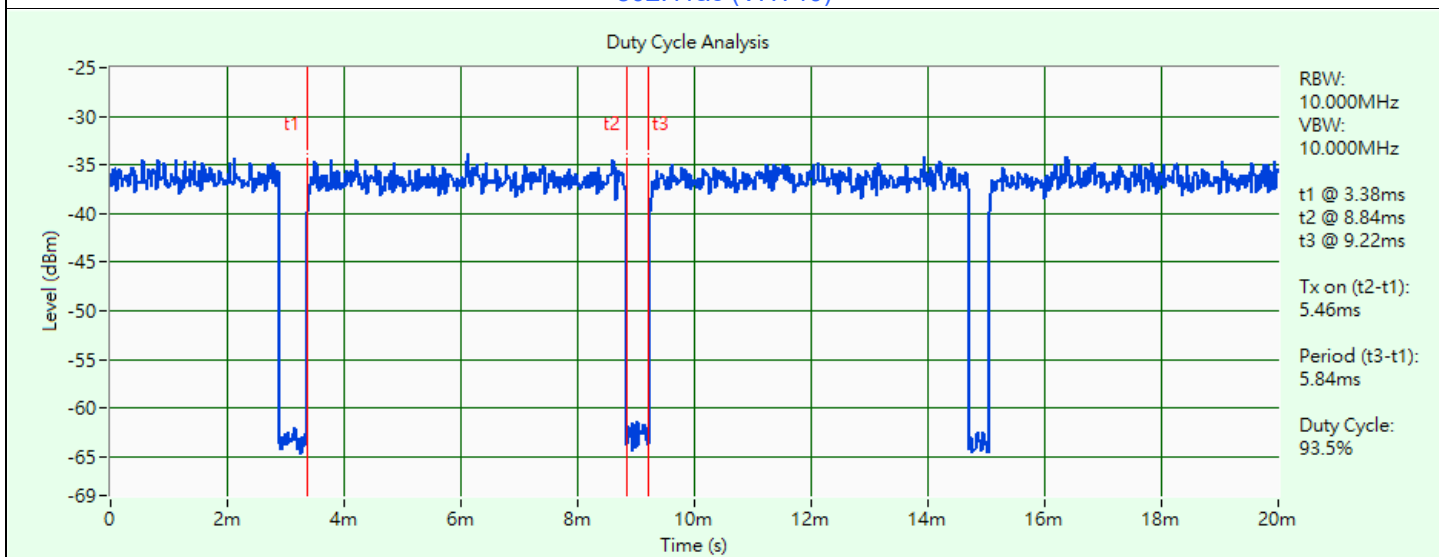

802.11ac (VHT80)

3.6 Test Program Used and Operation Descriptions

Controlling software QSPR Version 5.0-00197 has been activated to set the EUT under transmission condition continuously at specific channel frequency.

3.7 Connection Diagram of EUT and Peripheral Devices

For All test (Conducted Emissions test excluded)

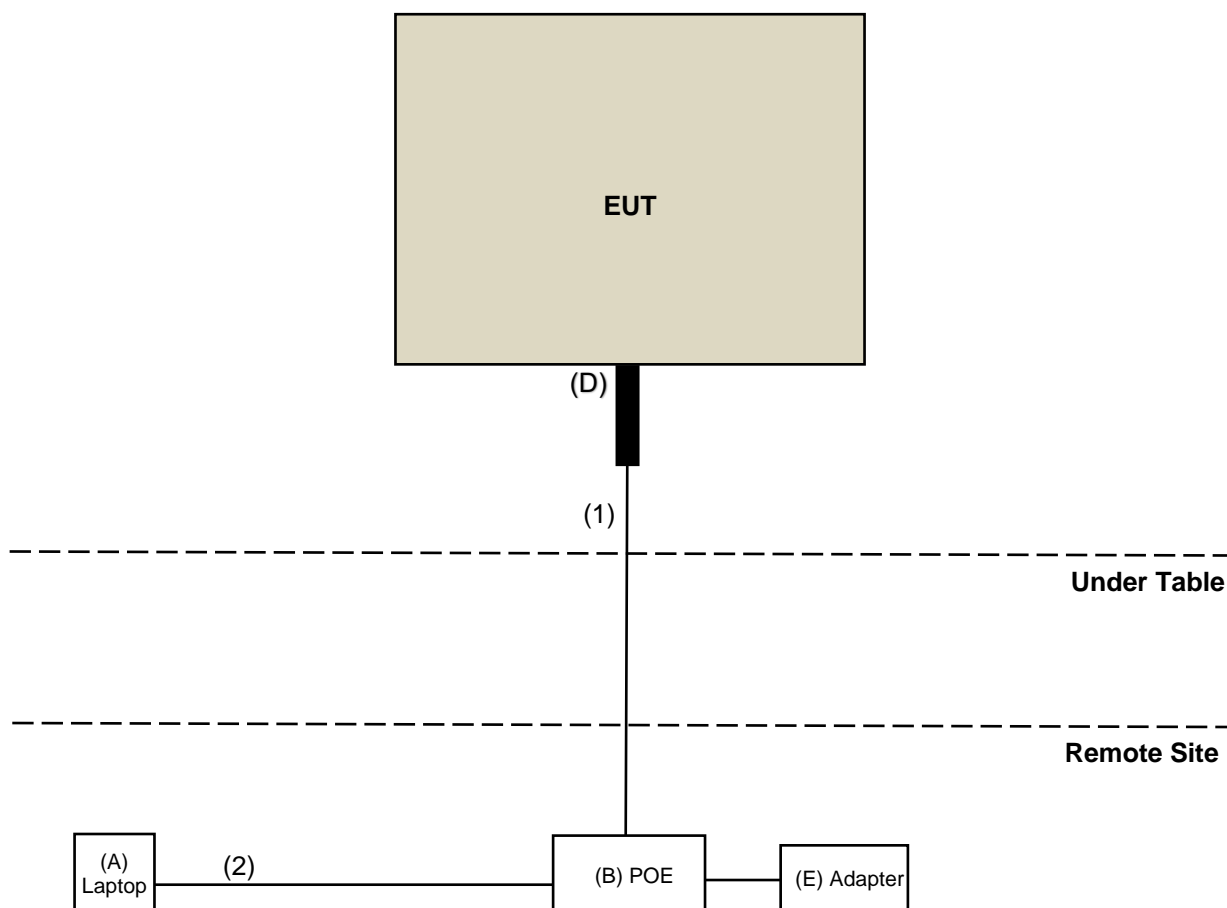

For AC Power Conducted Emissions only

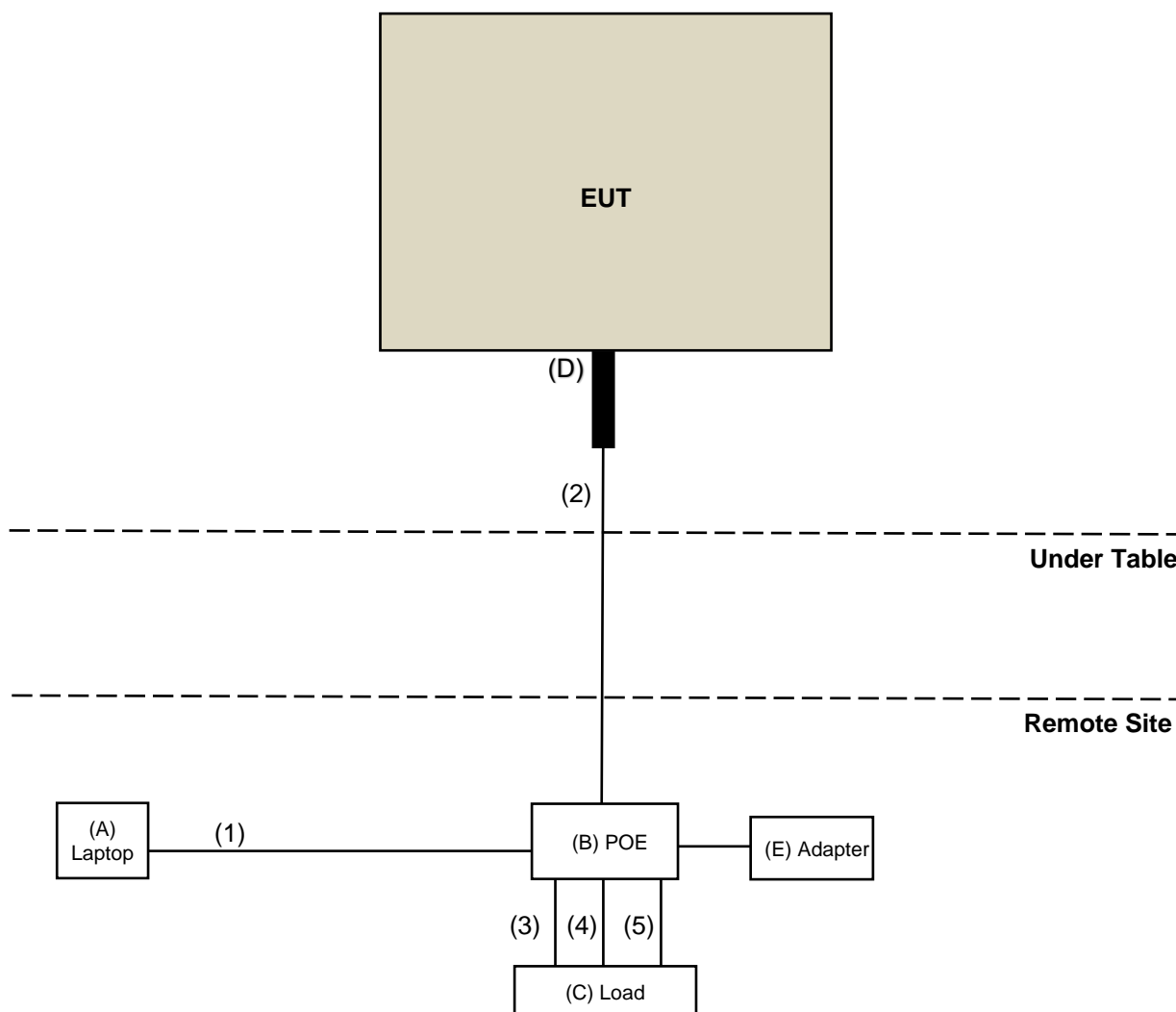

3.8 Configuration of Peripheral Devices and Cable Connections

ID	Product	Brand	Model No.	Serial No.	FCC ID	Remarks
A	Laptop	Lenovo	L470	PF0XEHC5	N/A	Provided by Lab
B	POE	NETGEAR	N/A	N/A	N/A	Supplied by applicant
C	Load	N/A	N/A	N/A	N/A	Provided by Lab
D	LAN port extension	N/A	N/A	N/A	N/A	Supplied by applicant
E	Adapter	N/A	N/A	N/A	N/A	Supplied by applicant

ID	Cable Descriptions	Qty.	Length (m)	Shielding (Yes/No)	Cores (Qty.)	Remarks
1	RJ-45 Cable	1	6.0	N	0	Provided by Lab
2	RJ-45 Cable	1	1.5	N	0	Provided by Lab
3	RJ-45 Cable	1	1.5	N	0	Provided by Lab
4	RJ-45 Cable	1	1.5	N	0	Provided by Lab
5	RJ-45 Cable	1	1.5	N	0	Provided by Lab

4 Test Instruments

The calibration interval of the all test instruments are 12 months and the calibrations are traceable to NML/ROC and NIST/USA.

4.1 26 dB Bandwidth

Description Manufacturer	Model No.	Serial No.	Calibrated Date	Calibrated Until
Signal & Spectrum Analyzer R&S	FSV3044	101105	2023/2/22	2024/2/21
Software BV	ADT_RF Test Software V6.6.5.4	N/A	N/A	N/A

Notes:

1. The test was performed in Oven room.
2. Tested Date: 2023/5/18 ~ 2023/5/21

4.2 RF Output Power

Description Manufacturer	Model No.	Serial No.	Calibrated Date	Calibrated Until
Signal & Spectrum Analyzer R&S	FSV3044	101105	2023/2/22	2024/2/21
Software BV	ADT_RF Test Software V6.6.5.4	N/A	N/A	N/A
USB Wideband Power Sensor Keysight	U2021XA	MY55050005/MY55190004/MY55190007/MY55210005	2022/7/13	2023/7/12

Notes:

1. The test was performed in Oven room.
2. Tested Date: 2023/5/18 ~ 2023/5/21

4.3 Power Spectral Density

Refer to section 4.1 to get information of the instruments.

4.4 6 dB Bandwidth

Refer to section 4.1 to get information of the instruments.

4.5 Occupied Bandwidth

Refer to section 4.1 to get information of the instruments.

4.6 Frequency Stability

Description Manufacturer	Model No.	Serial No.	Calibrated Date	Calibrated Until
3-channel DC power supply JIN YIH Technology	ODP3033	ODP30332128138	N/A	N/A
Digital Multimeter Fluke	87-III	70360742	2022/6/23	2023/6/22
Signal & Spectrum Analyzer R&S	FSV3044	101105	2023/2/22	2024/2/21
Software BV	ADT_RF Test Software V6.6.5.4	N/A	N/A	N/A
Temperature & Humidity Chamber Terchy	HRM-120RF	931022	2022/12/27	2023/12/26

Notes:

1. The test was performed in Oven room.
2. Tested Date: 2023/5/18 ~ 2023/5/21

4.7 AC Power Conducted Emissions

Description Manufacturer	Model No.	Serial No.	Calibrated Date	Calibrated Until
EMI Test Receiver Rohde&Schwarz	ESCI	100613	2022/12/5	2023/12/4
LISN R&S	ESH3-Z5	100311	2022/9/12	2023/9/11
LISN ROHDE & SCHWARZ	ENV216	101826	2023/3/23	2024/3/22
RF Coaxial Cable WOKEN	5D-FB	Cable-cond1-01	2023/1/7	2024/1/6
Software BVADT	BVADT_Cond_ V7.3.7.4	N/A	N/A	N/A
V-LISN Schwarzbeck	NNBL 8226-2	8226-142	2022/8/31	2023/8/30

Notes:

1. The test was performed in HY - Conduction 1.
2. Tested Date: 2023/5/25

4.8 Unwanted Emissions below 1 GHz

Description Manufacturer	Model No.	Serial No.	Calibrated Date	Calibrated Until
Antenna Tower & Turn BV ADT	AT100	AT93021705	N/A	N/A
Bi_Log Antenna Schwarbeck	VULB9168	9168-160	2022/10/20	2023/10/19
Loop Antenna EMCI	EM-6879	269	2022/9/19	2023/9/18
Loop Antenna TESEQ	HLA 6121	45745	2022/7/27	2023/7/26
MXE EMI Receiver KEYSIGHT	N9038A	MY55420137	2023/5/3	2024/5/2
Pre-amplifier EMCI	EMC001340	980201	2022/9/23	2023/9/22
Preamplifier Agilent	8447D	2944A10638	2023/5/7	2024/5/6
RF Coaxial Cable EMCI	5D-NM-BM	140903+140902	2023/1/7	2024/1/6
RF Coaxial Cable WOKEN	8D-FB	Cable-CH9-01	2023/5/7	2024/5/6
Signal & Spectrum Analyzer R&S	FSW43	101867	2022/12/30	2023/12/29
Software BV ADT	ADT_Radiated_ V7.6.15.9.5	N/A	N/A	N/A
Turn Table BV ADT	TT100	TT93021705	N/A	N/A
Turn Table Controller BV ADT	SC100	SC93021705	N/A	N/A

Notes:

1. The test was performed in HY - 966 chamber 4.
2. Tested Date: 2023/5/24

4.9 Unwanted Emissions above 1 GHz

Description Manufacturer	Model No.	Serial No.	Calibrated Date	Calibrated Until
Antenna Tower & Turn BV ADT	AT100	AT93021705	N/A	N/A
Boresight antenna tower fixture BV	BAF-02	5	N/A	N/A
Horn Antenna Schwarzbeck	9120D	9120D-1169	2022/11/13	2023/11/12
	BBHA 9170	9170-480	2022/11/13	2023/11/12
		BBHA9170243	2022/11/13	2023/11/12
MXE EMI Receiver KEYSIGHT	N9038A	MY55420137	2022/4/27 2023/5/3	2023/4/26 2024/5/2
Pre-Amplifier EMCI	EMC 184045	980116	2022/10/1	2023/9/30
Preamplifier Agilent	8449B	3008A02367	2023/2/15	2024/2/14
RF Coaxial Cable EMCI	EMC102-KM-KM-600	150928	2022/7/9	2023/7/8
	EMC102-KM-KM-3000	150929	2022/7/9	2023/7/8
RF Coaxial Cable HUBER+SUHNER	SUCOFLEX 104	CABLE-CH9-(250795/4)	2023/1/7	2024/1/6
RF Coaxial Cable HUBER+SUHNER&EMCI	SUCOFLEX 104& EMC104-SM-SM8000	CABLE-CH9-02 (248780+171006)	2023/1/7	2024/1/6
RF FLITER MICRO-TRONICS	BRM17690	004	2023/1/11	2024/1/10
	BRM50716	060	2023/1/11	2024/1/10
Signal & Spectrum Analyzer R&S	FSW43	101867	2022/12/30	2023/12/29
Software BV ADT	ADT_Radiated_ V7.6.15.9.5	N/A	N/A	N/A
Turn Table BV ADT	TT100	TT93021705	N/A	N/A
Turn Table Controller BV ADT	SC100	SC93021705	N/A	N/A

Notes:

1. The test was performed in HY - 966 chamber 4.
2. Tested Date: 2023/4/26 ~ 2023/5/19

5 Limits of Test Items

5.1 26 dB Bandwidth

The results are for reference only.

5.2 RF Output Power

Operation Band	Limit
U-NII-2A	250 mW (24 dBm) or 11 dBm+10 log B*
U-NII-2C	250 mW (24 dBm) or 11 dBm+10 log B*
U-NII-3	1 Watt (30 dBm)

*B is the 26 dB emission bandwidth in megahertz

Per KDB 662911 D01 Multiple Transmitter Output Method of conducted output power measurement on IEEE 802.11 devices,

Array Gain = 0 dB (i.e., no array gain) for $N_{ANT} \leq 4$;

Array Gain = 0 dB (i.e., no array gain) for channel widths ≥ 40 MHz for any N_{ANT} ;

Array Gain = $5 \log(N_{ANT}/N_{SS})$ dB or 3 dB, whichever is less, for 20-MHz channel widths with $N_{ANT} \geq 5$.

For power measurements on all other devices: Array Gain = $10 \log(N_{ANT}/N_{SS})$ dB.

5.3 Power Spectral Density

Operation Band	Limit
U-NII-2A	11 dBm/MHz
U-NII-2C	11 dBm/MHz
U-NII-3	30 dBm/500 kHz

5.4 6 dB Bandwidth

Within the 5.725-5.850 GHz band, the minimum 6 dB bandwidth of U-NII devices shall be at least 500 kHz.

5.5 Occupied Bandwidth

The results are for reference only.

5.6 Frequency Stability

The frequency of the carrier signal shall be maintained within band of operation.

5.7 AC Power Conducted Emissions

Frequency (MHz)	Conducted Limit (dBuV)	
	Quasi-peak	Average
0.15 - 0.5	66 - 56	56 - 46
0.50 - 5.0	56	46
5.0 - 30.0	60	50

Notes:

1. The lower limit shall apply at the transition frequencies.
2. The limit decreases in line with the logarithm of the frequency in the range of 0.15 to 0.50 MHz.

5.8 Unwanted Emissions below 1 GHz

Radiated emissions which fall in the restricted bands must comply with the radiated emission limits specified as below table.

Frequencies (MHz)	Field Strength (microvolts/meter)	Measurement Distance (meters)
0.009 ~ 0.490	2400/F(kHz)	300
0.490 ~ 1.705	24000/F(kHz)	30
1.705 ~ 30.0	30	30
30 ~ 88	100	3
88 ~ 216	150	3
216 ~ 960	200	3
Above 960	500	3

Notes:

1. The lower limit shall apply at the transition frequencies.
2. Emission level (dBuV/m) = 20 log Emission level (uV/m).

5.9 Unwanted Emissions above 1 GHz

Radiated emissions which fall in the restricted bands must comply with the radiated emission limits specified as below table.

Frequencies (MHz)	Field Strength (microvolts/meter)	Measurement Distance (meters)
Above 960	500	3

Notes:

1. The lower limit shall apply at the transition frequencies.
2. Emission level (dBuV/m) = 20 log Emission level (uV/m).
3. For frequencies above 1000 MHz, the field strength limits are based on average detector, however, the peak field strength of any emission shall not exceed the maximum permitted average limits, specified above by more than 20 dB under any condition of modulation.

Limits of unwanted emission out of the restricted bands

Applicable To	Limit	
789033 D02 General UNII Test Procedure New Rules v02r01	Field Strength at 3 m	
	PK: 74 (dBμV/m)	AV: 54 (dBμV/m)

For transmitters operating in the 5.25-5.35 GHz band:

Applicable To	EIRP Limit	Equivalent Field Strength at 3 m
15.407(b)(2)	PK: -27 (dBm/MHz)	PK: 68.2 (dBμV/m)

For transmitters operating in the 5.47-5.725 GHz band:

Applicable To	EIRP Limit	Equivalent Field Strength at 3 m
15.407(b)(3)	PK: -27 (dBm/MHz)	PK: 68.2 (dBμV/m)

For transmitters operating in the 5.725-5.850 GHz band:

Applicable To	EIRP Limit	Equivalent Field Strength at 3 m
15.407(b)(4)(i)	PK: -27 (dBm/MHz) ^{*1} PK: 10 (dBm/MHz) ^{*2} PK: 15.6 (dBm/MHz) ^{*3} PK: 27 (dBm/MHz) ^{*4}	PK: 68.2 (dBμV/m) ^{*1} PK: 105.2 (dBμV/m) ^{*2} PK: 110.8 (dBμV/m) ^{*3} PK: 122.2 (dBμV/m) ^{*4}

^{*1} beyond 75 MHz or more above of the band edge.

^{*2} below the band edge increasing linearly to 10 dBm/MHz at 25 MHz above.

^{*3} below the band edge increasing linearly to a level of 15.6 dBm/MHz at 5 MHz above.

^{*4} from 5 MHz above or below the band edge increasing linearly to a level of 27 dBm/MHz at the band edge.

Note: The following formula is used to convert the equipment isotropic radiated power (eirp) to field strength:

$$E = \frac{1000000 \sqrt{30P}}{3} \mu\text{V/m, where P is the eirp (Watts).}$$

6 Test Arrangements

6.1 26 dB Bandwidth

6.1.1 Test Setup

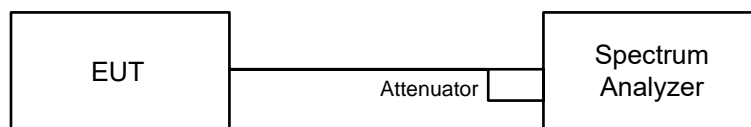

6.1.2 Test Procedure

- Set RBW = approximately 1% of the emission bandwidth.
- Set the VBW > RBW.
- Detector = Peak.
- Trace mode = max hold.
- Measure the maximum width of the emission that is 26 dB down from the peak of the emission. Compare this with the RBW setting of the analyzer. Readjust RBW and repeat measurement as needed until the RBW/EBW ratio is approximately 1%.

6.2 RF Output Power

6.2.1 Test Setup

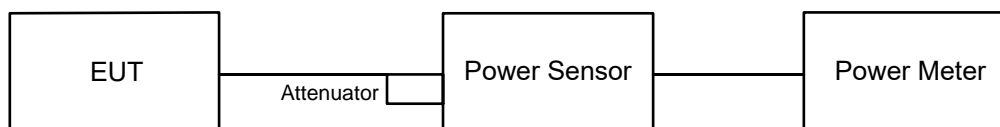

For channel straddling:

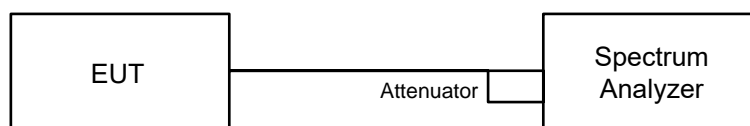

6.2.2 Test Procedure

Method PM is used to perform output power measurement, trigger and gating function of wide band power meter is enabled to measure max output power of TX on burst and set the detector to average. Duty factor is not added to measured value.

For channel straddling:

Method SA-2A

- Set span to encompass the entire emission bandwidth (EBW) of the signal.
- Set RBW = 1 MHz, Set VBW ≥ 3 MHz, Detector = RMS
- Sweep points ≥ $[2 \times \text{span} / \text{RBW}]$. (This gives bin-to-bin spacing ≤ RBW / 2, so that narrowband signals are not lost between frequency bins.)
- Manually set sweep time ≥ $10 \times (\text{number of points in sweep}) \times (\text{total on/off period of the transmitted signal})$.
- Perform a single sweep.
- Record the max value and add $10 \log (1/\text{duty cycle})$.

Note: When measuring straddle channel power, use compute power by integrating the spectrum across the 26 dB EBW or 99% OBW of the signal using the instrument's band power measurement function, with band limits set equal to the EBW or OBW band edges. If the instrument does not have a band power function, then sum the spectrum levels (in power units) at 1 MHz intervals extending across the 26 dB EBW or 99% OBW of the spectrum.

6.3 Power Spectral Density

6.3.1 Test Setup

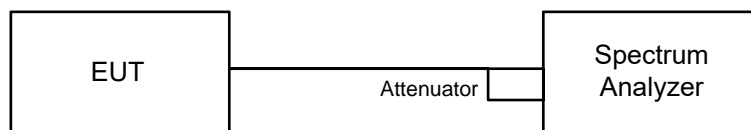

6.3.2 Test Procedure

For specified measurement bandwidth 1 MHz:

Method SA-2

- Set span to encompass the entire emission bandwidth (EBW) of the signal.
- Set RBW = 1 MHz, Set VBW \geq 3 MHz, Detector = RMS
- Sweep points \geq $[2 \times \text{span} / \text{RBW}]$. (This gives bin-to-bin spacing \leq RBW / 2, so that narrowband signals are not lost between frequency bins.)
- Sweep time = auto, trigger set to "free run".
- Trace average at least 100 traces in power averaging mode.
- Use the peak search function on the instrument to find the peak of the spectrum and record its value.
- Record the max value and add 10 log (1/duty cycle).

For specified measurement bandwidth 500 kHz:

Method SA-2

- Set span to encompass the entire emission bandwidth (EBW) of the signal.
- Set RBW = 300 kHz, Set VBW \geq 1 MHz, Detector = RMS
- Scale the observed power level to an equivalent value in 500 kHz by adjusting (increasing) the measured power by a bandwidth correction factor (BWCF) where $\text{BWCF} = 10\log(500 \text{ kHz}/300 \text{ kHz})$
- Sweep points \geq $[2 \times \text{span} / \text{RBW}]$. (This gives bin-to-bin spacing \leq RBW / 2, so that narrowband signals are not lost between frequency bins.)
- Sweep time = auto, trigger set to "free run".
- Trace average at least 100 traces in power averaging mode.
- Use the peak search function on the instrument to find the peak of the spectrum and record its value.
- Record the max value and add 10 log (1/duty cycle).

6.4 6 dB Bandwidth

6.4.1 Test Setup

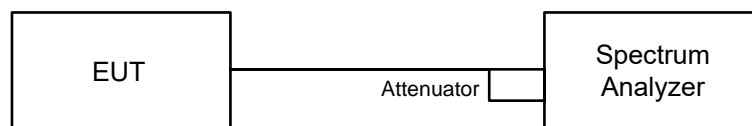

6.4.2 Test Procedure

- Set resolution bandwidth (RBW) = 100 kHz.
- Set the video bandwidth (VBW) \geq 3 x RBW, Detector = Peak.
- Trace mode = max hold.
- Sweep = auto couple.
- Measure the maximum width of the emission that is constrained by the frequencies associated with the two amplitude points (upper and lower) that are attenuated by 6 dB relative to the maximum level measured in the fundamental emission.

6.5 Occupied Bandwidth

6.5.1 Test Setup

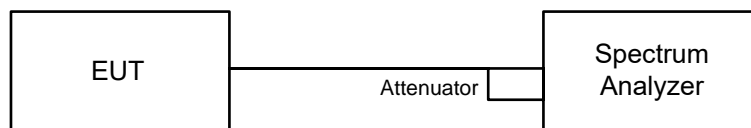

6.5.2 Test Procedure

The transmitter output was connected to the spectrum analyzer through an attenuator. The bandwidth of the fundamental frequency was measured by spectrum analyzer with resolution bandwidth in the range of 1% to 5% of the anticipated emission bandwidth, and a video bandwidth at least 3x the resolution bandwidth and set the detector to Sampling. The width of a frequency band such that, below the lower and above the upper frequency limits, the mean powers emitted are each equal to a specified percentage 0.5% of the total mean power of a given emission.

6.6 Frequency Stability

6.6.1 Test Setup

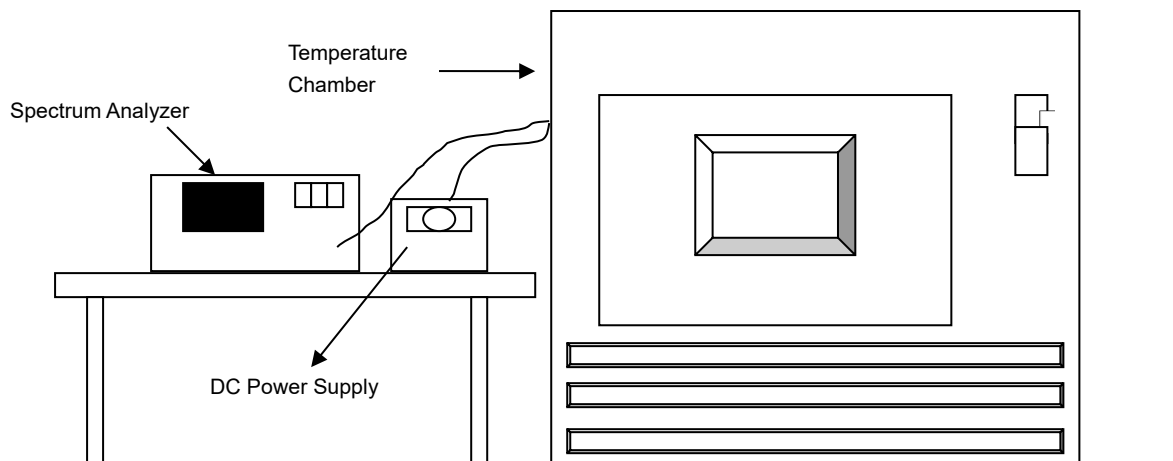

6.6.2 Test Procedure

- The EUT was placed inside the environmental test chamber and powered by nominal DC voltage.
- Turn the EUT on and couple its output to a spectrum analyzer.
- Turn the EUT off and set the chamber to the highest temperature specified.
- Allow sufficient time (approximately 30 min) for the temperature of the chamber to stabilize, turn the EUT on and measure the operating frequency after 2, 5, and 10 Minutes.
- Repeat step (d) with the temperature chamber set to the next desired temperature until measurements down to the lowest specified temperature have been completed.
- The test chamber was allowed to stabilize at +20 degree C for a minimum of 30 Minutes. The supply voltage was then adjusted on the EUT from 85% to 115% and the frequency record.

6.7 AC Power Conducted Emissions

6.7.1 Test Setup

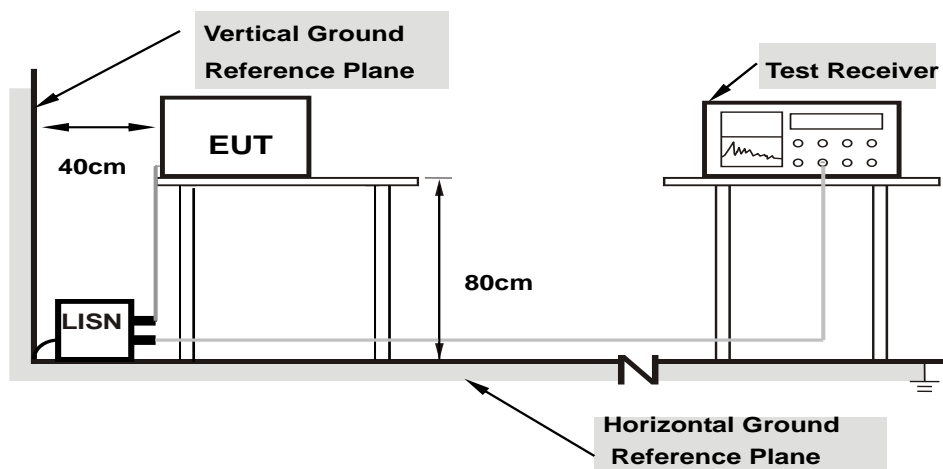

Note: 1.Support units were connected to second LISN.

For the actual test configuration, please refer to the attached file (Test Setup Photo).

6.7.2 Test Procedure

- The EUT was placed on a 0.8 meter to the top of table and placed 0.4 meters from the conducting wall of the shielded room with EUT being connected to the power mains through a line impedance stabilization network (LISN). Other support units were connected to the power mains through another LISN. The two LISNs provide 50 ohm/ 50 uH of coupling impedance for the measuring instrument.
- Both lines of the power mains connected to the EUT were checked for maximum conducted interference.
- The frequency range from 150 kHz to 30 MHz was searched. Emission levels under (Limit – 20 dB) was not recorded.

Note: The resolution bandwidth and video bandwidth of test receiver is 9 kHz for quasi-peak detection (QP) and average detection (AV) at frequency 0.15 MHz-30 MHz.

6.8 Unwanted Emissions below 1 GHz

6.8.1 Test Setup

For Radiated emission above 30 MHz

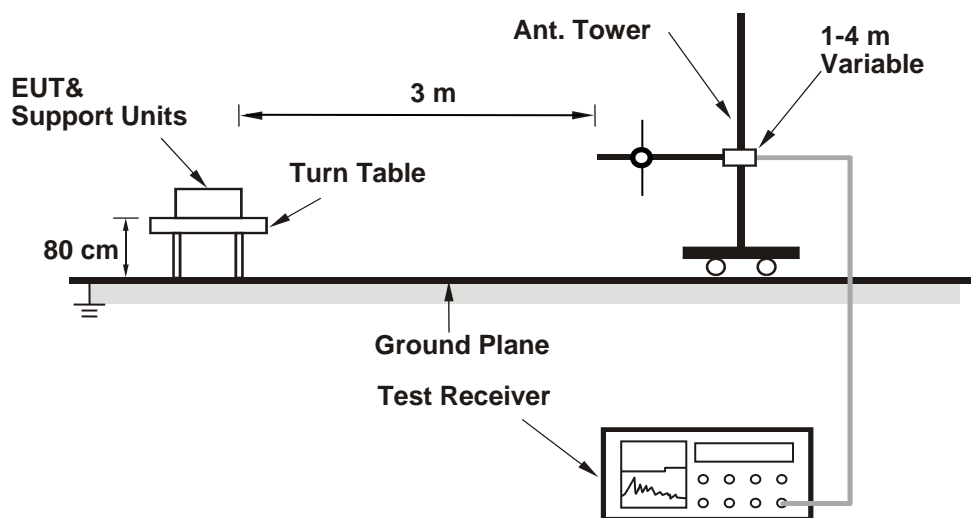

For the actual test configuration, please refer to the attached file (Test Setup Photo).

6.8.2 Test Procedure

For Radiated emission above 30 MHz

- a. The EUT was placed on the top of a rotating table 0.8 meters above the ground at 3 meter chamber room for test. The table was rotated 360 degrees to determine the position of the highest radiation.
- b. The EUT was set 3 meters away from the interference-receiving antenna, which was mounted on the top of a variable-height antenna tower.
- c. The height of antenna is varied from one meter to four meters above the ground to determine the maximum value of the field strength. Both horizontal and vertical polarizations of the antenna are set to make the measurement.
- d. For each suspected emission, the EUT was arranged to its worst case and then the antenna was tuned to heights from 1 meter to 4 meters and the rotatable table was turned from 0 degrees to 360 degrees to find the maximum reading.
- e. The test-receiver system was set to quasi-peak detect function and specified bandwidth with maximum hold mode when the test frequency is below 1 GHz.

Notes:

1. The resolution bandwidth and video bandwidth of test receiver/spectrum analyzer is 120 kHz for Quasi-peak detection (QP) at frequency below 1 GHz.
2. All modes of operation were investigated and the worst-case emissions are reported.

6.9 Unwanted Emissions above 1 GHz

6.9.1 Test Setup

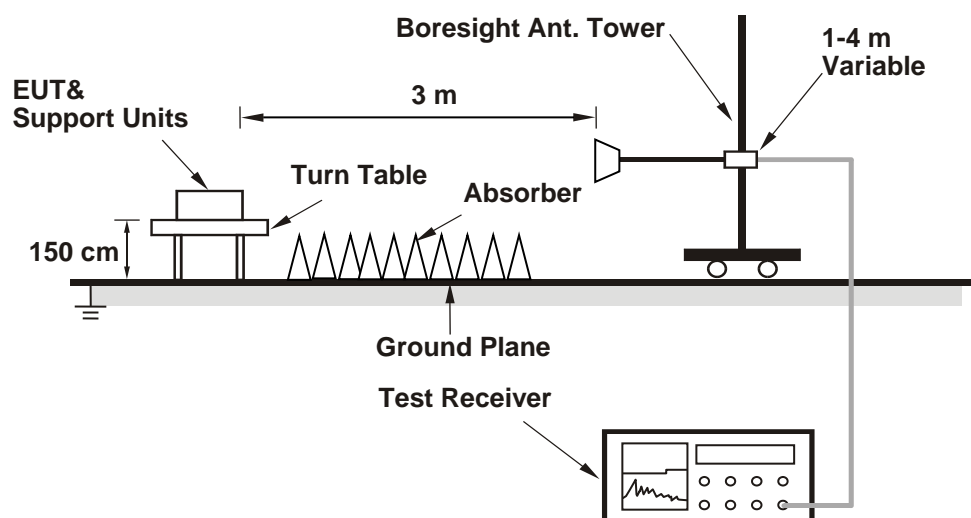

For the actual test configuration, please refer to the attached file (Test Setup Photo).

6.9.2 Test Procedure

- The EUT was placed on the top of a rotating table 1.5 meters above the ground at 3 meter chamber room for test. The table was rotated 360 degrees to determine the position of the highest radiation.
- The EUT was set 3 meters away from the interference-receiving antenna, which was mounted on the top of a variable-height antenna tower.
- The height of antenna is varied from one meter to four meters above the ground to determine the maximum value of the field strength. Both horizontal and vertical polarizations of the antenna are set to make the measurement.
- For each suspected emission, the EUT was arranged to its worst case and then the antenna was tuned to heights from 1 meter to 4 meters and the rotatable table was turned from 0 degrees to 360 degrees to find the maximum reading.
- The test-receiver system was set to peak and average detects function and specified bandwidth with maximum hold mode when the test frequency is above 1 GHz. If the peak reading value also meets average limit, measurement with the average detector is unnecessary.

Notes:

- The resolution bandwidth of test receiver/spectrum analyzer is 1 MHz and the video bandwidth is 3 MHz for Peak detection (PK) and Average detection (AV) at frequency above 1 GHz.
- For fundamental and harmonic signal measurement, the resolution bandwidth of test receiver/spectrum analyzer is 1 MHz and the video bandwidth is $\geq 1/T$ (Duty cycle $< 98\%$) or 10 Hz (Duty cycle $\geq 98\%$) for Average detection (AV) at frequency above 1 GHz.
- All modes of operation were investigated and the worst-case emissions are reported.

7 Test Results of Test Item

7.1 26 dB Bandwidth

Input Power:	54 Vdc	Environmental Conditions:	25°C, 60% RH	Tested By:	Tim Chen
--------------	--------	---------------------------	--------------	------------	----------

Mode A

802.11a

Channel	Frequency (MHz)	26 dB Bandwidth (MHz)			
		Chain 0	Chain 1	Chain 2	Chain 3
52	5260	19.08	19.31	19.47	19.15
60	5300	19.47	19.07	18.93	19.24
64	5320	19.17	19.10	19.56	19.23
100	5500	19.23	19.15	19.26	19.33
116	5580	19.08	19.24	19.24	19.38
140	5700	19.36	19.08	19.17	19.29
144 (U-NII-2C)	5720	14.73	14.73	14.52	14.75
144 (U-NII-3)	5720	4.57	4.81	4.53	4.44

Determined Output Power Limit			
Channel Number	Freq.(MHz)	Min. B(MHz)	Determined Conducted Power Limit (dBm)
52	5260	19.08	23.8 < 24
60	5300	18.93	23.77 < 24
64	5320	19.10	23.81 < 24
100	5500	19.15	23.82 < 24
116	5580	19.08	23.8 < 24
140	5700	19.08	23.8 < 24
144 (U-NII-2C)	5720	14.52	22.61 < 24

Note: For U-NII-2A, U-NII-2C Band output power limitation is determined based on 26dBc bandwidth.

802.11ax (HE20)

Channel	Frequency (MHz)	26 dB Bandwidth (MHz)			
		Chain 0	Chain 1	Chain 2	Chain 3
52	5260	21.52	21.39	21.34	21.52
60	5300	21.32	21.74	21.74	21.29
64	5320	21.65	21.42	21.85	21.34
100	5500	21.71	21.53	21.45	21.51
116	5580	21.51	21.43	21.48	21.46
140	5700	21.71	21.65	21.48	21.47
144 (U-NII-2C)	5720	15.86	15.76	15.64	15.74
144 (U-NII-3)	5720	5.87	5.64	5.48	5.88

Determined Output Power Limit			
Channel Number	Freq.(MHz)	Min. B(MHz)	Determined Conducted Power Limit (dBm)
52	5260	21.34	24.29 > 24
60	5300	21.29	24.28 > 24
64	5320	21.34	24.29 > 24
100	5500	21.45	24.31 > 24
116	5580	21.43	24.31 > 24
140	5700	21.47	24.31 > 24
144 (U-NII-2C)	5720	15.64	22.94 < 24

Note: For U-NII-2A, U-NII-2C Band output power limitation is determined based on 26dBc bandwidth.

802.11ax (HE40)

Channel	Frequency (MHz)	26 dB Bandwidth (MHz)			
		Chain 0	Chain 1	Chain 2	Chain 3
54	5270	41.23	41.38	40.99	41.41
62	5310	41.36	41.01	41.04	41.22
102	5510	41.29	41.07	41.07	40.92
110	5550	41.29	41.20	41.21	40.71
134	5670	41.32	41.06	41.01	40.95
142 (U-NII-2C)	5710	35.55	35.62	35.58	35.59
142 (U-NII-3)	5710	5.35	5.50	5.46	5.68

Determined Output Power Limit			
Channel Number	Freq.(MHz)	Min. B(MHz)	Determined Conducted Power Limit (dBm)
54	5270	40.99	27.12 > 24
62	5310	41.01	27.12 > 24
102	5510	40.92	27.11 > 24
110	5550	40.71	27.09 > 24
134	5670	40.95	27.12 > 24
142 (U-NII-2C)	5710	35.55	26.5 > 24

Note: For U-NII-2A, U-NII-2C Band output power limitation is determined based on 26dBc bandwidth.

802.11ax (HE80)

Channel	Frequency (MHz)	26 dB Bandwidth (MHz)			
		Chain 0	Chain 1	Chain 2	Chain 3
58	5290	83.22	83.37	83.14	83.30
106	5530	83.19	83.02	83.11	83.16
122	5610	83.21	83.07	83.20	83.48
138 (U-NII-2C)	5690	76.54	76.54	76.70	76.49
138 (U-NII-3)	5690	6.72	6.38	6.70	6.68

Determined Output Power Limit			
Channel Number	Freq.(MHz)	Min. B(MHz)	Determined Conducted Power Limit (dBm)
58	5290	83.14	30.19 > 24
106	5530	83.02	30.19 > 24
122	5610	83.07	30.19 > 24
138 (U-NII-2C)	5690	76.49	29.83 > 24

Note: For U-NII-2A, U-NII-2C Band output power limitation is determined based on 26dBc bandwidth.

Spectrum Plot of Minimum Value

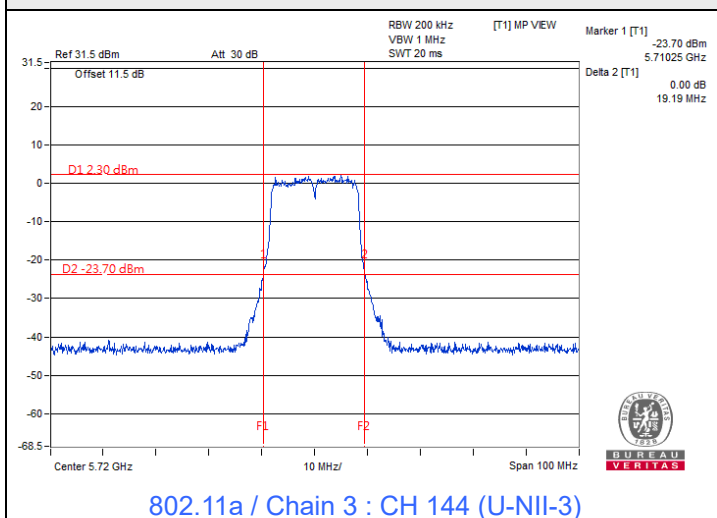

802.11a / Chain 3 : CH 144 (U-NII-3)

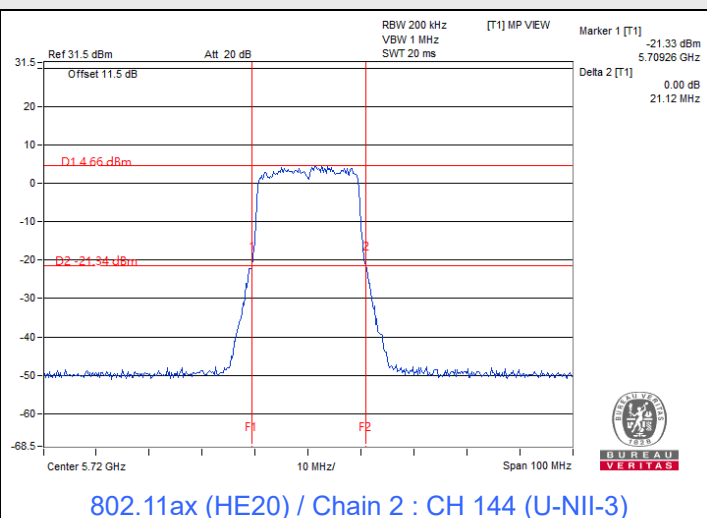

802.11ax (HE20) / Chain 2 : CH 144 (U-NII-3)

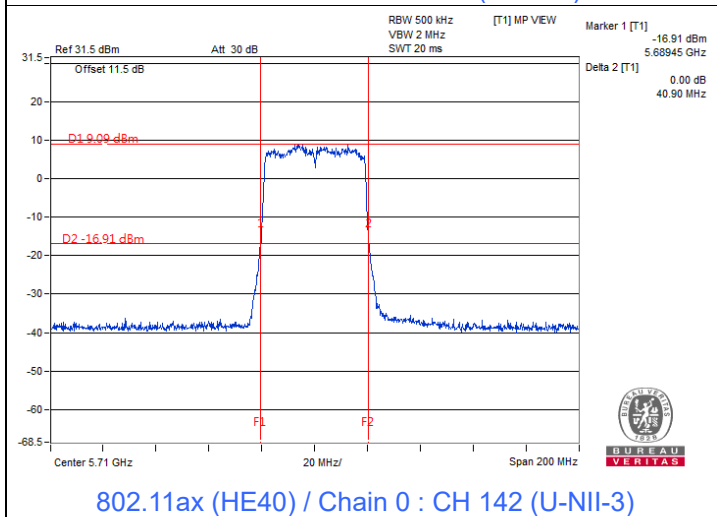

802.11ax (HE40) / Chain 0 : CH 142 (U-NII-3)

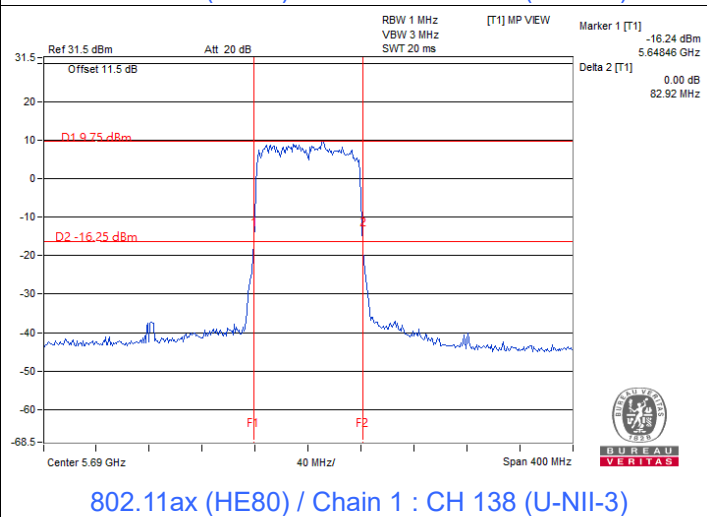

802.11ax (HE80) / Chain 1 : CH 138 (U-NII-3)

Notes:

1. For U-NII-2C straddle channel = 5725 MHz - Marker 1
2. For U-NII-3 straddle channel = Marker 1 + Delta 2 - 5725 MHz

Input Power:	54 Vdc	Environmental Conditions:	24°C, 65% RH	Tested By:	Matthew Yang
--------------	--------	---------------------------	--------------	------------	--------------

Mode B
802.11a

Channel	Frequency (MHz)	26 dB Bandwidth (MHz)	
		Chain 0	Chain 1
52	5260	21.26	21.25
60	5300	21.45	21.44
64	5320	21.05	20.90
100	5500	21.34	21.17
116	5580	22.24	22.31
140	5700	20.86	21.01
144 (U-NII-2C)	5720	17.63	17.35
144 (U-NII-3)	5720	7.84	7.62

Determined Output Power Limit			
Channel Number	Freq.(MHz)	Min. B(MHz)	Determined Conducted Power Limit (dBm)
52	5260	21.25	24.27 > 24
60	5300	21.44	24.31 > 24
64	5320	20.90	24.2 > 24
100	5500	21.17	24.25 > 24
116	5580	22.24	24.47 > 24
140	5700	20.86	24.19 > 24
144 (U-NII-2C)	5720	17.35	23.39 < 24

Note: For U-NII-2A, U-NII-2C Band output power limitation is determined based on 26dBc bandwidth.

802.11ac (VHT20)

Channel	Frequency (MHz)	26 dB Bandwidth (MHz)	
		Chain 0	Chain 1
52	5260	25.10	25.19
60	5300	25.09	24.62
64	5320	22.67	22.75
100	5500	25.09	25.35
116	5580	25.80	25.91
140	5700	22.46	23.24
144 (U-NII-2C)	5720	17.50	18.64
144 (U-NII-3)	5720	7.10	8.02

Determined Output Power Limit			
Channel Number	Freq.(MHz)	Min. B(MHz)	Determined Conducted Power Limit (dBm)
52	5260	25.10	24.99 > 24
60	5300	24.62	24.91 > 24
64	5320	22.67	24.55 > 24
100	5500	25.09	24.99 > 24
116	5580	25.80	25.11 > 24
140	5700	22.46	24.51 > 24
144 (U-NII-2C)	5720	17.50	23.43 < 24

Note: For U-NII-2A, U-NII-2C Band output power limitation is determined based on 26dBc bandwidth.

802.11ac (VHT40)

Channel	Frequency (MHz)	26 dB Bandwidth (MHz)	
		Chain 0	Chain 1
54	5270	47.31	48.60
62	5310	39.89	39.84
102	5510	40.00	39.80
110	5550	75.33	72.25
134	5670	40.24	39.99
142 (U-NII-2C)	5710	61.32	62.41
142 (U-NII-3)	5710	32.61	30.64

Determined Output Power Limit			
Channel Number	Freq.(MHz)	Min. B(MHz)	Determined Conducted Power Limit (dBm)
54	5270	47.31	27.74 > 24
62	5310	39.84	27 > 24
102	5510	39.80	26.99 > 24
110	5550	72.25	29.58 > 24
134	5670	39.99	27.01 > 24
142 (U-NII-2C)	5710	61.32	28.87 > 24

Note: For U-NII-2A, U-NII-2C Band output power limitation is determined based on 26dBc bandwidth.

802.11ac (VHT80)

Channel	Frequency (MHz)	26 dB Bandwidth (MHz)	
		Chain 0	Chain 1
58	5290	83.58	82.93
106	5530	83.44	82.64
122	5610	83.32	83.15
138 (U-NII-2C)	5690	120.38	114.27
138 (U-NII-3)	5690	50.29	41.06

Determined Output Power Limit			
Channel Number	Freq.(MHz)	Min. B(MHz)	Determined Conducted Power Limit (dBm)
58	5290	82.93	30.18 > 24
106	5530	82.64	30.17 > 24
122	5610	83.15	30.19 > 24
138 (U-NII-2C)	5690	114.27	31.57 > 24

Note: For U-NII-2A, U-NII-2C Band output power limitation is determined based on 26dBc bandwidth.

Spectrum Plot of Minimum Value

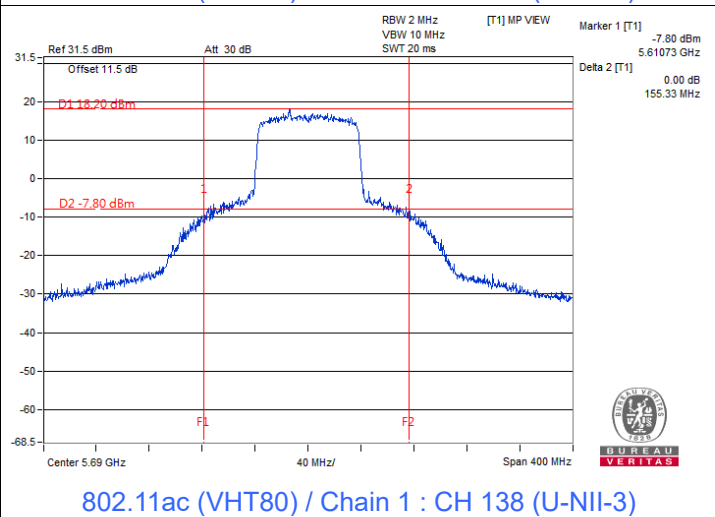
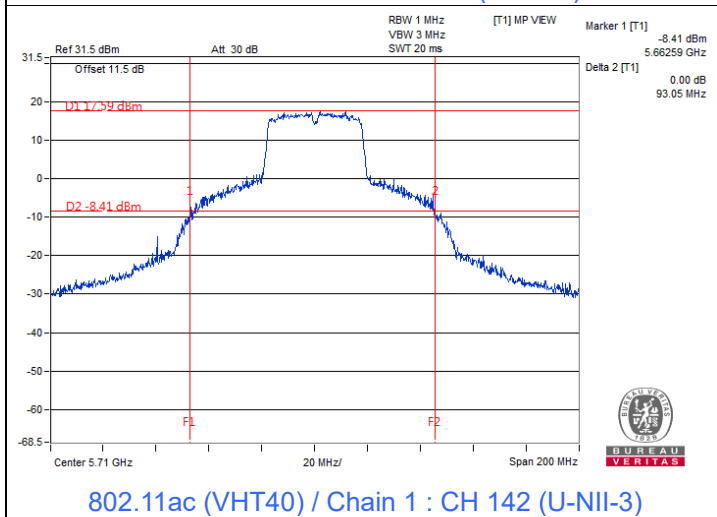
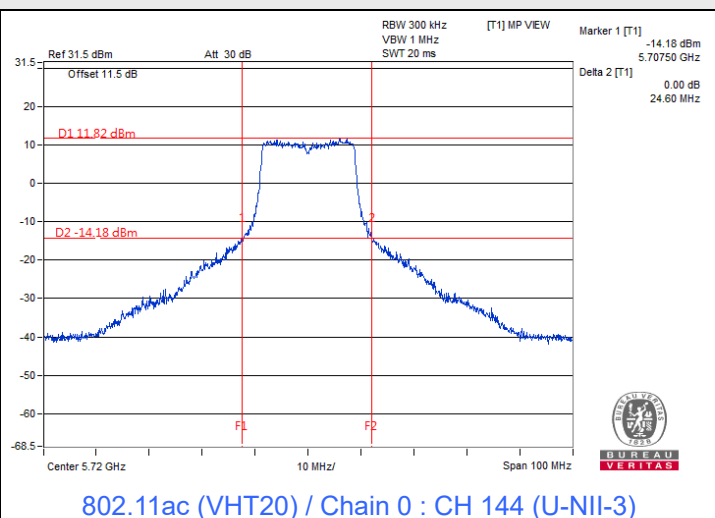
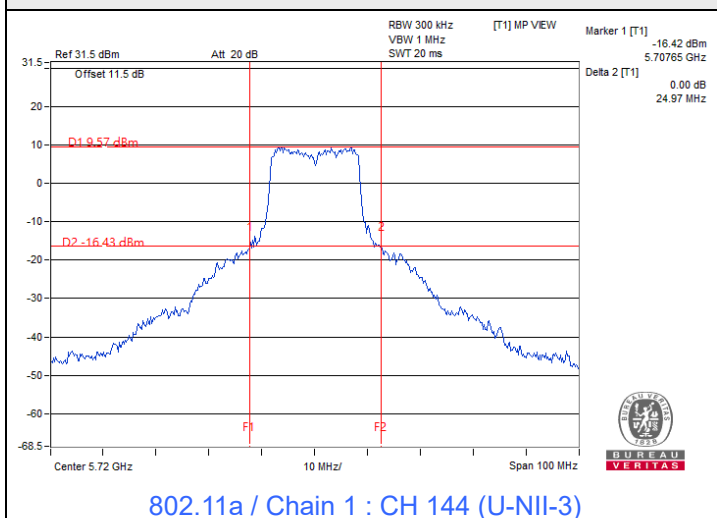

Notes:

1. For U-NII-2C straddle channel = 5725 MHz - Marker 1
2. For U-NII-3 straddle channel = Marker 1 + Delta 2 - 5725 MHz

7.2 RF Output Power

Input Power:	54 Vdc	Environmental Conditions:	25°C, 60% RH	Tested By:	Tim Chen
--------------	--------	---------------------------	--------------	------------	----------

Mode A

802.11a

Chan.	Chan. Freq. (MHz)	Average Power (dBm)				Total Power (mW)	Total Power (dBm)	Power Limit (dBm)	Test Result
		Chain 0	Chain 1	Chain 2	Chain 3				
52	5260	11.18	10.92	11.06	10.96	50.72	17.05	22.75	Pass
60	5300	10.70	11.23	11.00	11.13	50.584	17.04	22.74	Pass
64	5320	10.97	11.41	11.19	10.91	51.822	17.15	22.75	Pass
100	5500	10.56	10.82	10.45	10.35	45.385	16.57	22.33	Pass
116	5580	10.95	10.73	10.62	10.77	47.75	16.79	22.32	Pass
140	5700	10.96	10.65	10.76	10.63	47.562	16.77	22.36	Pass
*144 (U-NII-2C)	5720	9.65	9.55	9.63	9.42	37.083	15.69	21.14	Pass
*144 (U-NII-3)	5720	3.37	3.17	3.27	3.25	8.698	9.39	28.9	Pass

Notes:

- * : Test was performed in accordance with measurement follow FCC KDB 789033 UNII test procedure Method SA-2A and use spectrum analyzer test , the duty factor was included in the total power.
- Directional gain is the maximum gain of antennas.
- For U-NII-2A, the directional gain is 7.2 dBi > 6 dBi, so the output power limit shall be reduced to [Determined Conducted Power Limit-(7.2-6)].
- For U-NII-2C, the directional gain is 7.6 dBi > 6 dBi, so the output power limit shall be reduced to [Determined Conducted Power Limit-(7.6-6)].
- For U-NII-3, the directional gain is 7.1 dBi > 6 dBi, so the output power limit shall be reduced to $30-(7.1-6) = 28.9$ dBm.

802.11ax (HE20)

Chan.	Chan. Freq. (MHz)	Average Power (dBm)				Total Power (mW)	Total Power (dBm)	Power Limit (dBm)	Test Result
		Chain 0	Chain 1	Chain 2	Chain 3				
52	5260	11.85	11.55	11.44	11.57	57.886	17.63	22.8	Pass
60	5300	11.47	11.45	11.26	11.38	55.098	17.41	22.8	Pass
64	5320	11.48	11.84	11.69	11.55	58.382	17.66	22.8	Pass
100	5500	11.22	11.40	10.97	11.13	52.522	17.20	22.4	Pass
116	5580	11.36	10.96	11.24	10.81	51.506	17.12	22.4	Pass
140	5700	11.35	11.17	11.20	11.24	53.225	17.26	22.4	Pass
*144 (U-NII-2C)	5720	9.75	9.84	10.12	9.80	41.474	16.18	21.37	Pass
*144 (U-NII-3)	5720	4.87	3.53	3.80	4.74	11.406	10.57	28.9	Pass

Notes:

- * : Test was performed in accordance with measurement follow FCC KDB 789033 UNII test procedure Method SA-2A and use spectrum analyzer test , the duty factor was included in the total power.
- Directional gain is the maximum gain of antennas.
- For U-NII-2A, the directional gain is 7.2 dBi > 6 dBi, so the output power limit shall be reduced to [Determined Conducted Power Limit-(7.2-6)].
- For U-NII-2C, the directional gain is 7.6 dBi > 6 dBi, so the output power limit shall be reduced to [Determined Conducted Power Limit-(7.6-6)].
- For U-NII-3, the directional gain is 7.1 dBi > 6 dBi, so the output power limit shall be reduced to $30-(7.1-6) = 28.9$ dBm.

802.11ax (HE40)

Chan.	Chan. Freq. (MHz)	Average Power (dBm)				Total Power (mW)	Total Power (dBm)	Power Limit (dBm)	Test Result
		Chain 0	Chain 1	Chain 2	Chain 3				
54	5270	14.15	14.10	14.32	14.00	103.864	20.16	22.8	Pass
62	5310	13.23	13.72	13.58	13.70	90.834	19.58	22.8	Pass
102	5510	14.06	13.79	13.82	13.59	96.357	19.84	22.4	Pass
110	5550	14.02	14.06	14.14	13.89	101.136	20.05	22.4	Pass
134	5670	13.92	13.65	14.27	13.66	97.792	19.90	22.4	Pass
*142 (U-NII-2C)	5710	13.02	13.26	13.07	13.07	85.676	19.33	22.4	Pass
*142 (U-NII-3)	5710	3.49	2.34	2.13	3.49	8.186	9.13	28.9	Pass

Notes:

- * : Test was performed in accordance with measurement follow FCC KDB 789033 UNII test procedure Method SA-2A and use spectrum analyzer test , the duty factor was included in the total power.
- Directional gain is the maximum gain of antennas.
- For U-NII-2A, the maximum gain is 7.2 dBi > 6 dBi, so the output power limit shall be reduced to [Determined Conducted Power Limit-(7.2-6)].
- For U-NII-2C, the maximum gain is 7.6 dBi > 6 dBi, so the output power limit shall be reduced to [Determined Conducted Power Limit-(7.6-6)].
- For U-NII-3, the maximum gain is 7.1 dBi > 6 dBi, so the output power limit shall be reduced to $30-(7.1-6) = 28.9$ dBm.

802.11ax (HE80)

Chan.	Chan. Freq. (MHz)	Average Power (dBm)				Total Power (mW)	Total Power (dBm)	Power Limit (dBm)	Test Result
		Chain 0	Chain 1	Chain 2	Chain 3				
58	5290	10.96	11.58	11.24	11.55	54.455	17.36	22.8	Pass
106	5530	16.72	16.22	16.32	15.95	171.079	22.33	22.4	Pass
122	5610	16.62	16.14	16.33	15.86	168.536	22.27	22.4	Pass
*138 (U-NII-2C)	5690	14.76	15.04	14.76	14.89	130.227	21.15	22.4	Pass
*138 (U-NII-3)	5690	1.26	-0.07	-0.34	1.62	4.9899	6.98	28.9	Pass

Notes:

- * : Test was performed in accordance with measurement follow FCC KDB 789033 UNII test procedure Method SA-2A and use spectrum analyzer test , the duty factor was included in the total power.
- Directional gain is the maximum gain of antennas.
- For U-NII-2A, the maximum gain is 7.2 dBi > 6 dBi, so the output power limit shall be reduced to [Determined Conducted Power Limit-(7.2-6)].
- For U-NII-2C, the maximum gain is 7.6 dBi > 6 dBi, so the output power limit shall be reduced to [Determined Conducted Power Limit-(7.6-6)].
- For U-NII-3, the maximum gain is 7.1 dBi > 6 dBi, so the output power limit shall be reduced to 30-(7.1-6) = 28.9 dBm.

802.11ax (HE20) Beamforming

Chan.	Chan. Freq. (MHz)	Average Power (dBm)				Total Power (mW)	Total Power (dBm)	Power Limit (dBm)	Test Result
		Chain 0	Chain 1	Chain 2	Chain 3				
52	5260	11.26	10.97	10.83	10.95	50.42	17.03	17.18	Pass
60	5300	10.84	10.86	10.68	10.79	48.014	16.81	17.18	Pass
64	5320	10.86	11.23	11.06	10.92	50.588	17.04	17.18	Pass
100	5500	10.61	10.77	10.35	10.52	45.559	16.59	16.77	Pass
116	5580	10.74	10.33	10.65	10.23	44.806	16.51	16.77	Pass
140	5700	10.74	10.59	10.63	10.65	46.488	16.67	16.77	Pass
*144 (U-NII-2C)	5720	9.21	9.27	9.59	9.24	36.544	15.63	15.74	Pass
*144 (U-NII-3)	5720	4.33	2.99	3.23	4.18	10.044	10.02	23.03	Pass

Notes:

- * : Test was performed in accordance with measurement follow FCC KDB 789033 UNII test procedure Method SA-2A and use spectrum analyzer test , the duty factor was included in the total power.
- Directional gain = $10 \log[(10^{\text{Chain0}/20} + 10^{\text{Chain1}/20} + 10^{\text{Chain2}/20} + 10^{\text{Chain3}/20})^2 / 4]$
- For U-NII-2A, the directional gain is 12.82 dBi > 6 dBi, so the output power limit shall be reduced to [Determined Conducted Power Limit-(12.82-6)].
- For U-NII-2C, the directional gain is 13.23 dBi > 6 dBi, so the output power limit shall be reduced to [Determined Conducted Power Limit-(13.23-6)].
- For U-NII-3, the directional gain is 12.97 dBi > 6 dBi, so the output power limit shall be reduced to 30-(12.97-6) = 23.03 dBm.

802.11ax (HE40) Beamforming

Chan.	Chan. Freq. (MHz)	Average Power (dBm)				Total Power (mW)	Total Power (dBm)	Power Limit (dBm)	Test Result
		Chain 0	Chain 1	Chain 2	Chain 3				
54	5270	11.12	11.06	11.30	10.97	51.699	17.13	17.18	Pass
62	5310	10.71	11.20	11.05	11.17	50.785	17.06	17.18	Pass
102	5510	10.73	10.45	10.50	10.25	44.735	16.51	16.77	Pass
110	5550	10.71	10.73	10.81	10.54	46.981	16.72	16.77	Pass
134	5670	10.60	10.31	10.95	10.33	45.456	16.58	16.77	Pass
*142 (U-NII-2C)	5710	9.80	10.03	9.84	9.83	40.725	16.10	16.77	Pass
*142 (U-NII-3)	5710	0.27	-0.89	-1.10	0.25	3.8912	5.90	23.03	Pass

Notes:

- * : Test was performed in accordance with measurement follow FCC KDB 789033 UNII test procedure Method SA-2A and use spectrum analyzer test , the duty factor was included in the total power.
- Directional gain = $10 \log[(10^{\text{Chain0}/20} + 10^{\text{Chain1}/20} + 10^{\text{Chain2}/20} + 10^{\text{Chain3}/20})^2 / 4]$
- For U-NII-2A, the directional gain is 12.82 dBi > 6 dBi, so the output power limit shall be reduced to [Determined Conducted Power Limit-(12.82-6)].
- For U-NII-2C, the directional gain is 13.23 dBi > 6 dBi, so the output power limit shall be reduced to [Determined Conducted Power Limit-(13.23-6)].
- For U-NII-3, the directional gain is 12.97 dBi > 6 dBi, so the output power limit shall be reduced to $30-(12.97-6) = 23.03$ dBm.

802.11ax (HE80) Beamforming

Chan.	Chan. Freq. (MHz)	Average Power (dBm)				Total Power (mW)	Total Power (dBm)	Power Limit (dBm)	Test Result
		Chain 0	Chain 1	Chain 2	Chain 3				
58	5290	10.47	11.11	10.74	11.04	48.619	16.87	17.18	Pass
106	5530	11.15	10.63	10.69	10.34	47.129	16.73	16.77	Pass
122	5610	11.10	10.53	10.76	10.28	46.759	16.70	16.77	Pass
*138 (U-NII-2C)	5690	9.23	9.51	9.23	9.35	36.429	15.61	16.77	Pass
*138 (U-NII-3)	5690	-4.22	-5.54	-5.84	-3.86	1.4122	1.50	23.03	Pass

Notes:

- * : Test was performed in accordance with measurement follow FCC KDB 789033 UNII test procedure Method SA-2A and use spectrum analyzer test , the duty factor was included in the total power.
- Directional gain = $10 \log[(10^{\text{Chain0}/20} + 10^{\text{Chain1}/20} + 10^{\text{Chain2}/20} + 10^{\text{Chain3}/20})^2 / 4]$
- For U-NII-2A, the directional gain is 12.82 dBi > 6 dBi, so the output power limit shall be reduced to [Determined Conducted Power Limit-(12.82-6)].
- For U-NII-2C, the directional gain is 13.23 dBi > 6 dBi, so the output power limit shall be reduced to [Determined Conducted Power Limit-(13.23-6)].
- For U-NII-3, the directional gain is 12.97 dBi > 6 dBi, so the output power limit shall be reduced to $30-(12.97-6) = 23.03$ dBm.



Spectrum Plot for channel straddling

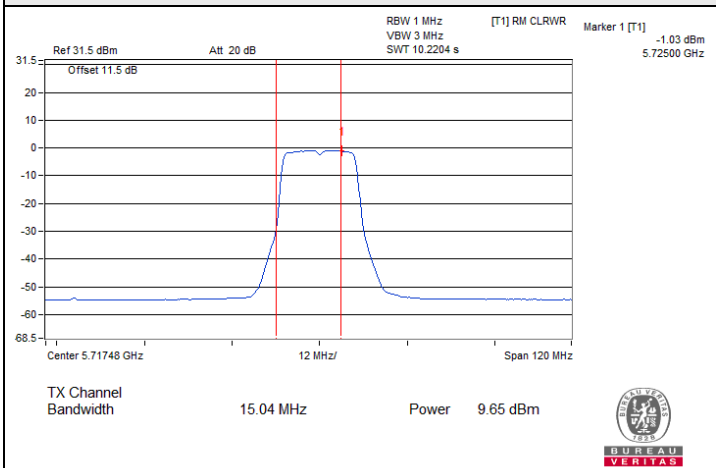

802.11a / Chain 0 : CH 144 (U-NII-2C)

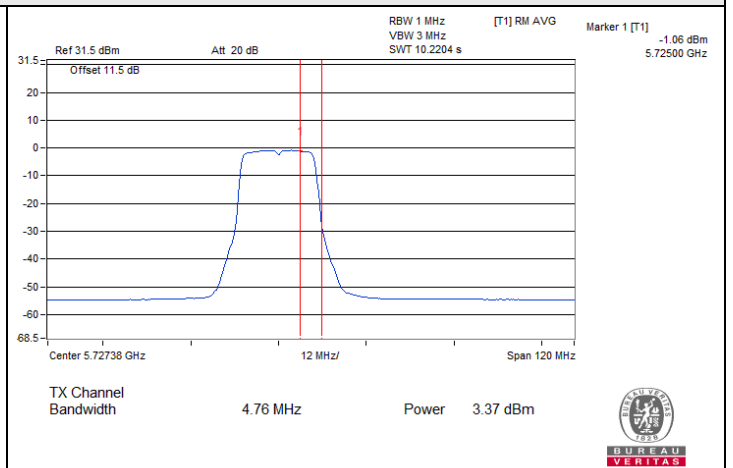

802.11a / Chain 0 : CH 144 (U-NII-3)

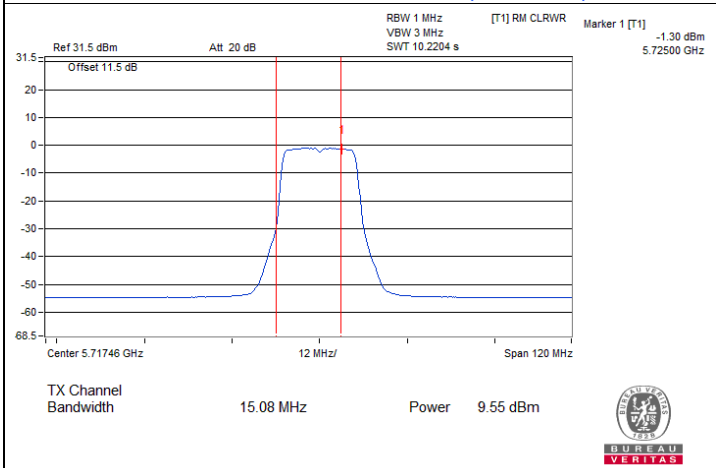

802.11a / Chain 1 : CH 144 (U-NII-2C)

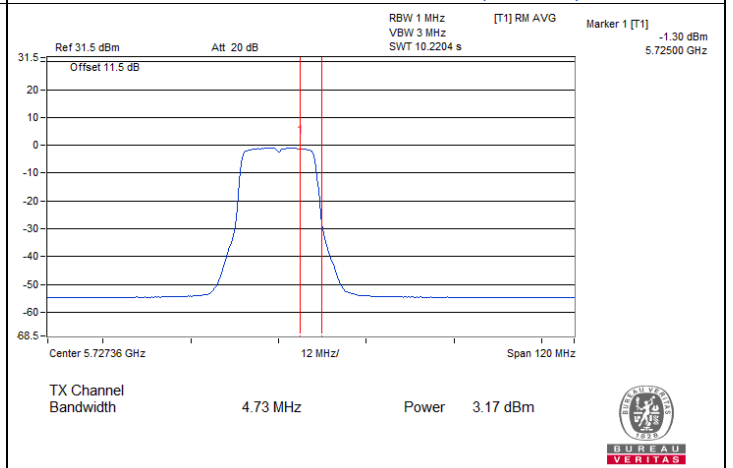

802.11a / Chain 1 : CH 144 (U-NII-3)

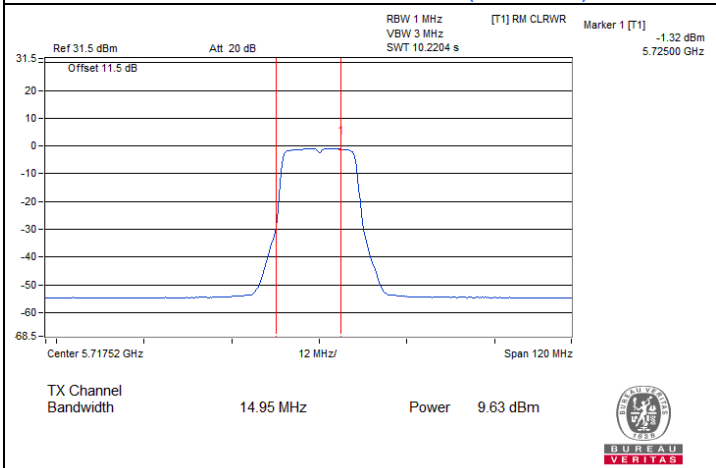

802.11a / Chain 2 : CH 144 (U-NII-2C)

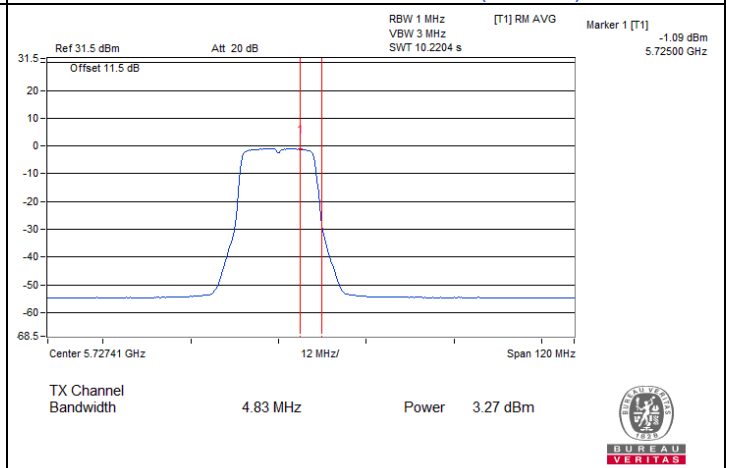

802.11a / Chain 2 : CH 144 (U-NII-3)

Spectrum Plot for channel straddling

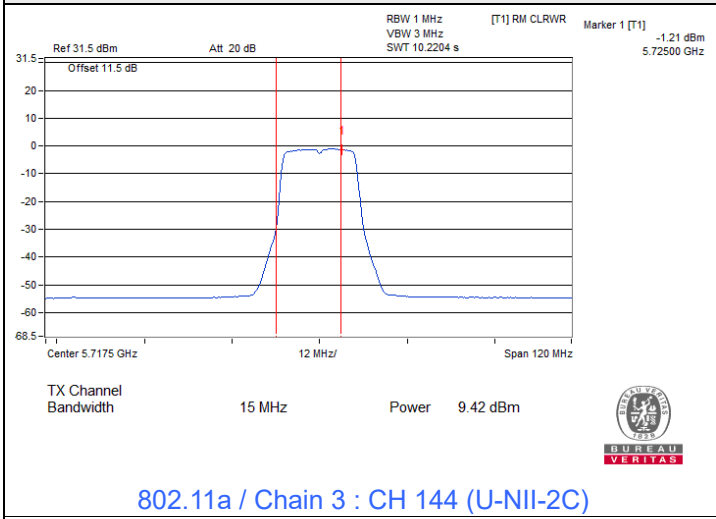

802.11a / Chain 3 : CH 144 (U-NII-2C)

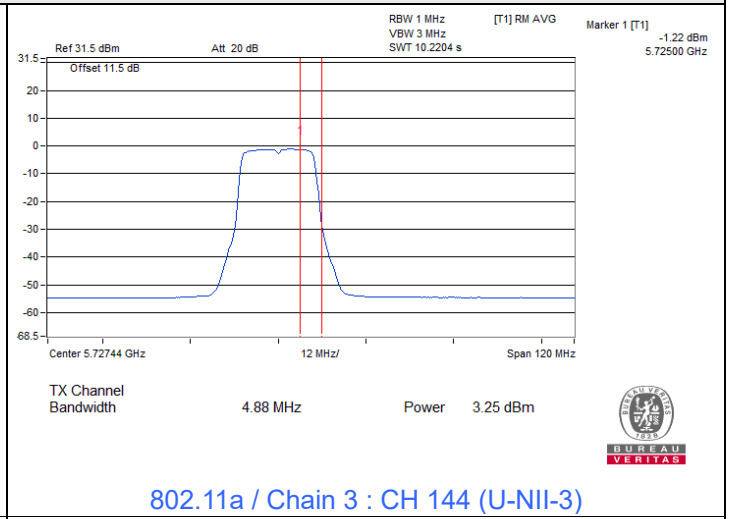

802.11a / Chain 3 : CH 144 (U-NII-3)

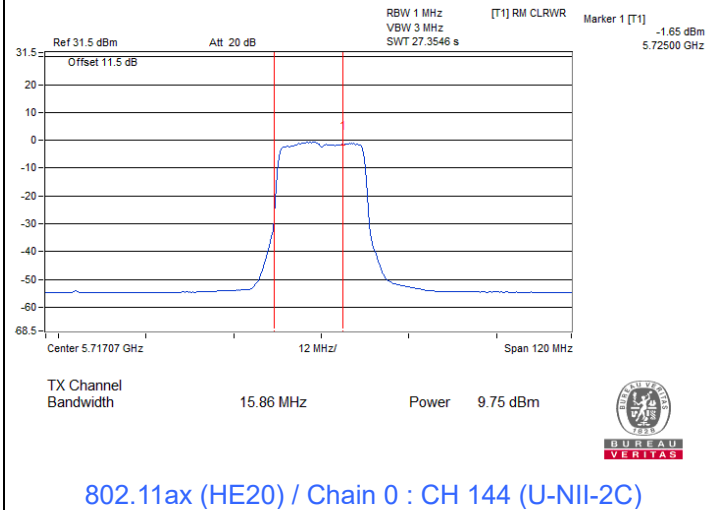

802.11ax (HE20) / Chain 0 : CH 144 (U-NII-2C)

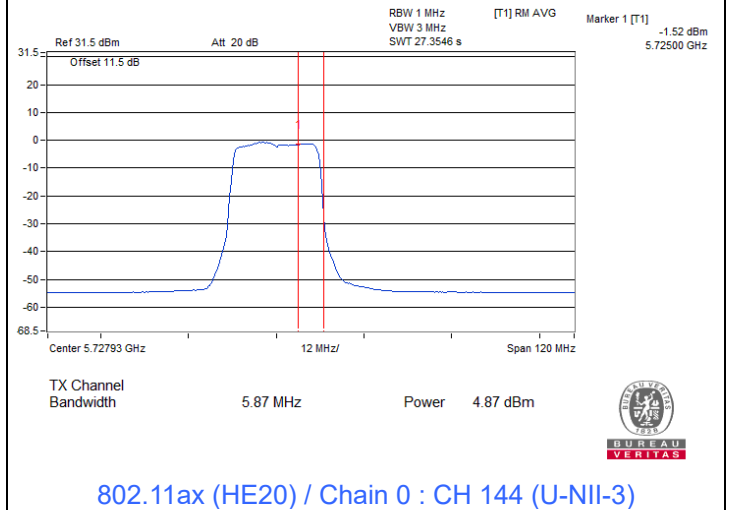

802.11ax (HE20) / Chain 0 : CH 144 (U-NII-3)

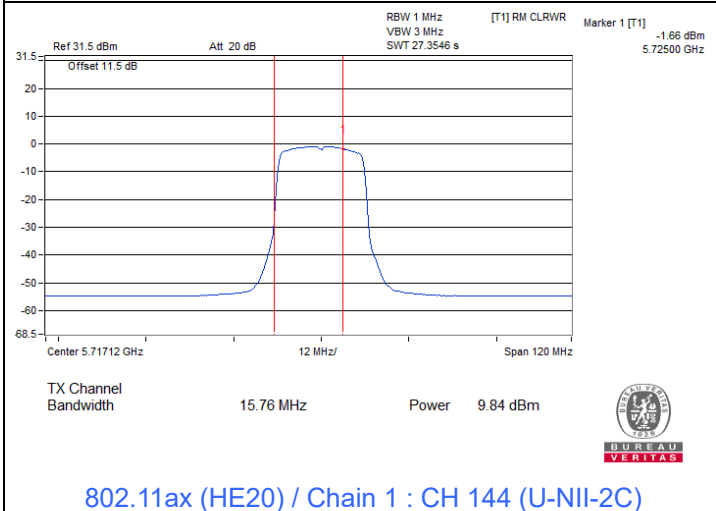

802.11ax (HE20) / Chain 1 : CH 144 (U-NII-2C)

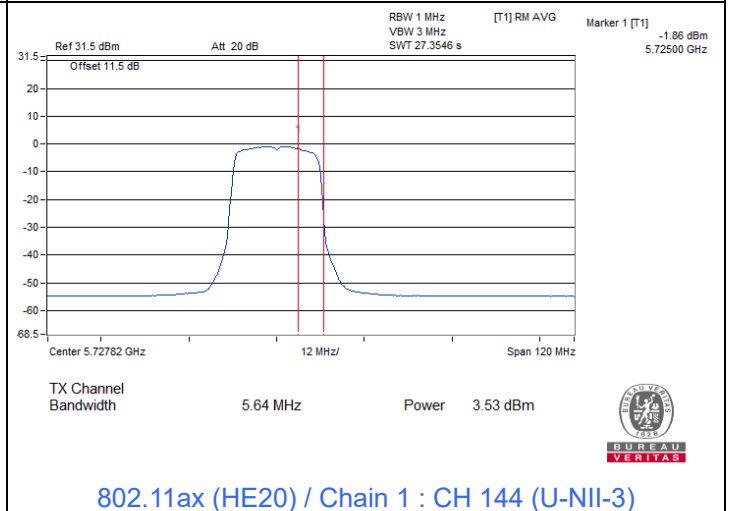

802.11ax (HE20) / Chain 1 : CH 144 (U-NII-3)



Spectrum Plot for channel straddling

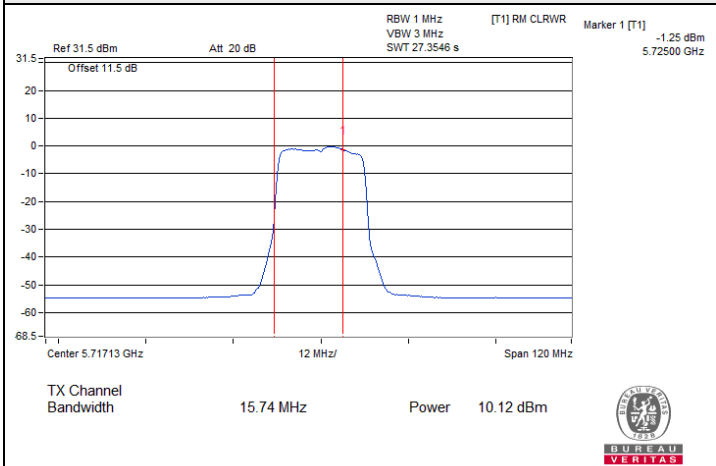

802.11ax (HE20) / Chain 2 : CH 144 (U-NII-2C)

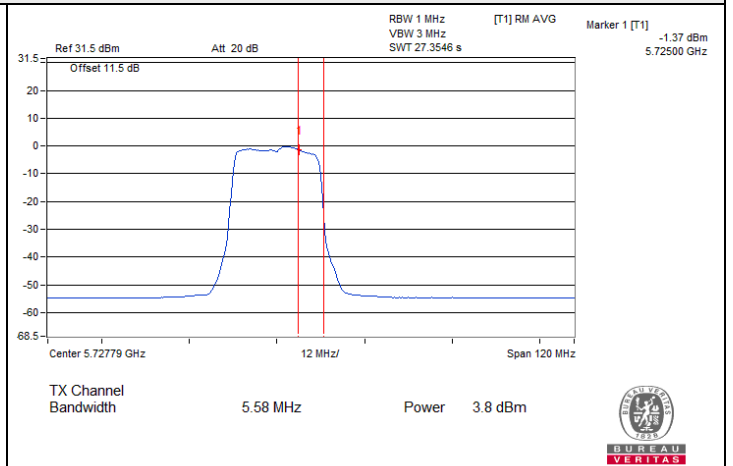

802.11ax (HE20) / Chain 2 : CH 144 (U-NII-3)

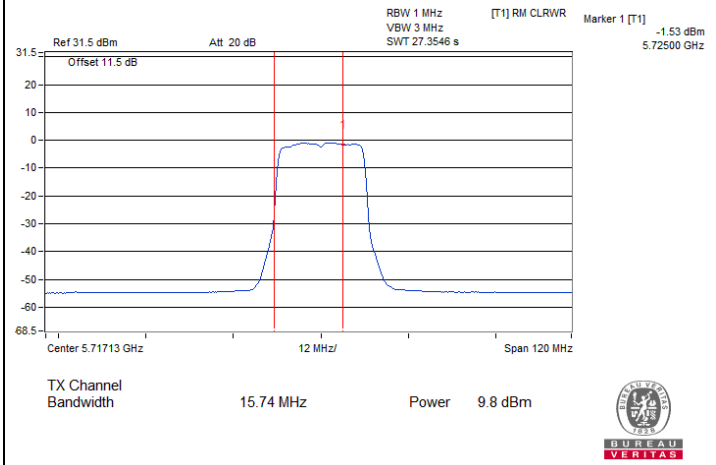

802.11ax (HE20) / Chain 3 : CH 144 (U-NII-2C)

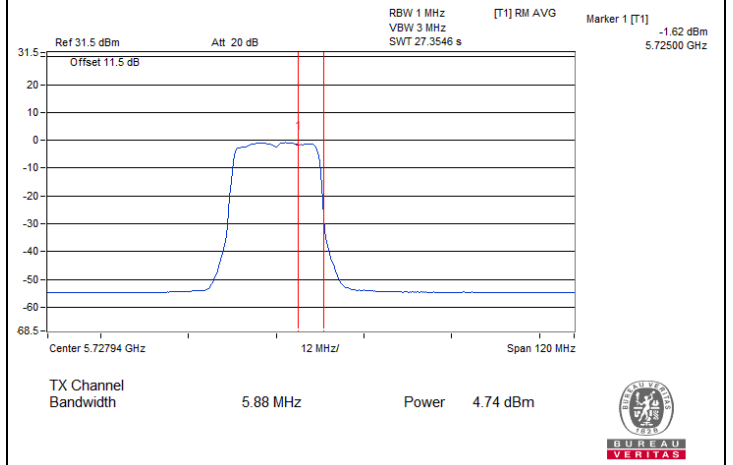

802.11ax (HE20) / Chain 3 : CH 144 (U-NII-3)

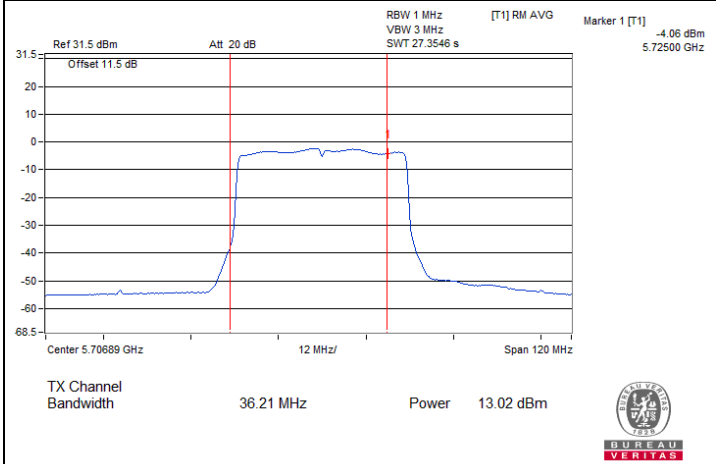

802.11ax (HE40) / Chain 0 : CH 142 (U-NII-2C)

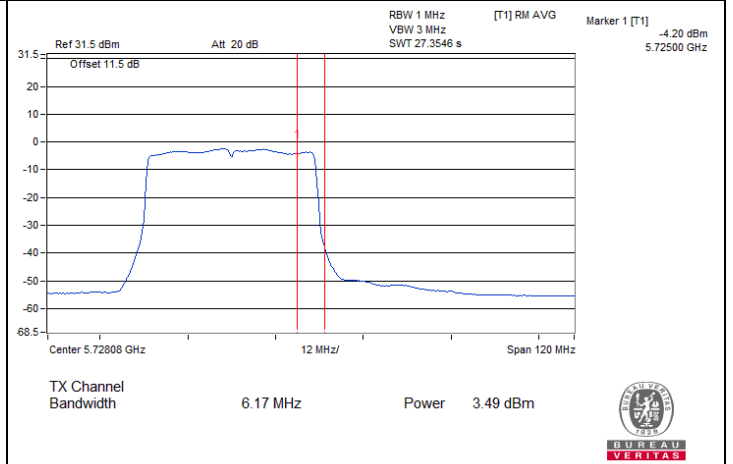

802.11ax (HE40) / Chain 0 : CH 142 (U-NII-3)



Spectrum Plot for channel straddling

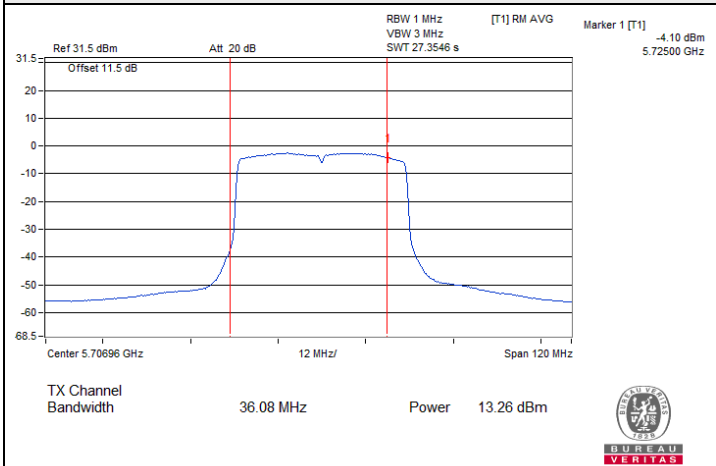

802.11ax (HE40) / Chain 1 : CH 142 (U-NII-2C)

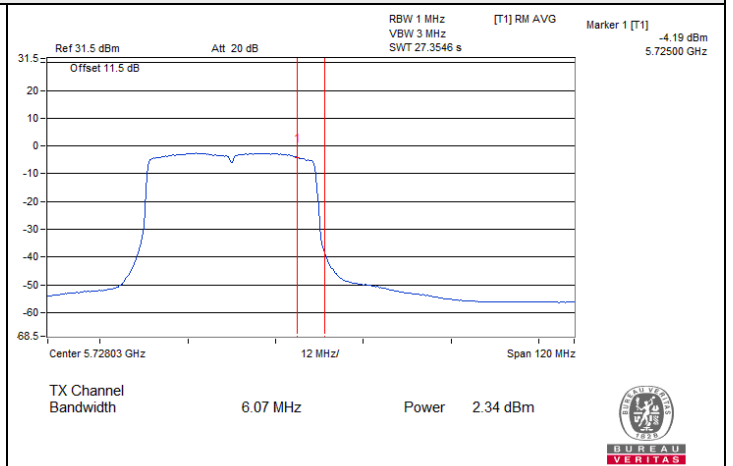

802.11ax (HE40) / Chain 1 : CH 142 (U-NII-3)

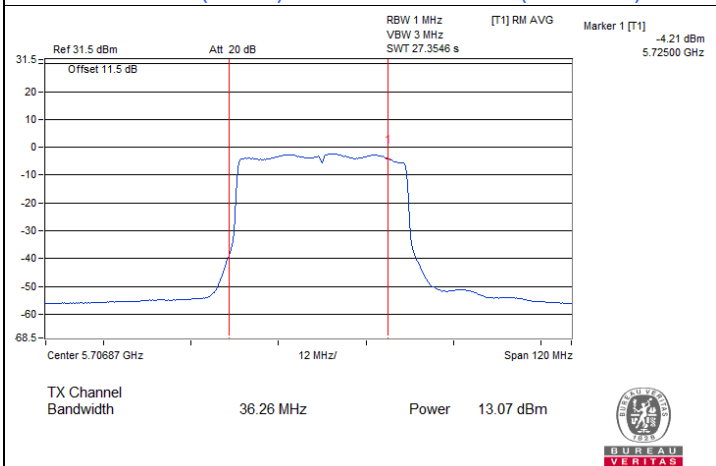

802.11ax (HE40) / Chain 2 : CH 142 (U-NII-2C)

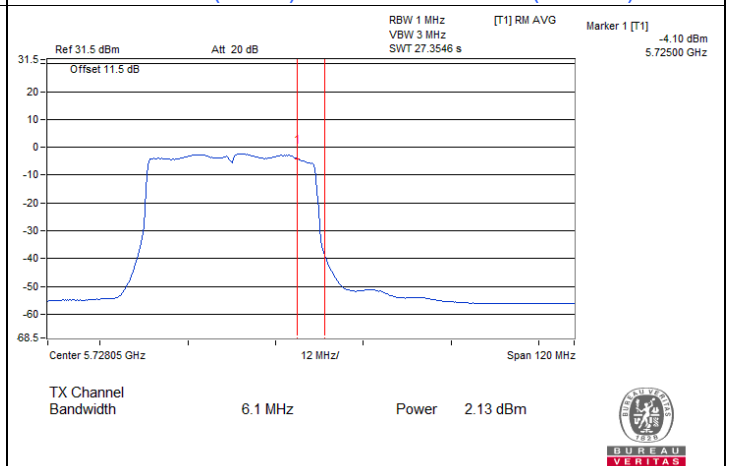

802.11ax (HE40) / Chain 2 : CH 142 (U-NII-3)

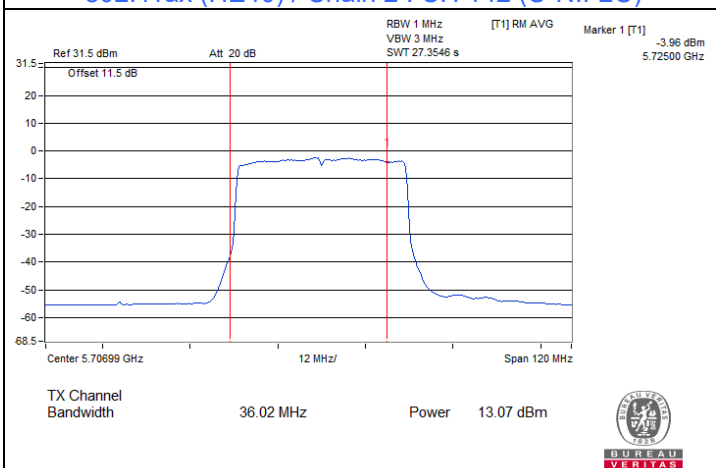

802.11ax (HE40) / Chain 3 : CH 142 (U-NII-2C)

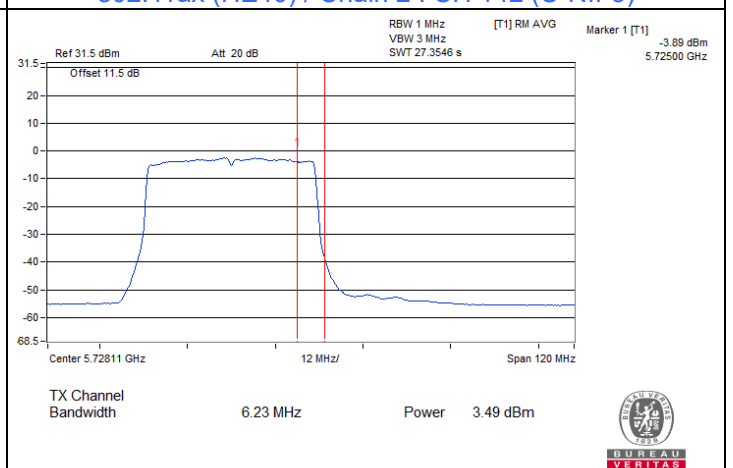

802.11ax (HE40) / Chain 3 : CH 142 (U-NII-3)



Spectrum Plot for channel straddling

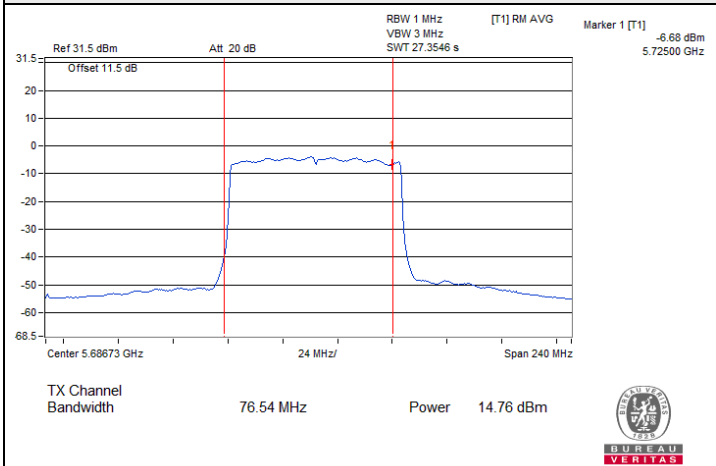

802.11ax (HE80) / Chain 0 : CH 138 (U-NII-2C)

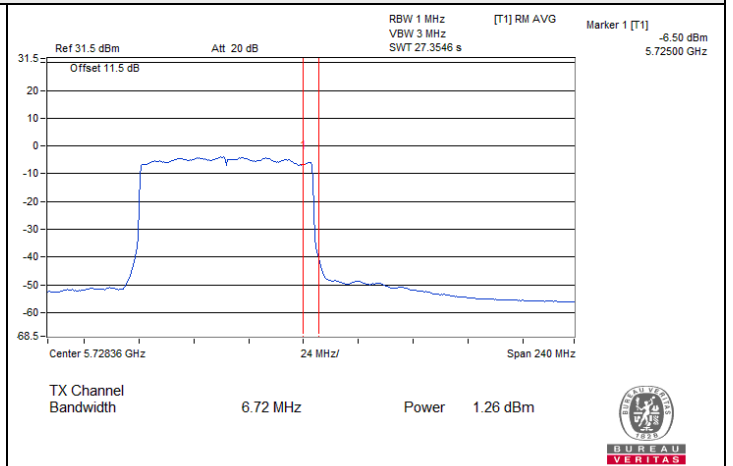

802.11ax (HE80) / Chain 0 : CH 138 (U-NII-3)

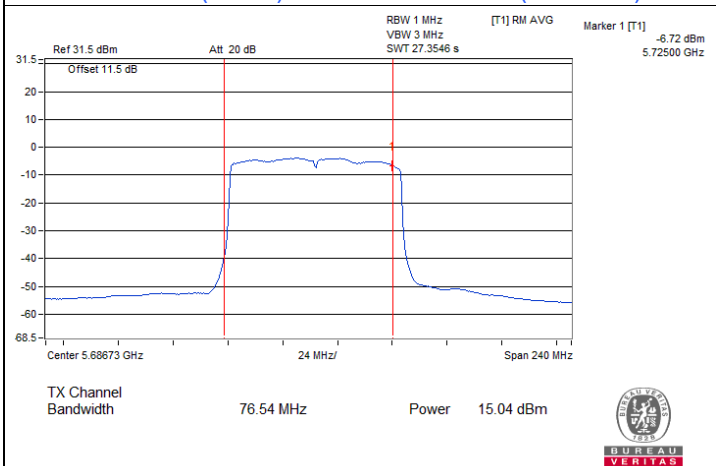

802.11ax (HE80) / Chain 1 : CH 138 (U-NII-2C)

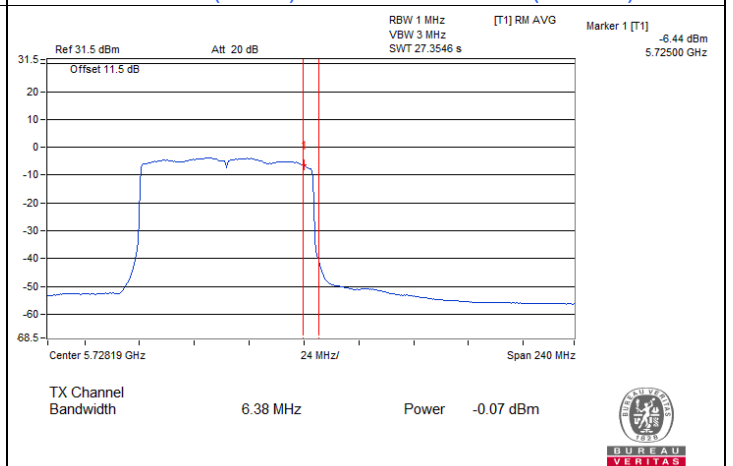

802.11ax (HE80) / Chain 1 : CH 138 (U-NII-3)

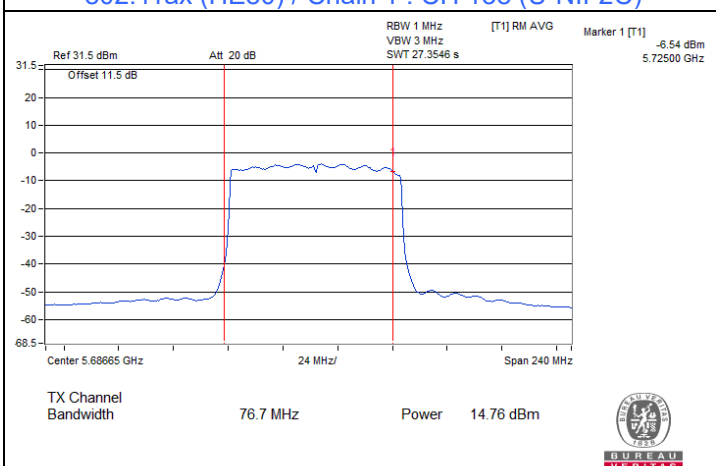

802.11ax (HE80) / Chain 2 : CH 138 (U-NII-2C)

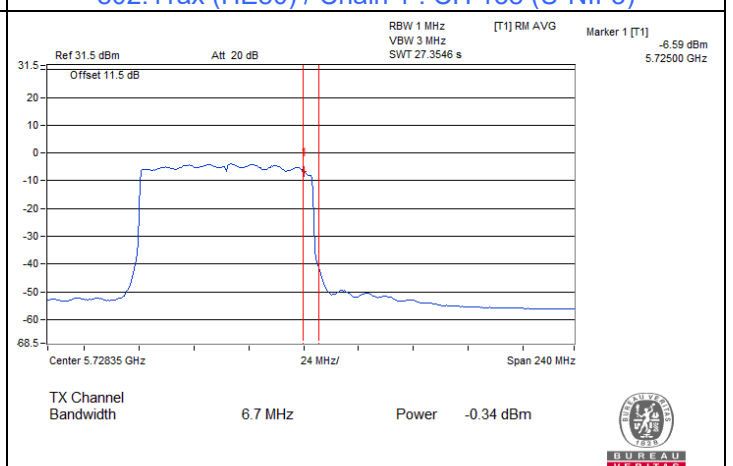

802.11ax (HE80) / Chain 2 : CH 138 (U-NII-3)



Spectrum Plot for channel straddling

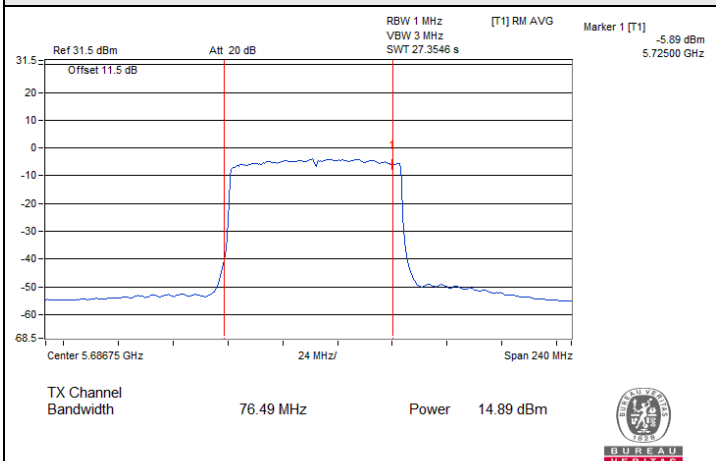

802.11ax (HE80) / Chain 3 : CH 138 (U-NII-2C)

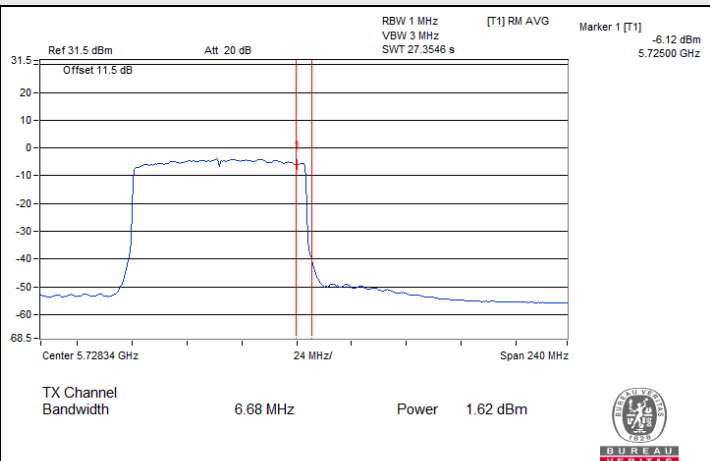

802.11ax (HE80) / Chain 3 : CH 138 (U-NII-3)



Input Power:	54 Vdc	Environmental Conditions:	24°C, 65% RH	Tested By:	Matthew Yang
--------------	--------	---------------------------	--------------	------------	--------------

Mode B

802.11a

Chan.	Chan. Freq. (MHz)	Average Power (dBm)		Total Power (mW)	Total Power (dBm)	Power Limit (dBm)	Test Result
		Chain 0	Chain 1				
52	5260	17.55	17.62	114.695	20.60	22.8	Pass
60	5300	17.45	17.41	110.671	20.44	22.8	Pass
64	5320	16.61	16.92	95.018	19.78	22.8	Pass
100	5500	16.85	17.06	99.233	19.97	24	Pass
116	5580	17.48	17.60	113.52	20.55	24	Pass
140	5700	15.83	15.75	75.866	18.80	24	Pass
*144 (U-NII-2C)	5720	16.04	16.03	83.905	19.24	23.39	Pass
*144 (U-NII-3)	5720	10.66	10.63	24.254	13.85	29.2	Pass

Notes:

- * : Test was performed in accordance with measurement follow FCC KDB 789033 UNII test procedure Method SA-2A and use spectrum analyzer test , the duty factor was included in the total power.
- Directional gain is the maximum gain of antennas.
- For U-NII-2A, the maximum gain is 7.2 dBi > 6 dBi, so the output power limit shall be reduced to [Determined Conducted Power Limit-(7.2-6)].
- For U-NII-2C, the maximum gain is 5.9 dBi < 6 dBi, so the output power limit shall not be reduced.
- For U-NII-3, the maximum gain is 6.8 dBi > 6 dBi, so the output power limit shall be reduced to 30-(6.8-6) = 29.2 dBm.

802.11ac (VHT20)

Chan.	Chan. Freq. (MHz)	Average Power (dBm)		Total Power (mW)	Total Power (dBm)	Power Limit (dBm)	Test Result
		Chain 0	Chain 1				
52	5260	17.38	17.68	113.315	20.54	22.8	Pass
60	5300	17.55	17.79	117.003	20.68	22.8	Pass
64	5320	16.84	17.19	100.666	20.03	22.8	Pass
100	5500	17.31	17.35	108.152	20.34	24	Pass
116	5580	17.35	17.62	112.135	20.50	24	Pass
140	5700	17.00	17.05	100.818	20.04	24	Pass
*144 (U-NII-2C)	5720	17.14	17.09	108.984	20.37	23.43	Pass
*144 (U-NII-3)	5720	12.40	12.34	36.548	15.63	29.2	Pass

Notes:

- * : Test was performed in accordance with measurement follow FCC KDB 789033 UNII test procedure Method SA-2A and use spectrum analyzer test , the duty factor was included in the total power.
- Directional gain is the maximum gain of antennas.
- For U-NII-2A, the maximum gain is 7.2 dBi > 6 dBi, so the output power limit shall be reduced to [Determined Conducted Power Limit-(7.2-6)].
- For U-NII-2C, the maximum gain is 5.9 dBi < 6 dBi, so the output power limit shall not be reduced.
- For U-NII-3, the maximum gain is 6.8 dBi > 6 dBi, so the output power limit shall be reduced to $30-(6.8-6) = 29.2$ dBm.

802.11ac (VHT40)

Chan.	Chan. Freq. (MHz)	Average Power (dBm)		Total Power (mW)	Total Power (dBm)	Power Limit (dBm)	Test Result
		Chain 0	Chain 1				
54	5270	19.22	19.14	165.595	22.19	22.8	Pass
62	5310	16.11	16.32	83.687	19.23	22.8	Pass
102	5510	17.16	17.32	105.951	20.25	24	Pass
110	5550	17.16	17.26	105.21	20.22	24	Pass
134	5670	17.31	17.56	110.843	20.45	24	Pass
*142 (U-NII-2C)	5710	19.45	19.51	189.134	22.77	24	Pass
*142 (U-NII-3)	5710	8.80	8.86	16.284	12.12	29.2	Pass

Notes:

- * : Test was performed in accordance with measurement follow FCC KDB 789033 UNII test procedure Method SA-2A and use spectrum analyzer test , the duty factor was included in the total power.
- Directional gain is the maximum gain of antennas.
- For U-NII-2A, the maximum gain is 7.2 dBi > 6 dBi, so the output power limit shall be reduced to [Determined Conducted Power Limit-(7.2-6)].
- For U-NII-2C, the maximum gain is 5.9 dBi < 6 dBi, so the output power limit shall not be reduced.
- For U-NII-3, the maximum gain is 6.8 dBi > 6 dBi, so the output power limit shall be reduced to $30-(6.8-6) = 29.2$ dBm.

802.11ac (VHT80)

Chan.	Chan. Freq. (MHz)	Average Power (dBm)		Total Power (mW)	Total Power (dBm)	Power Limit (dBm)	Test Result
		Chain 0	Chain 1				
58	5290	15.36	15.54	70.165	18.46	22.8	Pass
106	5530	15.62	16.08	77.026	18.87	24	Pass
122	5610	17.67	17.81	118.874	20.75	24	Pass
*138 (U-NII-2C)	5690	19.31	19.17	179.6	22.54	24	Pass
*138 (U-NII-3)	5690	5.44	5.21	7.293	8.63	29.2	Pass

Notes:

- * : Test was performed in accordance with measurement follow FCC KDB 789033 UNII test procedure Method SA-2A and use spectrum analyzer test , the duty factor was included in the total power.
- Directional gain is the maximum gain of antennas.
- For U-NII-2A, the maximum gain is 7.2 dBi > 6 dBi, so the output power limit shall be reduced to [Determined Conducted Power Limit-(7.2-6)].
- For U-NII-2C, the maximum gain is 5.9 dBi < 6 dBi, so the output power limit shall not be reduced.
- For U-NII-3, the maximum gain is 6.8 dBi > 6 dBi, so the output power limit shall be reduced to 30-(6.8-6) = 29.2 dBm.

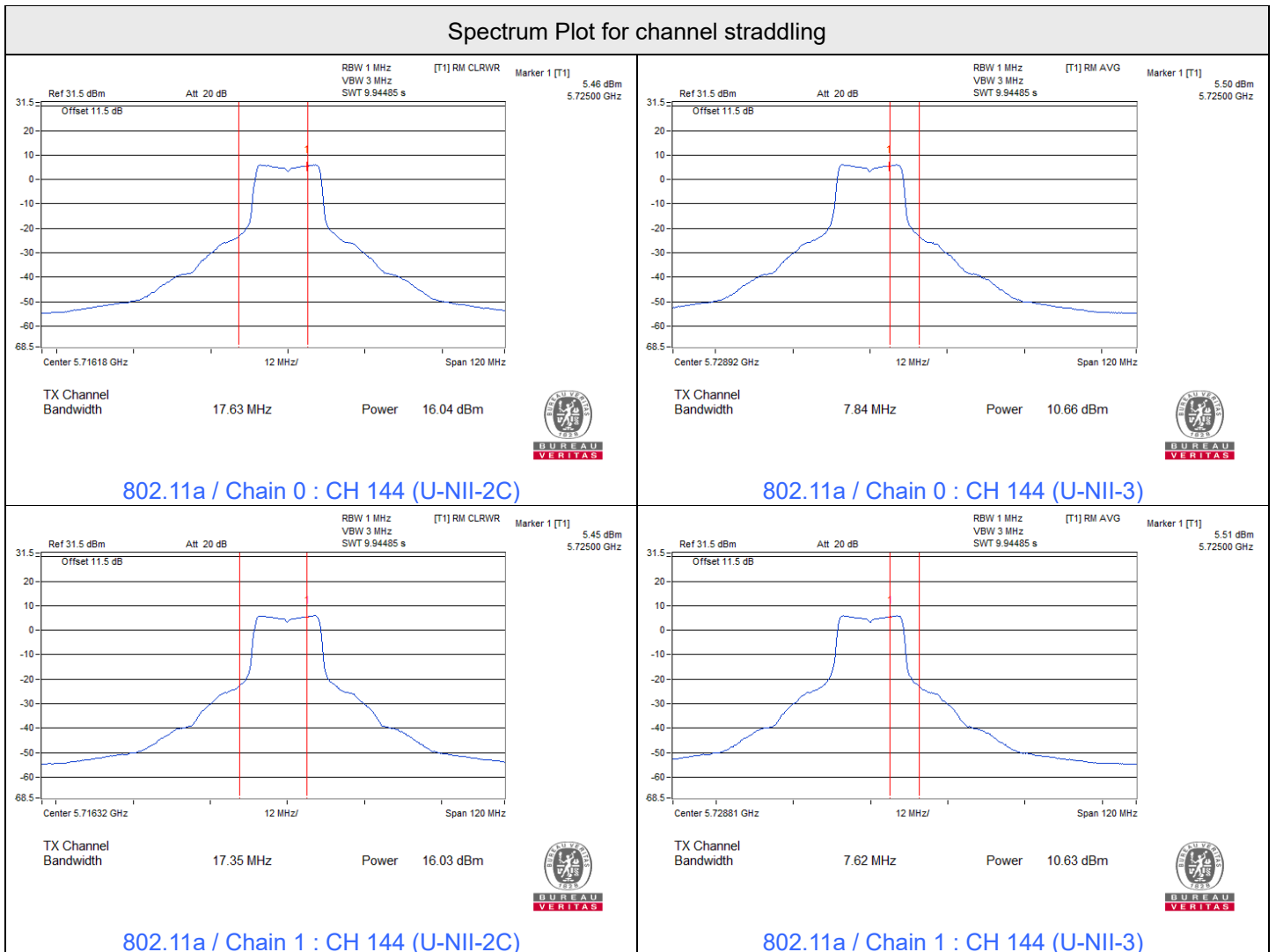



Spectrum Plot for channel straddling

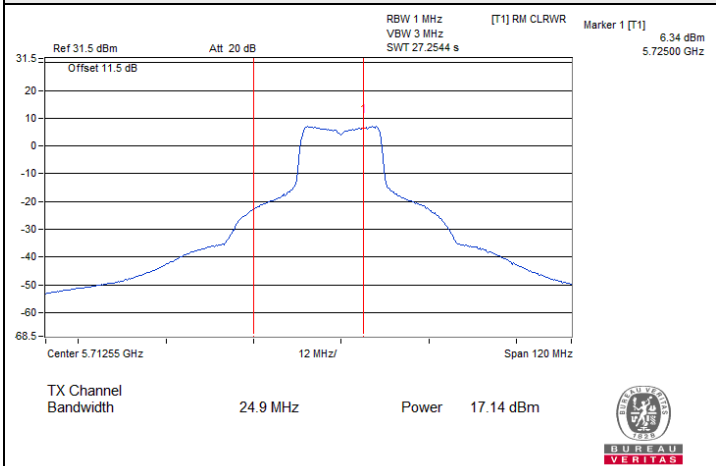

802.11ac (VHT20) / Chain 0 : CH 144 (U-NII-2C)

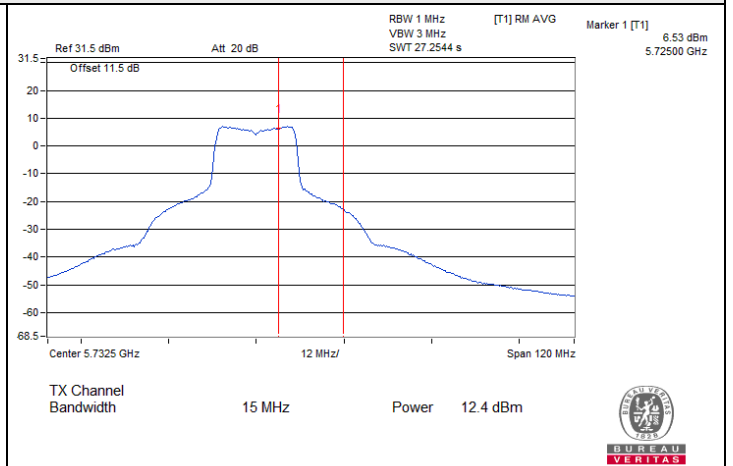

802.11ac (VHT20) / Chain 0 : CH 144 (U-NII-3)

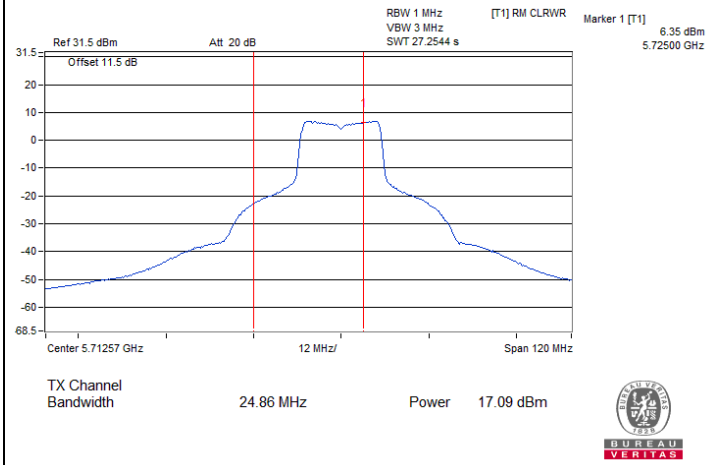

802.11ac (VHT20) / Chain 1 : CH 144 (U-NII-2C)

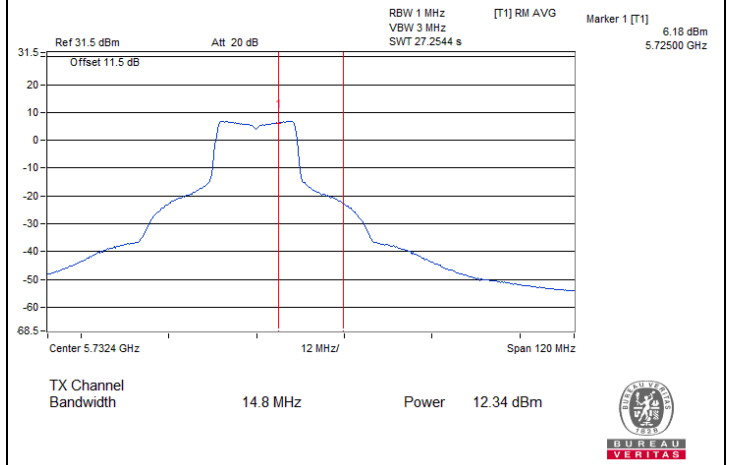

802.11ac (VHT20) / Chain 1 : CH 144 (U-NII-3)

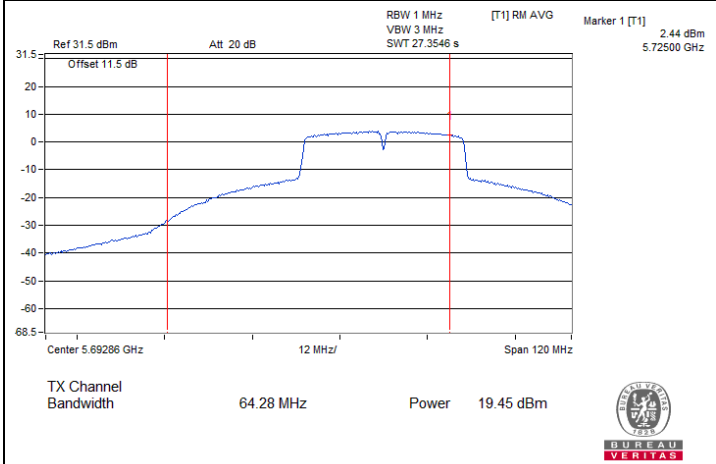

802.11ac (VHT40) / Chain 0 : CH 142 (U-NII-2C)

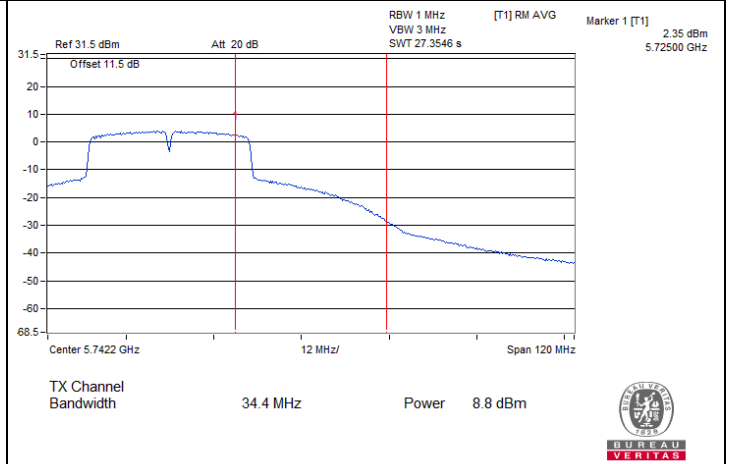

802.11ac (VHT40) / Chain 0 : CH 142 (U-NII-3)



Spectrum Plot for channel straddling

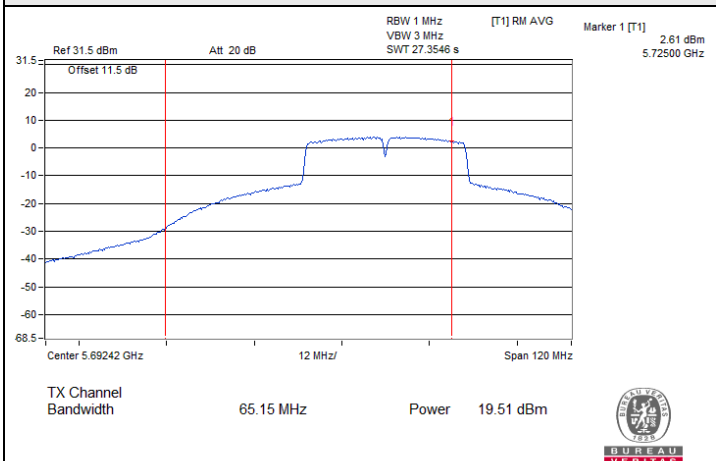

802.11ac (VHT40) / Chain 1 : CH 142 (U-NII-2C)

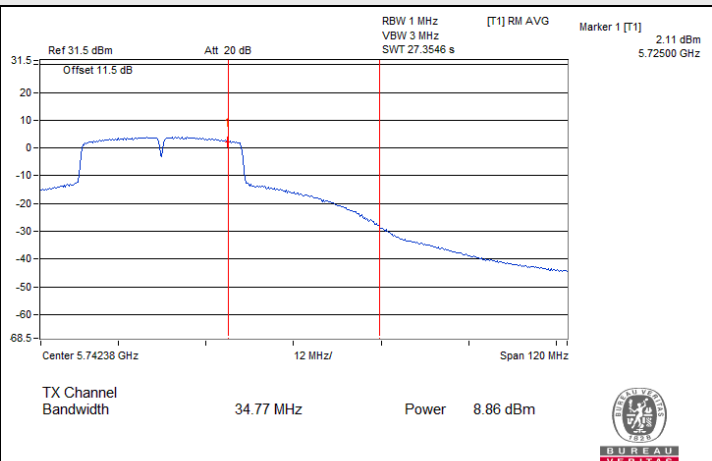

802.11ac (VHT40) / Chain 1 : CH 142 (U-NII-3)

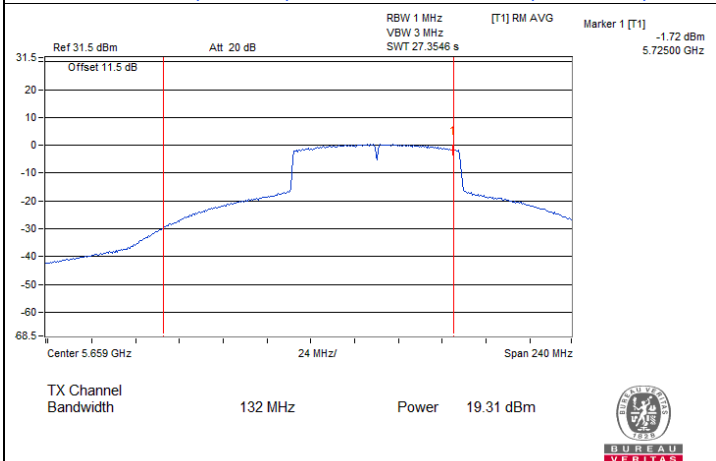

802.11ac (VHT80) / Chain 0 : CH 138 (U-NII-2C)

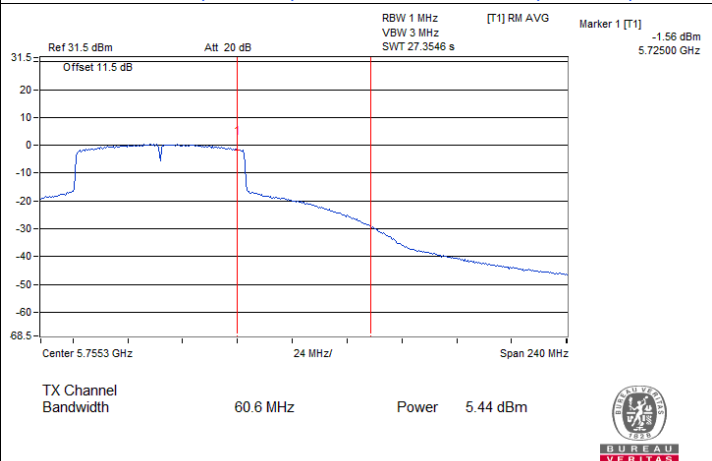

802.11ac (VHT80) / Chain 0 : CH 138 (U-NII-3)

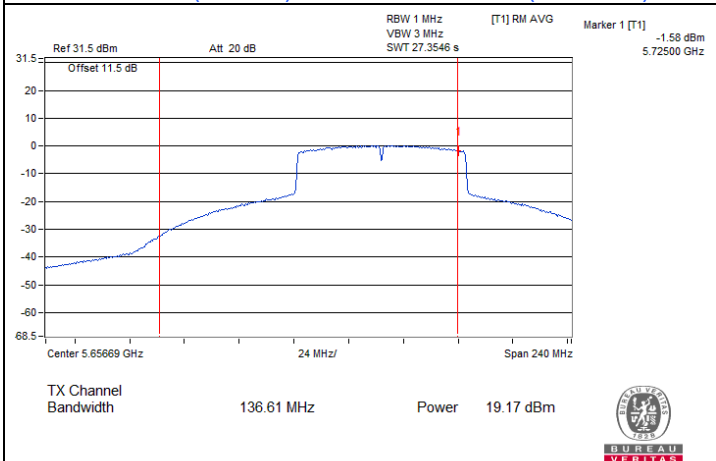

802.11ac (VHT80) / Chain 1 : CH 138 (U-NII-2C)

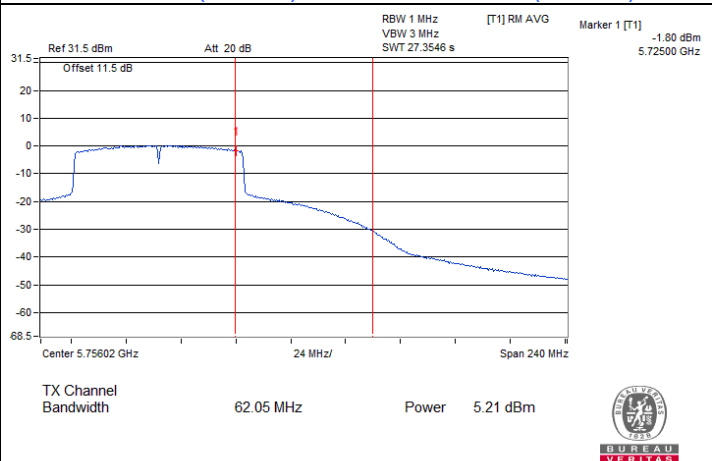

802.11ac (VHT80) / Chain 1 : CH 138 (U-NII-3)

7.3 Power Spectral Density

Input Power:	54 Vdc	Environmental Conditions:	25°C, 60% RH	Tested By:	Tim Chen
--------------	--------	---------------------------	--------------	------------	----------

Mode A

802.11a

Chan.	Chan. Freq. (MHz)	PSD w/o Duty Factor (dBm/MHz)				Duty Factor (dB)	Total PSD (dBm/MHz)	Max. PSD Limit (dBm/MHz)	Test Result
		Chain 0	Chain 1	Chain 2	Chain 3				
52	5260	-2.34	-2.35	-2.29	-2.35	0.11	3.80	4.18	Pass
60	5300	-2.51	-2.12	-2.37	-2.32	0.11	3.80	4.18	Pass
64	5320	-2.20	-2.28	-2.27	-2.57	0.11	3.80	4.18	Pass
100	5500	-2.45	-2.42	-2.92	-2.97	0.11	3.45	3.77	Pass
116	5580	-2.51	-2.49	-2.82	-2.68	0.11	3.51	3.77	Pass
140	5700	-2.64	-2.64	-2.60	-2.51	0.11	3.53	3.77	Pass
144 (U-NII-2C)	5720	-2.37	-2.52	-2.52	-2.71	0.11	3.60	3.77	Pass

Notes:

- Method E) 2) a) of power density measurement of KDB 662911 is using for calculating total power density. Total power density is summing entire spectra across corresponding frequency bins on the various outputs by computer.
- Directional gain = $10 \log[(10^{\text{Chain0}/20} + 10^{\text{Chain1}/20} + 10^{\text{Chain2}/20} + 10^{\text{Chain3}/20})^2 / 4]$
- For U-NII-2A, the directional gain is 12.82 dBi > 6 dBi, so the power density limit shall be reduced to $11-(12.82-6) = 4.18$ dBm/MHz.
- For U-NII-2C, the directional gain is 13.23 dBi > 6 dBi, so the power density limit shall be reduced to $11-(13.23-6) = 3.77$ dBm/MHz.

802.11ax (HE20)

Chan.	Chan. Freq. (MHz)	PSD w/o Duty Factor (dBm/MHz)				Duty Factor (dB)	Total PSD (dBm/MHz)	Max. PSD Limit (dBm/MHz)	Test Result
		Chain 0	Chain 1	Chain 2	Chain 3				
52	5260	-2.31	-2.25	-2.53	-2.20	0.28	3.98	4.18	Pass
60	5300	-2.04	-3.21	-2.42	-2.15	0.28	3.87	4.18	Pass
64	5320	-2.13	-2.35	-3.01	-2.62	0.28	3.79	4.18	Pass
100	5500	-2.89	-2.79	-2.91	-2.99	0.28	3.41	3.77	Pass
116	5580	-3.17	-3.02	-3.19	-2.50	0.28	3.34	3.77	Pass
140	5700	-2.20	-2.49	-3.22	-3.28	0.28	3.53	3.77	Pass
144 (U-NII-2C)	5720	-3.17	-2.59	-2.12	-2.75	0.28	3.66	3.77	Pass

Notes:

- Method E) 2) a) of power density measurement of KDB 662911 is using for calculating total power density. Total power density is summing entire spectra across corresponding frequency bins on the various outputs by computer.
- Directional gain = $10 \log[(10^{\text{Chain0}/20} + 10^{\text{Chain1}/20} + 10^{\text{Chain2}/20} + 10^{\text{Chain3}/20})^2 / 4]$
- For U-NII-2A, the directional gain is 12.82 dBi > 6 dBi, so the power density limit shall be reduced to $11-(12.82-6) = 4.18$ dBm/MHz.
- For U-NII-2C, the directional gain is 13.23 dBi > 6 dBi, so the power density limit shall be reduced to $11-(13.23-6) = 3.77$ dBm/MHz.

802.11ax (HE40)

Chan.	Chan. Freq. (MHz)	PSD w/o Duty Factor (dBm/MHz)				Duty Factor (dB)	Total PSD (dBm/MHz)	Max. PSD Limit (dBm/MHz)	Test Result
		Chain 0	Chain 1	Chain 2	Chain 3				
54	5270	-1.96	-2.96	-2.57	-2.00	0.20	3.87	4.18	Pass
62	5310	-2.01	-2.25	-2.04	-3.01	0.20	3.91	4.18	Pass
102	5510	-2.17	-2.52	-2.83	-3.05	0.20	3.59	3.77	Pass
110	5550	-3.30	-2.51	-2.16	-2.74	0.20	3.56	3.77	Pass
134	5670	-3.06	-2.98	-2.25	-2.44	0.20	3.55	3.77	Pass
142 (U-NII-2C)	5710	-2.15	-2.29	-3.38	-2.84	0.20	3.58	3.77	Pass

Notes:

- Method E) 2) a) of power density measurement of KDB 662911 is using for calculating total power density. Total power density is summing entire spectra across corresponding frequency bins on the various outputs by computer.
- Directional gain = $10 \log[(10^{\text{Chain0}/20} + 10^{\text{Chain1}/20} + 10^{\text{Chain2}/20} + 10^{\text{Chain3}/20})^2 / 4]$
- For U-NII-2A, the directional gain is 12.82 dBi > 6 dBi, so the power density limit shall be reduced to 11-(12.82-6) = 4.18 dBm/MHz.
- For U-NII-2C, the directional gain is 13.23 dBi > 6 dBi, so the power density limit shall be reduced to 11-(13.23-6) = 3.77 dBm/MHz.

802.11ax (HE80)

Chan.	Chan. Freq. (MHz)	PSD w/o Duty Factor (dBm/MHz)				Duty Factor (dB)	Total PSD (dBm/MHz)	Max. PSD Limit (dBm/MHz)	Test Result
		Chain 0	Chain 1	Chain 2	Chain 3				
58	5290	-9.86	-9.19	-9.71	-9.27	0.26	-3.22	4.18	Pass
106	5530	-2.78	-2.15	-3.16	-2.63	0.26	3.62	3.77	Pass
122	5610	-2.39	-2.97	-2.08	-3.50	0.26	3.58	3.77	Pass
138 (U-NII-2C)	5690	-2.74	-2.58	-2.68	-3.20	0.26	3.49	3.77	Pass

Notes:

- Method E) 2) a) of power density measurement of KDB 662911 is using for calculating total power density. Total power density is summing entire spectra across corresponding frequency bins on the various outputs by computer.
- Directional gain = $10 \log[(10^{\text{Chain0}/20} + 10^{\text{Chain1}/20} + 10^{\text{Chain2}/20} + 10^{\text{Chain3}/20})^2 / 4]$
- For U-NII-2A, the directional gain is 12.82 dBi > 6 dBi, so the power density limit shall be reduced to 11-(12.82-6) = 4.18 dBm/MHz.
- For U-NII-2C, the directional gain is 13.23 dBi > 6 dBi, so the power density limit shall be reduced to 11-(13.23-6) = 3.77 dBm/MHz.

802.11a

Chan.	Chan. Freq. (MHz)	PSD w/o Duty Factor (dBm/300kHz)				Total PSD w/o Duty Factor (dBm/300kHz)	Duty Factor (dB)	Total PSD (dBm/500kHz)	PSD Limit (dBm/500kHz)	Test Result
		Chain 0	Chain 1	Chain 2	Chain 3					
144 (U-NII-3)	5720	-11.13	-11.38	-11.21	-11.26	-5.22	0.11	-2.89	23.03	Pass

Notes:

- Method E) 2) b) Measure and sum spectral maxima across the outputs of KDB 662911 is using for calculating total power density.
- Directional gain = $10 \log[(10^{\text{Chain0}/20} + 10^{\text{Chain1}/20} + 10^{\text{Chain2}/20} + 10^{\text{Chain3}/20})^2 / 4]$
- For U-NII-3, the directional gain is 12.97 dBi > 6 dBi, so the power density limit shall be reduced to $30 - (12.97 - 6) = 23.03$ dBm/500kHz.

802.11ax (HE20)

Chan.	Chan. Freq. (MHz)	PSD w/o Duty Factor (dBm/300kHz)				Total PSD w/o Duty Factor (dBm/300kHz)	Duty Factor (dB)	Total PSD (dBm/500kHz)	PSD Limit (dBm/500kHz)	Test Result
		Chain 0	Chain 1	Chain 2	Chain 3					
144 (U-NII-3)	5720	-11.98	-12.88	-12.70	-12.38	-6.45	0.28	-3.95	23.03	Pass

Notes:

- Method E) 2) b) Measure and sum spectral maxima across the outputs of KDB 662911 is using for calculating total power density.
- Directional gain = $10 \log[(10^{\text{Chain0}/20} + 10^{\text{Chain1}/20} + 10^{\text{Chain2}/20} + 10^{\text{Chain3}/20})^2 / 4]$
- For U-NII-3, the directional gain is 12.97 dBi > 6 dBi, so the power density limit shall be reduced to $30 - (12.97 - 6) = 23.03$ dBm/500kHz.

802.11ax (HE40)

Chan.	Chan. Freq. (MHz)	PSD w/o Duty Factor (dBm/300kHz)				Total PSD w/o Duty Factor (dBm/300kHz)	Duty Factor (dB)	Total PSD (dBm/500kHz)	PSD Limit (dBm/500kHz)	Test Result
		Chain 0	Chain 1	Chain 2	Chain 3					
142 (U-NII-3)	5710	-13.48	-13.56	-14.36	-12.95	-7.54	0.2	-5.12	23.03	Pass

Notes:

- Method E) 2) b) Measure and sum spectral maxima across the outputs of KDB 662911 is using for calculating total power density.
- Directional gain = $10 \log[(10^{\text{Chain0}/20} + 10^{\text{Chain1}/20} + 10^{\text{Chain2}/20} + 10^{\text{Chain3}/20})^2 / 4]$
- For U-NII-3, the directional gain is 12.97 dBi > 6 dBi, so the power density limit shall be reduced to $30 - (12.97 - 6) = 23.03$ dBm/500kHz.

802.11ax (HE80)

Chan.	Chan. Freq. (MHz)	PSD w/o Duty Factor (dBm/300kHz)				Total PSD w/o Duty Factor (dBm/300kHz)	Duty Factor (dB)	Total PSD (dBm/500kHz)	PSD Limit (dBm/500kHz)	Test Result
		Chain 0	Chain 1	Chain 2	Chain 3					
138 (U-NII-3)	5690	-14.88	-16.36	-16.64	-15.71	-9.82	0.26	-7.34	23.03	Pass

Notes:

- Method E) 2) b) Measure and sum spectral maxima across the outputs of KDB 662911 is using for calculating total power density.
- Directional gain = $10 \log[(10^{\text{Chain0}/20} + 10^{\text{Chain1}/20} + 10^{\text{Chain2}/20} + 10^{\text{Chain3}/20})^2 / 4]$
- For U-NII-3, the directional gain is 12.97 dBi > 6 dBi, so the power density limit shall be reduced to $30 - (12.97 - 6) = 23.03$ dBm/500kHz.



Spectrum Plot of Maximum Value

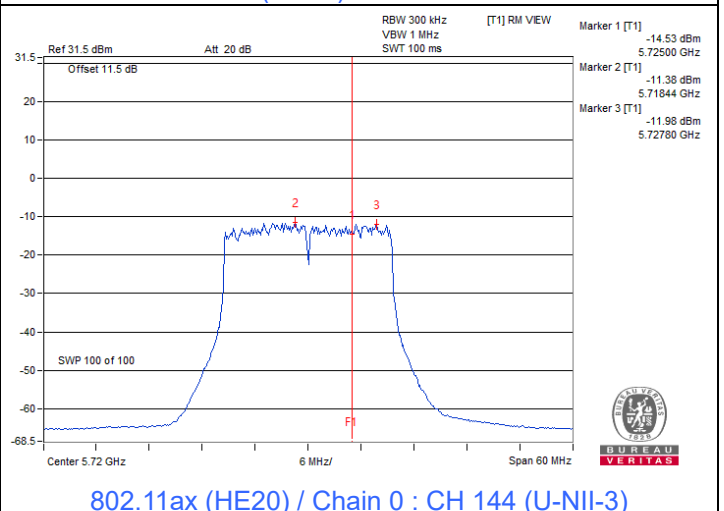
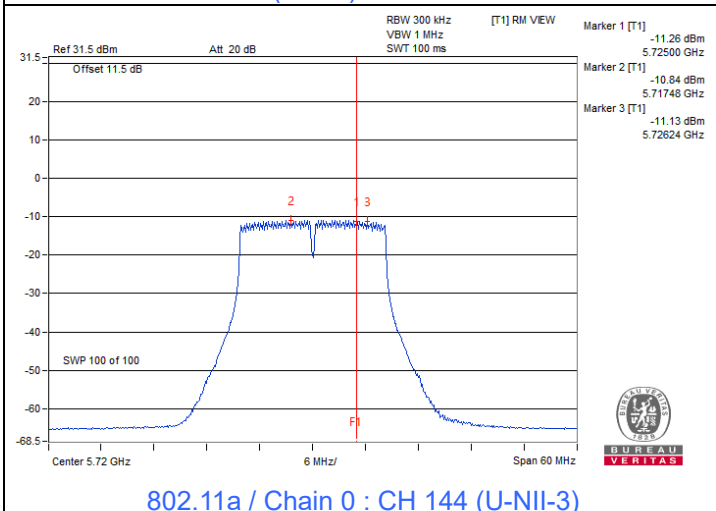
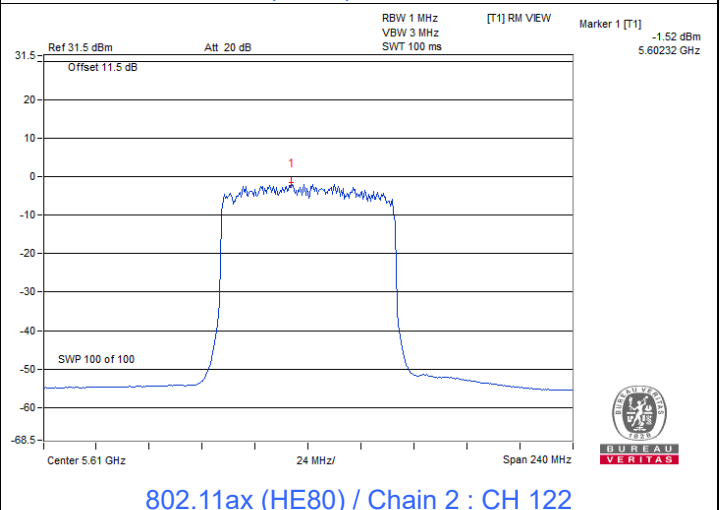
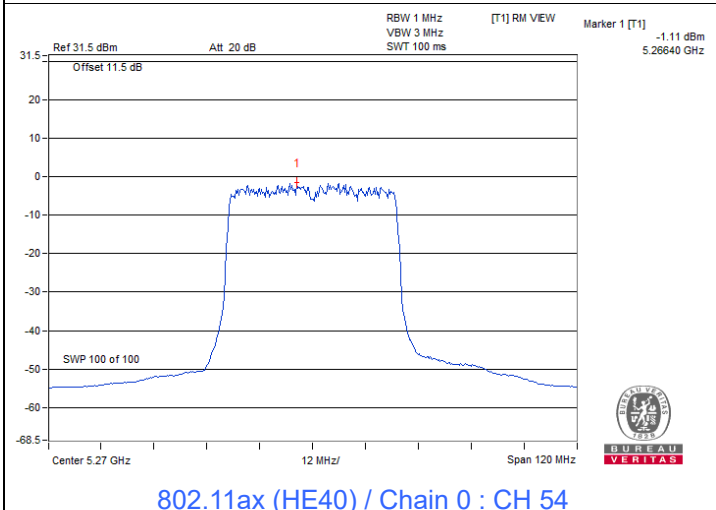
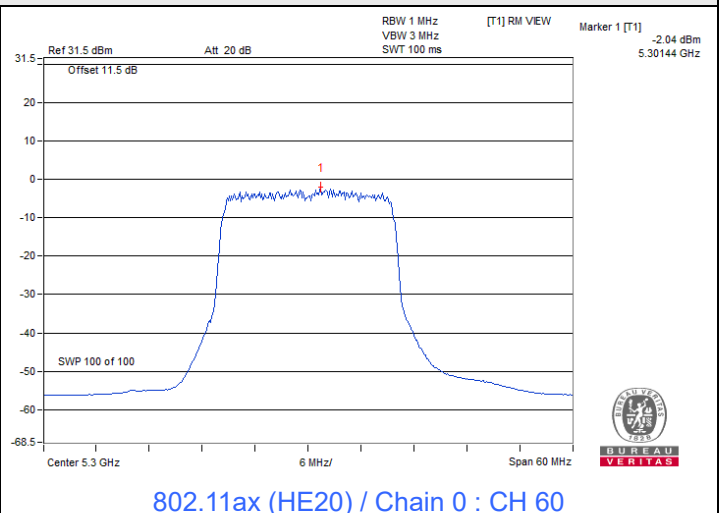
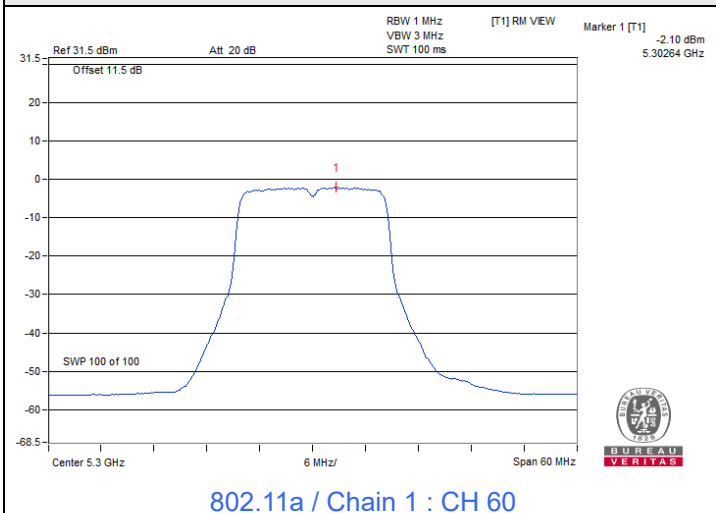



Spectrum Plot of Maximum Value

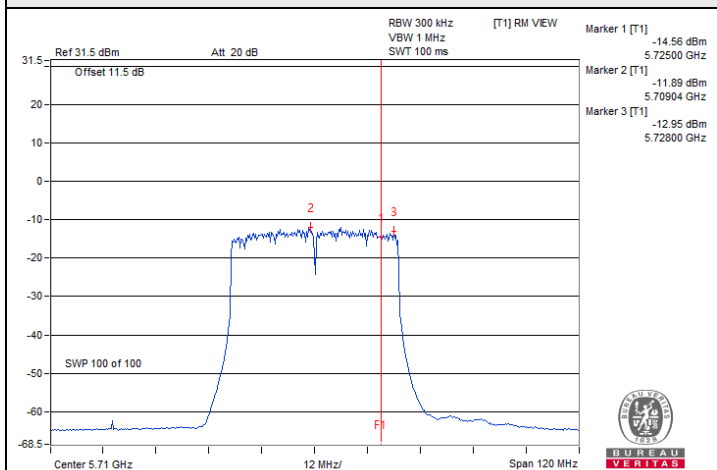

802.11ax (HE40) / Chain 3 : CH 142 (U-NII-3)

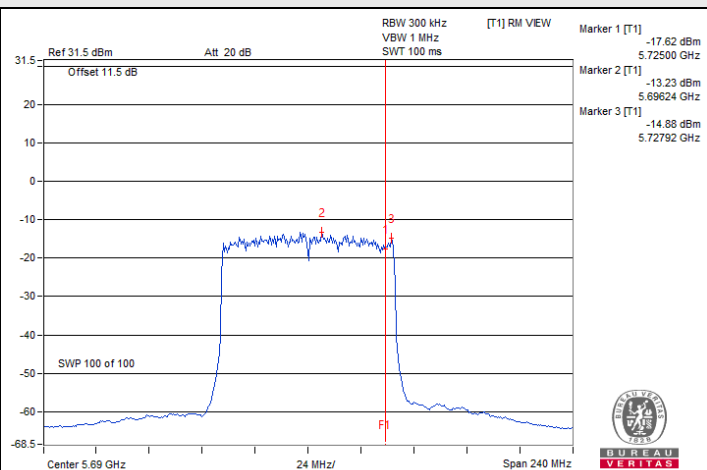

802.11ax (HE80) / Chain 0 : CH 138 (U-NII-3)

Input Power:	54 Vdc	Environmental Conditions:	24°C, 65% RH	Tested By:	Matthew Yang
--------------	--------	---------------------------	--------------	------------	--------------

Mode B

802.11a

Chan.	Chan. Freq. (MHz)	PSD w/o Duty Factor (dBm/MHz)		Duty Factor (dB)	Total PSD (dBm/MHz)	Max. PSD Limit (dBm/MHz)	Test Result
		Chain 0	Chain 1				
52	5260	4.27	4.28	0.19	7.48	7.55	Pass
60	5300	4.23	4.38	0.19	7.51	7.55	Pass
64	5320	3.04	3.35	0.19	6.40	7.55	Pass
100	5500	3.63	3.60	0.19	6.82	8.09	Pass
116	5580	4.57	4.78	0.19	7.88	8.09	Pass
140	5700	2.24	2.50	0.19	5.57	8.09	Pass
144 (U-NII-2C)	5720	4.70	4.72	0.19	7.91	8.09	Pass

Notes:

- Method E) 2) a) of power density measurement of KDB 662911 is using for calculating total power density. Total power density is summing entire spectra across corresponding frequency bins on the various outputs by computer.
- Directional gain = $10 \log[(10^{\text{Chain0}/20} + 10^{\text{Chain1}/20})^2 / 2]$
- For U-NII-2A, the directional gain is 9.45 dBi > 6 dBi, so the power density limit shall be reduced to $11 - (9.45 - 6) = 7.55$ dBm/MHz.
- For U-NII-2C, the directional gain is 8.91 dBi > 6 dBi, so the power density limit shall be reduced to $11 - (8.91 - 6) = 8.09$ dBm/MHz.

802.11ac (VHT20)

Chan.	Chan. Freq. (MHz)	PSD w/o Duty Factor (dBm/MHz)		Duty Factor (dB)	Total PSD (dBm/MHz)	Max. PSD Limit (dBm/MHz)	Test Result
		Chain 0	Chain 1				
52	5260	4.18	3.40	0.25	7.07	7.55	Pass
60	5300	3.94	4.45	0.25	7.46	7.55	Pass
64	5320	3.39	2.98	0.25	6.45	7.55	Pass
100	5500	3.40	3.04	0.25	6.48	8.09	Pass
116	5580	4.45	4.88	0.25	7.93	8.09	Pass
140	5700	2.50	1.94	0.25	5.49	8.09	Pass
144 (U-NII-2C)	5720	4.28	4.53	0.25	7.67	8.09	Pass

Notes:

- Method E) 2) a) of power density measurement of KDB 662911 is using for calculating total power density. Total power density is summing entire spectra across corresponding frequency bins on the various outputs by computer.
- Directional gain = $10 \log[(10^{\text{Chain0}/20} + 10^{\text{Chain1}/20})^2 / 2]$
- For U-NII-2A, the directional gain is 9.45 dBi > 6 dBi, so the power density limit shall be reduced to $11-(9.45-6) = 7.55$ dBm/MHz.
- For U-NII-2C, the directional gain is 8.91 dBi > 6 dBi, so the power density limit shall be reduced to $11-(8.91-6) = 8.09$ dBm/MHz.

802.11ac (VHT40)

Chan.	Chan. Freq. (MHz)	PSD w/o Duty Factor (dBm/MHz)		Duty Factor (dB)	Total PSD (dBm/MHz)	Max. PSD Limit (dBm/MHz)	Test Result
		Chain 0	Chain 1				
54	5270	1.36	1.57	0.28	4.76	7.55	Pass
62	5310	-2.23	-1.53	0.28	1.42	7.55	Pass
102	5510	-2.34	-0.55	0.28	1.94	8.09	Pass
110	5550	0.46	2.08	0.28	4.64	8.09	Pass
134	5670	-1.68	0.02	0.28	2.54	8.09	Pass
142 (U-NII-2C)	5710	2.54	1.84	0.28	5.49	8.09	Pass

Notes:

- Method E) 2) a) of power density measurement of KDB 662911 is using for calculating total power density. Total power density is summing entire spectra across corresponding frequency bins on the various outputs by computer.
- Directional gain = $10 \log[(10^{\text{Chain0}/20} + 10^{\text{Chain1}/20})^2 / 2]$
- For U-NII-2A, the directional gain is 9.45 dBi > 6 dBi, so the power density limit shall be reduced to $11-(9.45-6) = 7.55$ dBm/MHz.
- For U-NII-2C, the directional gain is 8.91 dBi > 6 dBi, so the power density limit shall be reduced to $11-(8.91-6) = 8.09$ dBm/MHz.

802.11ac (VHT80)

Chan.	Chan. Freq. (MHz)	PSD w/o Duty Factor (dBm/MHz)		Duty Factor (dB)	Total PSD (dBm/MHz)	Max. PSD Limit (dBm/MHz)	Test Result
		Chain 0	Chain 1				
58	5290	-5.63	-6.78	0.29	-2.87	7.55	Pass
106	5530	-7.20	-5.29	0.29	-2.84	8.09	Pass
122	5610	-3.51	-2.29	0.29	0.44	8.09	Pass
138 (U-NII-2C)	5690	0.10	-1.70	0.29	2.59	8.09	Pass

Notes:

- Method E) 2) a) of power density measurement of KDB 662911 is using for calculating total power density. Total power density is summing entire spectra across corresponding frequency bins on the various outputs by computer.
- Directional gain = $10 \log[(10^{\text{Chain0}/20} + 10^{\text{Chain1}/20})^2 / 2]$
- For U-NII-2A, the directional gain is 9.45 dBi > 6 dBi, so the power density limit shall be reduced to $11-(9.45-6) = 7.55$ dBm/MHz.
- For U-NII-2C, the directional gain is 8.91 dBi > 6 dBi, so the power density limit shall be reduced to $11-(8.91-6) = 8.09$ dBm/MHz.

802.11a

Chan.	Chan. Freq. (MHz)	PSD w/o Duty Factor (dBm/300kHz)		Total PSD w/o Duty Factor (dBm/300kHz)	Duty Factor (dB)	Total PSD (dBm/500kHz)	PSD Limit (dBm/500kHz)	Test Result
		Chain 0	Chain 1					
144 (U-NII-3)	5720	-3.94	-4.12	-1.02	0.19	1.39	26.63	Pass

Notes:

- Method E) 2) b) Measure and sum spectral maxima across the outputs of KDB 662911 is using for calculating total power density.
- Directional gain = $10 \log[(10^{\text{Chain0}/20} + 10^{\text{Chain1}/20})^2 / 2]$
- For U-NII-3, the directional gain is 9.37 dBi > 6 dBi, so the power density limit shall be reduced to $30-(9.37-6) = 26.63$ dBm/500kHz.

802.11ac (VHT20)

Chan.	Chan. Freq. (MHz)	PSD w/o Duty Factor (dBm/300kHz)		Total PSD w/o Duty Factor (dBm/300kHz)	Duty Factor (dB)	Total PSD (dBm/500kHz)	PSD Limit (dBm/500kHz)	Test Result
		Chain 0	Chain 1					
144 (U-NII-3)	5720	-3.48	-4.38	-0.9	0.25	1.57	26.63	Pass

Notes:

- Method E) 2) b) Measure and sum spectral maxima across the outputs of KDB 662911 is using for calculating total power density.
- Directional gain = $10 \log[(10^{\text{Chain0}/20} + 10^{\text{Chain1}/20})^2 / 2]$
- For U-NII-3, the directional gain is 9.37 dBi > 6 dBi, so the power density limit shall be reduced to $30-(9.37-6) = 26.63$ dBm/500kHz.

802.11ac (VHT40)

Chan.	Chan. Freq. (MHz)	PSD w/o Duty Factor (dBm/300kHz)		Total PSD w/o Duty Factor (dBm/300kHz)	Duty Factor (dB)	Total PSD (dBm/500kHz)	PSD Limit (dBm/500kHz)	Test Result
		Chain 0	Chain 1					
142 (U-NII-3)	5710	-8.38	-9.67	-5.97	0.28	-3.47	26.63	Pass

- Notes:
- Method E) 2) b) Measure and sum spectral maxima across the outputs of KDB 662911 is using for calculating total power density.
 - Directional gain = $10 \log[(10^{\text{Chain0}/20} + 10^{\text{Chain1}/20})^2 / 2]$
 - For U-NII-3, the directional gain is 9.37 dBi > 6 dBi, so the power density limit shall be reduced to $30 - (9.37 - 6) = 26.63$ dBm/500kHz.

802.11ac (VHT80)

Chan.	Chan. Freq. (MHz)	PSD w/o Duty Factor (dBm/300kHz)		Total PSD w/o Duty Factor (dBm/300kHz)	Duty Factor (dB)	Total PSD (dBm/500kHz)	PSD Limit (dBm/500kHz)	Test Result
		Chain 0	Chain 1					
138 (U-NII-3)	5690	-12.39	-12.90	-9.63	0.29	-7.12	26.63	Pass

- Notes:
- Method E) 2) b) Measure and sum spectral maxima across the outputs of KDB 662911 is using for calculating total power density.
 - Directional gain = $10 \log[(10^{\text{Chain0}/20} + 10^{\text{Chain1}/20})^2 / 2]$
 - For U-NII-3, the directional gain is 9.37 dBi > 6 dBi, so the power density limit shall be reduced to $30 - (9.37 - 6) = 26.63$ dBm/500kHz.

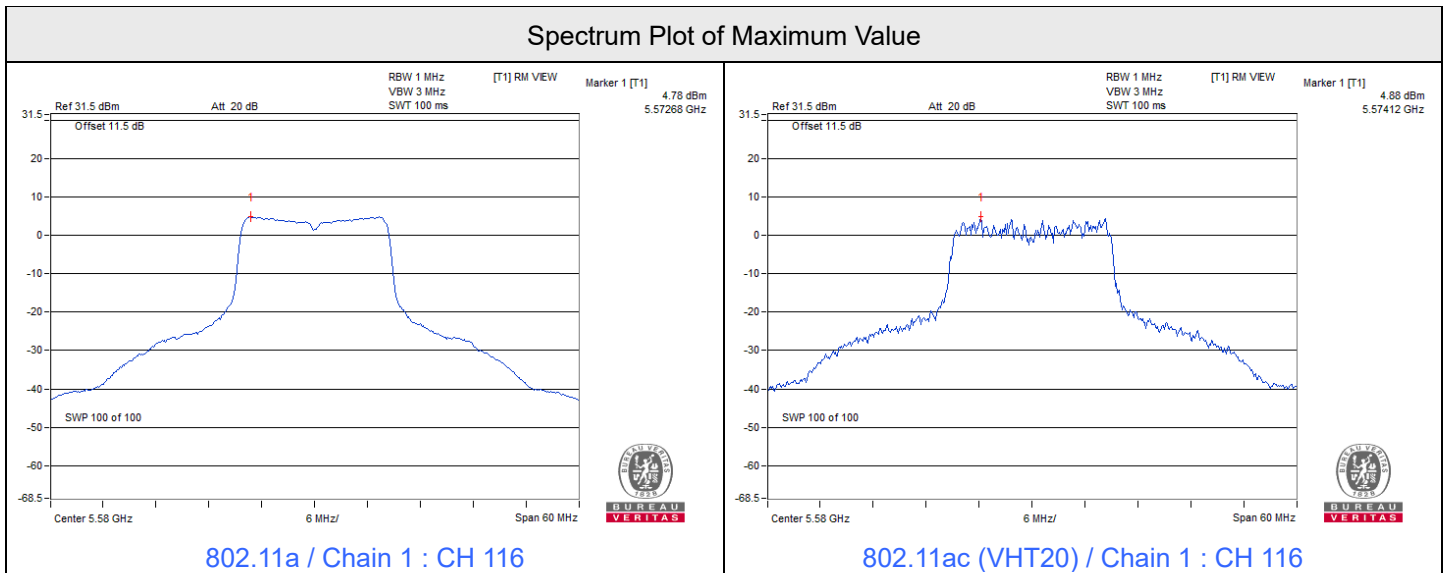

Spectrum Plot of Maximum Value

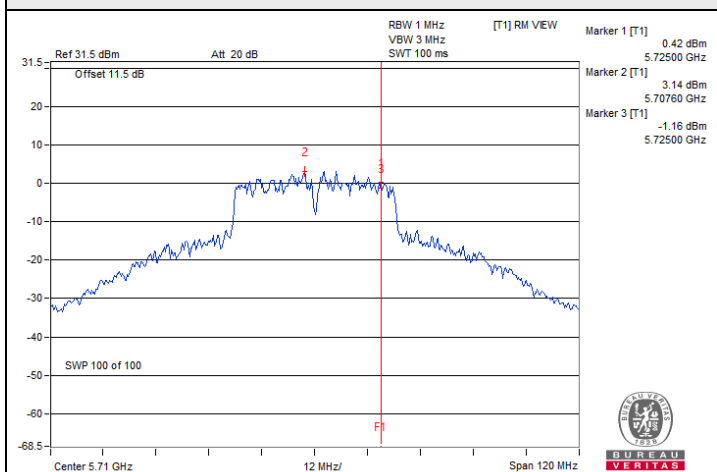

802.11ac (VHT40) / Chain 0 : CH 142 (U-NII-2C)

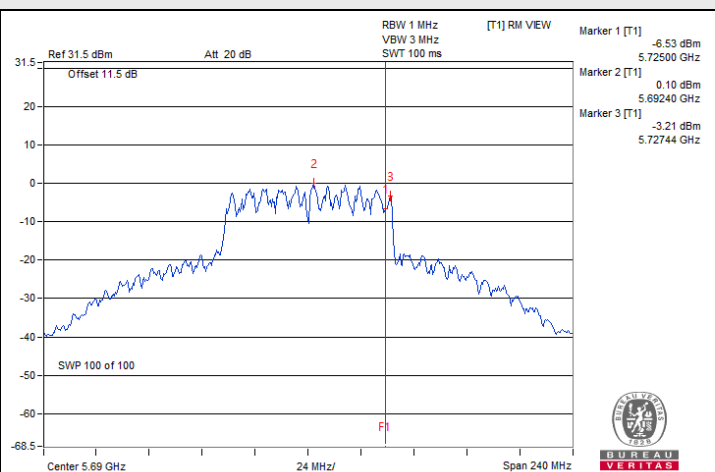

802.11ac (VHT80) / Chain 0 : CH 138 (U-NII-2C)

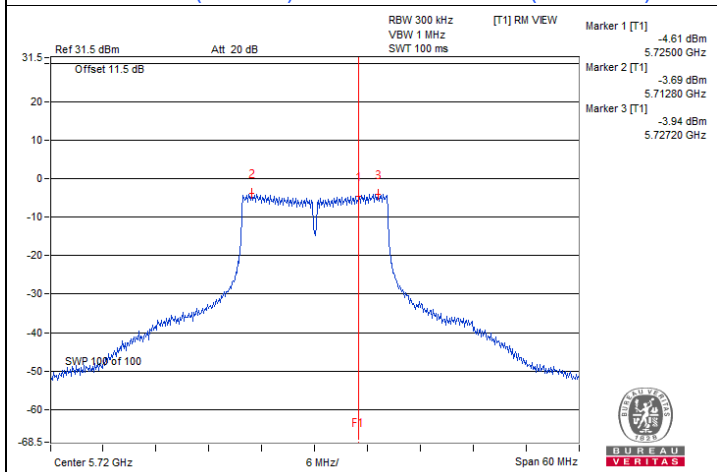

802.11a / Chain 0 : CH 144 (U-NII-3)

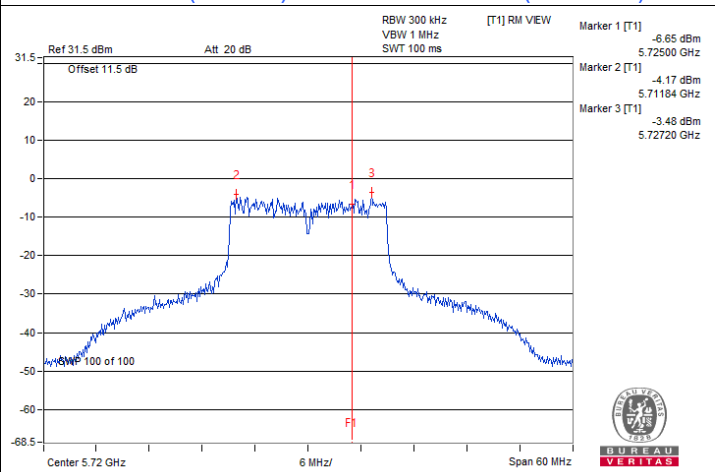

802.11ac (VHT20) / Chain 0 : CH 144 (U-NII-3)

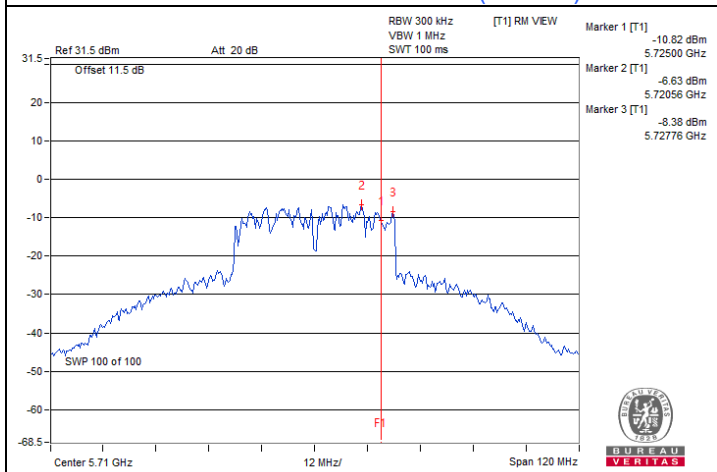

802.11ac (VHT40) / Chain 0 : CH 142 (U-NII-3)

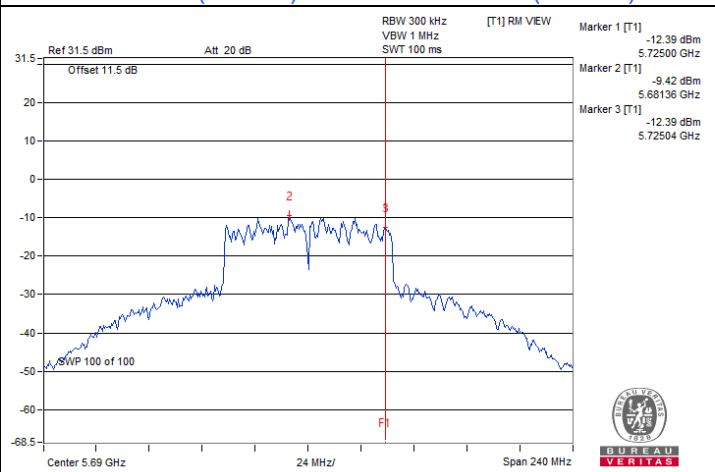

802.11ac (VHT80) / Chain 0 : CH 138 (U-NII-3)

7.4 6 dB Bandwidth

Input Power:	54 Vdc	Environmental Conditions:	25°C, 60% RH	Tested By:	Tim Chen
--------------	--------	---------------------------	--------------	------------	----------

Mode A

802.11a

Channel	Frequency (MHz)	6 dB Bandwidth (MHz)				Minimum Limit (MHz)	Test Result
		Chain 0	Chain 1	Chain 2	Chain 3		
144 (U-NII-3)	5720	3.17	3.17	3.16	3.17	0.5	Pass

802.11ax (HE20)

Channel	Frequency (MHz)	6 dB Bandwidth (MHz)				Minimum Limit (MHz)	Test Result
		Chain 0	Chain 1	Chain 2	Chain 3		
144 (U-NII-3)	5720	4.53	4.41	4.37	4.50	0.5	Pass

802.11ax (HE40)

Channel	Frequency (MHz)	6 dB Bandwidth (MHz)				Minimum Limit (MHz)	Test Result
		Chain 0	Chain 1	Chain 2	Chain 3		
142 (U-NII-3)	5710	4.05	3.63	3.87	4.07	0.5	Pass

802.11ax (HE80)

Channel	Frequency (MHz)	6 dB Bandwidth (MHz)				Minimum Limit (MHz)	Test Result
		Chain 0	Chain 1	Chain 2	Chain 3		
138 (U-NII-3)	5690	4.13	2.77	3.46	4.10	0.5	Pass

Spectrum Plot of Minimum Value

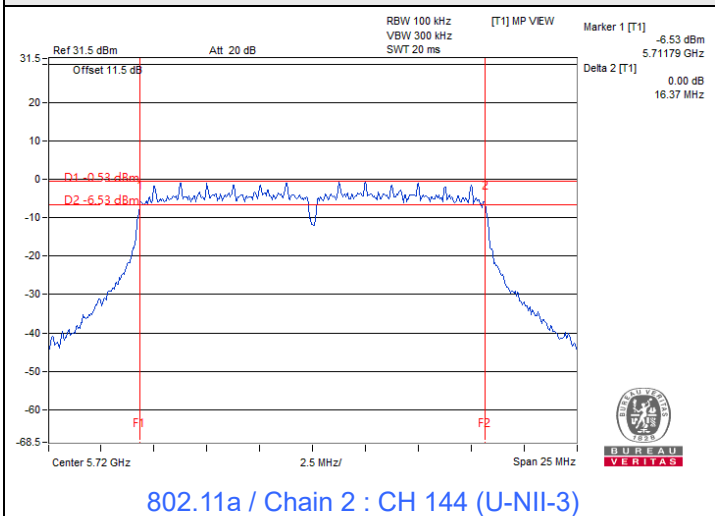

802.11a / Chain 2 : CH 144 (U-NII-3)

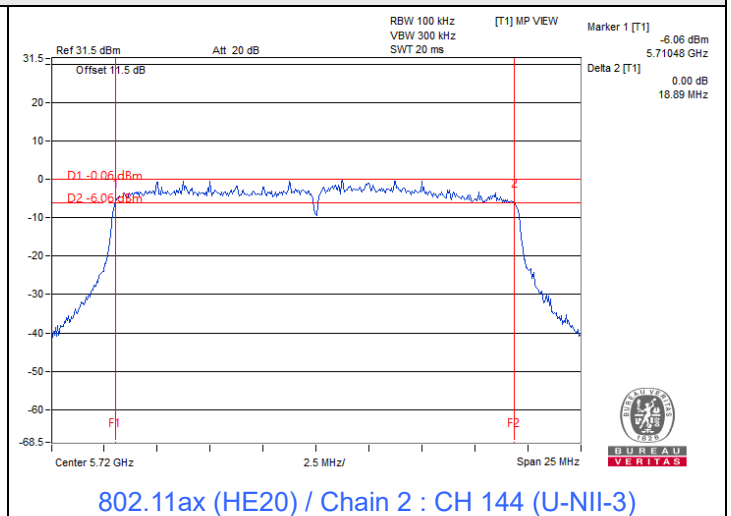

802.11ax (HE20) / Chain 2 : CH 144 (U-NII-3)

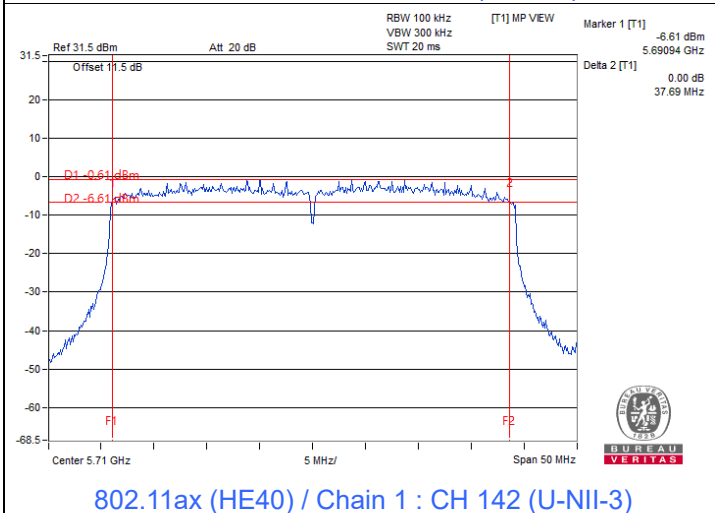

802.11ax (HE40) / Chain 1 : CH 142 (U-NII-3)

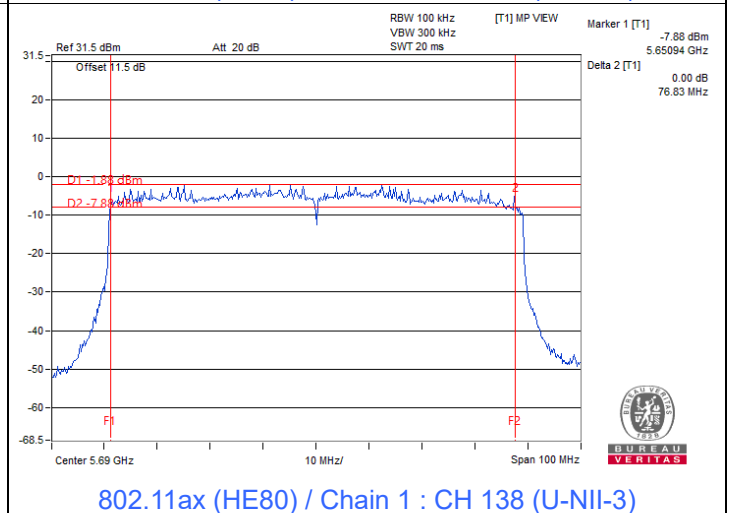

802.11ax (HE80) / Chain 1 : CH 138 (U-NII-3)

Note: For U-NII-3 straddle channel = Marker 1 + Delta 2 - 5725 MHz



Input Power:	54 Vdc	Environmental Conditions:	24°C, 65% RH	Tested By:	Matthew Yang
--------------	--------	---------------------------	--------------	------------	--------------

Mode B

802.11a

Channel	Frequency (MHz)	6 dB Bandwidth (MHz)		Minimum Limit (MHz)	Test Result
		Chain 0	Chain 1		
144 (U-NII-3)	5720	3.19	3.19	0.5	Pass

802.11ac (VHT20)

Channel	Frequency (MHz)	6 dB Bandwidth (MHz)		Minimum Limit (MHz)	Test Result
		Chain 0	Chain 1		
144 (U-NII-3)	5720	3.82	3.82	0.5	Pass

802.11ac (VHT40)

Channel	Frequency (MHz)	6 dB Bandwidth (MHz)		Minimum Limit (MHz)	Test Result
		Chain 0	Chain 1		
142 (U-NII-3)	5710	2.88	2.90	0.5	Pass

802.11ac (VHT80)

Channel	Frequency (MHz)	6 dB Bandwidth (MHz)		Minimum Limit (MHz)	Test Result
		Chain 0	Chain 1		
138 (U-NII-3)	5690	2.69	2.67	0.5	Pass



Spectrum Plot of Minimum Value

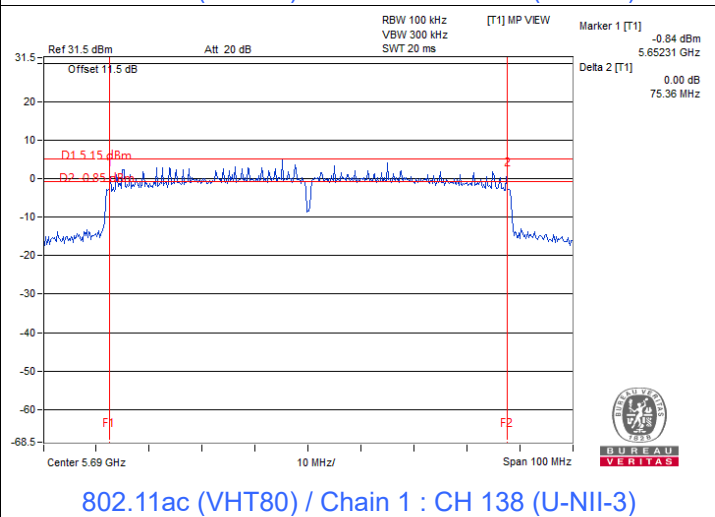
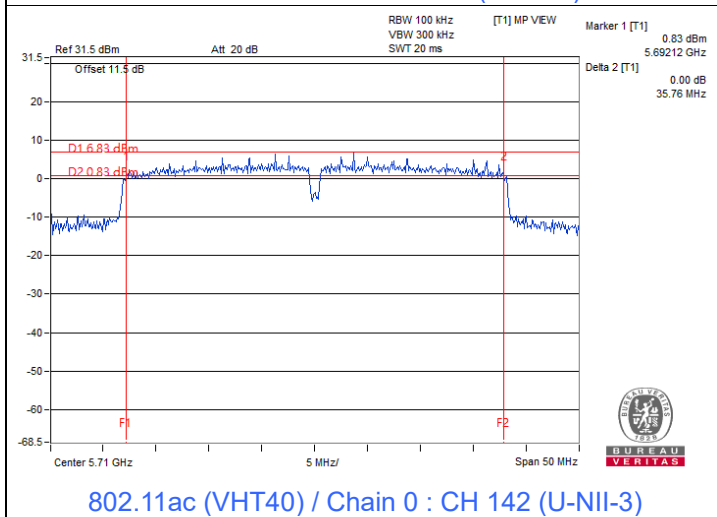
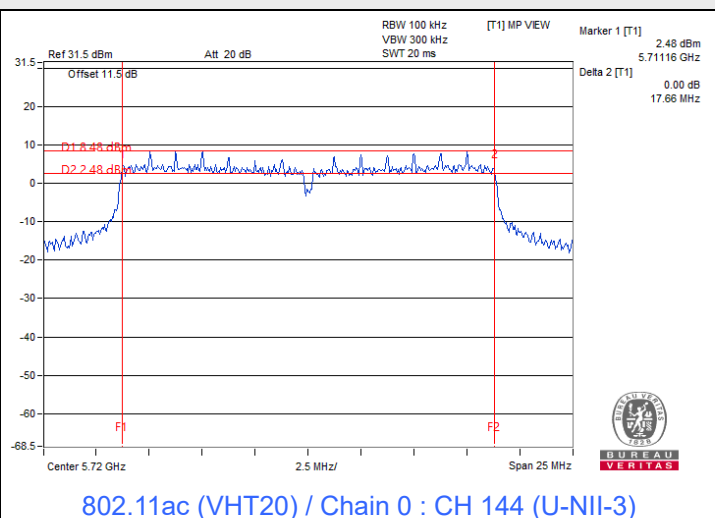
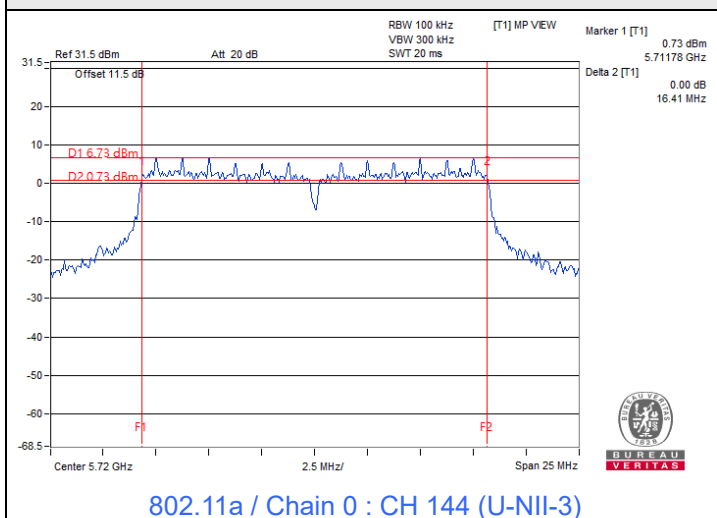

Note: For U-NII-3 straddle channel = Marker 1 + Delta 2 - 5725 MHz

7.5 Occupied Bandwidth

Input Power:	54 Vdc	Environmental Conditions:	25°C, 60% RH	Tested By:	Tim Chen
--------------	--------	---------------------------	--------------	------------	----------

Mode A

802.11a

Channel	Frequency (MHz)	Occupied Bandwidth (MHz)			
		Chain 0	Chain 1	Chain 2	Chain 3
52	5260	16.56	16.44	16.44	16.44
60	5300	16.44	16.44	16.44	16.44
64	5320	16.44	16.44	16.44	16.44
100	5500	16.44	16.44	16.44	16.44
116	5580	16.44	16.44	16.44	16.44
140	5700	16.44	16.56	16.44	16.44
144 (U-NII-2C)	5720	13.28	13.28	13.28	13.28
144 (U-NII-3)	5720	3.16	3.16	3.16	3.16

802.11ax (HE20)

Channel	Frequency (MHz)	Occupied Bandwidth (MHz)			
		Chain 0	Chain 1	Chain 2	Chain 3
52	5260	19.08	18.84	18.84	19.08
60	5300	19.08	19.08	19.08	19.08
64	5320	18.96	19.08	19.08	18.96
100	5500	19.08	18.96	18.96	18.84
116	5580	18.96	18.96	18.84	18.96
140	5700	18.96	19.08	18.96	18.96
144 (U-NII-2C)	5720	14.60	14.60	14.60	14.60
144 (U-NII-3)	5720	4.48	4.36	4.36	4.48

802.11ax (HE40)

Channel	Frequency (MHz)	Occupied Bandwidth (MHz)			
		Chain 0	Chain 1	Chain 2	Chain 3
54	5270	37.92	38.16	37.68	37.92
62	5310	38.16	37.92	37.92	38.16
102	5510	37.92	38.16	37.92	38.16
110	5550	37.92	37.80	38.04	38.04
134	5670	38.16	37.92	38.16	38.16
142 (U-NII-2C)	5710	33.96	34.20	34.20	33.96
142 (U-NII-3)	5710	3.96	3.96	3.96	3.96



802.11ax (HE80)

Channel	Frequency (MHz)	Occupied Bandwidth (MHz)			
		Chain 0	Chain 1	Chain 2	Chain 3
58	5290	77.28	77.28	77.28	77.28
106	5530	77.52	77.28	77.52	77.28
122	5610	77.28	76.80	77.28	77.28
138 (U-NII-2C)	5690	73.88	73.88	73.88	73.88
138 (U-NII-3)	5690	3.40	3.40	2.92	3.40

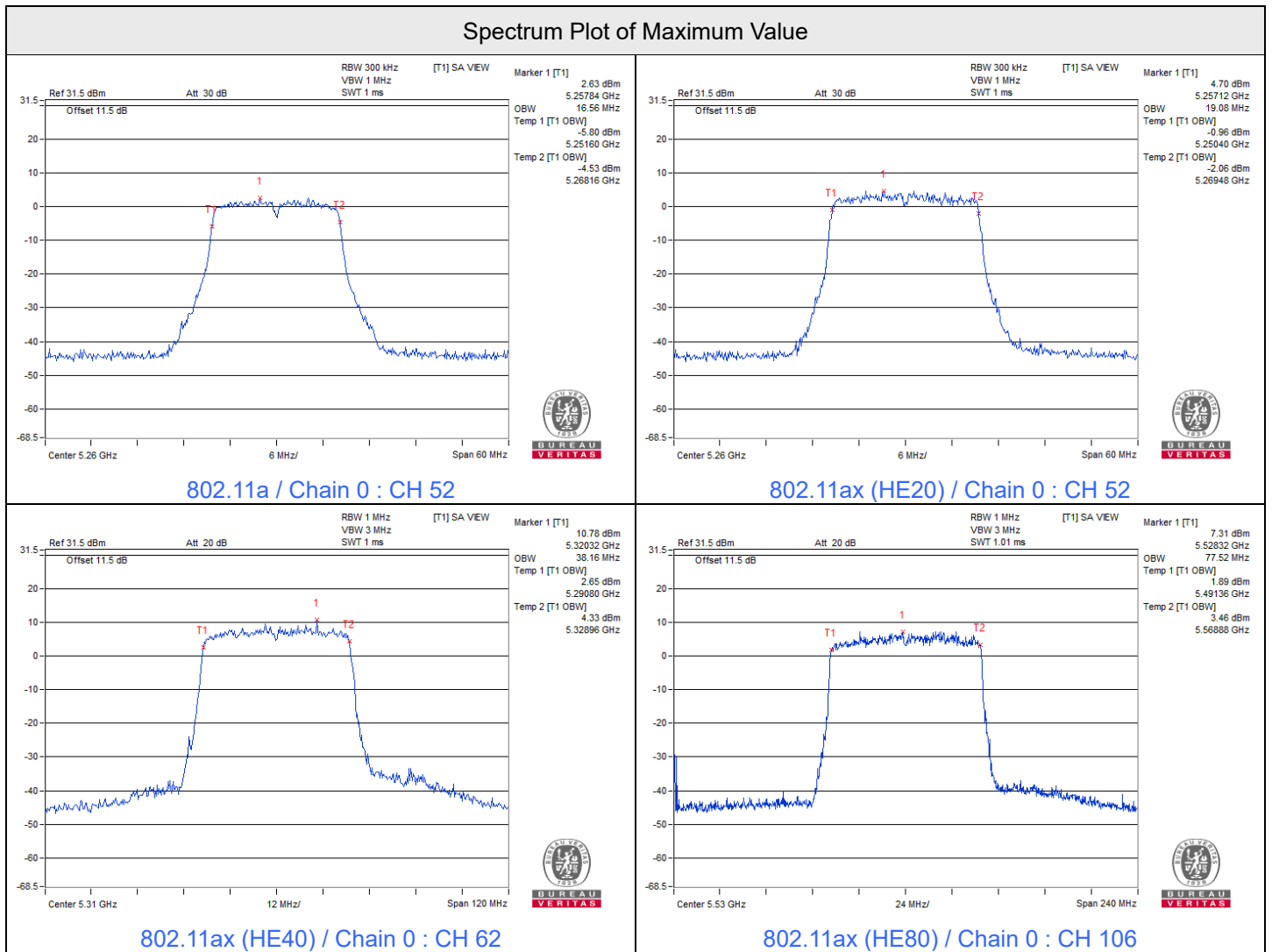



Input Power:	54 Vdc	Environmental Conditions:	24°C, 65% RH	Tested By:	Matthew Yang
--------------	--------	---------------------------	--------------	------------	--------------

Mode B

802.11a

Channel	Frequency (MHz)	Occupied Bandwidth (MHz)	
		Chain 0	Chain 1
52	5260	16.80	16.68
60	5300	16.80	16.68
64	5320	16.68	16.68
100	5500	16.80	16.68
116	5580	17.16	16.80
140	5700	16.68	16.68
144 (U-NII-2C)	5720	13.52	13.52
144 (U-NII-3)	5720	3.40	3.40

802.11ac (VHT20)

Channel	Frequency (MHz)	Occupied Bandwidth (MHz)	
		Chain 0	Chain 1
52	5260	18.12	18.12
60	5300	18.12	18.12
64	5320	17.88	17.88
100	5500	18.12	18.00
116	5580	19.56	18.48
140	5700	18.00	17.88
144 (U-NII-2C)	5720	14.60	14.60
144 (U-NII-3)	5720	4.48	4.60

802.11ac (VHT40)

Channel	Frequency (MHz)	Occupied Bandwidth (MHz)	
		Chain 0	Chain 1
54	5270	37.20	37.20
62	5310	36.24	36.24
102	5510	36.24	36.24
110	5550	37.20	38.40
134	5670	36.72	36.48
142 (U-NII-2C)	5710	43.80	44.28
142 (U-NII-3)	5710	13.80	14.04

802.11ac (VHT80)

Channel	Frequency (MHz)	Occupied Bandwidth (MHz)	
		Chain 0	Chain 1
58	5290	75.36	75.36
106	5530	75.36	75.36
122	5610	76.32	76.32
138 (U-NII-2C)	5690	73.40	73.88
138 (U-NII-3)	5690	3.40	2.92

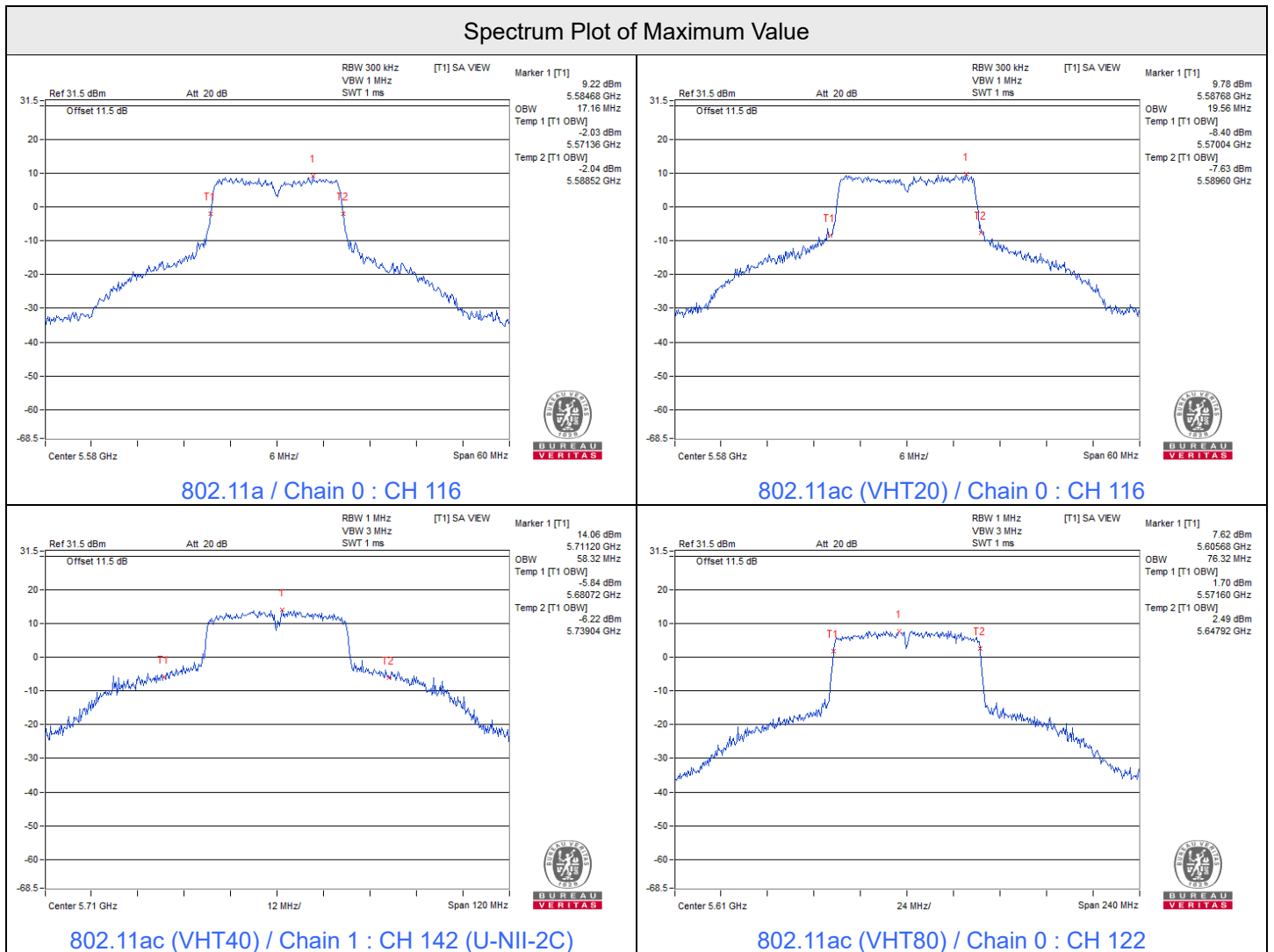

7.6 Frequency Stability

Input Power:	54 Vdc	Environmental Conditions:	25°C, 60% RH	Tested By:	Tim Chen
--------------	--------	---------------------------	--------------	------------	----------

Mode A

802.11a

Frequency Stability Versus Temperature									
Operating Frequency: 5260 MHz									
Temp. (°C)	Power Supply (Vdc)	0 Minute		2 Minutes		5 Minutes		10 Minutes	
		Measured Frequency (MHz)	Test Result	Measured Frequency (MHz)	Test Result	Measured Frequency (MHz)	Test Result	Measured Frequency (MHz)	Test Result
55	54	5260.0165	Pass	5260.0166	Pass	5260.0164	Pass	5260.0117	Pass
50	54	5259.9986	Pass	5259.9993	Pass	5259.9971	Pass	5259.9985	Pass
40	54	5260.0046	Pass	5260.005	Pass	5260.0053	Pass	5260.0005	Pass
30	54	5260.0057	Pass	5260.005	Pass	5260.0034	Pass	5260.0015	Pass
20	54	5259.9796	Pass	5259.9773	Pass	5259.9777	Pass	5259.9805	Pass
10	54	5260.0046	Pass	5260.006	Pass	5260.0033	Pass	5260.0033	Pass
0	54	5260.0039	Pass	5260.0052	Pass	5260.0028	Pass	5260.0048	Pass
-10	54	5260.0012	Pass	5259.9978	Pass	5260.0004	Pass	5259.9978	Pass
-20	54	5259.9997	Pass	5260.0016	Pass	5260.0013	Pass	5259.9983	Pass

Frequency Stability Versus Voltage									
Operating Frequency: 5260 MHz									
Temp. (°C)	Power Supply (Vdc)	0 Minute		2 Minutes		5 Minutes		10 Minutes	
		Measured Frequency (MHz)	Test Result	Measured Frequency (MHz)	Test Result	Measured Frequency (MHz)	Test Result	Measured Frequency (MHz)	Test Result
20	62.1	5259.9835	Pass	5259.9841	Pass	5259.9838	Pass	5259.9849	Pass
	54	5259.9796	Pass	5259.9773	Pass	5259.9777	Pass	5259.9805	Pass
	45.9	5259.9838	Pass	5259.9794	Pass	5259.9795	Pass	5259.9805	Pass



Input Power:	54 Vdc	Environmental Conditions:	24°C, 65% RH	Tested By:	Matthew Yang
--------------	--------	---------------------------	--------------	------------	--------------

Mode B

802.11a

Frequency Stability Versus Temperature									
Operating Frequency: 5260 MHz									
Temp. (°C)	Power Supply (Vdc)	0 Minute		2 Minutes		5 Minutes		10 Minutes	
		Measured Frequency (MHz)	Test Result	Measured Frequency (MHz)	Test Result	Measured Frequency (MHz)	Test Result	Measured Frequency (MHz)	Test Result
55	54	5260.0089	Pass	5260.0078	Pass	5260.0098	Pass	5260.0089	Pass
50	54	5259.995	Pass	5259.9961	Pass	5259.9943	Pass	5259.9943	Pass
40	54	5259.9854	Pass	5259.9882	Pass	5259.9904	Pass	5259.9864	Pass
30	54	5259.9969	Pass	5259.9987	Pass	5259.9973	Pass	5259.9977	Pass
20	54	5260.0141	Pass	5260.0138	Pass	5260.0132	Pass	5260.0151	Pass
10	54	5260.0065	Pass	5260.0087	Pass	5260.0112	Pass	5260.0065	Pass
0	54	5260.0167	Pass	5260.0118	Pass	5260.0132	Pass	5260.0154	Pass
-10	54	5260.017	Pass	5260.0128	Pass	5260.0122	Pass	5260.0152	Pass
-20	54	5260.0208	Pass	5260.0229	Pass	5260.0196	Pass	5260.0242	Pass

Frequency Stability Versus Voltage									
Operating Frequency: 5260 MHz									
Temp. (°C)	Power Supply (Vdc)	0 Minute		2 Minutes		5 Minutes		10 Minutes	
		Measured Frequency (MHz)	Test Result	Measured Frequency (MHz)	Test Result	Measured Frequency (MHz)	Test Result	Measured Frequency (MHz)	Test Result
20	62.1	5260.0179	Pass	5260.0188	Pass	5260.0189	Pass	5260.0187	Pass
	54	5260.0141	Pass	5260.0138	Pass	5260.0132	Pass	5260.0151	Pass
	45.9	5260.0147	Pass	5260.014	Pass	5260.0147	Pass	5260.0178	Pass

7.7 AC Power Conducted Emissions

Mode A

RF Mode	802.11ax (HE80)	Channel	CH 106 : 5530 MHz
Frequency Range	150kHz ~ 30MHz	Detector Function & Resolution Bandwidth	Quasi-Peak (QP) / Average (AV), 9 kHz
Input Power	120 Vac, 60 Hz	Environmental Conditions	23°C, 67% RH
Tested By	Adair Peng		

Phase Of Power : Line (L)										
No	Frequency (MHz)	Correction Factor (dB)	Reading Value (dBuV)		Emission Level (dBuV)		Limit (dBuV)		Margin (dB)	
			Q.P.	AV.	Q.P.	AV.	Q.P.	AV.	Q.P.	AV.
1	0.16600	9.63	35.03	20.57	44.66	30.20	65.16	55.16	-20.50	-24.96
2	0.18600	9.63	32.83	15.61	42.46	25.24	64.21	54.21	-21.75	-28.97
3	0.36835	9.67	37.08	33.60	46.75	43.27	58.54	48.54	-11.79	-5.27
4	0.97800	9.69	27.75	20.07	37.44	29.76	56.00	46.00	-18.56	-16.24
5	12.73400	9.79	18.73	13.42	28.52	23.21	60.00	50.00	-31.48	-26.79
6	29.21400	9.73	27.11	26.30	36.84	36.03	60.00	50.00	-23.16	-13.97

Remarks:

1. Q.P. and AV. are abbreviations of quasi-peak and average individually.
2. The emission levels of other frequencies were very low against the limit.
3. Margin value = Emission level – Limit value
4. Correction factor = Insertion loss + Cable loss
5. Emission Level = Correction Factor + Reading Value

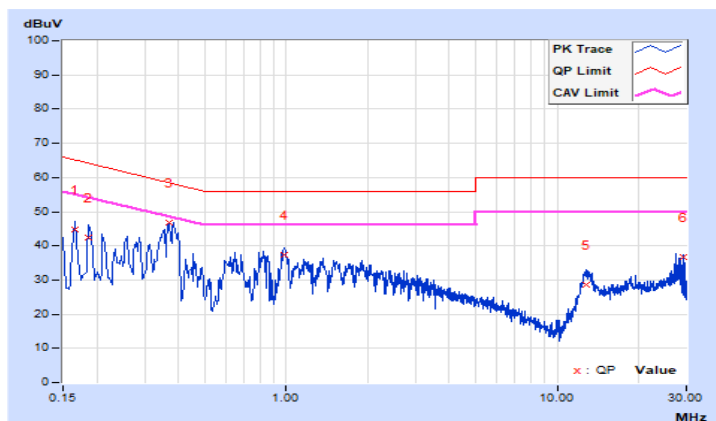

RF Mode	802.11ax (HE80)	Channel	CH 106 : 5530 MHz
Frequency Range	150kHz ~ 30MHz	Detector Function & Resolution Bandwidth	Quasi-Peak (QP) / Average (AV), 9 kHz
Input Power	120 Vac, 60 Hz	Environmental Conditions	23°C, 67% RH
Tested By	Adair Peng		

Phase Of Power : Neutral (N)										
No	Frequency (MHz)	Correction Factor (dB)	Reading Value (dBuV)		Emission Level (dBuV)		Limit (dBuV)		Margin (dB)	
			Q.P.	AV.	Q.P.	AV.	Q.P.	AV.	Q.P.	AV.
1	0.15800	9.62	40.22	22.98	49.84	32.60	65.57	55.57	-15.73	-22.97
2	0.17400	9.63	36.04	22.03	45.67	31.66	64.77	54.77	-19.10	-23.11
3	0.37000	9.67	37.38	34.11	47.05	43.78	58.50	48.50	-11.45	-4.72
4	1.00200	9.70	27.48	19.78	37.18	29.48	56.00	46.00	-18.82	-16.52
5	12.74200	9.83	17.93	12.60	27.76	22.43	60.00	50.00	-32.24	-27.57
6	29.21000	9.86	27.30	26.16	37.16	36.02	60.00	50.00	-22.84	-13.98

Remarks:

1. Q.P. and AV. are abbreviations of quasi-peak and average individually.
2. The emission levels of other frequencies were very low against the limit.
3. Margin value = Emission level – Limit value
4. Correction factor = Insertion loss + Cable loss
5. Emission Level = Correction Factor + Reading Value

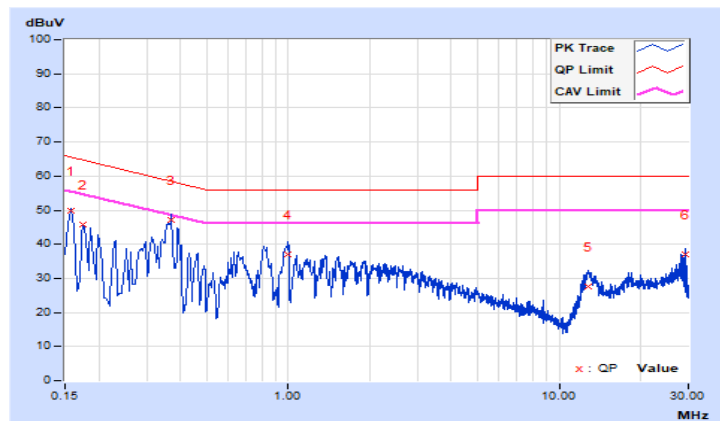

Mode B

RF Mode	802.11ac (VHT40)	Channel	CH 142 : 5710 MHz
Frequency Range	150kHz ~ 30MHz	Detector Function & Resolution Bandwidth	Quasi-Peak (QP) / Average (AV), 9 kHz
Input Power	120 Vac, 60 Hz	Environmental Conditions	23°C, 67% RH
Tested By	Adair Peng		

Phase Of Power : Line (L)

No	Frequency (MHz)	Correction Factor (dB)	Reading Value (dBuV)		Emission Level (dBuV)		Limit (dBuV)		Margin (dB)	
			Q.P.	AV.	Q.P.	AV.	Q.P.	AV.	Q.P.	AV.
1	0.15400	9.62	39.83	19.34	49.45	28.96	65.78	55.78	-16.33	-26.82
2	0.17400	9.63	36.52	22.82	46.15	32.45	64.77	54.77	-18.62	-22.32
3	0.36641	9.66	36.92	32.63	46.58	42.29	58.58	48.58	-12.00	-6.29
4	0.96600	9.69	28.34	22.55	38.03	32.24	56.00	46.00	-17.97	-13.76
5	12.80600	9.79	18.77	13.52	28.56	23.31	60.00	50.00	-31.44	-26.69
6	29.41400	9.72	26.25	24.82	35.97	34.54	60.00	50.00	-24.03	-15.46

Remarks:

1. Q.P. and AV. are abbreviations of quasi-peak and average individually.
2. The emission levels of other frequencies were very low against the limit.
3. Margin value = Emission level – Limit value
4. Correction factor = Insertion loss + Cable loss
5. Emission Level = Correction Factor + Reading Value

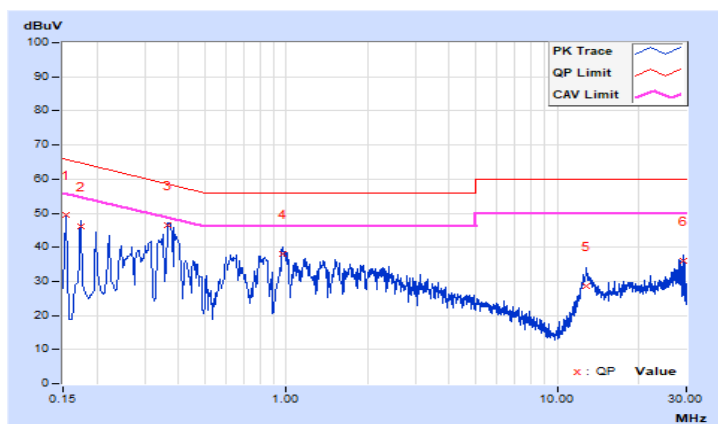

RF Mode	802.11ac (VHT40)	Channel	CH 142 : 5710 MHz
Frequency Range	150kHz ~ 30MHz	Detector Function & Resolution Bandwidth	Quasi-Peak (QP) / Average (AV), 9 kHz
Input Power	120 Vac, 60 Hz	Environmental Conditions	23°C, 67% RH
Tested By	Adair Peng		

Phase Of Power : Neutral (N)										
No	Frequency (MHz)	Correction Factor (dB)	Reading Value (dBuV)		Emission Level (dBuV)		Limit (dBuV)		Margin (dB)	
			Q.P.	AV.	Q.P.	AV.	Q.P.	AV.	Q.P.	AV.
1	0.18200	9.63	34.58	16.17	44.21	25.80	64.39	54.39	-20.18	-28.59
2	0.20577	9.64	30.42	14.46	40.06	24.10	63.37	53.37	-23.31	-29.27
3	0.37422	9.67	36.62	30.55	46.29	40.22	58.41	48.41	-12.12	-8.19
4	0.97380	9.70	27.94	20.87	37.64	30.57	56.00	46.00	-18.36	-15.43
5	12.89800	9.84	18.19	13.01	28.03	22.85	60.00	50.00	-31.97	-27.15
6	28.19800	9.87	25.76	23.68	35.63	33.55	60.00	50.00	-24.37	-16.45

Remarks:

1. Q.P. and AV. are abbreviations of quasi-peak and average individually.
2. The emission levels of other frequencies were very low against the limit.
3. Margin value = Emission level – Limit value
4. Correction factor = Insertion loss + Cable loss
5. Emission Level = Correction Factor + Reading Value

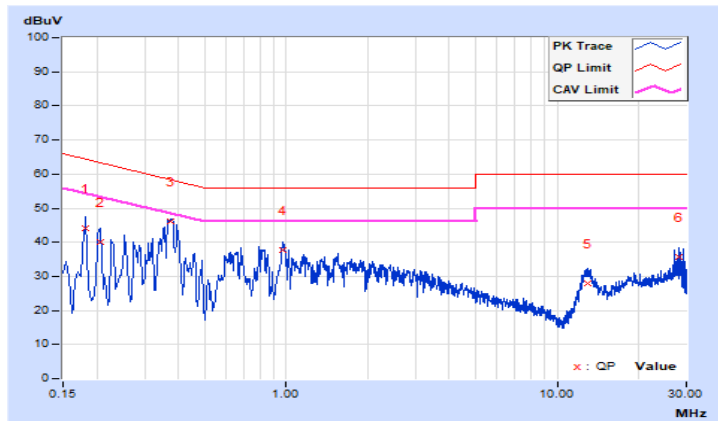

7.8 Unwanted Emissions below 1 GHz

Mode A

RF Mode	802.11ax (HE80)	Channel	CH 106 : 5530 MHz
Frequency Range	9 kHz ~ 1 GHz	Detector Function & Bandwidth	(QP) RB = 120kHz
Input Power	120 Vac, 60 Hz	Environmental Conditions	23°C, 67% RH
Tested By	Adair Peng		

Antenna Polarity & Test Distance : Horizontal at 3 m

No	Frequency (MHz)	Emission Level (dBuV/m)	Limit (dBuV/m)	Margin (dB)	Antenna Height (m)	Table Angle (Degree)	Raw Value (dBuV)	Correction Factor (dB/m)
1	67.83	28.5 QP	40.0	-11.5	1.50 H	57	39.3	-10.8
2	79.47	31.0 QP	40.0	-9.0	1.00 H	261	44.5	-13.5
3	111.55	28.7 QP	43.5	-14.8	1.00 H	111	40.8	-12.1
4	135.88	33.2 QP	43.5	-10.3	1.50 H	22	43.0	-9.8
5	167.74	37.3 QP	43.5	-6.2	1.00 H	143	46.5	-9.2
6	576.11	28.9 QP	46.0	-17.1	1.00 H	300	31.5	-2.6

Remarks:

- Emission Level(dBuV/m) = Raw Value(dBuV) + Correction Factor(dB/m)
- Correction Factor(dB/m) = Antenna Factor(dB/m) + Cable Factor(dB) – Pre-Amplifier Factor(dB)
- Margin value = Emission Level – Limit value
- The other emission levels were very low against the limit of frequency range 30 MHz ~ 1 GHz.
- The emission levels were very low against the limit of frequency range 9 kHz ~ 30 MHz: the amplitude of spurious emissions attenuated more than 20 dB below the permissible value to be report.

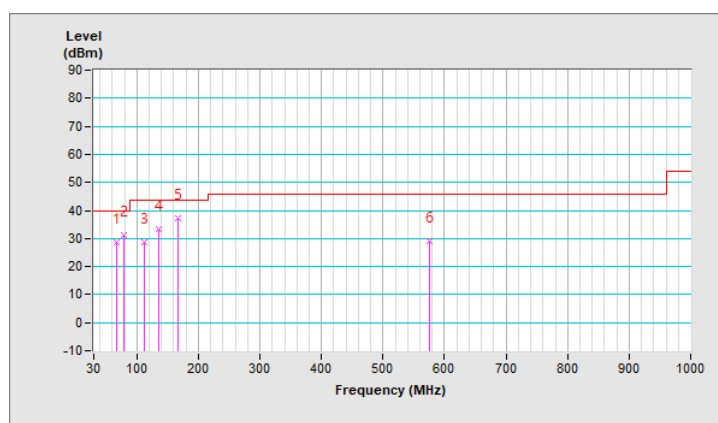

RF Mode	802.11ax (HE80)	Channel	CH 106 : 5530 MHz
Frequency Range	9 kHz ~ 1 GHz	Detector Function & Bandwidth	(QP) RB = 120kHz
Input Power	120 Vac, 60 Hz	Environmental Conditions	23°C, 67% RH
Tested By	Adair Peng		

Antenna Polarity & Test Distance : Vertical at 3 m								
No	Frequency (MHz)	Emission Level (dBuV/m)	Limit (dBuV/m)	Margin (dB)	Antenna Height (m)	Table Angle (Degree)	Raw Value (dBuV)	Correction Factor (dB/m)
1	71.71	30.0 QP	40.0	-10.0	1.50 V	207	41.7	-11.7
2	79.47	30.4 QP	40.0	-9.6	1.00 V	42	43.9	-13.5
3	111.48	29.1 QP	43.5	-14.4	2.00 V	183	41.2	-12.1
4	135.73	36.3 QP	43.5	-7.2	1.00 V	138	46.1	-9.8
5	438.37	27.5 QP	46.0	-18.5	1.50 V	133	32.6	-5.1
6	717.73	31.1 QP	46.0	-14.9	1.00 V	286	30.8	0.3

Remarks:

1. Emission Level(dBuV/m) = Raw Value(dBuV) + Correction Factor(dB/m)
2. Correction Factor(dB/m) = Antenna Factor(dB/m) + Cable Factor(dB) – Pre-Amplifier Factor(dB)
3. Margin value = Emission Level – Limit value
4. The other emission levels were very low against the limit of frequency range 30 MHz ~ 1 GHz.
5. The emission levels were very low against the limit of frequency range 9 kHz ~ 30 MHz: the amplitude of spurious emissions attenuated more than 20 dB below the permissible value to be report.

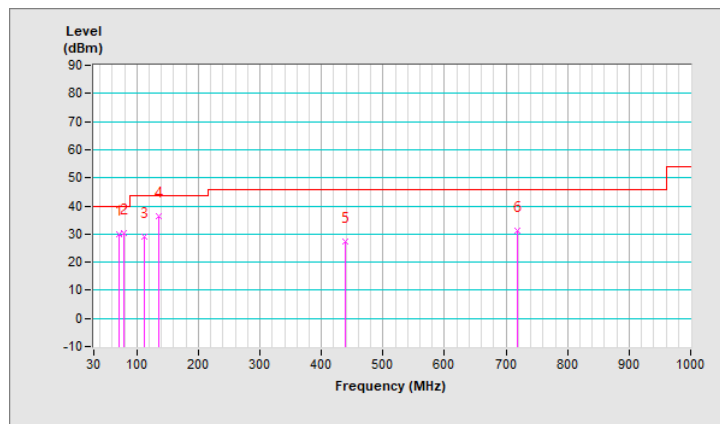

Mode B

RF Mode	802.11ac (VHT40)	Channel	CH 142 : 5710 MHz
Frequency Range	9 kHz ~ 1 GHz	Detector Function & Bandwidth	(QP) RB = 120kHz
Input Power	120 Vac, 60 Hz	Environmental Conditions	23°C, 67% RH
Tested By	Adair Peng		

Antenna Polarity & Test Distance : Horizontal at 3 m

No	Frequency (MHz)	Emission Level (dBuV/m)	Limit (dBuV/m)	Margin (dB)	Antenna Height (m)	Table Angle (Degree)	Raw Value (dBuV)	Correction Factor (dB/m)
1	71.71	29.6 QP	40.0	-10.4	1.00 H	227	41.3	-11.7
2	95.96	29.6 QP	43.5	-13.9	1.50 H	15	44.0	-14.4
3	111.48	28.7 QP	43.5	-14.8	1.00 H	80	40.8	-12.1
4	135.73	33.5 QP	43.5	-10.0	1.50 H	77	43.3	-9.8
5	168.11	38.2 QP	43.5	-5.3	1.50 H	151	47.4	-9.2
6	567.38	29.1 QP	46.0	-16.9	1.00 H	85	31.9	-2.8

Remarks:

1. Emission Level(dBuV/m) = Raw Value(dBuV) + Correction Factor(dB/m)
2. Correction Factor(dB/m) = Antenna Factor(dB/m) + Cable Factor(dB) – Pre-Amplifier Factor(dB)
3. Margin value = Emission Level – Limit value
4. The other emission levels were very low against the limit of frequency range 30 MHz ~ 1 GHz.
5. The emission levels were very low against the limit of frequency range 9 kHz ~ 30 MHz: the amplitude of spurious emissions attenuated more than 20 dB below the permissible value to be report.

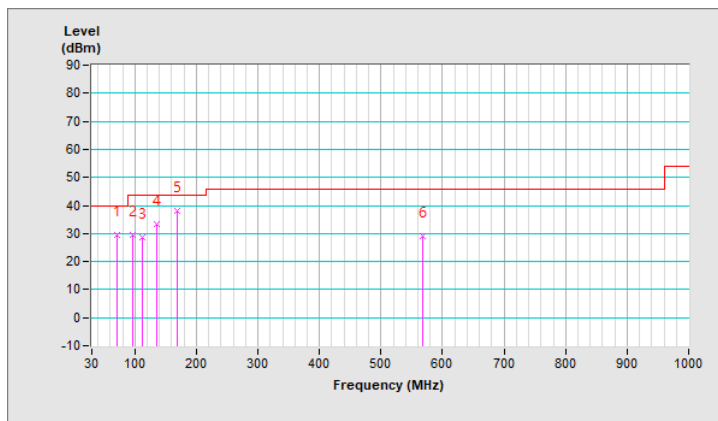

RF Mode	802.11ac (VHT40)	Channel	CH 142 : 5710 MHz
Frequency Range	9 kHz ~ 1 GHz	Detector Function & Bandwidth	(QP) RB = 120kHz
Input Power	120 Vac, 60 Hz	Environmental Conditions	23°C, 67% RH
Tested By	Adair Peng		

Antenna Polarity & Test Distance : Vertical at 3 m								
No	Frequency (MHz)	Emission Level (dBuV/m)	Limit (dBuV/m)	Margin (dB)	Antenna Height (m)	Table Angle (Degree)	Raw Value (dBuV)	Correction Factor (dB/m)
1	68.80	30.2 QP	40.0	-9.8	1.50 V	156	41.3	-11.1
2	100.81	29.2 QP	43.5	-14.3	1.00 V	57	42.7	-13.5
3	135.73	36.3 QP	43.5	-7.2	1.50 V	4	46.1	-9.8
4	472.32	28.0 QP	46.0	-18.0	1.00 V	15	32.4	-4.4
5	555.74	29.1 QP	46.0	-16.9	2.00 V	352	32.2	-3.1
6	689.60	30.3 QP	46.0	-15.7	1.00 V	175	30.6	-0.3

Remarks:

1. Emission Level(dBuV/m) = Raw Value(dBuV) + Correction Factor(dB/m)
2. Correction Factor(dB/m) = Antenna Factor(dB/m) + Cable Factor(dB) – Pre-Amplifier Factor(dB)
3. Margin value = Emission Level – Limit value
4. The other emission levels were very low against the limit of frequency range 30 MHz ~ 1 GHz.
5. The emission levels were very low against the limit of frequency range 9 kHz ~ 30 MHz: the amplitude of spurious emissions attenuated more than 20 dB below the permissible value to be report.

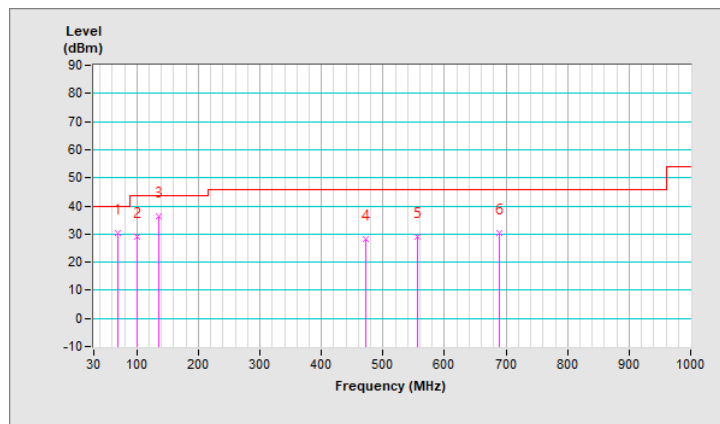

7.9 Unwanted Emissions above 1 GHz

Mode A

RF Mode	802.11a	Channel	CH 52 : 5260 MHz
Frequency Range	1 GHz ~ 40 GHz	Detector Function & Bandwidth	(PK) RB = 1 MHz, VB = 3 MHz (AV) RB = 1 MHz, VB = 1 kHz
Input Power	120 Vac, 60 Hz	Environmental Conditions	23°C, 67% RH
Tested By	Adair Peng/Rex Wang		

Antenna Polarity & Test Distance : Horizontal at 3 m

No	Frequency (MHz)	Emission Level (dBuV/m)	Limit (dBuV/m)	Margin (dB)	Antenna Height (m)	Table Angle (Degree)	Raw Value (dBuV)	Correction Factor (dB/m)
1	5150.00	61.3 PK	74.0	-12.7	3.65 H	351	40.3	21.0
2	5150.00	48.0 AV	54.0	-6.0	3.65 H	351	27.0	21.0
3	*5260.00	113.4 PK			3.65 H	351	72.6	40.8
4	*5260.00	104.1 AV			3.65 H	351	63.3	40.8
5	#10520.00	61.8 PK	68.2	-6.4	3.45 H	344	36.8	25.0

Antenna Polarity & Test Distance : Vertical at 3 m

No	Frequency (MHz)	Emission Level (dBuV/m)	Limit (dBuV/m)	Margin (dB)	Antenna Height (m)	Table Angle (Degree)	Raw Value (dBuV)	Correction Factor (dB/m)
1	5150.00	61.8 PK	74.0	-12.2	1.77 V	356	40.8	21.0
2	5150.00	48.5 AV	54.0	-5.5	1.77 V	356	27.5	21.0
3	*5260.00	119.9 PK			1.77 V	356	79.1	40.8
4	*5260.00	110.7 AV			1.77 V	356	69.9	40.8
5	#10520.00	62.3 PK	68.2	-5.9	2.32 V	341	37.3	25.0

Remarks:

1. Emission Level(dBuV/m) = Raw Value(dBuV) + Correction Factor(dB/m)
2. Correction Factor(dB/m) = Antenna Factor(dB/m) + Cable Factor(dB) – Pre-Amplifier Factor(dB)
3. Margin value = Emission Level – Limit value
4. The other emission levels were very low against the limit.
5. " * ": Fundamental frequency, the limit was restricted at the RF Output Power.
6. " # ": The radiated frequency is out of the restricted band.



RF Mode	802.11a	Channel	CH 60 : 5300 MHz
Frequency Range	1 GHz ~ 40 GHz	Detector Function & Bandwidth	(PK) RB = 1 MHz, VB = 3 MHz (AV) RB = 1 MHz, VB = 1 kHz
Input Power	120 Vac, 60 Hz	Environmental Conditions	23°C, 67% RH
Tested By	Adair Peng/Rex Wang		

Antenna Polarity & Test Distance : Horizontal at 3 m								
No	Frequency (MHz)	Emission Level (dBuV/m)	Limit (dBuV/m)	Margin (dB)	Antenna Height (m)	Table Angle (Degree)	Raw Value (dBuV)	Correction Factor (dB/m)
1	*5300.00	114.8 PK			2.96 H	12	74.0	40.8
2	*5300.00	105.8 AV			2.96 H	12	65.0	40.8
3	10600.00	62.4 PK	74.0	-11.6	2.79 H	299	37.4	25.0
4	10600.00	49.3 AV	54.0	-4.7	2.79 H	299	24.3	25.0

Antenna Polarity & Test Distance : Vertical at 3 m								
No	Frequency (MHz)	Emission Level (dBuV/m)	Limit (dBuV/m)	Margin (dB)	Antenna Height (m)	Table Angle (Degree)	Raw Value (dBuV)	Correction Factor (dB/m)
1	*5300.00	119.6 PK			2.18 V	3	78.8	40.8
2	*5300.00	110.7 AV			2.18 V	3	69.9	40.8
3	10600.00	62.6 PK	74.0	-11.4	2.18 V	360	37.6	25.0
4	10600.00	49.5 AV	54.0	-4.5	2.18 V	360	24.5	25.0

Remarks:

1. Emission Level(dBuV/m) = Raw Value(dBuV) + Correction Factor(dB/m)
2. Correction Factor(dB/m) = Antenna Factor(dB/m) + Cable Factor(dB) – Pre-Amplifier Factor(dB)
3. Margin value = Emission Level – Limit value
4. The other emission levels were very low against the limit.
5. " * " : Fundamental frequency, the limit was restricted at the RF Output Power.



RF Mode	802.11a	Channel	CH 64 : 5320 MHz
Frequency Range	1 GHz ~ 40 GHz	Detector Function & Bandwidth	(PK) RB = 1 MHz, VB = 3 MHz (AV) RB = 1 MHz, VB = 1 kHz
Input Power	120 Vac, 60 Hz	Environmental Conditions	23°C, 67% RH
Tested By	Adair Peng/Rex Wang		

Antenna Polarity & Test Distance : Horizontal at 3 m

No	Frequency (MHz)	Emission Level (dBuV/m)	Limit (dBuV/m)	Margin (dB)	Antenna Height (m)	Table Angle (Degree)	Raw Value (dBuV)	Correction Factor (dB/m)
1	*5320.00	115.6 PK			2.91 H	10	74.7	40.9
2	*5320.00	106.0 AV			2.91 H	10	65.1	40.9
3	5350.00	61.6 PK	74.0	-12.4	2.91 H	10	40.6	21.0
4	5350.00	48.7 AV	54.0	-5.3	2.91 H	10	27.7	21.0
5	10640.00	62.7 PK	74.0	-11.3	2.88 H	325	37.0	25.7
6	10640.00	49.7 AV	54.0	-4.3	2.88 H	325	24.0	25.7

Antenna Polarity & Test Distance : Vertical at 3 m

No	Frequency (MHz)	Emission Level (dBuV/m)	Limit (dBuV/m)	Margin (dB)	Antenna Height (m)	Table Angle (Degree)	Raw Value (dBuV)	Correction Factor (dB/m)
1	*5320.00	121.3 PK			2.49 V	1	80.4	40.9
2	*5320.00	111.6 AV			2.49 V	1	70.7	40.9
3	5350.00	62.8 PK	74.0	-11.2	2.49 V	1	41.8	21.0
4	5350.00	49.8 AV	54.0	-4.2	2.49 V	1	28.8	21.0
5	10640.00	63.1 PK	74.0	-10.9	2.36 V	344	37.4	25.7
6	10640.00	50.0 AV	54.0	-4.0	2.36 V	344	24.3	25.7

Remarks:

1. Emission Level(dBuV/m) = Raw Value(dBuV) + Correction Factor(dB/m)
2. Correction Factor(dB/m) = Antenna Factor(dB/m) + Cable Factor(dB) – Pre-Amplifier Factor(dB)
3. Margin value = Emission Level – Limit value
4. The other emission levels were very low against the limit.
5. " * ": Fundamental frequency, the limit was restricted at the RF Output Power.



RF Mode	802.11a	Channel	CH 100 : 5500 MHz
Frequency Range	1 GHz ~ 40 GHz	Detector Function & Bandwidth	(PK) RB = 1 MHz, VB = 3 MHz (AV) RB = 1 MHz, VB = 1 kHz
Input Power	120 Vac, 60 Hz	Environmental Conditions	23°C, 67% RH
Tested By	Adair Peng/Rex Wang		

Antenna Polarity & Test Distance : Horizontal at 3 m

No	Frequency (MHz)	Emission Level (dBuV/m)	Limit (dBuV/m)	Margin (dB)	Antenna Height (m)	Table Angle (Degree)	Raw Value (dBuV)	Correction Factor (dB/m)
1	5404.50	61.9 PK	74.0	-12.1	2.66 H	358	40.5	21.4
2	5404.50	49.6 AV	54.0	-4.4	2.66 H	358	28.2	21.4
3	5460.00	62.0 PK	74.0	-12.0	2.66 H	358	40.6	21.4
4	5460.00	48.9 AV	54.0	-5.1	2.66 H	358	27.5	21.4
5	#5470.00	62.6 PK	68.2	-5.6	2.66 H	358	41.2	21.4
6	*5500.00	117.0 PK			2.66 H	358	75.5	41.5
7	*5500.00	107.2 AV			2.66 H	358	65.7	41.5
8	11000.00	63.2 PK	74.0	-10.8	2.85 H	339	36.5	26.7
9	11000.00	50.2 AV	54.0	-3.8	2.85 H	339	23.5	26.7

Antenna Polarity & Test Distance : Vertical at 3 m

No	Frequency (MHz)	Emission Level (dBuV/m)	Limit (dBuV/m)	Margin (dB)	Antenna Height (m)	Table Angle (Degree)	Raw Value (dBuV)	Correction Factor (dB/m)
1	5404.50	62.9 PK	74.0	-11.1	2.59 V	3	41.5	21.4
2	5404.50	50.6 AV	54.0	-3.4	2.59 V	3	29.2	21.4
3	5460.00	62.2 PK	74.0	-11.8	2.59 V	3	40.8	21.4
4	5460.00	49.1 AV	54.0	-4.9	2.59 V	3	27.7	21.4
5	#5470.00	62.9 PK	68.2	-5.3	2.59 V	3	41.5	21.4
6	*5500.00	121.0 PK			2.59 V	3	79.5	41.5
7	*5500.00	111.9 AV			2.59 V	3	70.4	41.5
8	11000.00	63.5 PK	74.0	-10.5	2.38 V	285	36.8	26.7
9	11000.00	50.4 AV	54.0	-3.6	2.38 V	285	23.7	26.7

Remarks:

1. Emission Level(dBuV/m) = Raw Value(dBuV) + Correction Factor(dB/m)
2. Correction Factor(dB/m) = Antenna Factor(dB/m) + Cable Factor(dB) – Pre-Amplifier Factor(dB)
3. Margin value = Emission Level – Limit value
4. The other emission levels were very low against the limit.
5. " * ": Fundamental frequency, the limit was restricted at the RF Output Power.
6. " # ": The radiated frequency is out of the restricted band.



RF Mode	802.11a	Channel	CH 116 : 5580 MHz
Frequency Range	1 GHz ~ 40 GHz	Detector Function & Bandwidth	(PK) RB = 1 MHz, VB = 3 MHz (AV) RB = 1 MHz, VB = 1 kHz
Input Power	120 Vac, 60 Hz	Environmental Conditions	23°C, 67% RH
Tested By	Adair Peng/Rex Wang		

Antenna Polarity & Test Distance : Horizontal at 3 m								
No	Frequency (MHz)	Emission Level (dBuV/m)	Limit (dBuV/m)	Margin (dB)	Antenna Height (m)	Table Angle (Degree)	Raw Value (dBuV)	Correction Factor (dB/m)
1	*5580.00	116.6 PK			2.71 H	348	75.0	41.6
2	*5580.00	108.1 AV			2.71 H	348	66.5	41.6
3	11160.00	62.5 PK	74.0	-11.5	2.91 H	329	36.7	25.8
4	11160.00	49.5 AV	54.0	-4.5	2.91 H	329	23.7	25.8
Antenna Polarity & Test Distance : Vertical at 3 m								
No	Frequency (MHz)	Emission Level (dBuV/m)	Limit (dBuV/m)	Margin (dB)	Antenna Height (m)	Table Angle (Degree)	Raw Value (dBuV)	Correction Factor (dB/m)
1	*5580.00	122.0 PK			2.69 V	354	80.4	41.6
2	*5580.00	112.9 AV			2.69 V	354	71.3	41.6
3	11160.00	62.8 PK	74.0	-11.2	2.43 V	291	37.0	25.8
4	11160.00	49.7 AV	54.0	-4.3	2.43 V	291	23.9	25.8

Remarks:

1. Emission Level(dBuV/m) = Raw Value(dBuV) + Correction Factor(dB/m)
2. Correction Factor(dB/m) = Antenna Factor(dB/m) + Cable Factor(dB) – Pre-Amplifier Factor(dB)
3. Margin value = Emission Level – Limit value
4. The other emission levels were very low against the limit.
5. " * " : Fundamental frequency, the limit was restricted at the RF Output Power.

RF Mode	802.11a	Channel	CH 140 : 5700 MHz
Frequency Range	1 GHz ~ 40 GHz	Detector Function & Bandwidth	(PK) RB = 1 MHz, VB = 3 MHz (AV) RB = 1 MHz, VB = 1 kHz
Input Power	120 Vac, 60 Hz	Environmental Conditions	23°C, 67% RH
Tested By	Adair Peng/Rex Wang		

Antenna Polarity & Test Distance : Horizontal at 3 m

No	Frequency (MHz)	Emission Level (dBuV/m)	Limit (dBuV/m)	Margin (dB)	Antenna Height (m)	Table Angle (Degree)	Raw Value (dBuV)	Correction Factor (dB/m)
1	*5700.00	117.7 PK			2.72 H	350	76.0	41.7
2	*5700.00	108.2 AV			2.72 H	350	66.5	41.7
3	#5725.00	61.5 PK	68.2	-6.7	2.72 H	350	39.3	22.2
4	11400.00	63.8 PK	74.0	-10.2	2.81 H	340	36.8	27.0
5	11400.00	50.5 AV	54.0	-3.5	2.81 H	340	23.5	27.0

Antenna Polarity & Test Distance : Vertical at 3 m

No	Frequency (MHz)	Emission Level (dBuV/m)	Limit (dBuV/m)	Margin (dB)	Antenna Height (m)	Table Angle (Degree)	Raw Value (dBuV)	Correction Factor (dB/m)
1	*5700.00	122.3 PK			2.39 V	343	80.6	41.7
2	*5700.00	112.9 AV			2.39 V	343	71.2	41.7
3	#5725.00	63.6 PK	68.2	-4.6	2.39 V	343	41.4	22.2
4	11400.00	63.9 PK	74.0	-10.1	2.46 V	288	36.9	27.0
5	11400.00	50.6 AV	54.0	-3.4	2.46 V	288	23.6	27.0

Remarks:

1. Emission Level(dBuV/m) = Raw Value(dBuV) + Correction Factor(dB/m)
2. Correction Factor(dB/m) = Antenna Factor(dB/m) + Cable Factor(dB) – Pre-Amplifier Factor(dB)
3. Margin value = Emission Level – Limit value
4. The other emission levels were very low against the limit.
5. " * " : Fundamental frequency, the limit was restricted at the RF Output Power.
6. " # " : The radiated frequency is out of the restricted band.



RF Mode	802.11a	Channel	CH 144 : 5720 MHz
Frequency Range	1 GHz ~ 40 GHz	Detector Function & Bandwidth	(PK) RB = 1 MHz, VB = 3 MHz (AV) RB = 1 MHz, VB = 1 kHz
Input Power	120 Vac, 60 Hz	Environmental Conditions	23°C, 67% RH
Tested By	Adair Peng/Rex Wang		

Antenna Polarity & Test Distance : Horizontal at 3 m

No	Frequency (MHz)	Emission Level (dBuV/m)	Limit (dBuV/m)	Margin (dB)	Antenna Height (m)	Table Angle (Degree)	Raw Value (dBuV)	Correction Factor (dB/m)
1	#5470.00	61.7 PK	68.2	-6.5	2.65 H	344	40.3	21.4
2	*5720.00	117.7 PK			2.65 H	344	75.8	41.9
3	*5720.00	108.1 AV			2.65 H	344	66.2	41.9
4	#5850.00	62.4 PK	68.2	-5.8	2.65 H	344	39.9	22.5
5	11440.00	63.7 PK	74.0	-10.3	2.81 H	330	36.6	27.1
6	11440.00	50.5 AV	54.0	-3.5	2.81 H	330	23.4	27.1

Antenna Polarity & Test Distance : Vertical at 3 m

No	Frequency (MHz)	Emission Level (dBuV/m)	Limit (dBuV/m)	Margin (dB)	Antenna Height (m)	Table Angle (Degree)	Raw Value (dBuV)	Correction Factor (dB/m)
1	#5470.00	61.9 PK	68.2	-6.3	2.40 V	350	40.5	21.4
2	*5720.00	123.3 PK			2.40 V	350	81.4	41.9
3	*5720.00	112.9 AV			2.40 V	350	71.0	41.9
4	#5850.00	62.5 PK	68.2	-5.7	2.40 V	350	40.0	22.5
5	11440.00	63.9 PK	74.0	-10.1	2.51 V	293	36.8	27.1
6	11440.00	50.7 AV	54.0	-3.3	2.51 V	293	23.6	27.1

Remarks:

1. Emission Level(dBuV/m) = Raw Value(dBuV) + Correction Factor(dB/m)
2. Correction Factor(dB/m) = Antenna Factor(dB/m) + Cable Factor(dB) – Pre-Amplifier Factor(dB)
3. Margin value = Emission Level – Limit value
4. The other emission levels were very low against the limit.
5. " * ": Fundamental frequency, the limit was restricted at the RF Output Power.
6. " # ": The radiated frequency is out of the restricted band.



RF Mode	802.11ax (HE20)	Channel	CH 52 : 5260 MHz
Frequency Range	1 GHz ~ 40 GHz	Detector Function & Bandwidth	(PK) RB = 1 MHz, VB = 3 MHz (AV) RB = 1 MHz, VB = 1 kHz
Input Power	120 Vac, 60 Hz	Environmental Conditions	23°C, 67% RH
Tested By	Adair Peng/Rex Wang		

Antenna Polarity & Test Distance : Horizontal at 3 m								
No	Frequency (MHz)	Emission Level (dBuV/m)	Limit (dBuV/m)	Margin (dB)	Antenna Height (m)	Table Angle (Degree)	Raw Value (dBuV)	Correction Factor (dB/m)
1	5150.00	61.3 PK	74.0	-12.7	2.91 H	16	40.3	21.0
2	5150.00	48.5 AV	54.0	-5.5	2.91 H	16	27.5	21.0
3	*5260.00	117.4 PK			2.91 H	16	76.6	40.8
4	*5260.00	104.5 AV			2.91 H	16	63.7	40.8
5	#10520.00	62.0 PK	68.2	-6.2	2.77 H	327	37.0	25.0

Antenna Polarity & Test Distance : Vertical at 3 m								
No	Frequency (MHz)	Emission Level (dBuV/m)	Limit (dBuV/m)	Margin (dB)	Antenna Height (m)	Table Angle (Degree)	Raw Value (dBuV)	Correction Factor (dB/m)
1	5150.00	61.6 PK	74.0	-12.4	1.85 V	353	40.6	21.0
2	5150.00	48.7 AV	54.0	-5.3	1.85 V	353	27.7	21.0
3	*5260.00	122.2 PK			1.85 V	353	81.4	40.8
4	*5260.00	109.8 AV			1.85 V	353	69.0	40.8
5	#10520.00	62.4 PK	68.2	-5.8	2.24 V	338	37.4	25.0

Remarks:

1. Emission Level(dBuV/m) = Raw Value(dBuV) + Correction Factor(dB/m)
2. Correction Factor(dB/m) = Antenna Factor(dB/m) + Cable Factor(dB) – Pre-Amplifier Factor(dB)
3. Margin value = Emission Level – Limit value
4. The other emission levels were very low against the limit.
5. " * " : Fundamental frequency, the limit was restricted at the RF Output Power.
6. " # " : The radiated frequency is out of the restricted band.



RF Mode	802.11ax (HE20)	Channel	CH 60 : 5300 MHz
Frequency Range	1 GHz ~ 40 GHz	Detector Function & Bandwidth	(PK) RB = 1 MHz, VB = 3 MHz (AV) RB = 1 MHz, VB = 1 kHz
Input Power	120 Vac, 60 Hz	Environmental Conditions	23°C, 67% RH
Tested By	Adair Peng/Rex Wang		

Antenna Polarity & Test Distance : Horizontal at 3 m

No	Frequency (MHz)	Emission Level (dBuV/m)	Limit (dBuV/m)	Margin (dB)	Antenna Height (m)	Table Angle (Degree)	Raw Value (dBuV)	Correction Factor (dB/m)
1	*5300.00	117.6 PK			3.09 H	9	76.8	40.8
2	*5300.00	105.7 AV			3.09 H	9	64.9	40.8
3	10600.00	62.2 PK	74.0	-11.8	2.65 H	296	37.2	25.0
4	10600.00	49.3 AV	54.0	-4.7	2.65 H	296	24.3	25.0

Antenna Polarity & Test Distance : Vertical at 3 m

No	Frequency (MHz)	Emission Level (dBuV/m)	Limit (dBuV/m)	Margin (dB)	Antenna Height (m)	Table Angle (Degree)	Raw Value (dBuV)	Correction Factor (dB/m)
1	*5300.00	124.2 PK			2.75 V	350	83.4	40.8
2	*5300.00	111.5 AV			2.75 V	350	70.7	40.8
3	10600.00	62.5 PK	74.0	-11.5	2.38 V	345	37.5	25.0
4	10600.00	49.6 AV	54.0	-4.4	2.38 V	345	24.6	25.0

Remarks:

1. Emission Level(dBuV/m) = Raw Value(dBuV) + Correction Factor(dB/m)
2. Correction Factor(dB/m) = Antenna Factor(dB/m) + Cable Factor(dB) – Pre-Amplifier Factor(dB)
3. Margin value = Emission Level – Limit value
4. The other emission levels were very low against the limit.
5. " * " : Fundamental frequency, the limit was restricted at the RF Output Power.

RF Mode	802.11ax (HE20)	Channel	CH 64 : 5320 MHz
Frequency Range	1 GHz ~ 40 GHz	Detector Function & Bandwidth	(PK) RB = 1 MHz, VB = 3 MHz (AV) RB = 1 MHz, VB = 1 kHz
Input Power	120 Vac, 60 Hz	Environmental Conditions	23°C, 67% RH
Tested By	Adair Peng/Rex Wang		

Antenna Polarity & Test Distance : Horizontal at 3 m

No	Frequency (MHz)	Emission Level (dBuV/m)	Limit (dBuV/m)	Margin (dB)	Antenna Height (m)	Table Angle (Degree)	Raw Value (dBuV)	Correction Factor (dB/m)
1	*5320.00	119.7 PK			3.07 H	9	78.8	40.9
2	*5320.00	105.9 AV			3.07 H	9	65.0	40.9
3	5350.00	60.9 PK	74.0	-13.1	3.07 H	9	39.9	21.0
4	5350.00	48.5 AV	54.0	-5.5	3.07 H	9	27.5	21.0
5	10640.00	62.8 PK	74.0	-11.2	2.72 H	332	37.1	25.7
6	10640.00	49.8 AV	54.0	-4.2	2.72 H	332	24.1	25.7

Antenna Polarity & Test Distance : Vertical at 3 m

No	Frequency (MHz)	Emission Level (dBuV/m)	Limit (dBuV/m)	Margin (dB)	Antenna Height (m)	Table Angle (Degree)	Raw Value (dBuV)	Correction Factor (dB/m)
1	*5320.00	125.0 PK			2.18 V	355	84.1	40.9
2	*5320.00	111.5 AV			2.18 V	355	70.6	40.9
3	5350.00	64.3 PK	74.0	-9.7	2.18 V	355	43.3	21.0
4	5350.00	49.8 AV	54.0	-4.2	2.18 V	355	28.8	21.0
5	10640.00	63.1 PK	74.0	-10.9	2.24 V	305	37.4	25.7
6	10640.00	50.2 AV	54.0	-3.8	2.24 V	305	24.5	25.7

Remarks:

1. Emission Level(dBuV/m) = Raw Value(dBuV) + Correction Factor(dB/m)
2. Correction Factor(dB/m) = Antenna Factor(dB/m) + Cable Factor(dB) – Pre-Amplifier Factor(dB)
3. Margin value = Emission Level – Limit value
4. The other emission levels were very low against the limit.
5. " * ": Fundamental frequency, the limit was restricted at the RF Output Power.



RF Mode	802.11ax (HE20)	Channel	CH 100 : 5500 MHz
Frequency Range	1 GHz ~ 40 GHz	Detector Function & Bandwidth	(PK) RB = 1 MHz, VB = 3 MHz (AV) RB = 1 MHz, VB = 1 kHz
Input Power	120 Vac, 60 Hz	Environmental Conditions	23°C, 67% RH
Tested By	Adair Peng/Rex Wang		

Antenna Polarity & Test Distance : Horizontal at 3 m

No	Frequency (MHz)	Emission Level (dBuV/m)	Limit (dBuV/m)	Margin (dB)	Antenna Height (m)	Table Angle (Degree)	Raw Value (dBuV)	Correction Factor (dB/m)
1	5402.00	62.0 PK	74.0	-12.0	2.72 H	345	40.7	21.3
2	5402.00	49.0 AV	54.0	-5.0	2.72 H	345	27.7	21.3
3	5460.00	61.9 PK	74.0	-12.1	2.72 H	345	40.5	21.4
4	5460.00	48.5 AV	54.0	-5.5	2.72 H	345	27.1	21.4
5	#5470.00	62.8 PK	68.2	-5.4	2.72 H	345	41.4	21.4
6	*5500.00	118.6 PK			2.72 H	345	77.1	41.5
7	*5500.00	106.3 AV			2.72 H	345	64.8	41.5
8	11000.00	63.5 PK	74.0	-10.5	2.88 H	340	36.8	26.7
9	11000.00	50.3 AV	54.0	-3.7	2.88 H	340	23.6	26.7

Antenna Polarity & Test Distance : Vertical at 3 m

No	Frequency (MHz)	Emission Level (dBuV/m)	Limit (dBuV/m)	Margin (dB)	Antenna Height (m)	Table Angle (Degree)	Raw Value (dBuV)	Correction Factor (dB/m)
1	5402.00	62.3 PK	74.0	-11.7	2.37 V	354	41.0	21.3
2	5402.00	49.2 AV	54.0	-4.8	2.37 V	354	27.9	21.3
3	5460.00	62.1 PK	74.0	-11.9	2.37 V	354	40.7	21.4
4	5460.00	48.7 AV	54.0	-5.3	2.37 V	354	27.3	21.4
5	#5470.00	63.1 PK	68.2	-5.1	2.37 V	354	41.7	21.4
6	*5500.00	124.2 PK			2.37 V	354	82.7	41.5
7	*5500.00	111.3 AV			2.37 V	354	69.8	41.5
8	11000.00	63.6 PK	74.0	-10.4	2.63 V	284	36.9	26.7
9	11000.00	50.5 AV	54.0	-3.5	2.63 V	284	23.8	26.7

Remarks:

1. Emission Level(dBuV/m) = Raw Value(dBuV) + Correction Factor(dB/m)
2. Correction Factor(dB/m) = Antenna Factor(dB/m) + Cable Factor(dB) – Pre-Amplifier Factor(dB)
3. Margin value = Emission Level – Limit value
4. The other emission levels were very low against the limit.
5. " * ": Fundamental frequency, the limit was restricted at the RF Output Power.
6. " # ": The radiated frequency is out of the restricted band.



RF Mode	802.11ax (HE20)	Channel	CH 116 : 5580 MHz
Frequency Range	1 GHz ~ 40 GHz	Detector Function & Bandwidth	(PK) RB = 1 MHz, VB = 3 MHz (AV) RB = 1 MHz, VB = 1 kHz
Input Power	120 Vac, 60 Hz	Environmental Conditions	23°C, 67% RH
Tested By	Adair Peng/Rex Wang		

Antenna Polarity & Test Distance : Horizontal at 3 m

No	Frequency (MHz)	Emission Level (dBuV/m)	Limit (dBuV/m)	Margin (dB)	Antenna Height (m)	Table Angle (Degree)	Raw Value (dBuV)	Correction Factor (dB/m)
1	*5580.00	119.6 PK			2.61 H	352	78.0	41.6
2	*5580.00	107.1 AV			2.61 H	352	65.5	41.6
3	11160.00	62.6 PK	74.0	-11.4	2.91 H	322	36.8	25.8
4	11160.00	49.5 AV	54.0	-4.5	2.91 H	322	23.7	25.8

Antenna Polarity & Test Distance : Vertical at 3 m

No	Frequency (MHz)	Emission Level (dBuV/m)	Limit (dBuV/m)	Margin (dB)	Antenna Height (m)	Table Angle (Degree)	Raw Value (dBuV)	Correction Factor (dB/m)
1	*5580.00	125.6 PK			2.39 V	9	84.0	41.6
2	*5580.00	112.0 AV			2.39 V	9	70.4	41.6
3	11160.00	62.8 PK	74.0	-11.2	2.58 V	288	37.0	25.8
4	11160.00	49.8 AV	54.0	-4.2	2.58 V	288	24.0	25.8

Remarks:

1. Emission Level(dBuV/m) = Raw Value(dBuV) + Correction Factor(dB/m)
2. Correction Factor(dB/m) = Antenna Factor(dB/m) + Cable Factor(dB) – Pre-Amplifier Factor(dB)
3. Margin value = Emission Level – Limit value
4. The other emission levels were very low against the limit.
5. " * " : Fundamental frequency, the limit was restricted at the RF Output Power.

RF Mode	802.11ax (HE20)	Channel	CH 140 : 5700 MHz
Frequency Range	1 GHz ~ 40 GHz	Detector Function & Bandwidth	(PK) RB = 1 MHz, VB = 3 MHz (AV) RB = 1 MHz, VB = 1 kHz
Input Power	120 Vac, 60 Hz	Environmental Conditions	23°C, 67% RH
Tested By	Adair Peng/Rex Wang		

Antenna Polarity & Test Distance : Horizontal at 3 m

No	Frequency (MHz)	Emission Level (dBuV/m)	Limit (dBuV/m)	Margin (dB)	Antenna Height (m)	Table Angle (Degree)	Raw Value (dBuV)	Correction Factor (dB/m)
1	*5700.00	120.2 PK			2.69 H	350	78.5	41.7
2	*5700.00	106.6 AV			2.69 H	350	64.9	41.7
3	#5725.00	62.3 PK	68.2	-5.9	2.69 H	350	40.1	22.2
4	11400.00	63.6 PK	74.0	-10.4	2.79 H	330	36.6	27.0
5	11400.00	50.7 AV	54.0	-3.3	2.79 H	330	23.7	27.0

Antenna Polarity & Test Distance : Vertical at 3 m

No	Frequency (MHz)	Emission Level (dBuV/m)	Limit (dBuV/m)	Margin (dB)	Antenna Height (m)	Table Angle (Degree)	Raw Value (dBuV)	Correction Factor (dB/m)
1	*5700.00	124.6 PK			2.34 V	2	82.9	41.7
2	*5700.00	111.4 AV			2.34 V	2	69.7	41.7
3	#5725.00	62.6 PK	68.2	-5.6	2.34 V	2	40.4	22.2
4	11400.00	63.8 PK	74.0	-10.2	2.55 V	282	36.8	27.0
5	11400.00	50.9 AV	54.0	-3.1	2.55 V	282	23.9	27.0

Remarks:

1. Emission Level(dBuV/m) = Raw Value(dBuV) + Correction Factor(dB/m)
2. Correction Factor(dB/m) = Antenna Factor(dB/m) + Cable Factor(dB) – Pre-Amplifier Factor(dB)
3. Margin value = Emission Level – Limit value
4. The other emission levels were very low against the limit.
5. " * ": Fundamental frequency, the limit was restricted at the RF Output Power.
6. " # ": The radiated frequency is out of the restricted band.



RF Mode	802.11ax (HE20)	Channel	CH 144 : 5720 MHz
Frequency Range	1 GHz ~ 40 GHz	Detector Function & Bandwidth	(PK) RB = 1 MHz, VB = 3 MHz (AV) RB = 1 MHz, VB = 1 kHz
Input Power	120 Vac, 60 Hz	Environmental Conditions	23°C, 67% RH
Tested By	Adair Peng/Rex Wang		

Antenna Polarity & Test Distance : Horizontal at 3 m

No	Frequency (MHz)	Emission Level (dBuV/m)	Limit (dBuV/m)	Margin (dB)	Antenna Height (m)	Table Angle (Degree)	Raw Value (dBuV)	Correction Factor (dB/m)
1	#5470.00	61.7 PK	68.2	-6.5	2.71 H	347	40.3	21.4
2	*5720.00	119.6 PK			2.71 H	347	77.7	41.9
3	*5720.00	106.7 AV			2.71 H	347	64.8	41.9
4	#5850.00	61.7 PK	68.2	-6.5	2.71 H	347	39.2	22.5
5	11440.00	63.9 PK	74.0	-10.1	2.87 H	335	36.8	27.1
6	11440.00	50.6 AV	54.0	-3.4	2.87 H	335	23.5	27.1

Antenna Polarity & Test Distance : Vertical at 3 m

No	Frequency (MHz)	Emission Level (dBuV/m)	Limit (dBuV/m)	Margin (dB)	Antenna Height (m)	Table Angle (Degree)	Raw Value (dBuV)	Correction Factor (dB/m)
1	#5470.00	61.9 PK	68.2	-6.3	2.46 V	1	40.5	21.4
2	*5720.00	124.4 PK			2.46 V	1	82.5	41.9
3	*5720.00	111.5 AV			2.46 V	1	69.6	41.9
4	#5850.00	61.8 PK	68.2	-6.4	2.46 V	1	39.3	22.5
5	11440.00	64.0 PK	74.0	-10.0	2.62 V	288	36.9	27.1
6	11440.00	50.7 AV	54.0	-3.3	2.62 V	288	23.6	27.1

Remarks:

1. Emission Level(dBuV/m) = Raw Value(dBuV) + Correction Factor(dB/m)
2. Correction Factor(dB/m) = Antenna Factor(dB/m) + Cable Factor(dB) – Pre-Amplifier Factor(dB)
3. Margin value = Emission Level – Limit value
4. The other emission levels were very low against the limit.
5. " * " : Fundamental frequency, the limit was restricted at the RF Output Power.
6. " # " : The radiated frequency is out of the restricted band.

RF Mode	802.11ax (HE40)	Channel	CH 54 : 5270 MHz
Frequency Range	1 GHz ~ 40 GHz	Detector Function & Bandwidth	(PK) RB = 1 MHz, VB = 3 MHz (AV) RB = 1 MHz, VB = 1 kHz
Input Power	120 Vac, 60 Hz	Environmental Conditions	23°C, 67% RH
Tested By	Adair Peng/Rex Wang		

Antenna Polarity & Test Distance : Horizontal at 3 m

No	Frequency (MHz)	Emission Level (dBuV/m)	Limit (dBuV/m)	Margin (dB)	Antenna Height (m)	Table Angle (Degree)	Raw Value (dBuV)	Correction Factor (dB/m)
1	5150.00	63.6 PK	74.0	-10.4	2.98 H	11	42.6	21.0
2	5150.00	48.2 AV	54.0	-5.8	2.98 H	11	27.2	21.0
3	*5270.00	115.5 PK			2.98 H	11	74.7	40.8
4	*5270.00	102.5 AV			2.98 H	11	61.7	40.8
5	5390.00	64.4 PK	74.0	-9.6	2.98 H	11	43.1	21.3
6	5390.00	49.4 AV	54.0	-4.6	2.98 H	11	28.1	21.3
7	#10540.00	61.9 PK	68.2	-6.3	2.61 H	277	36.8	25.1

Antenna Polarity & Test Distance : Vertical at 3 m

No	Frequency (MHz)	Emission Level (dBuV/m)	Limit (dBuV/m)	Margin (dB)	Antenna Height (m)	Table Angle (Degree)	Raw Value (dBuV)	Correction Factor (dB/m)
1	5150.00	65.6 PK	74.0	-8.4	2.88 V	4	44.6	21.0
2	5150.00	48.7 AV	54.0	-5.3	2.88 V	4	27.7	21.0
3	*5270.00	122.2 PK			2.88 V	4	81.4	40.8
4	*5270.00	108.5 AV			2.88 V	4	67.7	40.8
5	5390.00	69.4 PK	74.0	-4.6	2.88 V	4	48.1	21.3
6	5390.00	49.7 AV	54.0	-4.3	2.88 V	4	28.4	21.3
7	#10540.00	62.4 PK	68.2	-5.8	2.36 V	328	37.3	25.1

Remarks:

1. Emission Level(dBuV/m) = Raw Value(dBuV) + Correction Factor(dB/m)
2. Correction Factor(dB/m) = Antenna Factor(dB/m) + Cable Factor(dB) – Pre-Amplifier Factor(dB)
3. Margin value = Emission Level – Limit value
4. The other emission levels were very low against the limit.
5. " * " : Fundamental frequency, the limit was restricted at the RF Output Power.
6. " # " : The radiated frequency is out of the restricted band.



RF Mode	802.11ax (HE40)	Channel	CH 62 : 5310 MHz
Frequency Range	1 GHz ~ 40 GHz	Detector Function & Bandwidth	(PK) RB = 1 MHz, VB = 3 MHz (AV) RB = 1 MHz, VB = 1 kHz
Input Power	120 Vac, 60 Hz	Environmental Conditions	23°C, 67% RH
Tested By	Adair Peng/Rex Wang		

Antenna Polarity & Test Distance : Horizontal at 3 m

No	Frequency (MHz)	Emission Level (dBuV/m)	Limit (dBuV/m)	Margin (dB)	Antenna Height (m)	Table Angle (Degree)	Raw Value (dBuV)	Correction Factor (dB/m)
1	*5310.00	115.5 PK			2.94 H	11	74.7	40.8
2	*5310.00	102.7 AV			2.94 H	11	61.9	40.8
3	5352.80	64.1 PK	74.0	-9.9	2.94 H	11	43.1	21.0
4	5352.80	51.2 AV	54.0	-2.8	2.94 H	11	30.2	21.0
5	10620.00	61.9 PK	74.0	-12.1	2.68 H	292	36.6	25.3
6	10620.00	49.4 AV	54.0	-4.6	2.68 H	292	24.1	25.3

Antenna Polarity & Test Distance : Vertical at 3 m

No	Frequency (MHz)	Emission Level (dBuV/m)	Limit (dBuV/m)	Margin (dB)	Antenna Height (m)	Table Angle (Degree)	Raw Value (dBuV)	Correction Factor (dB/m)
1	*5310.00	122.3 PK			2.99 V	2	81.5	40.8
2	*5310.00	108.9 AV			2.99 V	2	68.1	40.8
3	5352.80	67.0 PK	74.0	-7.0	2.99 V	2	46.0	21.0
4	5352.80	53.6 AV	54.0	-0.4	2.99 V	2	32.6	21.0
5	10620.00	62.2 PK	74.0	-11.8	2.41 V	348	36.9	25.3
6	10620.00	49.8 AV	54.0	-4.2	2.41 V	348	24.5	25.3

Remarks:

1. Emission Level(dBuV/m) = Raw Value(dBuV) + Correction Factor(dB/m)
2. Correction Factor(dB/m) = Antenna Factor(dB/m) + Cable Factor(dB) – Pre-Amplifier Factor(dB)
3. Margin value = Emission Level – Limit value
4. The other emission levels were very low against the limit.
5. " * ": Fundamental frequency, the limit was restricted at the RF Output Power.



RF Mode	802.11ax (HE40)	Channel	CH 102 : 5510 MHz
Frequency Range	1 GHz ~ 40 GHz	Detector Function & Bandwidth	(PK) RB = 1 MHz, VB = 3 MHz (AV) RB = 1 MHz, VB = 1 kHz
Input Power	120 Vac, 60 Hz	Environmental Conditions	23°C, 67% RH
Tested By	Adair Peng/Rex Wang		

Antenna Polarity & Test Distance : Horizontal at 3 m

No	Frequency (MHz)	Emission Level (dBuV/m)	Limit (dBuV/m)	Margin (dB)	Antenna Height (m)	Table Angle (Degree)	Raw Value (dBuV)	Correction Factor (dB/m)
1	5460.00	61.6 PK	74.0	-12.4	2.61 H	352	40.2	21.4
2	5460.00	49.3 AV	54.0	-4.7	2.61 H	352	27.9	21.4
3	#5470.00	62.7 PK	68.2	-5.5	2.61 H	352	41.3	21.4
4	*5510.00	117.7 PK			2.61 H	352	76.2	41.5
5	*5510.00	104.6 AV			2.61 H	352	63.1	41.5
6	11020.00	63.5 PK	74.0	-10.5	2.77 H	328	36.8	26.7
7	11020.00	50.0 AV	54.0	-4.0	2.77 H	328	23.3	26.7

Antenna Polarity & Test Distance : Vertical at 3 m

No	Frequency (MHz)	Emission Level (dBuV/m)	Limit (dBuV/m)	Margin (dB)	Antenna Height (m)	Table Angle (Degree)	Raw Value (dBuV)	Correction Factor (dB/m)
1	5460.00	61.8 PK	74.0	-12.2	2.35 V	10	40.4	21.4
2	5460.00	49.6 AV	54.0	-4.4	2.35 V	10	28.2	21.4
3	#5470.00	63.4 PK	68.2	-4.8	2.35 V	10	42.0	21.4
4	*5510.00	121.3 PK			2.35 V	10	79.8	41.5
5	*5510.00	109.1 AV			2.35 V	10	67.6	41.5
6	11020.00	63.6 PK	74.0	-10.4	2.59 V	284	36.9	26.7
7	11020.00	50.2 AV	54.0	-3.8	2.59 V	284	23.5	26.7

Remarks:

1. Emission Level(dBuV/m) = Raw Value(dBuV) + Correction Factor(dB/m)
2. Correction Factor(dB/m) = Antenna Factor(dB/m) + Cable Factor(dB) – Pre-Amplifier Factor(dB)
3. Margin value = Emission Level – Limit value
4. The other emission levels were very low against the limit.
5. " * " : Fundamental frequency, the limit was restricted at the RF Output Power.
6. " # " : The radiated frequency is out of the restricted band.



RF Mode	802.11ax (HE40)	Channel	CH 110 : 5550 MHz
Frequency Range	1 GHz ~ 40 GHz	Detector Function & Bandwidth	(PK) RB = 1 MHz, VB = 3 MHz (AV) RB = 1 MHz, VB = 1 kHz
Input Power	120 Vac, 60 Hz	Environmental Conditions	23°C, 67% RH
Tested By	Adair Peng/Rex Wang		

Antenna Polarity & Test Distance : Horizontal at 3 m

No	Frequency (MHz)	Emission Level (dBuV/m)	Limit (dBuV/m)	Margin (dB)	Antenna Height (m)	Table Angle (Degree)	Raw Value (dBuV)	Correction Factor (dB/m)
1	*5550.00	115.2 PK			2.58 H	359	73.7	41.5
2	*5550.00	103.9 AV			2.58 H	359	62.4	41.5
3	11100.00	62.9 PK	74.0	-11.1	2.85 H	338	36.7	26.2
4	11100.00	49.6 AV	54.0	-4.4	2.85 H	338	23.4	26.2

Antenna Polarity & Test Distance : Vertical at 3 m

No	Frequency (MHz)	Emission Level (dBuV/m)	Limit (dBuV/m)	Margin (dB)	Antenna Height (m)	Table Angle (Degree)	Raw Value (dBuV)	Correction Factor (dB/m)
1	*5550.00	120.9 PK			2.34 V	9	79.4	41.5
2	*5550.00	108.6 AV			2.34 V	9	67.1	41.5
3	11100.00	63.2 PK	74.0	-10.8	2.68 V	286	37.0	26.2
4	11100.00	49.8 AV	54.0	-4.2	2.68 V	286	23.6	26.2

Remarks:

1. Emission Level(dBuV/m) = Raw Value(dBuV) + Correction Factor(dB/m)
2. Correction Factor(dB/m) = Antenna Factor(dB/m) + Cable Factor(dB) – Pre-Amplifier Factor(dB)
3. Margin value = Emission Level – Limit value
4. The other emission levels were very low against the limit.
5. " * " : Fundamental frequency, the limit was restricted at the RF Output Power.

RF Mode	802.11ax (HE40)	Channel	CH 134 : 5670 MHz
Frequency Range	1 GHz ~ 40 GHz	Detector Function & Bandwidth	(PK) RB = 1 MHz, VB = 3 MHz (AV) RB = 1 MHz, VB = 1 kHz
Input Power	120 Vac, 60 Hz	Environmental Conditions	23°C, 67% RH
Tested By	Adair Peng/Rex Wang		

Antenna Polarity & Test Distance : Horizontal at 3 m

No	Frequency (MHz)	Emission Level (dBuV/m)	Limit (dBuV/m)	Margin (dB)	Antenna Height (m)	Table Angle (Degree)	Raw Value (dBuV)	Correction Factor (dB/m)
1	*5670.00	117.1 PK			2.60 H	355	75.4	41.7
2	*5670.00	104.0 AV			2.60 H	355	62.3	41.7
3	#5725.00	62.6 PK	68.2	-5.6	2.60 H	355	40.4	22.2
4	11340.00	63.2 PK	74.0	-10.8	2.83 H	330	36.8	26.4
5	11340.00	49.9 AV	54.0	-4.1	2.83 H	330	23.5	26.4

Antenna Polarity & Test Distance : Vertical at 3 m

No	Frequency (MHz)	Emission Level (dBuV/m)	Limit (dBuV/m)	Margin (dB)	Antenna Height (m)	Table Angle (Degree)	Raw Value (dBuV)	Correction Factor (dB/m)
1	*5670.00	121.8 PK			2.42 V	19	80.1	41.7
2	*5670.00	108.8 AV			2.42 V	19	67.1	41.7
3	#5725.00	62.7 PK	68.2	-5.5	2.42 V	19	40.5	22.2
4	11340.00	63.3 PK	74.0	-10.7	2.61 V	279	36.9	26.4
5	11340.00	50.1 AV	54.0	-3.9	2.61 V	279	23.7	26.4

Remarks:

1. Emission Level(dBuV/m) = Raw Value(dBuV) + Correction Factor(dB/m)
2. Correction Factor(dB/m) = Antenna Factor(dB/m) + Cable Factor(dB) – Pre-Amplifier Factor(dB)
3. Margin value = Emission Level – Limit value
4. The other emission levels were very low against the limit.
5. " * " : Fundamental frequency, the limit was restricted at the RF Output Power.
6. " # " : The radiated frequency is out of the restricted band.



RF Mode	802.11ax (HE40)	Channel	CH 142 : 5710 MHz
Frequency Range	1 GHz ~ 40 GHz	Detector Function & Bandwidth	(PK) RB = 1 MHz, VB = 3 MHz (AV) RB = 1 MHz, VB = 1 kHz
Input Power	120 Vac, 60 Hz	Environmental Conditions	23°C, 67% RH
Tested By	Adair Peng/Rex Wang		

Antenna Polarity & Test Distance : Horizontal at 3 m

No	Frequency (MHz)	Emission Level (dBuV/m)	Limit (dBuV/m)	Margin (dB)	Antenna Height (m)	Table Angle (Degree)	Raw Value (dBuV)	Correction Factor (dB/m)
1	#5470.00	61.6 PK	68.2	-6.6	2.69 H	359	40.2	21.4
2	*5710.00	117.6 PK			2.69 H	359	75.8	41.8
3	*5710.00	104.9 AV			2.69 H	359	63.1	41.8
4	#5850.00	62.3 PK	68.2	-5.9	2.69 H	359	39.8	22.5
5	11420.00	63.8 PK	74.0	-10.2	2.90 H	341	36.7	27.1
6	11420.00	50.6 AV	54.0	-3.4	2.90 H	341	23.5	27.1

Antenna Polarity & Test Distance : Vertical at 3 m

No	Frequency (MHz)	Emission Level (dBuV/m)	Limit (dBuV/m)	Margin (dB)	Antenna Height (m)	Table Angle (Degree)	Raw Value (dBuV)	Correction Factor (dB/m)
1	#5470.00	61.8 PK	68.2	-6.4	2.43 V	348	40.4	21.4
2	*5710.00	122.3 PK			2.43 V	348	80.5	41.8
3	*5710.00	109.5 AV			2.43 V	348	67.7	41.8
4	#5850.00	62.6 PK	68.2	-5.6	2.43 V	348	40.1	22.5
5	11420.00	64.1 PK	74.0	-9.9	2.57 V	283	37.0	27.1
6	11420.00	50.8 AV	54.0	-3.2	2.57 V	283	23.7	27.1

Remarks:

1. Emission Level(dBuV/m) = Raw Value(dBuV) + Correction Factor(dB/m)
2. Correction Factor(dB/m) = Antenna Factor(dB/m) + Cable Factor(dB) – Pre-Amplifier Factor(dB)
3. Margin value = Emission Level – Limit value
4. The other emission levels were very low against the limit.
5. " * " : Fundamental frequency, the limit was restricted at the RF Output Power.
6. " # " : The radiated frequency is out of the restricted band.

RF Mode	802.11ax (HE80)	Channel	CH 58 : 5290 MHz
Frequency Range	1 GHz ~ 40 GHz	Detector Function & Bandwidth	(PK) RB = 1 MHz, VB = 3 MHz (AV) RB = 1 MHz, VB = 1 kHz
Input Power	120 Vac, 60 Hz	Environmental Conditions	23°C, 67% RH
Tested By	Adair Peng/Rex Wang		

Antenna Polarity & Test Distance : Horizontal at 3 m

No	Frequency (MHz)	Emission Level (dBuV/m)	Limit (dBuV/m)	Margin (dB)	Antenna Height (m)	Table Angle (Degree)	Raw Value (dBuV)	Correction Factor (dB/m)
1	*5290.00	108.1 PK			2.99 H	11	67.3	40.8
2	*5290.00	95.0 AV			2.99 H	11	54.2	40.8
3	5365.50	62.9 PK	74.0	-11.1	2.99 H	11	41.9	21.0
4	5365.50	50.2 AV	54.0	-3.8	2.99 H	11	29.2	21.0
5	#10580.00	61.5 PK	68.2	-6.7	2.64 H	345	36.5	25.0

Antenna Polarity & Test Distance : Vertical at 3 m

No	Frequency (MHz)	Emission Level (dBuV/m)	Limit (dBuV/m)	Margin (dB)	Antenna Height (m)	Table Angle (Degree)	Raw Value (dBuV)	Correction Factor (dB/m)
1	*5290.00	113.9 PK			2.97 V	4	73.1	40.8
2	*5290.00	101.4 AV			2.97 V	4	60.6	40.8
3	5365.50	67.1 PK	74.0	-6.9	2.97 V	4	46.1	21.0
4	5365.50	53.7 AV	54.0	-0.3	2.97 V	4	32.7	21.0
5	#10580.00	61.6 PK	68.2	-6.6	2.32 V	288	36.6	25.0

Remarks:

1. Emission Level(dBuV/m) = Raw Value(dBuV) + Correction Factor(dB/m)
2. Correction Factor(dB/m) = Antenna Factor(dB/m) + Cable Factor(dB) – Pre-Amplifier Factor(dB)
3. Margin value = Emission Level – Limit value
4. The other emission levels were very low against the limit.
5. " * ": Fundamental frequency, the limit was restricted at the RF Output Power.
6. " # ": The radiated frequency is out of the restricted band.



RF Mode	802.11ax (HE80)	Channel	CH 106 : 5530 MHz
Frequency Range	1 GHz ~ 40 GHz	Detector Function & Bandwidth	(PK) RB = 1 MHz, VB = 3 MHz (AV) RB = 1 MHz, VB = 1 kHz
Input Power	120 Vac, 60 Hz	Environmental Conditions	23°C, 67% RH
Tested By	Adair Peng/Rex Wang		

Antenna Polarity & Test Distance : Horizontal at 3 m

No	Frequency (MHz)	Emission Level (dBuV/m)	Limit (dBuV/m)	Margin (dB)	Antenna Height (m)	Table Angle (Degree)	Raw Value (dBuV)	Correction Factor (dB/m)
1	5460.00	63.1 PK	74.0	-10.9	2.58 H	348	41.7	21.4
2	5460.00	49.8 AV	54.0	-4.2	2.58 H	348	28.4	21.4
3	#5470.00	63.8 PK	68.2	-4.4	2.58 H	348	42.4	21.4
4	*5530.00	114.7 PK			2.58 H	348	73.2	41.5
5	*5530.00	101.4 AV			2.58 H	348	59.9	41.5
6	11060.00	63.0 PK	74.0	-11.0	2.81 H	331	36.6	26.4
7	11060.00	50.0 AV	54.0	-4.0	2.81 H	331	23.6	26.4

Antenna Polarity & Test Distance : Vertical at 3 m

No	Frequency (MHz)	Emission Level (dBuV/m)	Limit (dBuV/m)	Margin (dB)	Antenna Height (m)	Table Angle (Degree)	Raw Value (dBuV)	Correction Factor (dB/m)
1	5460.00	64.4 PK	74.0	-9.6	2.45 V	9	43.0	21.4
2	5460.00	51.0 AV	54.0	-3.0	2.45 V	9	29.6	21.4
3	#5470.00	65.6 PK	68.2	-2.6	2.45 V	9	44.2	21.4
4	*5530.00	118.6 PK			2.45 V	9	77.1	41.5
5	*5530.00	106.1 AV			2.45 V	9	64.6	41.5
6	11060.00	63.2 PK	74.0	-10.8	2.63 V	287	36.8	26.4
7	11060.00	50.2 AV	54.0	-3.8	2.63 V	287	23.8	26.4

Remarks:

1. Emission Level(dBuV/m) = Raw Value(dBuV) + Correction Factor(dB/m)
2. Correction Factor(dB/m) = Antenna Factor(dB/m) + Cable Factor(dB) – Pre-Amplifier Factor(dB)
3. Margin value = Emission Level – Limit value
4. The other emission levels were very low against the limit.
5. " * " : Fundamental frequency, the limit was restricted at the RF Output Power.
6. " # " : The radiated frequency is out of the restricted band.

RF Mode	802.11ax (HE80)	Channel	CH 122 : 5610 MHz
Frequency Range	1 GHz ~ 40 GHz	Detector Function & Bandwidth	(PK) RB = 1 MHz, VB = 3 MHz (AV) RB = 1 MHz, VB = 1 kHz
Input Power	120 Vac, 60 Hz	Environmental Conditions	23°C, 67% RH
Tested By	Adair Peng/Rex Wang		

Antenna Polarity & Test Distance : Horizontal at 3 m

No	Frequency (MHz)	Emission Level (dBuV/m)	Limit (dBuV/m)	Margin (dB)	Antenna Height (m)	Table Angle (Degree)	Raw Value (dBuV)	Correction Factor (dB/m)
1	*5610.00	114.3 PK			2.58 H	354	72.7	41.6
2	*5610.00	101.8 AV			2.58 H	354	60.2	41.6
3	#5725.00	62.0 PK	68.2	-6.2	2.58 H	354	39.8	22.2
4	11220.00	62.5 PK	74.0	-11.5	2.91 H	333	36.7	25.8
5	11220.00	49.5 AV	54.0	-4.5	2.91 H	333	23.7	25.8

Antenna Polarity & Test Distance : Vertical at 3 m

No	Frequency (MHz)	Emission Level (dBuV/m)	Limit (dBuV/m)	Margin (dB)	Antenna Height (m)	Table Angle (Degree)	Raw Value (dBuV)	Correction Factor (dB/m)
1	*5610.00	119.1 PK			2.27 V	17	77.5	41.6
2	*5610.00	106.4 AV			2.27 V	17	64.8	41.6
3	#5725.00	62.2 PK	68.2	-6.0	2.27 V	17	40.0	22.2
4	11220.00	62.8 PK	74.0	-11.2	2.59 V	285	37.0	25.8
5	11220.00	49.8 AV	54.0	-4.2	2.59 V	285	24.0	25.8

Remarks:

1. Emission Level(dBuV/m) = Raw Value(dBuV) + Correction Factor(dB/m)
2. Correction Factor(dB/m) = Antenna Factor(dB/m) + Cable Factor(dB) – Pre-Amplifier Factor(dB)
3. Margin value = Emission Level – Limit value
4. The other emission levels were very low against the limit.
5. " * " : Fundamental frequency, the limit was restricted at the RF Output Power.
6. " # " : The radiated frequency is out of the restricted band.



RF Mode	802.11ax (HE80)	Channel	CH 138 : 5690 MHz
Frequency Range	1 GHz ~ 40 GHz	Detector Function & Bandwidth	(PK) RB = 1 MHz, VB = 3 MHz (AV) RB = 1 MHz, VB = 1 kHz
Input Power	120 Vac, 60 Hz	Environmental Conditions	23°C, 67% RH
Tested By	Adair Peng/Rex Wang		

Antenna Polarity & Test Distance : Horizontal at 3 m

No	Frequency (MHz)	Emission Level (dBUV/m)	Limit (dBUV/m)	Margin (dB)	Antenna Height (m)	Table Angle (Degree)	Raw Value (dBUV)	Correction Factor (dB/m)
1	#5470.00	62.4 PK	68.2	-5.8	2.78 H	357	41.0	21.4
2	*5690.00	114.8 PK			2.78 H	357	73.1	41.7
3	*5690.00	101.3 AV			2.78 H	357	59.6	41.7
4	#5850.00	61.5 PK	68.2	-6.7	2.78 H	357	39.0	22.5
5	11380.00	63.5 PK	74.0	-10.5	2.80 H	328	36.7	26.8
6	11380.00	50.5 AV	54.0	-3.5	2.80 H	328	23.7	26.8

Antenna Polarity & Test Distance : Vertical at 3 m

No	Frequency (MHz)	Emission Level (dBUV/m)	Limit (dBUV/m)	Margin (dB)	Antenna Height (m)	Table Angle (Degree)	Raw Value (dBUV)	Correction Factor (dB/m)
1	#5470.00	62.8 PK	68.2	-5.4	2.57 V	8	41.4	21.4
2	*5690.00	119.6 PK			2.57 V	8	77.9	41.7
3	*5690.00	106.0 AV			2.57 V	8	64.3	41.7
4	#5850.00	61.8 PK	68.2	-6.4	2.57 V	8	39.3	22.5
5	11380.00	63.7 PK	74.0	-10.3	2.69 V	290	36.9	26.8
6	11380.00	50.7 AV	54.0	-3.3	2.69 V	290	23.9	26.8

Remarks:

1. Emission Level(dBUV/m) = Raw Value(dBUV) + Correction Factor(dB/m)
2. Correction Factor(dB/m) = Antenna Factor(dB/m) + Cable Factor(dB) – Pre-Amplifier Factor(dB)
3. Margin value = Emission Level – Limit value
4. The other emission levels were very low against the limit.
5. " * " : Fundamental frequency, the limit was restricted at the RF Output Power.
6. " # " : The radiated frequency is out of the restricted band.

Mode A

802.11a Channel 52

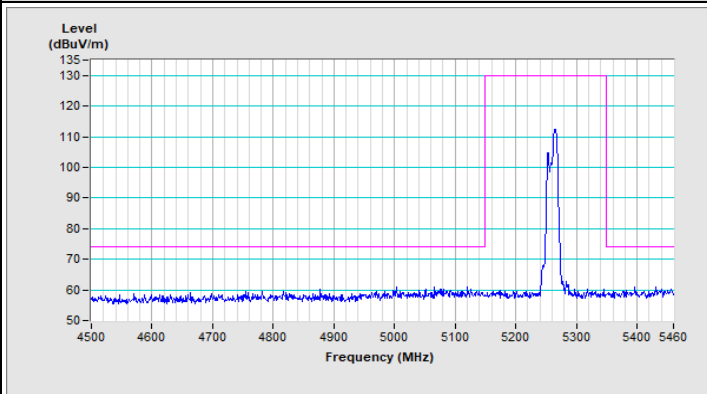

Horizontal (Peak)

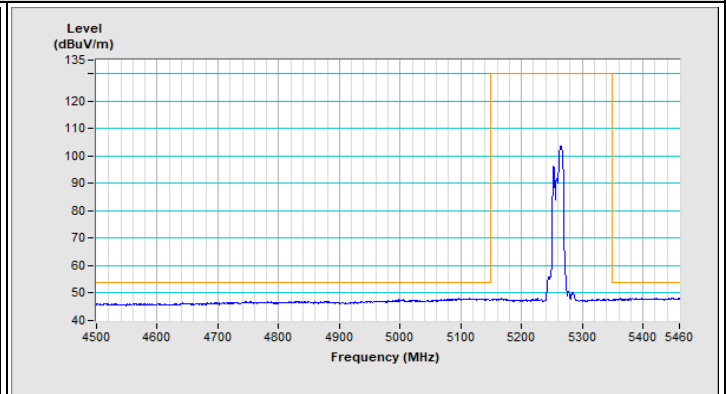

Horizontal (Average)

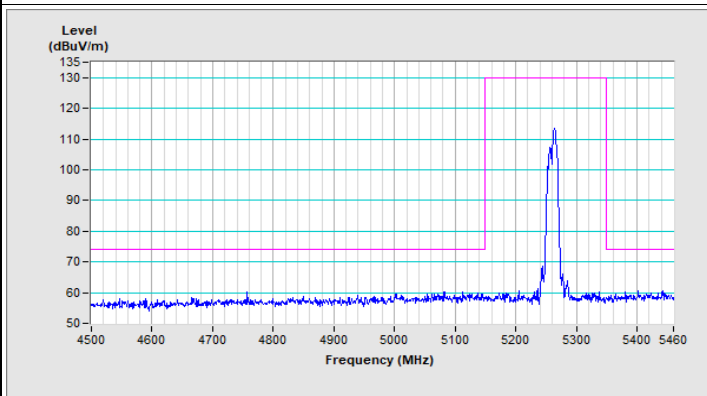

Vertical (Peak)

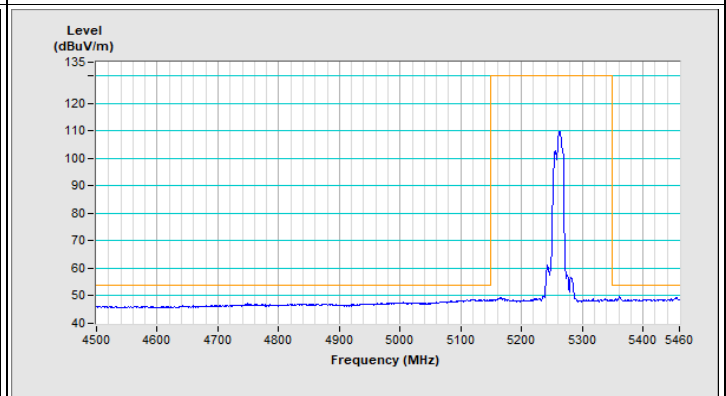

Vertical (Average)

802.11a Channel 64

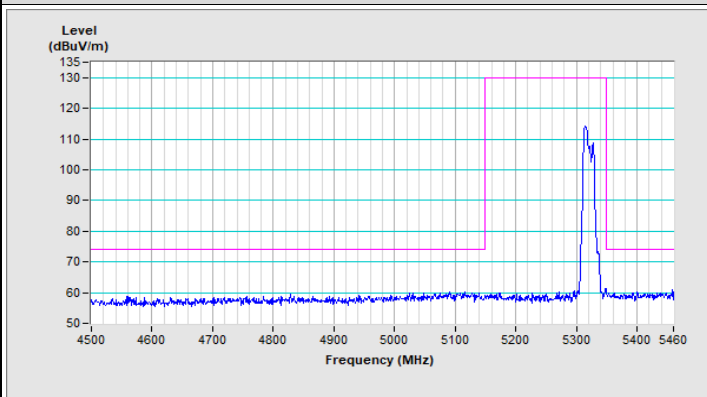

Horizontal (Peak)

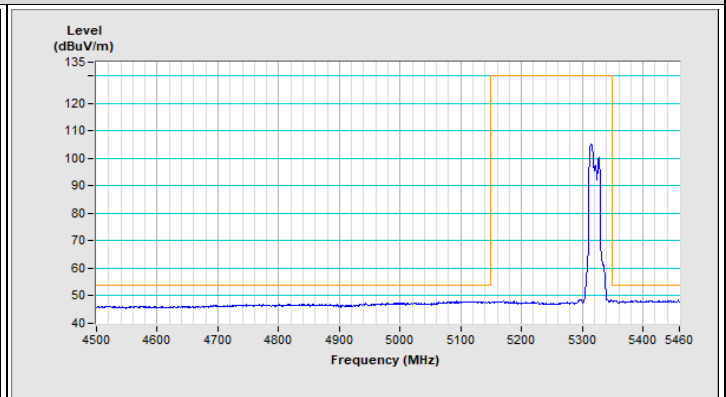

Horizontal (Average)

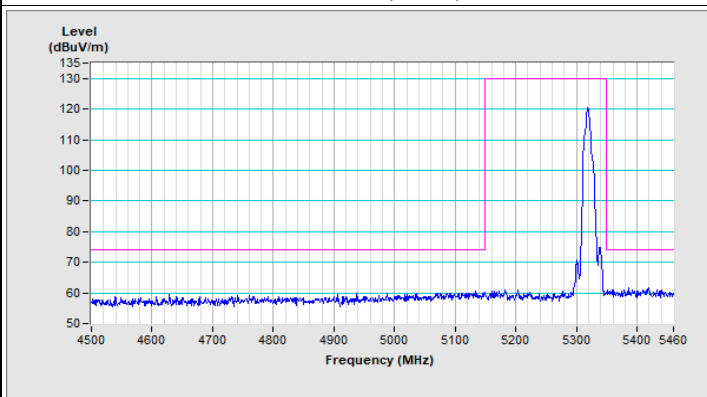

Vertical (Peak)

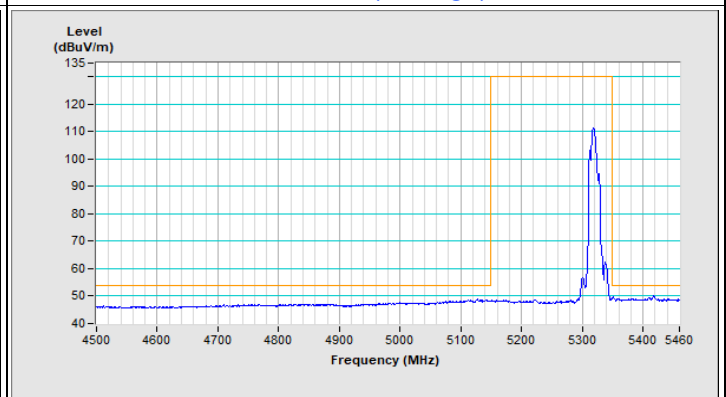

Vertical (Average)

802.11a Channel 100

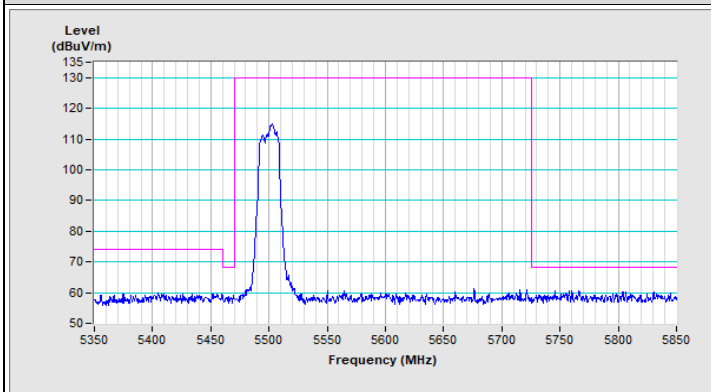

Horizontal (Peak)

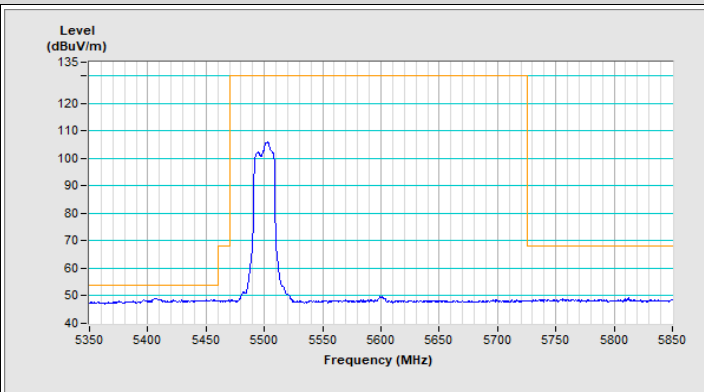

Horizontal (Average)

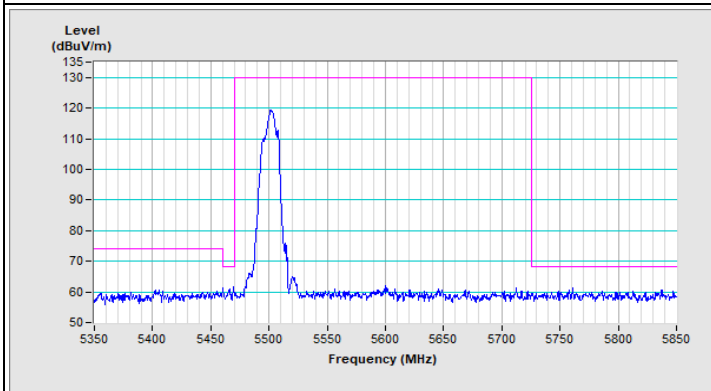

Vertical (Peak)

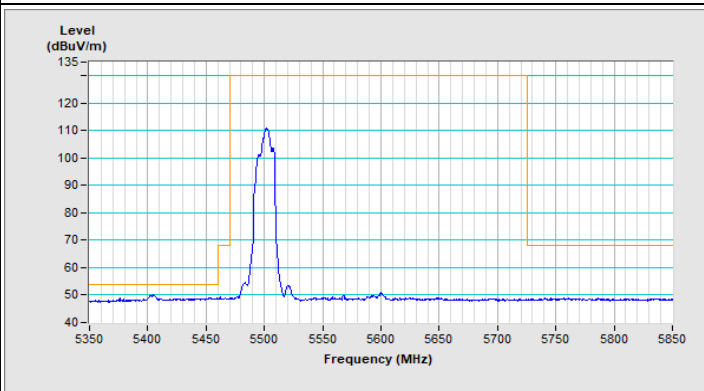

Vertical (Average)

802.11a Channel 140

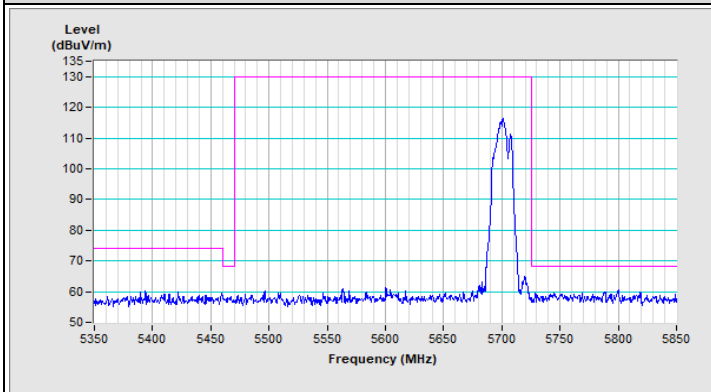

Horizontal (Peak)

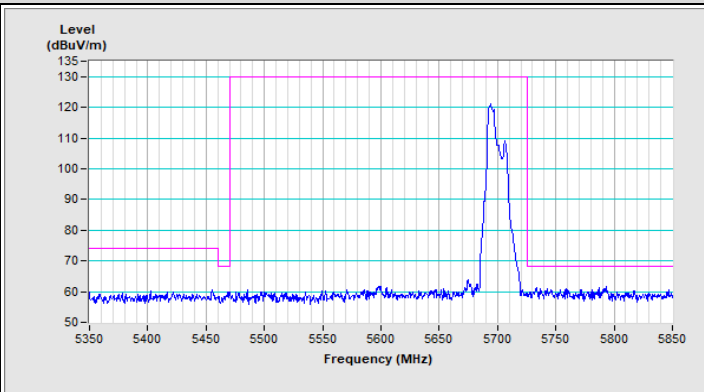

Vertical (Peak)

802.11a Channel 144

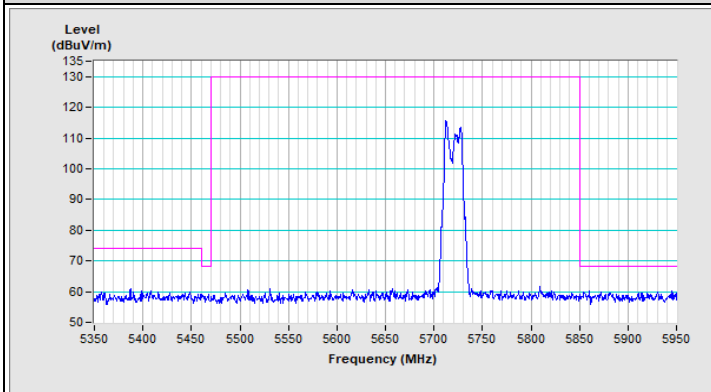

Horizontal (Peak)

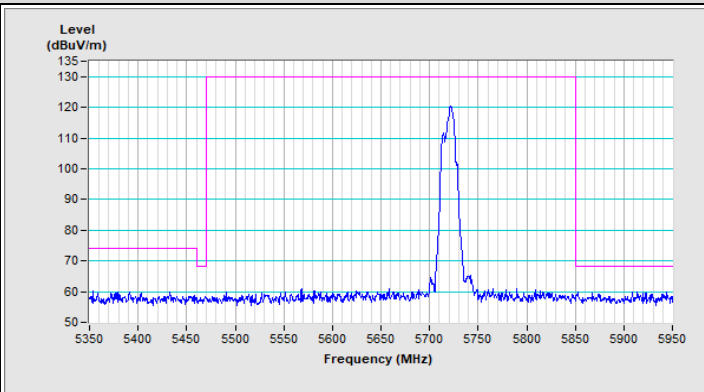

Vertical (Peak)

802.11ax (HE20) Channel 52

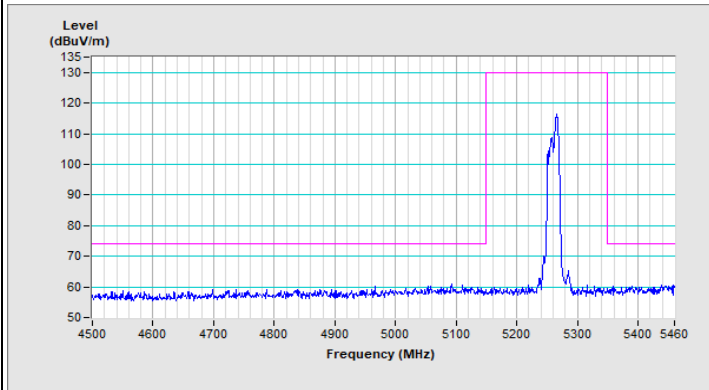

Horizontal (Peak)

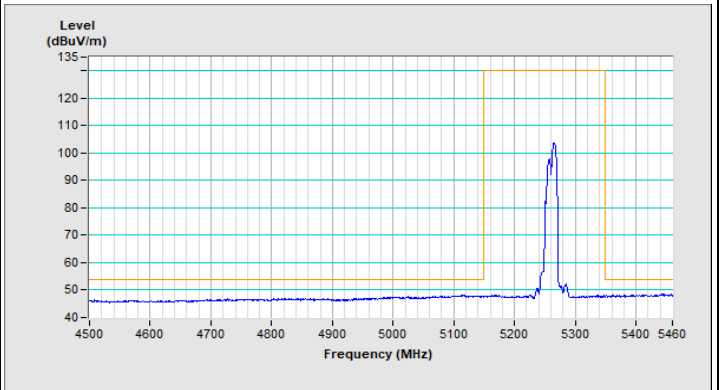

Horizontal (Average)

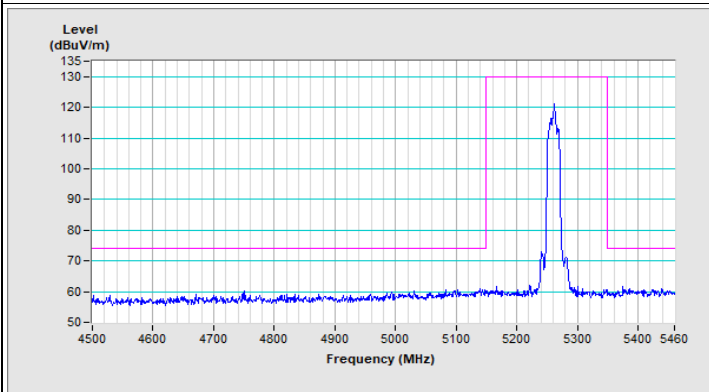

Vertical (Peak)

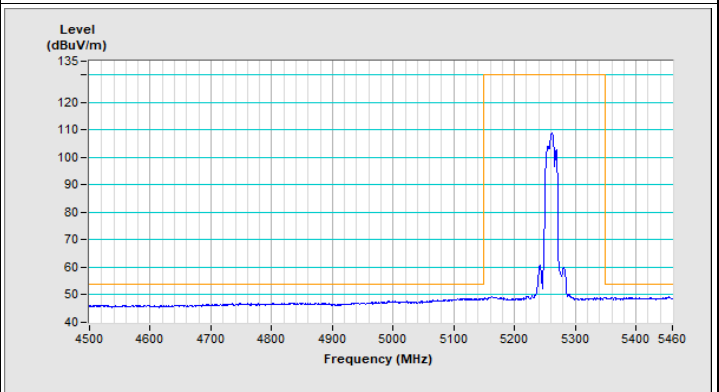

Vertical (Average)

802.11ax (HE20) Channel 64

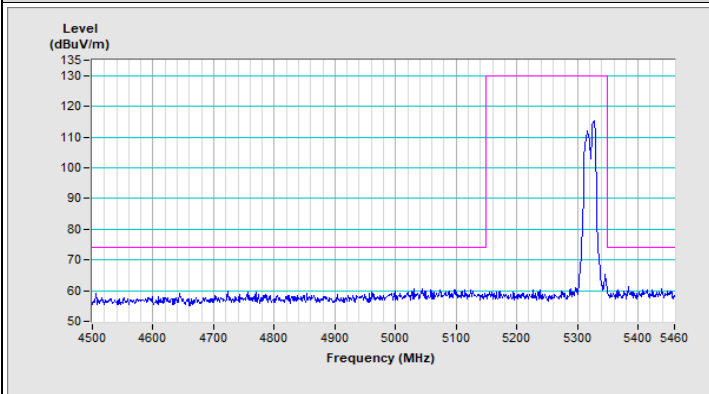

Horizontal (Peak)

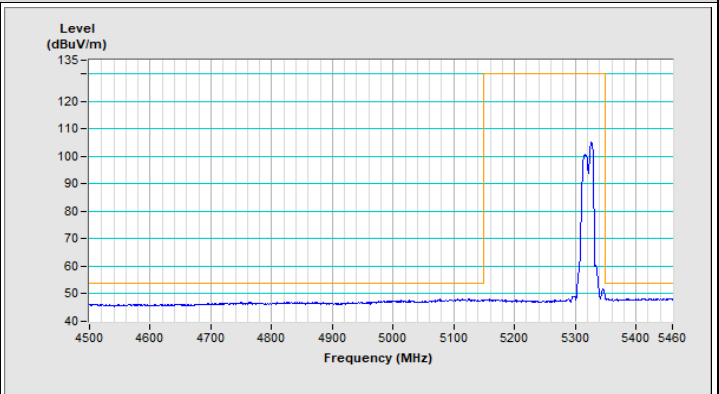

Horizontal (Average)

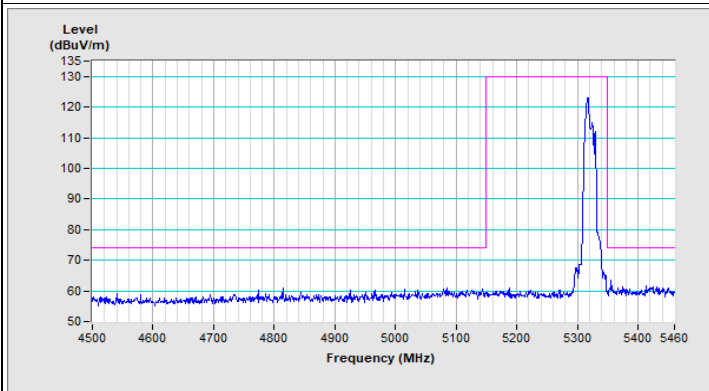

Vertical (Peak)

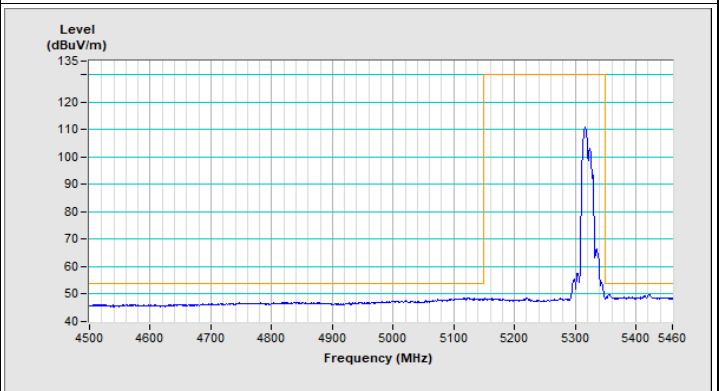

Vertical (Average)

802.11ax (HE20) Channel 100

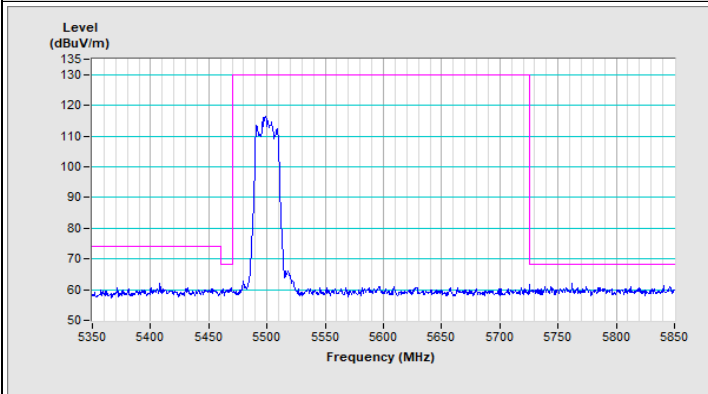

Horizontal (Peak)

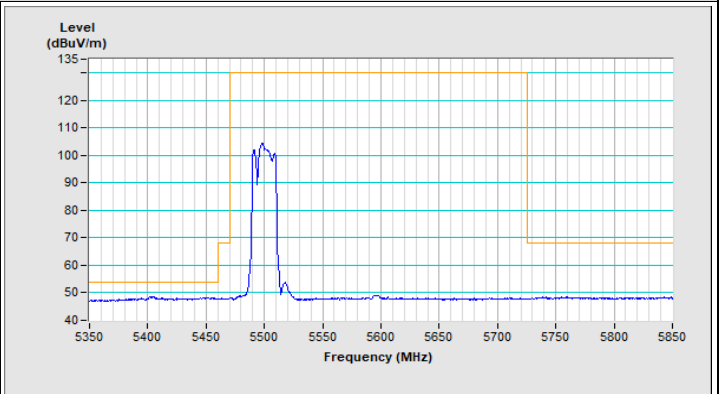

Horizontal (Average)

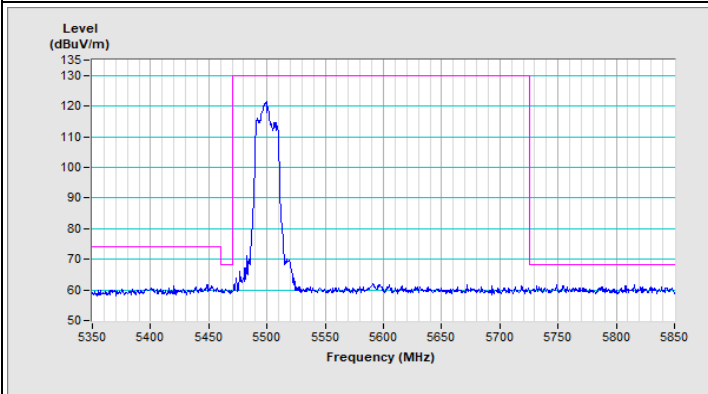

Vertical (Peak)

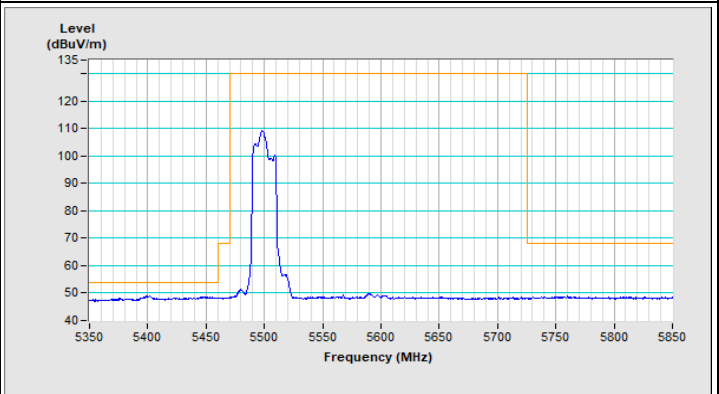

Vertical (Average)

802.11ax (HE20) Channel 140

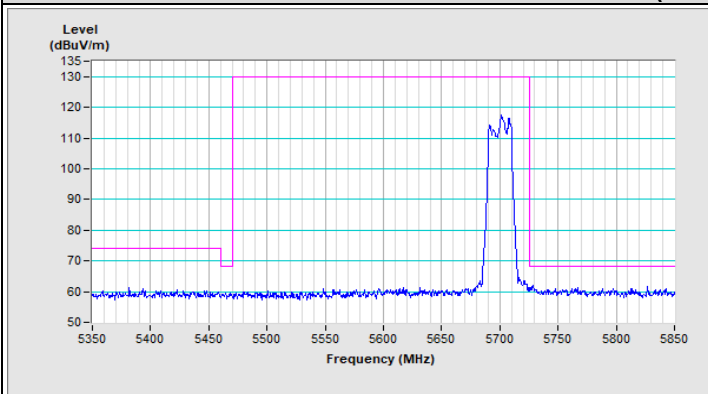

Horizontal (Peak)

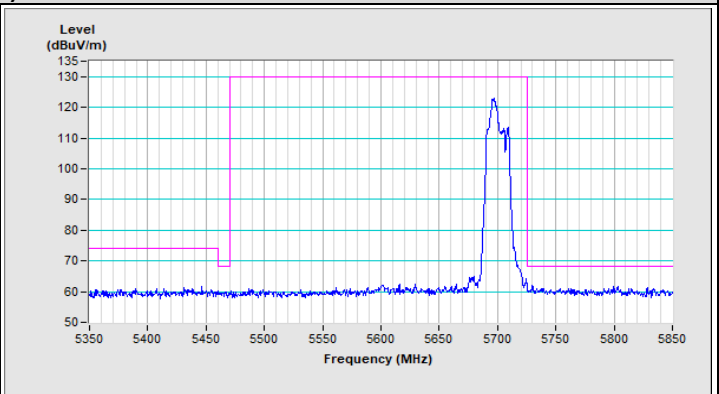

Vertical (Peak)

802.11ax (HE20) Channel 144

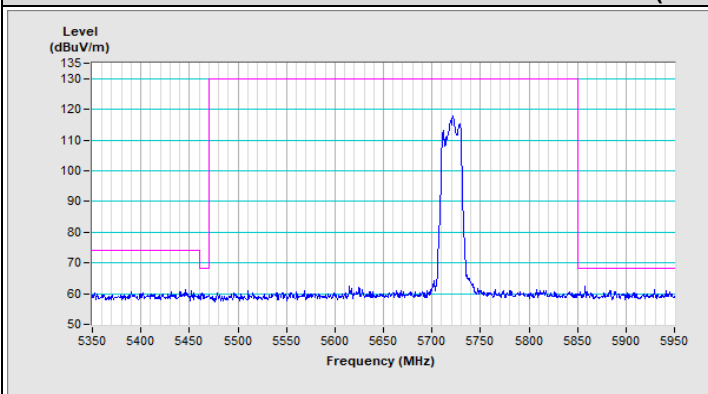

Horizontal (Peak)

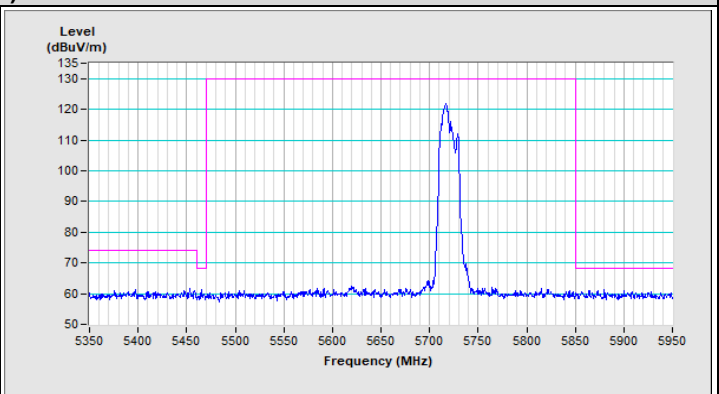

Vertical (Peak)



802.11ax (HE40) Channel 54

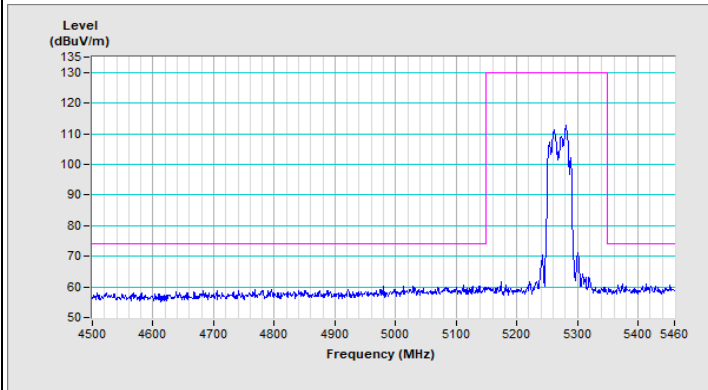

Horizontal (Peak)

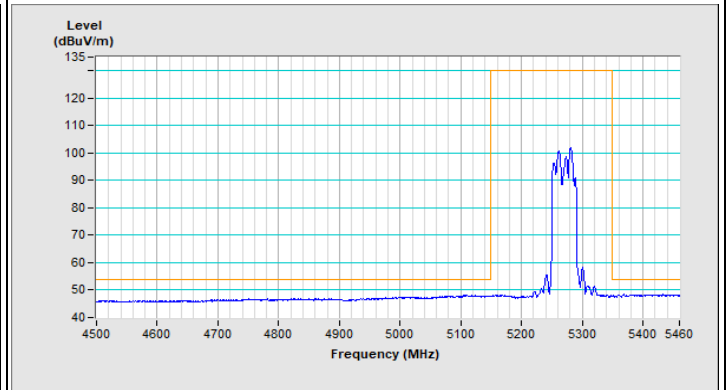

Horizontal (Average)

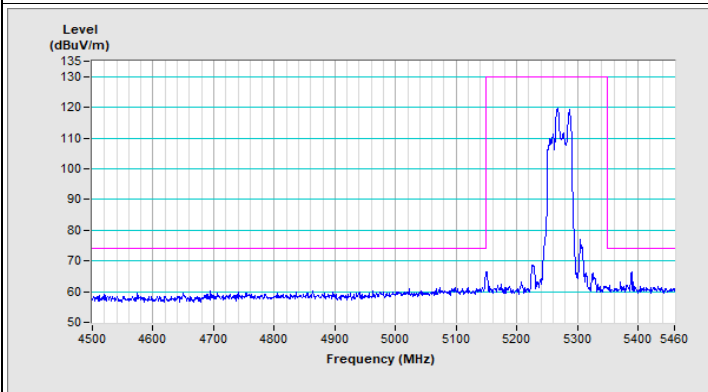

Vertical (Peak)

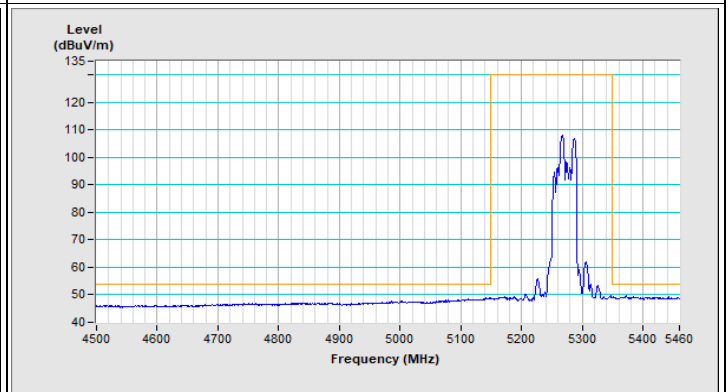

Vertical (Average)

802.11ax (HE40) Channel 62

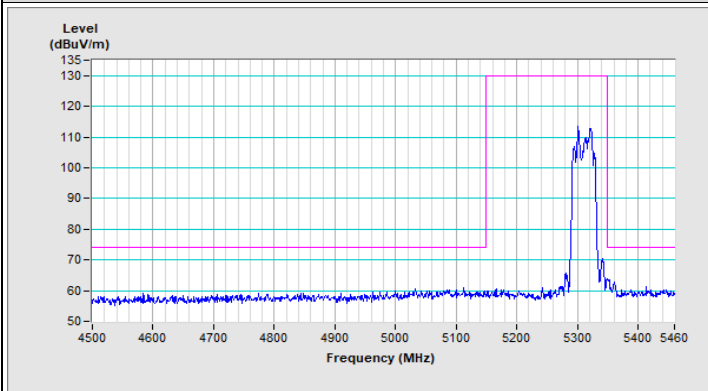

Horizontal (Peak)

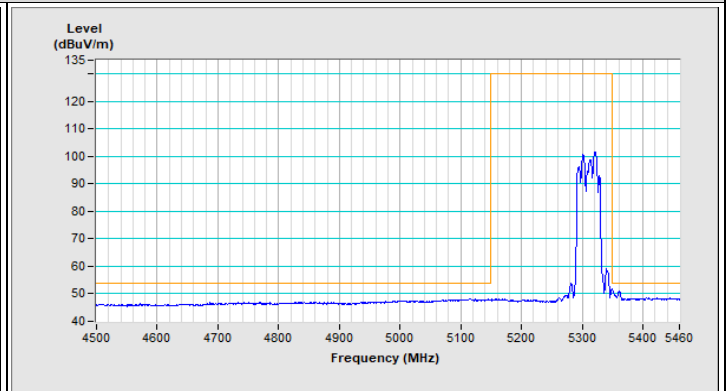

Horizontal (Average)

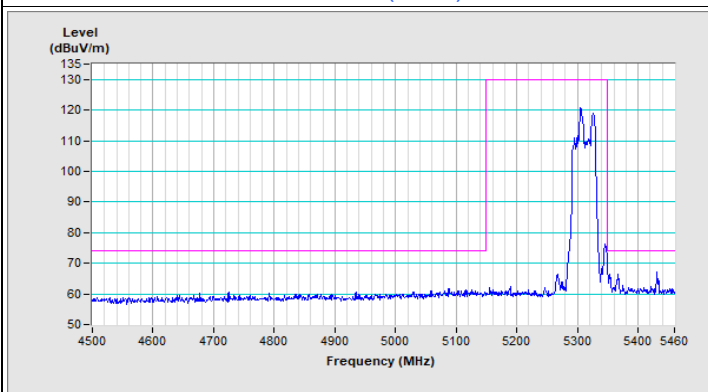

Vertical (Peak)

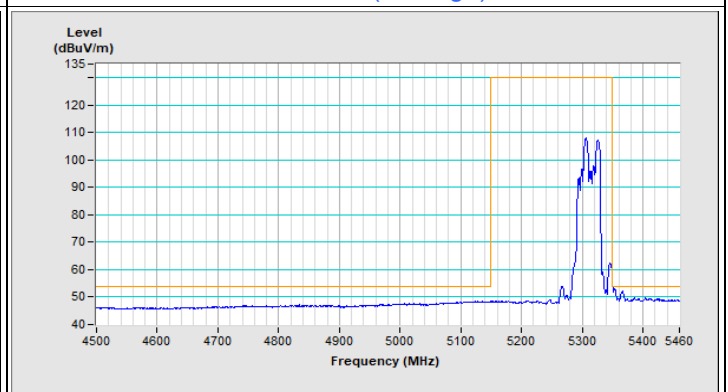

Vertical (Average)

802.11ax (HE40) Channel 102

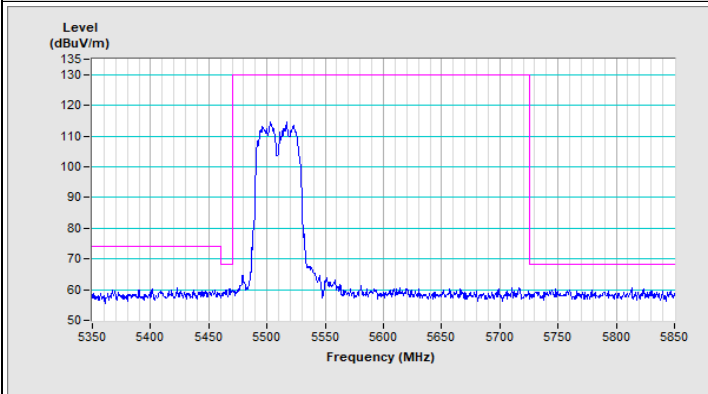

Horizontal (Peak)

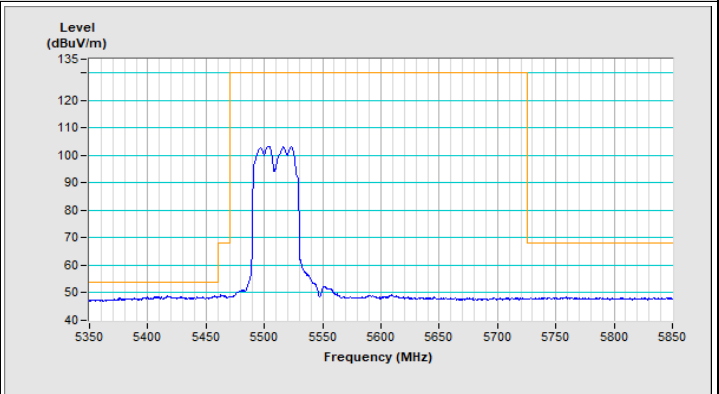

Horizontal (Average)

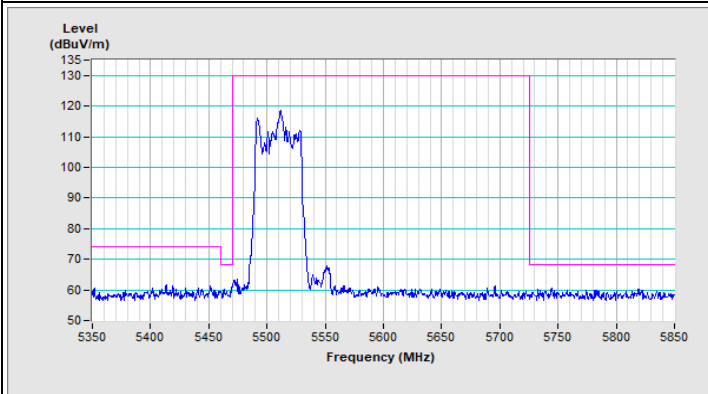

Vertical (Peak)

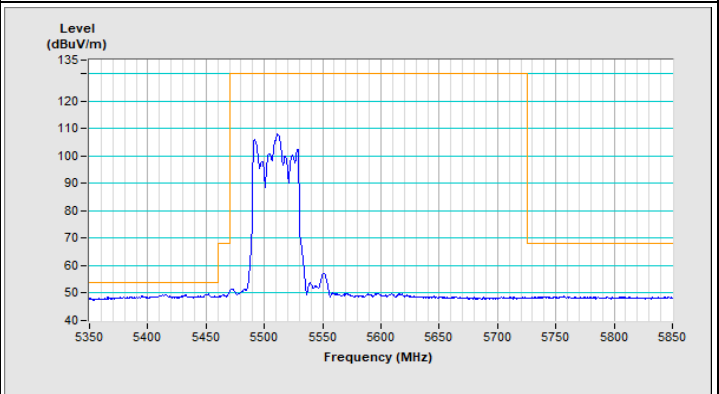

Vertical (Average)

802.11ax (HE40) Channel 134

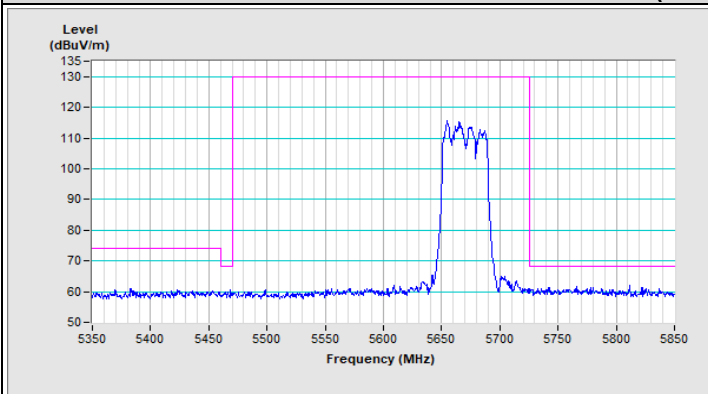

Horizontal (Peak)

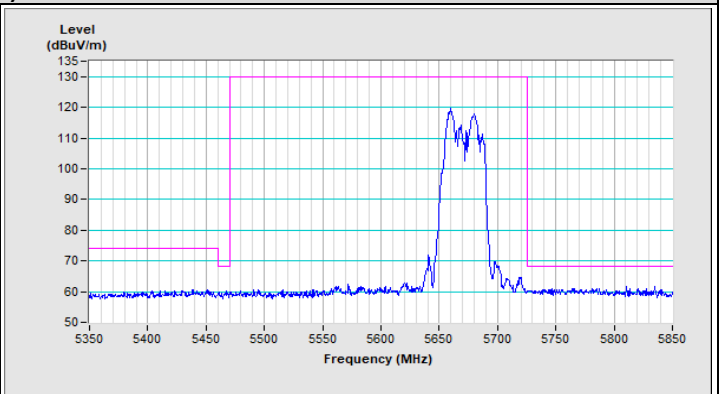

Vertical (Peak)

802.11ax (HE40) Channel 142

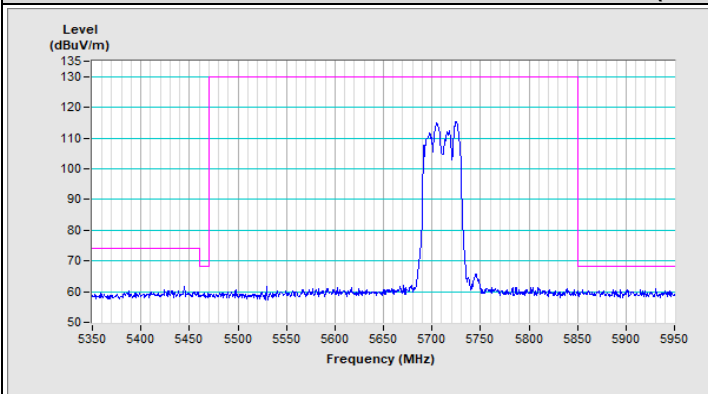

Horizontal (Peak)

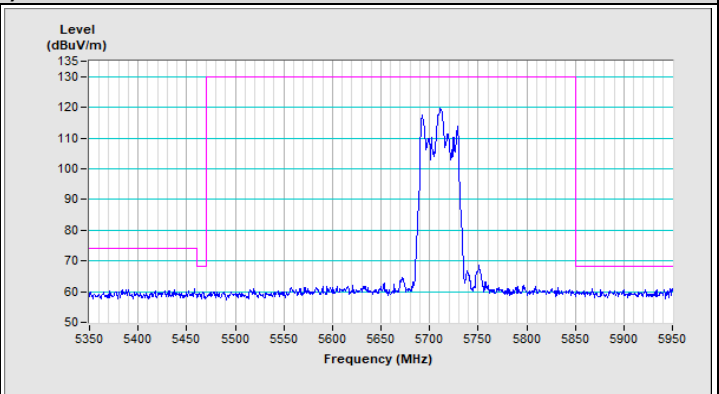

Vertical (Peak)

802.11ax (HE80) Channel 58

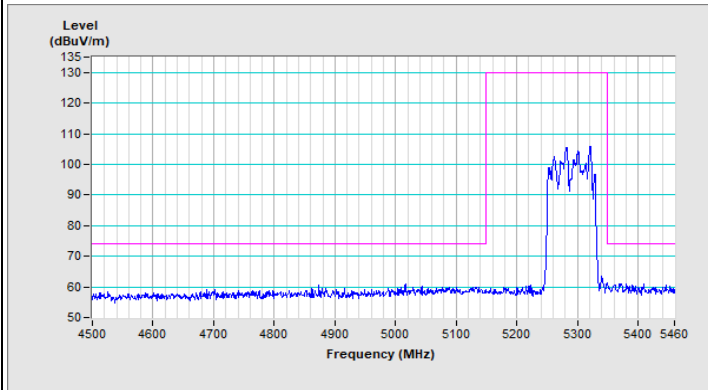

Horizontal (Peak)

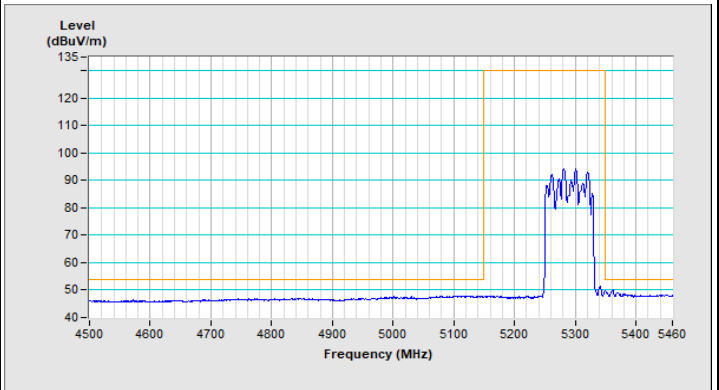

Horizontal (Average)

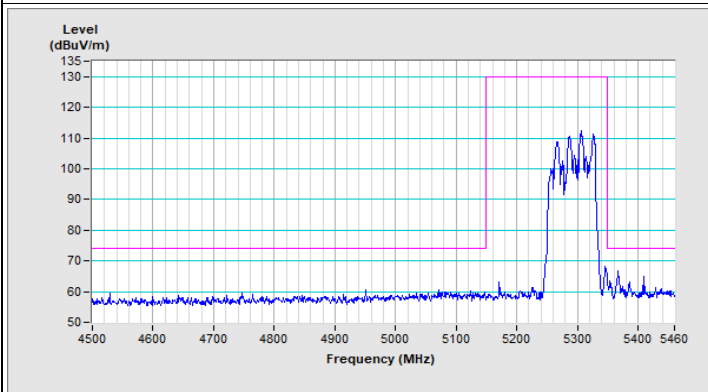

Vertical (Peak)

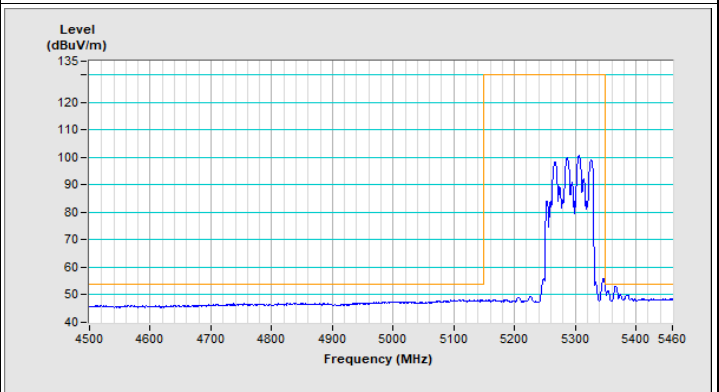

Vertical (Average)

802.11ax (HE80) Channel 106

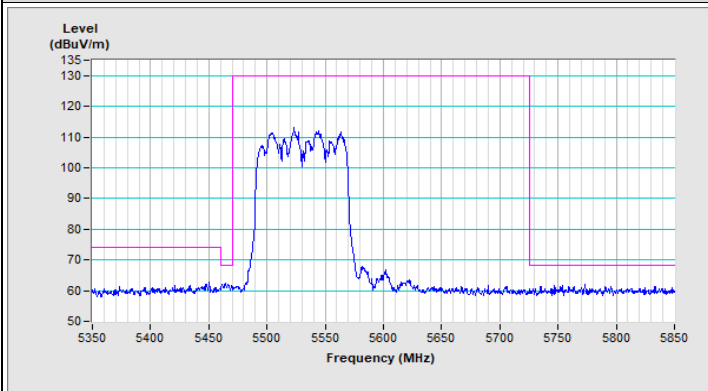

Horizontal (Peak)

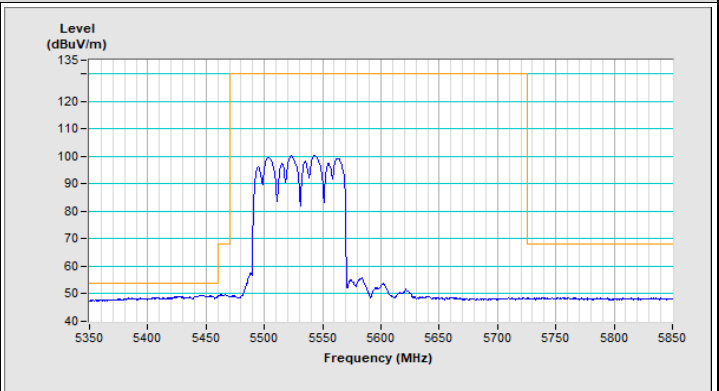

Horizontal (Average)

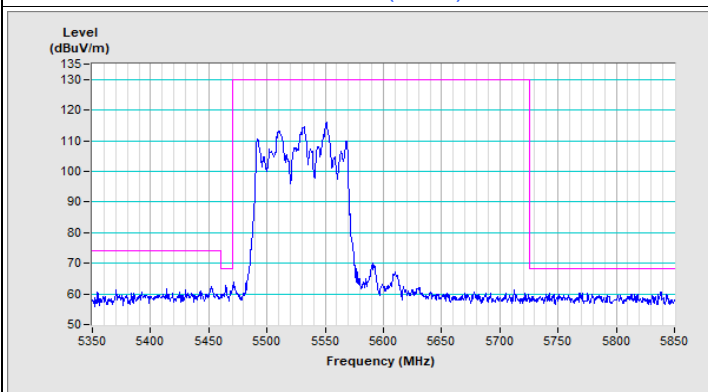

Vertical (Peak)

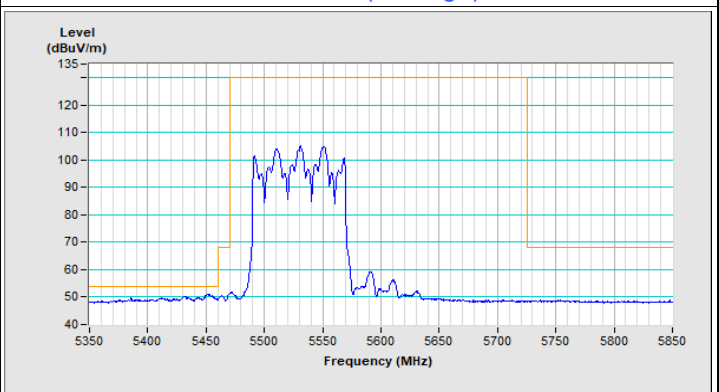

Vertical (Average)

802.11ax (HE80) Channel 122

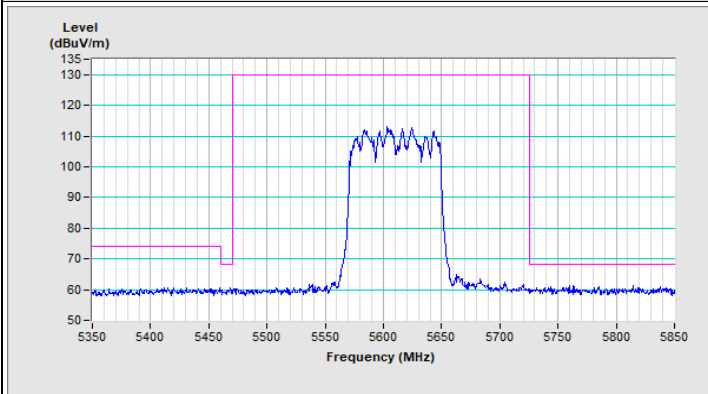

Horizontal (Peak)

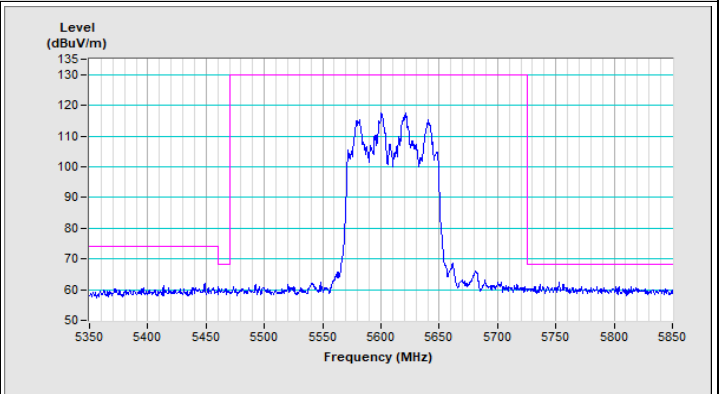

Vertical (Peak)

802.11ax (HE80) Channel 138

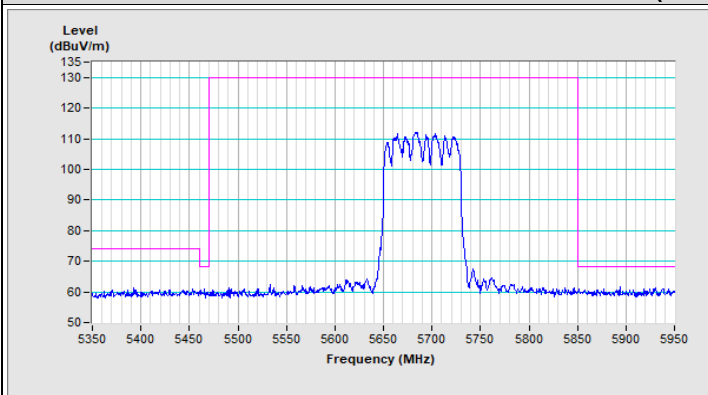

Horizontal (Peak)

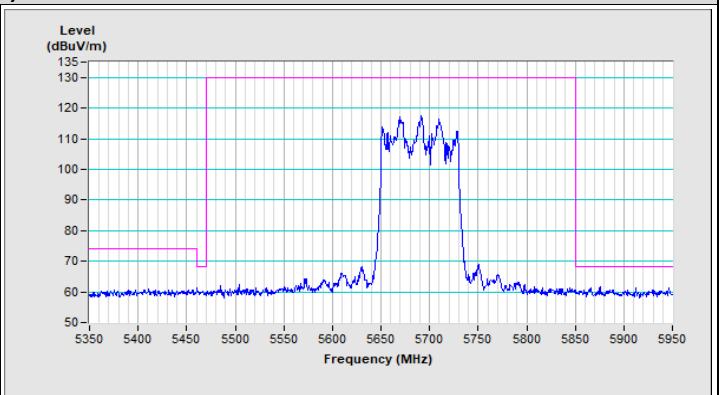

Vertical (Peak)

Mode B

RF Mode	802.11a	Channel	CH 52 : 5260 MHz
Frequency Range	1 GHz ~ 40 GHz	Detector Function & Bandwidth	(PK) RB = 1 MHz, VB = 3 MHz (AV) RB = 1 MHz, VB = 1 kHz
Input Power	120 Vac, 60 Hz	Environmental Conditions	23°C, 67% RH
Tested By	Adair Peng		

Antenna Polarity & Test Distance : Horizontal at 3 m								
No	Frequency (MHz)	Emission Level (dBuV/m)	Limit (dBuV/m)	Margin (dB)	Antenna Height (m)	Table Angle (Degree)	Raw Value (dBuV)	Correction Factor (dB/m)
1	5150.00	61.4 PK	74.0	-12.6	3.78 H	255	40.4	21.0
2	5150.00	48.1 AV	54.0	-5.9	3.78 H	255	27.1	21.0
3	*5260.00	114.6 PK			3.78 H	255	73.8	40.8
4	*5260.00	105.5 AV			3.78 H	255	64.7	40.8
5	#10520.00	62.1 PK	68.2	-6.1	3.05 H	222	37.1	25.0
Antenna Polarity & Test Distance : Vertical at 3 m								
No	Frequency (MHz)	Emission Level (dBuV/m)	Limit (dBuV/m)	Margin (dB)	Antenna Height (m)	Table Angle (Degree)	Raw Value (dBuV)	Correction Factor (dB/m)
1	5150.00	61.5 PK	74.0	-12.5	2.87 V	329	40.5	21.0
2	5150.00	48.2 AV	54.0	-5.8	2.87 V	329	27.2	21.0
3	*5260.00	118.3 PK			2.87 V	329	77.5	40.8
4	*5260.00	108.9 AV			2.87 V	329	68.1	40.8
5	#10520.00	62.4 PK	68.2	-5.8	2.59 V	178	37.4	25.0

Remarks:

1. Emission Level(dBuV/m) = Raw Value(dBuV) + Correction Factor(dB/m)
2. Correction Factor(dB/m) = Antenna Factor(dB/m) + Cable Factor(dB) – Pre-Amplifier Factor(dB)
3. Margin value = Emission Level – Limit value
4. The other emission levels were very low against the limit.
5. " * ": Fundamental frequency, the limit was restricted at the RF Output Power.
6. " # ": The radiated frequency is out of the restricted band.



RF Mode	802.11a	Channel	CH 60 : 5300 MHz
Frequency Range	1 GHz ~ 40 GHz	Detector Function & Bandwidth	(PK) RB = 1 MHz, VB = 3 MHz (AV) RB = 1 MHz, VB = 1 kHz
Input Power	120 Vac, 60 Hz	Environmental Conditions	23°C, 67% RH
Tested By	Adair Peng		

Antenna Polarity & Test Distance : Horizontal at 3 m

No	Frequency (MHz)	Emission Level (dBuV/m)	Limit (dBuV/m)	Margin (dB)	Antenna Height (m)	Table Angle (Degree)	Raw Value (dBuV)	Correction Factor (dB/m)
1	*5300.00	114.5 PK			3.81 H	251	73.7	40.8
2	*5300.00	105.6 AV			3.81 H	251	64.8	40.8
3	5350.00	61.6 PK	74.0	-12.4	3.81 H	251	40.6	21.0
4	5350.00	48.5 AV	54.0	-5.5	3.81 H	251	27.5	21.0
5	10600.00	61.8 PK	74.0	-12.2	3.13 H	229	36.8	25.0
6	10600.00	48.9 AV	54.0	-5.1	3.13 H	229	23.9	25.0

Antenna Polarity & Test Distance : Vertical at 3 m

No	Frequency (MHz)	Emission Level (dBuV/m)	Limit (dBuV/m)	Margin (dB)	Antenna Height (m)	Table Angle (Degree)	Raw Value (dBuV)	Correction Factor (dB/m)
1	*5300.00	118.2 PK			3.05 V	332	77.4	40.8
2	*5300.00	109.1 AV			3.05 V	332	68.3	40.8
3	5350.00	68.3 PK	74.0	-5.7	3.05 V	332	47.3	21.0
4	5350.00	52.2 AV	54.0	-1.8	3.05 V	332	31.2	21.0
5	10600.00	62.1 PK	74.0	-11.9	2.67 V	175	37.1	25.0
6	10600.00	49.1 AV	54.0	-4.9	2.67 V	175	24.1	25.0

Remarks:

1. Emission Level(dBuV/m) = Raw Value(dBuV) + Correction Factor(dB/m)
2. Correction Factor(dB/m) = Antenna Factor(dB/m) + Cable Factor(dB) – Pre-Amplifier Factor(dB)
3. Margin value = Emission Level – Limit value
4. The other emission levels were very low against the limit.
5. " * ": Fundamental frequency, the limit was restricted at the RF Output Power.



RF Mode	802.11a	Channel	CH 64 : 5320 MHz
Frequency Range	1 GHz ~ 40 GHz	Detector Function & Bandwidth	(PK) RB = 1 MHz, VB = 3 MHz (AV) RB = 1 MHz, VB = 1 kHz
Input Power	120 Vac, 60 Hz	Environmental Conditions	23°C, 67% RH
Tested By	Adair Peng		

Antenna Polarity & Test Distance : Horizontal at 3 m

No	Frequency (MHz)	Emission Level (dBuV/m)	Limit (dBuV/m)	Margin (dB)	Antenna Height (m)	Table Angle (Degree)	Raw Value (dBuV)	Correction Factor (dB/m)
1	*5320.00	112.5 PK			3.75 H	256	71.6	40.9
2	*5320.00	103.4 AV			3.75 H	256	62.5	40.9
3	5350.00	64.2 PK	74.0	-9.8	3.75 H	256	43.2	21.0
4	5350.00	49.6 AV	54.0	-4.4	3.75 H	256	28.6	21.0
5	10640.00	62.4 PK	74.0	-11.6	2.97 H	217	36.7	25.7
6	10640.00	49.6 AV	54.0	-4.4	2.97 H	217	23.9	25.7

Antenna Polarity & Test Distance : Vertical at 3 m

No	Frequency (MHz)	Emission Level (dBuV/m)	Limit (dBuV/m)	Margin (dB)	Antenna Height (m)	Table Angle (Degree)	Raw Value (dBuV)	Correction Factor (dB/m)
1	*5320.00	116.1 PK			2.76 V	329	75.2	40.9
2	*5320.00	107.0 AV			2.76 V	329	66.1	40.9
3	5350.00	69.6 PK	74.0	-4.4	2.76 V	329	48.6	21.0
4	5350.00	53.8 AV	54.0	-0.2	2.76 V	329	32.8	21.0
5	10640.00	62.6 PK	74.0	-11.4	2.52 V	174	36.9	25.7
6	10640.00	49.7 AV	54.0	-4.3	2.52 V	174	24.0	25.7

Remarks:

1. Emission Level(dBuV/m) = Raw Value(dBuV) + Correction Factor(dB/m)
2. Correction Factor(dB/m) = Antenna Factor(dB/m) + Cable Factor(dB) – Pre-Amplifier Factor(dB)
3. Margin value = Emission Level – Limit value
4. The other emission levels were very low against the limit.
5. " * ": Fundamental frequency, the limit was restricted at the RF Output Power.

RF Mode	802.11a	Channel	CH 100 : 5500 MHz
Frequency Range	1 GHz ~ 40 GHz	Detector Function & Bandwidth	(PK) RB = 1 MHz, VB = 3 MHz (AV) RB = 1 MHz, VB = 1 kHz
Input Power	120 Vac, 60 Hz	Environmental Conditions	23°C, 67% RH
Tested By	Adair Peng		

Antenna Polarity & Test Distance : Horizontal at 3 m

No	Frequency (MHz)	Emission Level (dBuV/m)	Limit (dBuV/m)	Margin (dB)	Antenna Height (m)	Table Angle (Degree)	Raw Value (dBuV)	Correction Factor (dB/m)
1	5460.00	60.4 PK	74.0	-13.6	3.89 H	258	39.0	21.4
2	5460.00	47.5 AV	54.0	-6.5	3.89 H	258	26.1	21.4
3	#5470.00	62.4 PK	68.2	-5.8	3.89 H	258	41.0	21.4
4	*5500.00	111.7 PK			3.89 H	258	70.2	41.5
5	*5500.00	102.1 AV			3.89 H	258	60.6	41.5
6	11000.00	63.1 PK	74.0	-10.9	3.31 H	225	36.4	26.7
7	11000.00	49.5 AV	54.0	-4.5	3.31 H	225	22.8	26.7

Antenna Polarity & Test Distance : Vertical at 3 m

No	Frequency (MHz)	Emission Level (dBuV/m)	Limit (dBuV/m)	Margin (dB)	Antenna Height (m)	Table Angle (Degree)	Raw Value (dBuV)	Correction Factor (dB/m)
1	5460.00	60.6 PK	74.0	-13.4	2.95 V	132	39.2	21.4
2	5460.00	47.8 AV	54.0	-6.2	2.95 V	132	26.4	21.4
3	#5470.00	67.2 PK	68.2	-1.0	2.95 V	132	45.8	21.4
4	*5500.00	115.6 PK			2.95 V	132	74.1	41.5
5	*5500.00	105.6 AV			2.95 V	132	64.1	41.5
6	11000.00	63.2 PK	74.0	-10.8	2.71 V	192	36.5	26.7
7	11000.00	49.7 AV	54.0	-4.3	2.71 V	192	23.0	26.7

Remarks:

1. Emission Level(dBuV/m) = Raw Value(dBuV) + Correction Factor(dB/m)
2. Correction Factor(dB/m) = Antenna Factor(dB/m) + Cable Factor(dB) – Pre-Amplifier Factor(dB)
3. Margin value = Emission Level – Limit value
4. The other emission levels were very low against the limit.
5. " * " : Fundamental frequency, the limit was restricted at the RF Output Power.
6. " # " : The radiated frequency is out of the restricted band.



RF Mode	802.11a	Channel	CH 116 : 5580 MHz
Frequency Range	1 GHz ~ 40 GHz	Detector Function & Bandwidth	(PK) RB = 1 MHz, VB = 3 MHz (AV) RB = 1 MHz, VB = 1 kHz
Input Power	120 Vac, 60 Hz	Environmental Conditions	23°C, 67% RH
Tested By	Adair Peng		

Antenna Polarity & Test Distance : Horizontal at 3 m

No	Frequency (MHz)	Emission Level (dBuV/m)	Limit (dBuV/m)	Margin (dB)	Antenna Height (m)	Table Angle (Degree)	Raw Value (dBuV)	Correction Factor (dB/m)
1	*5580.00	114.1 PK			3.71 H	259	72.5	41.6
2	*5580.00	105.4 AV			3.71 H	259	63.8	41.6
3	11160.00	62.2 PK	74.0	-11.8	3.09 H	228	36.4	25.8
4	11160.00	48.9 AV	54.0	-5.1	3.09 H	228	23.1	25.8

Antenna Polarity & Test Distance : Vertical at 3 m

No	Frequency (MHz)	Emission Level (dBuV/m)	Limit (dBuV/m)	Margin (dB)	Antenna Height (m)	Table Angle (Degree)	Raw Value (dBuV)	Correction Factor (dB/m)
1	*5580.00	118.2 PK			2.43 V	324	76.6	41.6
2	*5580.00	109.0 AV			2.43 V	324	67.4	41.6
3	11160.00	62.5 PK	74.0	-11.5	2.64 V	195	36.7	25.8
4	11160.00	49.2 AV	54.0	-4.8	2.64 V	195	23.4	25.8

Remarks:

1. Emission Level(dBuV/m) = Raw Value(dBuV) + Correction Factor(dB/m)
2. Correction Factor(dB/m) = Antenna Factor(dB/m) + Cable Factor(dB) – Pre-Amplifier Factor(dB)
3. Margin value = Emission Level – Limit value
4. The other emission levels were very low against the limit.
5. " * " : Fundamental frequency, the limit was restricted at the RF Output Power.

RF Mode	802.11a	Channel	CH 140 : 5700 MHz
Frequency Range	1 GHz ~ 40 GHz	Detector Function & Bandwidth	(PK) RB = 1 MHz, VB = 3 MHz (AV) RB = 1 MHz, VB = 1 kHz
Input Power	120 Vac, 60 Hz	Environmental Conditions	23°C, 67% RH
Tested By	Adair Peng		

Antenna Polarity & Test Distance : Horizontal at 3 m

No	Frequency (MHz)	Emission Level (dBuV/m)	Limit (dBuV/m)	Margin (dB)	Antenna Height (m)	Table Angle (Degree)	Raw Value (dBuV)	Correction Factor (dB/m)
1	*5700.00	112.3 PK			3.90 H	261	70.6	41.7
2	*5700.00	102.1 AV			3.90 H	261	60.4	41.7
3	#5725.00	65.3 PK	68.2	-2.9	3.90 H	261	43.1	22.2
4	11400.00	63.1 PK	74.0	-10.9	2.97 H	225	36.1	27.0
5	11400.00	49.8 AV	54.0	-4.2	2.97 H	225	22.8	27.0

Antenna Polarity & Test Distance : Vertical at 3 m

No	Frequency (MHz)	Emission Level (dBuV/m)	Limit (dBuV/m)	Margin (dB)	Antenna Height (m)	Table Angle (Degree)	Raw Value (dBuV)	Correction Factor (dB/m)
1	*5700.00	115.9 PK			2.77 V	132	74.2	41.7
2	*5700.00	105.5 AV			2.77 V	132	63.8	41.7
3	#5725.00	67.8 PK	68.2	-0.4	2.77 V	132	45.6	22.2
4	11400.00	63.4 PK	74.0	-10.6	2.75 V	205	36.4	27.0
5	11400.00	50.0 AV	54.0	-4.0	2.75 V	205	23.0	27.0

Remarks:

1. Emission Level(dBuV/m) = Raw Value(dBuV) + Correction Factor(dB/m)
2. Correction Factor(dB/m) = Antenna Factor(dB/m) + Cable Factor(dB) – Pre-Amplifier Factor(dB)
3. Margin value = Emission Level – Limit value
4. The other emission levels were very low against the limit.
5. " * " : Fundamental frequency, the limit was restricted at the RF Output Power.
6. " # " : The radiated frequency is out of the restricted band.

RF Mode	802.11a	Channel	CH 144 : 5720 MHz
Frequency Range	1 GHz ~ 40 GHz	Detector Function & Bandwidth	(PK) RB = 1 MHz, VB = 3 MHz (AV) RB = 1 MHz, VB = 1 kHz
Input Power	120 Vac, 60 Hz	Environmental Conditions	23°C, 67% RH
Tested By	Adair Peng		

Antenna Polarity & Test Distance : Horizontal at 3 m

No	Frequency (MHz)	Emission Level (dBUV/m)	Limit (dBUV/m)	Margin (dB)	Antenna Height (m)	Table Angle (Degree)	Raw Value (dBUV)	Correction Factor (dB/m)
1	#5470.00	60.8 PK	68.2	-7.4	3.75 H	252	39.4	21.4
2	*5720.00	115.0 PK			3.75 H	252	73.1	41.9
3	*5720.00	105.2 AV			3.75 H	252	63.3	41.9
4	#5850.00	61.8 PK	68.2	-6.4	3.75 H	252	39.3	22.5
5	11440.00	63.6 PK	74.0	-10.4	3.09 H	230	36.5	27.1
6	11440.00	50.1 AV	54.0	-3.9	3.09 H	230	23.0	27.1

Antenna Polarity & Test Distance : Vertical at 3 m

No	Frequency (MHz)	Emission Level (dBUV/m)	Limit (dBUV/m)	Margin (dB)	Antenna Height (m)	Table Angle (Degree)	Raw Value (dBUV)	Correction Factor (dB/m)
1	#5470.00	60.9 PK	68.2	-7.3	2.59 V	132	39.5	21.4
2	*5720.00	118.6 PK			2.59 V	132	76.7	41.9
3	*5720.00	108.7 AV			2.59 V	132	66.8	41.9
4	#5850.00	61.9 PK	68.2	-6.3	2.59 V	132	39.4	22.5
5	11440.00	63.8 PK	74.0	-10.2	2.63 V	192	36.7	27.1
6	11440.00	50.2 AV	54.0	-3.8	2.63 V	192	23.1	27.1

Remarks:

1. Emission Level(dBUV/m) = Raw Value(dBUV) + Correction Factor(dB/m)
2. Correction Factor(dB/m) = Antenna Factor(dB/m) + Cable Factor(dB) – Pre-Amplifier Factor(dB)
3. Margin value = Emission Level – Limit value
4. The other emission levels were very low against the limit.
5. " * " : Fundamental frequency, the limit was restricted at the RF Output Power.
6. " # " : The radiated frequency is out of the restricted band.

RF Mode	802.11ac (VHT20)	Channel	CH 52 : 5260 MHz
Frequency Range	1 GHz ~ 40 GHz	Detector Function & Bandwidth	(PK) RB = 1 MHz, VB = 3 MHz (AV) RB = 1 MHz, VB = 1 kHz
Input Power	120 Vac, 60 Hz	Environmental Conditions	23°C, 67% RH
Tested By	Adair Peng		

Antenna Polarity & Test Distance : Horizontal at 3 m

No	Frequency (MHz)	Emission Level (dBuV/m)	Limit (dBuV/m)	Margin (dB)	Antenna Height (m)	Table Angle (Degree)	Raw Value (dBuV)	Correction Factor (dB/m)
1	5150.00	61.1 PK	74.0	-12.9	3.79 H	252	40.1	21.0
2	5150.00	48.0 AV	54.0	-6.0	3.79 H	252	27.0	21.0
3	*5260.00	115.7 PK			3.79 H	252	74.9	40.8
4	*5260.00	105.5 AV			3.79 H	252	64.7	40.8
5	#10520.00	62.0 PK	68.2	-6.2	2.99 H	227	37.0	25.0

Antenna Polarity & Test Distance : Vertical at 3 m

No	Frequency (MHz)	Emission Level (dBuV/m)	Limit (dBuV/m)	Margin (dB)	Antenna Height (m)	Table Angle (Degree)	Raw Value (dBuV)	Correction Factor (dB/m)
1	5150.00	61.2 PK	74.0	-12.8	2.81 V	293	40.2	21.0
2	5150.00	48.1 AV	54.0	-5.9	2.81 V	293	27.1	21.0
3	*5260.00	119.1 PK			2.81 V	293	78.3	40.8
4	*5260.00	109.2 AV			2.81 V	293	68.4	40.8
5	#10520.00	62.3 PK	68.2	-5.9	2.63 V	179	37.3	25.0

Remarks:

1. Emission Level(dBuV/m) = Raw Value(dBuV) + Correction Factor(dB/m)
2. Correction Factor(dB/m) = Antenna Factor(dB/m) + Cable Factor(dB) – Pre-Amplifier Factor(dB)
3. Margin value = Emission Level – Limit value
4. The other emission levels were very low against the limit.
5. " * ": Fundamental frequency, the limit was restricted at the RF Output Power.
6. " # ": The radiated frequency is out of the restricted band.

RF Mode	802.11ac (VHT20)	Channel	CH 60 : 5300 MHz
Frequency Range	1 GHz ~ 40 GHz	Detector Function & Bandwidth	(PK) RB = 1 MHz, VB = 3 MHz (AV) RB = 1 MHz, VB = 1 kHz
Input Power	120 Vac, 60 Hz	Environmental Conditions	23°C, 67% RH
Tested By	Adair Peng		

Antenna Polarity & Test Distance : Horizontal at 3 m

No	Frequency (MHz)	Emission Level (dBuV/m)	Limit (dBuV/m)	Margin (dB)	Antenna Height (m)	Table Angle (Degree)	Raw Value (dBuV)	Correction Factor (dB/m)
1	*5300.00	116.2 PK			3.82 H	260	75.4	40.8
2	*5300.00	106.2 AV			3.82 H	260	65.4	40.8
3	5350.00	63.0 PK	74.0	-11.0	3.82 H	260	42.0	21.0
4	5350.00	49.1 AV	54.0	-4.9	3.82 H	260	28.1	21.0
5	10600.00	62.0 PK	74.0	-12.0	2.97 H	228	37.0	25.0
6	10600.00	49.0 AV	54.0	-5.0	2.97 H	228	24.0	25.0

Antenna Polarity & Test Distance : Vertical at 3 m

No	Frequency (MHz)	Emission Level (dBuV/m)	Limit (dBuV/m)	Margin (dB)	Antenna Height (m)	Table Angle (Degree)	Raw Value (dBuV)	Correction Factor (dB/m)
1	*5300.00	119.9 PK			2.80 V	327	79.1	40.8
2	*5300.00	109.6 AV			2.80 V	327	68.8	40.8
3	5350.00	69.3 PK	74.0	-4.7	2.80 V	327	48.3	21.0
4	5350.00	53.5 AV	54.0	-0.5	2.80 V	327	32.5	21.0
5	10600.00	62.2 PK	74.0	-11.8	2.69 V	174	37.2	25.0
6	10600.00	49.2 AV	54.0	-4.8	2.69 V	174	24.2	25.0

Remarks:

1. Emission Level(dBuV/m) = Raw Value(dBuV) + Correction Factor(dB/m)
2. Correction Factor(dB/m) = Antenna Factor(dB/m) + Cable Factor(dB) – Pre-Amplifier Factor(dB)
3. Margin value = Emission Level – Limit value
4. The other emission levels were very low against the limit.
5. " * ": Fundamental frequency, the limit was restricted at the RF Output Power.

RF Mode	802.11ac (VHT20)	Channel	CH 64 : 5320 MHz
Frequency Range	1 GHz ~ 40 GHz	Detector Function & Bandwidth	(PK) RB = 1 MHz, VB = 3 MHz (AV) RB = 1 MHz, VB = 1 kHz
Input Power	120 Vac, 60 Hz	Environmental Conditions	23°C, 67% RH
Tested By	Adair Peng		

Antenna Polarity & Test Distance : Horizontal at 3 m

No	Frequency (MHz)	Emission Level (dBuV/m)	Limit (dBuV/m)	Margin (dB)	Antenna Height (m)	Table Angle (Degree)	Raw Value (dBuV)	Correction Factor (dB/m)
1	*5320.00	113.3 PK			3.69 H	259	72.4	40.9
2	*5320.00	103.6 AV			3.69 H	259	62.7	40.9
3	5350.00	64.0 PK	74.0	-10.0	3.69 H	259	43.0	21.0
4	5350.00	50.0 AV	54.0	-4.0	3.69 H	259	29.0	21.0
5	10640.00	62.5 PK	74.0	-11.5	3.14 H	218	36.8	25.7
6	10640.00	49.5 AV	54.0	-4.5	3.14 H	218	23.8	25.7

Antenna Polarity & Test Distance : Vertical at 3 m

No	Frequency (MHz)	Emission Level (dBuV/m)	Limit (dBuV/m)	Margin (dB)	Antenna Height (m)	Table Angle (Degree)	Raw Value (dBuV)	Correction Factor (dB/m)
1	*5320.00	116.9 PK			2.90 V	329	76.0	40.9
2	*5320.00	107.4 AV			2.90 V	329	66.5	40.9
3	5350.00	69.0 PK	74.0	-5.0	2.90 V	329	48.0	21.0
4	5350.00	53.2 AV	54.0	-0.8	2.90 V	329	32.2	21.0
5	10640.00	62.7 PK	74.0	-11.3	2.65 V	177	37.0	25.7
6	10640.00	49.7 AV	54.0	-4.3	2.65 V	177	24.0	25.7

Remarks:

1. Emission Level(dBuV/m) = Raw Value(dBuV) + Correction Factor(dB/m)
2. Correction Factor(dB/m) = Antenna Factor(dB/m) + Cable Factor(dB) – Pre-Amplifier Factor(dB)
3. Margin value = Emission Level – Limit value
4. The other emission levels were very low against the limit.
5. " * ": Fundamental frequency, the limit was restricted at the RF Output Power.



RF Mode	802.11ac (VHT20)	Channel	CH 100 : 5500 MHz
Frequency Range	1 GHz ~ 40 GHz	Detector Function & Bandwidth	(PK) RB = 1 MHz, VB = 3 MHz (AV) RB = 1 MHz, VB = 1 kHz
Input Power	120 Vac, 60 Hz	Environmental Conditions	23°C, 67% RH
Tested By	Adair Peng		

Antenna Polarity & Test Distance : Horizontal at 3 m

No	Frequency (MHz)	Emission Level (dBuV/m)	Limit (dBuV/m)	Margin (dB)	Antenna Height (m)	Table Angle (Degree)	Raw Value (dBuV)	Correction Factor (dB/m)
1	5460.00	61.2 PK	74.0	-12.8	3.77 H	258	39.8	21.4
2	5460.00	47.9 AV	54.0	-6.1	3.77 H	258	26.5	21.4
3	#5470.00	63.4 PK	68.2	-4.8	3.77 H	258	42.0	21.4
4	*5500.00	113.2 PK			3.77 H	258	71.7	41.5
5	*5500.00	102.9 AV			3.77 H	258	61.4	41.5
6	11000.00	63.0 PK	74.0	-11.0	3.25 H	220	36.3	26.7
7	11000.00	49.6 AV	54.0	-4.4	3.25 H	220	22.9	26.7

Antenna Polarity & Test Distance : Vertical at 3 m

No	Frequency (MHz)	Emission Level (dBuV/m)	Limit (dBuV/m)	Margin (dB)	Antenna Height (m)	Table Angle (Degree)	Raw Value (dBuV)	Correction Factor (dB/m)
1	5460.00	61.5 PK	74.0	-12.5	2.94 V	127	40.1	21.4
2	5460.00	48.2 AV	54.0	-5.8	2.94 V	127	26.8	21.4
3	#5470.00	66.9 PK	68.2	-1.3	2.94 V	127	45.5	21.4
4	*5500.00	115.5 PK			2.94 V	127	74.0	41.5
5	*5500.00	106.4 AV			2.94 V	127	64.9	41.5
6	11000.00	63.3 PK	74.0	-10.7	2.68 V	197	36.6	26.7
7	11000.00	49.8 AV	54.0	-4.2	2.68 V	197	23.1	26.7

Remarks:

1. Emission Level(dBuV/m) = Raw Value(dBuV) + Correction Factor(dB/m)
2. Correction Factor(dB/m) = Antenna Factor(dB/m) + Cable Factor(dB) – Pre-Amplifier Factor(dB)
3. Margin value = Emission Level – Limit value
4. The other emission levels were very low against the limit.
5. " * " : Fundamental frequency, the limit was restricted at the RF Output Power.
6. " # " : The radiated frequency is out of the restricted band.



RF Mode	802.11ac (VHT20)	Channel	CH 116 : 5580 MHz
Frequency Range	1 GHz ~ 40 GHz	Detector Function & Bandwidth	(PK) RB = 1 MHz, VB = 3 MHz (AV) RB = 1 MHz, VB = 1 kHz
Input Power	120 Vac, 60 Hz	Environmental Conditions	23°C, 67% RH
Tested By	Adair Peng		

Antenna Polarity & Test Distance : Horizontal at 3 m

No	Frequency (MHz)	Emission Level (dBuV/m)	Limit (dBuV/m)	Margin (dB)	Antenna Height (m)	Table Angle (Degree)	Raw Value (dBuV)	Correction Factor (dB/m)
1	*5580.00	115.6 PK			3.64 H	252	74.0	41.6
2	*5580.00	106.0 AV			3.64 H	252	64.4	41.6
3	11160.00	62.4 PK	74.0	-11.6	3.13 H	218	36.6	25.8
4	11160.00	49.0 AV	54.0	-5.0	3.13 H	218	23.2	25.8

Antenna Polarity & Test Distance : Vertical at 3 m

No	Frequency (MHz)	Emission Level (dBuV/m)	Limit (dBuV/m)	Margin (dB)	Antenna Height (m)	Table Angle (Degree)	Raw Value (dBuV)	Correction Factor (dB/m)
1	*5580.00	119.5 PK			2.39 V	327	77.9	41.6
2	*5580.00	109.4 AV			2.39 V	327	67.8	41.6
3	11160.00	62.6 PK	74.0	-11.4	2.72 V	191	36.8	25.8
4	11160.00	49.3 AV	54.0	-4.7	2.72 V	191	23.5	25.8

Remarks:

1. Emission Level(dBuV/m) = Raw Value(dBuV) + Correction Factor(dB/m)
2. Correction Factor(dB/m) = Antenna Factor(dB/m) + Cable Factor(dB) – Pre-Amplifier Factor(dB)
3. Margin value = Emission Level – Limit value
4. The other emission levels were very low against the limit.
5. " * " : Fundamental frequency, the limit was restricted at the RF Output Power.

RF Mode	802.11ac (VHT20)	Channel	CH 140 : 5700 MHz
Frequency Range	1 GHz ~ 40 GHz	Detector Function & Bandwidth	(PK) RB = 1 MHz, VB = 3 MHz (AV) RB = 1 MHz, VB = 1 kHz
Input Power	120 Vac, 60 Hz	Environmental Conditions	23°C, 67% RH
Tested By	Adair Peng		

Antenna Polarity & Test Distance : Horizontal at 3 m

No	Frequency (MHz)	Emission Level (dBuV/m)	Limit (dBuV/m)	Margin (dB)	Antenna Height (m)	Table Angle (Degree)	Raw Value (dBuV)	Correction Factor (dB/m)
1	*5700.00	111.9 PK			3.82 H	255	70.2	41.7
2	*5700.00	102.3 AV			3.82 H	255	60.6	41.7
3	#5725.00	65.2 PK	68.2	-3.0	3.82 H	255	43.0	22.2
4	11400.00	63.3 PK	74.0	-10.7	3.25 H	222	36.3	27.0
5	11400.00	49.8 AV	54.0	-4.2	3.25 H	222	22.8	27.0

Antenna Polarity & Test Distance : Vertical at 3 m

No	Frequency (MHz)	Emission Level (dBuV/m)	Limit (dBuV/m)	Margin (dB)	Antenna Height (m)	Table Angle (Degree)	Raw Value (dBuV)	Correction Factor (dB/m)
1	*5700.00	115.8 PK			3.01 V	133	74.1	41.7
2	*5700.00	106.0 AV			3.01 V	133	64.3	41.7
3	#5725.00	67.7 PK	68.2	-0.5	3.01 V	133	45.5	22.2
4	11400.00	63.5 PK	74.0	-10.5	2.67 V	198	36.5	27.0
5	11400.00	50.1 AV	54.0	-3.9	2.67 V	198	23.1	27.0

Remarks:

1. Emission Level(dBuV/m) = Raw Value(dBuV) + Correction Factor(dB/m)
2. Correction Factor(dB/m) = Antenna Factor(dB/m) + Cable Factor(dB) – Pre-Amplifier Factor(dB)
3. Margin value = Emission Level – Limit value
4. The other emission levels were very low against the limit.
5. " * " : Fundamental frequency, the limit was restricted at the RF Output Power.
6. " # " : The radiated frequency is out of the restricted band.

RF Mode	802.11ac (VHT20)	Channel	CH 144 : 5720 MHz
Frequency Range	1 GHz ~ 40 GHz	Detector Function & Bandwidth	(PK) RB = 1 MHz, VB = 3 MHz (AV) RB = 1 MHz, VB = 1 kHz
Input Power	120 Vac, 60 Hz	Environmental Conditions	23°C, 67% RH
Tested By	Adair Peng		

Antenna Polarity & Test Distance : Horizontal at 3 m

No	Frequency (MHz)	Emission Level (dBuV/m)	Limit (dBuV/m)	Margin (dB)	Antenna Height (m)	Table Angle (Degree)	Raw Value (dBuV)	Correction Factor (dB/m)
1	#5470.00	61.4 PK	68.2	-6.8	3.84 H	254	40.0	21.4
2	*5720.00	116.5 PK			3.84 H	254	74.6	41.9
3	*5720.00	106.3 AV			3.84 H	254	64.4	41.9
4	#5850.00	61.8 PK	68.2	-6.4	3.84 H	254	39.3	22.5
5	11440.00	63.7 PK	74.0	-10.3	3.18 H	220	36.6	27.1
6	11440.00	50.1 AV	54.0	-3.9	3.18 H	220	23.0	27.1

Antenna Polarity & Test Distance : Vertical at 3 m

No	Frequency (MHz)	Emission Level (dBuV/m)	Limit (dBuV/m)	Margin (dB)	Antenna Height (m)	Table Angle (Degree)	Raw Value (dBuV)	Correction Factor (dB/m)
1	#5470.00	61.6 PK	68.2	-6.6	2.94 V	139	40.2	21.4
2	*5720.00	119.4 PK			2.94 V	139	77.5	41.9
3	*5720.00	109.7 AV			2.94 V	139	67.8	41.9
4	#5850.00	61.9 PK	68.2	-6.3	2.94 V	139	39.4	22.5
5	11440.00	63.9 PK	74.0	-10.1	2.69 V	195	36.8	27.1
6	11440.00	50.4 AV	54.0	-3.6	2.69 V	195	23.3	27.1

Remarks:

1. Emission Level(dBuV/m) = Raw Value(dBuV) + Correction Factor(dB/m)
2. Correction Factor(dB/m) = Antenna Factor(dB/m) + Cable Factor(dB) – Pre-Amplifier Factor(dB)
3. Margin value = Emission Level – Limit value
4. The other emission levels were very low against the limit.
5. " * ": Fundamental frequency, the limit was restricted at the RF Output Power.
6. " # ": The radiated frequency is out of the restricted band.



RF Mode	802.11ac (VHT40)	Channel	CH 54 : 5270 MHz
Frequency Range	1 GHz ~ 40 GHz	Detector Function & Bandwidth	(PK) RB = 1 MHz, VB = 3 MHz (AV) RB = 1 MHz, VB = 1 kHz
Input Power	120 Vac, 60 Hz	Environmental Conditions	23°C, 67% RH
Tested By	Adair Peng		

Antenna Polarity & Test Distance : Horizontal at 3 m

No	Frequency (MHz)	Emission Level (dBuV/m)	Limit (dBuV/m)	Margin (dB)	Antenna Height (m)	Table Angle (Degree)	Raw Value (dBuV)	Correction Factor (dB/m)
1	5150.00	60.6 PK	74.0	-13.4	3.78 H	255	39.6	21.0
2	5150.00	47.4 AV	54.0	-6.6	3.78 H	255	26.4	21.0
3	*5270.00	110.8 PK			3.78 H	255	70.0	40.8
4	*5270.00	100.7 AV			3.78 H	255	59.9	40.8
5	5350.00	61.8 PK	74.0	-12.2	3.78 H	255	40.8	21.0
6	5350.00	48.1 AV	54.0	-5.9	3.78 H	255	27.1	21.0
7	#10540.00	62.2 PK	68.2	-6.0	3.22 H	223	37.1	25.1

Antenna Polarity & Test Distance : Vertical at 3 m

No	Frequency (MHz)	Emission Level (dBuV/m)	Limit (dBuV/m)	Margin (dB)	Antenna Height (m)	Table Angle (Degree)	Raw Value (dBuV)	Correction Factor (dB/m)
1	5150.00	61.4 PK	74.0	-12.6	2.90 V	332	40.4	21.0
2	5150.00	48.4 AV	54.0	-5.6	2.90 V	332	27.4	21.0
3	*5270.00	114.9 PK			2.90 V	332	74.1	40.8
4	*5270.00	104.1 AV			2.90 V	332	63.3	40.8
5	5350.00	69.0 PK	74.0	-5.0	2.90 V	332	48.0	21.0
6	5350.00	53.1 AV	54.0	-0.9	2.90 V	332	32.1	21.0
7	#10540.00	62.5 PK	68.2	-5.7	2.69 V	191	37.4	25.1

Remarks:

1. Emission Level(dBuV/m) = Raw Value(dBuV) + Correction Factor(dB/m)
2. Correction Factor(dB/m) = Antenna Factor(dB/m) + Cable Factor(dB) – Pre-Amplifier Factor(dB)
3. Margin value = Emission Level – Limit value
4. The other emission levels were very low against the limit.
5. " * " : Fundamental frequency, the limit was restricted at the RF Output Power.
6. " # " : The radiated frequency is out of the restricted band.

RF Mode	802.11ac (VHT40)	Channel	CH 62 : 5310 MHz
Frequency Range	1 GHz ~ 40 GHz	Detector Function & Bandwidth	(PK) RB = 1 MHz, VB = 3 MHz (AV) RB = 1 MHz, VB = 1 kHz
Input Power	120 Vac, 60 Hz	Environmental Conditions	23°C, 67% RH
Tested By	Adair Peng		

Antenna Polarity & Test Distance : Horizontal at 3 m

No	Frequency (MHz)	Emission Level (dBuV/m)	Limit (dBuV/m)	Margin (dB)	Antenna Height (m)	Table Angle (Degree)	Raw Value (dBuV)	Correction Factor (dB/m)
1	*5310.00	107.9 PK			3.82 H	256	67.1	40.8
2	*5310.00	97.8 AV			3.82 H	256	57.0	40.8
3	5350.00	65.7 PK	74.0	-8.3	3.82 H	256	44.7	21.0
4	5350.00	50.1 AV	54.0	-3.9	3.82 H	256	29.1	21.0
5	10620.00	62.2 PK	74.0	-11.8	3.30 H	229	36.9	25.3
6	10620.00	49.1 AV	54.0	-4.9	3.30 H	229	23.8	25.3

Antenna Polarity & Test Distance : Vertical at 3 m

No	Frequency (MHz)	Emission Level (dBuV/m)	Limit (dBuV/m)	Margin (dB)	Antenna Height (m)	Table Angle (Degree)	Raw Value (dBuV)	Correction Factor (dB/m)
1	*5310.00	111.7 PK			2.73 V	330	70.9	40.8
2	*5310.00	101.3 AV			2.73 V	330	60.5	40.8
3	5350.00	67.5 PK	74.0	-6.5	2.73 V	330	46.5	21.0
4	5350.00	53.2 AV	54.0	-0.8	2.73 V	330	32.2	21.0
5	10620.00	62.5 PK	74.0	-11.5	2.60 V	195	37.2	25.3
6	10620.00	49.3 AV	54.0	-4.7	2.60 V	195	24.0	25.3

Remarks:

1. Emission Level(dBuV/m) = Raw Value(dBuV) + Correction Factor(dB/m)
2. Correction Factor(dB/m) = Antenna Factor(dB/m) + Cable Factor(dB) – Pre-Amplifier Factor(dB)
3. Margin value = Emission Level – Limit value
4. The other emission levels were very low against the limit.
5. " * ": Fundamental frequency, the limit was restricted at the RF Output Power.



RF Mode	802.11ac (VHT40)	Channel	CH 102 : 5510 MHz
Frequency Range	1 GHz ~ 40 GHz	Detector Function & Bandwidth	(PK) RB = 1 MHz, VB = 3 MHz (AV) RB = 1 MHz, VB = 1 kHz
Input Power	120 Vac, 60 Hz	Environmental Conditions	23°C, 67% RH
Tested By	Adair Peng		

Antenna Polarity & Test Distance : Horizontal at 3 m

No	Frequency (MHz)	Emission Level (dBuV/m)	Limit (dBuV/m)	Margin (dB)	Antenna Height (m)	Table Angle (Degree)	Raw Value (dBuV)	Correction Factor (dB/m)
1	5460.00	60.6 PK	74.0	-13.4	3.79 H	255	39.2	21.4
2	5460.00	48.1 AV	54.0	-5.9	3.79 H	255	26.7	21.4
3	#5470.00	63.9 PK	68.2	-4.3	3.79 H	255	42.5	21.4
4	*5510.00	107.9 PK			3.79 H	255	66.4	41.5
5	*5510.00	97.8 AV			3.79 H	255	56.3	41.5
6	11020.00	63.3 PK	74.0	-10.7	3.12 H	223	36.6	26.7
7	11020.00	49.6 AV	54.0	-4.4	3.12 H	223	22.9	26.7

Antenna Polarity & Test Distance : Vertical at 3 m

No	Frequency (MHz)	Emission Level (dBuV/m)	Limit (dBuV/m)	Margin (dB)	Antenna Height (m)	Table Angle (Degree)	Raw Value (dBuV)	Correction Factor (dB/m)
1	5460.00	62.1 PK	74.0	-11.9	2.91 V	130	40.7	21.4
2	5460.00	48.5 AV	54.0	-5.5	2.91 V	130	27.1	21.4
3	#5470.00	67.6 PK	68.2	-0.6	2.91 V	130	46.2	21.4
4	*5510.00	111.6 PK			2.91 V	130	70.1	41.5
5	*5510.00	101.1 AV			2.91 V	130	59.6	41.5
6	11020.00	63.6 PK	74.0	-10.4	2.61 V	191	36.9	26.7
7	11020.00	49.8 AV	54.0	-4.2	2.61 V	191	23.1	26.7

Remarks:

1. Emission Level(dBuV/m) = Raw Value(dBuV) + Correction Factor(dB/m)
2. Correction Factor(dB/m) = Antenna Factor(dB/m) + Cable Factor(dB) – Pre-Amplifier Factor(dB)
3. Margin value = Emission Level – Limit value
4. The other emission levels were very low against the limit.
5. " * " : Fundamental frequency, the limit was restricted at the RF Output Power.
6. " # " : The radiated frequency is out of the restricted band.



RF Mode	802.11ac (VHT40)	Channel	CH 110 : 5550 MHz
Frequency Range	1 GHz ~ 40 GHz	Detector Function & Bandwidth	(PK) RB = 1 MHz, VB = 3 MHz (AV) RB = 1 MHz, VB = 1 kHz
Input Power	120 Vac, 60 Hz	Environmental Conditions	23°C, 67% RH
Tested By	Adair Peng		

Antenna Polarity & Test Distance : Horizontal at 3 m

No	Frequency (MHz)	Emission Level (dBuV/m)	Limit (dBuV/m)	Margin (dB)	Antenna Height (m)	Table Angle (Degree)	Raw Value (dBuV)	Correction Factor (dB/m)
1	5460.00	64.6 PK	74.0	-9.4	3.89 H	256	43.2	21.4
2	5460.00	50.2 AV	54.0	-3.8	3.89 H	256	28.8	21.4
3	#5470.00	66.4 PK	68.2	-1.8	3.89 H	256	45.0	21.4
4	*5550.00	111.5 PK			3.89 H	256	70.0	41.5
5	*5550.00	101.5 AV			3.89 H	256	60.0	41.5
6	11100.00	62.8 PK	74.0	-11.2	3.21 H	226	36.6	26.2
7	11100.00	49.1 AV	54.0	-4.9	3.21 H	226	22.9	26.2

Antenna Polarity & Test Distance : Vertical at 3 m

No	Frequency (MHz)	Emission Level (dBuV/m)	Limit (dBuV/m)	Margin (dB)	Antenna Height (m)	Table Angle (Degree)	Raw Value (dBuV)	Correction Factor (dB/m)
1	5460.00	65.7 PK	74.0	-8.3	2.42 V	332	44.3	21.4
2	5460.00	50.5 AV	54.0	-3.5	2.42 V	332	29.1	21.4
3	#5470.00	67.7 PK	68.2	-0.5	2.42 V	332	46.3	21.4
4	*5550.00	115.0 PK			2.42 V	332	73.5	41.5
5	*5550.00	105.1 AV			2.42 V	332	63.6	41.5
6	11100.00	63.0 PK	74.0	-11.0	2.69 V	197	36.8	26.2
7	11100.00	49.4 AV	54.0	-4.6	2.69 V	197	23.2	26.2

Remarks:

1. Emission Level(dBuV/m) = Raw Value(dBuV) + Correction Factor(dB/m)
2. Correction Factor(dB/m) = Antenna Factor(dB/m) + Cable Factor(dB) – Pre-Amplifier Factor(dB)
3. Margin value = Emission Level – Limit value
4. The other emission levels were very low against the limit.
5. " * " : Fundamental frequency, the limit was restricted at the RF Output Power.
6. " # " : The radiated frequency is out of the restricted band.

RF Mode	802.11ac (VHT40)	Channel	CH 134 : 5670 MHz
Frequency Range	1 GHz ~ 40 GHz	Detector Function & Bandwidth	(PK) RB = 1 MHz, VB = 3 MHz (AV) RB = 1 MHz, VB = 1 kHz
Input Power	120 Vac, 60 Hz	Environmental Conditions	23°C, 67% RH
Tested By	Adair Peng		

Antenna Polarity & Test Distance : Horizontal at 3 m

No	Frequency (MHz)	Emission Level (dBuV/m)	Limit (dBuV/m)	Margin (dB)	Antenna Height (m)	Table Angle (Degree)	Raw Value (dBuV)	Correction Factor (dB/m)
1	*5670.00	110.5 PK			3.93 H	251	68.8	41.7
2	*5670.00	100.2 AV			3.93 H	251	58.5	41.7
3	#5725.00	64.8 PK	68.2	-3.4	3.93 H	251	42.6	22.2
4	11340.00	63.0 PK	74.0	-11.0	3.12 H	228	36.6	26.4
5	11340.00	49.5 AV	54.0	-4.5	3.12 H	228	23.1	26.4

Antenna Polarity & Test Distance : Vertical at 3 m

No	Frequency (MHz)	Emission Level (dBuV/m)	Limit (dBuV/m)	Margin (dB)	Antenna Height (m)	Table Angle (Degree)	Raw Value (dBuV)	Correction Factor (dB/m)
1	*5670.00	114.1 PK			2.86 V	132	72.4	41.7
2	*5670.00	103.6 AV			2.86 V	132	61.9	41.7
3	#5725.00	67.4 PK	68.2	-0.8	2.86 V	132	45.2	22.2
4	11340.00	63.4 PK	74.0	-10.6	2.72 V	192	37.0	26.4
5	11340.00	49.8 AV	54.0	-4.2	2.72 V	192	23.4	26.4

Remarks:

1. Emission Level(dBuV/m) = Raw Value(dBuV) + Correction Factor(dB/m)
2. Correction Factor(dB/m) = Antenna Factor(dB/m) + Cable Factor(dB) – Pre-Amplifier Factor(dB)
3. Margin value = Emission Level – Limit value
4. The other emission levels were very low against the limit.
5. " * " : Fundamental frequency, the limit was restricted at the RF Output Power.
6. " # " : The radiated frequency is out of the restricted band.

RF Mode	802.11ac (VHT40)	Channel	CH 142 : 5710 MHz
Frequency Range	1 GHz ~ 40 GHz	Detector Function & Bandwidth	(PK) RB = 1 MHz, VB = 3 MHz (AV) RB = 1 MHz, VB = 1 kHz
Input Power	120 Vac, 60 Hz	Environmental Conditions	23°C, 67% RH
Tested By	Adair Peng		

Antenna Polarity & Test Distance : Horizontal at 3 m

No	Frequency (MHz)	Emission Level (dBuV/m)	Limit (dBuV/m)	Margin (dB)	Antenna Height (m)	Table Angle (Degree)	Raw Value (dBuV)	Correction Factor (dB/m)
1	#5470.00	61.4 PK	68.2	-6.8	3.88 H	255	40.0	21.4
2	*5710.00	113.6 PK			3.88 H	255	71.8	41.8
3	*5710.00	103.3 AV			3.88 H	255	61.5	41.8
4	#5850.00	63.6 PK	68.2	-4.6	3.88 H	255	41.1	22.5
5	11420.00	63.9 PK	74.0	-10.1	3.08 H	231	36.8	27.1
6	11420.00	50.1 AV	54.0	-3.9	3.08 H	231	23.0	27.1

Antenna Polarity & Test Distance : Vertical at 3 m

No	Frequency (MHz)	Emission Level (dBuV/m)	Limit (dBuV/m)	Margin (dB)	Antenna Height (m)	Table Angle (Degree)	Raw Value (dBuV)	Correction Factor (dB/m)
1	#5470.00	61.5 PK	68.2	-6.7	2.95 V	135	40.1	21.4
2	*5710.00	117.1 PK			2.95 V	135	75.3	41.8
3	*5710.00	106.7 AV			2.95 V	135	64.9	41.8
4	#5850.00	64.9 PK	68.2	-3.3	2.95 V	135	42.4	22.5
5	11420.00	64.2 PK	74.0	-9.8	2.72 V	198	37.1	27.1
6	11420.00	50.5 AV	54.0	-3.5	2.72 V	198	23.4	27.1

Remarks:

1. Emission Level(dBuV/m) = Raw Value(dBuV) + Correction Factor(dB/m)
2. Correction Factor(dB/m) = Antenna Factor(dB/m) + Cable Factor(dB) – Pre-Amplifier Factor(dB)
3. Margin value = Emission Level – Limit value
4. The other emission levels were very low against the limit.
5. " * " : Fundamental frequency, the limit was restricted at the RF Output Power.
6. " # " : The radiated frequency is out of the restricted band.

RF Mode	802.11ac (VHT80)	Channel	CH 58 : 5290 MHz
Frequency Range	1 GHz ~ 40 GHz	Detector Function & Bandwidth	(PK) RB = 1 MHz, VB = 3 MHz (AV) RB = 1 MHz, VB = 1 kHz
Input Power	120 Vac, 60 Hz	Environmental Conditions	23°C, 67% RH
Tested By	Adair Peng		

Antenna Polarity & Test Distance : Horizontal at 3 m

No	Frequency (MHz)	Emission Level (dBuV/m)	Limit (dBuV/m)	Margin (dB)	Antenna Height (m)	Table Angle (Degree)	Raw Value (dBuV)	Correction Factor (dB/m)
1	*5290.00	104.2 PK			3.83 H	252	63.4	40.8
2	*5290.00	94.2 AV			3.83 H	252	53.4	40.8
3	5350.00	64.2 PK	74.0	-9.8	3.83 H	252	43.2	21.0
4	5350.00	49.2 AV	54.0	-4.8	3.83 H	252	28.2	21.0
5	#10580.00	62.0 PK	68.2	-6.2	3.33 H	218	37.0	25.0

Antenna Polarity & Test Distance : Vertical at 3 m

No	Frequency (MHz)	Emission Level (dBuV/m)	Limit (dBuV/m)	Margin (dB)	Antenna Height (m)	Table Angle (Degree)	Raw Value (dBuV)	Correction Factor (dB/m)
1	*5290.00	108.1 PK			2.98 V	330	67.3	40.8
2	*5290.00	97.5 AV			2.98 V	330	56.7	40.8
3	5350.00	69.9 PK	74.0	-4.1	2.98 V	330	48.9	21.0
4	5350.00	53.0 AV	54.0	-1.0	2.98 V	330	32.0	21.0
5	#10580.00	62.2 PK	68.2	-6.0	2.63 V	201	37.2	25.0

Remarks:

1. Emission Level(dBuV/m) = Raw Value(dBuV) + Correction Factor(dB/m)
2. Correction Factor(dB/m) = Antenna Factor(dB/m) + Cable Factor(dB) – Pre-Amplifier Factor(dB)
3. Margin value = Emission Level – Limit value
4. The other emission levels were very low against the limit.
5. " * ": Fundamental frequency, the limit was restricted at the RF Output Power.
6. " # ": The radiated frequency is out of the restricted band.



RF Mode	802.11ac (VHT80)	Channel	CH 106 : 5530 MHz
Frequency Range	1 GHz ~ 40 GHz	Detector Function & Bandwidth	(PK) RB = 1 MHz, VB = 3 MHz (AV) RB = 1 MHz, VB = 1 kHz
Input Power	120 Vac, 60 Hz	Environmental Conditions	23°C, 67% RH
Tested By	Adair Peng		

Antenna Polarity & Test Distance : Horizontal at 3 m

No	Frequency (MHz)	Emission Level (dBuV/m)	Limit (dBuV/m)	Margin (dB)	Antenna Height (m)	Table Angle (Degree)	Raw Value (dBuV)	Correction Factor (dB/m)
1	5460.00	62.8 PK	74.0	-11.2	3.93 H	258	41.4	21.4
2	5460.00	49.9 AV	54.0	-4.1	3.93 H	258	28.5	21.4
3	#5470.00	65.5 PK	68.2	-2.7	3.93 H	258	44.1	21.4
4	*5530.00	105.0 PK			3.93 H	258	63.5	41.5
5	*5530.00	94.9 AV			3.93 H	258	53.4	41.5
6	11060.00	63.1 PK	74.0	-10.9	3.11 H	224	36.7	26.4
7	11060.00	49.5 AV	54.0	-4.5	3.11 H	224	23.1	26.4

Antenna Polarity & Test Distance : Vertical at 3 m

No	Frequency (MHz)	Emission Level (dBuV/m)	Limit (dBuV/m)	Margin (dB)	Antenna Height (m)	Table Angle (Degree)	Raw Value (dBuV)	Correction Factor (dB/m)
1	5460.00	64.0 PK	74.0	-10.0	2.55 V	329	42.6	21.4
2	5460.00	51.1 AV	54.0	-2.9	2.55 V	329	29.7	21.4
3	#5470.00	67.4 PK	68.2	-0.8	2.55 V	329	46.0	21.4
4	*5530.00	107.8 PK			2.55 V	329	66.3	41.5
5	*5530.00	98.2 AV			2.55 V	329	56.7	41.5
6	11060.00	63.2 PK	74.0	-10.8	2.63 V	193	36.8	26.4
7	11060.00	49.7 AV	54.0	-4.3	2.63 V	193	23.3	26.4

Remarks:

1. Emission Level(dBuV/m) = Raw Value(dBuV) + Correction Factor(dB/m)
2. Correction Factor(dB/m) = Antenna Factor(dB/m) + Cable Factor(dB) – Pre-Amplifier Factor(dB)
3. Margin value = Emission Level – Limit value
4. The other emission levels were very low against the limit.
5. " * " : Fundamental frequency, the limit was restricted at the RF Output Power.
6. " # " : The radiated frequency is out of the restricted band.



RF Mode	802.11ac (VHT80)	Channel	CH 122 : 5610 MHz
Frequency Range	1 GHz ~ 40 GHz	Detector Function & Bandwidth	(PK) RB = 1 MHz, VB = 3 MHz (AV) RB = 1 MHz, VB = 1 kHz
Input Power	120 Vac, 60 Hz	Environmental Conditions	23°C, 67% RH
Tested By	Adair Peng		

Antenna Polarity & Test Distance : Horizontal at 3 m

No	Frequency (MHz)	Emission Level (dBuV/m)	Limit (dBuV/m)	Margin (dB)	Antenna Height (m)	Table Angle (Degree)	Raw Value (dBuV)	Correction Factor (dB/m)
1	#5470.00	63.4 PK	68.2	-4.8	3.77 H	258	42.0	21.4
2	*5610.00	107.1 PK			3.77 H	258	65.5	41.6
3	*5610.00	96.9 AV			3.77 H	258	55.3	41.6
4	#5725.00	63.2 PK	68.2	-5.0	3.77 H	258	41.0	22.2
5	11220.00	62.5 PK	74.0	-11.5	3.19 H	224	36.7	25.8
6	11220.00	48.8 AV	54.0	-5.2	3.19 H	224	23.0	25.8

Antenna Polarity & Test Distance : Vertical at 3 m

No	Frequency (MHz)	Emission Level (dBuV/m)	Limit (dBuV/m)	Margin (dB)	Antenna Height (m)	Table Angle (Degree)	Raw Value (dBuV)	Correction Factor (dB/m)
1	#5470.00	65.9 PK	68.2	-2.3	2.53 V	323	44.5	21.4
2	*5610.00	110.4 PK			2.53 V	323	68.8	41.6
3	*5610.00	100.5 AV			2.53 V	323	58.9	41.6
4	#5725.00	67.2 PK	68.2	-1.0	2.53 V	323	45.0	22.2
5	11220.00	62.7 PK	74.0	-11.3	2.67 V	190	36.9	25.8
6	11220.00	49.1 AV	54.0	-4.9	2.67 V	190	23.3	25.8

Remarks:

1. Emission Level(dBuV/m) = Raw Value(dBuV) + Correction Factor(dB/m)
2. Correction Factor(dB/m) = Antenna Factor(dB/m) + Cable Factor(dB) – Pre-Amplifier Factor(dB)
3. Margin value = Emission Level – Limit value
4. The other emission levels were very low against the limit.
5. " * " : Fundamental frequency, the limit was restricted at the RF Output Power.
6. " # " : The radiated frequency is out of the restricted band.

RF Mode	802.11ac (VHT80)	Channel	CH 138 : 5690 MHz
Frequency Range	1 GHz ~ 40 GHz	Detector Function & Bandwidth	(PK) RB = 1 MHz, VB = 3 MHz (AV) RB = 1 MHz, VB = 1 kHz
Input Power	120 Vac, 60 Hz	Environmental Conditions	23°C, 67% RH
Tested By	Adair Peng		

Antenna Polarity & Test Distance : Horizontal at 3 m

No	Frequency (MHz)	Emission Level (dBuV/m)	Limit (dBuV/m)	Margin (dB)	Antenna Height (m)	Table Angle (Degree)	Raw Value (dBuV)	Correction Factor (dB/m)
1	#5470.00	62.4 PK	68.2	-5.8	3.86 H	255	41.0	21.4
2	*5690.00	109.4 PK			3.86 H	255	67.7	41.7
3	*5690.00	99.3 AV			3.86 H	255	57.6	41.7
4	#5850.00	65.0 PK	68.2	-3.2	3.86 H	255	42.5	22.5
5	11380.00	63.6 PK	74.0	-10.4	3.08 H	223	36.8	26.8
6	11380.00	50.0 AV	54.0	-4.0	3.08 H	223	23.2	26.8

Antenna Polarity & Test Distance : Vertical at 3 m

No	Frequency (MHz)	Emission Level (dBuV/m)	Limit (dBuV/m)	Margin (dB)	Antenna Height (m)	Table Angle (Degree)	Raw Value (dBuV)	Correction Factor (dB/m)
1	#5470.00	62.9 PK	68.2	-5.3	2.65 V	131	41.5	21.4
2	*5690.00	112.8 PK			2.65 V	131	71.1	41.7
3	*5690.00	102.9 AV			2.65 V	131	61.2	41.7
4	#5850.00	67.7 PK	68.2	-0.5	2.65 V	131	45.2	22.5
5	11380.00	63.8 PK	74.0	-10.2	2.72 V	193	37.0	26.8
6	11380.00	50.2 AV	54.0	-3.8	2.72 V	193	23.4	26.8

Remarks:

1. Emission Level(dBuV/m) = Raw Value(dBuV) + Correction Factor(dB/m)
2. Correction Factor(dB/m) = Antenna Factor(dB/m) + Cable Factor(dB) – Pre-Amplifier Factor(dB)
3. Margin value = Emission Level – Limit value
4. The other emission levels were very low against the limit.
5. " * " : Fundamental frequency, the limit was restricted at the RF Output Power.
6. " # " : The radiated frequency is out of the restricted band.

Mode B

802.11a Channel 52

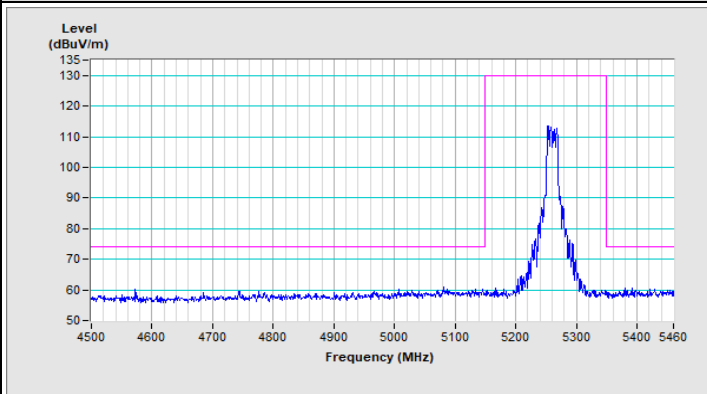

Horizontal (Peak)

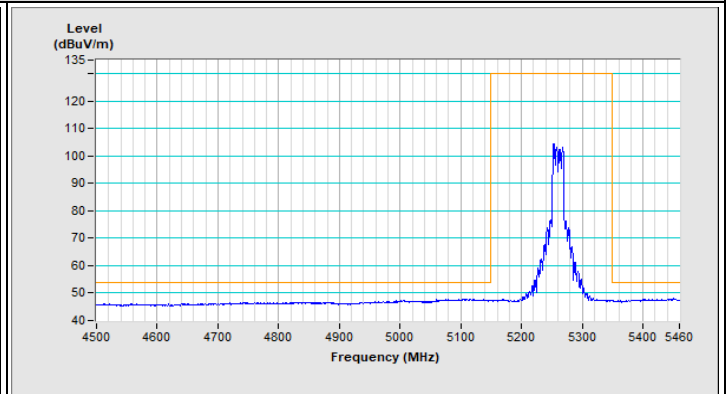

Horizontal (Average)

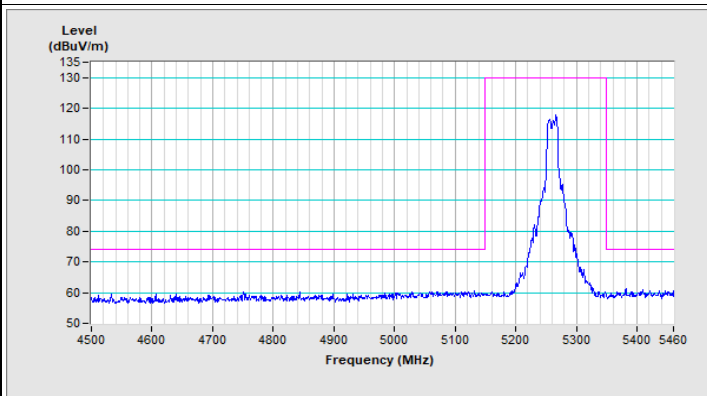

Vertical (Peak)

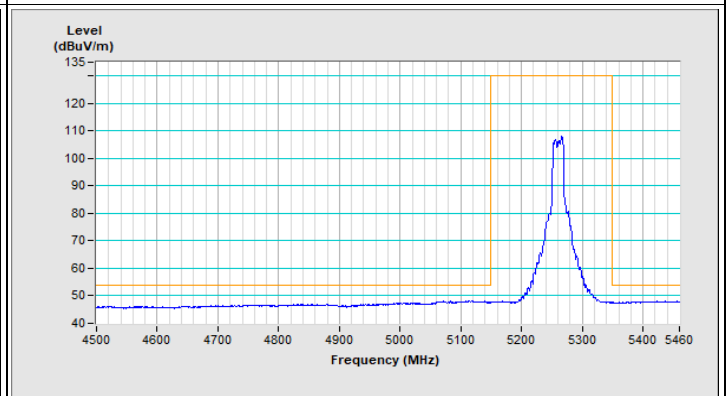

Vertical (Average)

802.11a Channel 64

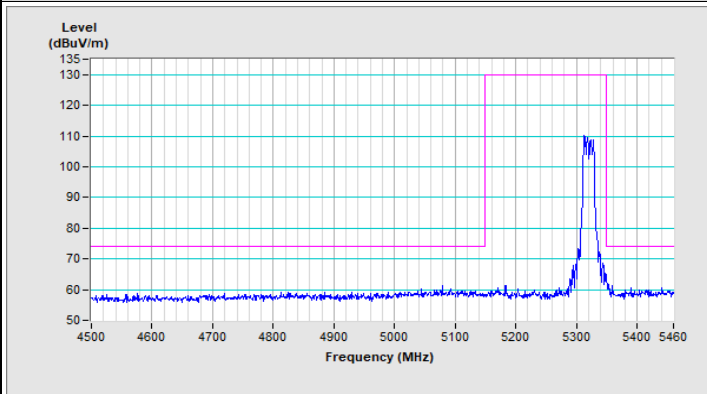

Horizontal (Peak)

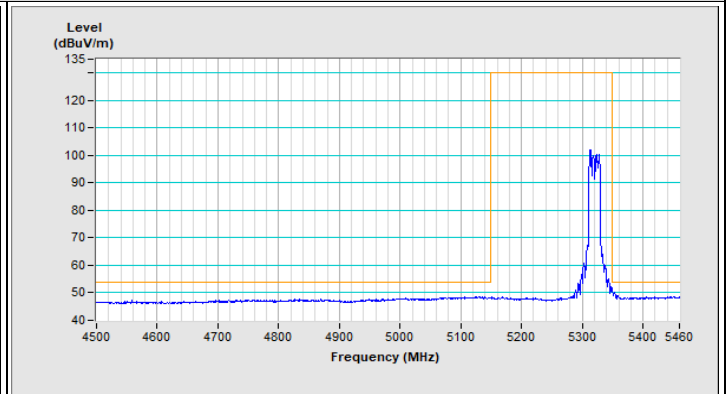

Horizontal (Average)

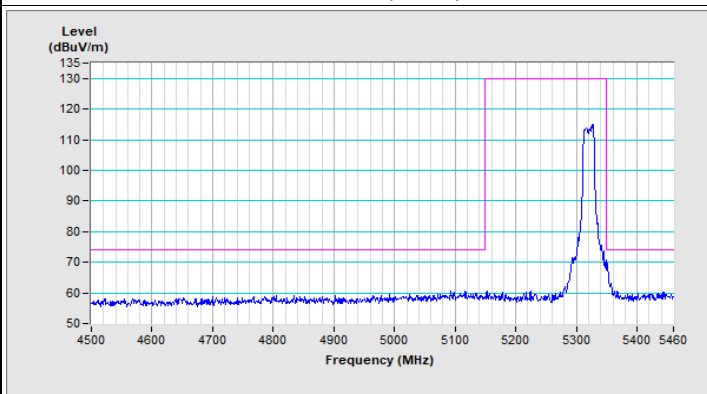

Vertical (Peak)

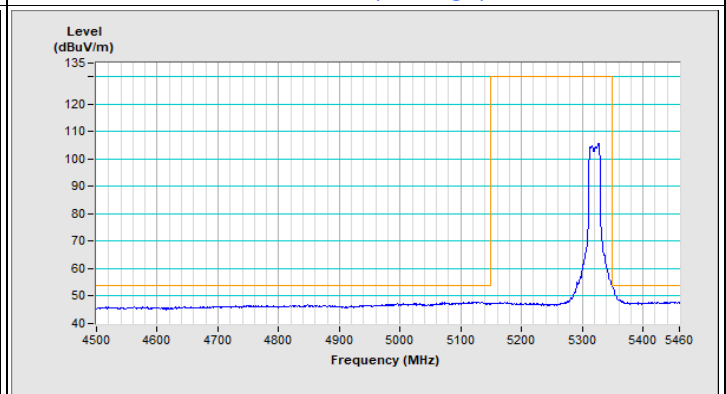

Vertical (Average)

802.11a Channel 100

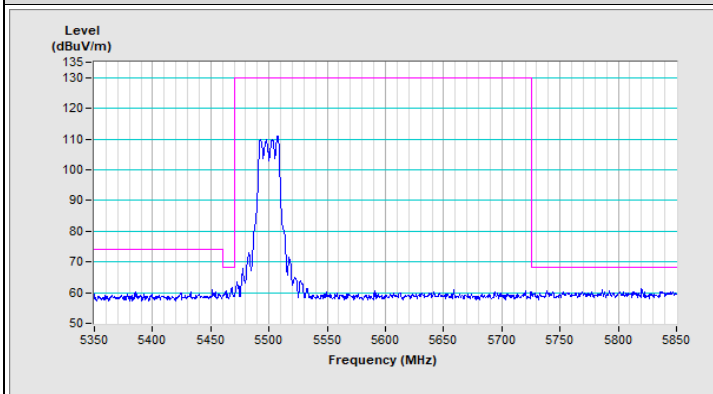

Horizontal (Peak)

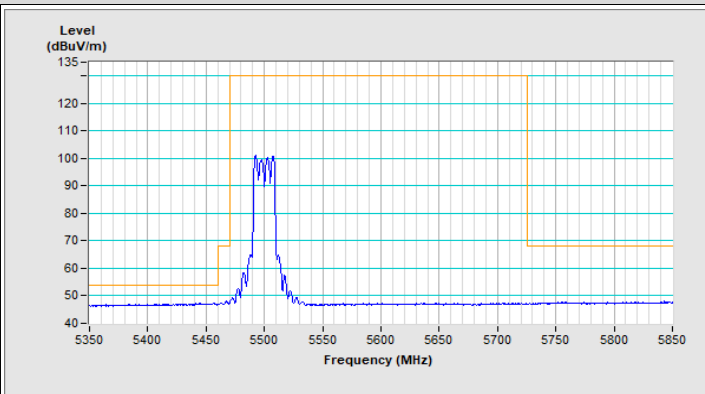

Horizontal (Average)

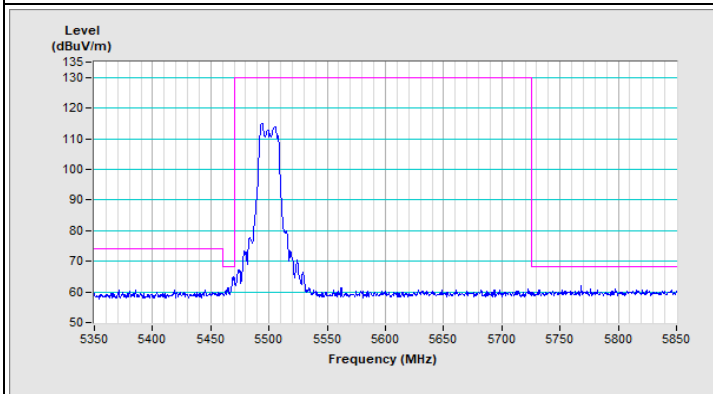

Vertical (Peak)

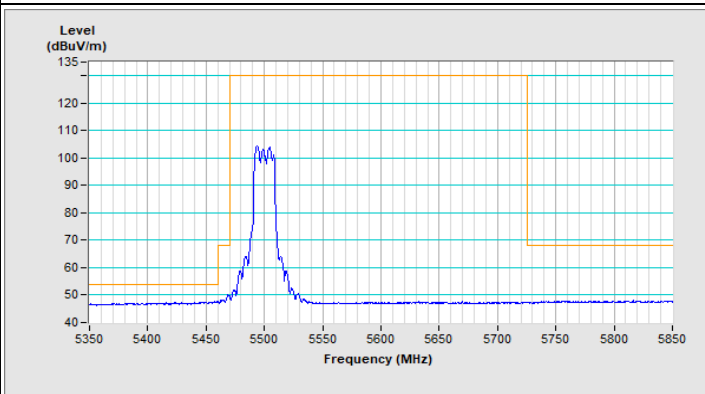

Vertical (Average)

802.11a Channel 140

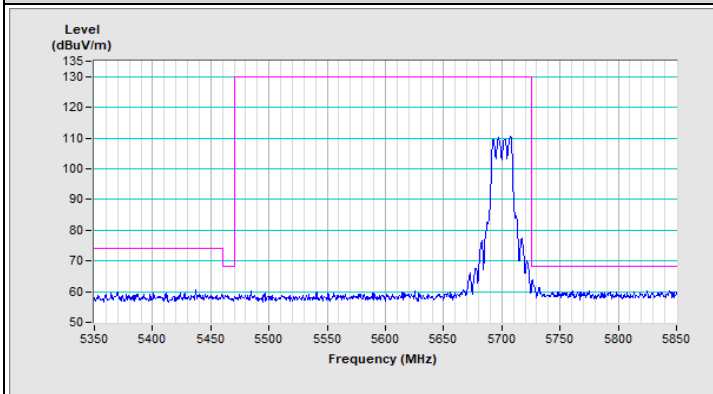

Horizontal (Peak)

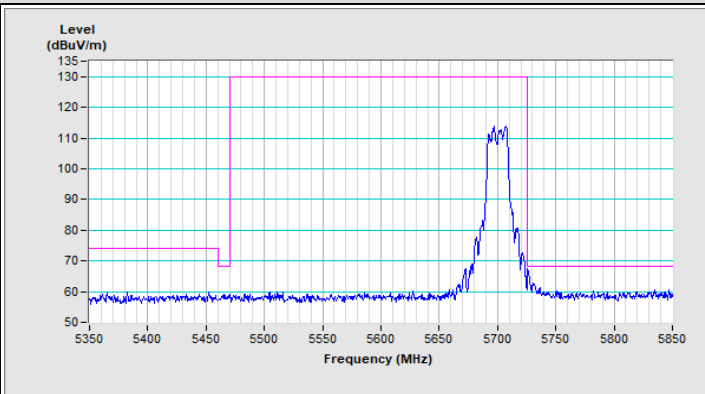

Vertical (Peak)

802.11a Channel 144

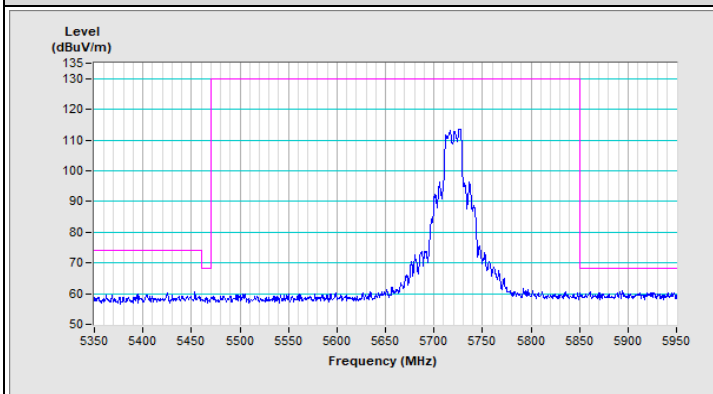

Horizontal (Peak)

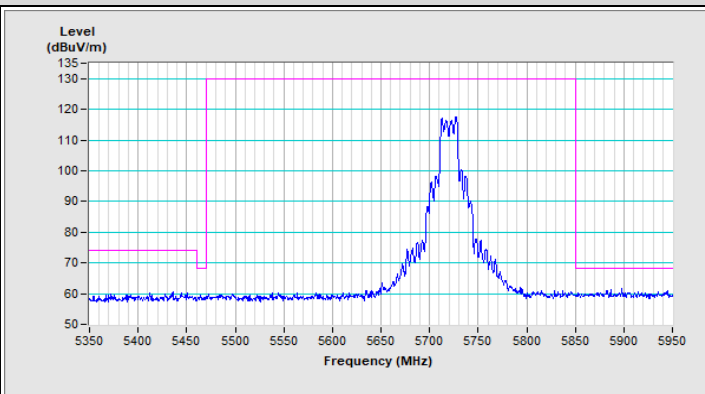

Vertical (Peak)

802.11ac (VHT20) Channel 52

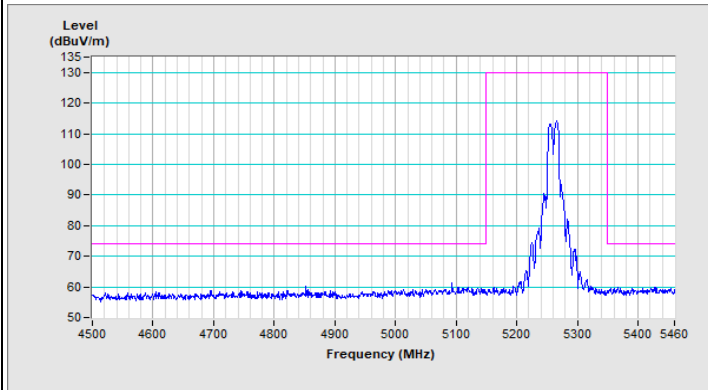

Horizontal (Peak)

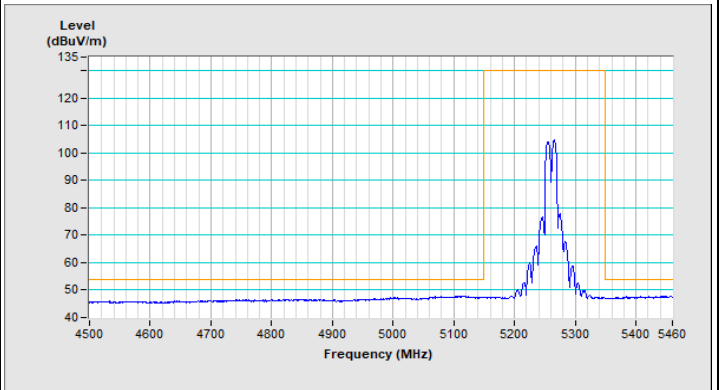

Horizontal (Average)

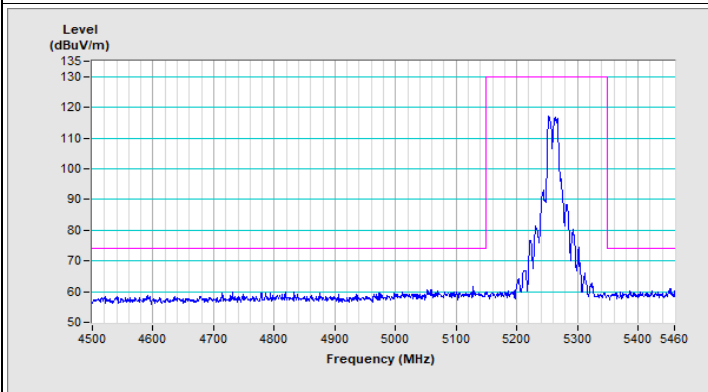

Vertical (Peak)

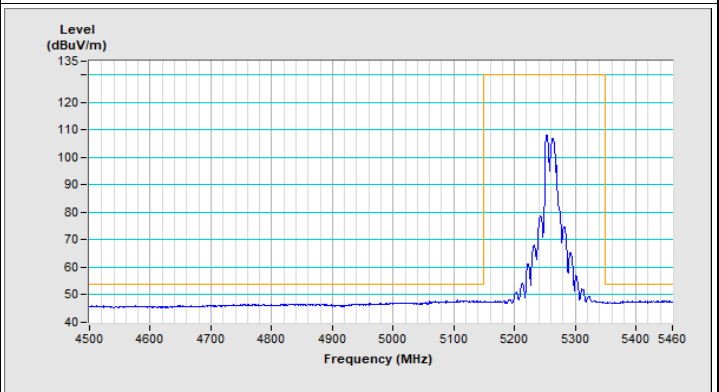

Vertical (Average)

802.11ac (VHT20) Channel 64

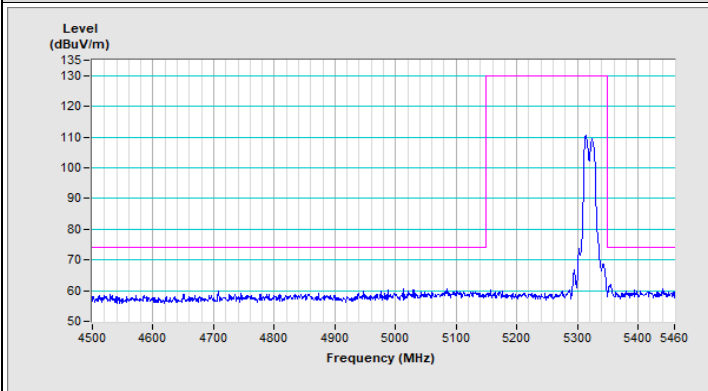

Horizontal (Peak)

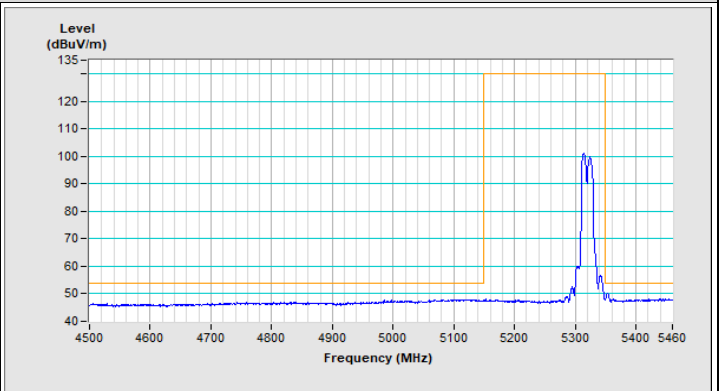

Horizontal (Average)

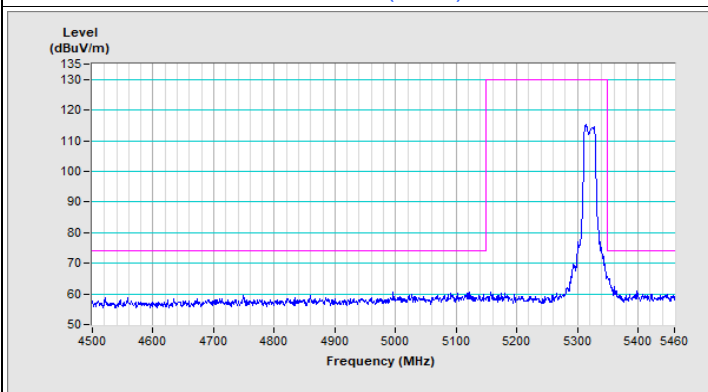

Vertical (Peak)

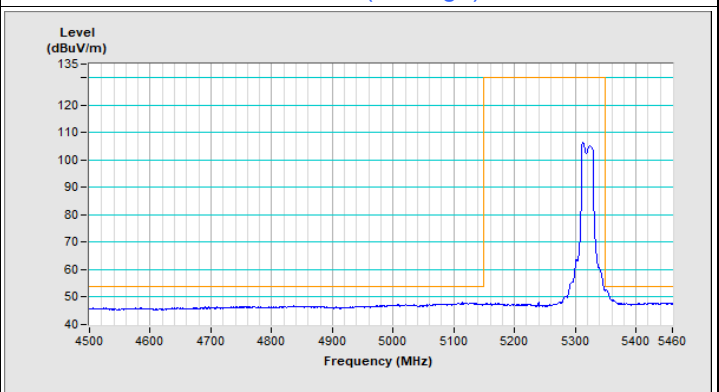

Vertical (Average)

802.11ac (VHT20) Channel 100

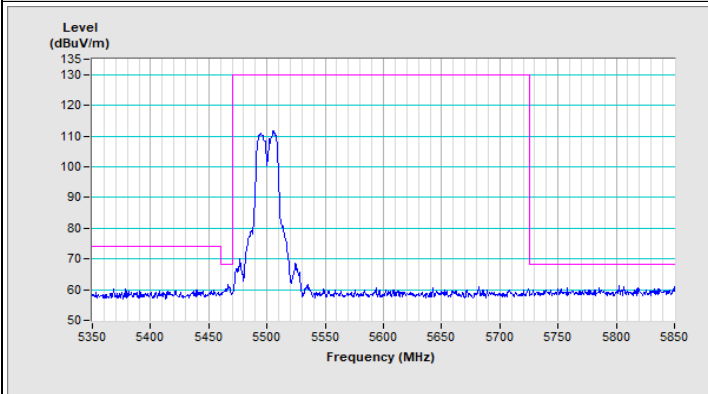

Horizontal (Peak)

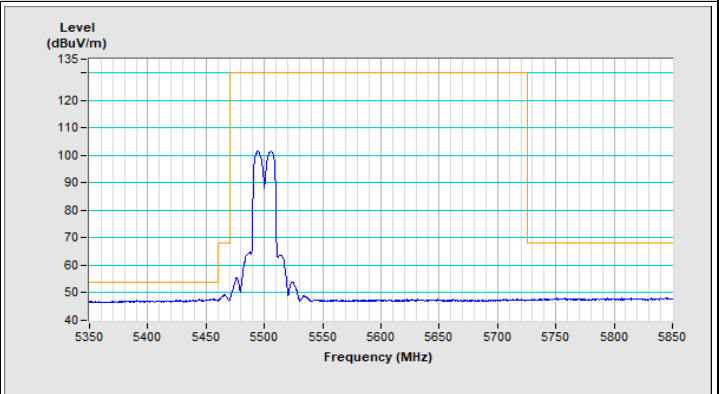

Horizontal (Average)

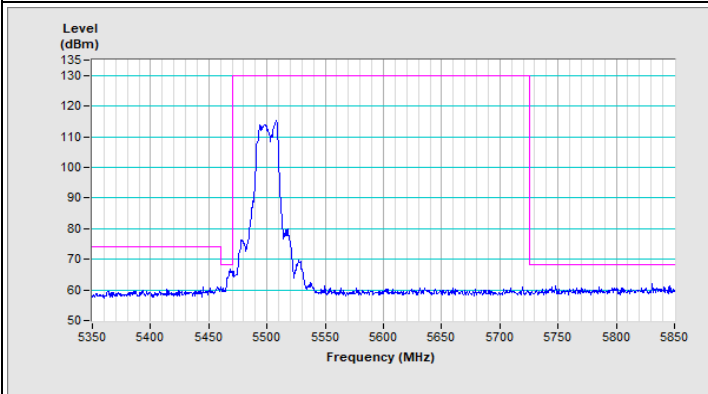

Vertical (Peak)

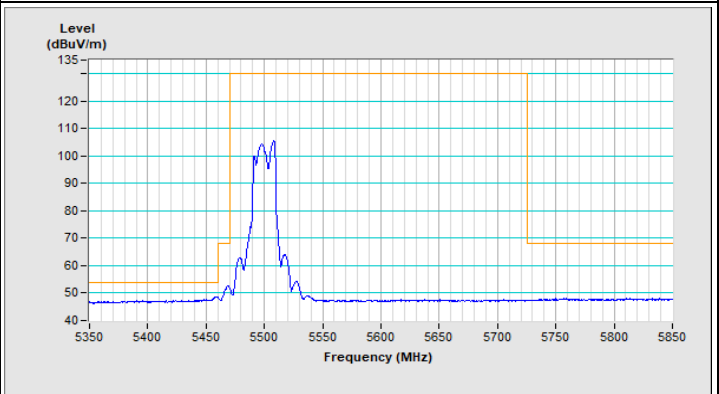

Vertical (Average)

802.11ac (VHT20) Channel 140

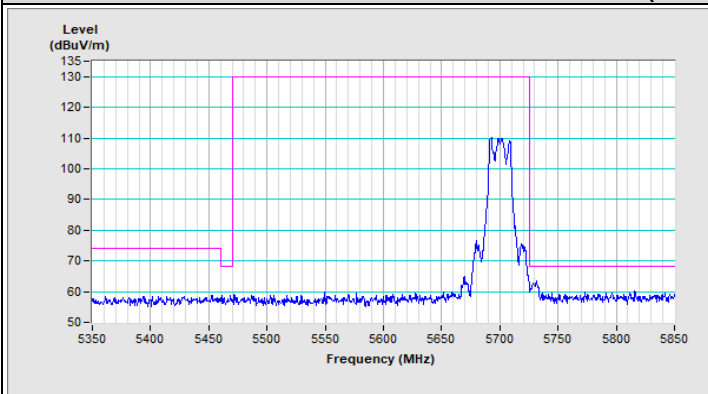

Horizontal (Peak)

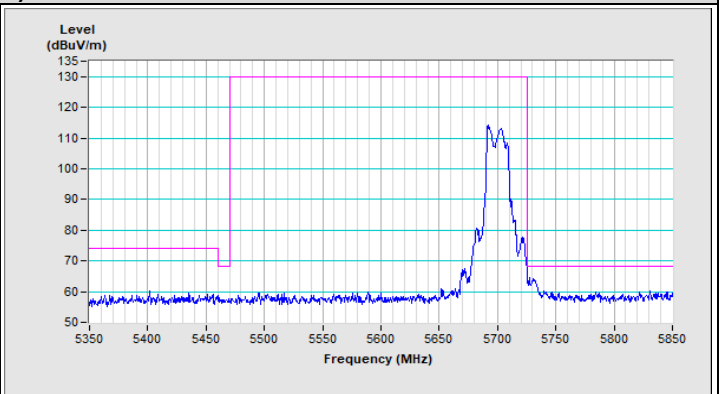

Vertical (Peak)

802.11ac (VHT20) Channel 144

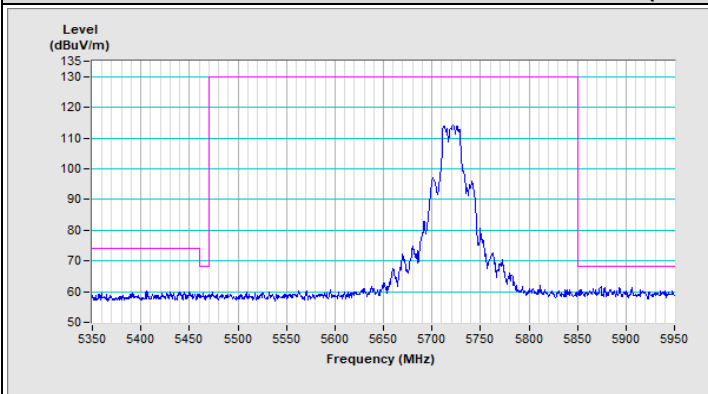

Horizontal (Peak)

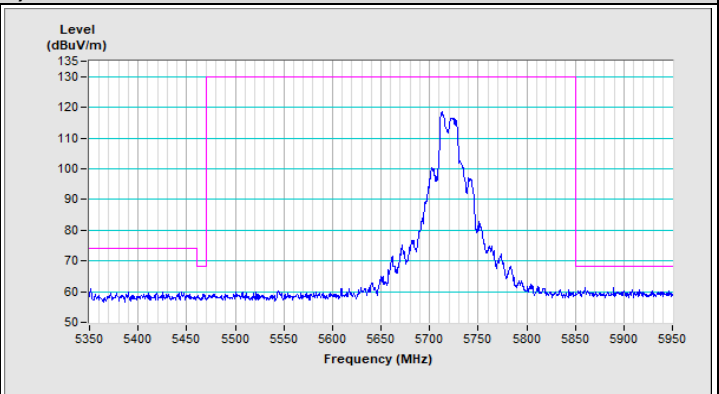

Vertical (Peak)

802.11ac (VHT40) Channel 54

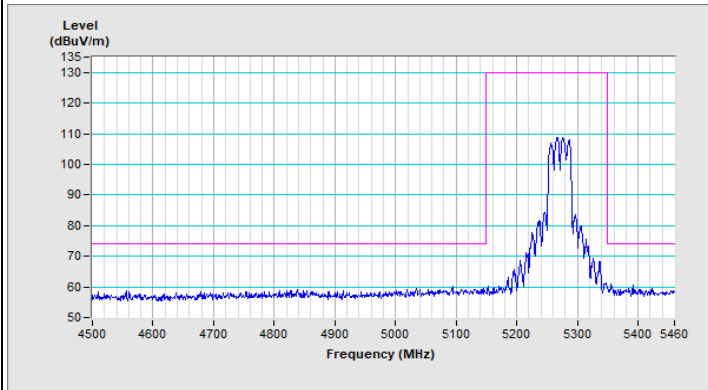

Horizontal (Peak)

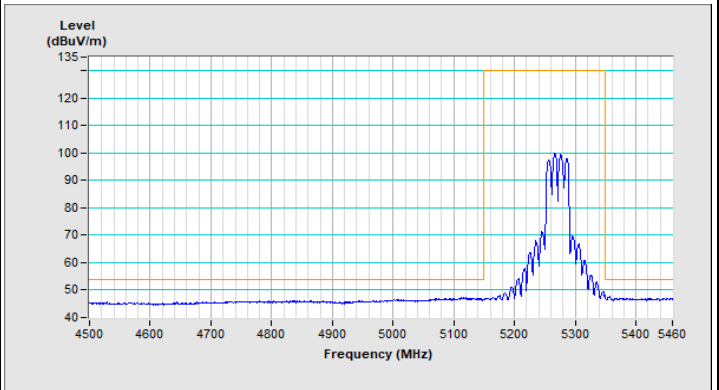

Horizontal (Average)

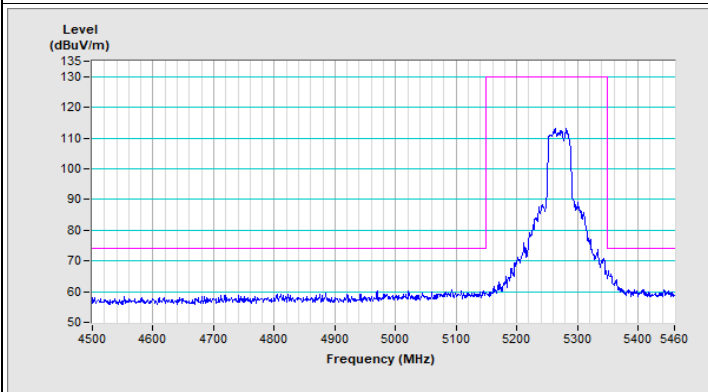

Vertical (Peak)

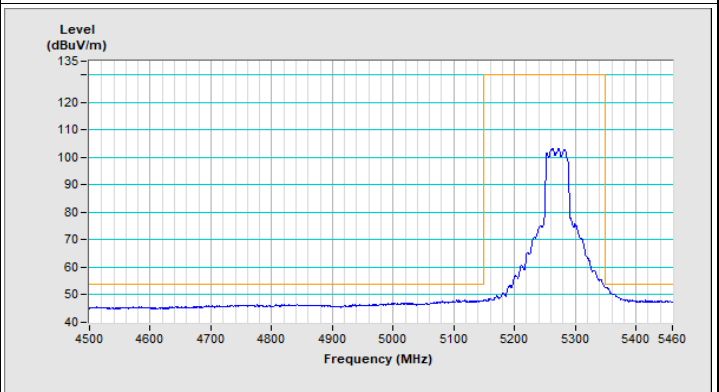

Vertical (Average)

802.11ac (VHT40) Channel 62

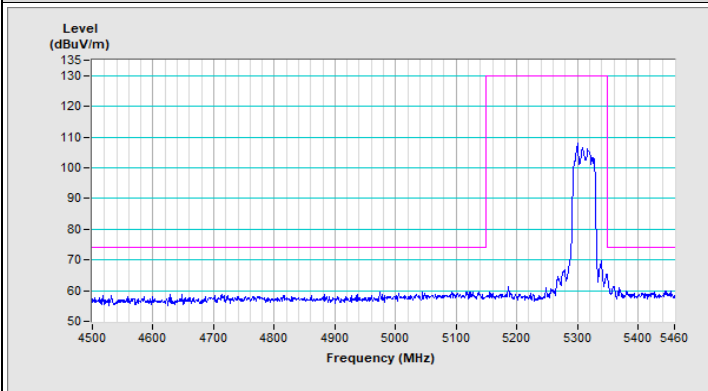

Horizontal (Peak)

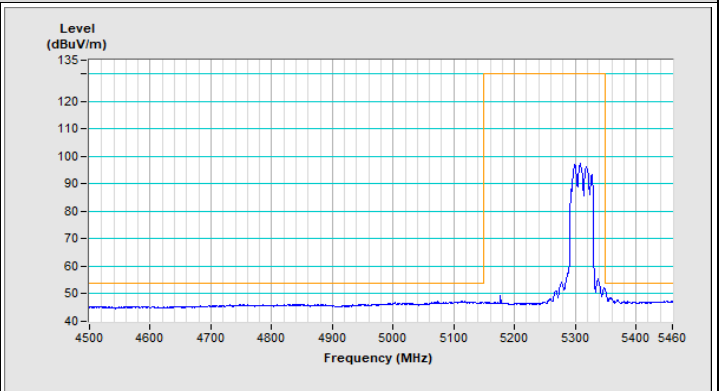

Horizontal (Average)

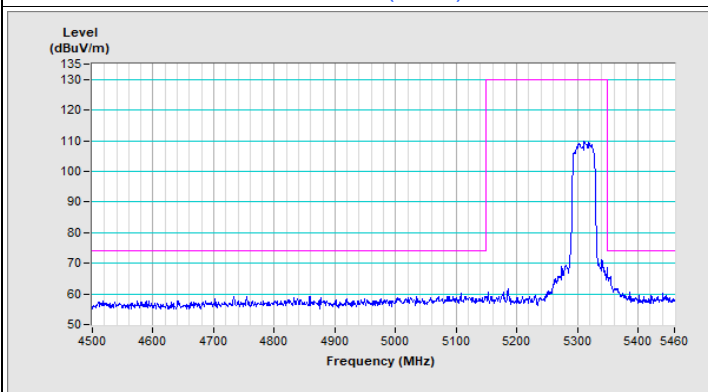

Vertical (Peak)

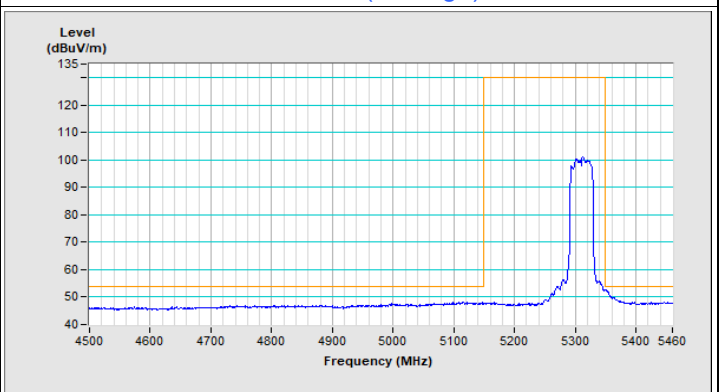

Vertical (Average)

802.11ac (VHT40) Channel 102

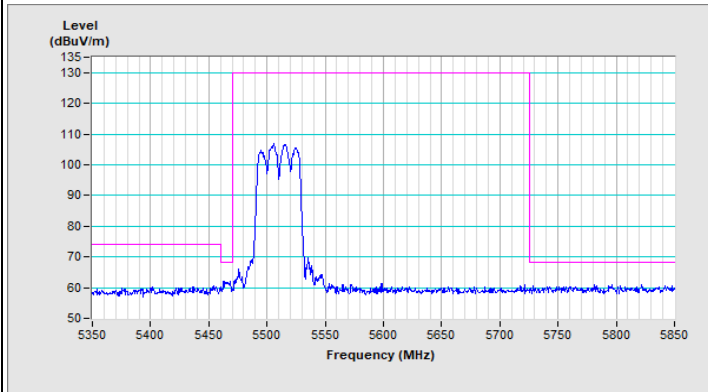

Horizontal (Peak)

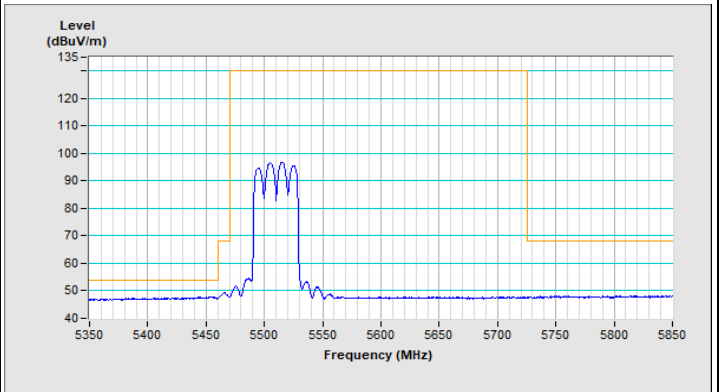

Horizontal (Average)

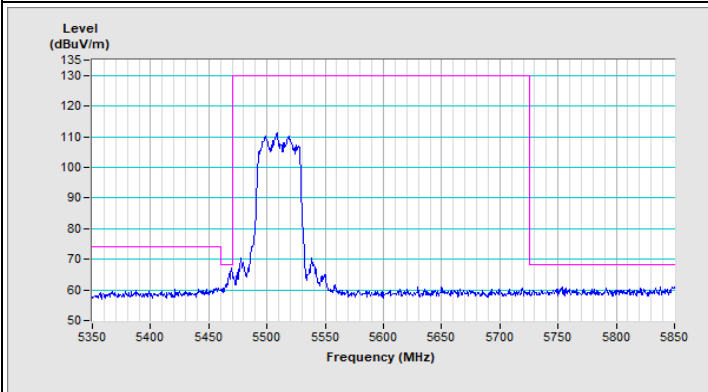

Vertical (Peak)

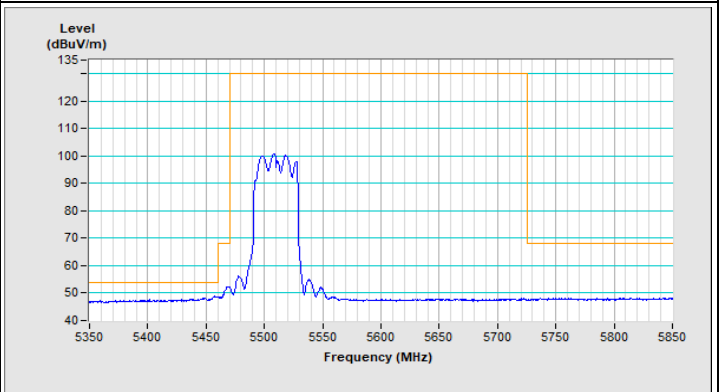

Vertical (Average)

802.11ac (VHT40) Channel 134

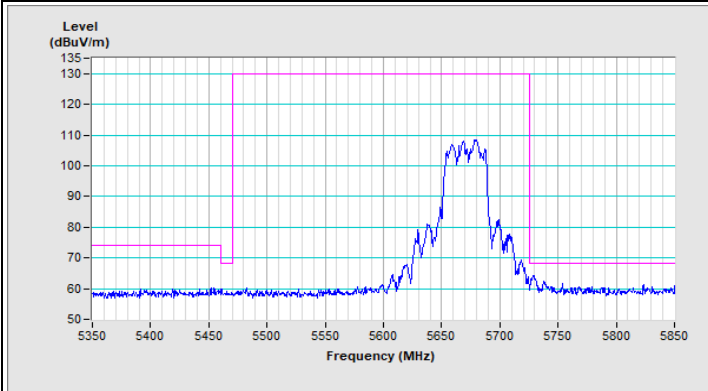

Horizontal (Peak)

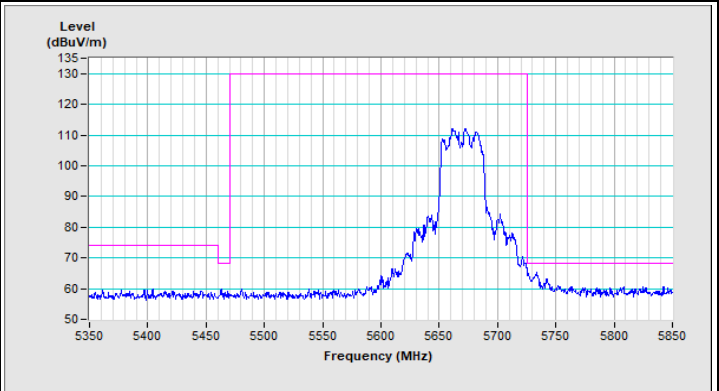

Vertical (Peak)

802.11ac (VHT40) Channel 142

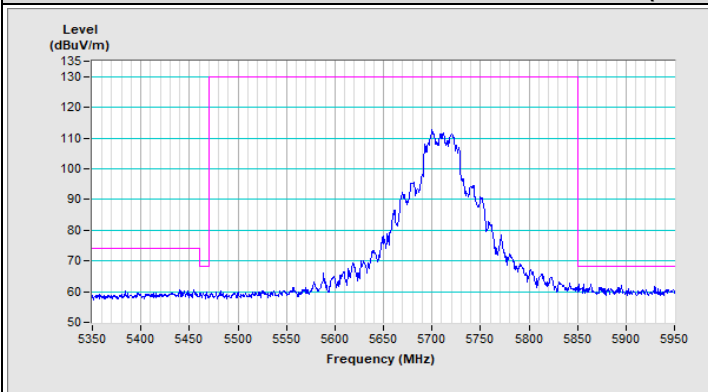

Horizontal (Peak)

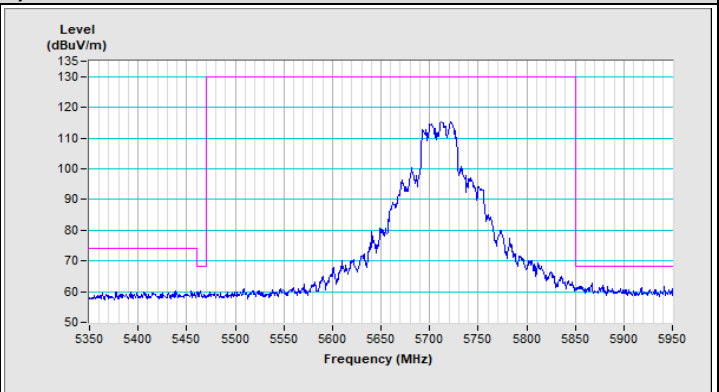

Vertical (Peak)

802.11ac (VHT80) Channel 58

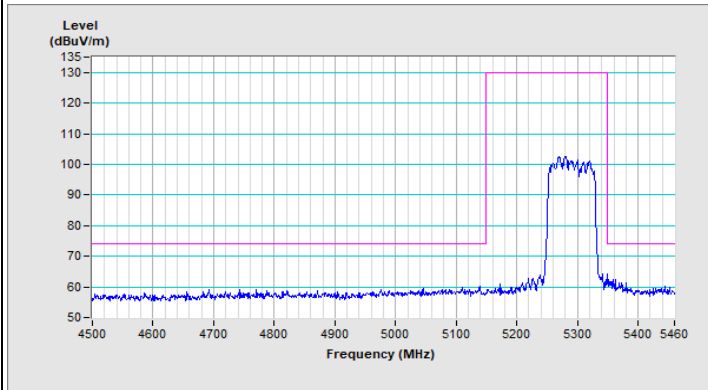

Horizontal (Peak)

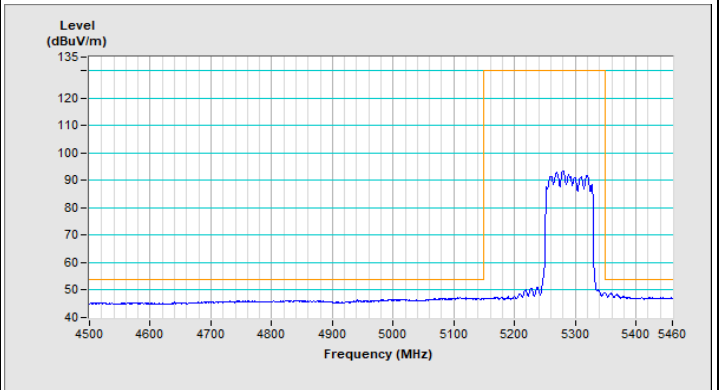

Horizontal (Average)

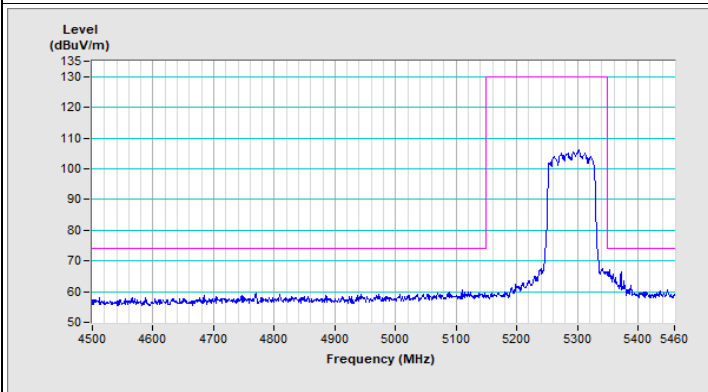

Vertical (Peak)

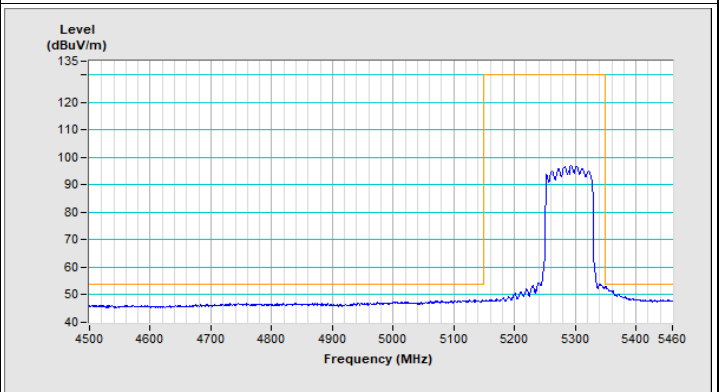

Vertical (Average)

802.11ac (VHT80) Channel 106

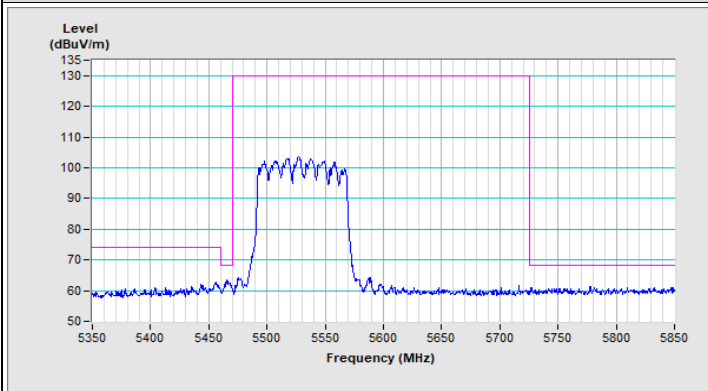

Horizontal (Peak)

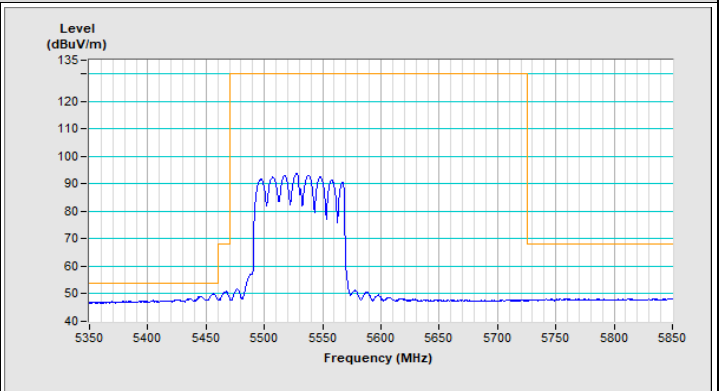

Horizontal (Average)

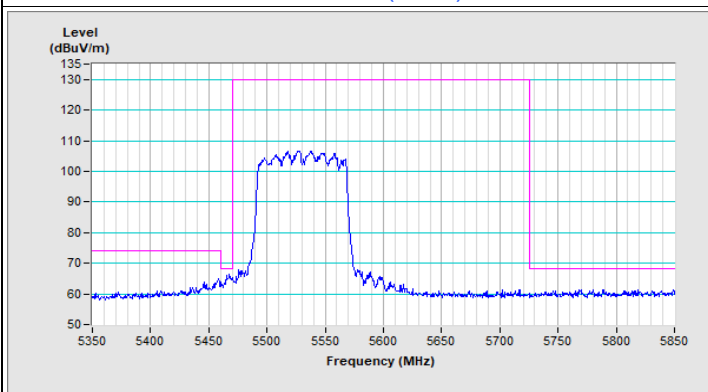

Vertical (Peak)

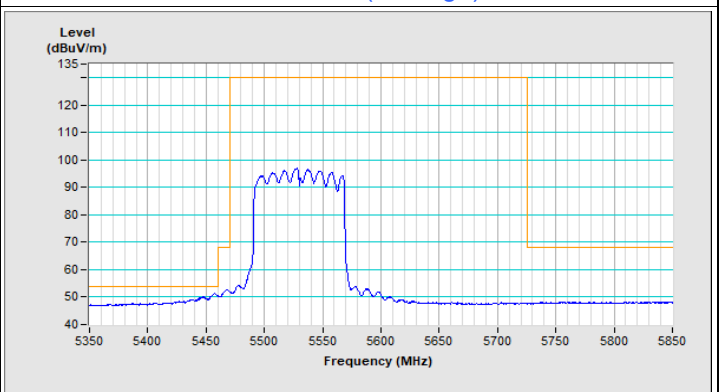

Vertical (Average)

802.11ac (VHT80) Channel 122

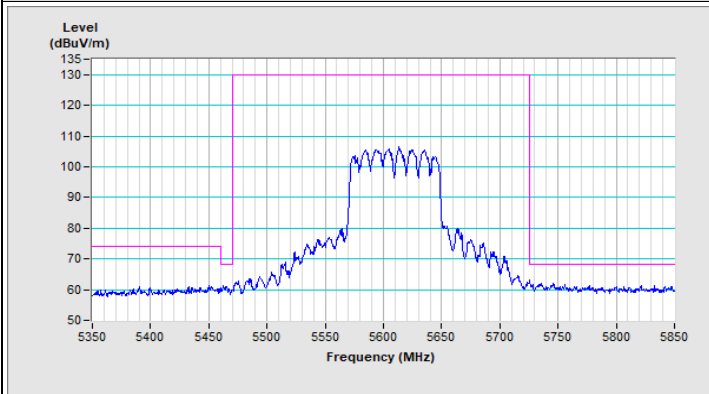

Horizontal (Peak)

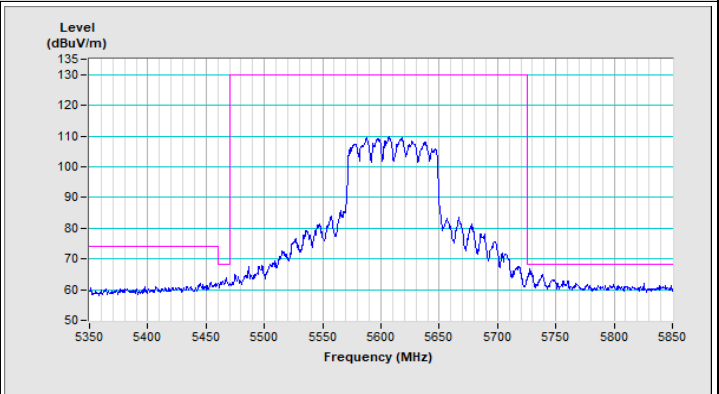

Vertical (Peak)

802.11ac (VHT80) Channel 138

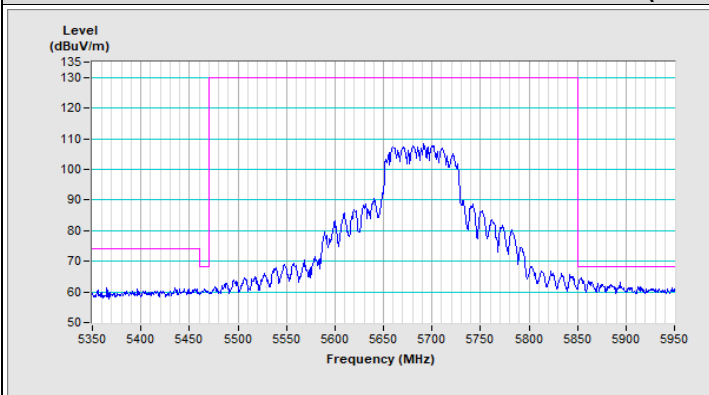

Horizontal (Peak)

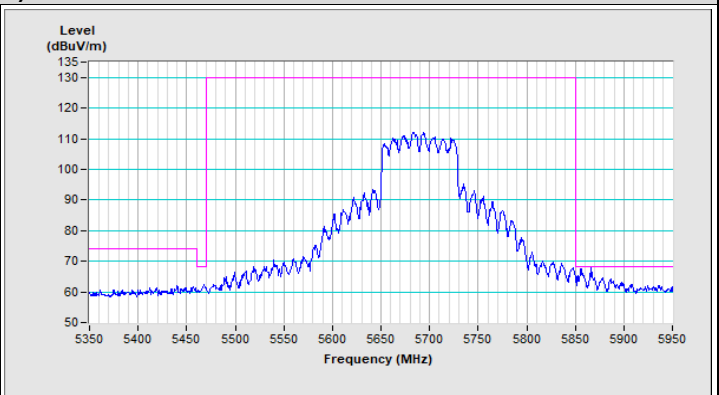

Vertical (Peak)

8 Pictures of Test Arrangements

Please refer to the attached file (Test Setup Photo)

9 Information of the Testing Laboratories

We, Bureau Veritas Consumer Products Services (H.K.) Ltd., Taoyuan Branch, were founded in 1988 to provide our best service in EMC, Radio, Telecom and Safety consultation. Our laboratories are FCC recognized accredited test firms and accredited according to ISO/IEC 17025.

If you have any comments, please feel free to contact us at the following:

Lin Kou EMC/RF Lab

Tel: 886-2-26052180

Fax: 886-2-26051924

Hsin Chu EMC/RF/Telecom Lab

Tel: 886-3-6668565

Fax: 886-3-6668323

Hwa Ya EMC/RF/Safety Lab

Tel: 886-3-3183232

Fax: 886-3-3270892

Email: service.adt@bureauveritas.com

Web Site: <http://ee.bureauveritas.com.tw>

The address and road map of all our labs can be found in our web site also.

--- END ---