

TEST REPORT

CERTIFICATE OF CONFORMITY

Standard: 47 CFR FCC Part 15, Subpart E (Section 15.407)
Report No.: RFBAPP-WTW-P23030958-1
FCC ID: PD5-NWA1100
Product: Indoor Wireless AP
Brand: Nile Global
Model No.: NWA1100
Received Date: 2023/3/31
Test Date: 2023/4/26 ~ 2023/12/25
Issued Date: 2024/1/5

Applicant: Delta Electronics, Inc.
Address: 31-1 Shien Pan Rd., Kuei San Industrial Zone, Taoyuan City 333, Taiwan
Issued By: Bureau Veritas Consumer Products Services (H.K.) Ltd., Taoyuan Branch
Lin Kou Laboratories
Lab Address: No. 47-2, 14th Ling, Chia Pau Vil., Lin Kou Dist., New Taipei City, Taiwan
Test Location: No. 19, Hwa Ya 2nd Rd., Wen Hwa Vil., Kewi Shan Dist., Taoyuan City 33383, Taiwan

FCC Registration / 788550 / TW0003
Designation Number:

Approved by: Jeremy Lin , **Date:** 2024/1/5
Jeremy Lin / Project Engineer

This test report consists of 124 pages in total. It may be duplicated completely for legal use with the approval of the applicant. It should not be reproduced except in full, without the written approval of our laboratory. The test results in the report only apply to the tested sample. The test results in this report are traceable to the national or international standards.

Prepared by : Gina Liu / Specialist



This report is governed by, and incorporates by reference, the Conditions of Testing as posted at the date of issuance of this report at <http://www.bureauveritas.com/home/about-us/our-business/cps/about-us/terms-conditions/> and is intended for your exclusive use. Any copying or replication of this report to or for any other person or entity, or use of our name or trademark, is permitted only with our prior written permission. This report sets forth our findings solely with respect to the test samples identified herein. The results set forth in this report are not indicative or representative of the quality or characteristics of the lot from which a test sample was taken or any similar or identical product unless specifically and expressly noted. Our report includes all of the tests requested by you and the results thereof based upon the information that you provided to us. Measurement uncertainty is only provided upon request for accredited tests. Statements of conformity are based on simple acceptance criteria without taking measurement uncertainty into account, unless otherwise requested in writing. You have 60 days from date of issuance of this report to notify us of any material error or omission caused by our negligence or if you require measurement uncertainty; provided, however, that such notice shall be in writing and shall specifically address the issue you wish to raise. A failure to raise such issue within the prescribed time shall constitute your unqualified acceptance of the completeness of this report, the tests conducted and the correctness of the report contents.

Table of Contents

Release Control Record	4
1 Certificate	5
2 Summary of Test Results	6
2.1 Measurement Uncertainty	6
2.2 Supplementary Information	6
3 General Information	7
3.1 General Description of EUT	7
3.2 Antenna Description of EUT	9
3.3 Channel List	10
3.4 Test Mode Applicability and Tested Channel Detail	11
3.5 Duty Cycle of Test Signal	13
3.6 Test Program Used and Operation Descriptions	17
3.7 Connection Diagram of EUT and Peripheral Devices	17
3.8 Configuration of Peripheral Devices and Cable Connections	18
4 Test Instruments	19
4.1 RF Output Power	19
4.2 Power Spectral Density	19
4.3 6 dB Bandwidth	19
4.4 Occupied Bandwidth	19
4.5 Frequency Stability	20
4.6 AC Power Conducted Emissions	20
4.7 Unwanted Emissions below 1 GHz	21
4.8 Unwanted Emissions above 1 GHz	22
5 Limits of Test Items	23
5.1 RF Output Power	23
5.2 Power Spectral Density	23
5.3 6 dB Bandwidth	23
5.4 Occupied Bandwidth	23
5.5 Frequency Stability	23
5.6 AC Power Conducted Emissions	24
5.7 Unwanted Emissions below 1 GHz	24
5.8 Unwanted Emissions above 1 GHz	25
6 Test Arrangements	26
6.1 RF Output Power	26
6.1.1 Test Setup	26
6.1.2 Test Procedure	26
6.2 Power Spectral Density	26
6.2.1 Test Setup	26
6.2.2 Test Procedure	26
6.3 6 dB Bandwidth	27
6.3.1 Test Setup	27
6.3.2 Test Procedure	27
6.4 Occupied Bandwidth	27
6.4.1 Test Setup	27
6.4.2 Test Procedure	27
6.5 Frequency Stability	28
6.5.1 Test Setup	28
6.5.2 Test Procedure	28
6.6 AC Power Conducted Emissions	29
6.6.1 Test Setup	29
6.6.2 Test Procedure	29
6.7 Unwanted Emissions below 1 GHz	30
6.7.1 Test Setup	30
6.7.2 Test Procedure	31



6.8	Unwanted Emissions above 1 GHz.....	32
6.8.1	Test Setup	32
6.8.2	Test Procedure.....	32
7	Test Results of Test Item	33
7.1	RF Output Power.....	33
7.2	Power Spectral Density	38
7.3	6 dB Bandwidth	46
7.4	Occupied Bandwidth.....	50
7.5	Frequency Stability	63
7.6	AC Power Conducted Emissions	65
7.7	Unwanted Emissions below 1 GHz	69
7.8	Unwanted Emissions above 1 GHz.....	73
8	Pictures of Test Arrangements	123
9	Information of the Testing Laboratories	124



Release Control Record

Issue No.	Description	Date Issued
RFBAPP-WTW-P23030958-1	Original release.	2024/1/5

1 Certificate

Product: Indoor Wireless AP

Brand: Nile Global

Test Model: NWA1100

Sample Status: Engineering sample

Applicant: Delta Electronics, Inc.

Test Date: 2023/4/26 ~ 2023/12/25

Standard: 47 CFR FCC Part 15, Subpart E (Section 15.407)

Measurement procedure: ANSI C63.10-2013
KDB 789033 D02 General UNII Test Procedure New Rules v02r01
KDB 662911 D01 Multiple Transmitter Output v02r01

The above equipment has been tested by **Bureau Veritas Consumer Products Services (H.K.) Ltd., Taoyuan Branch**, and found compliance with the requirement of the above standards. The test record, data evaluation & Equipment Under Test (EUT) configurations represented herein are true and accurate accounts of the measurements of the sample's RF characteristics under the conditions specified in this report.

2 Summary of Test Results

47 CFR FCC Part 15, Subpart E (Section 15.407)			
Clause	Test Item	Result	Remark
15.407(a)(1) 15.407(a)(3)	RF Output Power	Pass	Meet the requirement of limit.
15.407(a)(1) 15.407(a)(3)	Power Spectral Density	Pass	Meet the requirement of limit.
15.407(e)	6 dB Bandwidth	Pass	Meet the requirement of limit. (U-NII-3 Band only)
---	Occupied Bandwidth	-	Reference only.
15.407(g)	Frequency Stability	Pass	Meet the requirement of limit.
15.407(b)(9)	AC Power Conducted Emissions	Pass	Minimum passing margin is -3.77 dB at 0.37000 MHz
15.407(b)(9)	Unwanted Emissions below 1 GHz	Pass	Minimum passing margin is -5.1 dB at 65.89 MHz
15.407(b) (1/10) 15.407(b) (4(i)/10)	Unwanted Emissions above 1 GHz	Pass	Minimum passing margin is -0.3 dB at 5137.80, 5146.00, 5147.80, 5636.00 MHz
15.203	Antenna Requirement	Pass	Antenna connector is Ipx(MHF) not a standard connector.

Note: Determining compliance based on the results of the compliance measurement, not taking into account measurement instrumentation uncertainty.

2.1 Measurement Uncertainty

Where relevant, the following measurement uncertainty levels have been estimated for tests performed on the EUT as specified in CISPR 16-4-2:

Measurement	Specification	Expanded Uncertainty (k=2) (±)
Occupied Bandwidth	-	491.896 Hz
AC Power Conducted Emissions	9 kHz ~ 30 MHz	2.99 dB
Unwanted Emissions below 1 GHz	9 kHz ~ 30 MHz	3.59 dB
	30 MHz ~ 1 GHz	3.6 dB
Unwanted Emissions above 1 GHz	1 GHz ~ 18 GHz	2.29 dB
	18 GHz ~ 40 GHz	2.29 dB

The other instruments specified are routine verified to remain within the calibrated levels, no measurement uncertainty is required to be calculated.

2.2 Supplementary Information

There is not any deviation from the test standards for the test method, and no modifications required for compliance.

3 General Information

3.1 General Description of EUT

Product	Indoor Wireless AP
Brand	Nile Global
Test Model	NWA1100
Status of EUT	Engineering sample
Power Supply Rating	100-240V, 50/60Hz 54 Vdc (From POE)
Modulation Type	64QAM, 16QAM, QPSK, BPSK for OFDM 256QAM for OFDM in 11ac mode 1024QAM for OFDMA in 11ax HE mode
Modulation Technology	OFDM, OFDMA
Transfer Rate	802.11a: 54/48/36/24/18/12/9/6Mbps 802.11n (HT20/40): 6.5 to 600Mbps (MCS0 to MCS31) 802.11ac (VHT20/40/80): up to 1773.2Mbps (MCS0 to MCS9, NSS=1 to 4) 802.11ax (HE20/40/80): up to 2400Mbps (MCS0 to MCS11, NSS=1 to 4)
Operating Frequency	5.18 GHz ~ 5.24 GHz, 5.745 GHz ~ 5.825 GHz
Number of Channel	For Radio 2: 5180~5240MHz: 802.11a, 802.11n (HT20), 802.11ac (VHT20), 802.11ax (HE20): 4 802.11n (HT40), 802.11ac (VHT40), 802.11ax (HE40): 2 802.11ac (VHT80), 802.11ax (HE80): 1 5745~5825MHz: 802.11a, 802.11n (HT20), 802.11ac (VHT20), 802.11ax (HE20): 5 802.11n (HT40), 802.11ac (VHT40), 802.11ax (HE40): 2 802.11ac (VHT80), 802.11ax (HE80): 1 For Radio 3: 5180 ~ 5240MHz: 802.11a, 802.11n (HT20), 802.11ac (VHT20): 4 802.11n (HT40), 802.11ac (VHT40): 2 802.11ac (VHT80): 1 5745 ~ 5825MHz: 802.11a, 802.11n (HT20), 802.11ac (VHT20): 5 802.11n (HT40), 802.11ac (VHT40): 2 802.11ac (VHT80): 1
Output Power	For Radio 2: 5.18 GHz ~ 5.24 GHz : 359.423 mW (25.56 dBm) 5.745 GHz ~ 5.825 GHz : 773.447 mW (28.88 dBm) For Radio 3: 5.18 GHz ~ 5.24 GHz : 186.017 mW (22.70 dBm) 5.745 GHz ~ 5.825 GHz : 255.507 mW (24.07 dBm)
EUT Category	Indoor Access Point

Note:

1. The EUT uses following accessories.

POE (Support unit)		
Brand	Model	Specification
NETGEAR	GS305Pv2	DC Output : 54V,1.25A

2. There are four modules for the EUT.

Function	Radio
WLAN 2.4G (TX/RX)	1
WLAN 5G (TX/RX)	2
WLAN 2.4G & 5G & 6G (TX/RX)	3
BT LE	4
WLAN 6G (TX/RX)	5

3. Simultaneously transmission condition.

Condition	Technology		
1	WLAN 2.4G (Radio 1)	WLAN 5G (Radio 2)	WLAN 6G (Radio 5)
2	WLAN 2.4G (Radio 3)	WLAN 5G (Radio 3)	WLAN 6G (Radio 3)

Note: The emission of the simultaneous operation has been evaluated and no non-compliance was found.

4. The above EUT information is declared by manufacturer and for more detailed features description, please refers to the manufacturer's specifications or user's manual.

3.2 Antenna Description of EUT

1. The antenna information is listed as below.

Antenna Connector		Ipex(MHF)					
Antenna No.	Antenna Type	Gain (dBi)					
		2.4~2.4835GHz	5.15~5.25GHz	5.25~5.35GHz	5.47~5.725GHz	5.725~5.85GHz	
Radio 1	2G1	dipole	6.9	-	-	-	-
	2G2		6.9	-	-	-	-
	2G3		7.7	-	-	-	-
	2G4		6.4	-	-	-	-
Radio 2	5G1	dipole	-	6.7	6.7	7.2	6.6
	5G2		-	6.7	6.7	6.7	7.1
	5G3		-	7.2	7.2	7.6	7.1
	5G4		-	6.6	6.6	7.3	7.0
Radio 3	TB1	PIFA	5.1	7.2	7.2	5.9	5.9
	TB2		4.7	5.6	5.6	5.9	6.8
Radio 4	BLE		5.9	-	-	-	-

* Detail antenna specification please refer to antenna datasheet and/or antenna measurement report.

2. The EUT incorporates a MIMO function:

5 GHz Band				
Module	Modulation Mode	Beamforming Mode	TX & RX Configuration	
Radio 2	802.11a	Not Support	4TX	4RX
	802.11n (HT20)	Support	4TX	4RX
	802.11n (HT40)	Support	4TX	4RX
	802.11ac (VHT20)	Support	4TX	4RX
	802.11ac (VHT40)	Support	4TX	4RX
	802.11ac (VHT80)	Support	4TX	4RX
	802.11ax (HE20)	Support	4TX	4RX
	802.11ax (HE40)	Support	4TX	4RX
Radio 3	802.11a	Not Support	2TX	2RX
	802.11n (HT20)	Not Support	2TX	2RX
	802.11n (HT40)	Not Support	2TX	2RX
	802.11ac (VHT20)	Not Support	2TX	2RX
	802.11ac (VHT40)	Not Support	2TX	2RX
	802.11ac (VHT80)	Not Support	2TX	2RX

Note:

- All of modulation mode support beamforming function except 802.11a modulation mode.
- The EUT support Beamforming and CDD mode, therefore both mode were investigated and the worst case scenario was identified. The worst case data were presented in test report.
- The modulation and bandwidth are similar for 802.11n mode for 20 MHz (40 MHz), 802.11ac mode for 20 MHz (40 MHz, 80 MHz) and 802.11ax mode for 20 MHz (40 MHz, 80 MHz), therefore the manufacturer will control the power for 802.11n/ac mode is the same as the 802.11ax or more lower than it and investigated worst case to representative mode in test report.

3.3 Channel List

FOR 5180 ~ 5240 MHz

4 channels are provided for 802.11a, 802.11n (HT20), 802.11ac (VHT20), 802.11ax (HE20):

Channel	Frequency	Channel	Frequency
36	5180 MHz	44	5220 MHz
40	5200 MHz	48	5240 MHz

2 channels are provided for 802.11n (HT40), 802.11ac (VHT40), 802.11ax (HE40):

Channel	Frequency	Channel	Frequency
38	5190 MHz	46	5230 MHz

1 channel is provided for 802.11ac (VHT80), 802.11ax (HE80):

Channel	Frequency
42	5210 MHz

FOR 5745 ~ 5825 MHz:

5 channels are provided for 802.11a, 802.11n (HT20), 802.11ac (VHT20), 802.11ax (HE20):

Channel	Frequency	Channel	Frequency
149	5745 MHz	161	5805 MHz
153	5765 MHz	165	5825 MHz
157	5785 MHz		

2 channels are provided for 802.11n (HT40), 802.11ac (VHT40), 802.11ax (HE40):

Channel	Frequency	Channel	Frequency
151	5755 MHz	159	5795 MHz

1 channel is provided for 802.11ac (VHT80), 802.11ax (HE80):

Channel	Frequency
155	5775 MHz

3.4 Test Mode Applicability and Tested Channel Detail

Pre-Scan:	The EUT had been pre-tested on the positioned of each 3 axis (X-axis/ Y-axis/ Z-axis). Pre-scan these ways and find the worst case as a representative test condition.
Worst Case:	Z-AXIS for Mode A, X-AXIS for Mode B

Following channel(s) was (were) selected for the final test as listed below:

Test Item	EUT Configure Mode	Mode	Signal Mode	Tested Channel	Modulation	Data Rate Parameter
RF Output Power	A	802.11a	CDD	36, 40, 48, 149, 157, 165	BPSK	6Mb/s
		802.11ax (HE20)	CDD & Beamforming	36, 40, 48, 149, 157, 165	BPSK	MCS0
		802.11ax (HE40)	CDD & Beamforming	38, 46, 151, 159	BPSK	MCS0
		802.11ax (HE80)	CDD & Beamforming	42, 155	BPSK	MCS0
	B	802.11a	CDD	36, 40, 48, 149, 157, 165	BPSK	6Mb/s
		802.11ac (VHT20)	CDD	36, 40, 48, 149, 157, 165	BPSK	MCS0
		802.11ac (VHT40)	CDD	38, 46, 151, 159	BPSK	MCS0
		802.11ac (VHT80)	CDD	42, 155	BPSK	MCS0
Power Spectral Density	A	802.11a	CDD	36, 40, 48, 149, 157, 165	BPSK	6Mb/s
		802.11ax (HE20)	CDD	36, 40, 48, 149, 157, 165	BPSK	MCS0
		802.11ax (HE40)	CDD	38, 46, 151, 159	BPSK	MCS0
		802.11ax (HE80)	CDD	42, 155	BPSK	MCS0
	B	802.11a	CDD	36, 40, 48, 149, 157, 165	BPSK	6Mb/s
		802.11ac (VHT20)	CDD	36, 40, 48, 149, 157, 165	BPSK	MCS0
		802.11ac (VHT40)	CDD	38, 46, 151, 159	BPSK	MCS0
		802.11ac (VHT80)	CDD	42, 155	BPSK	MCS0
6 dB Bandwidth	A	802.11a	CDD	149, 157, 165	BPSK	6Mb/s
		802.11ax (HE20)	CDD	149, 157, 165	BPSK	MCS0
		802.11ax (HE40)	CDD	151, 159	BPSK	MCS0
		802.11ax (HE80)	CDD	155	BPSK	MCS0
	B	802.11a	CDD	149, 157, 165	BPSK	6Mb/s
		802.11ac (VHT20)	CDD	149, 157, 165	BPSK	MCS0
		802.11ac (VHT40)	CDD	151, 159	BPSK	MCS0
		802.11ac (VHT80)	CDD	155	BPSK	MCS0

Test Item	EUT Configure Mode	Mode	Signal Mode	Tested Channel	Modulation	Data Rate Parameter
Occupied Bandwidth	A	802.11a	CDD	36, 40, 48, 149, 157, 165	BPSK	6Mb/s
		802.11ax (HE20)	CDD	36, 40, 48, 149, 157, 165	BPSK	MCS0
		802.11ax (HE40)	CDD	38, 46, 151, 159	BPSK	MCS0
		802.11ax (HE80)	CDD	42, 155	BPSK	MCS0
	B	802.11a	CDD	36, 40, 48, 149, 157, 165	BPSK	6Mb/s
		802.11ac (VHT20)	CDD	36, 40, 48, 149, 157, 165	BPSK	MCS0
		802.11ac (VHT40)	CDD	38, 46, 151, 159	BPSK	MCS0
		802.11ac (VHT80)	CDD	42, 155	BPSK	MCS0
Frequency Stability	A,B	802.11a	-	36	un-modulation	-
AC Power Conducted Emissions	A	802.11ax (HE40)	CDD	159	BPSK	MCS0
	B	802.11a	CDD	149	BPSK	6Mb/s
Unwanted Emissions below 1 GHz	A	802.11ax (HE40)	CDD	159	BPSK	MCS0
	B	802.11a	CDD	149	BPSK	6Mb/s
Unwanted Emissions above 1 GHz	A	802.11a	CDD	36, 40, 48, 149, 157, 165	BPSK	6Mb/s
		802.11ax (HE20)	CDD	36, 40, 48, 149, 157, 165	BPSK	MCS0
		802.11ax (HE40)	CDD	38, 46, 151, 159	BPSK	MCS0
		802.11ax (HE80)	CDD	42, 155	BPSK	MCS0
	B	802.11a	CDD	36, 40, 48, 149, 157, 165	BPSK	6Mb/s
		802.11ac (VHT20)	CDD	36, 40, 48, 149, 157, 165	BPSK	MCS0
		802.11ac (VHT40)	CDD	38, 46, 151, 159	BPSK	MCS0
		802.11ac (VHT80)	CDD	42, 155	BPSK	MCS0
EUT Configure Mode:	A	5G Radio 2				
	B	Scan Radio 3				

3.5 Duty Cycle of Test Signal

Mode A:

802.11a: Duty cycle = 1.99 ms / 2.07 ms x 100% = 96.1%, duty factor = 10 * log (1/Duty cycle) = 0.17 dB

802.11ax (HE20): Duty cycle = 5.46 ms / 5.76 ms x 100% = 94.8%, duty factor = 10 * log (1/Duty cycle) = 0.23 dB

802.11ax (HE40): Duty cycle = 5.48 ms / 5.74 ms x 100% = 95.5%, duty factor = 10 * log (1/Duty cycle) = 0.20 dB

802.11ax (HE80): Duty cycle = 5.46 ms / 5.74 ms x 100% = 95.1%, duty factor = 10 * log (1/Duty cycle) = 0.22 dB

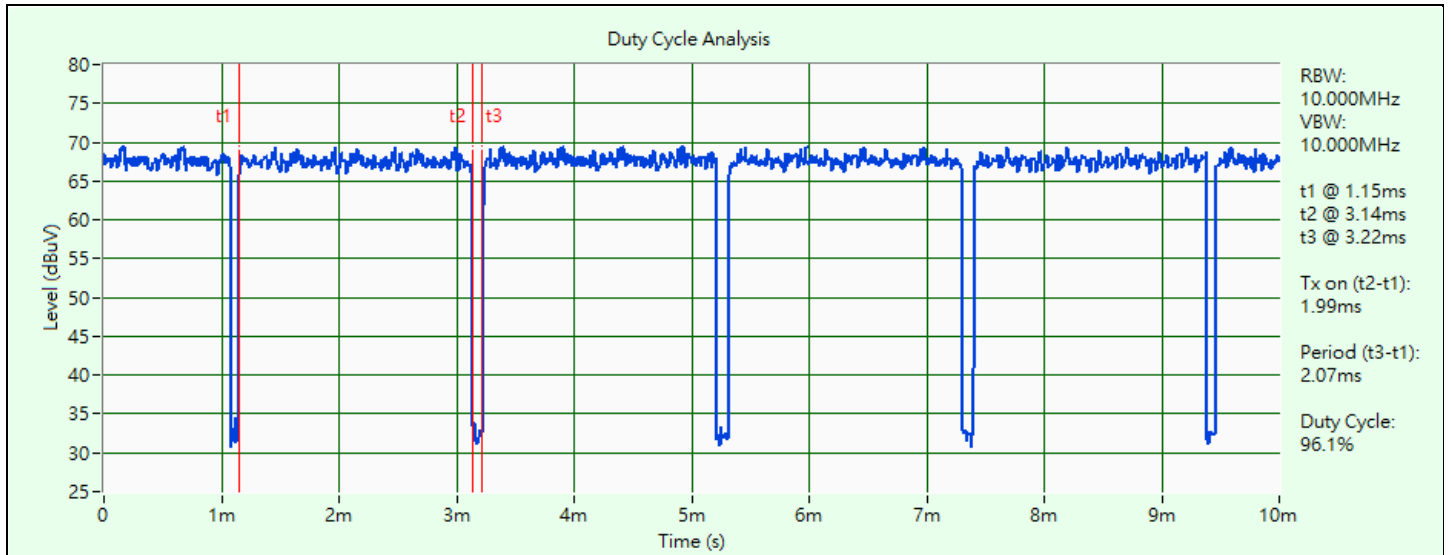

802.11a

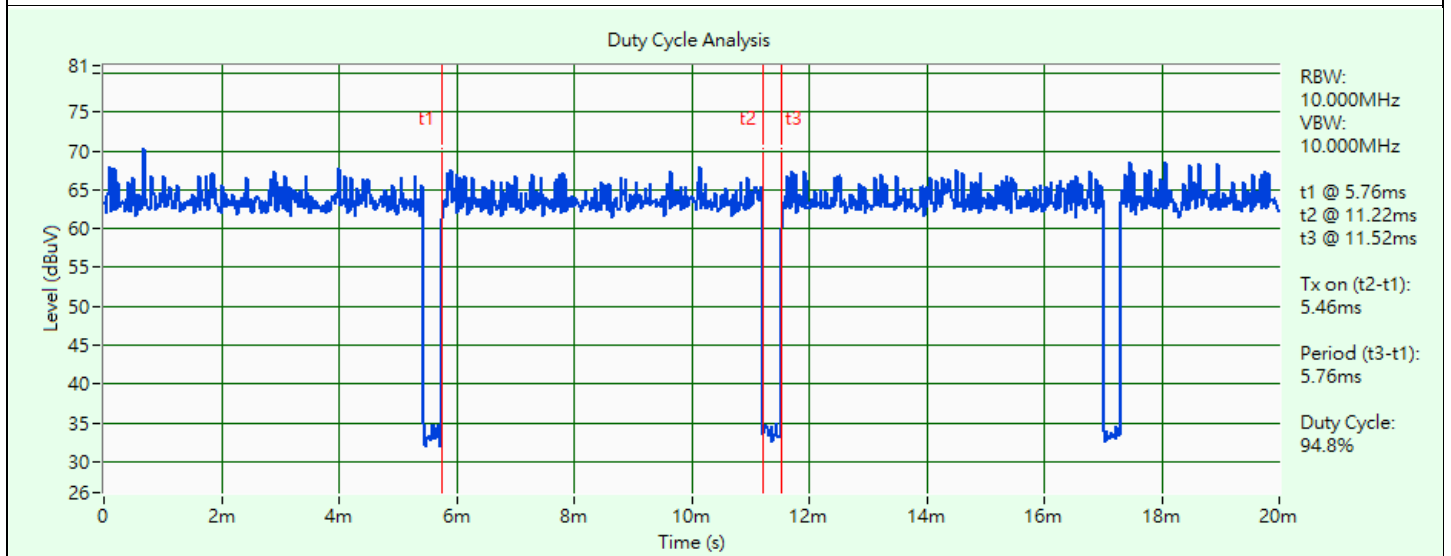

802.11ax (HE20)

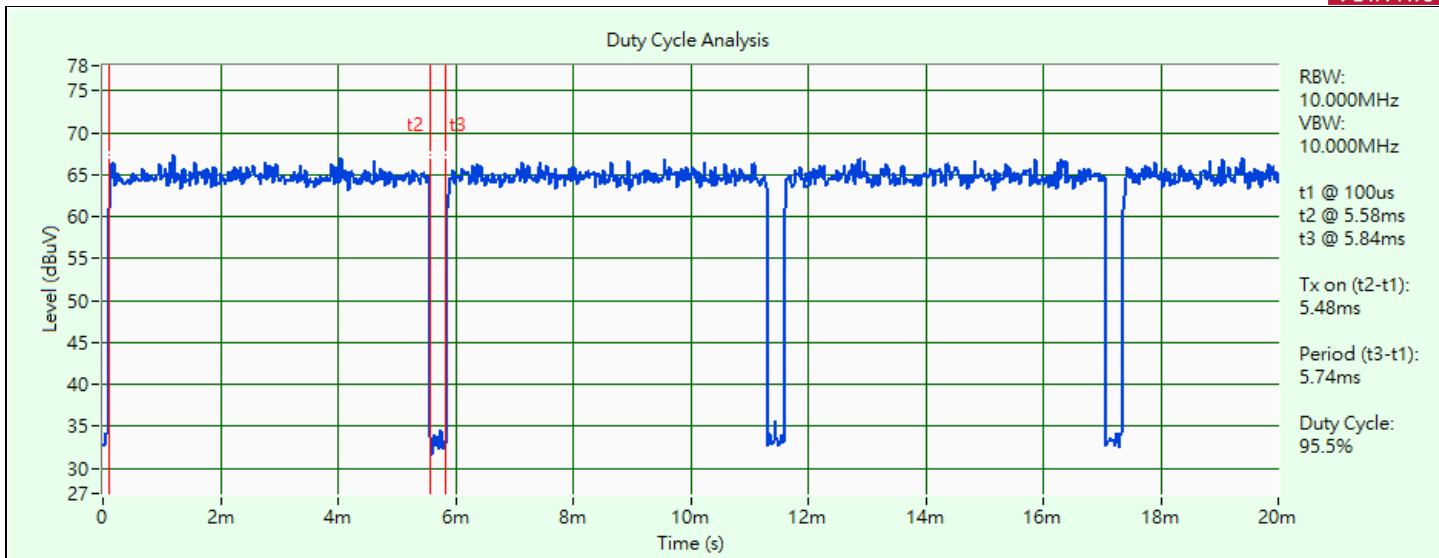

802.11ax (HE40)

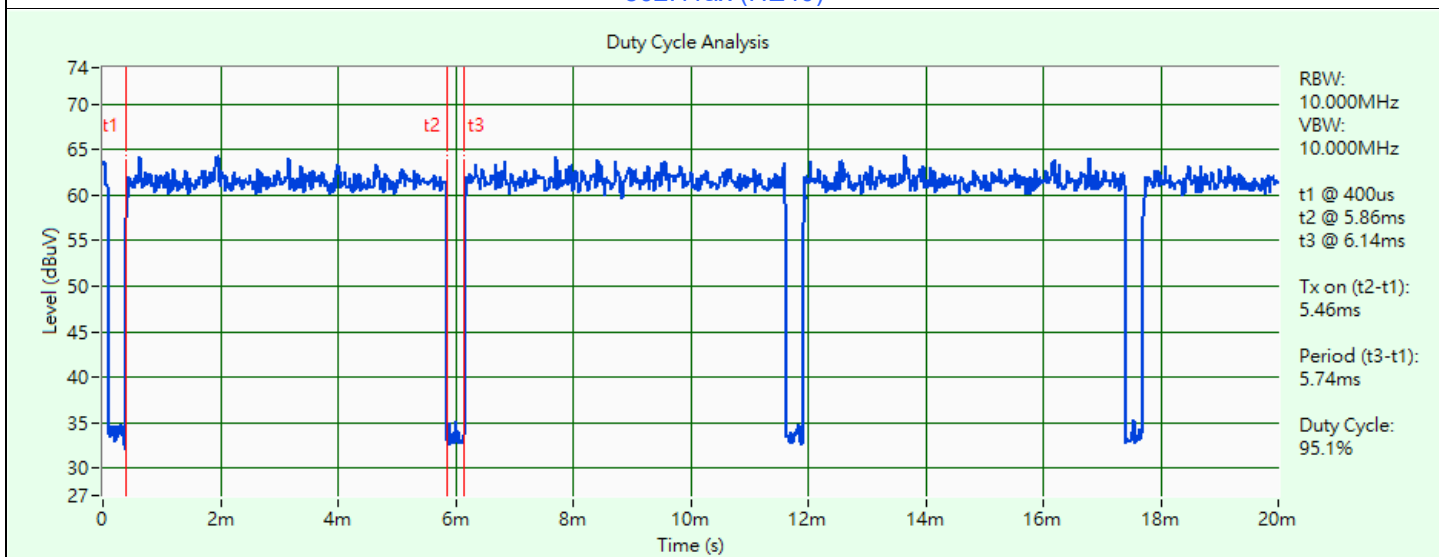

802.11ax (HE80)

Mode B

802.11a: Duty cycle = 1.985 ms / 2.08 ms x 100% = 95.4%, duty factor = 10 * log (1/Duty cycle) = 0.20 dB

802.11ac (VHT20): Duty cycle = 5.46 ms / 5.8 ms x 100% = 94.1%, duty factor = 10 * log (1/Duty cycle) = 0.26 dB

802.11ac (VHT40): Duty cycle = 5.44 ms / 5.8 ms x 100% = 93.8%, duty factor = 10 * log (1/Duty cycle) = 0.28 dB

802.11ac (VHT80): Duty cycle = 5.44 ms / 5.84 ms x 100% = 93.2%, duty factor = 10 * log (1/Duty cycle) = 0.31 dB

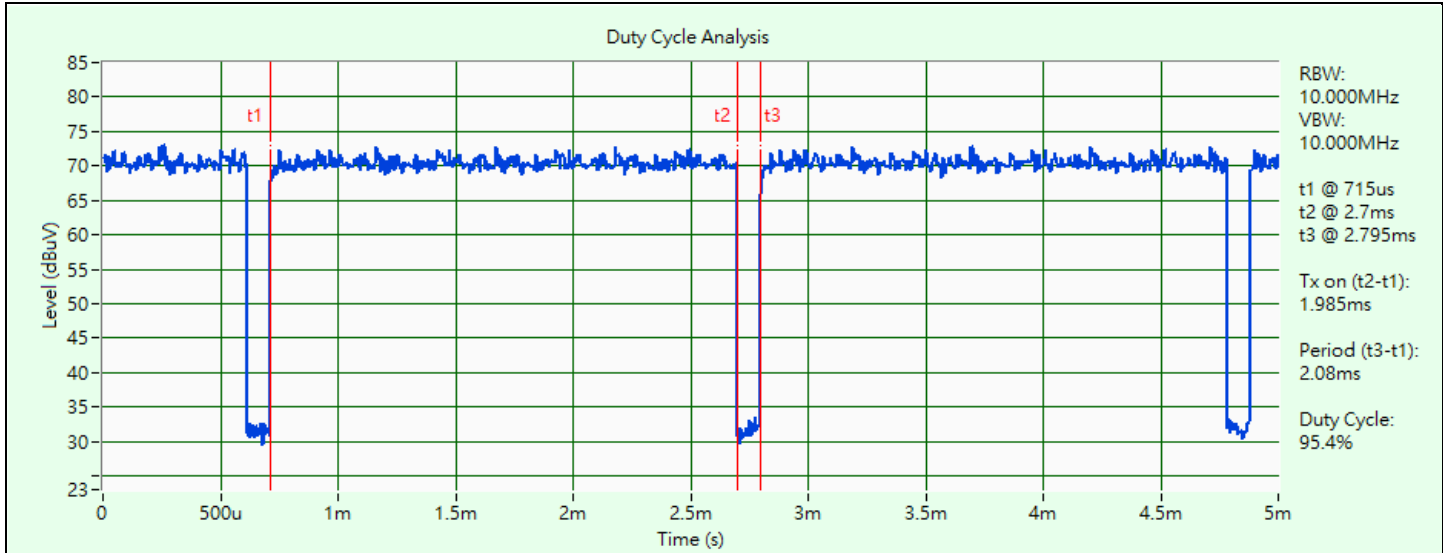

802.11a

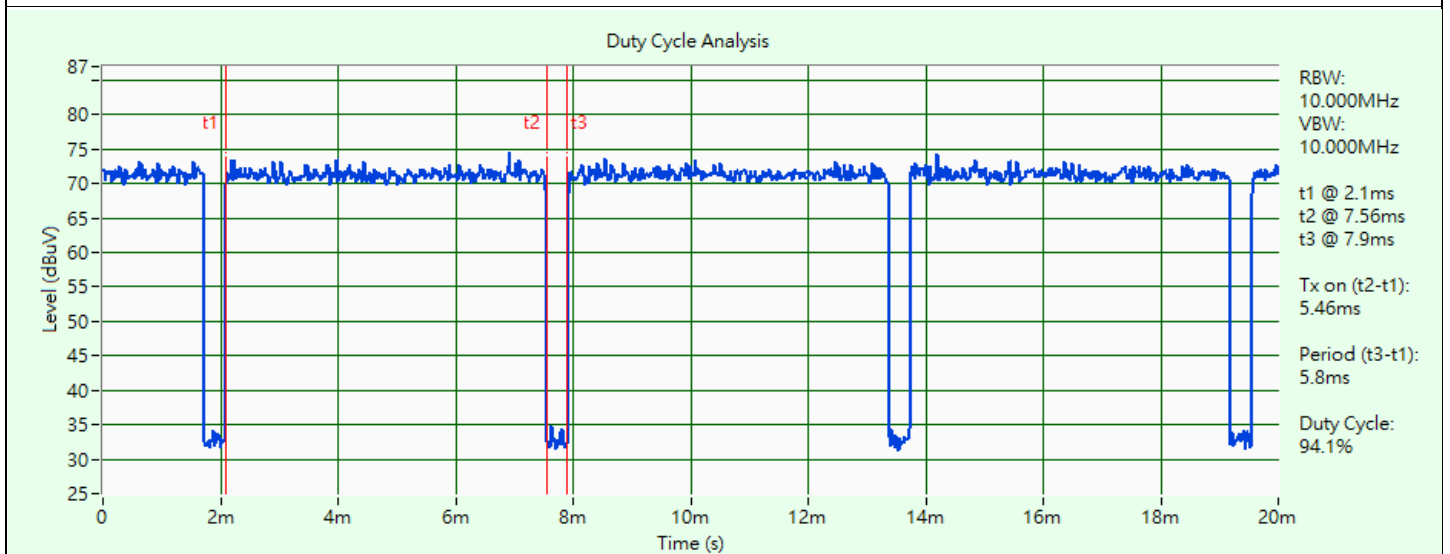

802.11ac (VHT20)

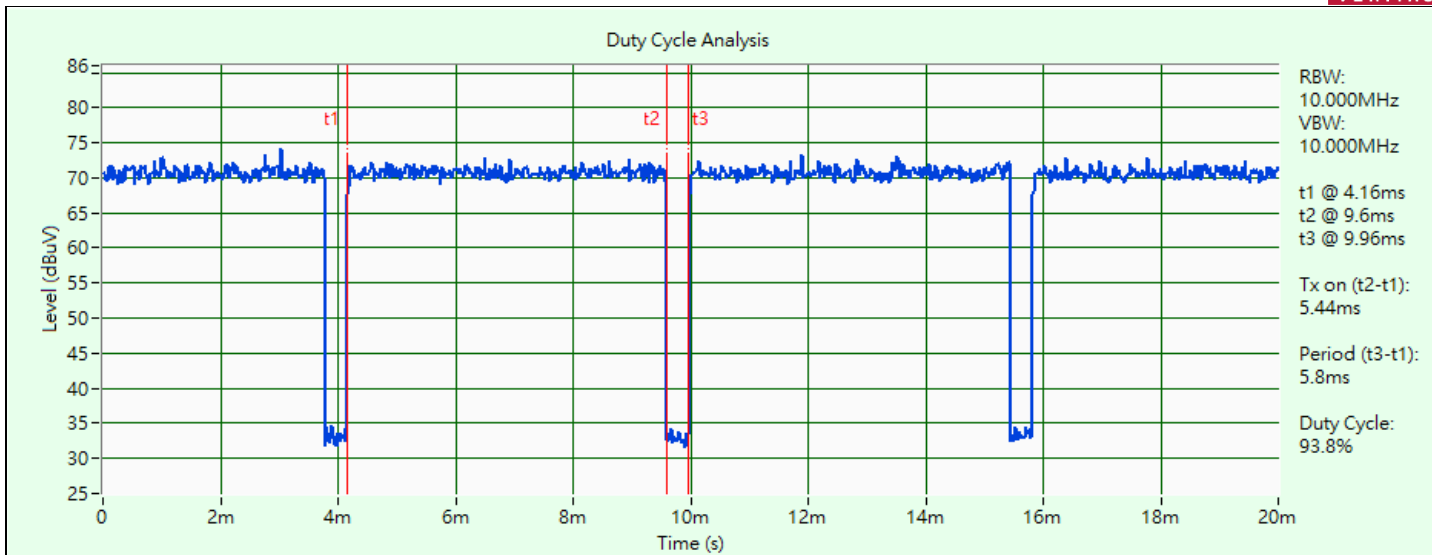

802.11ac (VHT40)

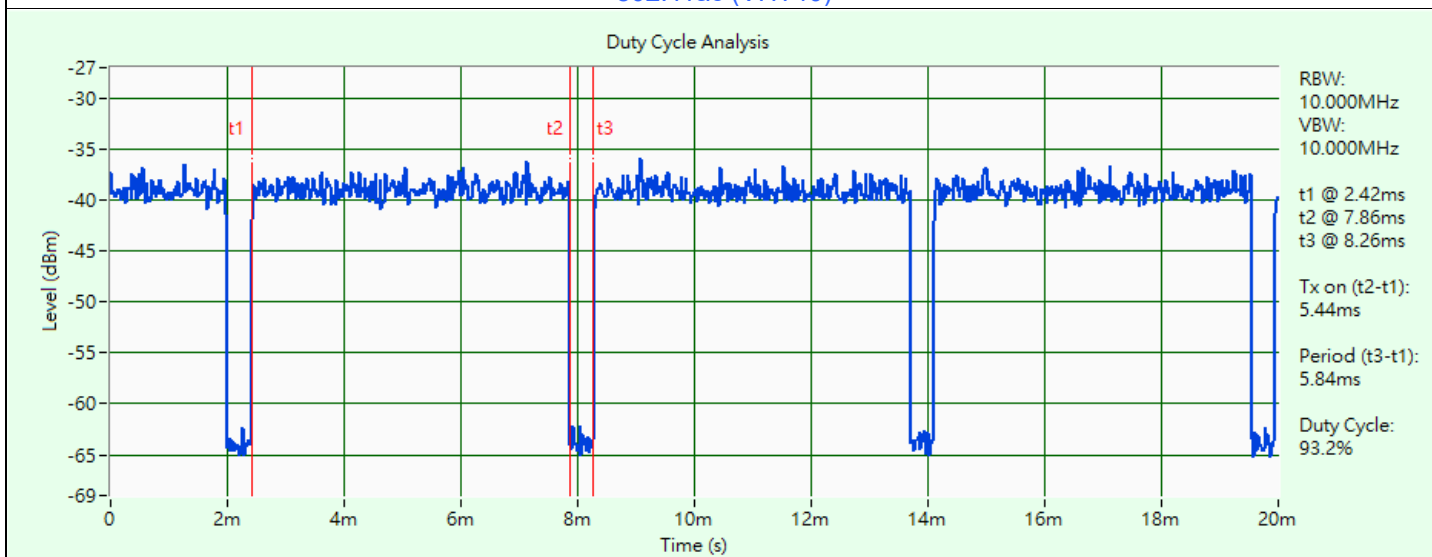

802.11ac (VHT80)

3.6 Test Program Used and Operation Descriptions

Controlling software QSPR Version 5.0-00197 has been activated to set the EUT under transmission condition continuously at specific channel frequency.

3.7 Connection Diagram of EUT and Peripheral Devices

For All test (Conducted Emissions test excluded)

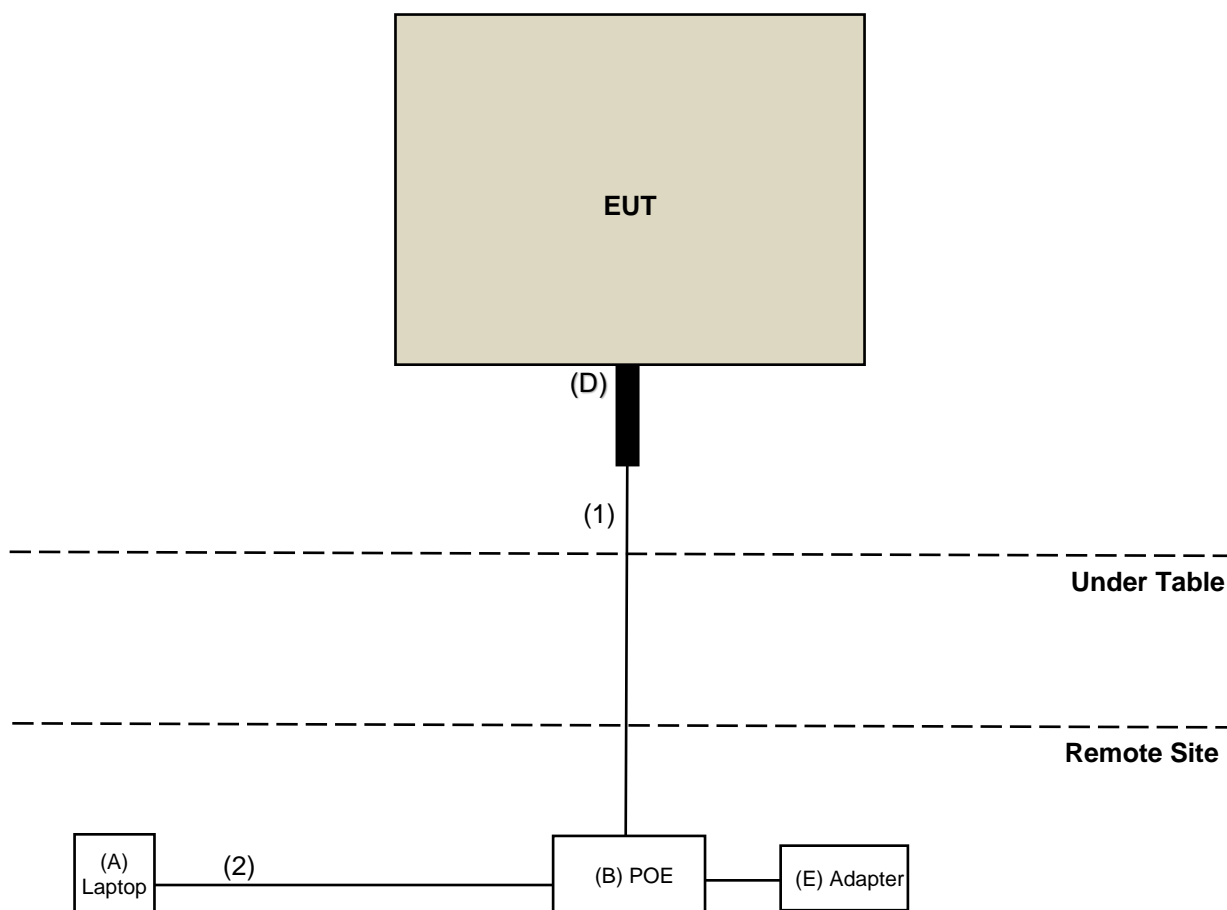

For AC Power Conducted Emissions only

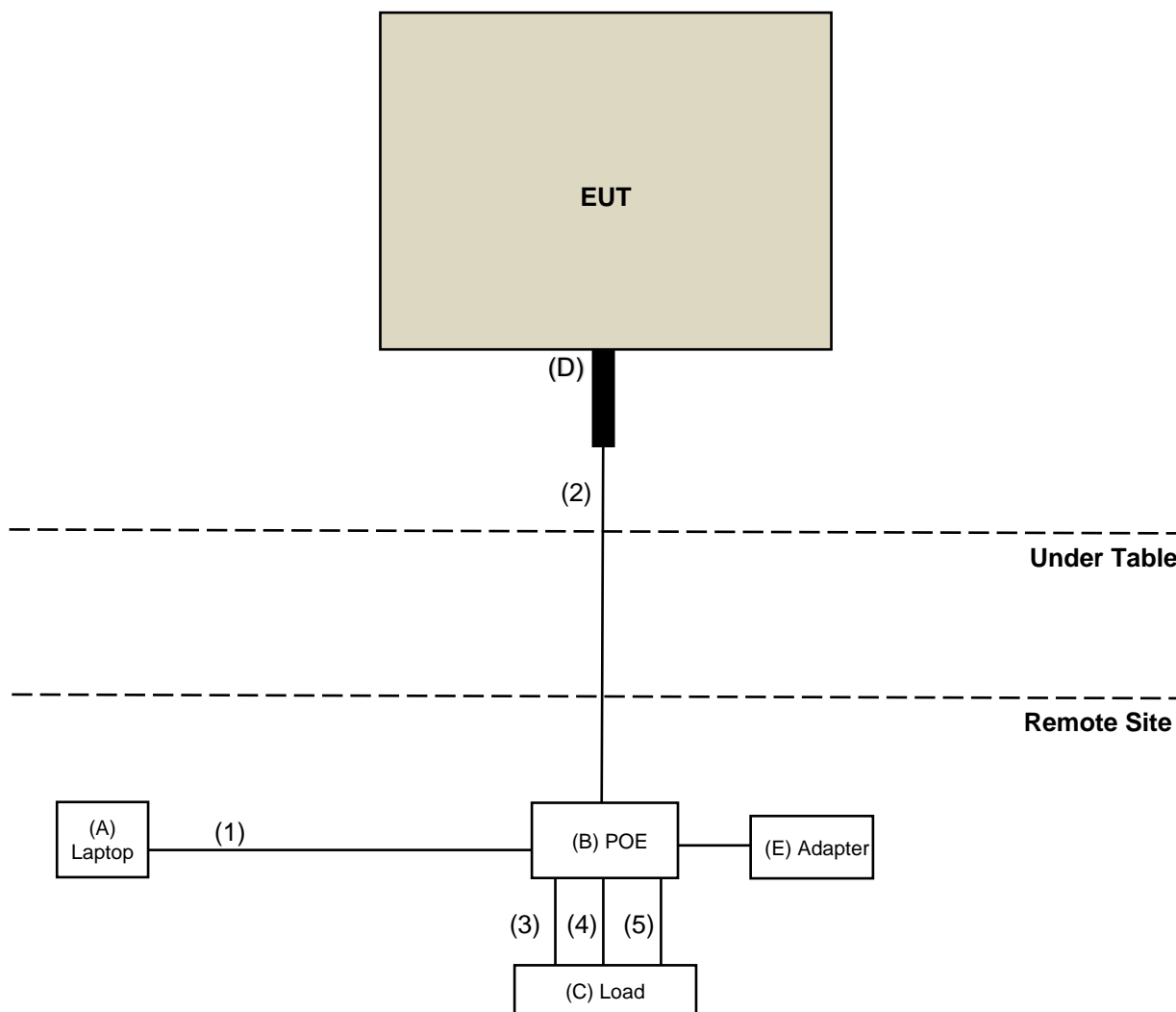

3.8 Configuration of Peripheral Devices and Cable Connections

ID	Product	Brand	Model No.	Serial No.	FCC ID	Remarks
A	Laptop	Lenovo	L470	PF0XEHC5	N/A	Provided by Lab
B	POE	NETGEAR	N/A	N/A	N/A	Supplied by applicant
C	Load	N/A	N/A	N/A	N/A	Provided by Lab
D	LAN port extension	N/A	N/A	N/A	N/A	Supplied by applicant
E	Adapter	N/A	N/A	N/A	N/A	Supplied by applicant

ID	Cable Descriptions	Qty.	Length (m)	Shielding (Yes/No)	Cores (Qty.)	Remarks
1	RJ-45 Cable	1	6.0	N	0	Provided by Lab
2	RJ-45 Cable	1	1.5	N	0	Provided by Lab
3	RJ-45 Cable	1	1.5	N	0	Provided by Lab
4	RJ-45 Cable	1	1.5	N	0	Provided by Lab
5	RJ-45 Cable	1	1.5	N	0	Provided by Lab

4 Test Instruments

The calibration interval of the all test instruments are 12 months and the calibrations are traceable to NML/ROC and NIST/USA.

4.1 RF Output Power

Description Manufacturer	Model No.	Serial No.	Calibrated Date	Calibrated Until
USB Wideband Power Sensor Keysight	U2021XA	MY55050005/MY55190004/MY55190007/MY55210005	2022/7/13	2023/7/12
			2023/7/19	2024/7/18

Notes:

1. The test was performed in Oven room.
2. Tested Date: 2023/5/14 ~ 2023/12/25

4.2 Power Spectral Density

Description Manufacturer	Model No.	Serial No.	Calibrated Date	Calibrated Until
Signal & Spectrum Analyzer R&S	FSV3044	101105	2023/2/22	2024/2/21
Software BV	ADT_RF Test Software V6.6.5.4	N/A	N/A	N/A

Notes:

1. The test was performed in Oven room.
2. Tested Date: 2023/5/14 ~ 2023/12/25

4.3 6 dB Bandwidth

Refer to section 4.2 to get information of the instruments.

4.4 Occupied Bandwidth

Refer to section 4.2 to get information of the instruments.

4.5 Frequency Stability

Description Manufacturer	Model No.	Serial No.	Calibrated Date	Calibrated Until
3-channel DC power supply JIN YIH Technology	ODP3033	ODP30332128138	N/A	N/A
Digital Multimeter Fluke	87-III	70360742	2022/6/23 2023/7/6	2023/6/22 2024/7/5
Signal & Spectrum Analyzer R&S	FSV3044	101105	2023/2/22	2024/2/21
Software BV	ADT_RF Test Software V6.6.5.4	N/A	N/A	N/A
Temperature & Humidity Chamber Terchy	HRM-120RF	931022	2022/12/27	2023/12/26

Notes:

1. The test was performed in Oven room.
2. Tested Date: 2023/5/14 ~ 2023/12/25

4.6 AC Power Conducted Emissions

Description Manufacturer	Model No.	Serial No.	Calibrated Date	Calibrated Until
EMI Test Receiver R&S	ESCI	100613	2022/12/5	2023/12/4
LISN R&S	ENV216 ESH3-Z5	101826 100311	2023/3/23 2022/9/12	2024/3/22 2023/9/11
RF Coaxial Cable Woken	5D-FB	Cable-cond1-01	2023/1/7	2024/1/6
Software BVADT	BVADT_Cond_ V7.3.7.4	N/A	N/A	N/A
V-LISN Schwarzbeck	NNBL 8226-2	8226-142	2022/8/31	2023/8/30

Notes:

1. The test was performed in HY - Conduction 1.
2. Tested Date: 2023/5/9

4.7 Unwanted Emissions below 1 GHz

Description Manufacturer	Model No.	Serial No.	Calibrated Date	Calibrated Until
Antenna Tower & Turn BV ADT	AT100	AT93021705	N/A	N/A
Bi_Log Antenna Schwarbeck	VULB 9168	9168-160	2022/10/20	2023/10/19
Loop Antenna Electro-Metrics	EM-6879	269	2022/9/19	2023/9/18
Loop Antenna TESEQ	HLA 6121	45745	2022/7/27	2023/7/26
MXE EMI Receiver Keysight	N9038A	MY55420137	2023/5/3	2024/5/2
Preamplifier Agilent	8447D	2944A10638	2023/5/7	2024/5/6
Preamplifier EMCI	EMC001340	980201	2022/9/23	2023/9/22
RF Coaxial Cable EMCI	5D-NM-BM	140903+140902	2023/1/7	2024/1/6
RF Coaxial Cable Woken	8D-FB	Cable-CH9-01	2023/5/7	2024/5/6
Signal & Spectrum Analyzer R&S	FSW43	101867	2022/12/30	2023/12/29
Software BV ADT	ADT_Radiated_ V7.6.15.9.5	N/A	N/A	N/A
Turn Table BV ADT	TT100	TT93021705	N/A	N/A
Turn Table Controller BV ADT	SC100	SC93021705	N/A	N/A

Notes:

1. The test was performed in HY - 966 chamber 4.
2. Tested Date: 2023/5/10

4.8 Unwanted Emissions above 1 GHz

Description Manufacturer	Model No.	Serial No.	Calibrated Date	Calibrated Until
Antenna Tower & Turn BV ADT	AT100	AT93021705	N/A	N/A
Boresight antenna tower fixture BV	BAF-02	5	N/A	N/A
Horn Antenna Schwarzbeck	BBHA 9120D	9120D-1169	2022/11/13	2023/11/12
	BBHA 9170	9170-480	2022/11/13	2023/11/12
		BBHA9170243	2022/11/13	2023/11/12
MXE EMI Receiver Keysight	N9038A	MY55420137	2022/04/27	2023/04/26
			2023/5/3	2024/5/2
Notch Filter Micro-Tronics	BRM17690	004	2023/1/11	2024/1/10
	BRM50716	060	2023/1/11	2024/1/10
Preamplifier Agilent	8449B	3008A02367	2023/2/15	2024/2/14
Preamplifier EMCI	EMC 184045	980116	2022/10/1	2023/9/30
RF Coaxial Cable EMCI	EMC102-KM-KM-600	150928	2022/7/9	2023/7/8
	EMC102-KM-KM-3000	150929	2022/7/9	2023/7/8
RF Coaxial Cable HUBER+SUHNER	SUCOFLEX 104	CABLE-CH9-(250795/4)	2023/1/7	2024/1/6
RF Coaxial Cable HUBER+SUHNER&EMCI	SUCOFLEX 104& EMC104-SM-SM8000	CABLE-CH9-02 (248780+171006)	2023/1/7	2024/1/6
Signal & Spectrum Analyzer R&S	FSW43	101867	2022/12/30	2023/12/29
Software BV ADT	ADT_Radiated_ V7.6.15.9.5	N/A	N/A	N/A
Turn Table BV ADT	TT100	TT93021705	N/A	N/A
Turn Table Controller BV ADT	SC100	SC93021705	N/A	N/A

Notes:

1. The test was performed in HY - 966 chamber 4.
2. Tested Date: 2023/4/26 ~ 2023/5/13

5 Limits of Test Items

5.1 RF Output Power

Operation Band	EUT Category	Limit
U-NII-1	Outdoor Access Point	1 Watt (30 dBm) (Max. e.i.r.p \leq 125mW(21 dBm) at any elevation angle above 30 degrees as measured from the horizon)
	Fixed point-to-point Access Point	1 Watt (30 dBm)
	Indoor Access Point	1 Watt (30 dBm)
	Mobile and Portable client device	250mW (24 dBm)

Operation Band	Limit
U-NII-3	1 Watt (30 dBm)

Per KDB 662911 D01 Multiple Transmitter Output Method of conducted output power measurement on IEEE 802.11 devices,

Array Gain = 0 dB (i.e., no array gain) for $N_{ANT} \leq 4$;

Array Gain = 0 dB (i.e., no array gain) for channel widths ≥ 40 MHz for any N_{ANT} ;

Array Gain = $5 \log(N_{ANT}/N_{SS})$ dB or 3 dB, whichever is less, for 20-MHz channel widths with $N_{ANT} \geq 5$.

For power measurements on all other devices: Array Gain = $10 \log(N_{ANT}/N_{SS})$ dB.

5.2 Power Spectral Density

Operation Band	EUT Category	Limit
U-NII-1	Outdoor Access Point	17 dBm/MHz
	Fixed point-to-point Access Point	
	Indoor Access Point	
	Mobile and Portable client device	11 dBm/MHz

Operation Band	Limit
U-NII-3	30 dBm/500 kHz

5.3 6 dB Bandwidth

Within the 5.725-5.850 GHz band, the minimum 6 dB bandwidth of U-NII devices shall be at least 500 kHz.

5.4 Occupied Bandwidth

The results are for reference only.

5.5 Frequency Stability

The frequency of the carrier signal shall be maintained within band of operation.

5.6 AC Power Conducted Emissions

Frequency (MHz)	Conducted Limit (dBuV)	
	Quasi-peak	Average
0.15 - 0.5	66 - 56	56 - 46
0.50 - 5.0	56	46
5.0 - 30.0	60	50

Notes:

1. The lower limit shall apply at the transition frequencies.
2. The limit decreases in line with the logarithm of the frequency in the range of 0.15 to 0.50 MHz.

5.7 Unwanted Emissions below 1 GHz

Radiated emissions which fall in the restricted bands must comply with the radiated emission limits specified as below table.

Frequencies (MHz)	Field Strength (microvolts/meter)	Measurement Distance (meters)
0.009 ~ 0.490	2400/F(kHz)	300
0.490 ~ 1.705	24000/F(kHz)	30
1.705 ~ 30.0	30	30
30 ~ 88	100	3
88 ~ 216	150	3
216 ~ 960	200	3
Above 960	500	3

Notes:

1. The lower limit shall apply at the transition frequencies.
2. Emission level (dBuV/m) = 20 log Emission level (uV/m).

5.8 Unwanted Emissions above 1 GHz

Radiated emissions which fall in the restricted bands must comply with the radiated emission limits specified as below table.

Frequencies (MHz)	Field Strength (microvolts/meter)	Measurement Distance (meters)
Above 960	500	3

Notes:

1. The lower limit shall apply at the transition frequencies.
2. Emission level (dBuV/m) = 20 log Emission level (uV/m).
3. For frequencies above 1000 MHz, the field strength limits are based on average detector, however, the peak field strength of any emission shall not exceed the maximum permitted average limits, specified above by more than 20 dB under any condition of modulation.

Limits of unwanted emission out of the restricted bands

Applicable To	Limit	
789033 D02 General UNII Test Procedure New Rules v02r01	Field Strength at 3 m	
	PK: 74 (dBμV/m)	AV: 54 (dBμV/m)

For transmitters operating in the 5.15-5.25 GHz band:

Applicable To	EIRP Limit	Equivalent Field Strength at 3 m
15.407(b)(1)	PK: -27 (dBm/MHz)	PK: 68.2 (dBμV/m)

For transmitters operating in the 5.725-5.850 GHz band:

Applicable To	EIRP Limit	Equivalent Field Strength at 3 m
15.407(b)(4)(i)	PK: -27 (dBm/MHz) ^{*1} PK: 10 (dBm/MHz) ^{*2} PK: 15.6 (dBm/MHz) ^{*3} PK: 27 (dBm/MHz) ^{*4}	PK: 68.2 (dBμV/m) ^{*1} PK: 105.2 (dBμV/m) ^{*2} PK: 110.8 (dBμV/m) ^{*3} PK: 122.2 (dBμV/m) ^{*4}

^{*1} beyond 75 MHz or more above of the band edge.

^{*2} below the band edge increasing linearly to 10 dBm/MHz at 25 MHz above.

^{*3} below the band edge increasing linearly to a level of 15.6 dBm/MHz at 5 MHz above.

^{*4} from 5 MHz above or below the band edge increasing linearly to a level of 27 dBm/MHz at the band edge.

Note: The following formula is used to convert the equipment isotropic radiated power (eirp) to field strength:

$$E = \frac{1000000 \sqrt{30P}}{3} \mu\text{V/m, where P is the eirp (Watts).}$$

6 Test Arrangements

6.1 RF Output Power

6.1.1 Test Setup

Conducted Measurement Method

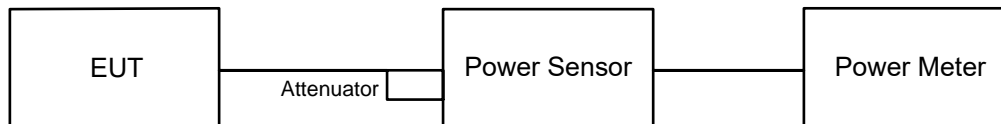

6.1.2 Test Procedure

Conducted Measurement Method

Method PM is used to perform output power measurement, trigger and gating function of wide band power meter is enabled to measure max output power of TX on burst and set the detector to average. Duty factor is not added to measured value.

6.2 Power Spectral Density

6.2.1 Test Setup

Conducted Measurement Method

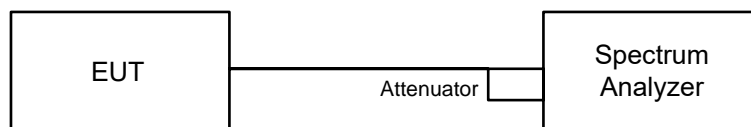

6.2.2 Test Procedure

Conducted Measurement Method

For specified measurement bandwidth 1 MHz:

Method SA-2

- Set span to encompass the entire emission bandwidth (EBW) of the signal.
- Set RBW = 1 MHz, Set VBW \geq 3 MHz, Detector = RMS
- Sweep points \geq $[2 \times \text{span} / \text{RBW}]$. (This gives bin-to-bin spacing \leq RBW / 2, so that narrowband signals are not lost between frequency bins.)
- Sweep time = auto, trigger set to "free run".
- Trace average at least 100 traces in power averaging mode.
- Use the peak search function on the instrument to find the peak of the spectrum and record its value.
- Record the max value and add $10 \log (1/\text{duty cycle})$.

For specified measurement bandwidth 500 kHz:

Method SA-2

- Set span to encompass the entire emission bandwidth (EBW) of the signal.
- Set RBW = 300 kHz, Set VBW \geq 1 MHz, Detector = RMS
- Scale the observed power level to an equivalent value in 500 kHz by adjusting (increasing) the measured power by a bandwidth correction factor (BWCF) where $\text{BWCF} = 10 \log(500 \text{ kHz}/300 \text{ kHz})$
- Sweep points \geq $[2 \times \text{span} / \text{RBW}]$. (This gives bin-to-bin spacing \leq RBW / 2, so that narrowband signals are not lost between frequency bins.)
- Sweep time = auto, trigger set to "free run".
- Trace average at least 100 traces in power averaging mode.
- Use the peak search function on the instrument to find the peak of the spectrum and record its value.
- Record the max value and add $10 \log (1/\text{duty cycle})$.

6.3 6 dB Bandwidth

6.3.1 Test Setup

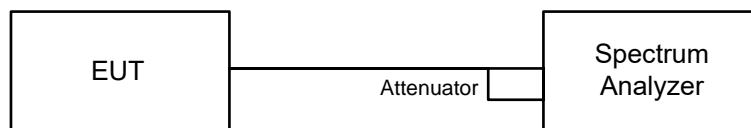

6.3.2 Test Procedure

- Set resolution bandwidth (RBW) = 100 kHz.
- Set the video bandwidth (VBW) $\geq 3 \times$ RBW, Detector = Peak.
- Trace mode = max hold.
- Sweep = auto couple.
- Measure the maximum width of the emission that is constrained by the frequencies associated with the two amplitude points (upper and lower) that are attenuated by 6 dB relative to the maximum level measured in the fundamental emission.

6.4 Occupied Bandwidth

6.4.1 Test Setup

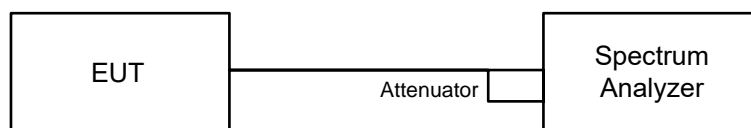

6.4.2 Test Procedure

The transmitter output was connected to the spectrum analyzer through an attenuator. The bandwidth of the fundamental frequency was measured by spectrum analyzer with resolution bandwidth in the range of 1% to 5% of the anticipated emission bandwidth, and a video bandwidth at least 3x the resolution bandwidth and set the detector to Sampling. The width of a frequency band such that, below the lower and above the upper frequency limits, the mean powers emitted are each equal to a specified percentage 0.5% of the total mean power of a given emission.

6.5 Frequency Stability

6.5.1 Test Setup

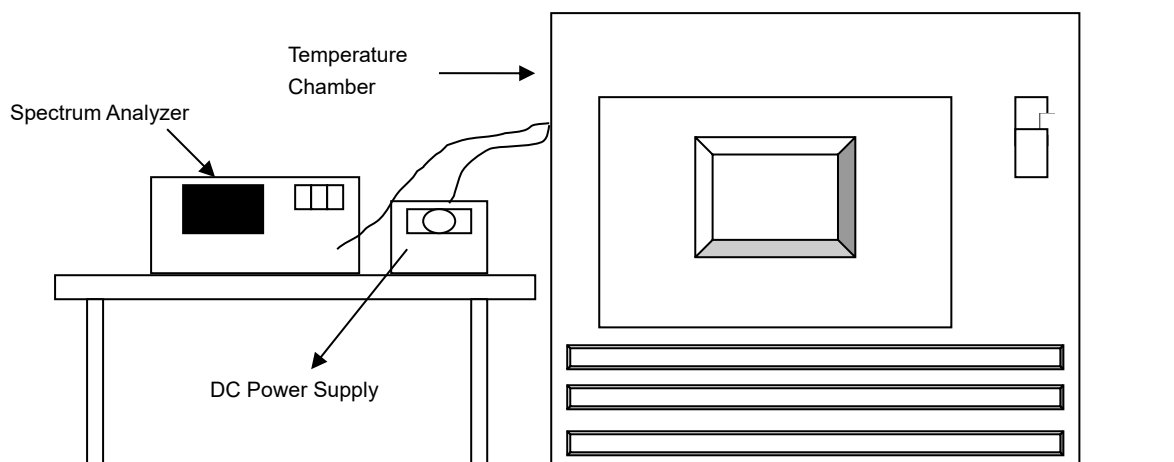

6.5.2 Test Procedure

- The EUT was placed inside the environmental test chamber and powered by nominal DC voltage.
- Turn the EUT on and couple its output to a spectrum analyzer.
- Turn the EUT off and set the chamber to the highest temperature specified.
- Allow sufficient time (approximately 30 min) for the temperature of the chamber to stabilize, turn the EUT on and measure the operating frequency after 2, 5, and 10 Minutes.
- Repeat step (d) with the temperature chamber set to the next desired temperature until measurements down to the lowest specified temperature have been completed.
- The test chamber was allowed to stabilize at +20 degree C for a minimum of 30 Minutes. The supply voltage was then adjusted on the EUT from 85% to 115% and the frequency record.

6.6 AC Power Conducted Emissions

6.6.1 Test Setup

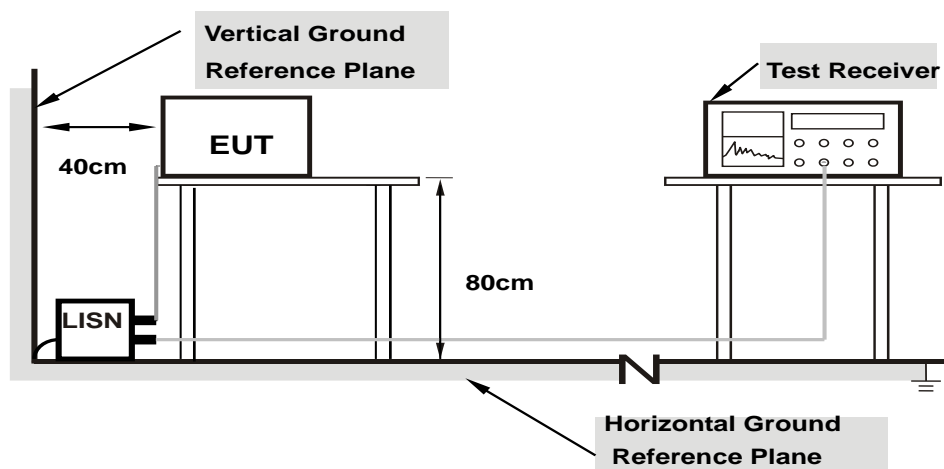

Note: 1.Support units were connected to second LISN.

For the actual test configuration, please refer to the attached file (Test Setup Photo).

6.6.2 Test Procedure

- The EUT was placed on a 0.8 meter to the top of table and placed 0.4 meters from the conducting wall of the shielded room with EUT being connected to the power mains through a line impedance stabilization network (LISN). Other support units were connected to the power mains through another LISN. The two LISNs provide 50 ohm/ 50 uH of coupling impedance for the measuring instrument.
- Both lines of the power mains connected to the EUT were checked for maximum conducted interference.
- The frequency range from 150 kHz to 30 MHz was searched. Emission levels under (Limit – 20 dB) was not recorded.

Note: The resolution bandwidth and video bandwidth of test receiver is 9 kHz for quasi-peak detection (QP) and average detection (AV) at frequency 0.15 MHz-30 MHz.

6.7 Unwanted Emissions below 1 GHz

6.7.1 Test Setup

For Radiated emission below 30 MHz

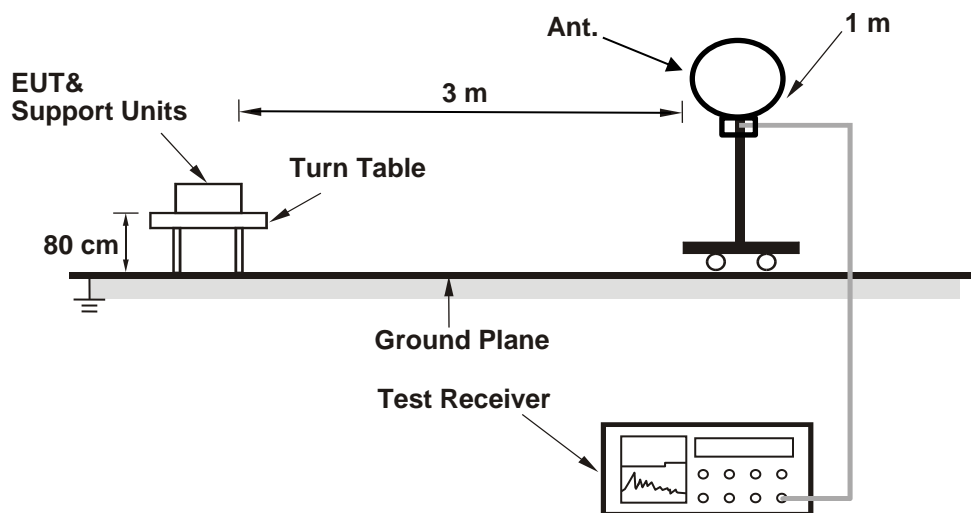

For Radiated emission above 30 MHz

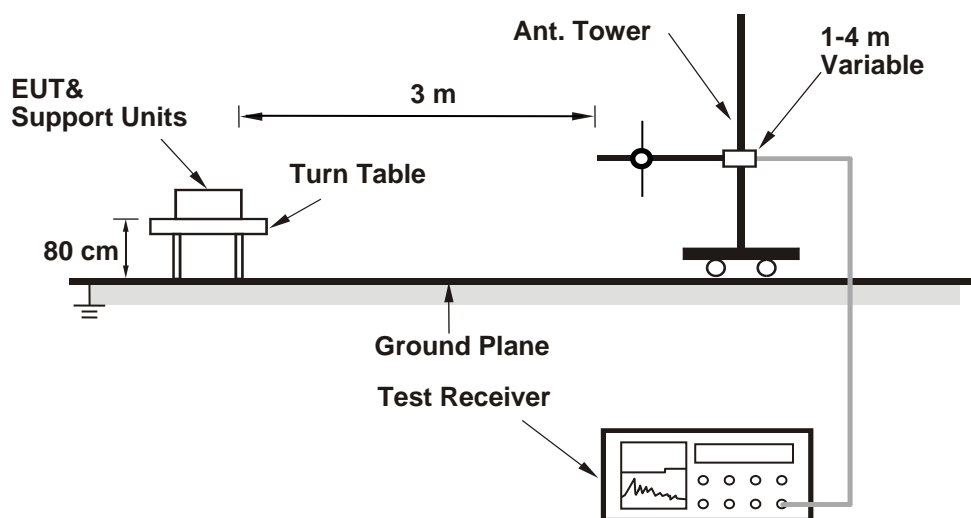

For the actual test configuration, please refer to the attached file (Test Setup Photo).

6.7.2 Test Procedure

For Radiated emission below 30 MHz

- a. The EUT was placed on the top of a rotating table 0.8 meters above the ground at 3 meter chamber room for test. The table was rotated 360 degrees to determine the position of the highest radiation.
- b. The EUT was set 3 meters away from the interference-receiving antenna, which was mounted on the top of a variable-height antenna tower.
- c. Parallel, perpendicular, and ground-parallel orientations of the antenna are set to make the measurement.
- d. For each suspected emission, the EUT was arranged to its worst case and the rotatable table was turned from 0 degrees to 360 degrees to find the maximum reading.
- e. The test-receiver system was set to Quasi-Peak Detect Function and Specified Bandwidth with Maximum Hold Mode, except for the frequency band (9 kHz to 90 kHz and 110 kHz to 490 kHz) set to average detect function and peak detect function.

Notes:

1. The resolution bandwidth and video bandwidth of test receiver/spectrum analyzer is 200 Hz at frequency below 150 kHz.
2. The resolution bandwidth and video bandwidth of test receiver/spectrum analyzer is 9 kHz or 10 kHz at frequency (150 kHz to 30 MHz).
3. All modes of operation were investigated and the worst-case emissions are reported.

For Radiated emission above 30 MHz

- a. The EUT was placed on the top of a rotating table 0.8 meters above the ground at 3 meter chamber room for test. The table was rotated 360 degrees to determine the position of the highest radiation.
- b. The EUT was set 3 meters away from the interference-receiving antenna, which was mounted on the top of a variable-height antenna tower.
- c. The height of antenna is varied from one meter to four meters above the ground to determine the maximum value of the field strength. Both horizontal and vertical polarizations of the antenna are set to make the measurement.
- d. For each suspected emission, the EUT was arranged to its worst case and then the antenna was tuned to heights from 1 meter to 4 meters and the rotatable table was turned from 0 degrees to 360 degrees to find the maximum reading.
- e. The test-receiver system was set to Quasi-peak(QP) detect function, Average(AV) detect function, Peak(PK) detect function and specified bandwidth with maximum hold mode when the test frequency is below 1 GHz.

Notes:

1. The resolution bandwidth and video bandwidth of test receiver/spectrum analyzer is 120 kHz for Quasi-peak detection (QP), Average detection (AV), Peak detection (PK) at frequency (30MHz to 1 GHz).
2. All modes of operation were investigated and the worst-case emissions are reported.

6.8 Unwanted Emissions above 1 GHz

6.8.1 Test Setup

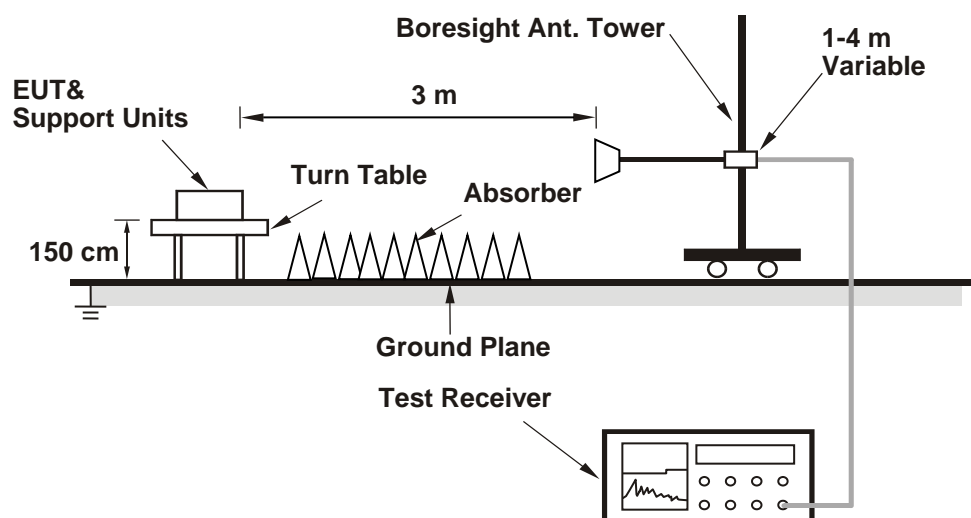

For the actual test configuration, please refer to the attached file (Test Setup Photo).

6.8.2 Test Procedure

- The EUT was placed on the top of a rotating table 1.5 meters above the ground at 3 meter chamber room for test. The table was rotated 360 degrees to determine the position of the highest radiation.
- The EUT was set 3 meters away from the interference-receiving antenna, which was mounted on the top of a variable-height antenna tower.
- The height of antenna is varied from one meter to four meters above the ground to determine the maximum value of the field strength. Both horizontal and vertical polarizations of the antenna are set to make the measurement.
- For each suspected emission, the EUT was arranged to its worst case and then the antenna was tuned to heights from 1 meter to 4 meters and the rotatable table was turned from 0 degrees to 360 degrees to find the maximum reading.
- The test-receiver system was set to peak and average detects function and specified bandwidth with maximum hold mode when the test frequency is above 1 GHz. If the peak reading value also meets average limit, measurement with the average detector is unnecessary.

Notes:

- The resolution bandwidth of test receiver/spectrum analyzer is 1 MHz and the video bandwidth is 3 MHz for Peak detection (PK) and Average detection (AV) at frequency above 1 GHz.
- For fundamental and harmonic signal measurement, the resolution bandwidth of test receiver/spectrum analyzer is 1 MHz and the video bandwidth is $\geq 1/T$ (Duty cycle $< 98\%$) or 10 Hz (Duty cycle $\geq 98\%$) for Average detection (AV) at frequency above 1 GHz.
- All modes of operation were investigated and the worst-case emissions are reported.

7 Test Results of Test Item

7.1 RF Output Power

Input Power:	54 Vdc	Environmental Conditions:	25°C, 60% RH	Tested By:	Matthew Yang
--------------	--------	---------------------------	--------------	------------	--------------

Mode A:

802.11a

Chan.	Chan. Freq. (MHz)	Average Power (dBm)				Total Power (mW)	Total Power (dBm)	Power Limit (dBm)	Test Result
		Chain 0	Chain 1	Chain 2	Chain 3				
36	5180	16.91	16.85	16.87	16.66	192.493	22.84	28.8	Pass
40	5200	16.84	16.69	16.75	16.60	187.996	22.74	28.8	Pass
48	5240	16.99	16.68	16.82	16.91	193.737	22.87	28.8	Pass
149	5745	22.93	22.65	22.11	22.41	717.149	28.56	28.9	Pass
157	5785	22.83	23.04	22.18	22.49	735.854	28.67	28.9	Pass
165	5825	23.07	22.92	22.15	22.35	734.503	28.66	28.9	Pass

Notes:

1. Directional gain is the maximum gain of antennas.
2. For U-NII-1, the directional gain is 7.2 dBi > 6 dBi, so the output power limit shall be reduced to $30-(7.2-6) = 28.8$ dBm.
3. For U-NII-3, the directional gain is 7.1 dBi > 6 dBi, so the output power limit shall be reduced to $30-(7.1-6) = 28.9$ dBm.

802.11ax (HE20)

Chan.	Chan. Freq. (MHz)	Average Power (dBm)				Total Power (mW)	Total Power (dBm)	Power Limit (dBm)	Test Result
		Chain 0	Chain 1	Chain 2	Chain 3				
36	5180	16.83	16.70	17.01	16.68	191.761	22.83	28.8	Pass
40	5200	17.00	16.65	16.75	16.59	189.276	22.77	28.8	Pass
48	5240	17.10	16.73	16.79	16.60	191.846	22.83	28.8	Pass
149	5745	22.93	22.65	22.31	22.24	718.123	28.56	28.9	Pass
157	5785	22.88	23.15	22.14	22.52	742.957	28.71	28.9	Pass
165	5825	23.15	22.78	22.26	22.45	740.268	28.69	28.9	Pass

Notes:

1. Directional gain is the maximum gain of antennas.
2. For U-NII-1, the directional gain is 7.2 dBi > 6 dBi, so the output power limit shall be reduced to $30-(7.2-6) = 28.8$ dBm.
3. For U-NII-3, the directional gain is 7.1 dBi > 6 dBi, so the output power limit shall be reduced to $30-(7.1-6) = 28.9$ dBm.

802.11ax (HE40)

Chan.	Chan. Freq. (MHz)	Average Power (dBm)				Total Power (mW)	Total Power (dBm)	Power Limit (dBm)	Test Result
		Chain 0	Chain 1	Chain 2	Chain 3				
38	5190	18.94	18.66	18.92	18.55	301.392	24.79	28.8	Pass
46	5230	19.75	19.44	19.61	19.33	359.423	25.56	28.8	Pass
151	5755	21.62	21.40	21.05	21.13	540.318	27.33	28.9	Pass
159	5795	23.15	23.33	22.38	22.52	773.447	28.88	28.9	Pass

Notes:

1. Directional gain is the maximum gain of antennas.
2. For U-NII-1, the maximum gain is 7.2 dBi > 6 dBi, so the output power limit shall be reduced to $30-(7.2-6) = 28.8$ dBm.
3. For U-NII-3, the maximum gain is 7.1 dBi > 6 dBi, so the output power limit shall be reduced to $30-(7.1-6) = 28.9$ dBm.

802.11ax (HE80)

Chan.	Chan. Freq. (MHz)	Average Power (dBm)				Total Power (mW)	Total Power (dBm)	Power Limit (dBm)	Test Result
		Chain 0	Chain 1	Chain 2	Chain 3				
42	5210	15.83	15.44	15.72	15.27	144.253	21.59	28.8	Pass
155	5775	19.36	19.12	18.33	18.23	302.56	24.81	28.9	Pass

Notes:

1. Directional gain is the maximum gain of antennas.
2. For U-NII-1, the maximum gain is 7.2 dBi > 6 dBi, so the output power limit shall be reduced to $30-(7.2-6) = 28.8$ dBm.
3. For U-NII-3, the maximum gain is 7.1 dBi > 6 dBi, so the output power limit shall be reduced to $30-(7.1-6) = 28.9$ dBm.

802.11ax (HE20) Beamforming

Chan.	Chan. Freq. (MHz)	Average Power (dBm)				Total Power (mW)	Total Power (dBm)	Power Limit (dBm)	Test Result
		Chain 0	Chain 1	Chain 2	Chain 3				
36	5180	16.83	16.70	17.01	16.68	191.761	22.83	23.18	Pass
40	5200	17.00	16.65	16.75	16.59	189.276	22.77	23.18	Pass
48	5240	17.10	16.73	16.79	16.60	191.846	22.83	23.18	Pass
149	5745	16.95	16.67	16.35	16.22	181.028	22.58	23.03	Pass
157	5785	16.91	17.10	16.20	16.50	186.732	22.71	23.03	Pass
165	5825	17.21	16.83	16.29	16.45	187.513	22.73	23.03	Pass

Notes:

1. Directional gain = $10 \log[(10^{\text{Chain0}/20} + 10^{\text{Chain1}/20} + 10^{\text{Chain2}/20} + 10^{\text{Chain3}/20})^2 / 4]$
2. For U-NII-1, the directional gain is 12.82 dBi > 6 dBi, so the output power limit shall be reduced to $30-(12.82-6) = 23.18$ dBm.
3. For U-NII-3, the directional gain is 12.97 dBi > 6 dBi, so the output power limit shall be reduced to $30-(12.97-6) = 23.03$ dBm.

802.11ax (HE40) Beamforming

Chan.	Chan. Freq. (MHz)	Average Power (dBm)				Total Power (mW)	Total Power (dBm)	Power Limit (dBm)	Test Result
		Chain 0	Chain 1	Chain 2	Chain 3				
38	5190	16.91	16.70	16.89	16.58	190.228	22.79	23.18	Pass
46	5230	17.24	16.96	17.13	16.85	202.684	23.07	23.18	Pass
151	5755	17.11	16.99	16.59	16.61	192.826	22.85	23.03	Pass
159	5795	17.08	17.31	16.42	16.53	193.709	22.87	23.03	Pass

Notes:

1. Directional gain = $10 \log[(10^{\text{Chain0}/20} + 10^{\text{Chain1}/20} + 10^{\text{Chain2}/20} + 10^{\text{Chain3}/20})^2 / 4]$
2. For U-NII-1, the directional gain is 12.82 dBi > 6 dBi, so the output power limit shall be reduced to $30-(12.82-6) = 23.18$ dBm.
3. For U-NII-3, the directional gain is 12.97 dBi > 6 dBi, so the output power limit shall be reduced to $30-(12.97-6) = 23.03$ dBm.

802.11ax (HE80) Beamforming

Chan.	Chan. Freq. (MHz)	Average Power (dBm)				Total Power (mW)	Total Power (dBm)	Power Limit (dBm)	Test Result
		Chain 0	Chain 1	Chain 2	Chain 3				
42	5210	15.83	15.44	15.72	15.27	144.253	21.59	23.18	Pass
155	5775	17.41	17.18	16.39	16.28	193.334	22.86	23.03	Pass

Notes:

1. Directional gain = $10 \log[(10^{\text{Chain0}/20} + 10^{\text{Chain1}/20} + 10^{\text{Chain2}/20} + 10^{\text{Chain3}/20})^2 / 4]$
2. For U-NII-1, the directional gain is 12.82 dBi > 6 dBi, so the output power limit shall be reduced to $30-(12.82-6) = 23.18$ dBm.
3. For U-NII-3, the directional gain is 12.97 dBi > 6 dBi, so the output power limit shall be reduced to $30-(12.97-6) = 23.03$ dBm.

Input Power:	54 Vdc	Environmental Conditions:	25°C, 60% RH	Tested By:	Matthew Yang
--------------	--------	---------------------------	--------------	------------	--------------

Mode B:
802.11a

Chan.	Chan. Freq. (MHz)	Average Power (dBm)		Total Power (mW)	Total Power (dBm)	Power Limit (dBm)	Test Result
		Chain 0	Chain 1				
36	5180	16.70	17.01	97.008	19.87	22.8	Pass
40	5200	17.05	17.12	102.222	20.10	22.8	Pass
48	5240	17.01	17.05	100.933	20.04	22.8	Pass
149	5745	21.24	20.88	255.507	24.07	29.2	Pass
157	5785	21.22	20.87	254.614	24.06	29.2	Pass
165	5825	20.87	20.84	243.519	23.87	29.2	Pass

Notes:

1. Directional gain is the maximum gain of antennas.
2. For U-NII-1, the maximum gain is 7.2 dBi > 6 dBi, so the output power limit shall be reduced to $24 - (7.2 - 6) = 22.8$ dBm.
3. For U-NII-3, the maximum gain is 6.8 dBi > 6 dBi, so the output power limit shall be reduced to $30 - (6.8 - 6) = 29.2$ dBm.

802.11ac (VHT20)

Chan.	Chan. Freq. (MHz)	Average Power (dBm)		Total Power (mW)	Total Power (dBm)	Power Limit (dBm)	Test Result
		Chain 0	Chain 1				
36	5180	17.72	17.94	121.386	20.84	22.8	Pass
40	5200	17.90	18.13	126.672	21.03	22.8	Pass
48	5240	17.71	17.89	120.538	20.81	22.8	Pass
149	5745	20.81	21.07	248.442	23.95	29.2	Pass
157	5785	20.83	21.03	247.825	23.94	29.2	Pass
165	5825	20.75	20.94	243.015	23.86	29.2	Pass

Notes:

1. Directional gain is the maximum gain of antennas.
2. For U-NII-1, the maximum gain is 7.2 dBi > 6 dBi, so the output power limit shall be reduced to $24 - (7.2 - 6) = 22.8$ dBm.
3. For U-NII-3, the maximum gain is 6.8 dBi > 6 dBi, so the output power limit shall be reduced to $30 - (6.8 - 6) = 29.2$ dBm.

802.11ac (VHT40)

Chan.	Chan. Freq. (MHz)	Average Power (dBm)		Total Power (mW)	Total Power (dBm)	Power Limit (dBm)	Test Result
		Chain 0	Chain 1				
38	5190	16.20	16.52	86.561	19.37	22.8	Pass
46	5230	19.64	19.73	186.017	22.70	22.8	Pass
151	5755	19.74	19.94	192.817	22.85	29.2	Pass
159	5795	20.69	21.03	243.985	23.87	29.2	Pass

Notes:

1. Directional gain is the maximum gain of antennas.
2. For U-NII-1, the maximum gain is 7.2 dBi > 6 dBi, so the output power limit shall be reduced to $24 - (7.2 - 6) = 22.8$ dBm.
3. For U-NII-3, the maximum gain is 6.8 dBi > 6 dBi, so the output power limit shall be reduced to $30 - (6.8 - 6) = 29.2$ dBm.

802.11ac (VHT80)

Chan.	Chan. Freq. (MHz)	Average Power (dBm)		Total Power (mW)	Total Power (dBm)	Power Limit (dBm)	Test Result
		Chain 0	Chain 1				
42	5210	15.24	15.48	68.738	18.37	22.8	Pass
155	5775	17.41	17.62	112.89	20.53	29.2	Pass

Notes:

1. Directional gain is the maximum gain of antennas.
2. For U-NII-1, the maximum gain is 7.2 dBi > 6 dBi, so the output power limit shall be reduced to $24 - (7.2 - 6) = 22.8$ dBm.
3. For U-NII-3, the maximum gain is 6.8 dBi > 6 dBi, so the output power limit shall be reduced to $30 - (6.8 - 6) = 29.2$ dBm.

7.2 Power Spectral Density

Input Power:	54 Vdc	Environmental Conditions:	25°C, 60% RH	Tested By:	Matthew Yang
--------------	--------	---------------------------	--------------	------------	--------------

Mode A:

802.11a

Chan.	Chan. Freq. (MHz)	PSD w/o Duty Factor (dBm/MHz)				Duty Factor (dB)	Total PSD (dBm/MHz)	Max. PSD Limit (dBm/MHz)	Test Result
		Chain 0	Chain 1	Chain 2	Chain 3				
36	5180	3.93	3.83	3.85	3.64	0.17	10.00	10.18	Pass
40	5200	3.81	3.72	3.78	3.64	0.17	9.93	10.18	Pass
48	5240	3.98	3.65	3.85	3.94	0.17	10.05	10.18	Pass

Notes:

- Method E) 2) a) of power density measurement of KDB 662911 is using for calculating total power density. Total power density is summing entire spectra across corresponding frequency bins on the various outputs by computer.
- Directional gain = $10 \log[(10^{\text{Chain0}/20} + 10^{\text{Chain1}/20} + 10^{\text{Chain2}/20} + 10^{\text{Chain3}/20})^2 / 4]$
- For U-NII-1, the directional gain is 12.82 dBi > 6dBi, so the power density limit shall be reduced to $17-(12.82-6) = 10.18$ dBm/MHz.

802.11ax (HE20)

Chan.	Chan. Freq. (MHz)	PSD w/o Duty Factor (dBm/MHz)				Duty Factor (dB)	Total PSD (dBm/MHz)	Max. PSD Limit (dBm/MHz)	Test Result
		Chain 0	Chain 1	Chain 2	Chain 3				
36	5180	3.82	3.73	4.00	3.72	0.23	10.07	10.18	Pass
40	5200	3.99	3.63	3.72	3.61	0.23	9.99	10.18	Pass
48	5240	4.08	3.70	3.82	3.62	0.23	10.06	10.18	Pass

Notes:

- Method E) 2) a) of power density measurement of KDB 662911 is using for calculating total power density. Total power density is summing entire spectra across corresponding frequency bins on the various outputs by computer.
- Directional gain = $10 \log[(10^{\text{Chain0}/20} + 10^{\text{Chain1}/20} + 10^{\text{Chain2}/20} + 10^{\text{Chain3}/20})^2 / 4]$
- For U-NII-1, the directional gain is 12.82 dBi > 6dBi, so the power density limit shall be reduced to $17-(12.82-6) = 10.18$ dBm/MHz.

802.11ax (HE40)

Chan.	Chan. Freq. (MHz)	PSD w/o Duty Factor (dBm/MHz)				Duty Factor (dB)	Total PSD (dBm/MHz)	Max. PSD Limit (dBm/MHz)	Test Result
		Chain 0	Chain 1	Chain 2	Chain 3				
38	5190	3.01	2.61	2.93	2.68	0.20	9.03	10.18	Pass
46	5230	3.72	3.42	3.59	3.28	0.20	9.73	10.18	Pass

Notes:

- Method E) 2) a) of power density measurement of KDB 662911 is using for calculating total power density. Total power density is summing entire spectra across corresponding frequency bins on the various outputs by computer.
- Directional gain = $10 \log[(10^{\text{Chain0}/20} + 10^{\text{Chain1}/20} + 10^{\text{Chain2}/20} + 10^{\text{Chain3}/20})^2 / 4]$
- For U-NII-1, the directional gain is 12.82 dBi > 6dBi, so the power density limit shall be reduced to $17-(12.82-6) = 10.18$ dBm/MHz.

802.11ax (HE80)

Chan.	Chan. Freq. (MHz)	PSD w/o Duty Factor (dBm/MHz)				Duty Factor (dB)	Total PSD (dBm/MHz)	Max. PSD Limit (dBm/MHz)	Test Result
		Chain 0	Chain 1	Chain 2	Chain 3				
42	5210	-2.96	-3.45	-3.18	-3.60	0.22	2.95	10.18	Pass

Notes:

- Method E) 2) a) of power density measurement of KDB 662911 is using for calculating total power density. Total power density is summing entire spectra across corresponding frequency bins on the various outputs by computer.
- Directional gain = $10 \log[(10^{\text{Chain0}/20} + 10^{\text{Chain1}/20} + 10^{\text{Chain2}/20} + 10^{\text{Chain3}/20})^2 / 4]$
- For U-NII-1, the directional gain is 12.82 dBi > 6dBi, so the power density limit shall be reduced to $17-(12.82-6) = 10.18$ dBm/MHz.

802.11a

Chan.	Chan. Freq. (MHz)	PSD w/o Duty Factor (dBm/300kHz)				Total PSD w/o Duty Factor (dBm/300kHz)	Duty Factor (dB)	Total PSD (dBm/500kHz)	PSD Limit (dBm/500kHz)	Test Result
		Chain 0	Chain 1	Chain 2	Chain 3					
149	5745	6.17	5.68	5.11	5.41	11.63	0.17	14.02	23.03	Pass
157	5785	5.86	6.32	5.21	5.60	11.79	0.17	14.18	23.03	Pass
165	5825	6.36	6.12	5.15	5.31	11.79	0.17	14.18	23.03	Pass

Notes:

- Method E) 2) b) Measure and sum spectral maxima across the outputs of KDB 662911 is using for calculating total power density.
- Directional gain = $10 \log[(10^{\text{Chain0}/20} + 10^{\text{Chain1}/20} + 10^{\text{Chain2}/20} + 10^{\text{Chain3}/20})^2 / 4]$
- For U-NII-3, the directional gain is 12.97 dBi > 6 dBi, so the power density limit shall be reduced to $30-(12.97-6) = 23.03$ dBm/500kHz.

802.11ax (HE20)

Chan.	Chan. Freq. (MHz)	PSD w/o Duty Factor (dBm/300kHz)				Total PSD w/o Duty Factor (dBm/300kHz)	Duty Factor (dB)	Total PSD (dBm/500kHz)	PSD Limit (dBm/500kHz)	Test Result
		Chain 0	Chain 1	Chain 2	Chain 3					
149	5745	5.56	5.21	4.88	4.70	11.12	0.23	13.57	23.03	Pass
157	5785	5.43	5.64	4.63	4.86	11.18	0.23	13.63	23.03	Pass
165	5825	5.68	5.34	4.73	4.71	11.16	0.23	13.61	23.03	Pass

Notes:

- Method E) 2) b) Measure and sum spectral maxima across the outputs of KDB 662911 is using for calculating total power density.
- Directional gain = $10 \log[(10^{\text{Chain0}/20} + 10^{\text{Chain1}/20} + 10^{\text{Chain2}/20} + 10^{\text{Chain3}/20})^2 / 4]$
- For U-NII-3, the directional gain is 12.97 dBi > 6 dBi, so the power density limit shall be reduced to $30-(12.97-6) = 23.03$ dBm/500kHz.

802.11ax (HE40)

Chan.	Chan. Freq. (MHz)	PSD w/o Duty Factor (dBm/300kHz)				Total PSD w/o Duty Factor (dBm/300kHz)	Duty Factor (dB)	Total PSD (dBm/500kHz)	PSD Limit (dBm/500kHz)	Test Result
		Chain 0	Chain 1	Chain 2	Chain 3					
151	5755	2.12	1.90	1.81	2.05	7.99	0.2	10.41	23.03	Pass
159	5795	3.29	3.60	2.71	2.90	9.16	0.2	11.58	23.03	Pass

Notes:

- Method E) 2) b) Measure and sum spectral maxima across the outputs of KDB 662911 is using for calculating total power density.
- Directional gain = $10 \log[(10^{\text{Chain0}/20} + 10^{\text{Chain1}/20} + 10^{\text{Chain2}/20} + 10^{\text{Chain3}/20})^2 / 4]$
- For U-NII-3, the directional gain is 12.97 dBi > 6 dBi, so the power density limit shall be reduced to $30 - (12.97 - 6) = 23.03 \text{ dBm/500kHz}$.

802.11ax (HE80)

Chan.	Chan. Freq. (MHz)	PSD w/o Duty Factor (dBm/300kHz)				Total PSD w/o Duty Factor (dBm/300kHz)	Duty Factor (dB)	Total PSD (dBm/500kHz)	PSD Limit (dBm/500kHz)	Test Result
		Chain 0	Chain 1	Chain 2	Chain 3					
155	5775	-2.59	-2.63	-3.50	-3.12	3.08	0.22	5.52	23.03	Pass

Notes:

- Method E) 2) b) Measure and sum spectral maxima across the outputs of KDB 662911 is using for calculating total power density.
- Directional gain = $10 \log[(10^{\text{Chain0}/20} + 10^{\text{Chain1}/20} + 10^{\text{Chain2}/20} + 10^{\text{Chain3}/20})^2 / 4]$
- For U-NII-3, the directional gain is 12.97 dBi > 6 dBi, so the power density limit shall be reduced to $30 - (12.97 - 6) = 23.03 \text{ dBm/500kHz}$.

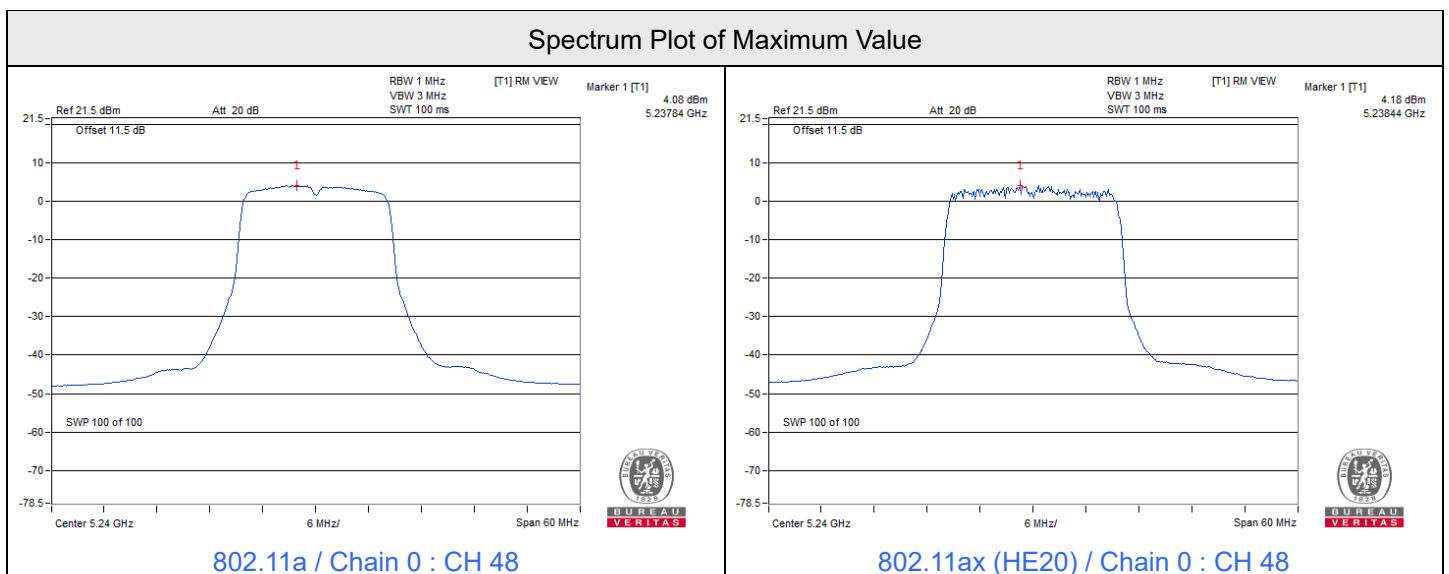



Spectrum Plot of Maximum Value

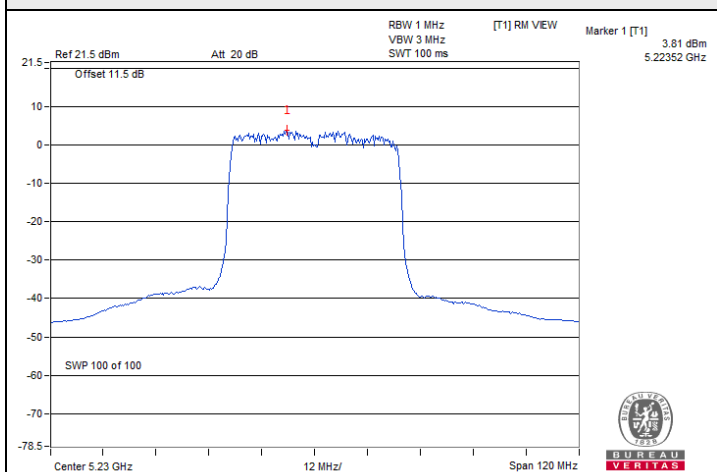

802.11ax (HE40) / Chain 0 : CH 46

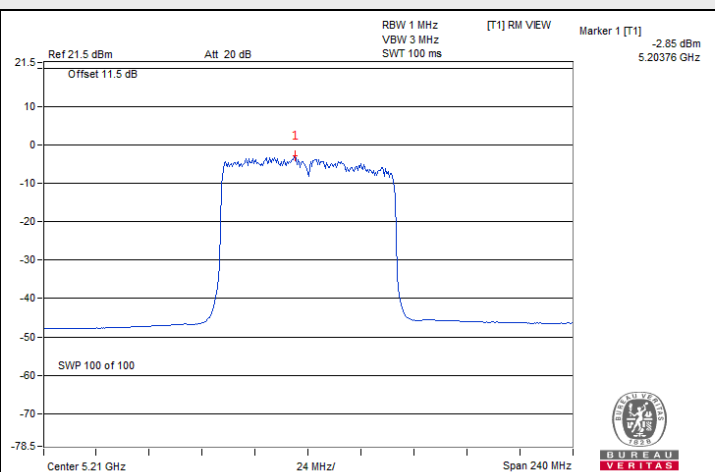

802.11ax (HE80) / Chain 0 : CH 42

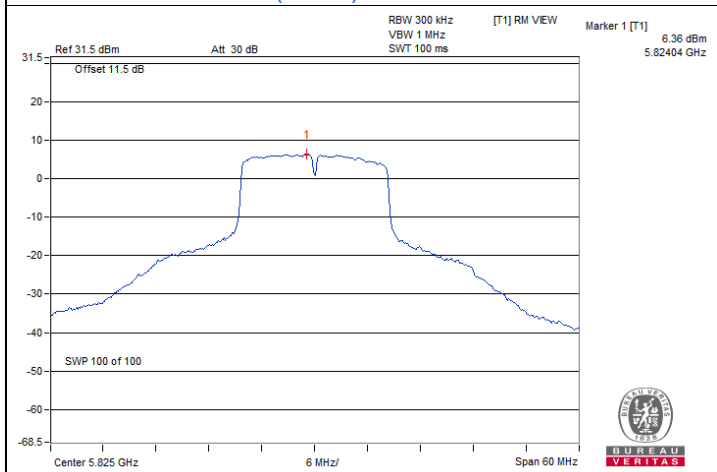

802.11a / Chain 0 : CH 165

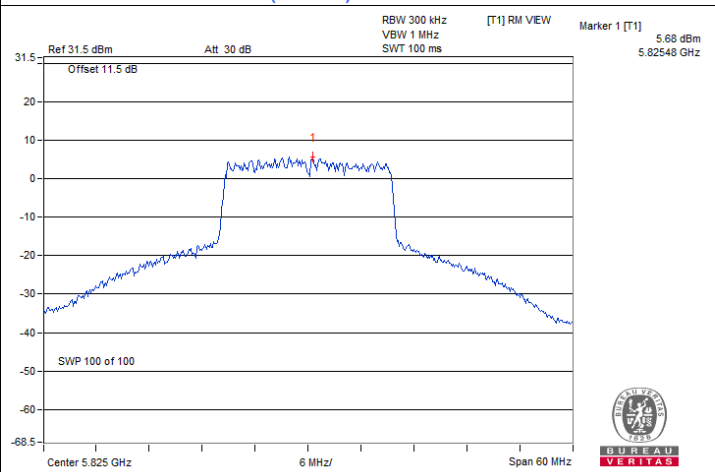

802.11ax (HE20) / Chain 0 : CH 165

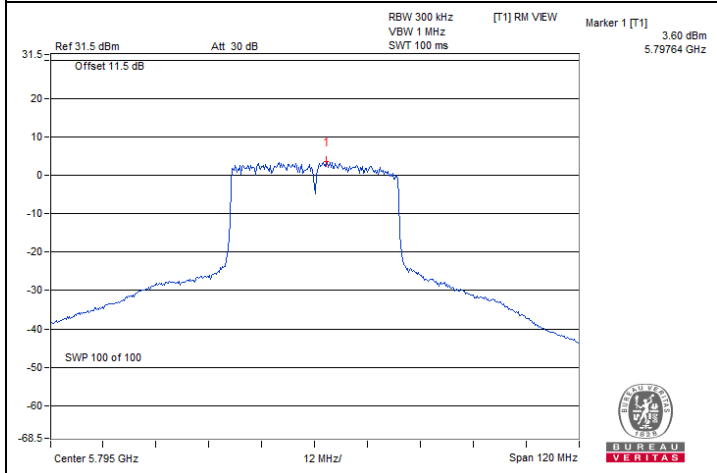

802.11ax (HE40) / Chain 1 : CH 159

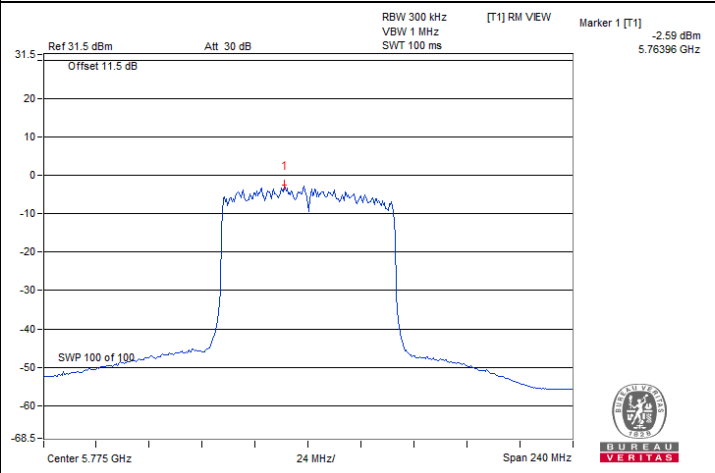

802.11ax (HE80) / Chain 0 : CH 155

Input Power:	54 Vdc	Environmental Conditions:	25°C, 60% RH	Tested By:	Matthew Yang
--------------	--------	---------------------------	--------------	------------	--------------

Mode B

802.11a

Chan.	Chan. Freq. (MHz)	PSD w/o Duty Factor (dBm/MHz)		Duty Factor (dB)	Total PSD (dBm/MHz)	Max. PSD Limit (dBm/MHz)	Test Result
		Chain 0	Chain 1				
36	5180	3.89	4.29	0.20	7.30	7.55	Pass
40	5200	4.28	4.32	0.20	7.51	7.55	Pass
48	5240	4.19	4.30	0.20	7.46	7.55	Pass

Notes:

- Method E) 2) a) of power density measurement of KDB 662911 is using for calculating total power density. Total power density is summing entire spectra across corresponding frequency bins on the various outputs by computer.
- Directional gain = $10 \log[(10^{\text{Chain0}/20} + 10^{\text{Chain1}/20})^2 / 2]$
- For U-NII-1, the directional gain is 9.45 dBi > 6dBi, so the power density limit shall be reduced to $11-(9.45-6) = 7.55$ dBm/MHz.

802.11ac (VHT20)

Chan.	Chan. Freq. (MHz)	PSD w/o Duty Factor (dBm/MHz)		Duty Factor (dB)	Total PSD (dBm/MHz)	Max. PSD Limit (dBm/MHz)	Test Result
		Chain 0	Chain 1				
36	5180	3.49	4.58	0.26	7.34	7.55	Pass
40	5200	3.52	4.41	0.26	7.26	7.55	Pass
48	5240	3.46	4.58	0.26	7.33	7.55	Pass

Notes:

- Method E) 2) a) of power density measurement of KDB 662911 is using for calculating total power density. Total power density is summing entire spectra across corresponding frequency bins on the various outputs by computer.
- Directional gain = $10 \log[(10^{\text{Chain0}/20} + 10^{\text{Chain1}/20})^2 / 2]$
- For U-NII-1, the directional gain is 9.45 dBi > 6dBi, so the power density limit shall be reduced to $11-(9.45-6) = 7.55$ dBm/MHz.

802.11ac (VHT40)

Chan.	Chan. Freq. (MHz)	PSD w/o Duty Factor (dBm/MHz)		Duty Factor (dB)	Total PSD (dBm/MHz)	Max. PSD Limit (dBm/MHz)	Test Result
		Chain 0	Chain 1				
38	5190	-1.16	-0.23	0.28	2.62	7.55	Pass
46	5230	2.08	2.11	0.28	5.39	7.55	Pass

Notes:

- Method E) 2) a) of power density measurement of KDB 662911 is using for calculating total power density. Total power density is summing entire spectra across corresponding frequency bins on the various outputs by computer.
- Directional gain = $10 \log[(10^{\text{Chain0}/20} + 10^{\text{Chain1}/20})^2 / 2]$
- For U-NII-1, the directional gain is 9.45 dBi > 6dBi, so the power density limit shall be reduced to $11-(9.45-6) = 7.55$ dBm/MHz.

802.11ac (VHT80)

Chan.	Chan. Freq. (MHz)	PSD w/o Duty Factor (dBm/MHz)		Duty Factor (dB)	Total PSD (dBm/MHz)	Max. PSD Limit (dBm/MHz)	Test Result
		Chain 0	Chain 1				
42	5210	-4.61	-4.06	0.31	-1.01	7.55	Pass

Notes:

- Method E) 2) a) of power density measurement of KDB 662911 is using for calculating total power density. Total power density is summing entire spectra across corresponding frequency bins on the various outputs by computer.
- Directional gain = $10 \log[(10^{\text{Chain0}/20} + 10^{\text{Chain1}/20})^2 / 2]$
- For U-NII-1, the directional gain is 9.45 dBi > 6dBi, so the power density limit shall be reduced to $11-(9.45-6) = 7.55$ dBm/MHz.

802.11a

Chan.	Chan. Freq. (MHz)	PSD w/o Duty Factor (dBm/300kHz)		Total PSD w/o Duty Factor (dBm/300kHz)	Duty Factor (dB)	Total PSD (dBm/500kHz)	PSD Limit (dBm/500kHz)	Test Result
		Chain 0	Chain 1					
149	5745	-1.84	-2.03	1.08	0.2	3.50	26.63	Pass
157	5785	-1.81	-2.13	1.04	0.2	3.46	26.63	Pass
165	5825	-2.01	-2.19	0.91	0.2	3.33	26.63	Pass

Notes:

- Method E) 2) b) Measure and sum spectral maxima across the outputs of KDB 662911 is using for calculating total power density.
- Directional gain = $10 \log[(10^{\text{Chain0}/20} + 10^{\text{Chain1}/20})^2 / 2]$
- For U-NII-3, the directional gain is 9.37 dBi > 6 dBi, so the power density limit shall be reduced to $30-(9.37-6) = 26.63$ dBm/500kHz.

802.11ac (VHT20)

Chan.	Chan. Freq. (MHz)	PSD w/o Duty Factor (dBm/300kHz)		Total PSD w/o Duty Factor (dBm/300kHz)	Duty Factor (dB)	Total PSD (dBm/500kHz)	PSD Limit (dBm/500kHz)	Test Result
		Chain 0	Chain 1					
149	5745	-2.04	-1.72	1.13	0.26	3.61	26.63	Pass
157	5785	-1.84	-2.14	1.02	0.26	3.50	26.63	Pass
165	5825	-2.34	-2.33	0.68	0.26	3.16	26.63	Pass

Notes:

- Method E) 2) b) Measure and sum spectral maxima across the outputs of KDB 662911 is using for calculating total power density.
- Directional gain = $10 \log[(10^{\text{Chain0}/20} + 10^{\text{Chain1}/20})^2 / 2]$
- For U-NII-3, the directional gain is 9.37 dBi > 6 dBi, so the power density limit shall be reduced to $30-(9.37-6) = 26.63$ dBm/500kHz.

802.11ac (VHT40)

Chan.	Chan. Freq. (MHz)	PSD w/o Duty Factor (dBm/300kHz)		Total PSD w/o Duty Factor (dBm/300kHz)	Duty Factor (dB)	Total PSD (dBm/500kHz)	PSD Limit (dBm/500kHz)	Test Result
		Chain 0	Chain 1					
151	5755	-6.78	-6.72	-3.74	0.28	-1.24	26.63	Pass
159	5795	-6.17	-5.93	-3.04	0.28	-0.54	26.63	Pass

Notes:

- Method E) 2) b) Measure and sum spectral maxima across the outputs of KDB 662911 is using for calculating total power density.
- Directional gain = $10 \log[(10^{\text{Chain0}/20} + 10^{\text{Chain1}/20})^2 / 2]$
- For U-NII-3, the directional gain is 9.37 dBi > 6 dBi, so the power density limit shall be reduced to $30 - (9.37 - 6) = 26.63 \text{ dBm/500kHz}$.

802.11ac (VHT80)

Chan.	Chan. Freq. (MHz)	PSD w/o Duty Factor (dBm/300kHz)		Total PSD w/o Duty Factor (dBm/300kHz)	Duty Factor (dB)	Total PSD (dBm/500kHz)	PSD Limit (dBm/500kHz)	Test Result
		Chain 0	Chain 1					
155	5775	-13.04	-12.85	-9.93	0.31	-7.40	26.63	Pass

Notes:

- Method E) 2) b) Measure and sum spectral maxima across the outputs of KDB 662911 is using for calculating total power density.
- Directional gain = $10 \log[(10^{\text{Chain0}/20} + 10^{\text{Chain1}/20})^2 / 2]$
- For U-NII-3, the directional gain is 9.37 dBi > 6 dBi, so the power density limit shall be reduced to $30 - (9.37 - 6) = 26.63 \text{ dBm/500kHz}$.

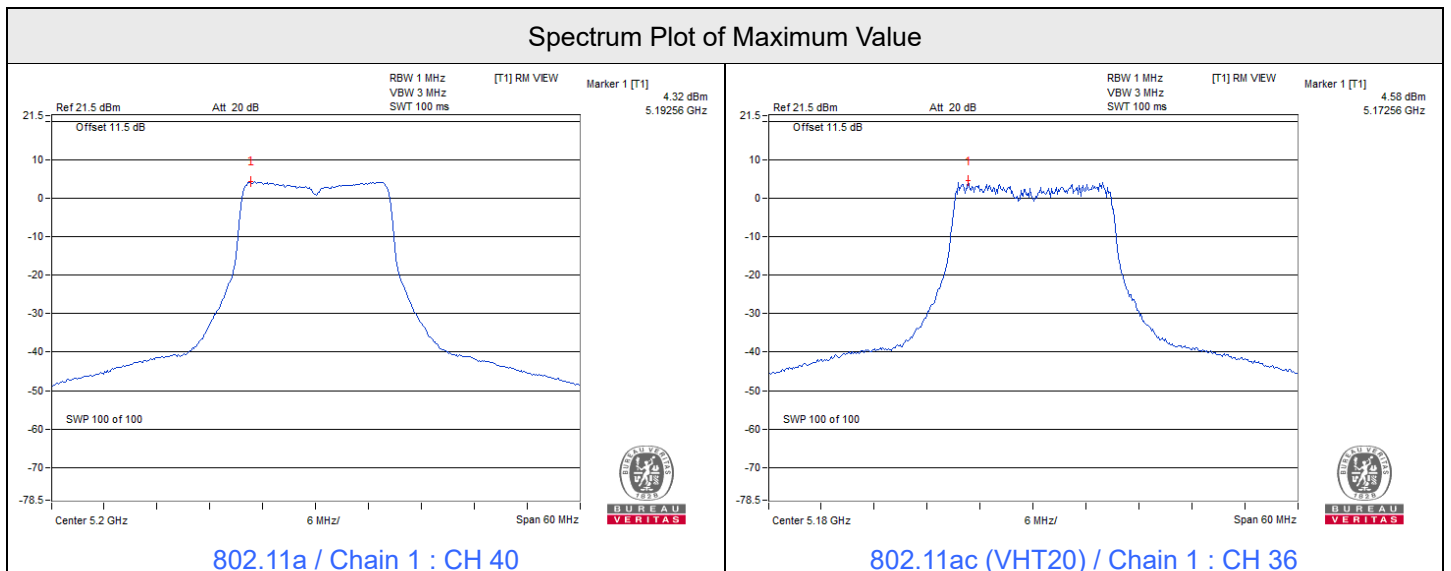

Spectrum Plot of Maximum Value

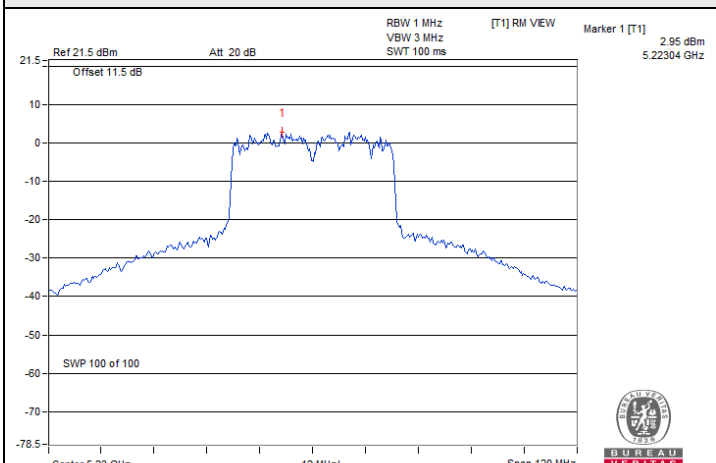

802.11ac (VHT40) / Chain 1 : CH 46

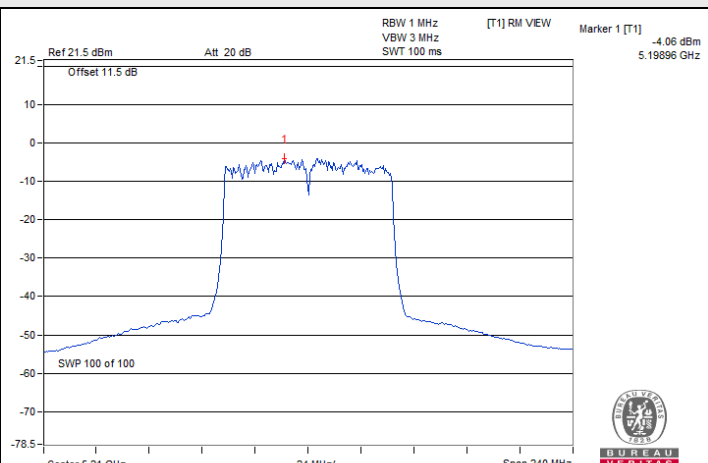

802.11ac (VHT80) / Chain 1 : CH 42

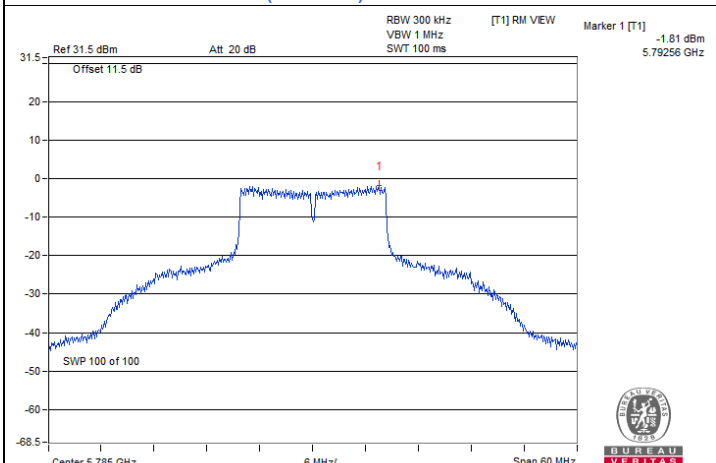

802.11a / Chain 0 : CH 157

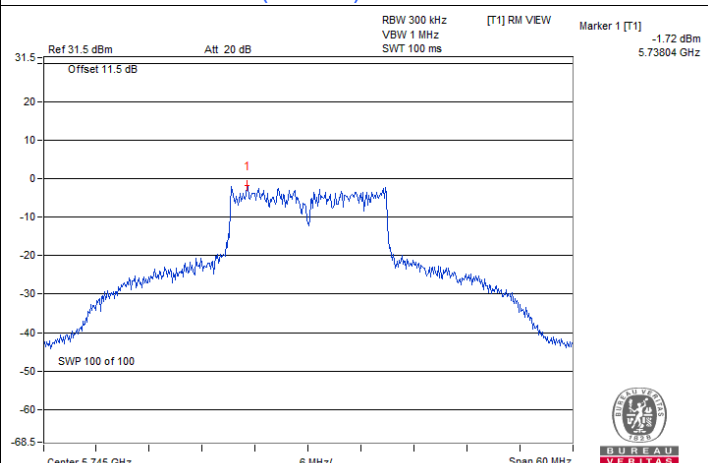

802.11ac (VHT20) / Chain 1 : CH 149

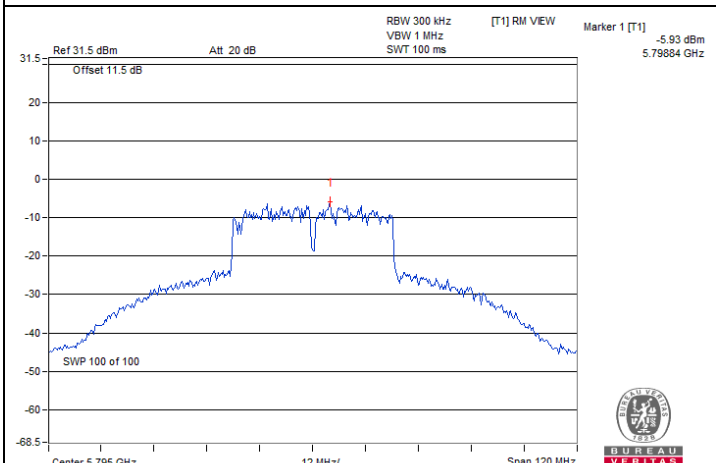

802.11ac (VHT40) / Chain 1 : CH 159

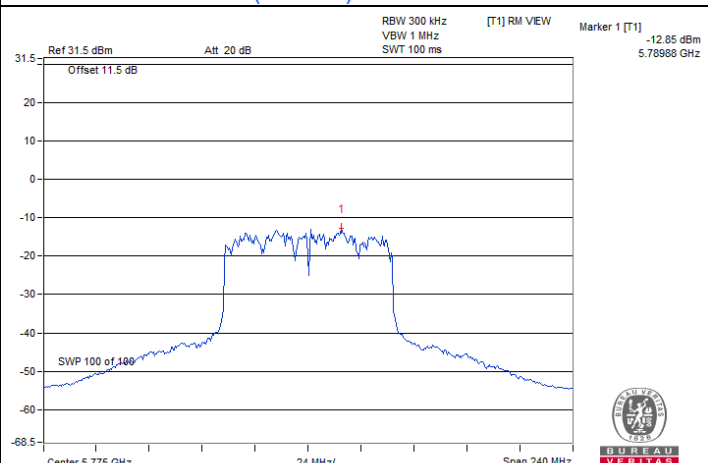

802.11ac (VHT80) / Chain 1 : CH 155

7.3 6 dB Bandwidth

Input Power:	54 Vdc	Environmental Conditions:	25°C, 60% RH	Tested By:	Matthew Yang
--------------	--------	---------------------------	--------------	------------	--------------

Mode A

802.11a

Channel	Frequency (MHz)	6 dB Bandwidth (MHz)				Minimum Limit (MHz)	Test Result
		Chain 0	Chain 1	Chain 2	Chain 3		
149	5745	16.34	16.38	15.99	16.37	0.5	Pass
157	5785	16.37	16.35	16.38	16.36	0.5	Pass
165	5825	15.78	15.98	16.40	16.35	0.5	Pass

802.11ax (HE20)

Channel	Frequency (MHz)	6 dB Bandwidth (MHz)				Minimum Limit (MHz)	Test Result
		Chain 0	Chain 1	Chain 2	Chain 3		
149	5745	19.04	18.78	18.92	18.89	0.5	Pass
157	5785	18.60	18.95	18.56	18.81	0.5	Pass
165	5825	18.85	18.82	17.88	18.90	0.5	Pass

802.11ax (HE40)

Channel	Frequency (MHz)	6 dB Bandwidth (MHz)				Minimum Limit (MHz)	Test Result
		Chain 0	Chain 1	Chain 2	Chain 3		
151	5755	37.94	38.07	36.95	37.97	0.5	Pass
159	5795	37.93	37.72	36.84	37.90	0.5	Pass

802.11ax (HE80)

Channel	Frequency (MHz)	6 dB Bandwidth (MHz)				Minimum Limit (MHz)	Test Result
		Chain 0	Chain 1	Chain 2	Chain 3		
155	5775	76.85	77.04	76.93	77.77	0.5	Pass

Spectrum Plot of Minimum Value

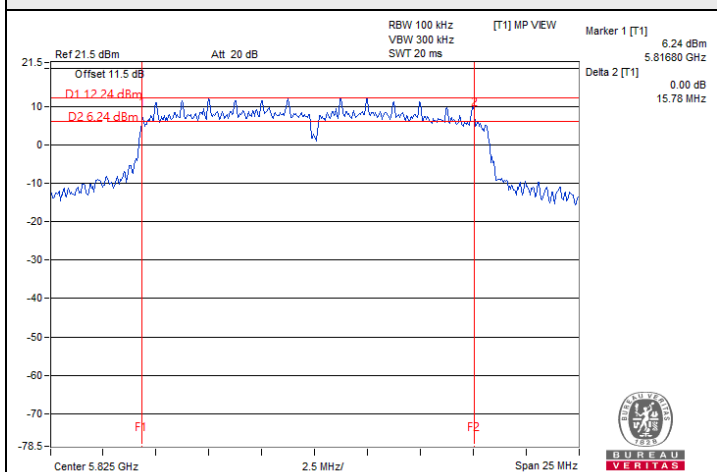

802.11a / Chain 0 : CH 165

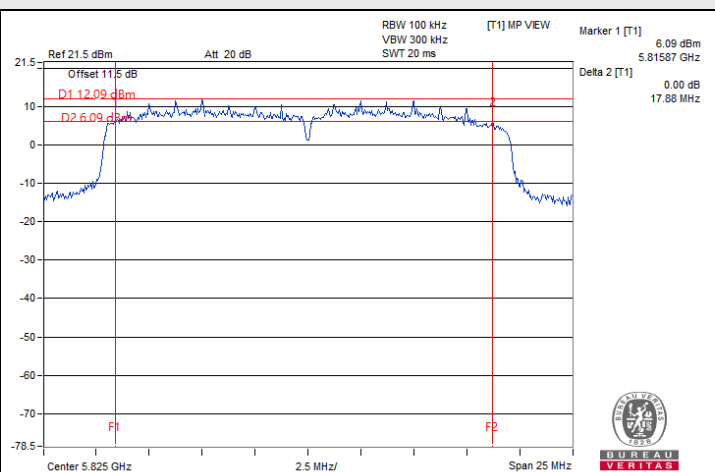

802.11ax (HE20) / Chain 2 : CH 165

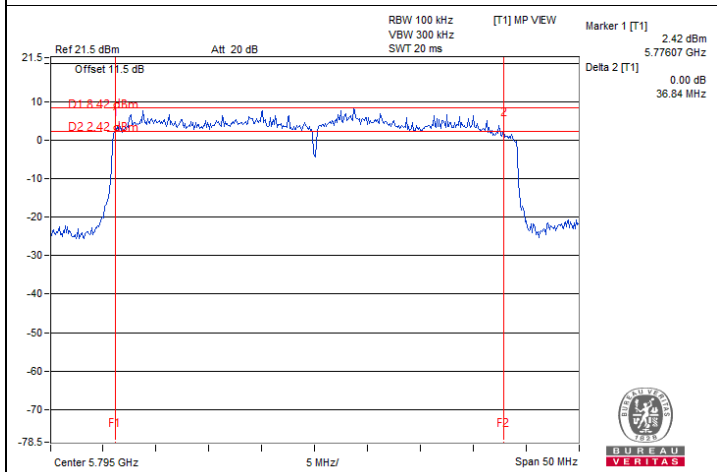

802.11ax (HE40) / Chain 2 : CH 159

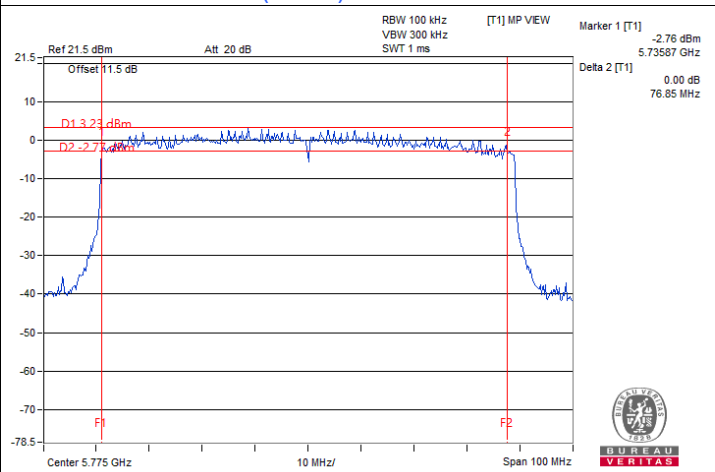

802.11ax (HE80) / Chain 0 : CH 155

Input Power:	54 Vdc	Environmental Conditions:	25°C, 60% RH	Tested By:	Matthew Yang
--------------	--------	---------------------------	--------------	------------	--------------

Mode B
802.11a

Channel	Frequency (MHz)	6 dB Bandwidth (MHz)		Minimum Limit (MHz)	Test Result
		Chain 0	Chain 1		
149	5745	16.38	16.39	0.5	Pass
157	5785	16.37	16.39	0.5	Pass
165	5825	16.38	16.38	0.5	Pass

802.11ac (VHT20)

Channel	Frequency (MHz)	6 dB Bandwidth (MHz)		Minimum Limit (MHz)	Test Result
		Chain 0	Chain 1		
149	5745	17.66	17.66	0.5	Pass
157	5785	17.65	17.66	0.5	Pass
165	5825	17.67	17.65	0.5	Pass

802.11ac (VHT40)

Channel	Frequency (MHz)	6 dB Bandwidth (MHz)		Minimum Limit (MHz)	Test Result
		Chain 0	Chain 1		
151	5755	35.68	36.04	0.5	Pass
159	5795	36.34	36.38	0.5	Pass

802.11ac (VHT80)

Channel	Frequency (MHz)	6 dB Bandwidth (MHz)		Minimum Limit (MHz)	Test Result
		Chain 0	Chain 1		
155	5775	75.60	75.55	0.5	Pass



Spectrum Plot of Minimum Value

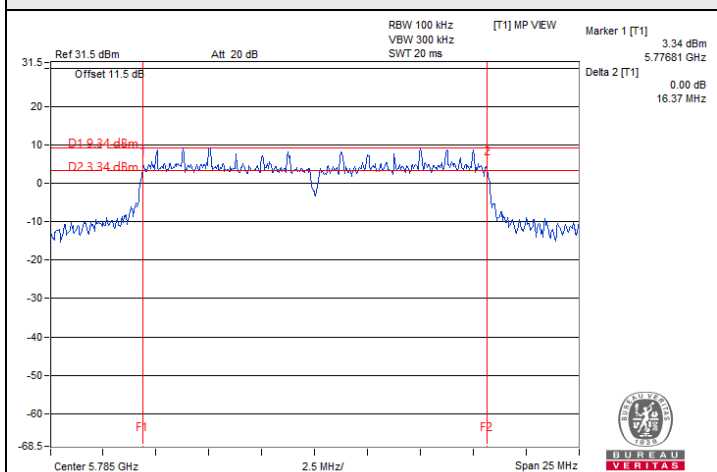

802.11a / Chain 0 : CH 157

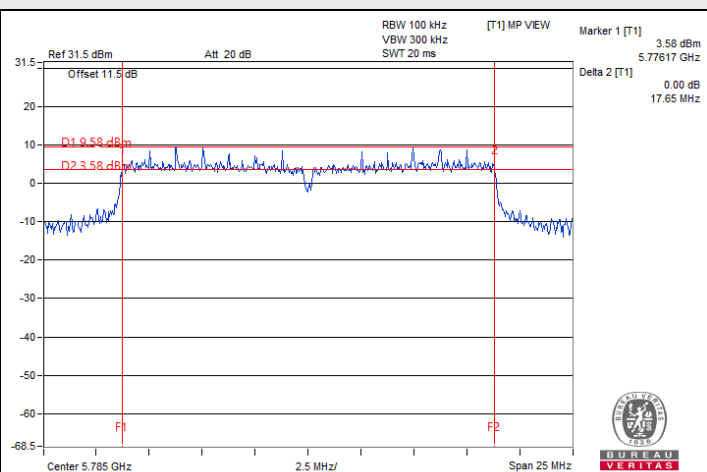

802.11ac (VHT20) / Chain 0 : CH 157

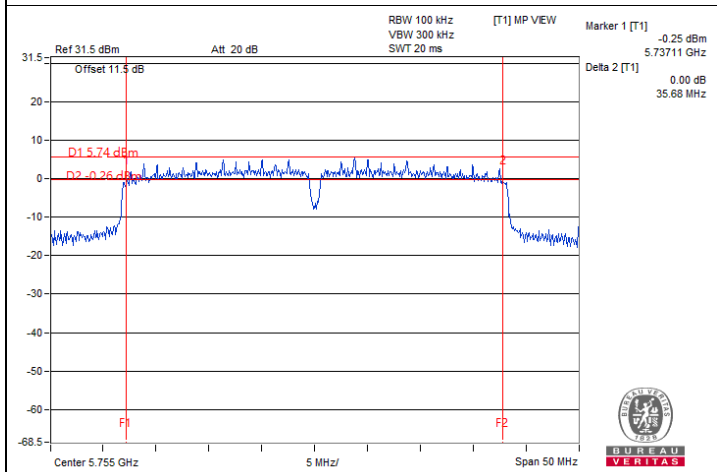

802.11ac (VHT40) / Chain 0 : CH 151

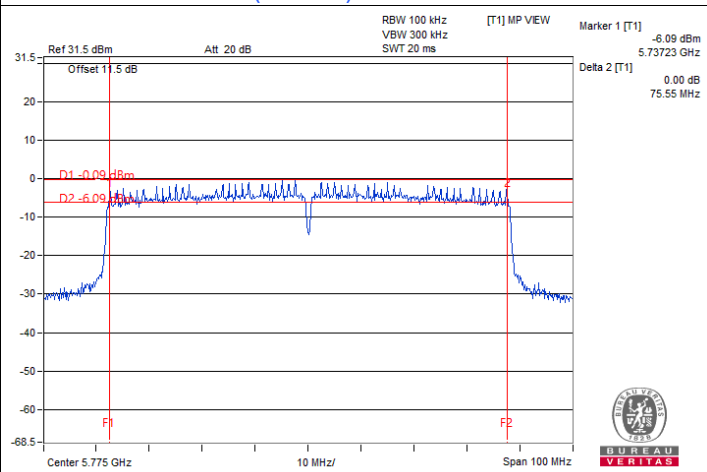

802.11ac (VHT80) / Chain 1 : CH 155

7.4 Occupied Bandwidth

Input Power:	54 Vdc	Environmental Conditions:	25°C, 60% RH	Tested By:	Matthew Yang
--------------	--------	---------------------------	--------------	------------	--------------

Mode A

802.11a

Channel	Frequency (MHz)	Occupied Bandwidth (MHz)			
		Chain 0	Chain 1	Chain 2	Chain 3
36	5180	16.44	16.44	16.44	16.44
40	5200	16.44	16.44	16.44	16.44
48	5240	16.44	16.44	16.56	16.44
149	5745	16.62	16.68	16.44	16.56
157	5785	17.16	16.56	16.56	16.80
165	5825	18.24	17.64	17.16	17.04

802.11ax (HE20)

Channel	Frequency (MHz)	Occupied Bandwidth (MHz)			
		Chain 0	Chain 1	Chain 2	Chain 3
36	5180	18.96	18.96	18.96	18.96
40	5200	19.08	18.96	19.08	18.84
48	5240	18.96	18.96	18.96	18.84
149	5745	19.08	18.96	19.08	19.08
157	5785	19.08	19.08	18.96	19.20
165	5825	19.56	19.32	19.20	19.32

802.11ax (HE40)

Channel	Frequency (MHz)	Occupied Bandwidth (MHz)			
		Chain 0	Chain 1	Chain 2	Chain 3
38	5190	37.68	38.16	37.92	37.92
46	5230	38.16	38.16	37.92	37.92
151	5755	38.16	38.16	37.92	38.16
159	5795	39.12	38.16	37.92	38.64

802.11ax (HE80)

Channel	Frequency (MHz)	Occupied Bandwidth (MHz)			
		Chain 0	Chain 1	Chain 2	Chain 3
42	5210	77.28	77.28	77.28	77.28
155	5775	76.80	76.80	76.80	77.28



Spectrum Plot of Maximum Value

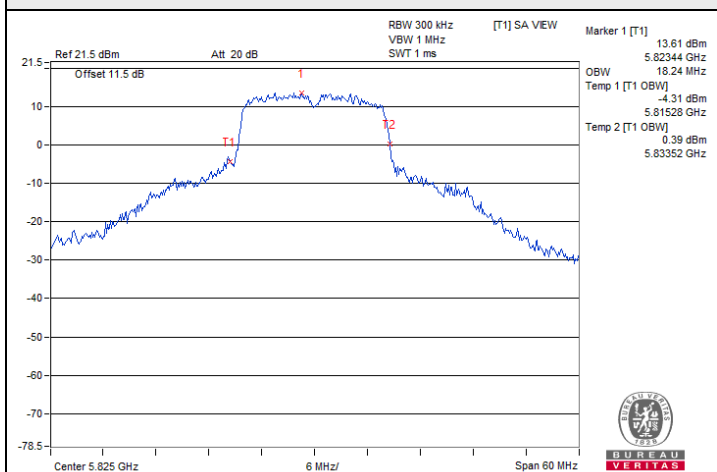

802.11a / Chain 0 : CH 165

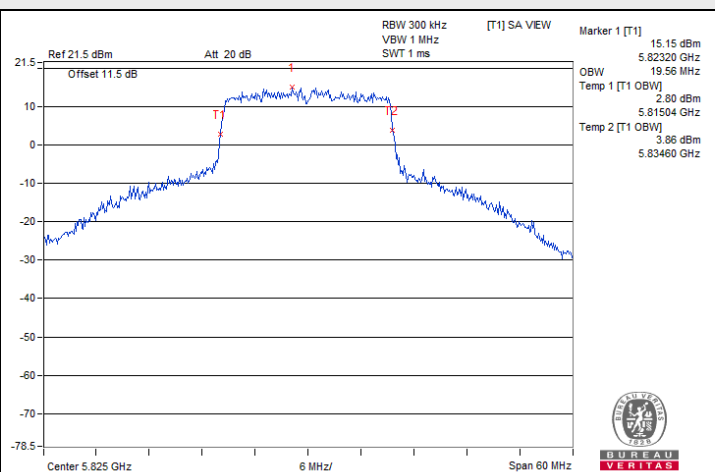

802.11ax (HE20) / Chain 0 : CH 165

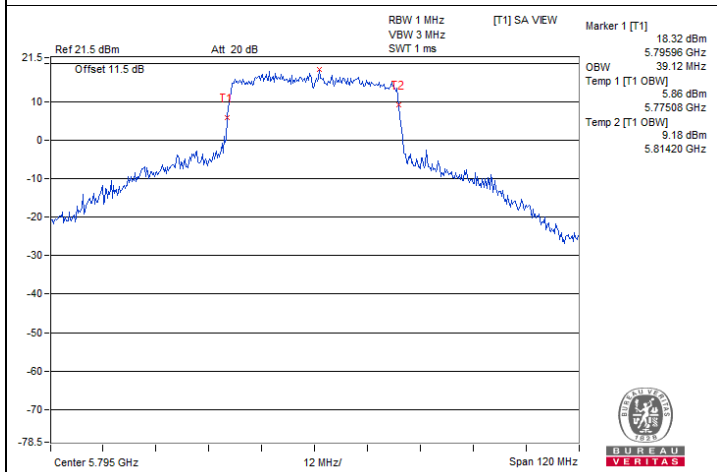

802.11ax (HE40) / Chain 0 : CH 159

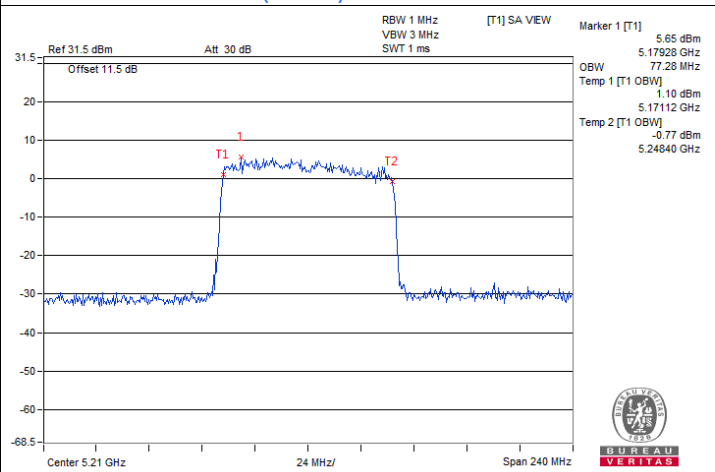

802.11ax (HE80) / Chain 0 : CH 42

Spectrum Plot for nearby DFS band (DFS is required, if 99% OCP straddle into U-NII-2A)

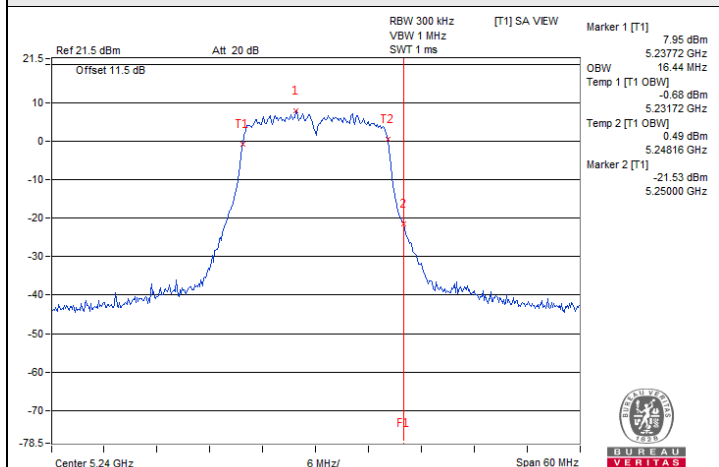
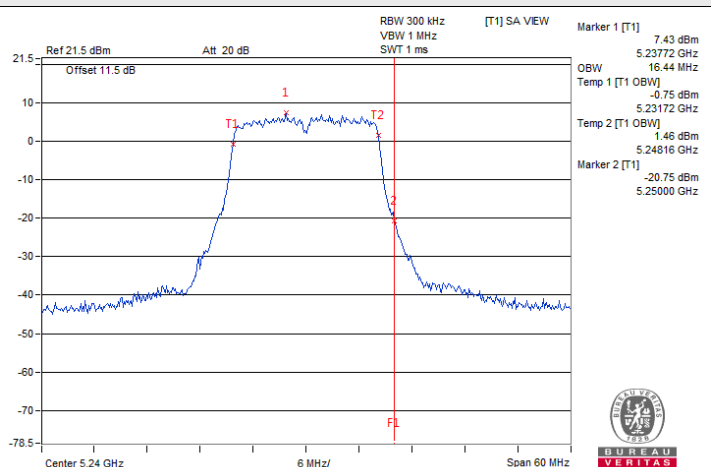
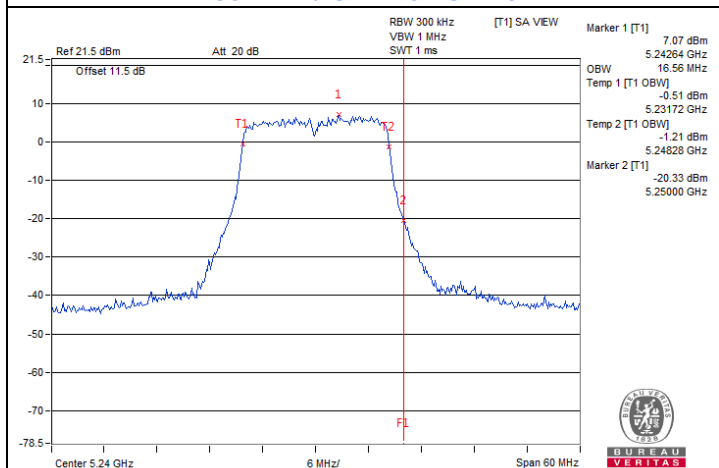
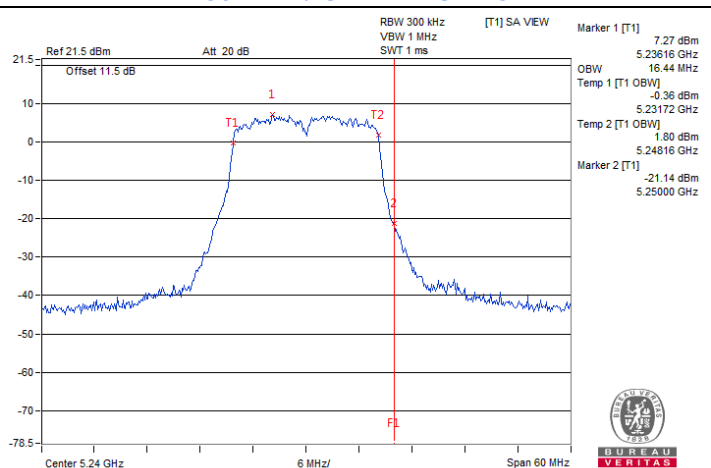
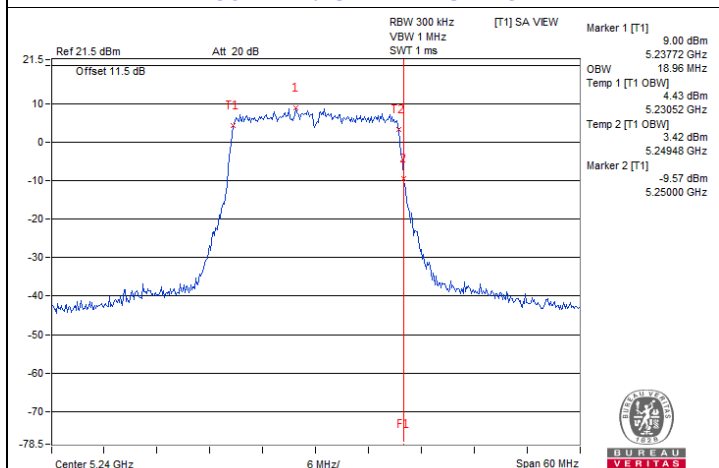
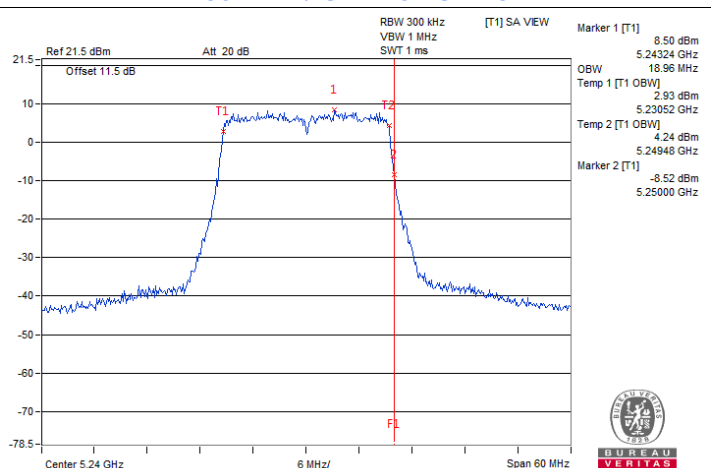
**802.11a / Chain 0 : CH 48****802.11a / Chain 1 : CH 48****802.11a / Chain 2 : CH 48****802.11a / Chain 3 : CH 48****802.11ax (HE20) / Chain 0 : CH 48****802.11ax (HE20) / Chain 1 : CH 48**

Spectrum Plot for nearby DFS band (DFS is required, if 99% OCP straddle into U-NII-2A)

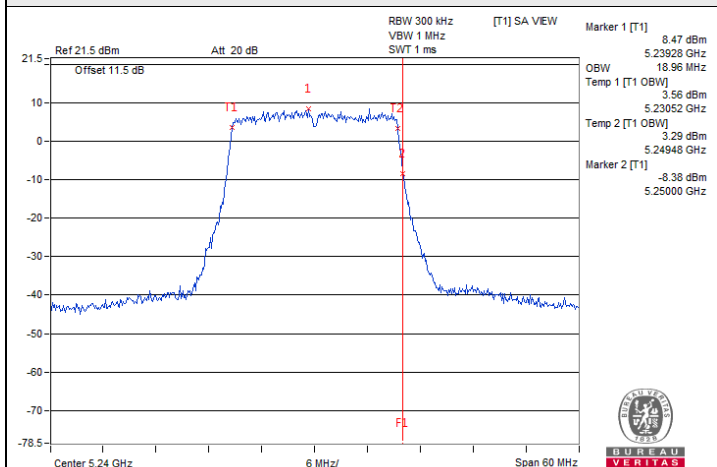
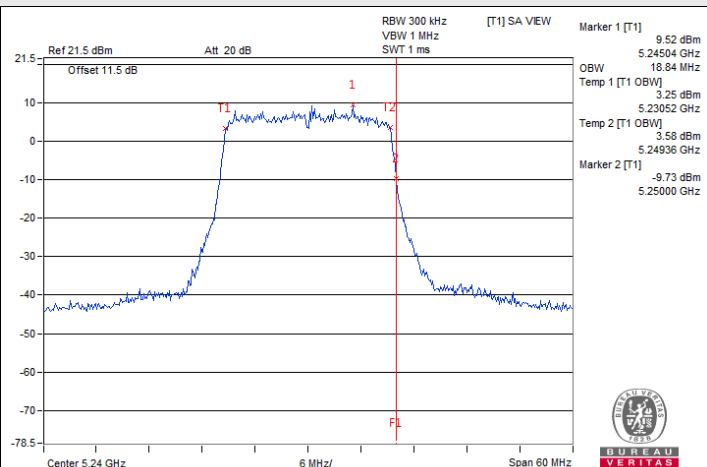
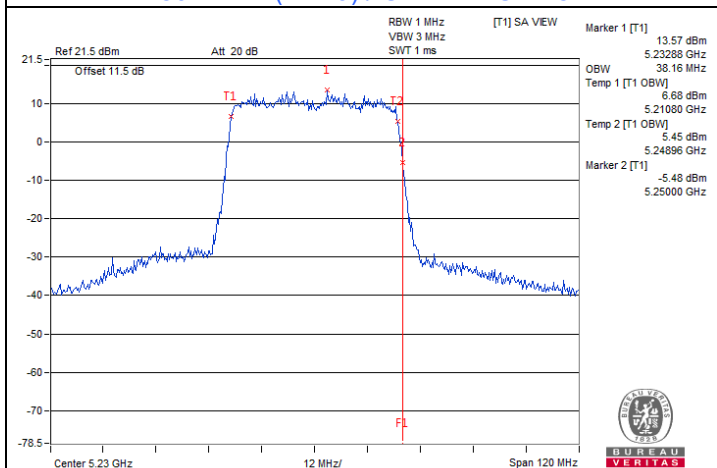
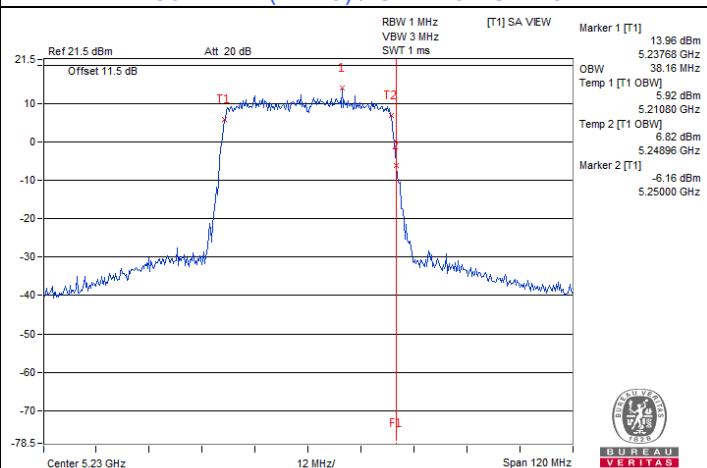
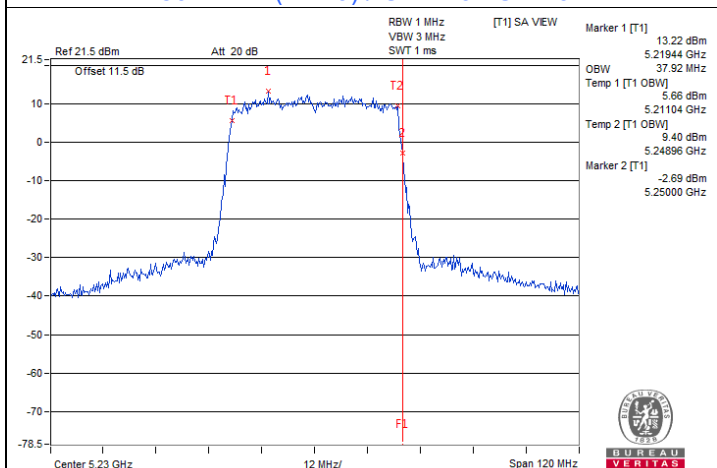
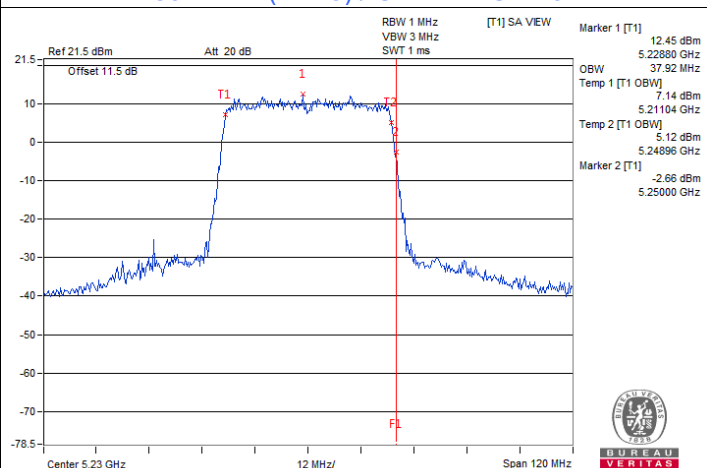
**802.11ax (HE20) / Chain 2 : CH 48****802.11ax (HE20) / Chain 3 : CH 48****802.11ax (HE40) / Chain 0 : CH 46****802.11ax (HE40) / Chain 1 : CH 46****802.11ax (HE40) / Chain 2 : CH 46****802.11ax (HE40) / Chain 3 : CH 46**

Spectrum Plot for nearby DFS band (DFS is required, if 99% OCP straddle into U-NII-2A)

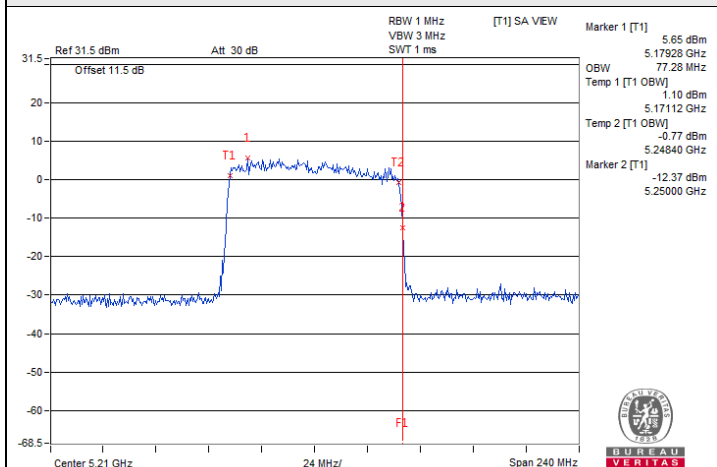

802.11ax (HE80) / Chain 0 : CH 42

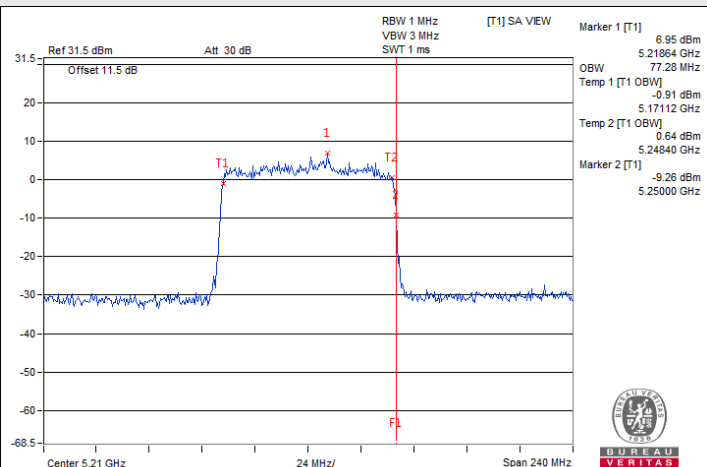

802.11ax (HE80) / Chain 1 : CH 42

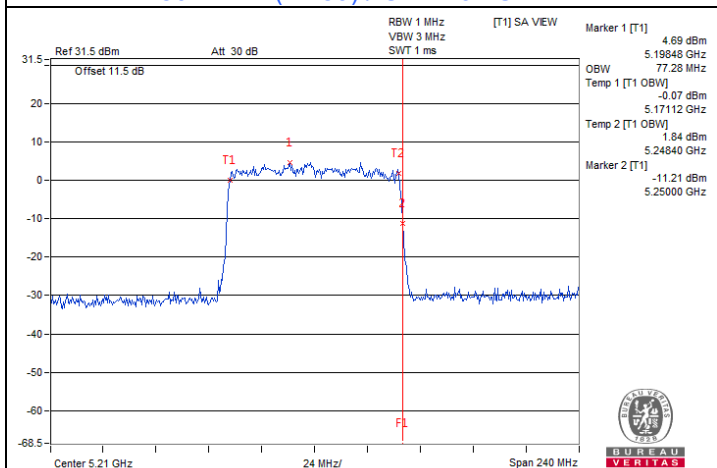

802.11ax (HE80) / Chain 2 : CH 42

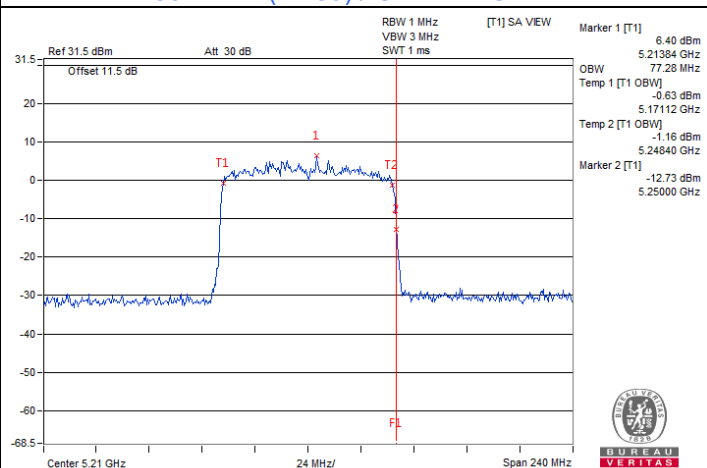

802.11ax (HE80) / Chain 3 : CH 42

Spectrum Plot for nearby DFS band (DFS is required, if 99% OCP straddle into U-NII-2C)

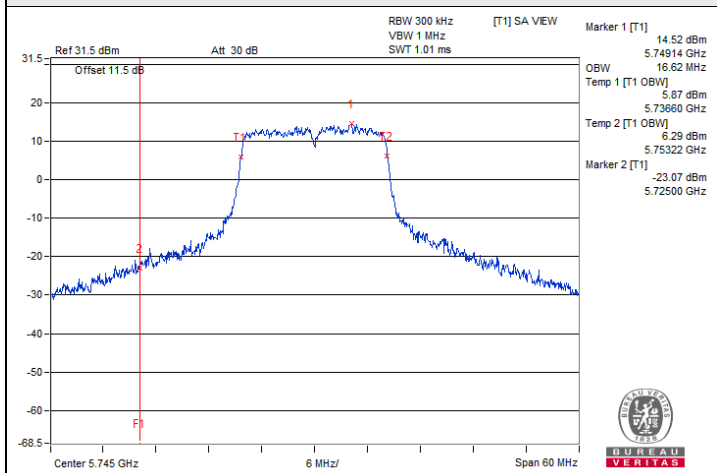

802.11a / Chain 0 : CH 149

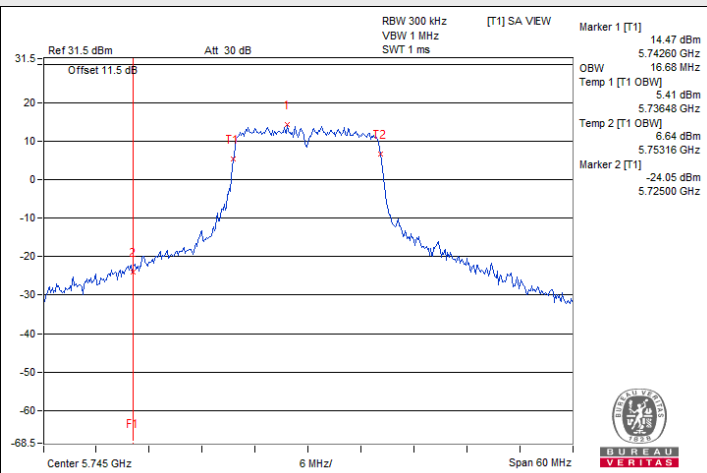

802.11a / Chain 1 : CH 149

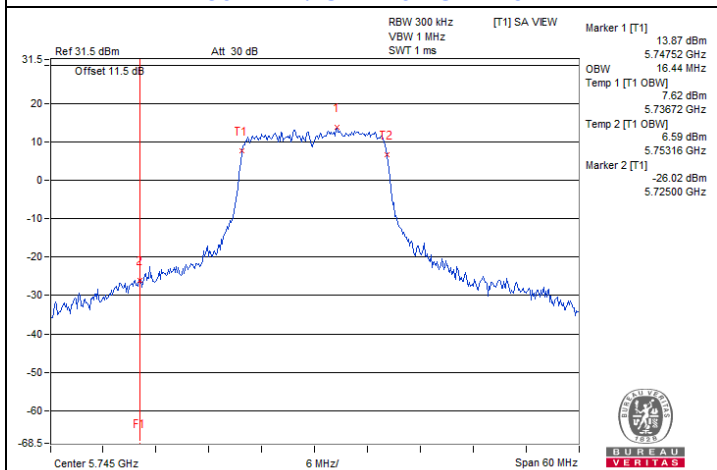

802.11a / Chain 2 : CH 149

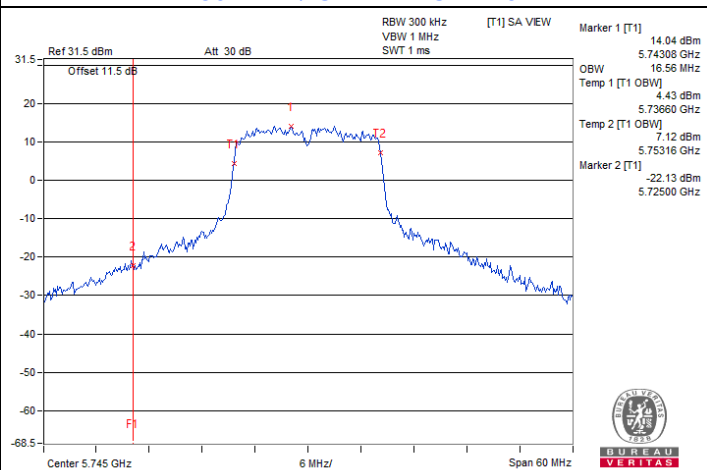

802.11a / Chain 3 : CH 149

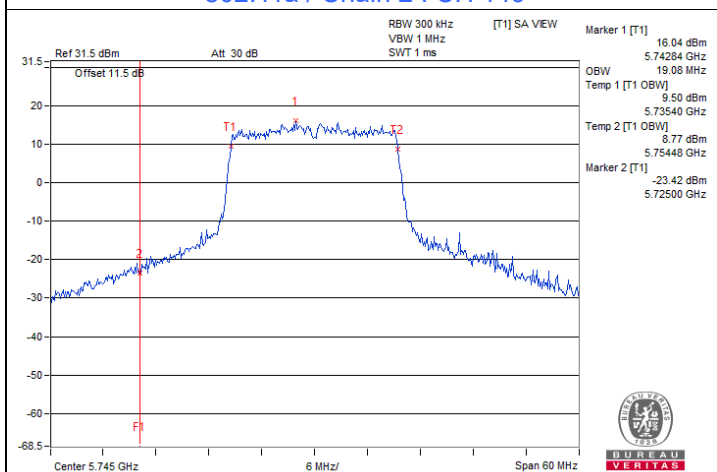

802.11ax (HE20) / Chain 0 : CH 149

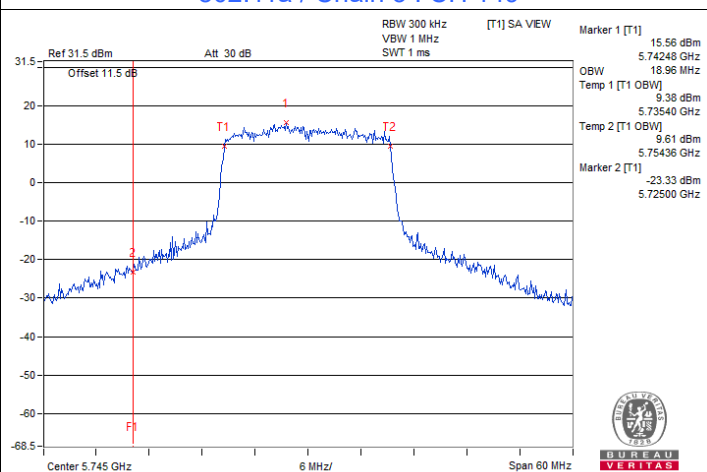

802.11ax (HE20) / Chain 1 : CH 149

Spectrum Plot for nearby DFS band (DFS is required, if 99% OCP straddle into U-NII-2C)

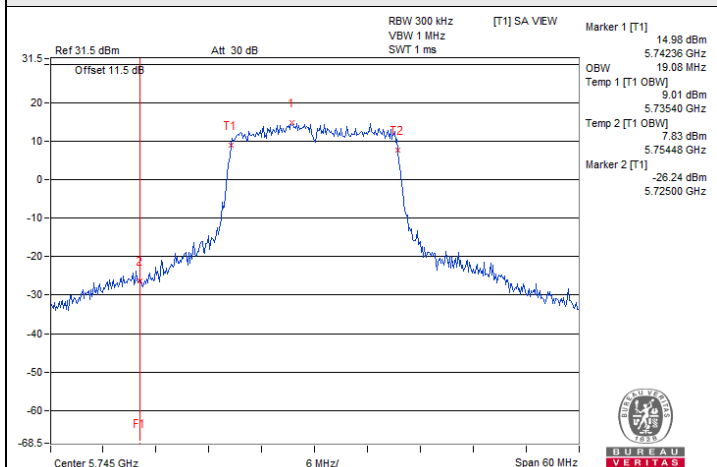

802.11ax (HE20) / Chain 2 : CH 149

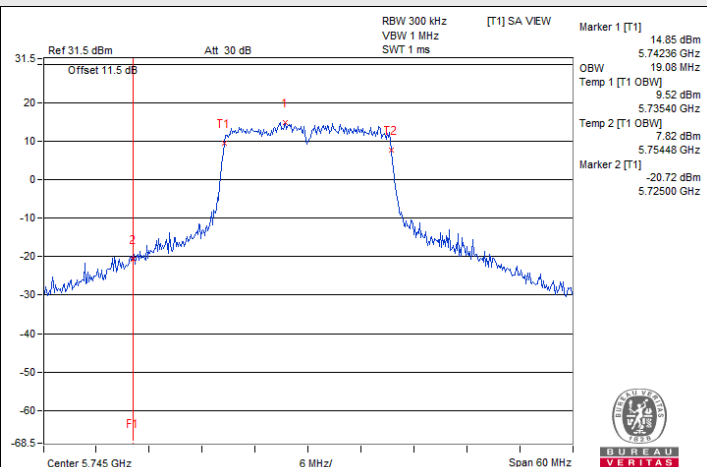

802.11ax (HE20) / Chain 3 : CH 149

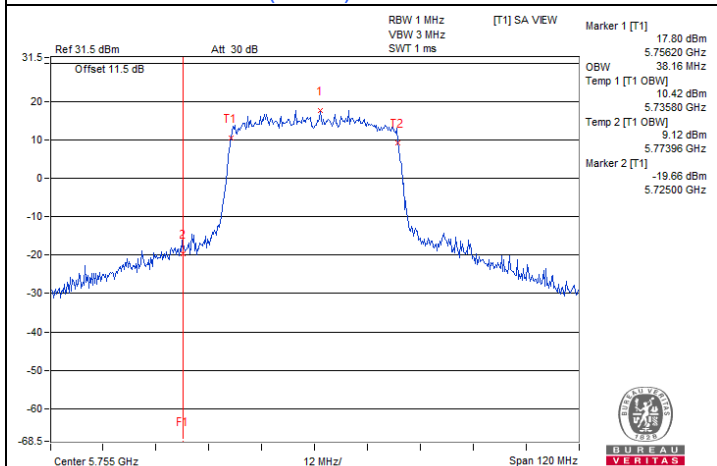

802.11ax (HE40) / Chain 0 : CH 151

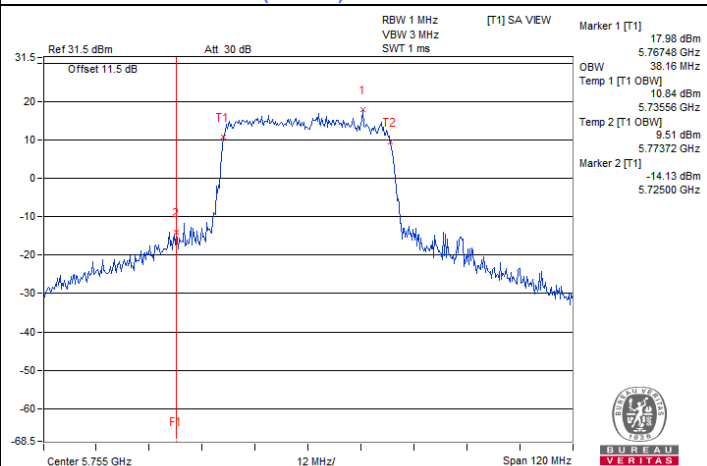

802.11ax (HE40) / Chain 1 : CH 151

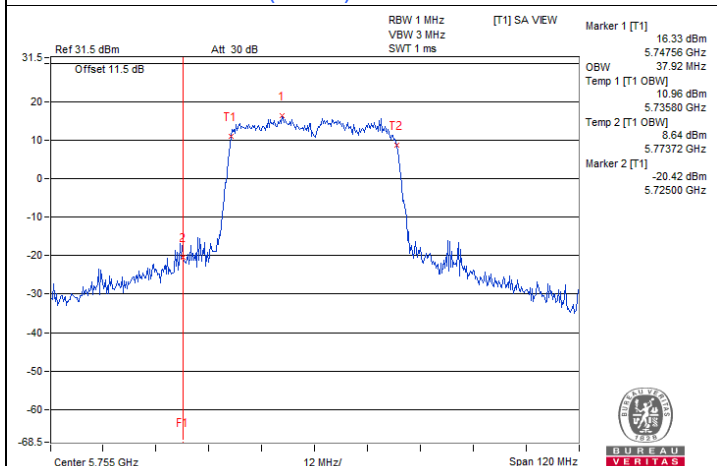

802.11ax (HE40) / Chain 2 : CH 151

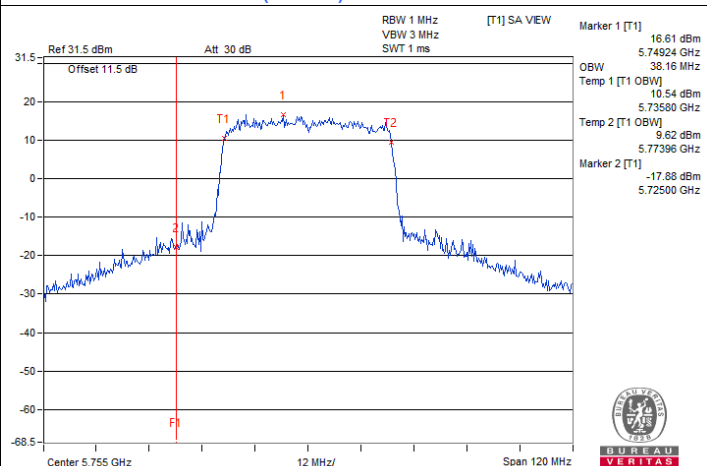

802.11ax (HE40) / Chain 3 : CH 151

Spectrum Plot for nearby DFS band (DFS is required, if 99% OCP straddle into U-NII-2C)

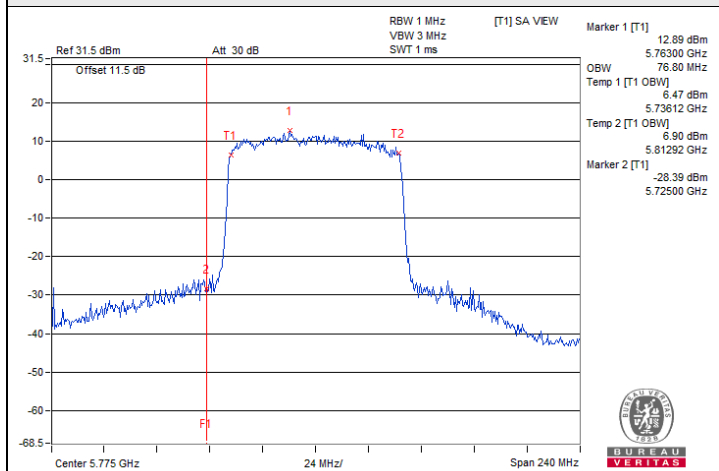

802.11ax (HE80) / Chain 0 : CH 155

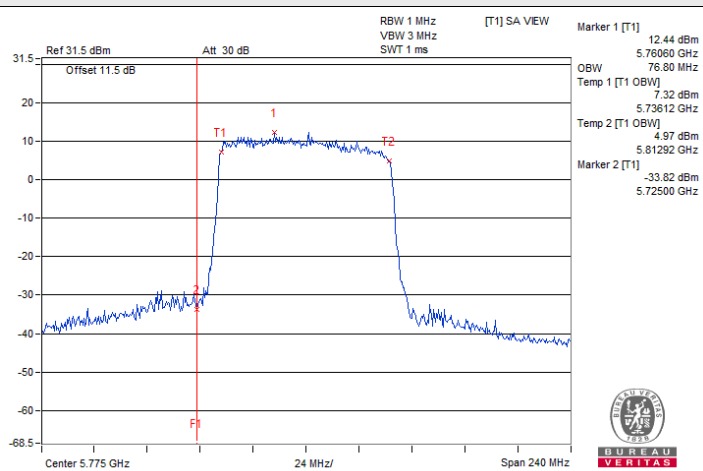

802.11ax (HE80) / Chain 1 : CH 155

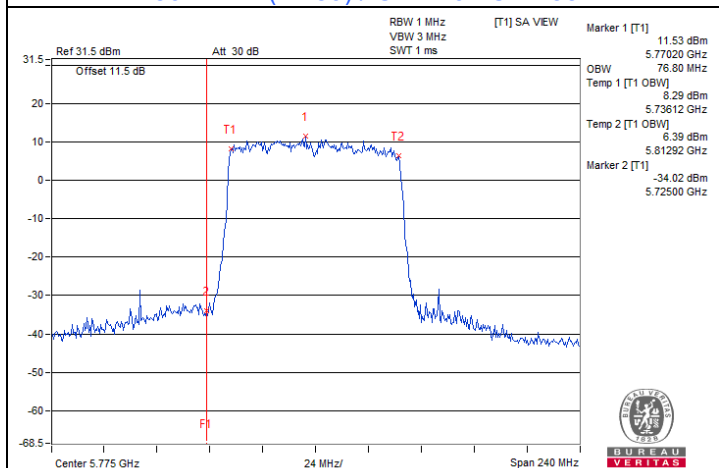

802.11ax (HE80) / Chain 2 : CH 155

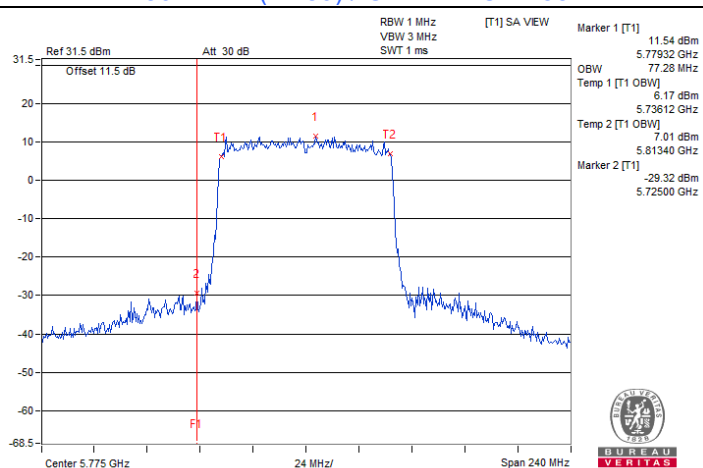

802.11ax (HE80) / Chain 3 : CH 155

Input Power:	54 Vdc	Environmental Conditions:	25°C, 60% RH	Tested By:	Matthew Yang
--------------	--------	---------------------------	--------------	------------	--------------

Mode B
802.11a

Channel	Frequency (MHz)	Occupied Bandwidth (MHz)	
		Chain 0	Chain 1
36	5180	16.68	16.68
40	5200	16.68	16.68
48	5240	16.68	16.68
149	5745	27.69	27.98
157	5785	27.12	28.84
165	5825	24.71	26.06

802.11ac (VHT20)

Channel	Frequency (MHz)	Occupied Bandwidth (MHz)	
		Chain 0	Chain 1
36	5180	17.88	17.88
40	5200	17.88	17.88
48	5240	17.88	17.88
149	5745	29.52	28.17
157	5785	27.98	29.16
165	5825	25.96	26.15

802.11ac (VHT40)

Channel	Frequency (MHz)	Occupied Bandwidth (MHz)	
		Chain 0	Chain 1
38	5190	36.24	36.24
46	5230	36.24	36.48
151	5755	44.04	43.27
159	5795	50.77	51.92

802.11ac (VHT80)

Channel	Frequency (MHz)	Occupied Bandwidth (MHz)	
		Chain 0	Chain 1
42	5210	75.36	75.36
155	5775	75.38	75.77

Spectrum Plot of Maximum Value

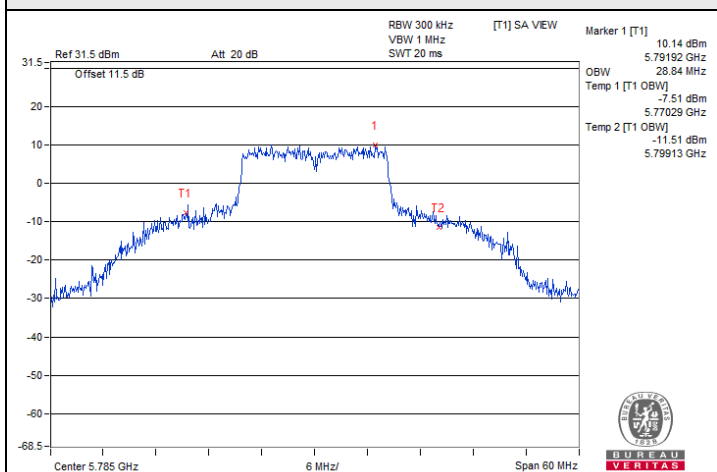

802.11a / Chain 1 : CH 157

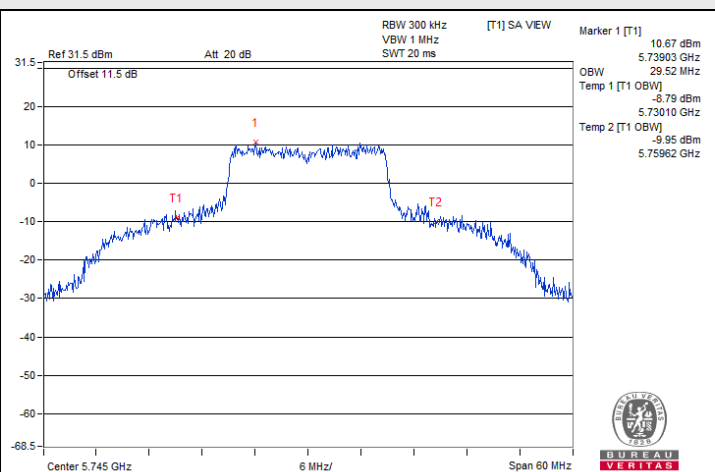

802.11ac (VHT20) / Chain 0 : CH 149

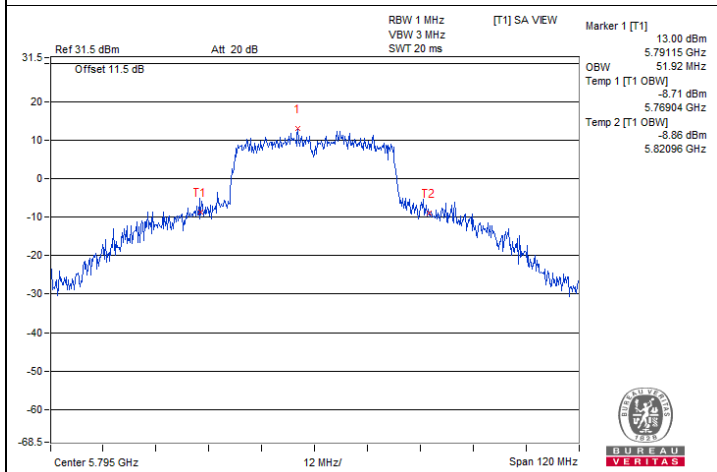

802.11ac (VHT40) / Chain 1 : CH 159

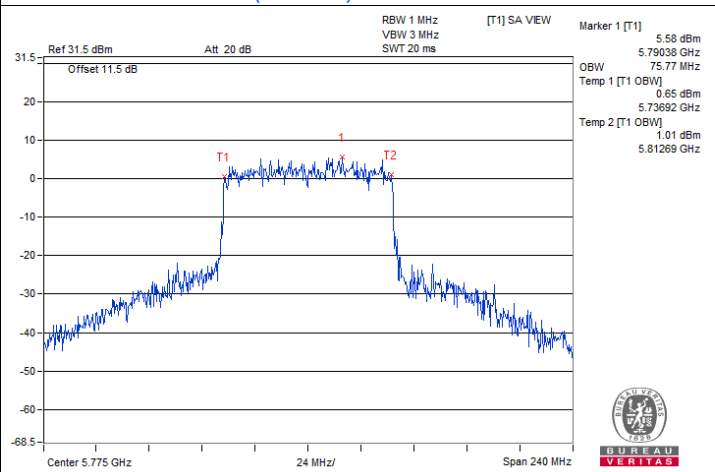

802.11ac (VHT80) / Chain 1 : CH 155

Spectrum Plot for nearby DFS band (DFS is required, if 99% OCP straddle into U-NII-2A)

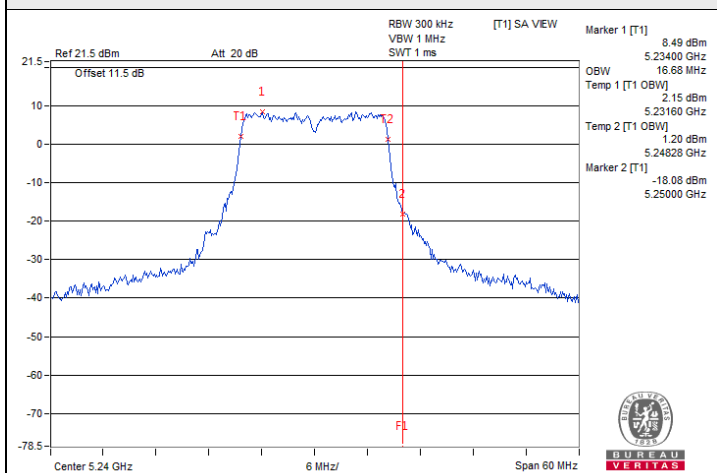

802.11a / Chain 0 : CH 48

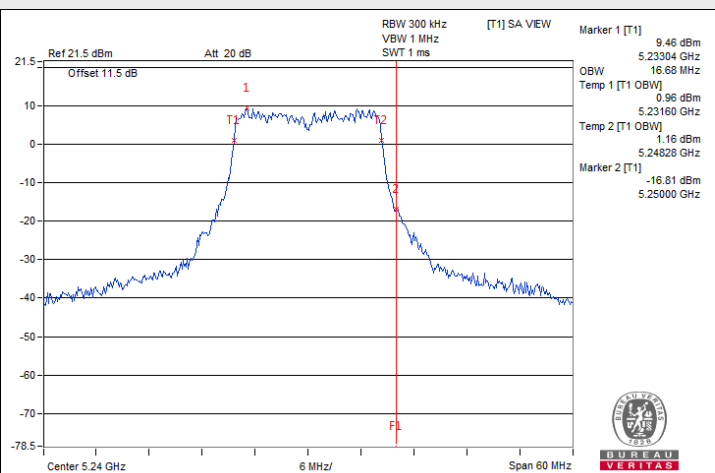

802.11a / Chain 1 : CH 48

Spectrum Plot for nearby DFS band (DFS is required, if 99% OCP straddle into U-NII-2A)

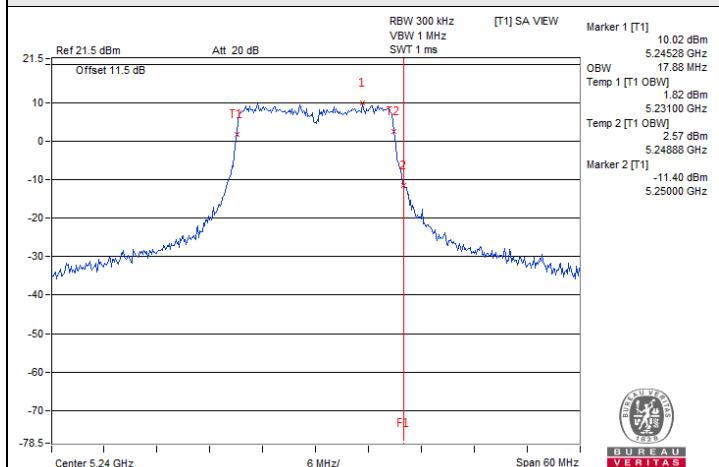
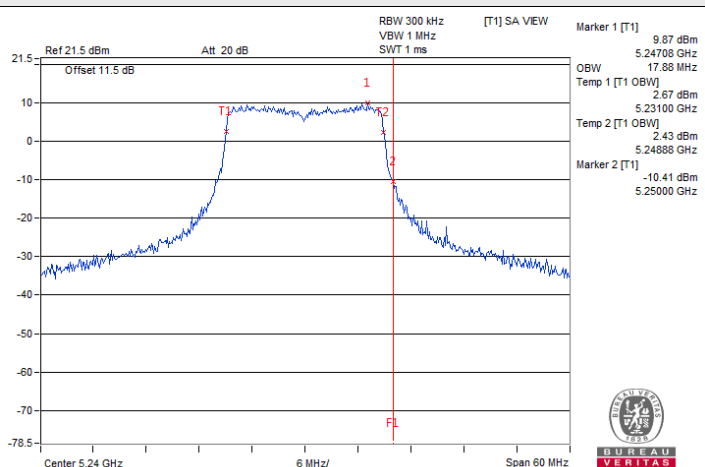
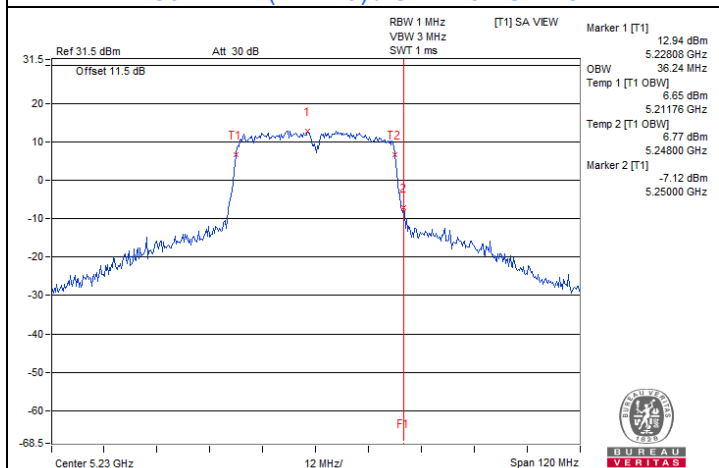
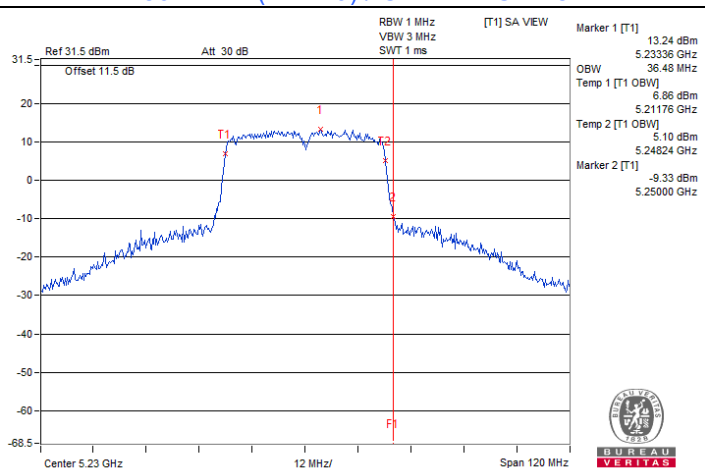
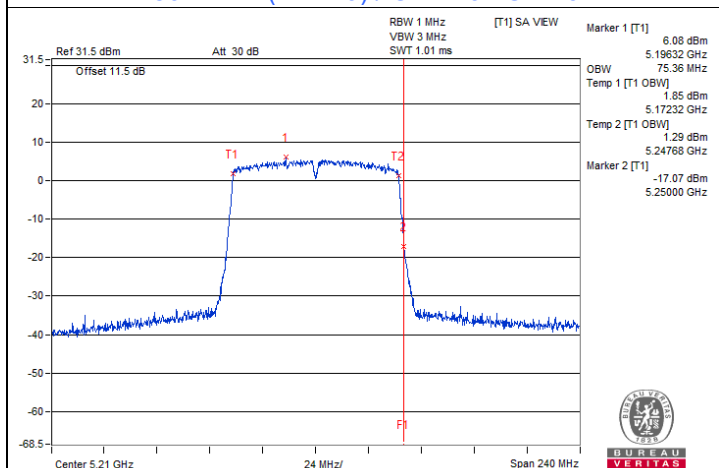
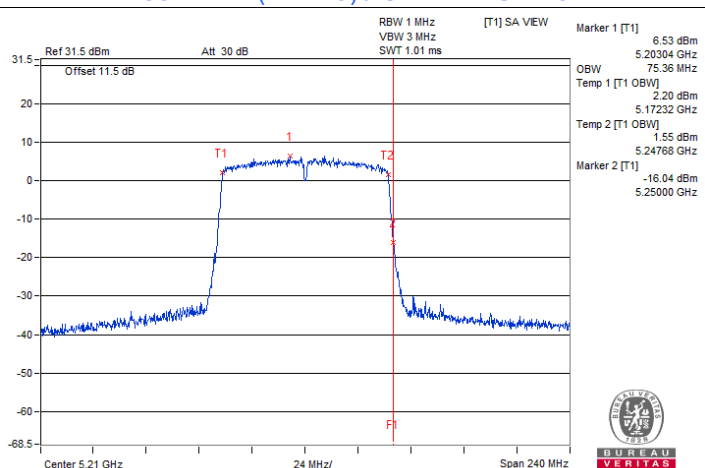
**802.11ac (VHT20) / Chain 0 : CH 48****802.11ac (VHT20) / Chain 1 : CH 48****802.11ac (VHT40) / Chain 0 : CH 46****802.11ac (VHT40) / Chain 1 : CH 46****802.11ac (VHT80) / Chain 0 : CH 42****802.11ac (VHT80) / Chain 1 : CH 42**

Spectrum Plot for nearby DFS band (DFS is required, if 99% OCP straddle into U-NII-2C)

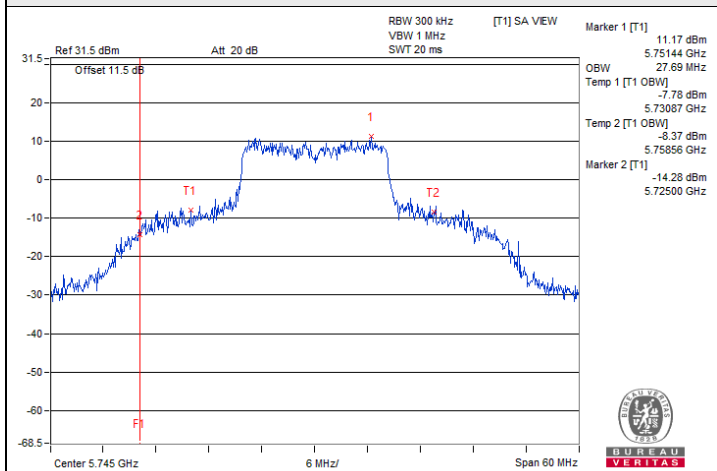

802.11a / Chain 0 : CH 149

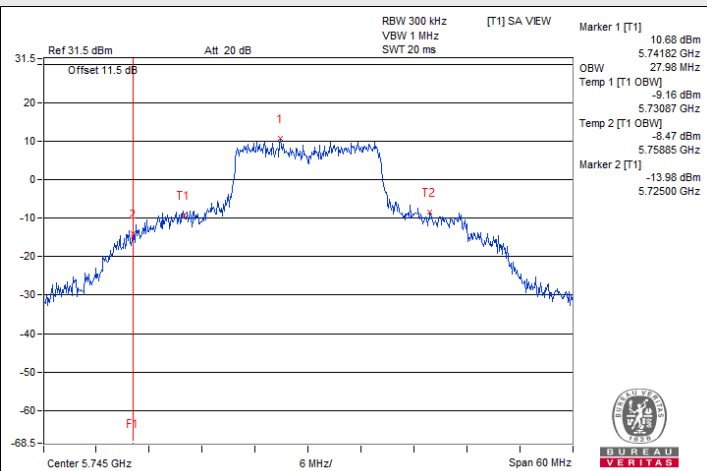

802.11a / Chain 1 : CH 149

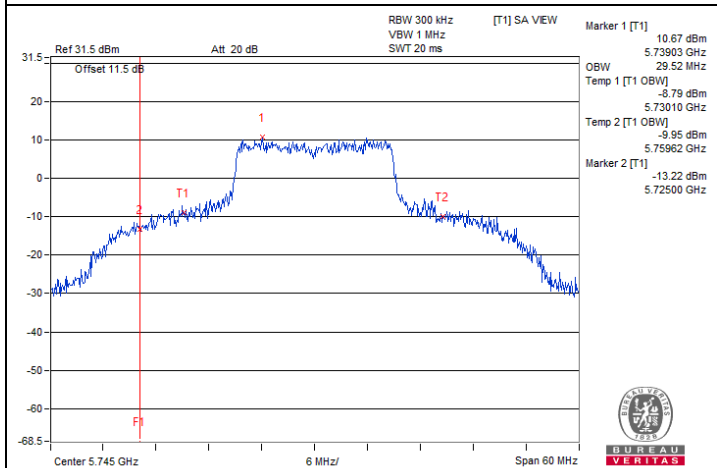

802.11ac (VHT20) / Chain 0 : CH 149

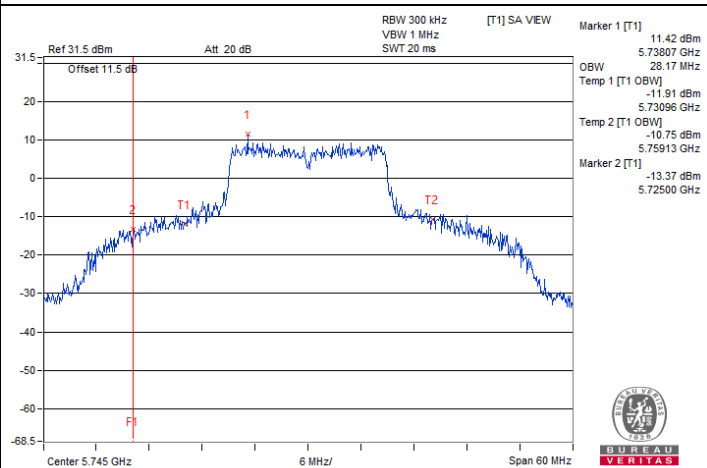

802.11ac (VHT20) / Chain 1 : CH 149

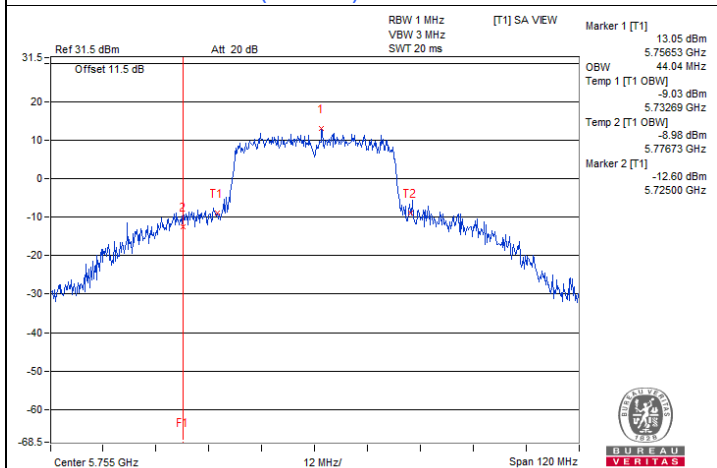

802.11ac (VHT40) / Chain 0 : CH 151

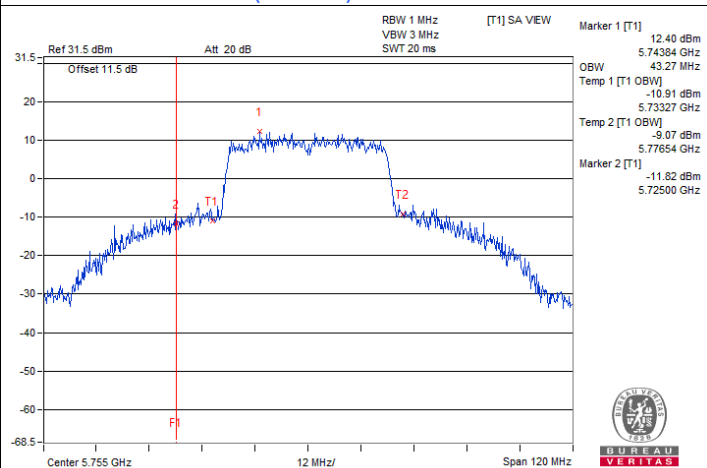

802.11ac (VHT40) / Chain 1 : CH 151



BUREAU VERITAS

Spectrum Plot for nearby DFS band (DFS is required, if 99% OCP straddle into U-NII-2C)

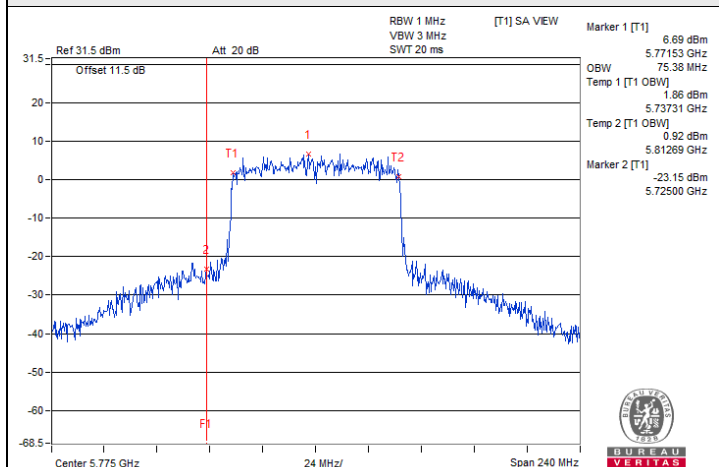

802.11ac (VHT80) / Chain 0 : CH 155

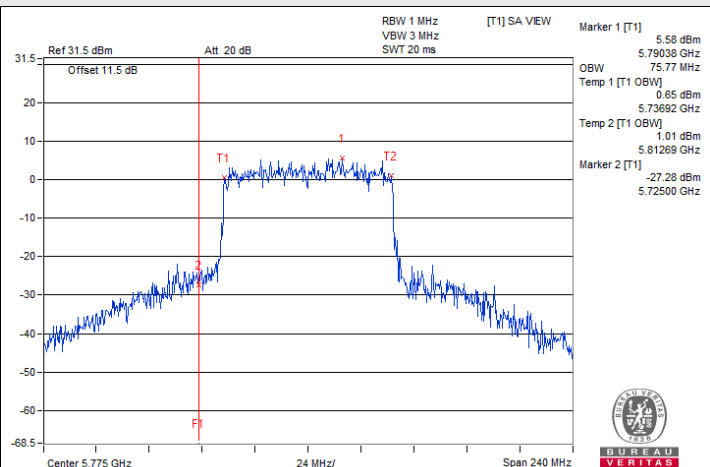

802.11ac (VHT80) / Chain 1 : CH 155

7.5 Frequency Stability

Input Power:	54 Vdc	Environmental Conditions:	25°C, 60% RH	Tested By:	Matthew Yang
--------------	--------	---------------------------	--------------	------------	--------------

Mode A

802.11a

Frequency Stability Versus Temperature									
Operating Frequency: 5180 MHz									
Temp. (°C)	Power Supply (Vdc)	0 Minute		2 Minutes		5 Minutes		10 Minutes	
		Measured Frequency (MHz)	Test Result	Measured Frequency (MHz)	Test Result	Measured Frequency (MHz)	Test Result	Measured Frequency (MHz)	Test Result
55	54	5180.021	Pass	5180.0199	Pass	5180.0219	Pass	5180.021	Pass
50	54	5180.0074	Pass	5180.0033	Pass	5180.0067	Pass	5180.0067	Pass
40	54	5179.998	Pass	5180.0007	Pass	5179.9977	Pass	5180.0004	Pass
30	54	5180.0244	Pass	5180.0262	Pass	5180.0248	Pass	5180.0252	Pass
20	54	5179.9843	Pass	5179.9892	Pass	5179.9886	Pass	5179.9853	Pass
10	54	5179.9901	Pass	5179.9871	Pass	5179.9895	Pass	5179.9901	Pass
0	54	5180.0101	Pass	5180.0104	Pass	5180.0067	Pass	5180.0088	Pass
-10	54	5180.0104	Pass	5180.0062	Pass	5180.0071	Pass	5180.01	Pass
-20	54	5179.9774	Pass	5179.9794	Pass	5179.9762	Pass	5179.9756	Pass

Frequency Stability Versus Voltage									
Operating Frequency: 5180 MHz									
Temp. (°C)	Power Supply (Vdc)	0 Minute		2 Minutes		5 Minutes		10 Minutes	
		Measured Frequency (MHz)	Test Result	Measured Frequency (MHz)	Test Result	Measured Frequency (MHz)	Test Result	Measured Frequency (MHz)	Test Result
20	62.1	5179.992	Pass	5179.9929	Pass	5179.993	Pass	5179.9928	Pass
	54	5179.9843	Pass	5179.9892	Pass	5179.9886	Pass	5179.9853	Pass
	45.9	5179.9957	Pass	5179.995	Pass	5179.9957	Pass	5179.9936	Pass



Input Power:	54 Vdc	Environmental Conditions:	25°C, 60% RH	Tested By:	Matthew Yang
--------------	--------	---------------------------	--------------	------------	--------------

Mode B

802.11a

Frequency Stability Versus Temperature									
Operating Frequency: 5180 MHz									
Temp. (°C)	Power Supply (Vdc)	0 Minute		2 Minutes		5 Minutes		10 Minutes	
		Measured Frequency (MHz)	Test Result	Measured Frequency (MHz)	Test Result	Measured Frequency (MHz)	Test Result	Measured Frequency (MHz)	Test Result
55	54	5179.994	Pass	5179.9928	Pass	5179.9949	Pass	5179.9939	Pass
50	54	5179.9804	Pass	5179.9814	Pass	5179.9797	Pass	5179.9797	Pass
40	54	5179.9761	Pass	5179.9736	Pass	5179.9759	Pass	5179.9771	Pass
30	54	5179.9874	Pass	5179.9839	Pass	5179.9877	Pass	5179.9829	Pass
20	54	5179.9991	Pass	5179.9989	Pass	5179.9983	Pass	5180.0001	Pass
10	54	5179.9969	Pass	5179.9939	Pass	5179.9963	Pass	5179.9969	Pass
0	54	5180.0168	Pass	5180.0119	Pass	5180.0134	Pass	5180.0155	Pass
-10	54	5180.0172	Pass	5180.013	Pass	5180.0125	Pass	5180.0154	Pass
-20	54	5180.0209	Pass	5180.0229	Pass	5180.0196	Pass	5180.0242	Pass

Frequency Stability Versus Voltage									
Operating Frequency: 5180 MHz									
Temp. (°C)	Power Supply (Vdc)	0 Minute		2 Minutes		5 Minutes		10 Minutes	
		Measured Frequency (MHz)	Test Result	Measured Frequency (MHz)	Test Result	Measured Frequency (MHz)	Test Result	Measured Frequency (MHz)	Test Result
20	62.1	5180.0031	Pass	5180.004	Pass	5180.004	Pass	5180.0039	Pass
	54	5179.9991	Pass	5179.9989	Pass	5179.9983	Pass	5180.0001	Pass
	45.9	5179.9999	Pass	5179.9992	Pass	5179.9999	Pass	5180.0029	Pass

7.6 AC Power Conducted Emissions

Mode A

RF Mode	802.11ax (HE40)	Channel	CH 159 : 5795 MHz
Frequency Range	150kHz ~ 30MHz	Detector Function & Resolution Bandwidth	Quasi-Peak (QP) / Average (AV), 9 kHz
Input Power	120 Vac, 60 Hz	Environmental Conditions	23°C, 67% RH
Tested By	Adair Peng		

Phase Of Power : Line (L)										
No	Frequency (MHz)	Correction Factor (dB)	Reading Value (dBUV)		Emission Level (dBUV)		Limit (dBUV)		Margin (dB)	
			Q.P.	AV.	Q.P.	AV.	Q.P.	AV.	Q.P.	AV.
1	0.15800	9.62	36.95	23.68	46.57	33.30	65.57	55.57	-19.00	-22.27
2	0.19000	9.64	29.72	15.79	39.36	25.43	64.04	54.04	-24.68	-28.61
3	0.36448	9.66	38.66	34.25	48.32	43.91	58.63	48.63	-10.31	-4.72
4	0.81400	9.68	28.59	22.73	38.27	32.41	56.00	46.00	-17.73	-13.59
5	0.97380	9.69	30.06	24.41	39.75	34.10	56.00	46.00	-16.25	-11.90
6	14.95000	9.79	15.82	9.90	25.61	19.69	60.00	50.00	-34.39	-30.31

Remarks:

1. Q.P. and AV. are abbreviations of quasi-peak and average individually.
2. The emission levels of other frequencies were very low against the limit.
3. Margin value = Emission level – Limit value
4. Correction factor = Insertion loss + Cable loss
5. Emission Level = Correction Factor + Reading Value

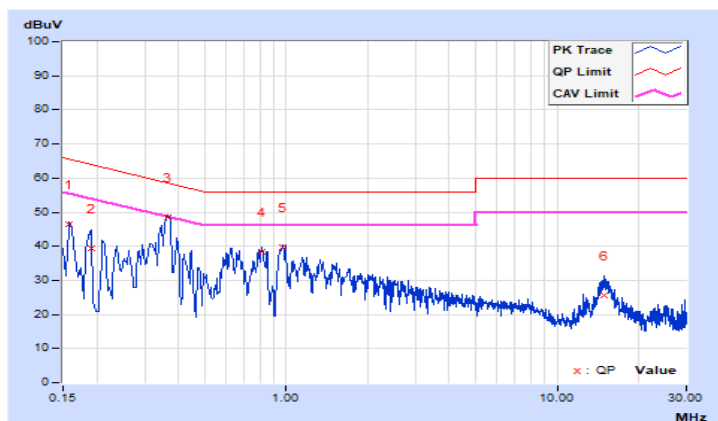

RF Mode	802.11ax (HE40)	Channel	CH 159 : 5795 MHz
Frequency Range	150kHz ~ 30MHz	Detector Function & Resolution Bandwidth	Quasi-Peak (QP) / Average (AV), 9 kHz
Input Power	120 Vac, 60 Hz	Environmental Conditions	23°C, 67% RH
Tested By	Adair Peng		

Phase Of Power : Neutral (N)										
No	Frequency (MHz)	Correction Factor (dB)	Reading Value (dBuV)		Emission Level (dBuV)		Limit (dBuV)		Margin (dB)	
			Q.P.	AV.	Q.P.	AV.	Q.P.	AV.	Q.P.	AV.
1	0.16579	9.63	34.11	22.18	43.74	31.81	65.17	55.17	-21.43	-23.36
2	0.19000	9.64	28.98	13.47	38.62	23.11	64.04	54.04	-25.42	-30.93
3	0.26600	9.65	28.69	22.53	38.34	32.18	61.24	51.24	-22.90	-19.06
4	0.37000	9.67	38.94	35.06	48.61	44.73	58.50	48.50	-9.89	-3.77
5	0.99800	9.70	27.59	19.81	37.29	29.51	56.00	46.00	-18.71	-16.49
6	15.87000	9.86	10.89	4.65	20.75	14.51	60.00	50.00	-39.25	-35.49

Remarks:

1. Q.P. and AV. are abbreviations of quasi-peak and average individually.
2. The emission levels of other frequencies were very low against the limit.
3. Margin value = Emission level – Limit value
4. Correction factor = Insertion loss + Cable loss
5. Emission Level = Correction Factor + Reading Value

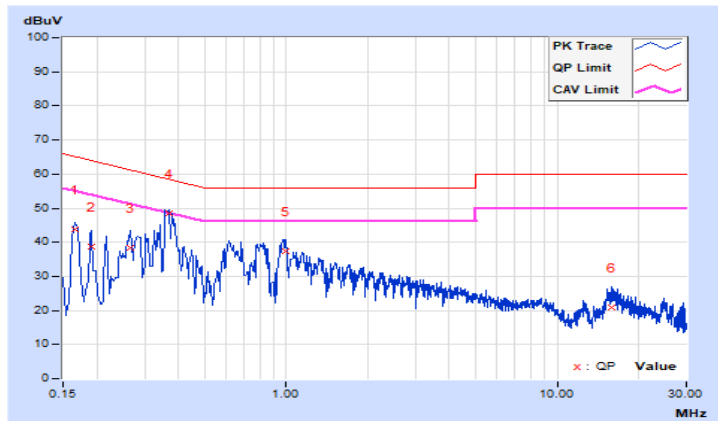

Mode B

RF Mode	802.11a	Channel	CH 149 : 5745 MHz
Frequency Range	150kHz ~ 30MHz	Detector Function & Resolution Bandwidth	Quasi-Peak (QP) / Average (AV), 9 kHz
Input Power	120 Vac, 60 Hz	Environmental Conditions	23°C, 67% RH
Tested By	Adair Peng		

Phase Of Power : Line (L)										
No	Frequency (MHz)	Correction Factor (dB)	Reading Value (dBuV)		Emission Level (dBuV)		Limit (dBuV)		Margin (dB)	
			Q.P.	AV.	Q.P.	AV.	Q.P.	AV.	Q.P.	AV.
1	0.16190	9.62	32.55	21.31	42.17	30.93	65.37	55.37	-23.20	-24.44
2	0.30956	9.66	31.40	25.93	41.06	35.59	59.98	49.98	-18.92	-14.39
3	0.36200	9.66	38.90	34.99	48.56	44.65	58.68	48.68	-10.12	-4.03
4	0.64200	9.68	26.30	20.48	35.98	30.16	56.00	46.00	-20.02	-15.84
5	0.95601	9.69	29.33	21.28	39.02	30.97	56.00	46.00	-16.98	-15.03
6	14.92600	9.79	15.66	9.78	25.45	19.57	60.00	50.00	-34.55	-30.43

Remarks:

1. Q.P. and AV. are abbreviations of quasi-peak and average individually.
2. The emission levels of other frequencies were very low against the limit.
3. Margin value = Emission level – Limit value
4. Correction factor = Insertion loss + Cable loss
5. Emission Level = Correction Factor + Reading Value

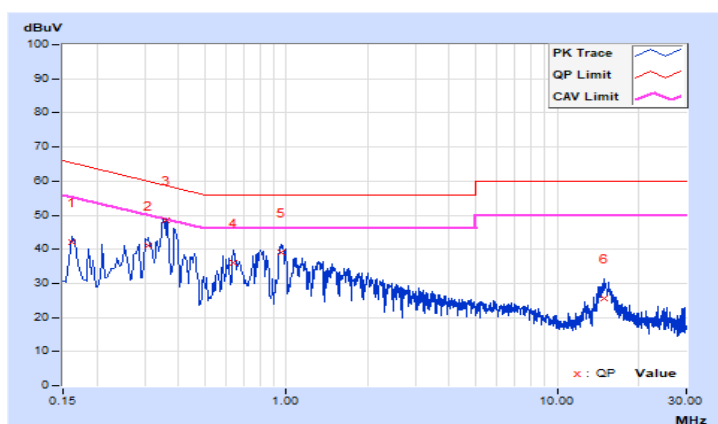

RF Mode	802.11a	Channel	CH 149 : 5745 MHz
Frequency Range	150kHz ~ 30MHz	Detector Function & Resolution Bandwidth	Quasi-Peak (QP) / Average (AV), 9 kHz
Input Power	120 Vac, 60 Hz	Environmental Conditions	23°C, 67% RH
Tested By	Adair Peng		

Phase Of Power : Neutral (N)										
No	Frequency (MHz)	Correction Factor (dB)	Reading Value (dBuV)		Emission Level (dBuV)		Limit (dBuV)		Margin (dB)	
			Q.P.	AV.	Q.P.	AV.	Q.P.	AV.	Q.P.	AV.
1	0.16200	9.62	34.20	22.68	43.82	32.30	65.36	55.36	-21.54	-23.06
2	0.19000	9.64	29.73	19.46	39.37	29.10	64.04	54.04	-24.67	-24.94
3	0.36162	9.66	38.84	34.36	48.50	44.02	58.69	48.69	-10.19	-4.67
4	0.85000	9.69	25.99	17.44	35.68	27.13	56.00	46.00	-20.32	-18.87
5	0.97000	9.70	30.07	24.07	39.77	33.77	56.00	46.00	-16.23	-12.23
6	16.75796	9.86	7.82	1.89	17.68	11.75	60.00	50.00	-42.32	-38.25

Remarks:

1. Q.P. and AV. are abbreviations of quasi-peak and average individually.
2. The emission levels of other frequencies were very low against the limit.
3. Margin value = Emission level – Limit value
4. Correction factor = Insertion loss + Cable loss
5. Emission Level = Correction Factor + Reading Value

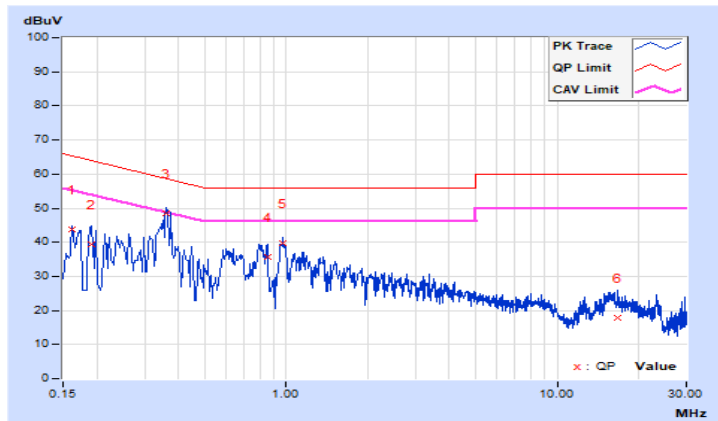

7.7 Unwanted Emissions below 1 GHz

Mode A

RF Mode	802.11ax (HE40)	Channel	CH 159 : 5795 MHz
Frequency Range	30 MHz ~ 1 GHz	Detector Function & Bandwidth	(QP) RB = 120kHz
Input Power	120 Vac, 60 Hz	Environmental Conditions	21°C, 77% RH
Tested By	Rex Wang		

Antenna Polarity & Test Distance : Horizontal at 3 m								
No	Frequency (MHz)	Emission Level (dBuV/m)	Limit (dBuV/m)	Margin (dB)	Antenna Height (m)	Table Angle (Degree)	Raw Value (dBuV)	Correction Factor (dB/m)
1	32.91	20.2 QP	40.0	-19.8	1.00 H	12	30.8	-10.6
2	55.22	23.6 QP	40.0	-16.4	1.00 H	206	32.8	-9.2
3	95.96	30.6 QP	43.5	-12.9	1.00 H	13	45.0	-14.4
4	135.73	33.6 QP	43.5	-9.9	1.00 H	15	43.4	-9.8
5	167.74	37.3 QP	43.5	-6.2	1.00 H	143	46.3	-9.0
6	553.80	30.4 QP	46.0	-15.6	1.00 H	96	32.1	-1.7

Remarks:

- Emission Level(dBuV/m) = Raw Value(dBuV) + Correction Factor(dB/m)
- Correction Factor(dB/m) = Antenna Factor(dB/m) + Cable Factor(dB) – Pre-Amplifier Factor(dB)
- Margin value = Emission Level – Limit value
- The other emission levels were very low against the limit of frequency range 30 MHz ~ 1 GHz.
- The emission levels were very low against the limit of frequency range 9 kHz ~ 30 MHz: the amplitude of spurious emissions attenuated more than 20 dB below the permissible value to be report.

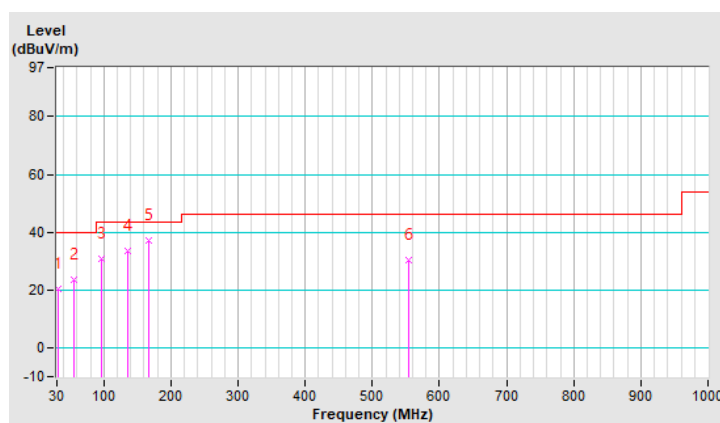

RF Mode	802.11ax (HE40)	Channel	CH 159 : 5795 MHz
Frequency Range	30 MHz ~ 1 GHz	Detector Function & Bandwidth	(QP) RB = 120kHz
Input Power	120 Vac, 60 Hz	Environmental Conditions	21°C, 77% RH
Tested By	Rex Wang		

Antenna Polarity & Test Distance : Vertical at 3 m								
No	Frequency (MHz)	Emission Level (dBuV/m)	Limit (dBuV/m)	Margin (dB)	Antenna Height (m)	Table Angle (Degree)	Raw Value (dBuV)	Correction Factor (dB/m)
1	65.89	23.1 QP	40.0	-16.9	1.25 V	6	33.5	-10.4
2	95.96	30.1 QP	43.5	-13.4	1.00 V	178	44.5	-14.4
3	141.55	24.2 QP	43.5	-19.3	1.00 V	149	33.4	-9.2
4	167.74	37.7 QP	43.5	-5.8	1.50 V	317	46.7	-9.0
5	434.49	38.4 QP	46.0	-7.6	1.50 V	29	42.1	-3.7
6	947.62	36.4 QP	46.0	-9.6	1.00 V	209	30.3	6.1

Remarks:

1. Emission Level(dBuV/m) = Raw Value(dBuV) + Correction Factor(dB/m)
2. Correction Factor(dB/m) = Antenna Factor(dB/m) + Cable Factor(dB) – Pre-Amplifier Factor(dB)
3. Margin value = Emission Level – Limit value
4. The other emission levels were very low against the limit of frequency range 30 MHz ~ 1 GHz.
5. The emission levels were very low against the limit of frequency range 9 kHz ~ 30 MHz: the amplitude of spurious emissions attenuated more than 20 dB below the permissible value to be report.

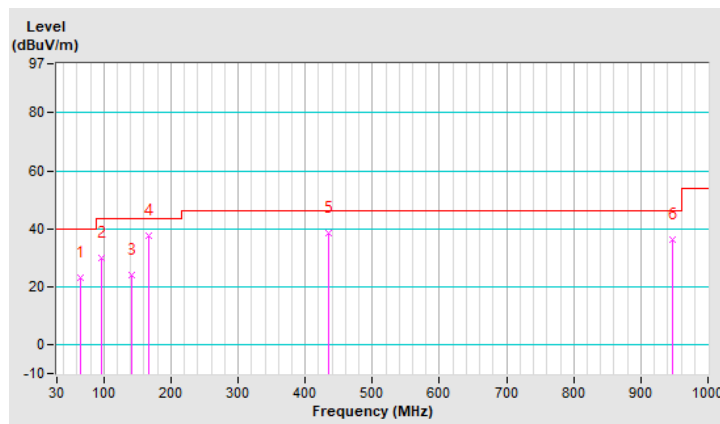

Mode B

RF Mode	802.11a	Channel	CH 149 : 5745 MHz
Frequency Range	30 MHz ~ 1 GHz	Detector Function & Bandwidth	(QP) RB = 120kHz
Input Power	120 Vac, 60 Hz	Environmental Conditions	21°C, 77% RH
Tested By	Rex Wang		

Antenna Polarity & Test Distance : Horizontal at 3 m								
No	Frequency (MHz)	Emission Level (dBuV/m)	Limit (dBuV/m)	Margin (dB)	Antenna Height (m)	Table Angle (Degree)	Raw Value (dBuV)	Correction Factor (dB/m)
1	71.71	29.8 QP	40.0	-10.2	1.50 H	21	41.3	-11.5
2	93.05	30.3 QP	43.5	-13.2	1.00 H	354	44.9	-14.6
3	111.48	29.0 QP	43.5	-14.5	1.50 H	6	41.1	-12.1
4	135.73	33.4 QP	43.5	-10.1	2.00 H	6	43.2	-9.8
5	167.74	37.2 QP	43.5	-6.3	1.00 H	236	46.2	-9.0
6	543.13	30.2 QP	46.0	-15.8	1.50 H	42	32.0	-1.8

Remarks:

1. Emission Level(dBuV/m) = Raw Value(dBuV) + Correction Factor(dB/m)
2. Correction Factor(dB/m) = Antenna Factor(dB/m) + Cable Factor(dB) – Pre-Amplifier Factor(dB)
3. Margin value = Emission Level – Limit value
4. The other emission levels were very low against the limit of frequency range 30 MHz ~ 1 GHz.
5. The emission levels were very low against the limit of frequency range 9 kHz ~ 30 MHz: the amplitude of spurious emissions attenuated more than 20 dB below the permissible value to be report.

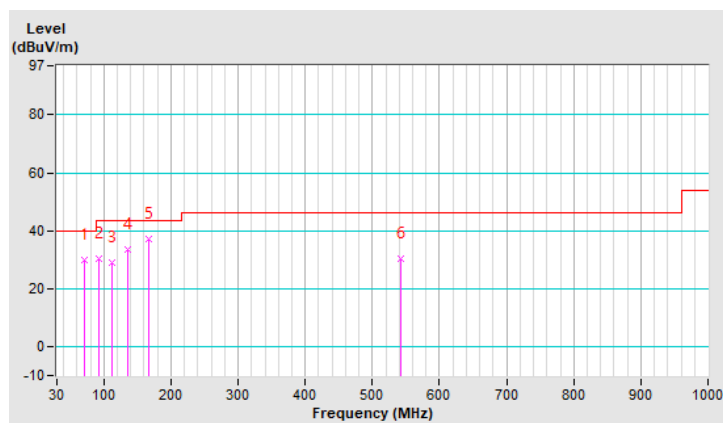

RF Mode	802.11a	Channel	CH 149 : 5745 MHz
Frequency Range	30 MHz ~ 1 GHz	Detector Function & Bandwidth	(QP) RB = 120kHz
Input Power	120 Vac, 60 Hz	Environmental Conditions	21°C, 77% RH
Tested By	Rex Wang		

Antenna Polarity & Test Distance : Vertical at 3 m								
No	Frequency (MHz)	Emission Level (dBUV/m)	Limit (dBUV/m)	Margin (dB)	Antenna Height (m)	Table Angle (Degree)	Raw Value (dBUV)	Correction Factor (dB/m)
1	55.22	22.4 QP	40.0	-17.6	1.00 V	70	31.6	-9.2
2	65.89	34.9 QP	40.0	-5.1	1.50 V	55	45.3	-10.4
3	95.96	29.2 QP	43.5	-14.3	1.00 V	193	43.6	-14.4
4	135.73	35.2 QP	43.5	-8.3	1.00 V	63	45.0	-9.8
5	167.74	37.4 QP	43.5	-6.1	1.50 V	84	46.4	-9.0
6	644.01	31.5 QP	46.0	-14.5	2.00 V	157	31.0	0.5

Remarks:

1. Emission Level(dBUV/m) = Raw Value(dBUV) + Correction Factor(dB/m)
2. Correction Factor(dB/m) = Antenna Factor(dB/m) + Cable Factor(dB) – Pre-Amplifier Factor(dB)
3. Margin value = Emission Level – Limit value
4. The other emission levels were very low against the limit of frequency range 30 MHz ~ 1 GHz.
5. The emission levels were very low against the limit of frequency range 9 kHz ~ 30 MHz: the amplitude of spurious emissions attenuated more than 20 dB below the permissible value to be report.

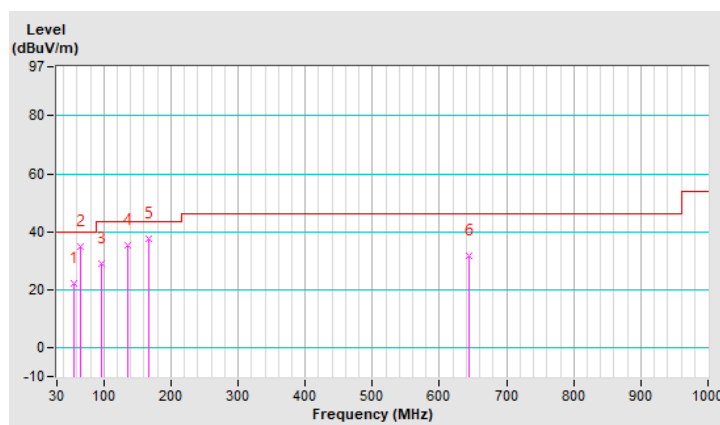

7.8 Unwanted Emissions above 1 GHz

Mode A

RF Mode	802.11a	Channel	CH 36 : 5180 MHz
Frequency Range	1 GHz ~ 40 GHz	Detector Function & Bandwidth	(PK) RB = 1 MHz, VB = 3 MHz (AV) RB = 1 MHz, VB = 1 kHz
Input Power	120 Vac, 60 Hz	Environmental Conditions	23°C, 67% RH
Tested By	Rex Wang		

Antenna Polarity & Test Distance : Horizontal at 3 m

No	Frequency (MHz)	Emission Level (dBuV/m)	Limit (dBuV/m)	Margin (dB)	Antenna Height (m)	Table Angle (Degree)	Raw Value (dBuV)	Correction Factor (dB/m)
1	5147.20	65.0 PK	74.0	-9.0	1.68 H	340	44.0	21.0
2	5147.20	50.3 AV	54.0	-3.7	1.68 H	340	29.3	21.0
3	*5180.00	118.8 PK			1.68 H	340	77.6	41.2
4	*5180.00	110.4 AV			1.68 H	340	69.2	41.2
5	#10360.00	60.8 PK	68.2	-7.4	2.68 H	275	36.4	24.4

Antenna Polarity & Test Distance : Vertical at 3 m

No	Frequency (MHz)	Emission Level (dBuV/m)	Limit (dBuV/m)	Margin (dB)	Antenna Height (m)	Table Angle (Degree)	Raw Value (dBuV)	Correction Factor (dB/m)
1	5147.80	67.8 PK	74.0	-6.2	1.94 V	358	46.8	21.0
2	5147.80	53.7 AV	54.0	-0.3	1.94 V	358	32.7	21.0
3	*5180.00	127.9 PK			1.94 V	358	86.7	41.2
4	*5180.00	118.0 AV			1.94 V	358	76.8	41.2
5	#10360.00	61.1 PK	68.2	-7.1	2.23 V	297	36.7	24.4

Remarks:

1. Emission Level(dBuV/m) = Raw Value(dBuV) + Correction Factor(dB/m)
2. Correction Factor(dB/m) = Antenna Factor(dB/m) + Cable Factor(dB) – Pre-Amplifier Factor(dB)
3. Margin value = Emission Level – Limit value
4. The other emission levels were very low against the limit.
5. " * " : Fundamental frequency, the limit was restricted at the RF Output Power.
6. " # " : The radiated frequency is out of the restricted band.



RF Mode	802.11a	Channel	CH 40 : 5200 MHz
Frequency Range	1 GHz ~ 40 GHz	Detector Function & Bandwidth	(PK) RB = 1 MHz, VB = 3 MHz (AV) RB = 1 MHz, VB = 1 kHz
Input Power	120 Vac, 60 Hz	Environmental Conditions	23°C, 67% RH
Tested By	Rex Wang		

Antenna Polarity & Test Distance : Horizontal at 3 m								
No	Frequency (MHz)	Emission Level (dBuV/m)	Limit (dBuV/m)	Margin (dB)	Antenna Height (m)	Table Angle (Degree)	Raw Value (dBuV)	Correction Factor (dB/m)
1	*5200.00	122.0 PK			1.65 H	340	80.9	41.1
2	*5200.00	112.2 AV			1.65 H	340	71.1	41.1
3	#10400.00	61.1 PK	68.2	-7.1	2.58 H	272	36.5	24.6
Antenna Polarity & Test Distance : Vertical at 3 m								
No	Frequency (MHz)	Emission Level (dBuV/m)	Limit (dBuV/m)	Margin (dB)	Antenna Height (m)	Table Angle (Degree)	Raw Value (dBuV)	Correction Factor (dB/m)
1	*5200.00	127.7 PK			2.13 V	335	86.6	41.1
2	*5200.00	118.3 AV			2.13 V	335	77.2	41.1
3	#10400.00	61.4 PK	68.2	-6.8	2.37 V	292	36.8	24.6

Remarks:

1. Emission Level(dBuV/m) = Raw Value(dBuV) + Correction Factor(dB/m)
2. Correction Factor(dB/m) = Antenna Factor(dB/m) + Cable Factor(dB) – Pre-Amplifier Factor(dB)
3. Margin value = Emission Level – Limit value
4. The other emission levels were very low against the limit.
5. " * ": Fundamental frequency, the limit was restricted at the RF Output Power.
6. " # ": The radiated frequency is out of the restricted band.

RF Mode	802.11a	Channel	CH 48 : 5240 MHz
Frequency Range	1 GHz ~ 40 GHz	Detector Function & Bandwidth	(PK) RB = 1 MHz, VB = 3 MHz (AV) RB = 1 MHz, VB = 1 kHz
Input Power	120 Vac, 60 Hz	Environmental Conditions	23°C, 67% RH
Tested By	Rex Wang		

Antenna Polarity & Test Distance : Horizontal at 3 m

No	Frequency (MHz)	Emission Level (dBuV/m)	Limit (dBuV/m)	Margin (dB)	Antenna Height (m)	Table Angle (Degree)	Raw Value (dBuV)	Correction Factor (dB/m)
1	*5240.00	120.0 PK			1.88 H	345	79.1	40.9
2	*5240.00	110.7 AV			1.88 H	345	69.8	40.9
3	5360.00	66.4 PK	74.0	-7.6	1.88 H	345	45.4	21.0
4	5360.00	49.0 AV	54.0	-5.0	1.88 H	345	28.0	21.0
5	#10480.00	61.4 PK	68.2	-6.8	2.63 H	284	36.5	24.9

Antenna Polarity & Test Distance : Vertical at 3 m

No	Frequency (MHz)	Emission Level (dBuV/m)	Limit (dBuV/m)	Margin (dB)	Antenna Height (m)	Table Angle (Degree)	Raw Value (dBuV)	Correction Factor (dB/m)
1	*5240.00	126.8 PK			2.19 V	7	85.9	40.9
2	*5240.00	116.5 AV			2.19 V	7	75.6	40.9
3	5358.90	69.3 PK	74.0	-4.7	2.19 V	7	48.3	21.0
4	5358.90	49.2 AV	54.0	-4.8	2.19 V	7	28.2	21.0
5	5437.30	64.7 PK	74.0	-9.3	2.19 V	7	43.3	21.4
6	5437.30	52.4 AV	54.0	-1.6	2.19 V	7	31.0	21.4
7	#10480.00	61.7 PK	68.2	-6.5	2.43 V	299	36.8	24.9

Remarks:

1. Emission Level(dBuV/m) = Raw Value(dBuV) + Correction Factor(dB/m)
2. Correction Factor(dB/m) = Antenna Factor(dB/m) + Cable Factor(dB) – Pre-Amplifier Factor(dB)
3. Margin value = Emission Level – Limit value
4. The other emission levels were very low against the limit.
5. " * " : Fundamental frequency, the limit was restricted at the RF Output Power.
6. " # " : The radiated frequency is out of the restricted band.

RF Mode	802.11ax (HE20)	Channel	CH 36 : 5180 MHz
Frequency Range	1 GHz ~ 40 GHz	Detector Function & Bandwidth	(PK) RB = 1 MHz, VB = 3 MHz (AV) RB = 1 MHz, VB = 1 kHz
Input Power	120 Vac, 60 Hz	Environmental Conditions	23°C, 67% RH
Tested By	Rex Wang		

Antenna Polarity & Test Distance : Horizontal at 3 m

No	Frequency (MHz)	Emission Level (dBuV/m)	Limit (dBuV/m)	Margin (dB)	Antenna Height (m)	Table Angle (Degree)	Raw Value (dBuV)	Correction Factor (dB/m)
1	5150.00	62.8 PK	74.0	-11.2	1.95 H	338	41.8	21.0
2	5150.00	51.5 AV	54.0	-2.5	1.95 H	338	30.5	21.0
3	*5180.00	120.6 PK			1.95 H	338	79.4	41.2
4	*5180.00	108.2 AV			1.95 H	338	67.0	41.2
5	#10360.00	60.9 PK	68.2	-7.3	2.65 H	271	36.5	24.4

Antenna Polarity & Test Distance : Vertical at 3 m

No	Frequency (MHz)	Emission Level (dBuV/m)	Limit (dBuV/m)	Margin (dB)	Antenna Height (m)	Table Angle (Degree)	Raw Value (dBuV)	Correction Factor (dB/m)
1	5137.60	68.0 PK	74.0	-6.0	2.37 V	344	47.0	21.0
2	5137.60	53.5 AV	54.0	-0.5	2.37 V	344	32.5	21.0
3	*5180.00	129.9 PK			2.37 V	344	88.7	41.2
4	*5180.00	117.0 AV			2.37 V	344	75.8	41.2
5	#10360.00	61.1 PK	68.2	-7.1	2.33 V	290	36.7	24.4

Remarks:

1. Emission Level(dBuV/m) = Raw Value(dBuV) + Correction Factor(dB/m)
2. Correction Factor(dB/m) = Antenna Factor(dB/m) + Cable Factor(dB) – Pre-Amplifier Factor(dB)
3. Margin value = Emission Level – Limit value
4. The other emission levels were very low against the limit.
5. " * " : Fundamental frequency, the limit was restricted at the RF Output Power.
6. " # " : The radiated frequency is out of the restricted band.

RF Mode	802.11ax (HE20)	Channel	CH 40 : 5200 MHz
Frequency Range	1 GHz ~ 40 GHz	Detector Function & Bandwidth	(PK) RB = 1 MHz, VB = 3 MHz (AV) RB = 1 MHz, VB = 1 kHz
Input Power	120 Vac, 60 Hz	Environmental Conditions	23°C, 67% RH
Tested By	Rex Wang		

Antenna Polarity & Test Distance : Horizontal at 3 m

No	Frequency (MHz)	Emission Level (dBuV/m)	Limit (dBuV/m)	Margin (dB)	Antenna Height (m)	Table Angle (Degree)	Raw Value (dBuV)	Correction Factor (dB/m)
1	5150.00	63.2 PK	74.0	-10.8	1.92 H	347	42.2	21.0
2	5150.00	49.3 AV	54.0	-4.7	1.92 H	347	28.3	21.0
3	*5200.00	123.4 PK			1.92 H	347	82.3	41.1
4	*5200.00	111.1 AV			1.92 H	347	70.0	41.1
5	#10400.00	61.2 PK	68.2	-7.0	2.59 H	274	36.6	24.6

Antenna Polarity & Test Distance : Vertical at 3 m

No	Frequency (MHz)	Emission Level (dBuV/m)	Limit (dBuV/m)	Margin (dB)	Antenna Height (m)	Table Angle (Degree)	Raw Value (dBuV)	Correction Factor (dB/m)
1	5142.80	67.8 PK	74.0	-6.2	2.36 V	328	46.8	21.0
2	5142.80	53.4 AV	54.0	-0.6	2.36 V	328	32.4	21.0
3	*5200.00	130.9 PK			2.36 V	328	89.8	41.1
4	*5200.00	118.3 AV			2.36 V	328	77.2	41.1
5	#10400.00	61.6 PK	68.2	-6.6	2.27 V	293	37.0	24.6

Remarks:

1. Emission Level(dBuV/m) = Raw Value(dBuV) + Correction Factor(dB/m)
2. Correction Factor(dB/m) = Antenna Factor(dB/m) + Cable Factor(dB) – Pre-Amplifier Factor(dB)
3. Margin value = Emission Level – Limit value
4. The other emission levels were very low against the limit.
5. " * ": Fundamental frequency, the limit was restricted at the RF Output Power.
6. " # ": The radiated frequency is out of the restricted band.

RF Mode	802.11ax (HE20)	Channel	CH 48 : 5240 MHz
Frequency Range	1 GHz ~ 40 GHz	Detector Function & Bandwidth	(PK) RB = 1 MHz, VB = 3 MHz (AV) RB = 1 MHz, VB = 1 kHz
Input Power	120 Vac, 60 Hz	Environmental Conditions	23°C, 67% RH
Tested By	Rex Wang		

Antenna Polarity & Test Distance : Horizontal at 3 m

No	Frequency (MHz)	Emission Level (dBuV/m)	Limit (dBuV/m)	Margin (dB)	Antenna Height (m)	Table Angle (Degree)	Raw Value (dBuV)	Correction Factor (dB/m)
1	*5240.00	123.4 PK			1.79 H	342	82.5	40.9
2	*5240.00	111.4 AV			1.79 H	342	70.5	40.9
3	5360.00	65.4 PK	74.0	-8.6	1.79 H	342	44.4	21.0
4	5360.00	49.0 AV	54.0	-5.0	1.79 H	342	28.0	21.0
5	#10480.00	61.6 PK	68.2	-6.6	2.65 H	277	36.7	24.9

Antenna Polarity & Test Distance : Vertical at 3 m

No	Frequency (MHz)	Emission Level (dBuV/m)	Limit (dBuV/m)	Margin (dB)	Antenna Height (m)	Table Angle (Degree)	Raw Value (dBuV)	Correction Factor (dB/m)
1	5141.30	63.5 PK	74.0	-10.5	2.44 V	344	42.5	21.0
2	5141.30	52.3 AV	54.0	-1.7	2.44 V	344	31.3	21.0
3	*5240.00	131.5 PK			2.44 V	344	90.6	40.9
4	*5240.00	118.7 AV			2.44 V	344	77.8	40.9
5	5360.00	68.2 PK	74.0	-5.8	2.44 V	344	47.2	21.0
6	5360.00	49.4 AV	54.0	-4.6	2.44 V	344	28.4	21.0
7	5428.00	64.7 PK	74.0	-9.3	2.44 V	344	43.3	21.4
8	5428.00	51.6 AV	54.0	-2.4	2.44 V	344	30.2	21.4
9	#10480.00	61.7 PK	68.2	-6.5	2.29 V	297	36.8	24.9

Remarks:

1. Emission Level(dBuV/m) = Raw Value(dBuV) + Correction Factor(dB/m)
2. Correction Factor(dB/m) = Antenna Factor(dB/m) + Cable Factor(dB) – Pre-Amplifier Factor(dB)
3. Margin value = Emission Level – Limit value
4. The other emission levels were very low against the limit.
5. " * " : Fundamental frequency, the limit was restricted at the RF Output Power.
6. " # " : The radiated frequency is out of the restricted band.

RF Mode	802.11ax (HE40)	Channel	CH 38 : 5190 MHz
Frequency Range	1 GHz ~ 40 GHz	Detector Function & Bandwidth	(PK) RB = 1 MHz, VB = 3 MHz (AV) RB = 1 MHz, VB = 1 kHz
Input Power	120 Vac, 60 Hz	Environmental Conditions	23°C, 67% RH
Tested By	Rex Wang		

Antenna Polarity & Test Distance : Horizontal at 3 m

No	Frequency (MHz)	Emission Level (dBuV/m)	Limit (dBuV/m)	Margin (dB)	Antenna Height (m)	Table Angle (Degree)	Raw Value (dBuV)	Correction Factor (dB/m)
1	5144.00	62.9 PK	74.0	-11.1	1.74 H	335	41.9	21.0
2	5144.00	50.9 AV	54.0	-3.1	1.74 H	335	29.9	21.0
3	*5190.00	116.8 PK			1.74 H	335	75.7	41.1
4	*5190.00	103.7 AV			1.74 H	335	62.6	41.1
5	#10380.00	60.9 PK	68.2	-7.3	2.59 H	262	36.4	24.5

Antenna Polarity & Test Distance : Vertical at 3 m

No	Frequency (MHz)	Emission Level (dBuV/m)	Limit (dBuV/m)	Margin (dB)	Antenna Height (m)	Table Angle (Degree)	Raw Value (dBuV)	Correction Factor (dB/m)
1	5137.80	68.6 PK	74.0	-5.4	2.41 V	324	47.6	21.0
2	5137.80	53.7 AV	54.0	-0.3	2.41 V	324	32.7	21.0
3	*5190.00	123.6 PK			2.41 V	324	82.5	41.1
4	*5190.00	110.3 AV			2.41 V	324	69.2	41.1
5	#10380.00	61.1 PK	68.2	-7.1	2.66 V	269	36.6	24.5

Remarks:

1. Emission Level(dBuV/m) = Raw Value(dBuV) + Correction Factor(dB/m)
2. Correction Factor(dB/m) = Antenna Factor(dB/m) + Cable Factor(dB) – Pre-Amplifier Factor(dB)
3. Margin value = Emission Level – Limit value
4. The other emission levels were very low against the limit.
5. " * " : Fundamental frequency, the limit was restricted at the RF Output Power.
6. " # " : The radiated frequency is out of the restricted band.

RF Mode	802.11ax (HE40)	Channel	CH 46 : 5230 MHz
Frequency Range	1 GHz ~ 40 GHz	Detector Function & Bandwidth	(PK) RB = 1 MHz, VB = 3 MHz (AV) RB = 1 MHz, VB = 1 kHz
Input Power	120 Vac, 60 Hz	Environmental Conditions	23°C, 67% RH
Tested By	Rex Wang		

Antenna Polarity & Test Distance : Horizontal at 3 m

No	Frequency (MHz)	Emission Level (dBuV/m)	Limit (dBuV/m)	Margin (dB)	Antenna Height (m)	Table Angle (Degree)	Raw Value (dBuV)	Correction Factor (dB/m)
1	5143.70	61.6 PK	74.0	-12.4	1.65 H	335	40.6	21.0
2	5143.70	49.8 AV	54.0	-4.2	1.65 H	335	28.8	21.0
3	*5230.00	118.3 PK			1.65 H	335	77.4	40.9
4	*5230.00	105.9 AV			1.65 H	335	65.0	40.9
5	5350.00	68.4 PK	74.0	-5.6	1.65 H	335	47.4	21.0
6	5350.00	48.4 AV	54.0	-5.6	1.65 H	335	27.4	21.0
7	#10460.00	61.4 PK	68.2	-6.8	2.59 H	278	36.5	24.9

Antenna Polarity & Test Distance : Vertical at 3 m

No	Frequency (MHz)	Emission Level (dBuV/m)	Limit (dBuV/m)	Margin (dB)	Antenna Height (m)	Table Angle (Degree)	Raw Value (dBuV)	Correction Factor (dB/m)
1	5138.20	65.6 PK	74.0	-8.4	2.41 V	322	44.6	21.0
2	5138.20	53.3 AV	54.0	-0.7	2.41 V	322	32.3	21.0
3	*5230.00	125.3 PK			2.41 V	322	84.4	40.9
4	*5230.00	112.1 AV			2.41 V	322	71.2	40.9
5	5350.00	71.0 PK	74.0	-3.0	2.41 V	322	50.0	21.0
6	5350.00	50.0 AV	54.0	-4.0	2.41 V	322	29.0	21.0
7	#10460.00	61.6 PK	68.2	-6.6	2.38 V	295	36.7	24.9

Remarks:

1. Emission Level(dBuV/m) = Raw Value(dBuV) + Correction Factor(dB/m)
2. Correction Factor(dB/m) = Antenna Factor(dB/m) + Cable Factor(dB) – Pre-Amplifier Factor(dB)
3. Margin value = Emission Level – Limit value
4. The other emission levels were very low against the limit.
5. " * " : Fundamental frequency, the limit was restricted at the RF Output Power.
6. " # " : The radiated frequency is out of the restricted band.

RF Mode	802.11ax (HE80)	Channel	CH 42 : 5210 MHz
Frequency Range	1 GHz ~ 40 GHz	Detector Function & Bandwidth	(PK) RB = 1 MHz, VB = 3 MHz (AV) RB = 1 MHz, VB = 1 kHz
Input Power	120 Vac, 60 Hz	Environmental Conditions	23°C, 67% RH
Tested By	Rex Wang		

Antenna Polarity & Test Distance : Horizontal at 3 m

No	Frequency (MHz)	Emission Level (dBuV/m)	Limit (dBuV/m)	Margin (dB)	Antenna Height (m)	Table Angle (Degree)	Raw Value (dBuV)	Correction Factor (dB/m)
1	5143.40	62.4 PK	74.0	-11.6	1.73 H	335	41.4	21.0
2	5143.40	50.2 AV	54.0	-3.8	1.73 H	335	29.2	21.0
3	*5210.00	110.6 PK			1.73 H	335	69.6	41.0
4	*5210.00	97.4 AV			1.73 H	335	56.4	41.0
5	#10420.00	61.2 PK	68.2	-7.0	2.61 H	279	36.6	24.6

Antenna Polarity & Test Distance : Vertical at 3 m

No	Frequency (MHz)	Emission Level (dBuV/m)	Limit (dBuV/m)	Margin (dB)	Antenna Height (m)	Table Angle (Degree)	Raw Value (dBuV)	Correction Factor (dB/m)
1	5136.40	66.3 PK	74.0	-7.7	2.49 V	323	45.3	21.0
2	5136.40	53.2 AV	54.0	-0.8	2.49 V	323	32.2	21.0
3	*5210.00	118.1 PK			2.49 V	323	77.1	41.0
4	*5210.00	104.5 AV			2.49 V	323	63.5	41.0
5	#10420.00	61.4 PK	68.2	-6.8	2.24 V	293	36.8	24.6

Remarks:

1. Emission Level(dBuV/m) = Raw Value(dBuV) + Correction Factor(dB/m)
2. Correction Factor(dB/m) = Antenna Factor(dB/m) + Cable Factor(dB) – Pre-Amplifier Factor(dB)
3. Margin value = Emission Level – Limit value
4. The other emission levels were very low against the limit.
5. " * ": Fundamental frequency, the limit was restricted at the RF Output Power.
6. " # ": The radiated frequency is out of the restricted band.



RF Mode	802.11a	Channel	CH 149 : 5745 MHz
Frequency Range	1 GHz ~ 40 GHz	Detector Function & Bandwidth	(PK) RB = 1 MHz, VB = 3 MHz (AV) RB = 1 MHz, VB = 1 kHz
Input Power	120 Vac, 60 Hz	Environmental Conditions	23°C, 67% RH
Tested By	Rex Wang		

Antenna Polarity & Test Distance : Horizontal at 3 m

No	Frequency (MHz)	Emission Level (dBuV/m)	Limit (dBuV/m)	Margin (dB)	Antenna Height (m)	Table Angle (Degree)	Raw Value (dBuV)	Correction Factor (dB/m)
1	#5628.80	60.7 PK	68.2	-7.5	2.52 H	1	38.9	21.8
2	*5745.00	121.3 PK			2.52 H	1	79.3	42.0
3	*5745.00	112.1 AV			2.52 H	1	70.1	42.0
4	#5944.00	61.5 PK	68.2	-6.7	2.52 H	1	39.0	22.5
5	11490.00	63.6 PK	74.0	-10.4	2.77 H	340	36.4	27.2
6	11490.00	50.4 AV	54.0	-3.6	2.77 H	340	23.2	27.2

Antenna Polarity & Test Distance : Vertical at 3 m

No	Frequency (MHz)	Emission Level (dBuV/m)	Limit (dBuV/m)	Margin (dB)	Antenna Height (m)	Table Angle (Degree)	Raw Value (dBuV)	Correction Factor (dB/m)
1	#5645.20	64.5 PK	68.2	-3.7	2.57 V	17	42.6	21.9
2	*5745.00	127.1 PK			2.57 V	17	85.1	42.0
3	*5745.00	116.9 AV			2.57 V	17	74.9	42.0
4	#5938.00	61.6 PK	68.2	-6.6	2.57 V	17	39.1	22.5
5	11490.00	63.8 PK	74.0	-10.2	2.26 V	290	36.6	27.2
6	11490.00	50.7 AV	54.0	-3.3	2.26 V	290	23.5	27.2

Remarks:

1. Emission Level(dBuV/m) = Raw Value(dBuV) + Correction Factor(dB/m)
2. Correction Factor(dB/m) = Antenna Factor(dB/m) + Cable Factor(dB) – Pre-Amplifier Factor(dB)
3. Margin value = Emission Level – Limit value
4. The other emission levels were very low against the limit.
5. " * ": Fundamental frequency, the limit was restricted at the RF Output Power.

RF Mode	802.11a	Channel	CH 157 : 5785 MHz
Frequency Range	1 GHz ~ 40 GHz	Detector Function & Bandwidth	(PK) RB = 1 MHz, VB = 3 MHz (AV) RB = 1 MHz, VB = 1 kHz
Input Power	120 Vac, 60 Hz	Environmental Conditions	23°C, 67% RH
Tested By	Rex Wang		

Antenna Polarity & Test Distance : Horizontal at 3 m

No	Frequency (MHz)	Emission Level (dBUV/m)	Limit (dBUV/m)	Margin (dB)	Antenna Height (m)	Table Angle (Degree)	Raw Value (dBUV)	Correction Factor (dB/m)
1	#5640.00	61.4 PK	68.2	-6.8	2.58 H	357	39.6	21.8
2	*5785.00	121.1 PK			2.58 H	357	78.9	42.2
3	*5785.00	112.3 AV			2.58 H	357	70.1	42.2
4	#5960.40	60.8 PK	68.2	-7.4	2.58 H	357	38.2	22.6
5	11570.00	63.7 PK	74.0	-10.3	2.79 H	338	36.5	27.2
6	11570.00	50.5 AV	54.0	-3.5	2.79 H	338	23.3	27.2

Antenna Polarity & Test Distance : Vertical at 3 m

No	Frequency (MHz)	Emission Level (dBUV/m)	Limit (dBUV/m)	Margin (dB)	Antenna Height (m)	Table Angle (Degree)	Raw Value (dBUV)	Correction Factor (dB/m)
1	#5641.60	62.8 PK	68.2	-5.4	2.87 V	6	41.0	21.8
2	*5785.00	127.4 PK			2.87 V	6	85.2	42.2
3	*5785.00	117.5 AV			2.87 V	6	75.3	42.2
4	#5934.40	60.8 PK	68.2	-7.4	2.87 V	6	38.3	22.5
5	11570.00	63.9 PK	74.0	-10.1	2.30 V	286	36.7	27.2
6	11570.00	50.7 AV	54.0	-3.3	2.30 V	286	23.5	27.2

Remarks:

1. Emission Level(dBUV/m) = Raw Value(dBUV) + Correction Factor(dB/m)
2. Correction Factor(dB/m) = Antenna Factor(dB/m) + Cable Factor(dB) – Pre-Amplifier Factor(dB)
3. Margin value = Emission Level – Limit value
4. The other emission levels were very low against the limit.
5. " * " : Fundamental frequency, the limit was restricted at the RF Output Power.
6. " # " : The radiated frequency is out of the restricted band.



RF Mode	802.11a	Channel	CH 165 : 5825 MHz
Frequency Range	1 GHz ~ 40 GHz	Detector Function & Bandwidth	(PK) RB = 1 MHz, VB = 3 MHz (AV) RB = 1 MHz, VB = 1 kHz
Input Power	120 Vac, 60 Hz	Environmental Conditions	23°C, 67% RH
Tested By	Rex Wang		

Antenna Polarity & Test Distance : Horizontal at 3 m

No	Frequency (MHz)	Emission Level (dBUV/m)	Limit (dBUV/m)	Margin (dB)	Antenna Height (m)	Table Angle (Degree)	Raw Value (dBUV)	Correction Factor (dB/m)
1	#5614.40	62.0 PK	68.2	-6.2	2.57 H	355	40.2	21.8
2	*5825.00	122.2 PK			2.57 H	355	79.8	42.4
3	*5825.00	112.5 AV			2.57 H	355	70.1	42.4
4	#5970.80	60.9 PK	68.2	-7.3	2.57 H	355	38.3	22.6
5	11650.00	62.9 PK	74.0	-11.1	2.82 H	338	36.4	26.5
6	11650.00	49.7 AV	54.0	-4.3	2.82 H	338	23.2	26.5

Antenna Polarity & Test Distance : Vertical at 3 m

No	Frequency (MHz)	Emission Level (dBUV/m)	Limit (dBUV/m)	Margin (dB)	Antenna Height (m)	Table Angle (Degree)	Raw Value (dBUV)	Correction Factor (dB/m)
1	#5629.60	62.4 PK	68.2	-5.8	2.95 V	1	40.6	21.8
2	*5825.00	126.9 PK			2.95 V	1	84.5	42.4
3	*5825.00	117.2 AV			2.95 V	1	74.8	42.4
4	#5987.60	60.5 PK	68.2	-7.7	2.95 V	1	37.9	22.6
5	11650.00	63.0 PK	74.0	-11.0	2.26 V	294	36.5	26.5
6	11650.00	49.9 AV	54.0	-4.1	2.26 V	294	23.4	26.5

Remarks:

1. Emission Level(dBUV/m) = Raw Value(dBUV) + Correction Factor(dB/m)
2. Correction Factor(dB/m) = Antenna Factor(dB/m) + Cable Factor(dB) – Pre-Amplifier Factor(dB)
3. Margin value = Emission Level – Limit value
4. The other emission levels were very low against the limit.
5. " * " : Fundamental frequency, the limit was restricted at the RF Output Power.
6. " # " : The radiated frequency is out of the restricted band.

RF Mode	802.11ax (HE20)	Channel	CH 149 : 5745 MHz
Frequency Range	1 GHz ~ 40 GHz	Detector Function & Bandwidth	(PK) RB = 1 MHz, VB = 3 MHz (AV) RB = 1 MHz, VB = 1 kHz
Input Power	120 Vac, 60 Hz	Environmental Conditions	23°C, 67% RH
Tested By	Rex Wang		

Antenna Polarity & Test Distance : Horizontal at 3 m

No	Frequency (MHz)	Emission Level (dBuV/m)	Limit (dBuV/m)	Margin (dB)	Antenna Height (m)	Table Angle (Degree)	Raw Value (dBuV)	Correction Factor (dB/m)
1	#5621.20	62.0 PK	68.2	-6.2	2.59 H	2	40.2	21.8
2	*5745.00	126.4 PK			2.59 H	2	84.4	42.0
3	*5745.00	112.8 AV			2.59 H	2	70.8	42.0
4	#5929.60	61.1 PK	68.2	-7.1	2.59 H	2	38.6	22.5
5	11490.00	63.6 PK	74.0	-10.4	2.81 H	345	36.4	27.2
6	11490.00	50.5 AV	54.0	-3.5	2.81 H	345	23.3	27.2

Antenna Polarity & Test Distance : Vertical at 3 m

No	Frequency (MHz)	Emission Level (dBuV/m)	Limit (dBuV/m)	Margin (dB)	Antenna Height (m)	Table Angle (Degree)	Raw Value (dBuV)	Correction Factor (dB/m)
1	#5648.00	64.2 PK	68.2	-4.0	2.42 V	346	42.3	21.9
2	*5745.00	131.1 PK			2.42 V	346	89.1	42.0
3	*5745.00	117.8 AV			2.42 V	346	75.8	42.0
4	#5938.80	62.2 PK	68.2	-6.0	2.42 V	346	39.7	22.5
5	11490.00	63.8 PK	74.0	-10.2	2.28 V	297	36.6	27.2
6	11490.00	50.7 AV	54.0	-3.3	2.28 V	297	23.5	27.2

Remarks:

1. Emission Level(dBuV/m) = Raw Value(dBuV) + Correction Factor(dB/m)
2. Correction Factor(dB/m) = Antenna Factor(dB/m) + Cable Factor(dB) – Pre-Amplifier Factor(dB)
3. Margin value = Emission Level – Limit value
4. The other emission levels were very low against the limit.
5. " * " : Fundamental frequency, the limit was restricted at the RF Output Power.
6. " # " : The radiated frequency is out of the restricted band.

RF Mode	802.11ax (HE20)	Channel	CH 157 : 5785 MHz
Frequency Range	1 GHz ~ 40 GHz	Detector Function & Bandwidth	(PK) RB = 1 MHz, VB = 3 MHz (AV) RB = 1 MHz, VB = 1 kHz
Input Power	120 Vac, 60 Hz	Environmental Conditions	23°C, 67% RH
Tested By	Rex Wang		

Antenna Polarity & Test Distance : Horizontal at 3 m

No	Frequency (MHz)	Emission Level (dBuV/m)	Limit (dBuV/m)	Margin (dB)	Antenna Height (m)	Table Angle (Degree)	Raw Value (dBuV)	Correction Factor (dB/m)
1	#5644.00	62.6 PK	68.2	-5.6	2.58 H	1	40.8	21.8
2	*5785.00	125.9 PK			2.58 H	1	83.7	42.2
3	*5785.00	113.0 AV			2.58 H	1	70.8	42.2
4	#5992.00	60.6 PK	68.2	-7.6	2.58 H	1	38.0	22.6
5	11570.00	63.7 PK	74.0	-10.3	2.71 H	334	36.5	27.2
6	11570.00	50.4 AV	54.0	-3.6	2.71 H	334	23.2	27.2

Antenna Polarity & Test Distance : Vertical at 3 m

No	Frequency (MHz)	Emission Level (dBuV/m)	Limit (dBuV/m)	Margin (dB)	Antenna Height (m)	Table Angle (Degree)	Raw Value (dBuV)	Correction Factor (dB/m)
1	#5644.00	62.3 PK	68.2	-5.9	2.60 V	350	40.5	21.8
2	*5785.00	130.0 PK			2.60 V	350	87.8	42.2
3	*5785.00	117.8 AV			2.60 V	350	75.6	42.2
4	#5984.80	61.2 PK	68.2	-7.0	2.60 V	350	38.6	22.6
5	11570.00	63.9 PK	74.0	-10.1	2.34 V	291	36.7	27.2
6	11570.00	50.6 AV	54.0	-3.4	2.34 V	291	23.4	27.2

Remarks:

1. Emission Level(dBuV/m) = Raw Value(dBuV) + Correction Factor(dB/m)
2. Correction Factor(dB/m) = Antenna Factor(dB/m) + Cable Factor(dB) – Pre-Amplifier Factor(dB)
3. Margin value = Emission Level – Limit value
4. The other emission levels were very low against the limit.
5. " * " : Fundamental frequency, the limit was restricted at the RF Output Power.
6. " # " : The radiated frequency is out of the restricted band.



RF Mode	802.11ax (HE20)	Channel	CH 165 : 5825 MHz
Frequency Range	1 GHz ~ 40 GHz	Detector Function & Bandwidth	(PK) RB = 1 MHz, VB = 3 MHz (AV) RB = 1 MHz, VB = 1 kHz
Input Power	120 Vac, 60 Hz	Environmental Conditions	23°C, 67% RH
Tested By	Rex Wang		

Antenna Polarity & Test Distance : Horizontal at 3 m

No	Frequency (MHz)	Emission Level (dBuV/m)	Limit (dBuV/m)	Margin (dB)	Antenna Height (m)	Table Angle (Degree)	Raw Value (dBuV)	Correction Factor (dB/m)
1	#5608.40	62.2 PK	68.2	-6.0	2.67 H	3	40.5	21.7
2	*5825.00	125.1 PK			2.67 H	3	82.7	42.4
3	*5825.00	112.5 AV			2.67 H	3	70.1	42.4
4	#5960.40	61.4 PK	68.2	-6.8	2.67 H	3	38.8	22.6
5	11650.00	62.9 PK	74.0	-11.1	2.68 H	345	36.4	26.5
6	11650.00	49.6 AV	54.0	-4.4	2.68 H	345	23.1	26.5

Antenna Polarity & Test Distance : Vertical at 3 m

No	Frequency (MHz)	Emission Level (dBuV/m)	Limit (dBuV/m)	Margin (dB)	Antenna Height (m)	Table Angle (Degree)	Raw Value (dBuV)	Correction Factor (dB/m)
1	#5632.80	63.4 PK	68.2	-4.8	2.67 V	355	41.6	21.8
2	*5825.00	129.2 PK			2.67 V	355	86.8	42.4
3	*5825.00	117.3 AV			2.67 V	355	74.9	42.4
4	#5947.20	61.7 PK	68.2	-6.5	2.67 V	355	39.2	22.5
5	11650.00	63.0 PK	74.0	-11.0	2.29 V	287	36.5	26.5
6	11650.00	49.7 AV	54.0	-4.3	2.29 V	287	23.2	26.5

Remarks:

1. Emission Level(dBuV/m) = Raw Value(dBuV) + Correction Factor(dB/m)
2. Correction Factor(dB/m) = Antenna Factor(dB/m) + Cable Factor(dB) – Pre-Amplifier Factor(dB)
3. Margin value = Emission Level – Limit value
4. The other emission levels were very low against the limit.
5. " * " : Fundamental frequency, the limit was restricted at the RF Output Power.
6. " # " : The radiated frequency is out of the restricted band.



RF Mode	802.11ax (HE40)	Channel	CH 151 : 5755 MHz
Frequency Range	1 GHz ~ 40 GHz	Detector Function & Bandwidth	(PK) RB = 1 MHz, VB = 3 MHz (AV) RB = 1 MHz, VB = 1 kHz
Input Power	120 Vac, 60 Hz	Environmental Conditions	23°C, 67% RH
Tested By	Rex Wang		

Antenna Polarity & Test Distance : Horizontal at 3 m

No	Frequency (MHz)	Emission Level (dBuV/m)	Limit (dBuV/m)	Margin (dB)	Antenna Height (m)	Table Angle (Degree)	Raw Value (dBuV)	Correction Factor (dB/m)
1	#5646.00	62.8 PK	68.2	-5.4	2.72 H	359	40.9	21.9
2	*5755.00	121.9 PK			2.72 H	359	79.8	42.1
3	*5755.00	109.2 AV			2.72 H	359	67.1	42.1
4	#5940.40	61.8 PK	68.2	-6.4	2.72 H	359	39.3	22.5
5	11510.00	63.7 PK	74.0	-10.3	2.68 H	335	36.4	27.3
6	11510.00	50.5 AV	54.0	-3.5	2.68 H	335	23.2	27.3

Antenna Polarity & Test Distance : Vertical at 3 m

No	Frequency (MHz)	Emission Level (dBuV/m)	Limit (dBuV/m)	Margin (dB)	Antenna Height (m)	Table Angle (Degree)	Raw Value (dBuV)	Correction Factor (dB/m)
1	#5636.00	67.9 PK	68.2	-0.3	2.42 V	346	46.1	21.8
2	*5755.00	126.6 PK			2.42 V	346	84.5	42.1
3	*5755.00	114.2 AV			2.42 V	346	72.1	42.1
4	#5992.00	62.8 PK	68.2	-5.4	2.42 V	346	40.2	22.6
5	11510.00	63.9 PK	74.0	-10.1	2.31 V	296	36.6	27.3
6	11510.00	50.6 AV	54.0	-3.4	2.31 V	296	23.3	27.3

Remarks:

1. Emission Level(dBuV/m) = Raw Value(dBuV) + Correction Factor(dB/m)
2. Correction Factor(dB/m) = Antenna Factor(dB/m) + Cable Factor(dB) – Pre-Amplifier Factor(dB)
3. Margin value = Emission Level – Limit value
4. The other emission levels were very low against the limit.
5. " * " : Fundamental frequency, the limit was restricted at the RF Output Power.
6. " # " : The radiated frequency is out of the restricted band.



RF Mode	802.11ax (HE40)	Channel	CH 159 : 5795 MHz
Frequency Range	1 GHz ~ 40 GHz	Detector Function & Bandwidth	(PK) RB = 1 MHz, VB = 3 MHz (AV) RB = 1 MHz, VB = 1 kHz
Input Power	120 Vac, 60 Hz	Environmental Conditions	23°C, 67% RH
Tested By	Rex Wang		

Antenna Polarity & Test Distance : Horizontal at 3 m

No	Frequency (MHz)	Emission Level (dBUV/m)	Limit (dBUV/m)	Margin (dB)	Antenna Height (m)	Table Angle (Degree)	Raw Value (dBUV)	Correction Factor (dB/m)
1	#5603.20	61.3 PK	68.2	-6.9	2.48 H	3	39.6	21.7
2	*5795.00	123.0 PK			2.48 H	3	80.8	42.2
3	*5795.00	110.0 AV			2.48 H	3	67.8	42.2
4	#5995.60	61.3 PK	68.2	-6.9	2.48 H	3	38.7	22.6
5	11590.00	63.4 PK	74.0	-10.6	2.66 H	343	36.3	27.1
6	11590.00	50.1 AV	54.0	-3.9	2.66 H	343	23.0	27.1

Antenna Polarity & Test Distance : Vertical at 3 m

No	Frequency (MHz)	Emission Level (dBUV/m)	Limit (dBUV/m)	Margin (dB)	Antenna Height (m)	Table Angle (Degree)	Raw Value (dBUV)	Correction Factor (dB/m)
1	#5632.80	64.0 PK	68.2	-4.2	2.54 V	343	42.2	21.8
2	*5795.00	128.1 PK			2.54 V	343	85.9	42.2
3	*5795.00	114.9 AV			2.54 V	343	72.7	42.2
4	#5989.20	61.9 PK	68.2	-6.3	2.54 V	343	39.3	22.6
5	11590.00	63.5 PK	74.0	-10.5	2.26 V	290	36.4	27.1
6	11590.00	50.2 AV	54.0	-3.8	2.26 V	290	23.1	27.1

Remarks:

1. Emission Level(dBUV/m) = Raw Value(dBUV) + Correction Factor(dB/m)
2. Correction Factor(dB/m) = Antenna Factor(dB/m) + Cable Factor(dB) – Pre-Amplifier Factor(dB)
3. Margin value = Emission Level – Limit value
4. The other emission levels were very low against the limit.
5. " * " : Fundamental frequency, the limit was restricted at the RF Output Power.
6. " # " : The radiated frequency is out of the restricted band.

RF Mode	802.11ax (HE80)	Channel	CH 155 : 5775 MHz
Frequency Range	1 GHz ~ 40 GHz	Detector Function & Bandwidth	(PK) RB = 1 MHz, VB = 3 MHz (AV) RB = 1 MHz, VB = 1 kHz
Input Power	120 Vac, 60 Hz	Environmental Conditions	23°C, 67% RH
Tested By	Rex Wang		

Antenna Polarity & Test Distance : Horizontal at 3 m

No	Frequency (MHz)	Emission Level (dBUV/m)	Limit (dBUV/m)	Margin (dB)	Antenna Height (m)	Table Angle (Degree)	Raw Value (dBUV)	Correction Factor (dB/m)
1	#5610.40	62.4 PK	68.2	-5.8	2.63 H	2	40.7	21.7
2	*5775.00	117.8 PK			2.63 H	2	75.7	42.1
3	*5775.00	104.3 AV			2.63 H	2	62.2	42.1
4	#5965.60	61.2 PK	68.2	-7.0	2.63 H	2	38.6	22.6
5	11550.00	63.8 PK	74.0	-10.2	2.76 H	347	36.5	27.3
6	11550.00	50.4 AV	54.0	-3.6	2.76 H	347	23.1	27.3

Antenna Polarity & Test Distance : Vertical at 3 m

No	Frequency (MHz)	Emission Level (dBUV/m)	Limit (dBUV/m)	Margin (dB)	Antenna Height (m)	Table Angle (Degree)	Raw Value (dBUV)	Correction Factor (dB/m)
1	#5636.00	67.1 PK	68.2	-1.1	2.59 V	344	45.3	21.8
2	*5775.00	121.5 PK			2.59 V	344	79.4	42.1
3	*5775.00	109.2 AV			2.59 V	344	67.1	42.1
4	#5990.40	62.1 PK	68.2	-6.1	2.59 V	344	39.5	22.6
5	11550.00	63.9 PK	74.0	-10.1	2.20 V	286	36.6	27.3
6	11550.00	50.5 AV	54.0	-3.5	2.20 V	286	23.2	27.3

Remarks:

1. Emission Level(dBUV/m) = Raw Value(dBUV) + Correction Factor(dB/m)
2. Correction Factor(dB/m) = Antenna Factor(dB/m) + Cable Factor(dB) – Pre-Amplifier Factor(dB)
3. Margin value = Emission Level – Limit value
4. The other emission levels were very low against the limit.
5. " * " : Fundamental frequency, the limit was restricted at the RF Output Power.
6. " # " : The radiated frequency is out of the restricted band.

Plot of Band Edge

802.11a Channel 36

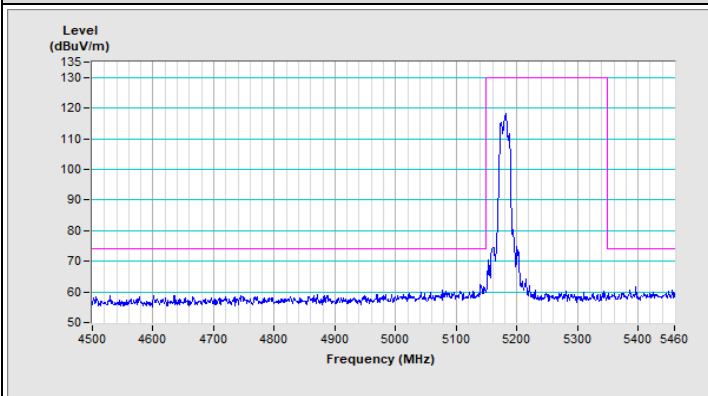

Horizontal (Peak)

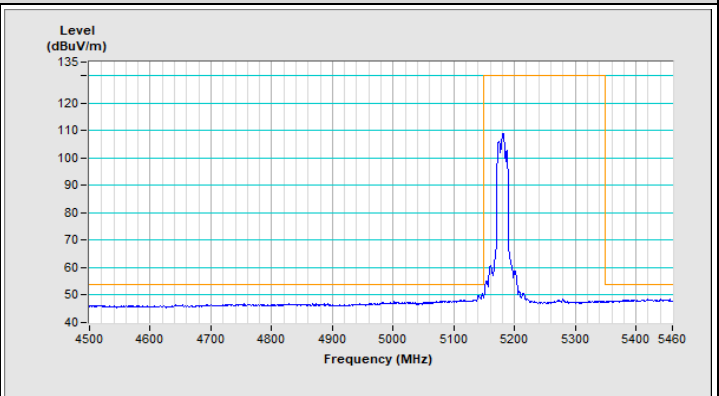

Horizontal (Average)

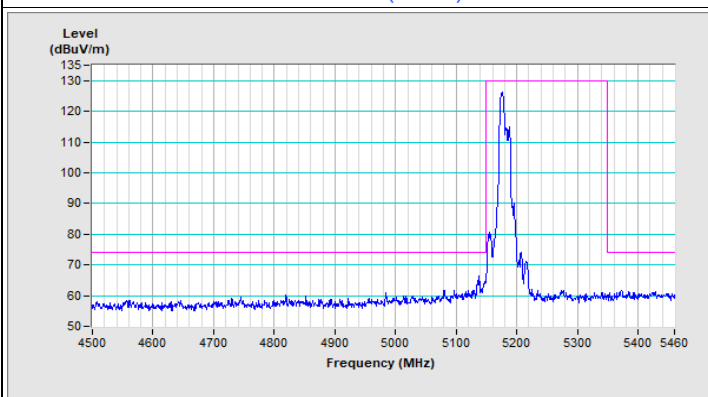

Vertical (Peak)

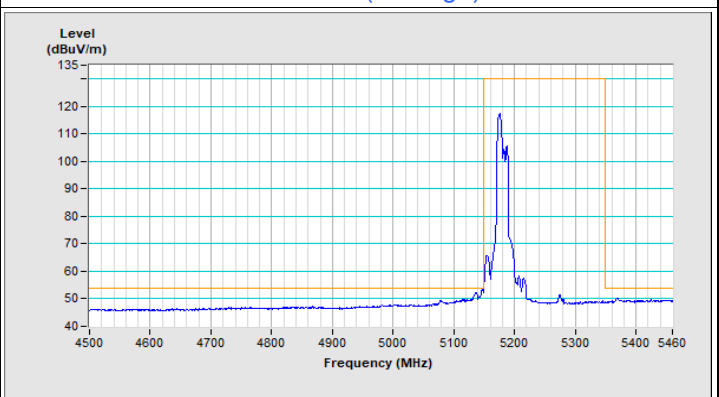

Vertical (Average)

802.11a Channel 48

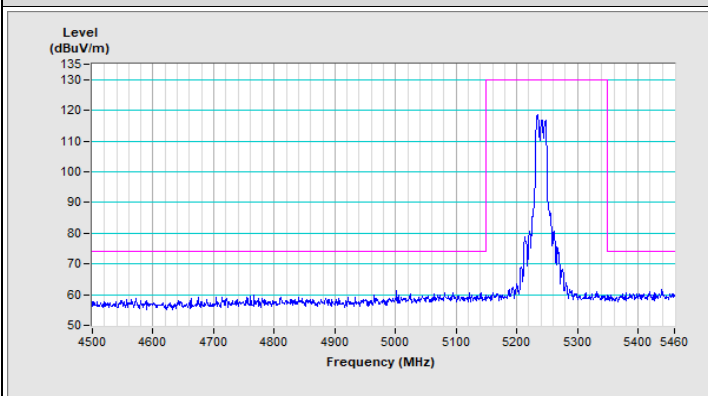

Horizontal (Peak)

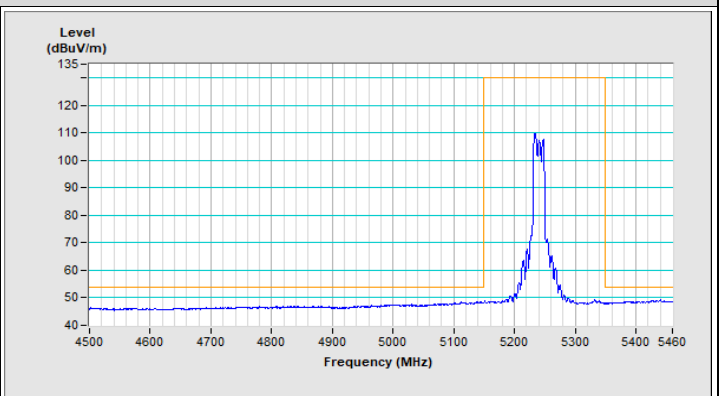

Horizontal (Average)

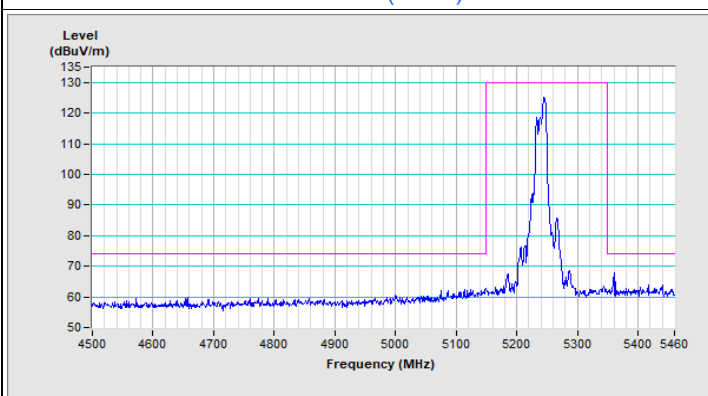

Vertical (Peak)

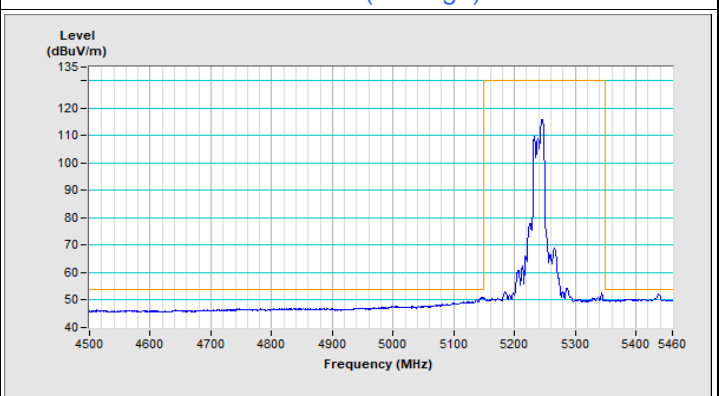

Vertical (Average)

802.11ax (HE20) Channel 36

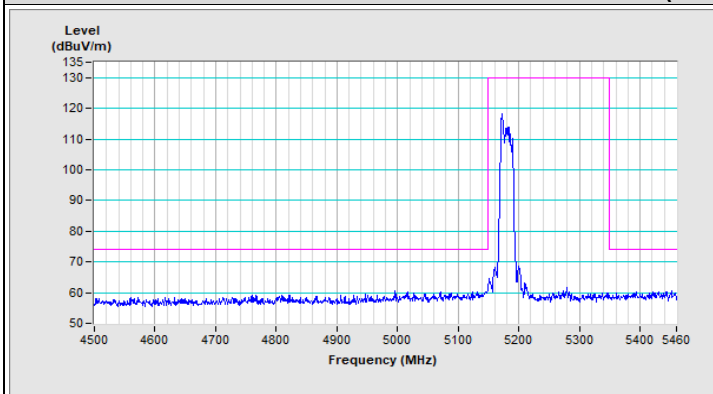

Horizontal (Peak)

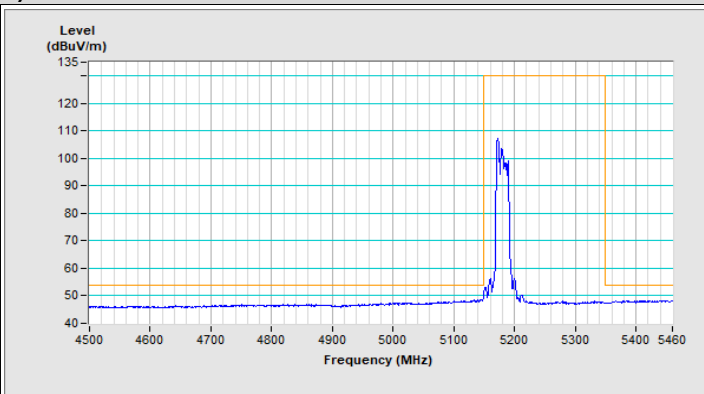

Horizontal (Average)

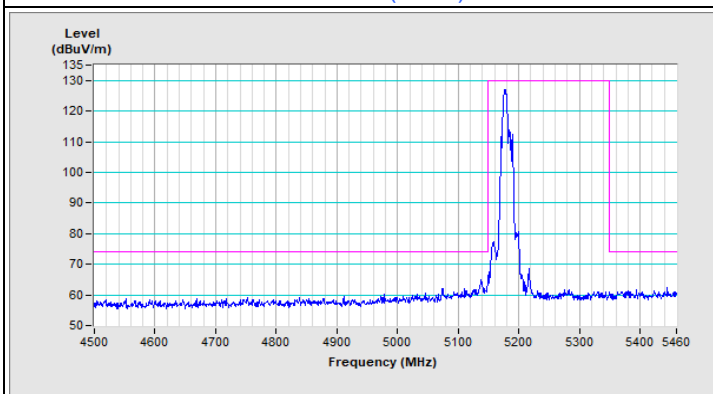

Vertical (Peak)

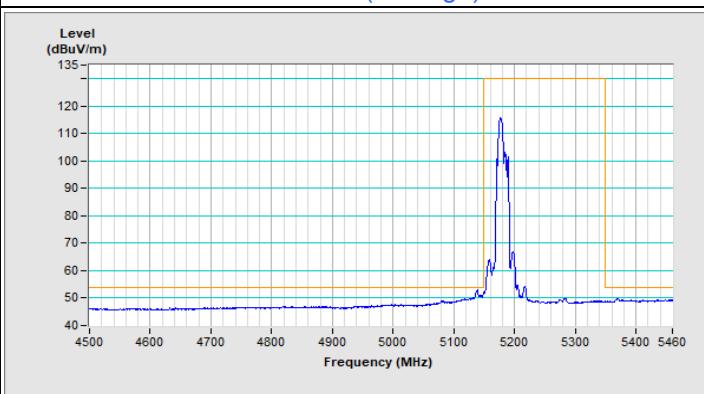

Vertical (Average)

802.11ax (HE20) Channel 48

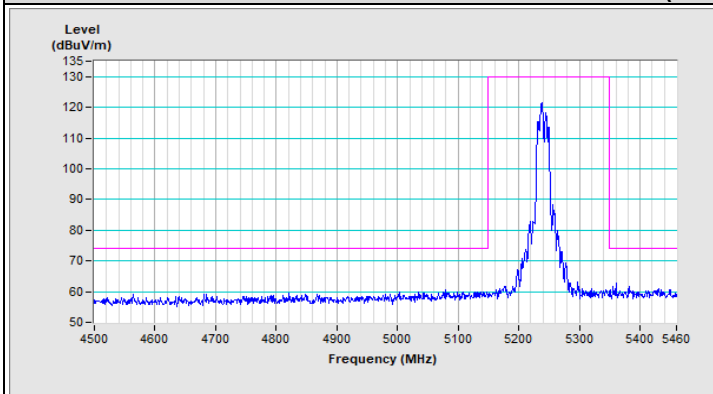

Horizontal (Peak)

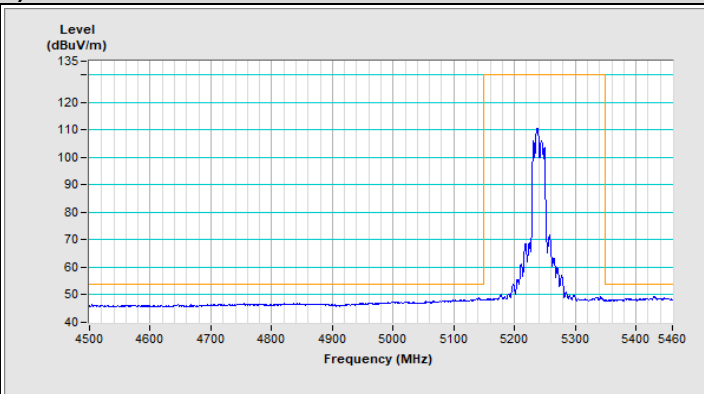

Horizontal (Average)

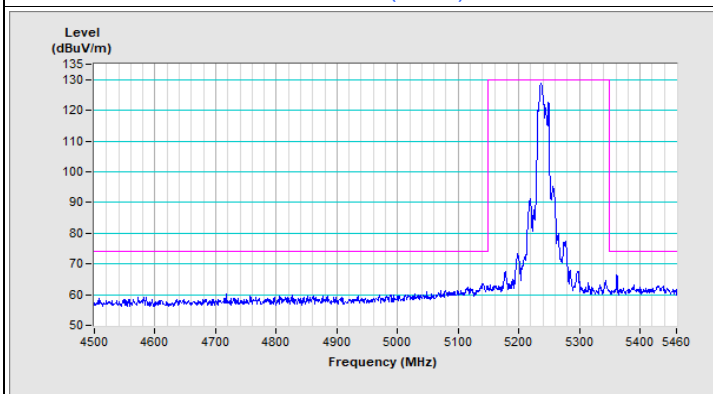

Vertical (Peak)

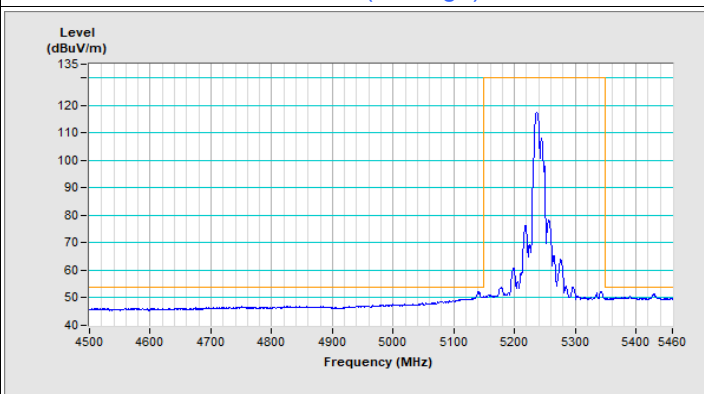

Vertical (Average)

802.11ax (HE40) Channel 38

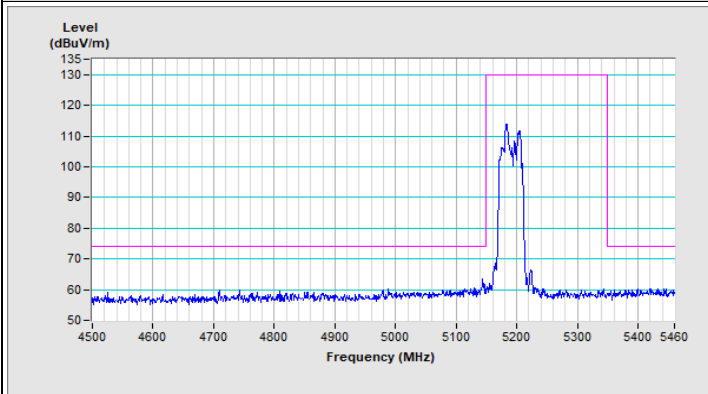

Horizontal (Peak)

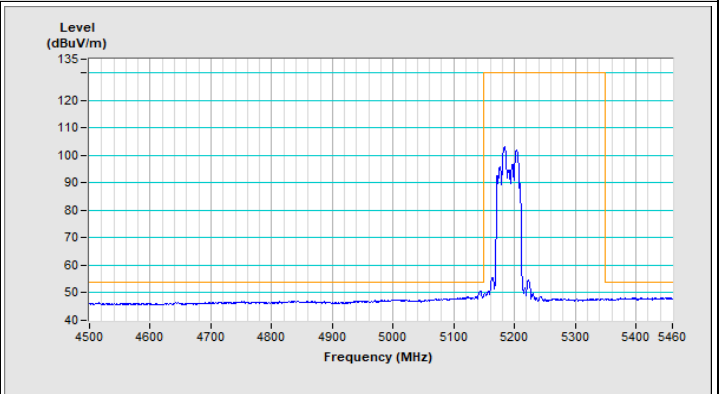

Horizontal (Average)

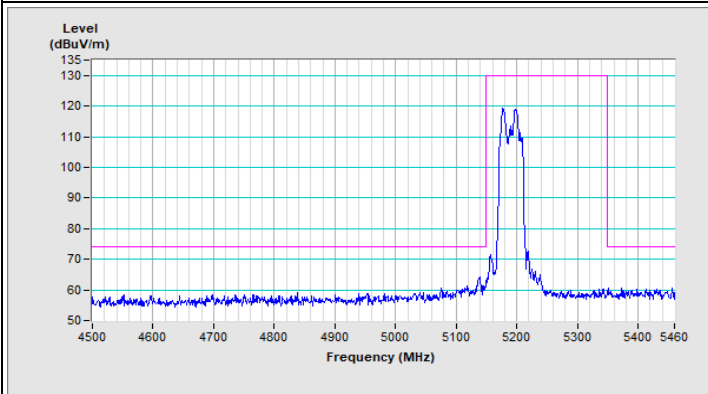

Vertical (Peak)

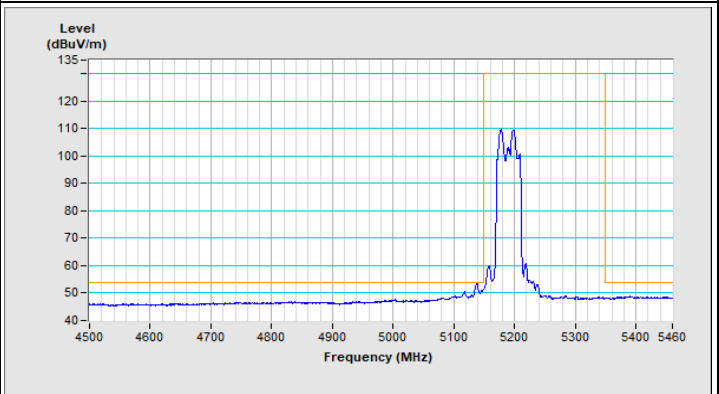

Vertical (Average)

802.11ax (HE40) Channel 46

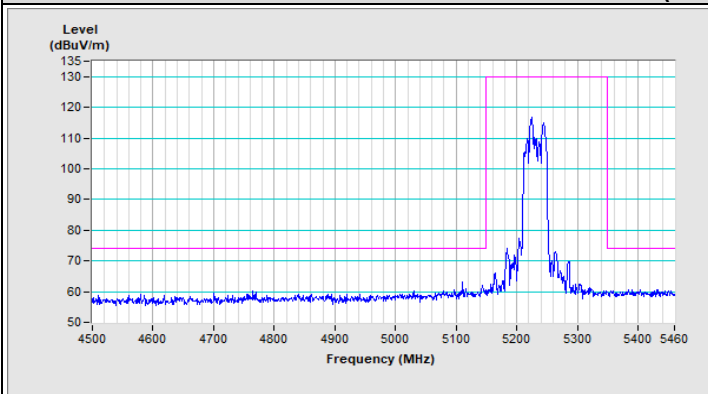

Horizontal (Peak)

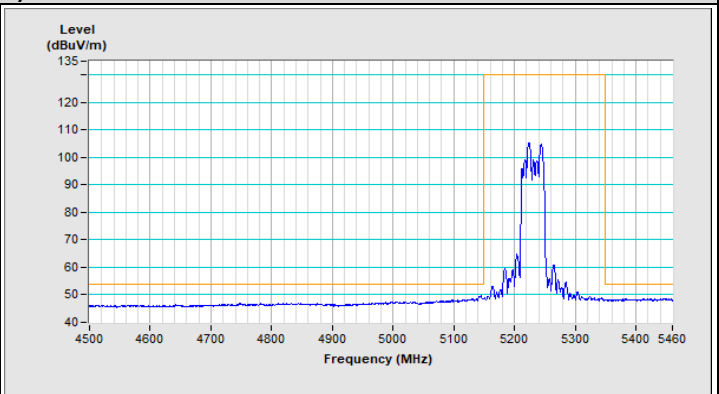

Horizontal (Average)

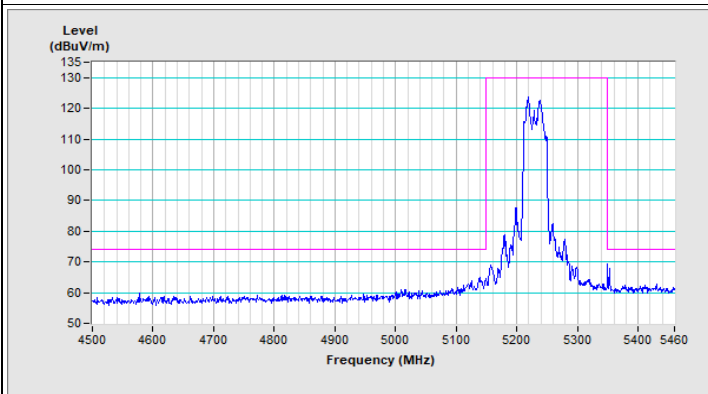

Vertical (Peak)

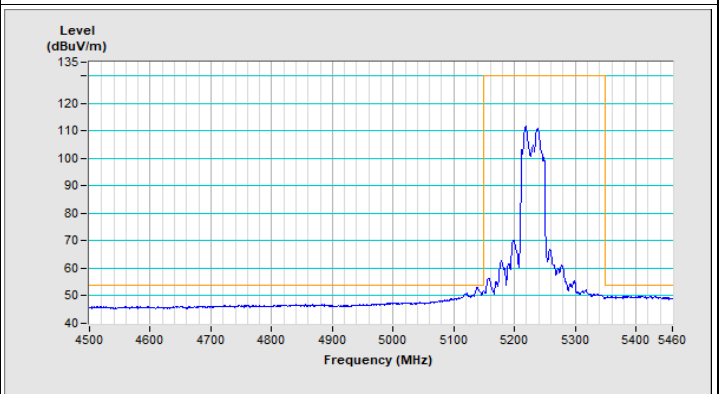

Vertical (Average)

802.11ax (HE80) Channel 42

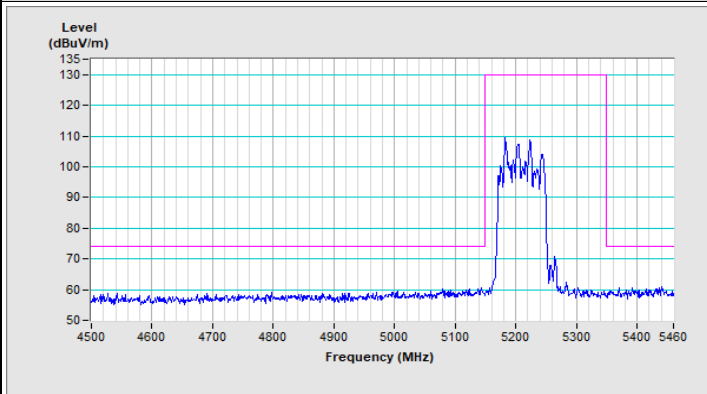

Horizontal (Peak)

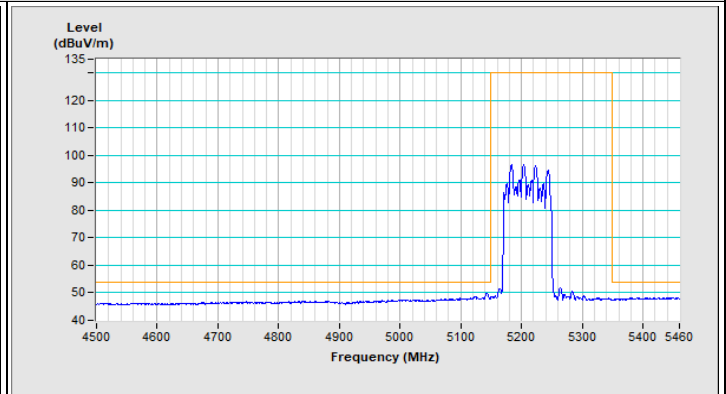

Horizontal (Average)

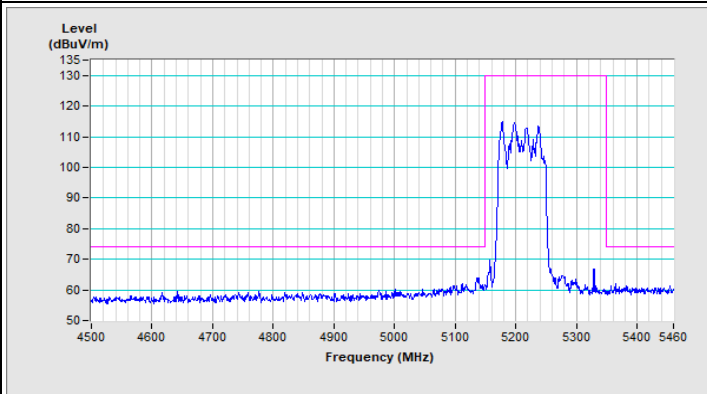

Vertical (Peak)

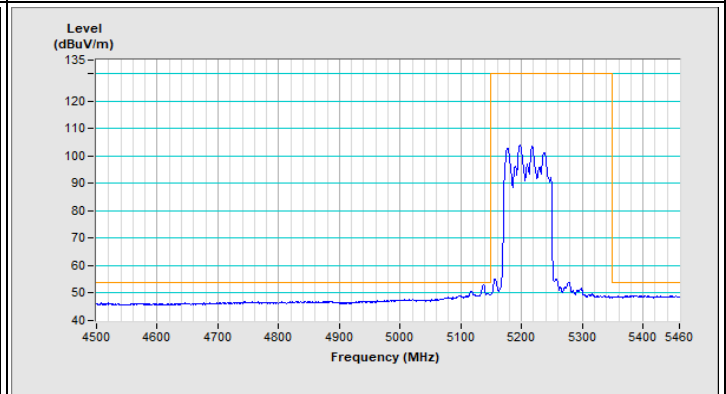

Vertical (Average)

802.11a Channel 149

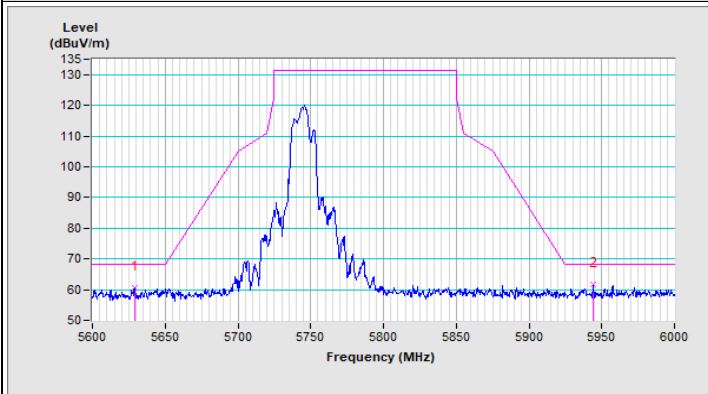

Horizontal (Peak)

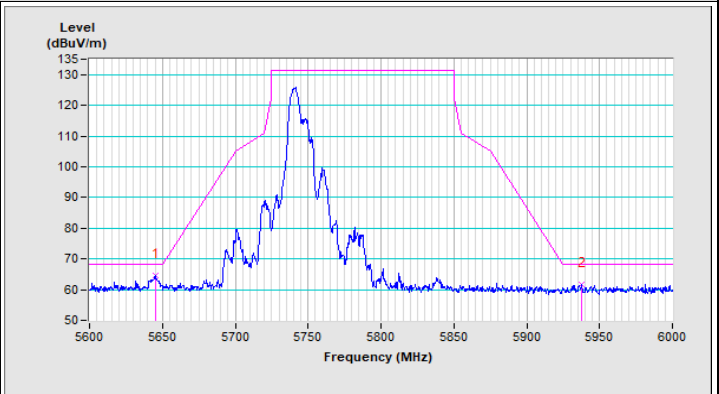

Vertical (Peak)

802.11a Channel 157

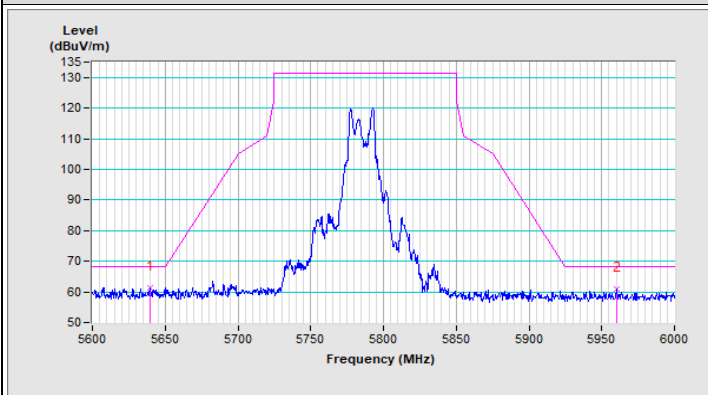

Horizontal (Peak)

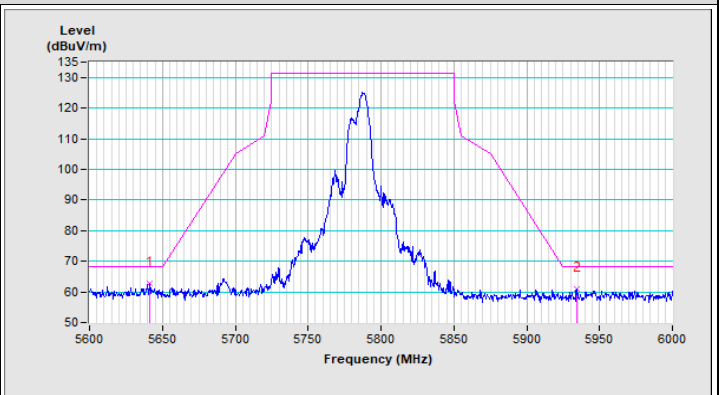

Vertical (Peak)

802.11a Channel 165

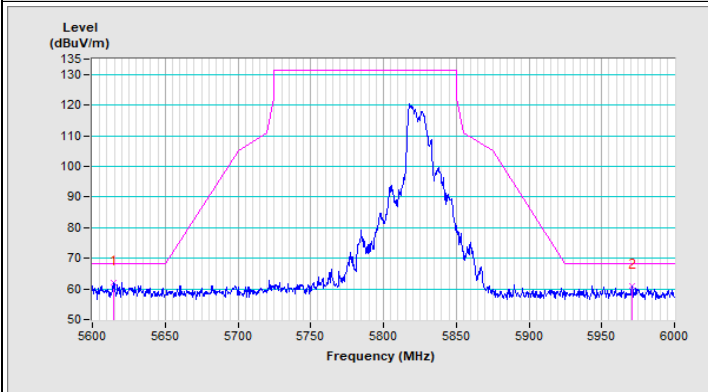

Horizontal (Peak)

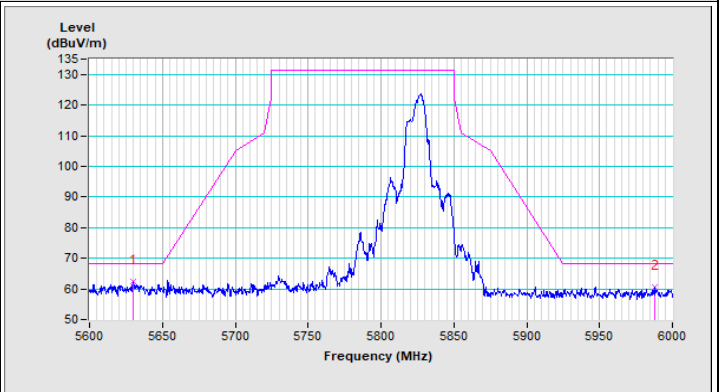

Vertical (Peak)

802.11ax (HE20) Channel 149

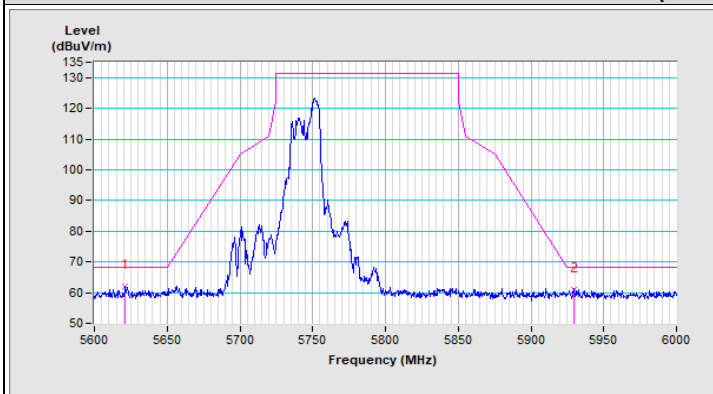

Horizontal (Peak)

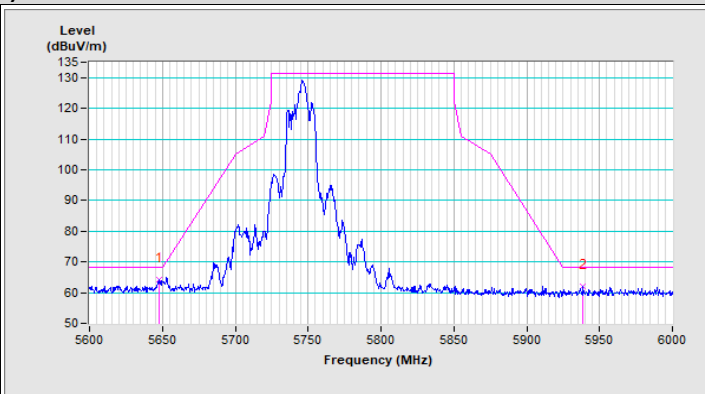

Vertical (Peak)

802.11ax (HE20) Channel 157

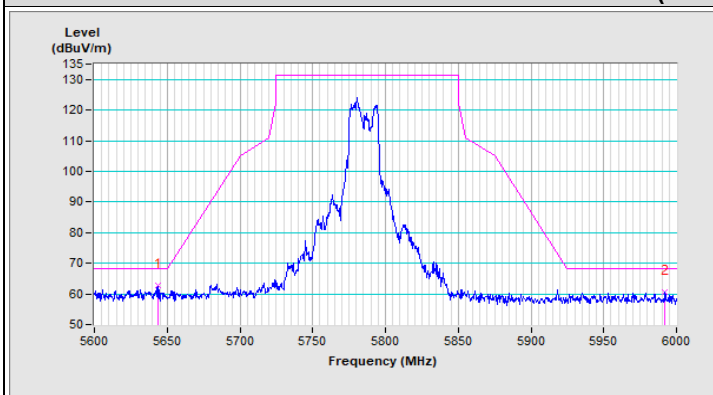

Horizontal (Peak)

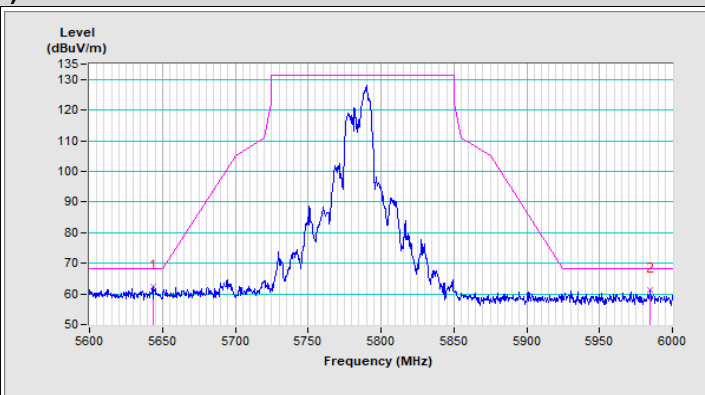

Vertical (Peak)

802.11ax (HE20) Channel 165

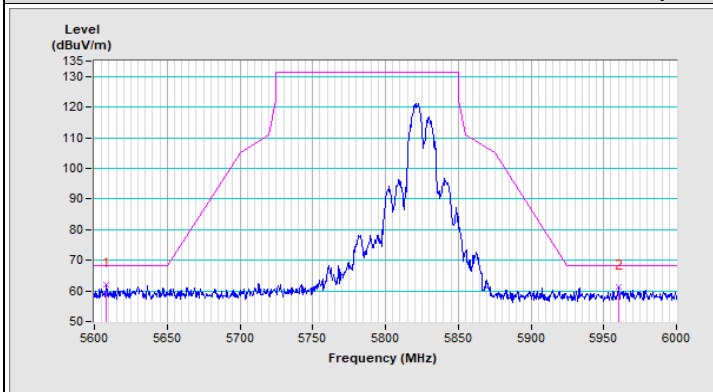

Horizontal (Peak)

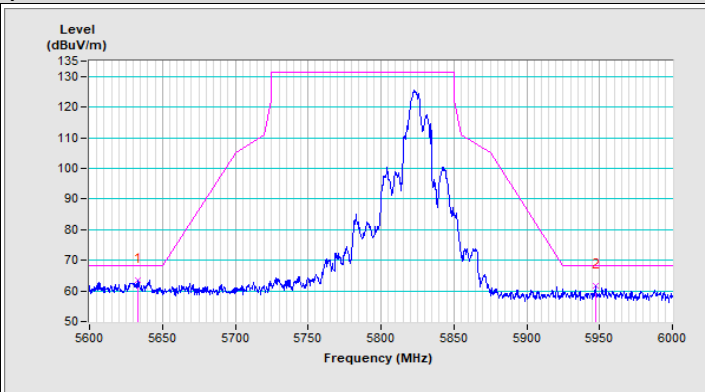

Vertical (Peak)

802.11ax (HE40) Channel 151

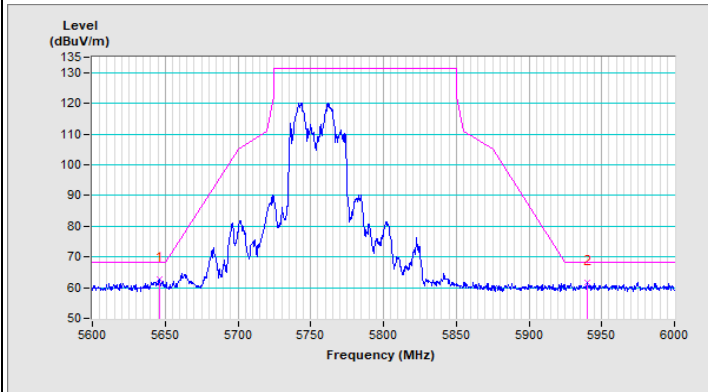

Horizontal (Peak)

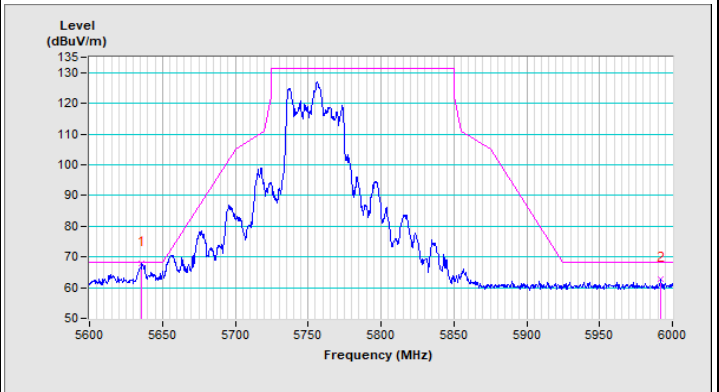

Vertical (Peak)

802.11ax (HE40) Channel 151

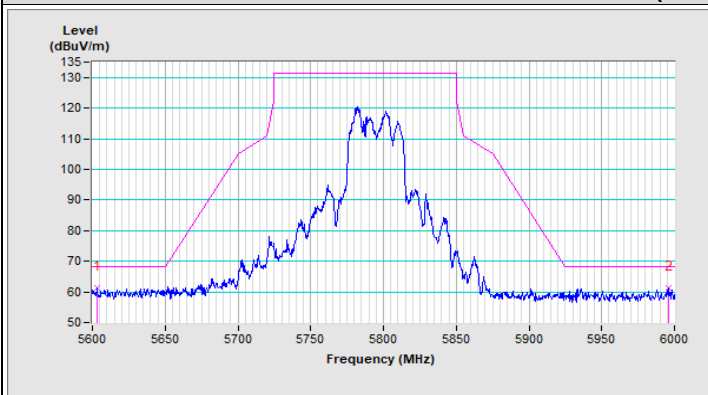

Horizontal (Peak)

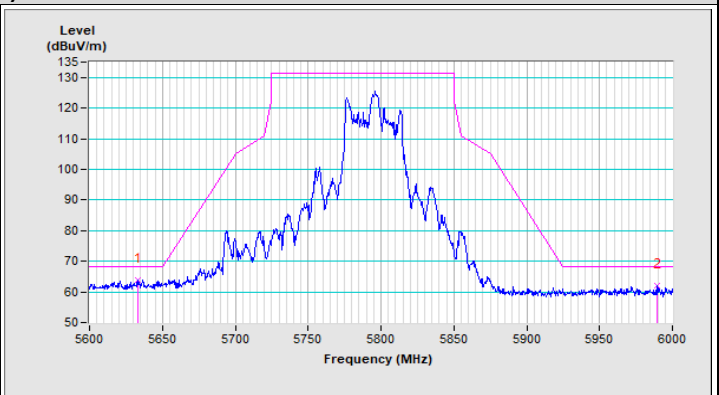

Vertical (Peak)

802.11ax (HE80) Channel 155

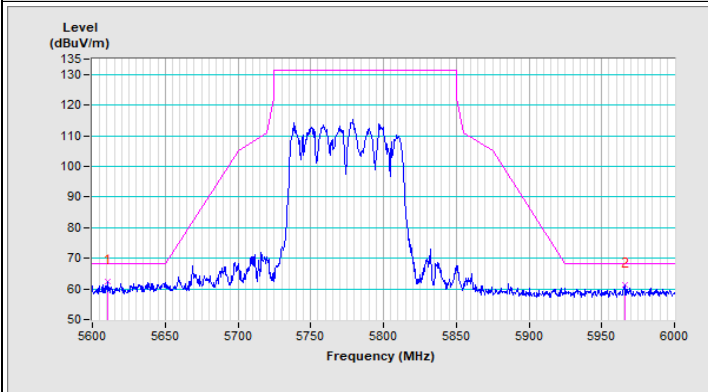

Horizontal (Peak)

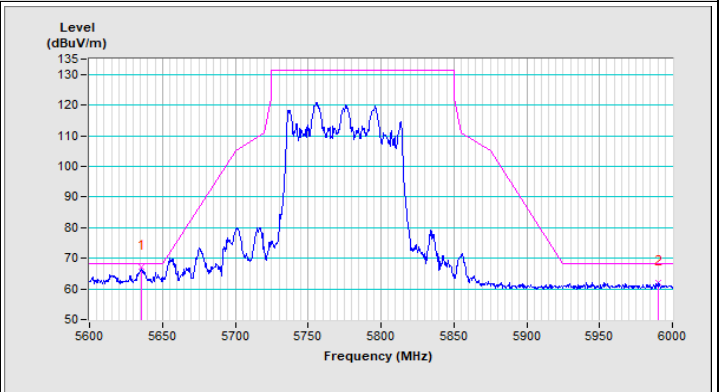

Vertical (Peak)

Mode B

RF Mode	802.11a	Channel	CH 36 : 5180 MHz
Frequency Range	1 GHz ~ 40 GHz	Detector Function & Bandwidth	(PK) RB = 1 MHz, VB = 3 MHz (AV) RB = 1 MHz, VB = 1 kHz
Input Power	120 Vac, 60 Hz	Environmental Conditions	23°C, 67% RH
Tested By	Adair Peng		

Antenna Polarity & Test Distance : Horizontal at 3 m

No	Frequency (MHz)	Emission Level (dBuV/m)	Limit (dBuV/m)	Margin (dB)	Antenna Height (m)	Table Angle (Degree)	Raw Value (dBuV)	Correction Factor (dB/m)
1	5146.80	60.7 PK	74.0	-13.3	3.56 H	261	39.7	21.0
2	5146.80	49.4 AV	54.0	-4.6	3.56 H	261	28.4	21.0
3	*5180.00	112.1 PK			3.56 H	261	70.9	41.2
4	*5180.00	102.1 AV			3.56 H	261	60.9	41.2
5	#10360.00	61.2 PK	68.2	-7.0	3.02 H	217	36.8	24.4

Antenna Polarity & Test Distance : Vertical at 3 m

No	Frequency (MHz)	Emission Level (dBuV/m)	Limit (dBuV/m)	Margin (dB)	Antenna Height (m)	Table Angle (Degree)	Raw Value (dBuV)	Correction Factor (dB/m)
1	5148.10	66.5 PK	74.0	-7.5	2.78 V	182	45.5	21.0
2	5148.10	53.2 AV	54.0	-0.8	2.78 V	182	32.2	21.0
3	*5180.00	115.3 PK			2.78 V	182	74.1	41.2
4	*5180.00	105.8 AV			2.78 V	182	64.6	41.2
5	#10360.00	61.6 PK	68.2	-6.6	2.42 V	167	37.2	24.4

Remarks:

1. Emission Level(dBuV/m) = Raw Value(dBuV) + Correction Factor(dB/m)
2. Correction Factor(dB/m) = Antenna Factor(dB/m) + Cable Factor(dB) – Pre-Amplifier Factor(dB)
3. Margin value = Emission Level – Limit value
4. The other emission levels were very low against the limit.
5. " * ": Fundamental frequency, the limit was restricted at the RF Output Power.
6. " # ": The radiated frequency is out of the restricted band.

RF Mode	802.11a	Channel	CH 40 : 5200 MHz
Frequency Range	1 GHz ~ 40 GHz	Detector Function & Bandwidth	(PK) RB = 1 MHz, VB = 3 MHz (AV) RB = 1 MHz, VB = 1 kHz
Input Power	120 Vac, 60 Hz	Environmental Conditions	23°C, 67% RH
Tested By	Adair Peng		

Antenna Polarity & Test Distance : Horizontal at 3 m

No	Frequency (MHz)	Emission Level (dBuV/m)	Limit (dBuV/m)	Margin (dB)	Antenna Height (m)	Table Angle (Degree)	Raw Value (dBuV)	Correction Factor (dB/m)
1	5150.00	62.5 PK	74.0	-11.5	3.43 H	256	41.5	21.0
2	5150.00	50.1 AV	54.0	-3.9	3.43 H	256	29.1	21.0
3	*5200.00	113.6 PK			3.43 H	256	72.5	41.1
4	*5200.00	104.5 AV			3.43 H	256	63.4	41.1
5	#10400.00	61.6 PK	68.2	-6.6	3.20 H	204	37.0	24.6

Antenna Polarity & Test Distance : Vertical at 3 m

No	Frequency (MHz)	Emission Level (dBuV/m)	Limit (dBuV/m)	Margin (dB)	Antenna Height (m)	Table Angle (Degree)	Raw Value (dBuV)	Correction Factor (dB/m)
1	5148.10	67.3 PK	74.0	-6.7	2.82 V	181	46.3	21.0
2	5148.10	53.6 AV	54.0	-0.4	2.82 V	181	32.6	21.0
3	*5200.00	118.0 PK			2.82 V	181	76.9	41.1
4	*5200.00	108.7 AV			2.82 V	181	67.6	41.1
5	#10400.00	61.9 PK	68.2	-6.3	2.44 V	168	37.3	24.6

Remarks:

1. Emission Level(dBuV/m) = Raw Value(dBuV) + Correction Factor(dB/m)
2. Correction Factor(dB/m) = Antenna Factor(dB/m) + Cable Factor(dB) – Pre-Amplifier Factor(dB)
3. Margin value = Emission Level – Limit value
4. The other emission levels were very low against the limit.
5. " * ": Fundamental frequency, the limit was restricted at the RF Output Power.
6. " # ": The radiated frequency is out of the restricted band.

RF Mode	802.11a	Channel	CH 48 : 5240 MHz
Frequency Range	1 GHz ~ 40 GHz	Detector Function & Bandwidth	(PK) RB = 1 MHz, VB = 3 MHz (AV) RB = 1 MHz, VB = 1 kHz
Input Power	120 Vac, 60 Hz	Environmental Conditions	23°C, 67% RH
Tested By	Adair Peng		

Antenna Polarity & Test Distance : Horizontal at 3 m

No	Frequency (MHz)	Emission Level (dBuV/m)	Limit (dBuV/m)	Margin (dB)	Antenna Height (m)	Table Angle (Degree)	Raw Value (dBuV)	Correction Factor (dB/m)
1	*5240.00	114.7 PK			3.18 H	258	73.8	40.9
2	*5240.00	104.9 AV			3.18 H	258	64.0	40.9
3	5350.00	60.9 PK	74.0	-13.1	3.18 H	258	39.9	21.0
4	5350.00	47.5 AV	54.0	-6.5	3.18 H	258	26.5	21.0
5	#10480.00	61.3 PK	68.2	-6.9	3.04 H	211	36.4	24.9

Antenna Polarity & Test Distance : Vertical at 3 m

No	Frequency (MHz)	Emission Level (dBuV/m)	Limit (dBuV/m)	Margin (dB)	Antenna Height (m)	Table Angle (Degree)	Raw Value (dBuV)	Correction Factor (dB/m)
1	*5240.00	119.0 PK			2.80 V	183	78.1	40.9
2	*5240.00	109.4 AV			2.80 V	183	68.5	40.9
3	5350.00	61.2 PK	74.0	-12.8	2.80 V	183	40.2	21.0
4	5350.00	47.7 AV	54.0	-6.3	2.80 V	183	26.7	21.0
5	#10480.00	61.6 PK	68.2	-6.6	2.45 V	172	36.7	24.9

Remarks:

1. Emission Level(dBuV/m) = Raw Value(dBuV) + Correction Factor(dB/m)
2. Correction Factor(dB/m) = Antenna Factor(dB/m) + Cable Factor(dB) – Pre-Amplifier Factor(dB)
3. Margin value = Emission Level – Limit value
4. The other emission levels were very low against the limit.
5. " * ": Fundamental frequency, the limit was restricted at the RF Output Power.
6. " # ": The radiated frequency is out of the restricted band.

RF Mode	802.11ac (VHT20)	Channel	CH 36 : 5180 MHz
Frequency Range	1 GHz ~ 40 GHz	Detector Function & Bandwidth	(PK) RB = 1 MHz, VB = 3 MHz (AV) RB = 1 MHz, VB = 1 kHz
Input Power	120 Vac, 60 Hz	Environmental Conditions	23°C, 67% RH
Tested By	Adair Peng		

Antenna Polarity & Test Distance : Horizontal at 3 m

No	Frequency (MHz)	Emission Level (dBuV/m)	Limit (dBuV/m)	Margin (dB)	Antenna Height (m)	Table Angle (Degree)	Raw Value (dBuV)	Correction Factor (dB/m)
1	5150.00	60.6 PK	74.0	-13.4	3.20 H	259	39.6	21.0
2	5150.00	48.9 AV	54.0	-5.1	3.20 H	259	27.9	21.0
3	*5180.00	112.0 PK			3.20 H	259	70.8	41.2
4	*5180.00	102.5 AV			3.20 H	259	61.3	41.2
5	#10360.00	61.1 PK	68.2	-7.1	2.96 H	205	36.7	24.4

Antenna Polarity & Test Distance : Vertical at 3 m

No	Frequency (MHz)	Emission Level (dBuV/m)	Limit (dBuV/m)	Margin (dB)	Antenna Height (m)	Table Angle (Degree)	Raw Value (dBuV)	Correction Factor (dB/m)
1	5147.00	67.2 PK	74.0	-6.8	2.61 V	182	46.2	21.0
2	5147.00	53.1 AV	54.0	-0.9	2.61 V	182	32.1	21.0
3	*5180.00	115.3 PK			2.61 V	182	74.1	41.2
4	*5180.00	105.4 AV			2.61 V	182	64.2	41.2
5	#10360.00	61.3 PK	68.2	-6.9	2.56 V	169	36.9	24.4

Remarks:

1. Emission Level(dBuV/m) = Raw Value(dBuV) + Correction Factor(dB/m)
2. Correction Factor(dB/m) = Antenna Factor(dB/m) + Cable Factor(dB) – Pre-Amplifier Factor(dB)
3. Margin value = Emission Level – Limit value
4. The other emission levels were very low against the limit.
5. " * ": Fundamental frequency, the limit was restricted at the RF Output Power.
6. " # ": The radiated frequency is out of the restricted band.

RF Mode	802.11ac (VHT20)	Channel	CH 40 : 5200 MHz
Frequency Range	1 GHz ~ 40 GHz	Detector Function & Bandwidth	(PK) RB = 1 MHz, VB = 3 MHz (AV) RB = 1 MHz, VB = 1 kHz
Input Power	120 Vac, 60 Hz	Environmental Conditions	23°C, 67% RH
Tested By	Adair Peng		

Antenna Polarity & Test Distance : Horizontal at 3 m

No	Frequency (MHz)	Emission Level (dBuV/m)	Limit (dBuV/m)	Margin (dB)	Antenna Height (m)	Table Angle (Degree)	Raw Value (dBuV)	Correction Factor (dB/m)
1	5144.00	63.6 PK	74.0	-10.4	3.44 H	260	42.6	21.0
2	5144.00	49.6 AV	54.0	-4.4	3.44 H	260	28.6	21.0
3	*5200.00	114.4 PK			3.44 H	260	73.3	41.1
4	*5200.00	104.6 AV			3.44 H	260	63.5	41.1
5	#10400.00	61.5 PK	68.2	-6.7	3.13 H	214	36.9	24.6

Antenna Polarity & Test Distance : Vertical at 3 m

No	Frequency (MHz)	Emission Level (dBuV/m)	Limit (dBuV/m)	Margin (dB)	Antenna Height (m)	Table Angle (Degree)	Raw Value (dBuV)	Correction Factor (dB/m)
1	5146.10	67.0 PK	74.0	-7.0	2.66 V	182	46.0	21.0
2	5146.10	53.0 AV	54.0	-1.0	2.66 V	182	32.0	21.0
3	*5200.00	118.0 PK			2.66 V	182	76.9	41.1
4	*5200.00	108.2 AV			2.66 V	182	67.1	41.1
5	#10400.00	61.9 PK	68.2	-6.3	2.72 V	160	37.3	24.6

Remarks:

1. Emission Level(dBuV/m) = Raw Value(dBuV) + Correction Factor(dB/m)
2. Correction Factor(dB/m) = Antenna Factor(dB/m) + Cable Factor(dB) – Pre-Amplifier Factor(dB)
3. Margin value = Emission Level – Limit value
4. The other emission levels were very low against the limit.
5. " * ": Fundamental frequency, the limit was restricted at the RF Output Power.
6. " # ": The radiated frequency is out of the restricted band.

RF Mode	802.11ac (VHT20)	Channel	CH 48 : 5240 MHz
Frequency Range	1 GHz ~ 40 GHz	Detector Function & Bandwidth	(PK) RB = 1 MHz, VB = 3 MHz (AV) RB = 1 MHz, VB = 1 kHz
Input Power	120 Vac, 60 Hz	Environmental Conditions	23°C, 67% RH
Tested By	Adair Peng		

Antenna Polarity & Test Distance : Horizontal at 3 m

No	Frequency (MHz)	Emission Level (dBuV/m)	Limit (dBuV/m)	Margin (dB)	Antenna Height (m)	Table Angle (Degree)	Raw Value (dBuV)	Correction Factor (dB/m)
1	*5240.00	115.1 PK			3.55 H	260	74.2	40.9
2	*5240.00	105.6 AV			3.55 H	260	64.7	40.9
3	5350.00	60.8 PK	74.0	-13.2	3.55 H	260	39.8	21.0
4	5350.00	47.6 AV	54.0	-6.4	3.55 H	260	26.6	21.0
5	#10480.00	61.3 PK	68.2	-6.9	2.96 H	204	36.4	24.9

Antenna Polarity & Test Distance : Vertical at 3 m

No	Frequency (MHz)	Emission Level (dBuV/m)	Limit (dBuV/m)	Margin (dB)	Antenna Height (m)	Table Angle (Degree)	Raw Value (dBuV)	Correction Factor (dB/m)
1	*5240.00	119.6 PK			2.80 V	180	78.7	40.9
2	*5240.00	109.6 AV			2.80 V	180	68.7	40.9
3	5350.00	60.9 PK	74.0	-13.1	2.80 V	180	39.9	21.0
4	5350.00	47.7 AV	54.0	-6.3	2.80 V	180	26.7	21.0
5	#10480.00	61.6 PK	68.2	-6.6	2.55 V	168	36.7	24.9

Remarks:

1. Emission Level(dBuV/m) = Raw Value(dBuV) + Correction Factor(dB/m)
2. Correction Factor(dB/m) = Antenna Factor(dB/m) + Cable Factor(dB) – Pre-Amplifier Factor(dB)
3. Margin value = Emission Level – Limit value
4. The other emission levels were very low against the limit.
5. " * ": Fundamental frequency, the limit was restricted at the RF Output Power.
6. " # ": The radiated frequency is out of the restricted band.

RF Mode	802.11ac (VHT40)	Channel	CH 38 : 5190 MHz
Frequency Range	1 GHz ~ 40 GHz	Detector Function & Bandwidth	(PK) RB = 1 MHz, VB = 3 MHz (AV) RB = 1 MHz, VB = 1 kHz
Input Power	120 Vac, 60 Hz	Environmental Conditions	23°C, 67% RH
Tested By	Adair Peng		

Antenna Polarity & Test Distance : Horizontal at 3 m

No	Frequency (MHz)	Emission Level (dBuV/m)	Limit (dBuV/m)	Margin (dB)	Antenna Height (m)	Table Angle (Degree)	Raw Value (dBuV)	Correction Factor (dB/m)
1	5150.00	64.6 PK	74.0	-9.4	3.54 H	259	43.6	21.0
2	5150.00	50.0 AV	54.0	-4.0	3.54 H	259	29.0	21.0
3	*5190.00	107.7 PK			3.54 H	259	66.6	41.1
4	*5190.00	97.6 AV			3.54 H	259	56.5	41.1
5	#10380.00	61.1 PK	68.2	-7.1	3.16 H	208	36.6	24.5

Antenna Polarity & Test Distance : Vertical at 3 m

No	Frequency (MHz)	Emission Level (dBuV/m)	Limit (dBuV/m)	Margin (dB)	Antenna Height (m)	Table Angle (Degree)	Raw Value (dBuV)	Correction Factor (dB/m)
1	5146.00	68.2 PK	74.0	-5.8	2.75 V	181	47.2	21.0
2	5146.00	53.6 AV	54.0	-0.4	2.75 V	181	32.6	21.0
3	*5190.00	110.9 PK			2.75 V	181	69.8	41.1
4	*5190.00	101.3 AV			2.75 V	181	60.2	41.1
5	#10380.00	61.3 PK	68.2	-6.9	2.56 V	175	36.8	24.5

Remarks:

1. Emission Level(dBuV/m) = Raw Value(dBuV) + Correction Factor(dB/m)
2. Correction Factor(dB/m) = Antenna Factor(dB/m) + Cable Factor(dB) – Pre-Amplifier Factor(dB)
3. Margin value = Emission Level – Limit value
4. The other emission levels were very low against the limit.
5. " * ": Fundamental frequency, the limit was restricted at the RF Output Power.
6. " # ": The radiated frequency is out of the restricted band.

RF Mode	802.11ac (VHT40)	Channel	CH 46 : 5230 MHz
Frequency Range	1 GHz ~ 40 GHz	Detector Function & Bandwidth	(PK) RB = 1 MHz, VB = 3 MHz (AV) RB = 1 MHz, VB = 1 kHz
Input Power	120 Vac, 60 Hz	Environmental Conditions	23°C, 67% RH
Tested By	Adair Peng		

Antenna Polarity & Test Distance : Horizontal at 3 m

No	Frequency (MHz)	Emission Level (dBuV/m)	Limit (dBuV/m)	Margin (dB)	Antenna Height (m)	Table Angle (Degree)	Raw Value (dBuV)	Correction Factor (dB/m)
1	*5230.00	110.5 PK			3.59 H	257	69.6	40.9
2	*5230.00	100.7 AV			3.59 H	257	59.8	40.9
3	5350.00	60.2 PK	74.0	-13.8	3.59 H	257	39.2	21.0
4	5350.00	47.5 AV	54.0	-6.5	3.59 H	257	26.5	21.0
5	#10460.00	61.5 PK	68.2	-6.7	3.05 H	204	36.6	24.9

Antenna Polarity & Test Distance : Vertical at 3 m

No	Frequency (MHz)	Emission Level (dBuV/m)	Limit (dBuV/m)	Margin (dB)	Antenna Height (m)	Table Angle (Degree)	Raw Value (dBuV)	Correction Factor (dB/m)
1	5147.00	66.6 PK	74.0	-7.4	2.92 V	178	45.6	21.0
2	5147.00	52.8 AV	54.0	-1.2	2.92 V	178	31.8	21.0
3	*5230.00	114.3 PK			2.92 V	178	73.4	40.9
4	*5230.00	104.6 AV			2.92 V	178	63.7	40.9
5	5350.00	60.5 PK	74.0	-13.5	2.92 V	178	39.5	21.0
6	5350.00	47.8 AV	54.0	-6.2	2.92 V	178	26.8	21.0
7	#10460.00	61.7 PK	68.2	-6.5	2.67 V	172	36.8	24.9

Remarks:

1. Emission Level(dBuV/m) = Raw Value(dBuV) + Correction Factor(dB/m)
2. Correction Factor(dB/m) = Antenna Factor(dB/m) + Cable Factor(dB) – Pre-Amplifier Factor(dB)
3. Margin value = Emission Level – Limit value
4. The other emission levels were very low against the limit.
5. " * ": Fundamental frequency, the limit was restricted at the RF Output Power.
6. " # ": The radiated frequency is out of the restricted band.

RF Mode	802.11ac (VHT80)	Channel	CH 42 : 5210 MHz
Frequency Range	1 GHz ~ 40 GHz	Detector Function & Bandwidth	(PK) RB = 1 MHz, VB = 3 MHz (AV) RB = 1 MHz, VB = 1 kHz
Input Power	120 Vac, 60 Hz	Environmental Conditions	23°C, 67% RH
Tested By	Adair Peng		

Antenna Polarity & Test Distance : Horizontal at 3 m

No	Frequency (MHz)	Emission Level (dBuV/m)	Limit (dBuV/m)	Margin (dB)	Antenna Height (m)	Table Angle (Degree)	Raw Value (dBuV)	Correction Factor (dB/m)
1	5150.00	62.8 PK	74.0	-11.2	3.61 H	258	41.8	21.0
2	5150.00	50.4 AV	54.0	-3.6	3.61 H	258	29.4	21.0
3	*5210.00	103.5 PK			3.61 H	258	62.5	41.0
4	*5210.00	93.4 AV			3.61 H	258	52.4	41.0
5	#10420.00	61.2 PK	68.2	-7.0	3.00 H	211	36.6	24.6

Antenna Polarity & Test Distance : Vertical at 3 m

No	Frequency (MHz)	Emission Level (dBuV/m)	Limit (dBuV/m)	Margin (dB)	Antenna Height (m)	Table Angle (Degree)	Raw Value (dBuV)	Correction Factor (dB/m)
1	5146.00	68.8 PK	74.0	-5.2	2.82 V	181	47.8	21.0
2	5146.00	53.7 AV	54.0	-0.3	2.82 V	181	32.7	21.0
3	*5210.00	107.6 PK			2.82 V	181	66.6	41.0
4	*5210.00	97.4 AV			2.82 V	181	56.4	41.0
5	#10420.00	61.6 PK	68.2	-6.6	2.66 V	174	37.0	24.6

Remarks:

1. Emission Level(dBuV/m) = Raw Value(dBuV) + Correction Factor(dB/m)
2. Correction Factor(dB/m) = Antenna Factor(dB/m) + Cable Factor(dB) – Pre-Amplifier Factor(dB)
3. Margin value = Emission Level – Limit value
4. The other emission levels were very low against the limit.
5. " * ": Fundamental frequency, the limit was restricted at the RF Output Power.
6. " # ": The radiated frequency is out of the restricted band.

RF Mode	802.11a	Channel	CH 149 : 5745 MHz
Frequency Range	1 GHz ~ 40 GHz	Detector Function & Bandwidth	(PK) RB = 1 MHz, VB = 3 MHz (AV) RB = 1 MHz, VB = 1 kHz
Input Power	120 Vac, 60 Hz	Environmental Conditions	23°C, 67% RH
Tested By	Adair Peng		

Antenna Polarity & Test Distance : Horizontal at 3 m

No	Frequency (MHz)	Emission Level (dBUV/m)	Limit (dBUV/m)	Margin (dB)	Antenna Height (m)	Table Angle (Degree)	Raw Value (dBUV)	Correction Factor (dB/m)
1	#5639.60	60.8 PK	68.2	-7.4	3.61 H	249	39.0	21.8
2	*5745.00	117.9 PK			3.61 H	249	75.9	42.0
3	*5745.00	107.6 AV			3.61 H	249	65.6	42.0
4	#5943.20	61.7 PK	68.2	-6.5	3.61 H	249	39.2	22.5
5	11490.00	63.6 PK	74.0	-10.4	3.13 H	210	36.4	27.2
6	11490.00	50.2 AV	54.0	-3.8	3.13 H	210	23.0	27.2

Antenna Polarity & Test Distance : Vertical at 3 m

No	Frequency (MHz)	Emission Level (dBUV/m)	Limit (dBUV/m)	Margin (dB)	Antenna Height (m)	Table Angle (Degree)	Raw Value (dBUV)	Correction Factor (dB/m)
1	#5649.60	61.5 PK	68.2	-6.7	2.79 V	135	39.6	21.9
2	*5745.00	121.1 PK			2.79 V	135	79.1	42.0
3	*5745.00	110.9 AV			2.79 V	135	68.9	42.0
4	#5948.00	62.2 PK	68.2	-6.0	2.79 V	135	39.7	22.5
5	11490.00	63.7 PK	74.0	-10.3	2.63 V	163	36.5	27.2
6	11490.00	50.3 AV	54.0	-3.7	2.63 V	163	23.1	27.2

Remarks:

1. Emission Level(dBUV/m) = Raw Value(dBUV) + Correction Factor(dB/m)
2. Correction Factor(dB/m) = Antenna Factor(dB/m) + Cable Factor(dB) – Pre-Amplifier Factor(dB)
3. Margin value = Emission Level – Limit value
4. The other emission levels were very low against the limit.
5. " * ": Fundamental frequency, the limit was restricted at the RF Output Power.

RF Mode	802.11a	Channel	CH 157 : 5785 MHz
Frequency Range	1 GHz ~ 40 GHz	Detector Function & Bandwidth	(PK) RB = 1 MHz, VB = 3 MHz (AV) RB = 1 MHz, VB = 1 kHz
Input Power	120 Vac, 60 Hz	Environmental Conditions	23°C, 67% RH
Tested By	Adair Peng		

Antenna Polarity & Test Distance : Horizontal at 3 m

No	Frequency (MHz)	Emission Level (dBuV/m)	Limit (dBuV/m)	Margin (dB)	Antenna Height (m)	Table Angle (Degree)	Raw Value (dBuV)	Correction Factor (dB/m)
1	#5628.40	61.1 PK	68.2	-7.1	3.57 H	247	39.3	21.8
2	*5785.00	118.3 PK			3.57 H	247	76.1	42.2
3	*5785.00	108.3 AV			3.57 H	247	66.1	42.2
4	#5932.00	63.2 PK	68.2	-5.0	3.57 H	247	40.7	22.5
5	11570.00	63.6 PK	74.0	-10.4	3.18 H	210	36.4	27.2
6	11570.00	50.3 AV	54.0	-3.7	3.18 H	210	23.1	27.2

Antenna Polarity & Test Distance : Vertical at 3 m

No	Frequency (MHz)	Emission Level (dBuV/m)	Limit (dBuV/m)	Margin (dB)	Antenna Height (m)	Table Angle (Degree)	Raw Value (dBuV)	Correction Factor (dB/m)
1	#5640.00	59.5 PK	68.2	-8.7	3.00 V	135	37.7	21.8
2	*5785.00	121.2 PK			3.00 V	135	79.0	42.2
3	*5785.00	111.3 AV			3.00 V	135	69.1	42.2
4	#5931.20	60.7 PK	68.2	-7.5	3.00 V	135	38.2	22.5
5	11570.00	63.8 PK	74.0	-10.2	2.69 V	165	36.6	27.2
6	11570.00	50.5 AV	54.0	-3.5	2.69 V	165	23.3	27.2

Remarks:

1. Emission Level(dBuV/m) = Raw Value(dBuV) + Correction Factor(dB/m)
2. Correction Factor(dB/m) = Antenna Factor(dB/m) + Cable Factor(dB) – Pre-Amplifier Factor(dB)
3. Margin value = Emission Level – Limit value
4. The other emission levels were very low against the limit.
5. " * " : Fundamental frequency, the limit was restricted at the RF Output Power.
6. " # " : The radiated frequency is out of the restricted band.

RF Mode	802.11a	Channel	CH 165 : 5825 MHz
Frequency Range	1 GHz ~ 40 GHz	Detector Function & Bandwidth	(PK) RB = 1 MHz, VB = 3 MHz (AV) RB = 1 MHz, VB = 1 kHz
Input Power	120 Vac, 60 Hz	Environmental Conditions	23°C, 67% RH
Tested By	Adair Peng		

Antenna Polarity & Test Distance : Horizontal at 3 m

No	Frequency (MHz)	Emission Level (dBuV/m)	Limit (dBuV/m)	Margin (dB)	Antenna Height (m)	Table Angle (Degree)	Raw Value (dBuV)	Correction Factor (dB/m)
1	#5626.80	60.4 PK	68.2	-7.8	3.64 H	248	38.6	21.8
2	*5825.00	117.3 PK			3.64 H	248	74.9	42.4
3	*5825.00	107.6 AV			3.64 H	248	65.2	42.4
4	#5938.40	61.4 PK	68.2	-6.8	3.64 H	248	38.9	22.5
5	11650.00	62.9 PK	74.0	-11.1	2.99 H	204	36.4	26.5
6	11650.00	49.5 AV	54.0	-4.5	2.99 H	204	23.0	26.5

Antenna Polarity & Test Distance : Vertical at 3 m

No	Frequency (MHz)	Emission Level (dBuV/m)	Limit (dBuV/m)	Margin (dB)	Antenna Height (m)	Table Angle (Degree)	Raw Value (dBuV)	Correction Factor (dB/m)
1	#5624.00	60.6 PK	68.2	-7.6	3.07 V	136	38.8	21.8
2	*5825.00	120.7 PK			3.07 V	136	78.3	42.4
3	*5825.00	110.9 AV			3.07 V	136	68.5	42.4
4	#5972.00	62.1 PK	68.2	-6.1	3.07 V	136	39.5	22.6
5	11650.00	63.0 PK	74.0	-11.0	2.58 V	161	36.5	26.5
6	11650.00	49.6 AV	54.0	-4.4	2.58 V	161	23.1	26.5

Remarks:

1. Emission Level(dBuV/m) = Raw Value(dBuV) + Correction Factor(dB/m)
2. Correction Factor(dB/m) = Antenna Factor(dB/m) + Cable Factor(dB) – Pre-Amplifier Factor(dB)
3. Margin value = Emission Level – Limit value
4. The other emission levels were very low against the limit.
5. " * " : Fundamental frequency, the limit was restricted at the RF Output Power.
6. " # " : The radiated frequency is out of the restricted band.

RF Mode	802.11ac (VHT20)	Channel	CH 149 : 5745 MHz
Frequency Range	1 GHz ~ 40 GHz	Detector Function & Bandwidth	(PK) RB = 1 MHz, VB = 3 MHz (AV) RB = 1 MHz, VB = 1 kHz
Input Power	120 Vac, 60 Hz	Environmental Conditions	23°C, 67% RH
Tested By	Adair Peng		

Antenna Polarity & Test Distance : Horizontal at 3 m

No	Frequency (MHz)	Emission Level (dBuV/m)	Limit (dBuV/m)	Margin (dB)	Antenna Height (m)	Table Angle (Degree)	Raw Value (dBuV)	Correction Factor (dB/m)
1	#5644.40	61.9 PK	68.2	-6.3	3.57 H	250	40.1	21.8
2	*5745.00	118.0 PK			3.57 H	250	76.0	42.0
3	*5745.00	107.9 AV			3.57 H	250	65.9	42.0
4	#5957.60	61.2 PK	68.2	-7.0	3.57 H	250	38.6	22.6
5	11490.00	63.7 PK	74.0	-10.3	3.65 H	250	36.5	27.2
6	11490.00	50.3 AV	54.0	-3.7	3.65 H	250	23.1	27.2

Antenna Polarity & Test Distance : Vertical at 3 m

No	Frequency (MHz)	Emission Level (dBuV/m)	Limit (dBuV/m)	Margin (dB)	Antenna Height (m)	Table Angle (Degree)	Raw Value (dBuV)	Correction Factor (dB/m)
1	#5647.20	61.1 PK	68.2	-7.1	2.77 V	135	39.2	21.9
2	*5745.00	121.2 PK			2.77 V	135	79.2	42.0
3	*5745.00	111.0 AV			2.77 V	135	69.0	42.0
4	#5969.60	61.4 PK	68.2	-6.8	2.77 V	135	38.8	22.6
5	11490.00	63.8 PK	74.0	-10.2	2.63 V	162	36.6	27.2
6	11490.00	50.5 AV	54.0	-3.5	2.63 V	162	23.3	27.2

Remarks:

1. Emission Level(dBuV/m) = Raw Value(dBuV) + Correction Factor(dB/m)
2. Correction Factor(dB/m) = Antenna Factor(dB/m) + Cable Factor(dB) – Pre-Amplifier Factor(dB)
3. Margin value = Emission Level – Limit value
4. The other emission levels were very low against the limit.
5. " * " : Fundamental frequency, the limit was restricted at the RF Output Power.
6. " # " : The radiated frequency is out of the restricted band.

RF Mode	802.11ac (VHT20)	Channel	CH 157 : 5785 MHz
Frequency Range	1 GHz ~ 40 GHz	Detector Function & Bandwidth	(PK) RB = 1 MHz, VB = 3 MHz (AV) RB = 1 MHz, VB = 1 kHz
Input Power	120 Vac, 60 Hz	Environmental Conditions	23°C, 67% RH
Tested By	Adair Peng		

Antenna Polarity & Test Distance : Horizontal at 3 m

No	Frequency (MHz)	Emission Level (dBuV/m)	Limit (dBuV/m)	Margin (dB)	Antenna Height (m)	Table Angle (Degree)	Raw Value (dBuV)	Correction Factor (dB/m)
1	#5639.60	60.3 PK	68.2	-7.9	3.57 H	250	38.5	21.8
2	*5785.00	117.6 PK			3.57 H	250	75.4	42.2
3	*5785.00	108.0 AV			3.57 H	250	65.8	42.2
4	#5965.60	61.5 PK	68.2	-6.7	3.57 H	250	38.9	22.6
5	11570.00	63.6 PK	74.0	-10.4	3.08 H	199	36.4	27.2
6	11570.00	50.2 AV	54.0	-3.8	3.08 H	199	23.0	27.2

Antenna Polarity & Test Distance : Vertical at 3 m

No	Frequency (MHz)	Emission Level (dBuV/m)	Limit (dBuV/m)	Margin (dB)	Antenna Height (m)	Table Angle (Degree)	Raw Value (dBuV)	Correction Factor (dB/m)
1	#5614.00	60.4 PK	68.2	-7.8	2.90 V	135	38.7	21.7
2	*5785.00	121.3 PK			2.90 V	135	79.1	42.2
3	*5785.00	111.3 AV			2.90 V	135	69.1	42.2
4	#5967.60	61.3 PK	68.2	-6.9	2.90 V	135	38.7	22.6
5	11570.00	63.8 PK	74.0	-10.2	2.65 V	160	36.6	27.2
6	11570.00	50.4 AV	54.0	-3.6	2.65 V	160	23.2	27.2

Remarks:

1. Emission Level(dBuV/m) = Raw Value(dBuV) + Correction Factor(dB/m)
2. Correction Factor(dB/m) = Antenna Factor(dB/m) + Cable Factor(dB) – Pre-Amplifier Factor(dB)
3. Margin value = Emission Level – Limit value
4. The other emission levels were very low against the limit.
5. " * " : Fundamental frequency, the limit was restricted at the RF Output Power.
6. " # " : The radiated frequency is out of the restricted band.

RF Mode	802.11ac (VHT20)	Channel	CH 165 : 5825 MHz
Frequency Range	1 GHz ~ 40 GHz	Detector Function & Bandwidth	(PK) RB = 1 MHz, VB = 3 MHz (AV) RB = 1 MHz, VB = 1 kHz
Input Power	120 Vac, 60 Hz	Environmental Conditions	23°C, 67% RH
Tested By	Adair Peng		

Antenna Polarity & Test Distance : Horizontal at 3 m

No	Frequency (MHz)	Emission Level (dBuV/m)	Limit (dBuV/m)	Margin (dB)	Antenna Height (m)	Table Angle (Degree)	Raw Value (dBuV)	Correction Factor (dB/m)
1	#5633.20	60.8 PK	68.2	-7.4	3.71 H	255	39.0	21.8
2	*5825.00	117.2 PK			3.71 H	255	74.8	42.4
3	*5825.00	107.7 AV			3.71 H	255	65.3	42.4
4	#5957.60	61.5 PK	68.2	-6.7	3.71 H	255	38.9	22.6
5	11650.00	63.3 PK	74.0	-10.7	3.11 H	212	36.8	26.5
6	11650.00	49.8 AV	54.0	-4.2	3.11 H	212	23.3	26.5

Antenna Polarity & Test Distance : Vertical at 3 m

No	Frequency (MHz)	Emission Level (dBuV/m)	Limit (dBuV/m)	Margin (dB)	Antenna Height (m)	Table Angle (Degree)	Raw Value (dBuV)	Correction Factor (dB/m)
1	#5630.40	61.0 PK	68.2	-7.2	3.04 V	135	39.2	21.8
2	*5825.00	120.8 PK			3.04 V	135	78.4	42.4
3	*5825.00	111.0 AV			3.04 V	135	68.6	42.4
4	#5938.40	61.4 PK	68.2	-6.8	3.04 V	135	38.9	22.5
5	11650.00	63.5 PK	74.0	-10.5	2.69 V	157	37.0	26.5
6	11650.00	50.0 AV	54.0	-4.0	2.69 V	157	23.5	26.5

Remarks:

1. Emission Level(dBuV/m) = Raw Value(dBuV) + Correction Factor(dB/m)
2. Correction Factor(dB/m) = Antenna Factor(dB/m) + Cable Factor(dB) – Pre-Amplifier Factor(dB)
3. Margin value = Emission Level – Limit value
4. The other emission levels were very low against the limit.
5. " * " : Fundamental frequency, the limit was restricted at the RF Output Power.
6. " # " : The radiated frequency is out of the restricted band.

RF Mode	802.11ac (VHT40)	Channel	CH 151 : 5755 MHz
Frequency Range	1 GHz ~ 40 GHz	Detector Function & Bandwidth	(PK) RB = 1 MHz, VB = 3 MHz (AV) RB = 1 MHz, VB = 1 kHz
Input Power	120 Vac, 60 Hz	Environmental Conditions	23°C, 67% RH
Tested By	Adair Peng		

Antenna Polarity & Test Distance : Horizontal at 3 m

No	Frequency (MHz)	Emission Level (dBUV/m)	Limit (dBUV/m)	Margin (dB)	Antenna Height (m)	Table Angle (Degree)	Raw Value (dBUV)	Correction Factor (dB/m)
1	#5646.80	65.0 PK	68.2	-3.2	3.77 H	259	43.1	21.9
2	*5755.00	114.1 PK			3.77 H	259	72.0	42.1
3	*5755.00	104.0 AV			3.77 H	259	61.9	42.1
4	#5959.60	61.7 PK	68.2	-6.5	3.77 H	259	39.1	22.6
5	11510.00	63.9 PK	74.0	-10.1	3.13 H	202	36.6	27.3
6	11510.00	49.9 AV	54.0	-4.1	3.13 H	202	22.6	27.3

Antenna Polarity & Test Distance : Vertical at 3 m

No	Frequency (MHz)	Emission Level (dBUV/m)	Limit (dBUV/m)	Margin (dB)	Antenna Height (m)	Table Angle (Degree)	Raw Value (dBUV)	Correction Factor (dB/m)
1	#5647.20	67.3 PK	68.2	-0.9	2.76 V	133	45.4	21.9
2	*5755.00	117.7 PK			2.76 V	133	75.6	42.1
3	*5755.00	107.3 AV			2.76 V	133	65.2	42.1
4	#5971.20	62.2 PK	68.2	-6.0	2.76 V	133	39.6	22.6
5	11510.00	64.1 PK	74.0	-9.9	2.55 V	162	36.8	27.3
6	11510.00	50.1 AV	54.0	-3.9	2.55 V	162	22.8	27.3

Remarks:

1. Emission Level(dBUV/m) = Raw Value(dBUV) + Correction Factor(dB/m)
2. Correction Factor(dB/m) = Antenna Factor(dB/m) + Cable Factor(dB) – Pre-Amplifier Factor(dB)
3. Margin value = Emission Level – Limit value
4. The other emission levels were very low against the limit.
5. " * " : Fundamental frequency, the limit was restricted at the RF Output Power.
6. " # " : The radiated frequency is out of the restricted band.

RF Mode	802.11ac (VHT40)	Channel	CH 159 : 5795 MHz
Frequency Range	1 GHz ~ 40 GHz	Detector Function & Bandwidth	(PK) RB = 1 MHz, VB = 3 MHz (AV) RB = 1 MHz, VB = 1 kHz
Input Power	120 Vac, 60 Hz	Environmental Conditions	23°C, 67% RH
Tested By	Adair Peng		

Antenna Polarity & Test Distance : Horizontal at 3 m

No	Frequency (MHz)	Emission Level (dBuV/m)	Limit (dBuV/m)	Margin (dB)	Antenna Height (m)	Table Angle (Degree)	Raw Value (dBuV)	Correction Factor (dB/m)
1	#5633.20	61.6 PK	68.2	-6.6	3.69 H	253	39.8	21.8
2	*5795.00	116.3 PK			3.69 H	253	74.1	42.2
3	*5795.00	105.2 AV			3.69 H	253	63.0	42.2
4	#5958.00	62.1 PK	68.2	-6.1	3.69 H	253	39.5	22.6
5	11590.00	63.9 PK	74.0	-10.1	3.16 H	208	36.8	27.1
6	11590.00	49.8 AV	54.0	-4.2	3.16 H	208	22.7	27.1

Antenna Polarity & Test Distance : Vertical at 3 m

No	Frequency (MHz)	Emission Level (dBuV/m)	Limit (dBuV/m)	Margin (dB)	Antenna Height (m)	Table Angle (Degree)	Raw Value (dBuV)	Correction Factor (dB/m)
1	#5649.20	62.5 PK	68.2	-5.7	2.95 V	135	40.6	21.9
2	*5795.00	119.4 PK			2.95 V	135	77.2	42.2
3	*5795.00	108.5 AV			2.95 V	135	66.3	42.2
4	#5931.20	63.6 PK	68.2	-4.6	2.95 V	135	41.1	22.5
5	11590.00	64.0 PK	74.0	-10.0	2.60 V	163	36.9	27.1
6	11590.00	50.1 AV	54.0	-3.9	2.60 V	163	23.0	27.1

Remarks:

1. Emission Level(dBuV/m) = Raw Value(dBuV) + Correction Factor(dB/m)
2. Correction Factor(dB/m) = Antenna Factor(dB/m) + Cable Factor(dB) – Pre-Amplifier Factor(dB)
3. Margin value = Emission Level – Limit value
4. The other emission levels were very low against the limit.
5. " * " : Fundamental frequency, the limit was restricted at the RF Output Power.
6. " # " : The radiated frequency is out of the restricted band.



RF Mode	802.11ac (VHT80)	Channel	CH 155 : 5775 MHz
Frequency Range	1 GHz ~ 40 GHz	Detector Function & Bandwidth	(PK) RB = 1 MHz, VB = 3 MHz (AV) RB = 1 MHz, VB = 1 kHz
Input Power	120 Vac, 60 Hz	Environmental Conditions	23°C, 67% RH
Tested By	Adair Peng		

Antenna Polarity & Test Distance : Horizontal at 3 m

No	Frequency (MHz)	Emission Level (dBuV/m)	Limit (dBuV/m)	Margin (dB)	Antenna Height (m)	Table Angle (Degree)	Raw Value (dBuV)	Correction Factor (dB/m)
1	#5644.80	65.3 PK	68.2	-2.9	3.67 H	256	43.4	21.9
2	*5775.00	109.3 PK			3.67 H	256	67.2	42.1
3	*5775.00	99.0 AV			3.67 H	256	56.9	42.1
4	#5931.60	62.3 PK	68.2	-5.9	3.67 H	256	39.8	22.5
5	11550.00	63.9 PK	74.0	-10.1	3.16 H	214	36.6	27.3
6	11550.00	50.0 AV	54.0	-4.0	3.16 H	214	22.7	27.3

Antenna Polarity & Test Distance : Vertical at 3 m

No	Frequency (MHz)	Emission Level (dBuV/m)	Limit (dBuV/m)	Margin (dB)	Antenna Height (m)	Table Angle (Degree)	Raw Value (dBuV)	Correction Factor (dB/m)
1	#5647.60	67.5 PK	68.2	-0.7	2.90 V	134	45.6	21.9
2	*5775.00	112.0 PK			2.90 V	134	69.9	42.1
3	*5775.00	102.1 AV			2.90 V	134	60.0	42.1
4	#5930.00	62.9 PK	68.2	-5.3	2.90 V	134	40.4	22.5
5	11550.00	64.1 PK	74.0	-9.9	2.57 V	158	36.8	27.3
6	11550.00	50.3 AV	54.0	-3.7	2.57 V	158	23.0	27.3

Remarks:

1. Emission Level(dBuV/m) = Raw Value(dBuV) + Correction Factor(dB/m)
2. Correction Factor(dB/m) = Antenna Factor(dB/m) + Cable Factor(dB) – Pre-Amplifier Factor(dB)
3. Margin value = Emission Level – Limit value
4. The other emission levels were very low against the limit.
5. " * " : Fundamental frequency, the limit was restricted at the RF Output Power.
6. " # " : The radiated frequency is out of the restricted band.

Plot of Band Edge

802.11a Channel 36

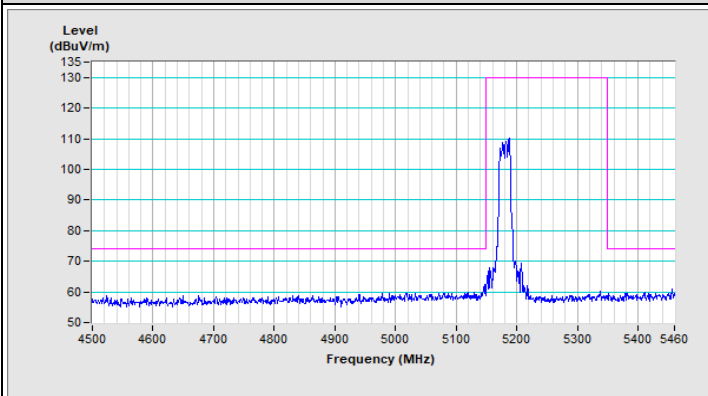

Horizontal (Peak)

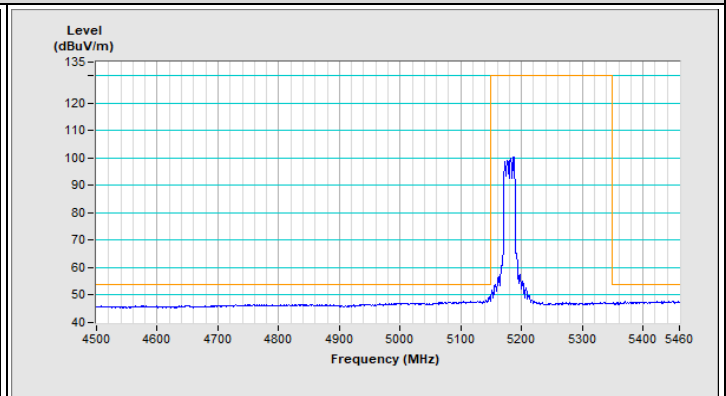

Horizontal (Average)

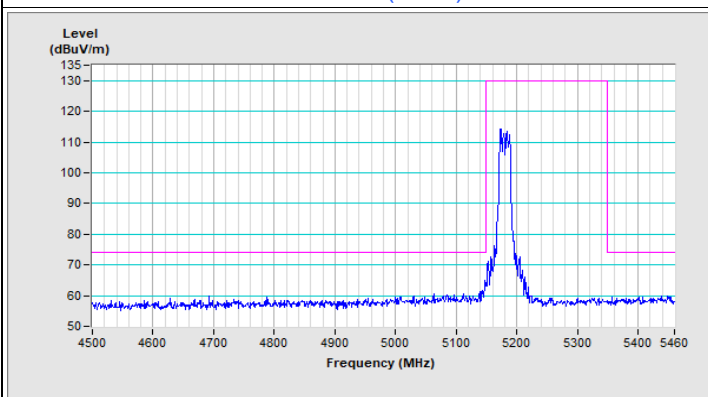

Vertical (Peak)

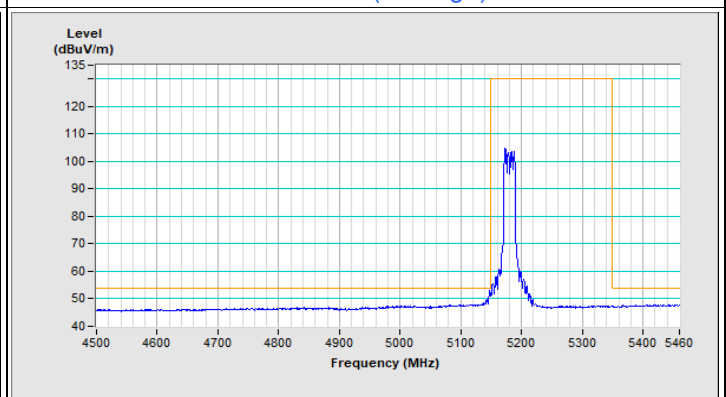

Vertical (Average)

802.11a Channel 48

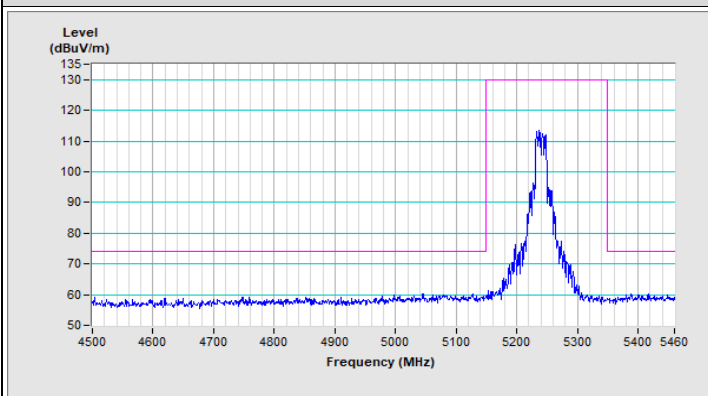

Horizontal (Peak)

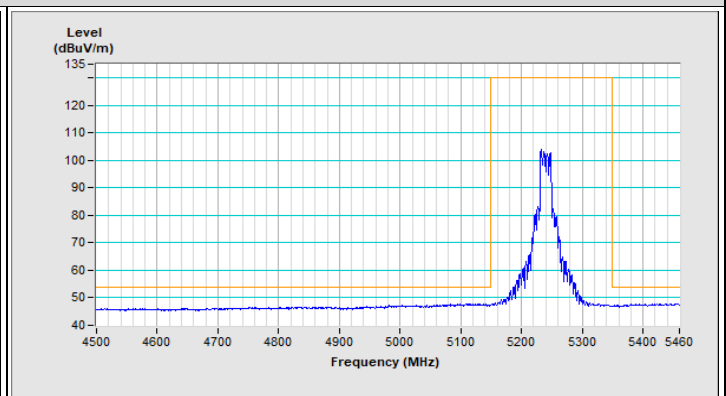

Horizontal (Average)

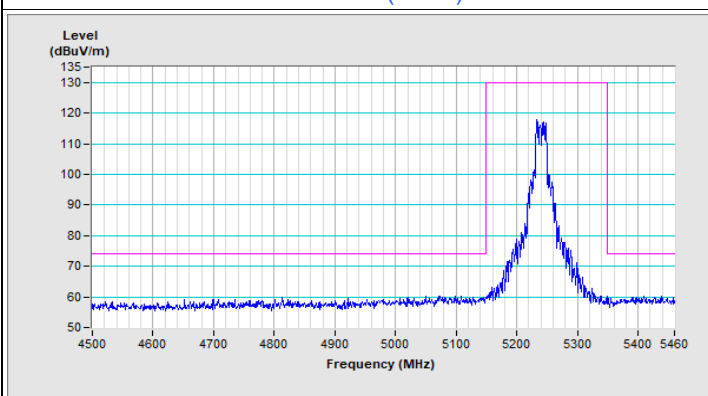

Vertical (Peak)

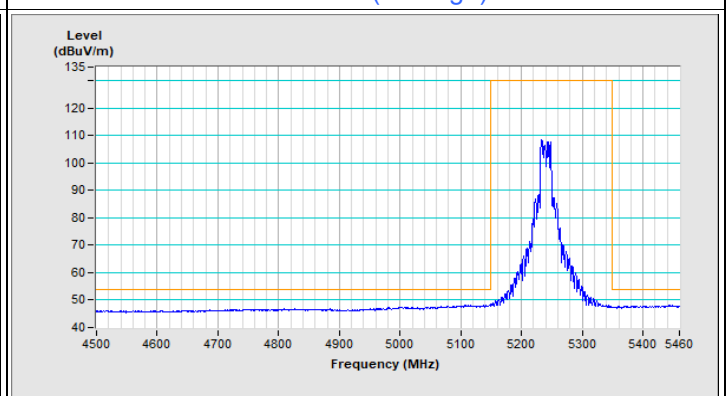

Vertical (Average)

802.11ac (VHT20) Channel 36

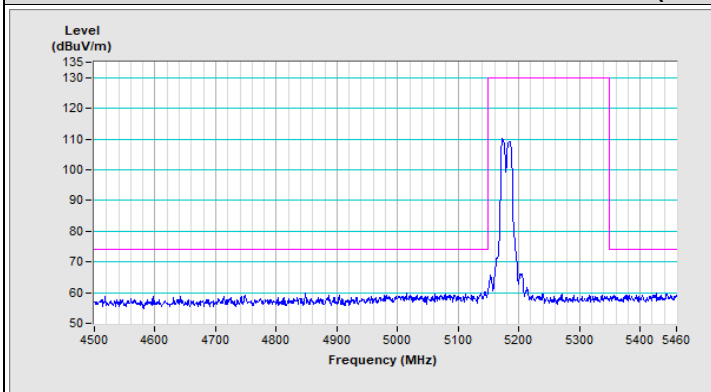

Horizontal (Peak)

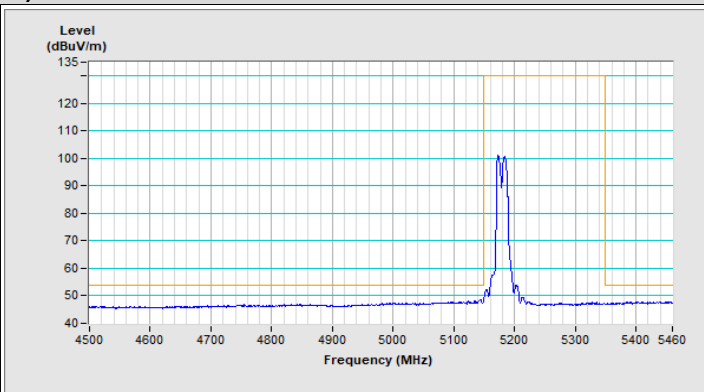

Horizontal (Average)

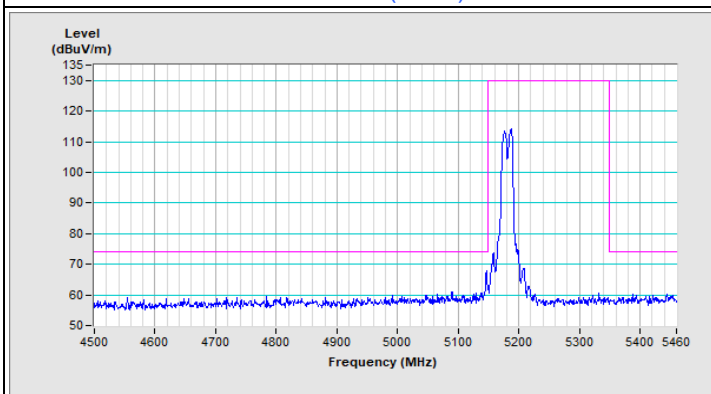

Vertical (Peak)

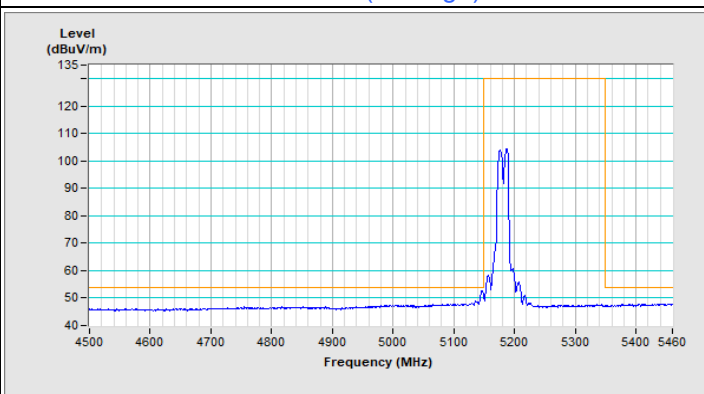

Vertical (Average)

802.11ac (VHT20) Channel 48

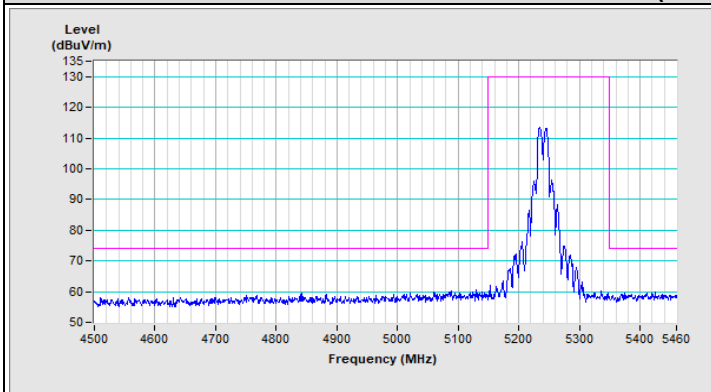

Horizontal (Peak)

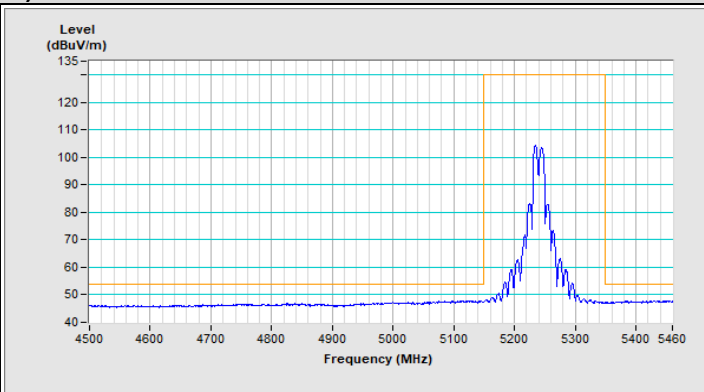

Horizontal (Average)

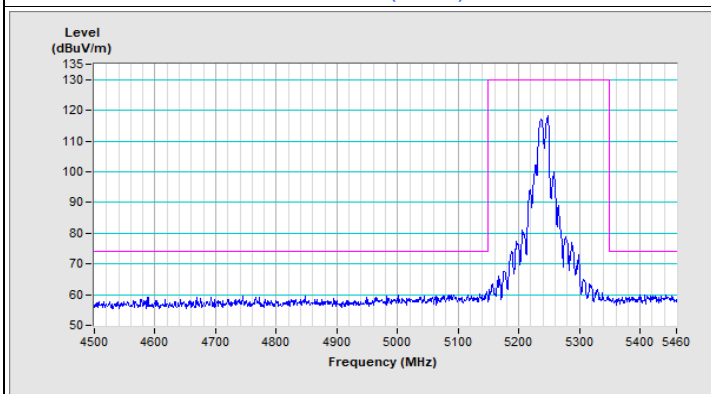

Vertical (Peak)

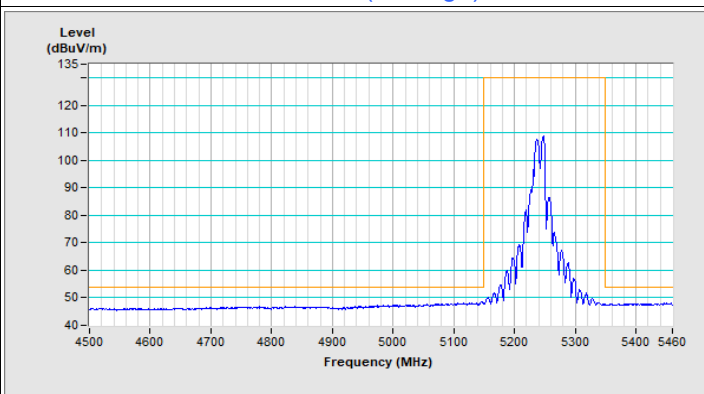

Vertical (Average)

802.11ac (VHT40) Channel 38

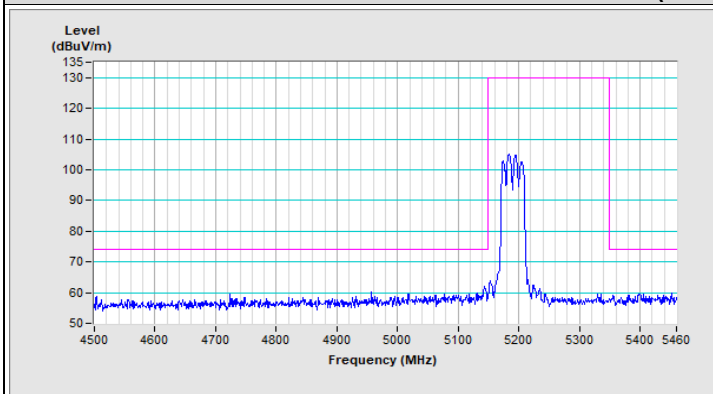

Horizontal (Peak)

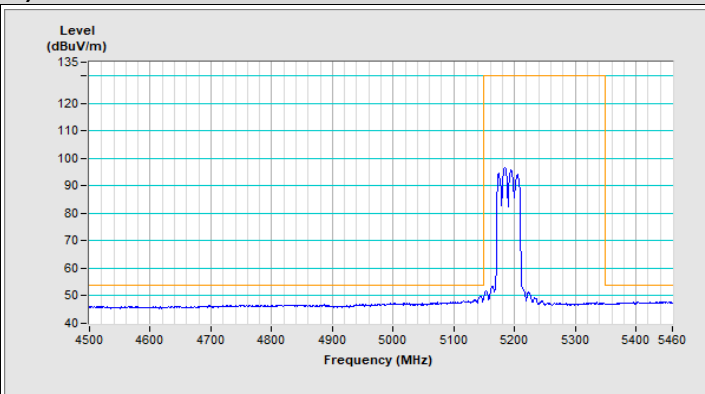

Horizontal (Average)

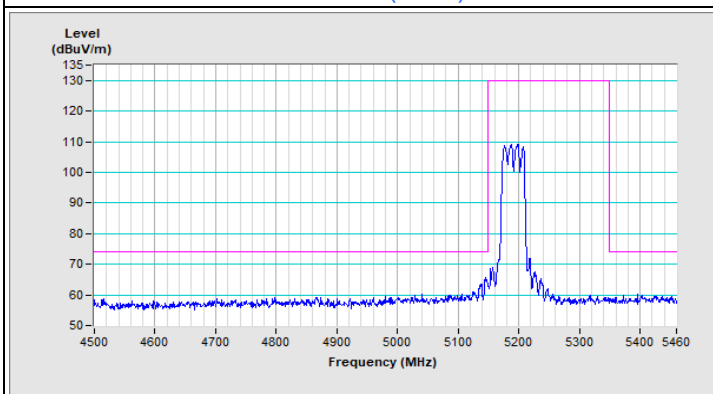

Vertical (Peak)

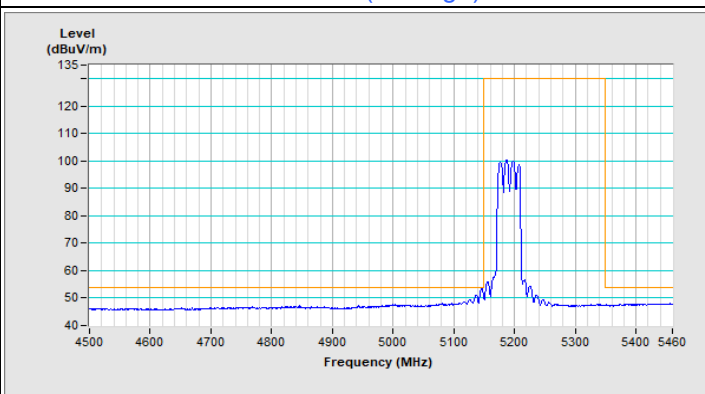

Vertical (Average)

802.11ac (VHT40) Channel 46

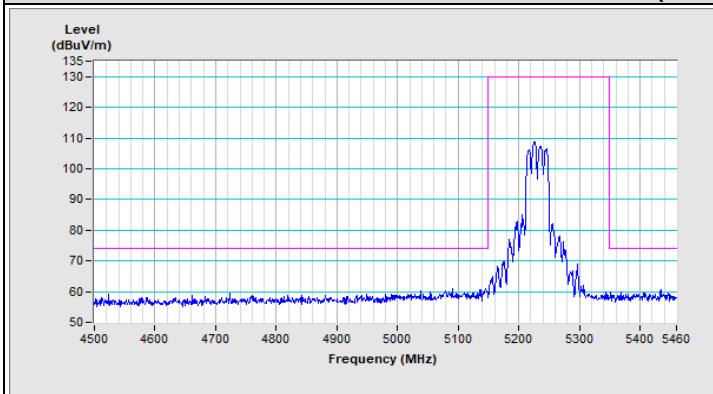

Horizontal (Peak)

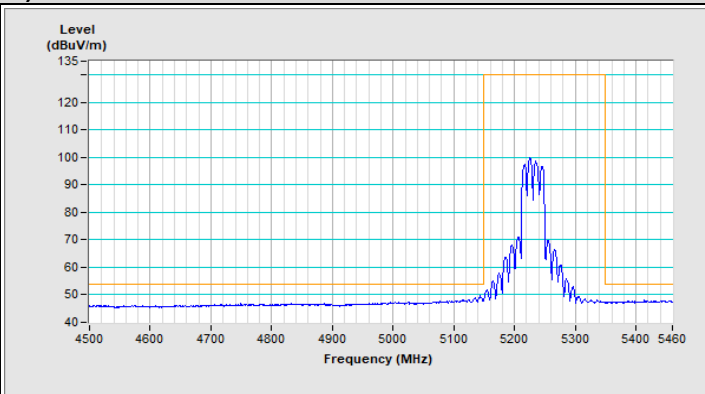

Horizontal (Average)

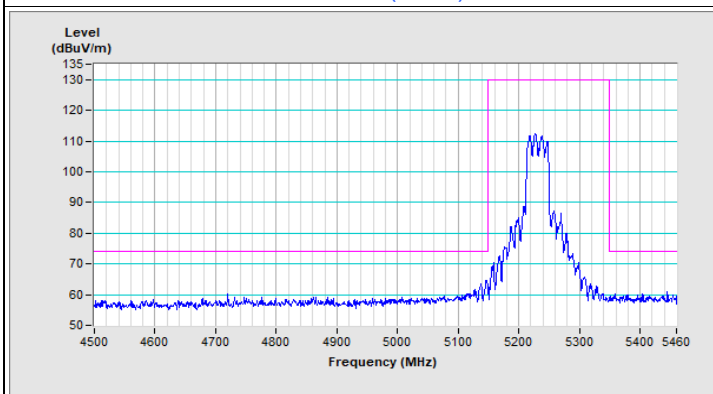

Vertical (Peak)

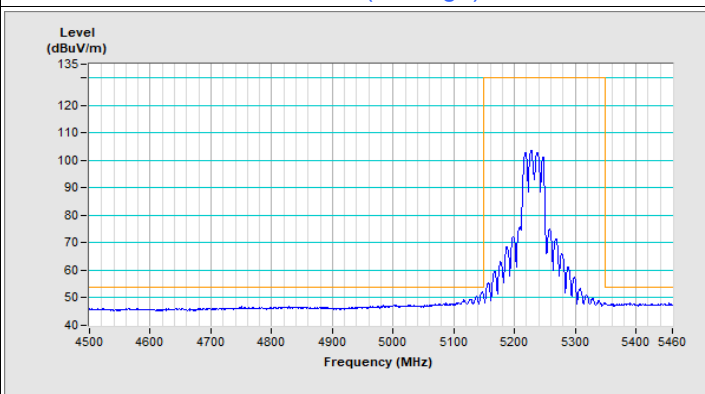

Vertical (Average)

802.11ac (VHT80) Channel 42

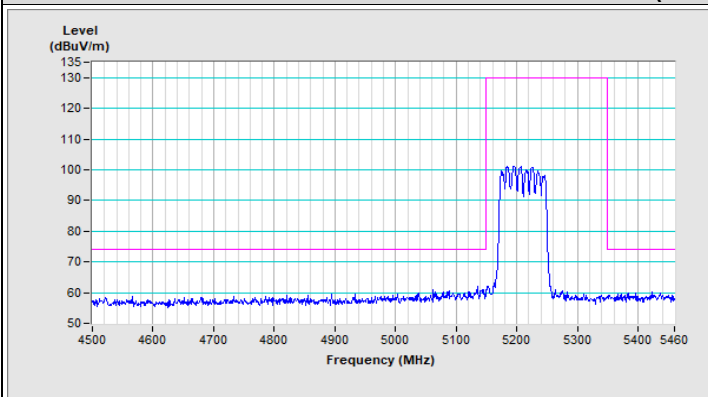

Horizontal (Peak)

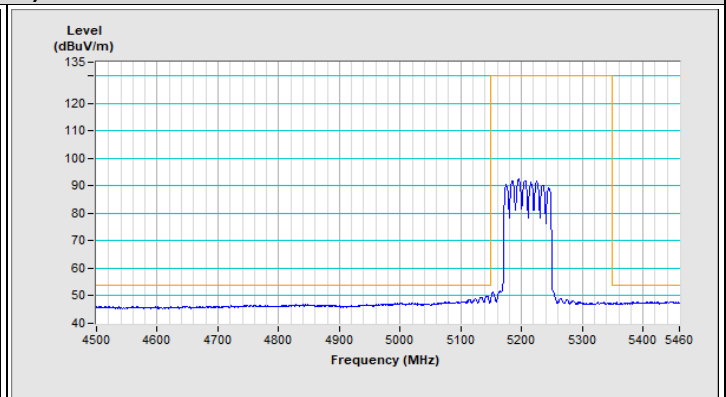

Horizontal (Average)

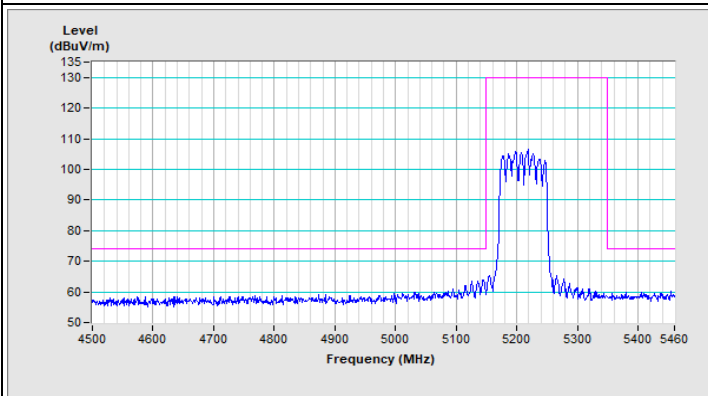

Vertical (Peak)

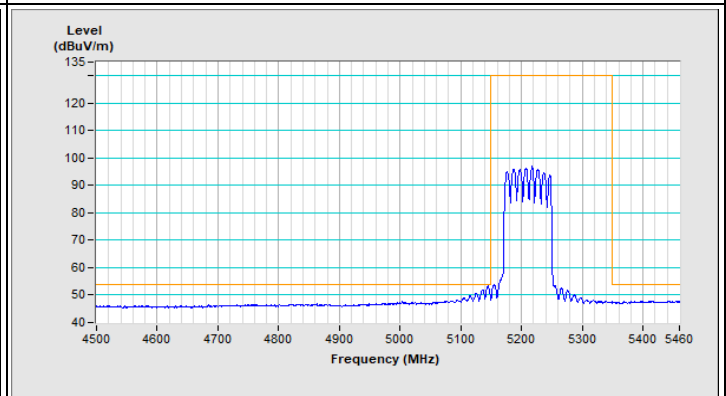

Vertical (Average)

802.11a Channel 149

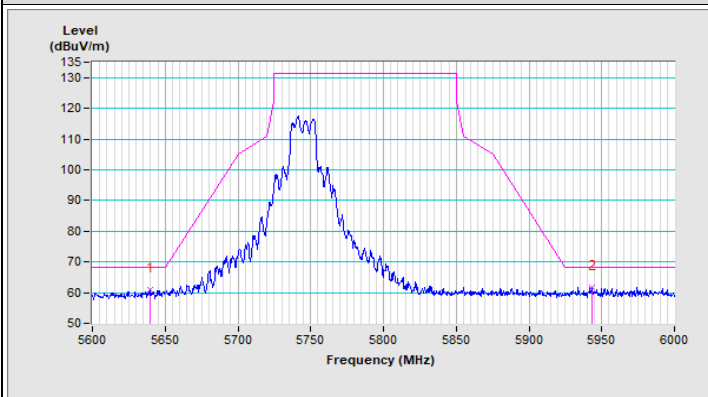

Horizontal (Peak)

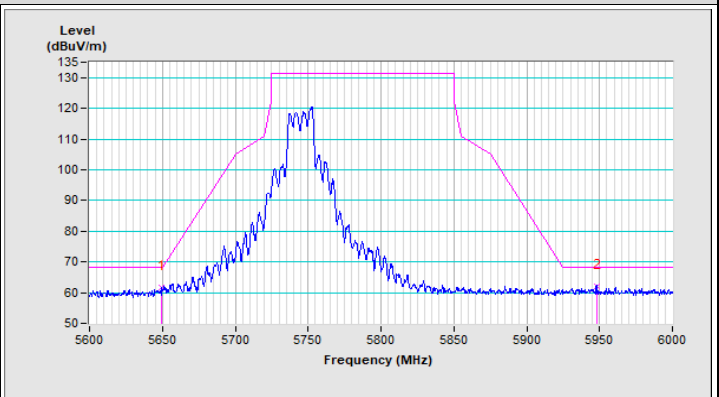

Vertical (Peak)

802.11a Channel 157

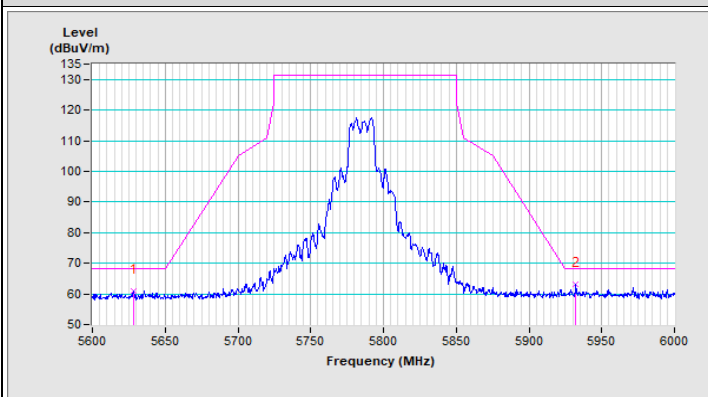

Horizontal (Peak)

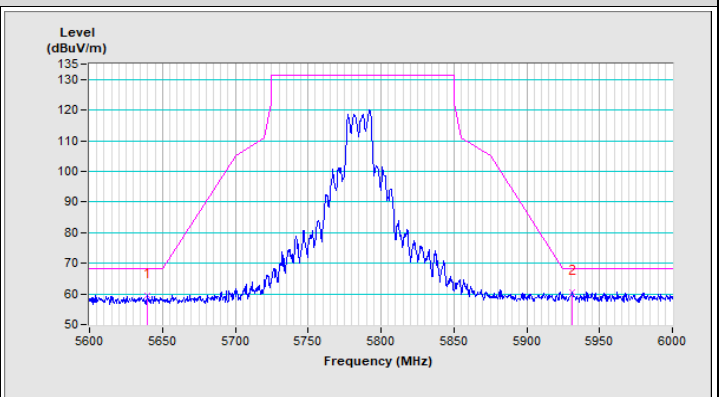

Vertical (Peak)

802.11a Channel 165

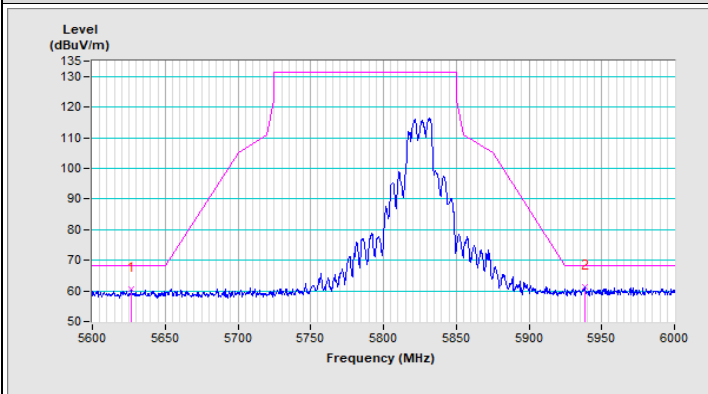

Horizontal (Peak)

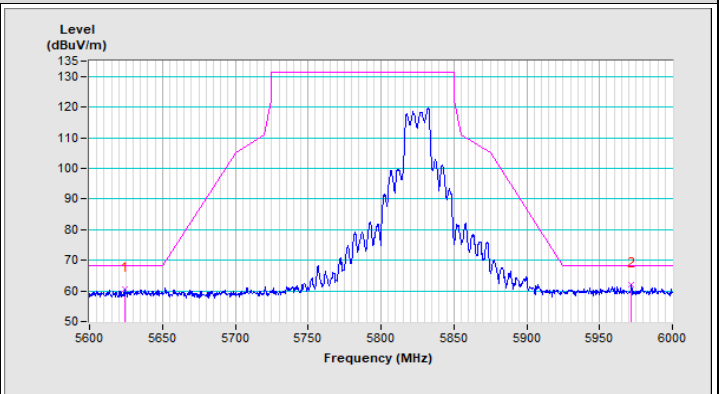

Vertical (Peak)

802.11ac (VHT20) Channel 149

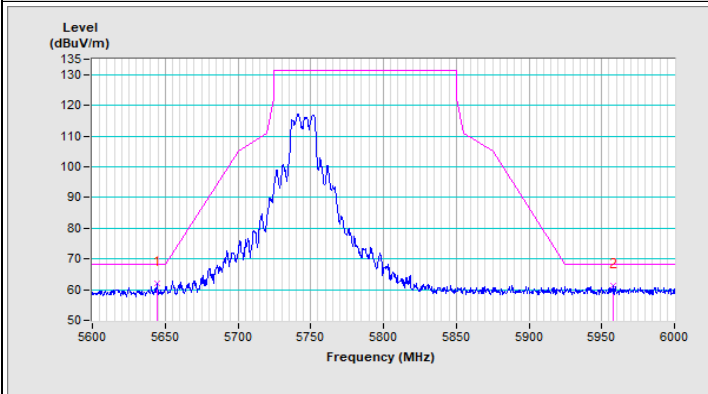

Horizontal (Peak)

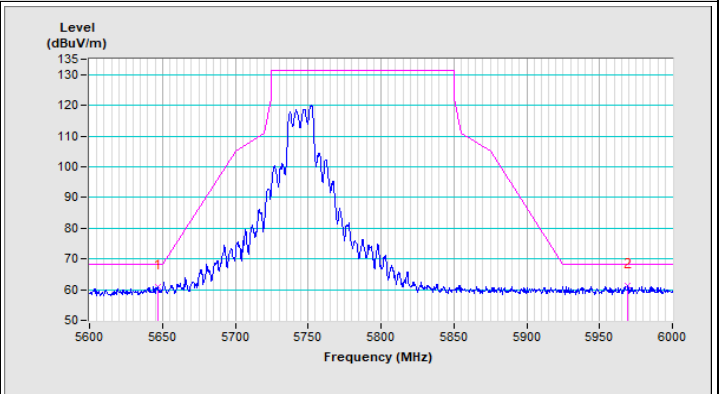

Vertical (Peak)

802.11ac (VHT20) Channel 157

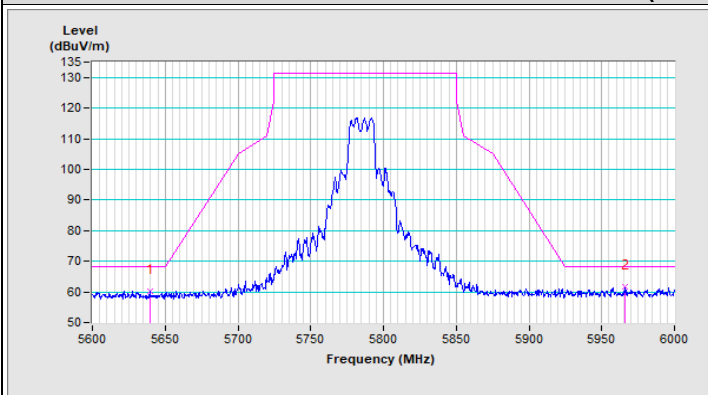

Horizontal (Peak)

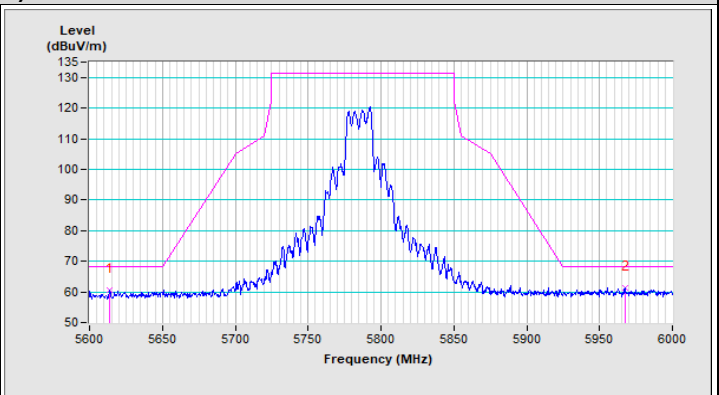

Vertical (Peak)

802.11ac (VHT20) Channel 165

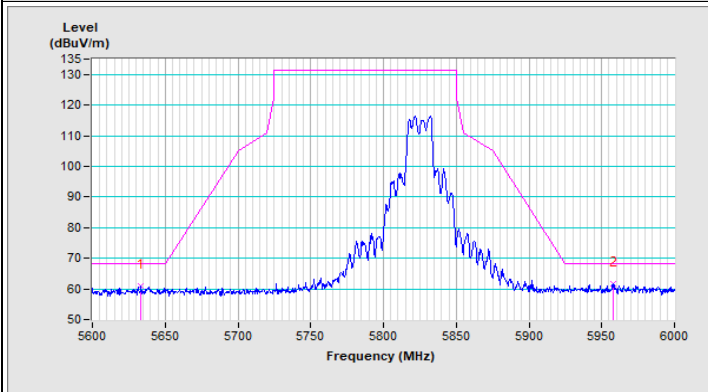

Horizontal (Peak)

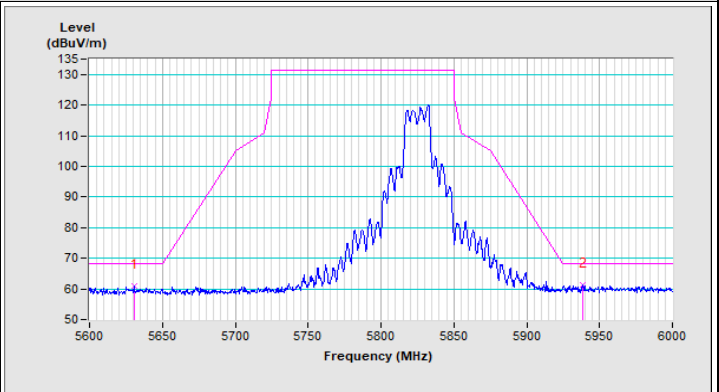

Vertical (Peak)

802.11ac (VHT40) Channel 151

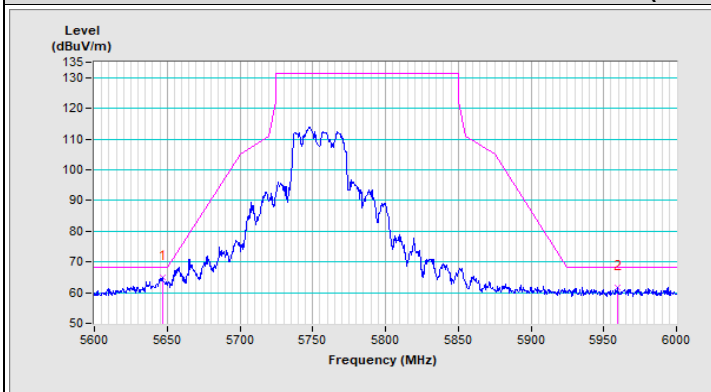

Horizontal (Peak)

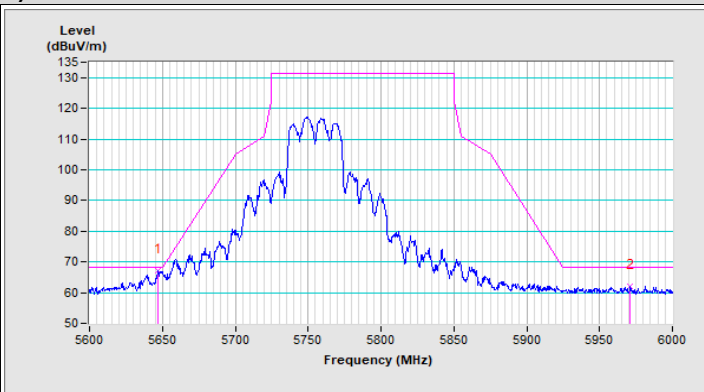

Vertical (Peak)

802.11ac (VHT40) Channel 159

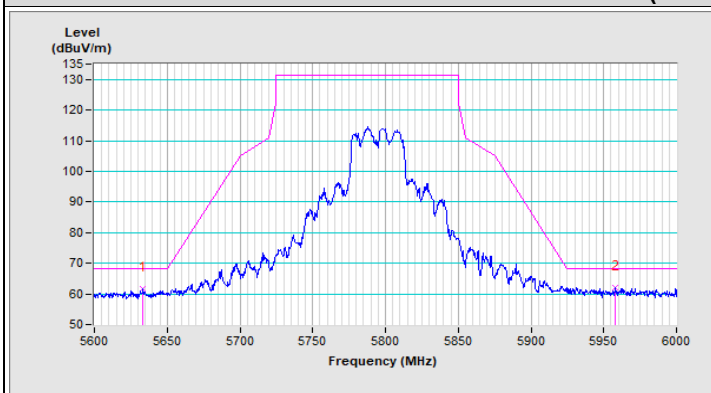

Horizontal (Peak)

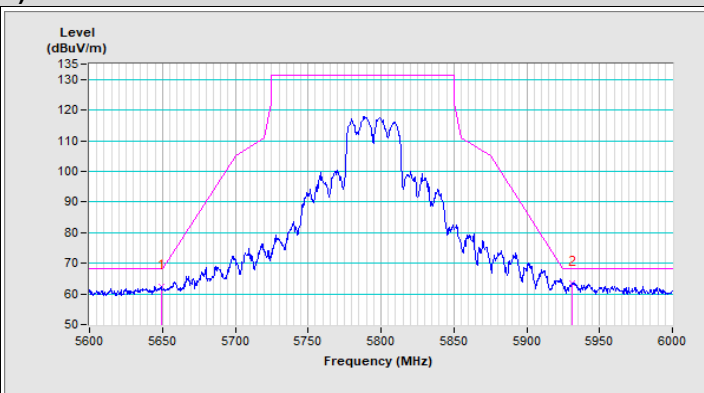

Vertical (Peak)

802.11ac (VHT80) Channel 155

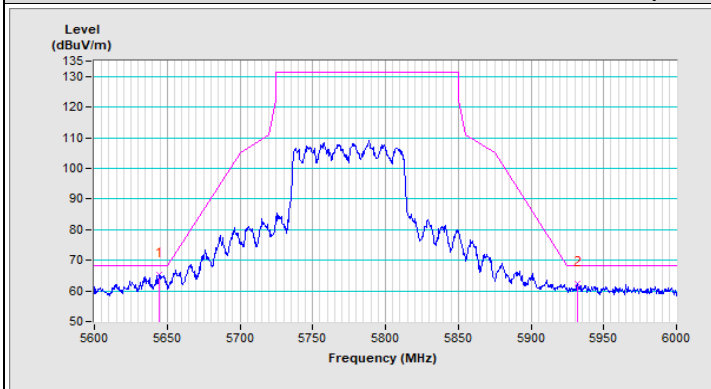

Horizontal (Peak)

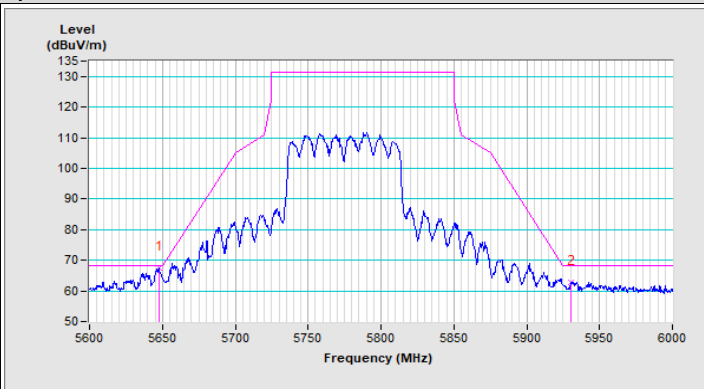

Vertical (Peak)

8 Pictures of Test Arrangements

Please refer to the attached file (Test Setup Photo)

9 Information of the Testing Laboratories

We, Bureau Veritas Consumer Products Services (H.K.) Ltd., Taoyuan Branch, were founded in 1988 to provide our best service in EMC, Radio, Telecom and Safety consultation. Our laboratories are FCC recognized accredited test firms and accredited according to ISO/IEC 17025.

If you have any comments, please feel free to contact us at the following:

Lin Kou EMC/RF Lab

Tel: 886-2-26052180

Fax: 886-2-26051924

Hsin Chu EMC/RF/Telecom Lab

Tel: 886-3-6668565

Fax: 886-3-6668323

Hwa Ya EMC/RF/Safety Lab

Tel: 886-3-3183232

Fax: 886-3-3270892

Email: service.adt@bureauveritas.com

Web Site: <http://ee.bureauveritas.com.tw>

The address and road map of all our labs can be found in our web site also.

--- END ---