

FCC Test Report

Report No.: RFBHJS-WTW-P20080454-1

FCC ID: PD5-NSE1000

Test Model: NSE1000

Received Date: Aug. 24, 2020

Test Date: Sep. 03 ~ Sep. 26, 2020

Issued Date: Dec. 28, 2020

Applicant: Delta Electronics, Inc.

Address: No. 252, Shang Ying Rd., Kuei San District, Taoyuan City 33341, Taiwan

Issued By: Bureau Veritas Consumer Products Services (H.K.) Ltd., Taoyuan Branch
Lin Kou Laboratories

Lab Address: No. 47-2, 14th Ling, Chia Pau Vil., Lin Kou Dist., New Taipei City, Taiwan

Test Location: No. 19, Hwa Ya 2nd Rd., Wen Hwa Vil., Kwei Shan Dist., Taoyuan City
33383, Taiwan

**FCC Registration /
Designation Number:** 788550 / TW0003



This report is for your exclusive use. Any copying or replication of this report to or for any other person or entity, or use of our name or trademark, is permitted only with our prior written permission. This report sets forth our findings solely with respect to the test samples identified herein. The results set forth in this report are not indicative or representative of the quality or characteristics of the lot from which a test sample was taken or any similar or identical product specifically and expressly noted. Our report includes all of the tests requested by you and the results thereof based upon the information that you provided to us. You have 60 days from date of issuance of this report to notify us of any material error or omission caused by our negligence, provided, however, that such notice shall be in writing and shall specifically address the issue you wish to raise. A failure to raise such issue within the prescribed time shall constitute your unqualified acceptance of the completeness of this report, the tests conducted and the correctness of the report contents. Unless specific mention, the uncertainty of measurement has been explicitly taken into account to declare the compliance or non-compliance to the specification.

Table of Contents

Release Control Record	4
1 Certificate of Conformity	5
2 Summary of Test Results	6
2.1 Measurement Uncertainty.....	6
2.2 Modification Record.....	6
3 General Information	7
3.1 General Description of EUT.....	7
3.2 Description of Test Modes.....	9
3.2.1 Test Mode Applicability and Tested Channel Detail.....	10
3.3 Duty Cycle of Test Signal.....	12
3.4 Description of Support Units.....	13
3.4.1 Configuration of System under Test.....	13
3.5 General Description of Applied Standards and References.....	13
4 Test Types and Results	14
4.1 Radiated Emission and Bandedge Measurement.....	14
4.1.1 Limits of Radiated Emission and Bandedge Measurement.....	14
4.1.2 Test Instruments.....	15
4.1.3 Test Procedures.....	16
4.1.4 Deviation from Test Standard.....	16
4.1.5 Test Setup.....	17
4.1.6 EUT Operating Conditions.....	18
4.1.7 Test Results.....	19
4.2 Conducted Emission Measurement.....	39
4.2.1 Limits of Conducted Emission Measurement.....	39
4.2.2 Test Instruments.....	39
4.2.3 Test Procedures.....	40
4.2.4 Deviation from Test Standard.....	40
4.2.5 Test Setup.....	40
4.2.6 EUT Operating Conditions.....	40
4.2.7 Test Results.....	41
4.3 Transmit Power Measurement.....	43
4.3.1 Limits of Transmit Power Measurement.....	43
4.3.2 Test Setup.....	43
4.3.3 Test Instruments.....	43
4.3.4 Test Procedure.....	43
4.3.5 Deviation from Test Standard.....	43
4.3.6 EUT Operating Conditions.....	43
4.3.7 Test Result.....	44
4.4 Occupied Bandwidth Measurement.....	48
4.4.1 Test Setup.....	48
4.4.2 Test Instruments.....	48
4.4.3 Test Procedure.....	48
4.4.4 Test Result.....	49
4.5 Peak Power Spectral Density Measurement.....	53
4.5.1 Limits of Peak Power Spectral Density Measurement.....	53
4.5.2 Test Setup.....	53
4.5.3 Test Instruments.....	53
4.5.4 Test Procedures.....	53
4.5.5 Deviation from Test Standard.....	54
4.5.6 EUT Operating Conditions.....	54
4.5.7 Test Results.....	55
4.6 Frequency Stability.....	60
4.6.1 Limits of Frequency Stability Measurement.....	60

4.6.2 Test Setup.....	60
4.6.3 Test Instruments	60
4.6.4 Test Procedure	60
4.6.5 Deviation from Test Standard	61
4.6.6 EUT Operating Condition	61
4.6.7 Test Results	61
4.7 6dB Bandwidth Measurement.....	62
4.7.1 Limits of 6dB Bandwidth Measurement.....	62
4.7.2 Test Setup.....	62
4.7.3 Test Instruments	62
4.7.4 Test Procedure	62
4.7.5 Deviation from Test Standard	62
4.7.6 EUT Operating Condition	62
4.7.7 Test Results	63
5 Pictures of Test Arrangements.....	65
Annex A - Radiated Out of Band Emission (OOBE) Measurement (For U-NII-3 band)	66
Annex B - Band Edge Measurement.....	69
Appendix – Information of the Testing Laboratories	73

Release Control Record

Issue No.	Description	Date Issued
RFBHJS-WTW-P20080454-1	Original release	Dec. 28, 2020

1 Certificate of Conformity

Product: Wireless Access Point
Brand: Nile Global
Test Model: NSE1000
Sample Status: Engineering sample
Applicant: Delta Electronics, Inc.
Test Date: Sep. 03 ~ Sep. 26, 2020
Standards: 47 CFR FCC Part 15, Subpart E (Section 15.407)
ANSI C63.10:2013

The above equipment has been tested by **Bureau Veritas Consumer Products Services (H.K.) Ltd., Taoyuan Branch**, and found compliance with the requirement of the above standards. The test record, data evaluation & Equipment Under Test (EUT) configurations represented herein are true and accurate accounts of the measurements of the sample's RF characteristics under the conditions specified in this report.

Prepared by : Pettie Chen, **Date:** Dec. 28, 2020
Pettie Chen / Senior Specialist

Approved by : Bruce Chen, **Date:** Dec. 28, 2020
Bruce Chen / Senior Project Engineer

2 Summary of Test Results

47 CFR FCC Part 15, Subpart E (Section 15.407)			
FCC Clause	Test Item	Result	Remarks
15.407(b)(6)	AC Power Conducted Emissions	Pass	Meet the requirement of limit. Minimum passing margin is -15.13dB at 0.54542MHz.
15.407(b)(1/2/3/4(i/ii)/6)	Radiated Emissions & Band Edge Measurement	Pass	Meet the requirement of limit. Minimum passing margin is -0.8dB at 5150.00MHz.
15.407(a)(1/2/3)	Max Average Transmit Power	Pass	Meet the requirement of limit.
---	Occupied Bandwidth Measurement	-	Reference only.
15.407(a)(1/2/3)	Peak Power Spectral Density	Pass	Meet the requirement of limit.
15.407(e)	6dB bandwidth	Pass	Meet the requirement of limit. (U-NII-3 Band only)
15.407(g)	Frequency Stability	Pass	Meet the requirement of limit.
15.203	Antenna Requirement	Pass	Antenna connector is i-pex (MHF) not a standard connector.

Note:

- For U-NII-3 band compliance with rule part 15.407(b)(4)(i), the OOB test plots were recorded in Annex A.
- For U-NII-1 band compliance with rule 15.407(b) of the band-edge items, the test plots were recorded in Annex B. Test Procedures refer to report 4.1.3.
- Determining compliance based on the results of the compliance measurement, not taking into account measurement instrumentation uncertainty.

2.1 Measurement Uncertainty

Where relevant, the following measurement uncertainty levels have been estimated for tests performed on the EUT as specified in CISPR 16-4-2:

Measurement	Frequency	Expanded Uncertainty (k=2) (\pm)
Conducted Emissions at mains ports	150kHz ~ 30MHz	2.79 dB
Radiated Emissions up to 1 GHz	9kHz ~ 30MHz	3.04 dB
	30MHz ~ 200MHz	3.86 dB
	200MHz ~ 1000MHz	3.87 dB
Radiated Emissions above 1 GHz	1GHz ~ 18GHz	2.29 dB
	18GHz ~ 40GHz	2.29 dB

2.2 Modification Record

There were no modifications required for compliance.

3 General Information

3.1 General Description of EUT

Product	Wireless Access Point
Brand	Nile Global
Test Model	NSE1000
Sample Status	Engineering sample
Power Supply Rating	100-240Vac, 50-60Hz, 0.5A Max
Modulation Type	256QAM, 64QAM, 16QAM, QPSK, BPSK
Modulation Technology	OFDM
Transfer Rate	802.11a: 54/48/36/24/18/12/9/6Mbps 802.11n: up to 300Mbps 802.11ac: up to 866.7Mbps
Operating Frequency	5180 ~ 5240MHz, 5745 ~ 5825MHz
Number of Channel	5180 ~ 5240MHz: 802.11a, 802.11n (HT20), 802.11ac (VHT20): 4 802.11n (HT40), 802.11ac (VHT40): 2 802.11ac (VHT80): 1 5745 ~ 5825MHz: 802.11a, 802.11n (HT20), 802.11ac (VHT20): 5 802.11n (HT40), 802.11ac (VHT40): 2 802.11ac (VHT80): 1
Output Power	CDD Mode: 5180 ~ 5240MHz: 241.579mW 5745 ~ 5825MHz: 545.229mW Beamforming Mode: 5180 ~ 5240MHz: 180.198mW 5745 ~ 5825MHz: 545.229mW
Antenna Type	Refer to note
Antenna Connector	Refer to note
Accessory Device	NA
Cable Supplied	NA

Note:

1. The EUT incorporates a MIMO function. Physically, the EUT provides 2 completed transmitters and 2 receivers.

Modulation Mode	Beamforming Mode	TX Function
802.11a	Not Support	2TX
802.11n (HT20)	Support	2TX
802.11n (HT40)	Support	2TX
802.11ac (VHT20)	Support	2TX
802.11ac (VHT40)	Support	2TX
802.11ac (VHT80)	Support	2TX

* The bandwidth and modulation are similar for HT20/HT40 on 802.11n mode and VHT20/VHT40 on 802.11ac mode. Therefore the investigated worst case is the representative mode in test report. (Final test mode refer section 3.2.1)

* For 802.11n and 802.11ac, CDD mode and Beamforming mode are presented in power output test item. For other test items, CDD mode is the worst case for final tests after pretesting.

2. The EUT uses following antennas.

Ant. Type	PIFA		
Ant. Connector	i-pex (MHF)		
Antenna Gain (dBi)			
Ant. No.	WLAN (2.4GHz Band)	WLAN (5.0GHz Band)	Bluetooth
Ant. 0	2.19	4.86	-
Ant. 1	2.86	3.70	-
Ant. 2	-	-	2.42

*The above Antenna information is declared by manufacturer and for more detailed features description, please refer to the manufacturer's specifications, the laboratory shall not be held responsible.

3. WLAN 2.4GHz and WLAN 5GHz technologies can transmit simultaneously.
WLAN 5GHz and Bluetooth technologies can transmit simultaneously.

3.2 Description of Test Modes

For 5180 ~ 5240MHz:

4 channels are provided for 802.11a, 802.11n (HT20), 802.11ac (VHT20):

Channel	Frequency	Channel	Frequency
36	5180 MHz	44	5220 MHz
40	5200 MHz	48	5240 MHz

2 channels are provided for 802.11n (HT40), 802.11ac (VHT40):

Channel	Frequency	Channel	Frequency
38	5190 MHz	46	5230 MHz

1 channel is provided for 802.11ac (VHT80):

Channel	Frequency
42	5210MHz

For 5745 ~ 5825MHz:

5 channels are provided for 802.11a, 802.11n (HT20), 802.11ac (VHT20):

Channel	Frequency	Channel	Frequency
149	5745MHz	161	5805MHz
153	5765MHz	165	5825MHz
157	5785MHz		

2 channels are provided for 802.11n (HT40), 802.11ac (VHT40):

Channel	Frequency	Channel	Frequency
151	5755MHz	159	5795MHz

1 channel is provided for 802.11ac (VHT80):

Channel	Frequency
155	5775MHz

3.2.1 Test Mode Applicability and Tested Channel Detail

EUT Configure Mode	Applicable to				Description
	RE \geq 1G	RE<1G	PLC	APCM	
-	√	√	√	√	-

Where RE \geq 1G: Radiated Emission above 1GHz & Bandedge Measurement
 RE<1G: Radiated Emission below 1GHz
 PLC: Power Line Conducted Emission
 APCM: Antenna Port Conducted Measurement

Note: The EUT had been pre-tested on the positioned of each 3 axis. The worst case was found when positioned on **Z-plane**.

Radiated Emission Test (Above 1GHz):

- Pre-Scan has been conducted to determine the worst-case mode from all possible combinations between available modulations, data rates and antenna ports (if EUT with antenna diversity architecture).
- Following channel(s) was (were) selected for the final test as listed below.

EUT Configure Mode	Mode	Frequency Band (MHz)	Available Channel	Tested Channel	Modulation Technology	Data Rate (Mbps)
-	802.11a	5180-5240	36 to 48	36, 40, 48	OFDM	6.0
	802.11ac (VHT20)		36 to 48	36, 40, 48	OFDM	6.5
	802.11ac (VHT40)		38 to 46	38, 46	OFDM	13.5
	802.11ac (VHT80)		42	42	OFDM	29.3
-	802.11a	5745-5825	149 to 165	149, 157, 165	OFDM	6.0
	802.11ac (VHT20)		149 to 165	149, 157, 165	OFDM	6.5
	802.11ac (VHT40)		151 to 159	151, 159	OFDM	13.5
	802.11ac (VHT80)		155	155	OFDM	29.3

Radiated Emission Test (Below 1GHz):

- Pre-Scan has been conducted to determine the worst-case mode from all possible combinations between available modulations, data rates and antenna ports (if EUT with antenna diversity architecture).
- Following channel(s) was (were) selected for the final test as listed below.

EUT Configure Mode	Mode	Frequency Band (MHz)	Available Channel	Tested Channel	Modulation Technology	Data Rate (Mbps)
-	802.11a	5180-5240	36 to 48	165	OFDM	6.0
	802.11a	5745-5825	149 to 165		OFDM	6.0

Power Line Conducted Emission Test:

- Pre-Scan has been conducted to determine the worst-case mode from all possible combinations between available modulations, data rates and antenna ports (if EUT with antenna diversity architecture).
- Following channel(s) was (were) selected for the final test as listed below.

EUT Configure Mode	Mode	Frequency Band (MHz)	Available Channel	Tested Channel	Modulation Technology	Data Rate (Mbps)
-	802.11a	5180-5240	36 to 48	165	OFDM	6.0
	802.11a	5745-5825	149 to 165		OFDM	6.0

Bandwidth, Power Spectral Density and Frequency Stability Measurement:

- This item includes all test value of each mode, but only includes spectrum plot of worst value of each mode.
- Pre-Scan has been conducted to determine the worst-case mode from all possible combinations between available modulations, data rates and antenna ports (if EUT with antenna diversity architecture).
- Following channel(s) was (were) selected for the final test as listed below.

EUT Configure Mode	Mode	Frequency Band (MHz)	Available Channel	Tested Channel	Modulation Technology	Data Rate (Mbps)
-	802.11a	5180-5240	36 to 48	36, 40, 48	OFDM	6.0
	802.11ac (VHT20)		36 to 48	36, 40, 48	OFDM	6.5
	802.11ac (VHT40)		38 to 46	38, 46	OFDM	13.5
	802.11ac (VHT80)		42	42	OFDM	29.3
-	802.11a	5745-5825	149 to 165	149, 157, 165	OFDM	6.0
	802.11ac (VHT20)		149 to 165	149, 157, 165	OFDM	6.5
	802.11ac (VHT40)		151 to 159	151, 159	OFDM	13.5
	802.11ac (VHT80)		155	155	OFDM	29.3

Transmit Power Measurement:

- This item includes all test value of each mode, but only includes spectrum plot of worst value of each mode.
- Pre-Scan has been conducted to determine the worst-case mode from all possible combinations between available modulations, data rates and antenna ports (if EUT with antenna diversity architecture).
- Following channel(s) was (were) selected for the final test as listed below.

EUT Configure Mode	Mode	Frequency Band (MHz)	Available Channel	Tested Channel	Modulation Technology	Data Rate (Mbps)
-	802.11a	5180-5240	36 to 48	36, 40, 48	OFDM	6.0
	802.11n (HT20)		36 to 48	36, 40, 48	OFDM	6.5
	802.11n (HT40)		38 to 46	38, 46	OFDM	13.5
	802.11ac (VHT20)		36 to 48	36, 40, 48	OFDM	6.5
	802.11ac (VHT40)		38 to 46	38, 46	OFDM	13.5
	802.11ac (VHT80)		42	42	OFDM	29.3
-	802.11a	5745-5825	149 to 165	149, 157, 165	OFDM	6.0
	802.11n (HT20)		149 to 165	149, 157, 165	OFDM	6.5
	802.11n (HT40)		151 to 159	151, 159	OFDM	13.5
	802.11ac (VHT20)		149 to 165	149, 157, 165	OFDM	6.5
	802.11ac (VHT40)		151 to 159	151, 159	OFDM	13.5
	802.11ac (VHT80)		155	155	OFDM	29.3

*802.11n (HT20), 802.11n (HT40) are for Conducted Output Power Measurement only.

Test Condition:

Applicable to	Environmental Conditions	Input Power	Tested by
RE \geq 1G	25 deg. C, 70% RH	120Vac, 60Hz	Luis Lee
RE<1G	25 deg. C, 70% RH	120Vac, 60Hz	Noah Chang
PLC	25 deg. C, 75% RH	120Vac, 60Hz	Noah Chang
APCM	25 deg. C, 76% RH	120Vac, 60Hz	Jisyong Wang

3.3 Duty Cycle of Test Signal

Duty cycle of test signal is < 98%, duty factor is required.

802.11a: Duty cycle = 2.043/2.159 = 0.946, Duty factor = $10 * \log(1/0.946) = 0.24$

802.11ac (VHT20): Duty cycle = 5.029/5.087 = 0.989

802.11ac (VHT40): Duty cycle = 2.42/2.521 = 0.96, Duty factor = $10 * \log(1/0.96) = 0.18$

802.11ac (VHT80): Duty cycle = 1.144/1.239 = 0.923, Duty factor = $10 * \log(1/0.923) = 0.35$

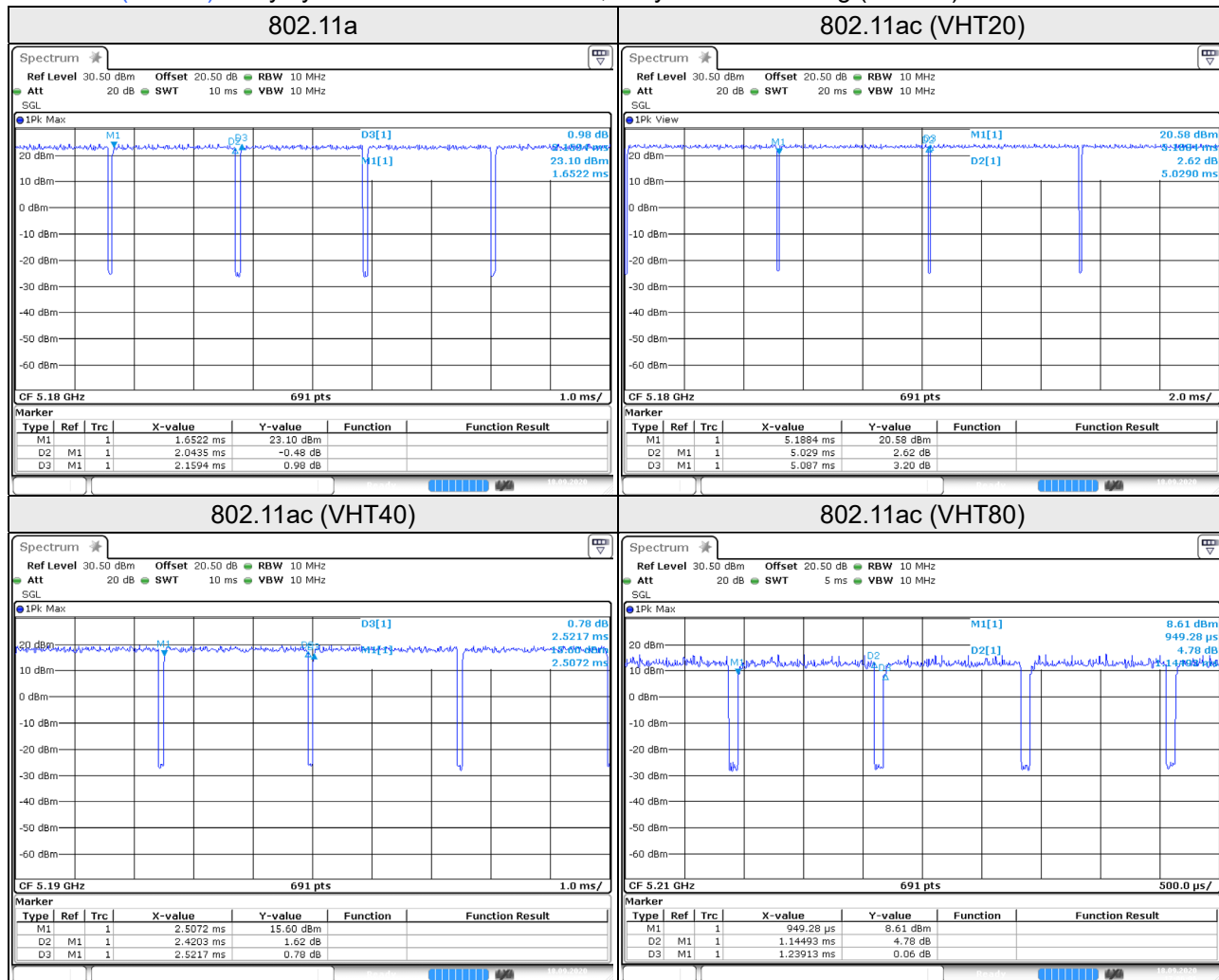

3.4 Description of Support Units

The EUT has been tested as an independent unit together with other necessary accessories or support units. The following support units or accessories were used to form a representative test configuration during the tests.

ID	Product	Brand	Model No.	Serial No.	FCC ID	Remarks
A.	Notebook	DELL	E5410	1HC2XM1	FCC DoC Approved	-
B.	Convertible board	NA	NA	NA	NA	Provided by client

Note:

1. All power cords of the above support units are non-shielded (1.8m).
2. Item A acted as a communication partners to transfer data.

ID	Descriptions	Qty.	Length (m)	Shielding (Yes/No)	Cores (Qty.)	Remarks
1.	LAN	1	10	N	0	RJ45, Cat5e

3.4.1 Configuration of System under Test

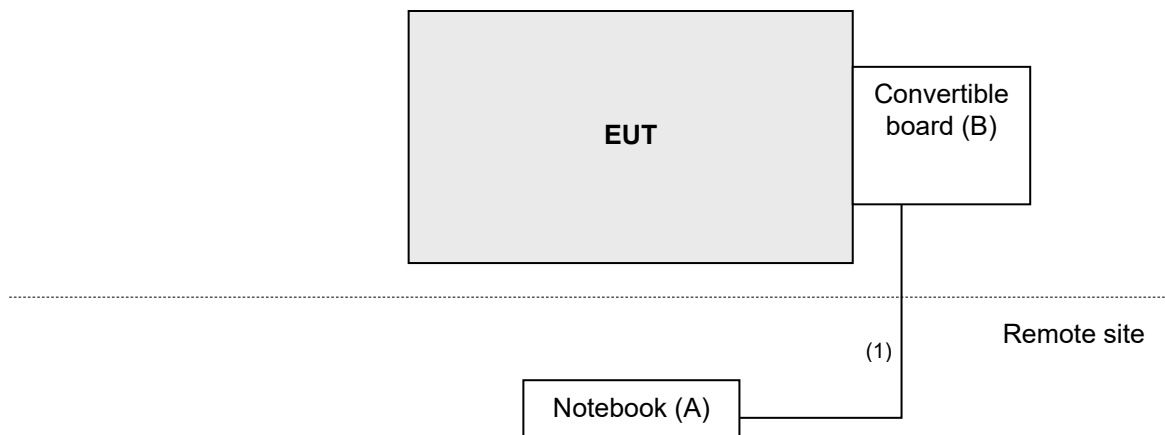

3.5 General Description of Applied Standards and References

The EUT is a RF Product. According to the specifications of the manufacturer, it must comply with the requirements of the following standards and references:

Test standard:

FCC Part 15, Subpart E (15.407)

ANSI C63.10:2013

All test items have been performed and recorded as per the above standards.

References Test Guidance:

KDB 789033 D02 General UNII Test Procedure New Rules v02r01

KDB 662911 D01 Multiple Transmitter Output v02r01

All test items have been performed as a reference to the above KDB test guidance.

4 Test Types and Results

4.1 Radiated Emission and Bandedge Measurement

4.1.1 Limits of Radiated Emission and Bandedge Measurement

Radiated emissions which fall in the restricted bands must comply with the radiated emission limits specified as below table.

Frequencies (MHz)	Field Strength (microvolts/meter)	Measurement Distance (meters)
0.009 ~ 0.490	2400/F(kHz)	300
0.490 ~ 1.705	24000/F(kHz)	30
1.705 ~ 30.0	30	30
30 ~ 88	100	3
88 ~ 216	150	3
216 ~ 960	200	3
Above 960	500	3

Note:

1. The lower limit shall apply at the transition frequencies.
2. Emission level (dBuV/m) = 20 log Emission level (uV/m).
3. For frequencies above 1000MHz, the field strength limits are based on average detector, however, the peak field strength of any emission shall not exceed the maximum permitted average limits, specified above by more than 20dB under any condition of modulation.

Limits of unwanted emission out of the restricted bands

Applicable To		Limit	
789033 D02 General UNII Test Procedure New Rules v02r01		Field Strength at 3m	
		PK: 74 (dBµV/m)	AV: 54 (dBµV/m)
Frequency Band	Applicable To	EIRP Limit	Equivalent Field Strength at 3m
5150~5250 MHz	15.407(b)(1)	PK: -27 (dBm/MHz)	PK: 68.2(dBµV/m)
5250~5350 MHz	15.407(b)(2)		
5470~5725 MHz	15.407(b)(3)		
5725~5850 MHz	<input checked="" type="checkbox"/> 15.407(b)(4)(i)	PK: -27 (dBm/MHz) ^{*1} PK: 10 (dBm/MHz) ^{*2} PK: 15.6 (dBm/MHz) ^{*3} PK: 27 (dBm/MHz) ^{*4}	PK: 68.2(dBµV/m) ^{*1} PK: 105.2 (dBµV/m) ^{*2} PK: 110.8(dBµV/m) ^{*3} PK: 122.2 (dBµV/m) ^{*4}
	<input type="checkbox"/> 15.407(b)(4)(ii)	Emission limits in section 15.247(d)	
^{*1} beyond 75 MHz or more above of the band edge.		^{*2} below the band edge increasing linearly to 10 dBm/MHz at 25 MHz above.	
^{*3} below the band edge increasing linearly to a level of 15.6 dBm/MHz at 5 MHz above.		^{*4} from 5 MHz above or below the band edge increasing linearly to a level of 27 dBm/MHz at the band edge.	

Note: The following formula is used to convert the equipment isotropic radiated power (eirp) to field strength:

$$E = \frac{1000000 \sqrt{30P}}{3} \text{ } \mu\text{V/m, where P is the eirp (Watts).}$$

4.1.2 Test Instruments

Description & Manufacturer	Model No.	Serial No.	Date of Calibration	Due Date of Calibration
Test Receiver ROHDE & SCHWARZ	ESCI	100424	Dec. 31, 2019	Dec. 30, 2020
Spectrum Analyzer ROHDE & SCHWARZ	FSP40	100269	Jun. 09, 2020	Jun. 08, 2021
BILOG Antenna SCHWARZBECK	VULB9168	9168-171	Nov. 11, 2019	Nov. 10, 2020
HORN Antenna SCHWARZBECK	9120D	209	Nov. 24, 2019	Nov. 23, 2020
HORN Antenna SCHWARZBECK	BBHA 9170	BBHA9170241	Nov. 24, 2019	Nov. 23, 2020
Loop Antenna TESEQ	HLA 6121	45745	Jul. 06, 2020	Jul. 05, 2021
Preamplifier Agilent (Below 1GHz)	8447D	2944A10631	Jun. 08, 2020	Jun. 07, 2021
Preamplifier KEYSIGHT (Above 1GHz)	83017A	MY53270295	Jun. 08, 2020	Jun. 07, 2021
RF Coaxial Cable WOKEN With 5dB PAD	8D-FB	Cable-CH4-01	Aug. 16, 2020	Aug. 15, 2021
RF Coaxial Cable EMCI	EMC102-KM-KM-3 000	150929	Aug. 16, 2020	Aug. 15, 2021
RF Coaxial Cable EMCI	EMC102-KM-KM-6 00	150928	Aug. 16, 2020	Aug. 15, 2021
Software BV ADT	ADT_Radiated_ V7.6.15.9.5	NA	NA	NA
Antenna Tower inn-co GmbH	MA 4000	013303	NA	NA
Antenna Tower Controller BV ADT	AT100	AT93021703	NA	NA
Turn Table BV ADT	TT100	TT93021703	NA	NA
Turn Table Controller BV ADT	SC100	SC93021703	NA	NA
Boresight Antenna Fixture	FBA-01	FBA-SIP01	NA	NA
USB Wideband Power Sensor KEYSIGHT	U2021XA	MY55050005/MY5 5190004/MY55190 007/MY55210005	Jul. 13, 2020	Jul. 12, 2021

Note: 1. The calibration interval of the above test instruments is 12 months and the calibrations are traceable to NML/ROC and NIST/USA.
2. The test was performed in HwaYa Chamber 4.

4.1.3 Test Procedures

For Radiated emission below 30MHz

- a. The EUT was placed on the top of a rotating table 0.8 meters above the ground at a 3 meter chamber room. The table was rotated 360 degrees to determine the position of the highest radiation.
- b. The EUT was set 3 meters away from the interference-receiving antenna, which was mounted on the top of a variable-height antenna tower.
- c. Parallel, perpendicular, and ground-parallel orientations of the antenna are set to make the measurement.
- d. For each suspected emission, the EUT was arranged to its worst case and the rotatable table was turned from 0 degrees to 360 degrees to find the maximum reading.
- e. The test-receiver system was set to Quasi-Peak Detect Function and Specified Bandwidth with Maximum Hold Mode.

Note:

1. The resolution bandwidth and video bandwidth of test receiver/spectrum analyzer is 9kHz at frequency below 30MHz.

For Radiated emission above 30MHz

- a. The EUT was placed on the top of a rotating table 0.8 meters (for 30MHz ~ 1GHz) / 1.5 meters (for above 1GHz) above the ground at 3 meter chamber room for test. The table was rotated 360 degrees to determine the position of the highest radiation.
- b. The EUT was set 3 meters away from the interference-receiving antenna, which was mounted on the top of a variable-height antenna tower.
- c. The height of antenna is varied from one meter to four meters above the ground to determine the maximum value of the field strength. Both horizontal and vertical polarizations of the antenna are set to make the measurement.
- d. For each suspected emission, the EUT was arranged to its worst case and then the antenna was tuned to heights from 1 meter to 4 meters and the rotatable table was turned from 0 degrees to 360 degrees to find the maximum reading.
- e. The test-receiver system was set to quasi-peak detect function and specified bandwidth with maximum hold mode when the test frequency is below 1 GHz.
- f. The test-receiver system was set to peak and average detect function and specified bandwidth with maximum hold mode when the test frequency is above 1 GHz. If the peak reading value also meets average limit, measurement with the average detector is unnecessary.

Note:

1. The resolution bandwidth and video bandwidth of test receiver/spectrum analyzer is 120kHz for Quasi-peak detection (QP) at frequency below 1GHz.
2. The resolution bandwidth of test receiver/spectrum analyzer is 1 MHz and the video bandwidth is 3 MHz for Peak detection (PK) at frequency above 1GHz.
3. The resolution bandwidth of test receiver/spectrum analyzer is 1MHz and the video bandwidth is $\geq 1/T$ (Duty cycle < 98%) or 10Hz (Duty cycle $\geq 98\%$) for Average detection (AV) at frequency above 1GHz. (802.11a: RBW = 1MHz, VBW = 1kHz; 802.11ac (VHT20): RBW = 1MHz, VBW = 10Hz; 802.11ac (VHT40): RBW = 1MHz, VBW = 1kHz; 802.11ac (VHT80): RBW = 1MHz, VBW = 1kHz)
4. All modes of operation were investigated and the worst-case emissions are reported.

4.1.4 Deviation from Test Standard

No deviation.

4.1.5 Test Setup

For Radiated emission below 30MHz

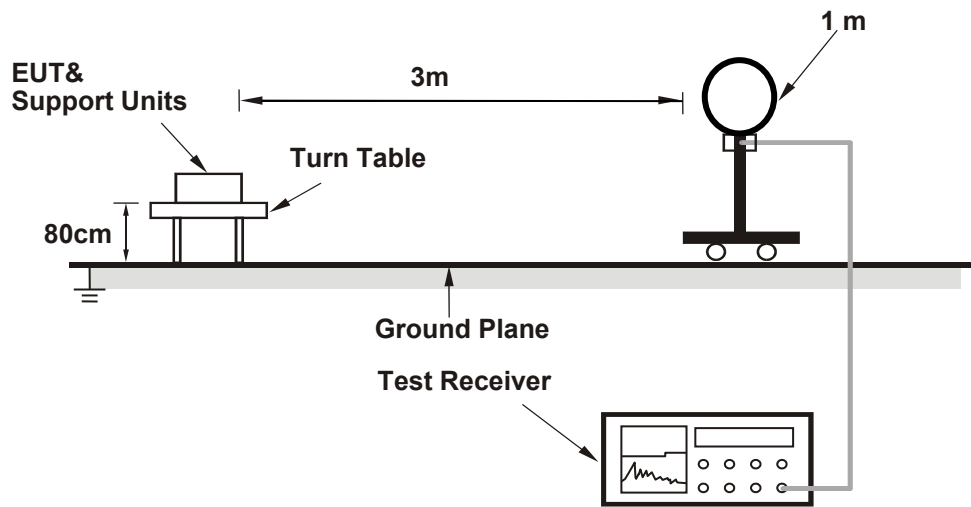

For Radiated emission 30MHz to 1GHz

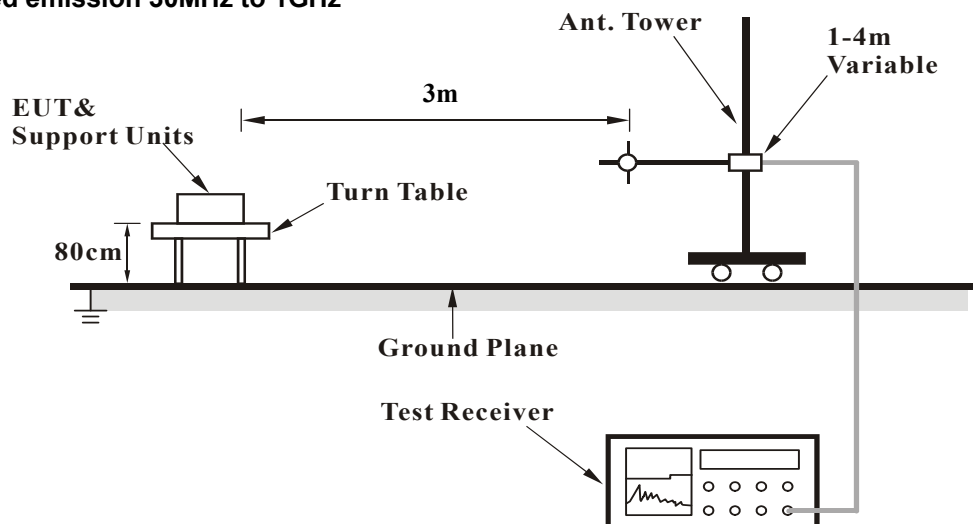

For Radiated emission above 1GHz

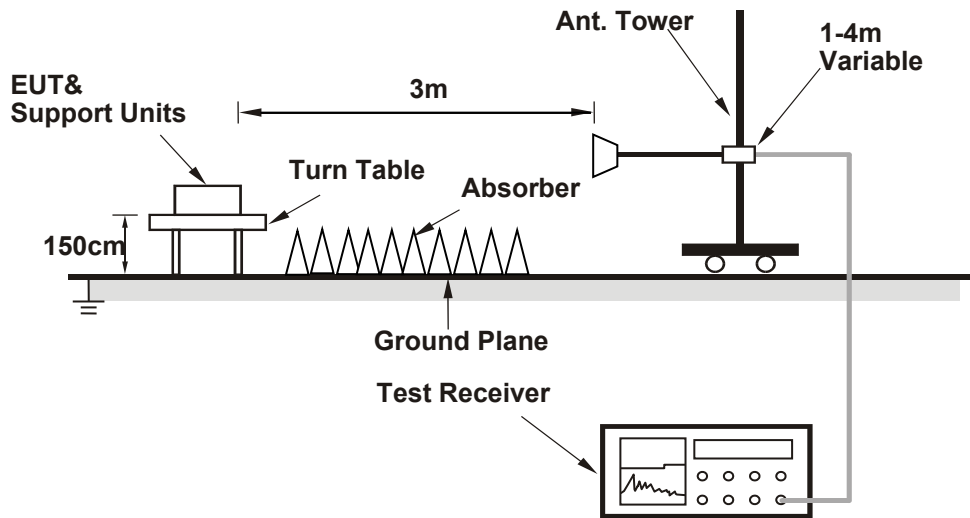

For the actual test configuration, please refer to the attached file (Test Setup Photo).

4.1.6 EUT Operating Conditions

- a. Placed the EUT on the testing table.
- b. Prepared a notebook to act as a communication partner and placed it outside of testing area.
- c. The communication partner connected with EUT via a RJ45 cable and ran a test program (provided by manufacturer) to enable EUT under transmission condition continuously at specific channel frequency.
- d. The communication partner sent data to EUT by command "PING".

4.1.7 Test Results

Above 1GHz data:

RF Mode	TX 802.11a	Channel	CH 36 : 5180 MHz
Frequency Range	1GHz ~ 40GHz	Detector Function	Peak (PK) Average (AV)

Antenna Polarity & Test Distance : Horizontal at 3 m								
No	Frequency (MHz)	Emission Level (dBuV/m)	Limit (dBuV/m)	Margin (dB)	Antenna Height (m)	Table Angle (Degree)	Raw Value (dBuV)	Correction Factor (dB/m)
1	5150.00	62.4 PK	74.0	-11.6	1.03 H	10	51.9	10.5
2	5150.00	50.1 AV	54.0	-3.9	1.03 H	10	39.6	10.5
3	*5180.00	104.8 PK			1.03 H	10	65.2	39.6
4	*5180.00	95.7 AV			1.03 H	10	56.1	39.6
5	#10360.00	59.3 PK	68.2	-8.9	1.11 H	105	38.2	21.1
Antenna Polarity & Test Distance : Vertical at 3 m								
No	Frequency (MHz)	Emission Level (dBuV/m)	Limit (dBuV/m)	Margin (dB)	Antenna Height (m)	Table Angle (Degree)	Raw Value (dBuV)	Correction Factor (dB/m)
1	5150.00	66.2 PK	74.0	-7.8	1.35 V	257	55.7	10.5
2	5150.00	53.0 AV	54.0	-1.0	1.35 V	257	42.5	10.5
3	*5180.00	109.3 PK			1.00 V	265	69.7	39.6
4	*5180.00	100.7 AV			1.00 V	265	61.1	39.6
5	#10360.00	59.7 PK	68.2	-8.5	1.03 V	262	38.6	21.1

Remarks:

1. Emission Level(dBuV/m) = Raw Value(dBuV) + Correction Factor(dB/m).
2. Correction Factor(dB/m) = Antenna Factor(dB/m) + Cable Factor(dB) – Pre-Amplifier Factor(dB).
3. Margin value = Emission Level – Limit value.
4. The other emission levels were very low against the limit.
5. " * " : Fundamental frequency.
6. " # " : The radiated frequency is out of the restricted band.

RF Mode	TX 802.11a	Channel	CH 40 : 5200 MHz
Frequency Range	1GHz ~ 40GHz	Detector Function	Peak (PK) Average (AV)

Antenna Polarity & Test Distance : Horizontal at 3 m								
No	Frequency (MHz)	Emission Level (dBuV/m)	Limit (dBuV/m)	Margin (dB)	Antenna Height (m)	Table Angle (Degree)	Raw Value (dBuV)	Correction Factor (dB/m)
1	*5200.00	105.9 PK			1.00 H	15	66.3	39.6
2	*5200.00	97.2 AV			1.00 H	15	57.6	39.6
3	#10400.00	60.0 PK	68.2	-8.2	1.09 H	29	38.3	21.7
Antenna Polarity & Test Distance : Vertical at 3 m								
No	Frequency (MHz)	Emission Level (dBuV/m)	Limit (dBuV/m)	Margin (dB)	Antenna Height (m)	Table Angle (Degree)	Raw Value (dBuV)	Correction Factor (dB/m)
1	*5200.00	109.5 PK			1.00 V	266	69.9	39.6
2	*5200.00	101.0 AV			1.00 V	266	61.4	39.6
3	#10400.00	60.3 PK	68.2	-7.9	1.09 V	306	38.6	21.7

Remarks:

1. Emission Level(dBuV/m) = Raw Value(dBuV) + Correction Factor(dB/m).
2. Correction Factor(dB/m) = Antenna Factor(dB/m) + Cable Factor(dB) – Pre-Amplifier Factor(dB).
3. Margin value = Emission Level – Limit value.
4. The other emission levels were very low against the limit.
5. " * ": Fundamental frequency.
6. " # ": The radiated frequency is out of the restricted band.

RF Mode	TX 802.11a	Channel	CH 48 : 5240 MHz
Frequency Range	1GHz ~ 40GHz	Detector Function	Peak (PK) Average (AV)

Antenna Polarity & Test Distance : Horizontal at 3 m								
No	Frequency (MHz)	Emission Level (dBuV/m)	Limit (dBuV/m)	Margin (dB)	Antenna Height (m)	Table Angle (Degree)	Raw Value (dBuV)	Correction Factor (dB/m)
1	*5240.00	105.8 PK			1.03 H	19	66.6	39.2
2	*5240.00	96.1 AV			1.03 H	19	56.9	39.2
3	5350.00	54.6 PK	74.0	-19.4	1.03 H	19	44.7	9.9
4	5350.00	43.7 AV	54.0	-10.3	1.03 H	19	33.8	9.9
5	#10480.00	59.3 PK	68.2	-8.9	3.26 H	333	38.4	20.9

Antenna Polarity & Test Distance : Vertical at 3 m								
No	Frequency (MHz)	Emission Level (dBuV/m)	Limit (dBuV/m)	Margin (dB)	Antenna Height (m)	Table Angle (Degree)	Raw Value (dBuV)	Correction Factor (dB/m)
1	*5240.00	108.6 PK			1.03 V	262	69.4	39.2
2	*5240.00	99.9 AV			1.03 V	262	60.7	39.2
3	5350.00	56.2 PK	74.0	-17.8	1.03 V	262	46.3	9.9
4	5350.00	45.0 AV	54.0	-9.0	1.03 V	262	35.1	9.9
5	#10480.00	59.8 PK	68.2	-8.4	1.69 V	105	38.9	20.9

Remarks:

1. Emission Level(dBuV/m) = Raw Value(dBuV) + Correction Factor(dB/m).
2. Correction Factor(dB/m) = Antenna Factor(dB/m) + Cable Factor(dB) – Pre-Amplifier Factor(dB).
3. Margin value = Emission Level – Limit value.
4. The other emission levels were very low against the limit.
5. " * ": Fundamental frequency.
6. " # ": The radiated frequency is out of the restricted band.

RF Mode	TX 802.11a	Channel	CH 149 : 5745 MHz
Frequency Range	1GHz ~ 40GHz	Detector Function	Peak (PK) Average (AV)

Antenna Polarity & Test Distance : Horizontal at 3 m								
No	Frequency (MHz)	Emission Level (dBuV/m)	Limit (dBuV/m)	Margin (dB)	Antenna Height (m)	Table Angle (Degree)	Raw Value (dBuV)	Correction Factor (dB/m)
1	#5614.40	58.8 PK	68.2	-9.4	1.00 H	10	48.4	10.4
2	*5745.00	107.7 PK			1.00 H	10	67.5	40.2
3	*5745.00	98.0 AV			1.00 H	10	57.8	40.2
4	#5939.60	60.0 PK	68.2	-8.2	1.00 H	10	49.1	10.9
5	11490.00	61.3 PK	74.0	-12.7	3.16 H	305	38.2	23.1
6	11490.00	50.4 AV	54.0	-3.6	3.16 H	305	27.3	23.1

Antenna Polarity & Test Distance : Vertical at 3 m								
No	Frequency (MHz)	Emission Level (dBuV/m)	Limit (dBuV/m)	Margin (dB)	Antenna Height (m)	Table Angle (Degree)	Raw Value (dBuV)	Correction Factor (dB/m)
1	#5630.00	59.3 PK	68.2	-8.9	1.13 V	286	49.0	10.3
2	*5745.00	112.6 PK			1.13 V	286	72.4	40.2
3	*5745.00	103.2 AV			1.13 V	286	63.0	40.2
4	#5936.80	61.1 PK	68.2	-7.1	1.13 V	286	50.2	10.9
5	11490.00	61.9 PK	74.0	-12.1	1.13 V	286	38.8	23.1
6	11490.00	50.4 AV	54.0	-3.6	1.13 V	286	27.3	23.1

Remarks:

1. Emission Level(dBuV/m) = Raw Value(dBuV) + Correction Factor(dB/m).
2. Correction Factor(dB/m) = Antenna Factor(dB/m) + Cable Factor(dB) – Pre-Amplifier Factor(dB).
3. Margin value = Emission Level – Limit value.
4. The other emission levels were very low against the limit.
5. " * " : Fundamental frequency.
6. " # " : The radiated frequency is out of the restricted band.

RF Mode	TX 802.11a	Channel	CH 157 : 5785 MHz
Frequency Range	1GHz ~ 40GHz	Detector Function	Peak (PK) Average (AV)

Antenna Polarity & Test Distance : Horizontal at 3 m								
No	Frequency (MHz)	Emission Level (dBuV/m)	Limit (dBuV/m)	Margin (dB)	Antenna Height (m)	Table Angle (Degree)	Raw Value (dBuV)	Correction Factor (dB/m)
1	#5600.80	58.0 PK	68.2	-10.2	1.00 H	30	47.6	10.4
2	*5785.00	106.9 PK			1.00 H	30	66.5	40.4
3	*5785.00	97.4 AV			1.00 H	30	57.0	40.4
4	#5931.60	59.4 PK	68.2	-8.8	1.00 H	30	48.4	11.0
5	11570.00	61.1 PK	74.0	-12.9	3.11 H	311	38.2	22.9
6	11570.00	49.8 AV	54.0	-4.2	3.11 H	311	26.9	22.9

Antenna Polarity & Test Distance : Vertical at 3 m								
No	Frequency (MHz)	Emission Level (dBuV/m)	Limit (dBuV/m)	Margin (dB)	Antenna Height (m)	Table Angle (Degree)	Raw Value (dBuV)	Correction Factor (dB/m)
1	#5620.40	60.1 PK	68.2	-8.1	1.00 V	286	49.7	10.4
2	*5785.00	111.9 PK			1.00 V	286	71.5	40.4
3	*5785.00	102.4 AV			1.00 V	286	62.0	40.4
4	#5992.00	59.3 PK	68.2	-8.9	1.00 V	286	48.3	11.0
5	11570.00	61.6 PK	74.0	-12.4	1.05 V	139	38.7	22.9
6	11570.00	50.2 AV	54.0	-3.8	1.05 V	139	27.3	22.9

Remarks:

1. Emission Level(dBuV/m) = Raw Value(dBuV) + Correction Factor(dB/m).
2. Correction Factor(dB/m) = Antenna Factor(dB/m) + Cable Factor(dB) – Pre-Amplifier Factor(dB).
3. Margin value = Emission Level – Limit value.
4. The other emission levels were very low against the limit.
5. " * " : Fundamental frequency.
6. " # " : The radiated frequency is out of the restricted band.

RF Mode	TX 802.11a	Channel	CH 165 : 5825 MHz
Frequency Range	1GHz ~ 40GHz	Detector Function	Peak (PK) Average (AV)

Antenna Polarity & Test Distance : Horizontal at 3 m								
No	Frequency (MHz)	Emission Level (dBuV/m)	Limit (dBuV/m)	Margin (dB)	Antenna Height (m)	Table Angle (Degree)	Raw Value (dBuV)	Correction Factor (dB/m)
1	#5604.80	58.8 PK	68.2	-9.4	1.00 H	28	48.4	10.4
2	*5825.00	106.5 PK			1.00 H	28	65.8	40.7
3	*5825.00	97.3 AV			1.00 H	28	56.6	40.7
4	#5961.20	59.2 PK	68.2	-9.0	1.00 H	28	48.2	11.0
5	11650.00	61.2 PK	74.0	-12.8	1.66 H	166	38.6	22.6
6	11650.00	49.5 AV	54.0	-4.5	1.66 H	166	26.9	22.6

Antenna Polarity & Test Distance : Vertical at 3 m								
No	Frequency (MHz)	Emission Level (dBuV/m)	Limit (dBuV/m)	Margin (dB)	Antenna Height (m)	Table Angle (Degree)	Raw Value (dBuV)	Correction Factor (dB/m)
1	#5647.20	59.4 PK	68.2	-8.8	1.07 V	280	49.0	10.4
2	*5825.00	112.8 PK			1.07 V	280	72.1	40.7
3	*5825.00	102.5 AV			1.07 V	280	61.8	40.7
4	#5983.60	59.5 PK	68.2	-8.7	1.07 V	280	48.6	10.9
5	11650.00	61.2 PK	74.0	-12.8	1.36 V	31	38.6	22.6
6	11650.00	49.9 AV	54.0	-4.1	1.36 V	31	27.3	22.6

Remarks:

1. Emission Level(dBuV/m) = Raw Value(dBuV) + Correction Factor(dB/m).
2. Correction Factor(dB/m) = Antenna Factor(dB/m) + Cable Factor(dB) – Pre-Amplifier Factor(dB).
3. Margin value = Emission Level – Limit value.
4. The other emission levels were very low against the limit.
5. " * " : Fundamental frequency.
6. " # " : The radiated frequency is out of the restricted band.

RF Mode	TX 802.11ac (VHT20)	Channel	CH 36 : 5180 MHz
Frequency Range	1GHz ~ 40GHz	Detector Function	Peak (PK) Average (AV)

Antenna Polarity & Test Distance : Horizontal at 3 m								
No	Frequency (MHz)	Emission Level (dBuV/m)	Limit (dBuV/m)	Margin (dB)	Antenna Height (m)	Table Angle (Degree)	Raw Value (dBuV)	Correction Factor (dB/m)
1	5150.00	62.1 PK	74.0	-11.9	1.00 H	10	51.6	10.5
2	5150.00	50.5 AV	54.0	-3.5	1.00 H	10	40.0	10.5
3	*5180.00	104.8 PK			1.00 H	10	65.2	39.6
4	*5180.00	95.3 AV			1.00 H	10	55.7	39.6
5	#10360.00	59.2 PK	68.2	-9.0	3.16 H	333	38.1	21.1

Antenna Polarity & Test Distance : Vertical at 3 m								
No	Frequency (MHz)	Emission Level (dBuV/m)	Limit (dBuV/m)	Margin (dB)	Antenna Height (m)	Table Angle (Degree)	Raw Value (dBuV)	Correction Factor (dB/m)
1	5150.00	65.1 PK	74.0	-8.9	1.00 V	264	54.6	10.5
2	5150.00	53.0 AV	54.0	-1.0	1.00 V	264	42.5	10.5
3	*5180.00	109.2 PK			1.00 V	264	69.6	39.6
4	*5180.00	99.5 AV			1.00 V	264	59.9	39.6
5	#10360.00	59.9 PK	68.2	-8.3	3.06 V	316	38.8	21.1

Remarks:

1. Emission Level(dBuV/m) = Raw Value(dBuV) + Correction Factor(dB/m).
2. Correction Factor(dB/m) = Antenna Factor(dB/m) + Cable Factor(dB) – Pre-Amplifier Factor(dB).
3. Margin value = Emission Level – Limit value.
4. The other emission levels were very low against the limit.
5. " * ": Fundamental frequency.
6. " # ": The radiated frequency is out of the restricted band.

RF Mode	TX 802.11ac (VHT20)	Channel	CH 40 : 5200 MHz
Frequency Range	1GHz ~ 40GHz	Detector Function	Peak (PK) Average (AV)

Antenna Polarity & Test Distance : Horizontal at 3 m								
No	Frequency (MHz)	Emission Level (dBuV/m)	Limit (dBuV/m)	Margin (dB)	Antenna Height (m)	Table Angle (Degree)	Raw Value (dBuV)	Correction Factor (dB/m)
1	*5200.00	105.5 PK			2.00 H	15	65.9	39.6
2	*5200.00	97.0 AV			2.00 H	15	57.4	39.6
3	#10400.00	60.1 PK	68.2	-8.1	2.55 H	215	38.4	21.7
Antenna Polarity & Test Distance : Vertical at 3 m								
No	Frequency (MHz)	Emission Level (dBuV/m)	Limit (dBuV/m)	Margin (dB)	Antenna Height (m)	Table Angle (Degree)	Raw Value (dBuV)	Correction Factor (dB/m)
1	*5200.00	109.8 PK			1.00 V	269	70.2	39.6
2	*5200.00	101.1 AV			1.00 V	269	61.5	39.6
3	#10400.00	60.6 PK	68.2	-7.6	3.16 V	15	38.9	21.7

Remarks:

1. Emission Level(dBuV/m) = Raw Value(dBuV) + Correction Factor(dB/m).
2. Correction Factor(dB/m) = Antenna Factor(dB/m) + Cable Factor(dB) – Pre-Amplifier Factor(dB).
3. Margin value = Emission Level – Limit value.
4. The other emission levels were very low against the limit.
5. " * ": Fundamental frequency.
6. " # ": The radiated frequency is out of the restricted band.

RF Mode	TX 802.11ac (VHT20)	Channel	CH 48 : 5240 MHz
Frequency Range	1GHz ~ 40GHz	Detector Function	Peak (PK) Average (AV)

Antenna Polarity & Test Distance : Horizontal at 3 m								
No	Frequency (MHz)	Emission Level (dBuV/m)	Limit (dBuV/m)	Margin (dB)	Antenna Height (m)	Table Angle (Degree)	Raw Value (dBuV)	Correction Factor (dB/m)
1	*5240.00	106.2 PK			1.05 H	13	67.0	39.2
2	*5240.00	95.9 AV			1.05 H	13	56.7	39.2
3	5350.00	54.2 PK	74.0	-19.8	1.05 H	13	44.3	9.9
4	5350.00	43.8 AV	54.0	-10.2	1.05 H	13	33.9	9.9
5	#10480.00	59.0 PK	68.2	-9.2	3.01 H	316	38.1	20.9

Antenna Polarity & Test Distance : Vertical at 3 m								
No	Frequency (MHz)	Emission Level (dBuV/m)	Limit (dBuV/m)	Margin (dB)	Antenna Height (m)	Table Angle (Degree)	Raw Value (dBuV)	Correction Factor (dB/m)
1	*5240.00	109.0 PK			1.05 V	264	69.8	39.2
2	*5240.00	99.9 AV			1.05 V	264	60.7	39.2
3	5350.00	55.5 PK	74.0	-18.5	1.05 V	264	45.6	9.9
4	5350.00	44.9 AV	54.0	-9.1	1.05 V	264	35.0	9.9
5	#10480.00	59.6 PK	68.2	-8.6	3.16 V	30	38.7	20.9

Remarks:

1. Emission Level(dBuV/m) = Raw Value(dBuV) + Correction Factor(dB/m).
2. Correction Factor(dB/m) = Antenna Factor(dB/m) + Cable Factor(dB) – Pre-Amplifier Factor(dB).
3. Margin value = Emission Level – Limit value.
4. The other emission levels were very low against the limit.
5. " * ": Fundamental frequency.
6. " # ": The radiated frequency is out of the restricted band.

RF Mode	TX 802.11ac (VHT20)	Channel	CH 149 : 5745 MHz
Frequency Range	1GHz ~ 40GHz	Detector Function	Peak (PK) Average (AV)

Antenna Polarity & Test Distance : Horizontal at 3 m								
No	Frequency (MHz)	Emission Level (dBuV/m)	Limit (dBuV/m)	Margin (dB)	Antenna Height (m)	Table Angle (Degree)	Raw Value (dBuV)	Correction Factor (dB/m)
1	#5622.40	59.0 PK	68.2	-9.2	1.00 H	28	48.6	10.4
2	*5745.00	107.5 PK			1.00 H	28	67.3	40.2
3	*5745.00	97.5 AV			1.00 H	28	57.3	40.2
4	#5928.80	58.8 PK	68.2	-9.4	1.00 H	28	47.8	11.0
5	11490.00	61.8 PK	74.0	-12.2	1.69 H	105	38.7	23.1
6	11490.00	49.8 AV	54.0	-4.2	1.69 H	105	26.7	23.1

Antenna Polarity & Test Distance : Vertical at 3 m								
No	Frequency (MHz)	Emission Level (dBuV/m)	Limit (dBuV/m)	Margin (dB)	Antenna Height (m)	Table Angle (Degree)	Raw Value (dBuV)	Correction Factor (dB/m)
1	#5647.20	61.2 PK	68.2	-7.0	1.07 V	283	50.8	10.4
2	*5745.00	112.5 PK			1.07 V	283	72.3	40.2
3	*5745.00	102.5 AV			1.07 V	283	62.3	40.2
4	#5982.80	59.2 PK	68.2	-9.0	1.07 V	283	48.3	10.9
5	11490.00	62.1 PK	74.0	-11.9	1.69 V	163	39.0	23.1
6	11490.00	50.5 AV	54.0	-3.5	1.69 V	163	27.4	23.1

Remarks:

1. Emission Level(dBuV/m) = Raw Value(dBuV) + Correction Factor(dB/m).
2. Correction Factor(dB/m) = Antenna Factor(dB/m) + Cable Factor(dB) – Pre-Amplifier Factor(dB).
3. Margin value = Emission Level – Limit value.
4. The other emission levels were very low against the limit.
5. " * " : Fundamental frequency.
6. " # " : The radiated frequency is out of the restricted band.

RF Mode	TX 802.11ac (VHT20)	Channel	CH 157 : 5785 MHz
Frequency Range	1GHz ~ 40GHz	Detector Function	Peak (PK) Average (AV)

Antenna Polarity & Test Distance : Horizontal at 3 m								
No	Frequency (MHz)	Emission Level (dBuV/m)	Limit (dBuV/m)	Margin (dB)	Antenna Height (m)	Table Angle (Degree)	Raw Value (dBuV)	Correction Factor (dB/m)
1	#5606.40	58.5 PK	68.2	-9.7	1.69 H	13	48.1	10.4
2	*5785.00	107.4 PK			1.69 H	13	67.0	40.4
3	*5785.00	106.7 AV			1.69 H	13	66.3	40.4
4	#5934.40	58.9 PK	68.2	-9.3	1.69 H	13	48.0	10.9
5	11570.00	61.2 PK	74.0	-12.8	1.11 H	158	38.3	22.9
6	11570.00	49.8 AV	54.0	-4.2	1.11 H	158	26.9	22.9

Antenna Polarity & Test Distance : Vertical at 3 m								
No	Frequency (MHz)	Emission Level (dBuV/m)	Limit (dBuV/m)	Margin (dB)	Antenna Height (m)	Table Angle (Degree)	Raw Value (dBuV)	Correction Factor (dB/m)
1	#5617.60	58.9 PK	68.2	-9.3	1.05 V	285	48.5	10.4
2	*5785.00	111.9 PK			1.05 V	285	71.5	40.4
3	*5785.00	102.5 AV			1.05 V	285	62.1	40.4
4	#5962.00	60.3 PK	68.2	-7.9	1.05 V	285	49.3	11.0
5	11570.00	61.8 PK	74.0	-12.2	3.16 V	333	38.9	22.9
6	11570.00	50.2 AV	54.0	-3.8	3.16 V	333	27.3	22.9

Remarks:

1. Emission Level(dBuV/m) = Raw Value(dBuV) + Correction Factor(dB/m).
2. Correction Factor(dB/m) = Antenna Factor(dB/m) + Cable Factor(dB) – Pre-Amplifier Factor(dB).
3. Margin value = Emission Level – Limit value.
4. The other emission levels were very low against the limit.
5. " * " : Fundamental frequency.
6. " # " : The radiated frequency is out of the restricted band.

RF Mode	TX 802.11ac (VHT20)	Channel	CH 165 : 5825 MHz
Frequency Range	1GHz ~ 40GHz	Detector Function	Peak (PK) Average (AV)

Antenna Polarity & Test Distance : Horizontal at 3 m								
No	Frequency (MHz)	Emission Level (dBuV/m)	Limit (dBuV/m)	Margin (dB)	Antenna Height (m)	Table Angle (Degree)	Raw Value (dBuV)	Correction Factor (dB/m)
1	#5604.00	58.8 PK	68.2	-9.4	1.96 H	20	48.4	10.4
2	*5825.00	107.9 PK			1.96 H	20	67.2	40.7
3	*5825.00	98.0 AV			1.96 H	20	57.3	40.7
4	#5956.80	59.3 PK	68.2	-8.9	1.96 H	20	48.3	11.0
5	11650.00	61.2 PK	74.0	-12.8	1.69 H	111	38.6	22.6
6	11650.00	49.6 AV	54.0	-4.4	1.69 H	111	27.0	22.6

Antenna Polarity & Test Distance : Vertical at 3 m								
No	Frequency (MHz)	Emission Level (dBuV/m)	Limit (dBuV/m)	Margin (dB)	Antenna Height (m)	Table Angle (Degree)	Raw Value (dBuV)	Correction Factor (dB/m)
1	#5614.80	59.6 PK	68.2	-8.6	1.19 V	285	49.2	10.4
2	*5825.00	112.6 PK			1.19 V	285	71.9	40.7
3	*5825.00	102.3 AV			1.19 V	285	61.6	40.7
4	#5958.40	60.2 PK	68.2	-8.0	1.19 V	285	49.2	11.0
5	11650.00	61.5 PK	74.0	-12.5	3.16 V	339	38.9	22.6
6	11650.00	50.0 AV	54.0	-4.0	3.16 V	339	27.4	22.6

Remarks:

1. Emission Level(dBuV/m) = Raw Value(dBuV) + Correction Factor(dB/m).
2. Correction Factor(dB/m) = Antenna Factor(dB/m) + Cable Factor(dB) – Pre-Amplifier Factor(dB).
3. Margin value = Emission Level – Limit value.
4. The other emission levels were very low against the limit.
5. " * " : Fundamental frequency.
6. " # " : The radiated frequency is out of the restricted band.

RF Mode	TX 802.11ac (VHT40)	Channel	CH 38 : 5190 MHz
Frequency Range	1GHz ~ 40GHz	Detector Function	Peak (PK) Average (AV)

Antenna Polarity & Test Distance : Horizontal at 3 m								
No	Frequency (MHz)	Emission Level (dBuV/m)	Limit (dBuV/m)	Margin (dB)	Antenna Height (m)	Table Angle (Degree)	Raw Value (dBuV)	Correction Factor (dB/m)
1	5150.00	61.1 PK	74.0	-12.9	1.00 H	26	50.6	10.5
2	5150.00	48.8 AV	54.0	-5.2	1.00 H	26	38.3	10.5
3	*5190.00	96.6 PK			1.00 H	26	57.0	39.6
4	*5190.00	86.8 AV			1.00 H	26	47.2	39.6
5	#10380.00	59.4 PK	68.2	-8.8	3.16 H	334	38.0	21.4

Antenna Polarity & Test Distance : Vertical at 3 m								
No	Frequency (MHz)	Emission Level (dBuV/m)	Limit (dBuV/m)	Margin (dB)	Antenna Height (m)	Table Angle (Degree)	Raw Value (dBuV)	Correction Factor (dB/m)
1	5150.00	66.2 PK	74.0	-7.8	1.00 V	269	55.7	10.5
2	5150.00	53.2 AV	54.0	-0.8	1.00 V	269	42.7	10.5
3	*5190.00	101.7 PK			1.00 V	269	62.1	39.6
4	*5190.00	93.3 AV			1.00 V	269	53.7	39.6
5	#10380.00	60.3 PK	68.2	-7.9	3.16 V	305	38.9	21.4

Remarks:

1. Emission Level(dBuV/m) = Raw Value(dBuV) + Correction Factor(dB/m).
2. Correction Factor(dB/m) = Antenna Factor(dB/m) + Cable Factor(dB) – Pre-Amplifier Factor(dB).
3. Margin value = Emission Level – Limit value.
4. The other emission levels were very low against the limit.
5. " * ": Fundamental frequency.
6. " # ": The radiated frequency is out of the restricted band.

RF Mode	TX 802.11ac (VHT40)	Channel	CH 46 : 5230 MHz
Frequency Range	1GHz ~ 40GHz	Detector Function	Peak (PK) Average (AV)

Antenna Polarity & Test Distance : Horizontal at 3 m								
No	Frequency (MHz)	Emission Level (dBuV/m)	Limit (dBuV/m)	Margin (dB)	Antenna Height (m)	Table Angle (Degree)	Raw Value (dBuV)	Correction Factor (dB/m)
1	*5230.00	102.3 PK			1.00 H	30	63.0	39.3
2	*5230.00	92.6 AV			1.00 H	30	53.3	39.3
3	5350.00	55.0 PK	74.0	-19.0	1.00 H	30	45.1	9.9
4	5350.00	43.6 AV	54.0	-10.4	1.00 H	30	33.7	9.9
5	#10460.00	59.1 PK	68.2	-9.1	3.16 H	306	38.0	21.1

Antenna Polarity & Test Distance : Vertical at 3 m								
No	Frequency (MHz)	Emission Level (dBuV/m)	Limit (dBuV/m)	Margin (dB)	Antenna Height (m)	Table Angle (Degree)	Raw Value (dBuV)	Correction Factor (dB/m)
1	*5230.00	106.7 PK			1.00 V	267	67.4	39.3
2	*5230.00	97.8 AV			1.00 V	267	58.5	39.3
3	5350.00	55.7 PK	74.0	-18.3	1.00 V	267	45.8	9.9
4	5350.00	45.1 AV	54.0	-8.9	1.00 V	267	35.2	9.9
5	#10460.00	59.4 PK	68.2	-8.8	1.66 V	155	38.3	21.1

Remarks:

1. Emission Level(dBuV/m) = Raw Value(dBuV) + Correction Factor(dB/m).
2. Correction Factor(dB/m) = Antenna Factor(dB/m) + Cable Factor(dB) – Pre-Amplifier Factor(dB).
3. Margin value = Emission Level – Limit value.
4. The other emission levels were very low against the limit.
5. " * ": Fundamental frequency.
6. " # ": The radiated frequency is out of the restricted band.

RF Mode	TX 802.11ac (VHT40)	Channel	CH 151 : 5755 MHz
Frequency Range	1GHz ~ 40GHz	Detector Function	Peak (PK) Average (AV)

Antenna Polarity & Test Distance : Horizontal at 3 m								
No	Frequency (MHz)	Emission Level (dBuV/m)	Limit (dBuV/m)	Margin (dB)	Antenna Height (m)	Table Angle (Degree)	Raw Value (dBuV)	Correction Factor (dB/m)
1	#5624.80	59.2 PK	68.2	-9.0	1.05 H	10	48.8	10.4
2	*5755.00	104.2 PK			1.05 H	10	64.0	40.2
3	*5755.00	94.5 AV			1.05 H	10	54.3	40.2
4	#5928.00	57.7 PK	68.2	-10.5	1.05 H	10	46.7	11.0
5	11510.00	61.2 PK	74.0	-12.8	1.11 H	115	38.2	23.0
6	11510.00	49.9 AV	54.0	-4.1	1.11 H	115	26.9	23.0

Antenna Polarity & Test Distance : Vertical at 3 m								
No	Frequency (MHz)	Emission Level (dBuV/m)	Limit (dBuV/m)	Margin (dB)	Antenna Height (m)	Table Angle (Degree)	Raw Value (dBuV)	Correction Factor (dB/m)
1	#5646.80	64.9 PK	68.2	-3.3	1.00 V	284	54.5	10.4
2	*5755.00	109.2 PK			1.00 V	284	69.0	40.2
3	*5755.00	99.6 AV			1.00 V	284	59.4	40.2
4	#5928.40	60.2 PK	68.2	-8.0	1.00 V	284	49.2	11.0
5	11510.00	61.9 PK	74.0	-12.1	1.69 V	155	38.9	23.0
6	11510.00	50.4 AV	54.0	-3.6	1.69 V	155	27.4	23.0

Remarks:

1. Emission Level(dBuV/m) = Raw Value(dBuV) + Correction Factor(dB/m).
2. Correction Factor(dB/m) = Antenna Factor(dB/m) + Cable Factor(dB) – Pre-Amplifier Factor(dB).
3. Margin value = Emission Level – Limit value.
4. The other emission levels were very low against the limit.
5. " * " : Fundamental frequency.
6. " # " : The radiated frequency is out of the restricted band.

RF Mode	TX 802.11ac (VHT40)	Channel	CH 159 : 5795 MHz
Frequency Range	1GHz ~ 40GHz	Detector Function	Peak (PK) Average (AV)

Antenna Polarity & Test Distance : Horizontal at 3 m								
No	Frequency (MHz)	Emission Level (dBuV/m)	Limit (dBuV/m)	Margin (dB)	Antenna Height (m)	Table Angle (Degree)	Raw Value (dBuV)	Correction Factor (dB/m)
1	#5630.00	58.4 PK	68.2	-9.8	1.59 H	31	48.1	10.3
2	*5795.00	105.9 PK			1.59 H	31	65.3	40.6
3	*5795.00	95.7 AV			1.59 H	31	55.1	40.6
4	#5934.00	60.4 PK	68.2	-7.8	1.59 H	31	49.5	10.9
5	11590.00	60.8 PK	74.0	-13.2	1.05 H	119	38.1	22.7
6	11590.00	49.5 AV	54.0	-4.5	1.05 H	119	26.8	22.7

Antenna Polarity & Test Distance : Vertical at 3 m								
No	Frequency (MHz)	Emission Level (dBuV/m)	Limit (dBuV/m)	Margin (dB)	Antenna Height (m)	Table Angle (Degree)	Raw Value (dBuV)	Correction Factor (dB/m)
1	#5634.40	60.3 PK	68.2	-7.9	1.00 V	285	50.0	10.3
2	*5795.00	108.8 PK			1.00 V	285	68.2	40.6
3	*5795.00	99.7 AV			1.00 V	285	59.1	40.6
4	#5935.20	62.0 PK	68.2	-6.2	1.00 V	285	51.1	10.9
5	11590.00	61.6 PK	74.0	-12.4	3.16 V	33	38.9	22.7
6	11590.00	49.7 AV	54.0	-4.3	3.16 V	33	27.0	22.7

Remarks:

1. Emission Level(dBuV/m) = Raw Value(dBuV) + Correction Factor(dB/m).
2. Correction Factor(dB/m) = Antenna Factor(dB/m) + Cable Factor(dB) – Pre-Amplifier Factor(dB).
3. Margin value = Emission Level – Limit value.
4. The other emission levels were very low against the limit.
5. " * " : Fundamental frequency.
6. " # " : The radiated frequency is out of the restricted band.

RF Mode	TX 802.11ac (VHT80)	Channel	CH 42 : 5210 MHz
Frequency Range	1GHz ~ 40GHz	Detector Function	Peak (PK) Average (AV)

Antenna Polarity & Test Distance : Horizontal at 3 m								
No	Frequency (MHz)	Emission Level (dBuV/m)	Limit (dBuV/m)	Margin (dB)	Antenna Height (m)	Table Angle (Degree)	Raw Value (dBuV)	Correction Factor (dB/m)
1	5150.00	61.7 PK	74.0	-12.3	1.49 H	30	51.2	10.5
2	5150.00	49.2 AV	54.0	-4.8	1.49 H	30	38.7	10.5
3	*5210.00	93.5 PK			1.49 H	31	54.0	39.5
4	*5210.00	84.2 AV			1.49 H	31	44.7	39.5
5	5350.00	55.0 PK	74.0	-19.0	1.49 H	30	45.1	9.9
6	5350.00	43.7 AV	54.0	-10.3	1.49 H	30	33.8	9.9
7	#10420.00	59.6 PK	68.2	-8.6	1.69 H	166	38.1	21.5

Antenna Polarity & Test Distance : Vertical at 3 m								
No	Frequency (MHz)	Emission Level (dBuV/m)	Limit (dBuV/m)	Margin (dB)	Antenna Height (m)	Table Angle (Degree)	Raw Value (dBuV)	Correction Factor (dB/m)
1	5150.00	63.6 PK	74.0	-10.4	1.49 V	268	53.1	10.5
2	5150.00	53.2 AV	54.0	-0.8	1.49 V	268	42.7	10.5
3	*5210.00	96.3 PK			1.49 V	268	56.8	39.5
4	*5210.00	88.2 AV			1.49 V	268	48.7	39.5
5	5350.00	55.8 PK	74.0	-18.2	1.49 V	268	45.9	9.9
6	5350.00	45.0 AV	54.0	-9.0	1.49 V	268	35.1	9.9
7	#10420.00	60.3 PK	68.2	-7.9	3.16 V	169	38.8	21.5

Remarks:

1. Emission Level(dBuV/m) = Raw Value(dBuV) + Correction Factor(dB/m).
2. Correction Factor(dB/m) = Antenna Factor(dB/m) + Cable Factor(dB) – Pre-Amplifier Factor(dB).
3. Margin value = Emission Level – Limit value.
4. The other emission levels were very low against the limit.
5. " * " : Fundamental frequency.
6. " # " : The radiated frequency is out of the restricted band.

RF Mode	TX 802.11ac (VHT80)	Channel	CH 155 : 5775 MHz
Frequency Range	1GHz ~ 40GHz	Detector Function	Peak (PK) Average (AV)

Antenna Polarity & Test Distance : Horizontal at 3 m								
No	Frequency (MHz)	Emission Level (dBuV/m)	Limit (dBuV/m)	Margin (dB)	Antenna Height (m)	Table Angle (Degree)	Raw Value (dBuV)	Correction Factor (dB/m)
1	#5643.60	64.9 PK	68.2	-3.3	1.00 H	10	54.5	10.4
2	*5775.00	98.4 PK			1.00 H	10	58.1	40.3
3	*5775.00	88.2 AV			1.00 H	10	47.9	40.3
4	#5932.80	61.4 PK	68.2	-6.8	1.00 H	10	50.5	10.9
5	11550.00	61.0 PK	74.0	-13.0	1.99 H	169	38.1	22.9
6	11550.00	49.4 AV	54.0	-4.6	1.99 H	169	26.5	22.9

Antenna Polarity & Test Distance : Vertical at 3 m								
No	Frequency (MHz)	Emission Level (dBuV/m)	Limit (dBuV/m)	Margin (dB)	Antenna Height (m)	Table Angle (Degree)	Raw Value (dBuV)	Correction Factor (dB/m)
1	#5634.40	66.9 PK	68.2	-1.3	1.00 V	287	56.6	10.3
2	*5775.00	102.1 PK			1.00 V	287	61.8	40.3
3	*5775.00	93.4 AV			1.00 V	287	53.1	40.3
4	#5929.20	63.6 PK	68.2	-4.6	1.00 V	287	52.6	11.0
5	11550.00	61.8 PK	74.0	-12.2	1.59 V	166	38.9	22.9
6	11550.00	50.3 AV	54.0	-3.7	1.59 V	166	27.4	22.9

Remarks:

1. Emission Level(dBuV/m) = Raw Value(dBuV) + Correction Factor(dB/m).
2. Correction Factor(dB/m) = Antenna Factor(dB/m) + Cable Factor(dB) – Pre-Amplifier Factor(dB).
3. Margin value = Emission Level – Limit value.
4. The other emission levels were very low against the limit.
5. " * " : Fundamental frequency.
6. " # " : The radiated frequency is out of the restricted band.

Below 1GHz Worst-Case Data:

RF Mode	TX 802.11a	Channel	CH 165 : 5825 MHz
Frequency Range	30MHz ~ 1GHz	Detector Function	Quasi-Peak (QP)

ANTENNA POLARITY & TEST DISTANCE: HORIZONTAL AT 3 M								
NO.	FREQ. (MHz)	EMISSION LEVEL (dBuV/m)	LIMIT (dBuV/m)	MARGIN (dB)	ANTENNA HEIGHT (m)	TABLE ANGLE (Degree)	RAW VALUE (dBuV)	CORRECTION FACTOR (dB/m)
1	35.72	32.2 QP	40.0	-7.8	1.00 H	70	42.2	-10.0
2	140.50	36.4 QP	43.5	-7.1	1.00 H	72	45.6	-9.2
3	650.83	37.4 QP	46.0	-8.6	1.00 H	223	37.5	-0.1
4	745.91	41.4 QP	46.0	-4.6	1.00 H	7	38.8	2.6
5	850.69	36.0 QP	46.0	-10.0	1.00 H	218	31.0	5.0
6	936.07	41.2 QP	46.0	-4.8	1.50 H	97	34.2	7.0

Remarks:

1. Emission Level(dBuV/m) = Raw Value(dBuV) + Correction Factor(dB/m).
2. Correction Factor(dB/m) = Antenna Factor(dB/m) + Cable Factor(dB) – Pre-Amplifier Factor(dB).
3. The other emission levels were very low against the limit of frequency range 30MHz ~ 1000MHz.
4. Margin value = Emission Level – Limit value.
5. The emission levels were very low against the limit of frequency range 9kHz ~ 30MHz: the amplitude of spurious emissions attenuated more than 20 dB below the permissible value to be report.

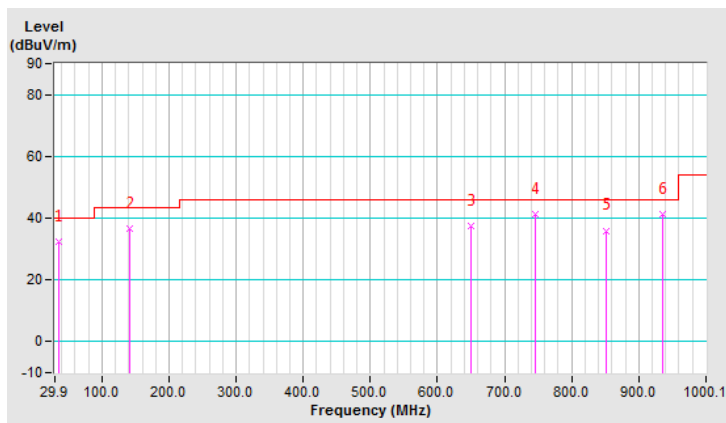

RF Mode	TX 802.11a	Channel	CH 165 : 5825 MHz
Frequency Range	30MHz ~ 1GHz	Detector Function	Quasi-Peak (QP)

ANTENNA POLARITY & TEST DISTANCE: VERTICAL AT 3 M								
NO.	FREQ. (MHz)	EMISSION LEVEL (dBuV/m)	LIMIT (dBuV/m)	MARGIN (dB)	ANTENNA HEIGHT (m)	TABLE ANGLE (Degree)	RAW VALUE (dBuV)	CORRECTION FACTOR (dB/m)
1	43.48	35.0 QP	40.0	-5.0	1.00 V	64	44.0	-9.0
2	146.32	29.8 QP	43.5	-13.7	2.00 V	337	38.6	-8.8
3	530.52	29.9 QP	46.0	-16.1	1.00 V	124	33.1	-3.2
4	650.83	34.4 QP	46.0	-11.6	1.00 V	259	34.5	-0.1
5	901.14	38.3 QP	46.0	-7.7	1.00 V	183	32.2	6.1
6	938.01	41.0 QP	46.0	-5.0	1.00 V	18	33.9	7.1

Remarks:

1. Emission Level(dBuV/m) = Raw Value(dBuV) + Correction Factor(dB/m).
2. Correction Factor(dB/m) = Antenna Factor(dB/m) + Cable Factor(dB) – Pre-Amplifier Factor(dB).
3. The other emission levels were very low against the limit of frequency range 30MHz ~ 1000MHz.
4. Margin value = Emission Level – Limit value.
5. The emission levels were very low against the limit of frequency range 9kHz ~ 30MHz: the amplitude of spurious emissions attenuated more than 20 dB below the permissible value to be report.

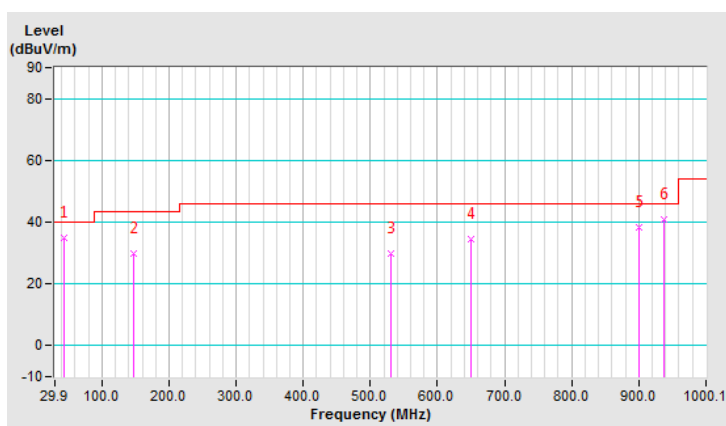

4.2 Conducted Emission Measurement

4.2.1 Limits of Conducted Emission Measurement

Frequency (MHz)	Conducted Limit (dBuV)	
	Quasi-peak	Average
0.15 - 0.5	66 - 56	56 - 46
0.50 - 5.0	56	46
5.0 - 30.0	60	50

Note: 1. The lower limit shall apply at the transition frequencies.

2. The limit decreases in line with the logarithm of the frequency in the range of 0.15 to 0.50MHz.

4.2.2 Test Instruments

Description & Manufacturer	Model No.	Serial No.	Cal. Date	Cal. Due
Test Receiver ROHDE & SCHWARZ	ESCI	100424	Dec. 31, 2019	Dec. 30, 2020
RF signal cable Woken	5D-FB	Cable-cond1-01	Sep. 04, 2020	Sep. 03, 2021
LISN/AMN ROHDE & SCHWARZ (EUT)	ENV216	101826	Feb. 20, 2020	Feb. 19, 2021
LISN/AMN ROHDE & SCHWARZ (Peripheral)	ESH3-Z5	100311	Aug. 28, 2020	Aug. 27, 2021
Software ADT	BV ADT_Cond_ V7.3.7.4	NA	NA	NA

Note: 1. The calibration interval of the above test instruments is 12 months and the calibrations are traceable to NML/ROC and NIST/USA.

2. The test was performed in HwaYa Shielded Room 1 (Conduction 1).

3. The VCCI Site Registration No. is C-12040.

4. Test Date: Sep. 04, 2020

4.2.3 Test Procedures

- The EUT was placed 0.4 meters from the conducting wall of the shielded room with EUT being connected to the power mains through a line impedance stabilization network (LISN). Other support units were connected to the power mains through another LISN. The two LISNs provide 50 ohm/ 50uH of coupling impedance for the measuring instrument.
- Both lines of the power mains connected to the EUT were checked for maximum conducted interference.
- The frequency range from 150kHz to 30MHz was searched. Emission levels under (Limit - 20dB) was not recorded.

Note: The resolution bandwidth and video bandwidth of test receiver is 9kHz for quasi-peak detection (QP) and average detection (AV) at frequency 0.15MHz-30MHz.

4.2.4 Deviation from Test Standard

No deviation.

4.2.5 Test Setup

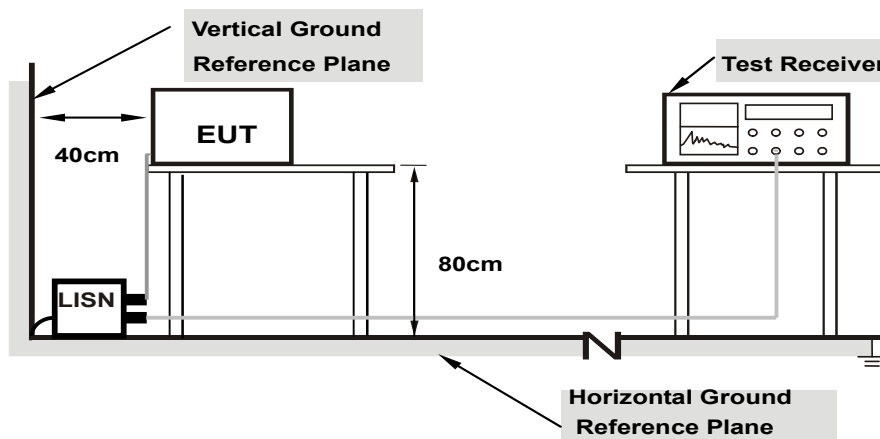

Note: 1.Support units were connected to second LISN.

For the actual test configuration, please refer to the attached file (Test Setup Photo).

4.2.6 EUT Operating Conditions

Same as 4.1.6.

4.2.7 Test Results

Worst-case data:

802.11a

Phase	Line (L)	Detector Function	Quasi-Peak (QP) / Average (AV)
-------	----------	-------------------	--------------------------------

No	Freq. [MHz]	Corr. Factor (dB)	Reading Value [dB (uV)]		Emission Level [dB (uV)]		Limit [dB (uV)]		Margin (dB)	
			Q.P.	AV.	Q.P.	AV.	Q.P.	AV.	Q.P.	AV.
			1	0.16535	9.63	26.94	19.58	36.57	29.21	65.19
2	0.18519	9.62	24.77	17.32	34.39	26.94	64.25	54.25	-29.86	-27.31
3	0.53800	9.66	20.43	14.07	30.09	23.73	56.00	46.00	-25.91	-22.27
4	9.36200	9.86	25.41	18.12	35.27	27.98	60.00	50.00	-24.73	-22.02
5	11.63000	9.88	24.67	17.55	34.55	27.43	60.00	50.00	-25.45	-22.57
6	17.61400	9.91	22.38	16.42	32.29	26.33	60.00	50.00	-27.71	-23.67

Remarks:

1. Q.P. and AV. are abbreviations of quasi-peak and average individually.
2. The emission levels of other frequencies were very low against the limit.
3. Margin value = Emission level - Limit value
4. Correction factor = Insertion loss + Cable loss
5. Emission Level = Correction Factor + Reading Value.

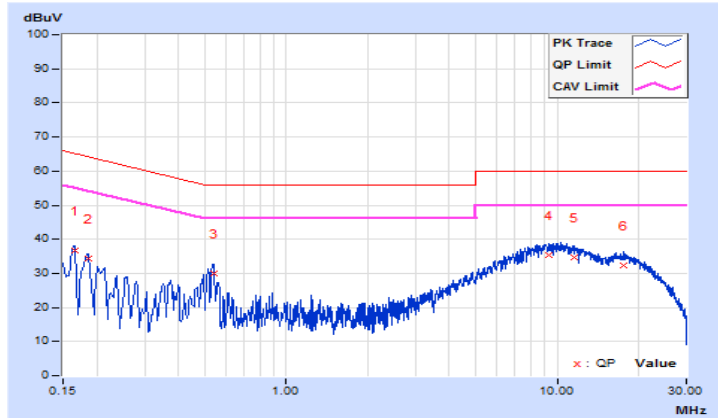

Phase	Neutral (N)	Detector Function	Quasi-Peak (QP) / Average (AV)
-------	-------------	-------------------	--------------------------------

No	Freq. [MHz]	Corr. Factor (dB)	Reading Value [dB (uV)]		Emission Level [dB (uV)]		Limit [dB (uV)]		Margin (dB)	
			Q.P.	AV.	Q.P.	AV.	Q.P.	AV.	Q.P.	AV.
			1	0.16190	9.66	26.12	12.56	35.78	22.22	65.37
2	0.18200	9.65	25.33	12.93	34.98	22.58	64.39	54.39	-29.41	-31.81
3	0.54542	9.68	26.13	21.19	35.81	30.87	56.00	46.00	-20.19	-15.13
4	6.56200	9.86	19.26	13.31	29.12	23.17	60.00	50.00	-30.88	-26.83
5	9.16200	9.90	21.60	15.43	31.50	25.33	60.00	50.00	-28.50	-24.67
6	17.61800	10.01	19.25	14.34	29.26	24.35	60.00	50.00	-30.74	-25.65

Remarks:

1. Q.P. and AV. are abbreviations of quasi-peak and average individually.
2. The emission levels of other frequencies were very low against the limit.
3. Margin value = Emission level - Limit value
4. Correction factor = Insertion loss + Cable loss
5. Emission Level = Correction Factor + Reading Value.

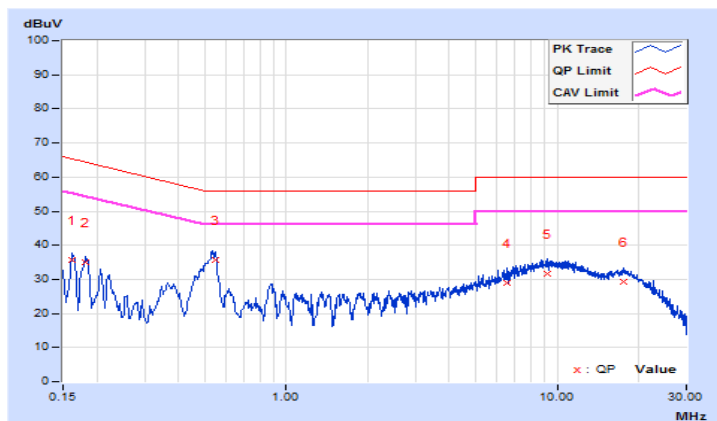

4.3 Transmit Power Measurement

4.3.1 Limits of Transmit Power Measurement

Operation Band	EUT Category		Limit
U-NII-1		Outdoor Access Point	1 Watt (30 dBm) (Max. e.i.r.p \leq 125mW(21 dBm) at any elevation angle above 30 degrees as measured from the horizon)
		Fixed point-to-point Access Point	1 Watt (30 dBm)
		Indoor Access Point	1 Watt (30 dBm)
	√	Mobile and Portable client device	250mW (24 dBm)
U-NII-2A	-		250mW (24 dBm) or 11 dBm+10 log B*
U-NII-2C	-		250mW (24 dBm) or 11 dBm+10 log B*
U-NII-3	√		1 Watt (30 dBm)

*B is the 26 dB emission bandwidth in megahertz

Per KDB 662911 Method of conducted output power measurement on IEEE 802.11 devices,

Array Gain = 0 dB (i.e., no array gain) for $N_{ANT} \leq 4$;

Array Gain = 0 dB (i.e., no array gain) for channel widths ≥ 40 MHz for any N_{ANT} ;

Array Gain = $5 \log(N_{ANT}/N_{SS})$ dB or 3 dB, whichever is less for 20-MHz channel widths with $N_{ANT} \geq 5$.

For power measurements on all other devices: Array Gain = $10 \log(N_{ANT}/N_{SS})$ dB.

4.3.2 Test Setup

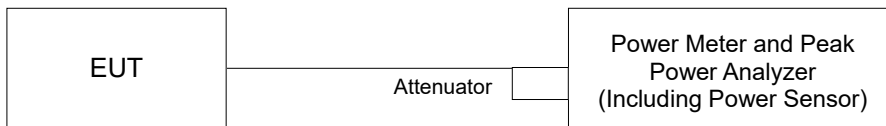

4.3.3 Test Instruments

Refer to section 4.1.2 to get information of above instrument.

4.3.4 Test Procedure

Method PM is used to perform output power measurement, trigger and gating function of wide band power meter is enabled to measure max output power of TX on burst and set the detector to average. Duty factor is not added to measured value.

4.3.5 Deviation from Test Standard

No deviation.

4.3.6 EUT Operating Conditions

The software provided by client to enable the EUT under transmission condition continuously at lowest, middle and highest channel frequencies individually.

4.3.7 Test Result

Power Output:

CDD Mode

802.11a

Chan.	Freq. (MHz)	Average Power (dBm)		Total Power (mW)	Total Power (dBm)	Power Limit (dBm)	Pass / Fail
		Chain 0	Chain 1				
36	5180	19.02	19.45	167.904	22.25	24.00	Pass
40	5200	19.13	19.42	169.345	22.29	24.00	Pass
48	5240	19.19	19.32	168.492	22.27	24.00	Pass
149	5745	23.97	23.76	487.144	26.88	30.00	Pass
157	5785	24.01	23.69	485.651	26.86	30.00	Pass
165	5825	23.89	23.79	484.238	26.85	30.00	Pass

802.11n (HT20)

Chan.	Freq. (MHz)	Average Power (dBm)		Total Power (mW)	Total Power (dBm)	Power Limit (dBm)	Pass / Fail
		Chain 0	Chain 1				
36	5180	19.19	19.63	174.818	22.43	24.00	Pass
40	5200	19.30	19.57	175.687	22.45	24.00	Pass
48	5240	19.27	19.77	179.370	22.54	24.00	Pass
149	5745	24.03	23.69	486.814	26.87	30.00	Pass
157	5785	23.94	23.68	481.088	26.82	30.00	Pass
165	5825	24.06	23.65	486.422	26.87	30.00	Pass

802.11n (HT40)

Chan.	Freq. (MHz)	Average Power (dBm)		Total Power (mW)	Total Power (dBm)	Power Limit (dBm)	Pass / Fail
		Chain 0	Chain 1				
38	5190	17.68	17.53	115.238	20.62	24.00	Pass
46	5230	20.75	20.85	240.469	23.81	24.00	Pass
151	5755	24.46	24.15	539.270	27.32	30.00	Pass
159	5795	24.40	24.27	542.724	27.35	30.00	Pass

802.11ac (VHT20)

Chan.	Freq. (MHz)	Average Power (dBm)		Total Power (mW)	Total Power (dBm)	Power Limit (dBm)	Pass / Fail
		Chain 0	Chain 1				
36	5180	19.21	19.66	175.838	22.45	24.00	Pass
40	5200	19.32	19.60	176.708	22.47	24.00	Pass
48	5240	19.29	19.79	180.198	22.56	24.00	Pass
149	5745	24.06	23.71	489.646	26.90	30.00	Pass
157	5785	23.96	23.70	483.309	26.84	30.00	Pass
165	5825	24.09	23.68	489.794	26.90	30.00	Pass

802.11ac (VHT40)

Chan.	Freq. (MHz)	Average Power (dBm)		Total Power (mW)	Total Power (dBm)	Power Limit (dBm)	Pass / Fail
		Chain 0	Chain 1				
38	5190	17.70	17.55	115.770	20.64	24.00	Pass
46	5230	20.77	20.87	241.579	23.83	24.00	Pass
151	5755	24.49	24.20	544.217	27.36	30.00	Pass
159	5795	24.42	24.29	545.229	27.37	30.00	Pass

802.11ac (VHT80)

Chan.	Freq. (MHz)	Average Power (dBm)		Total Power (mW)	Total Power (dBm)	Power Limit (dBm)	Pass / Fail
		Chain 0	Chain 1				
42	5210	16.79	16.33	90.707	19.58	24.00	Pass
155	5775	21.06	20.89	250.388	23.99	30.00	Pass

Beamforming Mode

802.11n (HT20)

Chan.	Freq. (MHz)	Average Power (dBm)		Total Power (mW)	Total Power (dBm)	Power Limit (dBm)	Pass / Fail
		Chain 0	Chain 1				
36	5180	19.18	19.64	174.839	22.43	22.69	Pass
40	5200	19.29	19.55	175.075	22.43	22.69	Pass
48	5240	19.24	19.76	178.570	22.52	22.69	Pass
149	5745	24.01	23.67	484.577	26.85	28.69	Pass
157	5785	23.91	23.65	477.776	26.79	28.69	Pass
165	5825	24.05	23.63	484.772	26.86	28.69	Pass

Note:

1. 5180-5240MHz: Directional gain = $10 \log[(10^{G^1/20} + 10^{G^2/20} + \dots + 10^{G^N/20})^2/2] = 7.31\text{dBi} > 6\text{dBi}$, so the power limit shall be reduced to $24 - (7.31 - 6) = 22.69\text{dBm}$.
2. 5745-5825MHz: Directional gain = $10 \log[(10^{G^1/20} + 10^{G^2/20} + \dots + 10^{G^N/20})^2/2] = 7.31\text{dBi} > 6\text{dBi}$, so the power limit shall be reduced to $30 - (7.31 - 6) = 28.69\text{dBm}$.

802.11n (HT40)

Chan.	Freq. (MHz)	Average Power (dBm)		Total Power (mW)	Total Power (dBm)	Power Limit (dBm)	Pass / Fail
		Chain 0	Chain 1				
38	5190	17.68	17.53	115.238	20.62	22.69	Pass
46	5230	18.75	18.85	151.726	21.81	22.69	Pass
151	5755	24.46	24.15	539.270	27.32	28.69	Pass
159	5795	24.40	24.27	542.724	27.35	28.69	Pass

Note:

1. 5180-5240MHz: Directional gain = $10 \log[(10^{G^1/20} + 10^{G^2/20} + \dots + 10^{G^N/20})^2/2] = 7.31\text{dBi} > 6\text{dBi}$, so the power limit shall be reduced to $24 - (7.31 - 6) = 22.69\text{dBm}$.
2. 5745-5825MHz: Directional gain = $10 \log[(10^{G^1/20} + 10^{G^2/20} + \dots + 10^{G^N/20})^2/2] = 7.31\text{dBi} > 6\text{dBi}$, so the power limit shall be reduced to $30 - (7.31 - 6) = 28.69\text{dBm}$.

802.11ac (VHT20)

Chan.	Freq. (MHz)	Average Power (dBm)		Total Power (mW)	Total Power (dBm)	Power Limit (dBm)	Pass / Fail
		Chain 0	Chain 1				
36	5180	19.21	19.66	175.838	22.45	22.69	Pass
40	5200	19.32	19.60	176.708	22.47	22.69	Pass
48	5240	19.29	19.79	180.198	22.56	22.69	Pass
149	5745	24.06	23.71	489.646	26.90	28.69	Pass
157	5785	23.96	23.70	483.309	26.84	28.69	Pass
165	5825	24.09	23.68	489.794	26.90	28.69	Pass

Note:

- 5180-5240MHz: Directional gain = $10 \log[(10^{G^1/20} + 10^{G^2/20} + \dots + 10^{G^N/20})^2/2] = 7.31\text{dBi} > 6\text{dBi}$, so the power limit shall be reduced to $24 - (7.31 - 6) = 22.69\text{dBm}$.
- 5745-5825MHz: Directional gain = $10 \log[(10^{G^1/20} + 10^{G^2/20} + \dots + 10^{G^N/20})^2/2] = 7.31\text{dBi} > 6\text{dBi}$, so the power limit shall be reduced to $30 - (7.31 - 6) = 28.69\text{dBm}$.

802.11ac (VHT40)

Chan.	Freq. (MHz)	Average Power (dBm)		Total Power (mW)	Total Power (dBm)	Power Limit (dBm)	Pass / Fail
		Chain 0	Chain 1				
38	5190	17.70	17.55	115.770	20.64	22.69	Pass
46	5230	18.77	18.87	152.426	21.83	22.69	Pass
151	5755	24.49	24.20	544.217	27.36	28.69	Pass
159	5795	24.42	24.29	545.229	27.37	28.69	Pass

Note:

- 5180-5240MHz: Directional gain = $10 \log[(10^{G^1/20} + 10^{G^2/20} + \dots + 10^{G^N/20})^2/2] = 7.31\text{dBi} > 6\text{dBi}$, so the power limit shall be reduced to $24 - (7.31 - 6) = 22.69\text{dBm}$.
- 5745-5825MHz: Directional gain = $10 \log[(10^{G^1/20} + 10^{G^2/20} + \dots + 10^{G^N/20})^2/2] = 7.31\text{dBi} > 6\text{dBi}$, so the power limit shall be reduced to $30 - (7.31 - 6) = 28.69\text{dBm}$.

802.11ac (VHT80)

Chan.	Freq. (MHz)	Average Power (dBm)		Total Power (mW)	Total Power (dBm)	Power Limit (dBm)	Pass / Fail
		Chain 0	Chain 1				
42	5210	16.79	16.33	90.707	19.58	22.69	Pass
155	5775	21.06	20.89	250.388	23.99	28.69	Pass

Note:

- 5180-5240MHz: Directional gain = $10 \log[(10^{G^1/20} + 10^{G^2/20} + \dots + 10^{G^N/20})^2/2] = 7.31\text{dBi} > 6\text{dBi}$, so the power limit shall be reduced to $24 - (7.31 - 6) = 22.69\text{dBm}$.
- 5745-5825MHz: Directional gain = $10 \log[(10^{G^1/20} + 10^{G^2/20} + \dots + 10^{G^N/20})^2/2] = 7.31\text{dBi} > 6\text{dBi}$, so the power limit shall be reduced to $30 - (7.31 - 6) = 28.69\text{dBm}$.

4.4 Occupied Bandwidth Measurement

4.4.1 Test Setup

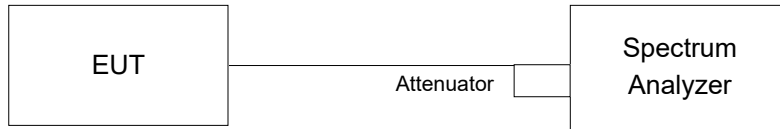

4.4.2 Test Instruments

Refer to section 4.1.2 to get information of above instrument.

4.4.3 Test Procedure

The transmitter output was connected to the spectrum analyzer through an attenuator. The bandwidth of the fundamental frequency was measured by spectrum analyzer with resolution bandwidth in the range of 1% to 5% of the anticipated emission bandwidth, and a video bandwidth at least 3x the resolution bandwidth and set the detector to sampling. The width of a frequency band such that, below the lower and above the upper frequency limits, the mean powers emitted are each equal to a specified percentage 0.5 %of the total mean power of a given emission.

4.4.4 Test Result

802.11a

Chan.	Freq. (MHz)	Occupied Bandwidth (MHz)	
		Chain 0	Chain 1
36	5180	16.56	16.56
40	5200	16.56	16.56
48	5240	16.56	16.56
149	5745	31.22	31.60
157	5785	33.60	33.60
165	5825	37.60	38.10

802.11ac (VHT20)

Chan.	Freq. (MHz)	Occupied Bandwidth (MHz)	
		Chain 0	Chain 1
36	5180	17.76	17.76
40	5200	17.76	17.76
48	5240	17.64	17.64
149	5745	34.78	34.70
157	5785	37.22	37.10
165	5825	40.50	40.60

802.11ac (VHT40)

Chan.	Freq. (MHz)	Occupied Bandwidth (MHz)	
		Chain 0	Chain 1
38	5190	36.00	36.00
46	5230	36.40	36.40
151	5755	57.25	56.67
159	5795	61.83	61.33

802.11ac (VHT80)

Chan.	Freq. (MHz)	Occupied Bandwidth (MHz)	
		Chain 0	Chain 1
42	5210	75.84	75.84
155	5775	77.30	77.00

Spectrum Plot of Worst Value

802.11a

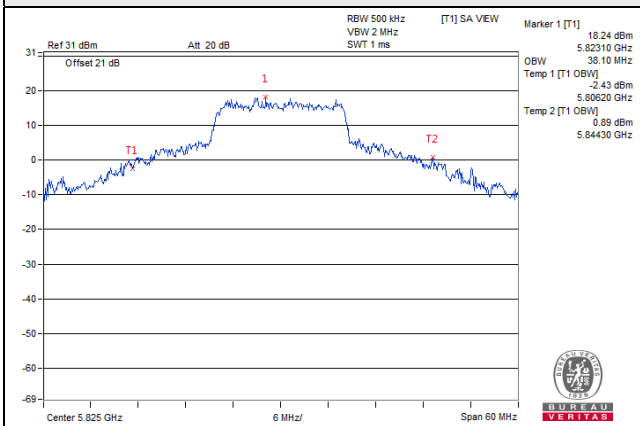

802.11ac (VHT20)

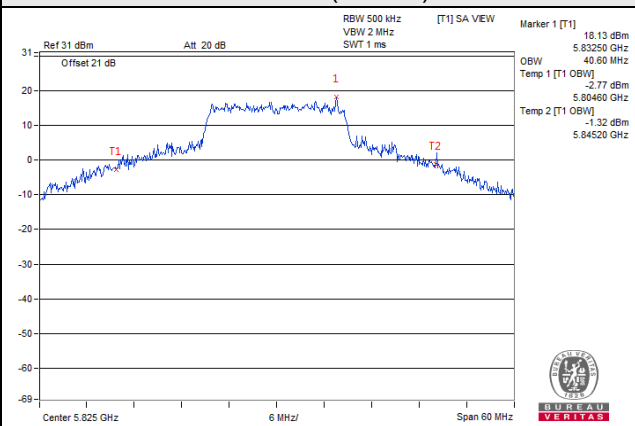

802.11ac (VHT40)

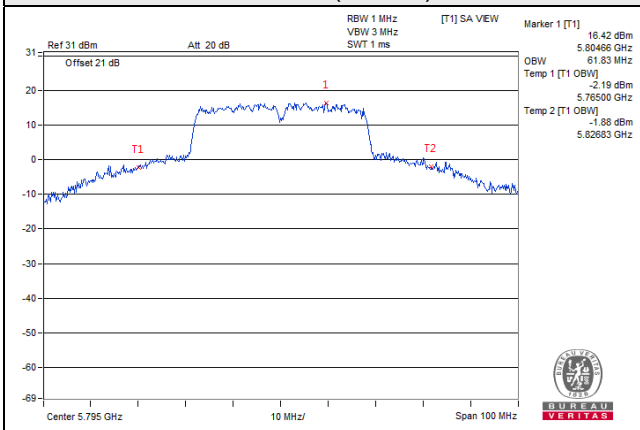

802.11ac (VHT80)

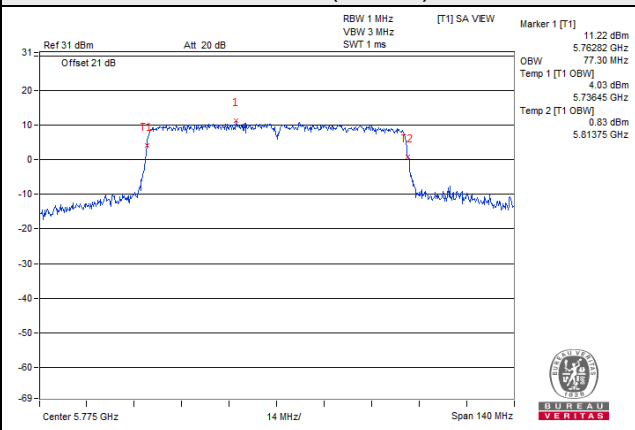

Spectrum Plot for near By DFS Band

802.11a / Chain 0 / CH 48

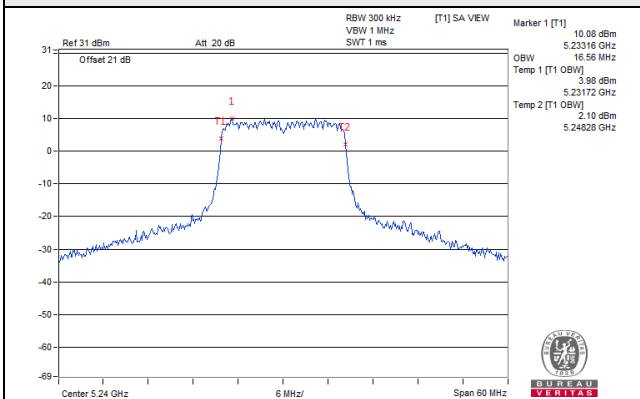

802.11a / Chain 1 / CH 48

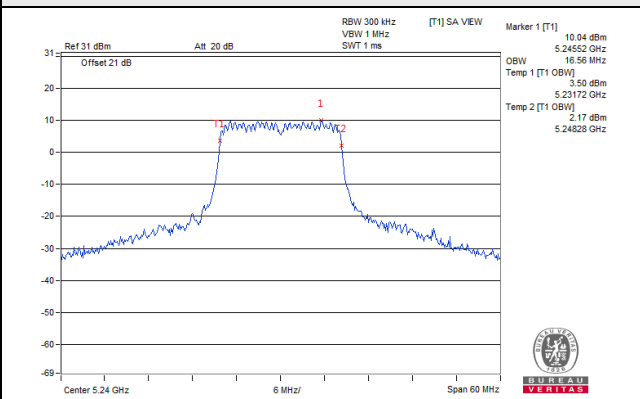

802.11ac (VHT20) / Chain 0 / CH 48

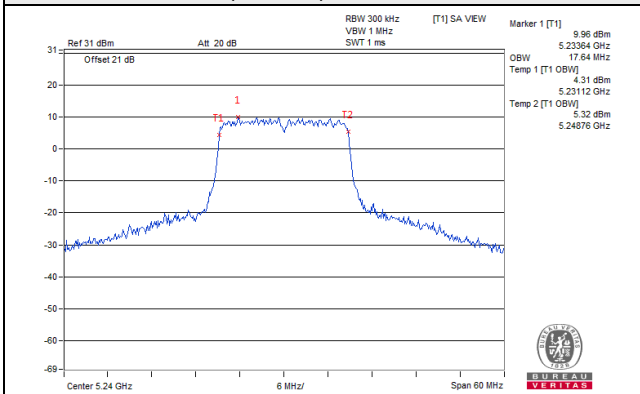

802.11ac (VHT20) / Chain 1 / CH 48

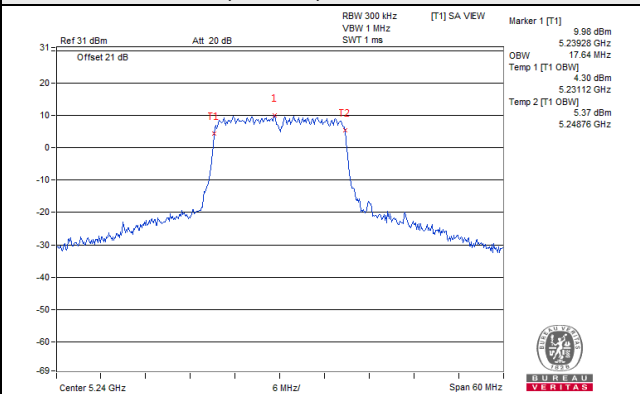

802.11ac (VHT40) / Chain 0 / CH 46

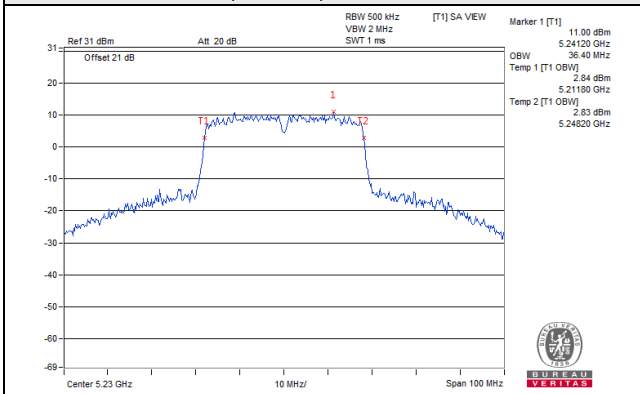

802.11ac (VHT40) / Chain 1 / CH 46

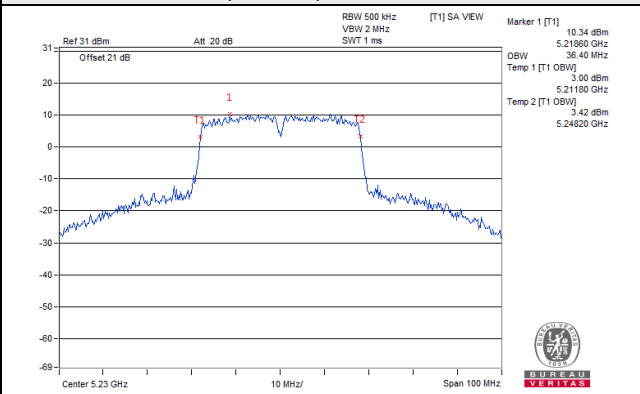

802.11ac (VHT80) / Chain 0 / CH 42

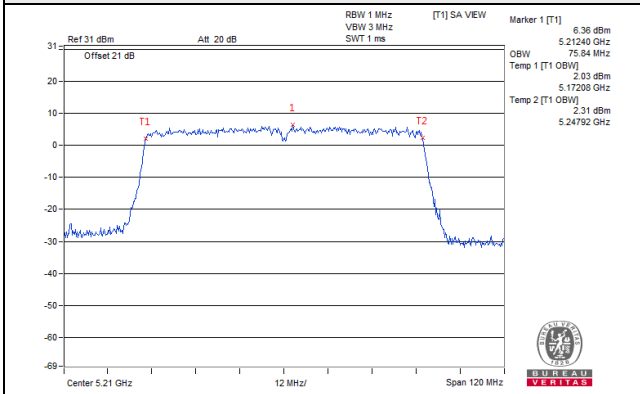

802.11ac (VHT80) / Chain 1 / CH 42

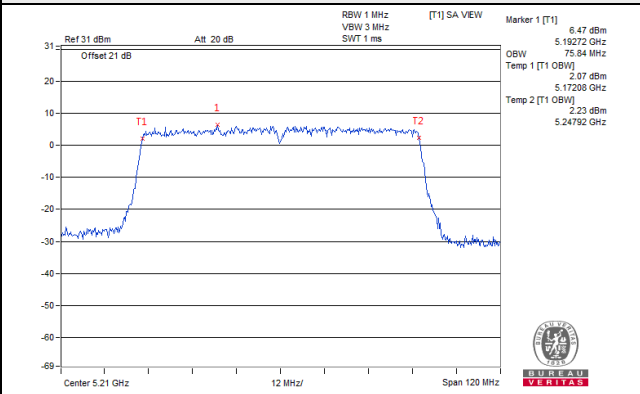

Spectrum Plot for near By DFS Band

802.11a / Chain 0 / CH 149

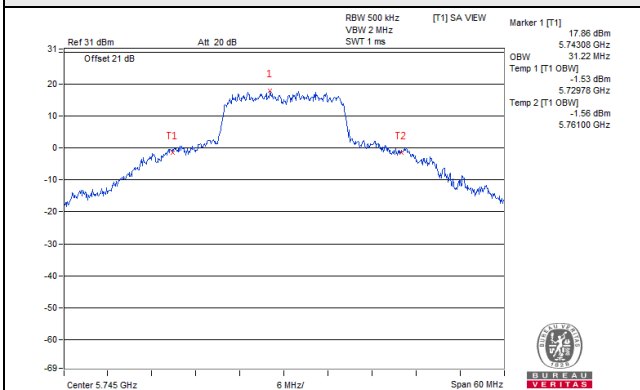

802.11a / Chain 1 / CH 149

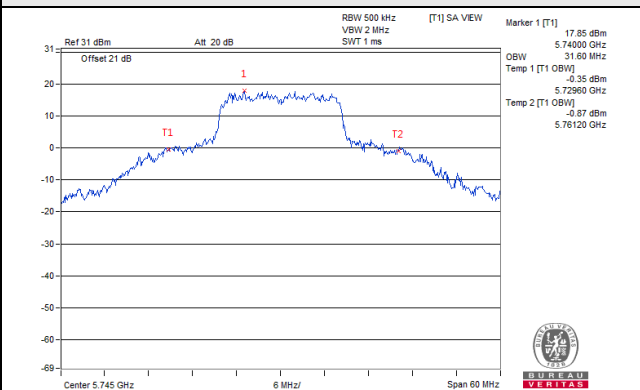

802.11ac (VHT20) / Chain 0 / CH 149

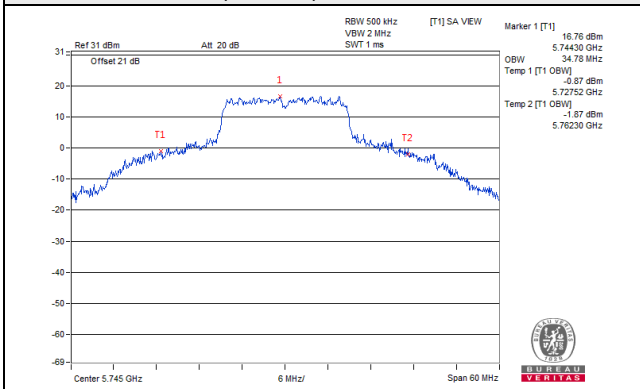

802.11ac (VHT20) / Chain 1 / CH 149

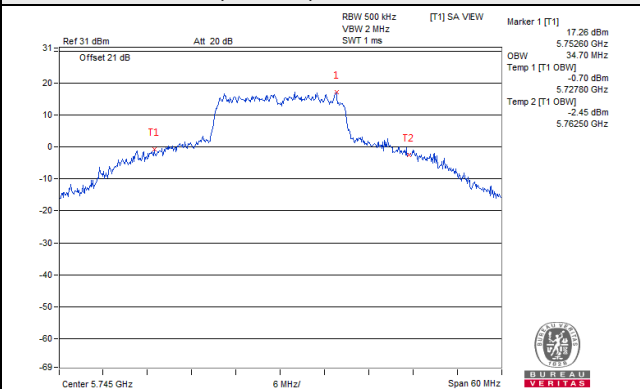

802.11ac (VHT40) / Chain 0 / CH 151

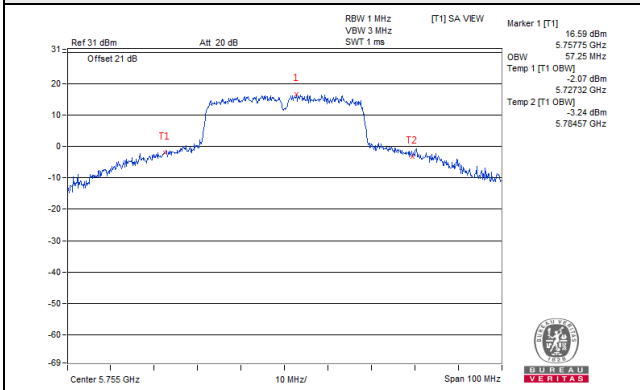

802.11ac (VHT40) / Chain 1 / CH 151

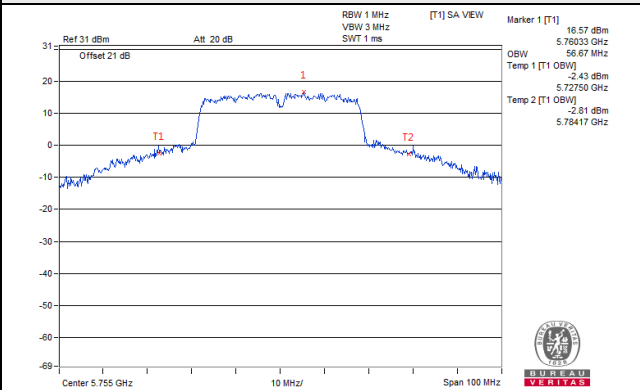

802.11ac (VHT80) / Chain 0 / CH 155

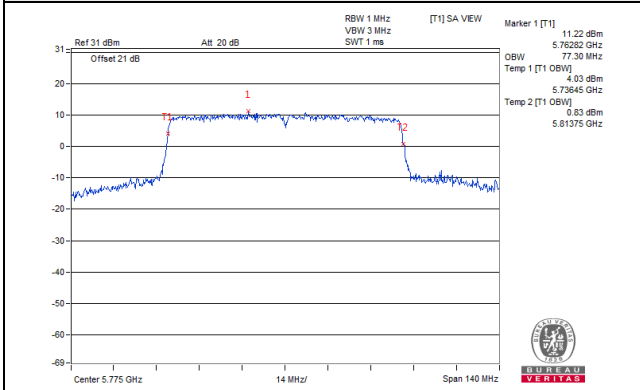

802.11ac (VHT80) / Chain 1 / CH 155

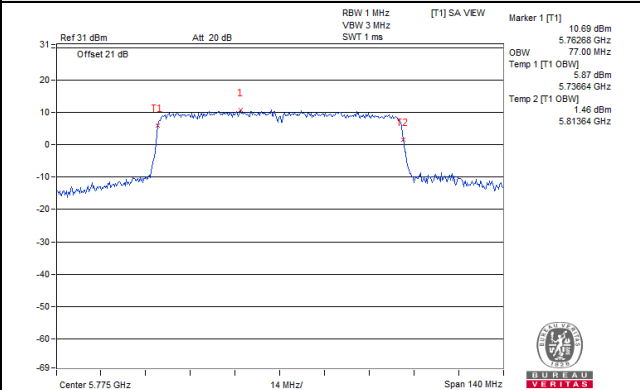

4.5 Peak Power Spectral Density Measurement

4.5.1 Limits of Peak Power Spectral Density Measurement

Operation Band	EUT Category		Limit
U-NII-1		Outdoor Access Point	17dBm/ MHz
		Fixed point-to-point Access Point	
		Indoor Access Point	
	√	Mobile and Portable client device	11dBm/ MHz
U-NII-2A	-		11dBm/ MHz
U-NII-2C	-		11dBm/ MHz
U-NII-3	√		30dBm/ 500kHz

4.5.2 Test Setup

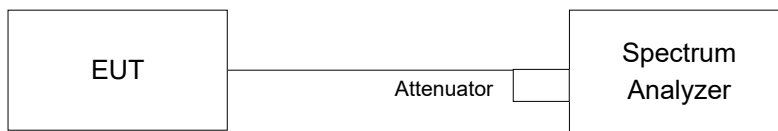

4.5.3 Test Instruments

Refer to section 4.1.2 to get information of above instrument.

4.5.4 Test Procedures

For U-NII-1 band:

Using method SA-1

- Set span to encompass the entire emission bandwidth (EBW) of the signal.
- Set RBW = 1 MHz, Set VBW \geq 3 MHz, Detector = RMS
- Sweep time = auto, trigger set to "free run".
- Trace average at least 100 traces in power averaging mode.
- Record the max value

Using method SA-2

- Set span to encompass the entire emission bandwidth (EBW) of the signal.
- Set RBW = 1MHz, Set VBW \geq 3 MHz, Detector = RMS
- Set Channel power measure = 1MHz
- Sweep time = auto, trigger set to "free run".
- Trace average at least 100 traces in power averaging mode.
- Record the max value and add $10 \log (1/\text{duty cycle})$

For U-NII-3 band:

Duty cycle of test signal is > 98%

- a. Set span to encompass the entire emission bandwidth (EBW) of the signal.
- b. Set RBW = 500 kHz, Set VBW \geq 2 MHz, Detector = RMS
- c. Use the peak marker function to determine the maximum power level in any 500 kHz band segment within the fundamental EBW.
- d. Sweep time = auto, trigger set to "free run".
- e. Trace average at least 100 traces in power averaging mode.
- f. Record the max value

Duty cycle of test signal is < 98%

- a. Set span to encompass the entire emission bandwidth (EBW) of the signal.
- b. Set RBW = 500 kHz, Set VBW \geq 2 MHz, Detector = RMS
- c. Use the peak marker function to determine the maximum power level in any 500 kHz band segment within the fundamental EBW.
- d. Sweep time = auto, trigger set to "free run".
- e. Trace average at least 100 traces in power averaging mode.
- f. Record the max value and add $10 \log (1/\text{duty cycle})$

4.5.5 Deviation from Test Standard

No deviation.

4.5.6 EUT Operating Conditions

Same as 4.3.6.

4.5.7 Test Results

For U-NII-1 band:

802.11a

Chan.	Freq. (MHz)	PSD w/o Duty Factor (dBm/MHz)		Duty Factor (dB)	Total PSD with Duty Factor (dBm/MHz)	Max. Limit (dBm/MHz)	Pass / Fail
		Chain 0	Chain 1				
36	5180	5.69	5.73	0.24	8.96	9.69	Pass
40	5200	5.68	5.66	0.24	8.92	9.69	Pass
48	5240	5.66	5.62	0.24	8.89	9.69	Pass

Note:

- Method E) 2) a) of power density measurement of KDB 662911 is using for calculating total power density. Total power density is summing entire spectra across corresponding frequency bins on the various outputs by computer.
- 5180-5240MHz: Directional gain = $10 \log[(10^{G1/20} + 10^{G2/20} + \dots + 10^{GN/20})^2/2]$ = 7.31dBi > 6dBi, so the power density limit shall be reduced to 11 - (7.31 - 6) = 9.69dBm.
- Refer to section 3.3 for duty cycle spectrum plot.

802.11ac (VHT20)

Chan.	Freq. (MHz)	PSD w/o Duty Factor (dBm/MHz)		Total PSD (dBm/MHz)	Max. Limit (dBm/MHz)	Pass / Fail
		Chain 0	Chain 1			
36	5180	5.57	5.60	8.60	9.69	Pass
40	5200	5.49	5.54	8.53	9.69	Pass
48	5240	5.57	5.56	8.58	9.69	Pass

Note:

- Method E) 2) a) of power density measurement of KDB 662911 is using for calculating total power density. Total power density is summing entire spectra across corresponding frequency bins on the various outputs by computer.
- 5180-5240MHz: Directional gain = $10 \log[(10^{G1/20} + 10^{G2/20} + \dots + 10^{GN/20})^2/2]$ = 7.31dBi > 6dBi, so the power density limit shall be reduced to 11 - (7.31 - 6) = 9.69dBm.
- Refer to section 3.3 for duty cycle spectrum plot.

802.11ac (VHT40)

Chan.	Freq. (MHz)	PSD w/o Duty Factor (dBm/MHz)		Duty Factor (dB)	Total PSD with Duty Factor (dBm/MHz)	Max. Limit (dBm/MHz)	Pass / Fail
		Chain 0	Chain 1				
38	5190	0.62	0.66	0.18	3.83	9.69	Pass
46	5230	3.96	3.93	0.18	7.14	9.69	Pass

Note:

- Method E) 2) a) of power density measurement of KDB 662911 is using for calculating total power density. Total power density is summing entire spectra across corresponding frequency bins on the various outputs by computer.
- 5180-5240MHz: Directional gain = $10 \log[(10^{G1/20} + 10^{G2/20} + \dots + 10^{GN/20})^2/2]$ = 7.31dBi > 6dBi, so the power density limit shall be reduced to 11 - (7.31 - 6) = 9.69dBm.
- Refer to section 3.3 for duty cycle spectrum plot.

802.11ac (VHT80)

Chan.	Freq. (MHz)	PSD w/o Duty Factor (dBm/MHz)		Duty Factor (dB)	Total PSD with Duty Factor (dBm/MHz)	Max. Limit (dBm/MHz)	Pass / Fail
		Chain 0	Chain 1				
42	5210	-4.20	-4.19	0.35	-0.83	9.69	Pass

Note:

- Method E) 2) a) of power density measurement of KDB 662911 is using for calculating total power density. Total power density is summing entire spectra across corresponding frequency bins on the various outputs by computer.
- 5180-5240MHz: Directional gain = $10 \log[(10^{G1/20} + 10^{G2/20} + \dots + 10^{GN/20})^2/2] = 7.31\text{dBi} > 6\text{dBi}$, so the power density limit shall be reduced to $11 - (7.31 - 6) = 9.69\text{dBm}$.
- Refer to section 3.3 for duty cycle spectrum plot.

Spectrum Plot of Worst Value

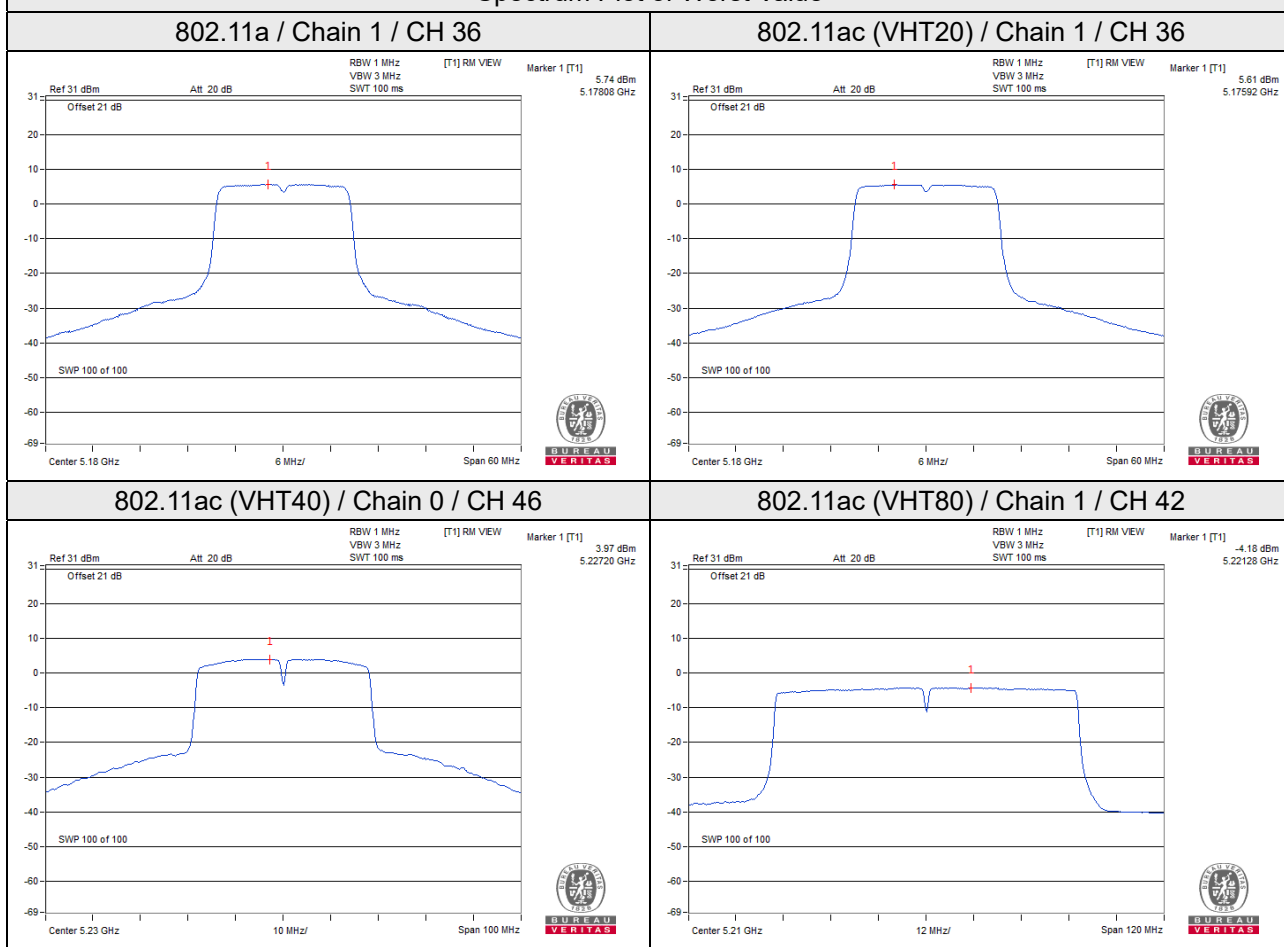

For U-NII-3 band:

802.11a

TX chain	Chan.	Freq. (MHz)	PSD w/o Duty Factor	10 log (N=2) dB	Duty Factor (dB)	Total PSD with Duty Factor (dBm/500kHz)	Limit (dBm/500 kHz)	Pass / Fail
			(dBm/500kHz)					
0	149	5745	1.24	3.01	0.24	4.49	28.69	Pass
	157	5785	1.37	3.01	0.24	4.62	28.69	Pass
	165	5825	1.60	3.01	0.24	4.85	28.69	Pass
1	149	5745	1.35	3.01	0.24	4.60	28.69	Pass
	157	5785	1.33	3.01	0.24	4.58	28.69	Pass
	165	5825	1.53	3.01	0.24	4.78	28.69	Pass

Note:

- Method E) 2) c) of power density measurement of KDB 662911 is using for calculating total power density, Measure and add 10 log (N_{ANT}) dB.
- 5745-5825MHz: Directional gain = $10 \log[(10^{G1/20} + 10^{G2/20} + \dots + 10^{GN/20})^2/2] = 7.31\text{dBi} > 6\text{dBi}$, so the power density limit shall be reduced to $30 - (7.31 - 6) = 28.69\text{dBm}$.
- Refer to section 3.3 for duty cycle spectrum plot.

802.11ac (VHT20)

TX chain	Chan.	Freq. (MHz)	PSD w/o Duty Factor	10 log (N=2) dB	Total PSD (dBm/500kHz)	Limit (dBm/500kHz)	Pass / Fail
			(dBm/500kHz)				
0	149	5745	1.04	3.01	4.05	28.69	Pass
	157	5785	0.97	3.01	3.98	28.69	Pass
	165	5825	1.26	3.01	4.27	28.69	Pass
1	149	5745	1.07	3.01	4.08	28.69	Pass
	157	5785	1.00	3.01	4.01	28.69	Pass
	165	5825	1.23	3.01	4.24	28.69	Pass

Note:

- Method E) 2) c) of power density measurement of KDB 662911 is using for calculating total power density, Measure and add 10 log (N_{ANT}) dB.
- 5745-5825MHz: Directional gain = $10 \log[(10^{G1/20} + 10^{G2/20} + \dots + 10^{GN/20})^2/2] = 7.31\text{dBi} > 6\text{dBi}$, so the power density limit shall be reduced to $30 - (7.31 - 6) = 28.69\text{dBm}$.

802.11ac (VHT40)

TX chain	Chan.	Freq. (MHz)	PSD w/o Duty Factor	10 log (N=2) dB	Duty Factor (dB)	Total PSD with Duty Factor (dBm/500kHz)	Limit (dBm/500 kHz)	Pass / Fail
			(dBm/500kHz)					
0	151	5755	-2.79	3.01	0.18	0.40	28.69	Pass
	159	5795	-2.86	3.01	0.18	0.33	28.69	Pass
1	151	5755	-2.71	3.01	0.18	0.48	28.69	Pass
	159	5795	-2.76	3.01	0.18	0.43	28.69	Pass

Note:

- Method E) 2) c) of power density measurement of KDB 662911 is using for calculating total power density, Measure and add 10 log (N_{ANT}) dB.
- 5745-5825MHz: Directional gain = $10 \log[(10^{G^1/20} + 10^{G^2/20} + \dots + 10^{G^N/20})^2/2] = 7.31\text{dBi} > 6\text{dBi}$, so the power density limit shall be reduced to $30 - (7.31 - 6) = 28.69\text{dBm}$.
- Refer to section 3.3 for duty cycle spectrum plot.

802.11ac (VHT80)

TX chain	Chan.	Freq. (MHz)	PSD w/o Duty Factor	10 log (N=2) dB	Duty Factor (dB)	Total PSD with Duty Factor (dBm/500kHz)	Limit (dBm/500 kHz)	Pass / Fail
			(dBm/500kHz)					
0	155	5775	-8.51	3.01	0.35	-5.15	28.69	Pass
1	155	5775	-8.56	3.01	0.35	-5.20	28.69	Pass

Note:

- Method E) 2) c) of power density measurement of KDB 662911 is using for calculating total power density, Measure and add 10 log (N_{ANT}) dB.
- 5745-5825MHz: Directional gain = $10 \log[(10^{G^1/20} + 10^{G^2/20} + \dots + 10^{G^N/20})^2/2] = 7.31\text{dBi} > 6\text{dBi}$, so the power density limit shall be reduced to $30 - (7.31 - 6) = 28.69\text{dBm}$.
- Refer to section 3.3 for duty cycle spectrum plot.

Spectrum Plot of Worst Value

802.11a

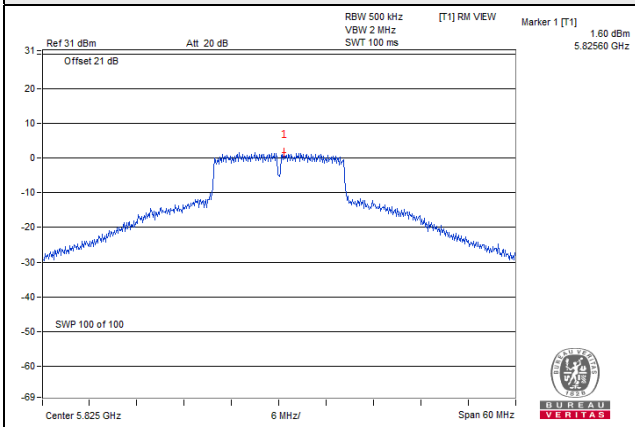

802.11ac (VHT20)

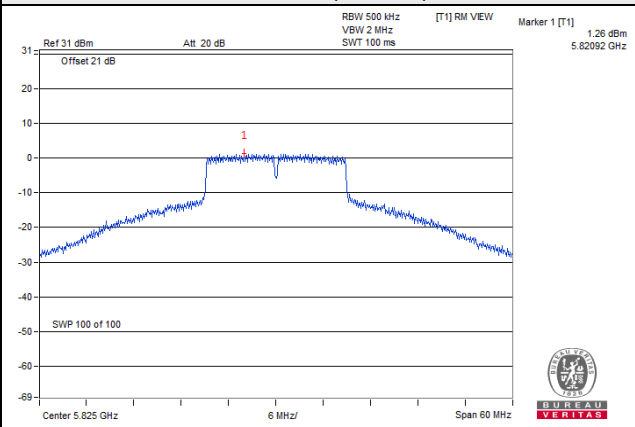

802.11ac (VHT40)

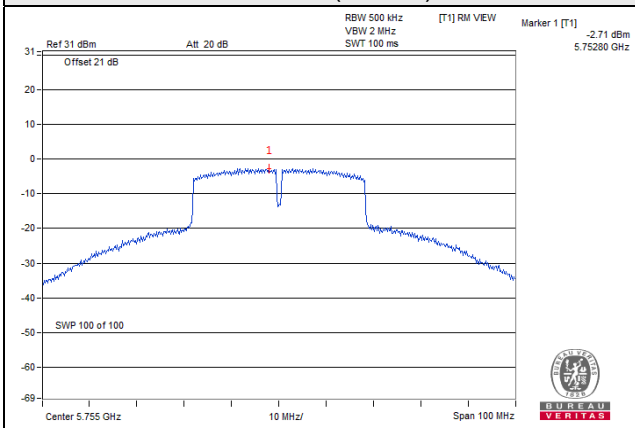

802.11ac (VHT80)

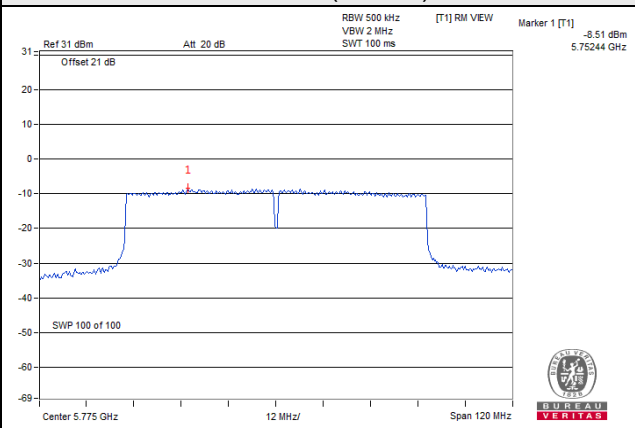

4.6 Frequency Stability

4.6.1 Limits of Frequency Stability Measurement

The frequency of the carrier signal shall be maintained within band of operation

4.6.2 Test Setup

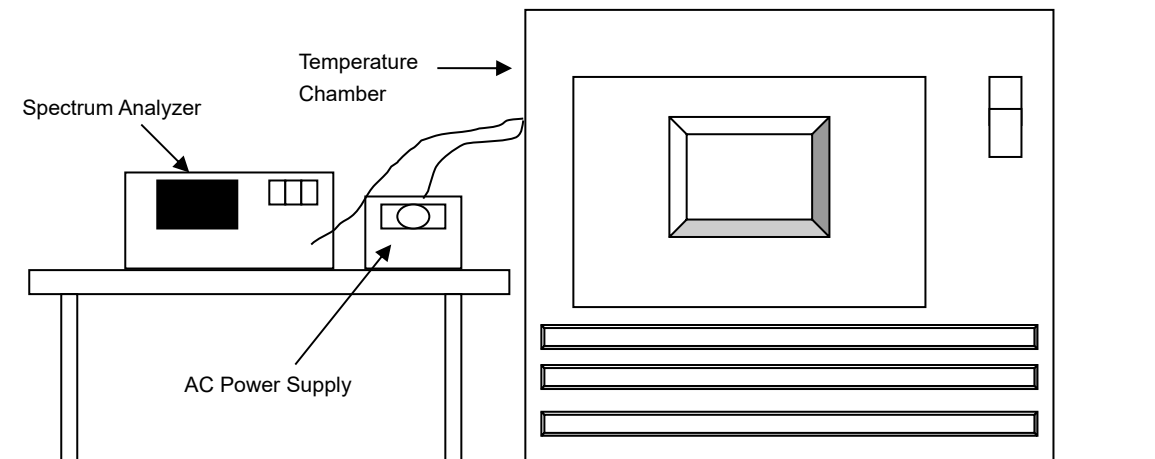

4.6.3 Test Instruments

Description & Manufacturer	Model No.	Serial No.	Cal. Date	Cal. Due
Spectrum Analyzer ROHDE & SCHWARZ	FSP40	100269	Jun. 09, 2020	Jun. 08, 2021
Standard Temperature And Humidity Chamber GIANT FORCE	GTH-120-40-CP-AR	MAA1306-019	Sep. 09, 2020	Sep. 08, 2021
Digital Multimeter Fluke	87-III	70360742	Jun. 23, 2020	Jun. 22, 2021
AC Power Supply Extech	CFW-105	E000603	NA	NA

Note: 1. The calibration interval of the above test instruments is 12 months and the calibrations are traceable to NML/ROC and NIST/USA.

2. Test Date: Sep. 25, 2020

4.6.4 Test Procedure

- The EUT was placed inside the environmental test chamber and powered by nominal AC voltage.
- Turn the EUT on and couple its output to a spectrum analyzer.
- Turn the EUT off and set the chamber to the highest temperature specified.
- Allow sufficient time (approximately 30 min) for the temperature of the chamber to stabilize, turn the EUT on and measure the operating frequency after 2, 5, and 10 minutes.
- Repeat step d with every 10 degrees reduction until the lowest temperature achieved.
- The test chamber was allowed to stabilize at +20 degree C for a minimum of 30 minutes. The supply voltage was then adjusted on the EUT from 85% to 115% and the frequency record.

4.6.5 Deviation from Test Standard

No deviation.

4.6.6 EUT Operating Condition

Set the EUT transmit at un-modulation mode to test frequency stability.

4.6.7 Test Results

Frequency Stability Versus Temp.									
Operating Frequency: 5180MHz									
Temp. (°C)	Power Supply (Vac)	0 Minute		2 Minute		5 Minute		10 Minute	
		Measured Frequency (MHz)	Result	Measured Frequency (MHz)	Result	Measured Frequency (MHz)	Result	Measured Frequency (MHz)	Result
50	120	5179.9748	PASS	5179.9784	PASS	5179.9778	PASS	5179.9754	PASS
40	120	5180.0101	PASS	5180.0069	PASS	5180.011	PASS	5180.0076	PASS
30	120	5180.0081	PASS	5180.0094	PASS	5180.0116	PASS	5180.0108	PASS
20	120	5180.0161	PASS	5180.0187	PASS	5180.0157	PASS	5180.0147	PASS
10	120	5180.0038	PASS	5180.0052	PASS	5180.0012	PASS	5180.0033	PASS
0	120	5180.0054	PASS	5180.0040	PASS	5180.0065	PASS	5180.0063	PASS
-10	120	5179.9875	PASS	5179.9867	PASS	5179.988	PASS	5179.9858	PASS
-20	120	5179.9904	PASS	5179.9930	PASS	5179.9901	PASS	5179.9940	PASS
-30	120	5180.0059	PASS	5180.0062	PASS	5180.0073	PASS	5180.0093	PASS

Frequency Stability Versus Voltage									
Operating Frequency: 5180MHz									
Temp. (°C)	Power Supply (Vac)	0 Minute		2 Minute		5 Minute		10 Minute	
		Measured Frequency (MHz)	Result	Measured Frequency (MHz)	Result	Measured Frequency (MHz)	Result	Measured Frequency (MHz)	Result
20	138	5180.0169	PASS	5180.0177	PASS	5180.0151	PASS	5180.0145	PASS
	120	5180.0161	PASS	5180.0187	PASS	5180.0157	PASS	5180.0147	PASS
	102	5180.0153	PASS	5180.0189	PASS	5180.0165	PASS	5180.0146	PASS

4.7 6dB Bandwidth Measurement

4.7.1 Limits of 6dB Bandwidth Measurement

The minimum of 6dB Bandwidth Measurement is 0.5MHz.

4.7.2 Test Setup

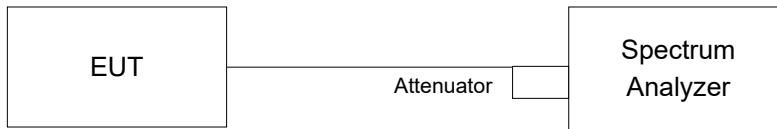

4.7.3 Test Instruments

Refer to section 4.1.2 to get information of above instrument.

4.7.4 Test Procedure

- Set resolution bandwidth (RBW) = 100kHz
- Set the video bandwidth (VBW) $\geq 3 \times$ RBW, Detector = Peak.
- Trace mode = max hold.
- Sweep = auto couple.
- Measure the maximum width of the emission that is constrained by the frequencies associated with the two amplitude points (upper and lower) that are attenuated by 6 dB relative to the maximum level measured in the fundamental emission

4.7.5 Deviation from Test Standard

No deviation.

4.7.6 EUT Operating Condition

The software provided by client to enable the EUT under transmission condition continuously at lowest, middle and highest channel frequencies individually.

4.7.7 Test Results

802.11a

Channel	Frequency (MHz)	6dB Bandwidth (MHz)		Minimum Limit (MHz)	Pass / Fail
		Chain 0	Chain 1		
149	5745	16.34	16.33	0.5	Pass
157	5785	16.10	16.32	0.5	Pass
165	5825	16.36	16.36	0.5	Pass

802.11ac (VHT20)

Channel	Frequency (MHz)	6dB Bandwidth (MHz)		Minimum Limit (MHz)	Pass / Fail
		Chain 0	Chain 1		
149	5745	17.58	17.57	0.5	Pass
157	5785	17.62	17.60	0.5	Pass
165	5825	17.62	17.58	0.5	Pass

802.11ac (VHT40)

Channel	Frequency (MHz)	6dB Bandwidth (MHz)		Minimum Limit (MHz)	Pass / Fail
		Chain 0	Chain 1		
151	5755	35.15	35.17	0.5	Pass
159	5795	34.52	35.09	0.5	Pass

802.11ac (VHT80)

Channel	Frequency (MHz)	6dB Bandwidth (MHz)		Minimum Limit (MHz)	Pass / Fail
		Chain 0	Chain 1		
155	5775	75.41	75.54	0.5	Pass

Spectrum Plot of Worst Value

802.11a

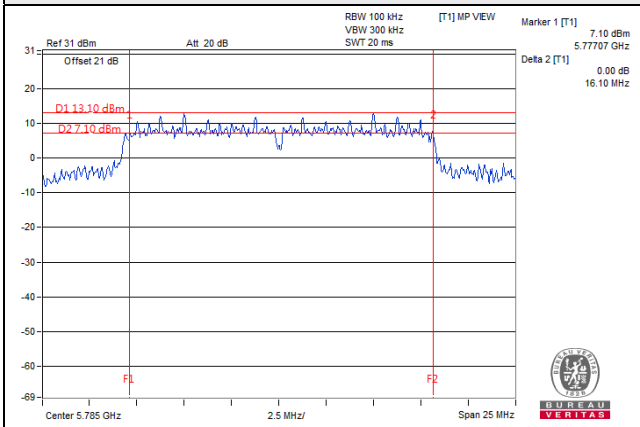

802.11ac (VHT20)

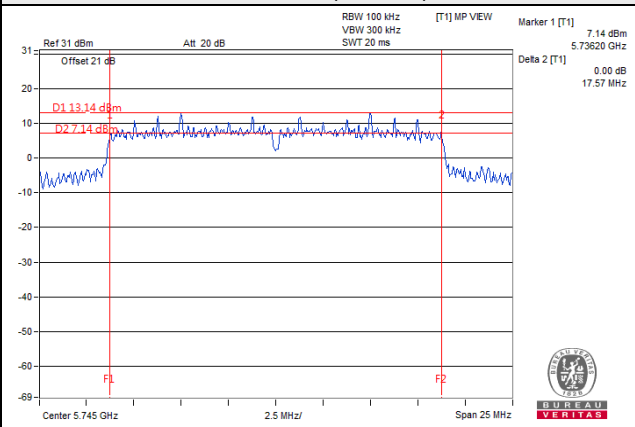

802.11ac (VHT40)

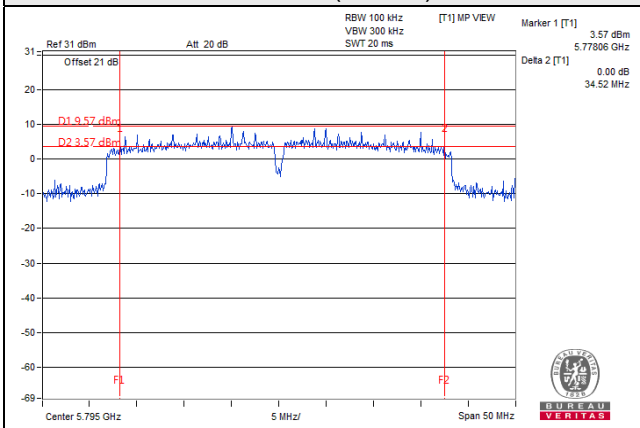

802.11ac (VHT80)

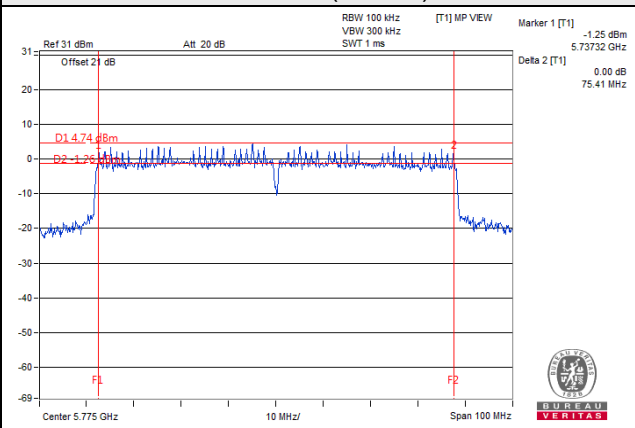

5 Pictures of Test Arrangements

Please refer to the attached file (Test Setup Photo).

Annex A - Radiated Out of Band Emission (OOBE) Measurement (For U-NII-3 band)

802.11a CH 149 : 5745 MHz

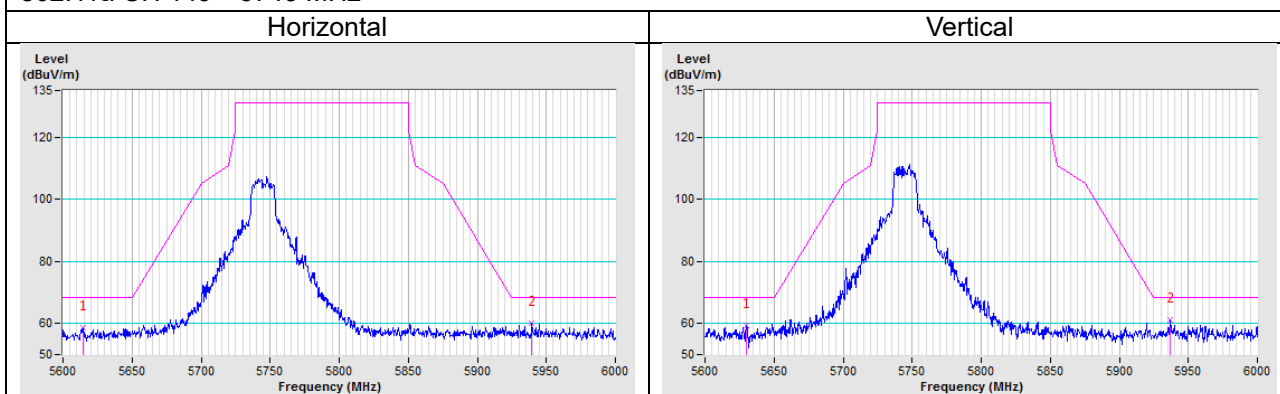

802.11a CH 157 : 5785 MHz

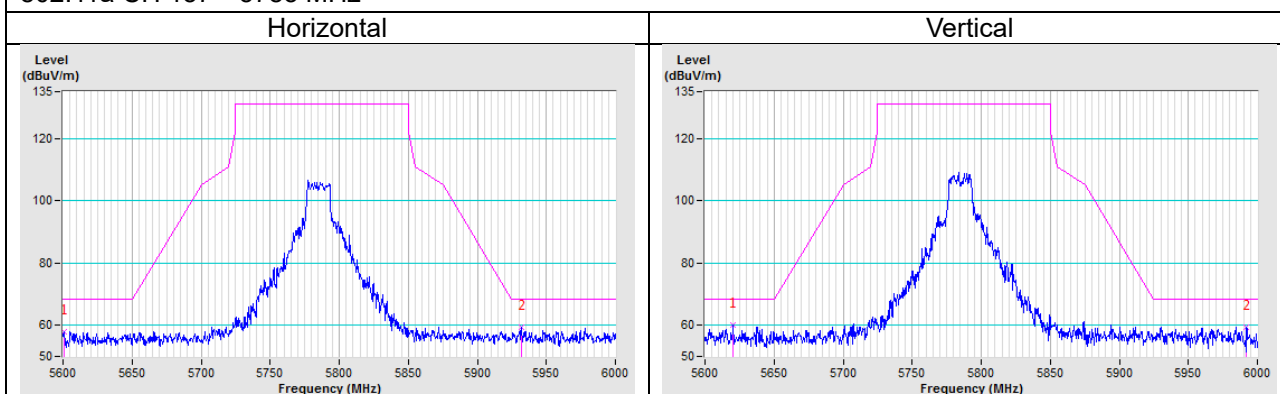

802.11a CH 165 : 5825 MHz

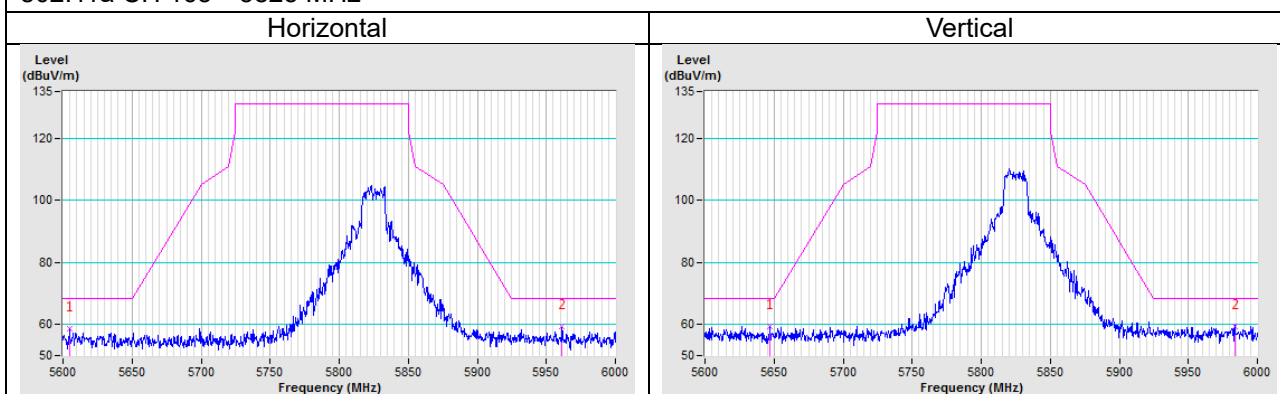

802.11ac (VHT20) CH 149 : 5745 MHz

Horizontal

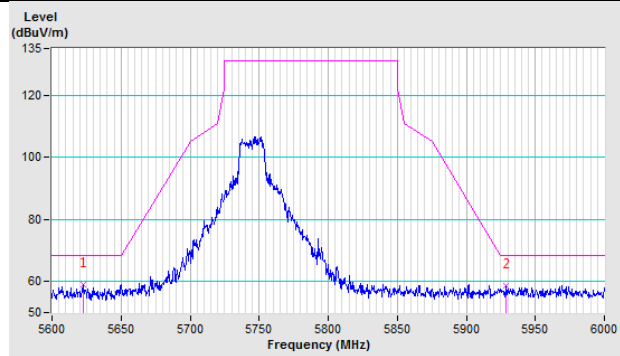

Vertical

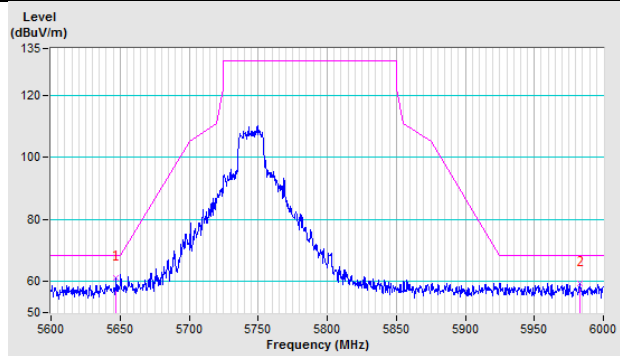

802.11ac (VHT20) CH 157 : 5785 MHz

Horizontal

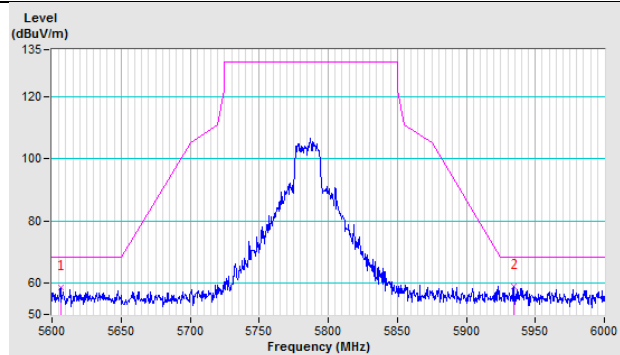

Vertical

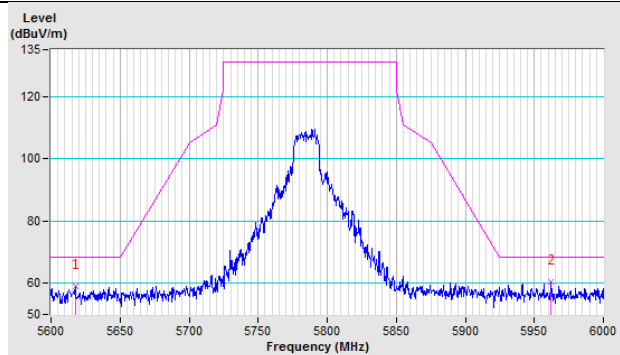

802.11ac (VHT20) CH 165 : 5825 MHz

Horizontal

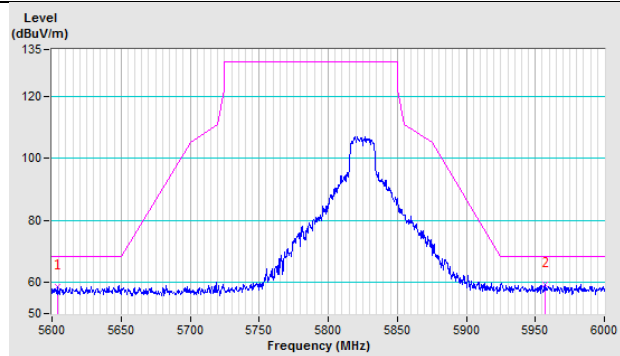

Vertical

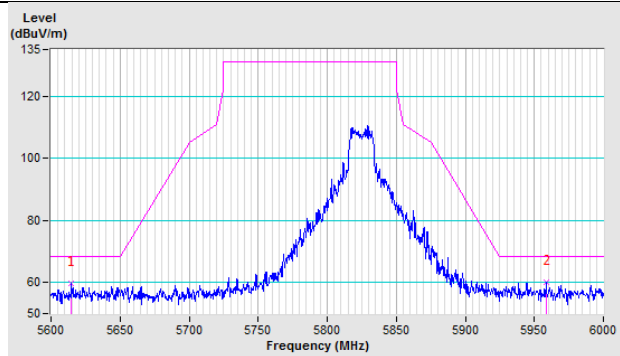

802.11ac (VHT40) CH 151 : 5755 MHz

Horizontal

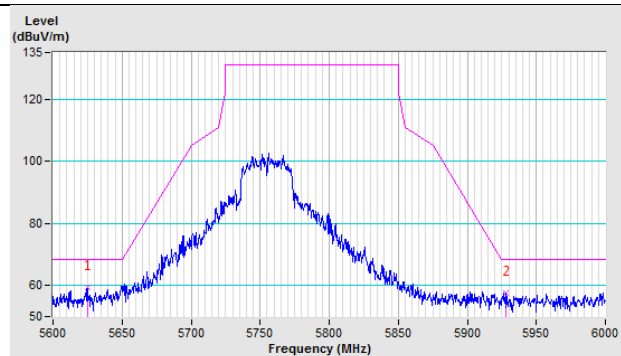

Vertical

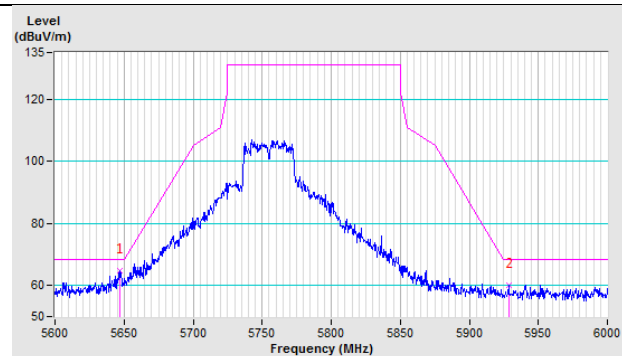

802.11ac (VHT40) CH 159 : 5795 MHz

Horizontal

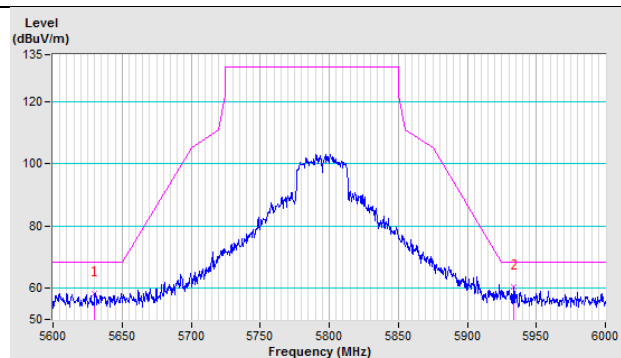

Vertical

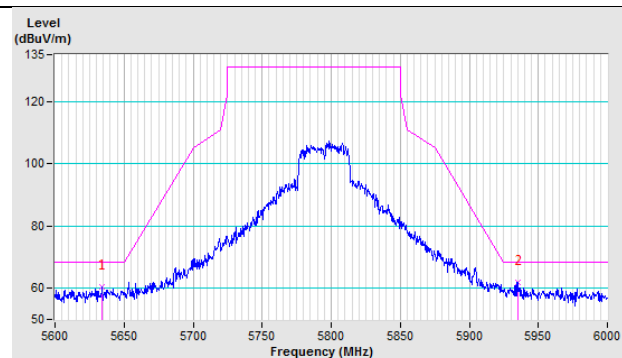

802.11ac (VHT80) CH 155 : 5775 MHz

Horizontal

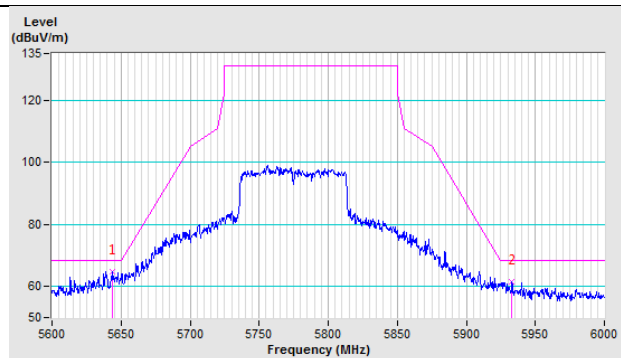

Vertical

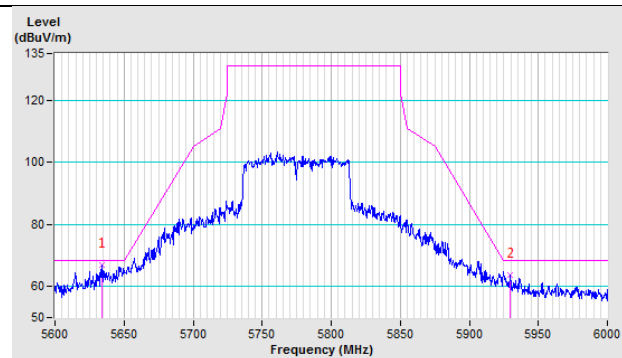

Annex B - Band Edge Measurement

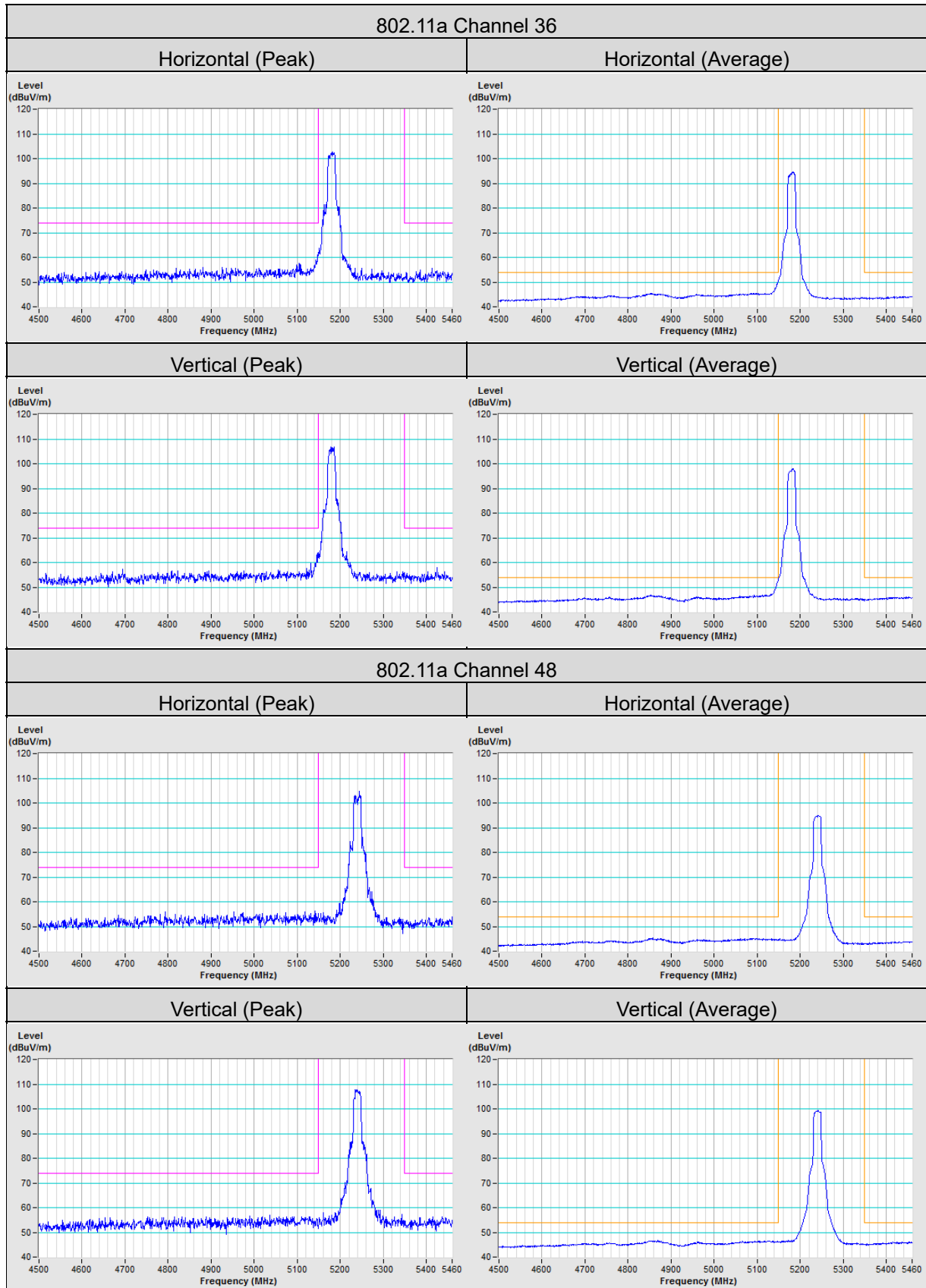

802.11ac (VHT20) Channel 36

Horizontal (Peak)Horizontal (Average)

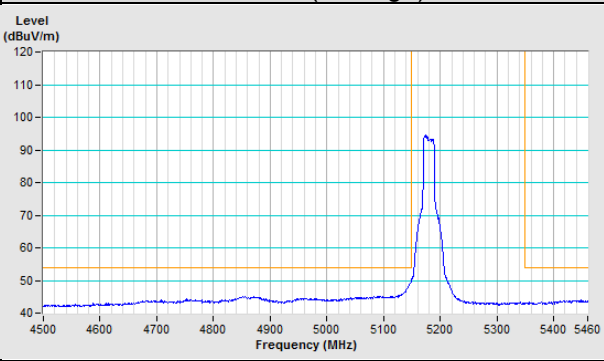
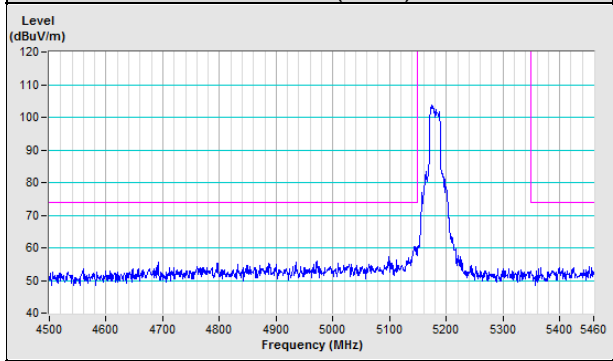

Vertical (Peak)

Vertical (Average)

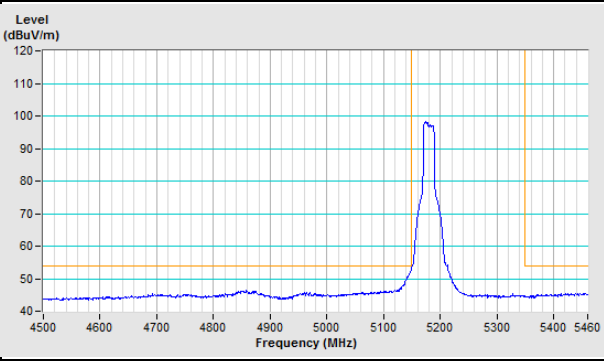
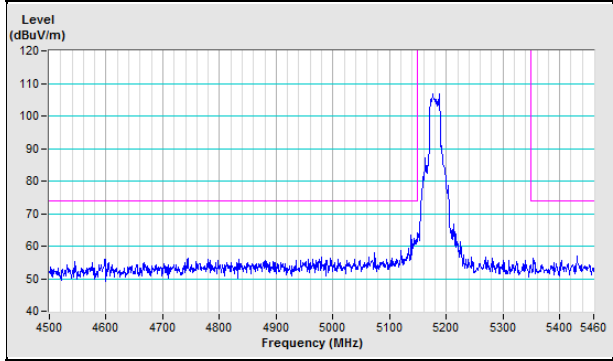

802.11ac (VHT20) Channel 48

Horizontal (Peak)Horizontal (Average)

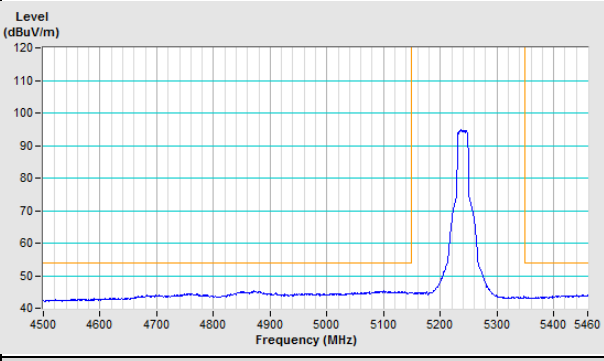
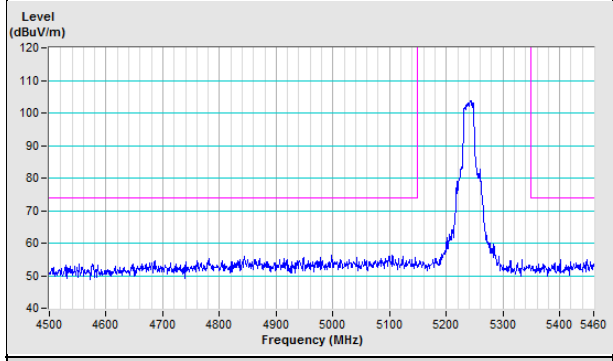

Vertical (Peak)

Vertical (Average)

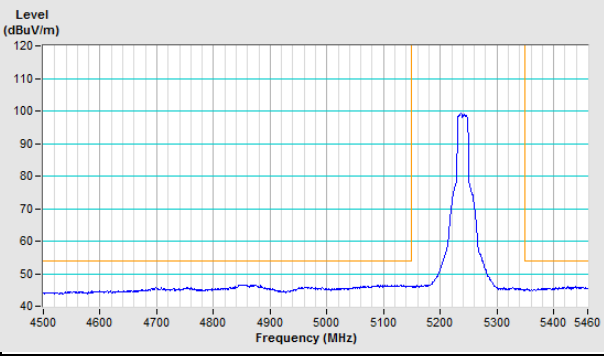
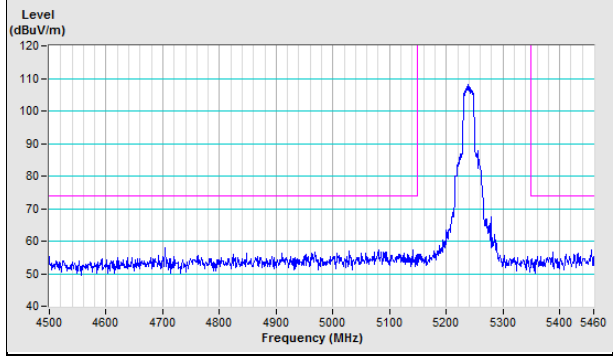

802.11ac (VHT40) Channel 38

Horizontal (Peak)

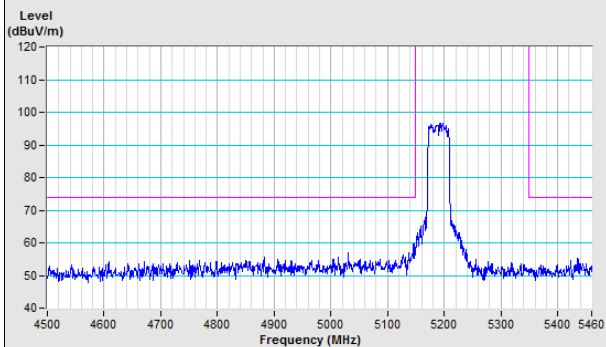

Horizontal (Average)

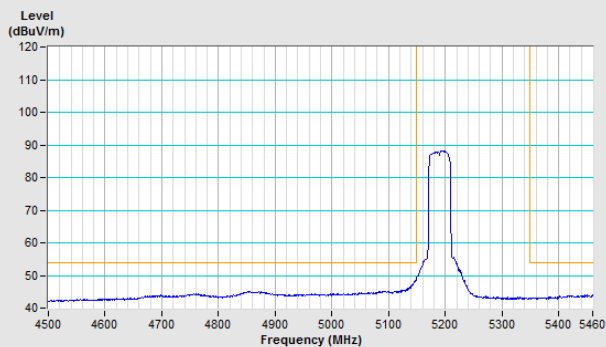

Vertical (Peak)

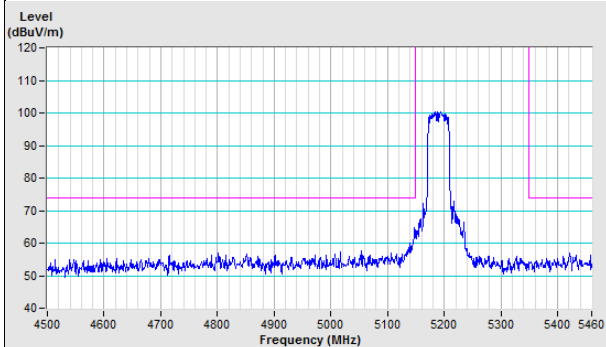

Vertical (Average)

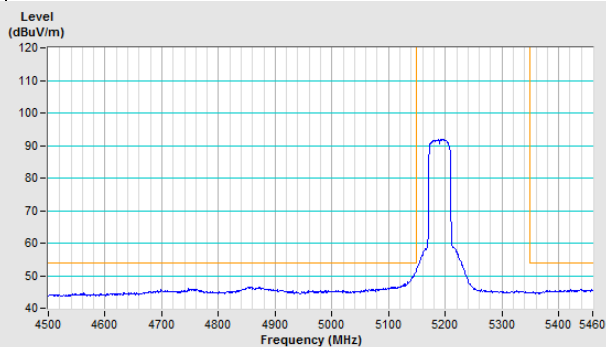

802.11ac (VHT40) Channel 46

Horizontal (Peak)

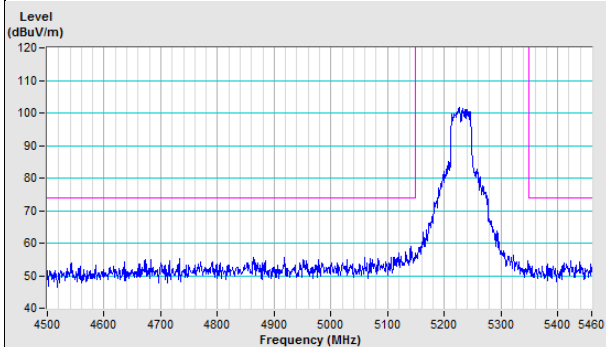

Horizontal (Average)

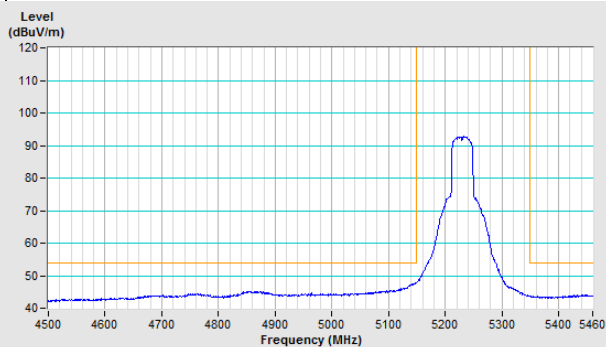

Vertical (Peak)

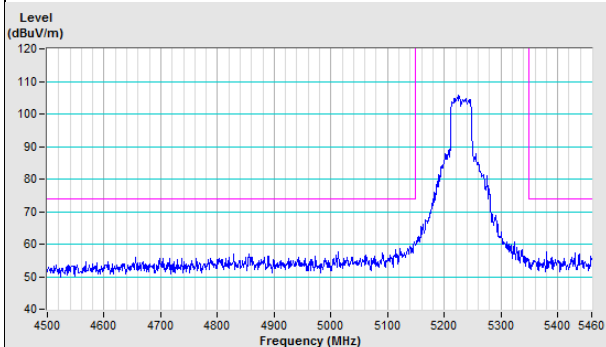

Vertical (Average)

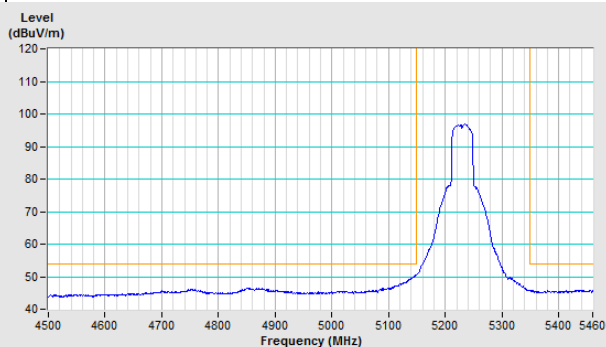

802.11ac (VHT80) Channel 42

Horizontal (Peak)

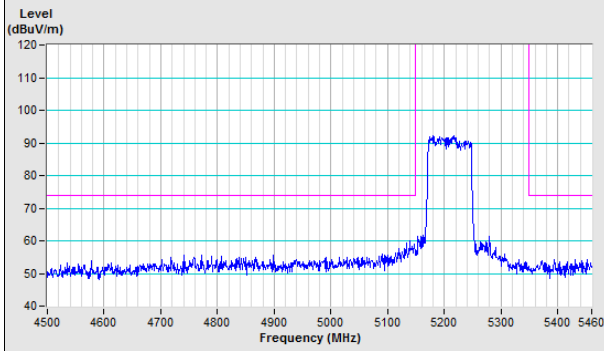

Horizontal (Average)

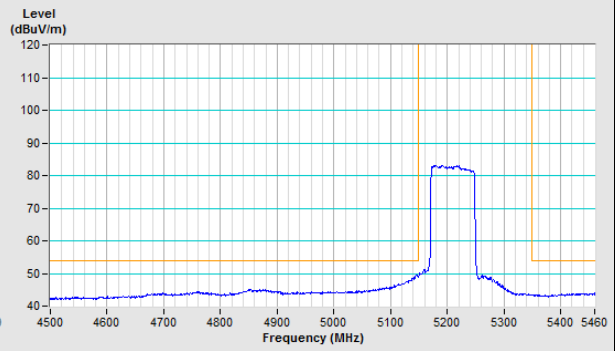

Vertical (Peak)

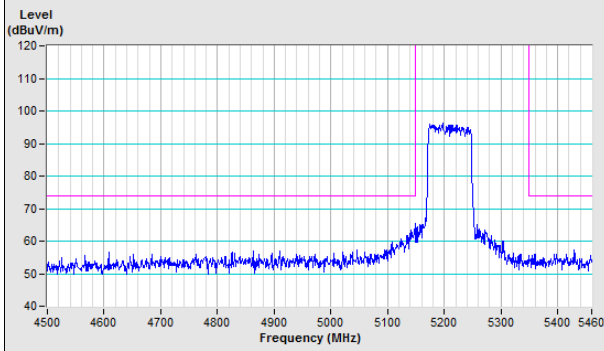

Vertical (Average)

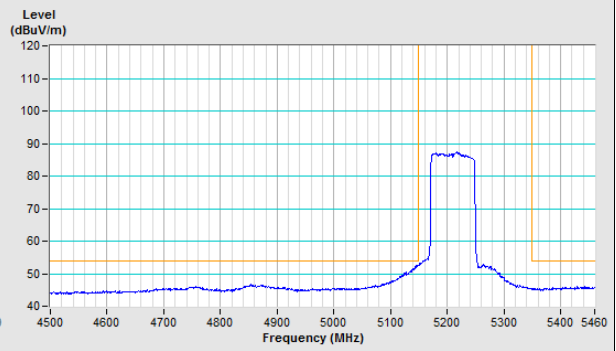

Appendix – Information of the Testing Laboratories

We, Bureau Veritas Consumer Products Services (H.K.) Ltd., Taoyuan Branch, were founded in 1988 to provide our best service in EMC, Radio, Telecom and Safety consultation. Our laboratories are FCC recognized accredited test firms and accredited and approved according to ISO/IEC 17025.

If you have any comments, please feel free to contact us at the following:

Lin Kou EMC/RF Lab

Tel: 886-2-26052180

Fax: 886-2-26051924

Hsin Chu EMC/RF/Telecom Lab

Tel: 886-3-6668565

Fax: 886-3-6668323

Hwa Ya EMC/RF/Safety Lab

Tel: 886-3-3183232

Fax: 886-3-3270892

Email: service.adt@tw.bureauveritas.com

Web Site: www.bureauveritas-adt.com

The address and road map of all our labs can be found in our web site also.

--- END ---