



RADIO TEST REPORT

FCC ID : PD5-CBW150AX
Equipment : Cisco Business 150AX Access Point
Brand Name : CISCO
Model Name : CBW150AX
Applicant : Delta Electronics, Inc.
31-1, Shien Pan Rd., Kuei San Industrial Zone,
Taoyuan City 333, Taiwan
Manufacturer : Delta Electronics, Inc.
31-1, Shien Pan Rd., Kuei San Industrial Zone,
Taoyuan City 333, Taiwan
Standard : 47 CFR FCC Part 15.247

The product was received on Aug. 24, 2021, and testing was started from Aug. 27, 2021 and completed on Nov. 15, 2021. We, Sporton International Inc. Hsinchu Laboratory, would like to declare that the tested sample has been evaluated in accordance with the procedures given in ANSI C63.10-2013 and shown compliance with the applicable technical standards.

The test results in this report apply exclusively to the tested model / sample. Without written approval of Sporton International Inc. Hsinchu Laboratory, the test report shall not be reproduced except in full.



Approved by: Sam Chen

Sporton International Inc. Hsinchu Laboratory
No.8, Ln. 724, Bo'ai St., Zhubei City, Hsinchu County 302010, Taiwan (R.O.C.)



Table of Contents

History of this test report.....3

Summary of Test Result.....4

1 General Description5

1.1 Information.....5

1.2 Applicable Standards9

1.3 Testing Location Information.....9

1.4 Measurement Uncertainty10

2 Test Configuration of EUT11

2.1 Test Channel Mode11

2.2 The Worst Case Measurement Configuration.....12

2.3 EUT Operation during Test13

2.4 Accessories13

2.5 Support Equipment.....14

2.6 Test Setup Diagram15

3 Transmitter Test Result18

3.1 AC Power-line Conducted Emissions18

3.2 DTS Bandwidth20

3.3 Maximum Conducted Output Power21

3.4 Power Spectral Density24

3.5 Emissions in Non-restricted Frequency Bands26

3.6 Emissions in Restricted Frequency Bands.....27

4 Test Equipment and Calibration Data32

Appendix A. Test Results of AC Power-line Conducted Emissions

Appendix B. Test Results of DTS Bandwidth

Appendix C. Test Results of Maximum Conducted Output Power

Appendix D. Test Results of Power Spectral Density

Appendix E. Test Results of Emissions in Non-restricted Frequency Bands

Appendix F. Test Results of Emissions in Restricted Frequency Bands

Appendix G. Test Photos

Photographs of EUT v01



History of this test report

Report No.	Version	Description	Issued Date
FR182329AC	01	Initial issue of report	Dec. 23, 2021



Summary of Test Result

Report Clause	Ref Std. Clause	Test Items	Result (PASS/FAIL)	Remark
1.1.2	15.203	Antenna Requirement	PASS	-
3.1	15.207	AC Power-line Conducted Emissions	PASS	-
3.2	15.247(a)	DTS Bandwidth	PASS	-
3.3	15.247(b)	Maximum Conducted Output Power	PASS	-
3.4	15.247(e)	Power Spectral Density	PASS	-
3.5	15.247(d)	Emissions in Non-restricted Frequency Bands	PASS	-
3.6	15.247(d)	Emissions in Restricted Frequency Bands	PASS	-

Declaration of Conformity:

The test results with all measurement uncertainty excluded are presented in accordance with the regulation limits or requirements declared by manufacturers.

Comments and Explanations:

1. The test configuration, test mode and test software were written in this test report are declared by the manufacturer.
2. The declared of product specification for EUT presented in the report are provided by the manufacturer, and the manufacturer takes all the responsibilities for the accuracy of product specification.

Reviewed by: Sam Chen**Report Producer: Viola Huang**



1 General Description

1.1 Information

1.1.1 RF General Information

Frequency Range (MHz)	Bluetooth Mode	Ch. Frequency (MHz)	Channel Number
2400-2483.5	LE	2402-2480	0-39 [40]

Band	Mode	BWch (MHz)	Nant
2.4-2.4835GHz	BT-LE(1Mbps)	1	1

Note:

- ♦ Bluetooth LE uses a GFSK modulation.
- ♦ BWch is the nominal channel bandwidth.



1.1.2 Antenna Information

Ant.	2.4GHz Port	5GHz Port	Bluetooth Port	Brand Name	Model Name	Antenna Type	Connector	Gain (dBi)
1	1	1	-	Delta	0990262017	Metal PIFA antenna	I-PEX	Note 1
2	2	2	-	Delta	0990262117	Metal PIFA antenna	I-PEX	
3	-	-	3	Delta	0990262217	Metal PIFA antenna	I-PEX	

Note 1:

Ant.	Gain (dBi)					
	2.4GHz	UNII 1	UNII 2A	UNII 2C	UNII 3	Bluetooth
1	3.9	4.9	4.9	4.2	5.1	-
2	3.1	4.6	4.6	5.4	5.4	-
3	-	-	-	-	-	4

Note 2: The EUT has three antennas.

Note 3: Directional gain information.

-	Maximum Output Power	Power Spectral Density
Non-BF	Directional gain = Max.gain + array gain. For power measurements on IEEE 802.11 devices Array Gain = 0 dB (i.e., no array gain) for N ANT ≤ 4	$DirectionalGain = 10 \cdot \log \left[\frac{\sum_{j=1}^{N_{SS}} \left\{ \sum_{k=1}^{N_{ANT}} g_{j,k} \right\}^2}{N_{ANT}} \right]$
BF	$DirectionalGain = 10 \cdot \log \left[\frac{\sum_{j=1}^{N_{SS}} \left\{ \sum_{k=1}^{N_{ANT}} g_{j,k} \right\}^2}{N_{ANT}} \right]$	$DirectionalGain = 10 \cdot \log \left[\frac{\sum_{j=1}^{N_{SS}} \left\{ \sum_{k=1}^{N_{ANT}} g_{j,k} \right\}^2}{N_{ANT}} \right]$



Ex.

Directional Gain (NSS1) formula :

$$DirectionalGain = 10 \cdot \log \left[\frac{\sum_{j=1}^{N_{SS}} \left\{ \sum_{k=1}^{N_{ANT}} g_{j,k} \right\}^2}{N_{ANT}} \right]$$

$$NSS1(g1,1) = 10^{G1/20}; NSS1(g1,2) = 10^{G2/20}; NSS1(g1,3) = 10^{G3/20}; NSS1(g1,4) = 10^{G4/20}$$

$$g_{j,k} = (NSS1(g1,1) + NSS1(g1,2) + NSS1(g1,3) + NSS1(g1,4))^2$$

$$DG = 10 \log[(NSS1(g1,1) + NSS1(g1,2) + NSS1(g1,3) + NSS1(g1,4))^2 / N_{ANT}] \Rightarrow 10 \log[(10^{G1/20} + 10^{G2/20} + 10^{G3/20} + 10^{G4/20})^2 / N_{ANT}]$$

Where ;G1 = Ant 1 Gain ; G2 = Ant 2 Gain

2.4GHz DG = 6.52 dBi

5 GHz Band1 DG = 7.76 dBi

5 GHz Band2 DG = 7.76 dBi

5 GHz Band3 DG = 7.83 dBi

5 GHz Band4 DG = 8.26 dBi

For 2.4GHz function:

For IEEE 802.11 b/g/n/VHT/ax mode (2TX/2RX)

Port 1 and Port 2 can be used as transmitting/receiving antenna.

Port 1 and Port 2 could transmit/receive simultaneously.

For 5GHz function:

For IEEE 802.11a/n/ac/ax mode (2TX/2RX)

Port 1 and Port 2 can be used as transmitting/receiving antenna.

Port 1 and Port 2 could transmit/receive simultaneously.

For bluetooth function:

For bluetooth (1TX/1RX)

Only Port 1 can be used as transmitting/receiving antenna.



1.1.3 Mode Test Duty Cycle

Mode	DC	DCF(dB)	T(s)	VBW(Hz) ≥ 1/T
BT-LE(1Mbps)	1	0	n/a (DC>=0.98)	n/a (DC>=0.98)

Note:

- ♦ DC is Duty Cycle.
- ♦ DCF is Duty Cycle Factor.

1.1.4 EUT Operational Condition

EUT Power Type	From PoE		
Function	<input checked="" type="checkbox"/> Point-to-multipoint	<input type="checkbox"/>	Point-to-point
Test Software Version	PUTTY 0.62.0.0		
Support Mode	<input checked="" type="checkbox"/>	LE 1M PHY: 1 Mb/s	
	<input type="checkbox"/>	LE Coded PHY (S=2): 500 Kb/s	
	<input type="checkbox"/>	LE Coded PHY (S=8): 125 Kb/s	
	<input type="checkbox"/>	LE 2M PHY: 2 Mb/s	

Note: The above information was declared by manufacturer.



1.2 Applicable Standards

According to the specifications of the manufacturer, the EUT must comply with the requirements of the following standards:

- ◆ 47 CFR FCC Part 15.247
- ◆ ANSI C63.10-2013

The following reference test guidance is not within the scope of accreditation of TAF.

- ◆ FCC KDB 558074 D01 v05r02
- ◆ FCC KDB 414788 D01 v01r01

1.3 Testing Location Information

Testing Location Information	
Test Lab. : Sporton International Inc. Hsinchu Laboratory	
Hsinchu (TAF: 3787)	ADD: No.8, Ln. 724, Bo'ai St., Zhubei City, Hsinchu County 302010, Taiwan (R.O.C.) TEL: 886-3-656-9065 FAX: 886-3-656-9085 Test site Designation No. TW3787 with FCC. Conformity Assessment Body Identifier (CABID) TW3787 with ISED.

Test Condition	Test Site No.	Test Engineer	Test Environment (°C / %)	Test Date
RF Conducted (for other test)	TH03-CB	Lucas Huang	23.2~24.6 / 54~57	Aug. 27, 2021~Nov. 08, 2021
RF Conducted (for emissions in restricted frequency bands below 1GHz)	TH03-CB	Lucas Huang	22.4~23.7 / 56~57	Nov. 25, 2021
Radiated below 1GHz (for cabinet test)	03CH05-CB	Eason Chen	23.5~24.6 / 55~59	Sep. 25, 2021~Nov. 15, 2021
Radiated above 1GHz (for cabinet test)	03CH03-CB	Eason Chen	23.7~24.8 / 56~59	Sep. 25, 2021~Nov. 15, 2021
AC Conduction	CO01-CB	Peter Wu	22~23 / 60~62	Nov. 02, 2021



1.4 Measurement Uncertainty

ISO/IEC 17025 requires that an estimate of the measurement uncertainties associated with the emissions test results be included in the report. The measurement uncertainties given below are based on a 95% confidence level (based on a coverage factor (k=2))

Test Items	Uncertainty	Remark
Conducted Emission (150kHz ~ 30MHz)	2.0 dB	Confidence levels of 95%
Radiated Emission (9kHz ~ 30MHz)	4.2 dB	Confidence levels of 95%
Radiated Emission (30MHz ~ 1,000MHz)	5.5 dB	Confidence levels of 95%
Radiated Emission (1GHz ~ 18GHz)	4.7 dB	Confidence levels of 95%
Radiated Emission (18GHz ~ 40GHz)	4.2 dB	Confidence levels of 95%
Conducted Emission	2.5 dB	Confidence levels of 95%
Output Power Measurement	1.3 dB	Confidence levels of 95%
Power Density Measurement	2.5 dB	Confidence levels of 95%
Bandwidth Measurement	0.9%	Confidence levels of 95%



2 Test Configuration of EUT

2.1 Test Channel Mode

Mode	Power Setting
BT-LE(1Mbps)	-
2402MHz	5
2440MHz	5
2480MHz	5



2.2 The Worst Case Measurement Configuration

The Worst Case Mode for Following Conformance Tests	
Tests Item	AC power-line conducted emissions
Condition	AC power-line conducted measurement for line and neutral Test Voltage: 120Vac / 60Hz
Operating Mode	Normal Link
1	EUT (Normal Link-WLAN & CTX-Bluetooth) + PoE

The Worst Case Mode for Following Conformance Tests	
Tests Item	DTS Bandwidth Maximum Conducted Output Power Power Spectral Density Emissions in Non-restricted Frequency Bands
Test Condition	Conducted measurement at transmit chains

The Worst Case Mode for Following Conformance Tests	
Tests Item	Emissions in Restricted Frequency Bands
Test Condition	Radiated measurement (Cabinet)
Operating Mode < 1GHz	CTX
1	EUT in Y axis_2.4GHz
2	EUT in Y axis_5GHz
3	EUT in Y axis_Bluetooth
For operating mode 2 is the worst case and it was record in this test report.	
Operating Mode > 1GHz	CTX The EUT was performed at X axis, Y axis and Z axis position, and the worst case was found at Y axis. So the measurement will follow this same test configuration.
1	EUT in Y axis



The Worst Case Mode for Following Conformance Tests	
Tests Item	Simultaneous Transmission Analysis - Co-location RF Exposure Evaluation
Operating Mode	
1	WLAN 2.4GHz + WLAN 5GHz + Bluetooth
Refer to Sporton Test Report No.: FA182329 for Co-location RF Exposure Evaluation.	

2.3 EUT Operation during Test

For CTX Mode:

The EUT was programmed to be in continuously transmitting mode.

For Normal Link Mode:

During the test, the EUT operation to normal function.

2.4 Accessories

Accessories			
Equipment Name	Brand Name	Model Name	Rating
PoE	RISUNIC	RP024W01-4800320ZG	IN PUT: 100-240V~50/60Hz, 0.6A Max OUT PUT: 48V, 0.32, 15.36W
Others			
Cradle*1			



2.5 Support Equipment

For AC Conduction:

Support Equipment				
No.	Equipment	Brand Name	Model Name	FCC ID
A	LAN NB	DELL	E6430	N/A
B	2.4G NB	DELL	E6430	N/A
C	5G NB	DELL	E6430	N/A

For Radiated:

Support Equipment				
No.	Equipment	Brand Name	Model Name	FCC ID
A	Notebook	DELL	E4300	N/A
B	Fixture	Delta	K-2 E239218	N/A

For RF Conducted:

Support Equipment				
No.	Equipment	Brand Name	Model Name	FCC ID
A	Notebook	DELL	E4300	N/A
B	Fixture	Delta	K-2 E239218	N/A

2.6 Test Setup Diagram

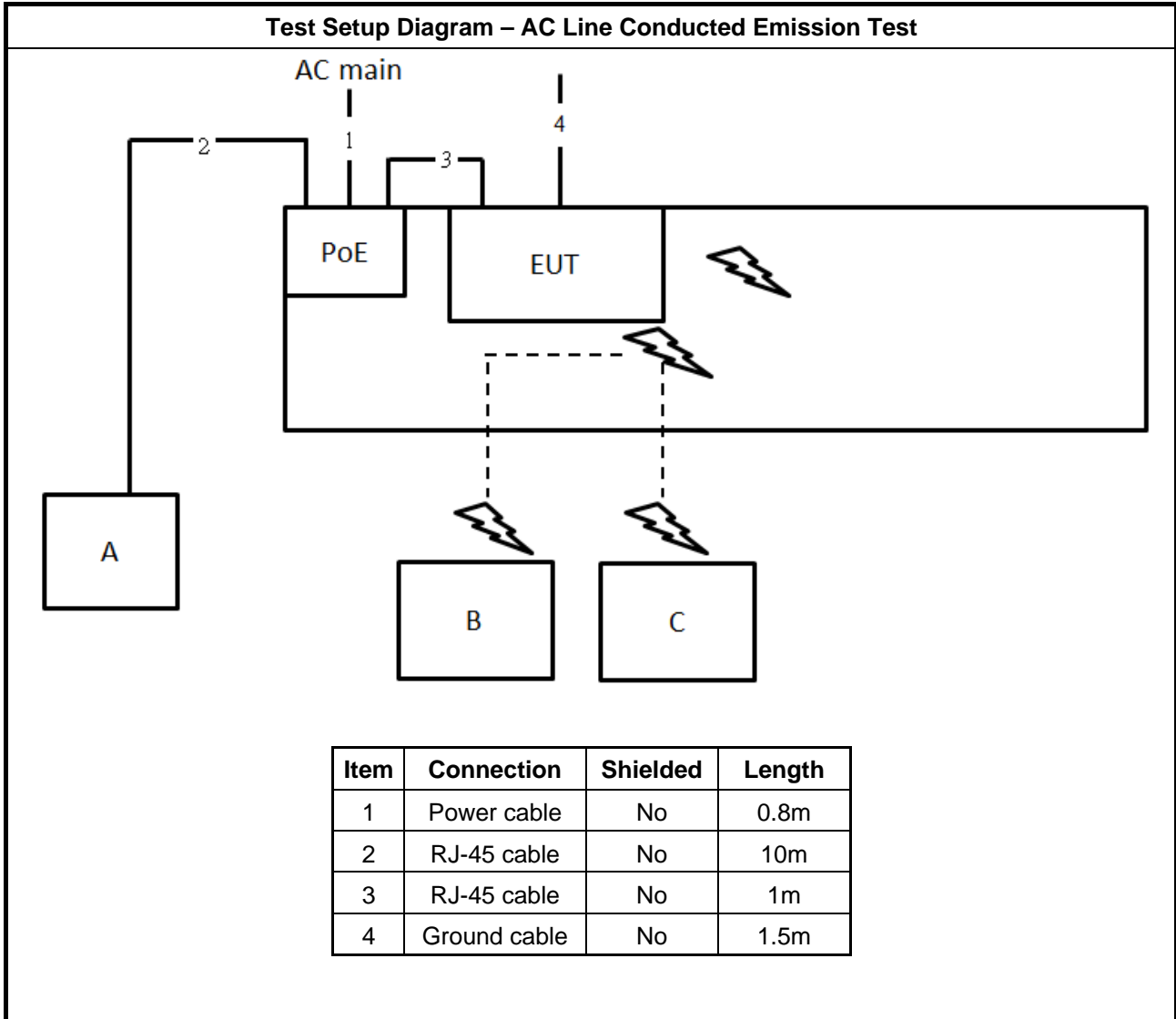

Test Setup Diagram - Radiated Test < 1GHz

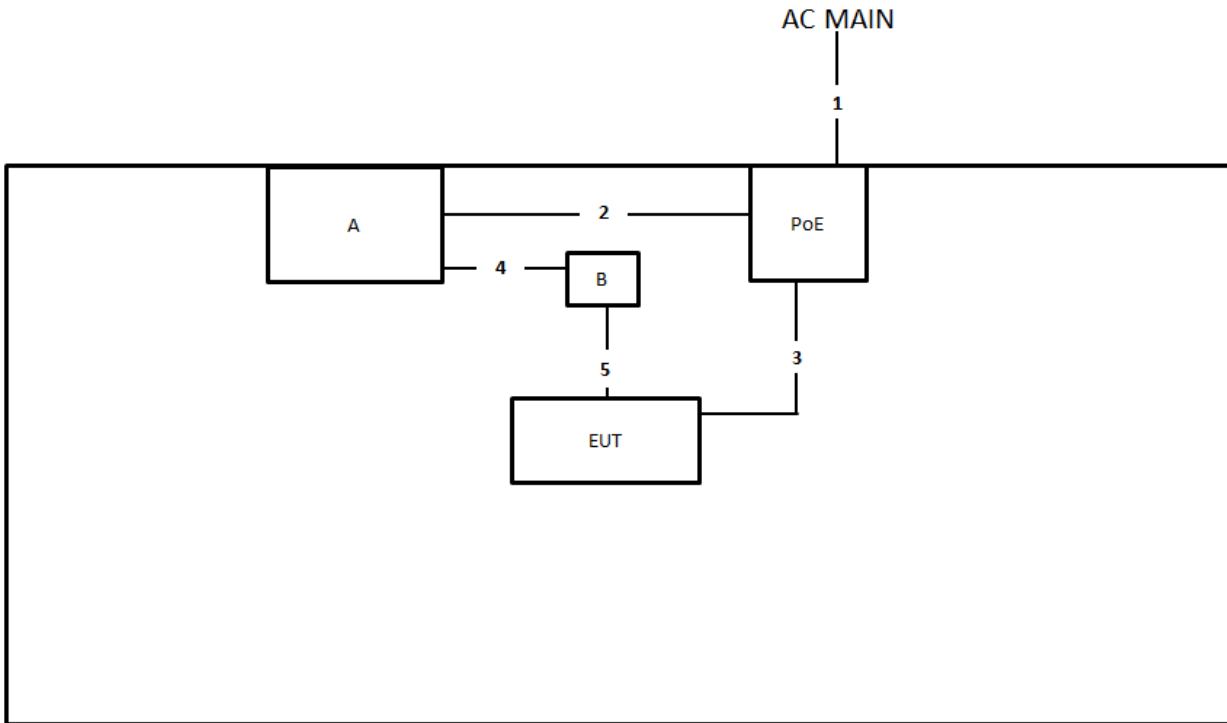

Item	Connection	Shielded	Length
1	Power cable	No	0.8m
2	RJ-45 cable	No	1.5m
3	RJ-45 cable	No	1.5m
4	Micro USB cable	Yes	0.5m
5	Console cable	No	0.25m

Test Setup Diagram - Radiated Test > 1GHz

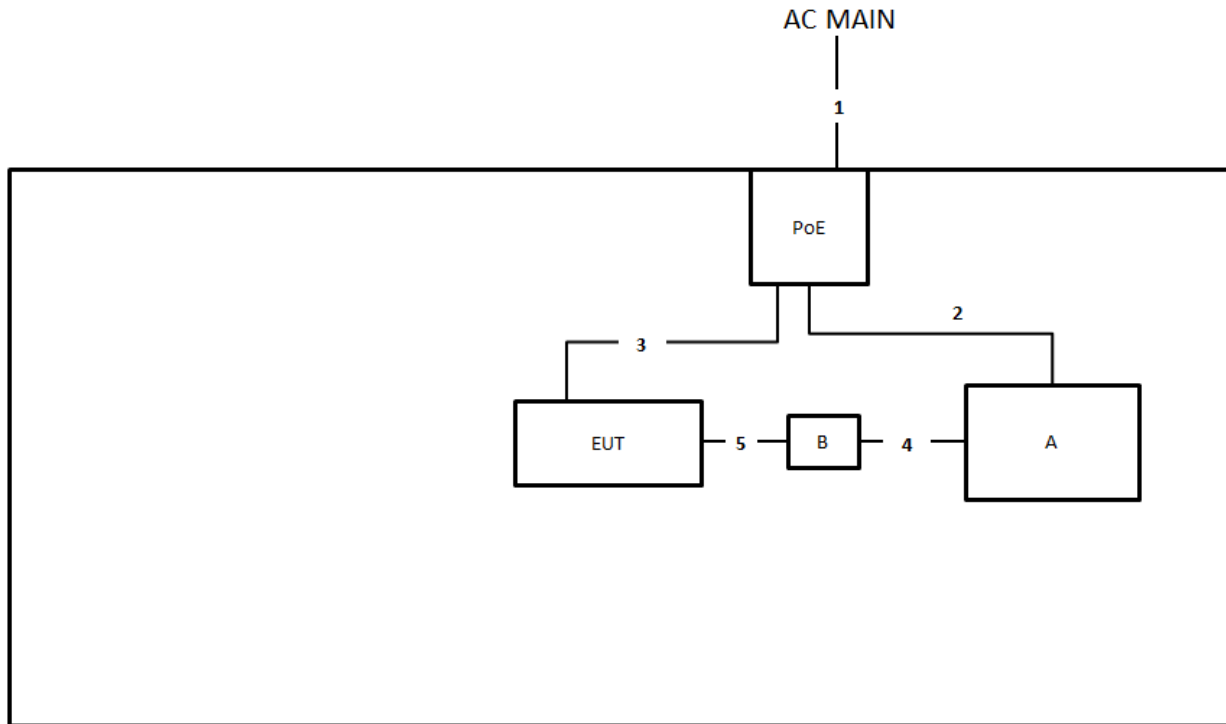

Item	Connection	Shielded	Length
1	Power cable	No	0.8m
2	RJ-45 cable	No	1.5m
3	RJ-45 cable	No	1.5m
4	Micro USB cable	Yes	0.5m
5	Console cable	No	0.25m



3 Transmitter Test Result

3.1 AC Power-line Conducted Emissions

3.1.1 AC Power-line Conducted Emissions Limit

AC Power-line Conducted Emissions Limit		
Frequency Emission (MHz)	Quasi-Peak	Average
0.15-0.5	66 - 56 *	56 - 46 *
0.5-5	56	46
5-30	60	50

Note 1: * Decreases with the logarithm of the frequency.

3.1.2 Measuring Instruments

Refer a test equipment and calibration data table in this test report.

3.1.3 Test Procedures

Test Method
▪ Refer as ANSI C63.10-2013, clause 6.2 for AC power-line conducted emissions.

3.1.4 Test Setup

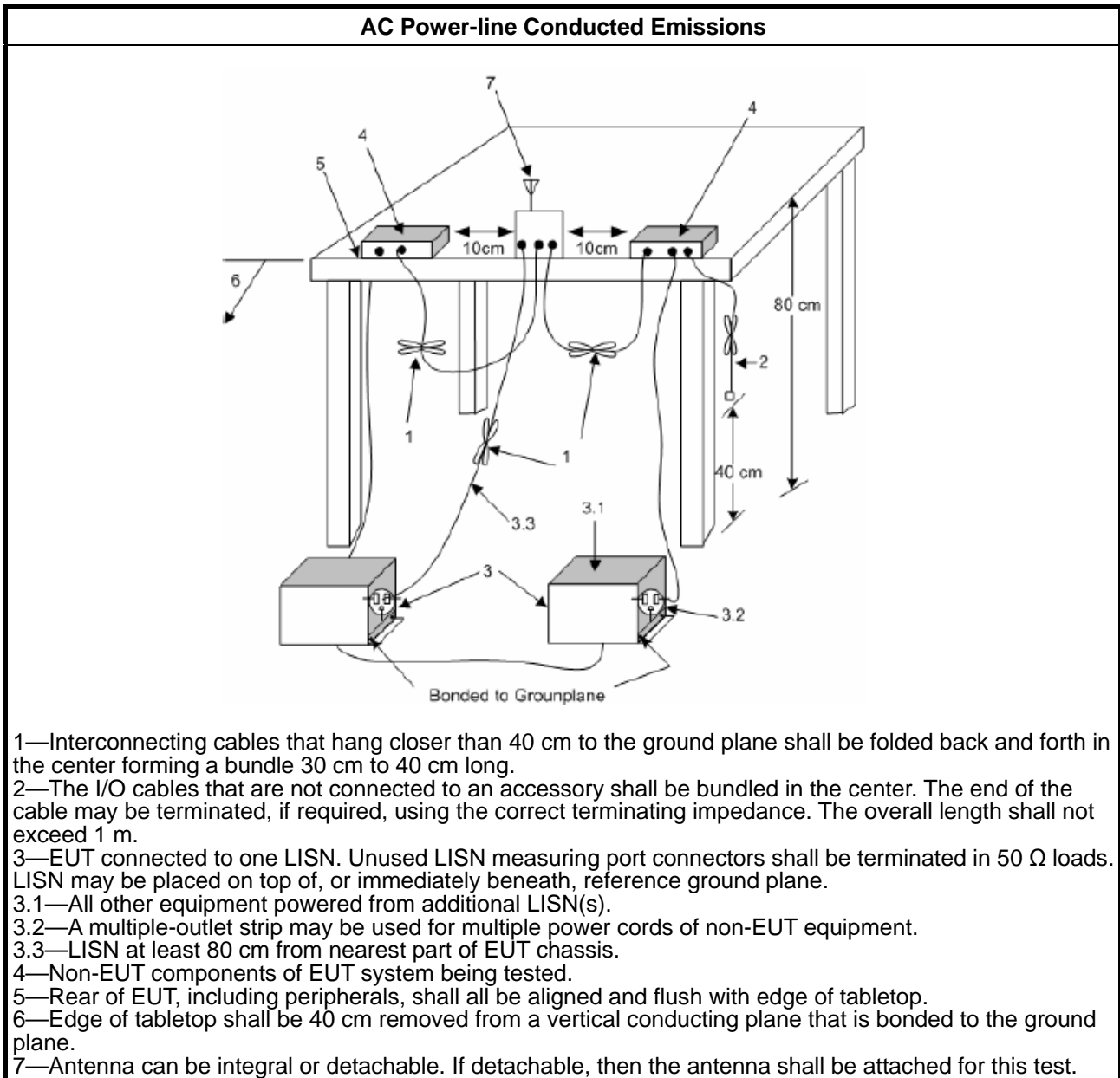

1.1.1. Measurement Results Calculation

The measured Level is calculated using:

- a. Corrected Reading: LISN Factor (LISN) + Attenuator (AT/AUX) + Cable Loss (CL) + Read Level (Raw) = Level
- b. Margin = -Limit + Level

3.1.5 Test Result of AC Power-line Conducted Emissions

Refer as Appendix A

3.2 DTS Bandwidth

3.2.1 6dB Bandwidth Limit

6dB Bandwidth Limit
Systems using digital modulation techniques:
<ul style="list-style-type: none"> ▪ 6 dB bandwidth \geq 500 kHz.

3.2.2 Measuring Instruments

Refer a test equipment and calibration data table in this test report.

3.2.3 Test Procedures

Test Method
<ul style="list-style-type: none"> ▪ For the emission bandwidth shall be measured using one of the options below:
<input checked="" type="checkbox"/> Refer as FCC KDB 558074, clause 8.2 & C63.10 clause 11.8.1 Option 1 for 6 dB bandwidth measurement.
<input type="checkbox"/> Refer as FCC KDB 558074, clause 8.2 & C63.10 clause 11.8.2 Option 2 for 6 dB bandwidth measurement.
<input type="checkbox"/> Refer as ANSI C63.10, clause 6.9.1 for occupied bandwidth testing.

3.2.4 Test Setup

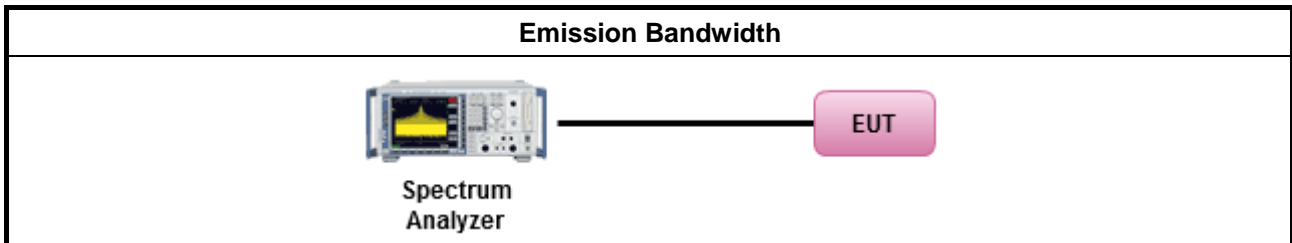

3.2.5 Test Result of Emission Bandwidth

Refer as Appendix B

3.3 Maximum Conducted Output Power

3.3.1 Maximum Conducted Output Power Limit

Maximum Conducted Output Power Limit	
	<ul style="list-style-type: none"> ▪ If $G_{TX} \leq 6$ dBi, then $P_{Out} \leq 30$ dBm (1 W)
	<ul style="list-style-type: none"> ▪ Point-to-multipoint systems (P2M): If $G_{TX} > 6$ dBi, then $P_{Out} = 30 - (G_{TX} - 6)$ dBm
	<ul style="list-style-type: none"> ▪ Point-to-point systems (P2P): If $G_{TX} > 6$ dBi, then $P_{Out} = 30 - (G_{TX} - 6)/3$ dBm
	<ul style="list-style-type: none"> ▪ Smart antenna system (SAS):
	<ul style="list-style-type: none"> - Single beam: If $G_{TX} > 6$ dBi, then $P_{Out} = 30 - (G_{TX} - 6)/3$ dBm
	<ul style="list-style-type: none"> - Overlap beam: If $G_{TX} > 6$ dBi, then $P_{Out} = 30 - (G_{TX} - 6)/3$ dBm
	<ul style="list-style-type: none"> - Aggregate power on all beams: If $G_{TX} > 6$ dBi, then $P_{Out} = 30 - (G_{TX} - 6)/3 + 8$ dB dBm
P_{Out} = maximum peak conducted output power or maximum conducted output power in dBm, G_{TX} = the maximum transmitting antenna directional gain in dBi.	

3.3.2 Measuring Instruments

Refer a test equipment and calibration data table in this test report.



3.3.3 Test Procedures

Test Method	
<ul style="list-style-type: none"> ▪ Maximum Peak Conducted Output Power 	
	<input type="checkbox"/> Refer as FCC KDB 558074, clause 8.3.1.1 & C63.10 clause 11.9.1.1 (RBW ≥ EBW method).
	<input type="checkbox"/> Refer as FCC KDB 558074, clause 8.3.1.3 & C63.10 clause 11.9.1.3 (peak power meter).
<ul style="list-style-type: none"> ▪ Maximum Conducted Output Power 	
[duty cycle ≥ 98% or external video / power trigger]	
	<input type="checkbox"/> Refer as FCC KDB 558074, clause 8.3.2.2 & C63.10 clause 11.9.2.2.2 Method AVGSA-1.
	<input type="checkbox"/> Refer as FCC KDB 558074, clause 8.3.2.2 & C63.10 clause 11.9.2.2.3 Method AVGSA-1A. (alternative)
duty cycle < 98% and average over on/off periods with duty factor	
	<input type="checkbox"/> Refer as FCC KDB 558074, clause 8.3.2.2 & C63.10 clause 11.9.2.2.4 Method AVGSA-2.
	<input type="checkbox"/> Refer as FCC KDB 558074, clause 8.3.2.2 & C63.10 clause 11.9.2.2.5 Method AVGSA-2A (alternative)
	<input type="checkbox"/> Refer as FCC KDB 558074, clause 8.3.2.2 & C63.10 clause 11.9.2.2.6 Method AVGSA-3
	<input type="checkbox"/> Refer as FCC KDB 558074, clause 8.3.2.2 & C63.10 clause 11.9.2.2.7 Method AVGSA-3A (alternative)
Measurement using a power meter (PM)	
	<input type="checkbox"/> Refer as FCC KDB 558074, clause 8.3.2.3 & C63.10 clause 11.9.2.3.1 Method AVGPM (using an RF average power meter).
	<input checked="" type="checkbox"/> Refer as FCC KDB 558074, clause 8.3.2.3 & C63.10 clause 11.9.2.3.2 Method AVGPM-G (using an gate RF average power meter).
<ul style="list-style-type: none"> ▪ For conducted measurement. 	
	<ul style="list-style-type: none"> ▪ If the EUT supports multiple transmit chains using options given below: Refer as FCC KDB 662911, In-band power measurements. Using the measure-and-sum approach, measured all transmit ports individually. Sum the power (in linear power units e.g., mW) of all ports for each individual sample and save them.
	<ul style="list-style-type: none"> ▪ If multiple transmit chains, EIRP calculation could be following as methods: $P_{total} = P_1 + P_2 + \dots + P_n$ (calculated in linear unit [mW] and transfer to log unit [dBm]) $EIRP_{total} = P_{total} + DG$

3.3.4 Test Setup

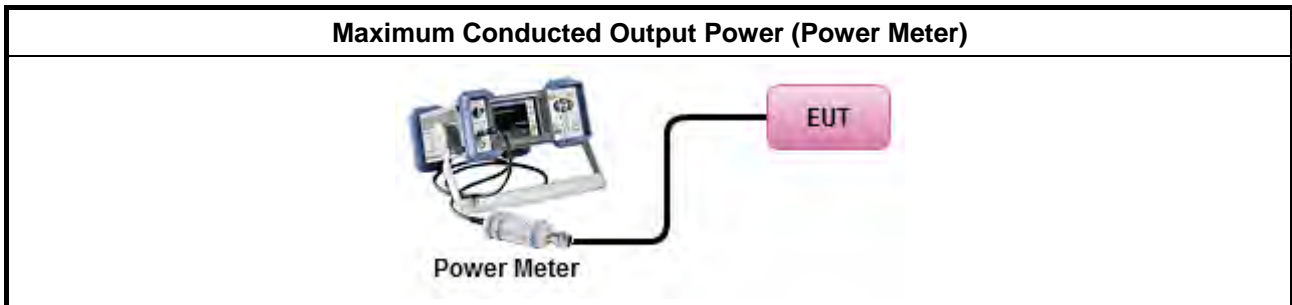

3.3.5 Test Result of Maximum Conducted Output Power

Refer as Appendix C



3.4 Power Spectral Density

3.4.1 Power Spectral Density Limit

Power Spectral Density Limit
<ul style="list-style-type: none"> Power Spectral Density (PSD) ≤ 8 dBm/3kHz

3.4.2 Measuring Instruments

Refer a test equipment and calibration data table in this test report.

3.4.3 Test Procedures

Test Method
<ul style="list-style-type: none"> Peak power spectral density procedures that the same method as used to determine the conducted output power. If maximum peak conducted output power was measured to demonstrate compliance to the output power limit, then the peak PSD procedure below (Method PKPSD) shall be used. If maximum conducted output power was measured to demonstrate compliance to the output power limit, then one of the average PSD procedures shall be used, as applicable based on the following criteria (the peak PSD procedure is also an acceptable option).
<input checked="" type="checkbox"/> Refer as FCC KDB 558074, clause 8.4 & C63.10 clause 11.10 Method Max. PSD. [duty cycle ≥ 98% or external video / power trigger]
<ul style="list-style-type: none"> For conducted measurement.
<ul style="list-style-type: none"> If The EUT supports multiple transmit chains using options given below: <ul style="list-style-type: none"> <input type="checkbox"/> Option 1: Measure and sum the spectra across the outputs. Refer as FCC KDB 662911, In-band power spectral density (PSD). Sample all transmit ports simultaneously using a spectrum analyzer for each transmit port. Where the trace bin-by-bin of each transmit port summing can be performed. (i.e., in the first spectral bin of output 1 is summed with that in the first spectral bin of output 2 and that from the first spectral bin of output 3, and so on up to the NTX output to obtain the value for the first frequency bin of the summed spectrum.). Add up the amplitude (power) values for the different transmit chains and use this as the new data trace. <input type="checkbox"/> Option 2: Measure and sum spectral maxima across the outputs. With this technique, spectra are measured at each output of the device at the required resolution bandwidth. The maximum value (peak) of each spectrum is determined. These maximum values are then summed mathematically in linear power units across the outputs. These operations shall be performed separately over frequency spans that have different out-of-band or spurious emission limits, <input type="checkbox"/> Option 3: Measure and add 10 log(N) dB, where N is the number of transmit chains. Refer as FCC KDB 662911, In-band power spectral density (PSD). Performed at each transmit chains and each transmit chains shall be compared with the limit have been reduced with 10 log(N). Or each transmit chains shall be add 10 log(N) to compared with the limit.

3.4.4 Test Setup

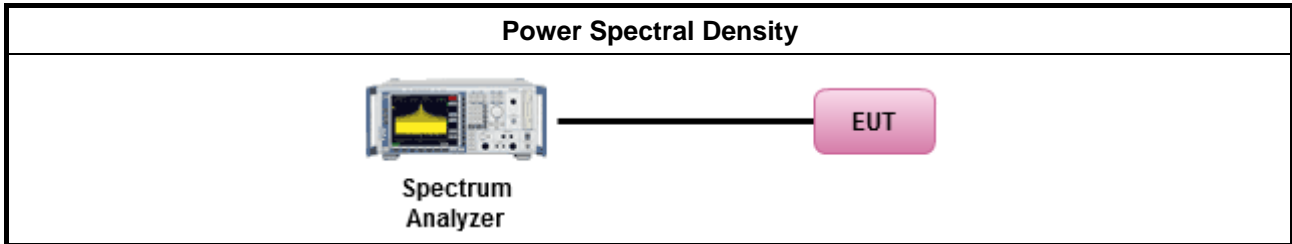

3.4.5 Test Result of Power Spectral Density

Refer as Appendix D

3.5 Emissions in Non-restricted Frequency Bands

3.5.1 Emissions in Non-restricted Frequency Bands Limit

Un-restricted Band Emissions Limit	
RF output power procedure	Limit (dBc)
Peak output power procedure	20
Average output power procedure	30

Note 1: If the peak output power procedure is used to measure the fundamental emission power to demonstrate compliance to requirements, then the peak conducted output power measured within any 100 kHz outside the authorized frequency band shall be attenuated by at least 20 dB relative to the maximum measured in-band peak PSD level.

Note 2: If the average output power procedure is used to measure the fundamental emission power to demonstrate compliance to requirements, then the power in any 100 kHz outside of the authorized frequency band shall be attenuated by at least 30 dB relative to the maximum measured in-band average PSD level.

3.5.2 Measuring Instruments

Refer a test equipment and calibration data table in this test report.

3.5.3 Test Procedures

Test Method
<ul style="list-style-type: none"> Refer as FCC KDB 558074, clause 8.5 for unwanted emissions into non-restricted bands.

3.5.4 Test Setup

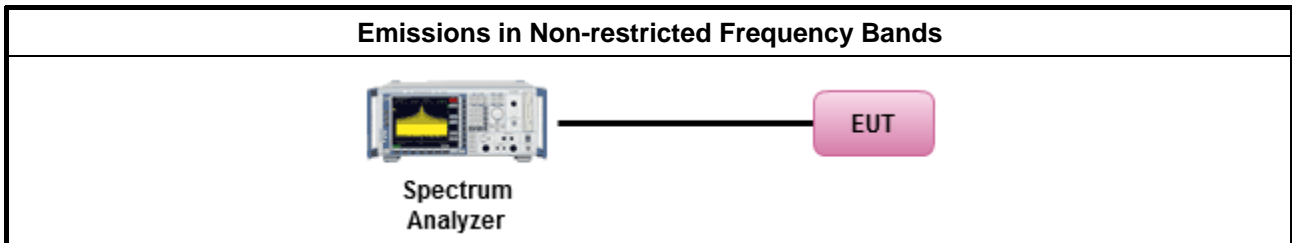

3.5.5 Test Result of Emissions in Non-restricted Frequency Bands

Refer as Appendix E



3.6 Emissions in Restricted Frequency Bands

3.6.1 Emissions in Restricted Frequency Bands Limit

Restricted Band Emissions Limit			
Frequency Range (MHz)	Field Strength (uV/m)	Field Strength (dBuV/m)	Measure Distance (m)
0.009~0.490	2400/F(kHz)	48.5 - 13.8	300
0.490~1.705	24000/F(kHz)	33.8 - 23	30
1.705~30.0	30	29	30
30~88	100	40	3
88~216	150	43.5	3
216~960	200	46	3
Above 960	500	54	3

Note 1: Test distance for frequencies at or above 30 MHz, measurements may be performed at a distance other than the limit distance provided they are not performed in the near field and the emissions to be measured can be detected by the measurement equipment. When performing measurements at a distance other than that specified, the results shall be extrapolated to the specified distance using an extrapolation factor of 20 dB/decade (inverse of linear distance for field-strength measurements, inverse of linear distance-squared for power-density measurements).

Note 2: Test distance for frequencies at below 30 MHz, measurements may be performed at a distance closer than the EUT limit distance; however, an attempt should be made to avoid making measurements in the near field. When performing measurements below 30 MHz at a closer distance than the limit distance, the results shall be extrapolated to the specified distance by either making measurements at a minimum of two or more distances on at least one radial to determine the proper extrapolation factor or by using the square of an inverse linear distance extrapolation factor (40 dB / decade). The test report shall specify the extrapolation method used to determine compliance of the EUT.

Note 3: Using the distance of 1m during the test for above 18 GHz, and the test value to correct for the distance factor at 3m.

3.6.2 Measuring Instruments

Refer a test equipment and calibration data table in this test report.



3.6.3 Test Procedures

Test Method	
<ul style="list-style-type: none"> ▪ The average emission levels shall be measured in [duty cycle \geq 98 or duty factor]. 	
<ul style="list-style-type: none"> ▪ Refer as ANSI C63.10, clause 6.10.3 band-edge testing shall be performed at the lowest frequency channel and highest frequency channel within the allowed operating band. 	
<ul style="list-style-type: none"> ▪ For the transmitter unwanted emissions shall be measured using following options below: 	
	<ul style="list-style-type: none"> ▪ Refer as FCC KDB 558074, clause 8.6 for unwanted emissions into restricted bands.
	<input type="checkbox"/> Refer as FCC KDB 558074, clause 8.6 & C63.10 clause 11.12.2.5.1(trace averaging for duty cycle \geq 98%).
	<input type="checkbox"/> Refer as FCC KDB 558074, clause 8.6 & C63.10 clause 11.12.2.5.2(trace averaging + duty factor).
	<input checked="" type="checkbox"/> Refer as FCC KDB 558074, clause 8.6 & C63.10 clause 11.12.2.5.3(Reduced VBW \geq 1/T).
	<input type="checkbox"/> Refer as ANSI C63.10, clause 11.12.2.5.3 (Reduced VBW). VBW \geq 1/T, where T is pulse time.
	<input type="checkbox"/> Refer as ANSI C63.10, clause 7.5 average value of pulsed emissions.
	<input checked="" type="checkbox"/> Refer as FCC KDB 558074, clause 8.6 & C63.10 clause 11.12.2.4 measurement procedure peak limit.
<ul style="list-style-type: none"> ▪ For the transmitter band-edge emissions shall be measured using following options below: 	
	<ul style="list-style-type: none"> ▪ Refer as FCC KDB 558074 clause 8.7 & c63.10 clause 11.13.1, When the performing peak or average radiated measurements, emissions within 2 MHz of the authorized band edge may be measured using the marker-delta method described below.
	<ul style="list-style-type: none"> ▪ Refer as FCC KDB 558074, clause 8.7 (ANSI C63.10, clause 6.10.6) for marker-delta method for band-edge measurements.
	<ul style="list-style-type: none"> ▪ Refer as FCC KDB 558074, clause 8.7 for narrower resolution bandwidth (100kHz) using the band power and summing the spectral levels (i.e., 1 MHz).
	<ul style="list-style-type: none"> ▪ For conducted unwanted emissions into restricted bands (absolute emission limits). Devices with multiple transmit chains using options given below: (1) Measure and sum the spectra across the outputs or (2) Measure and add 10 log(N) dB
	<ul style="list-style-type: none"> ▪ For FCC KDB 662911 The methodology described here may overestimate array gain, thereby resulting in apparent failures to satisfy the out-of-band limits even if the device is actually compliant. In such cases, compliance may be demonstrated by performing radiated tests around the frequencies at which the apparent failures occurred.



Test Method	
<ul style="list-style-type: none">▪ For conducted and cabinet radiation measurement, refer as FCC KDB 558074, clause 8.6 & C63.10 clause 11.12.2.2.	
<ul style="list-style-type: none">▪ For conducted unwanted emissions into non-restricted bands (relative emission limits). Devices with multiple transmit chains: Refer as FCC KDB 662911, when testing out-of-band and spurious emissions against relative emission limits, tests may be performed on each output individually without summing or adding 10 log(N) if the measurements are made relative to the in-band emissions on the individual outputs.	
<ul style="list-style-type: none">▪ For conducted unwanted emissions into restricted bands (absolute emission limits). Devices with multiple transmit chains using options given below: (1) Measure and sum the spectra across the outputs or (2) Measure and add 10 log(N) dB	
<ul style="list-style-type: none">▪ For FCC KDB 662911 The methodology described here may overestimate array gain, thereby resulting in apparent failures to satisfy the out-of-band limits even if the device is actually compliant. In such cases, compliance may be demonstrated by performing radiated tests around the frequencies at which the apparent failures occurred.	

3.6.4 Test Setup

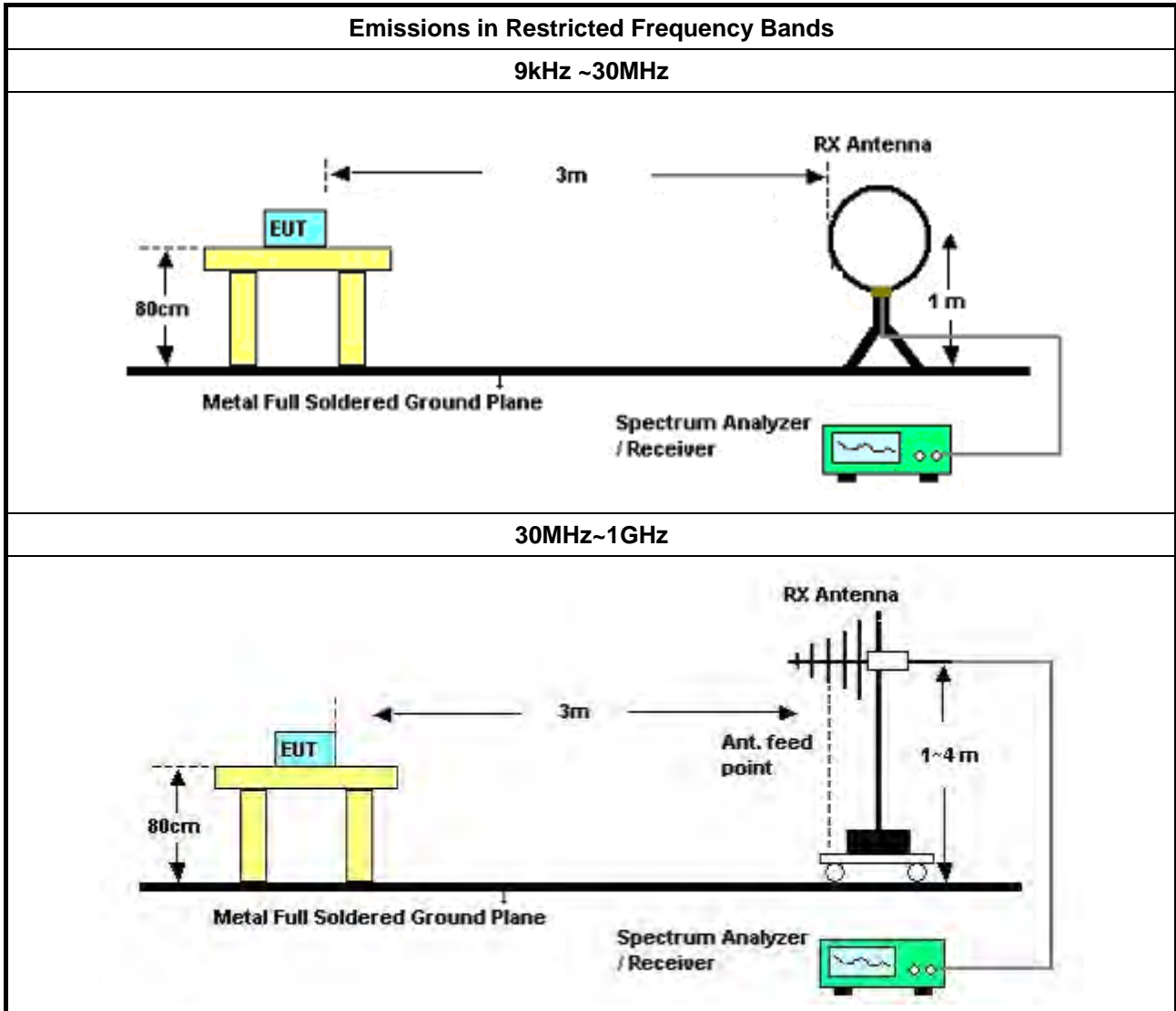

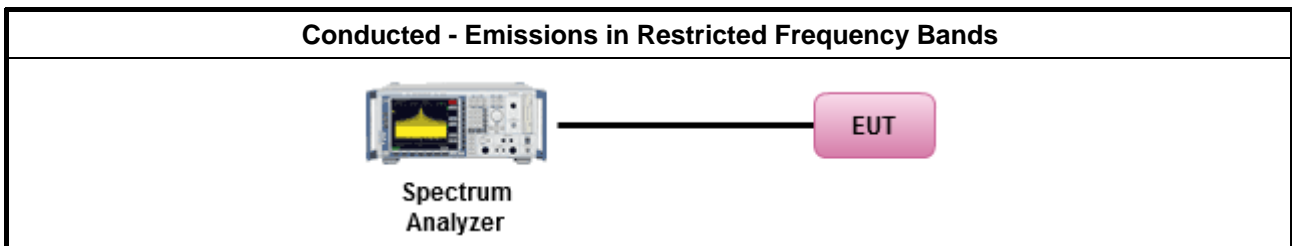
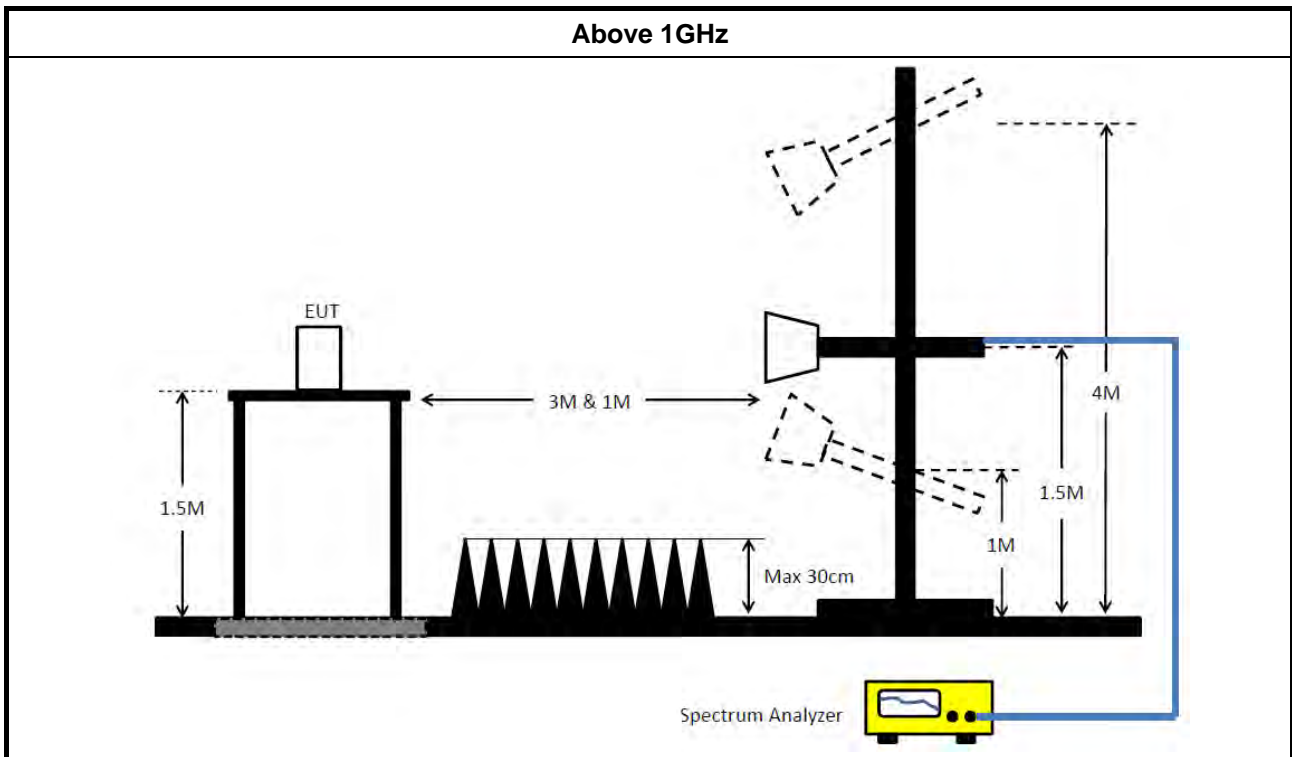

3.6.5 Measurement Results Calculation

The measured Level is calculated using:
 Corrected Reading: Antenna factor (AF) + Cable loss (CL) + Read level (Raw) - Preamp factor (PA)(if applicable) = Level.

3.6.6 Emissions in Restricted Frequency Bands (Below 30MHz)

There is a comparison data of both open-field test site and alternative test site - semi-Anechoic chamber according to KDB414788 Radiated Test Site, and the result came out very similar.
 All amplitude of spurious emissions that are attenuated by more than 20 dB below the permissible value has no need to be reported.
 The radiated emissions were investigated from 9 kHz or the lowest frequency generated within the device, up to the 10th harmonic or 40 GHz, whichever is appropriate.

3.6.7 Test Result of Emissions in Restricted Frequency Bands

Refer as Appendix F



4 Test Equipment and Calibration Data

Instrument	Brand	Model No.	Serial No.	Characteristics	Calibration Date	Calibration Due Date	Remark
EMI Receiver	Agilent	N9038A	My52260123	9kHz ~ 8.4GHz	Mar. 03, 2021	Mar. 02, 2022	Conduction (CO01-CB)
LISN	F.C.C.	FCC-LISN-50-16-2	04083	150kHz ~ 100MHz	Jan. 06, 2021	Jan. 05, 2022	Conduction (CO01-CB)
LISN	Schwarzbeck	NSLK 8127	8127647	9kHz ~ 30MHz	Mar. 07, 2021	Mar. 06, 2022	Conduction (CO01-CB)
Pulse Limiter	Rohde&Schwarz	ESH3-Z2	100430	9kHz ~ 30MHz	Jan. 30, 2021	Jan. 29, 2022	Conduction (CO01-CB)
Software	SPORTON	SENSE	V5.10	-	N.C.R.	N.C.R.	Conduction (CO01-CB)
EMI Receiver	Agilent	N9038A	My52260123	9kHz ~ 8.4GHz	Mar. 03, 2021	Mar. 02, 2022	Conduction (CO01-CB)
LISN	F.C.C.	FCC-LISN-50-16-2	04083	150kHz ~ 100MHz	Jan. 06, 2021	Jan. 05, 2022	Conduction (CO01-CB)
LISN	Schwarzbeck	NSLK 8127	8127647	9kHz ~ 30MHz	Mar. 07, 2021	Mar. 06, 2022	Conduction (CO01-CB)
Spectrum Analyzer	R&S	FSV40	101024	9kHz ~ 40GHz	Dec. 04, 2020	Dec. 03, 2021	Radiation (05CH01-CB)
Loop Antenna	Teseq	HLA 6120	24155	9kHz - 30 MHz	Apr. 14, 2021	Apr. 13, 2022	Radiation (05CH01-CB)
Pre-Amplifier	EMCI	EMC330N	980537	25MHz~1GHz	Mar. 04, 2021	Mar. 03, 2022	Radiation (05CH01-CB)
Bilog Antenna	Schaffner	CBL6112B	2894	25MHz ~ 1GHz	Feb. 09, 2021	Feb. 08, 2022	Radiation (05CH01-CB)
CABLE	Woken	N/A	Low Cable-06	25MHz ~ 1GHz	Dec. 31, 2020	Dec. 30, 2021	Radiation (05CH01-CB)
Test Software	SPORTON	SENSE	V5.10	-	N.C.R.	N.C.R.	Radiation (05CH01-CB)
3m Semi Anechoic Chamber VSWR	TDK	SAC-3M	03CH03-CB	1GHz ~18GHz 3m	May 06, 2021	May 05, 2022	Radiation (03CH03-CB)
Horn Antenna	ETS · Lindgren	3115	6821	750MHz~18GHz	Jan. 26, 2021	Jan. 25, 2022	Radiation (03CH03-CB)
Horn Antenna	Schwarzbeck	BBHA 9170	BBHA9170252	15GHz ~ 40GHz	Aug. 05, 2021	Aug. 04, 2022	Radiation (03CH03-CB)
Pre-Amplifier	Agilent	8449B	3008A02097	1GHz ~ 26.5GHz	Jul. 02, 2021	Jul. 01, 2022	Radiation (03CH03-CB)
Pre-Amplifier	MITEQ	TTA1840-35-HG	1864479	18GHz ~ 40GHz	Jul. 13, 2021	Jul. 12, 2022	Radiation (03CH03-CB)
Spectrum Analyzer	R&S	FSP40	100019	9kHz ~ 40GHz	Jun. 04, 2021	Jun. 03, 2022	Radiation (03CH03-CB)



Instrument	Brand	Model No.	Serial No.	Characteristics	Calibration Date	Calibration Due Date	Remark
RF Cable-high	Woken	RG402	High Cable-21	1GHz - 18GHz	Oct. 05, 2020	Oct. 04, 2021	Radiation (03CH03-CB)
RF Cable-high	Woken	RG402	High Cable-20+29	1GHz ~ 18GHz	Oct. 04, 2021	Oct. 03, 2022	Radiation (03CH03-CB)
RF Cable-high	Woken	RG402	High Cable-21+67	1GHz - 18GHz	Nov. 05, 2020	Nov. 04, 2021	Radiation (03CH03-CB)
RF Cable-high	Woken	RG402	High Cable-29	1GHz ~ 18GHz	Oct. 04, 2021	Oct. 03, 2022	Radiation (03CH03-CB)
RF Cable-high	Woken	RG402	High Cable-40G#1	18GHz ~ 40 GHz	Jul. 15, 2021	Jul. 14, 2022	Radiation (03CH03-CB)
RF Cable-high	Woken	RG402	High Cable-40G#2	18GHz ~ 40 GHz	Jul. 15, 2021	Jul. 14, 2022	Radiation (03CH03-CB)
Test Software	SPORTON	SENSE	V5.10	-	N.C.R.	N.C.R.	Radiation (03CH03-CB)
Spectrum analyzer	R&S	FSV40	101028	9kHz~40GHz	Dec. 31, 2020	Dec. 30, 2021	Conducted (TH03-CB)
Power Sensor	Anritsu	MA2411B	1726195	300MHz~40GHz	Aug. 22, 2021	Aug. 21, 2022	Conducted (TH03-CB)
Power Meter	Anritsu	ML2495A	1035008	300MHz~40GHz	Aug. 22, 2021	Aug. 21, 2022	Conducted (TH03-CB)
RF Cable-high	Woken	RG402	High Cable-11	1 GHz ~18 GHz	Oct. 05, 2020	Oct. 04, 2021	Conducted (TH03-CB)
RF Cable-high	Woken	RG402	High Cable-11	1 GHz ~18 GHz	Oct. 04, 2021	Oct. 03, 2022	Conducted (TH03-CB)
RF Cable-high	Woken	RG402	High Cable-12	1 GHz ~18 GHz	Oct. 05, 2020	Oct. 04, 2021	Conducted (TH03-CB)
RF Cable-high	Woken	RG402	High Cable-12	1 GHz ~18 GHz	Oct. 04, 2021	Oct. 03, 2022	Conducted (TH03-CB)
RF Cable-high	Woken	RG402	High Cable-13	1 GHz ~18 GHz	Oct. 05, 2020	Oct. 04, 2021	Conducted (TH03-CB)
RF Cable-high	Woken	RG402	High Cable-13	1 GHz ~18 GHz	Oct. 04, 2021	Oct. 03, 2022	Conducted (TH03-CB)
RF Cable-high	Woken	RG402	High Cable-14	1 GHz ~18 GHz	Oct. 05, 2020	Oct. 04, 2021	Conducted (TH03-CB)
RF Cable-high	Woken	RG402	High Cable-14	1 GHz ~18 GHz	Oct. 04, 2021	Oct. 03, 2022	Conducted (TH03-CB)
RF Cable-high	Woken	RG402	High Cable-15	1 GHz ~18 GHz	Oct. 05, 2020	Oct. 04, 2021	Conducted (TH03-CB)
RF Cable-high	Woken	RG402	High Cable-15	1 GHz ~18 GHz	Oct. 04, 2021	Oct. 03, 2022	Conducted (TH03-CB)
Test Software	SPORTON	SENSE	V5.10	-	N.C.R.	N.C.R.	Conducted (TH03-CB)

Note: Calibration Interval of instruments listed above is one year.

N.C.R. means Non-Calibration required.



Summary

Mode	Result	Type	Freq (Hz)	Level (dBuV)	Limit (dBuV)	Margin (dB)	Condition
Mode 1	Pass	QP	217.5k	52.32	62.92	-10.60	Neutral

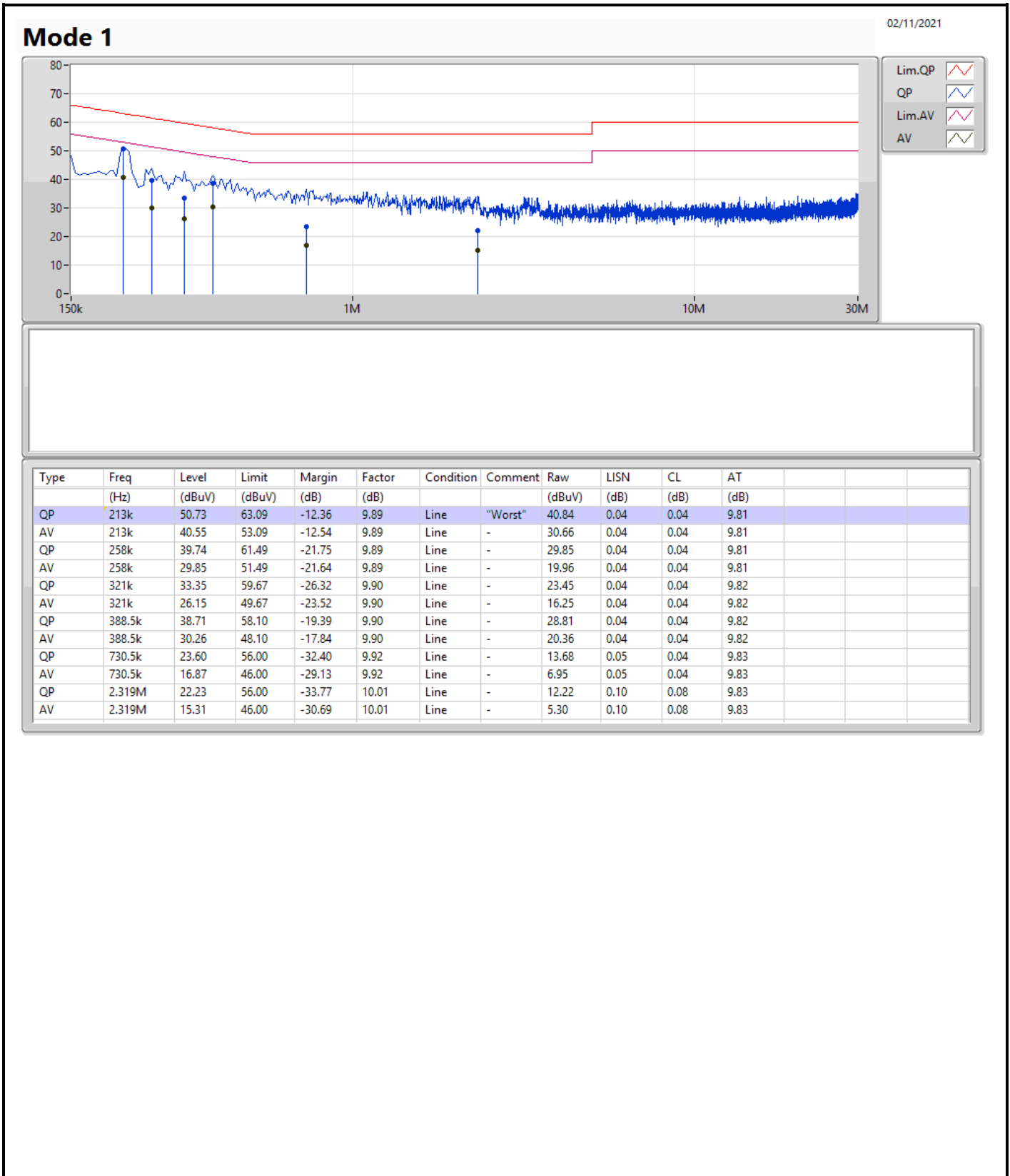

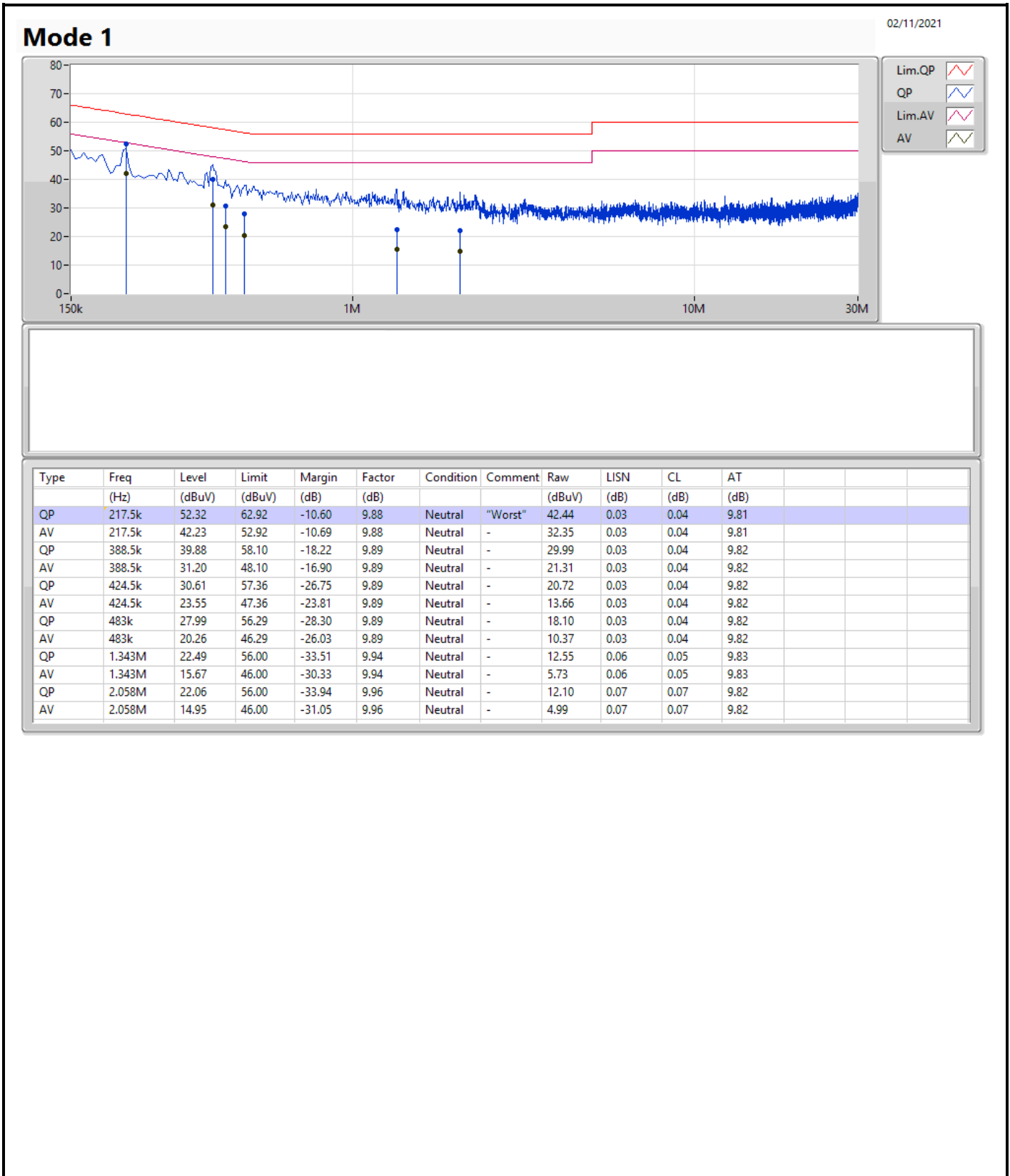



Summary

Mode	Max-N dB (Hz)	Max-OBW (Hz)	ITU-Code	Min-N dB (Hz)	Min-OBW (Hz)
2.4-2.4835GHz	-	-	-	-	-
BT-LE(1Mbps)	731.25k	1.066M	1M07F1D	705k	1.056M

Max-N dB = Maximum 6dB down bandwidth; Max-OBW = Maximum 99% occupied bandwidth;
Min-N dB = Minimum 6dB down bandwidth; Min-OBW = Minimum 99% occupied bandwidth



Result

Mode	Result	Limit (Hz)	Port 1-N dB (Hz)	Port 1-OBW (Hz)
BT-LE(1Mbps)	-	-	-	-
2402MHz	Pass	500k	705k	1.064M
2440MHz	Pass	500k	728.75k	1.056M
2480MHz	Pass	500k	731.25k	1.066M

Port X-N dB = Port X 6dB down bandwidth;
Port X-OBW = Port X 99% occupied bandwidth

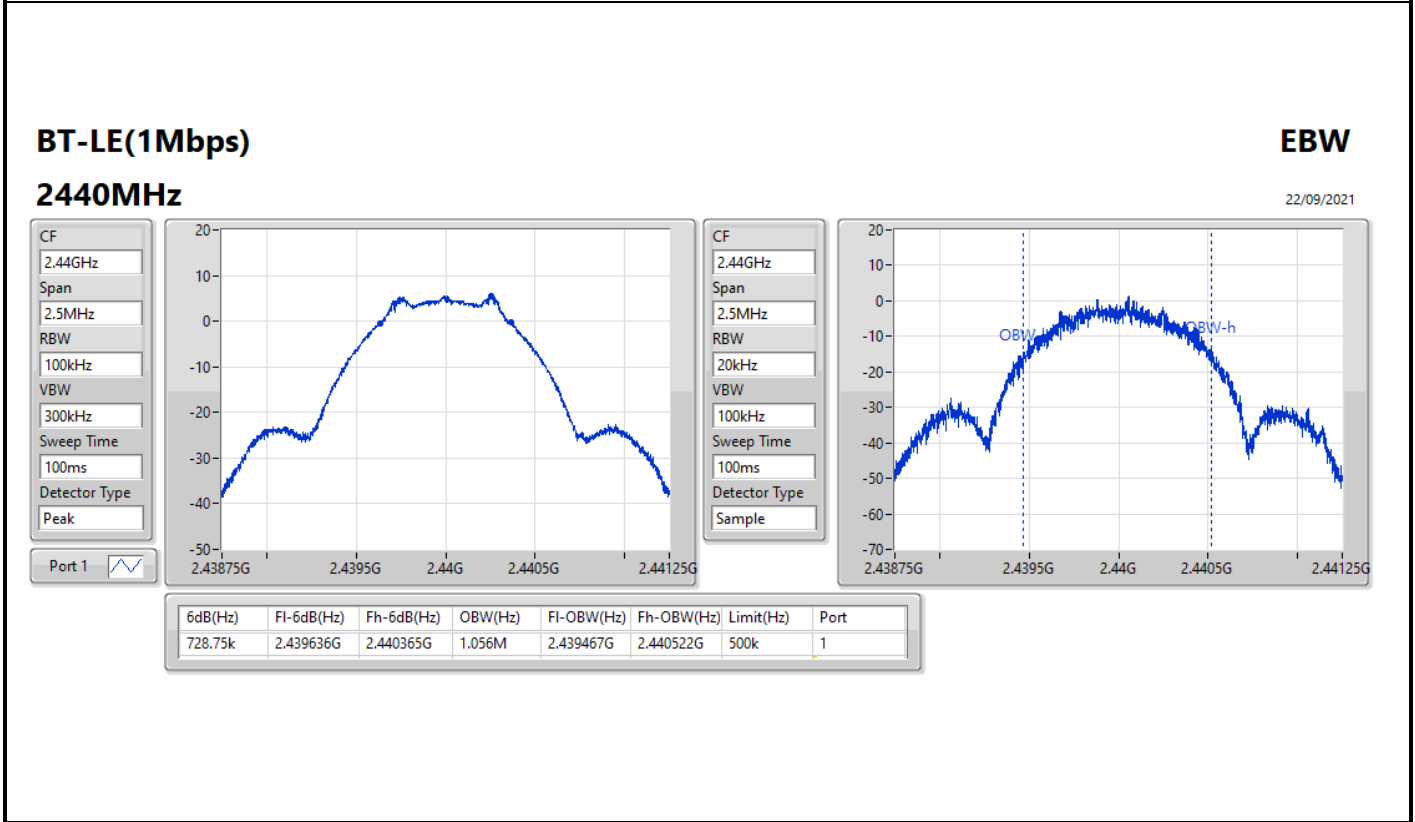
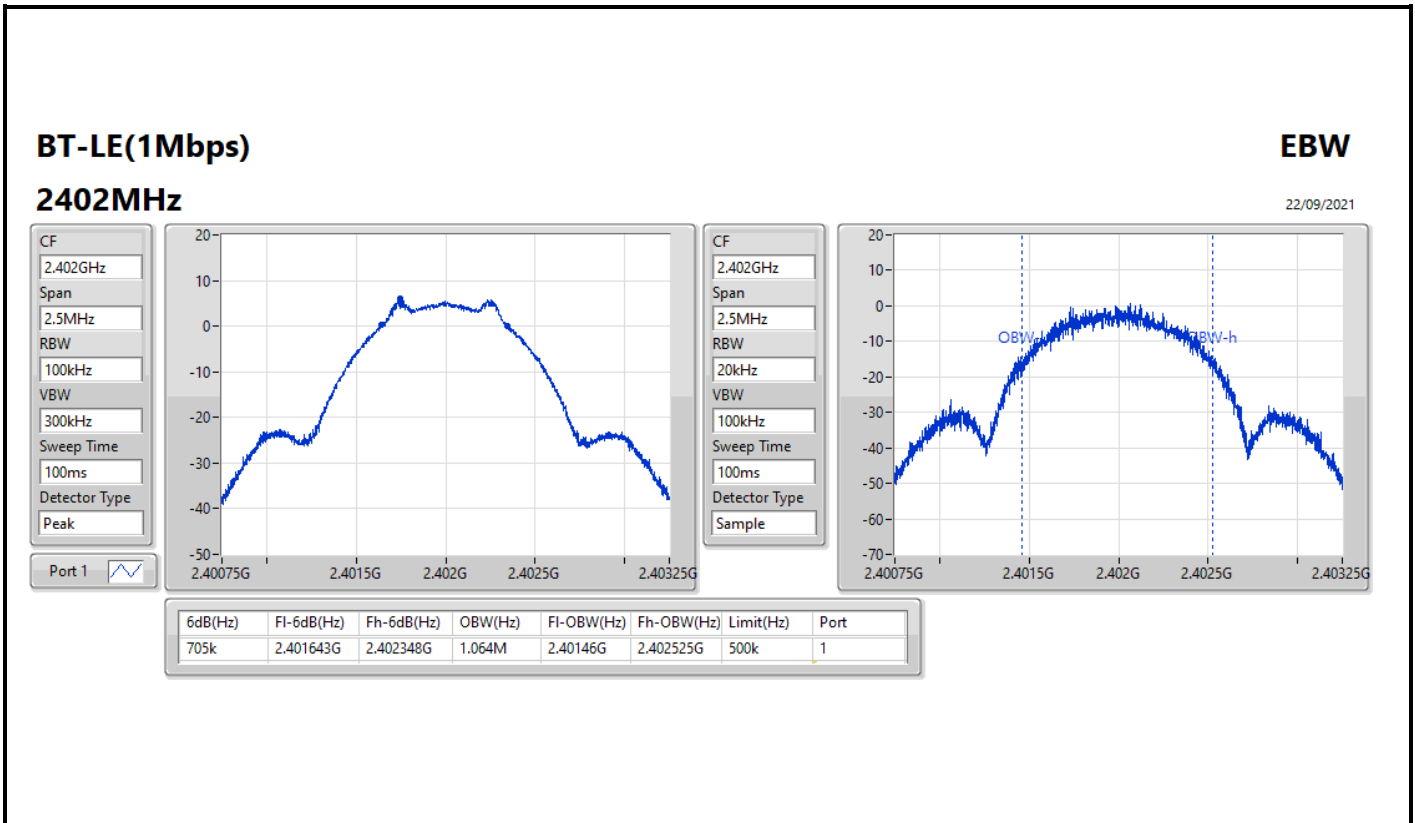

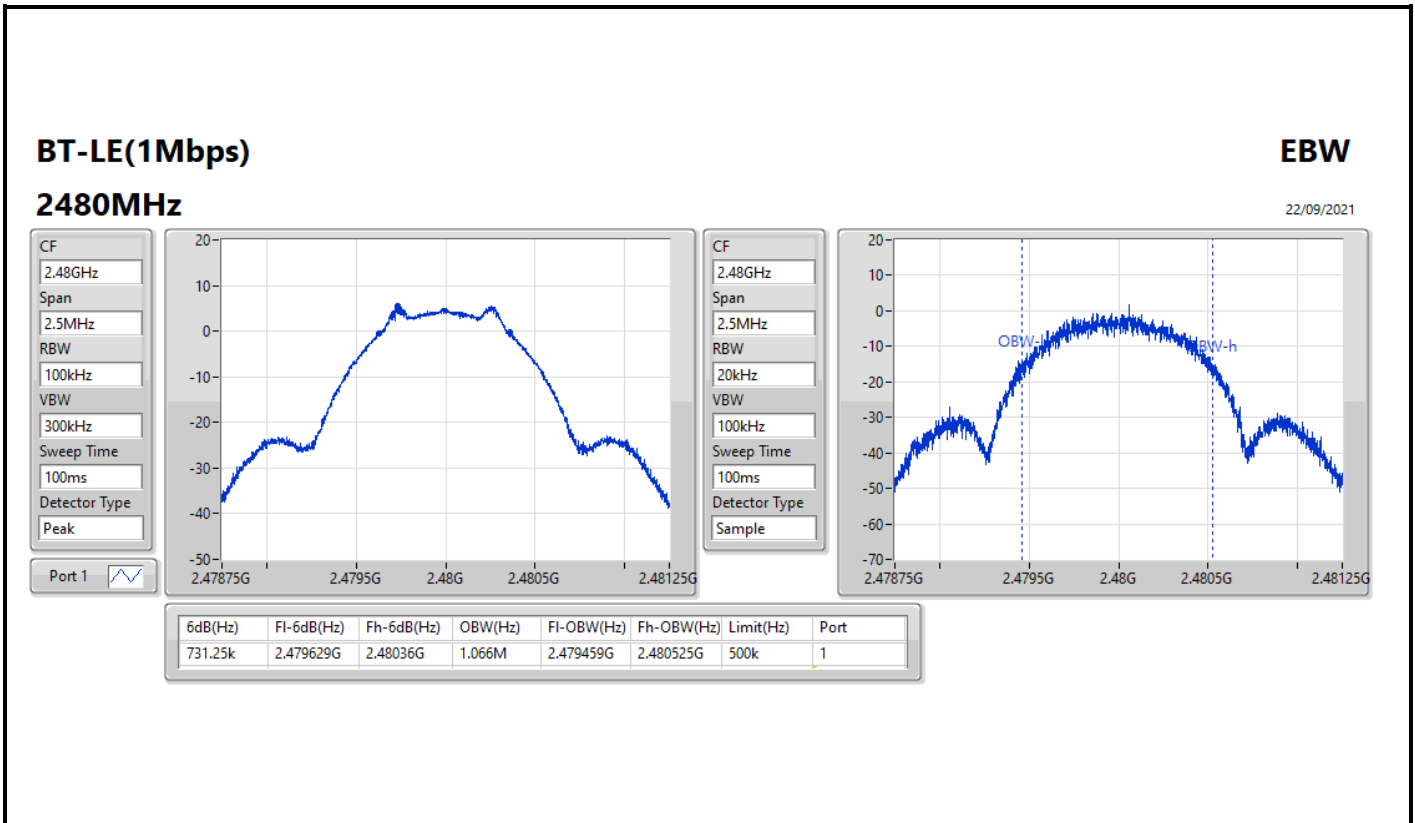



Summary

Mode	Total Power (dBm)	Total Power (W)
2.4-2.4835GHz	-	-
BT-LE(1Mbps)	5.61	0.00364



Result

Mode	Result	DG (dBi)	Port 1 (dBm)	Total Power (dBm)	Power Limit (dBm)
BT-LE(1Mbps)	-	-	-	-	-
2402MHz	Pass	4.00	5.61	5.61	30.00
2440MHz	Pass	4.00	5.41	5.41	30.00
2480MHz	Pass	4.00	5.18	5.18	30.00

DG = Directional Gain; Port X = Port X output power



Summary

Mode	PD (dBm/RBW)
2.4-2.4835GHz	-
BT-LE(1Mbps)	-6.05

RBW = 3kHz;

Result

Mode	Result	DG (dBi)	Port 1 (dBm/RBW)	PD (dBm/RBW)	PD Limit (dBm/RBW)
BT-LE(1Mbps)	-	-	-	-	-
2402MHz	Pass	4.00	-6.05	-6.05	8.00
2440MHz	Pass	4.00	-8.64	-8.64	8.00
2480MHz	Pass	4.00	-8.28	-8.28	8.00

DG = Directional Gain; RBW = 3kHz;
PD = trace bin-by-bin of each transmits port summing can be performed maximum power density; Port X = Port X Power Density;

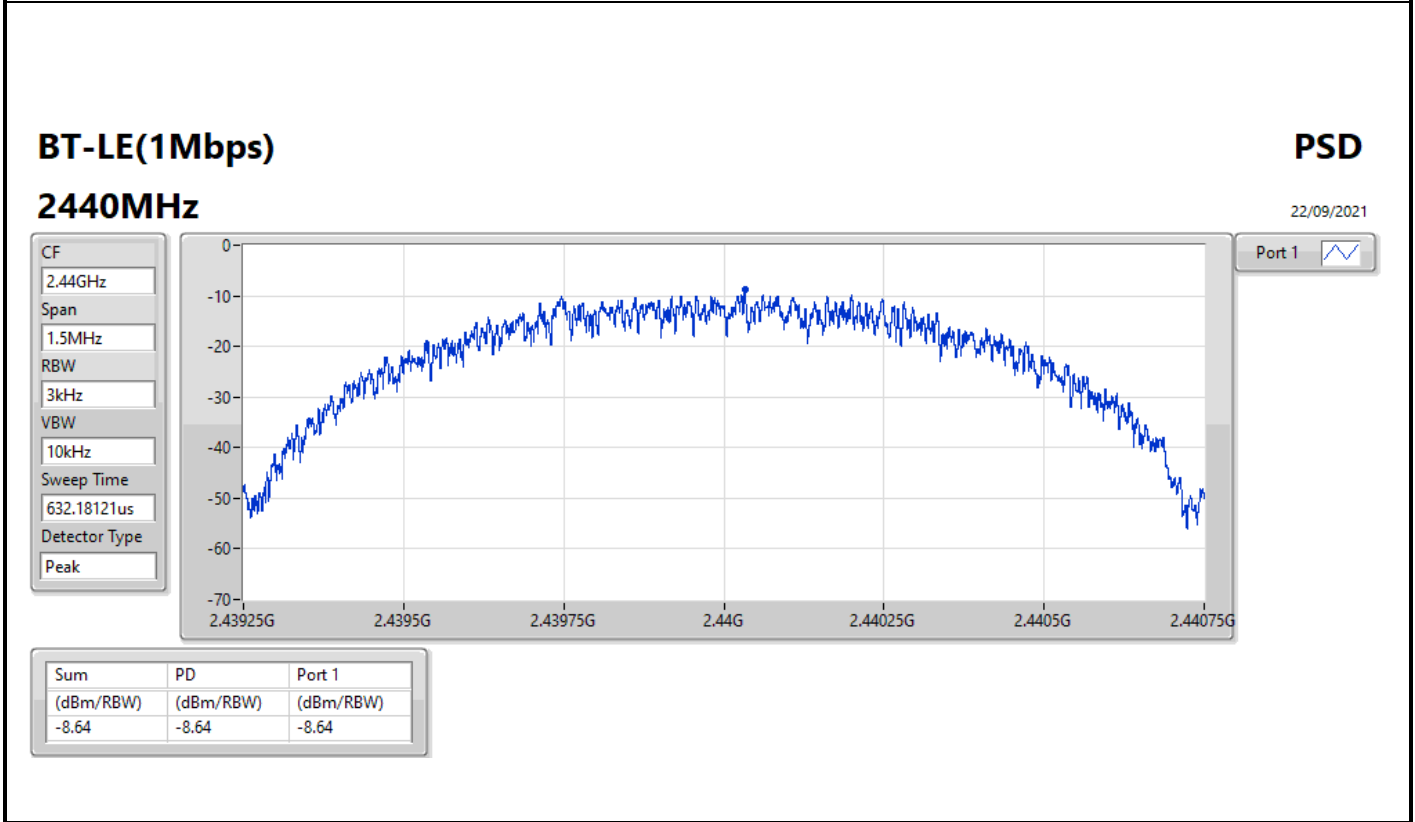
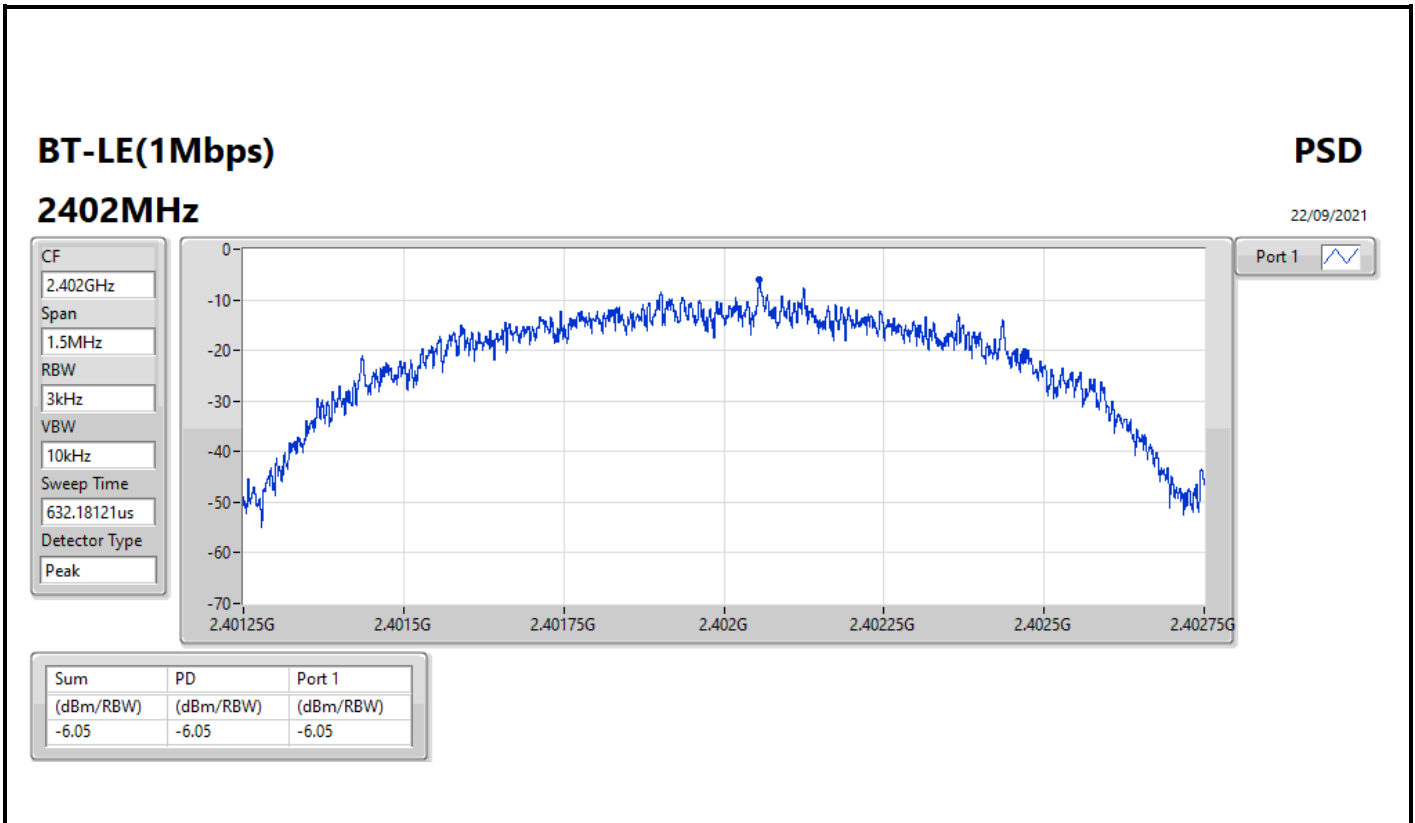

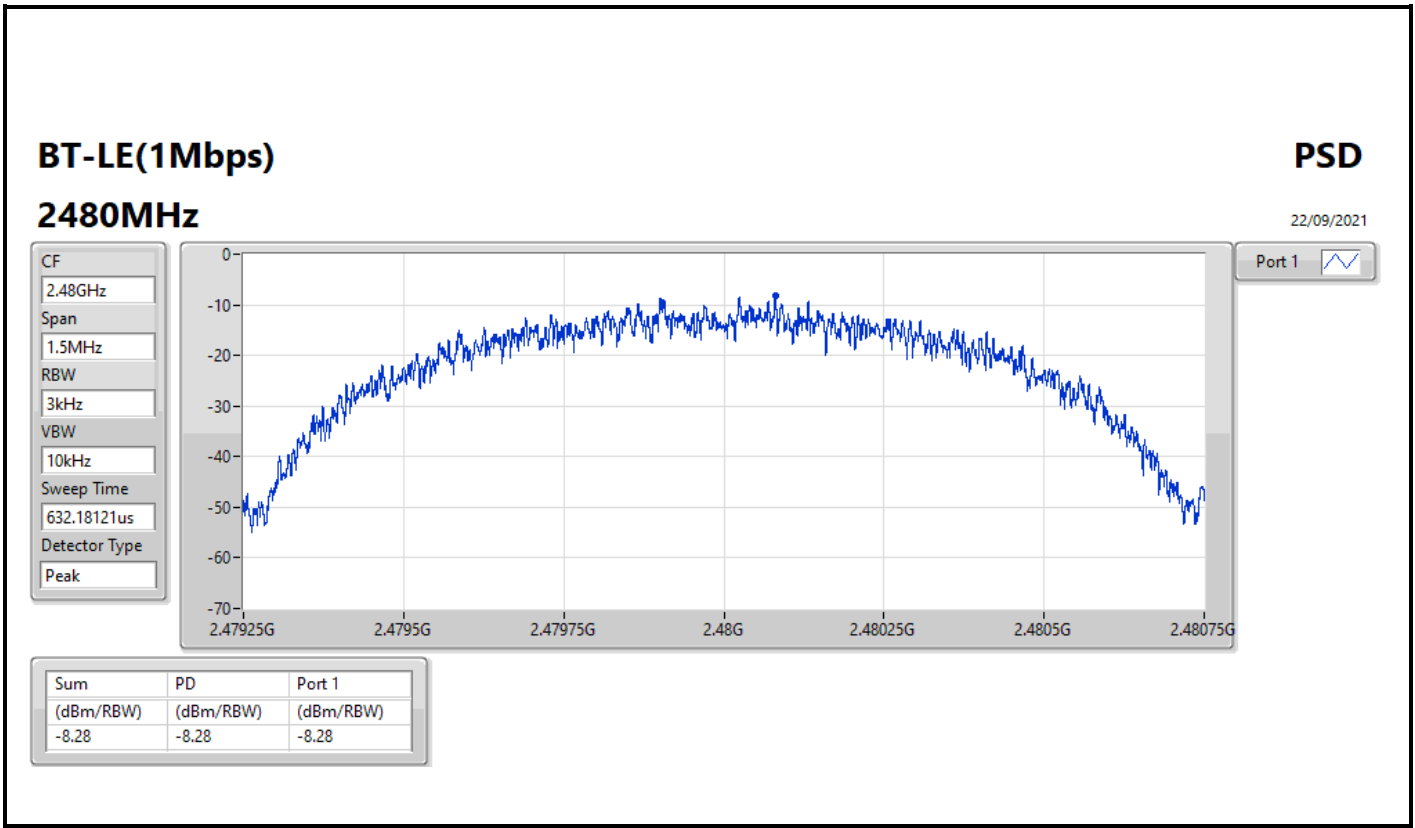



Summary

Mode	Result	Ref (Hz)	Ref (dBm)	Limit (dBm)	Freq (Hz)	Level (dBm)	Freq (Hz)	Level (dBm)	Freq (Hz)	Level (dBm)	Freq (Hz)	Level (dBm)	Freq (Hz)	Level (dBm)	Port
2.4-2.4835GHz	-	-	-	-	-	-	-	-	-	-	-	-	-	-	-
BT-LE(1Mbps)	Pass	2.402G	5.21	-24.79	775.92M	-52.32	2.4G	-42.00	2.4G	-42.63	2.48408G	-51.20	17.65746G	-46.22	1



Result

Mode	Result	Ref (Hz)	Ref (dBm)	Limit (dBm)	Freq (Hz)	Level (dBm)	Freq (Hz)	Level (dBm)	Freq (Hz)	Level (dBm)	Freq (Hz)	Level (dBm)	Freq (Hz)	Level (dBm)	Port
BT-LE(1Mbps)	-	-	-	-	-	-	-	-	-	-	-	-	-	-	-
2402MHz	Pass	2.402G	5.21	-24.79	775.92M	-52.32	2.4G	-42.00	2.4G	-42.63	2.48408G	-51.20	17.65746G	-46.22	1
2440MHz	Pass	2.402G	5.21	-24.79	1.75627G	-51.76	2.39806G	-51.54	2.4835G	-54.95	2.48534G	-51.51	16.2897G	-46.06	1
2480MHz	Pass	2.402G	5.21	-24.79	1.9907G	-51.96	2.39915G	-51.47	2.4835G	-51.66	2.48496G	-49.29	17.66309G	-45.89	1

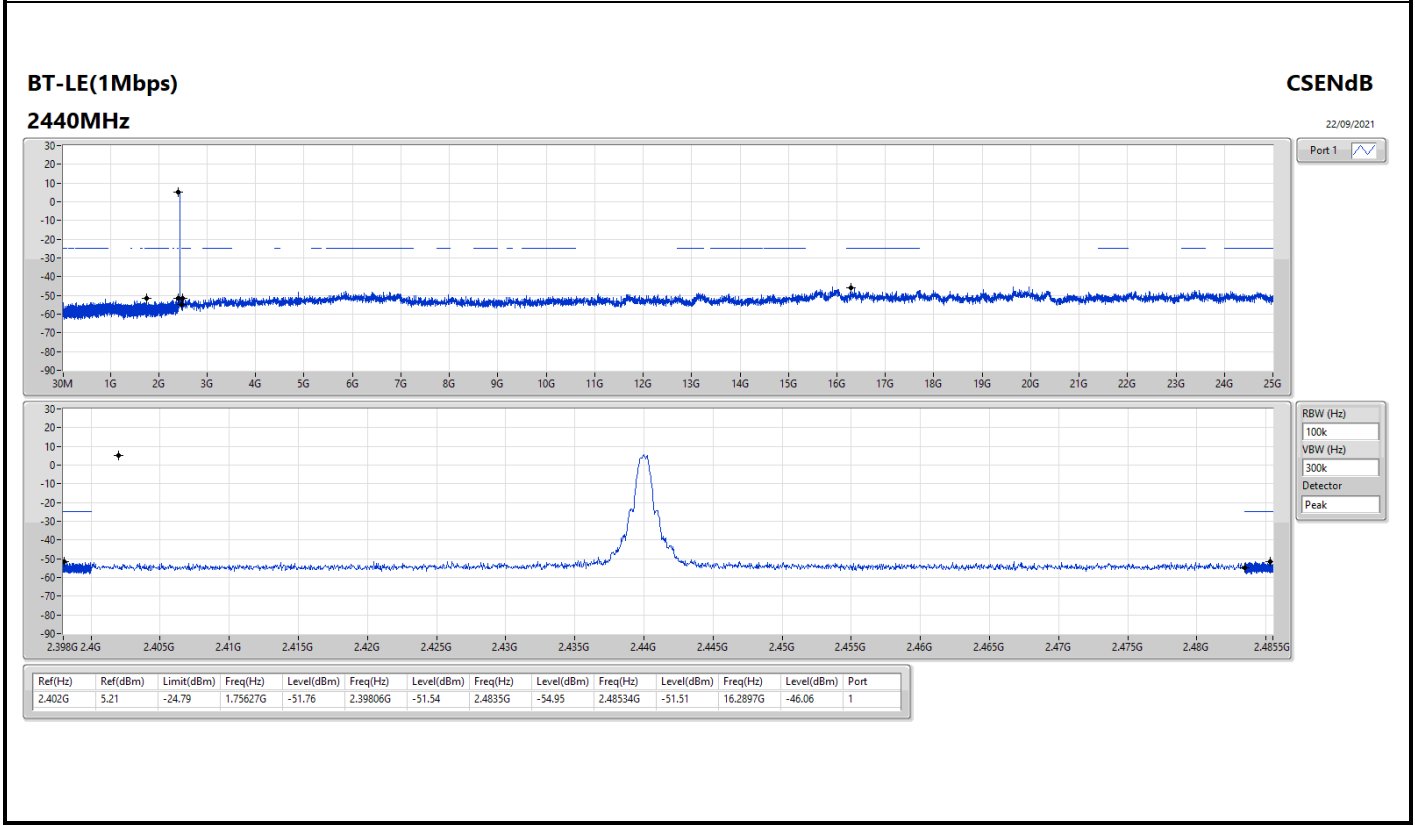
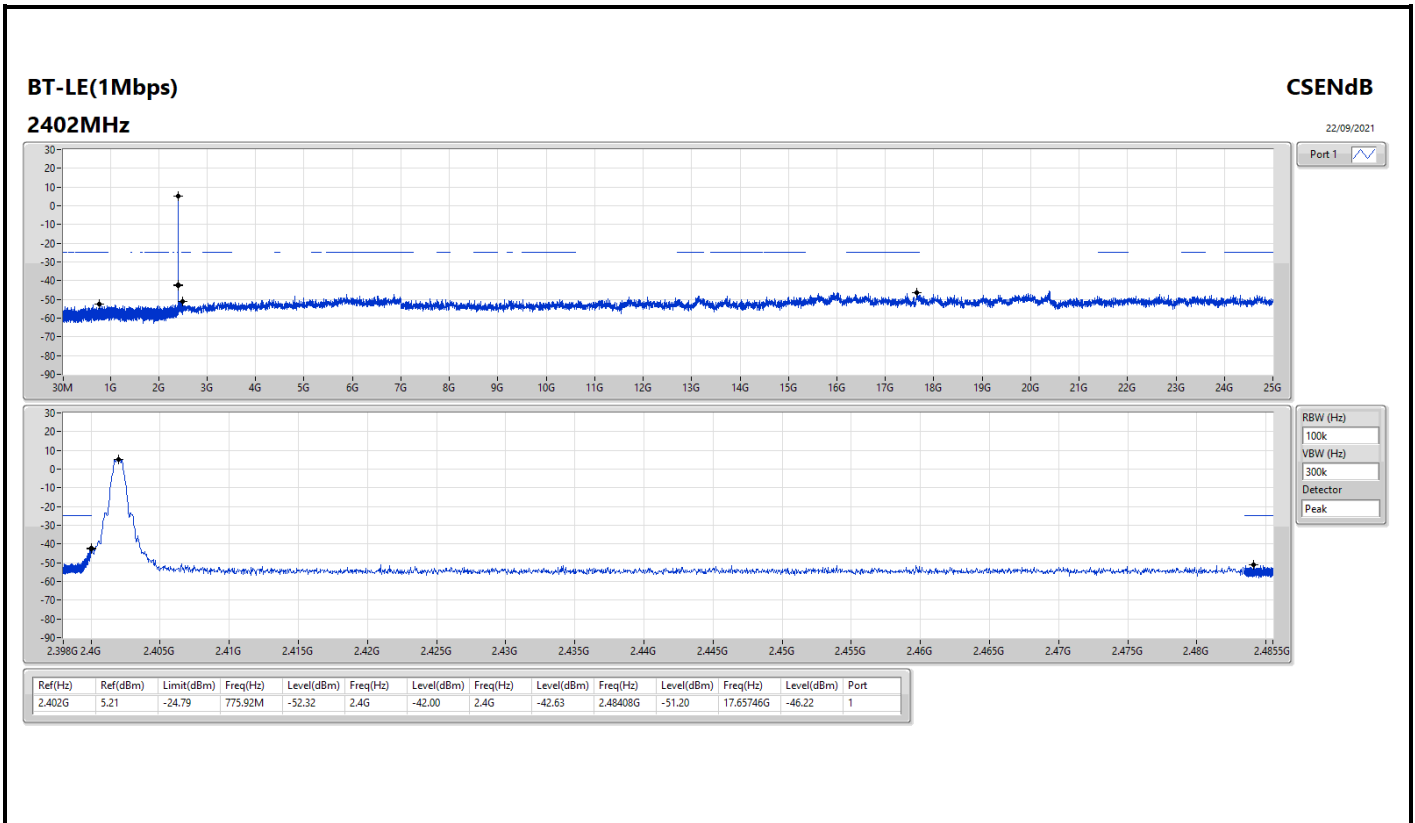

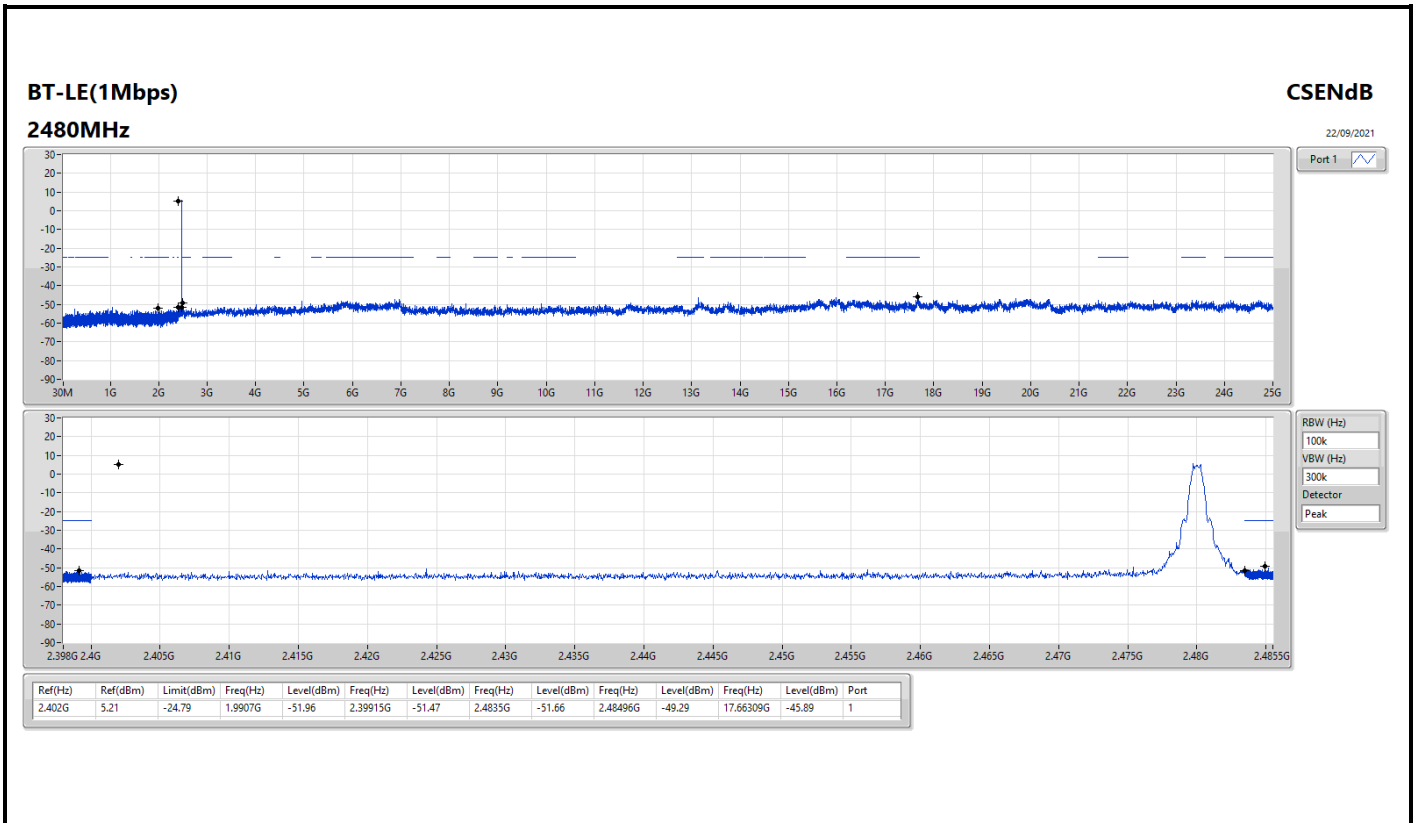



Summary

Mode	Result	F-Start (Hz)	F-Stop (Hz)	Type	Freq (Hz)	DG (dBi)	P1 (dBm)	P2 (dBm)	Psum (dBm)	EIRP (dBm)	Limit (dBm)	Margin (dB)
2.4-2.4835GHz	-	-	-	-	-	-	-	-	-	-	-	-
802.11ax HEW20_Nss1,(MCS0)_2TX	Pass	30M	1G	PK	35.94M	6.52	-90.35	-86.52	-85.02	-73.80	-55.20	-18.60

DG = Directional Gain ; PX=Port X; Psum=P1+P2+...PX



Result

Mode	Result	F-Start (Hz)	F-Stop (Hz)	Type	Freq (Hz)	DG (dBi)	P1 (dBm)	P2 (dBm)	Psum (dBm)	EIRP (dBm)	Limit (dBm)	Margin (dB)
802.11ax HEW20_Nss1,(MCS0)_2TX	-	-	-	-	-	-	-	-	-	-	-	-
2437MHz	Pass	30M	1G	PK	35.94M	6.52	-90.35	-86.52	-85.02	-73.80	-55.20	-18.60
2437MHz	Pass	30M	1G	PK	42.97M	6.52	-89.28	-88.51	-85.87	-74.65	-55.20	-19.45
2437MHz	Pass	30M	1G	PK	60.8M	6.52	-90.08	-87.86	-85.82	-74.60	-55.20	-19.40
2437MHz	Pass	30M	1G	PK	70.74M	6.52	-87.84	-90.00	-85.78	-74.56	-55.20	-19.36
2437MHz	Pass	30M	1G	PK	71.59M	6.52	-88.37	-88.77	-85.56	-74.34	-55.20	-19.14
2437MHz	Pass	30M	1G	PK	82.74M	6.52	-88.30	-88.94	-85.60	-74.38	-55.20	-19.18

DG = Directional Gain ; PX=Port X; Psum=P1+P2+...PX

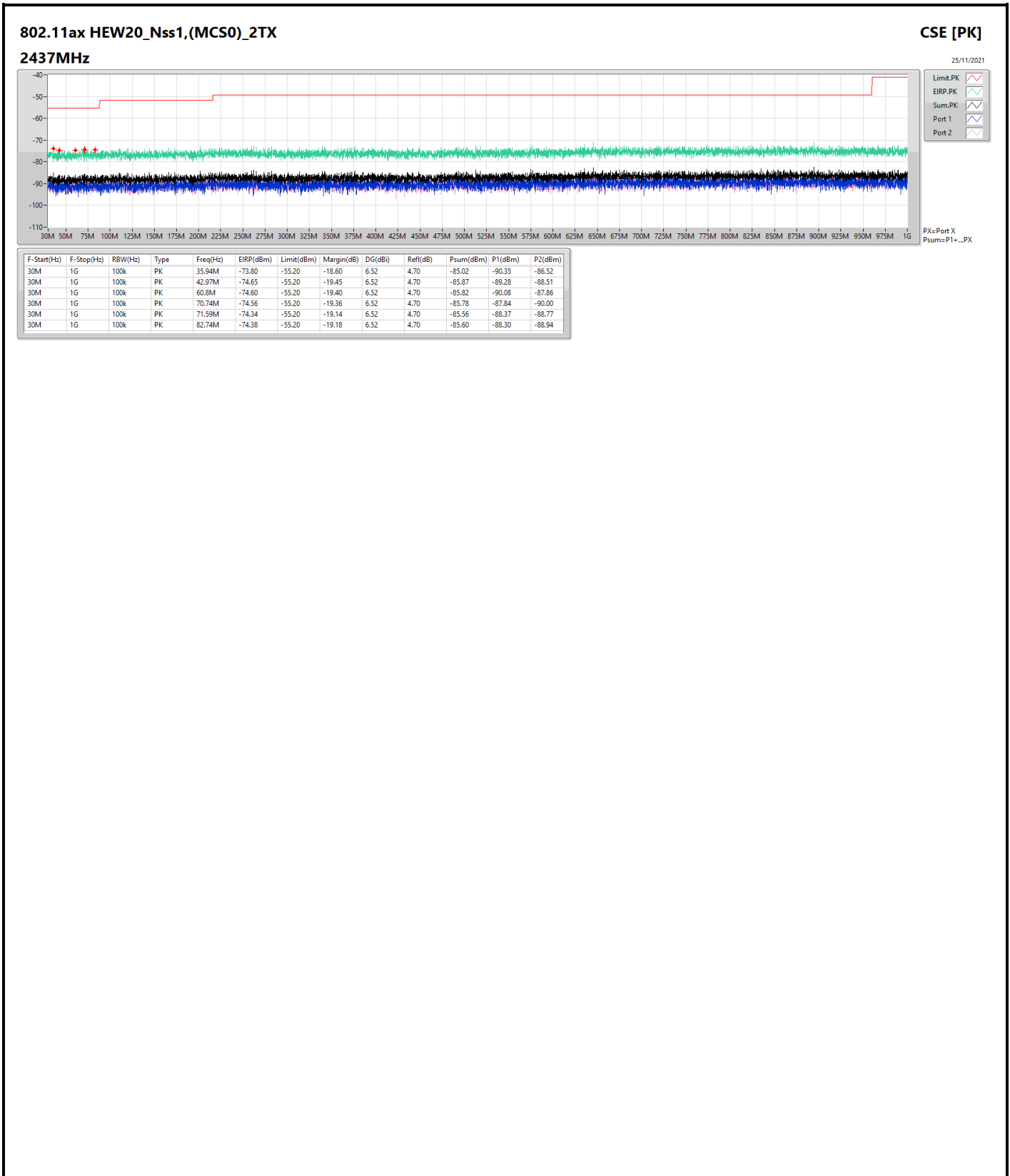



Summary

Mode	Result	Type	Freq (Hz)	Level (dBuV/m)	Limit (dBuV/m)	Margin (dB)	Condition
Mode 2	Pass	PK	499.48M	40.78	46.00	-5.22	Horizontal

Mode 2

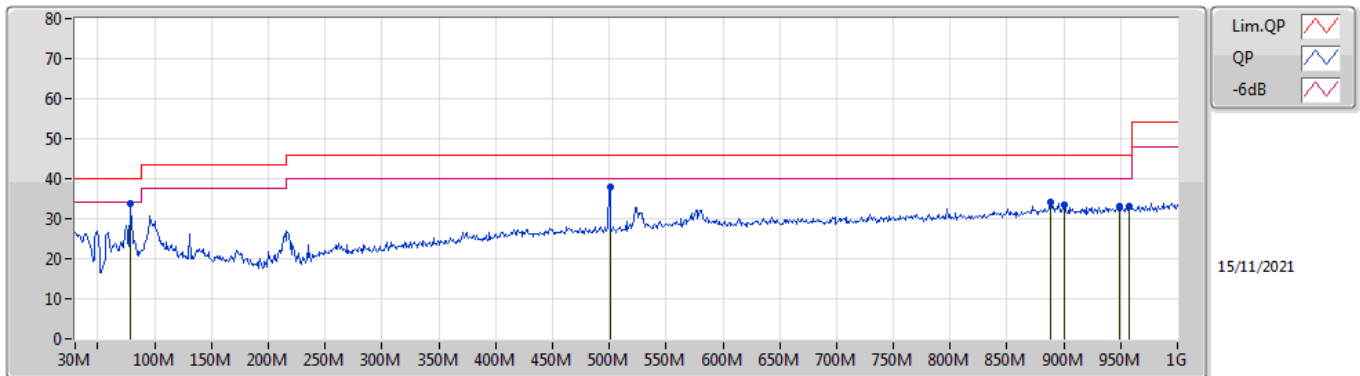

Type	Freq (Hz)	Level (dBuV/m)	Limit (dBuV/m)	Margin (dB)	Factor (dB/m)	Dist (m)	Condition	Azimuth (°)	Height (m)	Comment	Raw (dBuV/m)	AF (dB/m)	CL (dB)	PA (dB)
PK	78.5M	33.85	40.00	-6.15	-18.06	3	Vertical	234	1.25	"Worst"	51.91	12.55	1.30	31.91
PK	500.45M	37.96	46.00	-8.04	-5.65	3	Vertical	21	1.25	-	43.61	23.18	3.50	32.33
PK	888.45M	34.02	46.00	-11.98	-1.53	3	Vertical	321	1.00	-	35.55	26.19	4.93	32.65
PK	900.09M	33.30	46.00	-12.70	-1.44	3	Vertical	216	1.00	-	34.74	26.22	5.00	32.66
PK	948.59M	33.22	46.00	-12.78	-1.13	3	Vertical	256	1.00	-	34.35	26.44	5.00	32.57
PK	957.32M	33.27	46.00	-12.73	-0.98	3	Vertical	321	1.00	-	34.25	26.56	5.03	32.57

Mode 2

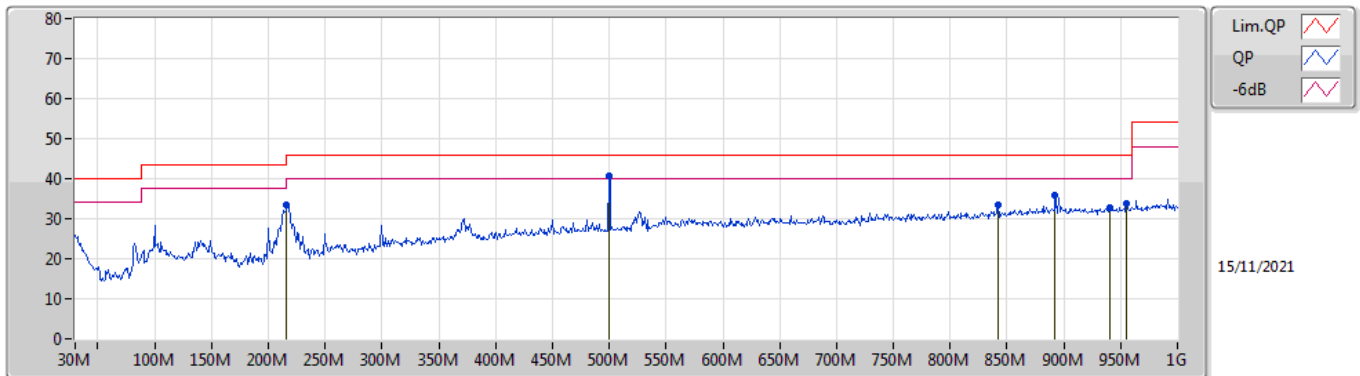

Type	Freq (Hz)	Level (dBuV/m)	Limit (dBuV/m)	Margin (dB)	Factor (dB/m)	Dist (m)	Condition	Azimuth (°)	Height (m)	Comment	Raw (dBuV/m)	AF (dB/m)	CL (dB)	PA (dB)
PK	216M	33.43	43.50	-10.07	-15.07	3	Horizontal	9	1.25	-	48.50	14.73	2.20	32.00
PK	499.48M	40.78	46.00	-5.22	-5.65	3	Horizontal	0	3.00	"Worst"	46.43	23.18	3.50	32.33
PK	841.89M	33.40	46.00	-12.60	-2.18	3	Horizontal	275	1.25	-	35.58	25.78	4.67	32.63
PK	892.33M	36.02	46.00	-9.98	-1.49	3	Horizontal	355	1.50	-	37.51	26.21	4.95	32.65
PK	940.83M	32.72	46.00	-13.28	-1.24	3	Horizontal	0	2.00	-	33.96	26.35	5.00	32.59
PK	955.38M	33.85	46.00	-12.15	-1.00	3	Horizontal	240	1.50	-	34.85	26.55	5.02	32.57



Summary

Mode	Result	F-Start (Hz)	F-Stop (Hz)	Type	Freq (Hz)	DG (dBi)	P1 (dBm)	Psum (dBm)	EIRP (dBm)	Limit (dBm)	Margin (dB)
2.4-2.4835GHz	-	-	-	-	-	-	-	-	-	-	-
BT-LE(1Mbps)	Pass	2.4G	2.4835G	AV	2.4835G	4.00	-53.19	-53.19	-49.19	-41.20	-7.99

DG = Directional Gain ; PX=Port X; Psum=P1+P2+...PX

Result

Mode	Result	F-Start (Hz)	F-Stop (Hz)	Type	Freq (Hz)	DG (dBi)	P1 (dBm)	Psum (dBm)	EIRP (dBm)	Limit (dBm)	Margin (dB)
BT-LE(1Mbps)	-	-	-	-	-	-	-	-	-	-	-
2402MHz	Pass	2.3G	2.398G	AV	2.3881G	4.00	-61.91	-61.91	-57.91	-41.20	-16.71
2402MHz	Pass	2.4G	2.4835G	AV	2.4835G	4.00	-64.16	-64.16	-60.16	-41.20	-18.96
2402MHz	Pass	2.4835G	2.4855G	AV	2.48364G	4.00	-62.75	-62.75	-58.75	-41.20	-17.55
2402MHz	Pass	2.4855G	2.6G	AV	2.55271G	4.00	-63.06	-63.06	-59.06	-41.20	-17.86
2402MHz	Pass	2.3G	2.398G	PK	2.38869G	4.00	-52.00	-52.00	-48.00	-21.20	-26.80
2402MHz	Pass	2.4G	2.4835G	PK	2.4835G	4.00	-54.35	-54.35	-50.35	-21.20	-29.15
2402MHz	Pass	2.4835G	2.4855G	PK	2.48414G	4.00	-51.55	-51.55	-47.55	-21.20	-26.35
2402MHz	Pass	2.4855G	2.6G	PK	2.56657G	4.00	-52.14	-52.14	-48.14	-21.20	-26.94
2440MHz	Pass	2.3G	2.398G	AV	2.34096G	4.00	-63.67	-63.67	-59.67	-41.20	-18.47
2440MHz	Pass	2.4G	2.4835G	AV	2.4835G	4.00	-64.04	-64.04	-60.04	-41.20	-18.84
2440MHz	Pass	2.4835G	2.4855G	AV	2.48464G	4.00	-62.40	-62.40	-58.40	-41.20	-17.20
2440MHz	Pass	2.4855G	2.6G	AV	2.49031G	4.00	-63.44	-63.44	-59.44	-41.20	-18.24
2440MHz	Pass	2.3G	2.398G	PK	2.36037G	4.00	-51.63	-51.63	-47.63	-21.20	-26.43
2440MHz	Pass	2.4G	2.4835G	PK	2.4835G	4.00	-53.73	-53.73	-49.73	-21.20	-28.53
2440MHz	Pass	2.4835G	2.4855G	PK	2.48451G	4.00	-51.38	-51.38	-47.38	-21.20	-26.18
2440MHz	Pass	2.4855G	2.6G	PK	2.57057G	4.00	-52.31	-52.31	-48.31	-21.20	-27.11
2480MHz	Pass	2.3G	2.398G	AV	2.36282G	4.00	-64.08	-64.08	-60.08	-41.20	-18.88
2480MHz	Pass	2.4G	2.4835G	AV	2.4835G	4.00	-53.19	-53.19	-49.19	-41.20	-7.99
2480MHz	Pass	2.4835G	2.4855G	AV	2.48351G	4.00	-53.67	-53.67	-49.67	-41.20	-8.47
2480MHz	Pass	2.4855G	2.6G	AV	2.48676G	4.00	-58.03	-58.03	-54.03	-41.20	-12.83
2480MHz	Pass	2.3G	2.398G	PK	2.33381G	4.00	-52.47	-52.47	-48.47	-21.20	-27.27
2480MHz	Pass	2.4G	2.4835G	PK	2.4835G	4.00	-44.75	-44.75	-40.75	-21.20	-19.55
2480MHz	Pass	2.4835G	2.4855G	PK	2.48352G	4.00	-43.75	-43.75	-39.75	-21.20	-18.55
2480MHz	Pass	2.4855G	2.6G	PK	2.48561G	4.00	-48.53	-48.53	-44.53	-21.20	-23.33

DG = Directional Gain ; PX=Port X; Psum=P1+P2+...PX

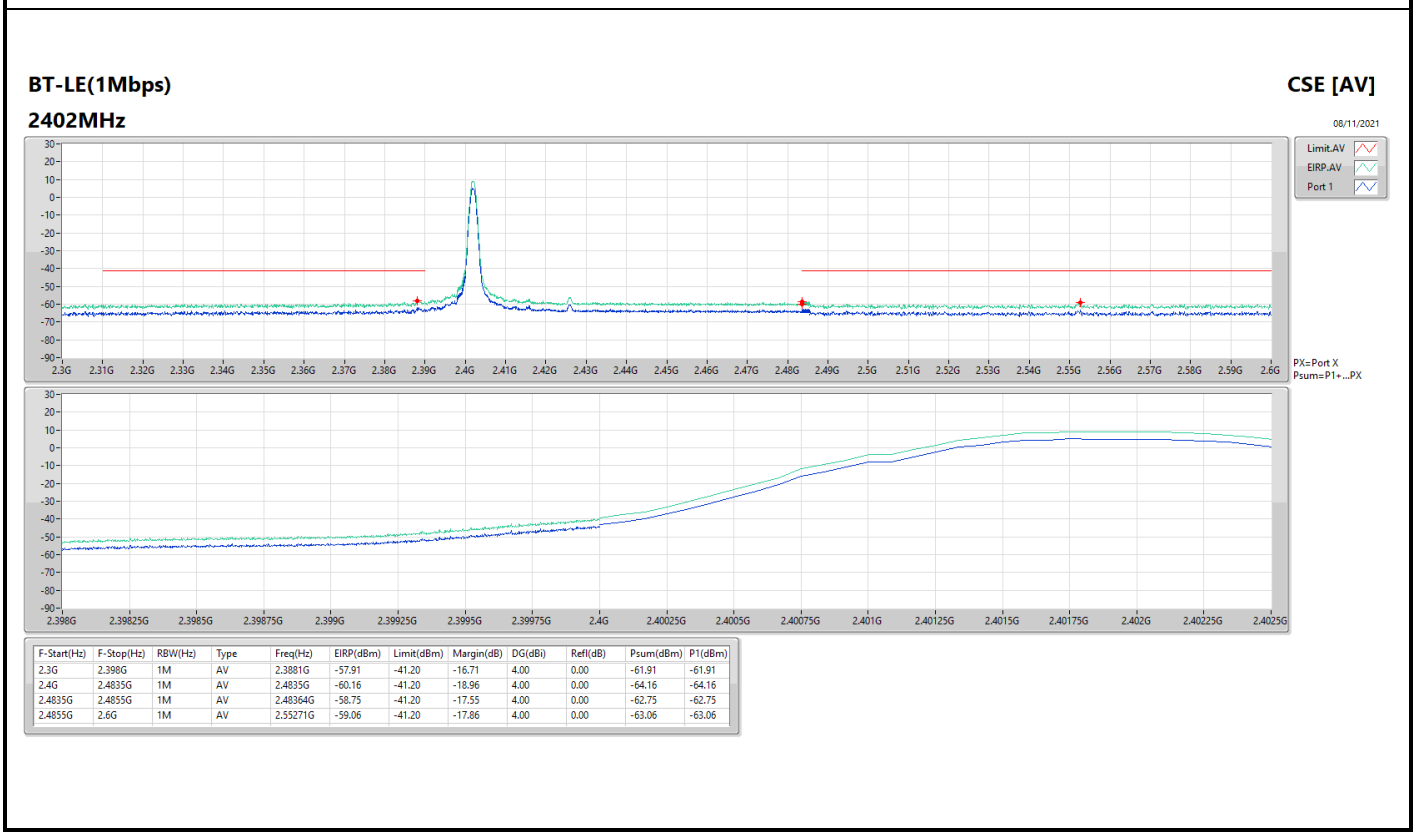
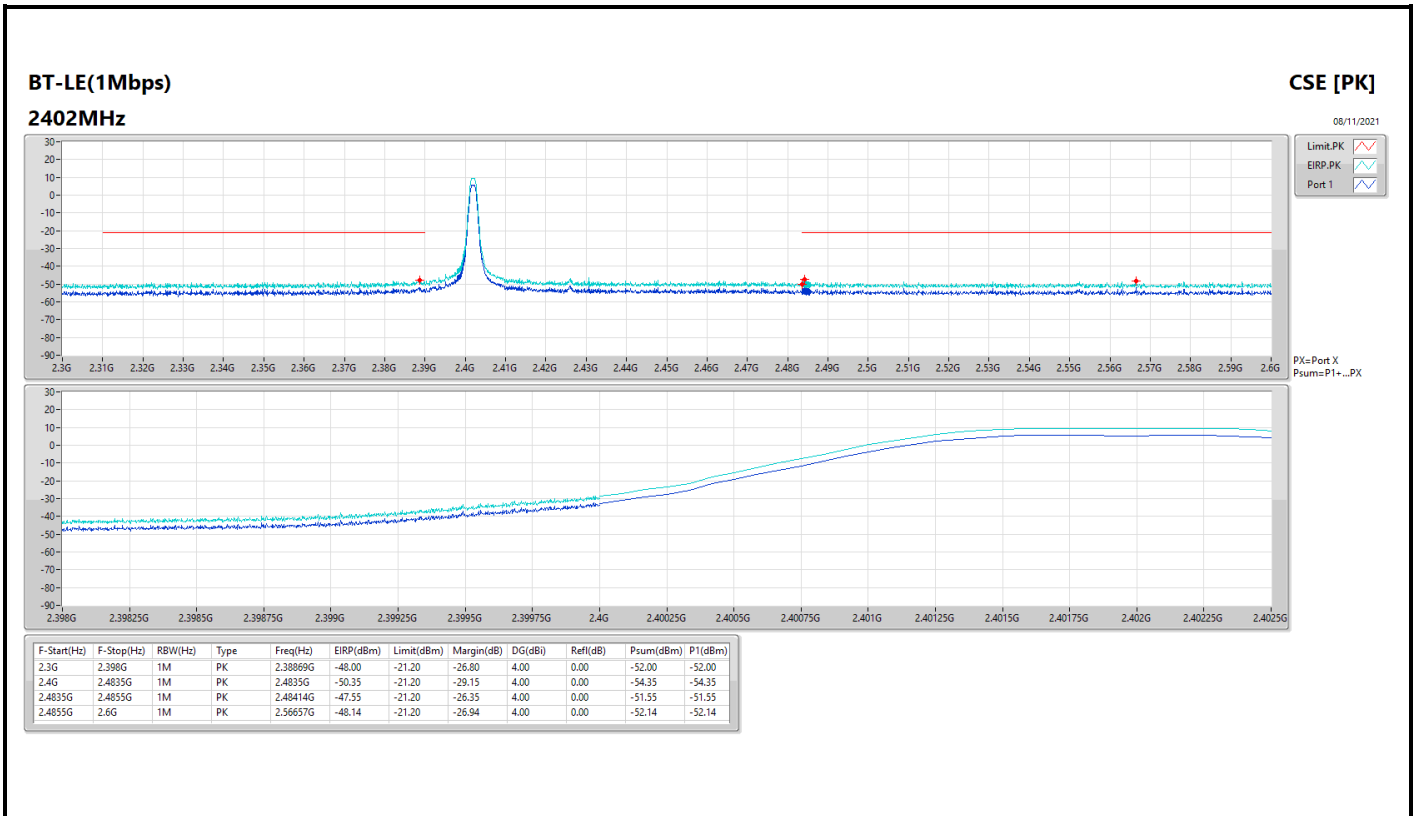

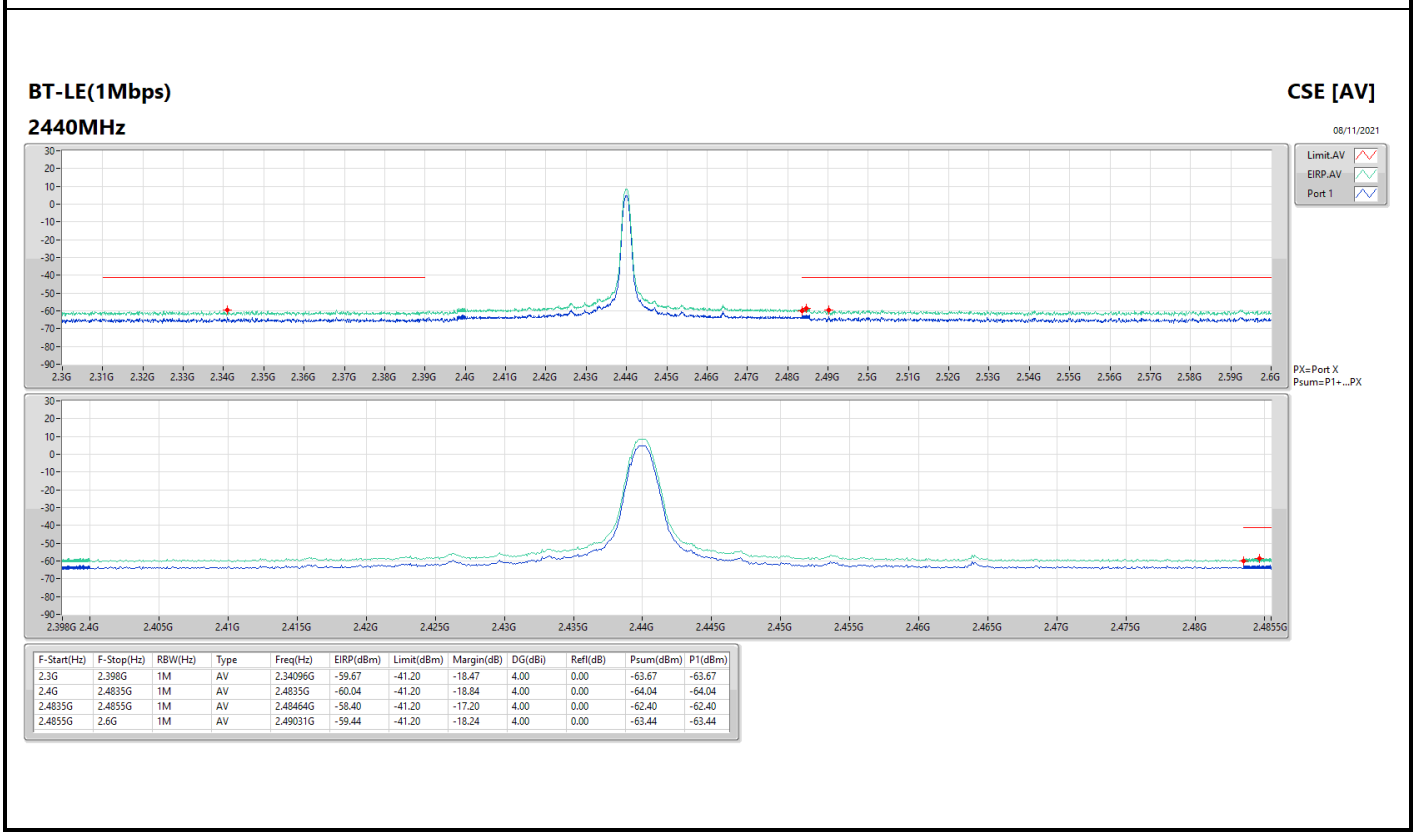
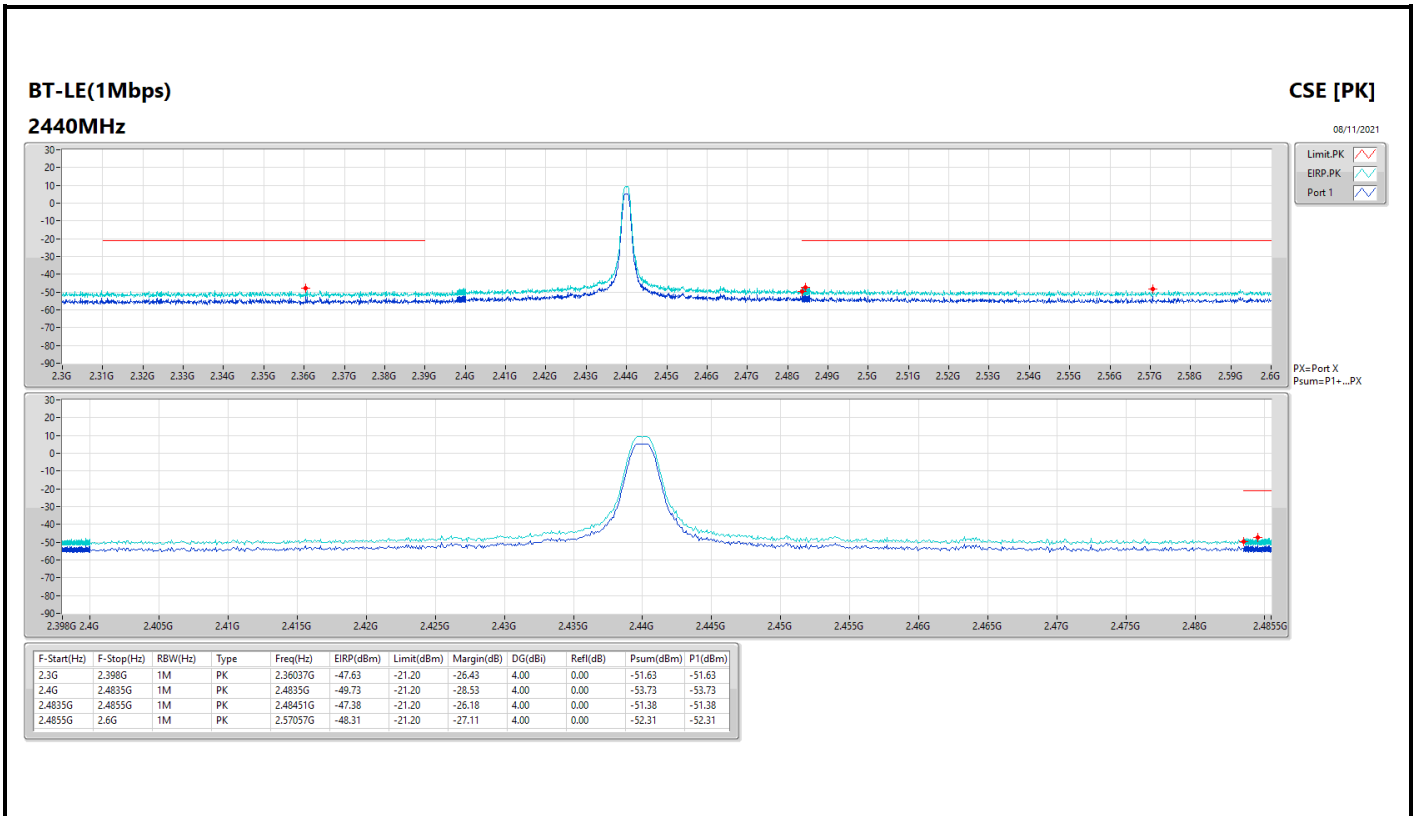

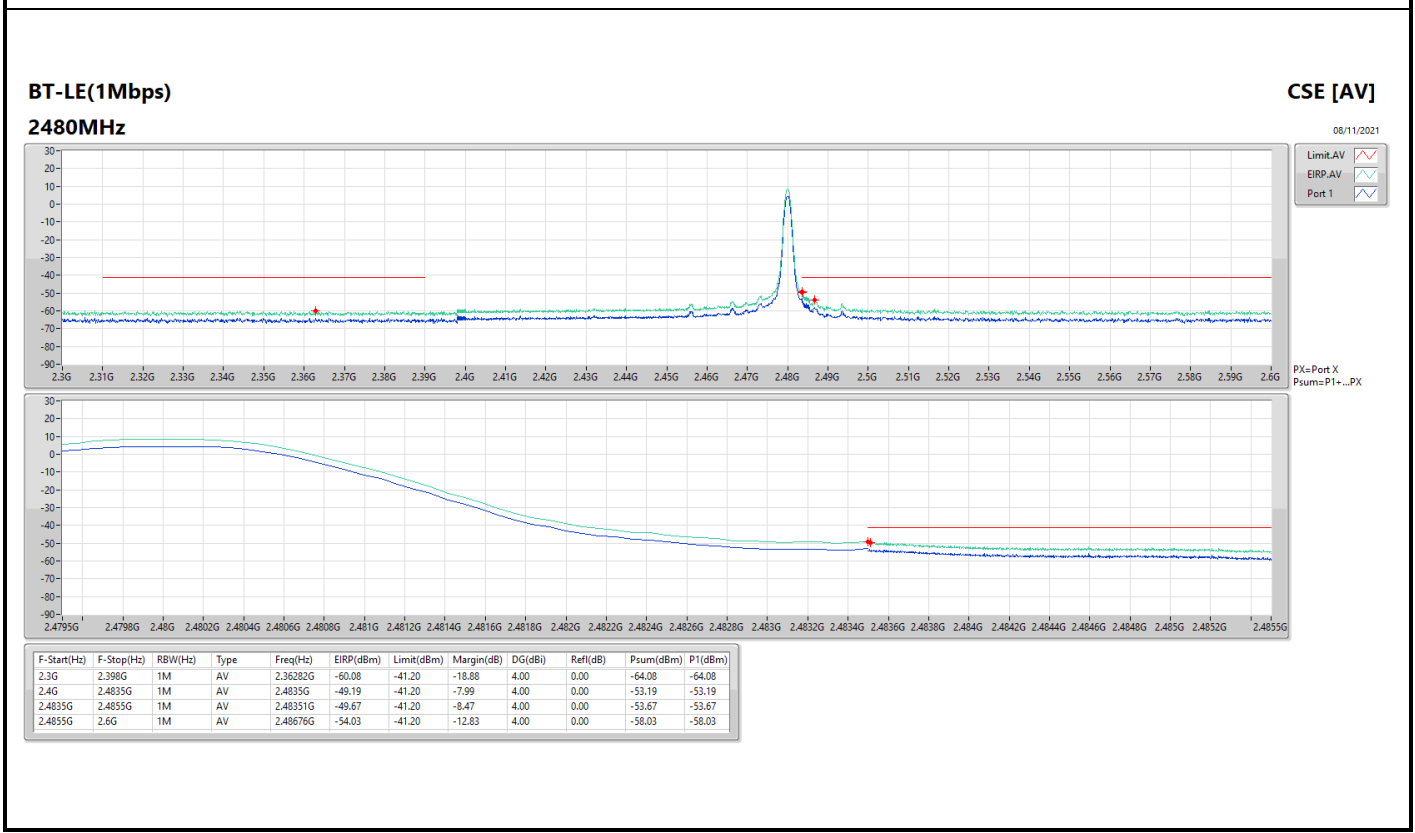
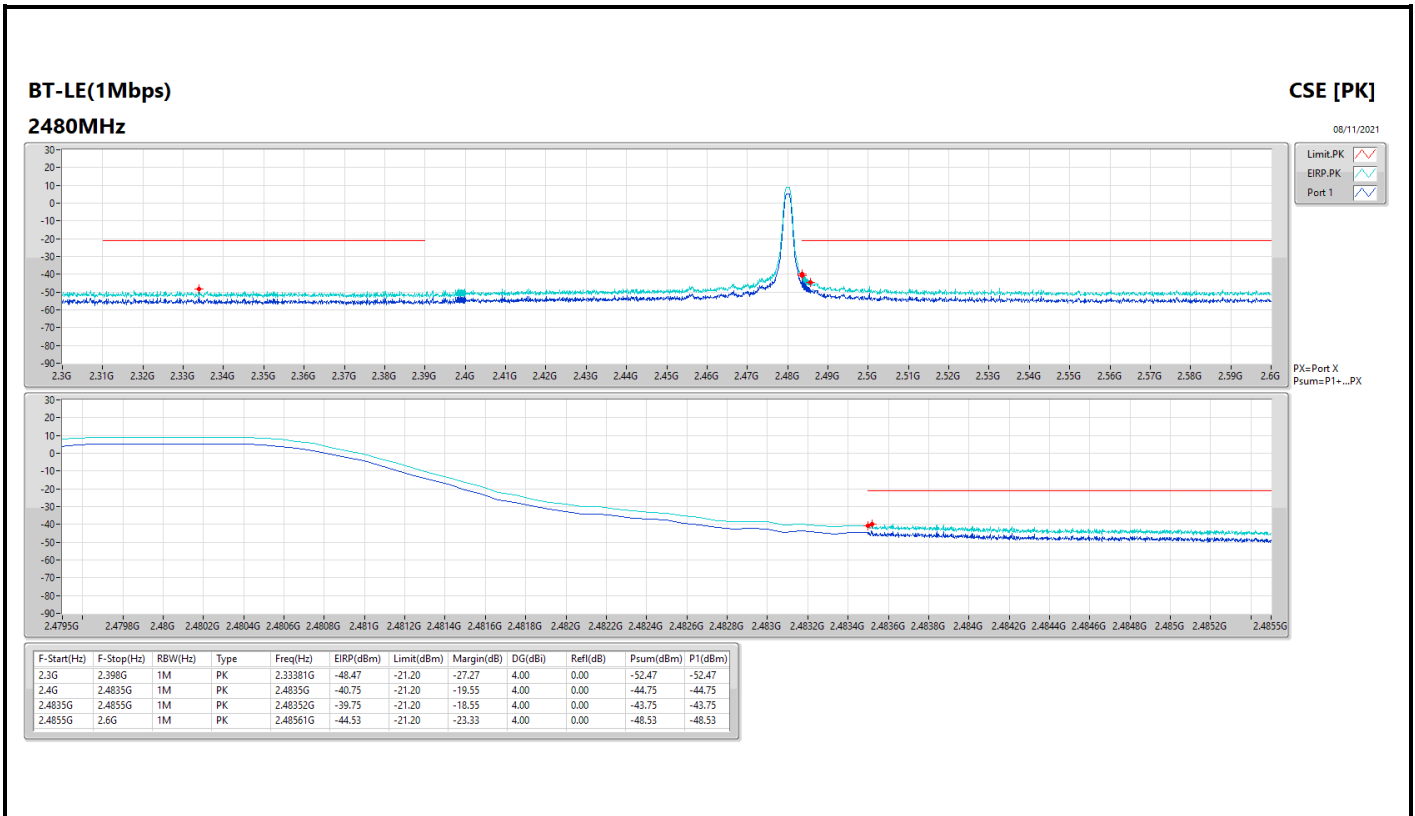



Summary

Mode	Result	F-Start (Hz)	F-Stop (Hz)	Type	Freq (Hz)	DG (dBi)	P1 (dBm)	Psum (dBm)	EIRP (dBm)	Limit (dBm)	Margin (dB)
2.4-2.4835GHz	-	-	-	-	-	-	-	-	-	-	-
BT-LE_Nss1_1TX	Pass	2.4855G	3G	AV	2.49347G	4.00	-63.66	-63.66	-59.66	-41.20	-18.46



Result

Mode	Result	F-Start (Hz)	F-Stop (Hz)	Type	Freq (Hz)	DG (dBi)	P1 (dBm)	Psum (dBm)	EIRP (dBm)	Limit (dBm)	Margin (dB)
BT-LE_Nss1_1TX	-	-	-	-	-	-	-	-	-	-	-
2402MHz	Pass	1G	2.398G	AV	2.37808G	4.00	-64.44	-64.44	-60.44	-41.20	-19.24
2402MHz	Pass	2.4G	2.4835G	AV	2.4835G	4.00	-76.22	-76.22	-72.22	-41.20	-31.02
2402MHz	Pass	2.4835G	2.4855G	AV	2.48425G	4.00	-75.59	-75.59	-71.59	-41.20	-30.39
2402MHz	Pass	2.4855G	3G	AV	2.70223G	4.00	-66.59	-66.59	-62.59	-41.20	-21.39
2402MHz	Pass	1G	2.398G	PK	2.38821G	4.00	-55.53	-55.53	-51.53	-21.20	-30.33
2402MHz	Pass	2.4G	2.4835G	PK	2.4835G	4.00	-67.46	-67.46	-63.46	-21.20	-42.26
2402MHz	Pass	2.4835G	2.4855G	PK	2.48472G	4.00	-64.39	-64.39	-60.39	-21.20	-39.19
2402MHz	Pass	2.4855G	3G	PK	2.70262G	4.00	-61.48	-61.48	-57.48	-21.20	-36.28
2440MHz	Pass	1G	2.398G	AV	2.135G	4.00	-68.70	-68.70	-64.70	-41.20	-23.50
2440MHz	Pass	2.4G	2.4835G	AV	2.4835G	4.00	-76.91	-76.91	-72.91	-41.20	-31.71
2440MHz	Pass	2.4835G	2.4855G	AV	2.4844G	4.00	-75.64	-75.64	-71.64	-41.20	-30.44
2440MHz	Pass	2.4855G	3G	AV	2.59239G	4.00	-68.73	-68.73	-64.73	-41.20	-23.53
2440MHz	Pass	1G	2.398G	PK	2.38699G	4.00	-61.60	-61.60	-57.60	-21.20	-36.40
2440MHz	Pass	2.4G	2.4835G	PK	2.4835G	4.00	-67.50	-67.50	-63.50	-21.20	-42.30
2440MHz	Pass	2.4835G	2.4855G	PK	2.48543G	4.00	-65.03	-65.03	-61.03	-21.20	-39.83
2440MHz	Pass	2.4855G	3G	PK	2.49232G	4.00	-60.90	-60.90	-56.90	-21.20	-35.70
2480MHz	Pass	1G	2.398G	AV	2.16995G	4.00	-65.92	-65.92	-61.92	-41.20	-20.72
2480MHz	Pass	2.4G	2.4835G	AV	2.4835G	4.00	-76.88	-76.88	-72.88	-41.20	-31.68
2480MHz	Pass	2.4835G	2.4855G	AV	2.4855G	4.00	-74.44	-74.44	-70.44	-41.20	-29.24
2480MHz	Pass	2.4855G	3G	AV	2.49347G	4.00	-63.66	-63.66	-59.66	-41.20	-18.46
2480MHz	Pass	1G	2.398G	PK	2.16995G	4.00	-61.79	-61.79	-57.79	-21.20	-36.59
2480MHz	Pass	2.4G	2.4835G	PK	2.4835G	4.00	-67.82	-67.82	-63.82	-21.20	-42.62
2480MHz	Pass	2.4835G	2.4855G	PK	2.4855G	4.00	-63.91	-63.91	-59.91	-21.20	-38.71
2480MHz	Pass	2.4855G	3G	PK	2.49386G	4.00	-56.28	-56.28	-52.28	-21.20	-31.08

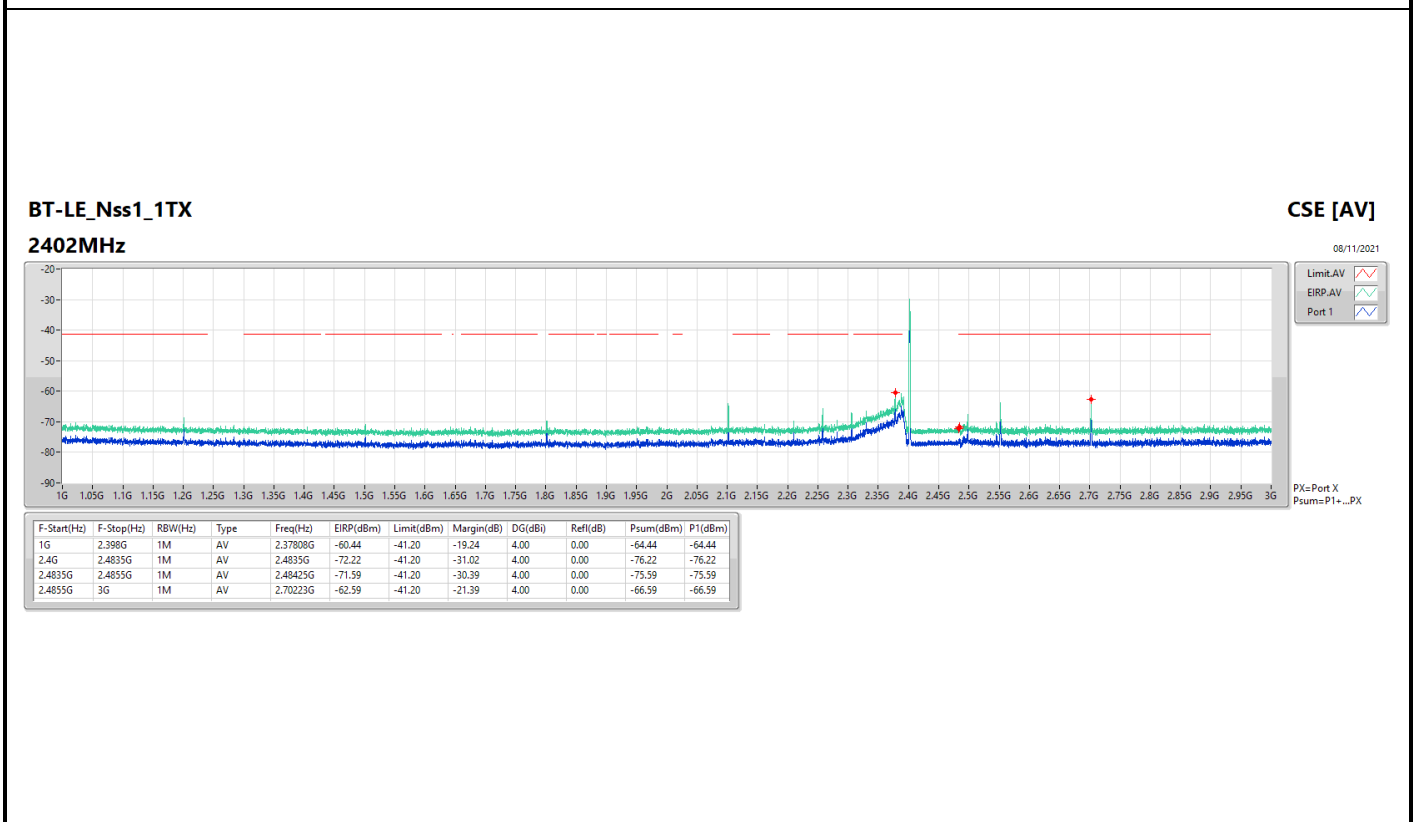
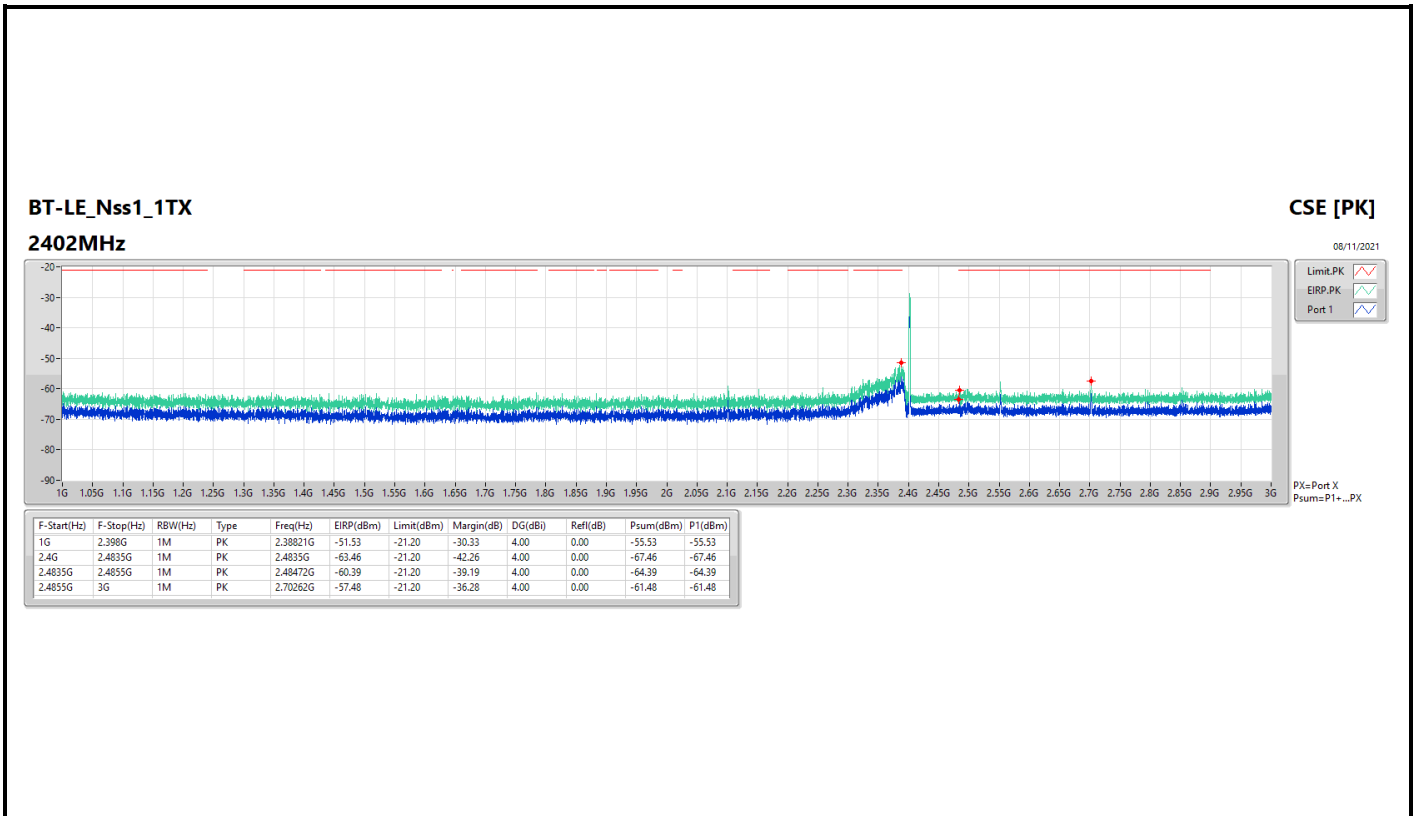

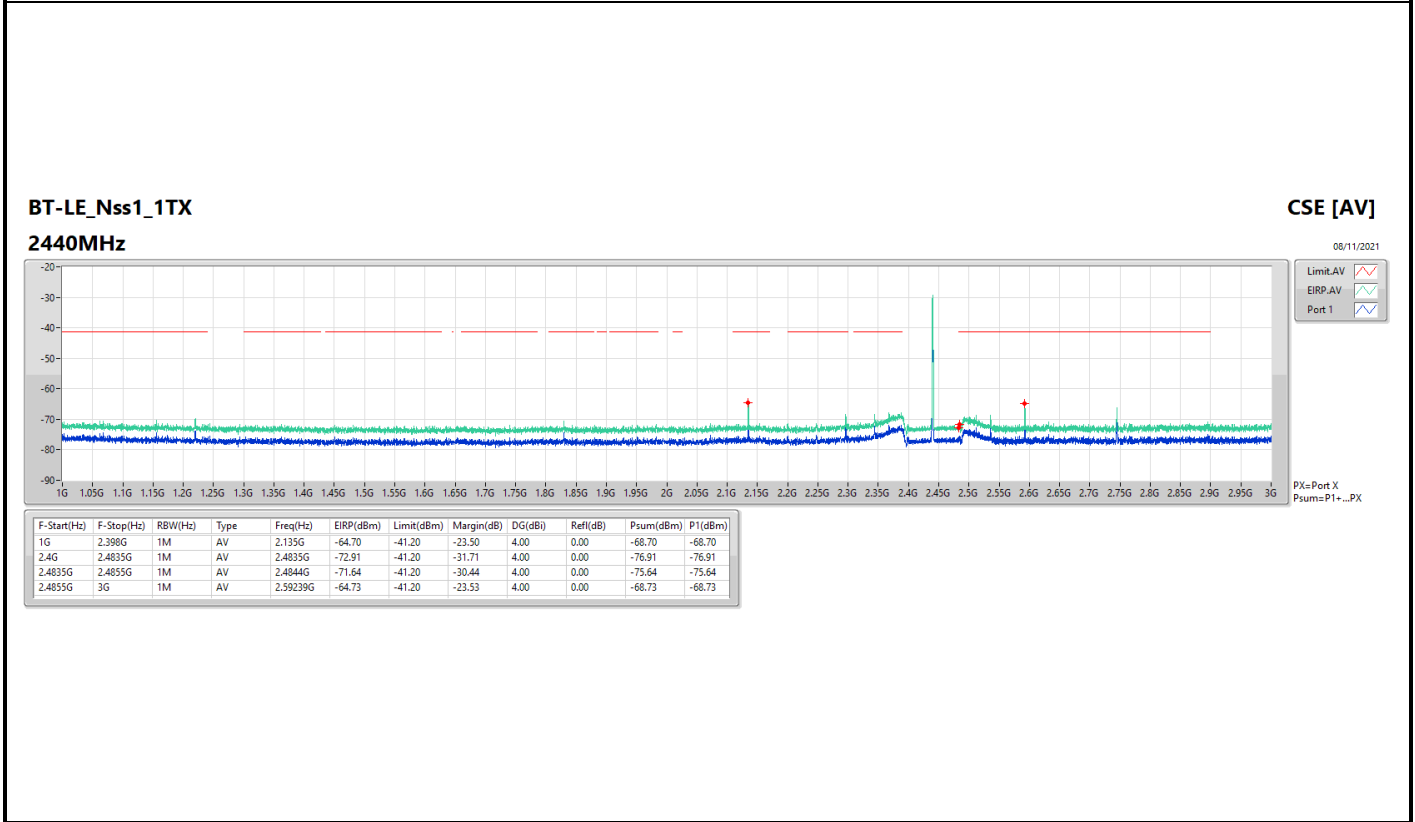
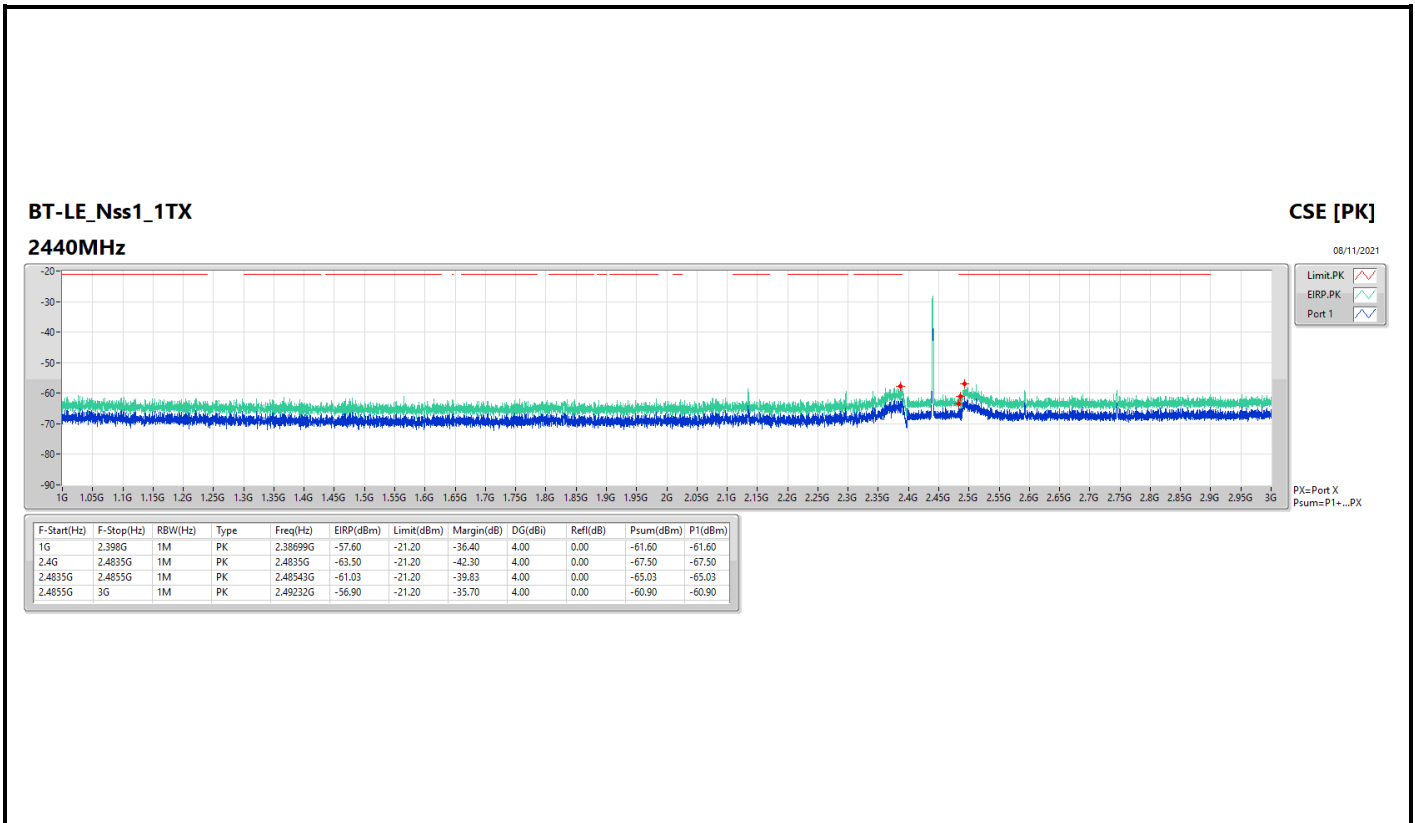

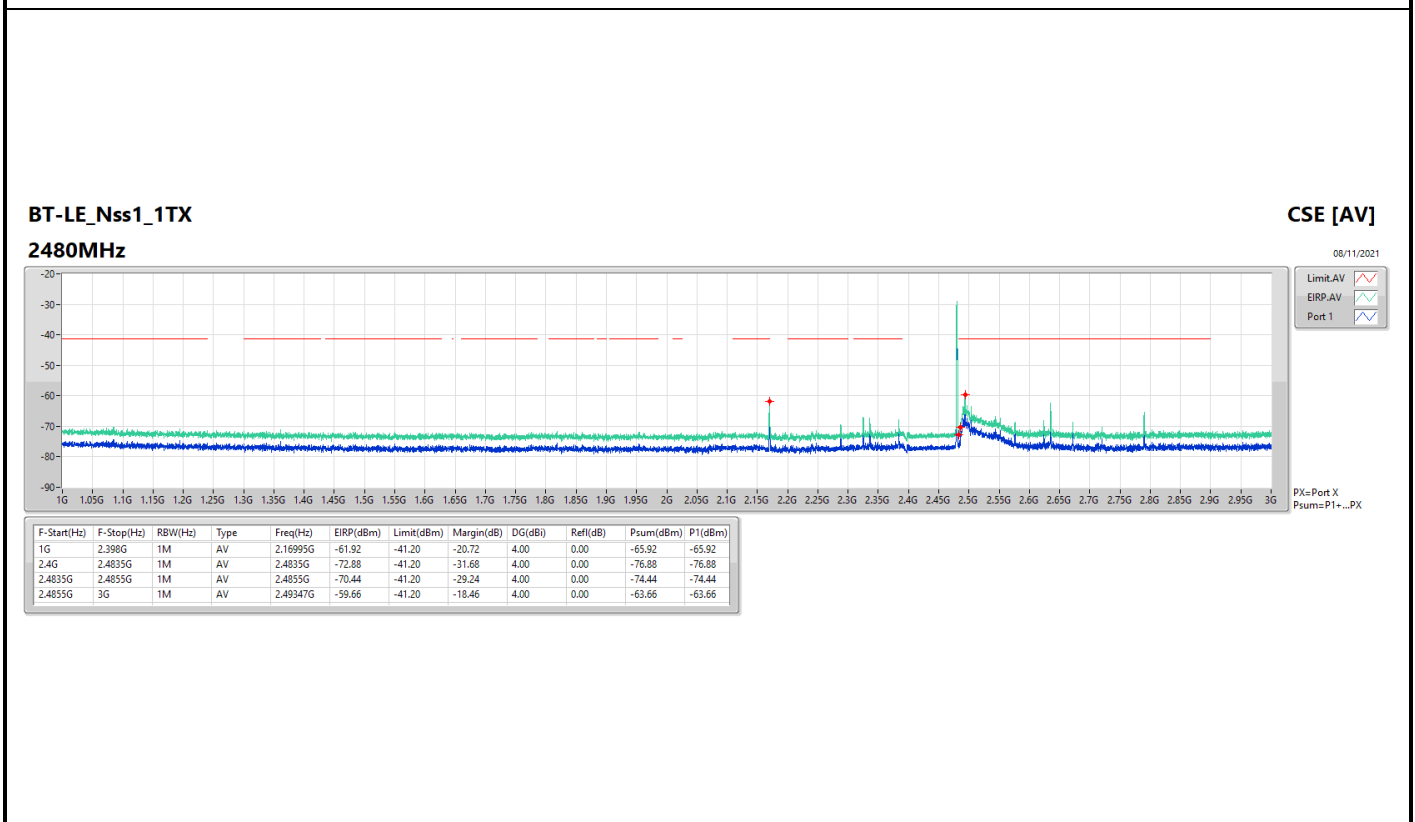
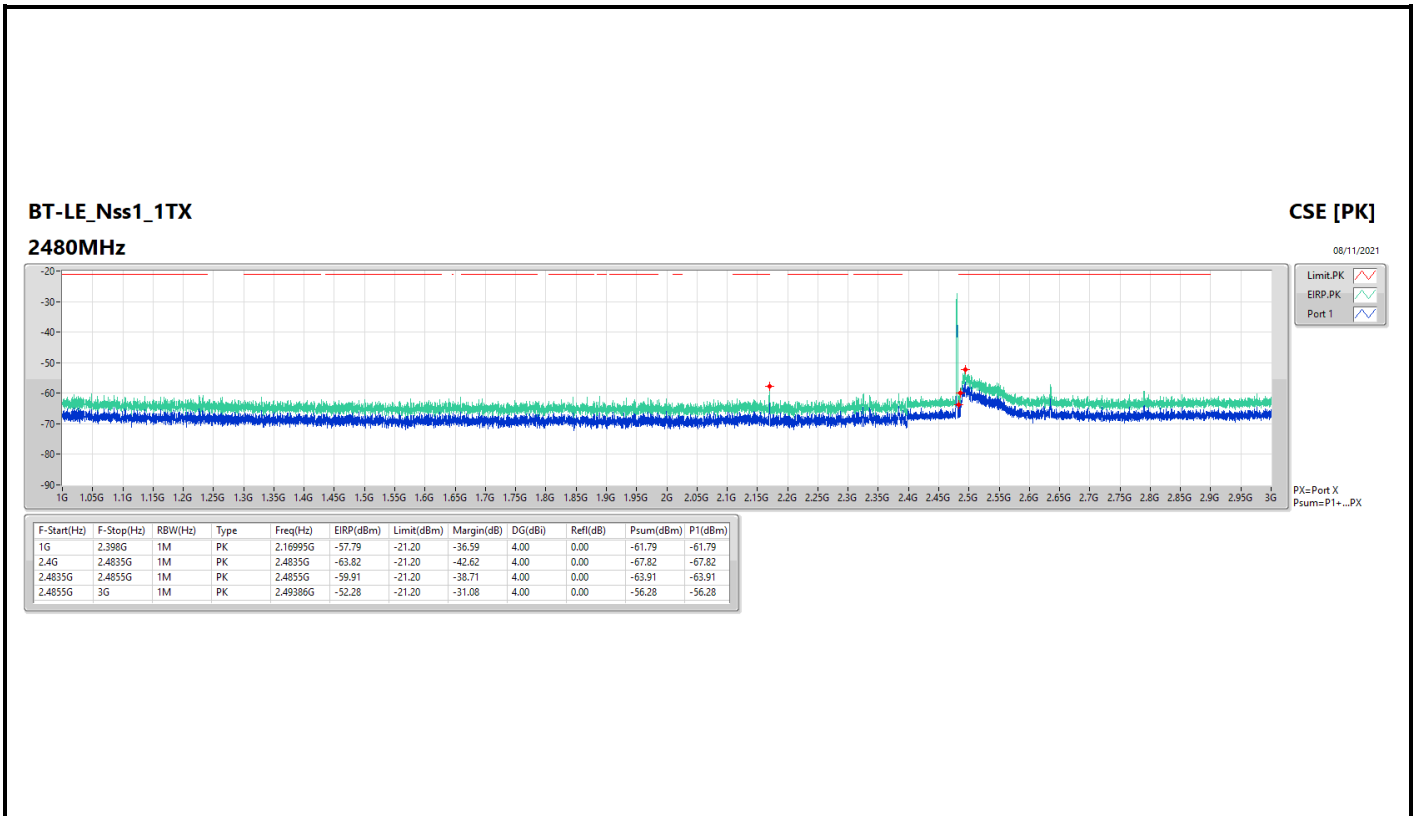



Summary

Mode	Result	F-Start (Hz)	F-Stop (Hz)	Type	Freq (Hz)	DG (dBi)	P1 (dBm)	Psum (dBm)	EIRP (dBm)	Limit (dBm)	Margin (dB)
2.4-2.4835GHz	-	-	-	-	-	-	-	-	-	-	-
BT-LE_Nss1_1TX	Pass	3G	7.5G	AV	4.87988G	4.00	-51.84	-51.84	-47.84	-41.20	-6.64

Result

Mode	Result	F-Start (Hz)	F-Stop (Hz)	Type	Freq (Hz)	DG (dBi)	P1 (dBm)	Psum (dBm)	EIRP (dBm)	Limit (dBm)	Margin (dB)
BT-LE_Nss1_1TX	-	-	-	-	-	-	-	-	-	-	-
2402MHz	Pass	3G	7.5G	AV	4.80338G	4.00	-51.88	-51.88	-47.88	-41.20	-6.68
2402MHz	Pass	7.5G	25G	AV	19.50719G	4.00	-77.93	-77.93	-73.93	-41.20	-32.73
2402MHz	Pass	3G	7.5G	PK	4.8045G	4.00	-49.04	-49.04	-45.04	-21.20	-23.84
2402MHz	Pass	7.5G	25G	PK	19.46781G	4.00	-68.15	-68.15	-64.15	-21.20	-42.95
2440MHz	Pass	3G	7.5G	AV	4.87988G	4.00	-51.84	-51.84	-47.84	-41.20	-6.64
2440MHz	Pass	7.5G	25G	AV	19.52688G	4.00	-77.94	-77.94	-73.94	-41.20	-32.74
2440MHz	Pass	3G	7.5G	PK	4.87931G	4.00	-48.96	-48.96	-44.96	-21.20	-23.76
2440MHz	Pass	3G	7.5G	PK	4.88044G	4.00	-49.17	-49.17	-45.17	-21.20	-23.97
2440MHz	Pass	7.5G	25G	PK	19.82438G	4.00	-68.12	-68.12	-64.12	-21.20	-42.92
2480MHz	Pass	3G	7.5G	AV	4.96031G	4.00	-53.96	-53.96	-49.96	-41.20	-8.76
2480MHz	Pass	7.5G	25G	AV	19.50063G	4.00	-77.28	-77.28	-73.28	-41.20	-32.08
2480MHz	Pass	3G	7.5G	PK	4.96031G	4.00	-50.81	-50.81	-46.81	-21.20	-25.61
2480MHz	Pass	7.5G	25G	PK	19.60781G	4.00	-69.21	-69.21	-65.21	-21.20	-44.01

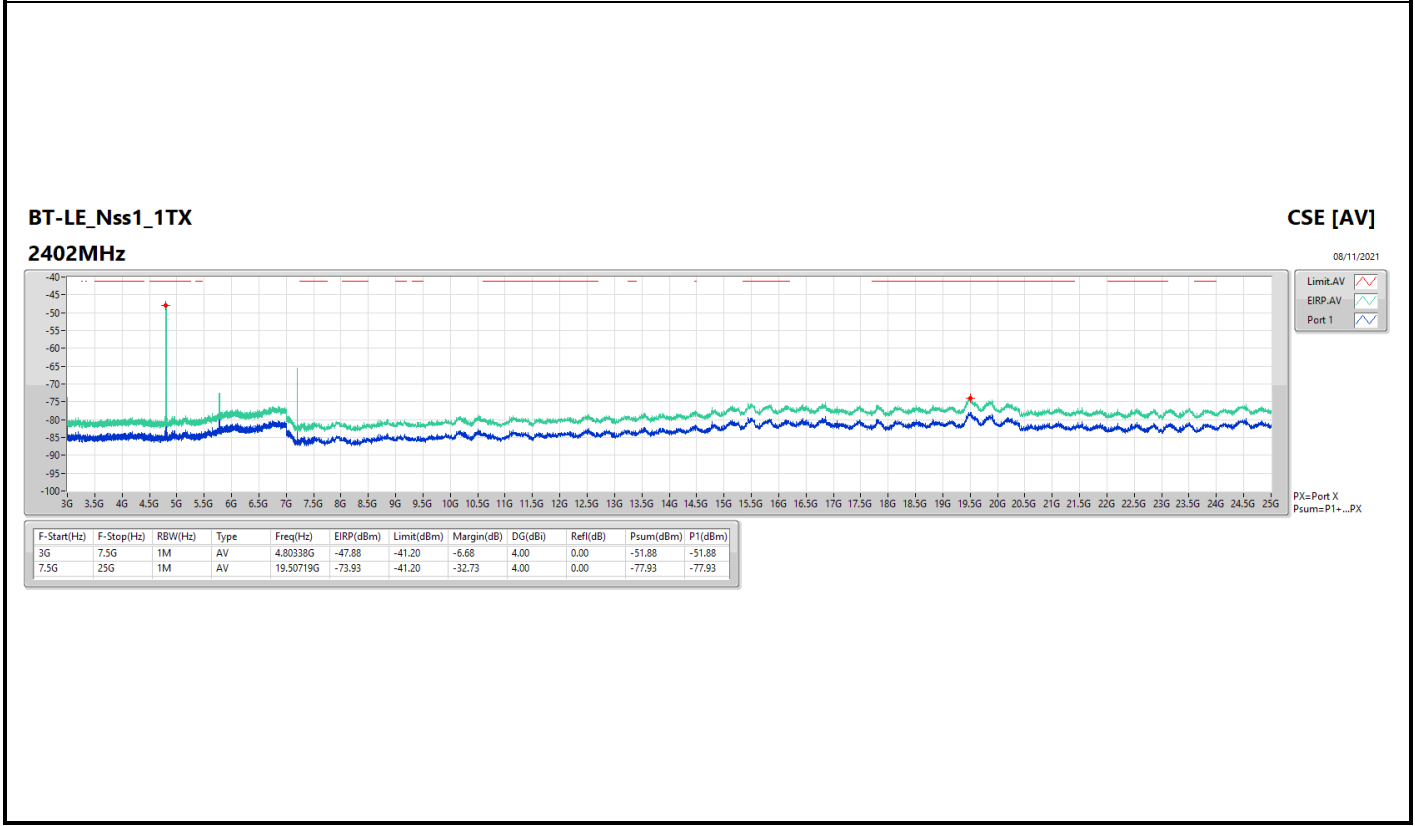
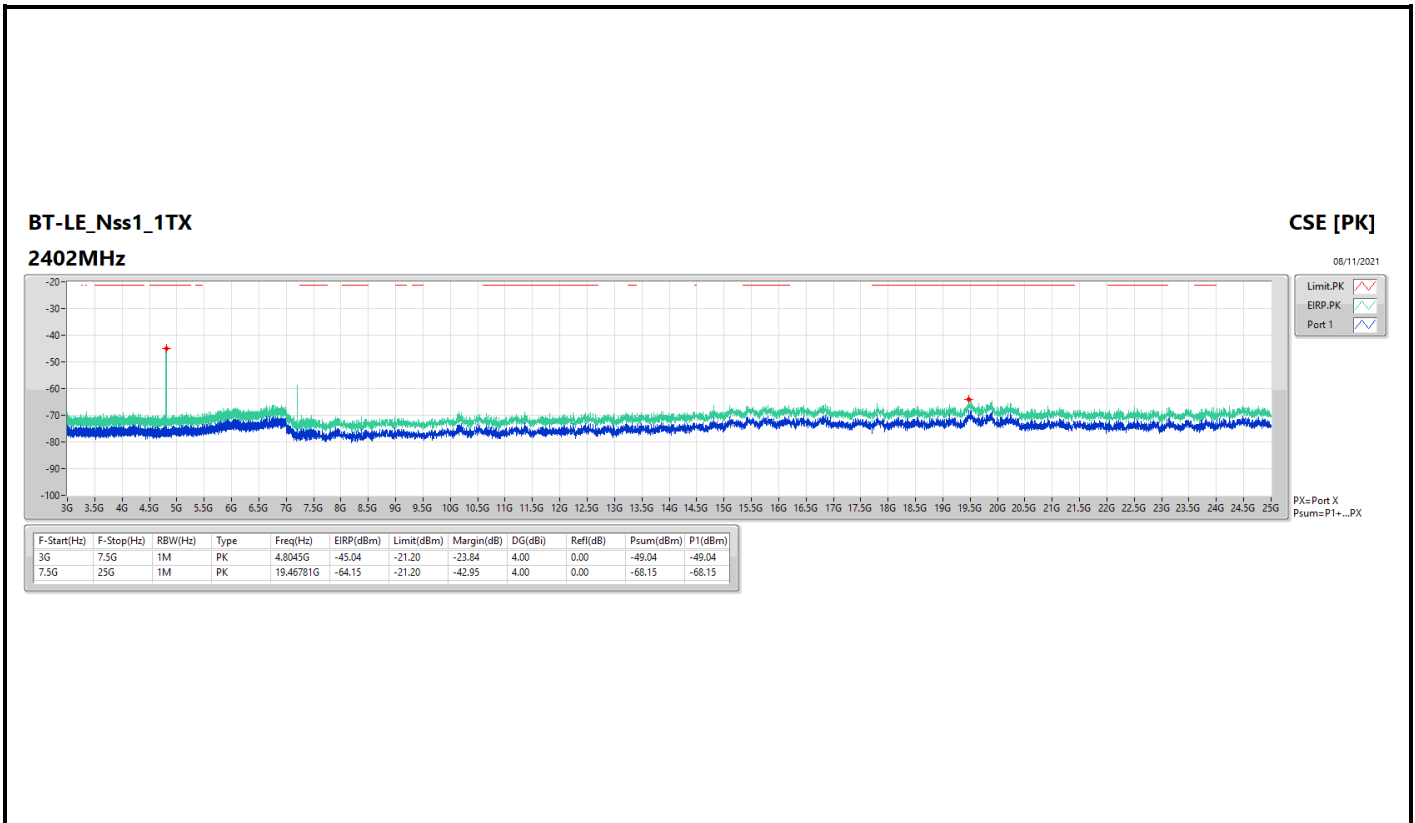

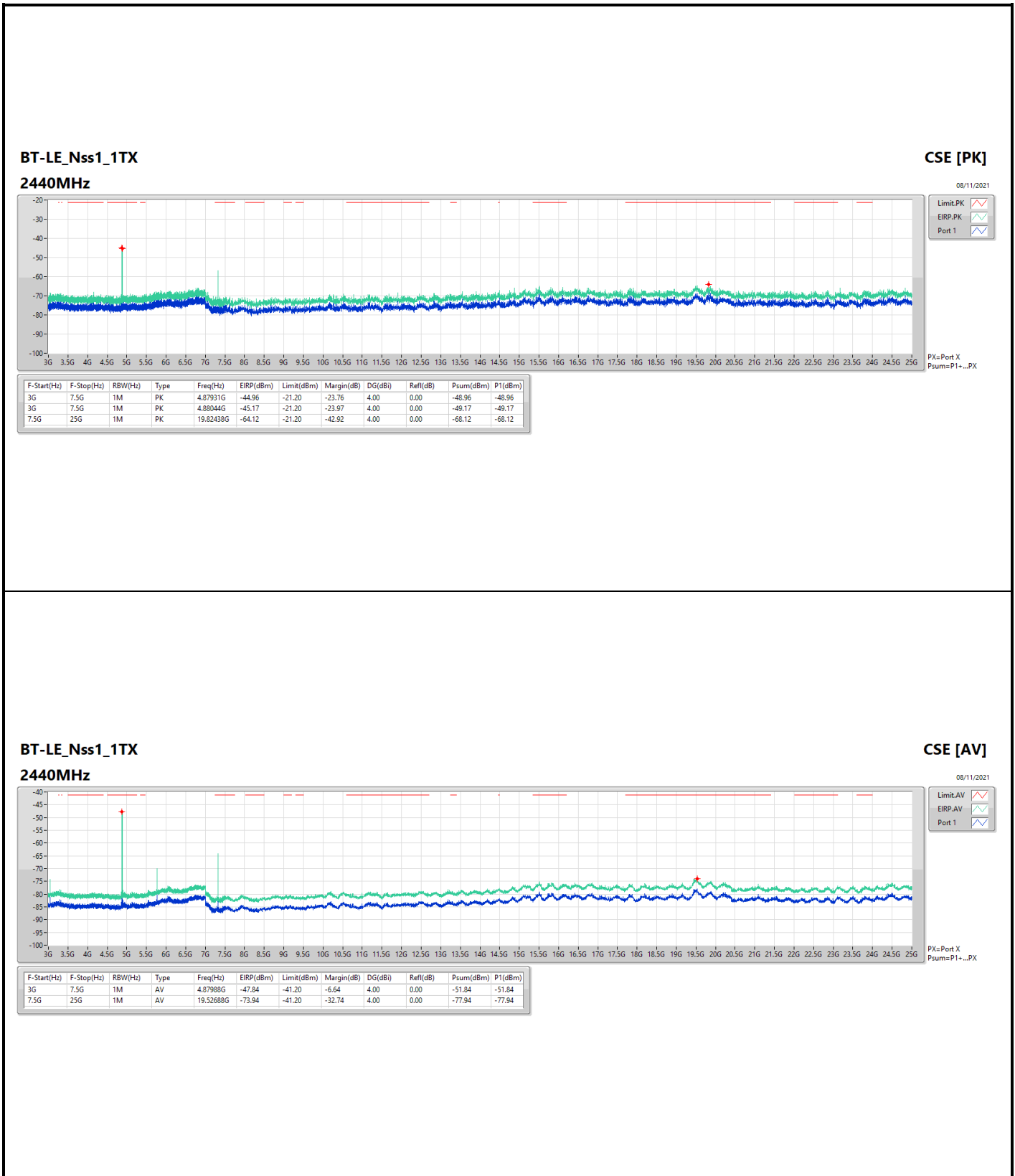

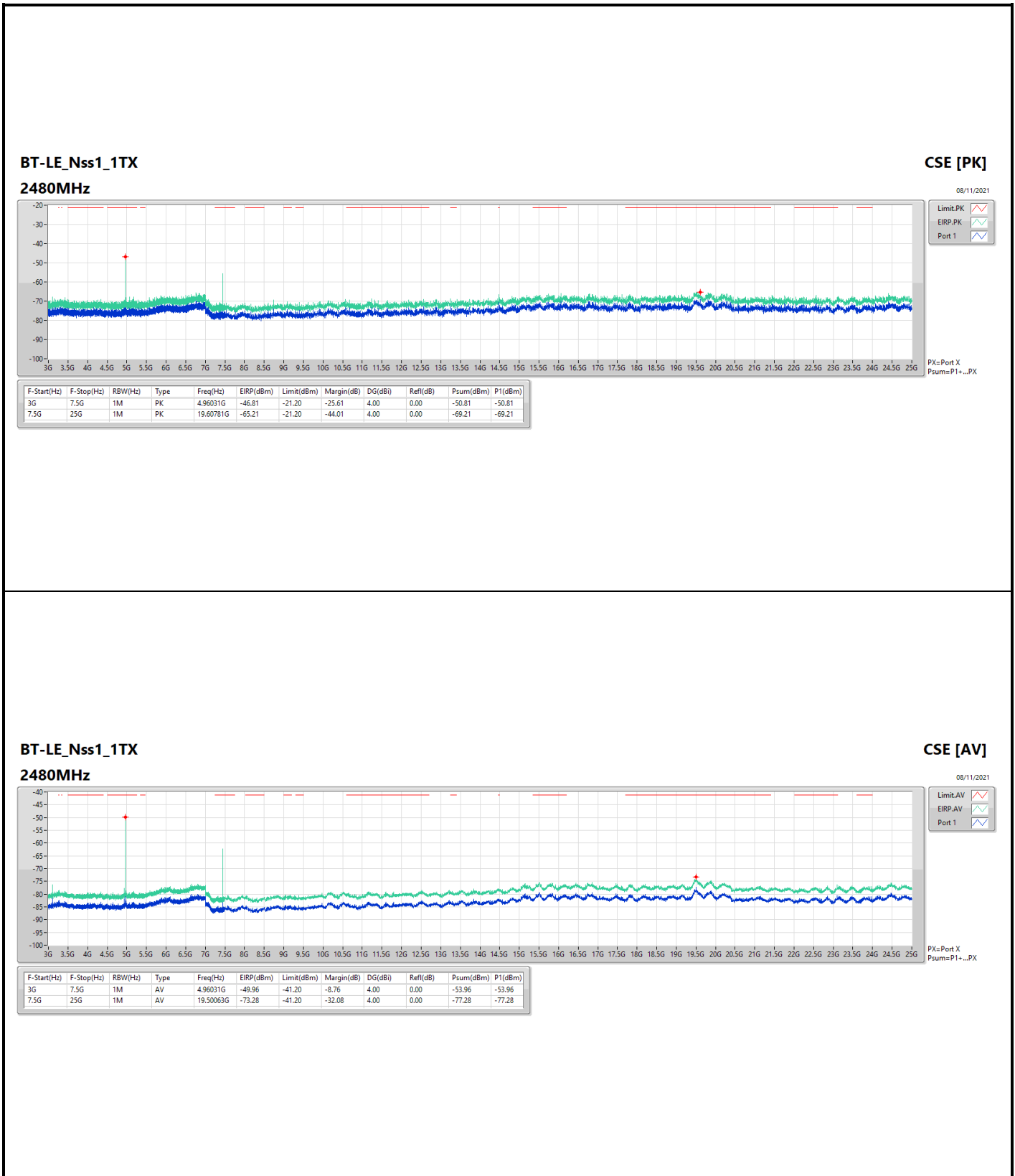



Summary

Mode	Result	Type	Freq (Hz)	Level (dBuV/m)	Limit (dBuV/m)	Margin (dB)	Dist (m)	Condition	Azimuth (°)	Height (m)	Comments
2.4-2.4835GHz	-	-	-	-	-	-	-	-	-	-	-
BT-LE(1Mbps)	Pass	AV	4G	38.45	54.00	-15.55	3	Vertical	12	1.77	-

BT-LE(1Mbps)

2402MHz_TX

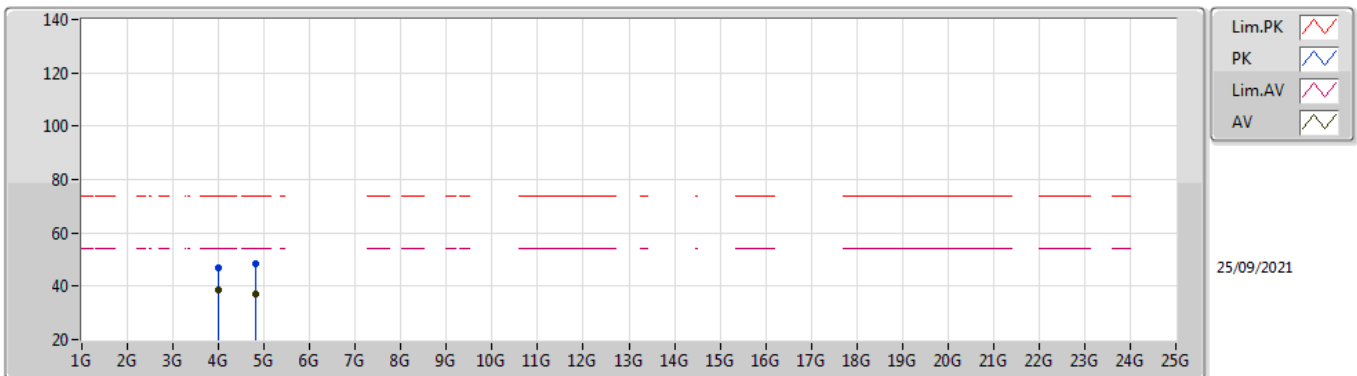

EUT Y_1TX
Setting 5
03-C-E-2

Type	Freq (Hz)	Level (dBuV/m)	Limit (dBuV/m)	Margin (dB)	Raw (dBuV)	Dist (m)	Condition	Azimuth (°)	Height (m)	Comment	AF (dB)	CL (dB)	PA (dB)
PK	4.00005G	47.11	74.00	-26.89	44.09	3	Vertical	12	1.77	-	32.80	5.70	35.48
AV	4G	38.45	54.00	-15.55	35.43	3	Vertical	12	1.77	-	32.80	5.70	35.48
PK	4.80345G	48.44	74.00	-25.56	43.97	3	Vertical	-0	3.00	-	33.40	6.50	35.43
AV	4.804G	37.00	54.00	-17.00	32.53	3	Vertical	-0	3.00	-	33.40	6.50	35.43

BT-LE(1Mbps)

2402MHz_TX

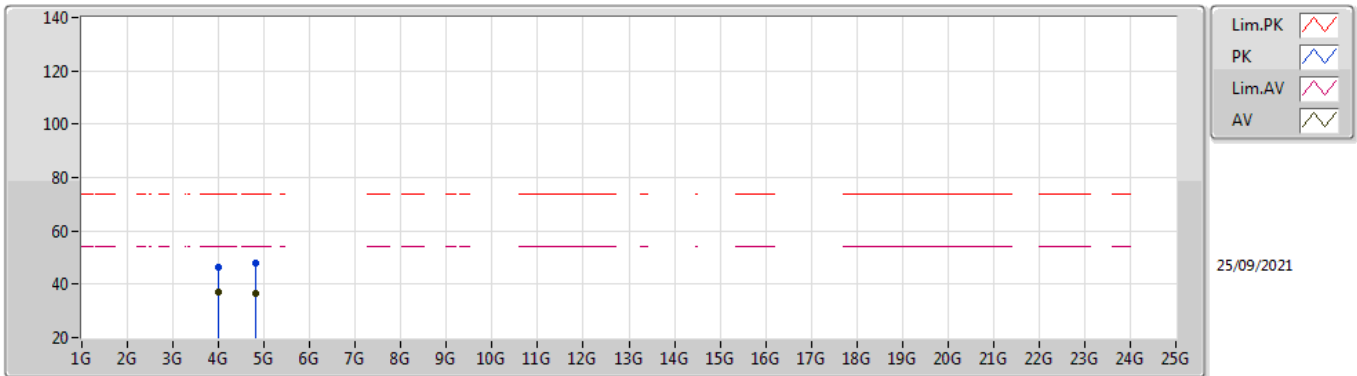

EUT Y_1TX
Setting 5
03-C-E-2

Type	Freq (Hz)	Level (dBuV/m)	Limit (dBuV/m)	Margin (dB)	Raw (dBuV)	Dist (m)	Condition	Azimuth (°)	Height (m)	Comment	AF (dB)	CL (dB)	PA (dB)
PK	4G	46.54	74.00	-27.46	43.52	3	Horizontal	308	1.69	-	32.80	5.70	35.48
AV	4G	36.91	54.00	-17.09	33.89	3	Horizontal	308	1.69	-	32.80	5.70	35.48
PK	4.8044G	47.94	74.00	-26.06	43.47	3	Horizontal	0	1.80	-	33.40	6.50	35.43
AV	4.80424G	36.53	54.00	-17.47	32.06	3	Horizontal	0	1.80	-	33.40	6.50	35.43