

FCC PART 15.249

TEST REPORT

For

OKIN Refined Electric Technology Co., Ltd.

Plant 4, No. 410, Xinyonglian Road, Wangjiangjing Development Zone, Jiaxing, Zhejiang, China

FCC ID: PCU-JLDP15013

Report Type: Original Report		Product Type: Control box	
Test Engineer:	Edison Hu	<i>Edison Hu</i>	
Report Number:	RSHA180122005-00B		
Report Date:	2018-02-08		
Reviewed By:	Oscar Ye RF Leader	<i>Oscar Ye</i>	
Test Laboratory:	Bay Area Compliance Laboratories Corp. (Kunshan) No.248 Chenghu Road,Kunshan,Jiangsu province,China Tel: +86-0512-86175000 Fax: +86-0512-88934268 www.baclcorp.com.cn		

Note: This test report is prepared for the customer shown above and for the device described herein. It may not be duplicated or used in part without prior written consent from Bay Area Compliance Laboratories Corp. This report is valid only with a valid digital signature. The digital signature may be available only under the Adobe software above version 7.0.

TABLE OF CONTENTS

GENERAL INFORMATION.....	3
PRODUCT DESCRIPTION FOR EQUIPMENT UNDER TEST (EUT)	3
OBJECTIVE	3
RELATED SUBMITTAL(S)/GRANT(S).....	3
TEST METHODOLOGY	3
MEASUREMENT UNCERTAINTY	4
TEST FACILITY	4
SYSTEM TEST CONFIGURATION.....	5
JUSTIFICATION	5
EUT EXERCISE SOFTWARE	5
SUPPORT EQUIPMENT LIST AND DETAILS	5
EXTERNAL I/O CABLE.....	5
BLOCK DIAGRAM OF TEST SETUP	6
SUMMARY OF TEST RESULTS	9
TEST EQUIPMENT LIST	10
FCC§15.203 - ANTENNA REQUIREMENT.....	11
APPLICABLE STANDARD	11
ANTENNA CONNECTOR CONSTRUCTION	11
FCC §15.207 (A) – AC LINE CONDUCTED EMISSIONS	12
APPLICABLE STANDARD	12
EUT SETUP	12
EMI TEST RECEIVER SETUP.....	12
TEST PROCEDURE	12
CORRECTED FACTOR & MARGIN CALCULATION	13
TEST RESULTS SUMMARY	13
TEST DATA	13
FCC§15.205, §15.209&§15.249- RADIATED EMISSIONS& OUT OF BAND EMISSION.....	16
APPLICABLE STANDARD	16
EUT SETUP	16
TEST EQUIPMENT SETUP	17
TEST PROCEDURE	17
CORRECTED AMPLITUDE & MARGIN CALCULATION	18
TEST RESULTS SUMMARY	18
TEST DATA	18
FCC §15.215(C) – 20 DB BANDWIDTH TESTING	25
APPLICABLE STANDARD	25
TEST PROCEDURE	25
TEST DATA	25

GENERAL INFORMATION

Product Description for Equipment under Test (EUT)

Applicant	OKIN Refined Electric Technology Co., Ltd.
Tested Model	JLDP.15.013.001
Series Model	JLDP.15.013.002; JLDP.15.013.003; JLDP.15.013.004; JLDP.15.013.005
Model Difference	Model name
Product Type	Control box
Dimension	140mm(L)*128mm(W)*49mm(H)
Power Supply	DC 29V from Adapter

Adapter Information:

Model: 02-290020

Input: AC100-240 V 50/60Hz 1.5A

Output: 29V, 2A

All measurement and test data in this report was gathered from production sample serial number: 20180122005. (Assigned by BACL, Kunshan). The EUT was received on 2018-01-22.

Objective

This type approval report is prepared on behalf of OKIN Refined Electric Technology Co., Ltd. in accordance with Part 2-Subpart J, and Part 15-Subparts A and C of the Federal Communication Commissions rules.

The tests were performed in order to determine compliance with FCC Part 15, Subpart C, and section 15.203, 15.205, 15.207, 15.209 and 15.249 rules.

Related Submittal(s)/Grant(s)

FCC Part15.249 DXX submission with FCC ID: PCU-RF366C.

Test Methodology

All measurements contained in this report were conducted with ANSI C63.10-2013, American National Standard of Procedures for Compliance Testing of Unlicensed Wireless Devices.

All radiated and conducted emissions measurement was performed at Bay Area Compliance Lab Corp. (Kunshan). The radiated testing was performed at an antenna-to-EUT distance of 3 meters.

Measurement Uncertainty

Item		Uncertainty
AC Power Lines Conducted Emissions		3.19 dB
RF conducted test with spectrum		0.9dB
RF Output Power with Power meter		0.5dB
Radiated emission	30MHz~1GHz	6.11dB
	1GHz~6GHz	4.45dB
	6GHz~18GHz	5.23dB
	18GHz~40GHz	5.65dB
Occupied Bandwidth		0.5kHz
Temperature		1.0°C
Humidity		6%

Test Facility

The test site used by Bay Area Compliance Laboratories Corp. (Kunshan) to collect test data is located on the No.248 Chenghu Road, Kunshan, Jiangsu province, China.

Bay Area Compliance Laboratories Corp. (Kunshan) Lab is accredited to ISO/IEC 17025 by A2LA (Lab code: 4323.01) and the FCC designation No. CN1185 under the FCC KDB 974614 D01. The facility also complies with the radiated and AC line conducted test site criteria set forth in ANSI C63.4-2014.

SYSTEM TEST CONFIGURATION

Justification

Channel list:

Channel	Frequency (MHz)	Channel	Frequency (MHz)
1	2403	40	2442
2	2404	41	2443
...
38	2440	77	2479
39	2441	78	2480

EUT was tested with channel 1, 40 and 78.

EUT Exercise Software

No software was used during the test.

Support Equipment List and Details

Manufacturer	Description	Model	Serial Number
OKIN Refined	Adapter	02-290020	RBD59 7201906
OKIN Refined	Motor 1	73842	68000010150A43990093
OKIN Refined	Motor 2	73851	68000009150B18360292
OKIN Refined	Motor 3	JLDQ-10 (75083)	68000004150531410901
OKIN Refined	Motor 4	JLDQ-10 (75083)	68000004150846080002
OKIN Refined	Power Down Box	74389	68000087161727012126

External I/O Cable

Cable Description	Length (m)	From Port	To
Power Cable	1.0	Adapter	AC Source

Block Diagram of Test Setup

For Conducted Emissions:

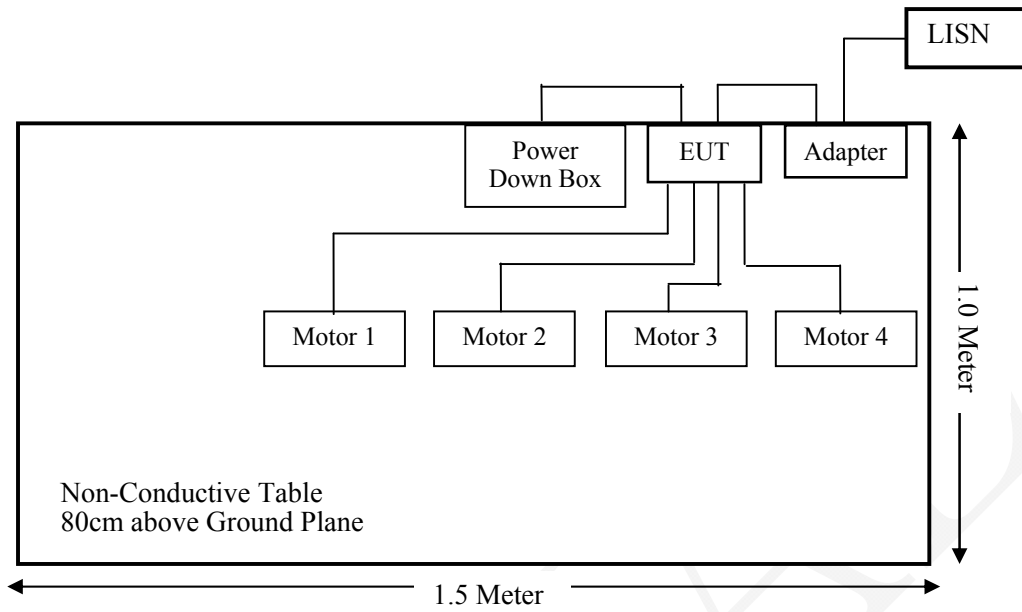

For Radiated Emissions(Below 1GHz):

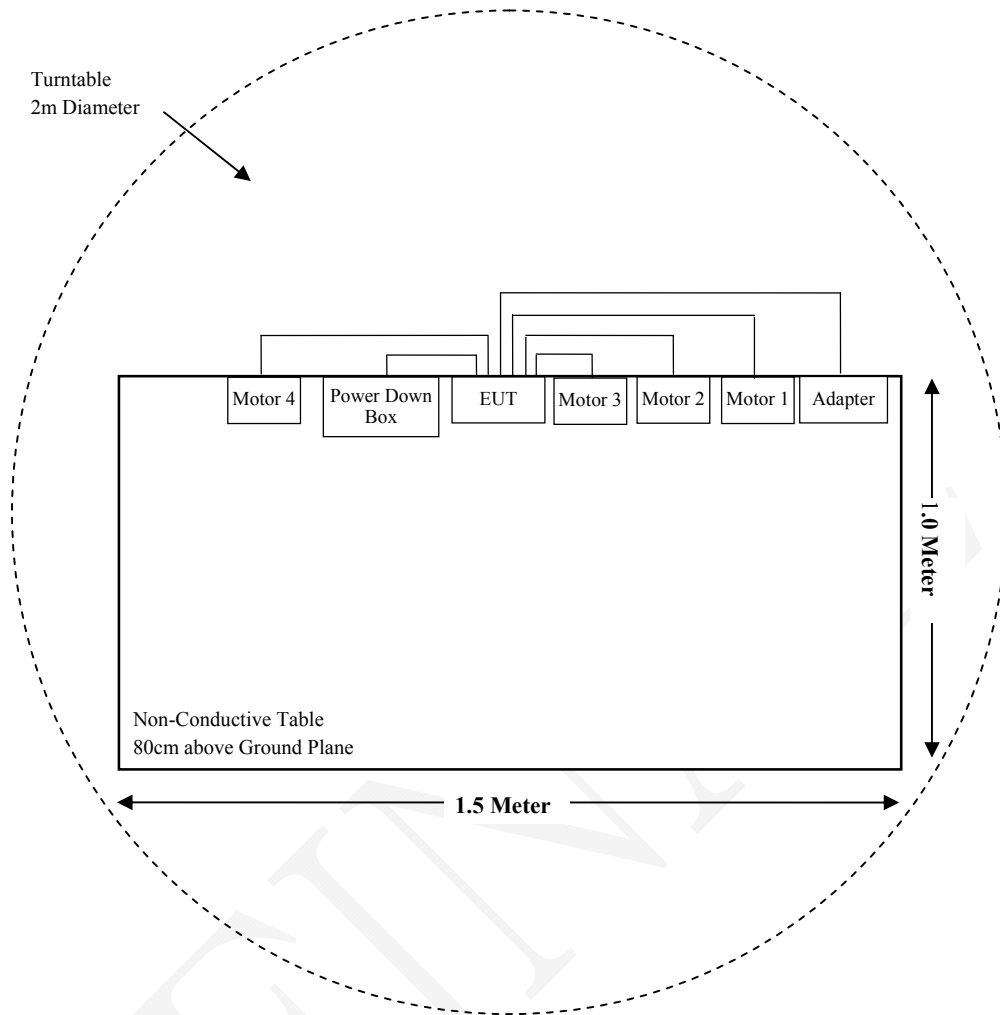

For Radiated Emissions(Above 1GHz):

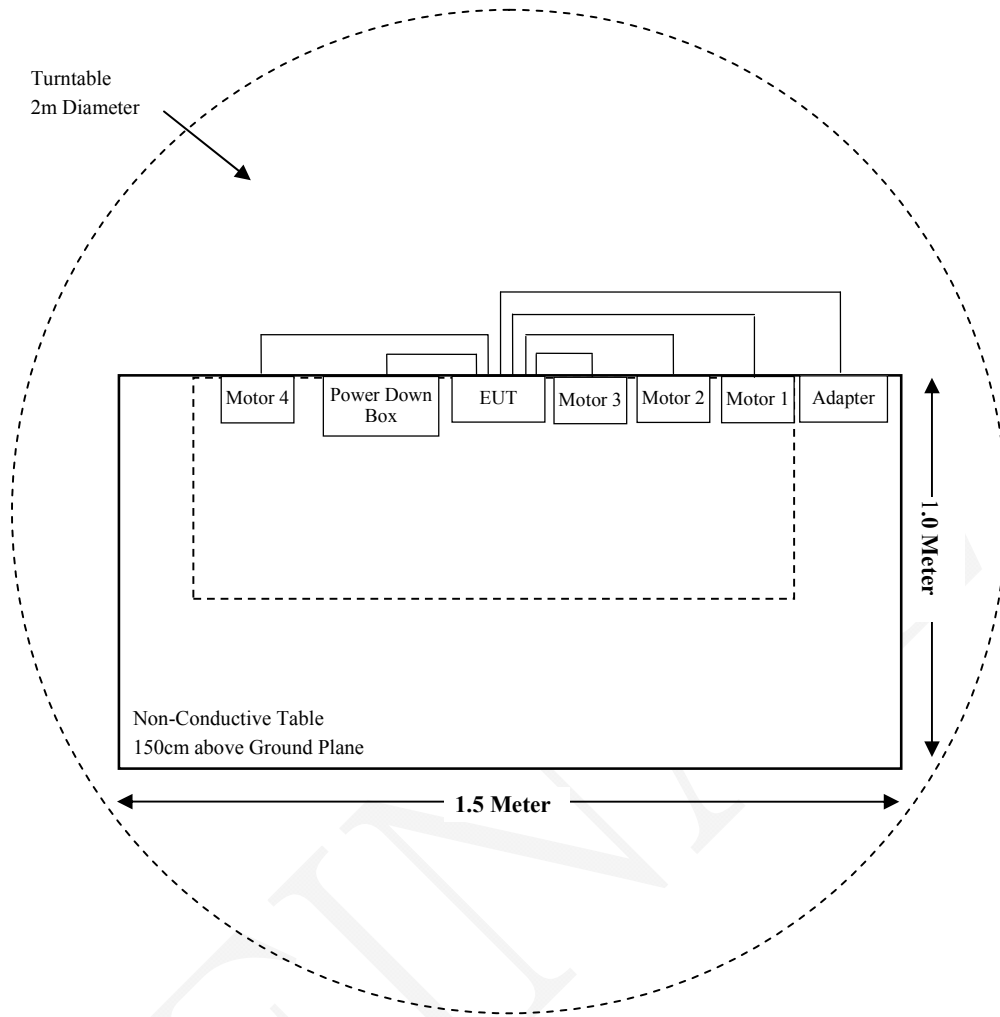

SUMMARY OF TEST RESULTS

FCC Rules	Description of Test	Result
§15.203	Antenna Requirement	Compliant
§15.207(a)	Conduction Emissions	Compliant
15.205, §15.209, §15.249	Radiated Emissions & Out of Band Emission	Compliant
§15.215 (e)	20 dB Bandwidth	Compliant

TEST EQUIPMENT LIST

Manufacturer	Description	Model	Serial Number	Calibration Date	Calibration Due Date
Radiated Emission Test (Chamber 1#)					
Rohde & Schwarz	EMI Test Receiver	ESCI	100195	2017-11-12	2018-11-11
Sunol Sciences	Broadband Antenna	JB3	A090413-1	2016-12-26	2019-12-25
Sonoma Instrument	Pre-amplifier	310N	171205	2017-08-15	2018-08-14
Rohde & Schwarz	Auto test Software	EMC32	100361	/	/
MICRO-COAX	Coaxial Cable	Cable-8	008	2017-08-15	2018-08-14
MICRO-COAX	Coaxial Cable	Cable-9	009	2017-08-15	2018-08-14
MICRO-COAX	Coaxial Cable	Cable-10	010	2017-08-15	2018-08-14
Radiated Emission Test (Chamber 2#)					
Rohde & Schwarz	EMI Test Receiver	ESU40	100207	2017-08-27	2018-08-26
ETS-LINDGREN	Horn Antenna	3115	6229	2016-01-11	2019-01-10
ETS-LINDGREN	Horn Antenna	3116	00084159	2016-10-18	2019-10-17
SINOSCITE	Band Reject Filter	BSF2400-2483MN-0995	/	2017-08-05	2018-08-04
Narda	Pre-amplifier	AFS42-00101800	2001270	2017-12-12	2018-12-11
Quinstar	Amplifier	QLW-18405536-J0	15964001009	2017-12-12	2018-12-11
Narda	Attenuator/10dB	10dB	/	2017-08-15	2018-08-14
Rohde & Schwarz	Auto test Software	EMC32	100361	/	/
MICRO-COAX	Coaxial Cable	Cable-6	006	2017-08-15	2018-08-14
MICRO-COAX	Coaxial Cable	Cable-11	011	2017-08-15	2018-08-14
MICRO-COAX	Coaxial Cable	Cable-12	012	2017-08-15	2018-08-14
MICRO-COAX	Coaxial Cable	Cable-13	013	2017-08-15	2018-08-14
RF Conducted Test					
Rohde & Schwarz	Signal Analyzer	FSIQ26	836131/009	2017-09-21	2018-09-20
Narda	Attenuator/6dB	6dB	/	2017-08-15	2018-08-14
OKIN Refined	RF Cable	/	/	/	/
Conducted Emission Test					
Rohde & Schwarz	EMI Test Receiver	ESCS30	834115/007	2017-11-12	2018-11-11
Rohde & Schwarz	LISN	ESH3-Z5	862770/011	2017-11-12	2018-11-11
Rohde & Schwarz	LISN	ENV216	3560655016	2017-11-12	2018-11-11
BACL	Auto test Software	BACL-EMC	CE001	/	/
Narda	Attenuator/6dB	10690812-2	26850-6	2017-01-10	2018-01-09
MICRO-COAX	Coaxial Cable	Cable-15	015	2017-08-15	2018-08-14

* **Statement of Traceability:** Bay Area Compliance Laboratories Corp. (Kunshan) attests that all calibrations have been performed in accordance to requirements that traceable to National Primary Standards and International System of Units (SI).

FCC§15.203 - ANTENNA REQUIREMENT

Applicable Standard

For intentional device, according to §15.203, an intentional radiator shall be designed to ensure that no antenna other than that furnished by the responsible party shall be used.

Antenna Connector Construction

The EUT has a PCB antenna and antenna gain is 0 dBi, which was permanently attached ,fulfill the requirement of this section, please refer to the EUT photos.

Result: Compliant.

FINAL

FCC §15.207 (a) – AC LINE CONDUCTED EMISSIONS

Applicable Standard

FCC§15.207

EUT Setup

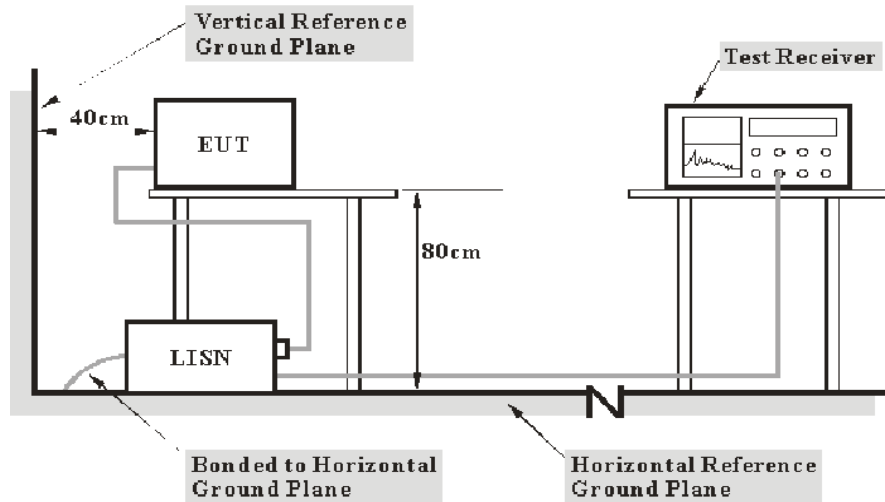

- Note: 1. Support units were connected to second LISN.
 2. Both of LISNs (AMN) 80 cm from EUT and at the least 80 cm from other units and other metal planes support units.

The setup of EUT is according with per ANSI C63.10-2013 measurement procedure. The specification used was with the FCC Part 15.207 limits.

The spacing between the peripherals was 10 cm.

EMI Test Receiver Setup

The EMI test receiver was set to investigate the spectrum from 150 kHz to 30 MHz.

During the conducted emission test, the EMI test receiver was set with the following configurations:

Frequency Range	IF B/W
150 kHz – 30 MHz	9 kHz

Test Procedure

During the conducted emission test, the adapter was connected to the outlet of the LISN.

Maximizing procedure was performed on the six (6) highest emissions of the EUT.

All data was recorded in the Quasi-peak and average detection mode.

Corrected Factor & Margin Calculation

The Corrected factor is calculated by adding LISN VDF (Voltage Division Factor), Cable Loss and Transient Limiter Attenuation. The basic equation is as follows:

$$\text{Corrected Factor} = \text{LISN VDF} + \text{Cable Loss} + \text{Transient Limiter Attenuation}$$

The “**Margin**” column of the following data tables indicates the degree of compliance with the applicable limit. For example, a margin of 7 dB means the emission is 7 dB below the limit. The equation for margin calculation is as follows:

$$\text{Margin} = \text{Limit} - \text{Reading}$$

Test Results Summary

According to the recorded data in following table, the EUT complied with the FCC Part 15.207.

Test Data

Environmental Conditions

Temperature:	24.6°C
Relative Humidity:	52%
ATM Pressure:	101.3 kPa

The testing was performed by Edison Hu on 2018-01-25.

EUT operation mode: Transmitting in low channel (worst case)

AC 120V/60 Hz, Line

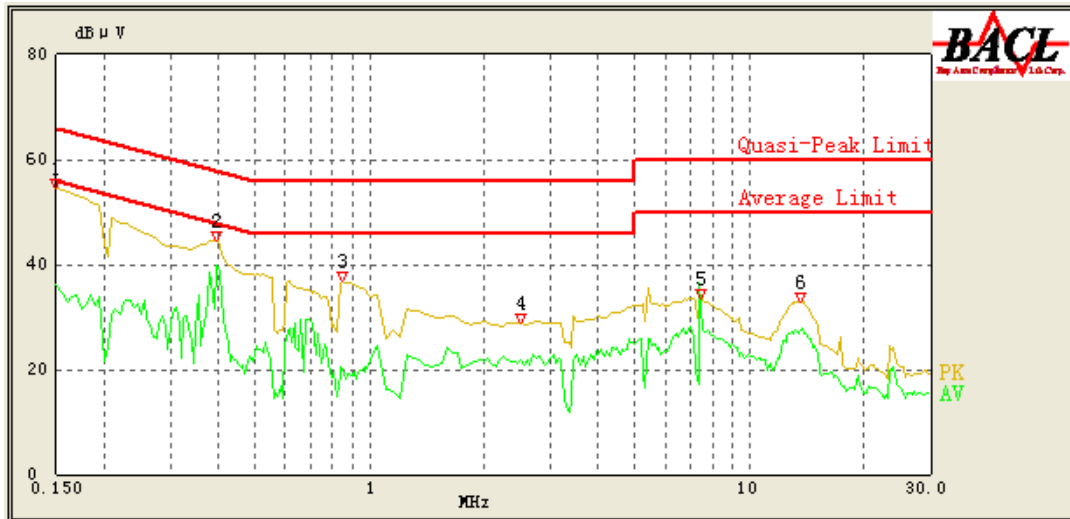

Frequency (MHz)	Reading (dBμV)	Detector (PK/AV/QP)	Bandwidth (kHz)	Line	Corrected Factor (dB)	Limit (dBμV)	Margin (dB)	Comment
0.150	54.54	QP	9.000	L1	16.06	66.00	11.46	Compliant
0.150	36.30	AV	9.000	L1	16.06	56.00	19.70	Compliant
0.395	44.65	QP	9.000	L1	16.06	59.00	14.35	Compliant
0.395	39.86	AV	9.000	L1	16.06	49.00	9.14	Compliant
0.845	36.75	QP	9.000	L1	15.92	56.00	19.25	Compliant
0.840	20.49	AV	9.000	L1	15.92	46.00	25.51	Compliant
2.500	28.84	QP	9.000	L1	15.85	56.00	27.16	Compliant
2.500	21.87	AV	9.000	L1	15.85	46.00	24.13	Compliant
7.450	33.58	QP	9.000	L1	15.99	60.00	26.42	Compliant
7.400	36.38	AV	9.000	L1	15.99	50.00	13.62	Compliant
13.600	32.92	QP	9.000	L1	16.17	60.00	27.08	Compliant
13.600	27.35	AV	9.000	L1	16.17	50.00	22.65	Compliant

AC 120V/60 Hz, Neutral

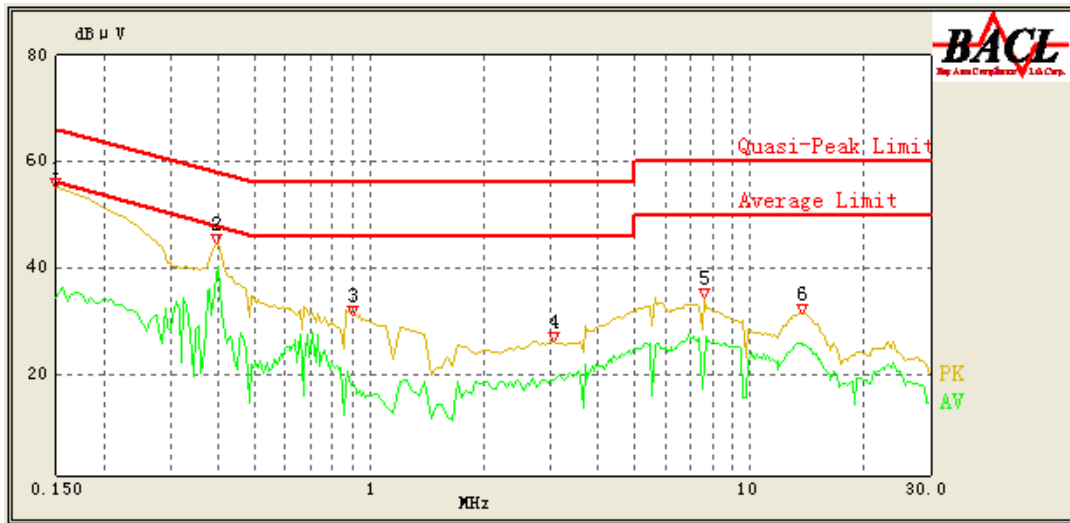

Frequency (MHz)	Reading (dBμV)	Detector (PK/AV/QP)	Bandwidth (kHz)	Line	Corrected Factor (dB)	Limit (dBμV)	Margin (dB)	Comment
0.150	55.05	QP	9.000	N	16.06	66.00	10.95	Compliant
0.150	34.51	AV	9.000	N	16.06	56.00	21.49	Compliant
0.395	44.64	QP	9.000	N	16.09	59.00	14.36	Compliant
0.395	38.58	AV	9.000	N	16.09	49.00	10.42	Compliant
0.900	31.25	QP	9.000	N	15.96	56.00	24.75	Compliant
0.905	18.12	AV	9.000	N	15.96	46.00	27.88	Compliant
3.050	26.05	QP	9.000	N	15.90	56.00	29.95	Compliant
3.050	18.86	AV	9.000	N	15.90	46.00	27.14	Compliant
7.600	34.29	QP	9.000	N	15.93	60.00	25.71	Compliant
7.650	26.68	AV	9.000	N	15.94	50.00	23.32	Compliant
13.700	31.44	QP	9.000	N	16.00	60.00	28.56	Compliant
13.700	25.96	AV	9.000	N	16.00	50.00	24.04	Compliant

Note:

- 1) Corrected Factor = LISN VDF + Cable Loss + Transient Limiter Attenuation
- 2) Margin = Limit – Reading

FCC§15.205, §15.209&§15.249- RADIATED EMISSIONS& OUT OF BAND EMISSION

Applicable Standard

As per FCC§15.249 (a), except as provided in paragraph (b) of this section, the field strength of emissions from intentional radiators operated within these frequency bands shall comply with the following:

Fundamental frequency	Field strength of fundamental (millivolts/meter)	Field strength of harmonics (microvolts/meter)
902–928 MHz	50	500
2400–2483.5 MHz	50	500
5725–5875 MHz	50	500
24.0–24.25 GHz	250	2500

As per FCC§15.249 (c), Field strength limits are specified at a distance of 3 meters.

(d) Emissions radiated outside of the specified frequency bands, except for harmonics, shall be attenuated by at least 50 dB below the level of the fundamental or to the general radiated emission limits in §15.209, whichever is the lesser attenuation.

EUT Setup

Below 1 GHz:

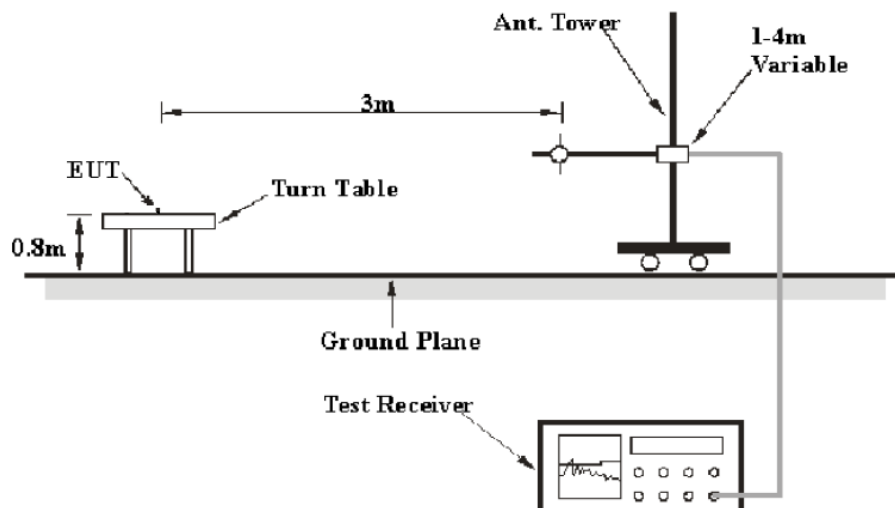

Above 1 GHz:

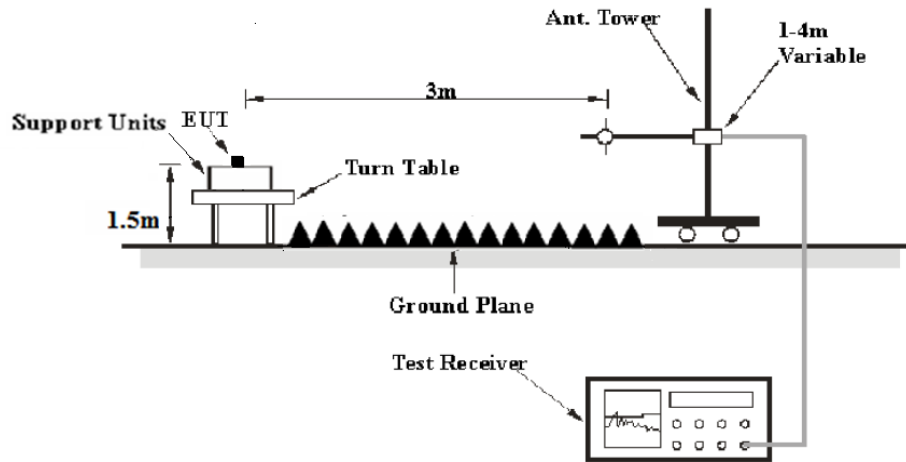

The radiated emission and out of band emission tests were performed in the 3 meters chamber test site, using the setup accordance with the ANSI C63.10-2013. The specification used was the FCC 15.209/15.205 and FCC 15.249 limits. The external I/O cables were draped along the test table and formed a bundle 30 to 40 cm long in the middle.

Test Equipment Setup

The system was investigated from 30 MHz to 25 GHz.

During the radiated emission test, the EMI test receiver was set with the following configurations:

Frequency Range	RBW	Video B/W	IF B/W	Detector
30 MHz – 1000 MHz	120 kHz	300 kHz	120 kHz	QP
Above 1GHz	1MHz	3 MHz	/	PK
	1MHz	3 MHz	/	Ave

Test Procedure

Maximizing procedure was performed on the highest emissions to ensure that the EUT complied with all installation combinations.

All data was recorded in the Quasi-peak detection mode from 30MHz to 1GHz, Peak and average detection mode above 1 GHz.

Corrected Amplitude & Margin Calculation

The Corrected Amplitude is calculated by adding the Antenna Factor and Cable Loss, and subtracting the Amplifier Gain from the Meter Reading. The basic equation is as follows:

$$\text{Corrected Amplitude} = \text{Meter Reading} + \text{Antenna Factor} + \text{Cable Loss} - \text{Amplifier Gain}$$

The “**Margin**” column of the following data tables indicates the degree of compliance with the applicable limit. For example, a margin of 7dB means the emission is 7dB below the limit. The equation for margin calculation is as follows:

$$\text{Margin} = \text{Limit} - \text{Corrected Amplitude}$$

Test Results Summary

According to the data in the following table, the EUT complied with the FCC Part 15.209 & 15.205 & 15.249.

Test Data

Environmental Conditions

Temperature:	24.6°C
Relative Humidity:	52%
ATM Pressure:	101.2 kPa

The testing was performed by Edison Hu on 2018-01-30.

Test Mode: Transmitting (Scan with X-Axis, Y-Axis and Z-Axis position, the worst case X-Axis was recorded)

Spurious Emission Test:

30MHz-1GHz

(Pre-scan with low, middle and high channels of operation in the X,Y and Z axes of orientation, the worst case low channel of operation in X-axis of orientation was recorded)

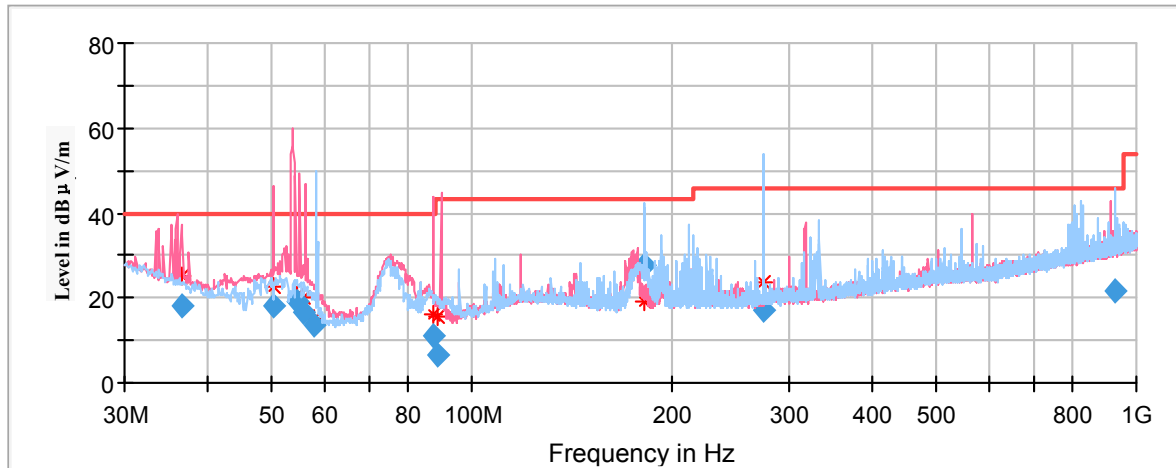

Frequency (MHz)	Corrected Amplitude	Rx Antenna		Turntable Degree	Corrected Factor (dB/m)	Limit (dBμV/m)	Margin (dB)
	Quasi-peak (dBμV/m)	Height (cm)	Polar (H/V)				
36.565090	17.94	101.0	V	213.0	-8.8	40.00	22.06
50.156680	18.03	198.0	V	37.0	-18.0	40.00	21.97
54.670190	18.97	101.0	V	313.0	-18.2	40.00	21.03
55.677840	16.78	101.0	V	299.0	-18.2	40.00	23.22
58.083940	13.63	101.0	H	217.0	-18.3	40.00	26.37
87.740130	11.32	198.0	V	132.0	-18.0	40.00	28.68
88.822690	6.49	198.0	V	107.0	-17.9	43.50	37.01
182.210620	27.60	198.0	H	266.0	-14.0	43.50	15.90
275.418780	17.14	101.0	H	142.0	-11.8	46.00	28.86
927.117010	21.63	198.0	H	181.0	0.7	46.00	24.37

1GHz-18GHz

(Pre-scan in the X, Y and Z axes of orientation, the worst case X-axis of orientation was recorded.)

Note:

1. This test was performed with the 2.4-2.4835GHz band reject filter.
2. Corrected Factor = Antenna factor (RX) + Cable Loss – Amplifier Factor
 Corrected Amplitude = Corrected Factor + Reading
 Margin = Limit – Corrected. Amplitude

Low Channel: 2403MHz

Full Spectrum

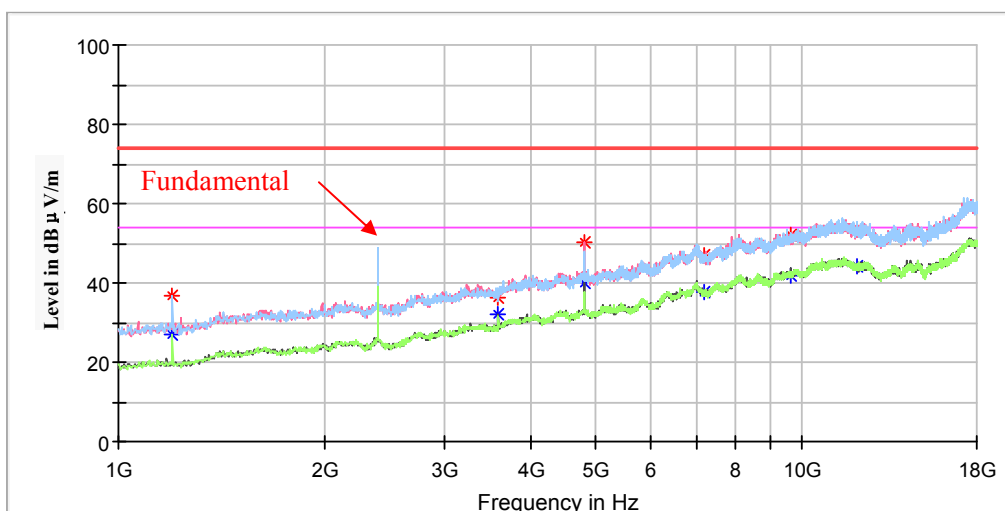

Frequency (MHz)	Corrected Amplitude		Rx Antenna		Turntable Degree	Corrected Factor (dB/m)	Limit (dBμV/m)	Margin (dB)
	MaxPeak (dBμV /m)	Average (dBμV /m)	Height (cm)	Polar (H/V)				
1200.600000	36.93	---	150.0	H	142.0	-10.4	74.00	37.07
1200.600000	---	27.02	150.0	H	142.0	-10.4	54.00	26.98
3597.600000	36.41	---	250.0	V	352.0	-0.6	74.00	37.59
3597.600000	---	32.17	250.0	V	352.0	-0.6	54.00	21.83
4806.000000	50.11	---	150.0	H	321.0	2.5	74.00	23.89
4806.000000	---	40.21	150.0	H	321.0	2.5	54.00	13.79
7209.000000	46.98	---	200.0	H	132.0	9.8	74.00	27.02
7209.000000	---	37.52	200.0	H	132.0	9.8	54.00	16.48
9615.600000	---	42.06	150.0	H	258.0	14.9	54.00	11.94
9615.600000	52.22	---	150.0	H	258.0	14.9	74.00	21.78
12016.000000	53.58	---	200.0	H	291.0	16.5	74.00	20.42
12016.000000	---	44.29	200.0	H	291.0	16.5	54.00	9.71

Middle Channel: 2442MHz

Full Spectrum

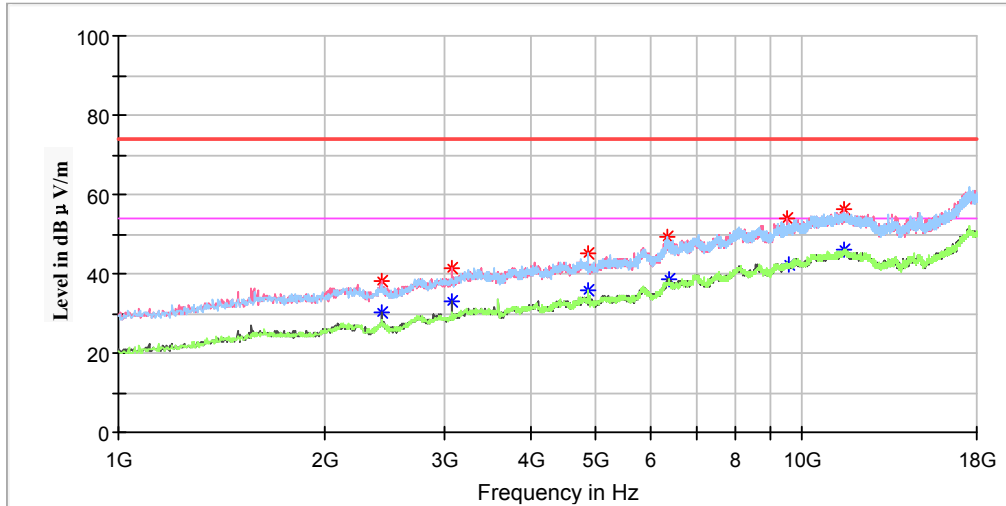

Frequency (MHz)	Corrected Amplitude		Rx Antenna		Turntable Degree	Corrected Factor (dB/m)	Limit (dBμV/m)	Margin (dB)
	MaxPeak (dBμV /m)	Average (dBμV /m)	Height (cm)	Polar (H/V)				
2431.400000	---	30.10	150.0	V	203.0	-4.8	54.00	23.90
2431.400000	38.34	---	150.0	V	203.0	-4.8	74.00	35.66
3070.600000	---	33.04	200.0	V	86.0	-1.9	54.00	20.96
3070.600000	41.20	---	200.0	V	86.0	-1.9	74.00	32.80
4884.000000	---	35.92	100.0	H	180.0	2.6	54.00	18.08
4884.000000	45.12	---	100.0	H	180.0	2.6	74.00	28.88
6361.800000	49.08	---	200.0	H	12.0	7.6	74.00	24.92
6361.800000	---	38.83	200.0	V	12.0	7.7	54.00	15.17
9530.600000	53.78	---	150.0	V	102.0	14.9	74.00	20.22
9530.600000	---	42.48	150.0	H	102.0	14.9	54.00	11.52
11529.800000	---	46.03	200.0	H	258.0	18.2	54.00	7.97
11529.800000	56.09	---	200.0	V	258.0	18.2	74.00	17.91

High Channel: 2480MHz

Full Spectrum

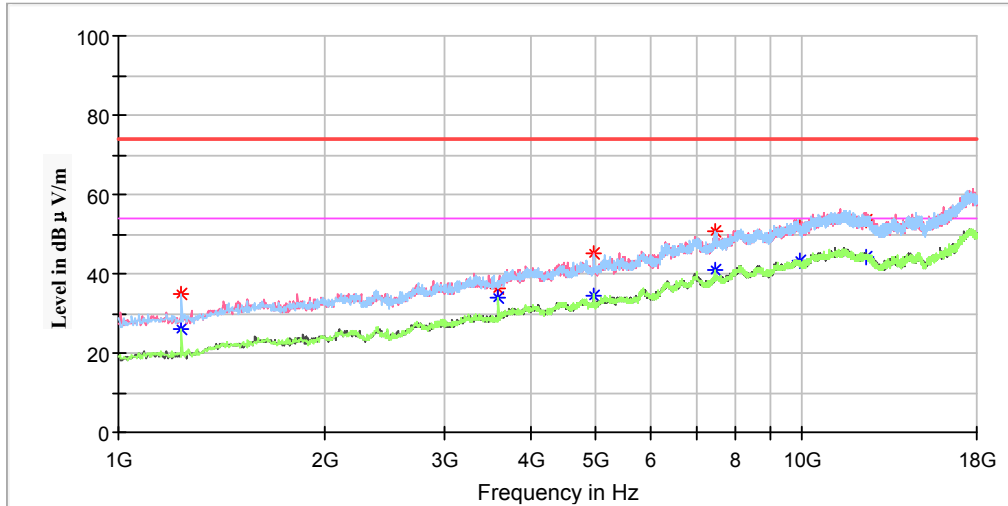

Frequency (MHz)	Corrected Amplitude		Rx Antenna		Turntable Degree	Corrected Factor (dB/m)	Limit (dBμV/m)	Margin (dB)
	MaxPeak (dBμV /m)	Average (dBμV /m)	Height (cm)	Polar (H/V)				
1238.000000	34.95	---	200.0	V	155.0	-10.1	74.00	39.05
1238.000000	---	25.97	200.0	V	155.0	-10.1	54.00	28.03
3597.600000	36.14	---	150.0	H	249.0	-0.6	74.00	37.86
3597.600000	---	33.76	150.0	H	249.0	-0.6	54.00	20.24
4960.000000	45.06	---	200.0	H	171.0	2.8	74.00	28.94
4960.000000	---	34.48	200.0	H	171.0	2.8	54.00	19.52
7440.000000	50.49	---	150.0	H	148.0	10.1	74.00	23.51
7440.000000	---	40.92	150.0	H	148.0	10.1	54.00	13.08
9921.600000	51.45	---	250.0	H	54.0	14.9	74.00	22.55
9921.600000	---	43.15	250.0	H	54.0	14.9	54.00	10.85
12400.200000	53.71	---	150.0	H	164.0	17.0	74.00	20.29
12400.200000	---	43.98	150.0	H	164.0	17.0	54.00	10.02

18GHz-25GHz

(Pre-scan with low, middle and high channels of operation in the X,Y and Z axes of orientation, the worst case low channel of operation in X-axis of orientation was recorded)

Horizontal

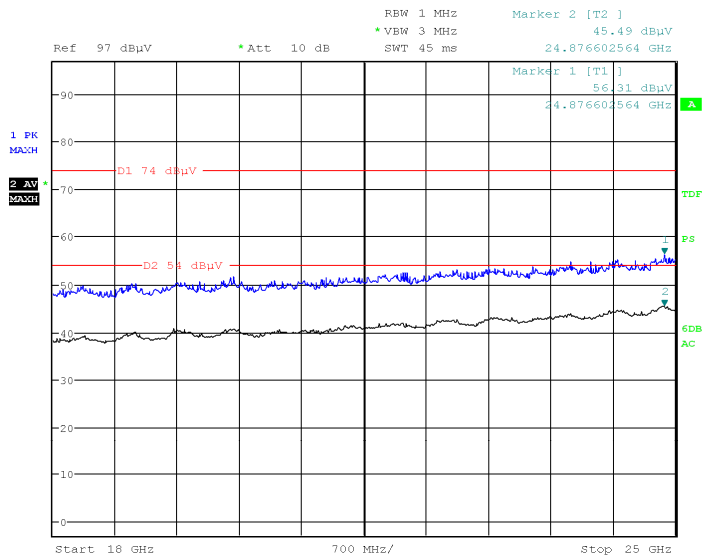

Date: 30.JAN.2018 10:55:02

Vertical

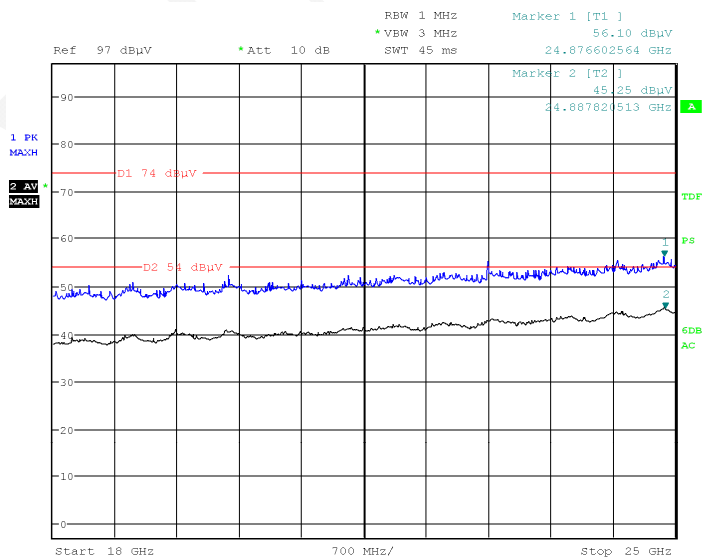

Date: 30.JAN.2018 10:34:38

Fundamental Test & Restricted Bands Emissions Test:*(Pre-scan in the X, Y and Z axes of orientation, the worst case X-axis of orientation was recorded.)*

Note:

1. Corrected Factor = Antenna factor (RX) + Cable Loss – Amplifier Factor
2. Corrected Amplitude = Corrected Factor + Reading
3. Margin = Limit - Corrected. Amplitude

Frequency (MHz)	Corrected Amplitude		Rx Antenna		Turntable Degree	Corrected Factor (dB/m)	Limit (dB μ V/m)	Margin (dB)
	MaxPeak (dB μ V /m)	Average (dB μ V /m)	Height (cm)	Polar (H/V)				
Low Channel: 2403MHz								
2390.00	49.06	---	200.0	H	93.0	5.1	74.00	24.94
2390.00	---	39.74	200.0	H	93.0	5.1	54.00	14.26
2403.00	---	92.89	250.0	H	209.0	5.1	94.00	1.11
2403.00	93.60	---	250.0	H	209.0	5.1	114.00	20.40
Middle Channel: 2442MHz								
2442.00	93.32	---	200.0	H	182.0	5.2	114.00	20.68
2442.00	---	92.85	200.0	H	182.0	5.2	94.00	1.15
High Channel: 2480MHz								
2480.00	---	92.84	250.0	H	143.0	5.3	94.00	1.16
2480.00	93.36	---	250.0	H	143.0	5.3	114.00	20.64
2483.50	49.37	---	150.0	H	281.0	5.3	74.00	24.63
2483.50	---	41.45	150.0	H	281.0	5.3	54.00	12.55

FCC §15.215(c) – 20 dB BANDWIDTH TESTING

Applicable Standard

Intentional radiators operating under the alternative provisions to the general emission limits, as contained in §§ 15.217 through 15.257 and in Subpart E of this part, must be designed to ensure that the 20 dB bandwidth of the emission, or whatever bandwidth may otherwise be specified in the specific rule section under which the equipment operates, is contained within the frequency band designated in the rule section under which the equipment is operated.

Test Procedure

1. Check the calibration of the measuring instrument using either an internal calibrator or a known signal from an external generator.
2. Position the EUT on the test table without connection to measurement instrument. Turn on the EUT. Then set it to any one convenient frequency within its operating range. Set a reference level on the measuring instrument equal to the highest peak value.
3. Measure the frequency difference of two frequencies that were attenuated 20 dB from the reference level. Record the frequency difference as the emission bandwidth.
4. Repeat above procedures until all frequencies measured were complete.

Test Data

Environmental Conditions

Temperature:	24.2°C
Relative Humidity:	51 %
ATM Pressure:	101.2kPa

The testing was performed by Edison Hu on 2018-01-29 to 2018-02-07.

Test Result: Compliant.

Test Mode: Transmitting

Channel	Frequency (MHz)	20 dB Bandwidth (MHz)
Low	2403.00	0.938
Middle	2442.00	0.986
High	2480.00	0.980

20 dB Bandwidth:

Low Channel

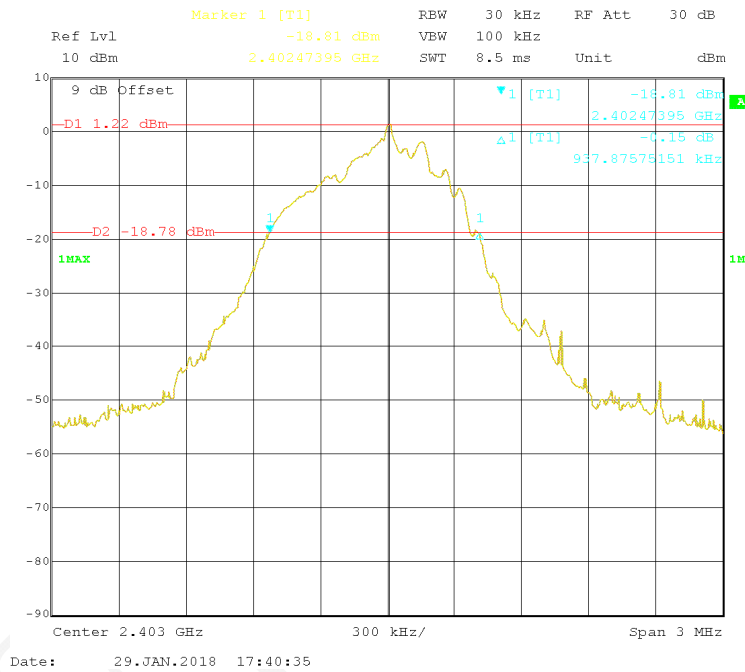

Middle Channel

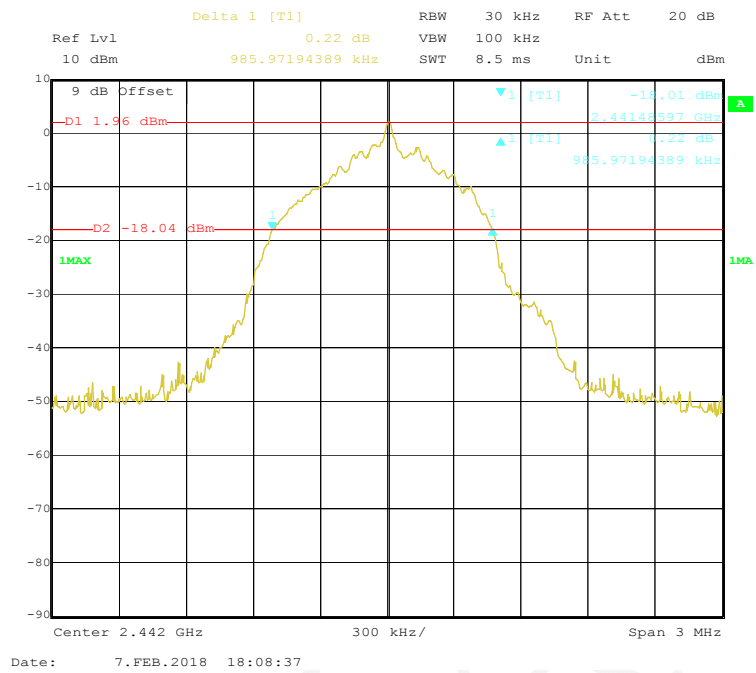

High Channel

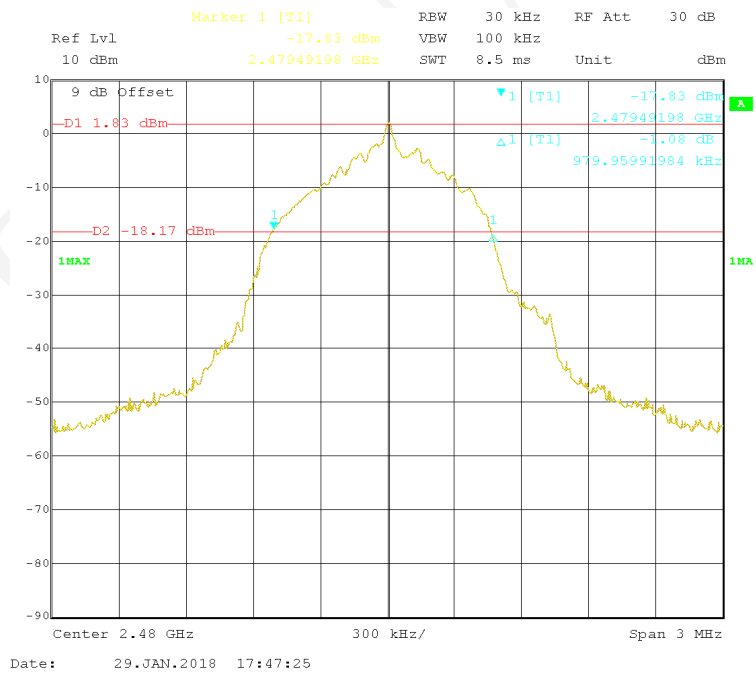

***** END OF REPORT *****