

CONFIGURATION MENU



CONFIGURATION		
1	EXT VIDEO INPUT OFF	Set the external video input ON / OFF ON / OFF
2	OUTPUT MODE	According to the setting circumstance, selects output mode. TV MODE AMP(amplifier) MODE
3	ADVANCED CONFIGURATION	Access to the other functions and settings of EG18000.

Press  three times to enter the configuration menu, then press the corresponding number on the left side of the function to select it's option.

※ Press the  button to exit the configuration menu.

ADVANCED CONFIGURATION MENU

ADVANCED CONFIGURATION		
1	SCORE CHECK	A singer can gauge his/her singing skills by score. ON / OFF
2	REAL TIME SCORE	Shows the score of the singer while the song is still being sung. ON / OFF
3	LYRIC START HELP	Turns on or off the countdown that flashes just before the lyrics start. ON / OFF
4	LYRIC LINE	Selects the number of lyric lines shown on the TV screen. Auto 2Lines / 3 Lines
5	LYRIC FORMAT	Selects the arrangement of lyric lines. Center / Left-Right Mix All
6	MESSAGE LANGUAGE	Selects the language used in the menus.
7	RES-SONG CONTROL	Stores and retrieves the list of reserved songs in the mic. The list is retained even after turning off the mic. Save / Delete Load / Done

Press  button three times, then press  to enter the Advanced Configuration Menu, then press the corresponding number on the left side of the function to select it's options.

※ Press the  button to exit the advanced configuration menu.

The Instruction for ADVANCED CONFIGURATION MENU

1 SCORE CHECK

This score shows how well you sing a song by evaluating tempo and pitch.

2 REAL TIME SCORE

This score shows how well you sing a song on real time.

3 LYRIC START HELP

It is used to turn on or off lyric countdown.
This function indicates when you start to sing a song.

4 LYRIC LINE

It is used to set a number of lyric lines on the screen.
(2 Line, 3 Line, Auto)

5 LYRIC FORMAT

It is used to set the position of the lyrics on the screen.
(Center, Left-Right, Mix All)

6 MESSAGE LANGUAGE

Select a language that you desire, the message will be changed automatically with the language you selected.

7 RES-SONG CONTROL

Stores and retrieves the list of reserved songs on the MAGICISING.
The list is retained even after turning off the MAGICISING.

After reserving all the songs that a user wants, simply access this function and select SAVE to store the list.

The next time the MAGICISING is turned on, simply access this function and then select LOAD to retrieve the list.

MAGICSING REMOTE CONTROLLER

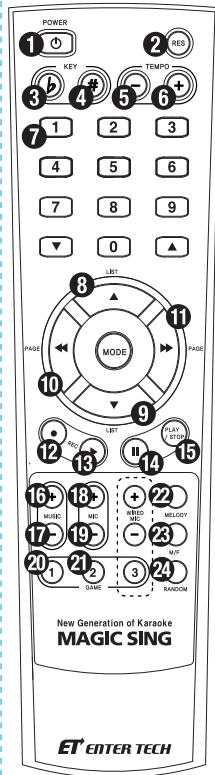

1 Power Button ON/OFF	13 REC ► Recording & Replay
2 RES Button Reservation	14 II Pause
3 KEY ↵ Button Level down	15 PLAY/STOP Play/Stop
4 KEY# Button Level up	16 MUSIC + Volume up
5 TEMPO - Button Tempo down	17 MUSIC - Volume down
6 TEMPO + Button Tempo up	18 MIC + Wireless mic vol up
7 0~9, [▼/▲] Number/ up & down	19 MIC - Wireless mic vol down
8 LIST ▲ List Up	20 GAME 1
9 LIST ▼ List down	21 GAME 2
10 PAGE ◀◀ Page down	22 MELODY Melody vol control
11 PAGE ▶▶ Page up	23 M/F Male or Female
12 REC ⊙ Recording	24 RANDOM Song Select Randomly
	Unused

USB DOWNLOAD MANAGER-INSTALLATION

This part of the user's manual shows you how to download recorded file to your computer.

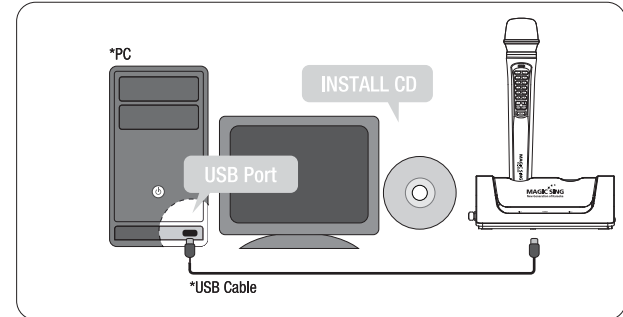

NOTE

This feature only available when you purchase a recording pack. Please consult with your retailer for detail.

Installation files for both USB driver and Download Manager are available from the Enter-tech web site. (www.enter-tech.com)

1 HOW TO INSTALL DRIVER

Please install the driver before connecting MAGIC SING to the PC. You just need to install the driver once. Please click the file which you downloaded from our web-site to install the driver.

When you see the screen below, click the <Continue Anyway>

2 HOW TO CONNECT MAGICISING TO PC WITH USB CABLE

Plug the USB cable to PC USB port as shown on the picture below.

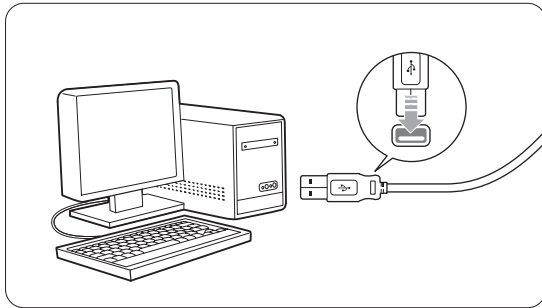

Plug the USB cable to the PC USB port as shown on the picture below.

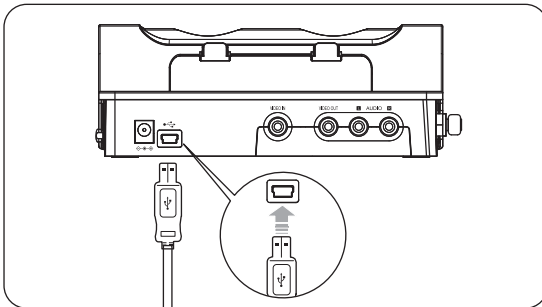

< CONNECTED > will appear on the LCD of MAGICISING.

3 THE FOUND NEW HARDWARE WIZARD

After connecting MAGICISING to PC with USB cable, you should see the < Found New Hardware Wizard > below, just click < Next >.

When you see the screens below, click the < Next > button.



4 HOW TO INSTALL USB DOWNLOAD MANAGER

- 1 Please visit our web-site (www.enter-tech.com), select a country, and then click the download icons on the download page.
- 2 Click on the download manager icon to download the installation file.
- 3 Double click on the installation file.
- 4 Select an operating language, and then click < Next >.

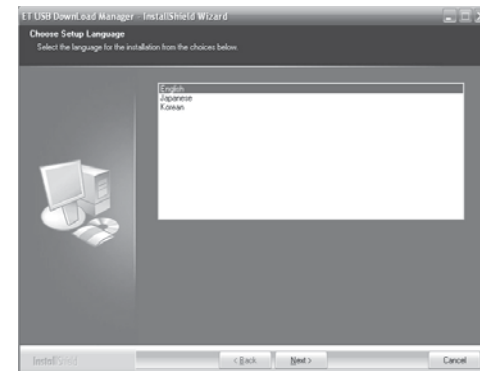

Functions & Settings - Chapter.03

- 5 The installation Wizard will start. Please click <Next>

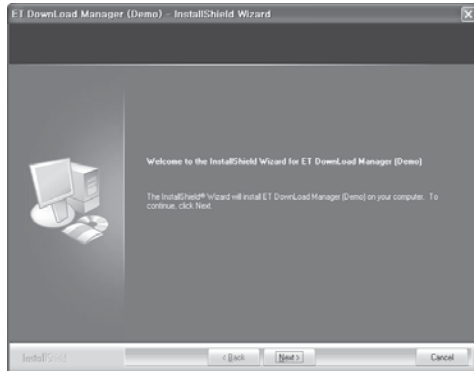

- 6 Check License Agreement :
Please read license agreement, and then click <Next> if you agree terms and condition of the agreement.

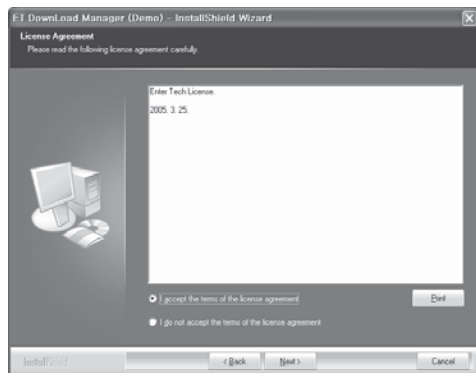

Chapter.03 - Functions & Settings

- 7 Last Step <Click Finish>

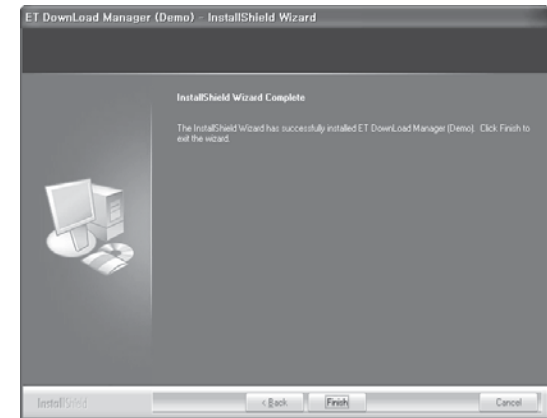

2nd WIRELESS MICROPHONE

Enjoy singing together with a 2nd Wireless Microphone. You can use the various function that are also available in the MAGIC SING. (Main station)

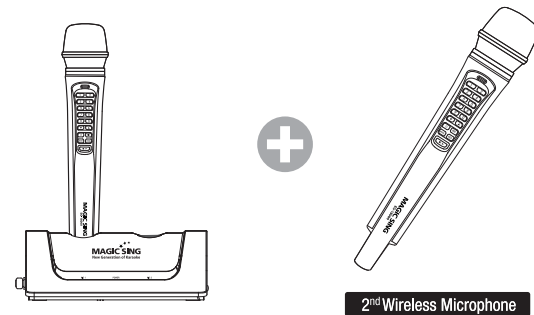

USB DOWNLOAD MANAGER-DESCRIPTION

1 FEATURES

A. RECORDING DATA

1 DOWNLOAD SUPPORT

Download recorded file(s) to PC from the recording pack.
Playback 'etw' or 'wave' file on PC.
Convert 'etw' file to 'wave' files.

B. FIRMWARE UPGRADE

Firmware version check and upgrade
Enable to check current version of the MAGICISING firmware
and upgrade firmware of MAGICISING with a file on PC.

2 DESCRIPTION FOR USB DOWNLOAD MANAGER

A. USER INTERFACE LAYOUT

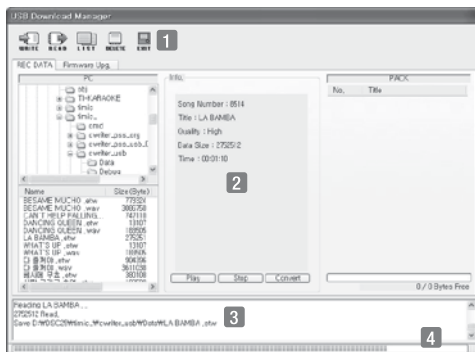

- 1 Basic button
- 2 Information each section
- 3 Show current
- 4 Bar graph displays

B. DESCRIPTION OF USER INTERFACE

1. FEATURES OF THE BASIC BUTTONS



- WRITE** Uploading data to the USB device
- READ** Downloading data from the USB device
- LIST** Downloading a list of data from the USB device
- DELETE** Delete selected data
- EXIT** Exit the current program

2. DESCRIPTION OF EACH SECTION AND BUTTON FUNCTION

RECORDING DATA

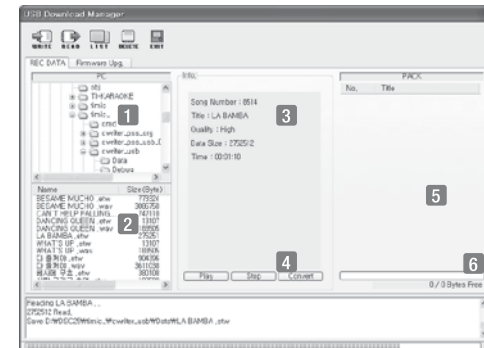

DESCRIPTION OF EACH SECTION

- 1 This section displays list of directory on PC.
- 2 This section displays list of recorded files on PC.
- 3 It displays detail information of a selected file on PC or on the pack.
- 4 Play : It is used to playback a recorded file.
Stop : It is used to stop Playback.
Convert : It is used to convert 'etw' to 'wave' file.
- 5 This section displays existing recorded file of the pack.
- 6 This bar-graph indicates available memory of the pack.

C. FIRMWARE UPGRADE

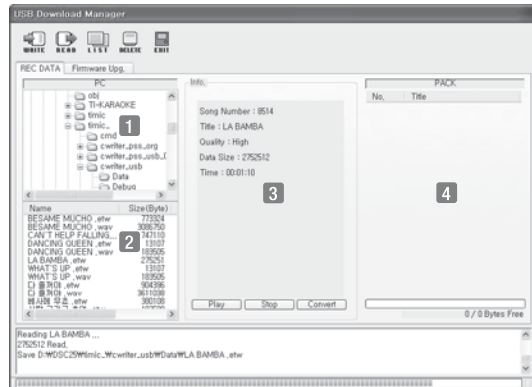

DESCRIPTION OF EACH SECTION

- 1 This section displays a list of directories on PC.
- 2 This section displays firmware file on PC.
- 3 This section displays the information of the selected file on PC.
- 4 This section displays firmware information of MAGICSING.

DESCRIPTION OF THE BUTTON FUNCTION

- LIST** Press the List button to display version information of MAGICSING firmware.
- WRITE** Press the Write button to upload and update firmware version of MAGICSING with selected file (*.BIN) on PC.

Recording Pack

You can record your own singing into the Recording Pack.

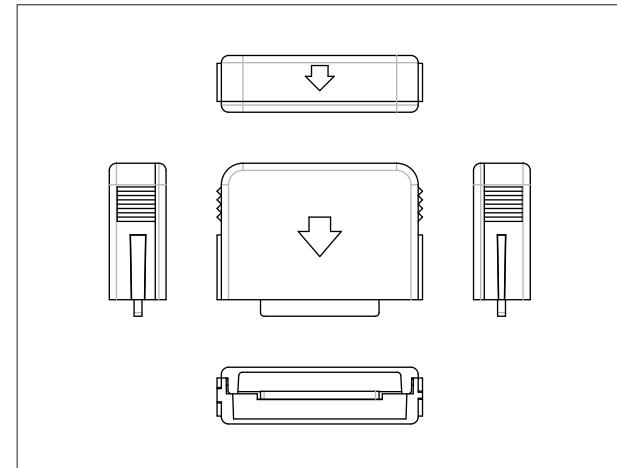

- Turn off the MAGICSING : The MAGICSING should be turned off first.
- Insert the Recording Pack into the slot on the back of the MAGICSING.
- Turn on the power of the MAGICSING then select a song number then press the REC (recording) button on the remote-control.
- To stop recording, press the REC (recording) button on The Remote-control or the MAGICSING. ■/▶ button can be used as the stop button.
- To replay the recorded songs, press the RES button on Remote-Control then your recorded songs are listed up on the screen then select your desirable song by using ▼/▲ buttons then press the ■/▶ button.
- To stop the playback, press the ■/▶ button.
- To delete recorded songs, first press the RES button then Recorded songs are listed up on the screen then select the song by using ▼/▲ buttons then press the RES (reservation) button.

Optional Items - Chapter.04

You can not record your own singing to the MAGICSING at the same time while you are recording your singing into the Recording Pack.

You cannot record your own singing from the middle of song being played. Although you press the REC button in the middle of song, the song will start at the beginning..

In case of additional recorded Song Pack and downloaded Song Pack, those of songs can not be deleted without recorded song chips. Please use the Duet-Mic with them.

The Recording Pack can be used to record about 50 minutes of songs. (about 10 songs)

The Tempo and Key do not work on playing recorded songs.

The recorded song quality is just normal.

Chapter.04 - Optional Items

Additional Song Chip

You can add your favorite songs. There are many varieties of songs available.

How to Setup the Additional Song Chip

Turn OFF the power. It is very important to power off first before removing or adding any additional Song Chip.

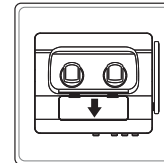

- Please turn off the power of the MAGICSING.
- Press down the back cover of MAGICSING as an arrow then remove the back cover.

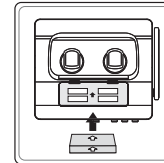

- Please make sure that the arrow direction of Song Chip are pointing upward when you insert the Song Chip. (Additional 4 Song chips can be inserted.)

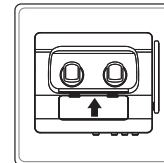

- After Song Chip are inserted then close the back cover as normal.
- Please turn on the power of the MAGICSING.

How to Add the Song List

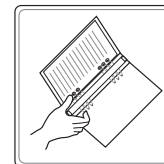

- Press the top and bottom metal tab of the binder to open the binder rings.
- Insert the new song list between the binder rings.
- Close the binder rings.

CAUTIONS



Use only the adaptor included with the MAGICSING. There are many adaptors that are plug compatible with the jack of the MAGICSING, but have different electrical specifications. These adaptors would work only for a short period of time but would very soon damage the MAGICSING.

USE THE RECOMMENDED ACCESSORIES ONLY DC 8V / 620mA



Do not drop the MAGICSING. Any sign of cosmetic or internal damage due to dropping is not covered under the warranty.



Do not insert or remove song packs while the MAGICSING is still powered on.



Do not store the MAGICSING in the direct sunlight, in a high temperature, or high humidity area.



Please do not use strong chemicals to clean the MAGICSING, as these chemicals may damage the unit. Keep the MAGICSING away from Pets and small Children.



Do not press on the LED part.



Never use a sharp object on the keypad.



In case the MAGICSING was stored in a high temperature setting, allow sufficient time to cool down before using the MAGICSING.



Do not immerse in water or splash water on MAGICSING, water damage is not covered under warranty.



Do not take apart the MAGICSING. This will void the warranty.



Do not plug in if the MAGICSING is wet. Immediately contact the service center. If any solid object or liquid gets inside of MAGICSING, unplug it and have it checked by a service center.

TROUBLESHOOTING

In case of problems please check the following recommendations

If MAGICSING doesn't power up

EG-18000 MAIN STATION

Please make sure the adaptor is plugged into the power outlet correctly. Check that the male plug if it is properly inserted into the female jack.

WIRELESS MICROPHONE

Please check if the battery type is AA. and If battery life is low, MAGICSING may not power up or work properly.

If the user's voice could not be heard

Press VOL button and check the volume of the wireless microphone.

If the TV does not show pictures or sound

Make sure all the AV connections are properly connected according to the correct colors. Check if the TV is already in the video mode.

When the TV screen stays still and the MAGICSING won't turn off

Press the power button for 3 seconds or longer to turn off the MAGICSING.

When the video does not show properly

To convert to PAL mode, press and hold button 8, Do not release this button yet. Using another finger press and release power button. Do not release button 8 until the word PAL appears on the TV screen. To convert to NTSC mode, press and hold button 9, Do not release this button yet. Using another finger press and release power button. Do not release button 9 until the word NTSC appears on the TV screen.

If there is any doubt about the product's performance

Press and hold the 0 button, Do not release this button yet. Using another finger press and release the power button. Do not release the 0 button until the words "USER RESET" appears on the TV screen.

When the wireless karaoke microphone needs to be repaired, the main station should be included and returned to A/S centers.

For Unit's repair services, please contact one of the following technical centers in the Warranty Card.

Additional page

User's Manual Information

Do not

Any changes or modifications to the equipment not expressly approved by the party responsible for compliance could void user's authority to operate the equipment.

FCC Compliance Statement

This device complies with part 15 of the FCC Rules. Operation is subject to the following two conditions:

- (1) This device may not cause harmful interference, and
- (2) This device must accept any interference received,

Including interference that may cause undesired operation

Information to User

This equipment has been tested and found to comply with the limits for a Class B digital device, Pursuant to part 15 of the FCC Rules. These limits are designed to provide reasonable protection against harmful interference in a residential installation. This equipment generates, uses and can radiate radio Frequency energy and, if not installed and used in accordance with the instructions, may cause harmful interference to radio communications.

However, there is no guarantee that interference will not occur in a particular installation. If this equipment does cause harmful interference to radio or television reception, which can be determined by turning the equipment off and on, the user is encouraged to try to correct the interference by one or more of the following measures:

- Reorient or relocate the receiving antenna.
- Increase the separation between the equipment and receiver
- Connect the equipment into an outlet on a circuit different from that to which the receiver is connected.
- Consult the dealer or an experienced radio/TV technician for help.



WWW.ENTER-TECH.COM

ENTER-TECH CO.,LTD.

Samhwa B/D, 401-5, Hwagok-7dong, Kangseo-gu, Seoul, Korea
TEL : +82-2-2605-0884 | FAX : +82-2-2691-5354 | E-MAIL : enter@enter-tech.com
Designed by ENTER-TECH KOREA | Printed in China